



# WRE2206

Wireless N300 Range Extender

Version 1.00  
Edition 1, 01/2015



## User's Guide

### Default Details

Web Address	http://zyxelsetup OR http://192.168.1.2
User Name	admin
Password	1234
SSID	ZyXEL
Pre-shared Key	00000000

---

**IMPORTANT!**

**READ CAREFULLY BEFORE USE.**

**KEEP THIS GUIDE FOR FUTURE REFERENCE.**

### **Related Documentation**

- Quick Start Guide

The Quick Start Guide shows how to connect the WRE2206 and access the Web Configurator wizards.

# Contents Overview

<b>User's Guide .....</b>	<b>7</b>
Introduction .....	9
The Web Configurator .....	13
Connection Wizard .....	15
Status .....	21
Tutorials .....	26
<b>Technical Reference .....</b>	<b>36</b>
Wireless LAN .....	38
LAN .....	47
System .....	49
Tools .....	50
Troubleshooting .....	56

# Table of Contents

<b>Contents Overview .....</b>	<b>3</b>
<b>Table of Contents .....</b>	<b>4</b>
<b>Part I: User's Guide .....</b>	<b>7</b>
<b>Chapter 1</b>	
<b>Introduction.....</b>	<b>9</b>
1.1 Overview .....	9
1.2 Securing the WRE2206 .....	10
1.3 Front Panel .....	10
1.4 The WPS Button .....	11
1.4.1 WiFi Protected Setup .....	12
<b>Chapter 2</b>	
<b>The Web Configurator .....</b>	<b>13</b>
2.1 Overview .....	13
2.2 Accessing the Web Configurator .....	13
2.3 Resetting the WRE2206 .....	14
<b>Chapter 3</b>	
<b>Connection Wizard .....</b>	<b>15</b>
3.1 Overview .....	15
3.2 Configuring the WRE2206 for Connection to an AP .....	15
3.2.1 Selecting Automatically Detected AP Parameters .....	15
3.2.2 Manually Configuring AP Parameters .....	17
3.3 Completing the Connection Wizard .....	18
<b>Chapter 4</b>	
<b>Status .....</b>	<b>21</b>
4.1 WRE2206 Status .....	21
4.1.1 Summary: Packet Statistics .....	23
4.1.2 Summary: WLAN Station Status .....	24
4.2 Navigation Panel .....	24
<b>Chapter 5</b>	
<b>Tutorials.....</b>	<b>26</b>
5.1 Overview .....	26

5.2 Connecting a Wireless Client using WPS .....	26
5.2.1 Push Button Configuration (PBC) .....	26
5.2.2 PIN Configuration .....	28
5.3 Connecting the WRE2206 to an AP .....	29
5.3.1 Connecting to an AP with the WPS PBC Method .....	30
5.3.2 Connecting to an AP with the WPS PIN Method .....	31
5.3.3 Selecting an AP from an Automatically Detected List .....	32
5.3.4 Selecting an AP by Manually Entering Security Information .....	34
<b>Part II: Technical Reference.....</b>	<b>36</b>
<b>Chapter 6</b>	
<b>Wireless LAN.....</b>	<b>38</b>
6.1 Overview .....	38
6.2 What You Can Do .....	38
6.3 What You Should Know .....	38
6.3.1 Wireless Security Overview .....	39
6.4 General Wireless LAN Screen .....	40
6.5 MAC Address List .....	41
6.6 Wireless LAN Advanced Screen .....	42
6.7 Quality of Service (QoS) Screen .....	43
6.8 WPS Screen .....	43
6.9 WPS Station Screen .....	44
6.10 AP Select Screen .....	45
<b>Chapter 7</b>	
<b>LAN .....</b>	<b>47</b>
7.1 Overview .....	47
7.2 What You Need To Know .....	47
7.3 LAN IP Screen .....	47
<b>Chapter 8</b>	
<b>System .....</b>	<b>49</b>
8.1 Overview .....	49
8.2 What You Can Do .....	49
8.3 System Password Screen .....	49
<b>Chapter 9</b>	
<b>Tools .....</b>	<b>50</b>
9.1 Overview .....	50
9.2 What You Can Do .....	50

9.3 Firmware Upload Screen .....	50
9.4 Configuration Screen .....	52
9.4.1 Backup Configuration .....	53
9.4.2 Restore Configuration .....	53
9.4.3 Back to Factory Defaults .....	54
9.5 Restart Screen .....	54
9.6 LED Screen .....	54
<b>Chapter 10</b>	
<b>Troubleshooting.....</b>	<b>56</b>
10.1 Power, Hardware Connections, and LEDs .....	56
10.2 WRE2206 Access and Login .....	57
10.3 Internet Access .....	58
10.4 Resetting the WRE2206 to Its Factory Defaults .....	60
10.5 Wireless Problems .....	60
Appendix A Legal Information.....	61
<b>Index .....</b>	<b>69</b>

---

# **PART I**

## **User's Guide**

---





# Introduction

## 1.1 Overview

The WRE2206 (N) is a universal repeater that is an access point and a wireless client at the same time. The WRE2206 (N) wirelessly relays communications from its wireless clients to the access point.

**Figure 1** Universal Repeater

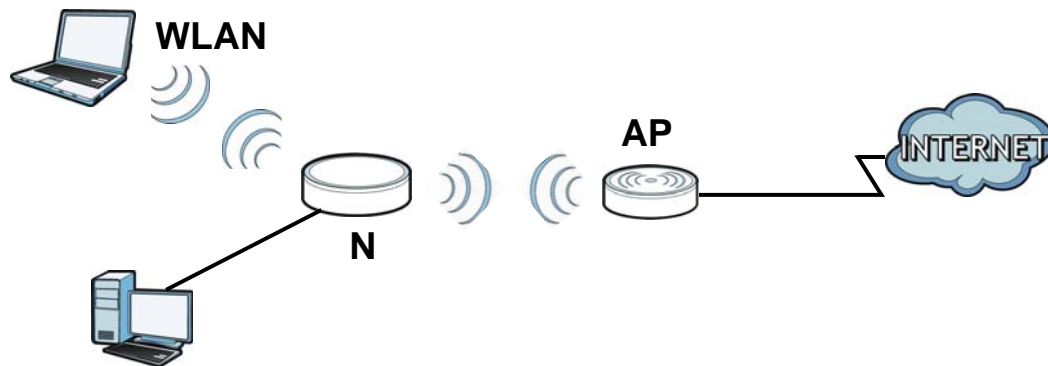

You can create the following connections using the WRE2206:

- **LAN.** You can connect network devices via the Ethernet port of the WRE2206 so that they can communicate with each other and access the Internet.
- **WLAN.** Wireless clients can connect to the WRE2206 to access network resources.

Use a (supported) web browser to manage the WRE2206.



See [Chapter 4 on page 21](#) for more information.

## 1.2 Securing the WRE2206

Do the following things regularly to make the WRE2206 more secure and to manage the WRE2206 more effectively.

- Change the password. Use a password that's not easy to guess and that consists of different types of characters, such as numbers and letters.
- Write down the password and put it in a safe place.
- Back up the configuration (and make sure you know how to restore it). Restoring an earlier working configuration may be useful if the device becomes unstable or even crashes. If you forget your password, you will have to reset the WRE2206 to its factory default settings. If you backed up an earlier configuration file, you would not have to totally re-configure the WRE2206. You could simply restore your last configuration.



## 1.3 Front Panel

Figure 2 Front Panel



The following table describes the LEDs and the WPS button.

**Table 1** Front Panel LEDs and WPS Button

LED	STATUS	DESCRIPTION
	3 LED On	The signal strength is 50-100%.
	2 LED On	The signal strength is 25-50%.
	1 LED On	The signal strength is <25%. The WRE2206 is in the process of starting up.
	Off	No signal detected, disconnected or the LED is turned off in the firmware.
	1 LED On	The number of wireless clients connecting to the WRE2206 is greater than or equal to ten.
	2 LED On	The number of wireless clients connecting to the WRE2206 is greater than or equal to five, but less than ten.
	3 LED On	The number of wireless clients connecting to the WRE2206 is greater than or equal to one, but less than five. The WRE2206 is in the process of starting up.
	Off	The wireless LAN is not ready. The number of wireless clients connecting to the WRE2206 is zero.
	On	This remains on for 5 minutes after a successful WPS connection has been established.
	Blinking Slowly	The WRE2206 is waiting for another WPS device to connect. The WRE2206 is in the process of starting up, rebooting or resetting.
	Blinking Rapidly	The WRE2206 fails to connect to a router or AP using WPS.
	Off	There is no WPS connection established or a WPS connection has been established for more than five minutes, or the LED is turned off in the firmware.

## 1.4 The WPS Button

The WPS button can be used to begin WiFi Protected Setup (WPS), reboot the WRE2206 while keeping it's configuration or reboot the WRE2206 to factory default configuration.

**Table 2** WPS Button Functions

ACTION	RESULT
Push once or hold for less than 5 seconds	The WRE2206 begins connecting to an AP via WPS. See <a href="#">Section 5.3 on page 29</a> .
Push twice	The WRE2206 begins connecting to a wireless client via WPS. See <a href="#">Section 5.2 on page 26</a> .
Hold for 5 to 10 seconds	The WRE2206 keeps its configuration and reboots.
Hold for more than 10 seconds	The WRE2206 resets its configuration to factory defaults and reboots. See <a href="#">Section 2.3 on page 14</a> .
Push three times	Push three times to turn off the WPS LED. After turning off the LED, the WRE2206 disconnects the connection to a wireless client via WPS and returns to the normal state.  The physical WPS button has priority over the WPS button in the Web Configurator.

## 1.4.1 WiFi Protected Setup

Your WRE2206 supports Wi-Fi Protected Setup (WPS), which is an easy way to set up a secure wireless network. WPS is an industry standard specification, defined by the WiFi Alliance.

WPS allows you to quickly set up a wireless network with strong security, without having to configure security settings manually. Each WPS connection works between two devices. Both devices must support WPS (check each device's documentation to make sure).

Depending on the devices you have, you can either press a button (recommended) on the device itself, or in its configuration utility or enter a PIN (a unique Personal Identification Number that allows one device to authenticate the other) in each of the two devices. When WPS is activated on a device, it has two minutes to find another device that also has WPS activated. Then, the two devices connect and set up a secure network by themselves.

For more information on using WPS, see [Section 5.2 on page 26](#).

# The Web Configurator

## 2.1 Overview

This chapter describes how to access the WRE2206 Web Configurator and provides an overview of its screens.

The Web Configurator is an HTML-based management interface that allows easy setup and management of the WRE2206 via Internet browser. Use Internet Explorer 6.0 and later versions, Mozilla Firefox 3 and later versions, or Safari 2.0 and later versions. The recommended screen resolution is 1024 by 768 pixels.

In order to use the Web Configurator you need to allow:

- Web browser pop-up windows from your device. Web pop-up blocking is enabled by default in Windows XP SP (Service Pack) 2.
- JavaScript (enabled by default).
- Java permissions (enabled by default).

Refer to [Chapter 10 Troubleshooting](#) to see how to make sure these functions are allowed in Internet Explorer.

## 2.2 Accessing the Web Configurator

- 1 Make sure your WRE2206 hardware is properly connected and prepare your computer or computer network to connect to the WRE2206 (refer to the Quick Start Guide).

**Note:** Your computer or the part of your network connected to the WRE2206 must be on the same subnet as the WRE2206.

The WRE2206's DHCP server is enabled before the WRE2206 is associated with your AP or wireless router and disabled after association. If this is the first time you are accessing your WRE2206, you can configure your computer as a DHCP client (computer factory default) so it will get an IP address automatically from the WRE2206. After the WRE2206 is associated with your wireless router, your computer will get its IP address from the wireless router.

- 2 Launch your web browser.
- 3 If this is the first time you are accessing your WRE2206, type "http://192.168.1.2" as the website address in your web browser. This is the default LAN IP address. Alternatively, after the WRE2206 has successfully associated with your wireless router, type "http://zyxelsetup" instead of the default IP address.

- 4 Type **admin** (default) as the user name and **1234** (default) as the password and click **OK**.

**Figure 3** Login Screen

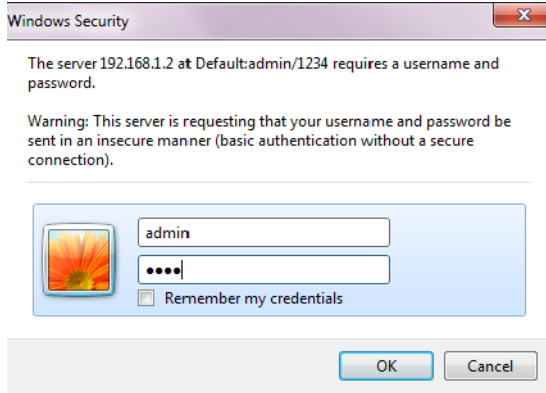

## 2.3 Resetting the WRE2206

If you forget your password or IP address, or you cannot access the Web Configurator, press the **WPS** button for more than 10 seconds to reload the factory-default configuration file. This means that you will lose all configurations that you had previously saved, the username will be reset to **admin** and password will be reset to **1234**. The IP address will be reset to "192.168.1.2".

- 1 Press and hold the **WPS** button, the WPS LED begins flashing immediately.
- 2 Release the **WPS** button. The WRE2206 reloads factory defaults and begins to reboot.

## Connection Wizard

### 3.1 Overview

This chapter provides information on the wizard setup screens in the Web Configurator.

The Web Configurator's wizard setup helps you configure your device. The first time you access the WRE2206 Web Configurator, the wizard displays automatically. For subsequent access, click  to start the wizardsetup.

### 3.2 Configuring the WRE2206 for Connection to an AP

In this step of the configuration wizard, you must configure the WRE2206 with the security parameters of the AP you want to connect to. These parameters can be configured by selecting those automatically detected by the WRE2206, or by configuring them manually. Manual configuration is useful when the AP is hidden.

#### 3.2.1 Selecting Automatically Detected AP Parameters

- 1 Select an AP using the following screen.

Figure 4 Wizard: Wireless Setup



The following table describes the labels in this screen.

**Table 3** Network > Wireless LAN > AP Select

LABEL	DESCRIPTION
Select	Use the radio button to select the wireless device to which you want to connect.
SSID	This displays the Service Set IDentity of the wireless device. The SSID is a unique name that identifies a wireless network. All devices in a wireless network must use the same SSID.
MAC	This displays the MAC address of the wireless device.
Channel	This displays the channel number used by this wireless device.
Mode	This displays which IEEE 802.11b/g/n wireless networking standards the wireless device supports.
Security Mode	This displays the type of security configured on the wireless device. When <b>no</b> is shown, no security is configured and you can connect to it without a password.
Strength	This displays the strength of the wireless signal. The signal strength mainly depends on the antenna output power and the distance between your WRE2206 and this device.
Setup repeater manually	Select this to setup the AP manually.
SSID	If <b>Setup repeater manually</b> is selected, use this field to type the SSID of the AP. This is useful when the AP's SSID is hidden.
Refresh	Click this to search for available wireless devices within transmission range and update this table.
BACK	Click this to go back to the previous step in the wizard.
NEXT	Click this to start the next step in the AP setup process.
EXIT	Click this to exit the wizard.
Previous	Click this to see the previous page of APs.
Next	Click this to see the next page of APs.

Note: The wireless stations and WRE2206 must use the same SSID, channel ID, WPA-PSK (if WPA-PSK is enabled) or WPA2-PSK (if WPA2-PSK is enabled) for wireless communication.

- 2 Type a key. The number of characters accepted by the KEY field is shown in the following table.

**Table 4** Maximum Key Lengths

ENCRYPTION	KEY FORMAT	KEY LENGTH
64-bit WEP	ASCII	5 characters
	Hex	10 characters
128-bit WEP	ASCII	13 characters
	Hex	26 characters
WPA pre-shared key	Passphrase	8-63 characters
	Hex	64 characters



Figure 5 Wizard: Type a Key

eaZy 123

**Wireless Setup**

1

Please enter your wireless network's password

KEY :

BACK NEXT EXIT

ZyXEL

### 3.2.2 Manually Configuring AP Parameters

If the AP you want to connect to is not listed, then follow these steps to configure the security settings of the AP manually.

- 1 Select **Setup repeater manually**.
- 2 Type the SSID of the AP into the **SSID** field.

Figure 6 Wizard: Manually Typing the SSID

eaZy 123

**Wireless Setup**

1

Select	SSID	MAC	Channel	Mode	Security Mode	Strength
<input type="radio"/>	Unizyx_WLAN	50:67:f0:37:a0:88	6	b/g/n	WPA2	96%
<input type="radio"/>	Unizyx_GUEST	e2:67:f0:37:a0:88	6	b/g/n	WPA2-PSK	96%
<input type="radio"/>	ESBU_MAC_AUTH	e6:67:f0:37:a0:88	6	b/g/n	WPA2-PSK	96%
<input type="radio"/>	Unizyx_WLAN_4F	ea:67:f0:37:a0:88	6	b/g/n	WPA2	96%
<input type="radio"/>	marcom	28:cf:da:b6:4a:c5	1	b/g/n	WPA2-PSK	82%

Setup repeater manually

SSID :

Previous 1/13 Next

Refresh NEXT EXIT

ZyXEL

- 3 Configure the security settings. The number of characters accepted by the KEY field is shown in the following table.

**Table 5** Maximum Key Lengths

ENCRYPTION	KEY FORMAT	KEY LENGTH
64-bit WEP	ASCII	5 characters
	Hex	10 characters
128-bit WEP	ASCII	13 characters
	Hex	26 characters
WPA pre-shared key	Passphrase	8-63 characters
	Hex	64 characters

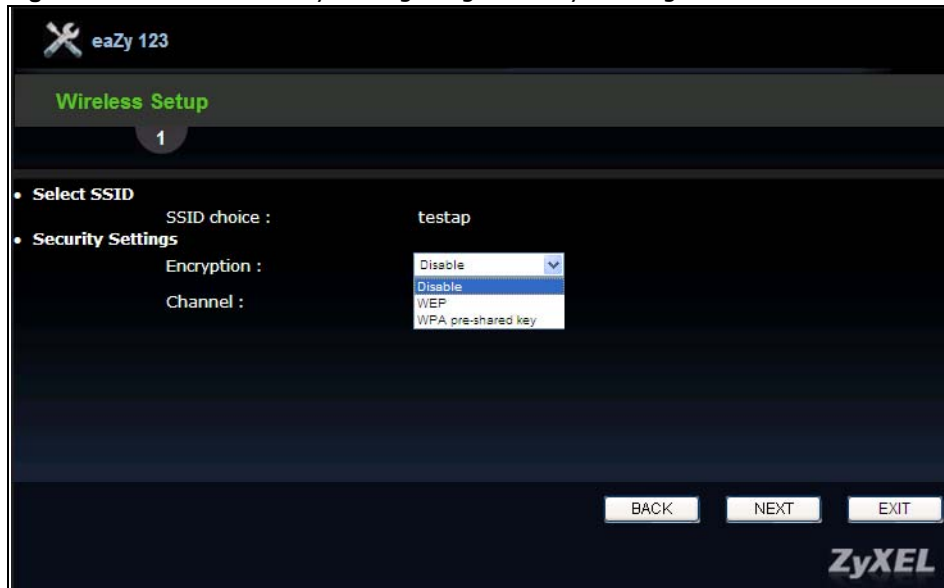
**Figure 7** Wizard: Manually Configuring Security Settings

### 3.3 Completing the Connection Wizard

- 1 Click **Next**. The key verification screen appears.

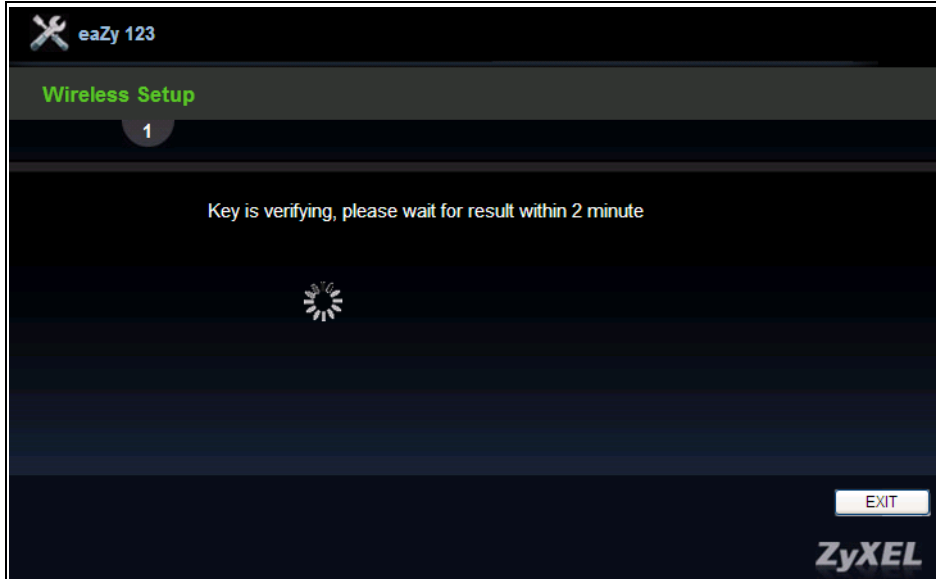
**Figure 8** Wizard: Verifying the Key

The following screen appears if the key verifies successfully.

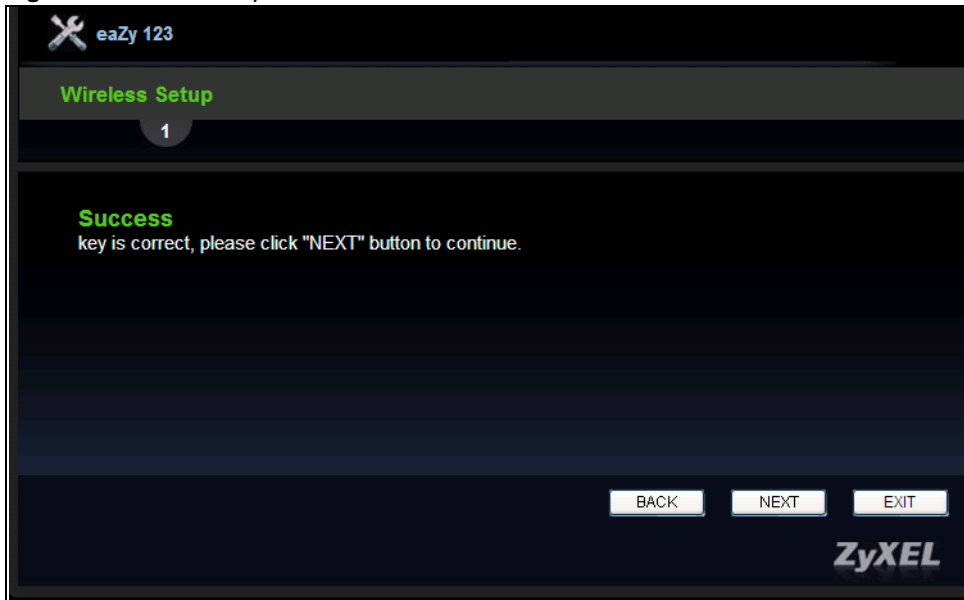
**Figure 9** Wizard: Key Verification Success

The following screen appears if the key fails to verify. Click **BACK** and check the key.

Figure 10 Wizard: Key Verification Failed

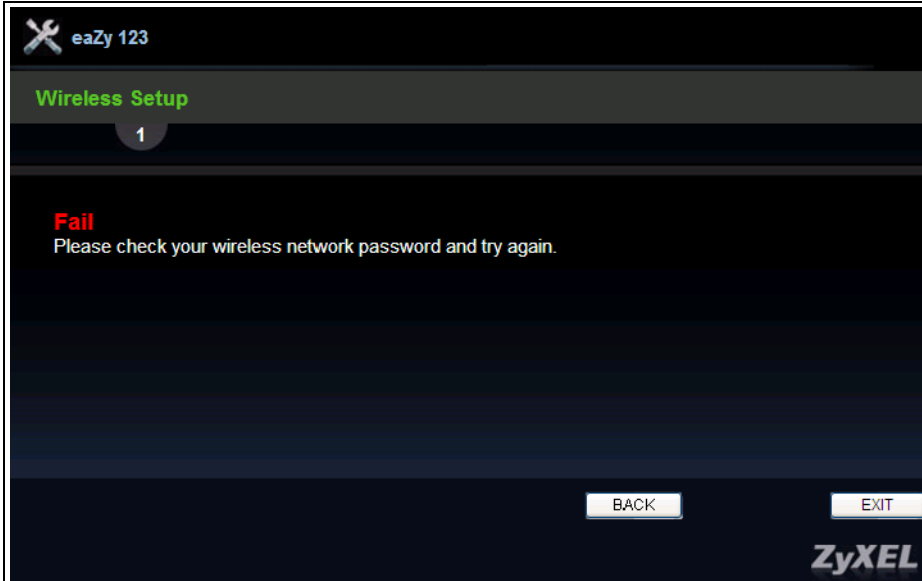

- 2 Click **Apply** to complete the wizard setup and restart the WRE2206.

Figure 11 Connection Wizard Complete

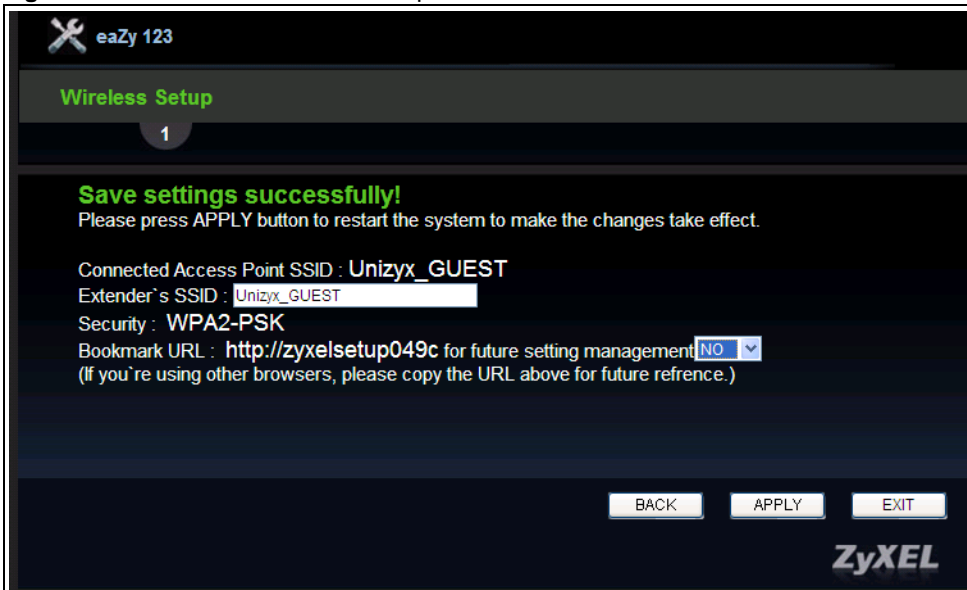

# Status

## 4.1 WRE2206 Status

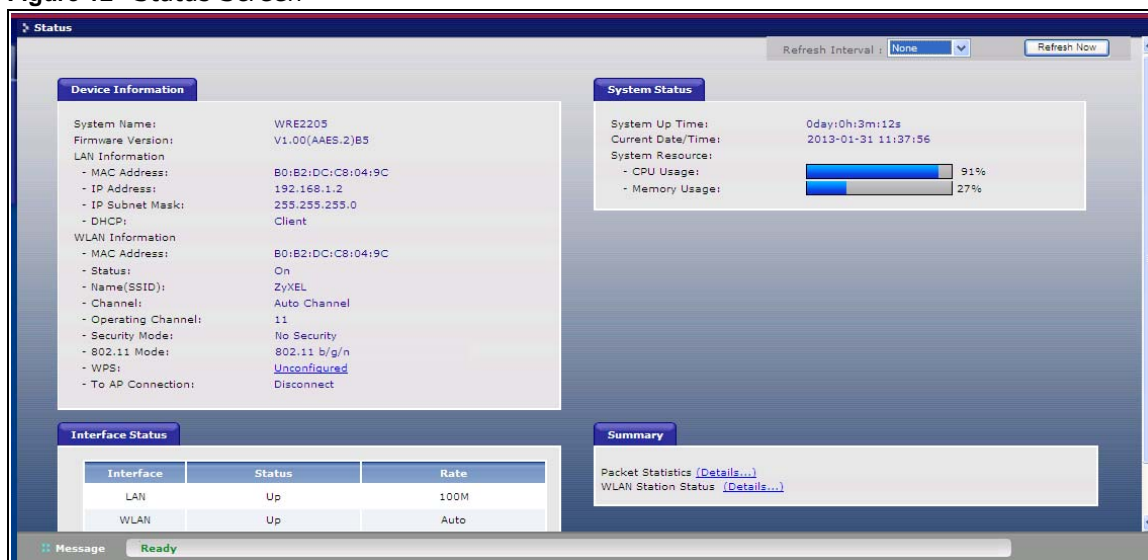

The screen below shows the status screen.

**Figure 12** Status Screen





The following table describes the icons shown in the **Status** screen.

**Table 6** Status Screen Icon Key

ICON	DESCRIPTION
	Click this icon to open the setup wizard.
	Click this icon to view copyright and a link for related product information.

**Table 6** Status Screen Icon Key (continued)

ICON	DESCRIPTION
	Select a number of seconds or <b>None</b> from the drop-down list box to refresh all screen statistics automatically at the end of every time interval or to not refresh the screen statistics.
	Click this button to refresh the status screen statistics.

The following table describes the labels shown in the **Status** screen.

**Table 7** Web Configurator Status Screen

LABEL	DESCRIPTION
Device Information	
System Name	This is the <b>System Name</b> .
Firmware Version	This is the current firmware version of the WRE2206.
LAN Information	
- MAC Address	This shows the LAN Ethernet adapter MAC Address of your device.
- IP Address	This shows the LAN port's IP address.
- IP Subnet Mask	This shows the LAN port's subnet mask.
- DHCP	This shows the LAN port's DHCP role.
WLAN Information	
- MAC Address	This shows the wireless adapter MAC Address of your device.
- Status	This shows the current status of the Wireless LAN - <b>On</b> or <b>Off</b> .
- Name (SSID)	This shows a descriptive name used to identify the WRE2206 in the wireless LAN.
- Channel	This shows the channel number which you select manually or the WRE2206 automatically scans and selects.
- Operating Channel	This shows the channel number which the WRE2206 is currently using over the wireless LAN.
- Security Mode	This shows the level of wireless security the WRE2206 is using.
- 802.11 Mode	This shows the wireless standard.
- WPS	This displays <b>Configured</b> when the WPS has been set up. This displays <b>Unconfigured</b> if the WPS has not been set up. Click the status to display <b>Network &gt; Wireless LAN &gt; WPS</b> screen.
- To AP Connection	This shows whether the WRE2206 is connected to an AP or not.
System Status	
System Up Time	This is the total time the WRE2206 has been on.
Current Date/Time	This field displays your WRE2206's present date and time.
System Resource	
- CPU Usage	This displays what percentage of the WRE2206's processing ability is currently used. When this percentage is close to 100%, the WRE2206 is running at full load, and the throughput is not going to improve anymore. If you want some applications to have more throughput, you should turn off other applications.
- Memory Usage	This shows what percentage of the heap memory the WRE2206 is using.
Interface Status	
Interface	This displays the WRE2206 port types. The port types are: <b>LAN</b> and <b>WLAN</b> .

**Table 7** Web Configurator Status Screen (continued)

LABEL	DESCRIPTION
Status	For the LAN port, this field displays <b>Down</b> (line is down) or <b>Up</b> (line is up or connected).  For the WLAN, it displays <b>Up</b> when the WLAN is enabled or <b>Down</b> when the WLAN is disabled.
Rate	For the LAN ports, this displays the port speed and duplex setting or <b>NA</b> when the line is disconnected.  For the WLAN, it displays the maximum transmission rate when the WLAN is enabled and <b>NA</b> when the WLAN is disabled or <b>Auto</b> .
Summary	
Packet Statistics	Use this screen to view port status and packet specific statistics.
WLAN Station Status	Use this screen to view the wireless stations that are currently associated to the WRE2206.

### 4.1.1 Summary: Packet Statistics

Click the **Packet Statistics (Details...)** hyperlink in the **Status** screen. Read-only information here includes port status, packet specific statistics and the "system up time". The **Poll Interval(s)** field is configurable and is used for refreshing the screen.

**Figure 13** Summary: Packet Statistics

Port	Status	TxPkts	RxPkts	Collisions	Tx B/s	Rx B/s
LAN	100M	4990	4374	0	2926	324
WLAN	Auto	2279	56158	0	199	7811

System Up Time : 0day:0h:23m:40s

Poll Interval : 5 sec    Set Interval    Stop

The following table describes the labels in this screen.

**Table 8** Summary: Packet Statistics

LABEL	DESCRIPTION
Port	This is the WRE2206's port type.
Status	For the LAN ports, this displays the port speed and duplex setting or <b>Down</b> when the line is disconnected.  For the WLAN, it displays <b>Up</b> when the WLAN is enabled or <b>Down</b> when the WLAN is disabled or <b>Auto</b> .
TxPkts	This is the number of transmitted packets on this port.
RxPkts	This is the number of received packets on this port.
Collisions	This is the number of collisions on this port.
Tx B/s	This displays the transmission speed in bytes per second on this port.
Rx B/s	This displays the reception speed in bytes per second on this port.

**Table 8** Summary: Packet Statistics (continued)

LABEL	DESCRIPTION
System Up Time	This is the total time the WRE2206 has been on.
Poll Interval	Enter the time interval for refreshing statistics in this field.
Set Interval	Click this button to apply the new poll interval you entered in the <b>Poll Interval</b> field.
Stop	Click <b>Stop</b> to stop refreshing statistics.

## 4.1.2 Summary: WLAN Station Status

Click the **WLAN Station Status (Details...)** hyperlink in the **Status** screen. View the wireless stations that are currently associated to the WRE2206 in the **Association List**. Association means that a wireless client (for example, your network or computer with a wireless network card) has connected successfully to the AP (or wireless router) using the same SSID, channel and security settings.

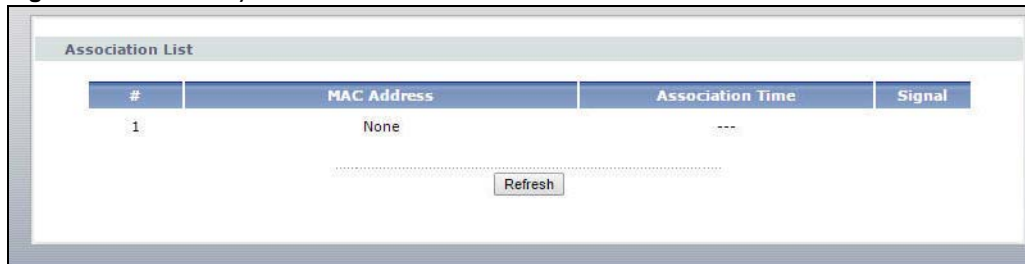
**Figure 14** Summary: WLAN Station Status

Association List			
#	MAC Address	Association Time	Signal
1	None	---	

Refresh

The following table describes the labels in this screen.

**Table 9** Summary: WLAN Station Status

LABEL	DESCRIPTION
#	This is the index number of an associated wireless station.
MAC Address	This field displays the MAC address of an associated wireless station.
Association Time	This field displays the time a wireless station first associated with the WRE2206's WLAN network.
Signal	This field displays the signal strength of a wireless station (client) associated with the WRE2206's wireless network. The number of signal strength shows from 10 to 100.
Refresh	Click <b>Refresh</b> to reload the list.

## 4.2 Navigation Panel

Use the menu in the navigation panel menus to configure WRE2206 features.



Figure 15 Menus



The following table describes the sub-menus.

Table 10 Menus

LINK	TAB	FUNCTION
Status		This screen shows the WRE2206's general device, system and interface status information. Use this screen to access the wizard, and summary statistics tables.
Network		
Wireless LAN	AP Select	Use this screen to connect to an access point.
	General	Use this screen to configure wireless LAN.
	MAC Address List	Use the MAC Address List screen to allow devices to access the WRE2206.
	Advanced	This screen allows you to configure advanced wireless settings.
	QoS	Use this screen to configure Wi-Fi Multimedia Quality of Service (WMM QoS). WMM QoS allows you to prioritize wireless traffic according to the delivery requirements of individual services.
	WPS	Use this screen to configure WPS.
	WPS Station	Use this screen to connect the WRE2206 to a wireless station or access point using WPS.
LAN	IP	Use this screen to configure LAN IP address, subnet mask and gateway.
Maintenance		
System	Password	Use this screen to change the password.
Tools	Firmware	Use this screen to upload firmware to your WRE2206.
	Configuration	Use this screen to backup and restore the configuration or reset the factory defaults to your WRE2206.
	Restart	This screen allows you to reboot the WRE2206 without turning the power off.
	LED	Use this screen to configure which LEDs are enabled or disabled.

## 5.1 Overview

This chapter provides tutorials for your WRE2206 as follows:

- Connecting a Wireless Client using WPS
  - [Push Button Configuration \(PBC\)](#)
  - [PIN Configuration](#)
- Connecting the WRE2206 to an AP
  - [Connecting to an AP with the WPS PBC Method](#)
  - [Connecting to an AP with the WPS PIN Method](#)
  - [Selecting an AP from an Automatically Detected List](#)
  - [Selecting an AP by Manually Entering Security Information](#)

## 5.2 Connecting a Wireless Client using WPS

This section gives you an example of how to connect a client to the WRE2206 using WPS.

There are two WPS methods for creating a secure connection. This tutorial shows you how to do both.

- **Push Button Configuration (PBC)** - create a secure wireless network by simply pressing the WPS button twice on the WRE2206's front panel or by clicking the **Start PBC** button in the **Network > Wireless LAN > WPS Station** screen. See [Section 5.2.1 on page 26](#). This is the easier method.
- **PIN Configuration** - create a secure wireless network simply by entering a wireless client's PIN (Personal Identification Number) in the WRE2206's interface. See [Section 5.2.2 on page 28](#). This is the more secure method, since one device can authenticate the other.

Note: The wireless client must be a WPS-aware device (for example, a WPS USB adapter or PCI card).

### 5.2.1 Push Button Configuration (PBC)

This section gives you an example of how to set up a wireless network using WPS PBC. This example uses the WRE2206 as the registrar and NWD210N as the wireless client in a notebook.

- 1 Make sure that your WRE2206 is turned on and that it is within range of your computer.

- 2 Make sure that you have installed the wireless client (this example uses the NWD210N) driver and utility in your notebook.
- 3 In the wireless client utility, find the WPS settings. Enable WPS and press the WPS button (**Start** or **WPS** button)
- 4 Log into WRE2206's Web Configurator and navigate to the **Network > Wireless LAN > WPS Station** screen.
- 5 In the WRE2206's Web Configurator, select **Registrar** in **Config Mode** and then press **Start PBC**.

Note: Your WRE2206 has a WPS button, as well as a **Start PBC** button in the Web Configurator. Both buttons have exactly the same function; you can use one or the other.

Note: It doesn't matter whether you press the button on the WRE2206 or the wireless client first. WPS times out after two minutes of pressing a button. Press the button on the second device within about a minute of the first, then wait two minutes for the WPS configuration to complete.

The WRE2206 sends the proper configuration settings to the wireless client. Then the wireless client is able to communicate with the WRE2206 securely.

The following figure shows an example of how to set up wireless network and security by pressing a button on both WRE2206 and wireless client (the NWD210N in this example).

**Figure 16** Example WPS Process: PBC Method

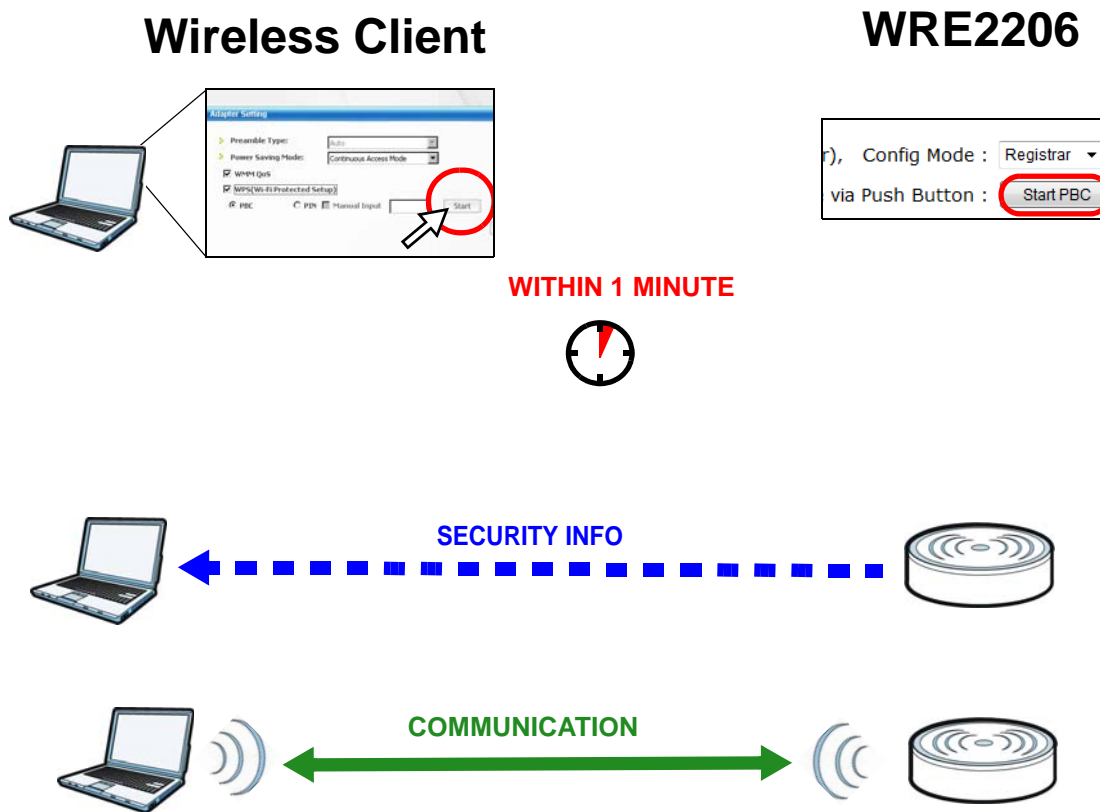

## 5.2.2 PIN Configuration

When you use the PIN configuration method, you need to use both WRE2206's configuration interface and the client's utilities.

- 1 Launch your wireless client's configuration utility. Go to the WPS settings and select the PIN method to get a PIN number.
- 2 On the WRE2206, navigate to the **Network > Wireless LAN > WPS Station** screen.
- 3 In the WRE2206's Web Configurator, select **Registrar** in **Config Mode**.
- 4 In the WRE2206's Web Configurator, enter the PIN number in the **Input client PIN code**.
- 5 Click the **Start** buttons (or the buttons next to the PIN fields) on both the wireless client utility screen and the WRE2206's **WPS Station** screen within about one minute, then wait two minutes for the WPS configuration to complete.

The WRE2206 authenticates the wireless client and sends the proper configuration settings to the wireless client. Then the wireless client is able to communicate with the WRE2206 securely.

The following figure shows an example of how to set up wireless network and security on WRE2206 and wireless client (ex. NWD210N in this example) by using PIN method.

Figure 17 Example WPS Process: PIN Method

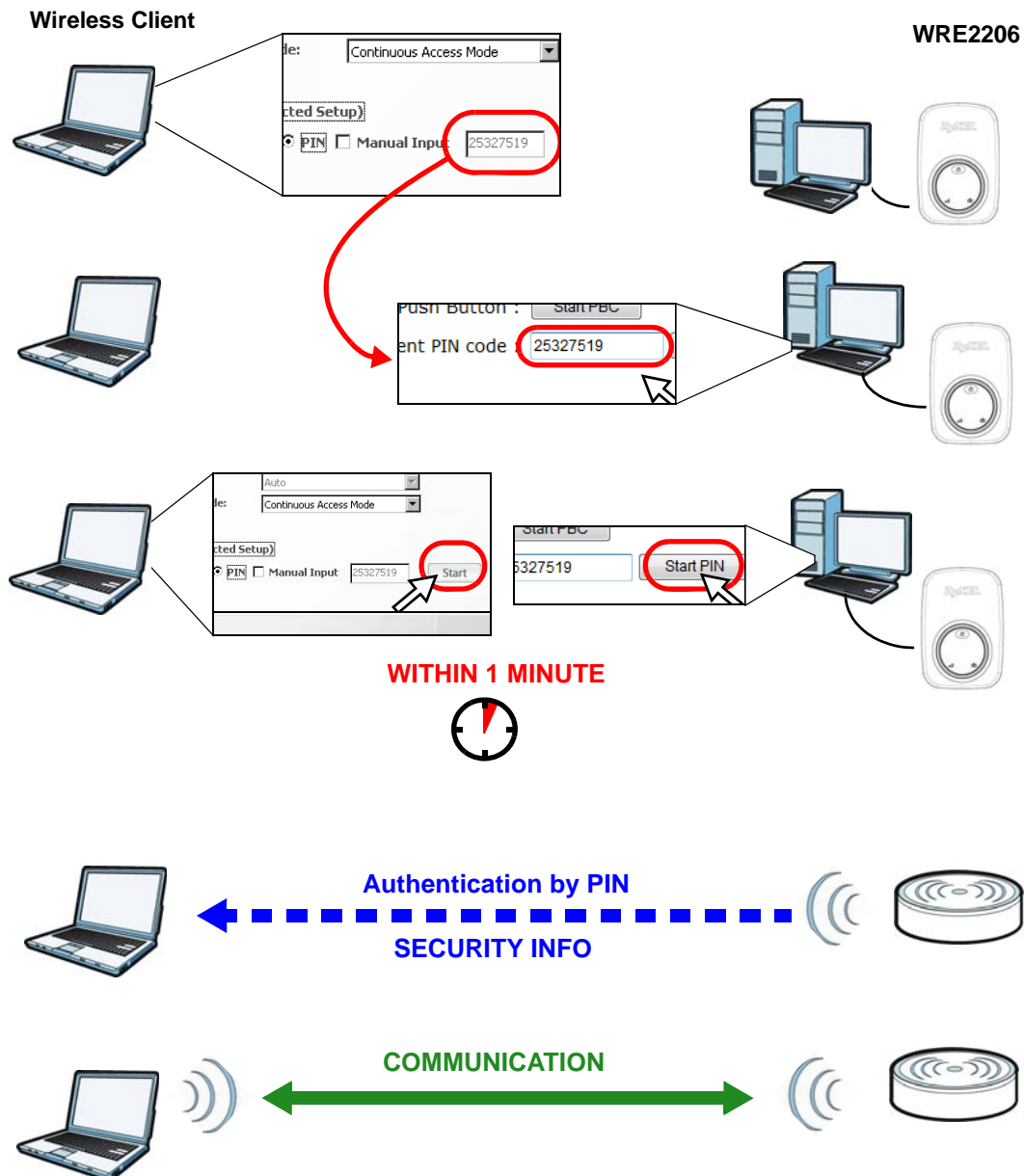

## 5.3 Connecting the WRE2206 to an AP

This section gives you an example of how to connect the WRE2206 to an AP.

There are four AP connection methods. This tutorial shows you how to use all of them.

- **Connecting to an AP with the WPS PBC method** - create a secure wireless network simply by pressing a button. See [Section 5.3.1 on page 30](#). This is the easier method.

- **Connecting to an AP with the WPS PIN method** - create a secure wireless network simply by entering the WRE2206's PIN (Personal Identification Number) in the AP's interface. See [Section 5.3.2 on page 31](#). This is the more secure method, since one device can authenticate the other.
- **Selecting an AP from an Automatically Detected List** - create a secure wireless network simply by selecting an AP from a list of detected APs. See [Section 5.3.3 on page 32](#). This is the easier method.
- **Selecting an AP by Manually Entering Security Information** - create a secure wireless network by manually entering the AP's wireless security settings in the WRE2206's interface. See [Section 5.3.4 on page 34](#). This is useful when the AP is hidden.

### 5.3.1 Connecting to an AP with the WPS PBC Method

This section gives you an example of how to connect to an AP using WPS PBC. This example uses the WRE2206 as the enrollee and an AP as the registrar.

- 1 Make sure that your WRE2206 is turned on and that it is within range of the AP.
- 2 Make sure that you have installed the AP and have access to the configuration interface of the AP or the AP's WPS button.
- 3 Log into WRE2206's Web Configurator and navigate to the **Network > Wireless LAN > WPS Station** screen. Select **Enrollee in Config Mode** and press **Start PBC**.
- 4 In the configuration interface of the AP, find the WPS settings. Enable WPS and press the WPS button (**Start** or **WPS** button)

Note: Your WRE2206 has a WPS button located on its panel, as well as a WPS button in its configuration utility. Both buttons have exactly the same function; you can use one or the other.

Note: It doesn't matter whether you press the button on the WRE2206 or the AP first. WPS times out after two minutes of pressing a button. Press the button on the second device within about a minute of the first, then wait two minutes for the WPS configuration to complete.

The AP sends the proper configuration settings to the WRE2206. Then the WRE2206 is able to communicate with the AP securely.

The following figure shows an example of how to set up wireless network and security by pressing a button on both WRE2206 and AP.

Figure 18 Example Connection to AP using WPS: PBC Method

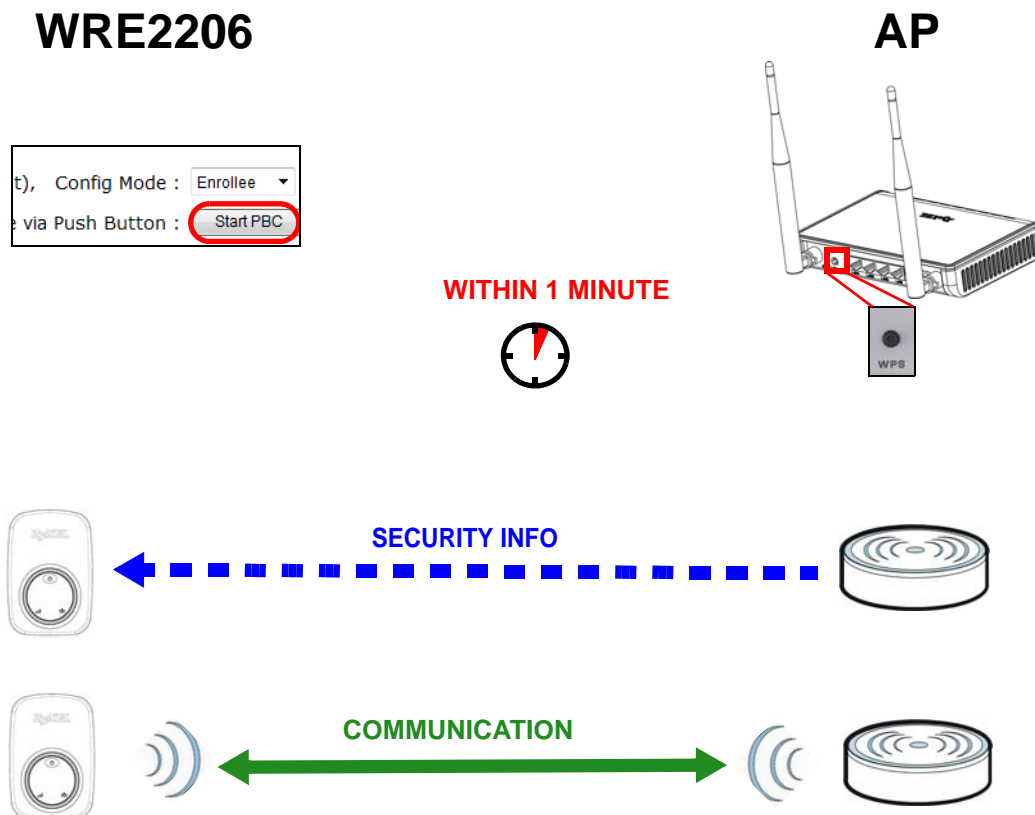

### 5.3.2 Connecting to an AP with the WPS PIN Method

When you use the PIN configuration method, you need to use both the configuration interface of the AP and the WRE2206's configuration interface.

- 1 Log into WRE2206's Web Configurator and navigate to the **Network > Wireless LAN > WPS Station** screen. Select **Enrollee** in **Config Mode** to get a PIN number.
- 2 Enter the PIN number in the WPS PIN field of the AP's configuration interface.
- 3 Click the **Start PIN** button on the WRE2206 and the Start button (or the button next to the PIN field) on the AP's configuration interface within about one minute, then wait two minutes for the WPS configuration to complete.

The AP authenticates the WRE2206 and sends the proper configuration settings to the WRE2206. This may take up to two minutes. Then the WRE2206 is able to communicate with the AP securely.

The following figure shows an example of how to set up wireless network and security on the AP and WRE2206 by using PIN method.

**Figure 19** Example Connection to AP using WPS: PIN Method

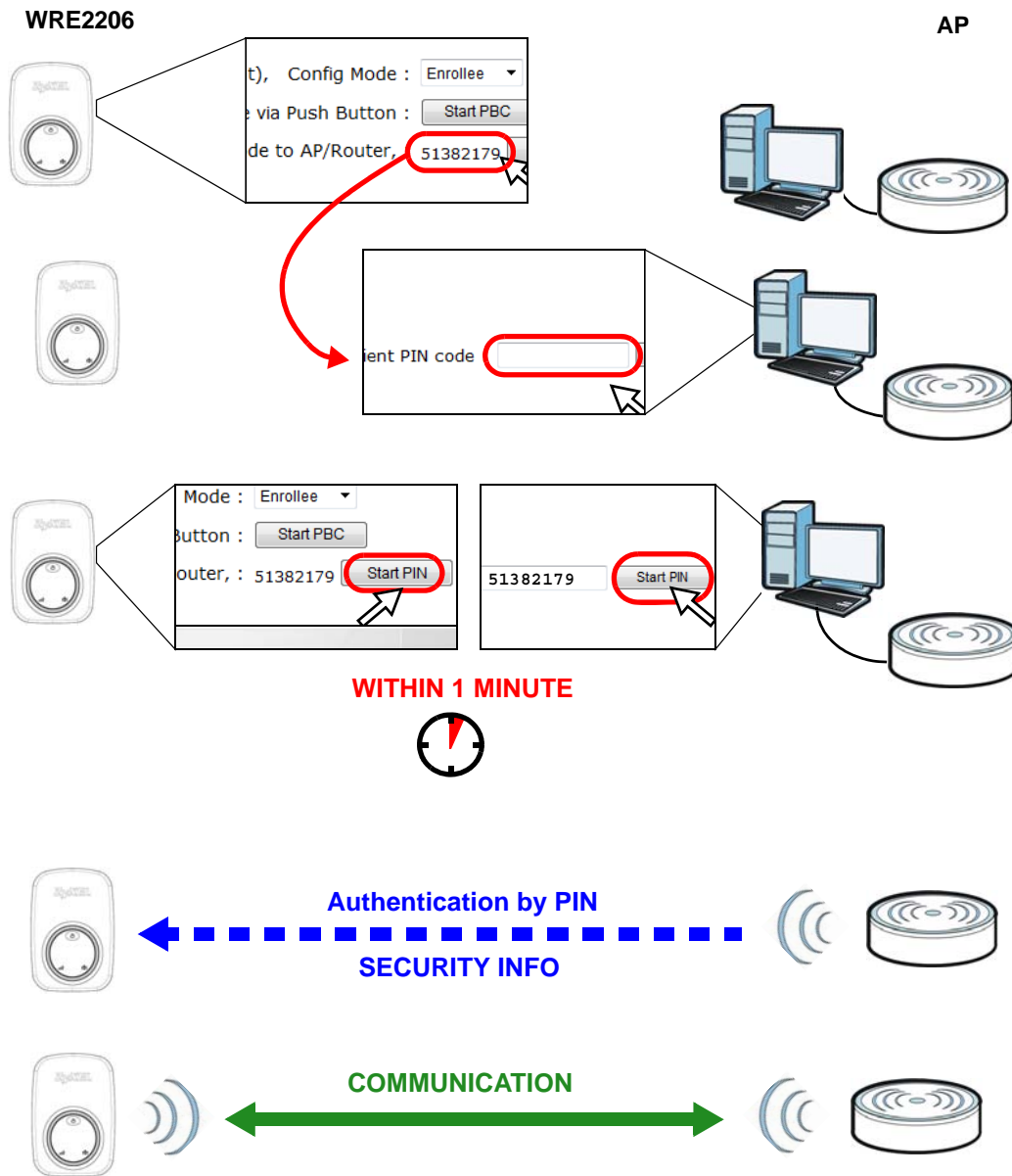

### 5.3.3 Selecting an AP from an Automatically Detected List

Follow the steps below to create a secure wireless network by selecting an AP from a list of detected APs.

The instructions require that your hardware is connected (see the Quick Start Guide) and you are logged into the Web Configurator through your LAN connection (see [Section 2.2 on page 13](#)).

- 1 Select an AP from the **Select** column and click **Next**.

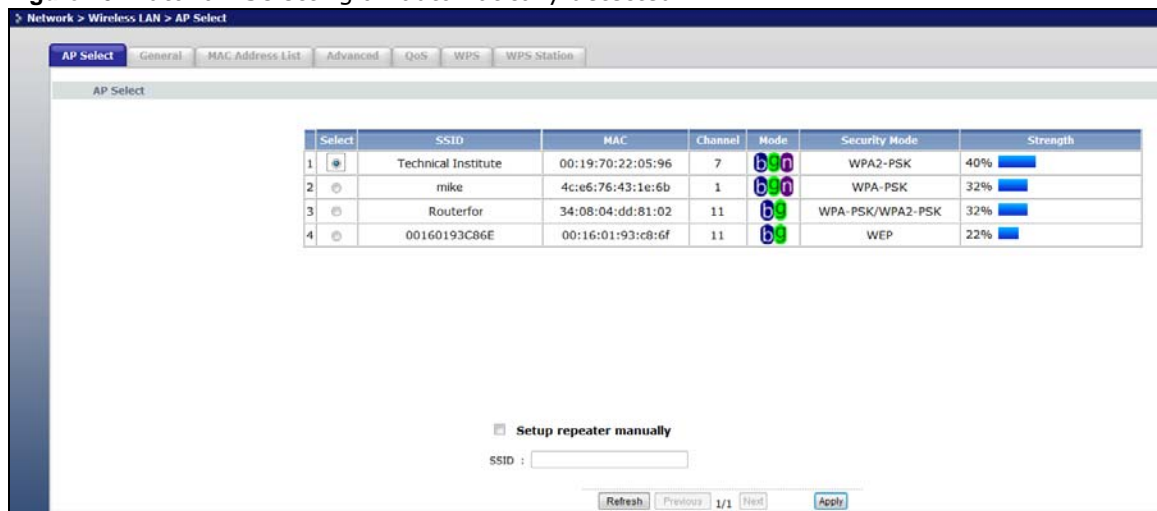
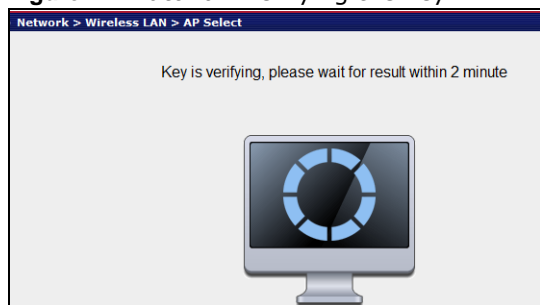

**Figure 20** Tutorial: Selecting an automatically detected AP

- 2 Type a key into the **KEY** field and click **Next**.

**Figure 21** Tutorial: The KEY field

- 3 Wait for the WRE2206 to verify the key with the AP.

**Figure 22** Tutorial: Verifying the key

- 4 When the key is verified, click **Next**.

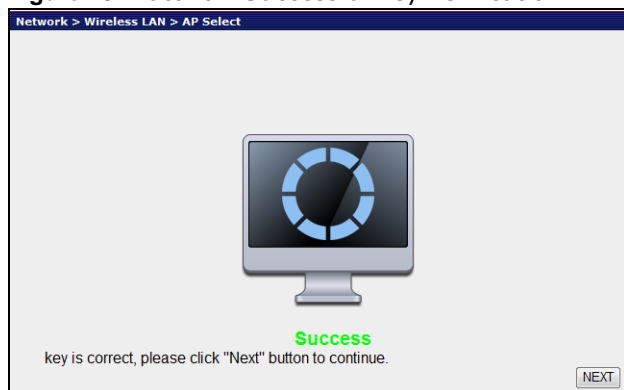
**Figure 23** Tutorial: Successful key verification

- Click **APPLY** to save settings and restart the WRE2206. Click **CONTINUE** to go to the Status screen without saving the settings and restarting the WRE2206.

**Figure 24** Tutorial: Saving settings

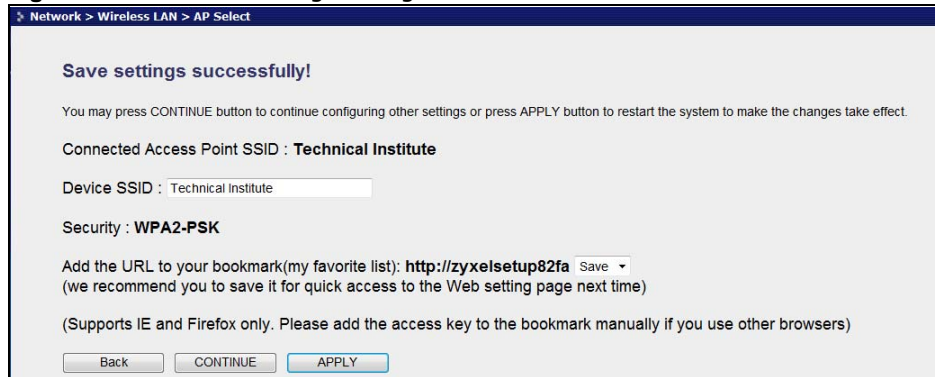

### 5.3.4 Selecting an AP by Manually Entering Security Information

This example shows you how to configure wireless security settings with the following parameters on your WRE2206.

<b>SSID</b>	ExampleSSID
<b>Channel</b>	7
<b>Security</b>	WPA2 PSK

Follow the steps below to create a secure wireless network by manually entering the AP’s wireless security settings in the WRE2206’s interface.

The instructions require that your hardware is connected (see the Quick Start Guide) and you are logged into the Web Configurator through your LAN connection (see [Section 2.2 on page 13](#)).

- Select **Setup repeater manually**.
- Type the SSID of the AP into the **SSID** field and click **Next**.

**Figure 25** Tutorial: Typing an SSID

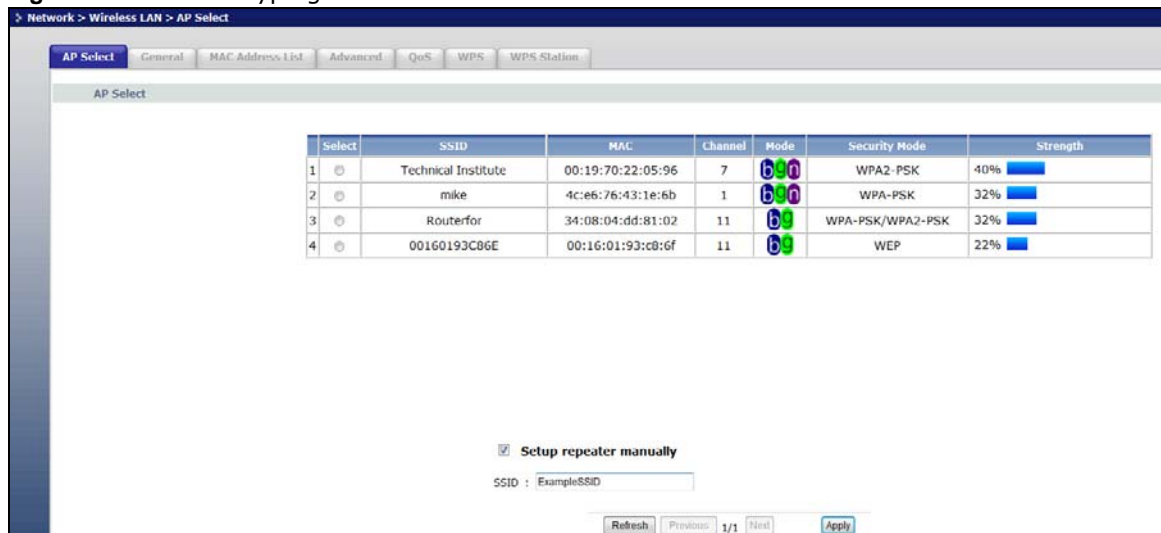

- 3 Select the security settings and click **Next**.

**Figure 26** Tutorial: Security Settings

The screenshot shows the 'Security' tab in the 'AP Select' configuration interface. The 'Security Settings' section is active, showing the following fields:

- Select SSID:** SSID choice is set to 'ExampleSSID'.
- Encryption:** Set to 'WPA pre-shared key'.
- WPA Unicast Cipher Suite:** Radio buttons for 'WPA(TKIP)', 'WPA2(AES)' (selected), and 'WPA2 Mixed'.
- Pre-shared Key Format:** Set to 'Passphrase'.
- Pre-shared Key:** An empty text input field.
- Channel:** Set to '7'.

Buttons for 'APPLY' and 'CANCEL' are located at the bottom right of the configuration area.

- 4 Click **Apply** to save settings and restart the WRE2206. Click **CONTINUE** to go to the Status screen without saving the settings and restarting the WRE2206.

**Figure 27** Tutorial: Saving settings

The screenshot shows a confirmation message: 'Save settings successfully!'. Below the message, it states: 'You may press CONTINUE button to continue configuring other settings or press APPLY button to restart the system to make the changes take effect.' The saved settings are displayed as:

- device SSID : **Technical Institute**
- Security : **WPA-shared key**

Below the settings, there is a bookmark instruction: 'Add the URL to your bookmark(my favorite list): <http://zyxelsetup82fa> Save' (we recommend you to save it for quick access to the Web setting page next time). A note at the bottom says: '(Supports IE and Firefox only. Please add the access key to the bookmark manually if you use other browsers)'. At the bottom of the screen are three buttons: 'Back', 'CONTINUE', and 'APPLY'.

---

# **PART II**

## **Technical Reference**

---



# Wireless LAN

## 6.1 Overview

This chapter discusses how to configure the wireless network settings in your WRE2206. See [Section 1.1 on page 9](#) for an overview of wireless networks.

## 6.2 What You Can Do

- Use the **General** screen to enable the Wireless LAN, enter the SSID and select the wireless security mode ([Section 6.4 on page 40](#)).
- Use the **MAC Address List** screen to allow or deny wireless stations based on their MAC addresses from connecting to the WRE2206 ([Section 6.5 on page 41](#)).
- Use the **Advanced** screen to allow intra-BSS networking and set the RTS/CTS Threshold ([Section 6.6 on page 42](#)).
- Use the **QoS** screen to enable Wifi MultiMedia Quality of Service (WMM QoS). WMM QoS prioritizes traffic using pre-defined voice, video, best-effort and background priorities ([Section 6.7 on page 43](#)).
- Use the **WPS** screen to quickly set up a wireless network with strong security, without having to configure security settings manually ([Section 6.8 on page 43](#)).
- Use the **WPS Station** screen to add a wireless station using WPS ([Section 6.9 on page 44](#)).
- Use the **AP Select** screen to choose an access point that you want the WRE2206 to connect to. You should know the security settings of the target AP ([Section 6.10 on page 45](#)).

## 6.3 What You Should Know

Every wireless network must follow these basic guidelines.

- Every wireless client in the same wireless network must use the same SSID.  
The SSID is the name of the wireless network. It stands for Service Set IDentity.
- If two wireless networks overlap, they should use different channels.  
Like radio stations or television channels, each wireless network uses a specific channel, or frequency, to send and receive information.
- Every wireless client in the same wireless network must use security compatible with the AP.  
Security stops unauthorized devices from using the wireless network. It can also protect the information that is sent in the wireless network.

## 6.3.1 Wireless Security Overview

The following sections introduce different types of wireless security you can set up in the wireless network.

### 6.3.1.1 MAC Address List

Every wireless client has a unique identification number, called a MAC address.<sup>1</sup> A MAC address is usually written using twelve hexadecimal characters<sup>2</sup>; for example, 00A0C5000002 or 00:A0:C5:00:00:02. To get the MAC address for each wireless client, see the appropriate User's Guide or other documentation.

You can use the MAC Address List to tell the AP which wireless clients are allowed to use the wireless network. If a wireless client is allowed to use the wireless network, it still has to have the correct settings (SSID, channel, and security). If a wireless client is not allowed to use the wireless network, it does not matter if it has the correct settings.

This type of security does not protect the information that is sent in the wireless network. Furthermore, there are ways for unauthorized devices to get the MAC address of an authorized wireless client. Then, they can use that MAC address to use the wireless network.

### 6.3.1.2 Encryption

Wireless networks can use encryption to protect the information that is sent in the wireless network. Encryption is like a secret code. If you do not know the secret code, you cannot understand the message.

**Table 11** Types of Encryption for Each Type of Authentication

	<b>NO AUTHENTICATION</b>
Weakest	No Security
↕	Static WEP
↕	WPA-PSK
Strongest	WPA2-PSK

For example, if users do not log in to the wireless network, you can choose no authentication, if users do log on to the wireless network, you can choose No Security, **Static WEP**, **WPA-PSK**, or **WPA2-PSK**.

Usually, you should set up the strongest encryption that every wireless client in the wireless network supports. Suppose the wireless network has two wireless clients. Device A only supports WEP, and device B supports WEP and WPA-PSK. Therefore, you should set up **Static WEP** in the wireless network.

**Note:** It is recommended that wireless networks use WPA-PSK, or stronger encryption. IEEE 802.1x and WEP encryption are better than none at all, but it is still possible for unauthorized devices to figure out the original information pretty quickly.

1. Some wireless devices, such as scanners, can detect wireless networks but cannot use wireless networks. These kinds of wireless devices might not have MAC addresses.
2. Hexadecimal characters are 0, 1, 2, 3, 4, 5, 6, 7, 8, 9, A, B, C, D, E, and F.

Many types of encryption use a key to protect the information in the wireless network. The longer the key, the stronger the encryption. Every wireless client in the wireless network must have the same key.

### 6.3.1.3 WPS

WiFi Protected Setup (WPS) is an industry standard specification, defined by the WiFi Alliance. WPS allows you to quickly set up a wireless network with strong security, without having to configure security settings manually. Depending on the devices in your network, you can either press a button (on the device itself, or in its configuration utility) or enter a PIN (Personal Identification Number) in the devices. Then, they connect and set up a secure network by themselves. See how to set up a secure wireless network using WPS in the [Section 5.2 on page 26](#).

## 6.4 General Wireless LAN Screen

Use this screen to enable the Wireless LAN, enter the SSID and select the wireless security mode.

**Note:** If you are configuring the WRE2206 from a computer connected to the wireless LAN and you change the WRE2206's SSID, channel or security settings, you will lose your wireless connection when you press **Apply** to confirm. You must then change the wireless settings of your computer to match the WRE2206's new settings.

Click **Network > Wireless LAN** to open the **General** screen.

**Figure 28** Network > Wireless LAN > General

The following table describes the general wireless LAN labels in this screen.

**Table 12** Network > Wireless LAN > General

LABEL	DESCRIPTION
WLAN STA Information	This shows the wireless and security settings of the selected AP wireless network.
SSID	This displays the Service Set IDentity of the wireless device to which you are connecting.
WLAN AP Information / Wireless Setup	Use this section to configure the wireless settings between the WRE2206 and its wireless clients.
Name(SSID)	(Service Set IDentity) The SSID identifies the Service Set with which a wireless station is associated. Wireless stations associating to the access point (AP) must have the same SSID. Enter a descriptive name (up to 32 printable 7-bit ASCII characters) for the wireless LAN.



**Table 12** Network > Wireless LAN > General (continued)

LABEL	DESCRIPTION
Hide SSID	Select this check box to hide the SSID in the outgoing beacon frame so a station cannot obtain the SSID through scanning using a site survey tool.
Operating Channel	This displays the channel the WRE2206 is currently using.
Apply	Click <b>Apply</b> to save your changes back to the WRE2206.
Reset	Click <b>Reset</b> to reload the previous configuration for this screen.

## 6.5 MAC Address List

The MAC Address List screen allows you to specify which devices are allowed to access the WRE2206, while denying access to all unspecified devices. Every Ethernet device has a unique MAC (Media Access Control) address. The MAC address is assigned at the factory and consists of six pairs of hexadecimal characters, for example, 00:A0:C5:00:00:02. You need to know the MAC address of the devices to configure this screen.

To change your WRE2206's MAC Address List settings, click **Network > Wireless LAN > MAC Address List**. The screen appears as shown.

**Figure 29** Network > Wireless LAN > MAC Address List

Network > Wireless LAN > MAC Address List

AP Select General **MAC Address List** Advanced QoS WPS WPS Station

MAC Address List

For security reason, the Wireless Repeater features MAC Address Filtering that only allows authorized MAC Addresses associating to the Wireless Repeater.

Active

Set	MAC Address
1	00:00:00:00:00:00
2	00:00:00:00:00:00
3	00:00:00:00:00:00
4	00:00:00:00:00:00
5	00:00:00:00:00:00
6	00:00:00:00:00:00
7	00:00:00:00:00:00
8	00:00:00:00:00:00
9	00:00:00:00:00:00
10	00:00:00:00:00:00
11	00:00:00:00:00:00
12	00:00:00:00:00:00
13	00:00:00:00:00:00
14	00:00:00:00:00:00
15	00:00:00:00:00:00
16	00:00:00:00:00:00

Apply Reset

The following table describes the labels in this menu.

**Table 13** Network > Wireless LAN > MAC Address List

LABEL	DESCRIPTION
Active	Select this to enable MAC address filtering.
Set	This is the index number of the MAC address.
MAC Address	Enter the MAC addresses of the wireless station that are allowed access to the WRE2206 in these address fields. Enter the MAC addresses in a valid MAC address format, that is, six hexadecimal character pairs, for example, 12:34:56:78:9a:bc.
Apply	Click <b>Apply</b> to save your changes back to the WRE2206.
Reset	Click <b>Reset</b> to reload the previous configuration for this screen.

## 6.6 Wireless LAN Advanced Screen

Use this screen to configure advanced wireless LAN parameters.

Click **Network > Wireless LAN > Advanced**. The screen appears as shown.

**Figure 30** Network > Wireless LAN > Advanced

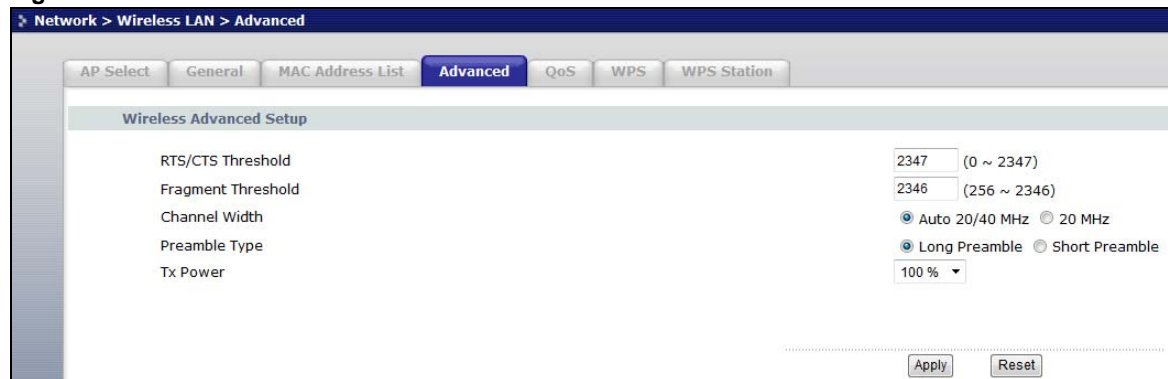

The following table describes the labels in this screen.

**Table 14** Network > Wireless LAN > Advanced

LABEL	DESCRIPTION
Wireless Advanced Setup	
RTS/CTS Threshold	Data with its frame size larger than this value will perform the RTS (Request To Send)/CTS (Clear To Send) handshake. Enter a value between <b>0</b> and <b>2347</b> .
Fragmentation Threshold	The threshold (number of bytes) for the fragmentation boundary for directed messages. It is the maximum data fragment size that can be sent. Enter an even number between <b>256</b> and <b>2346</b> .
Channel Width	Select whether the WRE2206 uses a wireless channel width of 20MHz or Auto 20/40MHz. A standard 20MHz channel offers transfer speeds of up to 150Mbps whereas a 40MHz channel uses two standard channels and offers speeds of up to 300 Mbps. Because not all devices support 40MHz channels, select Auto 20/40MHz to allow the WRE2206 to adjust the channel bandwidth automatically.

**Table 14** Network > Wireless LAN > Advanced (continued)

LABEL	DESCRIPTION
Preamble Type	A preamble affects the timing in your wireless network. There are two preamble modes: long and short. If a device uses a different preamble mode than the WRE2206 does, it cannot communicate with the WRE2206.
Tx Power	This field controls the transmission power of the WRE2206. When using the WRE2206 with a notebook computer, select a lower transmission power level when you are close to the AP in order to conserve battery power.
Apply	Click <b>Apply</b> to save your changes to the WRE2206.
Reset	Click <b>Reset</b> to reload the previous configuration for this screen.

## 6.7 Quality of Service (QoS) Screen

Use the **QoS** screen to enable Wifi MultiMedia Quality of Service (WMM QoS). WMM QoS prioritizes traffic using pre-defined voice, video, best-effort and background priorities.

Click **Network > Wireless LAN > QoS**. The following screen appears.

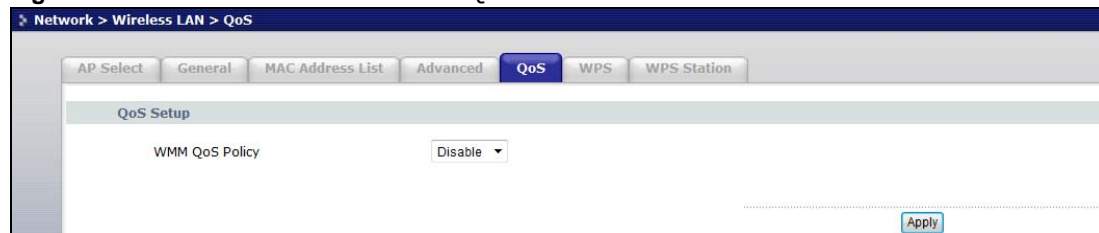
**Figure 31** Network > Wireless LAN > QoS

The following table describes the labels in this screen.

**Table 15** Network > Wireless LAN > QoS

LABEL	DESCRIPTION
WMM QoS Policy	Enable this to have the WRE2206 automatically give a service a priority level according to the ToS value in the IP header of packets it sends. WMM QoS (Wifi MultiMedia Quality of Service) gives high priority to voice and video, which makes them run more smoothly.
Apply	Click <b>Apply</b> to save your changes to the WRE2206.

## 6.8 WPS Screen

Use this screen to enable/disable WPS, view or generate a new PIN and check current WPS status. To open this screen, click **Network > Wireless LAN > WPS** tab.

**Figure 32** Network > Wireless LAN > WPS

The following table describes the labels in this screen.

**Table 16** Network > Wireless LAN > WPS

LABEL	DESCRIPTION
WPS Setup	
Enable WPS	Select this to enable the WPS feature.
PIN Number	This displays a PIN number last time system generated. Click <b>Generate</b> to generate a new PIN number.
WPS Status	
Status	This displays <b>Configured</b> when the WRE2206 has connected to a wireless network using WPS or when <b>Enable WPS</b> is selected and wireless or wireless security settings have been changed. The current wireless and wireless security settings also appear in the screen.  This displays <b>Unconfigured</b> if WPS is disabled and there are no wireless or wireless security changes on the WRE2206 or you click <b>Release_Configuration</b> to remove the configured wireless and wireless security settings.
Release Configuration	This button is only available when the WPS status displays <b>Configured</b> .  Click this button to remove all configured wireless and wireless security settings for WPS connections on the WRE2206.
Apply	Click <b>Apply</b> to save your changes back to the WRE2206.
Refresh	Click <b>Refresh</b> to get this screen information afresh.

## 6.9 WPS Station Screen

Use this screen when you want to add a wireless station using WPS.

**Note:** WPS can only be configured between two devices at a time. For example if devices A and B are first configured using WPS, then use either A or B to configure device C using WPS.

To open this screen, click **Network > Wireless LAN > WPS Station** tab.

Note: WPS times out after two minutes of pressing a button. Press the button on the second device within about a minute of the first, then wait two minutes for the WPS configuration to complete.

To add the second wireless station, you have to press these buttons on both device and the wireless station again after the first 2 minutes.

**Figure 33** Network > Wireless LAN > WPS Station



The following table describes the labels in this screen.

**Table 17** Network > Wireless LAN > WPS Station

LABEL	DESCRIPTION
Config Mode	Use this to select <b>Registrar</b> or <b>Enrollee</b> mode. Select <b>Registrar</b> mode to make wireless clients follow the wireless settings of the WRE2206. Select <b>Enrollee</b> mode to make the WRE2206 follow the wireless settings of an access point.
Push Button	Use this button when you use the PBC (Push Button Configuration) method to configure wireless stations's wireless settings. See <a href="#">Section 5.2.1 on page 26</a> .  Click this to start WPS-aware wireless station scanning and the wireless security information synchronization.
Input station's PIN number	Use this button when you use the PIN Configuration method to configure wireless station's wireless settings. See <a href="#">Section 5.2.2 on page 28</a> .  Type the same PIN number generated in the wireless station's utility. Then click <b>Start</b> to associate to each other and perform the wireless security information synchronization.

## 6.10 AP Select Screen

Use this screen to choose an access point that you want the WRE2206 to connect to. You should know the security settings of the target AP.

To open this screen, click **Network > Wireless LAN > AP Select** tab.

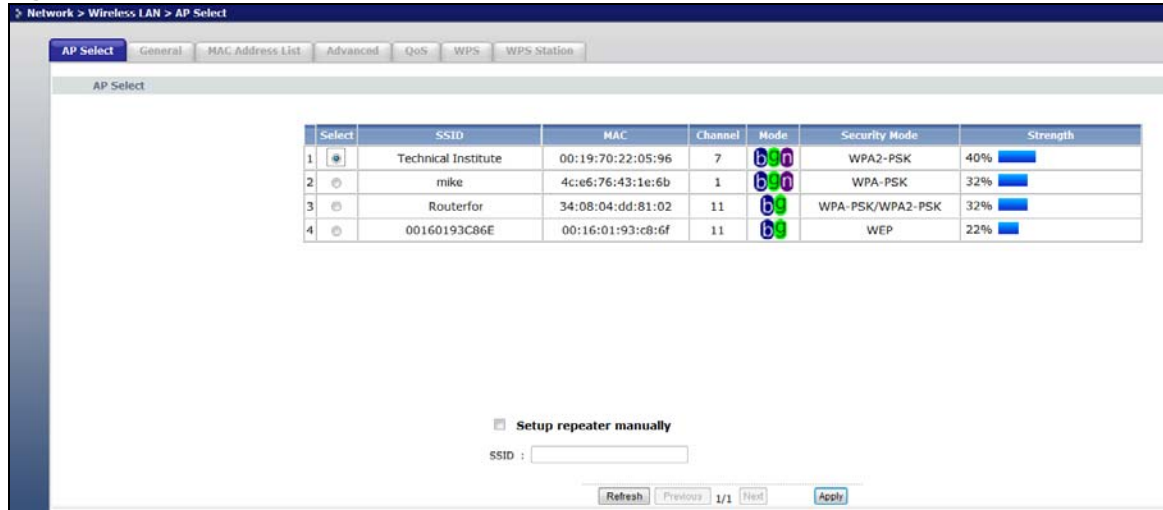
**Figure 34** Network > Wireless LAN > AP Select

The following table describes the labels in this screen.

**Table 18** Network > Wireless LAN > AP Select

LABEL	DESCRIPTION
Select	Use the radio button to select the wireless device to which you want to connect.
SSID	This displays the Service Set Identity of the wireless device. The SSID is a unique name that identifies a wireless network. All devices in a wireless network must use the same SSID.
MAC	This displays the MAC address of the wireless device.
Channel	This displays the channel number used by this wireless device.
Mode	This displays which IEEE 802.11b/g/n wireless networking standards the wireless device supports.
Security Mode	This displays the type of security configured on the wireless device. When <b>no</b> is shown, no security is configured and you can connect to it without a password.
Strength	This displays the strength of the wireless signal. The signal strength mainly depends on the antenna output power and the distance between your WRE2206 and this device.
Setup repeater manually	Select this to setup the AP manually.
SSID	If <b>Setup repeater manually</b> is selected, use this field to type the SSID of the AP. This is useful when the AP's SSID is hidden.
Refresh	Click this to search for available wireless devices within transmission range and update this table.
Previous	Click this to see the previous page of APs.
Next	Click this to see the next page of APs.
Apply	Click this to start the next step in the AP setup process.

## 7.1 Overview

This screen allows you to assign the WRE2206 a fixed or dynamic IP address. The default IP address is 192.168.1.2. In initial configuration, the WRE2206 acts as a DHCP server, so it can assign your computer an IP address in the same network range as the default IP. After the WRE2206 connects to an AP, the DHCP server function is disabled and your computer gets its IP from the AP. If the AP connection is dropped, connect to the WRE2206 again using the default domain name, <http://zyxelsetupxxxx> where xxxx is the last four numbers of the MAC address. The MAC address can be found on a label on the product.

## 7.2 What You Need To Know

The LAN parameters of the WRE2206 are preset in the factory with the following values:

- IP address of 192.168.1.2 with subnet mask of 255.255.255.0 (24 bits)

## 7.3 LAN IP Screen

Use this screen to change your basic LAN settings. Click **Network > LAN**.

**Figure 35** Network > LAN > IP

The screenshot shows the 'Network > LAN > IP' configuration page. At the top, there is a breadcrumb trail 'Network > LAN > IP' and a blue 'IP' button. Below this is a 'LAN TCP/IP' section with two radio buttons: 'Get from DHCP Server' (selected) and 'User Defined LAN IP'. Under 'User Defined LAN IP', there are three input fields: 'IP Address' (192.168.2.254), 'IP Subnet Mask' (255.255.255.0), and 'Gateway' (empty). At the bottom right, there are 'Apply' and 'Reset' buttons.

The following table describes the labels in this screen.

**Table 19** Network > LAN > IP

<b>LABEL</b>	<b>DESCRIPTION</b>
Get from DHCP Server	Select this to have the WRE2206 get a dynamic IP address from a DHCP server.
User Defined LAN IP	Click this to enable the manual IP configuration.
IP Address	Type the IP address of your WRE2206 in dotted decimal notation 192.168.1.2 (factory default).
IP Subnet Mask	The subnet mask specifies the network number portion of an IP address.
Apply	Click <b>Apply</b> to save your changes back to the WRE2206.
Reset	Click <b>Reset</b> to begin configuring this screen afresh.



## 8.1 Overview

This chapter provides information on the **System** screen.

## 8.2 What You Can Do

Use the **Password** screen to set the password ([Section 8.3 on page 49](#)).

## 8.3 System Password Screen

Use this screen to set the web configurator password. Click **Maintenance > System**. The following screen displays.

**Figure 36** Maintenance > System > Password

The following table describes the labels in this screen.

**Table 20** Maintenance > System > Password

LABEL	DESCRIPTION
Password Setup	Change your WRE2206's password (recommended) using the fields as shown.
Old Password	Type the default password or the existing password you use to access the system in this field.
New Password	Type your new system password (up to 30 characters). Note that as you type a password, the screen displays an asterisk (*) for each character you type.
Retype to Confirm	Type the new password again in this field.
Apply	Click <b>Apply</b> to save your changes back to the WRE2206.
Reset	Click <b>Reset</b> to begin configuring this screen afresh.

## 9.1 Overview

This chapter shows you how to upload a new firmware, upload or save backup configuration files, restart the WRE2206 and configure LEDs.

## 9.2 What You Can Do

- Use the **Firmware** screen to upload firmware to your WRE2206 ([Section 9.3 on page 50](#)).
- Use the **Configuration** screen to view information related to factory defaults, backup configuration, and restore configuration ([Section 9.4 on page 52](#)).
- Use the **Restart** screen to have the WRE2206 reboot ([Section 9.5 on page 54](#)).
- Use the **LED** screen to configure the LEDs ([Section 9.6 on page 54](#)).

## 9.3 Firmware Upload Screen

Find firmware at [www.zyxel.com](http://www.zyxel.com) in a file that (usually) uses the system model name with a “\*.bin” extension, e.g., “WRE2206.bin”. The upload process uses HTTP (Hypertext Transfer Protocol) and may take up to two minutes. After a successful upload, the system will reboot.

Click **Maintenance > Tools**. Follow the instructions in this screen to upload firmware to your WRE2206.

Figure 37 Maintenance &gt; Tools &gt; Firmware

The following table describes the labels in this screen.

Table 21 Maintenance &gt; Tools &gt; Firmware

LABEL	DESCRIPTION
Firmware Upgrade	Use this section if you have already manually downloaded new firmware from the website. Remember that you must decompress compressed (.zip) files before you can upload them.
File Path	Click <b>Choose File</b> to find the location of the firmware .bin file you want to upload.
Upload	Click <b>Upload</b> to begin the upload process. This process may take up to two minutes.
On-line Firmware Upgrade	Use this section if you have want to check for new firmware on the website and the WRE2206 has an Internet connection.
Check for latest Firmware Now	The following fields display when you click this button.
You are currently using firmware version:	The firmware version consists of the trunk version number, model code, and release number. For example, V1.00(AAAG.5) means V1.00 is the trunk number, AAAG represents WRE2206, and 5 means the fifth release.
The Latest Firmware Version	Compare the release number in the previous field with the release number in this one to see if you have the latest firmware. In this example, V1.00(AAAG.5), the numbers are the same (5), so the WRE2206 already has the latest firmware.
Release Date	The date the firmware was issued is shown in year-month-date format.
Release Note	The release note shows what has changed (new features, bug fixes, known issues) in this firmware version. Check the Release Note before deciding to use new firmware.
Size	This is the size of the firmware in bytes. 15073234 is about 15 MB.
Do_Firmware_Upgrade	Click this button to download and upgrade the new firmware to the WRE2206.

Note: Do not turn off the WRE2206 while firmware upload is in progress!

After you see the **Firmware Upgrading** screen, wait until the upgrade process is complete.

**Figure 38** Firmware Upgrading

The WRE2206 automatically restarts in this time causing a temporary network disconnect. In some operating systems, you may see the following icon on your desktop.

**Figure 39** Network Temporarily Disconnected

After the WRE2206 restarts, the **Upgrade Accomplished** screen appears.

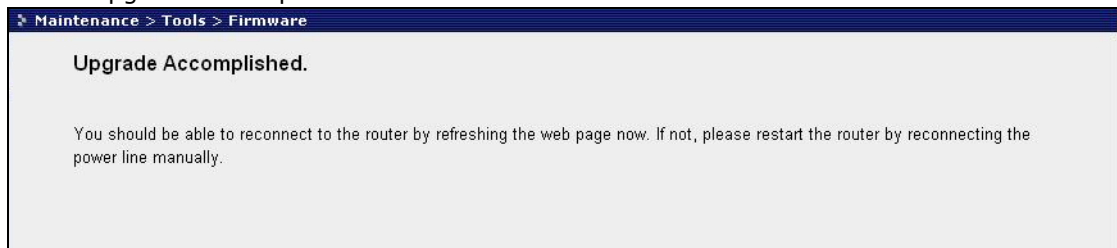
**Figure 40** Upgrade Accomplished

Refresh the web page and log in again and check your new firmware version in the **Status** screen.

## 9.4 Configuration Screen

Click **Maintenance > Tools > Configuration**. Information related to factory defaults, backup configuration, and restoring configuration appears as shown next.

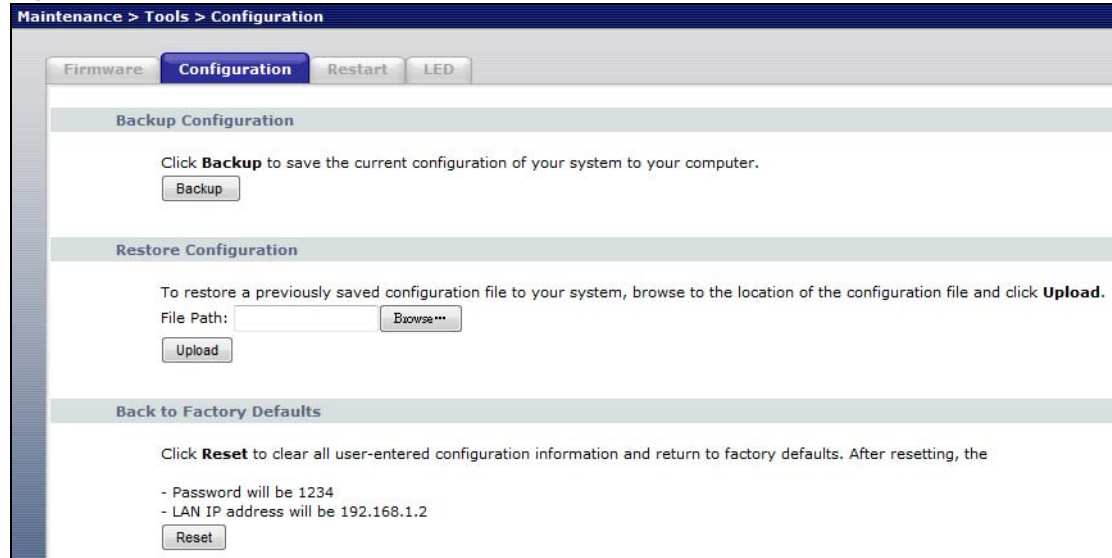
**Figure 41** Maintenance > Tools > Configuration

## 9.4.1 Backup Configuration

Backup configuration allows you to back up (save) the WRE2206's current configuration to a file on your computer. Once your WRE2206 is configured and functioning properly, it is highly recommended that you back up your configuration file before making configuration changes. The backup configuration file will be useful in case you need to return to your previous settings.

Click **Backup** to save the WRE2206's current configuration to your computer.

## 9.4.2 Restore Configuration

Restore configuration allows you to upload a new or previously saved configuration file from your computer to your WRE2206.

**Table 22** Maintenance Restore Configuration

LABEL	DESCRIPTION
File Path	Type in the location of the file you want to upload in this field or click <b>Browse...</b> to find it.
Browse...	Click <b>Browse...</b> to find the file you want to upload. Remember that you must decompress compressed (.ZIP) files before you can upload them.
Upload	Click <b>Upload</b> to begin the upload process.

**Note:** Do not turn off the WRE2206 while configuration file upload is in progress.

After you see a "configuration upload successful" screen, you must then wait one minute before logging into the WRE2206 again.

The WRE2206 automatically restarts in this time causing a temporary network disconnect. In some operating systems, you may see the following icon on your desktop.

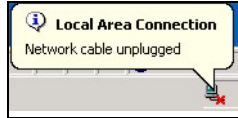
**Figure 42** Temporarily Disconnected

If you uploaded the default configuration file you may need to change the IP address of your computer to be in the same subnet as that of the default WRE2206 IP address (192.168.1.2). Refer to your operating system's help files for details on how to set up your computer's IP address.

### 9.4.3 Back to Factory Defaults

Pressing the **Reset** button on the Maintenance > Tools > Configuration screen clears all user-entered configuration information and returns the WRE2206 to its factory defaults.

You can also press the **WPS** button on the front panel for more than 10 seconds to reset the factory defaults of your WRE2206. Refer to [Section 2.3 on page 14](#) for more information on the resetting the WRE2206.

## 9.5 Restart Screen

System restart allows you to reboot the WRE2206 without turning the power off.

Click **Maintenance > Tools > Restart**. Click **Restart** to have the WRE2206 reboot. This does not affect the WRE2206's configuration.

**Figure 43** Maintenance > Tools > Restart

## 9.6 LED Screen

Click **Maintenance > Tools > LED**. Use this screen to configure which LEDs are enabled or disabled.

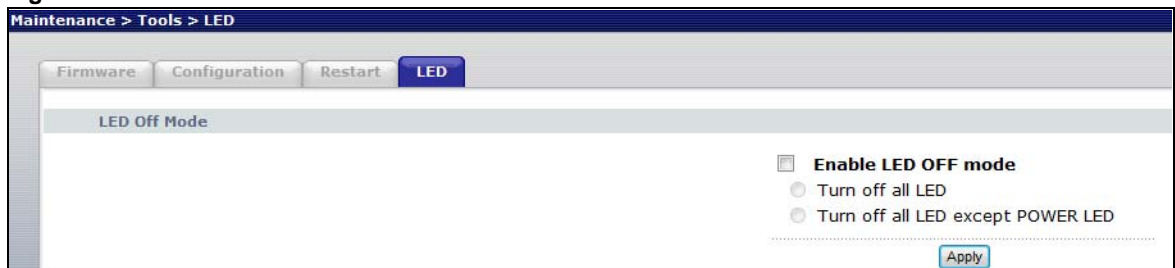
**Figure 44** Maintenance > Tools > LED

The following table describes the labels on the LED screen.

**Table 23** Maintenance > Tools > LED Screen

LABEL	DESCRIPTION
Enable LED OFF mode	Type in the location of the file you want to upload in this field or click <b>Browse...</b> to find it.
Turn off all LED	Select this to turn off all LEDs.
Turn off all LED except POWER LED	Select this to turn off all LEDs except the power LED.
Apply	Click <b>Apply</b> to save your changes back to the WRE2206.

# Troubleshooting

This chapter offers some suggestions to solve problems you might encounter. The potential problems are divided into the following categories.

- [Power, Hardware Connections, and LEDs](#)
- [WRE2206 Access and Login](#)
- [Internet Access](#)
- [Resetting the WRE2206 to Its Factory Defaults](#)
- [Wireless Problems](#)

## 10.1 Power, Hardware Connections, and LEDs

---

The WRE2206 does not turn on. None of the LEDs turn on.

---

- 1 Make sure the WRE2206 is plugged in to an appropriate power source. Make sure the power source is turned on.
- 2 Unplug and re-plug the WRE2206.
- 3 If the problem continues, contact the vendor.

---

One of the LEDs does not behave as expected.

---

- 1 Make sure you understand the normal behavior of the LED. See [Section 1.3 on page 10](#).
- 2 Make sure you understand how the LEDs are enabled or disabled. See [Section 9.6 on page 54](#).
- 3 Check the hardware connections. See the Quick Start Guide.
- 4 Inspect your cables for damage. Contact the vendor to replace any damaged cables.
- 5 Disconnect and re-connect the power adaptor to the WRE2206.
- 6 If the problem continues, contact the vendor.



## 10.2 WRE2206 Access and Login

---

### I don't know the IP address of my WRE2206.

---

- 1 Click **Start > Run**, enter **cmd**, and then enter **Ping zyxelsetup**. You can find the MAC address on a label on the WRE2206.
- 2 The default URL is **http://zyxelsetup**. The default IP address is 192.168.1.2.
- 3 If you changed the IP address and have forgotten it, you might get the IP address of the WRE2206 by looking up the IP address of the default gateway for your computer. To do this in most Windows computers, click **Start > Run**, enter **cmd**, and then enter **ipconfig**. The IP address of the **Default Gateway** might be the IP address of the WRE2206 (it depends on the network), so enter this IP address in your Internet browser. Login (see the Quick Start Guide for instructions) and go to the **Device Information** table in the **Status** screen. Your WRE2206's IP address is available in the **Device Information** table.
  - If the **DHCP** setting under **LAN information** is **None**, your device has a fixed IP address.
  - If the **DHCP** setting under **LAN information** is **Client**, then your device receives an IP address from a DHCP server on the network.
- 4 If your WRE2206 is a DHCP client, you can find your IP address from the DHCP server. This information is only available from the DHCP server which allocates IP addresses on your network. Find this information directly from the DHCP server or contact your system administrator for more information.
- 5 Reset your WRE2206 to change all settings back to their default. This means your current settings are lost. See [Section 10.4 on page 60](#) in the **Troubleshooting** for information on resetting your WRE2206.

---

### I forgot the username and password.

---

- 1 The default username is **admin** and default password is **1234**.
- 2 If this does not work, you have to reset the device to its factory defaults. See [Section 10.4 on page 60](#).

---

### I cannot see or access the **Login** screen in the Web Configurator.

---

- 1 Make sure you are using the correct URL and IP address.
  - The default URL is **http://zyxelsetup**. The default IP address is 192.168.1.2.
  - If you changed the IP address, use the new IP address.

- If you changed the IP address and have forgotten it, see the troubleshooting suggestions for [I don't know the IP address of my WRE2206](#).
- 2 Check the hardware connections, and make sure the LEDs are behaving as expected. See the Quick Start Guide.
  - 3 Make sure your Internet browser does not block pop-up windows and has JavaScript and Java enabled.
  - 4 Make sure your computer is in the same subnet as the WRE2206. (If you know that there are routers between your computer and the WRE2206, skip this step.)
    - If there is a DHCP server on your network, make sure your computer is using a dynamic IP address.
    - If there is no DHCP server on your network, make sure your computer's IP address is in the same subnet as the WRE2206.
  - 5 Reset the device to its factory defaults, and try to access the WRE2206 with the default IP address.
  - 6 If the problem continues, contact the network administrator or vendor, or try one of the advanced suggestions.

#### Advanced Suggestions

- If your computer is connected wirelessly, use a computer that is connected to a **LAN/ETHERNET** port.

---

I can see the [Login](#) screen, but I cannot log in to the WRE2206.

---

- 1 Make sure you have entered the password correctly. The default username is **admin** and default password is **1234**. This field is case-sensitive, so make sure [Caps Lock] is not on.
- 2 This can happen when you fail to log out properly from your last session. Try logging in again after 5 minutes.
- 3 Disconnect and re-connect the power adaptor or cord to the WRE2206.
- 4 If this does not work, you have to reset the device to its factory defaults. See [Section 10.4 on page 60](#).

## 10.3 Internet Access

---

I cannot access the Internet.

---

- 1 Check the hardware connections, and make sure the LEDs are behaving as expected. See the Quick Start Guide.

- 2 Try to connect directly to the AP. If you can access the Internet, check that the WRE2206 has associated with the AP by checking the **WLAN STA Information** SSID field shows the SSID of the AP. See [Section 6.4 on page 40](#).
- 3 If you are trying to access the Internet wirelessly, make sure the wireless settings in the wireless client are the same as the settings in the AP.
- 4 Disconnect all the cables from your device, and follow the directions in the Quick Start Guide again.
- 5 If the problem continues, contact your ISP.

---

I cannot access the Internet anymore. I had access to the Internet (with the WRE2206), but my Internet connection is not available anymore.

---

- 1 Check the hardware connections, and make sure the LEDs are behaving as expected. See the Quick Start Guide and [Section 1.3 on page 10](#).
- 2 Reboot the WRE2206.
- 3 Try to connect directly to the AP. If you can access the Internet, check that the WRE2206 has associated with the AP by checking the **WLAN STA Information** SSID field shows the SSID of the AP. See [Section 6.4 on page 40](#).
- 4 If the problem continues, contact your ISP.

---

The Internet connection is slow or intermittent.

---

- 1 There might be a lot of traffic on the network. Look at the LEDs, and check [Section 1.3 on page 10](#). If the WRE2206 is sending or receiving a lot of information, try closing some programs that use the Internet, especially peer-to-peer applications.
- 2 Check the signal strength. If the signal strength is low, try moving the WRE2206 closer to the AP if possible, and look around to see if there are any devices that might be interfering with the wireless network (for example, microwaves, other wireless networks, and so on).
- 3 Reboot the WRE2206.
- 4 If the problem continues, contact the network administrator or vendor, or try one of the advanced suggestions.

#### Advanced Suggestion

- Check the settings for QoS. If it is disabled, you might consider activating it.

## 10.4 Resetting the WRE2206 to Its Factory Defaults

If you reset the WRE2206, you lose all of the changes you have made. The WRE2206 re-loads its default settings, and the username/password resets to **admin/1234**. You have to make all of your changes again.

---

You will lose all of your changes when you reset the WRE2206 to its factory defaults.

---

To reset the WRE2206,

- 1 Make sure the power LED is on.
- 2 Press the **WPS** button for longer than 10 seconds to set the WRE2206 back to its factory-default configuration.

OR

- 3 Click **Maintenance > Tools > Restart** and then click **Restart**.

If the WRE2206 restarts automatically, wait for the WRE2206 to finish restarting, and log in to the Web Configurator. The username is **admin** and password is **1234**.

If the WRE2206 does not restart automatically, disconnect and reconnect the WRE2206's power. Then, follow the directions above again.

## 10.5 Wireless Problems

---

I cannot access the WRE2206 or ping any computer from the WLAN.

---

- 1 Make sure the wireless LAN is enabled on the WRE2206.
- 2 Make sure the wireless adapter on the wireless station is working properly.
- 3 Make sure the wireless adapter installed on your computer is IEEE 802.11 compatible and supports the same wireless standard as the WRE2206.
- 4 Make sure your computer (with a wireless adapter installed) is within the transmission range of the WRE2206.
- 5 Check that both the WRE2206 and your wireless station are using the same wireless and wireless security settings, and that both the WRE2206 and the AP are using the same wireless and wireless security settings.
- 6 Make sure traffic between the WLAN and the LAN is not blocked by the MAC Address List of the WRE2206. See [Section 6.5 on page 41](#).

# Legal Information

## Copyright

Copyright © 2015 by ZyxEL Communications Corporation.

The contents of this publication may not be reproduced in any part or as a whole, transcribed, stored in a retrieval system, translated into any language, or transmitted in any form or by any means, electronic, mechanical, magnetic, optical, chemical, photocopying, manual, or otherwise, without the prior written permission of ZyxEL Communications Corporation.

Published by ZyxEL Communications Corporation. All rights reserved.

## Disclaimer

ZyxEL does not assume any liability arising out of the application or use of any products, or software described herein. Neither does it convey any license under its patent rights nor the patent rights of others. ZyxEL further reserves the right to make changes in any products described herein without notice. This publication is subject to change without notice.

## Regulatory Notice and Statement

### UNITED STATE AMERICA



The following information applies if you use the product within USA area.

#### FCC EMC Statement

- The device complies with Part 15 of FCC rules. Operation is subject to the following two conditions:
  - (1) This device may not cause harmful interference, and
  - (2) this device must accept any interference received, including interference that may cause undesired operation.
- Changes or modifications not expressly approved by the party responsible for compliance could void the user's authority to operate the equipment.
- This product has been tested and complies with the specifications for a Class B digital device, pursuant to Part 15 of the FCC Rules. These limits are designed to provide reasonable protection against harmful interference in a residential installation. This equipment generates, uses, and can radiate radio frequency energy and, if not installed and used according to the instructions, may cause harmful interference to radio communications. However, there is no guarantee that interference will not occur in a particular installation.
- If this equipment does cause harmful interference to radio or television reception, which is found by turning the equipment off and on, the user is encouraged to try to correct the interference by one or more of the following measures:
  - Reorient or relocate the receiving antenna
  - Increase the separation between the equipment or devices
  - Connect the equipment to an outlet other than the receiver's
  - Consult a dealer or an experienced radio/TV technician for assistance

#### FCC Radiation Exposure Statement

This equipment complies with FCC RF radiation exposure limits set forth for an uncontrolled environment.

This transmitter must be at least 20 cm from the user and must not be co-located or operating in conjunction with any other antenna or transmitter.

### CANADA

The following information applies if you use the product within Canada area

#### Industry Canada ICES statement

CAN ICES-3 (B)/NMB-3(B)

#### Industry Canada RSS-GEN & RSS-210 statement

- This device complies with Industry Canada's licence-exempt RSSs. Operation is subject to the following two conditions: (1) This device may not cause interference; and (2) This device must accept any interference, including interference that may cause undesired operation of the device.

- This radio transmitter (2468C-WRE2206) has been approved by Industry Canada to operate with the antenna types listed below with the maximum permissible gain and required antenna impedance for each antenna type indicated. Antenna types not included in this list, having a gain greater than the maximum gain indicated for that type, are strictly prohibited for use with this device.
- If you use the produce with 5G wireless function, the following attention shall be paid that,
  - (i) the device for operation in the band 5150-5250 MHz is only for indoor use to reduce the potential for harmful interference to co-channel mobile satellite systems;
  - (ii) the maximum antenna gain permitted for devices in the bands 5250-5350 MHz and 5470-5725 MHz shall comply with the e.i.r.p. limit; and
  - (iii) the maximum antenna gain permitted for devices in the band 5725-5825 MHz shall comply with the e.i.r.p. limits specified for point-to-point and non point-to-point operation as appropriate.
  - (iv) high-power radars are allocated as primary users (i.e. priority users) of the bands 5250-5350 MHz and 5650-5850 MHz and that these radars could cause interference and/or damage to LE-LAN devices.
- Ce dispositif est conforme à la norme CNR-210 d'Industrie Canada applicable aux appareils radio exempts de licence. Son fonctionnement est sujet aux deux conditions suivantes: (1) le dispositif ne doit pas produire de brouillage préjudiciable, et (2) ce dispositif doit accepter tout brouillage reçu, y compris un brouillage susceptible de provoquer un fonctionnement indésirable.
- Le présent émetteur radio (2468C-WRE2206) de modèle s'il fait partie du matériel de catégorie I a été approuvé par Industrie Canada pour fonctionner avec les types d'antenne énumérés ci-dessous et ayant un gain admissible maximal et l'impédance requise pour chaque type d'antenne. Les types d'antenne non inclus dans cette liste, ou dont le gain est supérieur au gain maximal indiqué, sont strictement interdits pour l'exploitation de l'émetteur.
- Si vous utilisez le produit avec 5G sans fil fonction, suivant l'attention doit être versée que,
  - (i) les dispositifs fonctionnant dans la bande 5150-5250 MHz sont réservés uniquement pour une utilisation à l'intérieur afin de réduire les risques de brouillage préjudiciable aux systèmes de satellites mobiles utilisant les mêmes canaux;
  - (ii) le gain maximal d'antenne permis pour les dispositifs utilisant les bandes 5 250-5 350 MHz et 5 470-5 725 MHz doit se conformer à la limite de p.i.r.e.;
  - (iii) le gain maximal d'antenne permis (pour les dispositifs utilisant la bande 5 725-5 825 MHz) doit se conformer à la limite de p.i.r.e. spécifiée pour l'exploitation point à point et non point à point, selon le cas.
  - (iv) De plus, les utilisateurs devraient aussi être avisés que les utilisateurs de radars de haute puissance sont désignés utilisateurs principaux (c.-à-d., qu'ils ont la priorité) pour les bandes 5 250-5 350 MHz et 5 650-5 850 MHz et que ces radars pourraient causer du brouillage et/ou des dommages aux dispositifs LAN-EL.

**Industry Canada Radiation Exposure Statement**

This equipment complies with IC radiation exposure limits set forth for an uncontrolled environment. This equipment should be installed and operated with a minimum distance of 20cm between the radiator and your body.

**Déclaration d'exposition aux radiations:**

Cet équipement est conforme aux limites d'exposition aux rayonnements IC établies pour un environnement non contrôlé. Cet équipement doit être installé et utilisé avec un minimum de 20 cm de distance entre la source de rayonnement et votre corps.

**EUROPEAN UNION**



The following information applies if you use the product within the European Union.

**Declaration of Conformity with Regard to EU Directive 1999/5/EC (R&TTE Directive)**

Compliance information for 2.4GHz and/or 5GHz wireless products relevant to the EU and other Countries following the EU Directive 1999/5/EC (R&TTE)

Български (Bulgarian)	С настоящото ZyXEL декларира, че това оборудване е в съответствие със съществените изисквания и другите приложими разпоредбите на Директива 1999/5/EC.
Español (Spanish)	Por medio de la presente ZyXEL declara que el equipo cumple con los requisitos esenciales y cualesquiera otras disposiciones aplicables o exigibles de la Directiva 1999/5/CE.
Čeština (Czech)	ZyXEL tímto prohlašuje, že tento zařizení je ve shodě se základními požadavky a dalšími příslušnými ustanoveními směrnice 1999/5/EC.
Dansk (Danish)	Undertegnede ZyXEL erklærer herved, at følgende udstyr overholder de væsentlige krav og øvrige relevante krav i direktiv 1999/5/EF.
Deutsch (German)	Hiermit erklärt ZyXEL, dass sich das Gerät Ausstattung in Übereinstimmung mit den grundlegenden Anforderungen und den übrigen einschlägigen Bestimmungen der Richtlinie 1999/5/EU befindet.
Eesti keel (Estonian)	Käesolevaga kinnitab ZyXEL seadme seadmed vastavust direktiivi 1999/5/EÜ põhinõuetele ja nimetatud direktiivist tulenevatele teistele asjakohastele sätetele.
Ελληνικά (Greek)	ΜΕ ΤΗΝ ΠΑΡΟΥΣΑ ΖΥΧΕΛ ΔΗΛΩΝΕΙ ΟΤΙ ΕΞΟΠΛΙΣΜΟΣ ΣΥΜΜΟΡΦΩΝΕΤΑΙ ΠΡΟΣ ΤΙΣ ΟΥΣΙΩΔΕΙΣ ΑΠΑΙΤΗΣΕΙΣ ΚΑΙ ΤΙΣ ΛΟΙΠΕΣ ΣΧΕΤΙΚΕΣ ΔΙΑΤΑΞΕΙΣ ΤΗΣ ΟΔΗΓΙΑΣ 1999/5/ΕC.
English	Hereby, ZyXEL declares that this equipment is in compliance with the essential requirements and other relevant provisions of Directive 1999/5/EC.

Français (French)	Par la présente ZyXEL déclare que l'appareil équipements est conforme aux exigences essentielles et aux autres dispositions pertinentes de la directive 1999/5/EC.
Hrvatski (Croatian)	ZyXEL ovime izjavljuje da je radijska oprema tipa u skladu s Direktivom 1999/5/EC.
Íslenska (Icelandic)	Hér með lýsir, ZyXEL því yfir að þessi búnaður er í samræmi við grunnkröfur og önnur viðeigandi ákvæði tilskipunar 1999/5/EC.
Italiano (Italian)	Con la presente ZyXEL dichiara che questo attrezzatura è conforme ai requisiti essenziali ed alle altre disposizioni pertinenti stabilite dalla direttiva 1999/5/CE.
Latviešu valoda (Latvian)	Ar šo ZyXEL deklarē, ka iekārtas atbilst Direktīvas 1999/5/EK būtiskajām prasībām un citiem ar to saistītajiem noteikumiem.
Lietuvių kalba (Lithuanian)	Šiuo ZyXEL deklaruoja, kad šis įranga atitinka esminius reikalavimus ir kitas 1999/5/EB Direktyvos nuostatas.
Magyar (Hungarian)	Alulírott, ZyXEL nyilatkozom, hogy a berendezés megfelel a vonatkozó alapvető követelményeknek és az 1999/5/EK irányelv egyéb előírásainak.
Malti (Maltese)	Hawnhekk, ZyXEL, jiddikjara li dan tagħmir jikkonforma mal-ħtiġijiet essenzjali u ma provvedimenti oħrajn relevanti li hemm fid-Dirrettiva 1999/5/EC.
Nederlands (Dutch)	Hierbij verklaart ZyXEL dat het toestel uitrusting in overeenstemming is met de essentiële eisen en de andere relevante bepalingen van richtlijn 1999/5/EC.
Polski (Polish)	Niniejszym ZyXEL oświadcza, że sprzęt jest zgodny z zasadniczymi wymogami oraz pozostałymi stosownymi postanowieniami Dyrektywy 1999/5/EC.
Português (Portuguese)	ZyXEL declara que este equipamento está conforme com os requisitos essenciais e outras disposições da Directiva 1999/5/EC.
Română (Romanian)	Prin prezenta, ZyXEL declară că acest echipament este în conformitate cu cerințele esențiale și alte prevederi relevante ale Directivei 1999/5/EC.
Slovenčina (Slovak)	ZyXEL týmto vyhlasuje, že zariadenia spĺňa základné požiadavky a všetky príslušné ustanovenia Smernice 1999/5/EC.
Slovenščina (Slovene)	ZyXEL izjavlja, da je ta oprema v skladu z bistvenimi zahtevami in ostalimi relevantnimi določili direktive 1999/5/EC.
Suomi (Finnish)	ZyXEL vakuuttaa täten että laitteet tyyppinen laite on direktiivin 1999/5/EY oleellisten vaatimusten ja sitä koskevien direktiivin muiden ehtojen mukainen.
Svenska (Swedish)	Härmed intygar ZyXEL att denna utrustning står i överensstämmelse med de väsentliga egenskapskrav och övriga relevanta bestämmelser som framgår av direktiv 1999/5/EC.
Norsk (Norwegian)	Erklærer herved ZyXEL at dette utstyret er i samsvar med de grunnleggende kravene og andre relevante bestemmelser i direktiv 1999/5/EF.

### National Restrictions

This product may be used in all EU countries (and other countries following the EU Directive 1999/5/EC) without any limitation except for the countries mentioned below:

Ce produit peut être utilisé dans tous les pays de l'UE (et dans tous les pays ayant transposés la directive 1999/5/CE) sans aucune limitation, excepté pour les pays mentionnés ci-dessous:

Questo prodotto è utilizzabile in tutte i paesi EU (ed in tutti gli altri paesi che seguono le direttiva 1999/5/EC) senza nessuna limitazione, eccetto per i paesi menzionati di seguito:

Das Produkt kann in allen EU Staaten ohne Einschränkungen eingesetzt werden (sowie in anderen Staaten die der Richtlinie 1999/5/CE folgen) mit Ausnahme der folgenden aufgeführten Staaten:

In the majority of the EU and other European countries, the 2.4GHz and 5GHz bands have been made available for the use of wireless local area networks (LANs). Later in this document you will find an overview of countries in which additional restrictions or requirements or both are applicable.

The requirements for any country may evolve. ZyXEL recommends that you check with the local authorities for the latest status of their national regulations for both the 2.4GHz and 5GHz wireless LANs.

The following countries have restrictions and/or requirements in addition to those given in the table labeled "Overview of Regulatory Requirements for Wireless LANs":

#### Belgium

The Belgian Institute for Postal Services and Telecommunications (BIPT) must be notified of any outdoor wireless link having a range exceeding 300 meters. Please check <http://www.bipt.be> for more details.

Draadloze verbindingen voor buitengebruik en met een reikwijdte van meer dan 300 meter dienen aangemeld te worden bij het Belgisch Instituut voor postdiensten en telecommunicatie (BIPT). Zie <http://www.bipt.be> voor meer gegevens.

Les liaisons sans fil pour une utilisation en extérieur d'une distance supérieure à 300 mètres doivent être notifiées à l'Institut Belge des services Postaux et des Télécommunications (IBPT). Visitez <http://www.ibpt.be> pour de plus amples détails.

#### Denmark

In Denmark, the band 5150 - 5350 MHz is also allowed for outdoor usage.

I Danmark må frekvensbåndet 5150 - 5350 også anvendes udendørs.

**Italy**

This product meets the National Radio Interface and the requirements specified in the National Frequency Allocation Table for Italy. Unless this wireless LAN product is operating within the boundaries of the owner's property, its use requires a "general authorization." Please check <http://www.sviluppoeconomico.gov.it/> for more details.

Questo prodotto è conforme alla specifiche di Interfaccia Radio Nazionali e rispetta il Piano Nazionale di ripartizione delle frequenze in Italia. Se non viene installato all'interno del proprio fondo, l'utilizzo di prodotti Wireless LAN richiede una "Autorizzazione Generale". Consultare <http://www.sviluppoeconomico.gov.it/> per maggiori dettagli.

**Latvia**

The outdoor usage of the 2.4 GHz band requires an authorization from the Electronic Communications Office. Please check <http://www.esd.lv> for more details.

2.4 GHz frekvenču joslas izmantošanai ārpus telpām nepieciešama atļauja no Elektronisko sakaru direkcijas. Vairāk informācijas: <http://www.esd.lv>.

**Notes:**

1. Although Norway, Switzerland and Liechtenstein are not EU member states, the EU Directive 1999/5/EC has also been implemented in those countries.
2. The regulatory limits for maximum output power are specified in EIRP. The EIRP level (in dBm) of a device can be calculated by adding the gain of the antenna used (specified in dBi) to the output power available at the connector (specified in dBm).

**List of national codes**

COUNTRY	ISO 3166 2 LETTER CODE	COUNTRY	ISO 3166 2 LETTER CODE
Austria	AT	Liechtenstein	LI
Belgium	BE	Lithuania	LT
Bulgaria	BG	Luxembourg	LU
Croatia	HR	Malta	MT
Cyprus	CY	Netherlands	NL
Czech Republic	CZ	Norway	NO
Denmark	DK	Poland	PL
Estonia	EE	Portugal	PT
Finland	FI	Romania	RO
France	FR	Serbia	RS
Germany	DE	Slovakia	SK
Greece	GR	Slovenia	SI
Hungary	HU	Spain	ES
Iceland	IS	Switzerland	CH
Ireland	IE	Sweden	SE
Italy	IT	Turkey	TR
Latvia	LV	United Kingdom	GB

**Safety Warnings**

- DO NOT use this product near water, for example, in a wet basement or near a swimming pool.
- DO NOT expose your device to dampness, dust or corrosive liquids.
- DO NOT store things on the device.
- DO NOT install, use, or service this device during a thunderstorm. There is a remote risk of electric shock from lightning.
- Connect ONLY suitable accessories to the device.
- DO NOT open the device or unit. Opening or removing covers can expose you to dangerous high voltage points or other risks. ONLY qualified service personnel should service or disassemble this device. Please contact your vendor for further information.
- Make sure to connect the cables to the correct ports.
- Place connecting cables carefully so that no one will step on them or stumble over them.
- Always disconnect all cables from this device before servicing or disassembling.
- Use ONLY an appropriate power adaptor or cord for your device. Connect it to the right supply voltage (for example, 110V AC in North America or 230V AC in Europe).
- DO NOT remove the plug and connect it to a power outlet by itself; always attach the plug to the power adaptor first before connecting it to a power outlet.
- DO NOT allow anything to rest on the power adaptor or cord and do NOT place the product where anyone can walk on the power adaptor or cord.



- DO NOT use the device if the power adaptor or cord is damaged as it might cause electrocution.
  - If the power adaptor or cord is damaged, remove it from the device and the power source.
  - DO NOT attempt to repair the power adaptor or cord. Contact your local vendor to order a new one.
  - DO NOT use the device outside, and make sure all the connections are indoors. There is a remote risk of electric shock from lightning.
  - CAUTION: RISK OF EXPLOSION IF BATTERY (on the motherboard) IS REPLACED BY AN INCORRECT TYPE. DISPOSE OF USED BATTERIES ACCORDING TO THE INSTRUCTIONS. Dispose them at the applicable collection point for the recycling of electrical and electronic equipment. For detailed information about recycling of this product, please contact your local city office, your household waste disposal service or the store where you purchased the product.
  - DO NOT obstruct the device ventilation slots, as insufficient airflow may harm your device.
- The following warnings apply if product is disconnect device?
- A readily accessible disconnect device shall be incorporated external to the equipment; and/or
  - The socket-outlet shall be installed near the equipment and shall be easily accessible.

## Environment Statement

### ErP (Energy-related Products)

ZyXEL products put on the EU market in compliance with the requirement of the European Parliament and the Council published Directive 2009/125/EC establishing a framework for the setting of ecodesign requirements for energy-related products (recast), so called as "ErP Directive (Energy-related Products directive) as well as ecodesign requirement laid down in applicable implementing measures, power consumption has satisfied regulation requirements which are:

Network standby power consumption < 12W, and/or

Off mode power consumption < 0.5W, and/or

Standby mode power consumption < 0.5W.

Wireless setting, please refer to "Wireless" chapter for more detail.

### WEEE Directive



Your product is marked with this symbol, which is known as the WEEE mark. WEEE stands for Waste Electronics and Electrical Equipment. It means that used electrical and electronic products should not be mixed with general waste. Used electrical and electronic equipment should be treated separately.

"INFORMAZIONI AGLI UTENTI"

Ai sensi della Direttiva 2012/19/UE del Parlamento europeo e del Consiglio, del 4 luglio 2012, sui rifiuti di apparecchiature elettriche ed elettroniche (RAEE)



























Il simbolo del cassonetto barrato riportato sull'apparecchiatura o sulla sua confezione indica che il prodotto alla fine della propria vita utile deve essere raccolto separatamente dagli altri rifiuti.

La raccolta differenziata della presente apparecchiatura giunta a fine vita è organizzata e gestita dal produttore. L'utente che vorrà disfarsi della presente apparecchiatura dovrà quindi contattare il produttore e seguire il sistema che questo ha adottato per consentire la raccolta separata dell'apparecchiatura giunta a fine vita.

L'adeguata raccolta differenziata per l'avvio successivo dell'apparecchiatura dismessa al riciclaggio, al trattamento e allo smaltimento ambientalmente compatibile contribuisce ad evitare possibili effetti negativi sull'ambiente e sulla salute e favorisce il reimpiego e/o riciclo dei materiali di cui è composta l'apparecchiatura.

Lo smaltimento abusivo del prodotto da parte del detentore comporta l'applicazione delle sanzioni amministrative previste dalla normativa vigente."

Environmental Product Declaration

Български (Bulgarian)	Čeština (Czech)	Dansk (Danish)	Deutsch (German)
<p>Екологична продуктова декларация</p> <p>RoHS Директива 2011/65/EC WEEE Директива 2012/19/EC PPW Директива 94/62/EO REACH REGULATION (EC) No 1907/2006 ErP Директива 2009/125/EO</p> <p>Име/ титла : Richard Hsu / Quality Management Division Senior Manager Подпис : Дата (dd/mm/yyyy): 01/10/2014</p>  	<p>Environmentální prohlášení o produktu</p> <p>RoHS Směrnice 2011/65/EU WEEE Směrnice 2012/19/EU PPW Směrnice 94/62/ES REACH Nařízení (EÚ) č. 1907/2006 ErP Směrnice 2009/125/ES</p> <p>Jméno/ titul : Richard Hsu / Quality Management Division Senior Manager Podpis : Datum (dd/mm/yyyy): 01/10/2014</p>  	<p>Miljøvaredeklaration</p> <p>RoHS Direktiv 2011/65/EU WEEE Direktiv 2012/19/EU PPW Direktiv 94/62/EF REACH Forordning (EF) nr. 1907/2006 ErP Direktiv 2009/125/EF</p> <p>Navn/ titel : Richard Hsu / Quality Management Division Senior Manager Underskrift : Dato (dd/mm/åååå): 01/10/2014</p>  	<p>Produkt-Umweltdeklaration</p> <p>RoHS Richtlinie 2011/65/EU WEEE Richtlinie 2012/19/EU PPW Richtlinie 94/62/EG REACH VERORDNUNG (EG) Nr. 1907/2006 ErP Richtlinie 2009/125/EG</p> <p>Name/ Titel : Richard Hsu / Quality Management Division Senior Manager Unterschrift : Datum (dd/mm/jj): 2014/10/01</p>  
Esti keel (Estonian)	English	Español (Spanish)	Français (French)
<p>Toote keskkonnadeklaratsioon</p> <p>RoHS Direktiv 2011/65/EL WEEE Direktiv 2012/19/EL PPW Direktiv 94/62/EO REACH MÄÄRÜS (EÜ) nr 1907/2006 ErP Direktiv 2009/125/EO</p> <p>Nimi/ pealkiri : Richard Hsu / Quality Management Division Senior Manager Allkiri : Keskajal (pp/kk/aaaa): 01/10/2014</p>  	<p>Environmental product declaration</p> <p>RoHS Directive 2011/65/EU WEEE Directive 2012/19/EU PPW Directive 94/62/EC REACH Regulation (EC) No 1907/2006 ErP Directive 2009/125/EC</p> <p>Name/ title : Richard Hsu / Quality Management Division Senior Manager Signature : Date (dd/mm/yyyy) : 01/10/2014</p>  	<p>Declaraciones Ambientales de Producto</p> <p>RoHS Directiva 2011/65/UE WEEE Directiva 2012/19/UE PPW Directiva 94/62/CE REACH REGLAMENTO (CE) n.º 1907/2006 ErP Directiva 2009/125/CE</p> <p>Nombre/ título : Richard Hsu / Quality Management Division Senior Manager Firma : Fecha (aaaa/mm/dd): 2014/10/01</p>  	<p>Profil environnemental de produit</p> <p>RoHS Directive 2011/65/UE WEEE Directive 2012/19/UE PPW Directive 94/62/CE REACH RÈGLEMENT (CE) N° 1907/2006 ErP Directive 2009/125/CE</p> <p>Nom/ titre : Richard Hsu / Quality Management Division Senior Manager Signature : Date (aaaa/mm/jj): 2014/10/01</p>  
Hrvatski (Croatian)	Italiano (Italian)	Latviešu valoda (Latvian)	Lietuvių kalba (Lithuanian)
<p>Deklaraciju o zbirjanju proizvoda</p> <p>RoHS Direktiva 2011/65/EU WEEE Direktiva 2012/19/EU PPW Direktiva 94/62/EK REACH Uredbe (EZ) br. 1907/2006 ErP Direktiva 2009/125/EZ</p> <p>Ime/ naslov : Richard Hsu / Quality Management Division Senior Manager Podpis : Datum (dd/mm/yyyy): 01/10/2014</p>  	<p>Dichiarazione ambientale di prodotto</p> <p>RoHS Direttiva 2011/65/UE WEEE Direttiva 2012/19/UE PPW Direttiva 94/62/CE REACH REGOLAMENTO (CE) n. 1907/2006 ErP Direttiva 2009/125/CE</p> <p>Nome/ titolo : Richard Hsu / Quality Management Division Senior Manager Firma : Data (aaaa/mm/jj): 2014/10/01</p>  	<p>Produkta vides ietekmējuma deklarācija</p> <p>RoHS Direktīva 2011/65/ES WEEE Direktīva 2012/19/ES PPW Direktīva 94/62/EK REACH Regula (EK) Nr. 1907/2006 ErP Direktīva 2009/125/ES</p> <p>Nosaukums/ tituls : Richard Hsu / Quality Management Division Senior Manager Paraksts : Datums (dd/mm/yyyy): 01/10/2014</p>  	<p>Aplinkosauginę gaminių deklaraciją</p> <p>RoHS Direktyva 2011/65/ES WEEE Direktyva 2012/19/ES PPW Direktyva 94/62/EB REACH REGLAMENTAS (EB) Nr. 1907/2006 ErP Direktyva 2009/125/ES</p> <p>Vardas/ statusas : Richard Hsu / Quality Management Division Senior Manager Parašas : Data (mm/mm/yyyy): 01/10/2014</p>  
Magyar (Hungarian)	Malti (Maltese)	Nederlands (Dutch)	Polski (Polish)
<p>Környezetvédelmi terméknyilatkozatot</p> <p>RoHS 2011/65/EU irányelve WEEE 2012/19/EU irányelve PPW 94/62/EK irányelve REACH 1907/2006/EK Rendelet ErP 2009/125/EK irányelve</p> <p>Név/ cím : Richard Hsu / Quality Management Division Senior Manager Aláírás : Dátum (dd/mm/yyyy): 2014/10/01</p>  	<p>Dikjarazzjoni Ambjentali dwar il-Prodott</p> <p>RoHS Direttiva 2011/65/UE WEEE Direttiva 2012/19/UE PPW Direttiva 94/62/CE REACH REGOLAMENTO (KE) NRU 1907/2006 ErP Direttiva 2009/125/KE</p> <p>Isem/ titolu : Richard Hsu / Quality Management Division Senior Manager Firma : Data (aaaa/xx/jj): 2014/10/01</p>  	<p>Milieuproduktverklaring</p> <p>RoHS Richtlijn 2011/65/UE WEEE Richtlijn 2012/19/UE PPW Richtlijn 94/62/EG REACH Verordening (EG) nr. 1907/2006 ErP Richtlijn 2009/125/EG</p> <p>Naam/ titel : Richard Hsu / Quality Management Division Senior Manager Handtekening : Datum (dd/mm/jaar): 01/10/2014</p>  	<p>Deklaracja środowiskową produktu</p> <p>RoHS Dyrektywa 2011/65/UE WEEE Dyrektywa 2012/19/UE PPW Dyrektywa 94/62/WE REACH Rozporządzenie (WE) nr 1907/2006 ErP Dyrektywa 2009/125/WE</p> <p>Nazwisko/ tytuł : Richard Hsu / Quality Management Division Senior Manager Podpis : Data (dd/mm/rrrr): 2014/10/01</p>  
Português (Portuguese)	Română (Romanian)	Slovenčina (Slovak)	Slovenščina (Slovene)
<p>Declaração ambiental do produto</p> <p>RoHS Directiva 2011/65/UE WEEE Directiva 2012/19/UE PPW Directiva 94/62/CE REACH Regulamento (CE) n.º 1907/2006 ErP Directiva 2009/125/CE</p> <p>Nome/ título : Richard Hsu / Quality Management Division Senior Manager Assinatura : Data (dd/mm/aaaa): 01/10/2014</p>  	<p>Declarație de mediu privind produsele</p> <p>RoHS Directiva 2011/65/UE WEEE Directiva 2012/19/UE PPW Directiva 94/62/CE REACH REGULAMENTUL (CE) NR. 1907/2006 ErP Directiva 2009/125/CE</p> <p>Numele/ titlu : Richard Hsu / Quality Management Division Senior Manager Semnătura : Data (zz/ll/aaaa): 01/10/2014</p>  	<p>Vyhľadzenie o environmentálnom výrobku</p> <p>RoHS Smernica 2011/65/EU WEEE Smernica 2012/19/EU PPW Smernica 94/62/ES REACH Naariadenie (ES) č. 1907/2006 ErP Smernica 2009/125/ES</p> <p>Meno/ titul : Richard Hsu / Quality Management Division Senior Manager Podpis : Datum (dd/mm/yyyy): 01/10/2014</p>  	<p>Okojsko deklaracija izdelka</p> <p>RoHS Direktiva 2011/65/EU WEEE Direktiva 2012/19/EU PPW Direktiva 94/62/ES REACH Uredba (ES) št. 1907/2006 ErP Direktiva 2009/125/ES</p> <p>Ime/ naziv : Richard Hsu / Quality Management Division Senior Manager Podpis : Datum (dd/mm/ll): 01/10/2014</p>  
Suomi (Finnish)	Svenska (Swedish)	Ελληνικά (Greek)	Norsk (Norwegian)
<p>Standardin perustava ympäristötoueseloite</p> <p>RoHS Direktiv 2011/65/EU WEEE Direktiv 2012/19/EU PPW Direktiv 94/62/EY REACH ASETUS (EY) N:o 1907/2006 ErP Direktiv 2009/125/EY</p> <p>Nimi/ otsikko : Richard Hsu / Quality Management Division Senior Manager Alaikirjoitus : Päivämäärä (pp/kk/vvvv): 01/10/2014</p>  	<p>Miljöproduktdeklaration</p> <p>RoHS Direktiv 2011/65/EU WEEE Direktiv 2012/19/EU PPW Direktiv 94/62/EG REACH Förordning (EG) nr 1907/2006 ErP Direktiv 2009/125/EG</p> <p>Namn/ titel : Richard Hsu / Quality Management Division Senior Manager Namnteckning : Datum (dd/mm/åååå): 01/10/2014</p>  	<p>Περιβαλλοντική δήλωση προϊόντος</p> <p>RoHS Οδηγία 2011/65/ΕΕ WEEE Οδηγία 2012/19/ΕΕ PPW Οδηγία 94/62/ΕΚ REACH ή κανονισμός (ΕΚ) αριθ. 1907/2006 ErP Οδηγία 2009/125/ΕΚ</p> <p>Όνομα/ τίτλος : Richard Hsu / Quality Management Division Senior Manager Υπογραφή : Ημερομηνία (ηη/μμ/εεεε): 01/10/2014</p>  	<p>Miljødeklarasjon</p> <p>RoHS Direktiv 2011/65/EE WEEE Direktiv 2012/19/EE PPW Direktiv 94/62/EF REACH Forordning (EF) nr. 1907/2006 ErP Direktiv 2009/125/EF</p> <p>Navn/ tittel : Richard Hsu / Quality Management Division Senior Manager Signatur : Dato (dd/mm/åååå): 01/10/2014</p>  



台灣



以下訊息僅適用於產品銷售至台灣地區

第十二條 經型式認證合格之低功率射頻電機，非經許可，公司、商號或使用者均不得擅自變更頻率、加大功率或變更原設計之特性及功能。

第十四條 低功率射頻電機之使用不得影響飛航安全及干擾合法通信；經發現有干擾現象時，應立即停用，並改善至無干擾時方得繼續使用。

前項合法通信，指依電信法規定作業之無線電通信。低功率射頻電機須忍受合法通信或工業、科學及醫療用電波輻射性電機設備之干擾。

## Viewing Certifications

Go to <http://www.zyxel.com> to view this product's documentation and certifications.

## ZyXEL Limited Warranty

ZyXEL warrants to the original end user (purchaser) that this product is free from any defects in material or workmanship for a specific period (the Warranty Period) from the date of purchase. The Warranty Period varies by region. Check with your vendor and/or the authorized ZyXEL local distributor for details about the Warranty Period of this product. During the warranty period, and upon proof of purchase, should the product have indications of failure due to faulty workmanship and/or materials, ZyXEL will, at its discretion, repair or replace the defective products or components without charge for either parts or labor, and to whatever extent it shall deem necessary to restore the product or components to proper operating condition. Any replacement will consist of a new or re-manufactured functionally equivalent product of equal or higher value, and will be solely at the discretion of ZyXEL. This warranty shall not apply if the product has been modified, misused, tampered with, damaged by an act of God, or subjected to abnormal working conditions.

### Note

Repair or replacement, as provided under this warranty, is the exclusive remedy of the purchaser. This warranty is in lieu of all other warranties, express or implied, including any implied warranty of merchantability or fitness for a particular use or purpose. ZyXEL shall in no event be held liable for indirect or consequential damages of any kind to the purchaser.

To obtain the services of this warranty, contact your vendor. You may also refer to the warranty policy for the region in which you bought the device at [http://www.zyxel.com/web/support\\_warranty\\_info.php](http://www.zyxel.com/web/support_warranty_info.php).

## Registration

Register your product online to receive e-mail notices of firmware upgrades and information at [www.zyxel.com](http://www.zyxel.com) for global products, or at [www.us.zyxel.com](http://www.us.zyxel.com) for North American products.

## Open Source Licenses

This product contains in part some free software distributed under GPL license terms and/or GPL like licenses. Open source licenses are provided with the firmware package. You can download the latest firmware at [www.zyxel.com](http://www.zyxel.com). To obtain the source code covered under those Licenses, please contact [support@zyxel.com.tw](mailto:support@zyxel.com.tw) to get it.

# Index

## B

Backup configuration [53](#)

## C

certifications [63](#)

    viewing [68](#)

Channel [22](#)

Configuration

    backup [53](#)

    reset the factory defaults [54](#)

    restore [53](#)

copyright [61](#)

CPU usage [22](#)

## D

disclaimer [61](#)

documentation

    related [2](#)

duplex setting [23](#)

## E

encryption [39](#)

    key [40](#)

## F

FCC interference statement [63](#)

Firmware upload [50](#)

    file extension

    using HTTP

firmware version [22](#)

## G

General wireless LAN screen [40](#)

Guide

    Quick Start [2](#)

## I

IP Address [48](#)

## L

LAN setup [47](#)

Link type [22](#)

## M

MAC [41](#)

MAC address [39](#)

MAC address filtering [41](#)

MAC Address List [39, 41](#)

managing the device

    good habits [10](#)

Media access control [41](#)

Memory usage [22](#)

## N

Navigation Panel [24](#)

## O

other documentation [2](#)

overview [9](#)

## P

port speed [23](#)

## Q

Quality of Service (QoS) [43](#)

Quick Start Guide [2](#)

## R

related documentation [2](#)

Reset the device [14](#)

Restore configuration [53](#)

RTS/CTS Threshold [42](#)

## S

Service Set [40](#)

Service Set IDentification [16](#), [40](#), [46](#)

Service Set IDentity. See SSID.

SSID [16](#), [22](#), [38](#), [40](#), [46](#)

Subnet Mask [48](#)

Summary

    Packet statistics [23](#)

    Wireless station status [24](#)

System General Setup [49](#)

System restart [54](#)

## W

warranty [68](#)

    note [68](#)

Web Configurator

    how to access [13](#)

    Overview [13](#)

Wireless association list [24](#)

wireless channel [60](#)

wireless LAN [60](#)

Wireless LAN wizard [15](#)

Wireless network [39](#)

    basic guidelines [38](#)

    encryption [39](#)

    security [38](#)

    SSID [38](#)

Wireless security [38](#)

    overview [39](#)

    troubleshooting [60](#)

    type [39](#)

Wireless tutorial [26](#)

    WPS [26](#)

Wizard setup [15](#)

    complete [20](#)

    wireless LAN [15](#)

WPS button [11](#), [14](#)