

ADOBE® AFTER EFFECTS® CS3 PROFESSIONAL USER GUIDE

AE

© 2007 Adobe Systems Incorporated. All rights reserved.

Adobe® After Effects® CS3 User Guide for Windows® and Mac OS

If this guide is distributed with software that includes an end user agreement, this guide, as well as the software described in it, is furnished under license and may be used or copied only in accordance with the terms of such license. Except as permitted by any such license, no part of this guide may be reproduced, stored in a retrieval system, or transmitted, in any form or by any means, electronic, mechanical, recording, or otherwise, without the prior written permission of Adobe Systems Incorporated. Please note that the content in this guide is protected under copyright law even if it is not distributed with software that includes an end user license agreement.

The content of this guide is furnished for informational use only, is subject to change without notice, and should not be construed as a commitment by Adobe Systems Incorporated. Adobe Systems Incorporated assumes no responsibility or liability for any errors or inaccuracies that may appear in the informational content contained in this guide.

Please remember that existing artwork or images that you may want to include in your project may be protected under copyright law. The unauthorized incorporation of such material into your new work could be a violation of the rights of the copyright owner. Please be sure to obtain any permission required from the copyright owner.

Any references to company names in sample templates are for demonstration purposes only and are not intended to refer to any actual organization.

Adobe, the Adobe logo, Adobe Audition, Adobe Premiere, After Effects, Creative Suite, Encore, Fireworks, Flash, Photoshop, and Soundbooth are either registered trademarks or trademarks of Adobe Systems Incorporated in the United States and/or other countries.

Apple, Mac, and Mac OS are trademarks of Apple Inc., registered in the United States and other countries. Microsoft, OpenType, and Windows are either registered trademarks or trademarks of Microsoft Corporation in the United States and/or other countries. Dolby is a trademark of Dolby Laboratories. Intel is a registered trademark of Intel Corporation in the U.S. and other countries. SGI is a trademark of Silicon Graphics, Inc. UNIX is a registered trademark of The Open Group in the United States and other countries. All other trademarks are the property of their respective owners.

This product includes software developed by the Apache Software Foundation (<http://www.apache.org/>).

Portions of the TIFF I/O plug-in were written with MacApp®: ©1985-1988 Apple Inc. APPLE INC. MAKES NO WARRANTIES WHATSOEVER, EITHER EXPRESS OR IMPLIED, REGARDING THIS PRODUCT, INCLUDING WARRANTIES WITH RESPECT TO ITS MERCHANTABILITY OR ITS FITNESS FOR ANY PARTICULAR PURPOSE. The MacApp software is proprietary to Apple Inc. and is licensed to Adobe for distribution only for use in combination with Adobe After Effects.

MPEG Layer-3 audio compression technology licensed by Fraunhofer IIS and Thomson Multimedia (<http://www.mp3licensing.com>).

Speech compression and decompression technology licensed from Nellymoser, Inc. (www.nellymoser.com)

Flash CS3 video is powered by On2 TrueMotion video technology. © 1992-2005 On2 Technologies, Inc. All Rights Reserved. <http://www.on2.com>

This product includes software developed by the OpenSymphony Group (<http://www.opensymphony.com/>).

This product contains either BISAFE and/or TIPEM software by RSA Data Security, Inc.

Sorenson Spark™ video compression and decompression technology licensed from Sorenson Media, Inc.

Notice to U.S. Government end users: The Software and Documentation are “Commercial Items,” as that term is defined at 48 C.F.R. §2.101, consisting of “Commercial Computer Software” and “Commercial Computer Software Documentation,” as such terms are used in 48 C.F.R. §12.212 or 48 C.F.R. §227.7202, as applicable. Consistent with 48 C.F.R. §12.212 or 48 C.F.R. §§227.7202-1 through 227.7202-4, as applicable, the Commercial Computer Software and Commercial Computer Software Documentation are being licensed to U.S. Government end users (a) only as Commercial Items and (b) with only those rights as are granted to all other end users pursuant to the terms and conditions herein. Unpublished-rights reserved under the copyright laws of the United States. Adobe agrees to comply with all applicable equal opportunity laws including, if appropriate, the provisions of Executive Order 11246, as amended, Section 402 of the Vietnam Era Veterans Readjustment Assistance Act of 1974 (38 USC 4212), and Section 503 of the Rehabilitation Act of 1973, as amended, and the regulations at 41 CFR Parts 60-1 through 60-60, 60-250, and 60-741. The affirmative action clause and regulations contained in the preceding sentence shall be incorporated by reference.

Adobe Systems Incorporated, 345 Park Avenue, San Jose, California 95110, USA.

Contents

Chapter 1: Getting started

- Installation 1
- Adobe Help 2
- Resources 5
- What's new 11

Chapter 2: User interface

- Customizing the user interface 13
- Using the After Effects interface 18

Chapter 3: Planning and managing projects

- Project basics 23
- Project planning and setup 26
- Memory, storage, and performance 37
- Plug-ins and scripts 44

Chapter 4: Importing

- Importing and interpreting footage items 47
- Working with footage items 58
- Importing from After Effects and Adobe Premiere Pro 63
- Importing video and audio 67
- Importing 3D image files 77
- Importing still images 80
- Introduction to Camera Raw 86
- Navigating, opening, and saving images with Camera Raw 92
- Adjusting color in Camera Raw 94
- Modifying images with Camera Raw 101
- Camera Raw settings 104

Chapter 5: Compositions

- Composition basics 107
- Nesting, precomposing, and pre-rendering 113
- Markers 116

Chapter 6: Views and previews

- Previewing 120
- Modifying and using views 126

Chapter 7: Layers and properties

- Creating layers 133
- Selecting and arranging layers 137
- Managing layers 147
- Modify layer properties 152

Blending modes	163
Layer styles	168
Working with 3D layers	171
Cameras, lights, and points of interest	176
Chapter 8: Animation	
Animation basics	183
Setting, selecting, and deleting keyframes	187
Editing, moving, and copying keyframes	190
Creating and modifying motion paths	197
Assorted animation tools	200
Interpolation	204
Speed	210
Time-stretching and time-remapping	218
Animating with Puppet tools	226
Chapter 9: Color	
Color basics	234
Color management	241
Chapter 10: Masks, transparency, and keying	
Transparency overview	252
Creating and importing masks	254
Working with masks and mattes	257
Animating masks	264
Keying	268
Chapter 11: Text	
Creating and editing text layers	273
Formatting characters	278
Formatting paragraphs	283
Animating text	285
Examples of text animation	295
Chapter 12: Drawing and painting	
Using paint tools	302
Shape layers overview	312
Creating shapes and masks	318
Managing and editing shapes	325
Chapter 13: Motion tracking	
Motion tracking overview	335
Tracking motion	342
Chapter 14: Effects and animation presets	
Effects and animation presets overview	347
Working with effects and animation presets	350

Chapter 15: Effect reference	
Galleries of effects	355
3D Channel effects	367
Audio effects	371
Blur & Sharpen effects	375
Channel effects	381
Color Correction effects	387
Distort effects	404
Generate effects	419
Keying effects	440
Matte effects	450
Noise & Grain effects	452
Paint effects	471
Perspective effects	481
Simulation effects	486
Stylize effects	517
Text effects	524
Time effects	531
Transition effects	536
Utility effects	542
Chapter 16: Expressions	
Working with expressions	547
The expression language	556
After Effects expression elements reference	559
Expression examples	582
Chapter 17: Rendering and exporting	
Basics of rendering and exporting	587
Rendering and exporting to Flash formats	602
Rendering and exporting still images and still-image sequences	606
Exporting project information to other Adobe applications	608
Encoding and compression options for movies	612
Automated rendering and network rendering	622
Converting movies	630
Reviewing movies with Clip Notes comments	634
Chapter 18: Keyboard shortcuts	
Using and modifying keyboard shortcuts	638
Index	657

Chapter 1: Getting started

Installation

Requirements

❖ To review complete system requirements and recommendations for your Adobe® software, see the Read Me file on the installation disc.

Install the software

- 1 Close any other Adobe applications open on your computer.
- 2 Insert the installation disc into your DVD drive, and follow the on-screen instructions.

For each licensed copy of Adobe® After Effects® software, you can activate and use one copy of the full version of the application on one computer. You can also install additional copies on additional computers to use as After Effects *render engines*, which assist with network rendering. You install render engines in the same manner as the full version of the application, but you do not activate them. You run the render engine using the Adobe After Effects Render Engine shortcut in the Adobe After Effects CS3 folder.

Note: For more information, see the Read Me file on the installation DVD or visit the Adobe After Effects support website at www.adobe.com/go/learn_ae_support.

See also

“Network rendering with watch folders” on page 625

Activate the software

If you have a single-user retail license for your Adobe software, you will be asked to activate your software; this is a simple, anonymous process that you must complete within 30 days of starting the software.

For more information on product activation, see the Read Me file on your installation disc, or visit the Adobe website at www.adobe.com/go/activation.

- 1 If the Activation dialog box isn't already open, choose Help > Activate.
- 2 Follow the on-screen instructions.

Note: If you want to install the software on a different computer, you must first deactivate it on your computer. Choose Help > Deactivate.

Register

Register your product to receive complimentary installation support, notifications of updates, and other services.

❖ To register, follow the on-screen instructions in the Registration dialog box, which appears after you install and activate the software.



If you postpone registration, you can register at any time by choosing Help > Registration.

Read Me

The installation disc contains the Read Me file for your software. (This file is also copied to the application folder during product installation.) Open the file to read important information about topics such as the following:

- System requirements
- Installation (including uninstalling the software)
- Activation and registration
- Font installation
- Troubleshooting
- Customer support
- Legal notices

Adobe Help

Adobe Help resources

Documentation for your Adobe software is available in a variety of formats.

In-product and LiveDocs Help

In-product Help provides access to all documentation and instructional content available at the time the software ships. It is available through the Help menu in your Adobe software.

LiveDocs Help includes all the content from in-product Help, plus updates and links to additional instructional content available on the web. For some products, you can also add comments to the topics in LiveDocs Help. Find LiveDocs Help for your product in the Adobe Help Resource Center, at www.adobe.com/go/documentation.

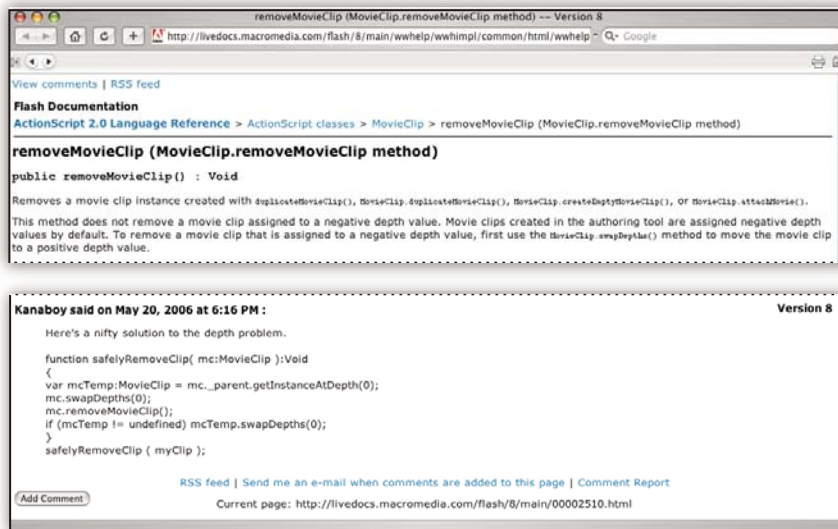

Most versions of in-product and LiveDocs Help let you search across the Help systems of multiple products. Topics may also contain links to relevant content on the web or to topics in the Help of another product.

Think of Help, both in the product and on the web, as a hub for accessing additional content and communities of users. The most complete and up-to-date version of Help is always on the web.

Adobe PDF documentation

The in-product Help is also available as a PDF that is optimized for printing. Other documents, such as installation guides and white papers, may also be provided as PDFs.

All PDF documentation is available through the Adobe Help Resource Center, at www.adobe.com/go/documentation. To see the PDF documentation included with your software, look in the Documents folder on the installation or content DVD.

Printed documentation

Printed editions of the in-product Help are available for purchase in the Adobe Store, at www.adobe.com/go/store. You can also find books published by Adobe publishing partners in the Adobe Store.

A printed workflow guide is included with all Adobe Creative Suite® 3 products, and stand-alone Adobe products may include a printed getting started guide.

Using Help in the product

In-product Help is available through the Help menu. After you start the Adobe Help Viewer, click Browse to see Help for additional Adobe products installed on your computer.

These Help features facilitate cross-product learning:

- Topics may contain links to the Help systems of other Adobe products or to additional content on the web.
- Some topics are shared across two or more products. For instance, if you see a Help topic with an Adobe Photoshop® CS3 icon and an Adobe After Effects® CS3 icon, you know that the topic either describes functionality that is similar in the two products or describes cross-product workflows.
- You can search across the Help systems of multiple products.



If you search for a phrase, such as “shape tool,” enclose it in quotation marks to see only those topics that include all the words in the phrase.

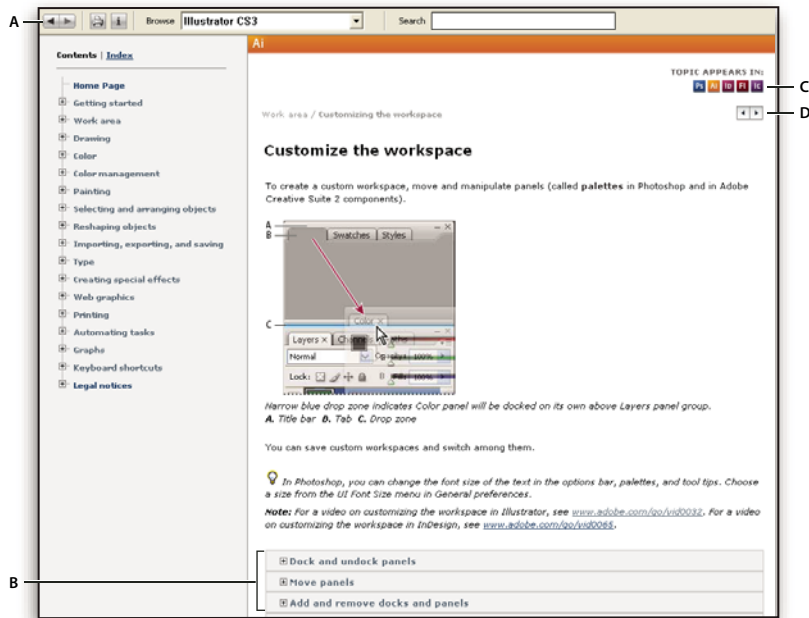

Adobe Help

A. Back/Forward buttons (previously visited links) **B.** Expandable subtopics **C.** Icons indicating shared topic **D.** Previous/Next buttons (topics in sequential order)

Accessibility features

Adobe Help content is accessible to people with disabilities—such as mobility impairments, blindness, and low vision. In-product Help supports these standard accessibility features:

- The user can change text size with standard context menu commands.
- Links are underlined for easy recognition.
- If link text doesn't match the title of the destination, the title is referenced in the Title attribute of the Anchor tag. For example, the Previous and Next links include the titles of the previous and next topics.
- Content supports high-contrast mode.
- Graphics without captions include alternate text.
- Each frame has a title to indicate its purpose.
- Standard HTML tags define content structure for screen reading or text-to-speech tools.
- Style sheets control formatting, so there are no embedded fonts.

Keyboard shortcuts for Help toolbar controls (Windows)

Back button Alt+Left Arrow

Forward button Alt+Right Arrow

Print Ctrl+P

About button Ctrl+I

Browse menu Alt+Down Arrow or Alt+Up Arrow to view Help for another application

Search box Ctrl+S to place the insertion point in the Search box

Keyboard shortcuts for Help navigation (Windows)

- To move between panes, press Ctrl+Tab (forward) and Shift+Ctrl+Tab (backward).
- To move through and outline links in a pane, press Tab (forward) or Shift+Tab (backward).
- To activate an outlined link, press Enter.
- To make text bigger, press Ctrl+equal sign.
- To make text smaller, press Ctrl+hyphen.

Resources

Adobe Video Workshop

The Adobe Creative Suite 3 Video Workshop offers over 200 training videos covering a wide range of subjects for print, web, and video professionals.

You can use the Adobe Video Workshop to learn about any Creative Suite 3 product. Many videos show you how to use Adobe applications together.

ADOBE CREATIVE SUITE 3 VIDEO WORKSHOP

Select a Product

- Fireworks CS3
- Flash CS3 Professional
- Illustrator CS3
- InDesign CS3
- Photoshop CS3
- Photoshop CS3 Extended
- Stock Photos

Select a Topic

- All (32 topics)
- Getting started
- New features
- ActionScript
- Animation
- Application design
- Automation and productivity
- CS3

Title	Time	Products
Importing, copying, and pasting between web applications	05:06	FW, FI, PS
Using 9-slice scaling	04:15	FW, FI, PS
Understanding 9-slice scaling	03:30	FW, FI, PS
Designing websites with Photoshop and Flash	06:01	FI, FW
Creating interactive PDF files	03:43	FI, AI, ID, PS
Using Bridge in a web design workflow	03:45	BR, CC, FW, PS, FI
Using shared elements of the Photoshop, Illustrator, InDesign, and Flash workspace	05:41	FI, AI, ID, PS
Using Bridge for a design workflow	08:24	BR, FI, AI, ID, PS
Using the Device Central workspace	08:36	ID, FW, FI, AI, PS
Importing images into Bridge	03:43	BR, CC, FW, PS, FI, AI, ID, PS

Details

Using shared elements of the Photoshop, Illustrator, InDesign, and Flash workspace
by Michael Ninness
This video shows you how to use interface elements that are shared between Photoshop, Illustrator, InDesign, and Flash. For example, you learn how to use panels and how to customize the workspace.

Level: Beginner Products: Flash CS3 Professional, Illustrator CS3, InDesign CS3, Photo...
Topics: Workspace | Getting started | New features

PLAY VIDEO (05:41)

- Bookmark video online
- Read the tutorial (HTML)
- Give feedback

lynda.com

When you start the Adobe Video Workshop, you choose the products you want to learn and the subjects you want to view. You can see details about each video to focus and direct your learning.

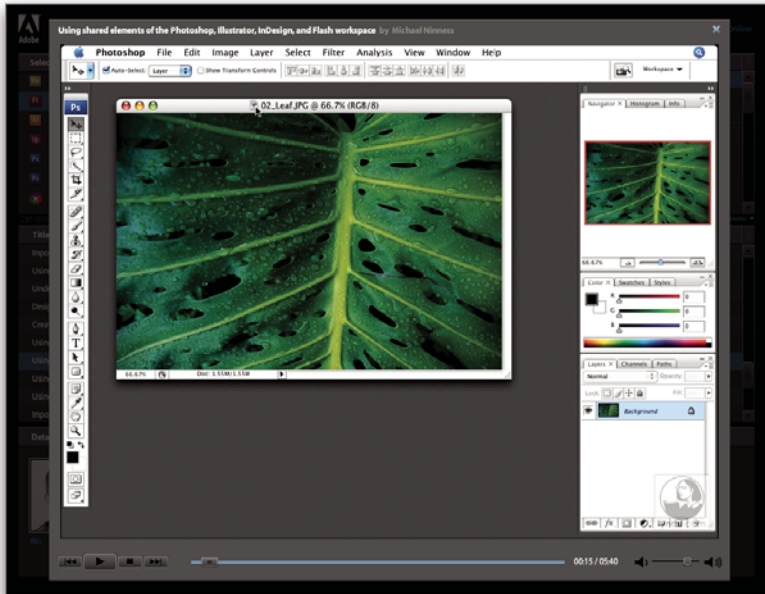

Community of presenters

With this release, Adobe Systems invited the community of its users to share their expertise and insights. Adobe and lynda.com present tutorials, tips, and tricks from leading designers and developers such as Joseph Lowery, Katrin Eismann, and Chris Georgenes. You can see and hear Adobe experts such as Lynn Grillo, Greg Rewis, and Russell Brown. In all, over 30 product experts share their knowledge.

Tutorials and source files

The Adobe Video Workshop includes training for novices and experienced users. You'll also find videos on new features and key techniques. Each video covers a single subject and typically runs about 3-5 minutes. Most videos come with an illustrated tutorial and source files, so you can print detailed steps and try the tutorial on your own.

Using Adobe Video Workshop

You can access Adobe Video Workshop using the DVD included with your Creative Suite 3 product. It's also available online at www.adobe.com/go/learn_videotutorials. Adobe will regularly add new videos to the online Video Workshop, so check in to see what's new.

After Effects CS3 videos

Adobe Video Workshop covers a wide range of subjects for Adobe After Effects® CS3, including these:

- Animating shape layers
- Applying effects
- Working with keyframes and the timeline
- Rendering and exporting

Videos also show you how to use After Effects CS3 with other Adobe products:

- Importing Photoshop files
- Using Dynamic Link
- Sending work for review using Clip Notes

To access Adobe Creative Suite 3 video tutorials, visit Adobe Video Workshop at www.adobe.com/go/learn_videotutorials.

Extras

You have access to a wide variety of resources that will help you make the most of your Adobe software. Some of these resources are installed on your computer during the setup process; additional helpful samples and documents are included on the installation or content disc. Unique extras are also offered online by the Adobe Exchange community, at www.adobe.com/go/exchange.

Installed resources

During software installation, a number of resources are placed in your application folder. To view those files, navigate to the application folder on your computer.

- Windows®: *[startup drive]\Program Files\Adobe\Adobe application*
- Mac OS®: *[startup drive]/Applications/[Adobe application]*

The application folder may contain the following resources:

Plug-ins Plug-in modules are small software programs that extend or add features to your software. Once installed, plug-in modules appear as options in the Import or Export menu; as file formats in the Open, Save As, and Export Original dialog boxes; or as filters in the Filter submenus. For example, a number of special effects plug-ins are automatically installed in the Plug-ins folder inside the Photoshop CS3 folder.

Presets Presets include a wide variety of useful tools, preferences, effects, and images. Product presets include brushes, swatches, color groups, symbols, custom shapes, graphic and layer styles, patterns, textures, actions, workspaces, and more. Preset content can be found throughout the user interface. Some presets (for example, Photoshop Brush libraries) become available only when you select the corresponding tool. If you don't want to create an effect or image from scratch, go to the preset libraries for inspiration.

Templates Template files can be opened and viewed from Adobe Bridge CS3, opened from the Welcome Screen, or opened directly from the File menu. Depending on the product, template files range from letterheads, newsletters,

and websites to DVD menus and video buttons. Each template file is professionally constructed and represents a best-use example of product features. Templates can be a valuable resource when you need to jump-start a project.



Samples Sample files include more complicated designs and are a great way to see new features in action. These files demonstrate the range of creative possibilities available to you.

Fonts Several OpenType® fonts and font families are included with your Creative Suite product. Fonts are copied to your computer during installation:

- Windows: *[startup drive]\Windows\Fonts*
- Mac OS X: *[startup drive]/Library/Fonts*

For information about installing fonts, see the Read Me file on the installation DVD.

DVD content

The installation or content DVD included with your product contains additional resources for use with your software. The Goodies folder contains product-specific files such as templates, images, presets, actions, plug-ins, and effects, along with subfolders for Fonts and Stock Photography. The Documentation folder contains a PDF version of the Help, technical information, and other documents such as specimen sheets, reference guides, and specialized feature information.

Adobe Exchange

For more free content, visit www.adobe.com/go/exchange, an online community where users download and share thousands of free actions, extensions, plug-ins, and other content for use with Adobe products.

Bridge Home

Bridge Home, a new destination in Adobe Bridge CS3, provides up-to-date information on all your Adobe Creative Suite 3 software in one convenient location. Start Adobe Bridge, then click the Bridge Home icon at the top of the Favorites panel to access the latest tips, news, and resources for your Creative Suite tools.

Note: Bridge Home may not be available in all languages.



Adobe Design Center

Adobe Design Center offers articles, inspiration, and instruction from industry experts, top designers, and Adobe publishing partners. New content is added monthly.

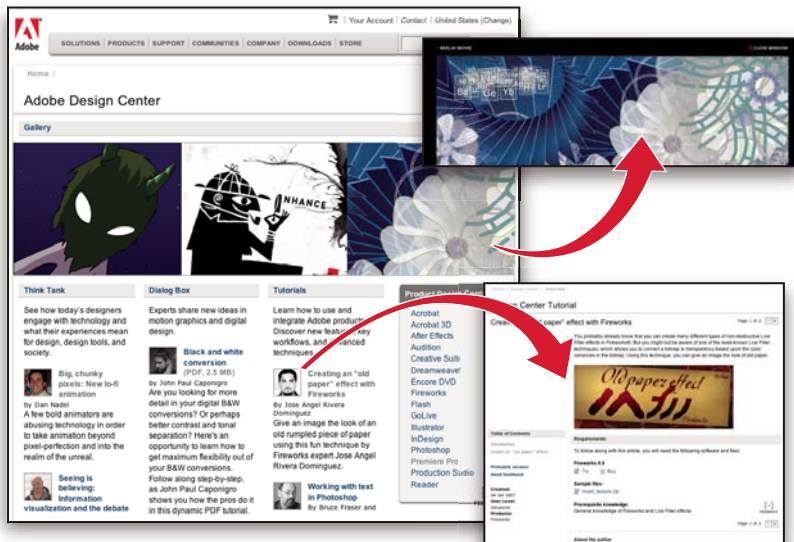

You can find hundreds of tutorials for design products and learn tips and techniques through videos, HTML tutorials, and sample book chapters.

New ideas are the heart of Think Tank, Dialog Box, and Gallery:

- Think Tank articles consider how today's designers engage with technology and what their experiences mean for design, design tools, and society.
- In Dialog Box, experts share new ideas in motion graphics and digital design.
- The Gallery showcases how artists communicate design in motion.

Visit Adobe Design Center at www.adobe.com/designcenter.

Adobe Developer Center

Adobe Developer Center provides samples, tutorials, articles, and community resources for developers who build rich Internet applications, websites, mobile content, and other projects using Adobe products. The Developer Center also contains resources for developers who develop plug-ins for Adobe products.

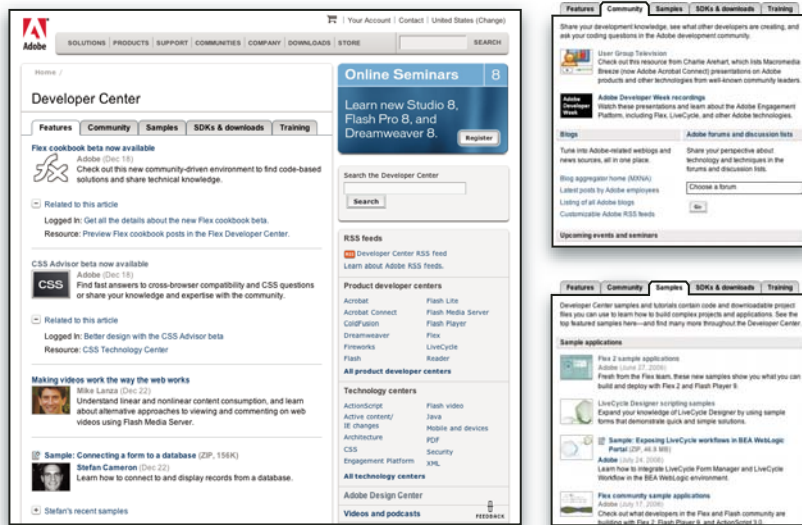

In addition to sample code and tutorials, you'll find RSS feeds, online seminars, SDKs, scripting guides, and other technical resources.

Visit Adobe Developer Center at www.adobe.com/go/developer.

Customer support

Visit the Adobe Support website, at www.adobe.com/support, to find troubleshooting information for your product and to learn about free and paid technical support options. Click the Training link for access to Adobe Press books, a variety of training resources, Adobe software certification programs, and more.

Downloads

Visit www.adobe.com/go/downloads to find free updates, tryouts, and other useful software. In addition, the Adobe Store (at www.adobe.com/go/store) provides access to thousands of plug-ins from third-party developers, helping you to automate tasks, customize workflows, create specialized professional effects, and more.

Adobe Labs

Adobe Labs gives you the opportunity to experience and evaluate new and emerging technologies and products from Adobe.

At Adobe Labs, you have access to resources such as these:

- Prerelease software and technologies
- Code samples and best practices to accelerate your learning
- Early versions of product and technical documentation
- Forums, wiki-based content, and other collaborative resources to help you interact with like-minded developers

Adobe Labs fosters a collaborative software development process. In this environment, customers quickly become productive with new products and technologies. Adobe Labs is also a forum for early feedback, which the Adobe development teams use to create software that meets the needs and expectations of the community.

Visit Adobe Labs at www.adobe.com/go/labs.

User communities

User communities feature forums, blogs, and other avenues for users to share technologies, tools, and information. Users can ask questions and find out how others are getting the most out of their software. User-to-user forums are available in English, French, German, and Japanese; blogs are posted in a wide range of languages.

To participate in forums or blogs, visit www.adobe.com/communities.

What's new

New features

Shape layers

Use new shape drawing tools to create and animate vector graphics. Strokes and fills—including editable gradients—can be added to shapes, and these properties can be animated. After Effects also includes shape layer operations based on Adobe® Illustrator® vector effects. See “About shapes and shape layers” on page 314.

To see a video tutorial introducing shape layers, go to the Adobe website at www.adobe.com/go/vid0224. To see a video tutorial on animating shape layers, go to the Adobe website at www.adobe.com/go/vid0225.

Puppet tools

Use Puppet tools to easily distort any image with natural, life-like motion. See “Animating with Puppet tools” on page 226.

Photoshop layer styles and video layers

Layer styles and video layers are preserved when you import a Photoshop file. You can also add and animate layer styles within After Effects and use advanced blending options. See “Layer styles” on page 168 and “Working with Photoshop and After Effects” on page 32.

To see a video tutorial on importing Photoshop files, go to the Adobe website at www.adobe.com/go/vid0252.

Flash integration

You can export FLV files with cue points that you create as markers within After Effects. Now, when you import a SWF file, the alpha channel is preserved, and graphics are continuously rasterized, so they stay sharp as you scale them up. See “Working with Flash and After Effects” on page 33 and “Rendering and exporting to Flash formats” on page 602.

To see a video tutorial on exporting to FLV files, go to the Adobe website at www.adobe.com/go/vid0262. To see a video tutorial on exporting markers as cue points, go to the Adobe website at www.adobe.com/go/vid0255.

Per-character 3D properties for text animation

Move or rotate individual characters or words in 3D space. See “Work with per-character 3D text properties” on page 293.

To see a video tutorial on animating text, go to the Adobe website at www.adobe.com/go/vid0226.

Brainstorm

Use Brainstorm to experiment with properties and see the results side by side. Choose the variants that you like and use as is or as input to further experimentation. See “Use Brainstorm to experiment and explore settings” on page 160.

Improved, simpler color management

You can now control the color for each footage item and each output item, all with a robust and simple interface, so colors look right on any output device. See “Color management” on page 241.

Clip Notes

Add queries to reviewers as markers and then export your composition as a PDF file. Reviewers can use Adobe Acrobat® or Adobe Reader® to make comments and then return the comments to you by e-mail or FTP. Comments are imported as markers, which you can see in the Timeline panel. See “Reviewing movies with Clip Notes comments” on page 634.

Performance improvements

You can use multiple CPUs or multiple processors on one CPU to render multiple frames simultaneously. You can also use hardware acceleration of previews to move processing to the GPU, freeing up your CPU and providing greater performance. See “Memory, storage, and performance” on page 37.

Export and preview video for mobile devices

New export presets in the Export Settings dialog box make it easier to export movies suitable for playback on mobile devices, such as mobile phones and the Apple® iPod®. You can view some output types using Adobe Device Central, which emulates many mobile devices. See “Preview a movie on a virtual mobile device using After Effects” on page 618.

Chapter 2: User interface

Customizing the user interface

About workspaces

Adobe video and audio applications provide a consistent, customizable workspace. Although each application has its own set of panels (such as Tools, Properties, Timeline, and so on), you move and group panels in the same way across products.

The main window of a program is the *application window*. Panels are organized in this window in an arrangement called a *workspace*. The default workspace contains groups of panels as well as panels that stand alone.

You customize a workspace by arranging panels in the layout that best suits your working style. You can create and save several custom workspaces for different tasks—for example, one for editing and one for previewing.

You can drag panels to new locations, move panels into or out of a group, place panels alongside each other, and undock a panel so that it floats in a new window above the application window. As you rearrange panels, the other panels resize automatically to fit the window.

 You can use floating windows to create a workspace more like those in previous versions of Adobe applications, or to place panels on multiple monitors.

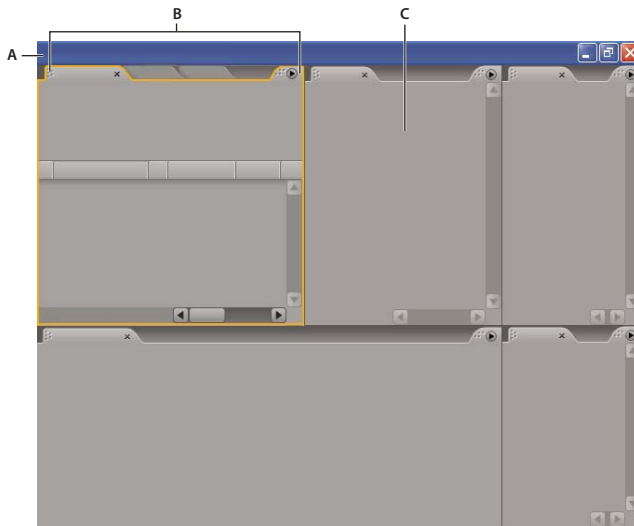

Example workspace

A. Application window B. Grouped panels C. Individual panel

For a video about the Adobe workspace, see www.adobe.com/go/vid0249.

Choose a workspace

Each Adobe video and audio application includes several predefined workspaces that optimize the layout of panels for specific tasks. When you choose one of these workspaces, or any custom workspaces you've saved, the current workspace is redrawn accordingly.

- ❖ Open the project you want to work on, choose Window > Workspace, and select the desired workspace.

Dock, group, or float panels

You can dock panels together, move panels into or out of a group, and undock a panel so that it floats in a new window above the application window. As you drag a panel, *drop zones*—areas onto which you can move the panel—become highlighted. The drop zone you choose determines where the panel is inserted, and whether it docks or groups with other panels.

Docking zones

Docking zones exist along the edges of a panel, group, or window. Docking a panel places it adjacent to the existing group, resizing all groups to accommodate the new panel.

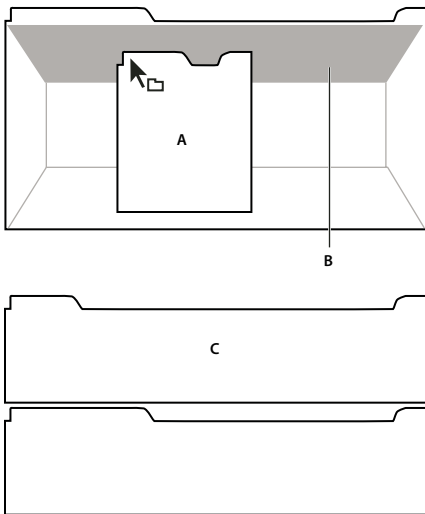

Dragging panel (A) onto docking zone (B) to dock it (C)

Grouping zones

Grouping zones exist in the middle of a panel or group, and along the tab area of panels. Grouping a panel stacks it with other panels.

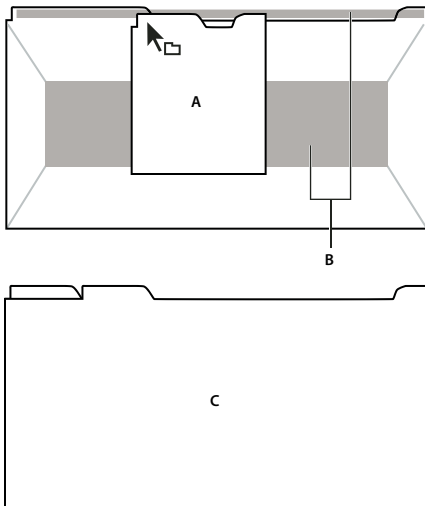

Dragging panel (A) onto grouping zone (B) to group it with existing panels (C)

Dock or group panels

1 If the panel you want to dock or group is not visible, choose it from the Window menu.

2 Do one of the following:

- To move an individual panel, drag the gripper area in the upper-left corner of a panel's tab onto the desired drop zone.

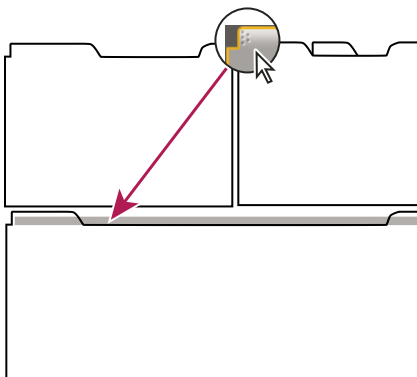

Drag panel gripper to move one panel

- To move an entire group, drag the group gripper at the upper-right corner onto the desired drop zone.

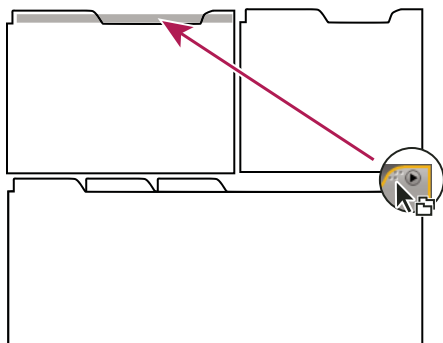

Drag group gripper to move entire group

The application docks or groups the panel, according to the type of drop zone.

Undock a panel in a floating window

When you undock a panel in a floating window, you can add panels to the window or otherwise modify it, as you do the application window. You can use floating windows to make use of a secondary monitor, or to create a workspace like those in earlier versions of Adobe applications.

❖ Select the panel you want to undock (if it's not visible, choose it from the Window menu), and then do one of the following:



- Choose Undock Panel or Undock Frame from the panel menu. Undock Frame undocks the panel group.
- Hold down Ctrl (Windows®) or Command (Mac OS®), and drag the panel or group from its current location. When you release the mouse button, the panel or group appears in a new floating window.
- Drag the panel or group outside the application window. (If the application window is maximized, drag the panel to the Windows task bar.)

Resize panel groups

When you position the pointer over dividers between panel groups, resize icons appear. When you drag these icons, all groups that share the divider are resized. For example, suppose your workspace contains three panel groups stacked vertically. If you drag the divider between the bottom two groups, they are resized, but the topmost group doesn't change.

 *To quickly maximize a panel beneath the pointer, press the tilde (~) key. (Do not press Shift.) Press the tilde key again to return the panel to its original size.*

1 Do either of the following:

- To resize either horizontally or vertically, position the pointer between two panel groups. The pointer becomes a double-arrow .
- To resize in both directions at once, position the pointer at the intersection between three or more panel groups. The pointer becomes a four-way arrow .

2 Hold down the mouse button, and drag to resize the panel groups.

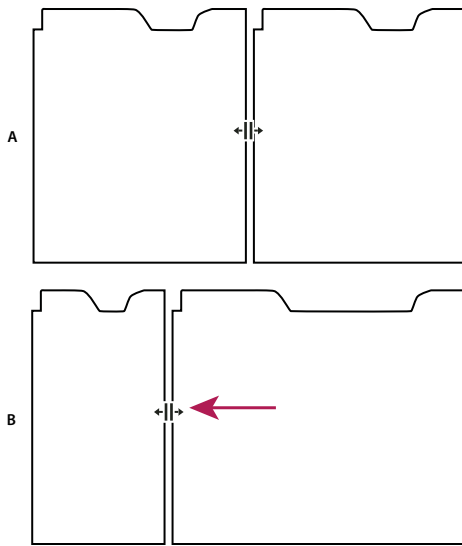

Dragging divider between panel groups to resize them horizontally
A. Original group with resize icon B. Resized groups

Open and close panels and windows

Even if a panel is open, it may be out of sight, beneath other panels. Choosing a panel from the Window menu opens it and brings it to the front.

When you close a panel group in the application window, the other groups resize to make use of the newly available space. When you close a floating window, the panels within it close, too.

- To open or close a panel, choose the panel from the Window menu.
- To close a panel or window, click its Close button .

Working with multiple monitors

To increase the available screen space, use multiple monitors. When you work with multiple monitors, the application window appears on the main monitor, and you place floating windows on the second monitor. Monitor configurations are stored in the workspace.

See also

“Dock, group, or float panels” on page 14

Save a custom workspace

As you customize a workspace, the application tracks your changes, storing the most recent layout. To store a specific layout more permanently, save a custom workspace. Saved custom workspaces appear in the Workspace menu, where you can return to and reset them.

- ❖ Arrange the frames and panels as desired, then choose Window > Workspace > New Workspace. Type a name for the workspace, and click OK.

Note: If a project saved with a custom workspace is opened on another system, the application looks for a workspace with a matching name. If it can't find a match (or the monitor configuration doesn't match), it uses the current local workspace.

Reset a workspace

Reset a workspace to return to its original, saved layout of panels.

- ❖ With the workspace you want to reset active, choose Window > Workspace > Reset *workspace name*.

Delete a workspace

- 1 Choose Window > Workspace > Delete Workspace.
- 2 Choose the workspace you want to delete, and then click OK.

Note: You cannot delete the currently active workspace.

Brighten or darken the interface

Changing the brightness preference affects panels, windows, and dialog boxes.

- 1 Choose Edit > Preferences > User Interface Colors (Windows) or After Effects > Preferences > User Interface Colors (Mac OS).
- 2 Drag the User Interface Brightness slider to the left or right. Click Default to restore the default brightness level.

Using the After Effects interface

Work with columns

The Project, Timeline, and Render Queue panels contain columns.

- To show or hide columns, right-click (Windows) or Control-click (Mac OS) a column heading (or choose Columns from the panel menu), and select the columns that you want to show or hide. A check mark indicates that the column is shown.
- To reorder columns, select a column name and drag it to a new location.
- To resize columns, drag the bar to the right of a column name. Drag left to make the column smaller and right to make it larger. Some columns—such as the Duration column in the Project panel—cannot be resized.

Scroll or zoom with the mouse wheel

You can use the mouse wheel to zoom in the Timeline, Composition, Layer, and Footage panels, and scroll in the Timeline, Project, Render Queue, Flowchart, Effect Controls, and Effects & Presets panels.

- To zoom into the center of the panel, or into the feature region when tracking, roll the mouse wheel forward.
- To zoom out of the center of the panel, or out of the feature region when tracking, roll the mouse wheel backward.
- To zoom into the area under the pointer, hold down Alt (Windows) or Option (Mac OS) as you roll the mouse wheel forward.
- To zoom out of the area under the pointer, hold down Alt (Windows) or Option (Mac OS) as you roll the mouse wheel backward.
- To scroll vertically, roll the mouse wheel forward or backward.
- To scroll horizontally, hold down Shift as you roll the mouse wheel backward or forward. When you are in the Timeline panel, rolling backward moves you forward in time and vice versa.

 You can scroll in a panel even if it is not currently active, as long as you move the pointer over it. For instance, you can scroll in the Composition panel even if the Effect Controls panel is currently active.

Open panel, viewer, and context menus

Panel menus provide commands relative to the active panel or frame. Viewer menus provide a list of compositions, layers, or footage items that can be shown in the viewer, as well as commands for closing items and locking the viewer. Context menus provide commands relative to the active tool or selected item.

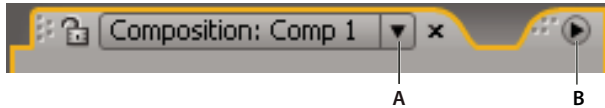

A. Triangle for opening viewer menu B. Triangle for opening panel menu

- To open a panel menu, click the triangle in the upper-right corner of the panel.
- To open a viewer menu, click the name of the active composition, layer, or footage item in the viewer tab.
- To open a context menu, right-click (Windows) or Control-click (Mac OS).

Work with viewers

A *viewer* is a panel that can contain multiple compositions, layers, or footage items, or multiple views of one such item. The Composition, Layer, Footage, Flowchart, and Effect Controls panels are viewers.

Locking a viewer prevents the currently displayed item from being replaced when you open or select a new item. Instead, when a viewer is locked and a new item is opened or selected, After Effects creates a new viewer panel for that item.

Instead of housing multiple items in a single viewer and using the menu to switch between them, you can choose to open a separate viewer for each open composition, layer, or footage item. When you have multiple viewers open, you can arrange them by docking or grouping them together, just as with any other panels.

For example, you can create one Composition viewer each for different 3D views (Top, Bottom, Back, Front) so that you can maximize each of the views with the ` (accent grave) keyboard command, which maximizes or restores the panel under the pointer.

 To create a custom workspace with multiple viewers, ensure that all viewers are unlocked before you save the workspace. Locked viewers are associated with a specific project context and are therefore not saved in the preferences file.

- To create a new viewer, choose New from the viewer menu.
- To lock or unlock a viewer, choose Locked from the viewer menu, or click the Toggle Viewer Lock  button.
- To lock the current viewer, split the current frame, and create a new viewer of the same type in the new frame, press Ctrl+Alt+Shift+N (Windows) or Command+Option+Shift+N (Mac OS).
- To cycle forward or backward through the items in the viewer menu list for the active viewer, press Shift+period or Shift+comma.

See also

“Choose a viewer to always preview” on page 124

“Shortcuts for panels, viewers, workspaces, and windows” on page 639

Activate a tool

The Tools panel can be displayed as a toolbar (as shown here) or as a normal panel.



Tools panel

A. Selection B. Hand C. Zoom D. Rotation E. Orbit Camera, Track XY Camera, Track Z Camera F. Pan Behind G. Mask and shape tools H. Pen tools I. Type tools J. Brush K. Clone Stamp L. Eraser M. Puppet tools N. Controls related to active tool

Note: Controls related to some tools appear only when the tool is active.

- Click the tool's button. If the button has a small triangle at its lower-right corner, hold down the mouse button to view the hidden tools. Then, click the tool you want to select.
- Press the tool's keyboard shortcut. (Positioning the pointer over a tool button displays a tool tip with the tool's name and keyboard shortcut.)
- To cycle through hidden tools, repeatedly press the tool's keyboard shortcut.
- To momentarily change from one tool to another tool, hold down the shortcut key for the desired tool; release the shortcut key to return to the previous tool. (This technique does not work with all tools.)
- To view panels most relevant to the active tool, click the panel button  if available. For example, clicking this button when a paint tool is active opens the Paint and Brush Tips panels.

See also

"Shortcuts for activating tools" on page 640

Tips for working with the After Effects user interface

- Use ClearType text anti-aliasing on Windows. ClearType makes the outlines of system text, such as menus and dialog boxes, easier to read. See Windows Help for information on how to enable ClearType text anti-aliasing.
- To show tool tips, select the Show Tool Tips preference (Edit > Preferences > General (Windows) or After Effects > Preferences > General (Mac OS)).
- To assign a keyboard shortcut to the current workspace, choose Window > Assign Shortcut To [Workspace Name] Workspace.
- If a frame contains more grouped panels than can be shown at once, drag the slider bar that appears above the tabs.

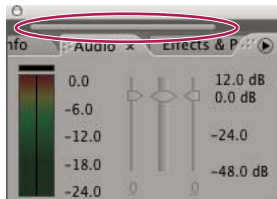

Slider bar for showing other tabs

- Use keyboard shortcuts.

Note: On Mac OS, some keyboard commands for interacting with the operating system conflict with keyboard commands for interacting with After Effects. Select Use System Shortcut Keys in the General preferences category to override the After Effects keyboard command in cases in which there's a conflict with the Mac OS keyboard command.

See also

“Using and modifying keyboard shortcuts” on page 638

Work with preferences

- To open the Preferences dialog box, choose Edit > Preferences > *[category name]* (Windows) or After Effects > Preferences > *[category name]* (Mac OS).
- To open the Preferences dialog box to the General category, press Ctrl+Alt+; (semicolon) (Windows) or Command+Option+; (Mac OS).
- To restore default preference settings, hold Ctrl+Alt+Shift (Windows) or Command+Option+Shift while the application is starting. To also restore default keyboard shortcuts, Alt-click (Windows) or Option-click (Mac OS) the OK button.

Preference reference

This section provides links to pages in which the various preferences—those that aren’t self-explanatory—are explained.

General

- Levels Of Undo: “Undo changes” on page 25
- Show Tool Tips: “Tips for working with the After Effects user interface” on page 20
- Create Layers At Composition Start Time: “About layers” on page 133
- Switches Affect Nested Comps: “About nesting and precomposing” on page 113
- Default Spatial Interpolation To Linear: “Controlling change with interpolation” on page 204
- Preserve Constant Vertex Count When Editing Masks: “Designate the first vertex for a Bezier path” on page 325
- Synchronize Time Of All Related Items: “About nesting and precomposing” on page 113
- Expression Pick Whip Writes Compact English: “Add, edit, and remove expressions” on page 549
- Create Split Layers Above Original Layer: “Split a layer” on page 146
- Allow Scripts To Write Files And Access Network: “Work with scripts” on page 45
- Enable JavaScript Debugger: [After Effects CS3 Professional Scripting Guide \(PDF\)](#)
- Use System Color Picker: “Select a color or edit a gradient” on page 236
- Create New Layers At Best Quality: “Layer image quality” on page 150
- Preserve Clipboard Data For Other Applications: “Copy between After Effects and Adobe Premiere Pro” on page 65
- Use System Shortcut Keys (Mac OS only): “Tips for working with the After Effects user interface” on page 20

Previews

- Adaptive Resolution Limit: “Preview modes” on page 124
- Enable OpenGL: “Render with OpenGL” on page 593
- Accelerate Effects Using: “Preview modes” on page 124
- Audio Preview Duration: “Preview video and audio” on page 120

Display

- Motion Path: “Work with motion paths” on page 197

- Disable Thumbnails In Project Panel: “Work with composition thumbnail images” on page 111
- Auto-zoom When Resolution Changes: “Resolution” on page 128
- Show Rendering Progress In Info Panel & Flowchart: “Preview video and audio” on page 120
- Hardware Accelerate Composition, Layer, And Footage Panels: “Improve performance” on page 41

Import

- Still Footage: “Create layers from footage items” on page 135
- Sequence Footage: “Import a single still image or a still-image sequence” on page 81
- Interpret Unlabeled Alpha As: “Specify alpha channel interpretation” on page 52
- Default Drag Import As: “Import footage items” on page 50

Output

- Overflow Volumes, Segment Sequences At, Segment Movie Files At, and Audio Block Duration: “Overflow volumes and segment settings” on page 629

Grids & Guides

- Safe Margins: “Work with safe zones, grids, guides, and rulers” on page 130

Label Colors and Label Defaults

- Label Colors and Label Defaults: “Work with color labels” on page 149

Memory & Cache

- Maximum Memory Usage, Maximum RAM Cache Size, Enable Disk Cache, and Maximum Disk Cache Size: “Memory & Cache preferences” on page 39
- Conformed Media Cache and Clean Database & Cache: “Work with the media cache” on page 67
- Prevent DLL Address Space Fragmentation (Windows only): “Memory & Cache preferences” on page 39

Video Previews

- Output Device, Output Mode, Output Quality, Output During, and Scale And Letterbox Output To Fit Video Monitor: “Preview on an external video monitor” on page 126

User Interface Colors

- Cycle Mask Colors: “Control mask path color” on page 260
- User Interface Brightness: “Brighten or darken the interface” on page 18

Auto-Save

- Automatically Save Projects and Maximum Project Versions: “Save and back up projects” on page 24

Multiprocessing

- Render Multiple Frames Simultaneously: “Render multiple frames simultaneously” on page 40

Audio Hardware and Audio Output Mapping

- Audio Hardware and Audio Output Mapping: “Preview video and audio” on page 120

Chapter 3: Planning and managing projects

Project basics

About project files

An After Effects *project* is a single file that stores compositions and references to all of the footage items that you use in that project. *Compositions* are collections of layers. Many layers use footage items as a source, though some layers—such as shape layers and text layers—contain graphics that you create within After Effects. A project file has the file-name extension `.aep`. The name of the current project appears at the top of the application window.

A *template project* is a file with the file-name extension `.aet`. You can use the many template projects included with After Effects—including DVD menu templates—as the basis for your own projects, and you can create new templates based on your projects.

 A great way to see how advanced users use After Effects is to open one of the template projects included with After Effects, select all of its layers, and press **U** or **UU** to reveal only the animated or modified properties. This shows you what changes the designer of the template project made to create the template. You may need to unlock some layers to select them.

Create and open projects

Only one project can be open at a time. If you create or open another project file while a project is open, After Effects prompts you to save changes in the open project, and then closes it. After you create a project, you can import footage into the project.

- To create a project, choose File > New > New Project.
- To open a project, choose File > Open Project, locate the project, and then click Open.
- To open the most recently opened project, press **Ctrl+Alt+Shift+P** (Windows) or **Command+Option+Shift+P** (Mac OS).

See also

“Import an After Effects project” on page 63

Work with template projects

When you open a template project, After Effects creates a new, untitled project based on the template. This means that saving changes to the project does not affect the template project.

Often, the creator of a template project will lock layers that should be left unmodified, and leave layers that should be modified unlocked. This is a convenient way to reuse material and prevent accidental or inappropriate modifications.

See also

“Lock or unlock a layer” on page 149

Open a template project

- To browse and open template projects using Adobe Bridge, choose File > Browse Template Projects. Double-click a template project to open it.
- To open a template project, choose File > Open Project. On Windows, choose Adobe After Effects Project Template from the Files Of Type menu.

Create a template project

- To convert a project to a template project, change the file-name extension from .aep to .aet.
- To save a copy of a project as a template project, choose File > Save A Copy, and then rename the copy with the file-name extension .aet.

Save and back up projects

- To save a project, choose File > Save.
- To save a copy of the project with a new automatically generated name, choose File > Increment And Save, or press Ctrl+Alt+Shift+S (Windows) or Command+Option+Shift+S (Mac OS).

A copy of the current project is saved in the same folder as the original project. The name of the copy is the name of the original followed by a number. If the name of the original ends with a number, that number is increased by 1.

- To save the project with a different name or to a different location, choose File > Save As.

The open project takes the new name and location; the original file remains unchanged.

- To save a copy of the project with a different name or to a different location, choose File > Save A Copy.

The open project retains its original name and location, and a copy is created with the new settings but is not opened.

- To automatically save copies of projects at regular intervals, choose Edit > Preferences > Auto-Save (Windows) or After Effects > Preferences > Auto-Save (Mac OS), and select Automatically Save Projects.

Auto-saved files are saved in the Adobe After Effects Auto-Save folder, which is located in the same folder as the original project file. Auto-saved file names are based on the project name: After Effects adds “auto-save *n*” (where *n* is the number of the file in the auto-save series) to the end of the file name. Maximum Project Versions specifies how many versions of each project file you want to save. When the number of versions saved reaches the maximum you specify, the Auto-Save feature overwrites them starting with the oldest file.

- To save a copy of the project and copies of assets used in the project, use the Collect Files command. (See “Collect files in one location” on page 594.)

Work with the Flowchart panel

In each composition’s flowchart, individual boxes (or tiles) represent each composition, footage item, and layer. Directional arrows represent the relationships between components.

Note: *The Flowchart panel shows you only the existing relationships. You cannot use it to change relationships between project elements.*

Nested compositions and other elements that make up the composition appear when you expand a composition tile.

Mid-gray lines between tiles in the flowchart indicate that the Video or Audio switch for those items is deselected in the Timeline panel. Black or light gray lines indicate that the switch is selected, depending on the User Interface Brightness preference setting.



- To open the project's flowchart, press Ctrl+F11 (Windows) or Command+F11 (Mac OS), or click the Project Flowchart View  button at the top of the vertical scroll bar on the right edge of the Project panel.
- To open a composition's flowchart, select the composition and choose Composition > Comp Flowchart View, or click the Comp Flowchart View button at the bottom of the Composition panel.
- To activate (select) an item, click its tile in the Flowchart panel.

When you click a composition in the flowchart, it becomes active in the Project panel and the Timeline panel. When you click a layer, it becomes active in the Timeline panel. When you click a footage item, it becomes active in the Project panel.

- To customize the appearance of the flowchart, use the Flowchart panel menu and the buttons along the bottom of the panel.



For tool tips identifying the buttons in the Flowchart panel, let your pointer hover over a button until the tool tip appears.

- To delete elements, select them and press Delete. If the selected element is a footage item or composition, it is deleted from the project and no longer appears in the Timeline and Project panels. If the selected element is a layer, it is deleted from the composition in which it appears.
- To access the context menu for a selected element, right-click (Windows) or Control-click (Mac OS) the icon to the left of the name in the element tile. The icons have various appearances, depending on the element type, such as layers  and compositions . For example, you can use the context menu for a layer to work with masks and effects, or to change switches, apply transformations, and adjust layer image quality.

Note: *When you change element properties in the Flowchart panel, be careful to context-click the icon in the tile, not the name of the element. The context menu associated with the element icon is different from the one that opens from the element name.*

Undo changes

You can undo only those actions that alter the project; for example, you can undo an edit, but you cannot undo the scrolling of a panel.

You can sequentially undo as many as 99 of the most recent changes made to the project, depending on the Levels Of Undo setting (Edit > Preferences > General (Windows) or After Effects > Preferences > General (Mac OS)). The default is 32.



To avoid wasting time undoing accidental modifications, lock a layer when you want to see it but do not want to modify it.

- To undo the most recent change, choose Edit > Undo [action].
- To undo a change and all changes after it, choose Edit > History, and select the first change that you want to undo.
- To revert to the last saved version of the project, choose File > Revert. All changes made and footage items imported since you last saved are lost. You cannot undo this action.

See also

“Lock or unlock a layer” on page 149

Project planning and setup

Workflow

Whether you use Adobe After Effects to animate a simple title or create complex special effects, you generally follow the same basic workflow, though you may repeat some steps—such as the cycle of modifying layer properties, animating, and previewing until everything looks right. You can choose a predefined workspace to facilitate each stage of your work, or you can create your own workspaces adapted to your needs.

Import and organize footage

After you create a project, add your footage to the Project panel. After Effects automatically interprets many common media formats, but you may also specify how you want After Effects to interpret attributes such as frame rate and pixel aspect ratio. You can view each item in a Footage panel and set its start and end times to fit your composition. For more information, see “Importing and interpreting footage items” on page 47.

Create and arrange layers in a composition

Create one or more compositions. Any footage item can be the source for one or more layers in a composition. You can arrange the layers spatially in the Composition panel or arrange them in time using the Timeline panel. You can stack layers in two dimensions or arrange them in three dimensions. You can use masks, blending modes, and keying tools to *composite*, or combine, the images of multiple layers. You can even use shape layers, text layers, and paint tools to create your own visual elements. For more information, see Compositions, Layers and properties, Drawing and painting, and Text.

Add effects and modify layer properties

You can add any combination of effects and modify any of a layer’s properties, such as size, position, and opacity. Using effects, you can alter a layer’s appearance or sound, and even generate visual elements from scratch. You can apply any of the hundreds of effects, animation presets, and layer styles. You can even create and save your own animation presets. For more information, see Effects and animation presets.

Animate

You can make any combination of a layer’s properties change over time, using keyframes and expressions. Use the motion tracking to stabilize motion or to animate one layer so that it follows the motion in another layer. For more information, see Animation, Expressions, and Motion tracking.

Preview

Previewing compositions on your computer monitor or an external video monitor is fast and convenient, even for complex projects, especially if you use OpenGL technology to accelerate previews. You can change the speed and quality of previews by specifying their resolution and frame rate, and by limiting the area and duration of the composition that you preview. You can use color management features to preview how your movie will look on another output device. For more information, see Views and previews and “Color management” on page 241.

Render and export

Add one or more compositions to the render queue to render them at the quality settings you choose, and to create movies in the formats that you specify. In some cases, you will export by using the File > Export or Composition menu, rather than by using the Render Queue panel. For more information, see Rendering and exporting.

Example workflow: Create a simple movie

This example assumes that you have already started After Effects and have not made any changes to the empty default project. This example skips the step of importing footage and shows you instead how to create your own visual elements. After you have rendered a final movie, you can import it into After Effects to view it and use it just as you would any other footage item.

Some people prefer to use the mouse and menus to interact with After Effects, whereas others prefer to use keyboard shortcuts for their common tasks. For several steps in this example, two alternative commands are shown that produce the same result—one demonstrating the discoverability of menu commands and one demonstrating the speed and convenience of keyboard shortcuts. You will likely find that you use some combination of keyboard shortcuts and menu commands in your work.

1 Create a new composition:

- Choose Composition > New Composition.
- Press Ctrl+N (Windows) or Command+N (Mac OS).

2 Change the Duration value in the Composition Settings dialog box to 5;00 (five seconds), choose Web Video from the Preset menu, and click OK.

3 Create a new text layer:

- Choose Layer > New > Text.
- Press Ctrl+Alt+Shift+T (Windows) or Command+Option+Shift+T (Mac OS).

4 Type your name. Press Enter on the numeric keypad or press Ctrl+Enter (Windows) or Command+Return (Mac OS) on the main keyboard to exit text-editing mode.

5 Set an initial keyframe for the Position property:

- Click the triangle to the left of the layer name in the Timeline panel, click the triangle to the left of the Transform group name, and then click the stopwatch button  to the left of the Position property name.
- Press Alt+Shift+P (Windows) or Option+Shift+P (Mac OS).

6 Activate the Selection tool:

- Click the Selection Tool button in the Tools panel.
- Press V.

7 Using the Selection tool, drag your text to the bottom-left corner of the frame in the Composition panel.

8 Move the current-time indicator to the last frame of the composition:

- Drag the current-time indicator in the Timeline panel to the far right of the timeline.
- Press End.

9 Using the Selection tool, drag your text to the top-right corner of the frame in the Composition panel.

A new keyframe is created at this time for the Position property. Motion is interpolated between keyframe values.

10 Preview your animation using standard preview:

- Click the Play button  in the Time Controls panel. Click Play again to stop the preview.
- Press the spacebar. Press the spacebar again to stop the preview.

11 Apply the Glow effect:

- Choose Effect > Stylize > Glow.

- Type **glow** in the Contains field at the top of the Effects & Presets panel to find the Glow effect. Double-click the effect name.

12 Add your composition to the render queue:

- Choose Composition > Add To Render Queue.
- Press Ctrl+Shift+/ (Windows) or Command+Shift+/ (Mac OS).

13 In the Render Queue panel, click the underlined text to the right of Output To. In the Output Movie To dialog box, choose a name and location for the output movie file, and then click Save. For the location, choose something easy to find, like your desktop.

14 Click the Render button to process all items in the render queue. The Render Queue panel shows the progress of the rendering operation. A sound is generated when rendering is complete.

You've just created, rendered, and exported a movie.

You can import the movie that you've just created and preview it in After Effects, or you can navigate to the movie and play it using a movie player such as QuickTime Player or Windows Media Player.

See also

"Using and modifying keyboard shortcuts" on page 638

"Import footage items" on page 50

Use Adobe Bridge with After Effects

Adobe Bridge is the control center for Adobe Creative Suite software. Use Adobe Bridge to browse for project templates and animation presets; run cross-product workflow automation scripts; view and manage files and folders; organize your files by assigning keywords, labels, and ratings to them; search for files and folders; and view, edit, and add metadata.

For more information about Adobe Bridge, see Adobe Bridge.

- To open Adobe Bridge from After Effects, choose File > Browse.
- To reveal a file in Adobe Bridge, select a file in the Project panel and choose File > Reveal In Bridge.
- To use Adobe Bridge to open template projects, choose File > Browse Template Projects.
- To use Adobe Bridge to browse for animation presets, choose Animation > Browse Presets.

See also

"Work with template projects" on page 23

"About animation presets" on page 347

Planning your project

Correct project settings, preparation of footage, and initial composition settings can help you to avoid errors and unexpected results when rendering your final output movie. Before you begin, think about what kind of work you'll be doing in After Effects and what kind of output you intend to create. Once you have planned your project and made some basic decisions about project settings, you'll be ready to start importing footage and assembling compositions from layers based on that footage.

The best way to ensure that your movie is suitable for a specific medium is to render a test movie and view it using the same type of equipment that your audience will use to view it. It's best to do this before you have completed the difficult and time-consuming parts of your work, to uncover problems early.

Aharon Rabinowitz has an article on the Creative COW website about planning your project with the final delivery specifications in mind: www.adobe.com/go/learn_ae_aharonplanning.

For introductions to digital video, digital audio, high-definition video, DVD, compression, and streaming video, visit the Adobe website at www.adobe.com/go/learn_dv_primers.

To see a video tutorial on creating and organizing projects, visit the Adobe website at www.adobe.com/go/vid0221.

Acquiring, choosing, and preparing footage

Before importing footage, first decide which media and formats you'll use for your finished movies, and then determine the best settings for your source material. Often, it's best to prepare footage before importing it into After Effects.

For example, if you want an image to fill your composition frame, configure the image in Adobe® Photoshop® so that the image size and pixel aspect ratio match the composition size and pixel aspect ratio. If the image is too large when you import it into After Effects, you'll increase the memory and processor requirements of the compositions that use it. If the image is too small, you'll lose image quality when you scale it to the desired size. See "Change pixel aspect ratio" on page 55.

If possible, use uncompressed footage: less compression means better results for many operations, such as keying and motion tracking. Certain kinds of compression—such as that used in DV encoding—are especially bad for color keying, because they discard the subtle differences in color that you depend on for good bluescreen or greenscreen keying. It's often best to wait until the final rendering phase to use compression. See "Keying overview and tips" on page 268.

If possible, use footage with a frame rate at least that of your output, so that After Effects doesn't have to use frame blending or similar methods to fill in missing frames. See "Change frame rate" on page 53.

The kind of work that you'll be doing in After Effects and the kind of output movie that you want to create can even influence how you shoot and acquire your footage. For example, if you know that you want to animate using motion tracking, you should consider shooting your scene in a manner that optimizes for motion tracking—for example, attaching a small, brightly colored ball to the object that you intend to track. See "Motion tracking workflow" on page 336.

Project settings

Project settings fall into three basic categories: how time is displayed in the project, how color data is treated in the project, and what sampling rate to use for audio. Of these, the color settings are the ones that you need to think about before you do much work in your project, because they determine how color data is interpreted as you import footage files, how color calculations are performed as you work, and how color data is converted for final output. See "Color management" on page 241 and "Change time display units" on page 131.

If you enable color management for your project, the colors that you see are the same colors that your audience will see when they view the movie that you create.

***Note:** Click the color depth indicator at the bottom of the Project panel to open the Project Settings dialog box. Alt-click (Windows) or Option-click (Mac OS) to cycle through color bit depths: 8 bpc, 16 bpc, and 32 bpc. See "Set the color depth" on page 234.*

Composition settings

After you prepare and import footage items, you use these footage items to create layers in a composition, where you animate and apply effects. When you create a composition, specify composition settings such as resolution, frame size, and pixel aspect ratio for your final rendered output. Although you can change composition settings at any time, it's best to set them correctly as you create each new composition to avoid unexpected results in your final rendered output. For example, the composition frame size should be the image size in the playback medium. See “Work with composition settings” on page 110.

 *If you'll be rendering a composition to more than one media format, always match the resolution setting for your composition to the highest resolution setting used for your output. Later, you can use output modules in the Render Queue panel to render a separate version of the composition for each format. See “Work with output module settings” on page 599.*

Performance, memory, and storage considerations

If you work with large compositions, make sure that you configure After Effects and your computer to maximize performance. Complex compositions can require a large amount of memory to render, and the rendered movies can take a large amount of disk space to store. Before you attempt to render a three-hour movie, make sure that you have the disk space available to store it. See “Memory, storage, and performance” on page 37.

Planning for playback from film, videotape, and DVD

If you're creating a movie for film, consider both the frame aspect ratio of your composition and the frame rate of your source footage. For footage that was transferred from film to video using the 3:2 pulldown telecine method, you must remove 3:2 pulldown before adding effects. See “Remove 3:2 or 24Pa pulldown from video” on page 72.

For film and video, try to match import and composition settings with settings in the output module used to render a movie. In some cases, you may want to conform footage to a frame rate different than the frame rate of the source footage. For example, you may want to conform 25 fps PAL to 24 fps for film. See “Converting movies” on page 630.

If your final output will be videotape, set up your composition to match the requirements of your capture card; or, if you use an IEEE 1394 (FireWire) port, choose the appropriate DV preset in the Composition Settings dialog box and in the export settings of the output module Render Queue panel.

Aharon Rabinowitz has an article on the Creative COW website about planning your project with the final delivery specifications in mind: www.adobe.com/go/learn_ae_aharonplanning.

See also

“Work with composition settings” on page 110

“Work with output module settings” on page 599

Planning for playback on computer monitors and mobile devices

When you create a movie for playback on a personal computer—whether downloaded from the web or played from a CD-ROM—specify composition settings, render settings, and output module settings that keep file size low. Consider that a movie with a high data rate may not play well from an older CD-ROM drive that cannot read data from the disc fast enough. Similarly, a large movie may take a long time to download over a dial-up network connection.

For more information about compression, see the Compression Primer (English only) on the Adobe website at www.adobe.com/go/learn_dv_compressionprimer.

When rendering your final movie, choose a file type and encoder appropriate for the final media. The corresponding decoder must be available on the system used by your intended audience; otherwise they will not be able to play the movie. Common codecs (encoders/decoders) include FLV, Sorenson, MPEG-4 video, and codecs installed with media players such as Flash® Player, RealPlayer, Windows Media Player, and QuickTime Player.

Aharon Rabinowitz has an article on the Creative COW website about planning your project with the final delivery specifications in mind: www.adobe.com/go/learn_ae_aharonplanning.

Mobile devices

Many of the considerations for creating movies for playback on mobile devices, such as mobile phones and the Apple iPod, are similar to those for creating movies for playback on personal computers—but the limitations are even more extreme. Because the amount of storage (disk space) and processor power are less for mobile phones than for personal computers, file size and data rate for movies need to be even more tightly controlled.

Use these tips when shooting video for mobile devices:

- Tight shots are better. It's hard to see a face on a tiny screen unless it's shot in relative close-up.
- Light your subjects well, and keep them separated from the background; the colors and brightness values between background and subject should not be too similar.
- Avoid excessive zooming and rolling, which hinder temporal compression schemes.
- Because stable (non-shaky) video is easier to compress, shoot video with a tripod to minimize the shaking of the camera.
- Avoid using auto-focus and auto-exposure features. When these engage, they change the appearance of all of the pixels in an image from one frame to the next, making compression using interframe encoding schemes less efficient.

Use the following tips when working with After Effects:

- Use a lower frame rate (15-22 fps) for mobile devices.
- Use motion-stabilization tools and noise-reduction or blur effects before rendering to final output, to aid the compressor in reducing file size.
- Match the color palette to the mobile devices that you are targeting. Mobile devices, in general, have a limited color gamut. Previewing in Adobe Device Central can help determine if the colors used are optimal for an individual device or range of devices.
- Use Format Options presets available through the output module in the Render Queue panel. Presets are available for 3GPP mobile devices, iPod video, and PlayStation Portable.
- Consider using cuts and other fast transitions instead of zooming in and out or using fades and dissolves. Fast cuts also make compression easier.

After you've rendered your movie, you can view it exactly as it will appear on any of a large variety of mobile devices, using Adobe Device Central.

See also

“Work with composition settings” on page 110

“Work with output module settings” on page 599

“Work with render settings” on page 597

“About compression of movie files” on page 618

“Preview a movie on a virtual mobile device using After Effects” on page 618

Working with Photoshop and After Effects

If you use Photoshop to create still images, you can use After Effects to bring those still images together and make them move and change. In After Effects, you can animate an entire Photoshop image or any of its layers. You can even animate individual properties of Photoshop images, such as the properties of a layer style.

If you use After Effects to create movies, you can use Photoshop to refine the individual frames of those movies. You can remove unwanted visual elements, draw on individual frames, or use the superior selection and masking tools in Photoshop to divide a frame into elements for animation or compositing.

Comparative advantages for specific tasks

The strengths of After Effects are in its animation and automation features. This means that After Effects excels at tasks that can be automated from one frame to another. For example, you can use the motion tracking features of After Effects to track the motion of a microphone boom, and then automatically apply that same motion to the Clone Stamp tool. In this manner, you can remove the microphone from every frame of a shot, without having to paint the microphone out by hand on each frame.

In contrast, Photoshop has excellent tools for painting, drawing, and selecting portions of an image. Tracing a complex shape to create a mask is much easier with the Photoshop Quick Selection tool or Magnetic Lasso tool than with the masking tools in After Effects. Rather than hand-drawing a mask on each frame in After Effects, consider doing this work in Photoshop. Similarly, if you are applying several paint strokes by hand to get rid of dust, consider using the Photoshop paint tools.

Deciding which application to use for painting depends on the task. Paint strokes in Photoshop directly affect the pixels of the layer. Paint strokes in After Effects are elements of an effect, each of which can be turned on or off or modified at any time. If the purpose of applying a paint stroke is to permanently modify a still image, use the Photoshop paint tools. If you want to have complete control of each paint stroke after you've applied it, or if you want to animate the paint strokes themselves, use the After Effects paint tools.

The animation and video features in Photoshop Extended include simple keyframe-based animation. After Effects uses a similar interface, though the breadth and flexibility of its animation features are far greater.

After Effects 3D functionality is limited to the manipulation of two-dimensional layers in three dimensions. Photoshop, however, can manipulate complete 3D models in 3DS and U3D formats, and output two-dimensional composites and cross-sections of these 3D models from any angle. You can then use these two-dimensional images in After Effects. After Effects can also automatically create 3D layers to mimic the planes created by the Photoshop Vanishing Point tool.

Exchanging still images

After Effects can import and export still images in many formats, but you will usually want to use the native Photoshop PSD format when transferring individual frames or still image sequences between After Effects and Photoshop.

When importing or exporting a PSD file, After Effects can preserve individual layers, masks, layer styles, and most other attributes. When you import a PSD file into After Effects, you can choose whether to import it as a flattened image or with its layers separate and intact.

It is often a good idea to prepare a still image in Photoshop before importing it into After Effects. Examples of such preparation include correcting color, scaling, and cropping. It is often better for you to do something once to the source image in Photoshop than to have After Effects perform the same operation many times per second as it renders each frame for previews or final output.

By creating your new PSD document from the Photoshop New File dialog box with a Film & Video preset, you can start with a document that is set up correctly for a specific video output type. If you are already working in After Effects, you can create a new PSD document that matches your composition and project settings by choosing File > New > Adobe Photoshop File.

Exchanging movies

You can also exchange video files, such as QuickTime movies, between Photoshop and After Effects. When you open a movie in Photoshop, a video layer is created that refers to the source footage file. Video layers allow you to paint nondestructively on the movie's frames, much as After Effects works with layers with movies as their sources. When you save a PSD file with a video layer, you are saving the edits that you made to the video layer, not edits to the source footage itself.

You can also render a movie directly from Photoshop. For example, you can create a QuickTime movie from Photoshop that can then be imported into After Effects.

Color

After Effects works internally with colors in an RGB (red, green, blue) color space. Though After Effects can convert CMYK images to RGB, you should do video work in Photoshop in RGB.

If relevant for your final output, it is better to ensure that the colors in your image are broadcast-safe in Photoshop before you import the image into After Effects. A good way to do this is to assign the appropriate destination color space—for example, SDTV (Rec. 601)—to the document in Photoshop. After Effects performs color management according to color profiles embedded in documents, including imported PSD files.

See also

“Preparing and importing Photoshop files” on page 83

Working with Flash and After Effects

If you use Adobe® Flash® to create video or animation, you can use After Effects® to edit and refine the video. For example, you can export Flash animations and applications as QuickTime movies or Flash Video (FLV) files. You can then use After Effects to edit and refine the video.

If you use After Effects to edit and composite video, you can then use Flash to publish that video. You can also export an After Effects video as Flash content for further editing in Flash.

Exporting QuickTime video from Flash

If you create animations or applications with Flash, you can export them as QuickTime movies using the File > Export > Export Movie command in Flash. For a Flash animation, you can optimize the video output for animation. For a Flash application, Flash renders video of the application as it runs, allowing the user to manipulate it. This lets you capture the branches or states of your application that you want to include in the video file.

Exporting Flash video (FLV) from After Effects

When you render finished video from After Effects, select FLV as the output format in the Render Queue panel to export directly to the Flash Video (FLV) format. You can specify size, compression, and other output options. Any After Effects markers are added to the FLV file as cue points.

You can then import the FLV file into Flash and publish it in a SWF file, which can be played by Flash Player.

Importing and publishing video in Flash

When you import a FLV file into Flash, you can use various techniques, such as scripting or Flash components, to control the visual interface that surrounds your video. For example, you might include playback controls or other graphics. You can also add graphic layers on top of the FLV file for composite effects.

Composite graphics, animation, and video

Flash and After Effects each include many capabilities that allow you to perform complex compositing of video and graphics. Which application you choose to use will depend on your personal preferences and the type of final output you want to create.

Flash is the more web-oriented of the two applications, with its small final file size. Flash also allows for runtime control of animation. After Effects is oriented towards video and film production, provides a wide range of visual effects, and is generally used to create video files as final output.

Both applications can be used to create original graphics and animation. Both use a timeline and offer scripting capabilities for controlling animation programmatically. After Effects includes a larger set of effects, while the Flash ActionScript™ language is the more robust of the two scripting environments.

Both applications allow you to place graphics on separate layers for compositing. These layers can be turned on and off as needed. Both also allow you to apply effects to the contents of individual layers.

In Flash, composites do not affect the video content directly; they affect only the appearance of the video during playback in Flash Player. In contrast, when you composite with imported video in After Effects, the video file you export actually incorporates the composited graphics and effects.

Because all drawing and painting in After Effects is done on layers separate from any imported video, it is always non-destructive. Flash has both destructive and non-destructive drawing modes.

Exporting After Effects content for use in Flash

You can export After Effects content for use in Flash. You can export a SWF file that can be played immediately in Flash Player or used as part of another Flash project. When you export content from After Effects in SWF format, the some of the content may be flattened and rasterized in the SWF file.

Importing Flash SWF files into After Effects

Flash has a unique set of vector art tools that make it useful for a variety of drawing not possible in After Effects or Adobe Illustrator®. You can import SWF files into After Effects to composite them with other video or render them as video with additional creative effects. When After Effects imports a SWF file, its internal keyframes are preserved so that you can continue to use them for timing other effects.

Each SWF file imported into After Effects is flattened into a single continuously rasterized layer, with its alpha channel preserved. Continuous rasterization means that graphics stay sharp as they are scaled up. This import method allows you to use the root layer or object of your SWF files as a smoothly rendered element in After Effects, allowing the best capabilities of each tool to work together.

Working with Adobe Premiere Pro and After Effects

Adobe Premiere® Pro is designed to capture, import, and edit film and video. After Effects is designed to produce motion graphics and visual effects for film, broadcast television, DVD, and the web. You can easily exchange projects, compositions, tracks, and layers between After Effects and Adobe Premiere Pro. You can import an Adobe Premiere Pro project into After Effects, or export an After Effects project as an Adobe Premiere Pro project. You can also import Adobe Premiere 6.0 and 6.5 projects into After Effects.

You can copy and paste layers and tracks between After Effects and Adobe Premiere Pro. If you have Adobe Creative Suite® 3 Production Premium, you can use Adobe Dynamic Link to export After Effects compositions into Adobe Premiere Pro or Adobe Encore without first rendering them, or you can start Adobe Premiere Pro from within After Effects and capture footage for use in After Effects.

See also

“Copy between After Effects and Adobe Premiere Pro” on page 65

“About Dynamic Link (Production Premium only)” on page 609

“Export an After Effects project to Adobe Premiere Pro” on page 608

Work with Adobe Encore and After Effects

You can use After Effects to quickly create buttons and button layers for importing into Adobe Encore®. Adobe Encore uses a naming standard to define a button and the role of individual layers as subpicture highlights and video thumbnails. When you select a group of layers to create as an Adobe Encore button, After Effects precomposes the layers and names the precomposition according to the naming standards for buttons.

Highlight layer names receive the prefix (=1), (=2), or (=3), and video thumbnail names receive the prefix (%).

 *After Effects includes template projects that include entire DVD menus for you to use as a basis for your own DVD menus. To use Adobe Bridge to browse and import these template projects, choose File > Browse Project Templates. (See “Work with template projects” on page 23.)*

See also

“Create a web link, chapter link, or cue point from a marker” on page 118

Create a button for Adobe Encore

- 1 In the Timeline panel, select the layers to be used in the button.
- 2 Choose Layer > Adobe Encore > Create Button.
- 3 Enter a name for the button.
- 4 Use the menus to assign up to three highlight layers and one video thumbnail layer, and then click OK.

A new composition is created with the button name. In keeping with the Adobe Encore naming standards, the prefix (+) is added to the name of the composition to indicate that it is a button.

Important: *If you rename the button, be sure to retain the (+) prefix. The prefix ensures that Adobe Encore recognizes the file as a button.*

Assign a subpicture highlight and video thumbnail to a layer

- 1 Select the layer.

- 2 Choose Layer > Adobe Encore > Assign To Subpicture [number] or Assign To Video Thumbnail.

Export a button for use in Adobe Encore

- 1 Open the composition that represents the button, and move the current-time indicator to the desired frame.
- 2 Choose Composition > Save Frame As > Photoshop Layers.

Creating an animated GIF movie

An *animated GIF* file is a sequence of GIF images that plays as a movie. This format is commonly used for small, short, simple movies that play in web browsers.

To play an animated GIF file, the web browser first loads the entire file into memory and then plays it from memory (not from disk). To prevent excessive delays before playback begins, and to avoid using too much memory, an animated GIF should have a short duration and a low frame rate. Frame rates of 5 frames per second (or less) are recommended, unless the duration is very short (1 second or so).

When you render a movie to the animated GIF format, colors are dithered to an 8-bit palette (256 colors). Before rendering your final movie, render a test composition so that you can adjust colors if the results are not what you expect. You can create a color palette in Adobe Photoshop if the default Web Safe or System color palettes don't give the results that you want.

A pixel in an animated GIF file is either completely opaque or completely transparent. When rendering an animated GIF movie, After Effects must convert the finely-graded alpha channel of the composition to this much simpler type of transparency. The transition between transparent and opaque areas is abrupt, and may not be desired for more subtle visual elements.

You render and export a movie as an animated GIF file using the render queue. Animated GIF is one of the formats available in the Format menu in the Output Module Settings dialog box.

See also

“Basics of rendering and exporting” on page 587

Cross-platform project considerations

After Effects project files are compatible with Mac OS and Windows operating systems, but some factors—mostly regarding the locations and naming of footage files and support files—can affect the ease of working with the same project across platforms.

File systems

If you want to transfer a project that contains footage stored on a server from Mac OS to Windows, be sure to mount the server by using AppleShare (AFP). If you mount the volume in Mac OS by using Samba (SMB), After Effects can't reestablish links to footage files stored on the server when you open the project on Windows.

Project paths

When you move a project to a different computer and open it, After Effects attempts to locate the project's footage files as follows: After Effects first searches the folder in which the project file is located; second, it searches the file's original path or folder location; finally, it searches the root of the directory where the project is located.

If you are building cross-platform projects, it's best if the full paths have the same names on Mac OS and Windows systems. If the footage and the project are on different volumes, make sure that the appropriate volume is mounted before opening the project and that network volume names are the same on both systems.

It's best to store footage in the same folder as the project file or in another folder within that folder. Here's a sample hierarchy:

```
/newproject/project_file.aep
```

```
/newproject/source/footage1.psd
```

```
/newproject/source/footage2.avi
```

You can then copy the newproject folder in its entirety across platforms, and After Effects will properly locate all of the footage.

***Note:** Use the Collect Files feature to gather copies of all the files in a project into a single folder. You can then move the folder containing the copied project to the other platform. See “Collect files in one location” on page 594.*

File-naming conventions

Name your footage and project files with the appropriate file-name extensions, such as .mov for QuickTime movies and .aep for After Effects projects. Don't use high-ASCII or other extended characters in file names to be used cross-platform. If files will be used on the web, be sure that file names adhere to applicable conventions for extensions and paths.

Supported file types

Some file types are supported on one platform but not another. See “Supported import formats” on page 48 and “Supported output formats” on page 588.

Resources

Ensure that all fonts, effects, codecs, and other resources are available on both systems. Such resources are often plug-ins.

If you use a native After Effects effect in a project on one operating system, the effect will still work on the other operating system to which you've transferred your project. However, some third-party effects and other third-party plug-ins may not continue to operate, even if you have versions of these plug-ins on the target system. In such cases, you may need to reapply some third-party effects.

See also

“About plug-ins” on page 44

“Work with fonts” on page 278

Memory, storage, and performance

Memory usage and storage

Memory requirements for viewing and rendering increase with the resolution of the composition frame, the memory requirement of the most memory-intensive layer in the composition, and the size of the project file.

After Effects renders each frame of a composition one layer at a time. For this reason, the memory requirement of each individual layer is more important than the duration of the composition or the number of layers in the composition. The memory requirement for a composition is equivalent to the memory requirement for the most memory-intensive single layer in the composition. For example, it generally takes less memory to render 30 layers at NTSC resolution than 2 layers at motion-picture film resolution.

Note: *If the Render Multiple Frames Simultaneously option is selected, each background copy of the After Effects application renders one frame at a time.*

When a layer includes a composition as a source item, everything in that composition must be rendered before the next layer is rendered.

The memory requirements of a layer increase under the following circumstances:

- Using a larger source image
- Enabling color management
- Adding a mask
- Adding per-character 3D properties
- Using certain blending modes, layer styles, or effects, especially those involving multiple layers
- Applying certain output options, such as 3:2 pulldown, cropping, and stretching
- Adding shadows or depth-of-field effects

If you have no problems viewing each frame of a full-resolution, best-quality preview of a composition, then you have enough memory to render the composition. Rendering a composition into a movie takes no more memory than displaying it on-screen with the same settings.

Occasionally, After Effects may display an alert message indicating that it requires more memory to display or render a composition. If you receive an out-of-memory alert, free memory or reduce the memory requirements of the most memory-intensive layers, and then try again.



Free memory immediately with one or more of the commands in the Edit > Purge menu.

After Effects requires a contiguous block of memory to store each frame; it cannot store a frame in pieces in fragmented memory.

Use the following formula to determine the number of megabytes required to store one uncompressed frame at full resolution:

$(\text{height in pixels}) \times (\text{width in pixels}) \times (\text{number of bits per channel}) / 2,097,152$

Note: *The value 2,097,152 is a conversion factor that accounts for the number of bytes per megabyte (2^{20}), the number of bits per byte (8), and the number of channels per pixel (4).*

For example, a DV NTSC frame in an 8-bpc project requires 1.3 megabytes, and a D1/DV PAL frame in an 8-bpc project requires 1.6 megabytes, whereas a 1080i60 DVCPRO HD frame in a 32-bpc project requires 21.1 megabytes.

The operating system imposes certain limits on the amount of memory that an application can use. After Effects on the Mac OS X operating system can use up to 3.5 GB of RAM, although only about 3GB is actually available to the foreground application, because Mac OS X uses approximately 500MB to load the user interface libraries. After Effects on 32-bit Windows operating systems can use up to 3 GB of RAM; however, to use more than 2 GB in After Effects, you must configure Windows XP or Windows Vista appropriately. (For details, see the Microsoft website or Jonas Hummelstrand's website: www.adobe.com/go/learn_ae_jonaswindows3gb.) After Effects on 64-bit Windows operating systems can use up to 4 GB of RAM with no special configuration.

Note: *These numbers are for each After Effects process. The background processes used to render multiple frames simultaneously can each use the amount of RAM mentioned above. (See “Render multiple frames simultaneously” on page 40.)*

Because video is typically compressed during encoding when you render to final output, you can't just multiply the amount of memory required for a single frame by the frame rate and composition duration to determine the amount of disk space needed to store your final output movie. However, such a calculation can give you a rough idea of the maximum storage space you might need. For example, one second of uncompressed standard-definition 8-bpc video requires approximately 40 megabytes (MB). A feature-length movie at that data rate would require more than 200 GB to store. Even with DV compression, which reduces file size to 3.6 MB per second of video, this translates to more than 20 GB for a typical feature-length movie. It is not unusual for a feature-film project—with its higher color bit depth and greater frame size—to require terabytes of storage for footage and rendered output movies.

RAM and disk caches

As you work on a composition, After Effects temporarily stores some rendered frames and source images in RAM, so that previewing and editing can occur more quickly. After Effects does not cache frames that require little time to render. Frames remain uncompressed in the cache. You can control how After Effects stores images by setting image-caching preferences.

After Effects also caches at the footage and layer level for faster previews; layers that have been modified are rendered during the preview, and unmodified layers are displayed from the cache.

Blue bars in the Timeline panel mark frames that are cached to disk. Green bars mark frames that are cached to RAM.



Choose Show Cache Indicators from the Timeline panel menu to turn the cache indicators on and off. Showing the cache indicators decreases performance slightly.

When the cache is full, any new frame added to the cache replaces a frame cached earlier. When After Effects renders frames for RAM previews, it stops adding frames to the cache when the cache is full and begins playing only the frames that could fit in the cache. The disk cache is not used for RAM previews. If disk caching is enabled, After Effects can store rendered items to your hard disk when the RAM cache is full during standard previews.

The RAM cache and disk cache are automatically purged when you quit After Effects.



To purge the RAM cache and disk cache, choose Edit > Purge > Image Caches.

Memory & Cache preferences

Set memory and caching preferences by choosing Edit > Preferences > Memory & Cache (Windows) or After Effects > Preferences > Memory & Cache (Mac OS).

For information on the Conformed Media Cache preferences, see “Work with the media cache” on page 67.

Maximum Memory Usage The maximum amount of memory that After Effects can use to render a single frame. This preference is only relevant during rendering, either for previews or for final output. When After Effects is not

rendering a frame, memory usage drops back down to, at most, the amount set by the Maximum RAM Cache Size preference.

You can specify values over 100% (where 100% equals the amount of physical RAM you have installed) because virtual memory uses hard-disk space. Values over 200% are not recommended. The default value is 120%.

Maximum RAM Cache Size The maximum amount of memory that After Effects will use when not rendering a frame. This memory includes image caches, the application itself, memory reserved for GPU acceleration, and so on. This setting determines the amount of memory available for (and therefore the duration of) RAM previews.

If you set this value to greater than the default value of 60%, you may encounter problems such as decreased performance when switching from one application to another or increased frequency of errors that say that After Effects is unable to create an image buffer. Like a hard disk, your address space can become fragmented; if you have Maximum RAM Cache Size set too high, the memory may become too fragmented to store the next rendered frame. By lowering the cache percentage, you reduce the chance of fragmentation. Set this value above 60% only if necessary. You should not set this value above 90%.

When you have enabled multiprocessing, the amount of RAM available to background processes is affected by the amount of RAM reserved for the foreground process. Decreasing Maximum RAM Cache Size can free memory for background processes. (See “Render multiple frames simultaneously” on page 40.)

Enable Disk Cache Moves rendered frames to your hard disk when the RAM cache is full. After Effects will only use the disk cache to store a frame if it’s faster to retrieve a frame from the cache than to re-render the frame. Select a folder to contain your cache, and click OK (Windows) or Choose (Mac OS). For the best performance, select a folder that’s on a different physical hard disk than your source footage. If possible, the folder should be on a hard disk that uses a different drive controller than the disk that contains your source footage. The disk cache folder can’t be the hard disk’s root folder.

Maximum Disk Cache Size Specifies the number of megabytes of hard disk space to use. This should be at least 2 gigabytes (GB).

Prevent DLL Address Space Fragmentation (Windows only) Select this option to give After Effects access to more contiguous memory on a computer with a large amount of RAM. This option may be incompatible with some OpenGL drivers, which can cause a crash when the application starts. If such a crash occurs, the option will become unchecked automatically to prevent further crashes when you start After Effects.

 For information on working with large images and avoiding the error message that says that After Effects “could not create image buffer”, see Jonas Hummelstrand’s website: www.adobe.com/go/learn_ae_jonasimagebuffererror.

Render multiple frames simultaneously

After Effects can start additional processes of the After Effects application to run in the background to assist the main application with the rendering of frames for RAM previews or final output. These background processes have the name AfterFX.exe (Windows) or aeselflink (Mac OS).

Each background process renders its own frame and runs on a separate processor core (CPU). The number of processes used to render multiple frames simultaneously is never more than the number of processors. The number of background processes that can run on your computer also depends on the total amount of system RAM and the amount of RAM that is assigned to the main application (Maximum RAM Cache Size). The amount of RAM required for each background process varies depending on your system configuration; at least 1GB per process is recommended.

Note: You can check the current value for Maximum RAM Cache Size by choosing Edit > Preferences > Memory & Cache (Windows) or After Effects > Preferences > Memory & Cache (Mac OS).

If background processes are used for rendering, then the main foreground application is not also used for rendering. This means that creating background processes only adds to the total number of processes used for rendering if there are enough resources for at least two background processes to run.

- 1 Choose Edit > Preferences > Multiprocessing (Windows) or After Effects > Preferences > Multiprocessing (Mac OS).
- 2 Select Render Multiple Frames Simultaneously.

The bottom of the Preferences dialog box shows how many additional processors (in addition to the worst-case scenario of one processor) will be used at the current settings. To increase the number of background processes that can run, decrease Maximum RAM Cache Size or install more RAM.

Selecting the Render Multiple Frames Simultaneously option does not immediately start the background processes. The background processes start when the first render operation (for a RAM preview or for final output) is initiated after the option is selected. The background processes continue running until the option is deselected.

Important: *You may experience a small delay when the background processes start for the first time, when the first render operation occurs. A message in the Info panel indicates when the background processes are initializing. Deselecting Render Multiple Frame Simultaneously stops the background processes; reselecting the option causes the same delay when the next render operation begins.*

Because antivirus software operates by monitoring every read and write operation, such software can decrease rendering speed, especially with the Render Multiple Frames Simultaneously preference selected.

If the rendering of a single frame requires more RAM than is available to the individual background processes, then After Effects will not render multiple frames simultaneously and will instead use only the main foreground process to render all frames for that composition. If After Effects can't use background processes to render multiple frames simultaneously, a message appears in the Info panel.

Note: *After Effects can also use multiple processes to accelerate rendering of a single frame. This form of multiprocessing can take advantage of hyper-threading. The number of CPUs that After Effects reports in the Multiprocessing Preferences dialog box for accelerating rendering within a single frame counts the virtual (logical) CPUs available due to hyper-threading.*

Improve performance

You can improve performance by optimizing your computer system, After Effects, your project, and your workflow.

GridIron Software provides Nucleo Pro 2, which improves rendering performance in After Effects in several ways: www.adobe.com/go/learn_ae_gridironnucleopro.

Improve performance before starting After Effects

- Make sure that you've installed the current version of After Effects, including any available updates. For more information about updates, visit the Adobe website at www.adobe.com/go/downloads.
- Make sure that you've installed the latest versions of drivers and plug-ins, especially video card drivers. To download updates for drivers and plug-ins, visit the provider's website.
- Quit applications that are not necessary for your work. This may include some applications that start automatically when the operating system starts.
- Make sure that your system includes a display card that supports OpenGL 2.0 or later (Windows) or OpenGL 1.5 or later (Mac OS). Though After Effects can function without it, OpenGL accelerates various types of rendering, including rendering to the screen for previews. See "Render with OpenGL" on page 593.

- Adjust the size of the virtual memory paging file (Windows only). Virtual memory enables the system to use hard-disk space to store information normally stored in RAM. Windows manages virtual memory using a paging file. To improve performance in After Effects, adjust the size of the paging file to a maximum of twice the amount of installed RAM—the default in Windows XP. (See Windows Help.)
- Defragment all hard disks regularly. See the documentation for your operating system for details.
- Make sure that your system has enough RAM. See the documentation for your operating system and computer for details on how to check the amount of installed RAM and how to install RAM.
- Stop or pause resource-intensive operations in other applications, such as video previews in Adobe Bridge.

Improve performance by optimizing memory, cache, and multiprocessing settings

- Use multiple processors to render multiple frames simultaneously by selecting the Render Multiple Frames Simultaneously preference. See “Render multiple frames simultaneously” on page 40.
- Enable caching frames to disk by selecting the Enable Disk Cache preference.
- Set the Maximum RAM Cache Size preference to an optimum value. See “Memory & Cache preferences” on page 39.
- Purge RAM and disk caches (choose Edit > Purge > Image Caches).

Improve performance by simplifying your project

By simplifying and dividing your project, you can prevent After Effects from using memory and other resources to process elements that you are not currently working with. Also, by controlling when After Effects performs certain processing, you can greatly improve overall performance. For example, you can avoid repeating an action that needs to happen only once, or you can postpone an action until it is more convenient for you.

- Delete unused elements from your project. See “Remove items from a project” on page 60.
- Divide complex projects into simpler projects, and then recombine them before you render the finished movie. To recombine projects, import all of the projects into a single project by choosing File > Import > File.
- Before rendering, put all of your source footage files on a local disk—not the one that the application runs from. A good way to do this is with the Collect Files command. See “Collect files in one location” on page 594.
- Prerender nested compositions. Render a completed composition as a movie so that After Effects doesn’t rerender the composition every time it is displayed. See “Pre-render a nested composition” on page 114.
- Restrict the influence of layer switches by choosing Edit > Preferences > General (Windows) or After Effects > Preferences > General (Mac OS), and deselecting Switches Affect Nested Comps. (Remember to select this option again before you render the composition for final output.)
- Collapse transformations for nested compositions. See “Render order and collapsing transformations” on page 115.
- Substitute a low-resolution or still-image proxy for a source item when not working directly with that item. See “Work with placeholders and proxies” on page 61.
- Lower the composition’s resolution. See “Resolution” on page 128.

Note: To increase the rendering speed of RAM previews, set the resolution of the Composition panel to match the magnification. For example, if the magnification is 50%, choose Half from the Resolution menu.

- Isolate the layer you’re working on by using the Solo switch. See “Solo a layer” on page 149.

- Deselect the Continuously Rasterize switch for a vector layer until you need to view or render it in detail. This prevents After Effects from rasterizing the entire layer after each change. See “Continuously rasterize a layer containing vector graphics” on page 151.

Improve performance by modifying screen output

You can improve performance in many ways that don't affect how After Effects treats your project data, only how output is drawn to the screen as you work. Although it is often useful to see certain items and information as you work, After Effects uses memory and processor resources to update this information, so be selective in what you choose to display as you work. You will likely need to see different aspects of your project at different points in your workflow, so you may apply the following suggestions in various combinations at various stages.

- Turn off display color management and output simulation when not needed. See “Simulate how colors will appear on a different output device” on page 248.
- Enable hardware acceleration of previews, which uses the GPU to assist in drawing previews to the screen. Choose Edit > Preferences > Display (Windows) or After Effects > Preferences > Display (Mac OS), and select Hardware Accelerate Composition, Layer, And Footage Panels.
- Close unneeded panels. After Effects must use memory and processor resources to update open panels, which may slow the work that you are doing in another panel.
- Create a region of interest. If you are working on a small part of your composition, limit which portion of the composition is rendered to the screen during previews. See “Work with the region of interest” on page 111.
- Deselect Show Cache Indicators in the Timeline panel menu to prevent After Effects from displaying green and blue bars in the time ruler to indicate cached frames.
- Deselect the Show Rendering Progress In Info Panel & Flowchart preference (in Display preferences) to prevent the details of each render operation for each frame from being written to the screen.
- Hide Current Render Details in the Render Queue panel by clicking the triangle beside Current Render Details in the Render Queue panel.
- Press the Caps Lock key to prevent After Effects from updating Footage, Layer, or Composition panels. When you make a change that would otherwise appear in a panel, After Effects adds a red bar with a text reminder at the bottom of the panel. After Effects continues to update panel controls such as motion paths, anchor points, and mask outlines as you move them. To resume panel updates and display all changes, press Caps Lock again.

Note: Pressing the Caps Lock key suspends updates (disables refresh) of previews in viewers during rendering for final output, too, although no red reminder bar appears.

- Lower a layer's display quality to Draft or Wireframe. See “Layer image quality” on page 150.
- Select Draft 3D in the Timeline panel menu, which disables all lights and shadows that fall on 3D layers. It also disables the camera's depth-of-field blur.
- Deselect Live Update in the Timeline panel menu to prevent After Effects from updating compositions dynamically.
- Display audio waveforms in the Timeline panel only when necessary.
- Disable pixel aspect ratio correction by clicking the Toggle Pixel Aspect Ratio Correction  button at the bottom of a Composition, Layer, or Footage panel.
- Deselect Mirror On Computer Monitor when previewing video on an external video monitor. See “Preview on an external video monitor” on page 126.
- Hide layer controls, such as masks, 3D reference axes, and layer handles. See “Show or hide layer controls in the Composition panel” on page 127.

- Lower the composition's magnification. When After Effects displays the Composition, Layer, and Footage panels at magnifications of 100% or greater, screen redraw speed decreases.

Improve performance when using effects

Some effects, such as blurs and distortions, require large amounts of memory and processor resources. By being selective about when and how you apply these effects, you can greatly improve overall performance.

- Apply memory-intensive and processor-intensive effects later. Animate your layers and do other work that requires real-time previews before you apply memory-intensive or processor-intensive effects (such as glows and blurs), which may make previews slower than real time.
- Temporarily turn off effects to increase the speed of previews. See “Delete or disable effects and animation presets” on page 352.
- Limit the number of particles generated by the Particle Playground effect.
- Choose Stiff Elasticity for the Mesh Warp, Reshape, and Smear effects in the Distort effects category.
- Turn off linear blending. See “Linearize working space and enable linear blending” on page 244.

Plug-ins and scripts

About plug-ins

Plug-ins are small software modules—with file-name extensions such as .aex and .8bi—that add functionality to an application. After Effects effects are implemented as plug-ins, as are some features for working with certain file formats. The Photoshop Camera Raw plug-in, for example, provides After Effects with its ability to work with camera raw files.

When After Effects starts, it loads plug-ins from the Plug-ins folder, which is in the Adobe After Effects CS3\Support Files (Windows) or Adobe After Effects CS3 (Mac OS) folder by default. Several plug-ins come with After Effects and are automatically installed in this folder. You can obtain other plug-ins for After Effects and other Adobe products from Adobe or other vendors. For specific instructions for installing a plug-in, refer to its documentation.

Note: (Mac OS) Some third-party plug-in installers incorrectly install their plug-ins into the Mac OS X Package for After Effects. To reveal these plug-ins, Control-click the After Effects application icon in the Finder and choose Show Package Contents. You can then move the plug-ins into the After Effects Plug-ins folder.

After Effects comes with several third-party plug-ins, including Foundry Keylight, Synthetic Aperture Color Finesse, and the Cycore FX plug-ins. Some plug-in installers—including those for Keylight and Color Finesse—install documentation for the plug-ins in their subfolders in the Plug-ins folder. Documentation for Cycore FX plug-ins is available on the Cycore website: www.adobe.com/go/learn_ae_cycorefxdocumentation.

When exchanging After Effects projects between computer systems, make sure that the plug-ins that the project depends on are installed on both systems.

For information on plug-ins available for After Effects, visit the Adobe website at www.adobe.com/go/learn_ae_plugins. Other resources for purchasing and learning to use plug-ins for After Effects include the Toolfarm website (www.adobe.com/go/learn_ae_toolfarmhome) and Lutz Albrecht's Mylenium website (www.adobe.com/go/learn_ae_lutzplugins).

For information on developing plug-ins for After Effects, visit the Adobe website at www.adobe.com/go/learn_ae_devcenter.

Plug-ins compiled for the Macintosh PowerPC processor architecture do not run natively on Macintosh computers that use Intel processors. To use plug-ins compiled for the PowerPC processor architecture, you can run After Effects CS3 under Rosetta. Rosetta is a software translator for Mac OS X that runs applications for PowerPC processors on Intel processors. As with any application running in an emulation environment, performance is not as good as it would be in the native environment.

See also

“Introduction to Camera Raw” on page 86

“About effects” on page 348

Work with scripts

A *script* is a series of commands that tells an application to perform a series of operations. You can use scripts in most Adobe applications to automate repetitive tasks, perform complex calculations, and even access some functionality not directly exposed through the graphical user interface. For example, you can direct After Effects to reorder the layers in a composition, find and replace source text in text layers, or send an e-mail message when rendering is complete.

After Effects scripts use the Adobe ExtendScript language, which is an extended form of JavaScript, similar to ActionScript. ExtendScript files have the .jsx file-name extension.

When After Effects starts, it searches the Scripts folder for scripts to load. Loaded scripts are available from the File > Scripts menu. If you edit a script while After Effects is running, you must save your changes for the changes to be applied. If you place a script in the Scripts folder while After Effects is running, you must restart After Effects for the script to appear in the Scripts menu, though you can immediately run the new script using the Run Script File command.

After Effects provides several prewritten scripts to assist you in performing common tasks, and to provide a basis for you to modify and create your own scripts.

 *Run the sample script DemoPalette.jsx to get an idea of what sorts of things you can do with scripts. For example, the Reverse Layer Order script makes reversing the stacking order of layers in the Timeline panel much easier than reordering the layers manually.*

You can write your own scripts for use in After Effects by using the script editor, which is part of the ExtendScript Toolkit. The ExtendScript Toolkit provides a convenient interface for creating, debugging, and testing your own scripts.

Note: *Scripts created in After Effects 6.5 or earlier that use an index to access a property may not work as expected in After Effects 7 or later. To resolve this issue, modify your scripts so that they contain equivalent expressions accessing properties by name.*

The default is for scripts to not be allowed to write files or send or receive communication over a network. To allow scripts to write files and communicate over a network, choose Edit > Preferences > General (Windows) or After Effects > Preferences > General (Mac OS), and select the Allow Scripts To Write Files And Access Network option.

- To run a loaded script, choose File > Scripts > [script name]
- To run a script that has not been loaded, choose File > Scripts > Run Script File, locate and select a script, and click Open.
- To start the script editor, choose File > Scripts > Open Script Editor.

For a complete description of the scripting capabilities available with After Effects, see the After Effects Scripting Guide on the Adobe website at www.adobe.com/devnet/aftereffects.

To exchange scripts and other useful tools with other After Effects users, visit the After Effects Exchange on the Adobe website at www.adobe.com/go/learn_ae_exchange.

Jeff Almasol provides a collection of useful scripts on his website: www.adobe.com/go/learn_ae_redefineryhome.

Dan Ebberts provides scripting tutorials and useful scripts on his website: www.adobe.com/go/learn_ae_danscripting.

The AE Enhancers forum provides example scripts and useful information about scripting (as well as expressions and animation presets) in After Effects: www.adobe.com/go/learn_ae_aeenhancershome.

This tutorial on the AE Enhancers forum leads the reader step by step through the creation of a script: www.adobe.com/go/learn_ae_aeenhancersgettingstarted.

Chapter 4: Importing

Importing and interpreting footage items

Working with imported files

You import *footage items* into a project and use them as sources for layers. You work with collections of layers in a *composition* to animate, composite, and apply effects. You can import many different kinds of files, collections of files, or components of files as sources for individual footage items, including moving image files, still-image files, still-image sequences, and audio files. You can even create footage items yourself within After Effects, such as solids and precompositions. You can import footage items into a project at any time.

When you import files, After Effects does not copy the image data itself into your project but creates a reference link to the footage item in the Project panel. This keeps project files relatively small.

If you delete, rename, or move an imported source file, you break the reference link to that file. When a link is broken, the name of the source file appears in italics in the Project panel, and the File Path column lists it as missing. If the footage item is available, you can reestablish the link—usually just by double-clicking the item and selecting the file again.

To reduce rendering time and increase performance, it is often best to prepare footage before you import it into After Effects. For example, it is often better to scale or crop a still image in Photoshop before you bring it into After Effects, rather than scaling and cropping the image in After Effects. It is better to perform an operation once in Photoshop than to force After Effects to perform the same action many times per second—once for each frame in which the image appears.

You can use the Footage panel to evaluate footage and perform simple editing tasks, such as trimming a footage item's duration.

To save time and minimize the size and complexity of a project, import a footage item once and then use it multiple times in a composition. It is occasionally useful, however, to import a footage item more than once, such as when you want to use it at two different frame rates.

If you use another application to modify a footage item that is used in a project, the changes appear in After Effects the next time that you open the project or select the footage item and choose File > Reload Footage.

 *To replace a layer's source footage item with another footage item, without affecting edits made to the layer properties, select the layer and then Alt-drag (Windows) or Option-drag (Mac OS) the new footage item onto the layer in the Timeline panel.*

For introductions to digital video, digital audio, high-definition video, DVD, compression, and streaming video, visit the Adobe website at www.adobe.com/go/learn_dv_primers.

See also

“Create layers from footage items” on page 135

“Shortcuts for working with footage” on page 644

Supported import formats

Some file-name extensions—such as MOV and AVI—denote *container* file formats rather than denoting a specific audio, video, or image data format. Container files can contain data encoded using various compression and encoding schemes. After Effects can import these container files, but the ability to import the data that they contain is dependent on which codecs (specifically, decoders) are installed.

By installing additional codecs, you can extend the ability of After Effects to import additional file types. Most codecs must be installed into the operating system (Windows or Mac OS) and work as a component inside the QuickTime or Video for Windows formats. Contact the manufacturer of your hardware or software for more information about codecs that work with the files that your specific devices or applications create.

The Automatic Duck Pro Import AE tool extends your ability to import assets in various formats, including those used by popular non-linear editing systems. For more information, see the Automatic Duck website:

www.adobe.com/go/learn_ae_automaticduckpiae.

Audio formats

- Advanced Audio Coding (AAC, M4A)
- Audio Interchange File Format (AIF, AIFF)
- MP3 (MP3, MPEG, MPG, MPA, MPE)
- Video for Windows (AVI, WAV; requires QuickTime on Mac OS)
- Waveform (WAV)

Still-image formats

- Adobe Illustrator (AI, AI4, AI5, EPS, PS; continuously rasterized)
- Adobe PDF (PDF; first page only; continuously rasterized)
- Adobe Photoshop (PSD)
- Bitmap (BMP, RLE, DIB)
- Camera raw (TIF, CRW, NEF, RAF, ORF, MRW, DCR, MOS, RAW, PEF, SRF, DNG, X3F, CR2, ERF)
- Cineon (CIN, DPX; converts to project's color bit depth: 8, 16, or 32 bpc)
- Discreet RLA/RPF (RLA, RPF; 16 bpc, imports camera data)
- EPS
- GIF
- JPEG (JPG, JPE)
- Maya camera data (MA)
- Maya IFF (IFF, TDI; 16 bpc)
- OpenEXR (EXR; 32 bpc)

Note: Plug-ins from *fnord* software provide access to multiple layers and channels of OpenEXR files:

www.adobe.com/go/learn_ae_fnordproexr.

- PCX
- PICT (PCT)
- Pixar (PXR)
- Portable Network Graphics (PNG; 16 bpc)

- Radiance (HDR, RGBE, XYZE; 32 bpc)
- SGI (SGI, BW, RGB; 16 bpc)
- Softimage (PIC)
- Targa (TGA, VDA, ICB, VST)
- TIFF (TIF)

 You can import files of any still-image format as a sequence. See “Importing still images” on page 80.

Video and animation formats

- Animated GIF (GIF)
- DV (in MOV or AVI container, or as containerless DV stream)
- ElectricImage (IMG, EI)
- Filmstrip (FLM)
- Flash (SWF; continuously rasterized)

Note: SWF files are imported with an alpha channel. Interactive content and scripted animation are not retained. Animation defined by keyframes is retained.

- Media eXchange Format (MXF; Op-Atom variety used by Panasonic DV, DVCPRO, DVCPRO50, and DVCPRO HD video cameras to record to Panasonic P2 media)
- MPEG-1, MPEG-2, and MPEG-4 formats (MPEG, MPE, MPG, M2V, MPA, MP2, M2A, MPV, M2P, M2T, AC3, MP4, M4V, M4A)

Note: Some MPEG data formats are stored in container formats with file-name extensions that are not recognized by After Effects; examples include .vob and .mod. In some cases, you can import these files into After Effects after changing the file-name extension to one of the recognized file-name extensions. Due to variations in implementation in these container formats, compatibility is not guaranteed.

- Open Media Framework (OMF; raw media [or essence] only; Windows only)
- QuickTime (MOV; 16 bpc, requires QuickTime)
- Adobe Photoshop with video layer (PSD; requires QuickTime)
- Video for Windows (AVI, WAV; requires QuickTime on Mac OS)

 You can import 10-bpc uncompressed YUV AVI files created in Adobe Premiere Pro into 16-bpc RGB After Effects projects. You can also render with 10-bpc YUV compression. (See “Specify Video for Windows compression options” on page 620.)

- Windows Media File (WMV, WMA, ASF; Windows only)

Project formats

- Advanced Authoring Format (AAF; Windows only)
- Adobe Premiere 6.0 and 6.5 (PP)
- Adobe Premiere Pro 1.0, 1.5, 2.0, CS3 (PRPROJ; 1.0, 1.5, and 2.0 Windows only)
- Adobe After Effects 4.0 and later (AEP, AET)
- XML Forms Data Format (XFDF; for importing of Clip Notes comments)

For information on importing Apple Motion projects into After Effects, see the Apple website: www.adobe.com/go/learn_ae_importmotionprojects.

See also

“Supported output formats” on page 588

“Import assets in Panasonic P2 format” on page 73

Import footage items

You can import media files into your project either by using the Import dialog box or by dragging. If the Interpret Footage dialog box appears after you import a footage item, it contains an unlabeled alpha channel, and you must select an alpha channel interpretation method or click Guess to let After Effects determine how to interpret the alpha channel.

Imported footage items appear in the Project panel.

See also

“Specify alpha channel interpretation” on page 52

“Import a single still image or a still-image sequence” on page 81

“Shortcuts for working with footage” on page 644

Import footage items using the Import dialog box

1 Choose File > Import > File or File > Import > Multiple Files, or double-click an empty area of the Project panel. If you choose Import Multiple Files, then you can perform the next step more than once without needing to choose an Import command multiple times.



To display only supported footage files (excluding project files), choose All Footage Files from the Files Of Type (Windows) or Enable (Mac OS) menu.

2 Do one of the following:

- Select a file, and then click Open.
- Ctrl-click (Windows) or Command-click (Mac OS) multiple files to select them, and then click Open.
- Click a file and then Shift-click another file to select a range of files, and then click Open.
- Select an entire folder, and then click Import Folder.

Note: *If the Sequence option is selected, multiple files from the folder will be imported as a sequence of still images.*

Import footage items by dragging



If you always want the layered footage that you drag into After Effects to be imported as a composition, choose Edit > Preferences > Import (Windows) or After Effects > Preferences > Import (Mac OS), and choose Comp from the Default Drag Import As menu.

- To import the contents of a folder as a sequence of still images that appear in the Project panel as a single footage item, drag a file or a folder from Windows Explorer (Windows) or the Finder (Mac OS) into the Project panel.
- To import the contents of the folder as individual footage items that appear in the Project panel in a folder, Alt-drag a folder from Windows Explorer (Windows) or Option-drag a folder from the Finder (Mac OS) into the Project panel.

Interpret footage items

After Effects uses a set of internal rules to *interpret* each footage item that you import according to its best guess for the source file's pixel aspect ratio, frame rate, color profile, and alpha channel type. If After Effects guesses wrong, or if you want to use the footage differently, you can modify these rules for all footage items of a particular kind by editing the interpretation rules file (interpretation.rules.txt), or you can modify the interpretation of a specific footage item using the Interpret Footage dialog box.

The interpretation settings tell After Effects the following about each footage item:

- How to interpret the alpha channel's interaction with other channels. (See "Specify alpha channel interpretation" on page 52.)
- What frame rate to assume for the footage item. (See "Change frame rate" on page 53.)
- Whether to separate fields and, if so, what field order to assume. (See "Separate video fields" on page 71 and "Determine the original field order" on page 72.)
- Whether to remove 3:2 or 24Pa pulldown. (See "Remove 3:2 or 24Pa pulldown from video" on page 72.)
- The pixel aspect ratio of the footage item. (See "Change pixel aspect ratio" on page 55.)
- The color profile of the footage item. (See "Interpret a footage item by assigning an input color profile" on page 245.)

Important: *In all of these cases, the information is used to make decisions about how to interpret data in the imported footage item. The interpretation settings in the Interpret Footage dialog box should match the settings used to create the source footage file. These settings are not to be used to specify settings for your final rendered output.*

Generally, you don't need to change interpretation settings. However, if a footage item isn't of a common kind, After Effects may need additional information from you to interpret it correctly.

You can use the controls in the Color Management section of the Interpret Footage dialog box to tell After Effects how to interpret the color information in a footage item. This is usually only necessary when the footage item does not contain an embedded color profile.

See also

"Shortcuts for working with footage" on page 644

Interpret a single footage item using the Interpret Footage dialog box

- ❖ Select a footage item in the Project panel and choose File > Interpret Footage > Main.

Apply Interpret Footage settings to multiple footage items

You can ensure that different footage items use the same settings by copying interpretation settings from one item and applying them to others.

- 1 In the Project panel, select the item with the interpretation settings that you want to apply.
- 2 Choose File > Interpret Footage > Remember Interpretation.
- 3 Select one or more footage items in the Project panel.
- 4 Choose File > Interpret Footage > Apply Interpretation.

Edit interpretation rules for all items of a specific kind

The interpretation rules file contains the rules that specify how After Effects interprets footage items. In most cases, you won't need to customize the interpretation rules file. When you import a footage item, After Effects looks for a match in the interpretation rules file, and then determines interpretation settings for the footage item. You can override these settings after importing, using the Interpret Footage dialog box.

In most cases, the name of the interpretation rules file is *interpretation.rules.txt*; however, some updates to After Effects install a new interpretation rules file with a name that indicates the updated version number, and the updated application uses this new file. If you have made changes to the old interpretation rules file, you may need to apply those changes to the new file, too.

- 1 Quit After Effects.
- 2 As a precaution, make a backup copy of the interpretation rules file. By default, this file is in the same location as the After Effects application.
- 3 Open the interpretation rules file in a text editor.
- 4 Modify the settings according to the instructions in the file.

Note: You must supply a four-character file-type code for each footage type or codec. If you don't know the code for a file or codec in a project, press **Alt** (Windows) or **Option** (Mac OS) as you select the file in the Project panel. The file-type code and codec code (if the file is compressed) appear in the last line of the file description at the top of the Project panel.

- 5 Save interpretation.rules.txt in the same folder as the After Effects application.

Specify alpha channel interpretation

Alpha channels store transparency information in one of two ways: straight or premultiplied. Although the alpha channels are the same, the color channels differ. *Straight* (unmatted) channels store transparency information only in the alpha channel, not in any of the visible color channels. *Premultiplied* (matted) channels store transparency information in the alpha channel and also in the visible RGB channels, which are multiplied with a background color. The colors of semitransparent areas, such as feathered mask edges, are shifted toward the background color in proportion to their degree of transparency.

Setting the alpha channel interpretation correctly can prevent problems when you import a file, such as undesirable colors at the edge of an image or a loss of image quality at the edges of the alpha channel. For example, if channels are interpreted as straight when they are actually premultiplied, semitransparent areas will retain some of the background color. If a color inaccuracy, such as a halo, appears along the semitransparent edges in a composition, try changing the interpretation method.



A footage item with premultiplied channels (top) appears with a black halo when interpreted as Straight-Unmatted (bottom left). When the footage item is interpreted as Premultiplied-Matted With Color and the background color is specified as black, the halo does not appear (bottom right).

See also

“About straight and premultiplied channels” on page 253

Set the alpha channel interpretation for a footage item

- 1 In the Project panel, select a footage item.
- 2 Choose File > Interpret Footage > Main.
- 3 If you want to switch the opaque and transparent areas of the image, select Invert Alpha.
- 4 In the Alpha section, select an interpretation method:

Guess Attempts to determine the type of channels used in the image. If After Effects cannot guess confidently, it beeps.

Ignore Disregards transparency information contained in alpha channel.

Straight - Unmatted Interprets the channels as straight.

Premultiplied - Matted With Color Interprets channels as premultiplied. Use the eyedropper or color picker to specify the color of the background with which the channels were premultiplied.

Set the default alpha channel preferences

- 1 Choose Edit > Preferences > Import (Windows) or After Effects > Preferences > Import (Mac OS).
- 2 Choose options from the Interpret Unlabeled Alpha As menu. The options in this menu are similar to the options in the Interpret Footage dialog box. Ask User specifies that the Interpret Footage dialog box opens each time a footage item with an unlabeled alpha channel is imported.

Change frame rate

The composition frame rate determines the number of frames displayed per second, and how time is divided into frames in the time ruler and time display. Composition frame rate is usually determined by the type of output that you are targeting. NTSC video has a frame rate of 29.97 frames per second (fps), PAL video has a frame rate of 25 fps, and motion picture film typically has a frame rate of 24 fps. Depending on the broadcast system, DVD video can have the same frame rate as NTSC video or PAL video, or a frame rate of 23.976. Cartoons and video intended for CD-ROM or the web are often 10 to 15 fps.

 *Setting the composition frame rate to twice the rate of the output format causes After Effects to display each field of interlaced source footage as its own, separate frame in the Composition panel. This process lets you set keyframes on individual fields and gain precision when animating masks.*

When you render a movie for final output, you can choose to use the composition frame rate or another frame rate. This is useful when you are using the same composition to create output for multiple media.

Each motion-footage item in a composition can also have its own frame rate. The relationship between the footage-item frame rate and the composition frame rate determines how smoothly the layer plays. For example, if the footage-item frame rate is 30 fps and the composition frame rate is 30 fps, then whenever the composition advances one frame, the next frame from the footage item is displayed. If the footage-item frame rate is 15 fps and the composition frame rate is 30 fps, then each frame of the footage item appears in two successive frames of the composition. (This assumes, of course, the simple case in which no time stretching or frame blending has been applied to the layer.)

Ideally, use source footage that matches the final output frame rate. This way, After Effects renders each frame, and the final output does not omit or duplicate frames. If, however, the source footage has a frame rate slightly different from what you want to output to (for example, 30-fps footage and 29.97-fps final output), you can make the footage frame rate match the composition frame rate by *conforming* it.

Conforming the frame rate of a footage item does not alter the original file, only the reference that After Effects uses. When conforming, After Effects changes the internal duration of frames but not the frame content. Afterward, the footage plays back at a different speed. For example, if you conform the frame rate from 15 fps to 30 fps, the footage plays back twice as fast. In most cases, conform the frame rate only when the difference between the footage frame rate and the output frame rate is small.

Note: *Conforming can change the synchronization of visual footage that has an audio track, because changing the frame rate changes the duration of the video but leaves the audio unchanged. If you want to stretch both audio and video, use the Time Stretch command. (See “Time-stretch a layer” on page 218.) Keyframes applied to the source footage remain at their original locations (which retains their synchronization within the composition but not the visual content of the layer). You may need to adjust keyframe locations after conforming a footage item.*

You can change the frame rate for any movie or sequence of still images. For example, you can import a sequence of ten still images and specify a frame rate for that footage item of 5 frames per second (fps); this sequence would then have a duration of two seconds when used in a composition.

Note: *If you remove 3:2 pulldown from interlaced video footage, After Effects automatically sets the frame rate of the resulting footage item to four-fifths of the original frame rate. When removing 3:2 pulldown from NTSC video, the resulting frame rate is 24 fps.*

The composition's frame rate should match that of the final output format. In most cases, you can simply choose a composition settings preset. In contrast, set the frame rate for each footage item to that of the original source footage.

See also

“Work with render settings” on page 597

“Converting movies” on page 630

Change frame rate for a footage item

- 1 Select the footage item in the Project panel.
- 2 Choose File > Interpret Footage > Main.
- 3 Select Conform To Frame Rate, enter a new frame rate for Frames Per Second, and then click OK.

Change frame rate for a composition

- 1 Choose Composition > Composition Settings.
- 2 Do one of the following:
 - Choose a composition settings preset from the Preset menu.
 - Set the Frame Rate value.

Note: Jeff Almasol provides a script to set the frame rate and duration of the current composition and all compositions nested within it: www.adobe.com/go/learn_ae_jeffcompsetter.

Change pixel aspect ratio

Pixel aspect ratio is the ratio of width to height of one pixel in an image. *Frame aspect ratio* is the ratio of width to height of the frame dimensions of an image.

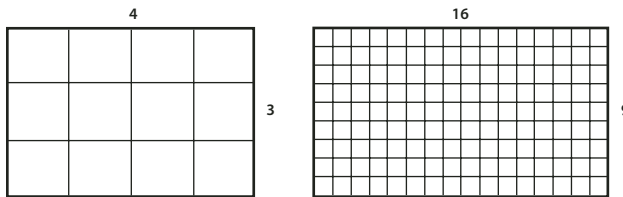

A 4:3 frame aspect ratio (left), and a wider 16:9 frame aspect ratio (right)

Most computer monitors use square pixels, but many video formats—including ITU-R 601 (D1) and DV—use non-square rectangular pixels.

Some video formats output the same frame aspect ratio but use a different pixel aspect ratio. For example, some NTSC digitizers produce a 4:3 frame aspect ratio, with square pixels (1.0 pixel aspect ratio), and a resolution of 640 x 480. D1 NTSC produces the same 4:3 frame aspect ratio but uses nonsquare pixels (0.9 pixel aspect ratio) and a resolution of 720 x 486. D1 pixels, which are always nonsquare, are vertically oriented in systems producing NTSC video and horizontally oriented in systems producing PAL video.

If you display nonsquare pixels on a square-pixel monitor without alteration, images and motion appear distorted; for example, circles distort into ellipses. However, when displayed on a broadcast monitor, the images are correct. When you import D1 NTSC or DV source footage into After Effects, the image looks slightly wider than it does on a D1 or DV system. (D1 PAL footage looks slightly narrower.) The opposite occurs when you import anamorphic footage using D1/DV NTSC Widescreen or D1/DV PAL Widescreen. Widescreen video formats have a frame aspect ratio of 16:9.

Note: To preview non-square pixels on a computer monitor, click the Toggle Pixel Aspect Ratio Correction button  at the bottom of the Composition panel.

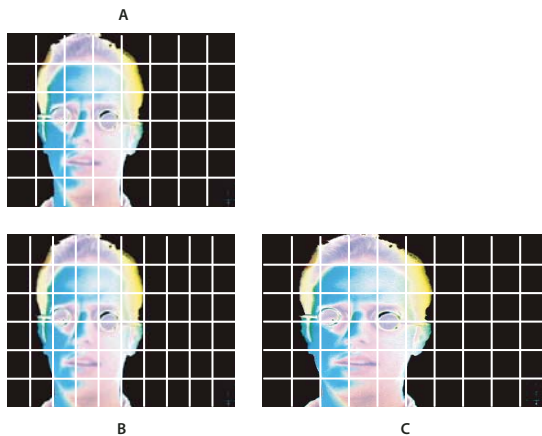

Square and nonsquare pixels

A. Square pixels and 4:3 frame aspect ratio B. Nonsquare pixels and 4:3 frame aspect ratio C. Nonsquare pixels displayed on a square-pixel monitor

If a footage item uses nonsquare pixels, After Effects displays the pixel aspect ratio next to the footage item's thumbnail image in the Project panel. You can change the pixel aspect ratio interpretation for individual footage items in the Interpret Footage dialog box. By ensuring that all footage items are interpreted correctly, you can combine footage items with different pixel aspect ratios in the same composition.

After Effects reads and writes pixel aspect ratios directly from QuickTime movies. For example, if you import a movie captured as widescreen (16:9 DV), After Effects automatically tags it correctly. Similarly, AVI and PSD files contain information that explicitly indicates the pixel aspect ratio of the images.

If a footage item does not contain information that explicitly indicates the image's pixel aspect ratio, After Effects uses the dimensions of the footage item's frame to make a guess. When you import a footage item with either the D1 resolution of 720 x 486 or the DV resolution of 720 x 480, After Effects automatically interprets that footage item as D1/DV NTSC. When you import a footage item with the D1 or DV resolution of 720 x 576, After Effects automatically interprets that footage item as D1/DV PAL. However, you can make sure that all files are interpreted correctly by looking in the Project panel or the Interpret Footage dialog box.

Note: Make sure to reset the pixel aspect ratio to Square Pixels when you import a square-pixel file that happens to have a D1 or DV resolution—for example, a non-DV image that happens to have a resolution of 720 x 480.

The composition's pixels aspect ratio setting should match that of the final output format. In most cases, you can simply choose a composition settings preset. In contrast, set the pixel aspect ratio for each footage item to that of the original source footage.

See also

"Common pixel aspect ratios" on page 57

Change pixel aspect ratio for a footage item

- 1 Select a footage item in the Project panel.
- 2 Choose File > Interpret Footage > Main.
- 3 Choose a ratio from the Pixel Aspect Ratio menu and click OK.

Change pixel aspect ratio for a composition

- 1 Choose Composition > Composition Settings.
- 2 Do one of the following:
 - Choose a composition settings preset from the Preset menu.
 - Choose a value from the Pixel Aspect Ratio menu.

Common pixel aspect ratios

Asset	Pixel aspect ratio	When to use
Square pixels	1.0	Footage has a 640 x 480 or 648 x 486 frame size, is 1920 x 1080 HD (not HDV or DVCPRO HD), is 1280 x 720 HD or HDV, or was exported from an application that doesn't support nonsquare pixels. This setting can also be appropriate for footage that was transferred from film or for customized projects.
D1/DV NTSC	0.9	Footage has a 720 x 486 or 720 x 480 frame size, and the desired result is a 4:3 frame aspect ratio. This setting can also be appropriate for footage that was exported from an application that works with nonsquare pixels, such as a 3D animation application.
D1/DV NTSC Widescreen	1.2	Footage has a 720 x 486 or 720 x 480 frame size, and the desired result is a 16:9 frame aspect ratio.
D1/DV PAL	1.0666	Footage has a 720 x 576 frame size, and the desired result is a 4:3 frame aspect ratio.
D1/DV PAL Widescreen	1.422	Footage has a 720 x 576 frame size, and the desired result is a 16:9 frame aspect ratio.
Anamorphic 2:1	2.0	Footage was shot using an anamorphic film lens, or it was anamorphically transferred from a film frame with a 2:1 aspect ratio.
HDV 1080/DVCPRO HD 720 (After Effects), HD Anamorphic 1080 (Adobe Premiere Pro)	1.33	Footage has a 1440 x 1080 or 960 x 720 frame size, and the desired result is a 16:9 frame aspect ratio.
DVCPRO HD 1080 (After Effects only)	1.5	Footage has a 1280 x 1080 frame size, and the desired result is a 16:9 frame aspect ratio.

Use square-pixel footage for output to D1/DV NTSC

If you intend to create a movie for the D1 output format, use the D1 NTSC or D1 PAL composition settings preset. The correct pixel aspect ratio for D1 NTSC or D1 PAL is chosen automatically when you choose the corresponding composition settings preset.

- 1 Prepare square-pixel footage that fills the entire frame for any of the following final output formats:
 - DV NTSC** Create and save it at a 720 x 534 frame size.
 - D1 NTSC** Create and save it at a 720 x 540 frame size.
 - D1/DV PAL** Create and save it at a 768 x 576 frame size.
- 2 Import the file into After Effects.
- 3 (Optional) If your square-pixel footage was created and saved at 720 x 486 or 720 x 480, select it and choose File > Interpret Footage > Main. Then choose Square Pixels from the Pixel Aspect Ratio menu and click OK.

- 4 Choose Composition > New Composition, and then do one of the following:
 - If your final output is DV, choose NTSC DV, 720 x 480 for Preset, and D1/DV NTSC (0.9) for Pixel Aspect Ratio.
 - If your final output is D1, choose NTSC D1, 720 x 486 for Preset, and D1/DV NTSC (0.9) for Pixel Aspect Ratio.
- 5 Select your other composition settings as desired, and then click OK.
- 6 Add your footage to the new composition.
- 7 Select the layer containing the square-pixel footage and apply the Fit To Comp command: press Ctrl+Alt+F (Windows) or Command+Option+F (Mac OS).

Note: If your footage was created and saved at a frame size other than those noted in step 1, skip step 7.

See also

“Change pixel aspect ratio” on page 55

Working with footage items

Organize and view items in the Project panel

Compositions and footage items are listed in the Project panel. Unlike items in the Timeline panel and Effect Controls panel, the order of items in the Project panel has no influence on the appearance of the movies that you create. This means that you can organize footage items and compositions however you like, including organizing them using folders. Solids are automatically placed in the Solids folder.

Folders that you create in the Project panel exist only in the Project panel. You can expand a folder to reveal its contents, and put folders inside other folders. To move a file or folder to the top level of the Project panel, drag it to the gray information area at the top of the panel.

You can use the File > Collect Files command to gather copies of all files in a project into a single folder.

See also

“Collect files in one location” on page 594

“Work with color labels” on page 149

“Shortcuts for working with projects” on page 639

Show information for items

- To show information about a footage item or composition, select it in the Project panel. Information is displayed at the top of the Project panel next to the thumbnail image.
- To show the file creator ID for a footage item, Alt-click (Windows) or Option-click (Mac OS) it in the Project panel.

Create a folder

- ❖ Choose File > New > New Folder, or click the Create Folder icon  at the bottom of the Project panel.

Rename and sort items

- To rename a composition, footage item, or folder, select it in the Project panel, press Enter (Windows) or Return (Mac OS), type the new name, and then press Enter or Return again.

Note: The names of items in the Project panel can be no more than 31 characters long. The same is true for names of layers, effects, and property groups in the Timeline panel and Effect Controls panel.

- To rename the Comments column, right-click (Windows) or Control-click (Mac OS) the column heading and choose Rename This.

 You can use the Comments column to create a custom sorting option. Rename the column, enter corresponding information for each item (for example, camera number), and then sort by that column.

- To sort items by entries in any column, click the column name in the Project panel.

Copy items

- To duplicate or copy an item in the Project panel, select it and choose Edit > Duplicate or Edit > Copy.
- To copy a footage item to Windows Explorer (Windows) or the Finder (Mac OS), drag the footage item from the Project panel to the desktop.

Find and view items in the Project panel





- To find items in the Project panel, choose File > Find, or click the Find  button at the bottom left of the panel. Select Find Missing Footage to locate all footage items that refer to a file that has been moved, deleted, or renamed.
- To find the next item that matches the most recently used search criteria, Alt-click (Windows) or Option-click (Mac OS) the Find button.

Working with footage items in the Footage panel

When you double-click a movie in the Project panel, it opens by default in the Footage panel or in a player window: QuickTime (.mov) files open in a QuickTime Player window; Video for Windows (.avi) files open in a Video for Windows player window. Still images always appear in the Footage panel. Certain AVI files are not supported by the AVI player window, and will open in the After Effects Footage panel. These include files created with Microsoft's DirectX DV codec and all files over 2 GB.

 To open a QuickTime or Video for Windows movie in the Footage panel instead of a player window, Alt-double-click (Windows) or Option-double-click (Mac OS) the footage item in the Project panel.

The QuickTime and Video for Windows player windows play the source file, not the edited and interpreted footage item based on the source file.

You can use the Set In Point , Set Out Point , Ripple Insert Edit , and Overlay Edit  controls in the Footage panel to trim a footage item and insert it into a composition. This can be more convenient than adding the footage item to a composition and then trimming in the Timeline panel.

See also

“Trim, extend, or slip-edit a layer” on page 141

“Shortcuts for working with footage” on page 644

Reveal footage items

- To reveal where a footage item is used in a composition, right-click (Windows) or Control-click (Mac OS) the footage item in the Project panel and choose Reveal In Composition; then select the specific instance you want to reveal (*composition name, layer name*).
- To reveal a layer's source footage item in the Project panel, right-click (Windows) or Control-click (Mac OS) the layer in the Timeline panel, and then choose Reveal Layer Source In Project.
- To reveal a footage item's location in Adobe Bridge, Windows Explorer, or the Finder, right-click (Windows) or Control-click (Mac OS) the footage item in the Project panel and choose Reveal In Bridge, Reveal In Windows Explorer, or Reveal In Finder.

Refresh footage items

- ❖ To refresh footage items selected in the Project panel to use the current versions of the source footage files, choose File > Reload Footage.

Edit footage in its original application

You can open and edit a footage item in the application in which it was created, directly from an After Effects project. The original application must be installed on the computer that you are using, which must have enough available RAM for it to run. When you edit and save changes to the footage in the original application, the changes are applied to all instances of the footage when After Effects becomes the active application.

Note: If you're editing footage that has an alpha channel, make sure that you're viewing and editing all of the channels, including the alpha channel, in the other application. Otherwise, changes you make might not be applied to the alpha channel, and it may become misaligned with the color channels.

When you edit a still-image sequence selected in the Timeline or Composition panel, the individual image that is currently displayed opens. When you edit a still-image sequence selected in the Project panel, the first image in the sequence opens.

- 1 In the Project panel, Composition panel, or Timeline panel, select the footage item or a layer that uses the footage item as its source. If you selected a still-image sequence from the Composition or Timeline panel, move the current-time indicator to the frame displaying the still image you want to edit.
- 2 Choose Edit > Edit Original.
- 3 Edit the footage in its original application, and save the changes.

Remove items from a project

- To remove an item from a project, select the item in the Project panel and press Delete.
- To remove all unused footage items from a project, choose File > Remove Unused Footage.
- To remove all duplicate footage items from a project, Choose File > Consolidate All Footage. Note that After Effects considers footage items to be duplicates only if they use the same Interpret Footage settings.

When a duplicate item is removed, layers that refer to the duplicate item are updated to refer to the remaining copy.

- To remove unselected compositions and unused footage items from selected compositions in the Project panel, choose File > Reduce Project. This command is available only when the Project panel is active, and removes both unused footage items and all other compositions that are not included within a selected composition as nested (subordinate) compositions.

If the selected composition includes items that are turned off (that is, the Video or Audio switch is deselected in the Timeline panel), the Reduce Project command does not remove those items.

If an expression in a selected composition refers to an element in a nonsubordinate composition, Reduce Project removes the nonsubordinate composition and the applied expression. A message appears after you choose Reduce Project to remind you of this possibility, so you can undo the command if needed. To avoid removing the expressions from a nonsubordinate composition, drag the nonsubordinate composition into the composition that refers to it. Then deselect the Audio and Video switches for the composition that you added.

Work with placeholders and proxies

When you want to temporarily use a substitute for a footage item, use either a *placeholder* or a *proxy*.

Placeholder A still image of color bars used to temporarily take the place of a missing footage item. Use a placeholder when you are building a composition and want to try out ideas for a footage item that is not yet available. After Effects generates placeholders automatically, so you do not have to provide a placeholder footage item.

Proxy Any file used to temporarily replace a footage item, but most often a lower-resolution or still version of an existing footage item used to replace the original. Often, storyboard images are used as proxies. You can use a proxy either before you have the final footage or when you have the actual footage item but you want to speed up previewing or rendering of test movies. You must have a file available to use as a proxy.

Any masks, attributes, expressions, effects, and keyframes that you apply to the layer are retained when you replace its placeholder or proxy with the final footage item.

In the Project panel, After Effects marks the footage name to indicate whether the actual footage item or its proxy is currently in use:

- A box containing a black square indicates that a proxy item is currently in use throughout the project; the name of the proxy appears in boldface in the project list.
- An empty box indicates that the actual footage item is in use throughout the project.
- No box indicates that no proxy is assigned to the footage item.

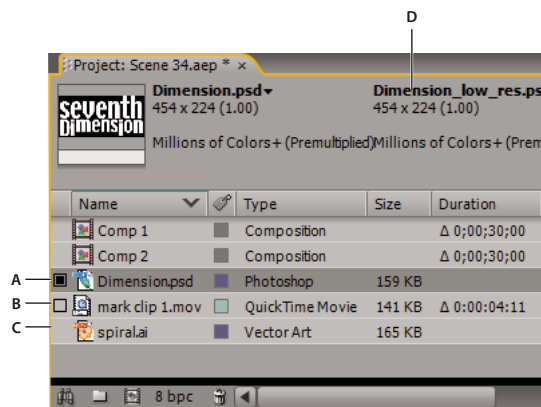

Proxy items in Project panel

A. Proxy assigned and in use B. Proxy assigned, but original in use C. No proxy assigned D. Proxy name

See also

“Work with render settings” on page 597

“Use a post-render action” on page 602

Work with placeholders and missing footage items

For best results, set the placeholder to exactly the same size, duration, and frame rate as the actual footage.

If After Effects cannot find source footage when you open a project, the footage item appears in the Project panel labeled Missing, and the name of the missing footage appears in italics. Any composition using that item replaces it with a placeholder. You can still work with the missing item in the project, and any effects you applied to the original footage remain intact. When you replace the placeholder with the source footage, After Effects places the footage in its correct location in all the compositions that use it.

- To use a placeholder, choose File > Import > Placeholder.
- To replace the selected footage item with a placeholder, choose File > Replace Footage > Placeholder.
- To replace a placeholder with the actual footage item, select the placeholder you want to replace in the Project panel, choose File > Replace Footage > File, and locate the actual footage.

Work with proxies for footage items

When you use a proxy, After Effects replaces the actual footage with the proxy in all compositions that use the actual footage item. When you finish working, you can switch back to the actual footage item in the project list. After Effects then replaces the proxy with the actual footage item in any composition.

When you render your composition as a movie, you may choose to use either all the actual high-resolution footage items or their proxies. You might want to use the proxies for a rendered movie if, for example, you simply want to test motion using a rough movie that renders quickly.

For best results, set a proxy so that it has the same aspect ratio as the actual footage item. For example, if the actual footage item is a 640 x 480-pixel movie, create and use a 160 x 120-pixel proxy. When a proxy item is imported, After Effects scales the item to the same size and duration as the actual footage. If you create a proxy with an aspect ratio that is different from that of the actual footage item, scaling will take longer.

❖ In the Project panel, do any of the following:

- To locate and use a proxy, select a footage item, choose File > Set Proxy > File, locate and select the file you want to use as a proxy, and click Open.
- To toggle between using the original footage and its proxy, click the proxy indicator to the left of the footage name.
- To stop using a proxy, select the original footage item, and choose File > Set Proxy > None.

Create a proxy

Use the Create Proxy command to create a proxy from footage or compositions selected in the Project panel or the Timeline panel. This command adds the selected footage to the Render Queue panel and sets the Post-Render Action option to Set Proxy.

- 1 Select a footage item or composition in the Project or Timeline panel.
- 2 Choose one of the following commands:
 - File > Create Proxy > Still to create a still image proxy.
 - File > Create Proxy > Movie to create a moving image proxy.
- 3 Specify a name and output destination for the proxy.
- 4 In the Render Queue panel, specify render settings, and click Render.

Note: To create a still image proxy from a movie or sequence footage item, open the footage item in the Footage panel and set as the poster frame the frame that you want to use as the proxy.

Create placeholders for output

You can create placeholder files that can be used in different compositions. For example, you can create a placeholder for an item in the render queue that will create a 24-fps movie and then drag that placeholder into a 30-fps composition. Then, when you render the 30-fps composition, After Effects first renders the placeholder at 24 fps and uses this rendered version as it renders the 30-fps composition.

❖ Drag the Output Module heading for a queued item from the Render Queue panel to the Project panel. After Effects creates a placeholder for output in the Project panel and sets the Post-Render Action option for the item to Import & Replace Usage.

Loop a footage item

If you intend to loop a visual footage item continuously in your project, you only need to create one cycle of the footage item in After Effects.

- 1 In the Project panel, select the footage item to loop.
- 2 Choose File > Interpret Footage > Main.
- 3 Type an integer value for Loop and click OK.

Importing from After Effects and Adobe Premiere Pro

Import an After Effects project

You can import one After Effects project into another. Everything from the imported project, including footage items, compositions, and folders, appears inside a new folder in the current Project panel.

You can import an After Effects project from a different operating system, as long as you maintain the file names, folder names, and either full or relative paths (folder locations) for all files in the project. To maintain relative paths, the source footage files must reside on the same volume as the project file. Use the File > Collect Files command to gather copies of all files in a project or composition into a single location.

***Note:** When you render a movie and export it to the QuickTime (MOV) or Video for Windows (AVI) container format, you can embed the After Effects project or a link to the project in the container file. To import the project, import the MOV or AVI file, and choose Project from the Import As menu in the Import File dialog box. If the file contains a link to a project that has been moved, you can browse to locate the project.*

- 1 Choose File > Import > File.
- 2 Select the After Effects project to import, and click Open.

If a file format is not supported by the operating system that you are using, if the file is missing, or if the reference link is broken, After Effects substitutes a placeholder item containing color bars. You can reconnect the placeholder to the appropriate file by double-clicking the entry in the Project panel and navigating to the source file. In most cases, you need to relink only one footage file. After Effects locates other missing items if they're in the same location.

See also

“Collect files in one location” on page 594

“Work with placeholders and proxies” on page 61

Import an Adobe Premiere Pro project

The ability to import Adobe Premiere Pro projects into After Effects eliminates the need to render the project in Premiere Pro before applying visual effects and animations in After Effects. When you import an Adobe Premiere Pro project, After Effects imports it into the Project panel as both a new composition containing each Adobe Premiere Pro clip as a layer, and as a folder containing each clip as an individual footage item. If your Adobe Premiere Pro project contains bins, After Effects converts them to folders within the Adobe Premiere Pro project folder. After Effects converts nested sequences to nested compositions. You can also import Adobe Premiere 6.0 and 6.5 projects into After Effects.

Note: *After Effects on Mac OS can't import Adobe Premiere Pro 1.0, 1.5, or 2.0 projects. After Effects on Mac OS can import Adobe Premiere Pro CS3 and Adobe Premiere 6.0 and 6.5 projects.*

After Effects preserves the order of clips in the timeline, the footage duration (including all trimmed In and Out points), and marker and transition locations. After Effects bases the arrangement of layers in the Timeline panel on the arrangement of clips in the Adobe Premiere Pro Timeline panel. After Effects adds Adobe Premiere Pro clips to the Timeline panel as layers in the order they appeared—from the bottom up and from left to right—in the Adobe Premiere Pro Timeline panel. After Effects preserves changes made to the speed of a clip, for example, with the Clip > Speed command, and these changes appear as a value in the Stretch column in the After Effects Timeline panel.

After Effects imports effects common to Adobe Premiere Pro and After Effects, and preserves keyframes for these effects. If you're working in Adobe Premiere Pro, an After Effects icon in the Effects panel denotes common effects used by both applications.

Transitions and titles (except for dissolves) included in your Adobe Premiere Pro project appear in the After Effects composition as solid layers with their original location and duration.

Audio Level keyframes are preserved.

- 1 Choose File > Import > File.
- 2 Select an Adobe Premiere Pro or Adobe Premiere project, and click OK.
- 3 Do any of the following:
 - To import only one sequence, choose a sequence from the menu.
 - To import audio, select Import Audio.



To add a single item from a track in an Adobe Premiere Pro project, copy the item in Adobe Premiere Pro, and choose Edit > Paste in After Effects.

See also

“Copy between After Effects and Adobe Premiere Pro” on page 65

“About nesting and precomposing” on page 113

Use Adobe Premiere Pro for capture (Production Premium only)

If you have Adobe Creative Suite 3 Production Premium, you can start Adobe Premiere Pro from inside After Effects and use it to capture footage for use in your After Effects project.

- ❖ Choose File > Import > Capture In Adobe Premiere Pro.

Copy between After Effects and Adobe Premiere Pro

You can copy and paste layers and assets between Adobe After Effects and Adobe Premiere Pro. For a video on the workflow between After Effects and Adobe Premiere Pro, see www.adobe.com/go/vid0256.

- From the After Effects Timeline panel, you can copy footage layers or solid layers and paste them into the Adobe Premiere Pro Timeline panel.
- From the Adobe Premiere Pro Timeline panel, you can copy assets (any items in a track) and paste them into the After Effects Timeline panel.
- From either After Effects or Adobe Premiere Pro, you can copy and paste footage to the other's Project panel.

Note: You can't, however, paste footage from the After Effects Project panel into the Adobe Premiere Timeline panel.

If you want to work with all clips or a single sequence from an Adobe Premiere Pro project, use the Import command instead to import the project into After Effects.



Use Adobe Dynamic Link to create dynamic links, without rendering, between new or existing compositions in After Effects and Adobe Premiere Pro.

See also

"About Dynamic Link (Production Premium only)" on page 609

Copy from After Effects to Adobe Premiere Pro

You can copy a footage layer from an After Effects composition and paste it into an Adobe Premiere Pro sequence. Adobe Premiere Pro converts footage layers to clips in the sequence and copies the source footage to its Project panel. If the layer contains an effect that is also used by Adobe Premiere Pro, Adobe Premiere Pro converts the effect and all of its settings and keyframes.

You can also copy nested compositions, Photoshop layers, solid layers, and audio layers. Adobe Premiere Pro converts nested compositions to nested sequences, and solid layers to color mattes. You cannot copy text, shape, camera, light, or adjustment layers to Adobe Premiere Pro.

- 1 Start Adobe Premiere Pro (you must start Adobe Premiere Pro before you copy the layer in After Effects).
- 2 Select a layer (or layers) from the After Effects Timeline panel.

Note: If you select multiple layers and the layers don't overlap in After Effects, they're placed on the same track in Adobe Premiere Pro. On the other hand, if the layers overlap in After Effects, the order in which you select them determines the order of their track placement in Adobe Premiere Pro. Each layer is placed on a separate track, and the last selected layer appears on Track 1. For example, if you select layers from top to bottom, the layers appear in the reverse order in Adobe Premiere Pro, with the bottommost layer on Track 1.

- 3 Choose Edit > Copy.
- 4 In Adobe Premiere Pro, open a sequence in the Timeline panel.
- 5 Move the current-time indicator to the desired location, and choose either Edit > Paste or Edit > Paste Insert.

Results of pasting into Adobe Premiere Pro

When you paste a layer into an Adobe Premiere Pro sequence, keyframes, effects, and other properties in the copied layer are converted as follows:

After Effects item	Converted to in Adobe Premiere Pro	Notes
Transform property values and keyframes	Motion or Opacity values and keyframes	The keyframe type—Bezier, Auto Bezier, Continuous Bezier, or Hold—is retained.
Effect properties and keyframes	Effect properties and keyframes, if the effect also exists in Adobe Premiere Pro	Adobe Premiere Pro lists unsupported effects as offline in the Effect Controls panel. Some After Effects effects have the same names as those in Adobe Premiere Pro, but since they're actually different effects, they aren't converted.
Audio volume property	Channel Volume filter	
Stereo Mixer effect	Channel Volume filter	
Masks and mattes	Not converted	
Time Stretch property	Speed property	Speed and time stretch have an inverse relationship. For example, 200% stretch in After Effects converts to 50% speed in Adobe Premiere Pro.
Layer-time markers	Clip markers	
Time Remapping properties	Not converted	
Blending modes	Not converted	
Expressions	Not converted	

Copy from Adobe Premiere Pro to After Effects

You can copy a video or audio asset from an Adobe Premiere Pro sequence and paste it into an After Effects composition. After Effects converts assets to footage layers and copies the source footage into its Project panel. If the asset contains an effect that is also used by After Effects, After Effects converts the effect and all of its settings and keyframes.

You can copy color mattes, stills, nested sequences, and offline files as well. After Effects converts color mattes into solid layers and converts nested sequences into nested compositions. When you copy a Photoshop still image into After Effects, After Effects retains the Photoshop layer information. You cannot paste Adobe Premiere Pro titles or effects into After Effects.

- 1 Select an asset from the Adobe Premiere Pro Timeline panel.
- 2 Choose Edit > Copy.
- 3 In After Effects, open a composition in the Timeline panel.
- 4 With the Timeline panel active, choose Edit > Paste. The asset appears as the topmost layer in the Timeline panel.

Note: To paste the asset at the current-time indicator, position the current-time indicator and press **Ctrl+Alt+V** (Windows) or **Command+Option+V** (Mac OS).

Results of pasting into After Effects

When you paste an asset into an After Effects composition, keyframes, effects, and other properties in a copied asset are converted as follows:

Adobe Premiere Pro asset	Converted to in After Effects	Notes
Motion or Opacity values and keyframes	Transform property values and keyframes	Keyframe type—Bezier, Auto Bezier, Continuous Bezier, or Hold—is retained.
Video effect properties and keyframes	Effect properties and keyframes, as long as the effect also exists in After Effects	After Effects doesn't display unsupported effects in the Effect Controls panel.
Crop filter	Mask layer	
Video and audio transitions	Opacity keyframes (Cross dissolve only) or solids	
Volume and Channel Volume audio filters	Stereo mixer effect	Other audio filters are not converted.
Speed property	Time Stretch property	Speed and time stretch have an inverse relationship. For example, 50% speed in Adobe Premiere Pro is converted to 200% stretch in After Effects.
Frame Hold	Time Remap	
Clip marker	Layer-time marker	
Sequence marker	Markers on a new solid layer	To copy sequence markers, you must either copy the sequence itself or import the entire Adobe Premiere Pro project as a composition.
Audio track	Audio layers	Audio tracks that are either 5.1 surround or greater than 16-bit aren't supported. Mono and stereo audio tracks are imported as one or two layers.
Color mattes	Solids	
Time Remapping effect	Not converted	
Titles	Not converted	
Bars and tone	Not converted	
Universal counting leaders	Not converted	

Importing video and audio

Work with the media cache

When After Effects imports video and audio in some formats, it processes and caches versions of these items that it can readily access when generating previews. Imported audio files are each conformed to a new .cfa file, and MPEG files are indexed to a new .mpgindex file. This greatly improves performance for previews, because the video and audio items do not need to be reprocessed for each preview.

Note: When you first import a file, you may experience a slight delay while the media is being processed and cached.

A database retains links to each of the cached media files. This media cache database is shared with Adobe Premiere Pro, Adobe Encore, and Adobe Soundbooth, so each of these applications can each read from and write to the same set of cached media files. If you change the location of the database from within any of these applications, the location is updated for the other applications, too. Each application can use its own cache folder, but the same database keeps track of them all.

❖ Choose Edit > Preferences > Memory & Cache (Windows) or After Effects > Preferences > Memory & Cache (Mac OS), and do one of the following:

- Click one of the Choose Folder buttons to change the location of the media cache database or the media cache itself.
- Click Clean Database & Cache to remove conformed and indexed files from the cache and to remove their entries from the database. This only affects footage items for which the source file is no longer available.

***Note:** Before clicking the Clean Database & Cache button, make sure that any drives that contain your currently used source media are connected to your computer. If footage is determined to be missing because the drive on which it is located is not connected, the associated files in the media cache will be removed. This will result in the need to reconfirm or reindex the footage when you attempt to use the footage later.*

Types of video and film

Some of the source footage you use may have been created digitally (for example, in Photoshop or Adobe Premiere Pro), but other footage may need to be transferred to the computer from analog sources, such as film and videotape. Understanding some of the media differences can help you decide how to handle footage as you transfer it between digital and analog devices.

For introductions to digital video, digital audio, high-definition video, DVD, compression, and streaming video, visit the Adobe website at www.adobe.com/go/learn_dv_primers.

Analog video Comes from an analog camera and carries picture and sound information by creating continuous variations in an electromagnetic signal. Before you can import analog video into After Effects, you need to capture it. Capturing transfers video from tape to your hard disk, and involves the conversion of the analog signal to a digital signal.

Digital video Comes from a digital video camera, and carries picture information by representing each pixel of a video frame as discrete color and intensity values and transmitting and storing the pixel values in the binary data format used by computers. Sound is also carried as binary data.

Digital video is not one format but a medium. There are many digital video file formats exist. Even if your source footage was created digitally, you need to make sure that it is stored in a file format that After Effects can import.

If you plan to distribute the movie digitally, for example on DVD, you must render it in a file format appropriate for your distribution method.

DV video format is a form of digital video that can be captured directly to your hard disk for editing in applications such as After Effects and Adobe Premiere Pro. Most DV cameras and decks can connect directly to a computer using an IEEE 1394 (FireWire/i.Link) interface.

***Note:** Some formats, such as Adobe Flash Video, have elements of conventional digital video, but represent an intermediate category between what has conventionally been thought of as a video format and what has conventionally been thought of as computer animation format.*

Analog film Carries picture information by creating variations in colored pigments on a strip of acetate (the long reel run through the traditional film projector). Examples include still transparencies and common motion-picture film.

To apply digital effects to motion-picture film using After Effects, you must first transfer the film to a digital format. You can transfer film in two ways:

- Use a film scanner to transfer each analog film frame directly to a digital movie frame. This method best preserves the image quality. Using a film scanner is preferable, because you scan the footage directly to the computer as noninterlaced, full-resolution, 24-fps footage; in other words, it is ready to use in After Effects.
- Transfer the analog film to analog videotape, and then digitize the videotape. This process is called *telecine transfer*. It converts 24-fps film footage to 30-fps videotape using 3:2 *pulldown*. Transferring using the 3:2 pulldown method introduces two issues: You must resolve the different frame rates of videotape and motion-picture film, and you must separate the fields of the interlaced video. After Effects can automatically resolve both of these issues while preserving image quality.

Note: To use an After Effects movie in an analog motion-picture film, you must transfer the movie back to the analog film medium. This transfer process is generally done at a post-production facility.

See also

“Working with Cineon footage items” on page 251

About high-definition (HD) video

High-definition (HD) video refers to any video format with a resolution higher than *standard-definition (SD) video* formats. Typically, *standard-definition* refers to digital formats with resolutions close to those of analog TV standards, such as NTSC and PAL (around 480 or 576 vertical lines, respectively). The most common HD formats have resolutions of 1280 x 720 or 1920 x 1080, with a widescreen aspect ratio of 16:9.

HD video formats include interlaced and noninterlaced varieties. Typically, the highest-resolution formats are interlaced at the higher frame rates, because noninterlaced video at this resolution would require a prohibitively high data rate.

HD video formats are designated by their vertical resolution, scan mode, and frame or field rate (depending on the scan mode). For example, *1080i60* denotes interlaced scanning of 60 interlaced 1920 x 1080 fields per second, whereas *720p30* denotes progressive scanning of 30 noninterlaced 1280 x 720 frames per second. In both cases, the frame rate is approximately 30 frames per second. For more information on high-definition video, see www.adobe.com/go/learn_dv_primer_highdef.

Programs in Adobe Creative Suite 3 Production Premium (Adobe Premiere Pro, Adobe After Effects, Adobe Soundbooth, and Adobe Encore) includes presets that are designed for working with various HD formats. Some of the most common HD video formats you may encounter include the following:

DVCPRO HD Panasonic’s high-definition variant of its DVCPRO format, which also includes DVCPRO25 and DVCPRO50. Whereas DVCPRO25 and DVCPRO50 support data rates of 25Mbits/s (megabits per second) and 50Mbit/s, respectively, DVCPRO HD supports a data rate of 100Mbit/s, from which it gets its other name, *DVCPRO100*.

HDCAM Sony’s high-definition version of its Digital Betacam format. A variant called *HDCAM SR* uses a tape with a higher particle density to record video with greater color sampling and at higher bit rates. However, *HDCAM SR* is supported by decks only, and not camcorders.

HDV Developed jointly by several companies, HDV employs a form of MPEG-2 compression to enable high-definition video to be encoded onto standard miniDV cassette media.

H.264 Also known as *MPEG-4 part 10* and *AVC (Advanced Video Coding)*, H.264 can deliver video over a range of bitrates more efficiently than previous standards. For example, H.264 can deliver the same quality as MPEG-2 at half

the data rate. H.264 is built into the Apple QuickTime 7 multimedia architecture, and it's supported by both HD-DVD and Blu-ray Disc, two newer DVD formats.

Uncompressed HD High-definition video in an uncompressed format. Without compression to reduce the video's data rate, uncompressed video requires relatively fast computer processors, hard disks, and a specialized capture device.

WM9 HDTV Microsoft's high-definition delivery format is among numerous formats included in the Windows Media 9 (WM9) framework. By employing an aggressive compression scheme, WM9 HDTV permits high-definition video encoding and playback at relatively low data rates.

About interlaced and noninterlaced video

Interlacing is a technique developed for transmitting standard-resolution television signals using limited bandwidth. In an interlaced system, only half the number of horizontal lines for each frame of video are transmitted at a time. But because of the speed of transmission, the afterglow inherent in cathode ray tubes, and the persistence of vision, the viewer perceives each frame in full resolution. All of the analog television standards use interlacing. Digital television standards include both *interlaced* and *noninterlaced* varieties. Typically, interlaced signals are generated from interlaced scanning while noninterlaced signals are generated from *progressive scanning*.

Each interlaced video frame consists of two *fields*. Each field contains half the number of horizontal lines in the frame; the *upper field* (or *Field 1*) contains the odd-numbered lines, and the *lower field* (or *Field 2*) contains the even-numbered lines. An interlaced video monitor displays each frame by first drawing all of the lines in one field and then drawing all of the lines in the other field. *Field order* specifies which field is drawn first. In NTSC video, new fields are drawn to the screen approximately 60 times per second, corresponding to a frame rate of approximately 30 frames per second.

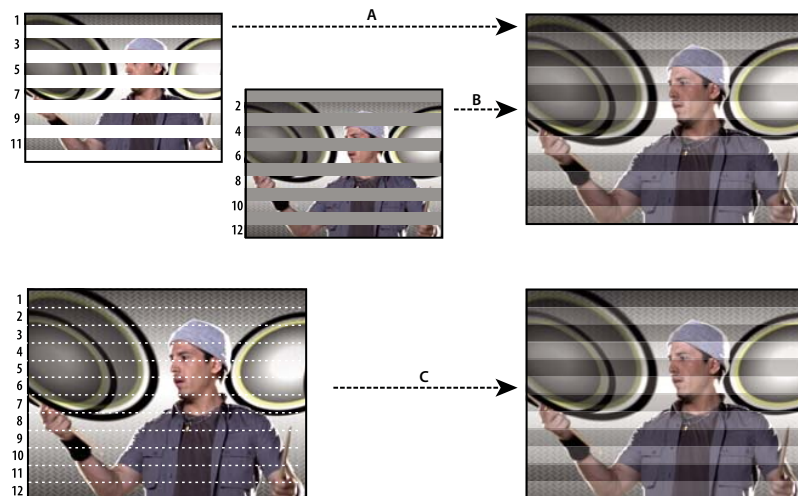

Interlaced scanning of interlaced video fields compared with progressive scanning of noninterlaced video frame.

A. For interlaced video, entire upper field is drawn to screen first, from top to bottom, in one pass. B. Next, entire lower field is drawn to screen, from top to bottom, in one pass. C. For noninterlaced video, entire frame is drawn to screen, from top to bottom, in one pass.

Noninterlaced video frames aren't separated into fields. A *progressive-scan* monitor displays a noninterlaced video frame by drawing all the horizontal lines, from top to bottom, in one pass. Computer monitors are almost all progressive-scan monitors, and most video displayed on computer monitors is noninterlaced.

The terms *progressive* and *noninterlaced* are thus closely related and are often used interchangeably, but *progressive* refers to the recording or drawing of the scan lines by a camera or monitor, whereas *noninterlaced* refers to the fact that the video data itself isn't separated into fields. For example, it's possible with some modern cameras to use progressive scanning to record two simultaneous fields per frame of interlaced video.

Separate video fields

If you want to use interlaced or field-rendered footage (such as NTSC video) in an After Effects project, you will get the best results if you separate the video fields when you import the footage. After Effects separates video fields by creating a full frame from each field, preserving all of the image data from the original footage.

Separating fields is critical if you plan to make significant changes to the footage. When you scale, rotate, or apply effects to interlaced video, unwanted artifacts, such as crossed fields, are often introduced. By separating fields, After Effects accurately converts the two interlaced frames in the video to noninterlaced frames, while preserving the maximum amount of image quality. Using noninterlaced frames allows After Effects to apply edits and effects consistently and at the highest quality.

After Effects creates field-separated footage from a single formerly interlaced field by splitting fields into two independent frames. Each new frame has only half the information of the original frame, so some frames may appear to have a lower resolution than others when viewed at Draft quality. When you render the final composition, After Effects reproduces high-quality interlaced frames for videotape. When you render a movie at Best quality, After Effects interpolates between the scan lines of a field to produce maximum image quality.

If your output will not be interlaced, it's best to use noninterlaced source footage, to avoid the need to separate fields. However, if a noninterlaced version of your source footage is not available, interlaced footage will work fine.

When you render a composition containing field-separated footage, set the Field Rendering option to the same field order as your video equipment. If you don't field-render the composition, or if you field-render with the incorrect settings, the final movie may appear too soft, jerky, or distorted.

 *To very quickly give video footage a more film-like appearance, import the footage twice, and interpret each footage item with a different field order. Then add them both to the same composition and blend them together. The misinterpreted layer will add some film-like blur.*

After Effects automatically separates fields for D1 and DV video footage items. You can manually separate fields for all other types of video footage in the Interpret Footage dialog box.

- 1 Select the footage item in the Project panel.
- 2 Choose File > Interpret Footage > Main.
- 3 Choose an option from the Separate Fields menu.
- 4 Click Preserve Edges (Best Quality Only) to increase image quality in nonmoving areas when the image is rendered at Best quality. Then click OK.

Note: *If the field settings in the Interpret Footage dialog box are correct for the input footage and the field settings in the Render Settings dialog box are correct for the output device, you can mix footage items of different field orders in a composition. If either of these settings is incorrect, however, the frames will be in the correct order, but the field order may be reversed, resulting in jerky, unacceptable images.*

Determine the original field order

The *field order* for an interlaced video footage item determines the order in which the two video fields (upper and lower) are displayed. A system that draws the upper lines before the lower lines is called *upper-field first*; one that draws the lower lines before the upper lines is called *lower-field first*. Many standard-definition formats (such as DV NTSC) are lower-field first, whereas many high-definition formats (such as 1080i DVCPRO HD) are upper-field first.

Note: *Upper-field first corresponds to Even Field First in an ElectricImage file.*

The order in which the fields are displayed is important, especially when the fields contain motion. If you separate video fields using the wrong field order, motion will not appear smooth.

Some programs, including After Effects, label the field order when rendering interlaced video files. When you import a labeled video file, After Effects honors the field order label automatically. You can override this field order by applying different footage interpretation settings.

If a file does not contain a field order label, you can match the original field order of your footage. If you are not sure which field order was used to interlace a footage item, use the procedure below to find out.

- 1 Select the item in the Project panel.
- 2 Choose File > Interpret Footage > Main.
- 3 In the Interpret Footage dialog box, select Upper Field First from the Separate Fields menu, and then click OK.
- 4 In the Project panel, press Alt (Windows) or Option (Mac OS) as you double-click the footage to open it in the Footage panel.
- 5 If the Time Controls panel is not visible, choose Window > Time Controls.
- 6 In the Footage panel, find a segment that contains one or more moving areas.
- 7 Using the Next Frame button  in the Time Controls panel, step forward at least five frames in the Footage panel. Moving areas should move consistently in one direction. If the moving areas move backward every other frame, the wrong field-separation option has been applied to the footage.

Remove 3:2 or 24Pa pulldown from video

When you transfer 24-fps film to 29.97-fps video, you use a process called *3:2 pulldown*, in which the film frames are distributed across video fields in a repeating 3:2 pattern. The first frame of film is copied to fields 1 and 2 of the first frame of video, and also to field 1 of the second video frame. The second frame of film is then spread across the next two fields of video—field 2 of the second video frame and field 1 of the third frame of video. This 3:2 pattern is repeated until four frames of film are spread over five frames of video, and then the pattern is repeated.

The 3:2 pulldown process results in *whole frames* (represented by a W) and *split-field* frames (represented by an S). The three whole video frames contain two fields from the same film frame. The remaining two split-field frames contain a video frame from two different film frames. The two split-field frames are always adjacent to each other. The *phase* of 3:2 pulldown refers to the point at which the two split-field frames fall within the first five frames of the footage.

Phase occurs as a result of two conversions that happen during 3:2 pulldown: 24-fps film is redistributed through 30-fps video, so each of four frames of 24-fps film is spread out over five frames of 30(29.97)-fps video. First, the film is slowed down 0.1% to match the speed difference between 29.97 fps and 30 fps. Next, each film frame is repeated in a special pattern and mated to fields of video.

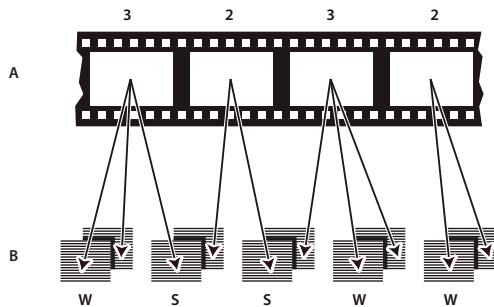

When you apply 3:2 pulldown to footage, one frame of the film (A) is separated into two or three interlaced video fields (B) which are grouped into video frames containing two fields each.

When importing interlaced video that was originally transferred from film, you can remove the 3:2 pulldown that was applied during the transfer from film to video as you separate fields so that effects you apply in After Effects don't appear distorted.

It's important to remove 3:2 pulldown from video footage that was originally film so that effects you add in After Effects synchronize perfectly with the original frame rate of film. Removing 3:2 pulldown reduces the frame rate by 1/5—from 30 to 24 fps or from 29.97 to 23.976 fps, which also reduces the number of frames you have to change. To remove 3:2 pulldown, you must also indicate the phase of the 3:2 pulldown.

After Effects also supports Panasonic DVX100 24p DV camera pulldown, called *24P Advance (24Pa)*. This format is used by some cameras to capture 23.976 progressive-scan imagery using standard DV tapes.

Before you remove 3:2 pulldown, separate the fields as either upper-field first or lower-field first. Once the fields are separated, After Effects can analyze the footage and determine the correct 3:2 pulldown phase and field order. If you already know the phase and field order, choose them from the Separate Fields and the Remove Pulldown menus in the Interpret Footage dialog box.

- 1 In the Project panel, select the footage item from which to remove 3:2 pulldown.
- 2 Choose File > Interpret Footage > Main.
- 3 In the Fields and Pulldown section, select Upper Field First or Lower Field First from the Separate Fields menu.
- 4 Do one of the following and click OK:
 - If you know the phase of the 3:2 or 24Pa pulldown, choose it from the Remove Pulldown menu.
 - To have After Effects determine the correct settings, click Guess 3:2 Pulldown or Guess 24Pa Pulldown.

Note: If your footage file contains frames from different sources, the phase may not be consistent. If this is the case, import the footage multiple times, once for each phase, and interpret each footage item with a different setting. Then, add each footage item to your composition and trim each layer to use only the appropriate frames.

Import assets in Panasonic P2 format

A P2 card is a solid-state memory device that plugs into the PCMCIA slot of a Panasonic P2 video camera, such as the AG-HVX200. The digital video and audio data from the video camera is recorded onto the card in a structured, codec-independent format known as *MXF (Media eXchange Format)*. Specifically, Adobe Premiere Pro and After Effects support the Panasonic Op-Atom variant of MXF, with video in DV, DVCPRO, DVCPRO50, and DVCPRO HD formats. A clip is said to be in the *P2 format* if its audio and video are contained in Panasonic Op-Atom MXF files, and these files are located in a specific folder structure.

The root of the P2 folder structure is a CONTENTS folder. Each *essence* item (an item of video or audio) is contained in a separate MXF wrapper file; the video MXF files are in the VIDEO subfolder, and the audio MXF files are in the AUDIO subfolder. The relationships between essence files and the metadata associated with them are tracked by XML files in the CLIP subfolder.

Note: *Adobe Premiere Pro and After Effects do not support proxies recorded by Panasonic P2 camcorders in P2 card PROXY folders.*

The video and audio on a P2 card are already in a digital form, as if the P2 card were a hard disk, so there is no *capture* step involved in importing media from a P2 card. The process of reading the data from the card and converting it to a format that can be used in a project is sometimes referred to as *ingest*.

For your computer to read P2 cards, you must install the appropriate driver, which you can download from the Panasonic website. Panasonic also provides the P2 Viewer application, with which you can browse and play media stored on a P2 card. See the Panasonic website for details: www.adobe.com/go/learn_pp_panasonicp2.

Because Panasonic P2 cards use the FAT32 file system, each file is limited to a size of 4 GB. When a shot is recorded that requires more than the 4 GB, a P2 camera creates another file and continues recording the shot to the new file without interruption. This is referred to as *clip spanning*, because the shot spans more than one file or clip. Similarly, a camera may span a shot across files on different P2 cards: if the camera has more than one P2 card loaded, it will record the shot until it runs out of room on the first P2 card, create a new file on the next P2 card with available space, and continue recording the shot to it. Although a single shot can be recorded to a group of multiple spanned clips, the multiple-file shot is designed to be treated as a single clip or footage item in a video editing application. For After Effects to automatically import a group of spanned clips simultaneously and assemble them into a single footage item, they must all have been recorded to the same P2 card and none of the files can be missing, including the associated XML metadata file.

1 (Optional) Copy the entire contents of the P2 card to a hard disk.

Though it is possible to import assets into Adobe Premiere Pro or After Effects directly from a P2 card, it is usually more efficient to copy the contents of the P2 card to a hard disk before importing.

2 Choose File > Import.

3 Navigate to the CONTENTS folder.

4 Select one or more MXF files:

- To import a video essence item and its associated audio essence items, select the MXF files from the VIDEO folder.
- To import only the audio essence items, select the MXF files from the AUDIO folder.
- To import a group of spanned clips for a shot that were recorded onto the same P2 card, select only one of the MXF files in the group from the VIDEO folder. The group will be imported as a single footage item with a duration equal to the total duration of all the spanned clips it includes. If you select more than one of these spanned clips, you will import duplicates of the whole group of spanned clips, as duplicate footage items in the Project panel.

You cannot import spanned clips from a shot that spans two different cards as a single footage item. Rather, you must select a single MXF file belonging to the shot from each card to create a separate footage item for the part of the shot recorded on each card. For example, if a group of spanned clips for a single shot itself spans two cards, you must select a spanned clip from the group on card 1 and another from the group on card 2. This will import the contents of the shot into two footage items in the Project panel.

The Date column in the Project panel shows when each source clip was acquired. After you import spanned clips, you can use the Date value to determine their correct chronological order within the shot.

For additional information on the Panasonic P2 format and workflows with Adobe digital video software, see the Adobe website:

- P2 workflow guide for Adobe digital video products: www.adobe.com/go/learn_dva_p2workflowguide
- Dave Helmly's video introduction to the P2 workflow in After Effects: www.adobe.com/go/learn_dva_p2davehelmly

Importing AAF and OMF files (Windows only)

AAF (Advanced Authoring Format) is a multimedia file interchange format that contains all of the editing decisions of a project from a non-linear editor (NLE). Using AAF, you can exchange NLE projects between platforms, systems, and applications. AAF files do not contain media, such as video and audio; rather, they contain editing decisions and links to media.

OMF (Open Media Framework) is an extensible, object-oriented format that provides a means of tracking production and post-production information. Unlike AAF files, OMF files can contain media as well as project information. An AAF file may link to an associated OMF file as a media source. When you import an AAF file that references an OMF file, the OMF footage is also imported. After Effects imports only raw (essence) OMF files, which are OMF files that have embedded media and no project information. After Effects doesn't import OMF project files.

You can use an application such as Automatic Duck to import OMF project files on Windows or Mac OS.

Note: You can also output to OMF. See “Render a composition to OMF (Windows only)” on page 622.

The following OMF codecs are supported for importing and outputting to OMF: Uncompressed, Avid AVR, Avid JPEG, JFIF, and DV.

The OMF file format supports video only. Avid editing systems store audio files as separate .wav files, which you can import into After Effects if desired. Depending on the resolution and codec, each frame may be composed of a full noninterlaced frame, two interlaced fields, or a single line-doubled field (for single-field media). The codec used to encode the media is displayed in the footage information area in the Project panel.

To ensure that the project that you want to import conforms to general AAF specifications and is compatible with After Effects, consider the following:

Character limits for names The folder name (based on the AAF file name) created in the Project panel is truncated to 31 characters, the maximum limit in After Effects. Names for items in the Project panel and for layers in the Timeline panel are also truncated to 31 characters.

Platform-specific footage references Footage references are saved with platform-specific paths and file names in the AAF file.

Separate video and audio tracks An AAF file can have separate clips for audio and video. When the AAF file is imported into After Effects, each clip is converted into a layer. For an audio clip, only the audio switch is enabled for the layer. For a video clip, only the video switch is enabled for the layer.

Clips on the same track Clips that appear on the same track in Avid appear as separate layers in After Effects.

Depth order of video and audio tracks During AAF import, video tracks are processed before audio tracks, so converted audio layers will appear above video layers in the After Effects Timeline panel.

Different image dimensions and pixel aspect ratios When an Avid editing system imports footage, it is scaled to the dimensions of the project regardless of the original dimensions of the footage. When the AAF file is imported into After Effects, footage appears with its original dimensions and pixel aspect ratio, which may be different from the dimensions of the project. You can use the Interpret Footage command in After Effects to make pixel aspect ratio adjustments.

Missing media Referenced media that is not accessible during the import operation appears as placeholder footage in After Effects.

Empty sequences If a sequence contains no tracks, the composition created when it is imported is set at DV resolution (720 x 480; 0.9 pixel aspect ratio) with a length of 10 seconds.

Cuts-only video and audio clips Supported.

Audio Audio gain (level) changes are supported, but audio pan is not. Mono and stereo audio are supported; 5.1 audio is not supported. Separate audio channel tracks (even if out of synchronization) are imported into After Effects as a single audio layer.

Clip Speed Clips with a Motion Effect are converted to the corresponding layer Stretch value (for slow or fast motion) or layer Time Remap keyframes (for reverse motion).

Empty tracks Ignored.

Muted tracks Avid does not save muted track information in an exported AAF file, so muted tracks cannot be preserved in After Effects.

Locators Ignored.

Composition size and pixel aspect ratio Created based on the StoredWidth and StoredHeight values for the first media file in the first sequence found.

Importing DDR-based footage

To find out if After Effects plug-ins are available for your digital disk recorder (DDR), contact your DDR manufacturer. For information on using your specific DDR with After Effects, refer to your DDR manufacturer's plug-in documentation.

Edit audio in Adobe Soundbooth or Adobe Audition

While working in After Effects, you may want to use the more comprehensive audio-editing capabilities of Adobe Soundbooth or Adobe Audition to fine-tune your audio layers. You can use the Edit In Adobe Soundbooth or Edit In Adobe Audition command to start Adobe Soundbooth or Adobe Audition from within After Effects.

If you edit an audio-only file (for example, a WAV file) in Adobe Soundbooth or Adobe Audition, you make changes to the original file. If you edit a layer that contains both audio and video (for example, an AVI file), you edit a copy of the layer's audio file.

Important: *Adobe Soundbooth is only available for Windows and for Mac OS running on Intel processors. Adobe Audition is only available for Windows. Neither Adobe Soundbooth nor Adobe Audition are available for Mac OS running on PowerPC processors.*

- 1 Select the layer that contains the audio that you want to edit. The item must be of a type that is editable in Adobe Soundbooth or Adobe Audition.
- 2 Choose Edit > Edit In Adobe Soundbooth or Edit > Edit In Adobe Audition to open the clip in Edit view in Adobe Soundbooth or Adobe Audition.
- 3 Edit the file, and then do one of the following:
 - If you're editing an audio-only layer, choose File > Save to apply your edits to the original audio file, or choose File > Save As to apply your edits to a copy of the audio file. If you choose File > Save As, you need to reimport the copy of the file into After Effects.

- If you're editing a layer that contains both audio and video, choose File > Save As. After you save the file, import it into After Effects, add it to the composition, and mute the original audio in the audio-video clip by deselecting the Audio switch in the Timeline panel.

Note: Any effects applied to audio in After Effects aren't included in the copy that is sent to Adobe Soundbooth or Adobe Audition.

Importing 3D image files

3D files from other applications

After Effects can import 3D-image files saved in Softimage PIC, RLA, RPF, and Electric Image EI format. These 3D-image files contain red, green, blue, and alpha (RGBA) channels, as well as auxiliary channels with optional information, such as z depth, object IDs, texture coordinates, and more.

Note: Some 3D applications, such as Cinema 4D, can export an After Effects composition directly.

With RLA and RPF files, all of the auxiliary channels are included in a single file. Softimage PIC files have a corresponding ZPIC file that contains the z-depth channel information. Although you can't import a ZPIC file, you can access the additional channel information as long as the ZPIC file is stored in the same folder as the imported PIC file.

Similarly, Electric Image (EI) files can have associated EIZ files with z-depth channel data. Just as with ZPIC files, you cannot import EIZ files into After Effects; instead, you simply store them in the same folder as the EI files. For information about creating EIZ files, see your Electric Image documentation.

After Effects can also import baked camera data, including focal length, film size, and transformation data, from Maya project files as a single composition or two compositions.

Though you can import composited files with 3D information into After Effects, you cannot manipulate or create 3D models directly with After Effects.

A common technique when working in a 3D modeling application is to insert null objects, such as null lights or null locator nodes in the locations where you want to composite in an image in After Effects. Then, after you have imported the 3D file into After Effects, you can use these null objects as a reference for the placements of other visual elements.

After Effects treats each composited 3D file from another application as a single 2D layer. That layer, as a whole, can be given 3D attributes and treated like any After Effects 3D layer, but the objects contained within that 3D file cannot be manipulated individually in 3D space. To access the 3D depth information and other auxiliary channel information in 3D image files, use the 3D Channel effects.

See also

“Working with 3D layers” on page 171

“Cameras, lights, and points of interest” on page 176

“3D Channel effects” on page 367

Importing 3D images from Photoshop Extended and Illustrator

3D models in Photoshop

Adobe Photoshop Extended can import and manipulate 3D models in several popular formats, including 3D Studio (.3ds) and Universal 3D (.u3d). You can manipulate these 3D models in Photoshop Extended and then save one or more frames as PSD files that you then import into After Effects.

Vanishing Point exchange

When you use the Vanishing Point feature in Photoshop Extended, you can then use the File > Export For After Effects CS3 (.vpe) command to save the results as a collection of PNG files—one for each plane—and a .vpe file that describes the geometry of the scene. You can then import the .vpe file into After Effects. After Effects uses the information in the .vpe file to recreate the scene as a composition containing a camera layer and one perspective-corrected 3D layer for each PNG file.

The camera is on the negative z axis, at $(x,y)=(0,0)$. The point of interest for the camera is in the center of the composition. The camera zoom is set according to the field of view in the Vanishing Point scene.

The 3D layers for the planes in the scene have a parent layer with its anchor point at the center of the composition, so the whole scene can be transformed together.

Vanishing Point exchange only works well for images that have square pixels in Photoshop.

Illustrator 3D effects

The effects in the 3D category in Illustrator—Extrude & Bevel, Revolve, and Rotate—give a three-dimensional appearance to any vector graphic object, including text and drawings. If you want to add depth to your vector art and text, consider creating it in Illustrator, using the 3D effects, and then importing the results into After Effects.

See also

“Working with 3D layers” on page 171

“Cameras, lights, and points of interest” on page 176

Import RLA or RPF data into a camera layer

After Effects imports camera data saved with RLA or RPF sequence files. That data is incorporated into camera layers—one for each camera in the sequence—that After Effects creates in the Timeline panel. You can access the camera data of an imported RLA or RPF sequence and create a camera layer containing that data.

- 1 Add the sequence to a composition, and select its layer in the Timeline panel.
- 2 Choose Animation > Keyframe Assistant > RPF Camera Import.

Note: To create an RLA or RPF file with the camera data in 3D Studio Max, save your rendering in RPF format with Coverage, Z Depth, and Alpha Channels enabled.

See also

“Working with 3D layers” on page 171

“Cameras, lights, and points of interest” on page 176

Baking and importing Maya data

After Effects imports camera data from Maya project files. Before importing Maya camera information, you need to *bake* it. This makes animating with keyframes easier later in your project. Baking places a keyframe at each frame of the animation. You can have 0, 1, or a fixed number of keyframes for each camera or transform property. For example, if a property is not animated in Maya, either no keyframes are set for this property or one keyframe is set at the start of the animation. If a property has more than one keyframe, it must have the same number as all of the other animation properties with more than one keyframe.

Reduce import time by creating or saving the simplest Maya file possible. In Maya, reduce keyframes by deleting static channels before baking, and save a version of the Maya project that contains the camera animation only.

Note: *The following transformation flags are not supported: query, relative, euler, objectSpace, worldSpace, worldSpace-Distance, preserve, shear, scaleTranslation, rotatePivot, rotateOrder, rotateTranslation, matrix, boundingBox, boundingBoxInvisible, pivots, CenterPivots, and zeroTransformPivots. After Effects skips these unsupported flags, and no warnings or error messages appear.*

By default, After Effects treats linear units specified in the Maya file as pixels.

You can import camera data from Maya project files (.ma) and work with the data as a single composition or two compositions.

For each Maya file you import, After Effects creates either one or two compositions:

- If the Maya project has a square pixel aspect ratio, After Effects creates a single, square-pixel composition containing the camera data and transformations.
- If the Maya project has a nonsquare pixel aspect ratio, After Effects creates two compositions. The first composition, which has a file name prefixed by *Square*, is a square-pixel composition containing the camera data. The second, or *parent*, composition is a nonsquare-pixel composition that retains the dimensions of the original file and contains the square-pixel composition. When working with imported camera data, use 3D layers and square-pixel footage in the square-pixel composition, and use all nonsquare-pixel footage in the parent composition.

When you import a Maya file with a 1-node camera, After Effects creates a camera in the square-pixel composition that carries the camera's focal length, film size, and transformation data.

When you import a Maya file with a 2-node or targeted camera, After Effects creates a camera and an additional parent node in the square-pixel composition. The parent node contains only the camera's transformation data. After Effects imports 2-node cameras automatically with the locator node as the point of interest, with the camera's Auto-Orientation option set to Orient Towards Point Of Interest.

After Effects doesn't read 3-node cameras.

Note: *After Effects reads only the rendering cameras in Maya files and ignores the orthographic and perspective cameras. Therefore, always generate a rendering camera from Maya, even if it's the same as the perspective camera. If you apply the FilmFit camera setting, make sure to use either horizontal or vertical FilmFit, not fill.*

After Effects can read Maya locator nodes, which enable you to track objects from the Maya scene as it is translated into After Effects. After Effects creates a null layer and applies the relevant transformations to it if a Maya locator node's name contains the word *Null*, *NULL*, or *null*. Avoid parenting locator nodes to each other in Maya; instead, parent the locator nodes to geometry.

Note: *After Effects doesn't read World or Underworld coordinates in the LocatorShape. Use a transform node to place them.*

See also

“Working with 3D layers” on page 171

“Cameras, lights, and points of interest” on page 176

Importing still images

Preparing still-image files for importing

You can import individual still images into After Effects or import a series of still images as a sequence. You can import still images from Adobe applications such as Photoshop and Illustrator, or import images using the Adobe Stock Photos service using Adobe Bridge. For information about the still-image formats that After Effects imports, see “Supported import formats” on page 48.

After Effects works internally in an RGB color space, but it can import and convert CMYK images. However, when possible, you should work in an RGB color space in applications such as Illustrator and Photoshop when creating images for video, film, and other non-print media. Working in RGB provides a larger gamut and more accurately reflects your final output.

Before you import a still image into After Effects, prepare it as completely as possible to reduce rendering time. It is usually easier and faster to prepare a still image in its original application than to modify it in After Effects. Consider doing the following to an image before importing it into After Effects:

- Make sure that the file format is supported by the operating system you plan to use.
- Crop the parts of the image that you do not want to be visible in After Effects.

***Note:** Illustrator files can have fractional dimensions (e.g., 216.5 x 275.5 pixels). When importing these files, After Effects compensates for the fractional dimensions by rounding-up to the next whole number of pixels (e.g., 217 x 278 pixels). This rounding results in a black line at the right (width) or bottom (height) edge of the imported image. When cropping in Illustrator, make sure that the dimensions of the cropped area are whole numbers of pixels.*

- If you want to designate areas as transparent, create an alpha channel or use the transparency tools in applications such as Photoshop or Illustrator.
- If final output will be broadcast video, avoid using thin horizontal lines (such as 1-pixel lines) for images or text because they may flicker as a result of interlacing. If you must use thin lines, add a slight blur so that the image or text appears in both video fields instead of flickering between them. (See “About interlaced and noninterlaced video” on page 70.)
- If final output will be broadcast video, make sure that important parts of the image fall within the action-safe and title-safe zones. When you create a document in Illustrator or Photoshop using a preset for film and video, the safe zones are shown as guide lines. (See “Work with safe zones, grids, guides, and rulers” on page 130.)
- If the final output will be broadcast video, keep colors within the broadcast-safe ranges. (See “Broadcast-safe colors” on page 250.)
- Save the file using the correct naming convention. For example, if you plan to import the file into After Effects on Windows, use a three-character file-name extension.

- Set the pixel dimensions to the resolution and frame aspect ratio that you will use in After Effects. If you plan to scale the image over time, set image dimensions that provide enough detail at the largest size the image has in the project. After Effects supports a maximum image size of 30,000 x 30,000 pixels for importing and rendering files, except for PICT (4,000 x 4,000 pixels) and BMP (16,000 x 30,000 pixels). The size of image that you can import or export is influenced by the amount of physical RAM available to After Effects. The maximum composition dimensions are also 30,000 x 30,000 pixels.

Note: *The image size or pixel dimensions setting in Photoshop (or other image-editing application) is relevant for the preparation of image data for import into After Effects—not dpi (dots per inch) or ppi (pixels per inch) settings. The image size determines how many pixels wide and tall an image is, whether those pixels are the tiny ones on a mobile device or the big ones on a motion billboard. The dpi or ppi settings are relevant to printing an image and to the scale of copied and pasted paths.*

See also

“Memory usage and storage” on page 37

“Copy a path from Illustrator, Photoshop, or Fireworks” on page 324

Import a single still image or a still-image sequence

You can import still image files as individual footage items, or you can import a series of still image files as a *still-image sequence*, which is a single footage item in which each still image is used as a single frame.

To import multiple image files as a single still-image sequence, the files must be in the same folder and use the same numeric or alphabetic filename pattern (such as Seq1, Seq2, Seq3).

When you import a file that appears to After Effects to be one file in a still-image sequence, After Effects will by default import all other files in the same folder that appear to be in the same sequence. Similarly, when you select multiple files that appear to be in a sequence, After Effects will by default import them as a sequence. You can see what After Effects is about to import by looking at the bottom of the Import dialog box. (You can also import images and sequences by dragging files and folders into the Project panel.

 *To prevent After Effects from importing unwanted files when you want to import only a single file, or to prevent After Effects from interpreting multiple files as a sequence, deselect the Sequence option in the Import dialog box. After Effects remembers this setting and will henceforth use it as the default.*

You can import multiple sequences from the same folder simultaneously by selecting files from different sequences and selecting Multiple Sequences at the bottom of the Import dialog box.

When importing a sequence of still images, you can use the Force Alphabetical Order option in the Import dialog box to import a sequence with gaps in its numbering (e.g., Seq1, Seq2, Seq3, Seq5). If you import a sequence with gaps in its numbering without selecting this option, After Effects warns you of missing frames and replaces them with placeholders.

After Effects uses settings of the first image in the sequence to determine how to interpret the images in the sequence.

If the image files in a sequence are of a layered file type—such as Adobe Photoshop or Adobe Illustrator documents—then you can choose to import the sequence as a standard footage item, or as a composition in which each layer in each file is imported as a separate sequence and appears as a separate layer in the Timeline panel.

Note: *When you render a composition that contains a numbered sequence, the output module uses the start frame number as the first frame number. For example, if you start to render on frame 25, the name of the file is 00025.*

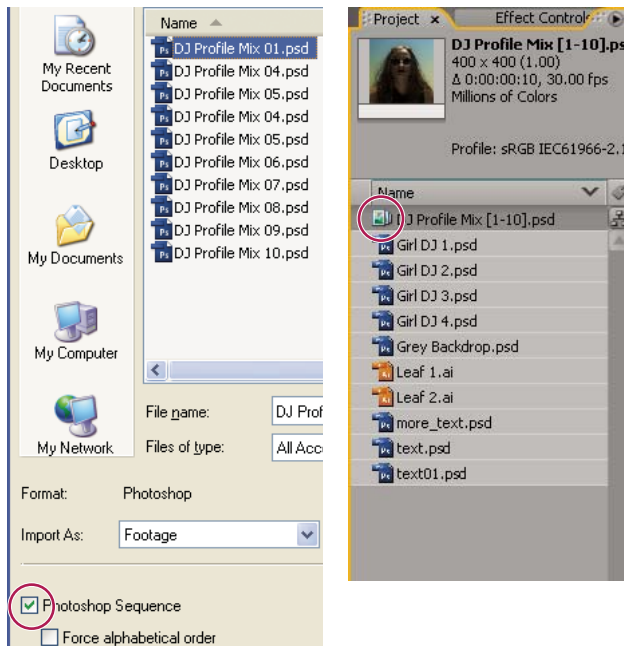

A sequence of still-image files (left) becomes one image sequence when imported into After Effects (right).

See also

“Work with output module settings” on page 599

“Import footage items” on page 50

Import a still-image sequence as a single footage item

- 1 Choose File > Import > File.
- 2 Select any file in the sequence. To import a subset of files in a sequence, select the first file, hold down Shift, and then select the last file to import.
- 3 Choose Footage from the Import Kind menu.
- 4 Click Open (Windows) or Import (Mac OS).
- 5 In the [filename] dialog box, choose one of the following from the Choose Layer menu:

Merged Layers Imports the sequence as a sequence footage item in which the layers in the file, if any, are merged into one layer.

Choose Layer Imports the sequence as a sequence footage item in which the same layer from each source file—for example, layer 3—is imported and used in the sequence. If you choose this option for a PSD sequence, then you can also choose whether to ignore layer styles or merge them into the layer. You must also choose a Footage Dimensions option: Layer Size matches the dimensions of the layer to the layer’s content; Document Size matches the dimensions of the layer to the original document’s size.

- 6 Click OK.

If at any time you decide that you want access to the individual components of the footage item, you can convert it to a composition. See “Convert a merged footage item into a composition” on page 83.

Import a still-image sequence as a composition

When you import a Photoshop or Illustrator file as a composition, you have access to the individual layers, blending modes, adjustment layers, layer styles, masks, guides, and other features created in Photoshop or Illustrator. The imported composition and a folder containing each of its layers as footage items appears in the Project panel.

- 1 Choose File > Import > File.
- 2 Select any file in the sequence. To import a subset of files in a sequence, select the first file, hold down Shift, and then select the last file to import.
- 3 Choose one of the following from the Import Kind menu:

Composition - Cropped Layers Import the layers with their original dimensions. This option makes it easier to manipulate layers and speeds their rendering time.

Composition Import layers and have them match the dimensions of the composition. This option is helpful when you need to align layers manually.

- 4 Click Open (Windows) or Import (Mac OS).

Change the frame rate of a sequence

When you import a sequence of still images, it assumes the frame rate specified by the Sequence Footage preference in the Import category. The default rate is 30 frames per second (fps). You can change the frame rate after importing by reinterpreting the footage item:

- ❖ Select the sequence in the Project panel, choose File > Interpret Footage > Main, and then enter a new value for Assume This Frame Rate.

For more information, see “Change frame rate” on page 53.

Convert a merged footage item into a composition

When you import a layered file, such as a Photoshop or Illustrator file, as footage, all of its layers are merged together. If at any time you decide that you want access to the individual components of the footage item, you can convert it to a composition.

- To convert all instances of a footage item, select it in the Project panel and choose File > Replace Footage > With Layered Comp.
- To convert only one instance of the footage item, select the layer in the Timeline panel, and choose Layer > Convert To Layered Comp.

Note: It may take a few moments to convert a merged footage item to a layered composition.

Preparing and importing Photoshop files

Because After Effects includes the Photoshop rendering engine, After Effects imports all attributes of Photoshop files, including position, blending modes, opacity, visibility, transparency (alpha channel), layer masks, layer groups (imported as nested compositions), adjustment layers, common layer styles, layer clipping paths, vector masks, image guides, and clipping groups.

To see a video tutorial on importing Photoshop files, visit the Adobe website at www.adobe.com/go/vid0252.

A very convenient command within After Effects is Layer > New > Adobe Photoshop File, which adds a layer to a composition and then opens the source of that layer in Photoshop for you to begin creating a visual element, such as a background layer for your movie. The layer in Photoshop is created with the correct settings for your After Effects composition. As with many of the Creative Suite applications, you can use the Edit Original command in After Effects to open a PSD file in Photoshop, make and save changes, and have those changes appear immediately in the movie that refers to the PSD source file. Even if you don't use Edit Original, you can use the Reload Footage command to have After Effects refresh its layers to use the current version of the PSD file. (See "Create a layer and new Photoshop footage item" on page 137 and "Edit footage in its original application" on page 60.)

Adobe Photoshop supports a transparent area and one optional layer mask (alpha channel) for each layer in a file. You can use these layer masks to specify how different areas within a layer are hidden or revealed. If you import one layer, After Effects combines the layer mask (if present) with the transparent area and imports the layer mask as a straight alpha channel.

If you import a layered Photoshop file as a merged file, After Effects merges the transparent areas and layer masks of all the layers into one alpha channel that is premultiplied with white.

If the layered Photoshop file contains clipping groups, After Effects imports each clipping group as a precomposition nested within the main composition. After Effects automatically applies the Preserve Underlying Transparency option to each layer in the clipping-group composition, maintaining transparency settings. These nested precompositions have the same dimensions as the main composition. (Paul Tiersley provides a script that crops the precompositions to the size of their contents, while retaining their correct position in the main composition: www.adobe.com/go/learn_ae_paulphotoshopcrop.)

When you import a Photoshop file as a composition, vector masks are converted to After Effects masks. You can then modify and animate these masks within After Effects.

After Effects also supports blending modes and layer styles applied to the file. When you import a Photoshop file with layer styles, you can choose the Editable Layer Styles option or the Merge Layer Styles Into Footage option:

Editable Layer Styles Matches appearance in Photoshop and preserves supported layer style properties as editable. Note that a layer with a layer style interferes with intersection of 3D layers and the casting of shadows.

Merge Layer Styles Into Footage Layer styles are merged into the layer for faster rendering, but the appearance may not match the appearance of the image in Photoshop. This option doesn't interfere with intersection of 3D layers or casting of shadows.

Photoshop files can even contain video and animation layers. After Effects can import these files just as any other Photoshop files, either as a footage item with all layers merged together or as a composition with each Photoshop layer separate and editable in After Effects. (Working with Photoshop video layers requires QuickTime 7.1 or later.)

Photoshop layer groups are imported as individual compositions.

It is often valuable to group layers into Smart Objects in Photoshop so that you can import meaningful collections of Photoshop layers as individual layers in After Effects. For example, if you used 20 layers to create your foreground object and 30 layers to create your background object in Photoshop, you probably don't need to import all of those individual layers into After Effects if all that you want to do is animate your foreground object flying in front of your background object; consider grouping them into a single foreground Smart Object and a single background Smart Object before importing the PSD file into After Effects.

Before you import a layered Photoshop file into After Effects, prepare it thoroughly to reduce preview and rendering time. Avoid problems importing and updating Photoshop layers by doing the following:

- Organize and name layers. If you change a layer name in a Photoshop file after you have imported it into After Effects, After Effects retains the link to the original layer. However, if you delete a layer, After Effects is unable to find the original layer and lists it as Missing in the Project panel.
- Make sure that each layer has a unique name. This is not a requirement of the software, but it will help to keep you from becoming confused.

See also

“Layer styles” on page 168

“Working with Photoshop and After Effects” on page 32

Preparing and importing Illustrator files

Before you save an Illustrator file for importing into After Effects, consider doing the following:

- Crop the image so that you are only saving the portion that you want to import into After Effects.
- To ensure that Illustrator files appear correctly in After Effects, select Create PDF Compatible File in the Illustrator Options dialog box.
- To copy paths between Illustrator and After Effects, make sure that the AICB and Preserve Paths options are selected in the Files & Clipboard section of the Illustrator Preferences dialog box. If you don't select AICB in Illustrator, After Effects prompts you when you attempt to paste the path.
- To ensure that files rasterize most faithfully in After Effects, save your file in AI format instead of Illustrator 8.x or 9.x EPS format.

When you import an Illustrator file, After Effects makes all empty areas transparent by converting them into an alpha channel.

***Note:** When you've imported an Illustrator file, you can specify whether anti-aliasing is to be performed at higher quality or at higher speed. Select the footage item in the Project panel and choose File > Interpret Footage > Main, and click the More Options button at the bottom of the dialog box.*

After Effects does not read embedded color profiles from Illustrator files. To ensure color fidelity, assign an input color profile to the Illustrator footage item that matches the color profile with which the Illustrator file was created.

See also

“Interpret a footage item by assigning an input color profile” on page 245

“Copy a path from Illustrator, Photoshop, or Fireworks” on page 324

Importing Cineon sequences

You can import Cineon 4.5 or Digital Picture Exchange (DPX) files directly into an After Effects project as individual frames or as a sequence of numbered stills. Once you have imported a Cineon file, you can use it in a composition and then render the composition as a Cineon sequence.

Cineon files are commonly used to transfer motion-picture film to a digital format. To preserve the full dynamic range of motion-picture film, Cineon files are stored using logarithmic 10-bpc color. However, After Effects internally uses 8-bpc, 16-bpc, or 32-bpc color, depending on the color bit depth of the project. Work with Cineon files in a 16- or 32-bpc project—by default, After Effects stretches the logarithmic values to the full range of values available.

In most cases, you should use color management features to automatically interpret the colors of Cineon footage. (See “Working with Cineon footage items” on page 251.) You can, though, use the Cineon Settings dialog box to control the conversion manually.

Manual settings in the Cineon Settings dialog box:

Converted Black Point Specifies the black point used for the layer in After Effects.

Converted White Point Specifies the white point used for the layer in After Effects.

10 Bit Black Point Specifies the black level (minimum density) for converting a 10-bit Cineon layer.

10 Bit White Point Specifies the white level (maximum density) for converting a 10-bit Cineon layer.

Current Gamma Specifies the target gamma value.

Highlight Rolloff Specifies the rolloff value used to correct bright highlights. To get over range values when working in 32 bpc, set the value to 0.

Logarithmic Conversion Converts the Cineon sequence from log color space to the target gamma specified by the Current Gamma setting. When you’re ready to produce output from the Cineon file, it is important that you reverse the conversion. (To convert from logarithmic to linear, set Current Gamma to 1.)

Units Specifies the units After Effects uses to display dialog values.

See also

“Set the color depth” on page 234

“Color management” on page 241

Introduction to Camera Raw

Note: This document describes features of Photoshop Camera Raw 4.1.

About camera raw files

A *camera raw* file contains unprocessed, uncompressed grayscale picture data from a digital camera’s image sensor, along with information about how the image was captured (metadata). Photoshop Camera Raw software interprets the camera raw file, using information about the camera and the image’s metadata to construct and process a color image.

Think of a camera raw file as your photo negative. You can reprocess the file at any time, achieving the results that you want by making adjustments for white balance, tonal range, contrast, color saturation, and sharpening. When you adjust a camera raw image, the original camera raw data is preserved. Adjustments are stored as metadata in an accompanying sidecar file, in a database, or in the file itself (in the case of DNG format).

When you shoot JPEG files with your camera, the camera automatically processes the JPEG to enhance and compress the image. You generally have little control over how this processing occurs. Shooting camera raw images with your camera gives you greater control than shooting JPEG images, because camera raw does not lock you into processing done by your camera. You can still edit JPEG and TIFF images in Camera Raw, but you will be editing pixels that were already processed by the camera. Camera raw files always contain the original, unprocessed pixels from the camera.

To shoot camera raw images, you need to set your camera to save files in its own camera raw file format.

Note: *The Photoshop Raw format (.raw) is a file format for transferring images between applications and computer platforms. Don't confuse Photoshop raw with camera raw file formats.*

Digital cameras capture and store camera raw data with a linear tone response curve (gamma 1.0). Both film and the human eye have a nonlinear, logarithmic response to light (gamma greater than 2). An unprocessed camera raw image viewed as a grayscale image would seem very dark, because what appears twice as bright to the photosensor and computer seems less than twice as bright to the human eye.

About Camera Raw

Camera Raw software is included as a plug-in with Adobe After Effects and Adobe Photoshop, and also adds functionality to Adobe Bridge. Camera Raw gives each of these applications the ability to import and work with camera raw files. You can also use Camera Raw to work with JPEG and TIFF files.

You must have Photoshop or After Effects installed to open files in the Camera Raw dialog box from Adobe Bridge. However, if Photoshop or After Effects is not installed, you can still preview the images and see their metadata in Adobe Bridge. If another application is associated with the image file type, it's possible to open the file in that application from Adobe Bridge.

Using Adobe Bridge, you can apply, copy, and clear image settings, and you can see previews and metadata for camera raw files without opening them in the Camera Raw dialog box. The preview in Adobe Bridge is a JPEG image generated using the current image settings; the preview is not the raw camera data itself, which would appear as a very dark grayscale image.

Note: *A caution icon  appears in the thumbnails and preview image in the Camera Raw dialog box while the preview is generated from the camera raw image.*

You can modify the default settings that Camera Raw uses for a particular model of camera. For each camera model, you can also modify the defaults for a particular ISO setting or a particular camera (by serial number). You can modify and save image settings as presets for use with other images.

When you use Camera Raw to make adjustments (including straightening and cropping) to a camera raw image, the image's original camera raw data is preserved. The adjustments are stored for each image in either the Camera Raw database, as metadata embedded in the image file, or in a *sidecar* XMP file (a metadata file that accompanies a camera raw file). For more information, see "Specify where Camera Raw settings are stored" on page 104.

After you process and edit a camera raw file using the Camera Raw plug-in, an icon  appears in the image thumbnail in Adobe Bridge.

If you open a camera raw file in Photoshop, you can save the image in other image formats, such as PSD, JPEG, Large Document Format (PSB), TIFF, Cineon, Photoshop Raw, PNG, or PBM. From the Camera Raw dialog box in Photoshop, you can save the processed files in Digital Negative (DNG), JPEG, TIFF, or Photoshop (PSD) formats. Although Photoshop Camera Raw software can open and edit a camera raw image file, it cannot save an image in a camera raw format.

Note: In Photoshop, the Camera Raw dialog box is automatically suppressed when you use a batch of files for a web photo gallery, picture package, or contact sheet.

As new versions of Camera Raw become available, you can update this software by installing a new version of the plug-in. You can check for updates to Adobe software by choosing Help > Updates.

For up-to-date documentation for Camera Raw, go to the Adobe website at www.adobe.com/go/learn_ps_camerarawhelp.

Different camera models save camera raw images in many different formats, and the data must be interpreted differently for these formats. Camera Raw includes profiles for many camera models, and it can interpret many camera raw formats.

Note: For a list of supported cameras and for more information about Camera Raw, see www.adobe.com/go/learn_ps_cameraraw.

About the Digital Negative (DNG) format

The Digital Negative (DNG) format is a non-proprietary, publicly documented, and widely supported format for storing raw camera data. Hardware and software developers use DNG because it results in a flexible workflow for processing and archiving camera raw data. You may also use DNG as an intermediate format for storing images that were originally captured using a proprietary camera raw format.

Because DNG metadata is publicly documented, software readers such as Camera Raw do not need camera-specific knowledge to decode and process files created by a camera that supports DNG. If support for a proprietary format is discontinued, users may not be able to access images stored in that format, and the images may be lost forever. Because DNG is publicly documented, it is far more likely that raw images stored as DNG files will be readable by software in the distant future, making DNG a safer choice for archival storage.

DNG is an extension of the TIFF 6.0 format and is compatible with the TIFF-EP standard. It is possible (but not required) for a DNG file to simultaneously comply with both the Digital Negative specification and the TIFF-EP standard.

Metadata for adjustments made to images stored as DNG files can be embedded in the DNG file itself instead of in a sidecar XMP file or in the Camera Raw database.

You can convert camera raw files to the DNG format by using the Adobe DNG Converter or the Camera Raw dialog box. For more information on the DNG format and DNG Converter, see www.adobe.com/go/learn_ps_dng.

Processing images with Camera Raw

1. Copy camera raw files to your hard disk, organize them, and (optionally) convert them to DNG.

Before you do any work on the images that your camera raw files represent, transfer them from the camera's memory card, organize them, give them useful names, and otherwise prepare them for use. Use the Get Photos From Camera command in Adobe Bridge to accomplish these tasks automatically.

2. Open the image files in Camera Raw.

You can open camera raw files in Camera Raw from Adobe Bridge, After Effects, or Photoshop. You can also open JPEG and TIFF files in Camera Raw from Adobe Bridge. (See "Open images in Camera Raw" on page 92.)

To see a video tutorial on importing images with Camera Raw, go to the Adobe website at www.adobe.com/go/vid0005.

3. Adjust color.

Color adjustments include white balance, tone, and saturation. You can make most adjustments on the Basic tab, and then use controls on the other tabs to fine-tune the results. If you want Camera Raw to analyze your image and apply approximate tonal adjustments, click Auto on the Basic tab.

To apply the settings used for the previous image, or to apply the default settings for the camera model, camera, or ISO settings, choose the appropriate command from the Camera Raw Settings menu . (See “Apply saved Camera Raw settings” on page 105.)

To see a video tutorial on adjusting images with Camera Raw, go to the Adobe website at www.adobe.com/go/vid0006.

To see a video tutorial on adjusting multiple images with Camera Raw, go to the Adobe website at www.adobe.com/go/vid0007.

4. Make other adjustments and image corrections.

Use other tools and controls in the Camera Raw dialog box to perform such tasks as sharpening the image, reducing noise, correcting for lens defects, and retouching.

5. (Optional) Save image settings as a preset or as default image settings.

To apply the same adjustments to other images later, save the settings as a preset. To save the adjustments as the defaults to be applied to all images from a specific camera model, a specific camera, or a specific ISO setting, save the image settings as the new Camera Raw defaults. (See “Save, reset, and load Camera Raw settings” on page 104.)

6. Set workflow options for Photoshop.

Set options to specify how images are saved from Camera Raw and how Photoshop should open them. You can access the Workflow Options settings by clicking the link beneath the image preview in the Camera Raw dialog box.

7. Save the image, or open it in Photoshop or After Effects.

When you finish adjusting the image in Camera Raw, you can apply the adjustments to the camera raw file, open the adjusted image in Photoshop or After Effects, save the adjusted image to another format, or cancel and discard adjustments. If you open the Camera Raw dialog box from After Effects or Photoshop, the Save and Done buttons are unavailable.

Save Applies the Camera Raw settings to the images and saves copies of them in JPEG, PSD, TIFF, or DNG format. Press Alt (Windows) or Option (Mac OS) to suppress the Camera Raw Save Options dialog box and save the files using the last set of save options. (See “Save a camera raw image in another format” on page 93.)

Open or OK Opens copies of the camera raw image files (with the Camera Raw settings applied) in Photoshop or After Effects. The original camera raw image file remains unaltered. Press Shift while clicking Open to open the raw file in Photoshop as a Smart Object. At any time, you can double-click the Smart Object layer that contains the raw file to adjust the Camera Raw settings.

Done Closes the Camera Raw dialog box and stores file settings either in the camera raw database file, in the sidecar XMP file, or in the DNG file.

Cancel Cancels the adjustments specified in the Camera Raw dialog box.

Import and interpret camera raw files

You can import sequences of camera raw files much as you import sequences of other kinds of still image files.

After Effects applies the settings for the first camera raw image in the sequence to all of the images in the sequence that do not have their own XMP sidecar files. After Effects does not check the Camera Raw database for image settings.

Note: Camera raw files are uncompressed. Their large size may increase rendering time.

- 1 Choose File > Import > File.
- 2 Select the camera raw file, and click Open.
- 3 Make any necessary adjustments in the Camera Raw dialog box, and click OK.

You can adjust a camera raw image after importing it. To open the image in the Camera Raw dialog box, select the footage item in the Project panel, choose File > Interpret Footage > Main, and click More Options.

Note: You can't assign an input color profile to a camera raw image for use in a color-managed project. For information on how colors are automatically interpreted, see "Interpret a footage item by assigning an input color profile" on page 245.

See also

"Import a single still image or a still-image sequence" on page 81

"Color management" on page 241

Camera Raw dialog box overview

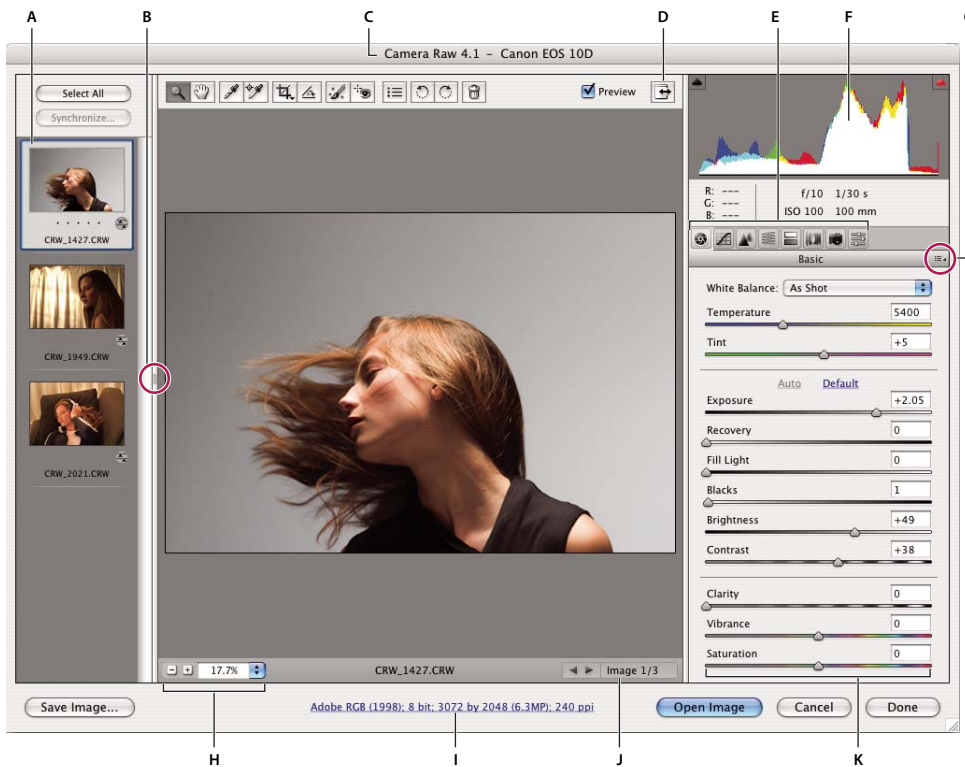

Camera Raw dialog box
 A. Filmstrip B. Toggle Filmstrip C. Camera, file name, and Exif information D. Toggle full screen mode E. Image adjustment tabs
 F. Histogram G. Camera Raw Settings menu H. Zoom levels I. Click to display workflow options J. Navigation arrows K. Adjustment sliders

Note: Some controls, such as the Workflow Options link, that are available when you open the Camera Raw dialog box from Adobe Bridge or Photoshop are not available when you open the Camera Raw dialog box from After Effects.

Camera Raw Settings menu

To open the Camera Raw Settings menu, click the button  in the upper-right corner of any of the image adjustment tabs. Several of the commands in this menu are also available from the Edit > Develop Settings menu in Adobe Bridge.

Camera Raw view controls

Zoom tool  Sets the preview zoom to the next higher preset value when you click the preview image. Alt-click (Windows) or Option-click (Mac OS) to use the next lower zoom value. Drag the Zoom tool in the preview image to zoom in on a selected area. To return to 100%, double-click the Zoom tool.

Hand tool Moves the image in the preview window if the preview image is set at a zoom level higher than 100%. Hold down the spacebar to temporarily activate the Hand tool while using another tool. Double-click the Hand tool to fit the preview image to the window.

Select Zoom Level Choose a magnification setting from the menu or click the Select Zoom Level buttons.

Preview Displays a preview of the image adjustments made in the current tab, combined with the settings in the other tabs. Deselect to show the image with the original settings of the current tab combined with the settings in the other tabs.

RGB Shows the red, green, and blue values of the pixel under the pointer in the preview image.

Shadows and Highlights Displays shadow and highlight clipping. Clipped shadows appear in blue, and clipped highlights appear in red. Highlight clipping is shown if any one of the three RGB channels is clipped (fully saturated with no detail). Shadow clipping is shown if all three RGB channels are clipped (black with no detail).

Image adjustment tabs

Basic Adjust white balance, color saturation, and tonality.

Tone Curve Fine-tune tonality using a Parametric curve and a Point curve.

Detail Sharpen images or reduce noise.

HSL / Grayscale Fine-tune colors using Hue, Saturation, and Luminance adjustments.

Split Toning Color monochrome images or create special effects with color images.

Lens Corrections Compensate for chromatic aberration and vignetting caused by the camera lens.

Camera Calibration Correct a color cast in the shadows and adjust non-neutral colors to compensate for the difference between the behavior of your camera and the Camera Raw profile for your camera model.

Presets Save and apply sets of image adjustment settings as presets.

Work with the Camera Raw cache in Adobe Bridge

When you view camera raw files in Adobe Bridge, the thumbnails and previews use either the default settings or your adjusted settings. The cache in Adobe Bridge and the Camera Raw cache store data for the file thumbnails, metadata, and file information. Caching this data shortens the loading time when you return to a previously viewed folder.

Because caches can become very large, you may want to purge the cache or limit its size. You can also purge and regenerate the cache if you suspect that it is corrupted or old. Purging the cache deletes thumbnail information and metadata added since the camera raw file was opened in Adobe Bridge.

Note: The Camera Raw cache holds data for about 200 images for each gigabyte of disk storage allocated to it. By default, the Camera Raw cache is set to a maximum size of 1 GB. You can increase its limit in the Camera Raw preferences.

1 In Adobe Bridge, choose Edit > Camera Raw Preferences (Windows) or Bridge > Camera Raw Preferences (Mac OS), or, with the Camera Raw dialog box open, click the Open Preferences Dialog button .

2 Do any of the following:

- To change the cache size, enter a Maximum Size value.
- To purge the camera raw cache, click the Purge Cache button.
- To change the location of the camera raw cache, click Select Location.



Navigating, opening, and saving images with Camera Raw

Process, compare, and rate multiple images in Camera Raw

The most convenient way to work with multiple camera raw images is to use the Filmstrip view in Camera Raw, which opens by default when you open multiple images in Camera Raw from Adobe Bridge.

Images can have three states in Filmstrip view: deselected, selected (but not active), and active (also selected). In general, adjustments are applied to all selected images.

You can also synchronize settings to apply settings from the active image to all selected images. You can quickly apply a set of adjustments to an entire set of images—such as all shots taken under the same conditions—and then do fine-tuning on the individual shots later, after you've determined which you'll use for your final output.

- To select an image, click its thumbnail. To select a range of images, Shift-click two thumbnails. To add an image to a selection, Ctrl-click (Windows) or Command-click (Mac OS) its thumbnail.
- To change which image is active without changing which images are selected, click a navigation arrow  at the bottom of the preview pane.
- To apply settings from the active image to all selected images, click the Synchronize button at the top of the Filmstrip pane and choose which settings to synchronize.
- To apply a star rating, click a rating under the image thumbnail.
- To mark selected images for deletion, click Mark For Deletion .

A red cross appears in the thumbnail of an image marked for deletion. The file is sent to the Recycle Bin (Windows) or Trash (Mac OS) when you close the Camera Raw dialog box. (If you decide to keep an image that you marked for deletion, select it in the Thumbnail pane and click Mark For Deletion again, before you close the Camera Raw dialog box.)

Open images in Camera Raw

- To process raw images in Camera Raw, select one or more camera raw files in Adobe Bridge, and then choose File > Open In Camera Raw or press Ctrl+R (Windows) or Command+R (Mac OS). When you finish making adjustments in the Camera Raw dialog box, click Done to accept changes and close the dialog box. You can also click Open to open a copy of the adjusted image in Photoshop.

- To process JPEG or TIFF images in Camera Raw, select one or more JPEG or TIFF files in Adobe Bridge, and then choose File > Open In Camera Raw or press Ctrl+R (Windows) or Command+R (Mac OS). When you finish making adjustments in the Camera Raw dialog box, click Done to accept changes and close the dialog box. You can specify whether JPEG or TIFF images with Camera Raw settings are always opened in Camera Raw in the JPEG and TIFF Handling section of the Camera Raw preferences. You can also specify that JPEG and TIFF images are opened in Camera Raw in the Thumbnail section of the Bridge preferences and the File Handling section of the Photoshop preferences.
- To import camera raw images in Photoshop, select one or more camera raw files in Adobe Bridge, and then choose File > Open With > Photoshop CS3. (You can also choose File > Open In Photoshop, and browse to select camera raw files.) When you finish making adjustments in the Camera Raw dialog box, click Open to accept changes. Press Shift while clicking Open to open the image as a Smart Object in Photoshop. At any time, you can double-click the Smart Object layer that contains the raw file to adjust the Camera Raw settings.

 *Shift-double-click a thumbnail in Adobe Bridge to open a camera raw image in Photoshop without opening the Camera Raw dialog box. Hold down Shift while choosing File > Open to open multiple selected images.*

- To import camera raw images in After Effects using Adobe Bridge, select one or more camera raw files in Adobe Bridge, and then choose File > Place In After Effects. (You can also choose a File > Import command in After Effects and browse to select camera raw files.) When you finish making adjustments in the Camera Raw dialog box, click OK to accept changes.
- To import TIFF and JPEG files into After Effects using Camera Raw, select File > Import in After Effects, select All Files from the Enable menu (Mac OS) or Files of Type menu (Windows) in the After Effects Import dialog box. Select the file to import, select Camera Raw from the Format menu, and click Open.
- Placing or dragging image stacks from Adobe Bridge into After Effects imports them as an image sequence. Add an extra bullet specific to importing camera raw files as a sequence into After Effects. Camera Raw settings applied to the first camera raw file upon import are applied to the remaining files in the sequence unless an XMP sidecar file is present for any subsequent file in the sequence. In that case, the settings in the XMP file or in the DNG file are applied to that specific frame in the sequence, all other frames use the settings that the first file in the sequence specifies.

Save a camera raw image in another format

You can save camera raw files from the Camera Raw dialog box in PSD, TIFF, JPEG, or DNG formats.

When you use the Save command in the Camera Raw dialog box, files are placed in a queue to be processed and saved. This is useful if you are processing several files in the Camera Raw dialog box and saving them in the same format.

- 1 In the Camera Raw dialog box, click the Save button in the lower-left corner of the dialog box.

 *Alt-click (Windows) or Option-click (Mac OS) Save to suppress the Camera Raw Save Options dialog box when saving a file.*

- 2 In the Save Options dialog box, specify the following options:

Destination Specifies where to save the file. If necessary, click the Select Folder button and navigate to the location.

File Naming Specifies the file name using a naming convention that includes elements such as date and camera serial number. Using informative file names based on a naming convention helps you keep image files organized.

- 3 Choose a file format from the Format menu.
- 4 Click Save.

Format options

Digital Negative Saves a copy of the camera raw file in the DNG file format.

- **Compressed (lossless)** Uses lossless compression, meaning that no information is lost while reducing the file size.
- **Convert To Linear Image** Stores the image data in an interpolated (demosaiced) format. The resulting interpolated image can be interpreted by other software even if that software does not have a profile for the digital camera that captured the image.
- **Embed Original Raw File** Stores all of the original camera raw image data in the DNG file.
- **JPEG Preview** Embeds a JPEG preview in the DNG file. If you decide to embed a JPEG preview, you can choose the preview size. If you embed JPEG previews, other applications can view the contents of the DNG file without parsing the camera raw data.

JPEG Saves copies of the camera raw files in JPEG (Joint Photographic Experts Group) format. To specify the amount of compression, enter a value from 0 to 12 or choose from the menu. Entering a higher value, or choosing High or Maximum, applies less compression and increases file size and image quality. JPEG format is commonly used to display photographs and other continuous-tone images in web photo galleries, slideshows, presentations, and other online services.

TIFF Saves copies of the camera raw files as TIFF (Tagged-Image File Format) files. Specify whether to apply no compression, or LZW or ZIP file compression. TIFF is a flexible bitmap image format supported by virtually all paint, image-editing, and page-layout applications. TIFF provides greater compression and compatibility with other applications than does PSD format.

Photoshop Saves copies of the camera raw files in the PSD file format. You can specify whether to preserve cropped pixel data in the PSD file.

Adjusting color in Camera Raw

Using histogram and RGB levels in Camera Raw

A *histogram* is a representation of the number of pixels at each luminance value in an image. A histogram that has nonzero values for each luminance value indicates an image that takes advantage of the full tonal scale. A histogram that doesn't use the full tonal range corresponds to a dull image that lacks contrast. A histogram with a spike at the left side indicates shadow clipping; a histogram with a spike on the right side indicates highlight clipping.

 *Select Shadows or Highlights to see, in the preview image, which pixels are being clipped. For more information, see “Preview highlight and shadow clipping in Camera Raw” on page 95.*

One common task for adjusting an image is to spread out the pixel values more evenly from left to right on the histogram, instead of having them bunched up at one end or the other.

A histogram is made up of three layers of color that represent the red, green, and blue color channels. White appears when all three channels overlap; yellow, magenta, and cyan appear when two of the RGB channels overlap (yellow equals the red + green channels, magenta equals the red + blue channels, and cyan equals the green + blue channels).

The histogram changes automatically as you adjust the settings in the Camera Raw dialog box.

The RGB values of the pixel under the pointer (in the preview image) appear below the histogram.

Note: You can also use the Color Sampler tool to place up to nine color samplers in the preview image. The RGB values appear above the preview image. To remove a color sampler, Alt-click (Windows) or Option-click (Mac OS) it. To clear the color samplers, click Clear Samplers.

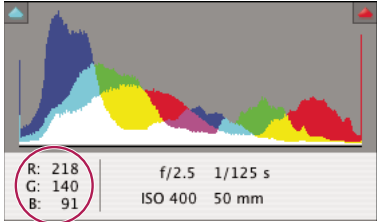

The Camera Raw dialog box displays the RGB values of the pixel under the pointer.

Preview highlight and shadow clipping in Camera Raw

Clipping occurs when a pixel's color values are higher than the highest value or lower than the lowest value that can be represented in the image; overbright values are clipped to output white, and overdark values are clipped to output black. The result is a loss of image detail.

- To see which pixels are being clipped with the rest of the preview image, select Shadows or Highlights options beneath the histogram.
- To see only the pixels that are being clipped, press Alt (Windows) or Option (Mac OS) while dragging the Exposure, Recovery, or Black sliders.

For highlights, pixels that are clipped in all color channels appear white. For shadows, pixels that are clipped in all color channels appear black. Clipping in one or two channels is shown by the primary color (red, green, blue) or a combined color (cyan, magenta, yellow).

Note: In some cases, clipping occurs because the color space that you are working has a gamut that is too small. If your colors are being clipped, consider working in a color space with a large gamut, such as ProPhoto RGB.

White balance controls in Camera Raw

In very simple terms, adjusting the white balance is a matter of identifying what objects in the image should be neutral-colored (white or gray) and then adjusting the colors in the image to make those objects neutral-colored. A white or gray object in a scene takes on the color cast by the ambient light or flash used to shoot the picture. When you use the White Balance tool to specify an object that should be white or gray, Camera Raw can determine the color of the light in which the scene was shot and then adjust for scene lighting automatically.

Color temperature (in Kelvins) is used as a measure of scene lighting because natural and incandescent light sources give off light in a predictable distribution according to their temperature.

A digital camera records the white balance at the time of exposure as a metadata entry. The Camera Raw plug-in reads this value and makes it the initial setting when you open the file in the Camera Raw dialog box. This setting usually yields the correct color temperature, or nearly so. You can adjust the white balance if it is not quite right.

Note: Not all color casts are a result of incorrect white balance. Use the controls in the Calibrate tab to correct a color cast that remains after the white balance is adjusted.

The Basic tab in the Camera Raw dialog box has three controls for correcting a color cast in an image:

White Balance Camera Raw applies the white balance setting and changes the Temperature and Tint properties in the Basic tab accordingly. Use these controls to fine-tune the color balance.

- **As Shot** Uses the camera's white balance settings, if they are available.
- **Auto** Calculates the white balance based on the image data.

Note: If Camera Raw doesn't recognize the white balance setting of a camera, choosing As Shot is the same as choosing Auto.

Temperature Sets the white balance to a custom color temperature. Decrease Temperature to correct a photo taken with a lower color temperature of light; the Camera Raw plug-in makes the image colors bluer to compensate for the lower color temperature (yellowish) of the ambient light. Conversely, increase Temperature to correct a photo taken with a higher color temperature of light; the image colors become warmer (yellowish) to compensate for the higher color temperature (bluish) of the ambient light.

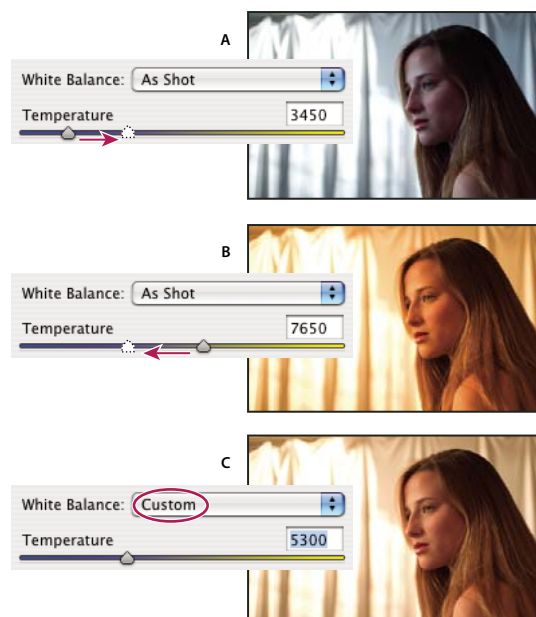

Note: The range and units for the Temperature and Tint controls are different when you are adjusting a non-camera raw image, such as a TIFF or JPEG image. For instance, Camera Raw provides a true-temperature adjustment slider for raw files from 2,000 Kelvin to 50,000 Kelvin. For JPEG or TIFF files, Camera Raw attempts to approximate a different color temperature or white balance, but because the original value was already used to alter the pixel data in the file, Camera Raw does not provide the true Kelvin temperature scale. In these instances an approximate scale of -100 to 100 is used in place of the temperature scale.



Correcting the white balance

A. Moving the Temperature slider to the right corrects a photo taken with a higher color temperature of light B. Moving the Temperature slider to the left corrects a photo taken with a lower color temperature of light C. Photo after color temperature adjustment

Tint Sets the white balance to compensate for a green or magenta tint. Decrease Tint to add green to the image; increase Tint to add magenta.

 To adjust the white balance quickly, select the White Balance tool , and then click an area in the preview image that should be a neutral gray or white. The Temperature and Tint properties adjust to make the selected color exactly neutral (if possible). If you're clicking whites, choose a highlight area that contains significant white detail rather than a specular highlight. You can double-click the White Balance button to reset White Balance to As Shot.

Adjust tone in Camera Raw

You adjust the image tonal scale using the tone controls in the Basic tab.

When you click Auto at the top of the tone controls section of the Basic tab, Camera Raw analyzes the camera raw image and makes automatic adjustments to the tone controls (Exposure, Recovery, Fill Light, Blacks, Brightness, and Contrast).

You can also apply automatic settings separately for individual tone controls. To apply an automatic adjustment to an individual tone control, such as Exposure or Recovery, press Shift and double-click the slider. To return an individual tone control to its original value, double-click its slider.

When you adjust tone automatically, Camera Raw ignores any adjustments previously made in other tabs (such as fine-tuning of tone in the Curves tab). For this reason, you should usually apply automatic tone adjustments first—if at all—to get an initial approximation of the best settings for your image. If you are very careful during shooting and have deliberately shot with different exposures, you probably don't want to undo that work by applying automatic tone adjustments. On the other hand, you can always try clicking Auto and then undo the adjustments if you don't like them.

Previews in Adobe Bridge use the default image settings. If you want the default image settings to include automatic tone adjustments, select Apply Auto Tone Adjustments in the Default Image Settings section of the Camera Raw preferences.

Note: *If you are comparing images based on their previews in Adobe Bridge, you may want to leave the Apply Auto Tone Adjustments preference deselected, which is the default. Otherwise, you'll be comparing images that have already been adjusted.*

As you make adjustments, keep an eye on the end points of the histogram, or use the shadow and highlight clipping previews.

 While moving the Exposure, Recovery, or Blacks slider, hold down Alt (Windows) or Option (Mac OS) to preview where highlights or shadows are clipped. Move the slider until clipping begins, and then reverse the adjustment slightly. (For more information, see "Preview highlight and shadow clipping in Camera Raw" on page 95.)

- To manually adjust a tone control, drag the slider, type a number in the text box, or select the value in the text box and press the Up or Down Arrow key.
- To reset a value to its default, double-click the slider control.

Exposure Adjusts the overall image brightness, with a greater effect in the high values. Decrease Exposure to darken the image; increase Exposure to brighten the image. The values are in increments equivalent to *f*-stops. An adjustment of +1.50 is similar to widening the aperture 1-1/2 stops. Similarly, an adjustment of -1.50 is similar to reducing the aperture 1-1/2 stops. (Use Recovery to bring highlight values down.)

Recovery Attempts to recover details from highlights. Camera Raw can reconstruct some details from areas in which one or two color channels are clipped to white.

Fill Light Attempts to recover details from shadows, without brightening blacks. Camera Raw can reconstruct some details from areas in which one or two color channels are clipped to black. Using Fill Light is similar to using the shadows portion of the Photoshop Shadow/Highlight filter or the After Effects Shadow/Highlight effect.

Blacks Specifies which input levels are mapped to black in the final image. Increasing Blacks expands the areas that are mapped to black. This sometimes creates the impression of increased contrast in the image. The greatest change is in the shadows, with much less change in the midtones and highlights. Using the Blacks slider is similar to using the black point slider for input levels when using the Photoshop Levels command or the After Effects Levels effect.

Brightness Adjusts the brightness or darkness of the image, much as the Exposure property does. However, instead of clipping the image in the highlights or shadows, Brightness compresses the highlights and expands the shadows when you move the slider to the right. Often, the best way to use this control is to set the overall tonal scale by first setting Exposure, Recovery, and Blacks; then set Brightness. Large Brightness adjustments can affect shadow or highlight clipping, so you may want to readjust the Exposure, Recovery, or Blacks property after adjusting Brightness.

Contrast Increases or decreases image contrast, mainly affecting midtones. When you increase contrast, the middle-to-dark image areas become darker, and the middle-to-light image areas become lighter. Generally, you use the Contrast property to adjust the contrast of the midtones after setting the Exposure, Blacks, and Brightness values.

Fine-tune tone curves in Camera Raw

Use tone curves to fine-tune images after you've made tone adjustments in the Basic tab. The tone curves represent changes made to the tonal scale of an image. The horizontal axis represents the original tone values of the image (input values), with black on the left and progressively lighter values toward the right. The vertical axis represents the changed tone values (output values), with black on the bottom and progressing to white at the top.

If a point on the curve moves up, the output is a lighter tone; if it moves down, the output is a darker tone. A straight, 45-degree line indicates no changes to the tone response curve: the original input values exactly match the output values.

Use the tone curve in the Parametric tab to adjust the values in specific tonal ranges in the image. The areas of the curve affected by the region properties (Highlights, Lights, Darks, or Shadows) depend on where you set the split controls at the bottom of the graph. The middle region properties (Darks and Lights) mostly affect the middle region of the curve. The Highlight and Shadows properties mostly affect the ends of the tonal range.

❖ To adjust tone curves, do any of the following:

- Drag the Highlights, Lights, Darks, or Shadows slider in the Parametric tab. You can expand or contract the curve regions that the sliders affect by dragging the region divider controls along the horizontal axis of the graph.
- Drag a point on the curve in the Point tab. As you drag the point, the Input and Output tonal values are displayed beneath the tone curve.
- Choose an option from the Curve menu in the Point tab. The setting you choose is reflected in the Point tab, but not in the settings in the Parametric tab. Medium Contrast is the default setting.

Clarity, Saturation, and Vibrance controls in Camera Raw

You can change the color saturation (vividness or color purity) of all colors by adjusting the Clarity, Vibrance, and Saturation controls on the Basic tab. (To adjust saturation for a specific range of colors, use the controls on the HSL / Grayscale tab.)

Clarity Adds depth to an image by increasing local contrast. This setting is similar to a large-radius unsharp mask. When using this setting, it is best to zoom in to 100% or greater. To maximize the effect, increase the setting until you see halos near the edge details of the image and then reduce the setting slightly.

Vibrance Adjusts the saturation so that clipping is minimized as colors approach full saturation, changing the saturation of all lower-saturated colors with less effect on the higher-saturated colors. Vibrance also prevents skin tones from becoming oversaturated.

Saturation Adjusts the saturation of all image colors equally from -100 (monochrome) to +100 (double the saturation).

HSL / Grayscale controls in Camera Raw

You can use the controls in the HSL / Grayscale tab to adjust individual color ranges. For example, if a red object looks too vivid and distracting, you can decrease the Reds values in the nested Saturation tab.

The following nested tabs contain controls for adjusting a color component for a specific color range:

Hue Changes the color. For example, you can change a blue sky (and all other blue objects) from cyan to purple.

Saturation Changes the color vividness or purity of the color. For instance, you can change a blue sky from gray to highly saturated blue.

Luminance Changes the brightness of the color range.

If you select Convert To Grayscale, you see only one nested tab:

Grayscale Mix Use controls in this tab to specify the contribution of each color range to the grayscale version of the image.

Tone a grayscale image in Camera Raw

Use the controls in the Split Toning tab to color a grayscale image. You can add one color throughout the tonal range, such as a sepia appearance, or create a split tone result, in which a different color is applied to the shadows and the highlights. The extreme shadows and highlights remain black and white.

You can also apply special treatments, such as a cross-processed look, to a color image.

- 1 Select a grayscale image. (This can be an image that you converted to grayscale by selecting Convert To Grayscale in the HSL / Grayscale tab.)
- 2 In the Split Toning tab, adjust the Hue and Saturation properties for the highlights and shadows. Hue sets the color of the tone; Saturation sets the magnitude of the result.
- 3 Adjust the Balance control to balance the influence between the Highlight and Shadow controls. Positive values increase the influence of the Shadow controls; negative values increase the influence of the Highlight controls.

Adjust color rendering for your camera in Camera Raw

For each camera model it supports, Camera Raw uses profiles to process raw images. The profiles are produced by photographing a color target under different white-balanced lighting conditions. When you set white balance, Camera Raw uses the profiles for your camera to extrapolate color information.

Sometimes colors rendered by the Camera Raw plug-in do not look as expected. The cause may be a difference between a camera's profile and the profile in Camera Raw for that camera model. Alternatively, the photo may have been taken under nonstandard lighting conditions beyond the compensating range of the Camera Raw plug-in.

To render non-neutral colors differently, use the Hue and Saturation controls in the Calibrate tab to adjust the settings for the profile built into Camera Raw. You can also specify whether to use the profiles built into Camera Raw or a profile built into the file itself.

- 1 In the Calibrate tab, choose a profile from the Camera Profile menu.

Important: The options in the Camera Profile menu vary, depending on whether the file has a profile embedded and whether a newer version of the profile has become available in Camera Raw.

ACR 2.4, 3.0, or higher Higher version numbers represent newer and improved camera profiles for some cameras. If you only see a lower version number, such as 2.4, your camera's profiles didn't require updating. If multiple options are available, you may want to choose a lower version number for consistent behavior with legacy images.

Embedded Use the profile embedded in the current file. TIFF, JPEG, and DNG files can have embedded profiles.

2 Adjust the Shadow Tint property to remove a color cast in the shadows. Usually, decreasing Shadow Tint adds green to the shadow areas, and increasing Shadow Tint adds magenta.

3 Use the Hue and Saturation controls to adjust the red, green, and blue in the image. Look at the preview image as you make adjustments until the image looks correct to you. In general, adjust the hue first, and then adjust its saturation.

4 Adjustments made in the Calibrate tab affect the selected image in the Camera Raw dialog box. If you want to save the adjustments and make them the default image settings for the files from a specific camera, choose Save New Camera Raw Defaults from the Camera Raw Settings menu ☰.

Note: To save settings as defaults for a specific camera (by serial number) or for a specific lighting condition (by ISO number), you can also modify the Default Image Settings preferences in the Camera Raw preferences. (See “Save, reset, and load Camera Raw settings” on page 104.)

Compensate for chromatic aberration in Camera Raw

Chromatic aberration is a common defect caused by the failure of the lens to focus different frequencies (colors) to the same spot. In one type of chromatic aberration, the image from each color of light is in focus, but each image is a slightly different size. This type of aberration is seen as a complementary color fringing in areas away from the center of the image. For example, you may see a red fringe on the side of an object toward the center of the image, and cyan fringe on the side of the object away from the center of the image.



Original image (top), and after fixing chromatic aberration (bottom)

Another type of chromatic artifact affects the edges of specular highlights, such as those found when light is reflected off of the surface of rippled water or edges of polished metal. This situation usually results in a purple fringe around each specular highlight. Similar-colored fringing can occur along edges between dark objects and very bright objects.

1 Zoom into an area near the corner of the preview image. For the best results, the area should contain very dark or black detail against a very light or white background. Look for the color fringing.

2 In the Lens Corrections tab, adjust any of these controls:

Fix Red/Cyan Fringe Adjusts the size of the red channel relative to the green channel. This compensates for red/cyan color fringing.

Fix Blue/Yellow Fringe Adjusts the size of the blue channel relative to the green channel. This compensates for blue/yellow color fringing.

Defringe Desaturates colored fringing around specular highlights. Choose All Edges to correct color fringing for all edges, including any sharp change in color values. If choosing All Edges results in thin grey lines near edges or other

unwanted effects, choose Highlight Edges to correct color fringing only in edges of highlighting, where fringing is most likely to occur. Choose Off to turn off defringing.

Look at the preview image as you move each slider left or right. If you're adjusting red/cyan color fringing, hold down Alt (Windows) or Option (Mac OS) to hide the blue/yellow color fringing. Similarly, hold down Alt (Windows) or Option (Mac OS) while adjusting the blue/yellow color fringing to hide the red/cyan color fringing. The goal is to reduce the color fringing as much as possible.



Compensate for lens vignetting in Camera Raw

Vignetting is a lens defect that causes the edges, especially the corners, of an image to be darker than the center. Use controls in the Lens Vignetting section of the Lens Correction tab to compensate for vignetting.

- 1 Increase Amount to lighten the corners, or decrease Amount to darken them.
- 2 Decrease Midpoint to apply the adjustment to a larger area away from the corners, or increase Midpoint to restrict the adjustment to an area closer to the corners.

Modifying images with Camera Raw

Rotate images with Camera Raw

- Click the Rotate Image 90° Counterclockwise button  (or press L).
- Click the Rotate Image 90° Clockwise button  (or press R).

Note: Using commands in the Edit menu, you can also rotate images in Adobe Bridge without opening the Camera Raw dialog box.

Straighten images in Camera Raw

- 1 In the Camera Raw dialog box, select the Straighten tool .
- 2 Drag the Straighten tool in the preview image to establish what's horizontal or vertical.

Note: The Crop tool is active immediately after you use the Straighten tool.

Crop selected images in Camera Raw

- 1 In the Camera Raw dialog box, select the Crop tool .

To constrain your initial crop area to a specific aspect ratio, hold the mouse button down as you select the Crop tool, and choose an option from the menu. To apply a constraint to a previously applied crop, Ctrl-click (Mac OS) or right-click (Windows) on the crop.

- 2 Drag in the preview image to draw the crop area box.
- 3 To move, scale, or rotate the crop area, drag the crop area or its handles.

When you are finished, the cropped area of the image remains visible, but is dimmed in the image preview.

Note: To cancel the crop operation, press Esc with the Crop tool active, or click and hold the Crop tool button and choose Clear Crop from the menu. To cancel the crop and close the Camera Raw dialog box without processing the camera raw image file, click the Cancel button or deselect the Crop tool and press Esc.

Remove red-eye in Camera Raw

- 1 Zoom the image in to at least 100%.
- 2 In the Toolbar, select the Red Eye Removal tool .
- 3 Drag a selection in the photo around the red eye.

Camera Raw sizes the selection to match the pupil. You can adjust the size of the selection by dragging its edges.

- 4 Drag the Pupil Size slider on the toolbar to the right to increase the size of the area corrected.
- 5 Drag the Darken slider to the right to darken the pupil area within the selection and the iris area outside the selection.

Deselect Show Overlay to turn off the selection and check your correction.

Note: Move between multiple selected red eye areas by clicking the selection.

Retouch images in Camera Raw

The Retouch tool lets you repair a selected area of an image with a sample from another area.

- 1 Select the Retouch tool  from the toolbar.
- 2 Select one of the following from the Type menu:

Heal Matches the texture, lighting, and shading of the sampled area to the selected area.

Clone Applies the sampled area of the image to the selected area.

- 3 (Optional) In the toolbar, drag the Radius slider to specify the size of the area that the Retouch tool affects.
- 4 Move the Retouch tool into the photo and click the part of the photo to retouch. A red and white dashed circle appears over the selected area. The green and white dashed circle designates the sampled area of the photo used to clone or heal.
- 5 Do any of the following:
 - To specify the sampled area, drag inside the green and white circle to move it to another area of the image.
 - To specify the selected area being cloned or healed, drag inside the red and white circle.
 - To adjust the size of the circles, move the pointer over the edge of either circle until it changes to a double-pointing arrow, and then drag to make both circles larger or smaller.
 - To cancel the operation, press Backspace (Windows) or Delete (Mac OS).

Repeat this procedure for each area of the image that needs retouching. To remove all sample areas and start over, click the Clear All button in the Toolbar.

Adjust sharpening in Camera Raw

The sharpening controls on the Detail tab adjust edge definition in the image. Camera Raw provides four adjustments to help you fine-tune image sharpness.

Use the Apply Sharpening To preference in the Camera Raw preferences to specify whether sharpening is applied to all images or just to previews.

- 1 Zoom the preview image to at least 100%.

2 In the Detail tab, adjust any of these controls:

Amount Adjusts edge definition. Increase the Amount value to increase sharpening. A value of zero (0) turns off sharpening. In general, set Amount to a lower value for cleaner images. The adjustment is a variation of Unsharp Mask, which locates pixels that differ from surrounding pixels based on the threshold you specify and increases the pixels' contrast by the amount you specify. When opening a camera raw image file, the Camera Raw plug-in calculates the threshold to use based on camera model, ISO, and exposure compensation.

Radius Adjusts the size of the details that sharpening is applied to. Photos with very fine details may need a lower setting. Photos with larger details may be able to use a larger radius. Using too large a radius generally results in unnatural-looking results.

Detail Adjusts how much high-frequency information is sharpened in the image and how much the sharpening process emphasizes edges. Lower settings primarily sharpen edges to remove blurring. Higher values are useful for making the textures in the image more pronounced.

Masking Controls an edge mask. With a setting of zero (0), everything in the image receives the same amount of sharpening. With a setting of 100, sharpening is mostly restricted to those areas near the strongest edges. Press Alt (Windows) or Option (Mac OS) while dragging this slider to see the areas to be sharpened (white) versus the areas masked out (black).

Reducing noise in Camera Raw

The Noise Reduction section of the Detail tab has controls for reducing *image noise*, the extraneous visible artifacts that degrade image quality. Image noise includes luminance (grayscale) noise, which makes an image look grainy, and chroma (color) noise, which is usually visible as colored artifacts in the image. Photos taken with high ISO speeds or less-sophisticated digital cameras can have noticeable noise.

The Luminance control reduces grayscale noise, and the Color control reduces chroma noise. Moving a slider to zero turns off noise reduction.

💡 *When making Luminance Smoothing or Color Noise Reduction adjustments, first zoom in on the preview image to at least 100% to see the noise reduction previewed.*

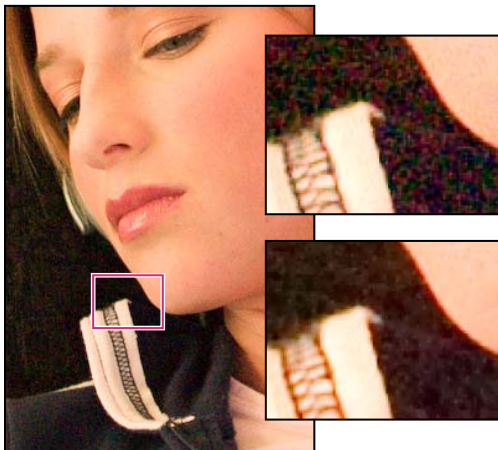

Moving Luminance Smoothing slider right reduces grayscale noise (above right), and moving Color Noise Reduction slider right reduces chroma noise (below right).

Camera Raw settings

Save, reset, and load Camera Raw settings

You can reuse the adjustments that you've made to an image. You can save all of the current Camera Raw image settings, or any subset of them, as a preset or as a new set of defaults. The default settings apply to a specific camera model, a specific camera serial number, or a specific ISO setting, depending on the settings in the Default Image Settings section of the Camera Raw preferences.

Presets appear by name in the Presets tab, in the Edit > Develop Settings menu in Adobe Bridge, in the context menu for camera raw images in Adobe Bridge, and in the Apply Presets submenu of the Camera Raw Settings menu in the Camera Raw dialog box. Presets are not listed in these locations if you don't save them to the Camera Raw settings folder. However, you can use the Load Settings command to browse for and apply settings saved elsewhere.



You can save and delete presets using the buttons at the bottom of the Presets tab.

❖ Click the Camera Raw Settings menu button , and choose a command from the menu:

Save Settings Saves the current settings as a preset. Choose which settings to save in the preset, and then name and save the preset.

Save New Camera Raw Defaults Saves the current settings as the new default settings for other images taken with the same camera, with the same camera model, or with the same ISO setting. Select the appropriate options in the Default Image Settings section of the Camera Raw preferences to specify whether to associate the defaults with a specific camera's serial number or with an ISO setting.

Reset Camera Raw Defaults Restores the original default settings for the current camera, camera model, or ISO setting.

Load Settings Opens the Load Raw Conversion Settings dialog box, in which you browse to the settings file, select it, and then click Load.

Specify where Camera Raw settings are stored

Choose a preference to specify where the settings are stored. The XMP files are useful if you plan to move or store the image files and want to retain the camera raw settings. You can use the Export Settings command to copy the settings in the Camera Raw database to sidecar XMP files or embed the settings in Digital Negative (DNG) files.

When a camera raw image file is processed with Camera Raw, the image settings are stored in one of two places: the Camera Raw database file or a sidecar XMP file. Settings for DNG files are typically stored in the DNG files themselves, as with TIFF and JPEG files.

Note: *When you import a sequence of camera raw files in After Effects, the settings for the first file are applied to all files in the sequence that do not have their own XMP sidecar files. After Effects does not check the Camera Raw database.*

You can set a preference to determine where settings are stored. When you reopen a camera raw image, all settings default to the values used when the file was last opened. Image attributes (target color space profile, bit depth, pixel size, and resolution) are not stored with the settings.

1 In Adobe Bridge, choose Edit > Camera Raw Preferences (Windows) or Bridge > Camera Raw Preferences (Mac OS).

2 In the Camera Raw Preferences dialog box, choose one of the following from the Save Image Settings In menu:

Camera Raw Database Stores the settings in a Camera Raw database file in the folder Document and Settings/[*user name*]/Application Data/Adobe/CameraRaw (Windows) or Users/[*user name*]/Library/Preferences (Mac OS). This database is indexed by file content, so the image retains camera raw settings even if the camera raw image file is moved or renamed.

Sidecar “.xmp” Files Stores the settings in a separate file, in the same folder as the camera raw file, with the same base name and an .xmp extension. This option is useful for long-term archiving of raw files with their associated settings, and for the exchange of camera raw files with associated settings in multiuser workflows. These same sidecar XMP files can store IPTC (International Press Telecommunications Council) data or other metadata associated with a camera raw image file. If you open files from a read-only volume such as a CD or DVD, be sure to copy the files to your hard disk before opening them. The Camera Raw plug-in cannot write an XMP file to a read-only volume and writes the settings to the Camera Raw database file instead. You can view XMP files in Adobe Bridge by choosing View > Show Hidden Files.

Important: *If you are using a revision control system to manage your files and are storing settings in sidecar XMP files, keep in mind that you must check your sidecar files in and out to make changes to camera raw images; similarly, you must manage (e.g., rename, move, delete) XMP sidecar files together with their camera raw files. Adobe Bridge, Photoshop, After Effects, and Camera Raw take care of this file synchronization when you work with files locally.*

 *If you store the camera raw settings in the Camera Raw database and plan to move the files to a different location (CD, DVD, another computer, and so forth), you can use the Export Settings To XMP command to export the settings to sidecar XMP files.*

3 If you want to store all adjustments to DNG files in the DNG files themselves, select Ignore Sidecar “.xmp” Files in the DNG File Handling section of the Camera Raw Preferences dialog box.

Copy and paste Camera Raw settings

In Adobe Bridge, you can copy and paste the Camera Raw settings from one image file to another.

1 In Adobe Bridge, select a file and choose Edit > Develop Settings > Copy Camera Raw Settings.

2 Select one or more files and choose Edit > Develop Settings > Paste Settings.

 *You can also right-click (Windows) or Control-click (Mac OS) image files to copy and paste using the context menu.*

3 In the Paste Camera Raw Settings dialog box, choose which settings to apply.

Apply saved Camera Raw settings

1 In Adobe Bridge or in the Camera Raw dialog box, select one or more files.

2 In Bridge, choose Edit > Develop Settings or right-click a selected file. Or, in the Camera Raw dialog box, choose Camera Raw Settings ≡ ▾.

3 Choose one of the following:

Image Settings Uses the settings from the selected camera raw image. This option is available only from the Settings menu in the Camera Raw dialog box.

Camera Raw Defaults Uses the saved default settings for a specific camera, camera model, or ISO setting.

Previous Conversion Uses the settings from the previous image of the same camera, camera model, or ISO setting.

A preset name Uses the settings (which can be a subset of all image settings) saved as a preset.

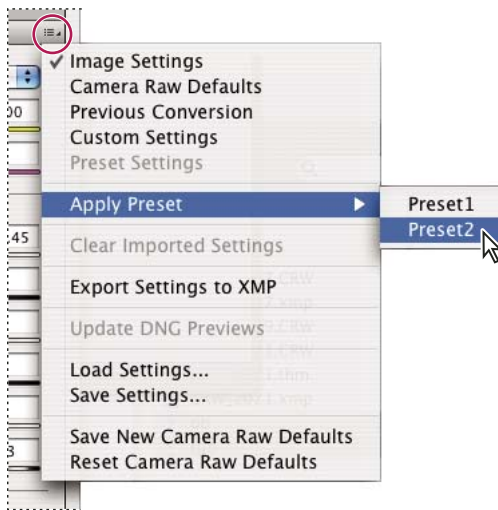

Applying a preset

Note: You can also apply presets from the Presets tab.

Export Camera Raw settings and DNG previews

If you store file settings in the Camera Raw database, you can use the Export Settings To XMP command to copy the settings to sidecar XMP files or embed them in DNG files. This is useful for preserving the image settings with your camera raw files when you move them.

You can also update the JPEG previews embedded in DNG files.

- 1 Open the files in the Camera Raw dialog box.
- 2 If you are exporting settings or previews for multiple files, select their thumbnails in the Filmstrip view.
- 3 In the Camera Raw Settings menu , choose Export Settings To XMP or Update DNG Previews.

The sidecar XMP files are created in the same folder as the camera raw image files. If you saved the camera raw image files in DNG format, the settings are embedded in the DNG files themselves.

Chapter 5: Compositions

Composition basics

Introduction to compositions

A *composition* is the framework for a movie. A typical composition includes multiple layers that represent components such as video and audio footage items, animated text and vector graphics, still images, and lights. You add a footage item to a composition by creating a layer for which the footage item is the source. You then arrange layers within a composition in space and time, and *composite* using transparency features to determine which parts of underlying layers show through the layers stacked on top of them. You *render* a composition to create a final output movie.

Simple projects may include only one composition; complex projects may include hundreds of compositions to organize large amounts of footage or many effects.

In some places in the After Effects user interface, *composition* is abbreviated as *comp*.

Use the Composition panel to preview a composition and modify its contents manually. The Composition panel contains the *composition frame* and a pasteboard area outside of the frame that you can use to move layers into and out of the composition frame. Only the area inside the composition frame is previewed and rendered. The offstage extents of layers—the portions not in the composition frame—are shown as rectangular outlines.

Each composition has an entry in the Project panel. Double-click a composition's entry in the Project panel to open the composition in its own Timeline panel. To select a composition in the Project panel, right-click (Windows) or Control-click (Mac OS) in the composition's Composition panel or Timeline panel and choose Reveal Composition In Project from the context menu.

Use the Flowchart panel to see the structure of a complex composition.

Timeline button  Click this button at the bottom of the Composition panel to activate the Timeline panel for the current composition.

 Press the backslash (\) key to switch activation between the Composition panel and Timeline panel for the current composition.

Comp button  Click this button at the upper-right of the Timeline panel to activate the Composition panel for the current composition.

Flowchart button  Click this button at the bottom of the Composition panel to activate the Flowchart panel for the current composition.

When working with a complex project, you may find it easiest to organize the project by *nesting* compositions—putting one or more compositions into another composition. You can create a composition from any number of layers by *precomposing* them. If you are finished making changes to some layers of your composition, you can precompose those layers and then *pre-render* the precomposition, replacing it with a rendered movie.

See also

“Creating layers” on page 133

“Preview video and audio” on page 120

“Work with the Flowchart panel” on page 24

Create a composition

You can change a composition's settings at any time. However, it's best to specify settings such as frame aspect ratio and frame size when you create the composition, with your final output in mind. Because After Effects bases certain calculations on these composition settings, changing them late in your workflow can affect your final output.

Note: You can override some composition settings when rendering to final output. For example, you can use different frame sizes for the same movie. For more information see “Work with render settings” on page 597 and “Work with output module settings” on page 599.

When you create a composition without changing settings in the Composition Settings dialog box, the new composition uses the settings from the previous time that composition settings were set.

Note: The previous Preserve Frame Rate When Nested Or In Render Queue and Preserve Resolution When Nested settings are not inherited by new compositions.

See also

“Work with composition settings” on page 110

“About nesting and precomposing” on page 113

Create a composition and manually set composition settings

❖ Choose Composition > New Composition, or press Ctrl+N (Windows) or Command+N (Mac OS).

Create a composition from a single footage item

❖ Drag the footage item to the Create A New Composition button  at the bottom of the Project panel or choose File > New Comp From Selection.

Composition settings, including frame size (width and height) and pixel aspect ratio, are automatically set to match the characteristics of the footage item.

Create a single composition from multiple footage items

- 1 Select footage items in the Project panel.
- 2 Drag the selected footage items to the Create A New Composition button  at the bottom of the Project panel, or choose File > New Comp From Selection.
- 3 Select Single Composition and other settings in the New Composition From Selection dialog box:

Use Dimensions From Choose the footage item from which the new composition gets composition settings, including frame size (width and height) and pixel aspect ratio.

Still Duration The duration for the still images being added.

Add To Render Queue Add the new composition to the render queue.

Sequence Layers, Overlap, Duration, and Transition Arrange the layers in a sequence, optionally overlap them in time, set the duration of the transitions, and choose a transition type.

Create multiple composition from multiple footage items

- 1 Select footage items in the Project panel.
- 2 Drag the selected footage items to the Create A New Composition button  at the bottom of the Project panel, or choose File > New Comp From Selection.
- 3 Select Multiple Compositions and other settings in the New Composition From Selection dialog box:

Still Duration The duration of the compositions created from still images.

Add To Render Queue Add the new compositions to the render queue.

Duplicate a composition

- 1 Select the composition in the Project panel.
- 2 Choose Edit > Duplicate or press Control+D (Windows) or Command+D (Mac OS).

Timeline panel overview

Each composition has its own Timeline panel. You use the Timeline panel to perform many tasks, such as animating layer properties, arranging layers in time, and setting blending modes. The layers at the bottom of the layer stacking order in the Timeline panel are rendered first and—in the case of 2D image layers— appear farthest back in the Composition panel.

 To cycle forward through Timeline panels, press Alt+Shift+period (.) (Windows) or Option+Shift+period (.) (Mac OS). To cycle backward through Timeline panels, press Alt+Shift+comma (,) (Windows) or Option+Shift+comma (,) (Mac OS).

A composition's current time is indicated by the current-time indicator, the vertical red line in the time graph. A composition's current time also appears in the current time display in the upper-left corner of the Timeline panel. For more information on moving the current-time indicator, see "Move the current-time indicator" on page 123.

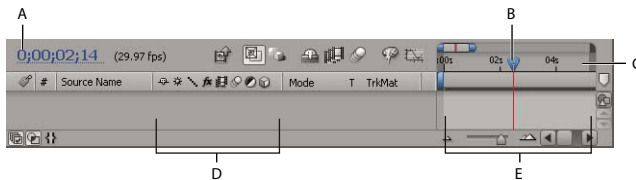

A. Current-time display B. Current-time indicator C. Time ruler D. Layer switches E. Time graph

The left side of the Timeline panel consists of columns of controls for layers. The right side of the Timeline panel—the time graph—contains a time ruler, markers, keyframes, expressions, duration bars for layers (in layer bar mode), and the Graph Editor (in Graph Editor mode).

 Press the backslash (\) key to switch activation between the Composition panel and Timeline panel for the current composition.

See also

- “Show and hide layers in the Timeline panel” on page 150
- “Layer switches and columns in the Timeline panel” on page 147
- “Work with the Graph Editor” on page 184





“Work with columns” on page 18

“Using and modifying keyboard shortcuts” on page 638

Work with composition settings

You can enter composition settings manually, or you can use composition settings presets to automatically set frame size (width and height), pixel aspect ratio, and frame rate for many common output formats. You can also create and save your own custom composition settings presets for later use. Resolution, Start Timecode, Duration, and Advanced composition settings are not saved with composition settings presets.

Note: *The limit for composition duration is three hours. You can use footage items longer than three hours, but time after three hours does not display correctly. The maximum composition size is 30,000 x 30,000 pixels. Note that a 30,000 x 30,000 8bpc image requires approximately 3.5 GB; your maximum composition size may be less, depending on your operating system and available RAM.*

- To open the Composition Settings dialog box to change composition settings, select a composition in the Project panel or activate the Timeline or Composition panel for a composition, and then choose Composition > Composition Settings, or press Ctrl+K (Windows) or Command+K (Mac OS).
- To save a custom composition settings preset, set Width, Height, Pixel Aspect Ratio, and Frame Rate values in the Composition Settings dialog box, and then click the Save button .
- To delete a composition settings preset, choose it from the Preset menu in the Composition Settings dialog box, and click the Delete button .
- To restore default composition settings presets, Alt-click (Windows) or Option-click (Mac OS) the Delete button  or the Save button  in the Composition Settings dialog box.
- To scale an entire composition, choose File > Scripts > DemoPalette.jsx to run the DemoPalette script, and then click the Scale Comp button.

Jeff Almasol provides a script to set the frame rate and duration of the current composition and all compositions nested within it: www.adobe.com/go/learn_ae_jeffcompsetter.

See also

“Change pixel aspect ratio” on page 55

“Change frame rate” on page 53

“Resolution” on page 128

“Specify resolution to use for rendering shadows” on page 181

“About nesting and precomposing” on page 113

“Use motion blur” on page 200

Composition settings

Basic composition settings

For information on specific Basic composition settings not listed here, see the related sections.

Resolution This setting affects rendering, both for previews and for final output. You can also use the Resolution menu at the bottom of the Composition panel to modify this setting.

Start Timecode or Start Frame Timecode or frame number assigned to the first frame of the composition. This value does not affect rendering; it merely specifies where to start counting from.

Advanced composition settings

For information on specific Advanced composition settings not listed here, see the related sections.

Anchor Click an arrow button to anchor layers to a corner or edge of the composition as it is resized.

Work with the region of interest

The *region of interest* is the area of the composition, layer, or footage item that is previewed. Create a smaller region of interest to use less processing power and memory when previewing, thereby improving interaction speed and increasing RAM preview duration. Changing the region of interest does not affect file output, though you can change the size of your composition and select what portion is rendered by cropping to the region of interest.

Note: When the region of interest is selected, the Info panel displays the horizontal and vertical distances of the top (T), left (L), bottom (B), and right (R) edges of the region from the top-left corner of the composition.

- To draw a region of interest, click the Region Of Interest button  at the bottom of the Composition, Layer, or Footage panel, and then drag to select a viewable area of the panel.



To start over with the marquee tool, hold down Alt (Windows) or Option (Mac OS) and click the Region Of Interest button.

- To switch between using the region of interest and using the full composition, layer, or footage frame, click the Region Of Interest button.
- To move or resize the region of interest, drag its edges or handles. Shift-drag a corner handle to resize while preserving aspect ratio.
- To crop to the region of interest, choose Composition > Crop Comp To Region Of Interest.

Set composition background color

The default background color for the Composition panel is black, but you can change the color at any time.

- ❖ Choose Composition > Background Color, and then click the color swatch or use the eyedropper to pick a color.

Note: When you add one composition to another (nesting), the containing composition's background color is preserved, and the nested composition's background becomes transparent. To preserve the nested composition's background color, create a solid-color layer to use as a background layer in the nested composition.

See also

“Select a color or edit a gradient” on page 236

“Create or modify a solid-color layer” on page 136



Work with composition thumbnail images

You can choose which frame of a composition to show as a thumbnail image in the Project panel. By default, a composition's thumbnail image is the first frame of the composition, with transparent portions shown as black.

- To set the thumbnail image for a composition, move the current-time indicator to the desired frame in the composition's Timeline panel, and choose Composition > Set Poster Time.
- To add a transparency grid to the thumbnail view, choose Thumbnail Transparency Grid from the Project panel menu.

- To hide the thumbnail images in the Project panel, choose Edit > Preferences > Display (Windows) or After Effects > Preferences > Display (Mac OS) and select Disable Thumbnails In Project Panel.

Zoom in or out in time

- In the Timeline panel, click the Zoom In button  or the Zoom Out button , or drag the zoom slider between the buttons.
- On the main keyboard, press the = (equal sign) key to zoom in or press the – (hyphen) key to zoom out in time.
- In the navigator view, drag the Time Navigator Start or Time Navigator End brackets to magnify or shrink a section of the time ruler.

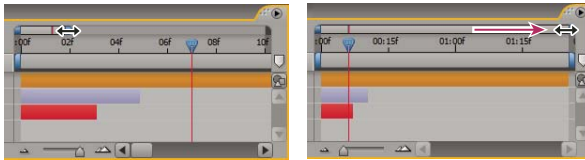

Dragging Time Navigator End bracket to show more of time ruler.

 When zoomed in time, press D to center the time graph on the current time.

Set the work area

The *work area* is the part of the duration of a composition that is previewed or rendered. In the Timeline panel, the work area appears in a lighter shade of gray.

- To set the work area start time or end time to the current time, press B (begin) or N (end), respectively.
- To set the work area, move the start and end work area markers in the time ruler.

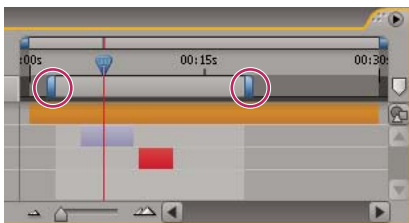

Work-area markers indicate the composition duration rendered for previews or output.

- To move the work area, drag the center of the work area bar left or right.

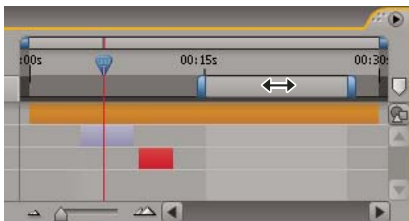

Dragging center of work area bar to move work area

- To expand the work area to the size of the composition, double-click the center of the work area bar.

See also

“Preview video and audio” on page 120

Nesting, precomposing, and pre-rendering

About nesting and precomposing

Nesting is the inclusion of one composition within another. The nested composition appears as a layer in the containing composition.

If you want to group some layers that are already in a composition, you can *precompose* those layers. Precomposed layers are placed in a new composition (sometimes called a *precomposition*), and the new composition becomes the source for a single layer in the original composition. The new composition appears in the Project panel and is available for rendering or use in any other composition.

You can also nest compositions by adding an existing composition to another composition, just as you would add a footage item to a composition.

Note: To open a precomposition, *Alt-double-click (Windows) or Option-double-click (Mac OS) it in the Timeline panel. To open the composition that contains the current precomposition, click the Open Parent Composition  button at the top of the Timeline panel.*

Precomposing and nesting are very useful for managing and organizing complex compositions.

By precomposing and nesting, you can do the following:

Apply complex changes to an entire composition You can create a composition that contains multiple layers, nest the composition within the overall composition, and animate and apply effects to the nested composition so that all of the layers change in the same ways over the same time period.

Reuse anything you build You can build an animation in its own composition and then drag that composition into other compositions as many times as you want.

Update in one step When you make changes to a nested composition, those changes affect every composition in which it is used, just like changes made to a source footage item affect every composition in which it is used.

Alter the default rendering order of a layer You can specify that After Effects render a transformation (such as rotation) before rendering effects, so that the effect applies to the rotated footage.

Add another set of transform properties to a layer The layer that represents the composition has its own properties, in addition to the properties of the layers that it contains. This allows you to apply an additional set of transformations to a layer or set of layers.

For example, you can use nesting to make a planet both rotate and revolve (moving like the Earth, which spins on its own axis and also travels around the Sun). To do this, you animate the Rotation property of the planet layer, precompose that layer, modify the Anchor Point property of the precomposition layer, and then animate the Rotation property of the precomposition layer.

Because a precomposition is itself a layer, you can control its behavior using layer switches and composition switches in the Timeline panel. You can choose whether changes made to the switches in the containing composition are propagated to the nested composition. To prevent layer switches from affecting nested compositions, choose Edit > Preferences > General (Windows) or After Effects > Preferences > General (Mac OS), and then deselect Switches Affect Nested Comps.

In the Advanced composition settings (Composition > Composition Settings), choose Preserve Resolution When Nested or Preserve Frame Rate When Nested Or In Render Queue for a composition to retain its own resolution or frame rate, and not inherit those settings from the containing composition. For example, if you deliberately used a low frame rate in a composition to create a jerky, hand-animated result, you should preserve the frame rate for that composition when it is nested. Similarly, the results of rotoscoping may look wrong when converted to a different frame rate or resolution. Use this setting instead of the Posterize Time effect, which is less efficient.

Changing the current time in one panel updates the current time in other panels associated with that composition. By default, the current time is also updated for all compositions related to the current composition by nesting. To prevent compositions related by nesting from updating their current times when you change the current time in one composition, deselect the Synchronize Time Of All Related Items preference (Edit > Preferences > General (Windows) or After Effects > Preferences > General (Mac OS)).

See also

“Create layers from footage items” on page 135

“How render order and collapsed transformations affect 3D layers” on page 175

“Layer switches and columns in the Timeline panel” on page 147

“Work with parent and child layers” on page 158

Precompose layers

Precomposing layers places them in a new composition (sometimes called a *precomposition*), which replaces the layers in the original composition. Precomposing a single layer is useful for adding transform properties to a layer and influencing the order in which elements of a composition are rendered.

1 Select the layers in the Timeline panel, and choose Layer > Pre-compose or press Ctrl+Shift+C (Windows) or Command+Shift+C (Mac OS).

2 Select one of the following:

Leave All Attributes In Leaves the properties and keyframes of the precomposed layer in the original composition, applied to the new layer that represents the precomposition. The frame size of the new composition is the same as the size of the selected layer. This option is not available when you select more than one layer, a text layer, or a shape layer.

Move All Attributes Into The New Composition Moves the properties and keyframes of the precomposed layers one level further from the root composition in the composition hierarchy. When you use this option, changes you applied to the properties of the layers remain with the individual layers within the precomposition. The frame size of the new composition is the same as that of the original composition.

Pre-render a nested composition

A complex nested composition can take a long time to preview and render. If you have a nested composition that you do not expect to work on further, you can save time during each previewing and rendering operation by pre-rendering the nested composition into a movie and replacing the composition with the rendered movie. You can still make changes to the original nested composition, because it remains in the project list. If you make a significant change to the original nested composition, just render it again.

Pre-rendering a nested composition is particularly beneficial when you will use it multiple times in a project. Using a pre-rendered movie in place of a nested composition also saves time and memory when you render the final version of the main composition.

Note: Apply your final output settings when you pre-render the nested composition.

- 1 Select the composition in the Project or Composition panel.
- 2 Choose Composition > Pre-render.

The Pre-render command adds the composition to the render queue and sets the Import & Replace Usage post-render action to replace the composition with the rendered movie.

- 3 In the Render Queue panel, adjust settings as necessary, and click the Render button to render the composition.

Note: An alternative to replacing the composition with the movie is to use the rendered movie as a proxy for the nested composition.

See also

“Use a post-render action” on page 602

“Work with placeholders and proxies” on page 61

“Basics of rendering and exporting” on page 587

Render order and collapsing transformations

A composition consists of layers stacked on top of one another in the Timeline panel. When the composition is rendered—either for previewing or for final output—the bottom layer is rendered first. Within each raster (non-vector) layer, elements are applied in the following order: masks, effects, transformations, and layer styles. For continuously rasterized vector layers, transformations occur before masks and effects.

Transformations are changes to those properties grouped under the Transform category in the Timeline panel, including Anchor Point, Position, Scale, Rotation, and Opacity. What you see in the Layer panel is the result of the rendering before transformations are performed.

Note: For additional control over when transformations are performed, you can apply the Transform effect and reorder it with respect to other effects.

In a group of effects or masks, items are processed from top to bottom. For example, if you apply the Circle effect and then apply the Magnify effect, the circle is magnified. However, if you drag the Magnify effect above (before) the Circle effect in the Effect Controls or Timeline panel, the circle is drawn after the magnification and isn't magnified.

After a layer has been rendered, rendering begins for the next layer. The rendered layer below may be used as input to the rendering of the layer above—for example, for determining the result of a blending mode.

If a composition contains other compositions nested within it, the nested composition is rendered before other layers.

If the Collapse Transformations switch  is selected for a nested composition, then the transformations for the nested composition are not performed until after the masks and effects for the containing composition are rendered. This allows the transformations for the nested composition and the containing composition to be combined—or *collapsed*—and performed together. The same is true for vector layers that are not continuously rasterized.

Note: Instead of a Collapse Transformations switch, vector layers have a Continuously Rasterize switch in the same location. Vector layers include shape layers, text layers, and layers with vector graphic files as the source footage. Text layers and shape layers are always continuously rasterized.

Collapsing transformations can, for example, preserve resolution when a layer is scaled down by half in a nested composition, and the nested composition is scaled up by a factor of two in the containing composition. In this case, rather than performing both transformations and losing image data in the process, one transformation can be performed—doing nothing, because the individual transformations cancel each other.

If transformations are not collapsed, a nested composition that contains 3D layers is rendered as a 2D image of the 3D arrangement, using the default composition camera. This prevents the nested composition from intersecting with 3D layers, casting shadows on 3D layers, and receiving shadows from 3D layers in the containing composition. The nested composition is also not controlled by the containing composition's cameras and lights.

If transformations are collapsed, the 3D properties of the layers in the nested composition are exposed to the containing composition. Thus, the nested composition can intersect with 3D layers, cast shadows on 3D layers, and receive shadows from 3D layers in the containing composition. The containing composition's camera and lights can also control the nested composition.

When a closed mask (with mask mode other than None), a layer style, or an effect is applied to a nested composition with collapsed transformations, the layers in the nested composition are first rendered on their own, then masks and effects are applied, and then the result is composited into the main composition. This rendering order means that the blending modes of the nested layers are not applied to any underlying layers in the main composition, and that 3D layers above and below the collapsed layer cannot intersect or cast shadows on each other.

See also

“How render order and collapsed transformations affect 3D layers” on page 175

“Change the stacking order for selected layers” on page 138

“Transform effect” on page 417

Markers

About markers

Use composition-time markers and layer-time markers to mark important times in a composition or in a specific layer. Both kinds of markers can hold the same information, but composition-time markers appear in the time ruler for the entire composition, whereas layer-time markers appear on a specific layer duration bar.

When you render a composition that contains markers, the markers can be converted to web links, chapter links, Flash Video cue points, or Clip Notes comments, depending on the values that you set in the marker dialog box. The default comment for a composition-time marker is a number, whereas the default comment for a layer-time marker is nothing.

To view a video tutorial on working with markers and cue points, visit the Adobe website at www.adobe.com/go/vid0255.

 *Markers make it easier to align layers or the current-time indicator with specific points in time: When you drag a keyframe, the current-time indicator, or a layer duration bar in the Timeline panel, hold down Shift to snap these items to markers.*

A marker that contains data other than a comment has a small dot in its icon.

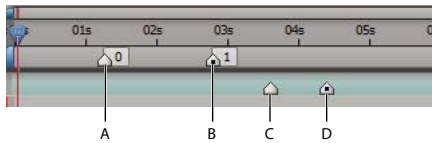

A. Composition-time marker B. Composition-time marker with cue-point data C. Layer-time marker D. Layer-time marker with cue-point data

If you add one composition to another, the original composition becomes a layer in the composition. All of the nested composition's composition-time markers become layer-time markers in the timeline of the parent composition. These markers are not linked to the original composition-time markers. Changes you make to the composition-time markers in the original composition do not affect layer-time markers in the nested composition. For example, if you remove one of the original composition-time markers, the corresponding layer-time marker for the nested composition remains in place.

See also

“Reviewing movies with Clip Notes comments” on page 634

Work with composition-time markers

Composition-time markers appear on the time ruler in the Timeline panel. If you remove a marker, the other markers remain numbered as they were. If you change the comment from the default number, that number may be reused by a composition-time marker created later.

Note: Numbering of composition-time markers begins at 0. In After Effects 7.0 and earlier, numbering started at 1.

When you render a composition for comments using Adobe Clip Notes, the comments in composition-time markers are included as comments in the Clip Notes PDF. When you import the comments from a Clip Notes review back into After Effects, the reviewers' PDF comments are converted back to composition-time markers.

- To add a composition-time marker from the bin, drag the marker from the Comp Marker Bin  button.



Dragging a composition-time marker from the Comp marker bin.

- To add a composition-time marker at the current time, press Shift + a number key (0 to 9) on the main keyboard.

Note: If the number you press is already used by another composition-time marker, After Effects does not create a new marker. Instead, it moves the existing marker with that number to the new position.

- To move a composition-time marker, drag it to a different time or double-click it and enter a time in the dialog box.
- To edit a marker's data, double-click the marker.
- To remove a composition-time marker, drag the marker to the Comp Marker Bin button or Ctrl-click (Windows) or Command-click (Mac OS) the marker.

See also

“Reviewing movies with Clip Notes comments” on page 634

Work with layer-time markers

Layer-time markers are retained when you render to AVI or QuickTime format.

Layer-time markers appear as small triangles on a layer-duration bar. You can have any number of layer-time markers in a layer. You can also drag existing markers to new time locations or remove them, as needed. You can double-click the layer-time marker at any time to view or modify its attributes.

- To add a layer-time marker to selected layers at the current time, choose Layer > Add Marker or press * (multiply) on the numeric keypad.
- To move a layer-time marker, drag it to a different time or double-click it and enter a time in the dialog box.
- To edit a marker's data, double-click the marker.
- To remove a layer-time marker, Ctrl-click (Windows) or Command-click (Mac OS) the marker.
- To remove all layer-time markers from selected layers, right-click (Windows) or Control-click (Mac OS) a marker, and choose Delete All Markers.
- To lock layer-time markers, right-click (Windows) or Control-click (Mac OS) a marker, and choose Lock Markers.

Paul Tuersley provides a script for splitting layers at layer-time markers:

www.adobe.com/go/learn_ae_paulsplitatmarkers.

Create a web link, chapter link, or cue point from a marker

You can associate a Uniform Resource Locator (URL) with a marker to create an automatic link to that site. After Effects embeds this information within certain kinds of movies, including Flash (SWF), Windows Media, and QuickTime movies. When these movies are played in a web browser, the embedded URL is recognized, initiating a jump to the specified URL. You can target a specific frame in the site.

You can also associate a chapter reference point with a marker. Chapter links are similar to chapters used in CD-ROM and DVD discs. Like the chapters of a book, a chapter link divides a movie into segments. Chapter links are supported in QuickTime and Windows Media movies.

 *Adobe Encore can read chapter references in After Effects layer-time markers when you export to the AVI or MPEG-2 file format. To be compatible with DVD format, make sure that markers are at least 15 frames apart.*

Flash Video cue points can each have any number of parameters, each with a name and a value. You can only add three parameters using the marker dialog box. To work with more than three parameters, use the scripting interface.

 *To convert selected properties to Flash Video cue point parameters in layer-time markers, choose File > Scripts > Convert Selected Properties To Markers.jsx. This script adds a layer-time marker on the layer at the same time as each keyframe for each selected property. The markers' cue point parameters indicate the name of the property and its value at that time. If the selected property has an expression, a marker is created for each frame, with the values sampled at each frame.*



- 1 Double-click a marker to open the marker dialog box.
- 2 Enter information in the appropriate boxes in the marker dialog box:
 - To create a web link, enter a Uniform Resource Locator in the URL box in the Chapter And Web Links area of the marker dialog box. To activate a specific frame in a site, enter the file name of the frame for Frame Target.
 - Enter the chapter name and number (if available) in the Chapter text box in the Chapter And Web Links area of the marker dialog box.
 - Enter the Flash Video cue point's name, and names and values for any parameters. Select Event or Navigation to determine what kind of cue point to create.

See also

“Work with scripts” on page 45

Synchronize markers to audio

After Effects provides a quick way to add and label markers for significant points in a layer’s audio track, such as a rhythmic beat in music or spoken words in dialogue. After markers are created, you can use them to synchronize video or other effects.

- 1** In the Time Controls panel, click the Audio button , and then click the RAM preview button .
- 2** At the points in time where you want to add a marker, press the multiply key (*) on the numeric keypad to create a layer-time marker.
- 3** When previewing is complete, double-click a marker you just created, and add comments or otherwise modify the markers as you would any other layer-time markers.

See also

“Preview video and audio” on page 120

Chapter 6: Views and previews



Previewing

Preview video and audio

You can *preview* all or part of your composition as you work, without rendering to final output. Many of the controls for previewing are in the Time Controls panel.

With all previewing methods—as with rendering to final output—a layer is only visible if its Video layer switch  is selected.

Some factors that influence the speed with which previews are rendered include layer switches, Fast Previews settings, and composition settings. One of the simplest and most influential of the preview settings is the Resolution/Down Sample Factor setting at the bottom of the Composition panel; set this to a value other than Full to see all previews at a lower resolution.

 *To turn pixel-aspect ratio correction on or off for previews, click the Toggle Pixel Aspect Ratio Correction button  at the bottom of the panel. Because the scaling is not of high quality, use pixel aspect ratio correction to evaluate shapes, not fine pixel detail. (See “Change pixel aspect ratio” on page 55.)*

When possible, preview on the same sort of device that your audience will be using to view your final output. For example, you can preview on an external video monitor. To see your composition as it will appear on a mobile device—such as a mobile phone—first render your composition to final output, and then use Adobe Device Central to view the movie.

If color management is enabled, you can preview a composition, layer, or footage item as it will appear in the output color space. (See “Simulate how colors will appear on a different output device” on page 248.)

Note: *Select Show Rendering Progress In Info Panel & Flowchart (Edit > Preferences > Display (Windows) or After Effects > Preferences > Display (Mac OS)) to see additional information in the Info panel or Flowchart panel during rendering, either for previews or for final output.*

See also

“Preview a movie on a virtual mobile device using After Effects” on page 618

“Set the work area” on page 112

“Shortcuts for working with previews” on page 642

“Shortcuts for using and modifying views” on page 644

“Layer switches and columns in the Timeline panel” on page 147

Use standard preview

Standard preview (commonly called *spacebar play*) plays video in the active Composition, Layer, or Footage panel from the current time. Standard previews play at a speed as close to that of real time as possible; however, for complex compositions, the speed of the preview may be much less than that of real time.

❖ Click the Play button  in the Time Controls panel, or press the spacebar.

Use RAM preview

RAM preview allocates RAM to play video and audio in the Timeline, Layer, or Footage panel in real time. The number of frames that can be stored for real-time playback depends on the amount of RAM available to the application and the settings in the Time Controls panel.

In the Time Controls panel, you can specify two sets of RAM preview options: RAM Preview Options and Shift+RAM Preview Options. For example, you may decide to set RAM Preview Options for full frame rate and full resolution, and set Shift+RAM Preview Options to skip one out of every two frames and preview at half resolution.

In the Layer and Footage panels, RAM previews play untrimmed footage.

1 To modify RAM preview options, click the RAM Preview Options menu in the center of the Time Controls panel and choose RAM Preview Options or Shift+RAM Preview Options. You can change any of the following:

Mute Audio  Include or exclude audio from RAM preview.

Frame Rate Choose Auto to use the composition frame rate.



Skip The number of frames to skip between each rendered frame. Choose 0 to render all frames.

Resolution Choose Auto to use the composition resolution.

From Current Time Select From Current Time to play from the current time; otherwise, RAM Preview will play the work area or from the beginning of the composition, layer, or footage item.

Full Screen Play RAM preview at the full size of the composition, layer, or footage item on a screen that is the background color. You can change the panel's background color using the User Interface Brightness control in User Interface Colors preferences.

2 Do one of the following:

- To preview using RAM Preview Options, click the RAM Preview button  in the Time Controls panel or press 0 (zero) on the numeric keypad.
- To preview using Shift+RAM Preview Options, Shift-click the RAM Preview button  in the Time Controls panel or press Shift+0 (zero) on the numeric keypad.

 *Press the asterisk key (*) on the numeric keypad during a RAM preview to place a layer marker on the selected layers at the currently previewed frame. This is a convenient way to place markers corresponding to important points in an audio track.*

Note: *The performance of RAM previews performed with the Render Multiple Frames Simultaneously preference selected may be decreased if antivirus software is running. (See "Render multiple frames simultaneously" on page 40.)*

Save a RAM preview as a movie

After Effects can save RAM previews as uncompressed AVI files (Windows) or MOV files (Mac OS). When saving a RAM preview, keep the following in mind:

- After Effects uses the composition frame size and resolution setting to determine the final dimension in pixels of a saved RAM preview. It doesn't consider the zoom level.
- RAM preview doesn't generate interlaced fields, so a saved RAM preview never contains fields.

Note: *The 3D View of the active composition panel must be set to Active Camera for Save RAM Preview to work, even if the composition doesn't contain 3D layers.*

1 After you generate a RAM preview, choose Composition > Save RAM Preview.

2 Type a name, specify a location, and click Save.

Loop options for previews

Click the Loop Options button in the Time Controls panel until it shows the desired state:

Loop  Repeatedly plays preview from beginning to end.

Play Once  Plays preview once.

Ping Pong  Repeatedly plays preview, alternating between backward and forward play.

Preview audio

When you preview audio, it's played back in real time, unless you've applied Audio effects other than Stereo Mixer, in which case you may have to wait for audio to render before it plays back.

Note: If audio must be rendered for a preview, then only the amount of audio specified by the Duration setting in the Previews preferences will be rendered and played for the preview.

Set the sample rate for audio for the entire project in the Project Settings dialog box (File > Project Settings). CD-quality sound is 44.1 KHz, 16-bit stereo.

The Audio Hardware and Audio Output Mapping preferences determine the behavior of audio previews. These preferences do not affect final output. The quality of audio in final output is determined by the output module setting.

- To preview only audio from the current time, choose Composition > Preview > Audio Preview (Here Forward) or press the period key (.) on the numeric keypad.
- To preview only audio in the work area, choose Composition > Preview > Audio Preview (Work Area) or press Alt+period (.) (Windows) or Option+period (.) (Mac OS) on the numeric keypad.

Manually preview (scrub) video and audio

- To manually preview (*scrub*) video in the Timeline panel or go to a specific frame, drag the current-time indicator.
- To scrub audio in the Timeline panel, Ctrl+Alt-drag (Windows) or Command+Option-drag (Mac OS) the current-time indicator.
- To scrub audio and video in the Timeline panel, Ctrl-drag (Windows) or Command-drag (Mac OS) the current-time indicator.

If you stop moving the current-time indicator while keeping the mouse button depressed, a short section of audio loops.

Audio panel options

During previews, the Audio panel's volume unit (VU) meter actively displays audio volume levels. At the top of the VU meter, signals indicate when the audio is *clipping*—a distortion that occurs when the audio signal exceeds the maximum level that the audio device allows.

To view the VU meter and levels controls in more detail, increase the height of the Audio panel.

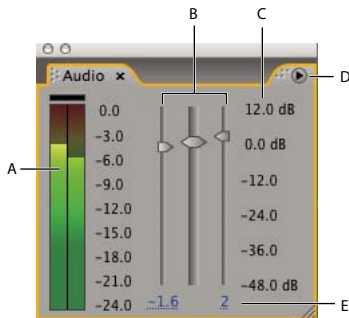

Audio panel

A. VU meter B. Level controls C. Level units D. Audio panel menu E. Level values

Choose Options on the Audio panel menu to specify the following options:

Units Choose whether to display audio levels in decibels or in percentages. 100% equals 0 decibels (0 dB).

Slider Minimum The minimum audio level to display in the Audio panel.

Move the current-time indicator

The most basic way of previewing frames is to manually preview by moving or dragging the *current-time indicator*.

The *time ruler* visually represents the time dimension of a composition, a layer, or a footage item. In a Layer or Footage panel, the time ruler appears near the bottom of the panel. For a Composition panel, the time ruler appears in the corresponding Timeline panel. The time rulers in different panels represent different durations. The time ruler in a Layer or Footage panel represents the duration of the contents of that panel; the time ruler in the Timeline panel represents the duration of the entire composition.

On a time ruler, the *current-time indicator* indicates the frame you are viewing or editing.

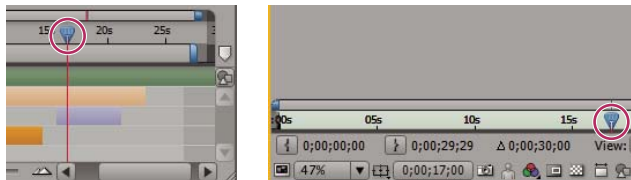

Current-time indicator in the time ruler in the Timeline panel (left) and in the Layer panel (right)

- To go forward or backward one frame, click the Next Frame ► or Previous Frame ◀ button in the Time Controls panel, or press Page Down or Page Up.
- To go forward or backward ten frames, Shift-click the Next Frame or Previous Frame button, or press Shift+Page Down or Shift+Page Up.
- To go forward a specific period of time or number of frames, click the current-time display, and then enter the plus sign (+) followed by the timecode or number of frames to advance. For example, enter **+20** to go forward 20 frames or **1:00** to go forward one second. Precede the value by the minus sign (-) to go backward. For example, enter **+ -20** to go backward 20 frames or **+ -1:00** to go backward one second.
- To go to the first or last frame, click the First Frame ◀ or Last Frame ► button in the Time Controls panel, or press Home or End.
- To go to the first or last frame of the work area, press Shift+Home or Shift+End.

- To go to a specific frame, click in the time ruler; click the current-time display in the Footage, Layer, Composition, or Timeline panel; or press Alt+Shift+J (Windows) or Option+Shift+J (Mac OS).
- Shift-drag the current-time indicator to snap to keyframes, markers, In and Out points, the beginning or end of the composition, or the beginning or end of the work area.

See also

“Shortcuts for time navigation” on page 643

Choose a viewer to always preview

Designating a viewer as the default panel to preview is particularly useful when you have a Composition viewer that represents your final output, and you always want to preview that viewer even when you’re changing settings in other panels.

The panel that’s set to always preview appears frontmost for the duration of the preview.

- ❖ Click the Always Preview This View button  in the bottom left corner of the panel.

Note: When multiple views are open, previews use the frontmost composition view for 2D compositions and the Active Camera view for 3D compositions. To turn off the Active Camera, deselect Previews Favor Active Camera in the Time Controls menu.

See also

“Work with viewers” on page 19

Preview modes

Each preview mode provides a different balance between quality and speed for playback and for updating of images during editing and other interactions.

Draft 3D and Live Update modes apply to all views of a composition.

Draft 3D Disables lights, shadows, and cameras’ depth-of-field blur. To turn Draft 3D mode on or off, click the Draft 3D button  at the top of the Timeline panel.

Live Update Updates images in the Composition or Layer panel during editing and other interactions. When Live Update is deselected, After Effects displays wireframe representations during edits, such as dragging a layer in the Composition panel or modifying a property value in the Timeline panel. To turn Live Update mode on or off, click the Live Update button , at the top of the Timeline panel.



To temporarily toggle Live Update mode, hold Alt (Windows) or Option (Mac OS) while dragging to move a layer, modify a property value, or move the current-time indicator.

Fast Previews You can use a different Fast Previews mode for each view in the Composition panel. For example, in a 4 Views layout, you could use OpenGL for the Active Camera view and Wireframe for Left, Right, and Top views. Click the Fast Previews button , at the bottom of the Composition panel to set Fast Previews preferences or choose from the following Fast Previews modes:

- **Wireframe** Represents each layer as a wireframe outline, which increases playback speed and allows you to quickly reposition a layer with a high resolution or several effects applied.

- **Adaptive Resolution** Decreases the preview resolution of layers when necessary to maintain speed of updating of images during editing and other interactions. The Adaptive Resolution Limit value in the Fast Previews area in the Previews preferences category specifies the maximum reduction in resolution to use.
- **OpenGL-Interactive or OpenGL-Always On** OpenGL mode provides high-quality previews that require less rendering time than other playback modes. OpenGL can also be used to speed up rendering to final output. OpenGL features in After Effects rely on OpenGL features of your video hardware. When OpenGL does not support a feature, it simply creates a preview without using that feature. For example, if your layers contain shadows and your OpenGL hardware does not support shadows, the preview will not contain shadows. Select OpenGL-Interactive to use OpenGL only for interactions, such as manually previewing (*scrubbing*) in the Timeline panel or dragging a layer in the Composition panel. You can tell that OpenGL is engaging by looking at the Fast Previews icon, which will light up. Select OpenGL-Always On to use OpenGL for all previews. In this mode, “OpenGL” will appear in the upper-left corner of each view in the Composition panel.

Note: The *Enable OpenGL* option in the *Fast Previews* area of the *Preview preferences* category must be selected for you to use OpenGL.

 To prevent After Effects from updating images in the Footage, Layer, or Composition panels, press the Caps Lock key. When you make a change that would otherwise appear in a panel, After Effects adds a red bar at the bottom of the panel with a text reminder that image refresh is disabled. After Effects continues to update panel controls such as motion paths, anchor points, and mask outlines as you move them. To resume panel updates and display all changes, press Caps Lock again. Pressing Caps Lock is a good way to prevent views from being refreshed for each frame during rendering for final output.

See also

“Render with OpenGL” on page 593



Work with snapshots

When you want to compare one view to another in the Composition, Layer, or Footage panel, take a *snapshot*. For example, you might want to compare two frames at different times in a movie.

Snapshots taken in one kind of panel can be displayed in another kind. For example, you can take a snapshot of a Layer panel and display the snapshot in the Composition or Footage panel. Displaying a snapshot does not replace the content of the panel. If the snapshot has a different size or aspect ratio than the panel in which you display it, the snapshot is resized to fit the current view.

Snapshots are for reference only and do not become part of the layer, composition, or rendered movie.

A sound is generated when you take a snapshot.

- To take a snapshot, click the Take Snapshot button  at the bottom of the panel or press Shift+F5, Shift+F6, Shift+F7, or Shift+F8.
- To view the most recent snapshot, click and hold the Show Last Snapshot button  at the bottom of the panel.
- To view a specific snapshot, press and hold F5, F6, F7, or F8.
- To purge a snapshot, hold down Ctrl+Shift (Windows) or Command+Shift (Mac OS) and press F5, F6, F7, or F8.
- To free all memory used to store snapshots, choose Edit > Purge > Snapshot.

Preview on an external video monitor

You can preview the contents of your Layer, Footage, or Composition panel on an external video monitor. This requires additional hardware, such as a video capture card or a FireWire port. If you're using a video digitizing card to connect an external video monitor, follow the directions that came with your video digitizing card to connect the monitor for viewing previews. If you're using a FireWire port, first connect a digital camcorder or video tape recorder (VTR) to the port, then connect the video monitor to the camcorder or VTR. For more information on setting up FireWire previews, see the documentation that came with your digital camcorder or VCR.

Whether or not color management is enabled for the project, After Effects does not manage the color of previews on an external video monitor. The colors sent to the external video monitor are in the project's working color space. For more information, see "Choose a working color space and enable color management" on page 243.

- 1 Choose Edit > Preferences > Video Preview (Windows) or After Effects > Preferences > Video Preview (Mac OS).
- 2 Choose an external device from the Output Device menu. (If a device is available, it's automatically listed in this menu.)
- 3 Choose a mode from the Output Mode menu. The choices listed depend on the device you are using. The Frame Size value that appears under the Output Mode menu is dependent on the value that you select from the Output Mode menu, and is not dependent on any other After Effects settings.

- 4 Set any of the following options:

Previews Displays RAM previews or standard previews on the external monitor only.

Mirror On Computer Monitor Displays RAM previews or standard previews simultaneously on the external monitor and on the computer screen. This may slow down the previews.

Interactions Displays interactive previews, such as scrubbing in the Timeline panel or dragging in the Composition panel, on the computer screen and simultaneously on the external monitor.

Renderers Displays each frame on the computer screen and simultaneously on the external monitor as the frames render in the render queue.

- 5 Select Scale And Letterbox Output To Fit Video Monitor if you are working with image sizes that don't match your preview device frame size and you want to see the entire image scaled to fit.

 *After choosing an output device in the Video Preview preferences, you can preview the current frame on the output device by pressing the forward slash (/) key on the numeric keypad. Press Ctrl+/ (Windows) or Command+/ (Mac OS) to toggle the preference to Desktop Only or to the output device you specified.*

Modifying and using views

Select a view layout and share view settings

The Composition panel can show one, two, or four views at a time. By default, viewer options (such as grids and rulers) affect only the currently selected view.

- To select a view layout, choose an option from the Select View Layout menu at the bottom of the Composition panel.
- To scroll through view layouts, position the pointer over the Select View Layout menu and spin the mouse wheel.
- To apply view settings to all views in the current layout, choose Share View Options from the Select View Layout menu. Hold Ctrl (Windows) or Command (Mac OS) to momentarily reverse this behavior.

See also

“Select a 3D view” on page 127

“Work with viewers” on page 19

Select a 3D view

You can view your 3D layers from several angles, using orthographic views or custom views that employ perspective. You can switch views at any time. The orthographic views (Front, Back, Left, Top, Right, and Bottom) show layers' positions in the composition but do not show perspective.

You can adjust the point of view and direction of view for the custom views with the camera tools.

You can also choose to look at selected layers or all layers. When you do this, After Effects changes the point of view and direction of view to include the layers that you have selected.

- Choose a view from the 3D View menu at the bottom of the Composition panel.
- Choose View > Switch 3D View, and choose a view from the menu.
- Choose View > Switch To Last 3D View.
- To switch to the previous 3D view, press Esc.
- To see selected layers, choose View > Look At Selected Layers.
- To see layers that aren't visible in the active view, choose View > Look At All Layers.
- To select one of the 3D views with keyboard shortcuts, press F10, F11, or F12.

 *To change which 3D view is assigned to a keyboard shortcut, switch to a view and then press Shift and the shortcut key. For example, to make F12 the shortcut for Top view, switch to Top view and then press Shift+F12. You can also use the View > Assign Shortcut To menu command for this purpose.*

See also

“Working with 3D layers” on page 171

“Cameras, lights, and points of interest” on page 176

“Select a view layout and share view settings” on page 126

Show or hide layer controls in the Composition panel

You can assign different options to each view in the Composition panel, so that you can see any combination of camera and light wireframes, layer handles, mask and shape paths, effect control points, and motion path controls.

- To choose which layer controls to show in a view, choose View > View Options, or press Ctrl+Alt+U (Windows) or Command+Option+U (Mac OS).
- To show or hide layer controls in a view, choose View > Show Layer Controls, or press Ctrl+Shift+H (Windows) or Command+Shift+H (Mac OS). This also shows or hides the 3D reference axes.
- To show or hide mask path and shape paths in a view, click the Toggle Mask And Shape Path Visibility button  at the bottom of the Composition panel.

Zoom

The Magnification Ratio control in the lower-left corner of a Composition, Layer, or Footage panel shows and controls the current magnification. By default, the magnification is set to fit the current size of the panel. When you change magnification, you change the appearance of the pixels in the panel that you are previewing, not the actual resolution of the composition.

Note: After Effects renders vector objects before zooming (scaling for preview), so some vector objects may appear jagged when you zoom in on them. This does not affect scaling of layers or rendering to final output.

- To zoom in to or out from the center of the active view, press the period (.) key or the comma (,) key. Each keypress additionally increases or decreases the magnification.
- To zoom in to or out from the center of the view using the mouse scroll wheel, position the pointer over the panel and move the scroll wheel.
- To zoom in on or out from a specific point using the mouse scroll wheel, position the pointer over the panel and Alt-move (Windows) or Option-move (Mac OS) the scroll wheel.
- To zoom in on a specific point using the Zoom tool , click the area in the panel you want to magnify. Each click additionally magnifies the image, centering the display on the point you click. You can also drag the tool to magnify a specific area.
- To zoom out from a specific point using the Zoom tool, Alt-click (Windows) or Option-click (Mac OS) the point that you want to be the center of the zoomed-out view. Each click additionally decreases the magnification of the image, centering the display on the point you click.
- To zoom the active view to 100%, double-click the Zoom tool button in the Tools panel.
- To zoom to fit or to zoom to a preset magnification, choose a zoom level from the Magnification Ratio menu. To change the magnification of all views in a Composition panel, hold down Ctrl (Windows) or Command (Mac OS) while choosing a zoom level from the menu. Choose Fit to make the image fit the Composition panel; choose Fit Up To 100% to limit the zoom level to 100%.



To pan around in the Composition, Layer, or Footage panel while zoomed in, drag with the Hand tool, which you can activate by holding down the spacebar or the H key.

See also

“Shortcuts for using and modifying views” on page 644

Resolution

Resolution determines the dimensions of the image in pixels, which affects the image quality of the previewed or rendered composition. Rendering time and memory for each frame are roughly proportional to the number of pixels being rendered.



You can use a low resolution setting when animating or previewing a movie, and then increase the resolution before rendering your final movie.

For previewing purposes, you can automatically zoom in and out depending on the Resolution setting by selecting the Auto-zoom When Resolution Changes preference (Edit > Preferences > Display (Windows) or After Effects > Preferences > Display (Mac OS)). Deselect this preference to maintain the composition's size in the Composition panel.

You can choose from the following Resolution settings in the Composition Settings (Composition > Composition Settings) dialog box or at the bottom of the Composition panel:

Full Renders each pixel in a composition. This setting gives the best image quality, but takes the longest to render.

Half Renders one-quarter of the pixels contained in the full-resolution image—half the columns and half the rows.

Third Renders one-ninth of the pixels contained in the full-resolution image.

Quarter Renders one-sixteenth of the pixels contained in the full-resolution image.

Custom Renders the image at the resolution you specify.

Viewing a color channel or alpha channel

You can view red, green, blue, and alpha channels—together or separately—in a Footage, Layer, or Composition panel by clicking the Show Channel button  at the bottom of the panel and choosing from the menu. When you view a single color channel, the image appears as a grayscale image, with the color value of each pixel mapped to a scale from black (0 value for the color) to white (maximum value for the color).



To see color values displayed in the channel's own color instead of white, choose Colorize from the Show Channel menu.

When you preview the alpha channel, the image appears as a grayscale image, with the transparency value of each pixel mapped to a scale from black (completely transparent) to white (completely opaque).

Note: When you choose RGB Straight, which shows straight RGB values before they are matted (premultiplied) with the alpha channel, pixels with complete transparency are undefined and therefore may contain unexpected colors.

You can view other channel values, such as saturation and hue, by applying the Channel Combiner effect and choosing Lightness from the To menu.



To switch between showing the alpha channel and showing all RGB channels, Alt-click (Windows) or Option-click (Mac OS) the Show Channel button.

See also

“About alpha channels and mattes” on page 252

“About straight and premultiplied channels” on page 253

“Shortcuts for using and modifying views” on page 644

“Channel Combiner effect” on page 383

Adjust exposure for previews

You can adjust the exposure (in f-stop units) for previews with the Adjust Exposure control, which is located to the right of the Reset Exposure button  at the bottom of a Composition, Layer, or Footage panel. Each viewer can have its own Adjust Exposure setting.

When the Adjust Exposure control is set to a value other than zero, the center of the Reset Exposure button is orange .

The Adjust Exposure control doesn't affect final output, only how video appears during previews. To make tonal adjustments to a layer that appear in final output, use the Exposure effect.

 The *Adjust Exposure* control is useful for finding the black point or white point in an image. For example, drag the value control to the right (positive values) until the entire image is white except for one area; that area is the darkest area in the image.

- To adjust exposure for a viewer, drag the *Adjust Exposure* control to the left or right, or click the control and enter a value in the text box.
- To reset exposure, click the *Reset Exposure* button. To return to the most recent non-zero setting, click the button again.

See also

“Exposure effect” on page 397

Work with safe zones, grids, guides, and rulers

In the Footage, Layer, and Composition panels, you can display safe zones, grids, rulers, and guide lines to align and arrange visual elements. After Effects preserves guides when importing Photoshop files saved with guides.

Television sets enlarge a video image and allow some portion of its outer edges to be cut off by the edge of the screen. This is known as *overscan*. The amount of overscan is not consistent between television sets, so you should keep important parts of a video image within margins known as *safe zones*. The conventional action-safe zone is 90% of the width and height of the frame; keep important visual elements within this zone. The conventional title-safe zone is 80% of the width and height of the frame; keep text that you intend for the audience to read within this zone. Safe-zone margins represent the percentage of image dimensions not included in the safe zone. You should always design from one edge of the frame to the other, because computer monitors and some television sets may show the entire frame.

Grids, guides, and rulers can help you to arrange and align layers. The size of proportional grids increases or decreases when the composition size changes; the size of standard grid squares remains the same regardless of composition size.

You can change the origin, or *zero point*, in both rulers. The position of the pointer measured from the new zero point is shown in the Info panel as X' and Y' coordinates.

Grids and guides are not rendered, either for RAM previews or for final output.

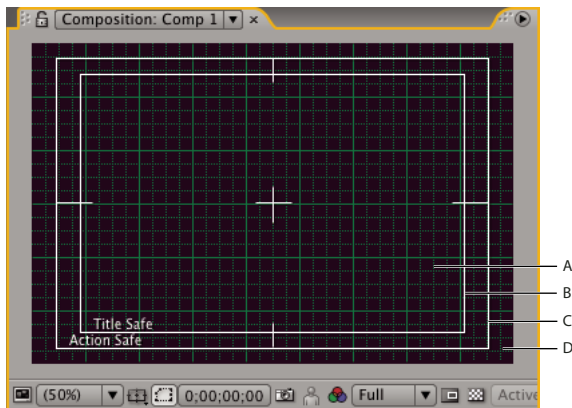

Composition panel's zones and grids

A. Grid B. Title-safe zone C. Action-safe zone D. Overscan

- To change the portion of the composition marked as title-safe or action-safe, as well as other options for grids and guides, choose Edit > Preferences > Grids & Guides (Windows) or After Effects > Preferences > Grids & Guides (Mac OS).
- To show or hide safe zones, grids, guides, or rulers, click the Grid And Guides Options button  and choose the appropriate menu item, or use a menu command or keyboard shortcut in the View menu.
- To toggle between showing and hiding the safe zones, Alt-click (Windows) or Option-click (Mac OS) the Grid And Guide Options button.
- To make layer edges and mask edges snap to grids or guides, choose View > Snap To Grid or View > Snap To Guides.
- To create a guide line, drag from either ruler.
- To delete a guide line, drag it to a ruler using the Selection tool.
- To delete all guide lines, choose View > Clear Guides.
- To move a guide line, drag it using the Selection tool.
- To lock or unlock guides, choose View > Lock Guides. Locking a guide prevents it from being accidentally moved.
- To set the zero point for the rulers, drag the crosshair from the intersection of the two rulers (in the upper-left corner) into the image area. Reset the zero point by double-clicking the intersection of the rulers.

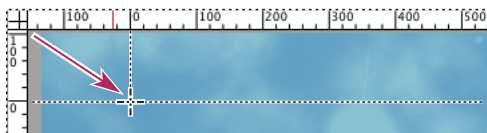

Dragging the zero point crosshair

See also

“Shortcuts for using and modifying views” on page 644

Change time display units

Many quantities in After Effects are either points in time or spans of time, including current time, layer In and Out points, and durations of layers, footage items, and compositions.

By default, After Effects displays time in Society of Motion Picture and Television Engineers (SMPTE) *timecode*: hours, minutes, seconds, and frames. You can change to another system of time display, such as frames, or feet and frames of 16mm or 35mm film.

Video-editing workstations often use SMPTE timecode that is recorded onto videotape for reference. If you are creating video that will be synchronized with video that uses SMPTE timecode, use the default timecode display style.

You may want to see time values in a feet plus frames format, for example, if you are preparing a movie for eventual output to film, or in simple frame numbers if you plan to use your movie in an animation program such as Flash. The format you choose applies to the current project only.

Important: *Changing the time display format does not alter the frame rate of your assets or output—it changes only how frames are numbered for display in After Effects.*

The current-time display appears in the upper-left corner of the Timeline panel and at the bottom of the Layer, Composition, and Footage panels.

- To cycle through Timecode Base, Frames, and Feet + Frames, Ctrl-click (Windows) or Command-click (Mac OS) the current-time display at the bottom of the Composition, Layer, or Footage panel, or at the top of the Timeline panel.
- To change time display units, choose File > Project Settings, and choose from the options in the Display Style section.

Timecode Base Displays time as timecode, using the frame rate that you specify as the timecode base. Auto uses the rounded frame rate of the footage item or composition. If an item doesn't have timecode (such as an audio file), After Effects uses a default value (30 fps for English and Japanese versions of After Effects, or 25 fps for French, German, Spanish, and Italian versions) or the last non-auto value you specified in the Project Settings dialog box. You can also specify that After Effects use a specific frame rate.

Note: *You can specify specific frame rates for display in the Timecode Base menu; however, in most cases, you should leave the timecode base set to Auto.*

Drop Frame versus Non-Drop Frame Two of the more commonly used combinations of time display settings are 30 fps drop-frame timecode and 30 fps non-drop-frame timecode. When the frame rate is a non-integer number—as is the case with the NTSC frame rate of 29.97 frames per second—a compromise of one sort or another must be made in displaying time. Either the time display can accurately show clock time (after one hour, the time display shows 1:00:00:00) or the time display can be continuously numbered (frame n is always followed by frame $n + 1$, modulo the number of frames per second). Drop-frame timecode does the former; non-drop-frame timecode does the latter. In the case of NTSC 30 fps drop-frame timecode, two frame numbers are skipped for each minute, except for every tenth minute. Drop-frame timecode is conventionally indicated by separating the time units with semicolons. The most common case for which drop-frame versus non-drop-frame timecode is relevant is 29.97 fps NTSC, but it also applies to 23.976 fps (which is treated by After Effects as non-drop-frame timecode) and 59.94 fps.

Timecode for 59.94 fps compositions and footage items matches that in Adobe Premiere Pro: When the timecode base is 30 fps, each timecode value repeats twice. When the timecode base is 60 fps drop-frame, frame numbers 0,1,2,3 are dropped in exactly the same places as where 0,1 are dropped for drop-frame timecode with a timecode base of 30 fps.

Feet + Frames Displays number of feet of film, plus frames for fractional feet, for 16mm or 35mm film. Numbering starts at the frame number that you specify with the Start Numbering Frames At value.

Frames Displays frame number instead of time. Use this setting for convenience when doing work that you are integrating with a frame-based format, like Flash.

Chapter 7: Layers and properties

Creating layers

About layers

Layers are the elements that make up a composition. Without layers, a composition is only an empty frame. Use as many layers as necessary to create your composition. Some compositions contain thousands of layers, whereas some compositions contain only one layer.

Layers in After Effects are similar to tracks in Adobe Premiere Pro. The primary difference is that each After Effects layer can have no more than one footage item as its source, whereas a Premiere Pro track typically contains multiple clips. Layers in After Effects are also very similar to layers in Photoshop, though the interface for working with layers differs.

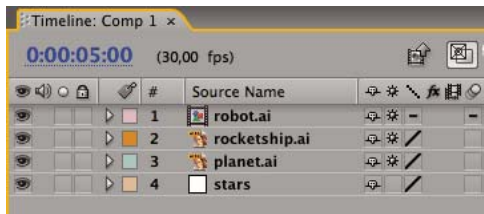

Four layers as viewed in the Composition panel (top) and in the Timeline panel (bottom)

You can create several kinds of layers:

- Video and audio layers that are based on footage items that you import, such as still images, movies, and audio tracks
- Layers that you create within After Effects to perform special functions, such as cameras, lights, adjustment layers, and null objects
- Solid-color layers that are based on solid-color footage items that you create within After Effects
- Synthetic layers that hold visual elements that you create within After Effects, such as shape layers and text layers
- Precomposition layers, which use compositions as their source footage items

To see a video tutorial on creating and managing layers, visit the Adobe website at www.adobe.com/go/vid0222.

When you make a change to a layer, you do not affect its source footage item. This means that you can use the same footage item as the source for more than one layer, and use the footage differently in each instance. (See “Importing and interpreting footage items” on page 47.)

Changes made to one layer do not affect other layers, unless you specifically link the layers. For example, you can move, rotate, and draw masks for one layer without disturbing any other layers in the composition.

After Effects automatically numbers all layers in a composition. By default, these numbers are visible in the Timeline panel next to the layer name. The number corresponds to the position of that layer in the stacking order. When the stacking order changes, After Effects changes all numbers accordingly. The layer stacking order affects rendering order, and therefore affects how the composition appears for previews and final rendered output. (See “Render order and collapsing transformations” on page 115.)

After you add a layer, you can reposition it in the Composition panel. In the Timeline panel, you can change a layer’s duration, starting time, and place in the layer stacking order.

Note: By default, new layers begin at the beginning of the composition duration. You can instead choose to have new layers begin at the current time by deselecting the *Create Layers At Composition Start Time* preference (Edit > Preferences > General (Windows) or After Effects > Preferences > General (Mac OS)).

See also

“Creating and editing text layers” on page 273

“Working with 3D layers” on page 171

“Shortcuts for working with layers” on page 645

“Cameras, lights, and points of interest” on page 176

“About shapes and shape layers” on page 314

“Create a null object” on page 159

Work with the Layer panel

You can perform many tasks—such as drawing masks—in either the Composition panel or the Layer panel. However, other tasks—such as tracking motion and using the paint tools—must be performed in the Layer panel.

The Layer panel shows you a layer before any transforms are applied to the layer. For example, the Layer panel does not show the result of modifying a layer’s Rotation properties. To see a layer in context with other layers and with the results of transforms, use the Composition panel.

Layers that are not based on a source footage item are *synthetic* layers. Synthetic layers include text layers and shape layers. You cannot open a synthetic layer in the Layer panel. You can, however, precompose a synthetic layer and open the precomposition in the Layer panel.

- To open a layer in the Layer panel, double-click the layer in the Timeline panel.
- To view changes to a layer (such as masks or effects), select Render in the Layer panel. Deselect Render to view the original, unaltered layer.

See also

“Work with viewers” on page 19

“Modifying and using views” on page 126

“Shortcuts for working with layers” on page 645

“Precompose layers” on page 114

Create layers from footage items

You can create a layer from any footage item in the Project panel, including another composition. After you add a footage item to a composition, you can modify and animate the resulting layer.

When you add a composition to another composition, you create a layer that uses the composition that you added as its source. (See “Nesting, precomposing, and pre-rendering” on page 113.)

The Still Footage preference setting (Preferences > Import) controls the default duration of layers that use still footage items as their sources. By default, when you create a layer with a still image as its source, the layer’s duration is the duration of the composition. You can change the duration of the layer after it’s created by trimming the layer.

Note: By default, new layers begin at the beginning of the composition duration. You can instead choose to have new layers begin at the current time by deselecting the *Create Layers At Composition Start Time* preference (Edit > Preferences > General (Windows) or After Effects > Preferences > General (Mac OS)).

Often, the next step after adding a layer to a composition is scaling and positioning the layer to fit in the frame. (See “Scale a layer” on page 155.)

See also

“Working with footage items” on page 58

“Trim, extend, or slip-edit a layer” on page 141

“Shortcuts for working with layers” on page 645

Create layers from one or more footage items

When you create layers from multiple footage items, the layers appear in the layer stacking order in the Timeline panel in the order in which they were selected in the Project panel.

- 1 Select one or more footage items and folders in the Project panel.
- 2 Do one of the following:
 - Drag the selected footage items to the Composition panel, or press Ctrl+/ (Windows) or Command+/ (Mac OS).
 - Drag the selected footage items to the Timeline panel. When you drag the item into the layer outline, a highlight bar indicates where the layer will appear when you release the mouse button. If you drag the item over the time graph area, a time marker indicates where the layer’s In point will be when you release the mouse button.
 - Drag the selected footage items to the composition name or icon in the Project panel.

Create a layer from a trimmed footage item

You can trim a moving-image footage item in the Footage panel before inserting a layer based on that footage item into a composition.

- 1 To open a footage item in the Footage panel, double-click it in the Project panel.

Double-clicking opens some footage items—including MOV and some AVI movies—in a media player window. To open some kinds of footage items in the Footage panel, you must Alt-double-click (Windows) or Option-double-click (Mac OS) them. (See “Working with footage items in the Footage panel” on page 59.)

- 2 Move the current-time indicator in the Footage panel to the frame that you want to use as the layer’s In point, and click the Set In Point button  at the bottom of the Footage panel.

- 3 Move the current-time indicator in the Footage panel to the frame that you want to use as the layer’s Out point, and click the Set Out Point button  at the bottom of the Footage panel.

4 To create a layer based on this trimmed footage item, click an Edit button at the bottom of the Footage panel:

Overlay Edit  Creates the new layer at the top of the layer stacking order, with the In point set at the current time in the Timeline panel.

Ripple Insert Edit  Also creates the new layer at the top of the layer stacking order, with the In point set at the current time in the Timeline panel, but splits all other layers. Newly created split layers are moved later in time so that their In points are at the same time as the inserted layer's Out point.

Replace layer sources with references to another footage item

- 1 Select one or more layers in the Timeline panel
- 2 Alt-drag (Windows) or Option-drag (Mac OS) a footage item from the Project panel onto a selected layer in the Timeline panel.

Create or modify a solid-color layer

You can create layers of any solid color and any size (up to 30,000 x 30,000 pixels). Solid-color layers have solid-color footage items as their sources. Solids work just like any other footage item: You can add masks, modify transform properties, and apply effects to a layer that has a solid as its source footage item. Use solid layers to color a background, as the basis of a control layer for a compound effect, or to create simple graphic images.

Solid-color footage items are automatically stored in the Solids folder in the Project panel.

See also

“Working with footage items” on page 58

“Trim, extend, or slip-edit a layer” on page 141

“Shortcuts for working with layers” on page 645

Create a solid-color layer or solid-color footage item

- To create a solid footage item but not create a layer for it in a composition, choose File > Import > Solid.
- To create a solid footage item and create a layer for it in the current composition, choose Layer > New > Solid or press Ctrl+Y (Windows) or Command+Y (Mac OS).

To create a layer that fits the composition when you create a solid-color layer, choose Make Comp Size.

Modify settings for solid-color layers and solid-color footage items

- To modify settings for the selected solid-color layer or footage item, choose Layer > Solid Settings.

To apply the changes to all solid-color layers that use the footage item, select Affect All Layers That Use This Solid. If you don't select this option, you create a new footage item, which becomes the source for the selected layer.

Create an adjustment layer

When you apply an effect to an ordinary layer, the effect applies only to that layer and no others. However, an effect can exist independently if you create an *adjustment layer* for it. Any effects applied to an adjustment layer affect all layers below it in the layer stacking order. An adjustment layer at the bottom of the layer stacking order has no visible result.

Because effects on adjustment layers apply to all layers beneath them, they are useful for applying effects to many layers at once. In all other respects, an adjustment layer behaves exactly like other layers; for example, you can use keyframes or expressions with any adjustment layer property.

Note: *If you want to apply an effect or transformation to a collection of layers, you can precompose the layers and then apply the effect or transformation to the precomposition layer. (See “Precompose layers” on page 114.)*

Use masks on an adjustment layer to apply an effect to only parts of the underlying layers. You can animate masks to follow moving subjects in the underlying layers.

- To create a new adjustment layer, choose Layer > New > Adjustment Layer.
- To convert selected layers to adjustment layers, select the Adjustment Layer switch  for the layers in the Timeline panel or choose Layer > Switches > Adjustment Layer.

Note: *You can deselect the Adjustment Layer switch for a layer to convert it to a normal layer.*

See also

“Apply an effect or animation preset” on page 351

“Creating and importing masks” on page 254

Create a layer and new Photoshop footage item

When you create a new Adobe Photoshop file from After Effects, Photoshop starts and creates a new PSD file. This PSD file consists of a blank Photoshop layer that has the same dimensions as your composition, with the appropriate title-safe and action-safe guides. The color bit depth of the PSD file is the same as that of your After Effects project.

The newly created PSD file is automatically imported into After Effects as a footage item. Any changes that you save in Photoshop appear in the footage item in After Effects.

- To create a new Photoshop footage item and use it as the source for a new layer in the current composition, choose Layer > New > Adobe Photoshop File. The Photoshop layer is added as the top layer in your composition.
- To create a new Photoshop footage item with the settings of the most recently open composition, without adding it to a composition, choose File > New > Adobe Photoshop File.

See also

“Working with footage items” on page 58

“Preparing and importing Photoshop files” on page 83

“Working with Photoshop and After Effects” on page 32

Selecting and arranging layers

Select layers

Selected layers that also have properties selected are indicated with a hollow highlight in the Timeline panel. A selected layer that has no properties selected is indicated with a solid highlight.

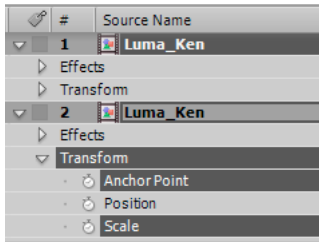

Top layer selected, but no properties selected; bottom layer selected with properties selected.



To scroll the topmost selected layer to the top of the Timeline panel, press X.

- To select a layer, click the layer in the Composition panel, click the layer's name or duration bar in the Timeline panel, or click the layer's name in the Flowchart panel.
- To select a layer that is obscured in the Composition panel, right-click (Windows) or Control-click (Mac OS) over the layer in the Composition panel, and choose **Select > [layer name]**.
- To select a layer if the layer is open in its own Layer panel, choose the layer name from the Window menu or the Layer panel viewer menu.
- To select a layer by position number, type the layer number on the numeric keypad. If the layer number has more than one digit, type the digits quickly so that After Effects can recognize them as one number.
- To select the next layer in the stacking order, press **Ctrl+Down Arrow** (Windows) or **Command+Down Arrow** (Mac OS). To select the previous layer, press **Ctrl+Up Arrow** (Windows) or **Command+Up Arrow** (Mac OS).
- To extend the selection to the next layer in the stacking order, press **Ctrl+Shift+Down Arrow** (Windows) or **Command+Shift+Down Arrow** (Mac OS). To extend the selection to the previous layer in the stacking order, press **Ctrl+Shift+Up Arrow** (Windows) or **Command+Shift+Up Arrow** (Mac OS).
- To select all layers, choose **Edit > Select All** while the Timeline or Composition panel is active. To deselect all layers, choose **Edit > Deselect All**.
- To deselect any currently selected layers and select all other layers; with at least one layer selected, choose **Invert Selection** from the context menu in the Composition or Timeline panel.
- To select all layers that use the same color label, click the layer's color label in the Timeline panel, and choose **Select Label Group**, or select the layer and choose **Edit > Label > Select Label Group**.
- To select all child layers assigned to a parent layer, select the parent layer and choose **Select Children** from the context menu in the Composition or Timeline panel. The child layers are added to the existing selection.

See also

“Work with parent and child layers” on page 158

“Work with color labels” on page 149

“Shortcuts for working with layers” on page 645

Change the stacking order for selected layers

The vertical arrangement of layers in the Timeline panel is the *layer stacking order*, which is directly related to the *render order*. You can change the order in which layers are composed with one another by changing the layer stacking order.

Note: Because of their depth properties, the stacking order of 3D layers in the Timeline panel does not necessarily indicate their spatial position in the composition.

- In the Timeline panel, drag the layer names to a new position in the layer stacking order.
- To move the selected layers up one level in the layer stacking order, press Ctrl+Alt+Up Arrow (Windows) or Command+Option+Up Arrow (Mac OS); to move the selected layers down one level, press Ctrl+Alt+Down Arrow (Windows) or Command+Option+Down Arrow (Mac OS).
- To move the selected layers to the top of the layer stacking order, press Ctrl+Alt+Shift+Up Arrow (Windows) or Command+Option+Shift+Up Arrow (Mac OS); to move the selected layers to the bottom, press Ctrl+Alt+Shift+Down Arrow (Windows) or Command+Option+Shift+Down Arrow (Mac OS).
- Choose Layer, and then choose Bring Layer Forward, Send Layer Backward, Bring Layer To Front, or Send Layer To Back.

 When you copy (or cut) and paste layers, the layers are pasted so that they appear from top to bottom in the Timeline panel in the same order in which they were selected prior to the copy (or cut) operation. This means that you can Ctrl-click (Windows) or Command-click (Mac OS) layers to select them in any arbitrary order, cut them, and then immediately paste them to reorder the layers in the order in which they were selected.

See also

“Render order and collapsing transformations” on page 115

“How render order and collapsed transformations affect 3D layers” on page 175

About coordinate systems

As you move the pointer over the layer frame in the Layer panel, the Info panel displays the coordinates of the pixel under the pointer in layer space. The X coordinate represents position on the horizontal axis, and the Y coordinate represents position on the vertical axis. Values for these coordinates are in pixels. The X and Y coordinates are relative to the origin (0,0), which is fixed at the upper left corner of the layer.

You can modify the rulers' zero point, but you can't modify the origin of layer space. If the zero point differs from the origin, X' and Y' coordinates appear in the Info panel below the X and Y coordinates, indicating coordinates based on the rulers' zero point.

When you move the pointer over the composition frame in the Composition panel, the Info panel displays coordinates in composition space. As you drag a layer, the lower portion of the Info panel displays the coordinates of the layer's anchor point.

See also

“Work with safe zones, grids, guides, and rulers” on page 130

“Work with layer anchor points” on page 154

Move layers in space

When you move a layer in space, you modify its Position property.

 You can manipulate the x, y, and z components of a layer's position independently by applying the Separate XYZ Position animation preset to the layer and then modifying the Separate XYZ Position effect's properties.

See also

“Work with safe zones, grids, guides, and rulers” on page 130

“Work with layer anchor points” on page 154

“Select layers” on page 137

“Modify layer properties” on page 152

“Working with effects and animation presets” on page 350

“Shortcuts for working with layers” on page 645

“Shortcuts for modifying properties” on page 648

Move layers by dragging in the Composition panel



To snap a layer's edges to grids or guides as you drag, choose *View > Snap To Grid* or *View > Snap To Guides*.

- Select one or more layers, and then drag a selected layer using the Selection tool .

When you move a layer by dragging it in the Composition panel, the Info panel shows the change in the Position property as you drag.

Move layers by directly modifying the Position property

- 1 Select one or more layers.
- 2 Press P to show the Position property in the Timeline panel.
- 3 Modify the Position property in the Timeline panel.

Move layers with arrow keys

- 1 Select one or more layers.
- 2 To move selected layers one pixel left, right, up, or down, press an arrow key. To move 10 pixels, hold Shift as you press the arrow key.

Align or distribute layers in 2D space

Use the Align panel to line up or evenly space selected layers. You can align or distribute layers vertically or horizontally.

Note: To align, you must select two or more layers; to distribute, you must select three or more layers.

- 1 Select the layers to align or distribute.
- 2 In the Align panel, click the button representing the desired type of alignment or distribution.

When you align and distribute selected layers, keep the following in mind:

- An alignment option aligns selected layers to the layer that most closely represents the new alignment. For example, for right-edge alignment, all selected layers align to the selected layer that is farthest to the right.
- A distribution option evenly spaces selected layers between the two most extreme layers. For example, for a vertical distribution option, the selected layers are distributed between the topmost and bottommost selected layers.

- When you distribute layers of different sizes, the spaces between layers may not be uniform. For example, distributing layers by their centers creates equal space between the centers—but different-sized layers extend by different amounts into the space between layers.
- Alignment or distribution options cannot move locked layers.
- The Align panel does not affect text alignment.

See also

“Select layers” on page 137

“Work with safe zones, grids, guides, and rulers” on page 130

“Align and justify text” on page 283

Trim, extend, or slip-edit a layer

The beginning of a layer’s duration is its *In point*, and the end is its *Out point*. The duration is the span between the In point and the Out point, and the bar that extends from the In point to the Out point is the *layer duration bar*.

To *trim* a layer is to modify its In or Out point so that the layer has a different duration. When you trim a layer that is based on moving source footage, you affect which frames of the source footage item are shown in the layer; the first frame to appear is at the In point, and the last frame to appear is at the Out point.

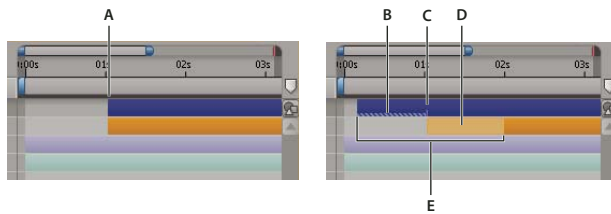

Trimming a layer in the Timeline panel

A. Original In point B. Negative layer time indicator for still image layer C. Original In point D. Slip-edit bar, representing excluded frames for motion footage layer E. New In points

When you use a footage item as a source for different layers, you can trim each layer differently to show different portions of the source. Trimming a layer does not alter the footage item or the original source file.

You can trim a layer by changing the In and Out points in the Layer panel or the Timeline panel. (You can also trim a footage item before using it to create a layer. See “Create layers from footage items” on page 135.)

The In point $\{$, Out point $\}$, and duration Δ values for a layer are shown at the bottom of the Layer panel. To show this information for all layers in the Timeline panel, click the In/Out/Duration/Stretch button $\{\}$ in the lower-left corner of the Timeline panel. The duration, In point, and Out point for the selected layer are also shown in the Info panel.

In the Layer panel, In and Out points are expressed in layer time. In the Timeline panel, In and Out points are expressed in composition time. The duration is the same in both cases (unless time-remapping or time-stretching is enabled for the layer).

You can extend many kinds of layers for any duration, extending their In points and Out points out past their original times. This applies to time-remapped layers, shape layers, layers based on still-image footage items, camera layers, light layers, and text layers. If you extend a layer back in time so that the layer extends into negative layer time (past layer time zero), a series of hash marks on the bottom of the layer bar indicates the portions of the layer that are in negative layer time. This indication is useful if you've applied an effect to the layer—such as Particle Playground—that uses layer time to calculate its results.

See also

“Timeline panel overview” on page 109

“Work with the Layer panel” on page 134

“Shortcuts for working with layers” on page 645

“Using and modifying keyboard shortcuts” on page 638

Trim or extend layers in the Timeline panel



Dragging the Out point of a layer duration bar.

- 1 Select one or more layers in the Timeline panel.
- 2 Do one of the following:
 - Drag either end of a layer duration bar.
 - Move the current-time indicator to the time at which you want to set the In point or Out point. To set the In point to the current time, press Alt+[(Windows) or Option+[(Mac OS). To set the Out point to the current time, press Alt+] (Windows) or Option+] (Mac OS).

Trim or extend a layer in the Layer panel

- Open the layer in the Layer panel and drag either end of the layer duration bar.
- Move the current-time indicator in the Layer panel to the time at which you want the footage to begin or end, and then click the In ¶ or Out ¶ button to set the In or Out point to the current time.

Slip-edit a layer

After you've trimmed a layer based on moving footage, a pale *slip-edit bar* represents the frames of the footage item that you are excluding from the composition. This pale rectangle does not appear for a trimmed layer based on a still footage item. You can choose which frames are played within a trimmed duration by dragging the slip-edit bar. The layer's In and Out points are not affected.

Moving only a layer's In or Out point doesn't move keyframes. Dragging the layer duration bar moves all keyframes. Dragging the slip edit bar moves selected keyframes, but does not move unselected keyframes.

 When performing a slip edit, you probably want to move some keyframes with the source footage—such as mask keyframes. Other keyframes should stay where they are in time. Press Shift+F2 to deselect keyframes and leave the layer selected.

- Drag the slip-edit bar to the left or right.

Remove part of a layer's duration

1 In the Timeline panel, set the work area to include only the portion of the layers' duration to remove: Move the current-time indicator to the time that the work area is to begin, and press B. Move the current-time indicator to the time at which the work area is to end, and press N.

2 Do one of the following:

- Select the layers from which to remove a section.
- Select the Lock switch  for layers that you do not want affected by the extraction. Press F2 to deselect all layers.

Note: If no layers are selected, the following step removes the section from all unlocked layers.

3 Do one of the following:

- To remove the section and leave a gap of the same duration as the removed section, choose Edit > Lift Work Area.
- To remove the section, choose Edit > Extract Work Area. The gap is closed by ripple deletion.

See also

“Set the work area” on page 112

“Select layers” on page 137

Place a layer in time

The layer duration bar represents the layer duration visually. The In, Out, and Duration columns in the Timeline panel represent the layer duration numerically.

Note: To choose which columns are visible in the Timeline panel, choose Columns from the panel menu, or right-click (Windows) or Control-click (Mac OS) a column heading.

These procedures move the entire layer in time.

- To set the In point or Out point numerically, click the number in the In or Out column for the layer in the Timeline panel.
- To move the In point or Out point to the current time, Alt-click (Windows) or Option-click (Mac OS) the number in the In or Out column for the layer in the Timeline panel.
- To move the In points of selected layers to the beginning of the composition, press Alt+Home (Windows) or Option+Home (Mac OS).
- To move the Out points of selected layers to the end of the composition, press Alt+End (Windows) or Option+End (Mac OS).
- To move selected layers one frame later, press Alt+Page Down (Windows) or Option+Page Down (Mac OS). To move selected layers 10 frames later, press Alt+Shift+Page Down (Windows) or Option+Shift+Page Down (Mac OS).
- To move selected layers one frame earlier, press Alt+Page Up (Windows) or Option+Page Up (Mac OS). To move selected layers 10 frames earlier, press Alt+Shift+Page Up (Windows) or Option+Shift+Page Up (Mac OS).

- To move the entire layer in time by dragging, drag the layer duration bar to the left or right. To snap the layer duration bar to significant points in time (such as markers, or the start or end of the composition), Shift-drag the layer duration bar.

Note: When you drag a layer in the Timeline panel, the Info panel displays the name, duration, change in time, and In and Out points for the layer.



Before and after dragging the duration bar

See also

“Layer switches and columns in the Timeline panel” on page 147

“Select layers” on page 137

“Shortcuts for working with layers” on page 645

“Trim, extend, or slip-edit a layer” on page 141

“Timeline panel overview” on page 109

Arrange layers in time sequentially

Use the Sequence Layers keyframe assistant to automatically arrange layers in a sequence. When you apply the keyframe assistant, the first layer you select remains at its initial time, and the other selected layers move to new times in the Timeline panel based on the order in which you selected them.

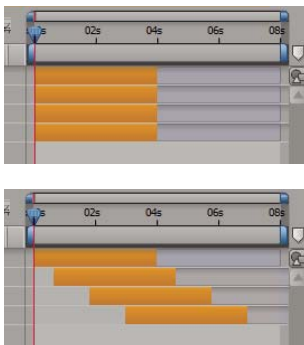

Layers selected in Timeline panel (top), and layers arranged in sequence by applying the Sequence Layers Keyframe Assistant (bottom)

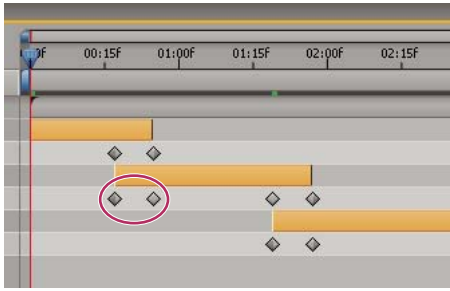

Overlapping layers can have Opacity keyframes set automatically to create a cross-dissolve.

For a layer to be put into a sequence, its duration must be less than the length of the composition so that it leaves time for other layers. (See “Trim, extend, or slip-edit a layer” on page 141.)

- 1 In the Timeline panel, hold down Ctrl (Windows) or Command (Mac OS) and select layers in sequential order, beginning with the layer to appear first.
- 2 Choose Animation > Keyframe Assistant > Sequence Layers.
- 3 In the Sequence Layers dialog box, do one of the following:
 - To arrange the layers end to end, leave the Overlap option unselected.
 - To overlap layers, select Overlap, enter a Duration value for the duration of the overlap, and select a transition. Select Cross Dissolve Front And Back Layers to use the transparency of the selected layers; otherwise, choose Dissolve Front Layer.
 - To leave gaps between the layers, select Overlap and enter a negative Duration value.

See also

“Select layers” on page 137

Copy or duplicate a layer

When you copy a layer, you copy all of its properties, including effects, keyframes, expressions, and masks.

Duplicating a layer is a shortcut with which you copy and paste the layer with one command. Duplicating a layer with a track matte preserves the relative ordering of the layer and its track matte.

When you paste layers, they are placed in the order in which you selected them before copying. The first layer selected is the last one to be placed, so it ends up on the top in the layer stacking order. If you select layers from the top first, they will end up in the same stacking order when pasted.

 *If you have a component of a layer—such as a mask or keyframe—selected when you copy, you copy only that component. Before copying, press Shift+F2 to deselect all of a layer’s components and leave the layer selected.*

- To copy selected layers and place the In points of the copies at the current time, choose Edit > Copy, and then press Ctrl+Alt+V (Windows) or Command+Option+V (Mac OS).
- To copy selected layers and place the copies at the same times as the originals, choose Edit > Copy, and then choose Edit > Paste.

 *To place copies at the top of the layer stack in the Timeline panel instead of immediately above the originals, press F2 to deselect the originals before you paste.*

- To duplicate selected layers, choose Edit > Duplicate or press Ctrl+D (Windows) or Command+D (Mac OS).

See also

“Copy and paste keyframes” on page 191

“Work with layer properties in the Timeline panel” on page 152

“Shortcuts for working with layers” on page 645

Split a layer

In the Timeline panel, you can split a layer at any time, creating two independent layers. This is a time-saving alternative to duplicating and trimming the layer—something you might do when you want to change the stacking-order position of the layer in the middle of the composition.

Note: To make new split layers appear above the original layer in the Timeline panel, select *Create Split Layers Above Original Layer* (*Edit > Preferences > General (Windows)* or *After Effects > Preferences > General (Mac OS)*). Deselect this option to make the layers appear below the original layer.

- 1 Select one or more layers.
- 2 Move the current-time indicator to the time at which to split the layers.
- 3 Choose *Edit > Split Layer*.

When you split a layer, both resulting layers contain all of the keyframes that were in the original layer in their original positions. Any applied track mattes retain their order, on top of the layer.

After you split a layer, the duration of the original layer ends at the point of the split, and the new layer starts at that point in time.

If no layer is selected when you choose *Edit > Split Layer*, all layers are split at the current time.

Paul Tuersley provides a script for splitting layers at layer-time markers:
www.adobe.com/go/learn_ae_paulsplitatmarkers.

See also

“Change the stacking order for selected layers” on page 138

“Select layers” on page 137

“Shortcuts for working with layers” on page 645

Auto-Orientation options

Each layer’s auto-orientation options (*Layer > Transform > Auto-Orient*) specify how its orientation depends on motion paths, points of interest, and cameras.

Off The layer rotates freely, independent of the motion path, point of interest, or other layers.

Orient Along Path The layer faces in the direction of the motion path. For example, use this option for a camera to depict a driver’s perspective while looking at the road ahead while driving.

Orient Towards Camera The layer is always oriented so that it faces the active camera. This option is available for 3D layers; this option is not available for 2D layers, cameras, or lights.

Orient Towards Point Of Interest The camera or light always points at its point of interest. This option is not available for layers other than cameras and lights.

Note: If you specify an auto-orientation option, and then change the layer's Orientation or X, Y, or Z Rotation properties, the layer orientation is offset by the new values. For example, you can set a camera with Orient Along Path, and then rotate the camera 90 degrees to the right to depict the perspective of a passenger looking out the side window of a car as it moves.

The automatic orientation to point to the point of interest occurs before the Rotation and Orientation properties' transformations are applied. This means that a camera or light with the Orient Towards Point Of Interest option can still be made to look temporarily away from the point of interest by means of animation of the Rotation and Orientation transform properties.

See also

“Working with 3D layers” on page 171

“Cameras, lights, and points of interest” on page 176

“Work with motion paths” on page 197

Managing layers

View and change layer information

- To rename a layer or property group, select it in the Timeline panel and press Enter on the main keyboard (Windows) or Return (Mac OS).

Layer names can be no more than 31 characters long. The same is true for names of footage items in the Project panel.

- To alternate between viewing the name of a selected layer's source footage item and the name of the layer in the Timeline panel, click the Layer Name/Source Name column heading in the Timeline panel.
- To show the name of a selected layer's source footage file in the Info panel, press Ctrl+Alt+E (Windows) or Command+Option+E (Mac OS).
- To see what footage item is the source for a layer, right-click (Windows) or Control-click (Mac OS) the layer in the Timeline panel and choose Reveal Layer Source In Project.

The source footage item is selected in the Project panel.

See also

“Select layers” on page 137



“Working with footage items” on page 58

“Timeline panel overview” on page 109

“Shortcuts for working with layers” on page 645

Layer switches and columns in the Timeline panel

Many of a layer's characteristics are determined by its layer switches, which are arranged in the Timeline panel in columns. By default, the A/V Features column appears to the left of the layer name, and the Switches and Modes (Transfer Controls) columns appear to the right, but you can arrange columns in a different order. (See “Work with columns” on page 18.)

To show or hide columns in the Timeline panel, click the Layer Switches , Transfer Controls , or In/Out/Duration/Stretch  button in the bottom left of the Timeline panel. Press Shift+F4 to show or hide the Parent column. Press F4 to toggle the Switches and Modes columns.

The results of some layer switch settings depend on the settings of composition switches, which are in the upper right of the layer outline in the Timeline panel.

 Quickly change the state of a switch for multiple layers by clicking the switch for one layer and dragging up or down that column for the adjacent layers.

Switches in the A/V Features column



Video  Toggles layer visuals on or off. (See “Exclude a layer from previews and final output” on page 148.)

Audio  Toggles layer sounds on or off.

Solo  Includes the current layer in previews and renders, ignoring layers without this switch set. (See “Solo a layer” on page 149.)

Lock  Locks layer contents, preventing all changes. (See “Lock or unlock a layer” on page 149.)





Switches in the Switches column



Shy  Hides the current layer when the Hide Shy Layers composition switch  is selected. (See “Show and hide layers in the Timeline panel” on page 150.)

Collapse Transformations/Continuously Rasterize  Collapses transformations if the layer is a precomposition; continuously rasterizes if the layer is a shape layer, text layer, or layer with a vector graphics file (such as an Adobe Illustrator file) as the source footage. Selecting this switch for a vector layer causes After Effects to rerasterize the layer for each frame, which improves image quality, but also increases the time required for previewing and rendering. (See “Render order and collapsing transformations” on page 115 and “Continuously rasterize a layer containing vector graphics” on page 151.)



Quality  Toggles between Best and Draft options for layer quality for rendering, including rendering to the screen for previews. (See “Layer image quality” on page 150.)

Effect  Select to render the layer with effects. The switch does not affect the setting for individual effects on the layer. (See “Delete or disable effects and animation presets” on page 352.)

Frame Blend  Sets frame blending to one of three states: Frame Mix , Pixel Motion , or off. If the Enable Frame Blending composition switch  is not selected, the layer’s frame blending setting is irrelevant. (See “Apply frame blending to a layer” on page 225.)

Motion Blur  Toggles motion blur on or off for the layer. If the Enable Motion Blur  composition switch is not selected, the layer’s motion blur setting is irrelevant. (See “Use motion blur” on page 200.)

Adjustment Layer  Identifies the layer as an adjustment layer. (See “Create an adjustment layer” on page 136.)

3D Layer  Identifies the layer as a 3D layer. If the layer is a 3D layer with 3D sublayers—as is the case for a text layer with per-character 3D properties—the switch looks like this: . (See “About 3D layers” on page 171.)

See also

“Shortcuts for working with layers” on page 645

Exclude a layer from previews and final output

- To prevent a layer from being rendered—both for previews and for final output—deselect the layer’s Video switch .



- To select the Video switch for all layers, choose Layer > Switches > Show All Video.
- To deselect the Video switch for all layers except the selected layers, choose Layer > Switches > Hide Other Video.

See also

“Layer switches and columns in the Timeline panel” on page 147

Solo a layer

You can isolate one or more layers for animating, previewing, or final output by *soloing*. Soloing excludes all other layers of the same type from being rendered—both for previews in the Composition panel and for final output. For example, if you solo a video layer, any lights and audio layers are unaffected, so they appear when you preview or render the composition. However, the other video layers do not appear.

- To solo one or more layers, select the layers in the Timeline panel, and click the Solo icon  to the left of the layer names.
- To solo one layer and unsolo all other layers, Alt-click (Windows) or Option-click (Mac OS) the Solo icon  to the left of the layer name.

The Video switch  is dimmed for other layers when a layer is soloed, indicating that the other layers are not visible.

See also

“Layer switches and columns in the Timeline panel” on page 147

Lock or unlock a layer

The Lock switch prevents layers from being edited accidentally. When a layer is locked, you cannot select it in either the Composition or Timeline panels. If you try to select or modify a locked layer, the layer flashes in the Timeline panel.

When a layer is locked, the Lock icon  appears in the A/V Features column, which appears by default to the left of the layer name in the Timeline panel.

- To lock or unlock a layer, click the Lock switch for the layer in the Timeline panel.
- To unlock all layers in the active composition, choose Layer > Switches > Unlock All Layers.

See also

“Layer switches and columns in the Timeline panel” on page 147

Work with color labels

You can use labels (colored boxes in the Label column) in the Project panel and Timeline panel to organize and manage footage items and layers. By default, different label colors indicate different kinds of footage items, but you can assign label colors to indicate whatever categories you choose. Layer handles and motion paths in the Composition and Layer panels display the label color of the layer.

- To select all layers with the same label color, select a layer with that label color and choose Edit > Label > Select Label Group.
- To change the color of a label for one layer, click the label in the Timeline panel and choose a color.



- To change the color of a label for all layers with that label color, select one of the layers belonging to the label group, choose Edit > Label > Select Label Group, and choose Edit > Label > [color name].
- To change the default colors for labels, choose Edit > Preferences > Label Colors (Windows) or After Effects > Preferences > Label Colors (Mac OS).
- To change the default associations of label colors with source types, choose Edit > Preferences > Label Defaults (Windows) or After Effects > Preferences > Label Defaults (Mac OS).

See also

“Select a color or edit a gradient” on page 236

Show and hide layers in the Timeline panel

You can mark a layer as *shy* and then use the Hide Shy Layers  composition switch at the top of the Timeline panel to hide all shy layers in the Timeline panel layer outline. Making layers shy is useful for making room in the Timeline panel to show the layers and layer properties that you want to adjust.

The icon in the Switches column indicates whether a layer is shy  or not shy .

Shy layers are still rendered, both for previews and for final output. To exclude layers from previews or final output, use the Video switch or make the layer a guide layer.

- To toggle a layer between shy and not shy, click the Shy switch for the layer, or select the layer in the Timeline panel and choose Layer > Switches > Shy.
- To toggle between hiding and showing all shy layers, click to select or deselect the Hide Shy Layers  composition switch at the top of the Timeline panel, or choose Hide Shy Layers from the Timeline panel menu.

See also

“Layer switches and columns in the Timeline panel” on page 147

Layer image quality

A layer’s quality setting determines how precisely it is rendered, as well as influencing the precision of other calculations involving the layer, such as motion tracking and the use of the layer as a control layer for a compound effect.

The default quality of new layers is determined by the Create New Layers At Best Quality preference in the General preferences category.

Duplicated or split layers retain the Quality setting of the original layer.

To toggle between Best and Draft quality of selected layers, click the Quality switch in the Timeline panel. To choose from all three options, choose Layer > Quality:

Best Displays and renders a layer using subpixel positioning, anti-aliasing, 3D shading, and complete calculation of any applied effects. Best requires the most time for rendering—both for previews and for final output.

Draft Displays a layer so that you can see it, but only at rough quality. Draft quality displays and renders a layer without anti-aliasing and subpixel positioning, and some effects are not precisely calculated. Draft quality is often the most useful setting for general work and for video layers (to avoid blurring when matching compositions to raw video footage).

Wireframe Displays a layer as a box, without layer contents. Layer wireframes are displayed and rendered faster than layers rendered with Best or Draft settings.

See also

“Layer switches and columns in the Timeline panel” on page 147

“Preview modes” on page 124

Continuously rasterize a layer containing vector graphics

When you import vector graphics, After Effects automatically rasterizes them. However, if you want to scale a layer that contains vector graphics above 100%, then you need to continuously rasterize the layer to maintain image quality. You can continuously rasterize vector graphics in layers based on Illustrator, Flash SWF, EPS, and PDF files. Continuously rasterizing causes After Effects to rasterize the file as needed based on the transformation for each frame. A continuously rasterized layer generally produces higher-quality results, but it may render more slowly.

Shape layers and text layers are always continuously rasterized.

When you apply an effect to a continuously rasterized layer, the results may be different than when you apply the effect to a layer without continuous rasterization. This is because the default rendering order for the layer changes. The default rendering order for a layer without continuous rasterization is masks, followed by effects, and then transformations; whereas the default rendering order for a continuously rasterized layer is masks, followed by transformations, and then effects.

Whether or not you continuously rasterize, if you view and render a composition using Best Quality, After Effects *anti-aliases* (smooths) the vector graphics.

You cannot open or interact with a continuously rasterized layer in a Layer panel. This means that you can't paint directly on a continuously rasterized layer. However, you can apply the Paint effect, and you can copy and paste paint strokes from other layers.

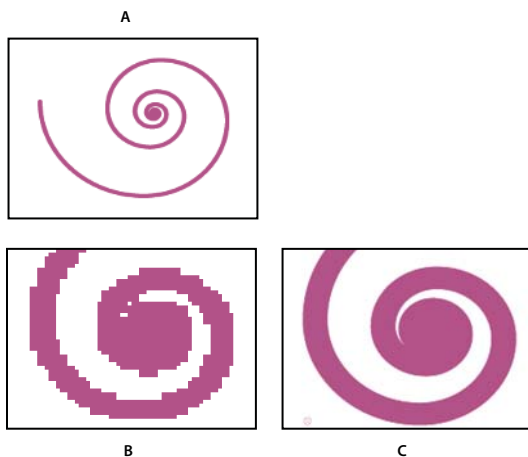



Image from imported Illustrator file

A. Original B. Enlarged with Continuously Rasterize switch turned off C. Enlarged with Continuously Rasterize switch turned on

❖ In the Timeline panel, click the layer's Continuously Rasterize switch , which is the same as the Collapse Transformations switch for nested composition layers.

See also

“Layer switches and columns in the Timeline panel” on page 147

“Render order and collapsing transformations” on page 115

Modify layer properties

Work with layer properties in the Timeline panel

Each layer has *properties*, many of which you can modify and animate. The basic group of properties that every layer has is the Transform group, which includes Position and Opacity properties. When you add certain features to a layer—for example, by adding masks or effects, or by converting the layer to a 3D layer—the layer gains additional properties, collected in property groups.

All layer properties are *temporal*—they can change the layer over time. Some layer properties, such as Position, are also *spatial*—they can move the layer across composition space.

You can expand the layer outline to display layer properties and change property values.

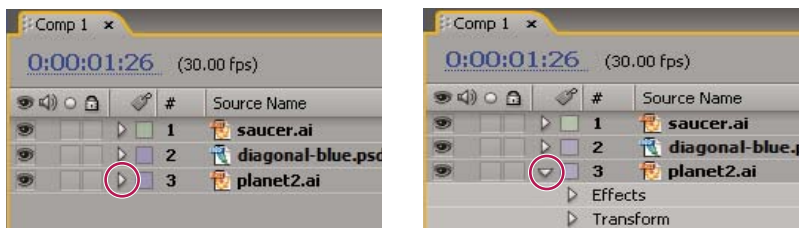

Collapsed property group (left) compared to expanded property group (right) in layer outline

Properties in the Effects property group (*effect properties*) are also layer properties. Many effect properties can also be modified in the Effect Controls panel.

See also

- “Work with effects in the Effect Controls panel” on page 350
- “Shortcuts for showing properties in the Timeline panel” on page 647
- “Shortcuts for working with layers” on page 645
- “Shortcuts for showing properties in the Timeline panel” on page 647
- “Shortcuts for modifying properties” on page 648

Show or hide properties in the Timeline panel

- To expand or collapse a property group, click the triangle to the left of the layer name or property group name.
- To expand or collapse a property group and all of its children, Ctrl-click (Windows) or Command-click (Mac OS) the triangle.
- To expand or collapse all groups for selected layers, press Ctrl+~ (tilde) (Windows) or Command+~ (tilde) (Mac OS).
- To reveal an effect property in the Timeline panel, double-click the property name in the Effect Controls panel.
- To hide a property or property group, Alt+Shift-click (Windows) or Option+Shift-click (Mac OS) the name in the Timeline panel.
- To show only the selected properties or property groups in the Timeline panel, press SS.

Note: This is especially useful for working with paint strokes. Select the paint stroke in the Layer panel, and press SS to open the property group for that stroke in the Timeline panel.

- To show only a specific property or property group, press its shortcut key or keys.
- To add a property or property group to the properties shown in the Timeline panel, hold Shift while pressing the shortcut key for the property or property group.
- To show only properties that have been modified from their default values, press **UU**, or choose Animation > Reveal Modified Properties.
- To show only properties that have keyframes or expressions, press **U**, or choose Animation > Reveal Animating Properties.

Note: The **U** and **UU** commands are especially useful for learning how animation presets, template projects, or other animated items work, because they isolate the properties that were modified by the designer of those items.

Select a property or property group in the Timeline panel

- To select a property or property group—including all values, keyframes, and expressions—click the name in the layer outline in the Timeline panel.

Copy or duplicate a property or property group in the Timeline panel

- To copy properties from one layer or property group to another, select the layer, property, or property group, press Ctrl+C (Windows) or Command+C (Mac OS), select the target layer, property, or property group, and press Ctrl+V (Windows) or Command+V (Mac OS).
- To duplicate a property group, select the property group and press Ctrl+D (Windows) or Command+D (Mac OS).

You can only duplicate some property groups, including shapes, masks, and effects. However, you can't duplicate top-level property groups such as Contents, Masks, Effects, and Transforms. If you attempt to duplicate a top-level property group, the entire layer is duplicated, instead.

Set a property value

If multiple layers are selected and you change a property for one layer, then the property is changed for all selected layers. Sliders, angle controls, and some other property controls are only available in the Effect Controls panel.

 *To change the units for a property, right-click (Windows) or Control-click (Mac OS) the underlined value, choose Edit Value, and choose from the Units menu. The available units are different for different property types. You can't change the units for some properties.*

- Place the pointer over the underlined value, and drag to the left or right.
- Click the underlined value, enter a new value, and then press Enter (Windows) or Return (Mac OS).

Note: You can enter simple arithmetic expressions for property values and other number entries. For example, you can enter **2*3** instead of **6**, **4/2** instead of **2**, and **2e2** instead of **200**.

- Right-click (Windows) or Control-click (Mac OS) the underlined value and choose Edit Value.
- Drag the slider left or right.
- Click a point inside the angle control  or drag the angle control line.

Note: After you click inside the angle control, you can drag outside it for more precision.

- To increase or decrease the property value by 1 unit, click the underlined value and press the Up Arrow or Down Arrow key. To increase or decrease by 10 units, hold Shift while pressing the Up Arrow or Down Arrow key. To increase or decrease by 0.1 units, hold Ctrl (Windows) or Command (Mac OS) while pressing the Up Arrow or Down Arrow key.

- To reset properties in a property group to their default values, click Reset next to the property group name. To reset an individual property, right-click (Windows) or Control-click (Mac OS) the property name (not the value) and choose Reset from the context menu.

If the property contains keyframes, a keyframe is added at the current time with the default value.

 Alan Shisko provides a video tutorial that shows how to use label colors and multiple selections to rapidly change properties for multiple layers simultaneously: www.adobe.com/go/learn_ae_alanmultilayer.

See also

“Work with effects in the Effect Controls panel” on page 350

“Shortcuts for showing properties in the Timeline panel” on page 647

“Shortcuts for modifying properties” on page 648

Work with layer anchor points

Transformations, such as rotation and scale, occur around a layer’s anchor point (sometimes called *transformation point* or *transformation center*). By default, the anchor point  for most layer types is at the center of a layer.

 The easiest way to pan and scan over a large image is to animate Anchor Point and Scale properties.



Anchor point in center of text layer (left) compared to anchor point moved to the end of the text layer (right)



When you use the Pan Behind tool to move the anchor point in the Composition panel (left), After Effects automatically compensates for the move so that the layer maintains its position relative to the composition frame (right).

Note: If you don’t see the anchor point in the Layer panel, select Anchor Point Path from the View menu at the bottom right of the Layer panel.

See also

“Work with the Layer panel” on page 134

“Selecting and arranging layers” on page 137

“Shortcuts for modifying properties” on page 648

Move a layer anchor point

- Drag the anchor point using the Selection tool in the Layer panel.

Note: Layers of some types, such as text layers and shape layers, can't be opened in the Layer panel.

- To move a layer anchor point 1 pixel, choose Anchor Point Path from the View menu at the bottom right of the Layer panel, and press an arrow key. To move 10 pixels, hold Shift as you press an arrow key. Pixel measurements are at the current magnification in the Layer panel.
- To move a layer anchor point in the Composition panel without moving the layer, select the layer and use the Pan Behind tool  to drag the anchor point.

Note: Moving an anchor point with the Pan Behind tool changes Position and Anchor Point values so that the layer remains where it was in the composition before you moved the anchor point. To change only the Anchor Point value, Alt-drag (Windows) or Option-drag (Mac OS) with the Pan Behind tool.

Reset a layer anchor point

- To reset the anchor point to its default location in the layer, double-click the Pan Behind tool  button in the Tools panel.
- To reset the anchor point to its default location in the layer, Alt-double-click (Windows) or Option-double-click (Mac OS) the Pan Behind tool button. The layer moves to the center of the composition

Scale a layer

As with other transformations, scaling occurs around the layer's anchor point. You can scale a layer beyond the composition frame.

For information on scaling exponentially, as with a zoom lens, see "Use Exponential Scale" on page 218.

- To scale a layer proportionally in the Composition panel, Shift-drag any layer handle.
- To scale a layer freely in the Composition panel, drag a corner layer handle.
- To scale one dimension only in the Composition panel, drag a side layer handle.
- To increase or decrease Scale for a selected layer by 1%, hold down Alt (Windows) or Option (Mac OS) as you press + or – on the numeric keypad.
- To increase or decrease Scale for selected layers by 10%, hold down Alt+Shift (Windows) or Option+Shift (Mac OS) as you press + or – on the numeric keypad.
- To scale to a specific set of pixel dimensions, right-click (Windows) or Control-click (Mac OS) the Scale value in the Timeline panel, choose Edit Value, and change the units to pixels in the Scale dialog box.
- To scale an entire composition, choose File > Scripts > DemoPalette.jsx to run the DemoPalette script, and then click the Scale Comp button.
- To scale and center selected layers to fit in the composition frame, choose Layer > Transform > Fit To Comp.
- To scale and center selected layers to fit the width or height of the composition frame, while preserving the layer's aspect ratio, choose Layer > Transform > Fit To Comp Width, or Layer > Transform > Fit To Comp Height.
- To scale a layer proportionally in the Timeline panel, select the layer, press S to display the Scale property, click the Constrain Proportions icon  to the left of the Scale values, and enter a new value for the x, y, or z scale.

 To activate the Constrain Proportions icon and match the height to the width, Alt-click (Windows) or Option-click (Mac OS) it.

Scaling a raster (non-vector) layer down sometimes causes a slight softening or blurring of the image. Scaling a raster layer up by a large factor can cause the image to appear blocky or pixelated. Plug-ins that provide high-quality upscaling include Digital Anarchy ReSizer (www.adobe.com/go/learn_ae_digitalanarchyresizer) and Red Giant Instant HD (www.adobe.com/go/learn_ae_redgiantinstanthd).

For a script that scales multiple compositions simultaneously, see the AE Enhancers forum: www.adobe.com/go/learn_ae_scriptscalemultiplecompositions.

See also

“Show or hide layer controls in the Composition panel” on page 127

“Selecting and arranging layers” on page 137

“Work with layer anchor points” on page 154

“Shortcuts for modifying properties” on page 648

Flip a layer

A layer flips around its anchor point. If you move the anchor point away from the center of the layer, the layer may move when you flip it.

- 1 Select one or more layers.
- 2 Press S to reveal the Scale property.
- 3 Right-click (Windows) or Control-click (Mac OS) the underlined Scale value and choose Edit Value from the pop-up menu that appears.
- 4 In the Scale dialog box, choose None from the Preserve pop-up menu.
- 5 Do one of the following:
 - To flip horizontally, enter a negative Width value.
 - To flip vertically, enter a negative Height value.

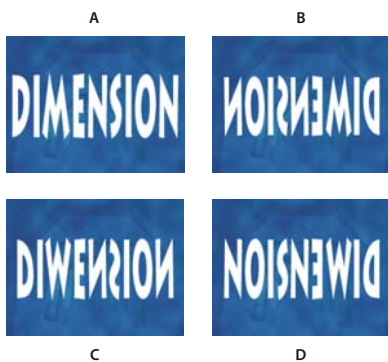

Layer flipped with varying Height and Width values

A. Width 100, Height 100 B. Width -100, Height 100 C. Width 100, Height -100 D. Width -100, Height -100



To flip a layer by dragging in the Composition panel, drag a layer handle across the layer’s anchor point. (See “Show or hide layer controls in the Composition panel” on page 127.)

See also

“Work with layer anchor points” on page 154

“Selecting and arranging layers” on page 137

“Shortcuts for modifying properties” on page 648

Rotate a 2D layer

As with other transformations, rotation occurs around the layer’s anchor point.



To reveal the Rotation property value for selected layers in the Timeline panel, press R. The first part of the property value is the number of whole rotations; the second part is the fractional rotation in degrees.

For information on rotating 3D layers, see “Rotate or orient a 3D layer” on page 173.

- To rotate a layer by dragging in the Composition panel, drag the layer using the Rotation tool . To constrain rotation to 45° increments, hold down Shift as you drag.
- To rotate selected layers by 1 degree, press plus (+) or minus (-) on the numeric keypad.
- To rotate selected layers by 10 degrees, press Shift+plus (+) or Shift+minus (-) on the numeric keypad.

See also

“Work with layer anchor points” on page 154

“Selecting and arranging layers” on page 137

“Shortcuts for modifying properties” on page 648

Adjust audio volume levels

When you use footage containing audio, the default audio level for playback is 0 dB, meaning that the level is unadjusted in After Effects. Setting a positive decibel level increases volume, and setting a negative decibel level decreases volume.

Note: Double-clicking an Audio Levels keyframe activates the Audio panel.

The VU meter in the Audio panel displays the volume range for the audio as it plays. The red blocks at the top of the meter represent your system’s volume limit.



For more precision in setting audio levels by dragging sliders, increase the height of the Audio panel.

❖ In the Audio panel, to adjust volume, do one of the following:

- To set the level of the left and right channels together, drag the center slider up or down.
- To set the level of the left channel, drag the left slider up or down, or type a new value in the levels box at the bottom of the left slider.
- To set the level of the right channel, drag the right slider up or down, or type a new value in the levels box at the bottom of the right slider.

See also

“Preview video and audio” on page 120

Work with parent and child layers

To synchronize changes to layers by assigning one layer's transformations to another layer, use *parenting*. After a layer is made a parent to another layer, the other layer is called the *child layer*. When you assign a parent, the child layer's transform properties become relative to the parent layer instead of to the composition. For example, if a parent layer moves 5 pixels to the right of its starting position, then the child layer also moves 5 pixels to the right of its position. Parenting is similar to grouping; transformations made to the group are relative to the parent's anchor point.

Parenting affects all transform properties except Opacity: Position, Scale, Rotation, and (for 3D layers) Orientation.

A layer can have only one parent, but a layer can be a parent to any number of layers in the same composition.

You can animate child layers independent of their parent layers. You can also parent using null objects, which are hidden layers.

You cannot animate the act of assigning and removing the parent designation—that is, you cannot designate a layer as a parent at one point in time and designate it as a normal layer at a different point in time.

When you create a parenting relationship, you can choose whether to have the child take on the parent's transform property values or retain its own. If you choose to have the child take on the parent's transform property values, the child layer *jumps* to the parent's position. If you choose to have the child retain its own transform property values, then the child stays where it is. In both cases, subsequent changes to the parent's transform property values are applied to the child. Similarly, you can choose whether the child *jumps* when the parenting relationship is removed.



Dragging the pick whip in the Timeline panel to designate the planet layer as the parent to the saucer layer

Note: To show or hide the Parent column in the Timeline panel, choose Columns > Parent from the Timeline panel menu.

Angie Taylor provides a character animation tutorial that shows how to use parenting and expressions: www.adobe.com/go/learn_ae_angietutorials.

Guy Chen provides a simple project that demonstrates the animation of several 3D layers arranged as a cube, controlled by a parent null layer: www.adobe.com/go/learn_ae_guy3dcube.

- To parent a layer, in the Parent column, drag the pick whip from the layer that is to be the child layer to the layer that is to be the parent layer.
- To parent a layer, in the Parent column, click the menu of the layer that you want to be the child, and choose a parent layer name from the menu.
- To remove a parent from a layer, in the Parent column, click the menu of the layer to remove the parent from, and choose None.
- To extend the selection to include all child layers of a selected parent layer, right-click (Windows) or Control-click (Mac OS) the layer in the Composition or Timeline panel, and choose Select Children.
- To make a child layer jump when a parent is assigned or removed, hold down Alt (Windows) or Option (Mac OS) as you assign or remove the parent.
- To remove a parent from a layer (i.e., set Parent to None), Ctrl-click (Windows) or Command-click (Mac OS) the child layer's parenting pickwhip in the Timeline panel. Alt+Ctrl-click (Windows) or Option+Command-click (Mac OS) the child layer's parenting pickwhip to remove the parent and cause the child layer to jump.

Paul Tuersley provides a script for duplicating a parent layer and all of its children, preserving the parenting hierarchy: www.adobe.com/go/learn_ae_paulduplicateparenting.

See also

“Work with columns” on page 18

Create a null object

To assign a parent layer, but keep that layer from being a visible element in your project, use a *null object*. A null object is an invisible layer that has all the properties of a visible layer so that it can be a parent to any layer in the composition. Adjust and animate a null object as you would any other layer. You use the same commands to modify settings for a null object that you use for a solid-color layer (Layer > Solid Settings).

 You can apply Expression Controls effects to null objects and then use the null object as a control layer for effects and animations in other layers. For example, when working with a camera or light layer, create a null object and use an expression to link the camera or light's Point Of Interest property to the null layer's Position property. Then, you can animate the Point Of Interest property by moving the null object. It is often easier to select and see a null object than it is to select and see the point of interest.

A composition can contain any number of null objects. A null object is visible only in the Composition and Layer panels and appears in the Composition panel as a rectangular outline with layer handles. Effects are not visible on null objects.

❖ Select the Timeline or Composition panel and choose Layer > New > Null Object.

Note: The anchor point of a new null object layer appears in the upper-left corner of the layer, and the layer is anchored in the center of the composition at its anchor point. Change the anchor point as you would for any other layer.

 If a null object is visually distracting in your composition frame, consider dragging it out of the frame, onto the pasteboard.

Guy Chen provides a simple project that demonstrates the animation of several 3D layers arranged as a cube, controlled by a parent null layer: www.adobe.com/go/learn_ae_guy3dcube.

See also

“Using Expression Controls effects” on page 555

“Work with layer anchor points” on page 154

Work with guide layers

You can create *guide layers* from existing layers to use for reference in the Composition panel, to help you position and edit elements. For example, you can use guide layers for visual reference, for audio timing, for timecode reference, or for storing comments to yourself.

A guide layer icon  appears next to a guide layer's source or layer name in the Timeline panel.

By default, guide layers aren't rendered when you create output but can be rendered when desired by changing the composition's render settings.

Note: Guide layers in nested compositions can't be viewed in the parent composition.

- To convert selected layers to guide layers, choose Layer > Guide Layer.

- To render a composition with its visible guide layers, click Render Settings in the Render Queue panel, and choose Current Settings from the Guide Layers menu in the Render Settings dialog box.
- To render a composition without rendering guide layers, click Render Settings in the Render Queue panel, and choose All Off from the Guide Layers menu in the Render Settings dialog box.

See also

“Work with render settings” on page 597

Use Brainstorm to experiment and explore settings

Brainstorm creates multiple temporary variants of your composition and displays them in a grid. You can save any number of these variants, apply one to the current composition, or redo the Brainstorm operation using only the variants that you choose as input.

Brainstorm uses genetic algorithms to mutate and select property values used as input into each Brainstorm operation. You decide which variants to include as input to each generation and how much mutation (randomness) to use.

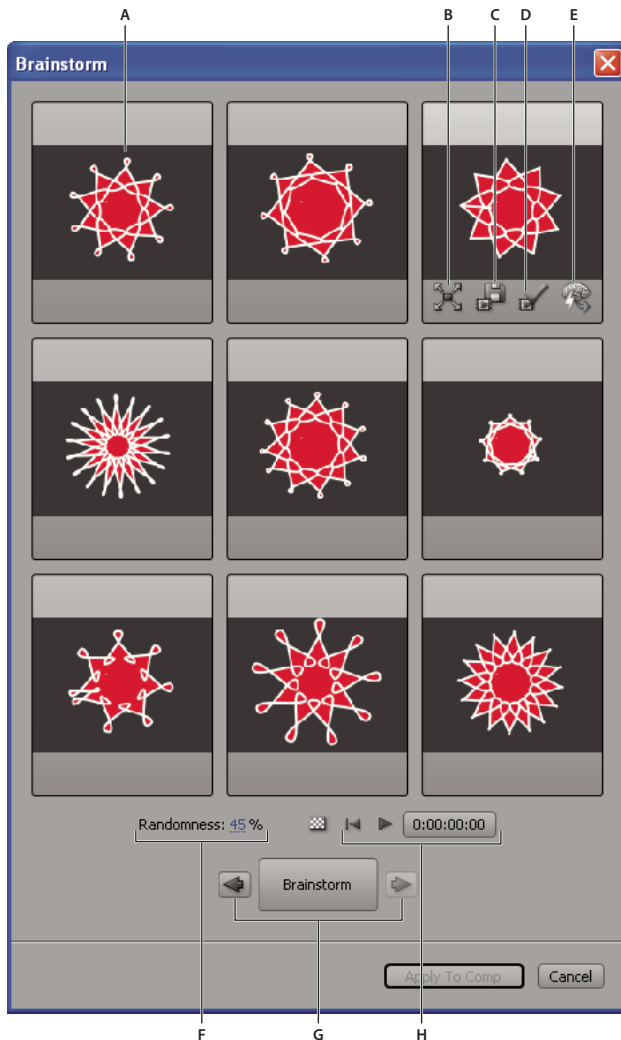

Brainstorm dialog box in Randomness mode

A. Original composition (original in center tile when using Brainstorm on single numerical value) **B.** Maximize Tile **C.** Save As New Composition **D.** Apply To Composition **E.** Use In Next Brainstorm **F.** Randomness control (Spread control when using Brainstorm on single numerical value) **G.** Back and Forward to previous and next generations **H.** Playback controls

With Brainstorm, you can rapidly accomplish the following:

- Compare the results of multiple values for a single property so that you can find the value that works best.
- Explore the results of randomly modifying any number of properties to achieve a creative result.

 *Open a template project or apply an animation preset to a layer, select some properties (or entire property groups), and then use Brainstorm to quickly modify these properties. Starting from such complete material, you can use Brainstorm to very quickly create your own projects and animations.*

You can use Brainstorm on any number of properties and property groups, from one or more layers in the same composition. For example, you can use Brainstorm to refine the single Stroke Width property for a star on a shape layer; or you can select the entire Contents property group and use Brainstorm to explore the entire space of properties for all shapes on the layer.

You can use Brainstorm on any property that has numeric values or options in a pop-up menu in the Timeline panel. Examples of properties on which you can't use Brainstorm are Source Text, Mask Path, and the Histogram property for the Levels effect; however, you can use Brainstorm on the properties of the Levels (Individual Controls) effect.

Brainstorm operates on all selected keyframes. For a property with no keyframes, Brainstorm operates on the global, constant value.

If you use Brainstorm on a single one-dimensional property (such as Opacity, but not Position), the Randomness value that controls the amount of variation (mutation) is replaced by a Spread value. The variants that are presented in the Brainstorm dialog box are then not random, but represent a range of values around the central value. The original composition appears in the center tile of the dialog box, and you can only select one variant on which to base the next Brainstorm operation.







Though you can't directly use Brainstorm on expressions, you can use Brainstorm on the properties of Expression Control effects, to which expressions can refer.

1 Set a work area and region of interest for the duration and spatial area of the composition that you want to preview during the Brainstorm session. (See “Set the work area” on page 112 and “Work with the region of interest” on page 111.)

2 Select one more properties or property groups in the Timeline panel, and click the Brainstorm button  at the top of the Timeline panel.

The variant compositions all play in the Brainstorm dialog box simultaneously. Controls for each variant are only visible when the pointer is over it. Use the playback controls at the bottom of the Brainstorm dialog box to play, pause, or rewind the previews.

3 In the Brainstorm dialog box, do any of the following:

- To get a better look at a variant, click its Maximize Tile  button. Click the Restore Tile Size  button to return to the grid view of all variants.
- To show or hide the transparency grid, click the Toggle Transparency Grid  button at the bottom of the Brainstorm dialog box.
- To mark a variant for inclusion in the next Brainstorm operation, click that variant's Include In Next Brainstorm  button.
- To save a variant as a new composition in the current project, click that variant's Save As New Composition  button.
- To increase the randomness or spread for the next generation, adjust the Randomness or Spread value at the bottom of the Brainstorm dialog box. Make this number small for precision work; make it larger for experimentation and exploration.

4 (Optional) To create another generation of variants from those marked for inclusion in the next Brainstorm operation, click Brainstorm at the bottom of the Brainstorm dialog box and return to step 2. If you click Brainstorm without marking any variants for inclusion, the Brainstorm operation is repeated using the same input as the current generation.

If the Brainstorm operation uses Randomness, the variants marked for input into the next generation are included unchanged into the next generation, and remain in their positions in the dialog box. If the Brainstorm operation uses Spread, only one variant is carried into the next generation, and it appears in the center tile.

Repeat this cycle until you have found the variant that you want to save as the current composition.

You can move back or forward a generation by clicking the arrow buttons on either side of the Brainstorm button at the bottom of the Brainstorm dialog box. If you move back a generation and then perform another Brainstorm operation, the later generations are lost.

Note: Press *Esc* to close the Brainstorm dialog box.

See also

“Work with layer properties in the Timeline panel” on page 152

Blending modes

Change a layer’s blending mode

Blending modes for layers control how each layer blends with or interacts with layers beneath it. Blending modes for layers in After Effects (formerly referred to as *layer modes* and sometimes called *transfer modes*) are identical to blending modes in Adobe Photoshop.

Most blending modes modify only color values of the source layer, not the alpha channel. The Alpha Add blending mode affects the alpha channel of the source layer, and the silhouette and stencil blending modes affect the alpha channels of layers beneath them.

You can’t directly animate blending modes by using keyframes. To change a blending mode at a certain time, split the layer at that time and apply the new blending mode to the part of the layer that continues. You can also use the Compound Arithmetic effect, the results of which are similar to those for blending modes but can change over time.

Each layer has a blending mode, even if that blending mode is the default Normal blending mode.

Note: To blend colors with a gamma value of 1, choose *File > Project Settings* and select *Blend Colors Using 1.0 Gamma*. Deselect this option to blend colors in the project’s color space. (See “Linearize working space and enable linear blending” on page 244.)

Blending modes for multiple masks on a single layer are called *mask modes*.

Some effects include their own blending mode options. For details, see the descriptions of the individual effects.

- To cycle through blending modes for selected layers, hold down the Shift key and press - (hyphen) or = (equals sign) on the main keyboard.

Note: This is a great way to experiment with the appearance of various blending modes.

- To apply a blending mode to selected layers, choose a blending mode from the menu in the Mode column in the Timeline panel or from the Layer > Blending Mode menu.
- To show the Modes column in the Timeline panel, choose Columns > Modes from the panel menu, or click the Expand Or Collapse The Transfer Controls button  at the bottom left of the Timeline panel.

See also

“Mask modes” on page 260

“Split a layer” on page 146

Blending mode reference

All blending modes described in this section are available for blending between layers. Some of these options are available for paint strokes, layer styles, and effects.

For in-depth information about the concepts and algorithms behind these blending modes, see the PDF reference material on the Adobe website at www.adobe.com/go/learn_general_blendingmodes.

Blending mode gallery

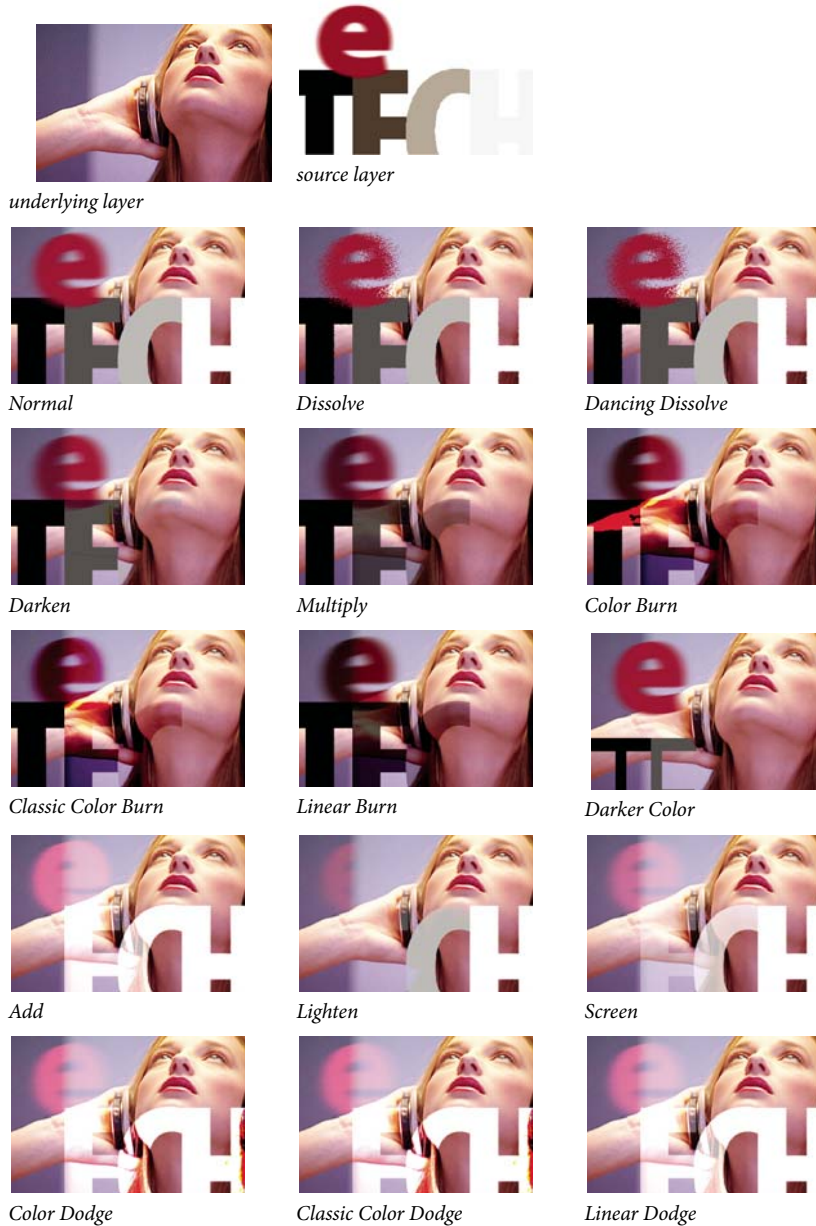



Lighter Color



Overlay



Soft Light



Hard Light



Linear Light



Vivid Light



Pin Light



Hard Mix



Difference



Classic Difference



Exclusion



Hue



Saturation



Color



Luminosity



Stencil Alpha



Stencil Luma



Silhouette Alpha



Silhouette Luma



Alpha Add



Luminescent Premul

Blending mode descriptions

In the following descriptions, these terms are used:

- The *source color* is the color of the layer or paint stroke to which the blending mode is applied.

- The *underlying color* is the color of the composited layers below the source layer or paint stroke in the layer stacking order in the Timeline panel.
- The *result color* is the output of the blending operation; the color of the composite.

The stencil and silhouette blending modes use either a layer's alpha channel or its luma values to affect the alpha channel of all layers beneath the layer. This differs from a track matte, which affects only one layer. Stencil modes cut through all layers, so that you can, for example, show multiple layers through the stencil layer's alpha channel. Silhouette modes block out all layers below, so you can cut a hole through several layers at once. To keep the silhouette and stencil blending modes from cutting through or blocking all layers underneath, precompose the layers that you want to affect and nest them in your composition.

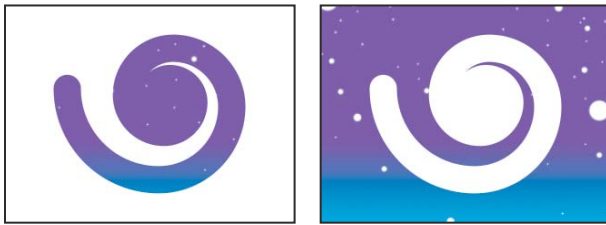

Stencil (left) shows all layers below through the frame of the stencil layer's alpha channel; silhouette (right) cuts a hole through all layers below.

Normal The result color is the source color. This mode ignores the underlying color. This is the default mode.

Dissolve The result color for each pixel is either the source color or the underlying color. The probability that the result color is the source color depends on the opacity of the source. If opacity of the source is 100%, then the result color is the source color. If opacity of the source is 0%, then the result color is the underlying color. Dissolve and Dancing Dissolve do not work on 3D layers.

Dancing Dissolve Same as Dissolve, except that the probability function is recalculated for each frame, so the result varies over time.

Darken Each result color channel value is the lower (darker) of the source color channel value and the corresponding underlying color channel value.

Multiply For each color channel, multiplies source color channel value with underlying color channel value and divides by maximum value for 8-bpc, 16-bpc, or 32-bpc pixels, depending on the color depth of the project. The result color is never brighter than the original. If either input color is black, the result color is black. If either input color is white, the result color is the other input color. This blending mode simulates drawing with multiple marking pens on paper or placing multiple gels in front of a light. When blending with a color other than black or white, each layer or paint stroke with this blending mode results in a darker color.

Color Burn The result color is a darkening of the source color to reflect the underlying layer color by increasing the contrast. Pure white in the original layer does not change the underlying color.

Classic Color Burn The Color Burn mode from After Effects 5.0 and earlier, renamed Classic Color Burn. Use it to preserve compatibility with older projects; otherwise, use Color Burn.

Linear Burn The result color is a darkening of the source color to reflect the underlying color. Pure white produces no change.

Darker Color Each result pixel is the color of darker of the source color value and the corresponding underlying color value. This is similar to Darken, but Darker Color does not operate on individual color channels.

Add Each result color channel value is the sum of the corresponding color channel values of the source color and underlying color. The result color is never darker than either input color.

Lighten Each result color channel value is the higher (lighter) of the source color channel value and the corresponding underlying color channel value.

Screen Multiplies the complements of the channel values, and then takes the complement of the result. The result color is never darker than either input color. Using the Screen mode is similar to superimposing two different film negatives and printing the result.

Color Dodge The result color is a lightening of the source color to reflect the underlying layer color by decreasing the contrast. If the source color is pure black, the result color is the underlying color.

Classic Color Dodge The Color Dodge mode from After Effects 5.0 and earlier, renamed Classic Color Dodge. Use it to preserve compatibility with older projects; otherwise, use Color Dodge.

Linear Dodge The result color is a lightening of the source color to reflect the underlying color by increasing the brightness. If the source color is pure black, the result color is the underlying color.

Lighter Color Each result pixel is the color of lighter of the source color value and the corresponding underlying color value. This is similar to Lighten, but Lighter Color does not operate on individual color channels.

Overlay Multiplies or screens the input color channel values, depending on the underlying color. The result preserves highlights and shadows in the underlying layer.

Soft Light Darkens or lightens the color channel values of the underlying layer, depending on the source color. The result is similar to shining a diffused spotlight on the underlying layer. For each color channel value, if the source color is lighter than 50% gray, the result color is lighter than the underlying color, as if dodged. If the source color is darker than 50% gray, the result color is darker than the underlying color, as if burned. A layer with pure black or white becomes markedly darker or lighter, but does not become pure black or white.

Hard Light Multiplies or screens the input color channel value, depending on the original source color. The result is similar to shining a harsh spotlight on the layer. For each color channel value, if the underlying color is lighter than 50% gray, the layer lightens as if it were screened. If the underlying color is darker than 50% gray, the layer darkens as if it were multiplied. This mode is useful for creating the appearance of shadows on a layer.

Linear Light Burns or dodges the colors by decreasing or increasing the brightness, depending on the underlying color. If the underlying color is lighter than 50% gray, the layer is lightened because the brightness is increased. If the underlying color is darker than 50% gray, the layer is darkened because the brightness is decreased.

Vivid Light Burns or dodges the colors by increasing or decreasing the contrast, depending on the underlying color. If the underlying color is lighter than 50% gray, the layer is lightened because the contrast is decreased. If the underlying color is darker than 50% gray, the layer is darkened because the contrast is increased.

Pin Light Replaces the colors, depending on the underlying color. If the underlying color is lighter than 50% gray, pixels darker than the underlying color are replaced, and pixels lighter than the underlying color do not change. If the underlying color is darker than 50% gray, pixels lighter than the underlying color are replaced, and pixels darker than the underlying color do not change.

Hard Mix Enhances the contrast of the underlying layer that is visible beneath a mask on the source layer. The mask size determines the contrasted area; the inverted source layer determines the center of the contrasted area.

Difference For each color channel, subtracts the darker of the input values from the lighter. Painting with white inverts the backdrop color; painting with black produces no change.

Classic Difference The Difference mode from After Effects 5.0 and earlier, renamed Classic Difference. Use it to preserve compatibility with older projects; otherwise, use Difference.

Exclusion Creates a result similar to but lower in contrast than the Difference mode. If the source color is white, the result color is the complement of the underlying color. If the source color is black, the result color is the underlying color.

Hue Result color has luminance and saturation of the underlying color, and the hue of the source color.

Saturation Result color has luminance and hue of the underlying color, and the saturation of the source color.

Color Result color has luminance of the underlying color, and hue and saturation of the source color. This preserves the gray levels in the underlying color. This is useful for coloring grayscale image and for tinting color images.

Luminosity Result color has hue and saturation of the underlying color, and luminance of the source color. This mode is the opposite of the Color mode.

Stencil Alpha Creates a stencil using the layer's alpha channel.

Stencil Luma Creates a stencil using the layer's luma values. The lighter pixels of the layer are more opaque than the darker pixels.

Silhouette Alpha Creates a silhouette using the layer's alpha channel.

Silhouette Luma Creates a silhouette using the layer's luma values. Creates transparency in painted areas of the layer, allowing you to see underlying layers or background. The luminance value of the blend color determines opacity in the result color. The lighter pixels of the source cause more transparency than the darker pixels. Painting with pure white creates 0% opacity. Painting with pure black produces no change.

Alpha Add Composites layers normally, but adds complementary alpha channels to create a seamless area of transparency. Useful for removing visible edges from two alpha channels that are inverted relative to each other or from the alpha channel edges of two touching layers that are being animated.

Luminescent Premul Prevents clipping of color values that exceed the alpha channel value after compositing by adding them to the composition. Useful for compositing rendered lens or light effects (such as lens flare) from footage with premultiplied alpha channels. May also improve results when compositing footage from other manufacturers' matting software. When applying this mode, you may get the best results by changing interpretation of the premultiplied-alpha source footage to straight alpha.

Layer styles

About layer styles

Photoshop provides a variety of layer styles—such as shadows, glows, and bevels—that change the appearance of a layer. After Effects can preserve these layer styles when importing Photoshop layers. You can also apply layer styles in After Effects and animate their properties.

In addition to the layer styles that add visual elements—like a drop shadow or a color overlay—each layer's Layer Styles property group contains a Blending Options property group. You can use the Blending Options settings for powerful and flexible control over blending operations.

Though layer styles are referred to as *effects* in Photoshop, they behave more like blending modes in After Effects. Layer styles follow transformations in the standard render order, whereas effects precede transformations. Another difference is that each layer style blends directly with the underlying layers in the composition, whereas an effect is rendered on the layer to which it's applied, the result of which then interacts with the underlying layers as a whole.

When you import a Photoshop file that includes layers as a composition, you can retain editable layer styles or merge layer styles into footage. When you import only one layer that includes layer styles, you can choose to ignore the layer styles or merge layer styles into footage. At any time, you can convert merged layer styles into editable layer styles for each After Effects layer based on a Photoshop footage item.

After Effects can preserve all layer styles in imported Photoshop files, but you can only add and modify some layer styles and controls within After Effects.

Layer styles that you can apply and edit in After Effects

Drop Shadow Adds a shadow that falls behind the layer.

Inner Shadow Adds a shadow that falls inside the layer's contents, giving the layer a recessed appearance.

Outer Glow Adds a glow that emanates outward from the layer's contents.

Inner Glow Adds a glow that emanates inward from the layer's contents.

Bevel And Emboss Adds various combinations of highlights and shadows.

Satin Applies interior shading that creates a satiny finish.

Color Overlay Fills the layer's contents with a color.

Gradient Overlay Fills the layer's contents with a gradient.

Stroke Outlines the layer's contents.

See also

“Preparing and importing Photoshop files” on page 83

“Render order and collapsing transformations” on page 115

“How render order and collapsed transformations affect 3D layers” on page 175

Work with layer styles

- To convert merged layer styles into editable layer styles, select one or more layers and choose Layer > Layer Styles > Convert To Editable Styles.
- To add a layer style to selected layers, choose Layer > Layer Styles, and choose a layer style from the menu.
- To remove a layer style, select it in the Timeline panel and press Delete.
- To remove all layer styles from selected layers, choose Layer > Layer Styles > Remove All.

When a layer style is applied to a vector layer—such as a text layer, a shape layer, or a layer based on an Illustrator footage item—visual elements that apply to the edges of the layer's contents apply to the outlines of the vector objects, such as text characters or shapes. When a layer style is applied to a layer based on a non-vector footage item, the layer style applies to the edges of the layer's bounds or masks.

You can apply a layer style to a 3D layer, but a layer with a layer style can't intersect with other 3D layers or interact with other 3D layers for casting and receiving shadows. 3D layers on either side of a layer with a layer style can't intersect one another or cast shadows on one another.

When you use the Layer > Convert To Editable Text command on a text layer from a Photoshop file, any layer styles on that layer are also converted to editable layer styles.

See also

“Preparing and importing Photoshop files” on page 83

“Render order and collapsing transformations” on page 115

“How render order and collapsed transformations affect 3D layers” on page 175

Layer style settings

Each layer style has its own collection of properties in the Timeline panel.

Align With Layer Uses the bounding box of the layer to calculate the gradient fill.

Altitude For the Bevel And Emboss layer style, the elevation of the light source above the layer, in degrees.

Choke Shrinks the boundaries of the matte of an Inner Shadow or Inner Glow prior to blurring.

Distance The offset distance for a Shadow or Satin layer style

Highlight Mode, Shadow Mode Specifies the blending mode of a bevel or emboss highlight or shadow.

Jitter Varies the application of a gradient's color and opacity.

Layer Knocks Out Drop Shadow Controls the drop shadow's visibility in a semitransparent layer.

Reverse Flips the orientation of a gradient.

Scale Resizes the gradient.

Spread Expands the boundaries of the matte prior to blurring.

Use Global Light Set this to On to use the Global Light Angle and Global Light Altitude in the Blending Options property group instead of the individual layer style's Angle and Altitude settings. This is useful if you have multiple layer styles applied to the same layer and want to animate the position of the light for all of them.

Working with blending options for layer styles

Each layer style has its own blending mode, which determines how it interacts with underlying layers. The underlying layer in this context may or may not include the layer to which the layer style is applied. For example, a drop shadow does not blend with the layer to which it's applied, because the shadow falls behind the layer; whereas an inner shadow does blend with the layer to which it's applied.

Layer styles can be categorized as interior layer styles or exterior layer styles. Interior layer styles affect the opaque pixels of the layer to which they're applied. These include Inner Glow, Inner Shadow, Color Overlay, Gradient Overlay, Satin, and Bevel And Emboss. Exterior layer styles do not blend with the pixels of the layer to which they're applied, but only interact with the underlying layers. These include Outer Glow and Drop Shadow.

If Blend Interior Styles As Group is set to On, interior layer styles use the blending mode of the layer.

If you modify a layer's Opacity property, the opacity of the layer's contents and the opacity of the layer styles are all affected. If, however, you modify the Fill Opacity property in the Blending Options property group, the opacity of the layer styles is unaffected. For example, if a text layer has the Drop Shadow layer style applied, decreasing the Fill Opacity to 0 makes the text disappear, but the drop shadow remains visible.

Use the Blend Ranges From Source option to use the advanced blending options set for the Photoshop file that determine what blending operations to perform based on the color characteristics of the input layer.

Exclude channels from blending

You can exclude one or more of a layer's color channels from blending operations.

 *The Blending Options property group is only included for a layer if the layer has had a layer style added to it. To add a Blending Options property group without a layer style, add an arbitrary layer style and then immediately delete it; the Blending Options property group and its containing Layer Styles property group will remain.*

- 1 Expand the layer's Blending Options property group in the Layer Styles property group in the Timeline panel.
- 2 To exclude a channel from blending, set Red, Green, or Blue to Off in the Advanced Blending property group.

You can animate these properties, so you can exclude a channel from blending at some times but include the channel at other times.

Working with 3D layers

About 3D layers

The basic objects that you manipulate in After Effects are flat, two-dimensional (2D) layers. When you make a layer a 3D layer, the layer itself remains flat, but it gains additional properties: Position (z), Anchor Point (z), Scale (z), Orientation, X Rotation, Y Rotation, Z Rotation, and Material Options properties. Material Options properties specify how the layer interacts with light and shadows. Only 3D layers interact with shadows, lights, and cameras.

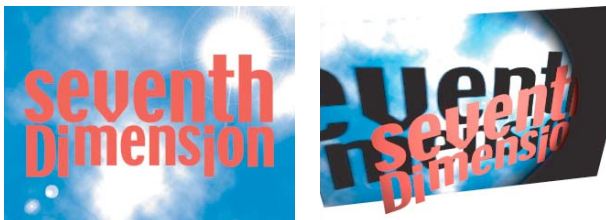

2D layers (left) and layers with 3D properties (right)

Any layer can be a 3D layer, except an audio-only layer. Individual characters within text layers can optionally be 3D sublayers, each with their own 3D properties. A text layer with Enable Per-character 3D selected behaves just like a precomposition that consists of a 3D layer for each character. All camera and light layers have 3D properties.

By default, layers are at a depth (z-axis position) of 0. In After Effects, the origin of the coordinate system is at the upper-left corner; x (width) increases from left to right, y (height) increases from top to bottom, and z (depth) increases from near to far. Some video and 3D applications use a coordinate system that is rotated 180 degrees around the x axis; in these systems, y increases from bottom to top, and z increases from far to near.

You can transform 3D layers relative to the composition's coordinate space, the layer's coordinate space, or a custom space by selecting an axis mode.

You can add effects and masks to 3D layers, composite 3D layers with 2D layers, and create and animate camera and light layers to view or illuminate 3D layers from any angle.

All effects are 2D, including effects that simulate 3D distortions. This means that, for example, viewing a layer with the Bulge effect from the side will not show a protrusion.

As with all masks, mask coordinates on a 3D layer are in the 2D coordinate space of the layer.

Note: *After Effects 7.0 and earlier included a Standard 3D rendering plug-in; this plug-in is not included with After Effects CS3. In After Effects 6.0 and later, the default plug-in for rendering 3D layers has been the Advanced 3D rendering plug-in. When you open a project that was created with the Standard 3D rendering plug-in, the project is converted to use the Advanced 3D rendering plug-in. As third-party plug-ins become available, you can choose them from the Advanced section of the Composition Settings dialog box.*

Paul Tuersley provides a pair of scripts for converting a composition based on a layered Photoshop file into a set of 3D layers, www.adobe.com/go/learn_ae_paulphotoshop3dlayers.

You can download an example project from the AE Enhancers forum that shows how to arrange several 3D layers in the shape of a sphere, control the layers with a null layer, and light them: www.adobe.com/go/learn_ae_oscarussphere3d.

Several plug-ins add the ability to manipulate, warp, and extrude 3D shapes in After Effects. Rich Young of AE Portal provides information about Zaxwerks 3D Warps and Zaxwerks Invigorator PRO, two such products: www.adobe.com/go/learn_ae_richzaxwerks3d.

See also

“Work with per-character 3D text properties” on page 293

“3D files from other applications” on page 77

“Shortcuts for 3D layers” on page 649

“Cameras, lights, and points of interest” on page 176

“Layer 3D attributes and methods” on page 572

Convert 3D layers

When you convert a layer to 3D, a depth (z) value is added to its Position, Anchor Point, and Scale properties, and the layer gains Orientation, Y Rotation, X Rotation, and Material Options properties. The single Rotation property is renamed Z Rotation.

When you convert a 3D layer back to 2D, the Y Rotation, X Rotation, Orientation, and Material Options properties are removed, including all values, keyframes, and expressions. (These values cannot be restored by converting the layer back to a 3D layer.) The Anchor Point, Position, and Scale properties remain, along with their keyframes and expressions, but their z values are hidden and ignored.

See also

“Work with per-character 3D text properties” on page 293

“Layer switches and columns in the Timeline panel” on page 147

“Shortcuts for 3D layers” on page 649

Convert a layer to a 3D layer

❖ Select the layer’s 3D Layer switch  in the Timeline panel, or select the layer and choose Layer > 3D Layer.

Convert a text layer to a 3D layer with per-character 3D properties enabled

❖ Choose Animation > Animate Text > Enable Per-Character 3D, or choose Enable Per-Character 3D from the layer’s Animate menu in the Timeline panel.

Convert a 3D layer to a 2D layer

- ❖ Deselect the layer's 3D Layer switch in the Timeline panel, or select the layer and choose Layer > 3D Layer.

Show or hide 3D axes and layer controls

3D axes are color-coded arrows: red for x, green for y, and blue for z.

- To show or hide 3D axes, camera and light wireframe icons, layer handles, and the point of interest, choose View > Show Layer Controls.

 *If the axis that you want to manipulate is difficult to see, try a different setting in the Select View Layout menu at the bottom of the Composition panel.*

- To show or hide a set of persistent 3D reference axes, click the Grid And Guides Options button  at the bottom of the Composition panel, and choose 3D Reference Axes.

See also

“Show or hide layer controls in the Composition panel” on page 127

Move a 3D layer

- 1 Select the 3D layer that you want to move.
- 2 Do one of the following:
 - In the Composition panel, use the Selection tool  to drag the arrowhead of the 3D axis layer control corresponding to the axis along which you want to move the layer. Shift-drag to move the layer more quickly.
 - In the Timeline panel, modify the Position property values.

 *Press P to show Position.*

See also

“Selecting and arranging layers” on page 137

“Modify layer properties” on page 152

“Shortcuts for 3D layers” on page 649

Rotate or orient a 3D layer

You can turn a 3D layer by changing the layer's Orientation values or by changing its Rotation values. In both cases, the layer turns around its anchor point. The Orientation and Rotation properties differ in how the layer moves when you animate them.

When you animate a 3D layer's Orientation property, the layer turns as directly as possible to reach the specified orientation. When you animate any of a 3D layer's X, Y, or Z Rotation properties, the layer rotates along each individual axis according to the individual property values. In other words, Orientation values specify an angular destination, whereas Rotation values specify an angular route. Animate Rotation properties to make a layer turn multiple times.

Animating the Orientation property is often better for natural, smooth motion, whereas animating the Rotation properties provides more precise control.

Donat Van Bellinghen provides a some expressions for placing and orienting a 3D layer in the plane defined by three points: www.adobe.com/go/learn_ae_donat3dlayer3points.

See also

“Selecting and arranging layers” on page 137

“Modify layer properties” on page 152

“Shortcuts for 3D layers” on page 649

Rotate or orient a 3D layer in the Composition panel

- 1 Select the 3D layer that you want to turn.
- 2 Select the Rotation tool , and choose Orientation or Rotation from the Set menu to determine whether the tool affects Orientation or Rotation properties.
- 3 In the Composition panel, do one of the following:
 - Drag the arrowhead of the 3D axis layer control corresponding to the axis around which you want to turn the layer.
 - Drag a layer handle. Dragging a corner handle turns the layer around the z axis; dragging a left or right center handle turns the layer around the y axis; dragging a top or bottom handle turns the layer around the x axis.
 - Drag the layer.



Shift-drag to constrain your manipulations to 45-degree increments.

Rotate or orient a 3D layer in the Timeline panel

- 1 Select the 3D layer that you want to turn.
- 2 In the Timeline panel, modify the Rotation or Orientation property values.





Press R to show Rotation and Orientation properties.

Axis modes

Axis modes specify on which set of axes a 3D layer is transformed. Choose a mode in the Tools panel.

Local Axis mode  Aligns the axes to the surface of a 3D layer.

World Axis mode  Aligns the axes to the absolute coordinates of the composition. Regardless of the rotations you perform on a layer, the axes always represent 3D space relative to the 3D world.

View Axis mode  Aligns the axes to the view you have selected. For example, suppose that a layer has been rotated and the view changed to a custom view; any subsequent transformation made to that layer while in View Axis mode happens along the axes corresponding to the direction from which you are looking at the layer.

Note: The camera tools always adjust along the view's local axes, so the action of the camera tools is not affected by the axis modes.

See also

“About coordinate systems” on page 139

How render order and collapsed transformations affect 3D layers

The positions of certain kinds of layers in the layer stacking order in the Timeline panel prevent groups of 3D layers from being processed together to determine intersections and shadows.

A shadow cast by a 3D layer does not affect a 2D layer or any layer that is on the other side of the 2D layer in the layer stacking order. Similarly, a 3D layer will not intersect with a 2D layer or any layer that is on the other side of the 2D layer in the layer stacking order. No such restriction exists for lights.

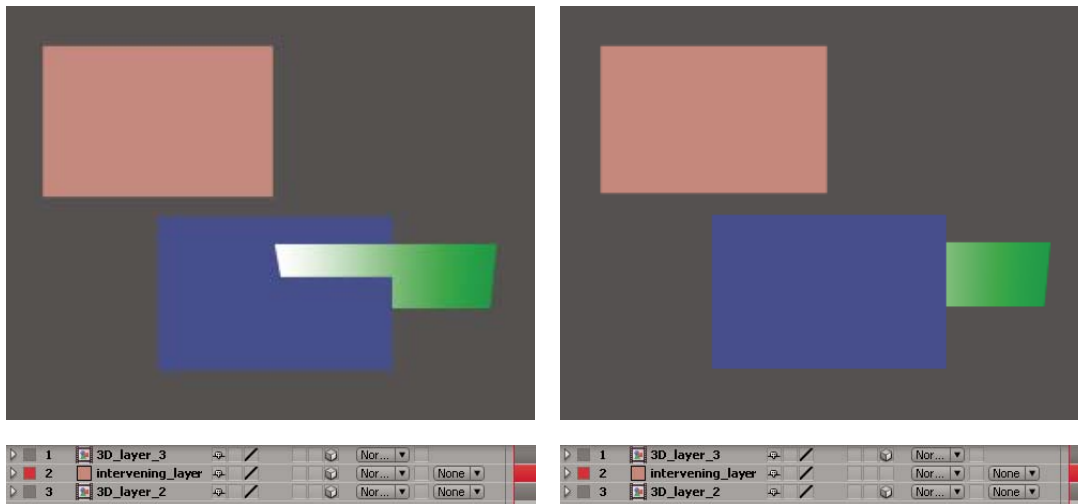

3D layers intersecting (left), and 3D layers prevented from intersecting by intervening 2D layer (right)

Just like 2D layers, other types of layers also prevent 3D layers on either side from intersecting or casting shadows on one another:

- An adjustment layer
- A 3D layer with a layer style applied
- A 3D precomposition to which an effect, closed mask (with mask mode other than None), or track matte has been applied
- A 3D precomposition layer without collapsed transformations

A precomposition with collapsed transformations (Collapse Transformations switch  selected) does not interfere with the interaction of 3D layers on either side—as long as all of the layers in the precomposition are themselves 3D layers. Collapsing transformations exposes the 3D properties of the layers that compose the precomposition. Essentially, collapsing transformations in this case allows each 3D layer to be composited into the main composition individually, rather than creating a single 2D composite for the precomposition layer and compositing that into the main composition. The tradeoff is that this setting removes your ability to specify certain layer settings for the precomposition as a whole—such as blending mode, quality, and motion blur.

Shadows cast by continuously rasterized 3D layers (including text layers) are not affected by effects applied to that layer. If you want the shadow to show the results of the effect, then precompose the layer with the effect.



To ensure that the shadow remains where expected on a 3D layer with a track matte, precompose the 3D layer and the track matte layer together (but don't collapse transformations), and then apply the shadow to the precomposition.

Effects on continuously rasterized vector layers with 3D properties are rendered in 2D and then projected onto the 3D layer. OpenGL rendering does not support this sort of projection, so results may differ when rendering using OpenGL. This projection does not occur for compositions with collapsed transformations.

See also

“Render order and collapsing transformations” on page 115

“Precompose layers” on page 114

“Continuously rasterize a layer containing vector graphics” on page 151

Cameras, lights, and points of interest

Create a camera layer and change camera settings

You can view 3D layers from any angle and distance using *camera* layers. Just as it's easier in the real world to move cameras through and around a scene than it is to move and rotate the scene itself, it's often easiest to get different views of a composition by setting up a camera layer and moving it around in a composition.

You can modify and animate camera settings to configure the camera to match the real camera and settings that were used to record footage with which you're compositing. You can also use camera settings to add camera-like behaviors—from depth-of-field blur to pans and dolly shots—to synthetic effects and animations.

Cameras affect only 3D layers and 2D layers to which you've applied an effect with a Comp Camera attribute. With effects that have a Comp Camera attribute, you can use the active composition camera or lights to view or light an effect from various angles to simulate more sophisticated 3D effects.

You can choose to view a composition through the active camera or through a named custom camera. The active camera is the topmost camera in the Timeline panel at the current time for which the Video switch  is selected. The active camera view is the point of view used for creating final output and nesting compositions. If you have not created a custom camera, then the active camera is the same as the default composition view.

All cameras are listed in the 3D View menu at the bottom of the Composition panel, where you can access them at any time.

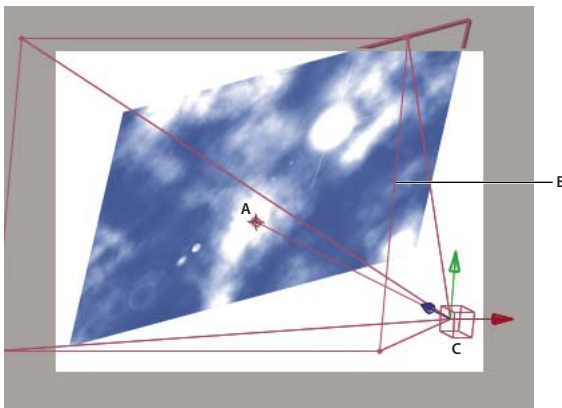

Example of a camera
A. Point of interest B. Frame C. Camera

Note: If you import or open an After Effects 5.x project containing a 3D composition that used a default camera, After Effects adds an AE 5.x Default Camera to the composition.

Dale Bradshaw provides a script and sample project for automating the rigging of a camera on the Creative Workflow Hacks website: www.adobe.com/go/learn_ae_dale3dcamerarigging.

See also

“Working with 3D layers” on page 171

“Auto-Orientation options” on page 146

“Shortcuts for 3D layers” on page 649

“Effects with a Comp Camera attribute” on page 349

“Select a view layout and share view settings” on page 126

Create a camera layer

❖ Choose Layer > New > Camera, or press Ctrl+Alt+Shift+C (Windows) or Command+Option+Shift+C (Mac OS).

Note: By default, new layers begin at the beginning of the composition duration. You can instead choose to have new layers begin at the current time by deselecting the Create Layers At Composition Start Time preference (Edit > Preferences > General (Windows) or After Effects > Preferences > General (Mac OS)).

Change camera settings

You can change camera settings at any time.

❖ Double-click the camera layer in the Timeline panel, or select the layer and then choose Layer > Camera Settings.

Camera settings

You can change camera settings at any time by double-clicking the layer in the Timeline panel or selecting the layer and choosing Layer > Camera Settings.

Name The name of the camera. By default, Camera 1 is the name of first camera that you create in a composition, and all subsequent cameras are numbered in ascending order. You should choose distinctive names for multiple cameras to make it easier to distinguish them.

Preset The type of camera settings you want to use. The presets are named according to focal lengths. Each preset is meant to represent the behavior of a 35mm camera with a lens of a certain focal length. Therefore, the preset also sets the Angle Of View, Zoom, Focus Distance, Focal Length, and Aperture values. The default preset is 50mm. You can also create a custom camera by specifying new values for any of the settings.

Zoom The distance from the lens to the image plane. In other words, a layer that is the Zoom distance away appears at its full size, a layer that is twice the Zoom distance away appears half as tall and wide, and so on.

Angle Of View The width of the scene captured in the image. The Focal Length, Film Size, and Zoom values determine the angle of view. A wider angle of view creates the same result as a wide-angle lens.

Enable Depth Of Field Applies custom variables to the Focus Distance, Aperture, F-Stop, and Blur Level settings. Using these variables, you can manipulate the depth of field to create more realistic camera-focusing effects. (The depth of field is the distance range within which the image is in focus. Images outside the distance range are blurred.)

Focus Distance The distance from the camera to the plane that is in perfect focus.

Lock To Zoom Makes the Focus Distance value match the Zoom value.

Note: If you change the settings of the Zoom or Focus Distance options in the Timeline panel, the Focus Distance value becomes unlocked from the Zoom value. If you need to change the values and want the values to remain locked, then use the Camera Settings dialog box instead of the Timeline panel. Alternatively, you can add an expression to the Focus Distance property in the Timeline panel: Select the Focus Distance property, and choose Animation > Add Expression; then drag the expression pick whip to the Zoom property. (See “Working with expressions” on page 547.)

Aperture The size of the lens opening. The Aperture setting also affects the depth of field—increasing the aperture increases the depth of field blur. When you modify Aperture, the values for F-Stop change to match it.

Note: In a real camera, increasing the aperture also allows in more light, which affects exposure. Like most 3D compositing and animation applications, After Effects ignores this result of the change in aperture values.

F-Stop Represents the ratio of the focal length to aperture. Most cameras specify aperture size using the f-stop measurement; thus, many photographers prefer to set the aperture size in f-stop units. When you modify F-Stop, Aperture changes to match it.

Blur Level The amount of depth-of-field blur in an image. A setting of 100% creates a natural blur as dictated by the camera settings. Lower values reduce the blur.

Film Size The size of the exposed area of film, which is directly related to the composition size. When you modify Film Size, the Zoom value changes to match the perspective of a real camera.

Focal Length The distance from the film plane to the camera lens. In After Effects, the camera's position represents the center of the lens. When you modify Focal Length, the Zoom value changes to match the perspective of a real camera. In addition, the Preset, Angle Of View, and Aperture values change accordingly.

Units The units of measurement in which the camera setting values are expressed.

Measure Film Size The dimensions used to depict the film size.

Create a light and change settings

A *light* layer can affect the colors of the 3D layers that it shines on, depending on the light's settings and the Material Options properties of the 3D layers. Each light, by default, points to its *point of interest*.

Lights can be used to illuminate 3D layers and to cast shadows, either to match lighting conditions of the scene into which you are compositing or to create more interesting visual results such as the appearance of light streaming through a layer as if it were made of stained glass.



Parts of a light

A. Point of interest B. Spotlight cone C. Light

You can animate all of a light's settings, except for Casts Shadows.

You can specify which 3D layers a light affects by designating the light as an adjustment layer—place the light in the Timeline panel above the layers on which you want it to shine. Layers that are above a light adjustment layer in the layer stacking order in the Timeline panel do not receive the light, regardless of the layers' positions in the Composition panel.

See also

“Working with 3D layers” on page 171

“Auto-Orientation options” on page 146

“Create an adjustment layer” on page 136

Create a light

❖ Choose Layer > New > Light, or press Ctrl+Alt+Shift+L (Windows) or Command+Option+Shift+L (Mac OS).

Note: By default, new layers begin at the beginning of the composition duration. You can instead choose to have new layers begin at the current time by deselecting the Create Layers At Composition Start Time preference (Edit > Preferences > General (Windows) or After Effects > Preferences > General (Mac OS)).

Change light settings

❖ Double-click a light layer in the Timeline panel or select the layer and choose Layer > Light Settings.

Light settings

Light Type Parallel emits directional, unconstrained light from an infinitely distant source. Spot emits light from a source that is constrained by a cone, like the spotlight used in stage productions. Point emits unconstrained omnidirectional light, like the rays from a bare light bulb. Ambient creates light that has no source but rather contributes to the overall brightness of a scene and casts no shadows.

Intensity The brightness of the light. Negative values create nonlight. Nonlight subtracts color from a layer. For example, if a layer is already lit, creating a directional light with negative values also pointing at that layer darkens an area on the layer.

Cone Angle The angle of the cone surrounding the source of a light, which determines the width of the beam at a distance. This option is active only if Spot is selected for Light Type.

Cone Feather The edge softness of a spotlight. This option is active only if Spot is selected for Light Type.

Color The color of the light.

Casts Shadows Specifies whether the light source causes a layer to cast a shadow. The Accepts Shadows material option must be On for a layer to receive a shadow; this is the default. The Casts Shadows material option must be On for a layer to cast shadows; this is not the default.



Press Alt+Shift+C (Windows) or Option+Shift+C (Mac OS) to toggle Casts Shadows for selected layers. Press AA to show Material Options properties in the Timeline panel.

Shadow Darkness Sets the darkness level of the shadow. This option is active only if Casts Shadows is selected.

Shadow Diffusion Sets the softness of a shadow based on its apparent distance from the shadowing layer. Larger values create softer shadows. This option is active only if Casts Shadows is selected.

Move a camera, light, or point of interest

Camera layers and light layers each include a Point Of Interest property, which specifies the point in the composition at which the camera or light points. By default, the point of interest is at the center of the composition. You can move the point of interest at any time.





Before moving a camera, choose a view other than Active Camera so that you can see the point of interest icon and the boundaries defining its angle.

1 Select a camera or light layer.

2 (Optional) To set the camera or light to ignore the point of interest, choose Layer > Transform > Auto-Orient and select an option other than Orient Towards Point Of Interest.

3 Using the Selection or Rotation tool, do one of the following:

- To move the camera or light and its point of interest, position the pointer over the axis you want to adjust, and drag.
- To move the camera or light along a single axis without moving the point of interest, Ctrl-drag (Windows) or Command-drag (Mac OS) the axis.
- To move the camera or light freely without moving the point of interest, drag the camera icon  or light icon.
- To move the point of interest, drag the point of interest icon .

Note: As with all properties, you can also modify a camera or light's position, rotation, and orientation properties directly in the Timeline panel.

 When working with a camera or light layer, create a null object and use an expression to link the camera or light's Point Of Interest property to the null layer's Position property. Then, you can animate the Point Of Interest property by moving the null object. It is often easier to select and see a null object than it is to select and see the point of interest.

See also

“Working with 3D layers” on page 171

“Auto-Orientation options” on page 146

Adjust a camera view

Use the camera tools to adjust the camera view. These tools are specifically for manipulating the 3D views and are only available for compositions with 3D layers.

Note: If you adjust one of the fixed views (Front, Left, Top, Back, Right, or Bottom), no property values are affected. You can't use the Orbit Camera tool on the fixed views.

1 In the 3D View menu, choose the camera view you want to adjust.

2 In the Tools panel, select a camera tool:

Orbit Camera  Rotate the current 3D view around the point of interest.

Track XY Camera  Adjust the 3D view horizontally or vertically.

Track Z Camera tool  Adjust the 3D view along the line leading to and from the point of interest or, if you are using an orthogonal view, to adjust the scale of the view.

 Hold down the mouse button on a camera tool to see all of the available tools.

3 Drag in the Composition panel. You can drag outside the panel once you've begun dragging within it.

After you've modified a 3D view, you can reset it by choosing View > Reset 3D View.

See also

“Select a 3D view” on page 127

“Select a view layout and share view settings” on page 126

“Shortcuts for 3D layers” on page 649

Material Options properties

3D layers have Material Options properties, which determine how a 3D layer interacts with light and shadow.

Casts Shadows Specifies whether a layer casts shadows on other layers. The direction and angle of the shadows are determined by the direction and angle of the light sources. Set Casts Shadows to Only if you want the layer to be invisible but still cast a shadow.



Use the Only setting and a non-zero Light Transmission setting to project the colors of an invisible layer onto another layer.

Light Transmission The percentage of light that shines through the layer, casting the layer's color on other layers as a shadow. 0% specifies that no light passes through the layer, casting a black shadow. 100% specifies that the full color value of the shadow-casting layer is projected onto the layer accepting the shadow.



Use partial light transmission to create the appearance of light passing through a stained glass window.

Accepts Shadows Specifies whether the layer shows shadows cast on it by other layers.

Accepts Lights Specifies whether the color of a layer is affected by light that reaches it. This setting does not affect shadows.

Ambient Ambient (nondirectional) reflectivity of the layer. 100% specifies the most reflectivity; 0% specifies no ambient reflectivity.

Diffuse Diffuse (omnidirectional) reflectivity of the layer. Applying diffuse reflectivity to a layer is like draping a dull, plastic sheet over it. Light that falls on this layer reflects equally in all directions. 100% specifies the most reflectivity; 0% specifies no diffuse reflectivity.

Specular Specular (directional) reflectivity of the layer. Specular light reflects from the layer as if from a mirror. 100% specifies the most reflectivity; 0% specifies no specular reflectivity.

Shininess Determines the size of the specular highlight. This value is active only if the Specular setting is greater than zero. 100% specifies a reflection with a small specular highlight. 0% specifies a reflection with a large specular highlight.

Metal The contribution of the layer color to the color of the specular highlight. 100% specifies that the highlight color is the color of the layer. For example, with a Metal value of 100%, an image of a gold ring reflects golden light. 0% specifies that the color of the specular highlight is the color of the light source. For example, a layer with a Metal value of 0% under a white light has a white highlight.

See also

“Working with 3D layers” on page 171

“Create a light and change settings” on page 178

Specify resolution to use for rendering shadows

The Advanced 3D rendering plug-in is used to render compositions containing intersecting 3D layers. To render shadows, the plug-in uses shadow maps, which are images rendered from the point of view of each light source. Normally, a shadow's resolution is computed automatically based on the composition resolution and the layers' quality settings. If normal resolution doesn't create the quality you want, or renders too slowly, you can adjust the shadow map resolution. For example, if shadows are blurry and the Shadow Diffusion material option is set to 0, increase the shadow map resolution. Or, if shadows render too slowly, decrease the shadow map resolution.

When a shadow-casting layer intersects another layer, sometimes there is a small gap behind the intersection that is supposed to be shadowed. To decrease the size of the gap, increase the shadow map resolution.

- 1** Choose Composition > Composition Settings, click the Advanced tab, and click Options.
- 2** Choose a value (in pixels) from the Shadow Map Resolution menu.

Choose Comp Size or a resolution larger than the composition size for best results. Lower resolutions may result in shadows that appear blurry.

Chapter 8: Animation

Animation basics

About animation, keyframes, and expressions

Animation is change over time. You animate a layer or an effect on a layer by changing one or more of its properties over time. For example, you can animate a layer's Opacity property from 0% to 100% to make the layer fade in. Any property with a stopwatch button  to the left of its name in the Timeline panel or Effect Controls panel can be animated.

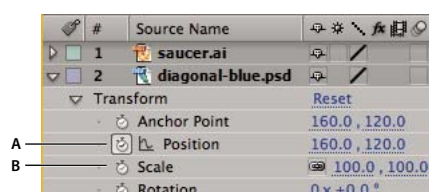

Stopwatch icons

A. Active stopwatch B. Inactive stopwatch

You animate layer properties using keyframes, expressions, or both.

To see a video tutorial on animating using keyframes, visit the Adobe website at www.adobe.com/go/vid0227.

Some tools, such as Motion Sketch and the Puppet tools, automatically set keyframes for you to match motion that you sketch.

Many animation presets include keyframes and expressions so that you can simply apply the animation preset to the layer to achieve a complex animated result.

You work with keyframes and expressions in After Effects in one of two modes: *layer bar mode* or *Graph Editor mode*. Layer bar mode is the default, which shows layers as duration bars, with keyframes and expressions aligned vertically with their properties in the Timeline panel. Graph Editor mode does not show layer bars, and shows keyframes and expression results in value graphs or speed graphs. (See “Work with the Graph Editor” on page 184.)

Keyframes

Keyframes are used to set parameters for motion, effects, audio, and many other properties, usually changing them over time. A keyframe marks the point in time where you specify a value, such as spatial position, opacity, or audio volume. Values between keyframes are *interpolated*. When you use keyframes to create a change over time, you typically use at least two keyframes—one for the state at the beginning of the change, and one for the new state at the end of the change. (See “Set keyframes” on page 187.)

When a keyframe is selected, information regarding its value, speed, and interpolation method are shown in the Info panel. Different information is shown depending on whether the Timeline panel is in Graph Editor mode or layer bar mode. You can also place the pointer over a keyframe in the Graph Editor to see some of this information.



Right-click (Windows) or Control-click (Mac OS) a keyframe to open its context menu. Alt-click (Windows) or Option-click (Mac OS) two keyframes in layer bar mode to display the duration between them in the Info panel.

When the stopwatch is active for a specific property, After Effects automatically sets or changes a keyframe for the property at the current time whenever you change property value. When the stopwatch is inactive for a property, the property has no keyframes. If you change the value for a layer property while the stopwatch is inactive, the value remains in effect for the duration of the layer.

If you deselect the stopwatch, all keyframes for that layer property are deleted, and the constant value for the property becomes the value at the current time. Don't deselect the stopwatch unless you're sure that you want to permanently delete all of the keyframes for that property.



Change the keyframe icons in layer bar mode to numbers by choosing Use Keyframe Indices in the Timeline panel menu.

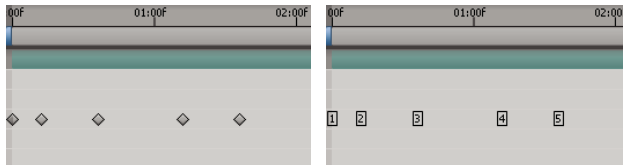

Keyframes as icons compared to keyframes as numbers

Before you make any changes to a keyframe, make sure that the current-time indicator is positioned at an existing keyframe. If you change a property value when the current-time indicator is not at an existing keyframe, After Effects adds a new keyframe. However, if you double-click a keyframe to modify it, the current-time indicator location is not relevant, nor is it relevant when you change a keyframe's interpolation method.

Expressions

Expressions use a scripting language based on JavaScript to specify the values of a property and to relate properties to one another. You can create simple expressions by connecting properties with the pick whip.

See also

“Interpolation” on page 204

“About animation presets” on page 347

“Shortcuts for keyframes” on page 650

Work with the Graph Editor

The Graph Editor represents property values using a two-dimensional graph, with composition time represented horizontally (from left to right). In layer bar mode, on the other hand, the time graph represents only the horizontal time element, without showing a graphical, vertical representation of changing values.



To toggle between layer bar mode and Graph Editor mode, click the Graph Editor button  in the Timeline panel or press Shift+F3.

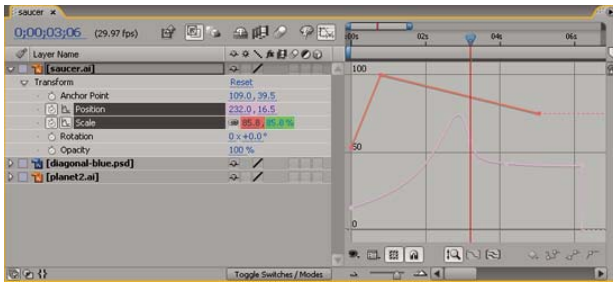

Two animated properties (Position and Scale) shown in the Graph Editor

There are two types of graphs available in the Graph Editor: value graphs, which show property values; and speed graphs, which show rates of change of property values. For temporal properties, such as Opacity, the Graph Editor defaults to the value graph. For spatial properties, After Effects defaults to the speed graph.

In the Graph Editor, each property is represented by its own curve. You can view and work on one property at a time, or you can view multiple properties simultaneously. When more than one property is visible in the Graph Editor, each property's curve has the same color as the property's value in the layer outline.

When you drag a keyframe in the Graph editor with the Snap button  selected, the keyframe snaps to keyframe values, keyframe times, the current time, In and Out points, markers, the beginning and end of the work area, and the beginning and end of the composition. When the keyframe snaps to one of these items, an orange line appears in the Graph Editor to indicate the object you're snapping to. Hold Ctrl (Windows) or Command (Mac OS) after you've begun dragging to temporarily toggle snapping behavior.

Keyframes in Graph Editor mode may have direction handles attached to one or both sides. Direction handles are used to control Bezier interpolation.

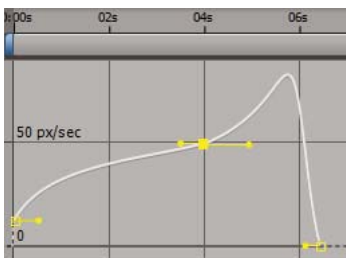

Keyframes in the Graph Editor with direction handles

See also

“Interpolation” on page 204

“About speed graphs” on page 210

Select which properties are shown in the Graph Editor

❖ Click the Show Properties button  at the bottom of the Graph Editor, and select from the following options:

Show Selected Properties Displays selected properties in the Graph Editor.

Show Animated Properties Displays animated properties of selected layers in the Graph Editor.

Show Graph Editor Set Displays properties that have the Graph Editor switch  selected. This switch is next to the stopwatch, to the left of the property name.

Graph Options in the Graph Editor

Click the Graph Options button  at the bottom of the Graph Editor to select from the following options:

Auto-Select Graph Type Automatically selects the appropriate graph type for a property: speed graphs for spatial properties (such as Position), and value graphs for other properties.

Edit Value Graph Displays the value graph for all properties.

Edit Speed Graph Displays the speed graph for all properties.

Show Reference Graph Displays the unselected graph type in the background for viewing only. (The gray numbers to the right of the Graph Editor indicate the values for the reference graph.)

Show Audio Waveforms Displays the audio waveform for any layer that has at least one property in the Graph Editor.

Show Layer In/Out Points Displays In and Out points of all layers that have a property in the Graph Editor.

Show Layer Markers Displays layer-time markers in the Graph Editor, if they exist.

Show Graph Tool Tips Toggles the graph tool tips on and off.

Show Expression Editor Shows or hides the expression editor field.

Allow Keyframes Between Frames Allows placement of keyframes between frames for fine tuning animation.

Pan and zoom in the Graph Editor

- To pan vertically or horizontally, drag with the Hand tool .





To activate the Hand tool momentarily when using another tool, press and hold the spacebar.

- To pan vertically, spin the mouse scroll wheel.
- To pan horizontally, press the Shift key as you spin the mouse scroll wheel.
- To zoom in, click with the Zoom tool.
- To zoom out, Alt-click (Windows) or Option-click (Mac OS) with the Zoom tool.
- To zoom using the mouse scroll wheel, press Alt (Windows) or Option (Mac OS) while scrolling to zoom horizontally; press Ctrl (Windows) or Command (Mac OS) to zoom vertically.
- To zoom horizontally, Alt-drag (Windows) or Option-drag to the left with the Zoom tool to zoom out or to the right to zoom in.
- To zoom vertically, Alt-drag (Windows) or Option-drag up with the Zoom tool to zoom in or down to zoom out.

Note: You cannot pan or zoom vertically when Auto Zoom Height  is selected.

Auto Zoom Height and Fit

Auto Zoom Height  Toggles Auto Zoom Height mode, which automatically scales the height of the graph so that it fits the height of the Graph Editor. The horizontal zoom must still be adjusted manually.

Fit Selection  Adjusts the value (vertical) and time (horizontal) scale of the graph to fit the selected keyframes in the Graph Editor.

Fit All  Adjusts the value (vertical) and time (horizontal) scale of the graph to fit all of the graphs in the Graph Editor.

Setting, selecting, and deleting keyframes

Set keyframes

When the stopwatch is active for a specific property, After Effects automatically adds or changes a keyframe for the property at the current time whenever you change the property value.

- 1 Move the current-time indicator to the time where you want to begin the animation.
- 2 Set the layer property to the value you want at that point in time; for example, move the layer to a new position.
- 3 Do one of the following:
 - Click the Stopwatch icon  next to the property name to activate it. After Effects creates a keyframe at the current time for that property value.
 - Choose Animation > Add [x] Keyframe, where [x] is the name of the property you are animating.
- 4 Move the current-time indicator to the time where you want to add an additional keyframe.
- 5 Change the value for the property in the layer outline.
- 6 Repeat steps 4 and 5 as many times as you want to add more keyframes.

See also



“About animation, keyframes, and expressions” on page 183

“Shortcuts for keyframes” on page 650

“Move the current-time indicator” on page 123

“Shortcuts for showing properties in the Timeline panel” on page 647

Add a keyframe without changing a value

- 1 In the Timeline panel, select the layer that you want to animate.
- 2 Show the layer property for which you want to add a keyframe. The property must already contain at least one keyframe.
- 3 Move the current-time indicator to the point where you want to add a new keyframe. If the current-time indicator is after the last keyframe for that layer property, the new keyframe will have the same value as the preceding keyframe. Otherwise, the new keyframe’s value will be an interpolated value based on the previous and next keyframe values.
- 4 Do one of the following:
 - Click the keyframe navigator button  for the layer property.
 - Choose Animation > Add [x] Keyframe, where [x] is the name of the property you are animating.
 - Click on a segment of the layer property’s graph in the Graph Editor with the Pen tool .

See also

“About animation, keyframes, and expressions” on page 183

“Work with the Graph Editor” on page 184

“Shortcuts for keyframes” on page 650

“Shortcuts for showing properties in the Timeline panel” on page 647

Move the current-time indicator to a keyframe

After you set the initial keyframe for a property, After Effects displays the keyframe navigator, which you can use to move from keyframe to keyframe or to set or remove keyframes. When the keyframe navigator box is filled with a yellow diamond ◀ ◆ ▶, the current-time indicator lies precisely at a keyframe for that layer property. When the keyframe navigator box is not filled ◀ ◆ ▶, the current-time indicator lies between keyframes.

 To detach the keyframe navigator from the A/V Features column to function as its own column, choose *Column > Keys* from the Timeline panel menu.

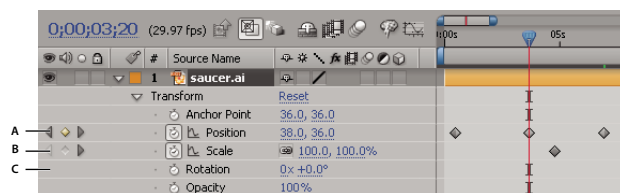

Keyframe navigator in Timeline panel

A. Keyframe at current time B. No keyframe at current time C. No keyframes for layer property

- To move to the next or previous keyframe, click a keyframe navigator arrow.
- To snap to a keyframe or marker, Shift-drag the current-time indicator.
- To move to the next or previous visible item in the time ruler (keyframe, marker, or work area end), press K or J.

See also

“About animation, keyframes, and expressions” on page 183

“Work with the Graph Editor” on page 184

Select keyframes

In layer bar mode, selected keyframes are yellow. Unselected keyframes are gray.

In Graph Editor mode, the appearance of a keyframe icon depends on whether the keyframe is selected, unselected, or semi-selected (another keyframe in the same property is selected). Selected keyframes are solid yellow. Unselected keyframes retain the color of their corresponding graph. Semi-selected keyframes are represented by a hollow yellow box.

- To select a keyframe, click the keyframe icon.
- To select multiple keyframes, Shift-click the keyframes or drag a marquee around the keyframes.

Note: To toggle viewing of the free-transform bounding box in the Graph Editor, click the Show Transform Box button  at the bottom of the Graph Editor.

- To select all keyframes for a layer property, Alt-click (Windows) or Option-click (Mac OS) a segment between two keyframes in the Graph Editor, or click the layer property name in the layer outline.
- To select all keyframes for a property that have the same value, right-click (Windows) or Control-click (Mac OS) a keyframe, and choose Select Equal Keyframes.

- To select all keyframes that follow or precede a selected keyframe, right-click (Windows) or Control-click (Mac OS) a keyframe, and choose Select Previous Keyframes or Select Following Keyframes.

Note: The Select Previous/Following Keyframes commands aren't available if more than one keyframe is selected.

See also

"About animation, keyframes, and expressions" on page 183

"Work with the Graph Editor" on page 184

"Shortcuts for keyframes" on page 650

"Shortcuts for showing properties in the Timeline panel" on page 647

Keyframe menu commands

When you select one or more keyframes, the keyframe menu  becomes available at the bottom of the Graph Editor.



To open the keyframe menu, right-click (Windows) or Control-click (Mac OS) a keyframe.

[Value] Displays the value of the selected keyframe. If more than one keyframe is selected, the Display Value command is available, which displays the value of the highlighted keyframe in the selection.

Edit Value Opens a dialog box in which you can edit the value of the keyframe.

Select Equal Keyframes Selects all keyframes in a property that have the same value.

Select Previous Keyframes Selects all keyframes preceding the currently selected keyframe.

Select Following Keyframes Selects all keyframes following the currently selected keyframe.

Toggle Hold Keyframe Holds the property value at the value of the current keyframe until the next keyframe is reached.

Keyframe Interpolation Opens the Keyframe Interpolation dialog box.

Rove Across Time Toggles Rove Across Time for spatial properties.

Keyframe Velocity Opens the Keyframe Velocity dialog box.

Keyframe Assistant Opens a submenu with the following options:

- **Convert Audio To Keyframes** Analyzes amplitude within the composition work area and creates keyframes to represent the audio.
- **Convert Expression To Keyframes** Analyzes the current expression and creates keyframes to represent the property values it describes.
- **Easy Ease** Automatically adjusts the influence into and out of a keyframe to smooth out sudden changes.
- **Easy Ease In** Automatically adjusts the influence into a keyframe.
- **Easy Ease Out** Automatically adjusts the influence out of a keyframe.
- **Exponential Scale** Converts the rate of change in scale from linear to exponential.
- **RPF Camera Import** Imports RPF camera data from third-party 3D modeling applications.
- **Sequence Layers** Opens the Sequence Layers assistant.

- **Time-Reverse Keyframes** Reverses selected keyframes in time.

See also

“Interpolation” on page 204

Delete or disable keyframes

- To delete any number of keyframes, select them, and then press the Delete key.
- To delete one keyframe in the Graph Editor, Ctrl-click (Windows) or Command-click (Mac OS) a keyframe with the Selection tool.
- To delete all keyframes for one layer property, click the stopwatch button  to the left of the name of the layer property to deactivate it.

When you click the stopwatch button to deactivate it, keyframes for that property are permanently removed and the value of that property becomes the value at the current time. You cannot restore deleted keyframes by clicking the stopwatch button again. Deleting all keyframes does not delete or disable expressions.

- To temporarily disable keyframes for a property, add an expression that sets the property to a constant value. For example, you can add this very simple expression to the Opacity property to set it to 100%: `100`.

 *Click the Enable Expression button to toggle the expression on and off, which toggles the keyframes off and on as a side effect.*

If you accidentally delete keyframes, choose Edit > Undo.

See also

“About animation, keyframes, and expressions” on page 183

“Work with the Graph Editor” on page 184

“Shortcuts for keyframes” on page 650

“Shortcuts for showing properties in the Timeline panel” on page 647

Editing, moving, and copying keyframes

Edit a keyframe in the Graph Editor

A value graph in the Graph Editor displays the values for each keyframe and the interpolated values between keyframes. When the value graph of a layer property is level, the value of the property is unchanged between keyframes. When the value graph goes up or down, the value of a layer property increases or decreases between keyframes.

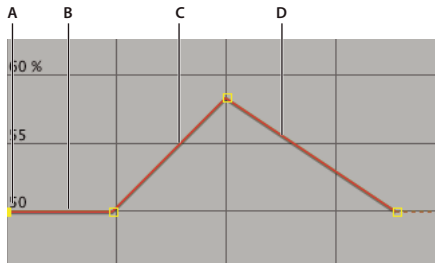

Value graph

A. Keyframe. B. A level value graph indicates unchanging values. C. A rising graph indicates increasing values. D. A falling graph indicates decreasing values.

You can change layer property values by moving the points (keyframes) on the value graph up or down. For example, you can increase a Rotation keyframe's value by dragging a keyframe marker on the Rotation property's value graph higher up on the graph.

Note: Values for the Anchor Point, Mask Path, effect control points, 3D Orientation, and Position properties are spatial, so they use speed graphs by default instead of value graphs.

- 1 In the Timeline panel, display a temporal property for a layer.
- 2 If necessary, click the Graph Editor button or press Shift+F3 to enter Graph Editor mode.
- 3 If necessary, add a keyframe at the point in time you want the change to occur.
- 4 Drag the keyframe up or down to set a new value for the layer property.

See also

"Work with layer properties in the Timeline panel" on page 152

"Work with the Graph Editor" on page 184

View or edit a keyframe value

- Move the current-time indicator to the time of the keyframe. The value of the property appears next to the property name, where you can edit it.
- In layer bar mode, right-click (Windows) or Control-click (Mac OS) the keyframe. The keyframe value appears at the top of the context menu that appears. Choose Edit Value to edit the value, if desired.

See also

"Keyframe menu commands" on page 189

"Work with layer properties in the Timeline panel" on page 152

Copy and paste keyframes

You can copy keyframes from only one layer at a time. When you paste keyframes into another layer, they appear in the corresponding property in the destination layer. The earliest keyframe appears at the current time, and the other keyframes follow in relative order. The keyframes remain selected after pasting, so you can immediately move them in the destination layer.

You can copy keyframes between layers for the same property (such as Position) or between different properties that use the same type of data.

Note: When copying and pasting between the same properties, you can copy from more than one property to more than one property at a time. However, when copying and pasting to different properties, you can copy only from one property to one property at a time.

- 1 In the Timeline panel, display the layer property containing the keyframes you want to copy.
- 2 Select one or more keyframes.
- 3 Choose Edit > Copy.
- 4 In the Timeline panel containing the destination layer, move the current-time indicator to the point in time where you want the keyframes to appear.
- 5 Do one of the following:
 - To paste to the same property of the copied keyframes, select the destination layer.
 - To paste to a different property, select the destination property.
- 6 Choose Edit > Paste.

See also

“Work with layer properties in the Timeline panel” on page 152

“About animation, keyframes, and expressions” on page 183

“Shortcuts for keyframes” on page 650

“Shortcuts for showing properties in the Timeline panel” on page 647

Edit keyframe values using a spreadsheet

You can copy and paste keyframe data as tab-delimited text for use in a spreadsheet (such as Microsoft Excel) or other text-editing program. This allows you to take advantage of the powerful features of spreadsheet programs, either for numerical analysis of keyframe data or for the creation or editing of keyframe values.

You can copy and paste most properties, including the Transform properties (such as Position and Opacity), Material Options properties, and motion trackers.



You can use the motion tracking tools to track the motion of an object in a layer, and then paste the tracker data into a spreadsheet to perform numerical analysis on the data.

You can copy keyframes from only one layer at a time as tab-delimited text.

- 1 In the Timeline panel, select keyframes for one or more properties on the same layer. To select all keyframes for a property, click the property's name.
- 2 Move the current-time indicator to the first selected keyframe. Write down the time of this keyframe. (When you paste the edited data back in, you will need to paste it at this time.)
- 3 Choose Edit > Copy.
- 4 Paste keyframe data into the spreadsheet. Assuming that the first column in the spreadsheet is labeled A and the first row is labeled 1, you should paste into cell A1. Frame numbers appear in column B. Property values appear in columns C, D, and E, depending on the dimensions of the property. (Position in a 3D layer has values in all three columns; Opacity has only a value in column C.)
- 5 Edit the numerical information for the keyframes. Do not change any text other than frame numbers and property values.

- 6 Select the cells that contain your data. The top-left cell in your selection should be A1. The bottom row of your selection should be the row that contains the text *End of Keyframe Data*.
- 7 Copy the data from the spreadsheet.
- 8 In After Effects, move the current-time indicator to the time at which you want to paste the new keyframe data. This will usually be the time of the first keyframe that you selected and copied at the beginning of this procedure.
- 9 Choose Edit > Paste.

See also

“Work with layer properties in the Timeline panel” on page 152

“About animation, keyframes, and expressions” on page 183

Move keyframes in to another time

With multiple keyframes selected, you can copy or delete them simultaneously or move the keyframes together without changing their positions relative to each other.

- 1 Select one or more keyframes.
- 2 Drag any of the selected keyframe icons to the desired time. If you selected multiple keyframes, then all of the selected keyframes maintain their relative distance from the keyframe that you drag.

See also

“Select keyframes” on page 188

“About animation, keyframes, and expressions” on page 183

“Shortcuts for keyframes” on page 650

“Shortcuts for showing properties in the Timeline panel” on page 647

Move a keyframe to a specific time

- 1 Move the current-time indicator to the desired time.
- 2 Do one of the following:
 - In layer bar mode, hold down Shift after you begin to drag a keyframe icon to the current-time indicator.
 - In Graph Editor mode, drag a keyframe to the current-time indicator.

When you drag over the current-time indicator, the keyframe snaps to the current-time indicator.

See also

“About animation, keyframes, and expressions” on page 183

“Work with the Graph Editor” on page 184

“Shortcuts for keyframes” on page 650

“Shortcuts for showing properties in the Timeline panel” on page 647

Expand or contract a group of keyframes in layer bar mode

- 1 Select at least three keyframes.
- 2 Hold down Alt (Windows) or Option (Mac OS) and drag the first or last selected keyframe to the desired time.

See also

“Select keyframes” on page 188

“About animation, keyframes, and expressions” on page 183

“Shortcuts for keyframes” on page 650

“Shortcuts for showing properties in the Timeline panel” on page 647

Move a layer duration bar but not its keyframes

- 1 Make a note of the time at which the first keyframe appears.
- 2 In the layer outline, click the name of one or more layer properties containing the keyframes you want to keep at the same times.
- 3 Choose Edit > Cut.
- 4 Move or stretch the layer duration bar to its new In and Out points.
- 5 Move the current-time indicator to the time at which the first keyframe appeared before you cut the keyframes.
- 6 Choose Edit > Paste.

See also

“Shortcuts for keyframes” on page 650

“Shortcuts for showing properties in the Timeline panel” on page 647

Copy a value from a layer property that contains no keyframes

You can copy the current value of a layer property to another layer, even when the original layer contains no keyframes. This can save you the time of having to set up a property the same way on various layers.

- 1 In the Timeline panel, display the layer property containing the value you want to copy.
- 2 Click the name of the layer property to select it.

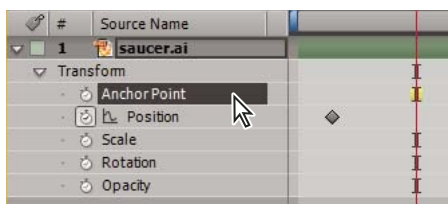

Anchor Point property selected

- 3 Choose Edit > Copy.
- 4 Select the layer into which you want to paste the value.

- 5 If the target layer contains keyframes, move the current-time indicator to the time where you want to paste the value. If the target layer does not contain keyframes, the new value applies to the entire duration of the layer.
- 6 Choose Edit > Paste.

See also

“Shortcuts for keyframes” on page 650

“Shortcuts for showing properties in the Timeline panel” on page 647

Change multiple keyframe values at once

You can change the values of multiple keyframes on multiple layers at one time; however, all keyframes you select must belong to the same layer property. The way the values change depends on the method you use to make the change:

- If you change a value numerically, all selected keyframes use the new value exactly. In other words, you make an *absolute* change. For example, if you select several Position keyframes on a motion path and numerically specify a Position value for one of them, all selected keyframes change to the same position value.
- If you change a value by dragging the underlined value, all selected keyframes change by the same amount. In other words, you make a *relative* change. For example, if you select several Position keyframes on a motion path and drag the underlined value for one of them, all selected keyframe values change by the same amount.
- If you change a value graphically in the Composition or Layer panel, all selected keyframes change using the difference between the old and new values, not the values themselves. In other words, you make a relative change. For example, if you select several Position keyframes on a motion path and then drag one of them 10 pixels to the left, they all move 10 pixels to the left of their original positions.

You can also change the value of several layers at once in layer bar mode by *parenting* them.

- 1 Select the keyframes you want to change. All keyframes you select must be on the same property.
- 2 Change the value of any selected keyframe by one of the methods above. All other selected keyframes change accordingly.

See also

“Work with parent and child layers” on page 158

“About animation, keyframes, and expressions” on page 183

“Shortcuts for keyframes” on page 650

“Shortcuts for showing properties in the Timeline panel” on page 647

Edit multiple keyframes in the Graph Editor

You can edit and move multiple keyframes simultaneously using the Graph Editor. When you select multiple keyframes with the Show Transform Box button toggled, a free-transform bounding box surrounds the selected keyframes, and an anchor point appears in the center of the bounding box to mark the center point for the transformation. You can move the selected keyframes in time or value by dragging the bounding box or its handles. You can also change the position of the anchor point.

Adjusting a free-transform bounding box in a value graph moves the selected keyframes in time and value. Adjusting a free-transform bounding box in a speed graph moves the selected keyframes in time only.

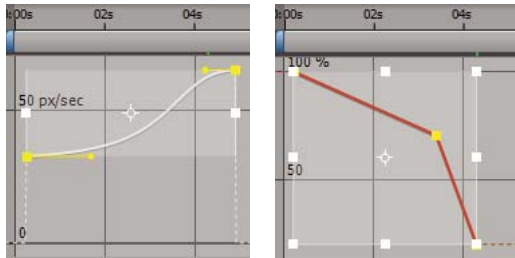

When you select multiple keyframes in the Graph Editor, a free-transform bounding box appears.

- 1 Switch to the Graph Editor view and display the keyframes you want to adjust.
- 2 Using the Selection tool, do one of the following:
 - To select keyframes, Shift-click the keyframes or drag to draw a marquee around the keyframes.
 - To select all keyframes for a property, Alt-click (Windows) or Option-click (Mac OS) a segment between two keyframes.
- 3 Do any of the following:
 - To move keyframes in time or value, position the pointer inside the bounding box and drag. Shift-drag to constrain the move horizontally or vertically.
 - To move keyframes in time or value by scaling the bounding box, position the pointer on a bounding box handle. When the pointer changes to a straight, double-sided arrow \leftrightarrow , drag the bounding box to a new size. Shift-drag to constrain the ratio of width to height. Ctrl-drag (Windows) or Command-drag (Mac OS) to scale around the bounding box's anchor point. When dragging a corner handle, Alt-drag (Windows) or Option-drag (Mac OS) to move only that handle.



Scale by negative amounts to reverse the keyframes in time.

- To taper keyframe values vertically, Ctrl+Alt-drag (Windows) or Command+Option-drag (Mac OS). Tapering keyframe values allows you to reduce or expand the amplitude of a repeated animation.
- To move one side of the bounding box up or down, Ctrl+Alt+Shift-drag (Windows) or Command+Option+Shift-drag (Mac OS).
- To move the bounding box's anchor point, position the Selection tool over the anchor point until the tool changes to the Move Anchor Point tool , and then drag to position the anchor point.

See also

“Work with the Graph Editor” on page 184

“About animation, keyframes, and expressions” on page 183

Creating and modifying motion paths

Work with motion paths

When you animate spatial properties—including Position and Anchor Point properties, as well as effect control point properties—the motion is shown as a motion path. Position motion paths appear in the Composition panel; Anchor Point and effect control point motion paths appear in the Layer panel. A motion path appears as a sequence of dots, where each dot marks the position of the layer at each frame. A box in the path marks the position of a keyframe.

Note: The density of dots between the boxes in a motion path indicates the layer's relative speed. Dots close together indicate a lower speed; dots farther apart indicate a greater speed.

Motion paths are simply an alternative visual, spatial way of viewing and working with spatial properties and their keyframes, in addition to the ways that you work with properties in the Timeline panel. You can modify a motion path by changing an existing keyframe or adding a new keyframe. You can modify a motion path's shape by changing the spatial interpolation methods for its keyframes.

Note: Right-click (Windows) or Command-click (Mac OS) a keyframe to open its context menu.

Using the Pen tool or Selection tool to edit keyframes for a spatial property in the Composition or Layer panel is similar to modifying a Bezier path for a mask or for a shape on a shape layer. (See “About paths” on page 313.)

A motion path is less complex and generally easier to modify when you use fewer keyframes to describe the path. You can use The Smoother to remove extraneous keyframes from a motion path.

Jonas Hummelstrand and Dan Ebberts provide an animation preset and instructions for scaling and rotating a motion path: www.adobe.com/go/learn_ae_jonasscalemotionpath.

See also

“Work with layer properties in the Timeline panel” on page 152

“About animation, keyframes, and expressions” on page 183

“Modify a Bezier mask path or shape path” on page 323

Show motion path controls

- To show motion path controls in the Composition panel, choose Composition > View Options, and select Effect Controls, Keyframes, Motion Paths, and Motion Handles. To see a Position motion path in the Composition panel, the Position property must be selected.
- To show motion path controls in the Layer panel, choose the property or effect from the View menu at the bottom of the Layer panel.
- To specify how many keyframes to show for a motion path, choose Edit > Preferences > Display (Windows) or After Effects > Preferences > Display (Mac OS), and select an option in the Motion Path section.

Move motion path keyframes

- 1 In the Timeline panel, select the layer for which to modify the motion path.
- 2 If you cannot see the keyframe you want to modify in the Composition panel or Layer panel, move the current-time indicator to the keyframe.
- 3 In the Composition panel or Layer panel, use the Selection tool to drag a keyframe or its handles.

Note: The current-time indicator does not need to be located on a keyframe before you drag it.

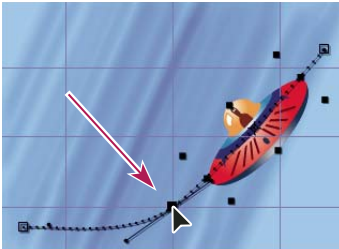
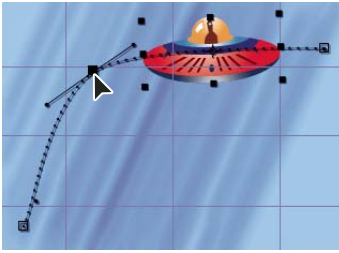

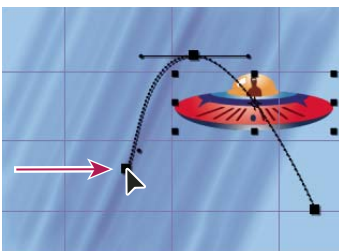
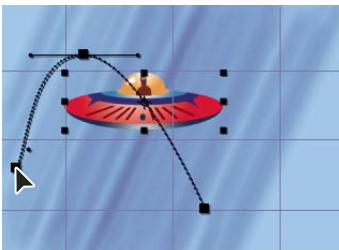

Drag a keyframe in the Composition panel to move one Position keyframe.

You can move multiple keyframes at one time by selecting them in the Timeline panel before you drag them in the Composition panel or Layer panel. To move the entire motion path, select all keyframes by clicking the property name in the Timeline panel before dragging a keyframe in the Composition panel.



Dragging all keyframes on a motion path by one keyframe

Add a keyframe to a motion path using the Pen tool

- 1 Display the motion path that you want to modify in the Composition panel or Layer panel.
- 2 Select the Pen tool  or Add Vertex tool  from the Tools panel.
- 3 In the Composition panel, move the Pen tool over the motion path where you want to add the new keyframe and click to add the keyframe.

A new keyframe appears at the frame you clicked, on the motion path and in the Timeline panel. To move the keyframe, use the Selection tool.

Note: Though the results are different, the tools for manipulating motion-path curves with the Pen tool work in much the same way as those used to create and modify other Bezier paths, such as mask and shape paths.

Sketch a motion path with Motion Sketch

You can draw a path for the motion of a selected layer using Motion Sketch, which records the position of the layer and the speed at which you draw. As you draw, a Position keyframe is generated at each frame.

Motion Sketch does not affect keyframes that you have set for other properties. For example, if you set Rotation keyframes for an image of a ball, you can use Motion Sketch to generate Position keyframes, so that the ball appears to roll along the path you created.

- 1 In the Composition or Timeline panel, select the layer for which you want to sketch a motion path.
- 2 In the Timeline panel, set the work-area markers to the duration in which you want to sketch motion.
- 3 Choose Window > Motion Sketch.
- 4 Select the appropriate Motion Sketch options:

Show Wireframe Displays a wireframe view of the layer as you sketch the motion path.

Show Background Displays the static contents of the frame at which you started sketching in the Composition panel while you sketch. This is useful if you want to sketch motion relative to other images in your composition.

Smoothing Eliminates unnecessary keyframes from the motion path. This setting has the same result as using the Tolerance setting with The Smoother. Higher values produce smoother curves, but too high a value may not preserve the shape of the curve that you draw.

Note: You can smooth a motion path after it has been created by using the `smooth` expression or The Smoother.

Capture Speed At The ratio of the speed of the recorded motion to playback speed. If Capture Speed At is 100%, the motion is played back at the speed at which it was recorded. If Capture Speed At is greater than 100%, the motion plays back slower than it was recorded.

- 5 Click Start Capture and then drag in the Composition panel to create the motion path. Release the mouse button to stop capturing.

Note: After Effects automatically ends capturing when the capture time reaches the end of the work area (which, by default, is the composition duration).

See also

“Set the work area” on page 112

“About animation, keyframes, and expressions” on page 183

Create a motion path from a mask, shape, or paint path

You can create a motion path from any of several types of paths:

- A Mask Path property
- A shape's Path property on a shape layer
- A Path property for a paint stroke

- A path copied from Illustrator or Photoshop

You can paste any of these paths into the Position or Anchor Point property for a layer, or into an effect control point's position property. The pasted keyframes are set to rove in time, except for the first and last ones, to create a constant velocity along the path.

By default, the duration of the pasted motion path is 2 seconds. You can adjust the duration by dragging the first or last keyframe in the Timeline panel.

1 Copy a path to the clipboard:

- Select a Path property in the Timeline panel, and choose Edit > Copy.
- Select a path in Illustrator or Photoshop, and choose Edit > Copy.

2 In the Timeline panel, select the property into which to paste the path. The property must be animated—that is, it must have at least one keyframe or an expression.

3 Place the current-time indicator at the time for the first keyframe of the motion path.

4 Choose Edit > Paste.

See also

“Copy a path from Illustrator, Photoshop, or Fireworks” on page 324

“About paths” on page 313

Assorted animation tools

Use motion blur

When you view one frame of motion-picture film or video containing a moving object, the image is often blurred, because a frame represents a sample of time (in film, a frame is 1/24 of a second long). In that time, a moving object occupies more than one position as it travels across the frame, so it doesn't appear as a sharp, still object. The faster the object moves, the more it is blurred. The camera shutter angle and shutter phase also affect the appearance of the blur, determining how long the shutter stays open and when the shutter opens relative to the beginning of the frame.

In contrast, in a single frame of a computer-generated animation, you may not be able to tell which objects are moving because all moving objects may appear as sharp and clear as nonmoving objects. Without motion blur, layer animation produces a strobe-like effect of distinct steps instead of an appearance of continuous change. Adding motion blur to layers you animate in After Effects makes motion appear smoother and more natural.

You enable motion blur for each layer individually, and you also determine whether the motion blur is rendered for previews and final rendering. Use the Enable Motion Blur composition switch  at the top of the Timeline panel to enable or disable motion blur rendering for previews. Modify the render settings in the Render Queue panel to enable or disable motion blur rendering for final output.

Motion blur slows rendering, so you may want to disable the composition switch while working, and only enable it when you need to see the finished result.

You can use motion blur when you animate a layer—for example, moving a layer of text across the screen. You cannot add motion blur to motion that already exists within a layer, such as live-action video, by means of the Motion Blur layer switch and Enable Motion Blur composition switch. You can add motion blur to motion within a layer by using an effect. The CC Force Motion blur effect, which is included in the full version of After Effects, analyzes motion from frame to frame within a layer and uses this information to add motion blur to motion within the layer. The ReelSmart Motion Blur effect from RE:Vision Effects performs a similar function: www.adobe.com/go/learn_ae_reelsmartmotionblur.

If you want to smooth live-action video to which you assigned a frame rate much lower or higher than the original, use frame blending.

Note: Previous versions of After Effects included an effect called Motion Blur. That effect is now named Directional Blur, to avoid confusion with motion blur applied to layers.

- Click the Motion Blur  layer switch for the layer in the Timeline panel.
- Select the layer and choose Layer > Switches > Motion Blur.

The number of samples that After Effects uses to calculate motion blur adapts for each layer, depending on the motion of that layer. This provides high-quality motion blur without unnecessarily sampling the motion of a slow-moving layer as frequently as that of a fast-moving layer. High sampling rates decrease rendering performance.

See also

“Apply frame blending to a layer” on page 225

“Apply motion blur to a mask” on page 267

“Work with render settings” on page 597

“About effects” on page 348

Motion blur settings in the Advanced tab of Composition Settings

Samples Per Frame The minimum number of samples. This is the number of samples used for frames for which After Effects is not able to determine an adaptive sampling rate based on layer motion. This sample rate is used for 3D layers and shape layers.

Adaptive Sample Limit The maximum number of samples.

Shutter Angle The shutter angle is measured in degrees, simulating the exposure allowed by a rotating shutter. The shutter angle uses the footage frame rate to determine the simulated exposure, which affects the amount of motion blur. For example, entering 90° (25% of 360°) for 24-fps footage creates an effective exposure of 1/96 of a second (25% of 1/24 of a second). Entering 1° applies almost no motion blur, and entering 720° applies a large amount of blur.

Shutter Phase The shutter phase is also measured in degrees. It defines an offset that determines when the shutter opens relative to the beginning of a frame. Adjusting this value can help if an object with motion blur applied appears to lag behind the position of the object without motion blur applied.

 A Shutter Phase value that is -1/2 of the Shutter Angle value is best for a layer that is composited on top of another using motion tracking data. (For example, Shutter Phase = -90, Shutter Angle = 180.) This setting combination causes a blur that is centered on the original object.

Smooth motion and velocity

Smooth motion paths, value curves, and velocity curves to eliminate bumpiness or excess keyframes using The Smoother, which adds keyframes or removes unnecessary keyframes. You can also use the `smooth` expression to accomplish this.

Although you can smooth a curve for any property, The Smoother is most useful when applied to curves that have been automatically generated by Motion Sketch, where you may have excess keyframes. Applying The Smoother to keyframes that have been set manually may result in unexpected changes to the curve.

***Note:** To avoid the need to use The Smoother on a path generated by Motion Sketch, set the Smoothing option in the Motion Sketch panel before sketching the motion path.*

When you apply The Smoother to properties that change spatially (such as Position), you can smooth only the spatial curve (the curve defined by the motion). When you apply The Smoother to properties that change only in time (such as Opacity), you can smooth only the value and velocity curves (the curve defined by the value or the velocity).

In addition to adding keyframes or eliminating unnecessary keyframes, The Smoother also applies Bezier interpolation at each keyframe when smoothing the temporal curve.

- 1** In the Timeline panel, either select all the keyframes for a property to smooth the entire curve, or select at least three keyframes to smooth only a portion of a curve.
- 2** Choose Window > The Smoother. In the Apply To menu, The Smoother automatically selects Spatial Path or Temporal Graph, depending on the type of property for which you selected keyframes in step 1.
- 3** Set a value for Tolerance. The units of Tolerance match those of the property you are smoothing. New keyframe values will vary no more than the specified value from the original curve. Higher values produce smoother curves, but too high a value may not preserve the original shape of the curve.
- 4** Click Apply and preview the results.
- 5** If necessary, choose Edit > Undo The Smoother to reset the keyframes, adjust the value for Tolerance, and then reapply The Smoother.

See also

“Sketch a motion path with Motion Sketch” on page 199

“Select keyframes” on page 188

Add randomness to a property with The Wiggler

You can add randomness to any property as it varies over time by using The Wiggler. You can also use the `wiggle` expression to accomplish this. In most cases, it is easier to use the expression than to use The Wiggler. (See “Property attributes and methods” on page 576.)

Depending on the property and the options you specify, The Wiggler adds a certain number of deviations to a property by adding keyframes and randomizing interpolations coming into or out of existing keyframes. You need at least two keyframes to use The Wiggler.

Using The Wiggler, you can more closely simulate natural movement within specified limits. For example, add randomness to an animated butterfly to produce fluttering. Add it to brightness or opacity to simulate the flicker of an old projector.

- 1** Select a range of keyframes for the property.
- 2** Choose Window > The Wiggler.

3 For Apply To, select the type of curve you want The Wiggler to change. If you selected keyframes for a property that varies spatially, you can select Spatial Path to add deviations to the motion, or Temporal Graph to add deviations to the velocity. If you selected keyframes for a property that does not vary spatially, you can select only Temporal Graph.

4 Select a Noise Type option to specify the type of deviation due to randomly distributed pixel values (noise):

Smooth Noise Produces deviations that occur more gradually, without sudden changes.

Jagged Noise Produces sudden changes.

5 Select the dimensions of the property you want to affect:

One Dimension Adds deviations to only one dimension of the selected property. Choose the dimension from the menu.

All Dimensions Independently adds a different set of deviations to each dimension.

All Dimensions The Same Adds the same set of deviations to all dimensions.

6 Set Frequency to specify how many deviations (keyframes) per second After Effects adds to the selected keyframes. A low value produces only occasional deviations, while a high value produces more erratic results. A value between 0 and 1 creates keyframes at intervals of less than one per second. For example, a value of 0.5 creates one keyframe every 2 seconds.

7 Set Magnitude to specify the maximum size of the deviations. After Effects sets the specified magnitude to the units of the selected property, so a value for one property may produce very different results in another property.

8 Click Apply and preview the results.

9 If necessary, choose Edit > Undo The Wiggler to reset the keyframes, adjust the values for Frequency and Magnitude, and then reapply The Wiggler.

See also

“Select keyframes” on page 188

Convert audio to keyframes

The Convert Audio To Keyframes keyframe assistant analyzes audio amplitude within the work area and creates keyframes for audio amplitude.

❖ Select the Timeline panel, and then choose Animation > Keyframe Assistant > Convert Audio To Keyframes.

This keyframe assistant creates a new Audio Amplitude layer representing all audio sources in the composition, with three Expression Controls effects with Slider properties that contain the keyframes: Left Channel, Right Channel, and Both Channels.

To make use of the keyframes created by this keyframe assistant, you must link the changes in audio amplitude to other layer properties. For example, use an expression to link the audio keyframes to the Scale property of a layer to make the layer grow and shrink as the amplitude increases and decreases.

Aharon Rabinowitz provides a video tutorial that shows how to link the audio amplitude keyframes to other properties, in this case the properties of the Wave Warp effect, to synchronize animation with sound:

www.adobe.com/go/learn_ae_aharonwaveform.

The Trapcode Sound Keys effect also converts audio values to keyframes, but provides more control than the built-in Convert Audio To Keyframes keyframe assistant: www.adobe.com/go/learn_ae_trapcodesoundkeys.

See also

“Set the work area” on page 112

Interpolation

Controlling change with interpolation

After you create keyframes and motion paths to change values over time, you may want to make more precise adjustments to the way that change occurs. After Effects provides several interpolation methods that affect how change occurs through and between keyframes. For example, if you are setting up motion, you can choose to make a layer change direction abruptly or smoothly through a curve. After Effects interpolates values for a change using the values of the keyframes on both ends of the change.

Interpolation is the process of filling in the unknown data between two known values. This usually means generating new values between two keyframes. For example, if you want a graphic element (such as a title) to move fifty pixels across the screen to the left, and you want it to do so in 15 frames, you'd set the position of the graphic in the first and 15th frames, and mark them both as keyframes. Then the software would complete the work of interpolating the frames in between to make the movement appear smooth. Because interpolation generates all the frames *between* the two keyframes, interpolation is sometimes called *tweening*. Interpolation between keyframes can be used to animate movement, effects, audio levels, image adjustments, transparency, color changes, and many other visual and audio elements.

You can control interpolation between keyframe values over time for all layer properties. For *spatial* properties—which are layer properties that involve movement, such as Position, Anchor Point, and effect point properties—you can also control interpolation between motion-path keyframes through space.

Temporal interpolation and the value graph

Using the value graph in the Graph Editor, you can make precise adjustments to the temporal property keyframes you've created for your animation. The value graph displays x values as red, y values as green, and z values (3D only) as blue. The value graph provides complete information about the value of keyframes at any point in time in a composition and allows you to control it. In addition, the Info panel displays the temporal interpolation method of a selected keyframe.

Spatial interpolation and the motion path

When you apply or change spatial interpolation for a property such as Position, you adjust the motion path in the Composition panel. The different keyframes on the motion path provide information about the type of interpolation at any point in time. The Info panel displays the spatial interpolation method of a selected keyframe.

When you create spatial changes in a layer, After Effects uses Auto Bezier as the default spatial interpolation.



To change the default to linear interpolation, choose *Edit > Preferences > General (Windows)* or *After Effects > Preferences > General (Mac OS)*, and select *Default Spatial Interpolation To Linear*.

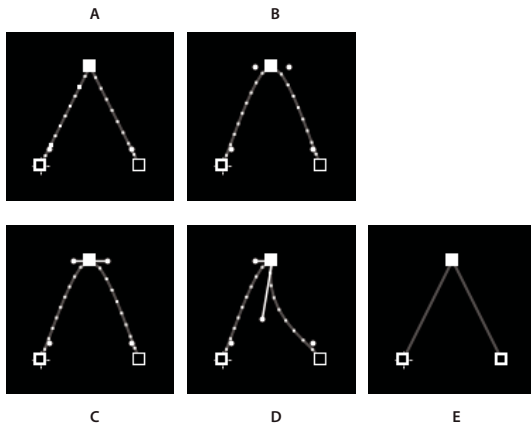

Motion path interpolation
A. Linear B. Auto Bezier C. Continuous Bezier D. Bezier E. Hold

Note: In some cases, the Auto Bezier spatial interpolation for Position keyframes can cause undesired back-and-forth (boomerang) motion between two keyframes with equal values. In such a case, you can change the earlier keyframe to use Hold interpolation or change both keyframes to use Linear interpolation.

See also

- “About changes in speed” on page 210
- “Work with the Graph Editor” on page 184
- “Shortcuts for keyframes” on page 650
- “Shortcuts for showing properties in the Timeline panel” on page 647

Keyframe interpolation methods

In layer bar mode, the appearance of a keyframe icon depends on the interpolation method you choose for the interval between keyframes. When half of the icon is dark gray , the dark half indicates that there is no keyframe adjacent to that side, or that its interpolation is overridden by the Hold interpolation applied to the preceding keyframe.

By default, a keyframe uses one interpolation method, but you can apply two methods: the *incoming* method applies to the property value as the current time approaches a keyframe, and the *outgoing* method applies to the property value as the current time leaves a keyframe. When you set different incoming and outgoing interpolation methods, the keyframe icon in layer bar mode changes accordingly. It displays the left half of the incoming interpolation icon and the right half of the outgoing interpolation icon.

 To toggle between keyframe icons and keyframe numbers, select *Use Keyframe Icons* or *Use Keyframe Indices* from the Timeline panel menu.

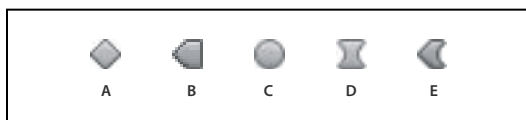

Examples of keyframe icons in Timeline panel in layer bar mode
A. Linear B. Linear in, Hold out C. Auto Bezier D. Continuous Bezier or Bezier E. Linear in, Bezier out

All interpolation methods used by After Effects are based on the *Bezier* interpolation method, which provides direction handles so that you can control the transitions between keyframes. Interpolation methods that don't use direction handles are constrained versions of Bezier interpolation and are convenient for certain tasks.

To learn more about how different interpolation methods affect temporal properties, experiment by setting up at least three keyframes with different values for a temporal layer property—such as Opacity—and change the interpolation methods as you view the value graph in Graph Editor mode in the Timeline panel.

To learn more about how different interpolation methods affect a motion path, experiment by setting up three keyframes for a spatial property—such as Position—with different values on a motion path, and change the interpolation methods as you preview the motion in the Composition panel.

Note: To change interpolation methods, right-click a keyframe, select *Keyframe Interpolation* from the menu that appears, and then select an option from the *Temporal Interpolation* drop-down menu.

In the following descriptions of interpolation methods, the result of each method is described as if you had applied it to all of the keyframes for a layer property. This is done to clarify the examples. In practice, you can apply any available interpolation method to any keyframe.

See also

“About animation, keyframes, and expressions” on page 183

“Shortcuts for keyframes” on page 650

“Shortcuts for showing properties in the Timeline panel” on page 647

“Work with the Graph Editor” on page 184

No interpolation

No interpolation is the state in which there are no keyframes for a layer property—when the stopwatch is turned off and the I-beam icon ¶ appears in the Timeline panel under the current-time indicator. In this state, when you set the value of a layer property, it maintains that value for the layer's duration, unless overridden by an expression. By default, no interpolation is applied to a layer property. If any keyframes are present for a layer property, some kind of interpolation is in use.

Linear interpolation

Linear interpolation creates a uniform rate of change between keyframes, which can add a mechanical look to animations. After Effects interpolates the values between two adjacent keyframes as directly as possible without accounting for the values of other keyframes.

If you apply Linear interpolation to all keyframes of a temporal layer property, change begins instantly at the first keyframe and continues to the next keyframe at a constant speed. At the second keyframe, the rate of change switches immediately to the rate between it and the third keyframe. When the layer reaches the final keyframe value, change stops instantly. In the value graph, the segment connecting two keyframes with Linear interpolation appears as a straight line.

Bezier interpolation

Bezier interpolation provides the most precise control because you manually adjust the shape of the value graph or motion path segments on either side of the keyframe. Unlike Auto Bezier or Continuous Bezier, the two direction handles on a Bezier keyframe operate independently in both the value graph and motion path.



If you apply Bezier interpolation to all keyframes of a layer property, After Effects creates a smooth transition between keyframes. The initial position of the direction handles is calculated using the same method used in Auto Bezier interpolation. After Effects maintains existing direction handle positions as you change a Bezier keyframe value.

Unlike other interpolation methods, Bezier interpolation lets you create any combination of curves and straight lines along the motion path. Because the two Bezier direction handles operate independently, a curving motion path can suddenly turn into a sharp corner at a Bezier keyframe. Bezier spatial interpolation is ideal for drawing a motion path that follows a complex shape, such as a map route or the outline of a logo.

Existing direction handle positions persist as you move a motion-path keyframe. The speed of motion along the path is controlled by the temporal interpolation applied at each keyframe.

Auto Bezier interpolation

Auto Bezier interpolation creates a smooth rate of change through a keyframe. You might use Auto Bezier spatial interpolation to create the path of a car turning on a curving road.

As you change an Auto Bezier keyframe  value, the positions of Auto Bezier direction handles change automatically to maintain a smooth transition between keyframes. The automatic adjustments change the shape of the value graph or motion path segments on either side of the keyframe. If the previous and next keyframes also use Auto Bezier interpolation, the shape of the segments on the far side of the previous or next keyframes also changes. If you adjust an Auto Bezier direction handle manually, you convert it to a Continuous Bezier keyframe .

Auto Bezier is the default spatial interpolation.

Continuous Bezier interpolation

Like Auto Bezier interpolation, Continuous Bezier interpolation creates a smooth rate of change through a keyframe. However, you set the positions of Continuous Bezier direction handles manually. Adjustments you make change the shape of the value graph or motion path segments on either side of the keyframe.

If you apply Continuous Bezier interpolation to all keyframes of a property, After Effects adjusts the values at each keyframe to create smooth transitions. After Effects maintains these smooth transitions as you move a Continuous Bezier keyframe  on either the motion path or the value graph.

Hold interpolation

Hold interpolation is available only as a temporal interpolation method. Use it to change the value of a layer property over time, but without a gradual transition. This method is useful for strobe effects, or when you want layers to appear or disappear suddenly.

If you apply Hold temporal interpolation to all keyframes of a layer property, the value of the first keyframe holds steady until the next keyframe, when the values change immediately. In the value graph, the graph segment following a Hold keyframe  appears as a horizontal straight line.

Even though Hold interpolation is available only as a temporal interpolation method, the keyframes on the motion path are visible, but they are not connected by layer-position dots. For example, if you animate a layer's Position property using Hold interpolation, the layer holds at the position value of the previous keyframe until the current-time indicator reaches the next keyframe, at which point the layer disappears from the old position and appears at the new position.

You can easily freeze the current frame for the duration of the layer using the Freeze Frame command. To freeze a frame, position the current time indicator at the frame you want to freeze. Make sure the layer is selected and then choose Layer > Time > Freeze Frame. Time-remapping is enabled, and a Hold keyframe is placed at the position of the current time indicator to freeze the frame.

Note: If you previously enabled time-remapping on the layer, any keyframes you created will be deleted when you apply the Freeze Frame command.

You can use Hold interpolation only for outgoing temporal interpolation (for the frames following a keyframe). If you create a new keyframe following a Hold keyframe, the new keyframe will use incoming Hold interpolation.



To apply or remove Hold interpolation as outgoing interpolation for a keyframe, select the keyframe in the Timeline panel, and choose Animation > Toggle Hold Keyframe.

Apply and change keyframe interpolation methods

You can apply and change the interpolation method for any keyframe. You can apply changes using the Keyframe Interpolation dialog box, or you can apply them directly to a keyframe in layer bar mode, in a motion path, or in the Graph Editor. You can also change the default interpolation After Effects uses for spatial properties.

See also

“Select keyframes” on page 188

“About animation, keyframes, and expressions” on page 183

“Shortcuts for keyframes” on page 650

“Shortcuts for showing properties in the Timeline panel” on page 647

Change interpolation method with the Keyframe Interpolation dialog box

The Keyframe Interpolation dialog box provides options for setting temporal and spatial interpolation and—for spatial properties only—roving settings.

1 In layer bar mode or in the Graph Editor, select the keyframes you want to change.

2 Choose Animation > Keyframe Interpolation.

3 For Temporal Interpolation, choose one of the following options:

Current Settings Preserves the interpolation values already applied to the selected keyframes. Choose this option when multiple or manually adjusted keyframes are selected and you do not want to change the existing settings.

Linear, Bezier, Continuous Bezier, Auto Bezier, and Hold Apply a temporal interpolation method using default values.

4 If you selected keyframes of a spatial layer property, choose one of the following options for Spatial Interpolation:

Current Settings Preserves the interpolation settings already applied to the selected keyframes.

Linear, Bezier, Continuous Bezier, and Auto Bezier Apply a spatial interpolation method using default values.

5 If you selected keyframes of a spatial layer property, use the Roving menu to choose how a keyframe determines its position in time, and then click OK:

Current Settings Preserves the currently applied method of positioning the selected keyframes in time.

Rove Across Time Smooths the rate of change through the selected keyframes by automatically varying their position in time, based on the positions of the keyframes immediately before and after the selection.

Lock To Time keeps the selected keyframes at their current position in time. They stay in place unless you move them manually.

For more information on smoothing the rate of change through selected keyframes, see “Smooth motion with roving keyframes” on page 216.

Change interpolation method with the Selection tool in layer bar mode

- ❖ Using the Selection tool, do one of the following:
 - If the keyframe uses Linear interpolation, Ctrl-click (Windows) or Command-click (Mac OS) the keyframe to change it to Auto Bezier .
 - If the keyframe uses Bezier, Continuous Bezier, or Auto Bezier interpolation, Ctrl-click (Windows) or Command-click (Mac OS) the keyframe to change it to Linear.

Change interpolation method in the Graph Editor

- Click the keyframe with the Convert Vertex tool  to toggle between linear and Auto Bezier interpolation.
- Select one or more keyframes, and then click the Hold, Linear, or Auto Bezier button at the bottom of the screen to change the interpolation method.

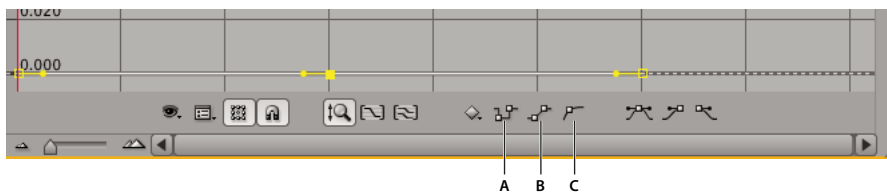

Interpolation buttons in the Graph Editor
A. Hold B. Linear C. Auto-Bezier

Modify Bezier direction handles

In the Graph Editor, keyframes that use Bezier interpolation have direction handles attached to them. You can retract, extend, or rotate the direction handles to fine-tune the Bezier interpolation curve.

Retracting a direction handle makes a tighter, sharper Bezier curve. Extending a direction handle makes a larger, smoother Bezier curve. By default, when you retract or extend a direction handle, the opposite handle on the keyframe moves with it. Splitting direction handles makes the two direction handles attached to a keyframe behave independently.

- To retract or extend direction handles, drag the direction handle toward or away from the center of its keyframe with the Selection tool.
- To split direction handles, Alt-drag (Windows) or Option-drag (Mac OS) a keyframe with the Selection tool. You can also Alt-drag (Windows) or Option-drag (Mac OS) outside a keyframe to draw new handles, whether or not there are existing handles.
- To manipulate the direction handles of two neighboring keyframes simultaneously, drag the value graph segment between the keyframes.

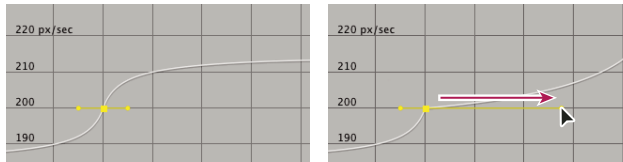

Modifying a Bezier direction handle

See also

“Work with the Graph Editor” on page 184

“About animation, keyframes, and expressions” on page 183

Speed

About speed graphs

You can fine-tune changes over time using the speed graph in the Graph Editor. The speed graph provides information about and control of the value and rate of change for all spatial and temporal values at any frame in a composition. To view the speed graph, choose Edit Speed Graph from the Choose Graph Type menu .

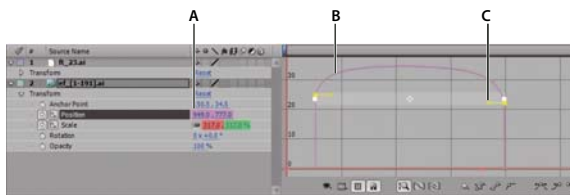

Speed graph controls

A. Value at the current-time indicator B. Speed graph C. Direction handle (controls speed)

See also

“Work with the Graph Editor” on page 184

“About animation, keyframes, and expressions” on page 183

About changes in speed

When you animate a property in the Graph Editor, you can view and adjust the rate of change of the property in the speed graph, or on the motion path in the Composition or Layer panel. As you adjust the rate in one panel, you can view the changes in the other. In the speed graph, changes in the graph height indicate changes in speed. Level values indicate constant speed; higher values indicate increased speed.

In the Composition or Layer panel, the spacing between dots in a motion path indicates speed. Each dot represents a frame, based on the frame rate of the composition. Even spacing indicates a constant speed, and wider spacing indicates a higher speed. Keyframes using Hold interpolation display no dots because there is no intermediate transition between keyframe values; the layer simply appears at the next keyframe’s position.

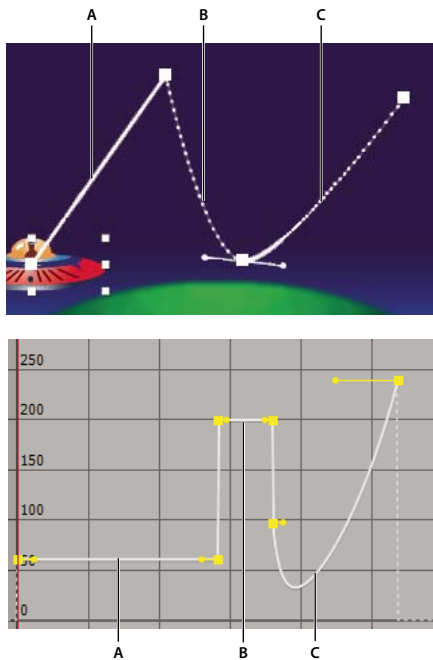

Motion path in Composition panel (top) compared to speed graph in Graph Editor (bottom)

A. Dots are close together, indicating lower speed (top); speed is constant (bottom). **B.** Dots are far apart, indicating greater speed (top); speed is constant (bottom). **C.** Inconsistent spacing of dots indicates changing speed (top); speed decreases and then increases (bottom).

The change of speed over time is affected by the following factors:

- The time difference between keyframes in the Timeline panel. The shorter the time interval between keyframes, the more quickly the layer has to change to reach the next keyframe value. If the interval is longer, the layer changes more slowly, because it must make the change over a longer period of time. You can adjust the rate of change by moving keyframes forward or backward along the timeline.
- The difference between the values of adjacent keyframes. A large difference between keyframe values, such as the difference between 75% and 20% opacity, creates a faster rate of change than a smaller difference, such as the difference between 30% and 20% opacity. You can adjust the rate of change by increasing or decreasing the value of a layer property at a keyframe.
- The interpolation type applied for a keyframe. For example, it is difficult to make a value change smoothly through a keyframe when the keyframe is set to Linear interpolation, but you can switch to Bezier interpolation at any time, which provides a smooth change through a keyframe. If you use Bezier interpolation, you can adjust the rate of change even more precisely using direction handles.

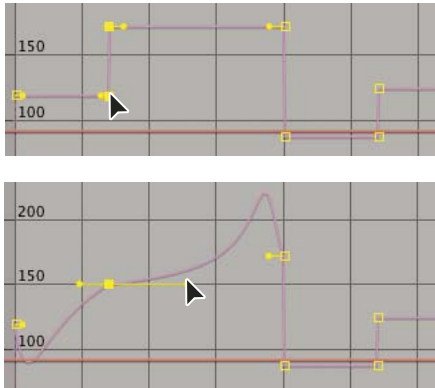

Linear interpolation (top) causes sharp changes; Bezier interpolation (bottom) creates smoother changes.

See also

“Work with the Graph Editor” on page 184

“About animation, keyframes, and expressions” on page 183

Control speed between keyframes

- In the Composition or Layer panel, adjust the spatial distance between two keyframes on the motion path. Increase speed by moving one keyframe position farther away from the other, or decrease speed by moving one keyframe position closer to the other.

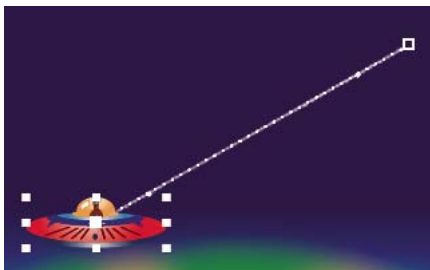
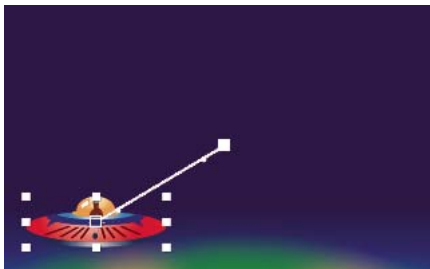

More spatial distance between keyframes increases layer speed.

- In layer bar mode or in the Graph Editor, adjust the time difference between two keyframes. Decrease speed by moving one keyframe farther away from the other, or increase speed by moving one keyframe closer to the other.

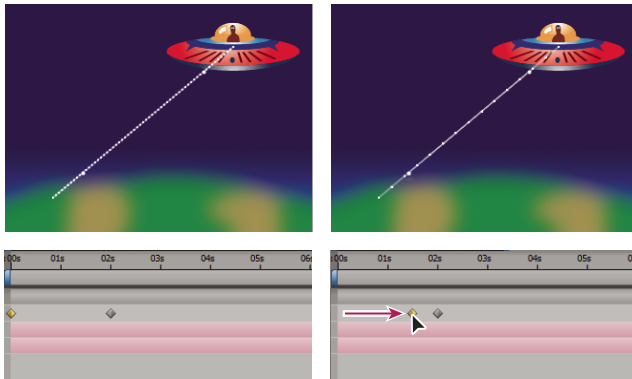

Shorter temporal distance between keyframes increases layer speed.

- Apply the Easy Ease keyframe assistant, which automatically adjusts the speed of change as motion advances toward and retreats from a keyframe.

See also

“Work with the Graph Editor” on page 184

“About animation, keyframes, and expressions” on page 183

Work with the speed graph

After you have set the shape of a motion path or created keyframes for a property, you can adjust the speed. Using the speed graph, you can adjust the rate of change of a value.

For example, you can change the motion of a layer so that it slows just before a keyframe and then speeds up just after the keyframe, or so that it moves quickly over a certain distance and then slows down smoothly. By adjusting the rise and fall of the speed graph, you can control how fast or slow a value changes from keyframe to keyframe.

Note: Like the value graph, the speed graph displays x, y, and z (3D only) values in different colors: x values are red, y values are green, and z values are blue.

You can control the values approaching and leaving a keyframe together, or you can control each value separately. The incoming handle increases the speed or velocity when you drag it up, and decreases the speed or velocity when you drag it down. The outgoing handle influences the next keyframe in the same way. You can also control the influence on speed by dragging the handles left or right.

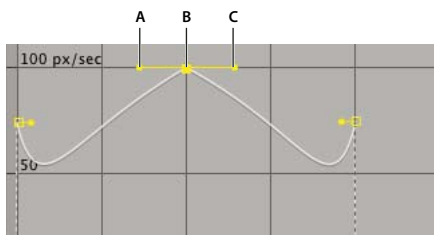

Direction handles in speed graphs

A. Incoming direction handle B. Speed control C. Outgoing direction handle

Note: If you want a handle to have influence over more than one keyframe, use roving keyframes.

See also

“Work with the Graph Editor” on page 184

“Modify Bezier direction handles” on page 209

Adjust the rate of change with the speed graph

- 1 In the Timeline panel, expand the outline for the keyframe you want to adjust.
- 2 Click the Graph Editor button and select Edit Speed Graph from the Graph Options menu .
- 3 Using the Selection tool, click the keyframe you want to adjust.
- 4 (Optional) Do one of the following:
 - To split the incoming and outgoing direction handles, Alt-drag (Windows) or Option-drag (Mac OS) a direction handle.
 - To join the direction handles, Alt-drag (Windows) or Option-drag (Mac OS) a split direction handle up or down until it meets the other handle.
- 5 Do any of the following:
 - Drag a keyframe with joined direction handles up to accelerate or down to decelerate entering and leaving the keyframe.
 - Drag a split direction handle up to accelerate or down to decelerate the speed entering or leaving a keyframe.
 - To increase the influence of the keyframe, drag the direction handle away from the center of the keyframe. To decrease the influence, drag the direction handle toward the center of the keyframe.

Note: When you drag a direction handle beyond the top or bottom of the Graph Editor with Auto Zoom Graph Height  on, After Effects calculates a new minimum or maximum value based on how far you dragged outside the graph, and it redraws the graph so that all the values you specify for that layer property are visible in the graph by default.

Create a bounce or peak

Use direction handles to simulate the type of acceleration seen in a bouncing ball. When you create this type of effect, the speed graph appears to rise quickly and peak.

- 1 In the Timeline panel, expand the outline for the keyframe you want to adjust.
- 2 Click the Graph Editor button and display the speed graph for the property.
- 3 Make sure the interpolation method for the keyframe you want to peak is set to Continuous Bezier or Bezier.
- 4 Drag the desired keyframe (with joined direction handles) up until it is near the top of the graph.
- 5 Drag the direction handles on either side of the keyframe toward the center of the keyframe.

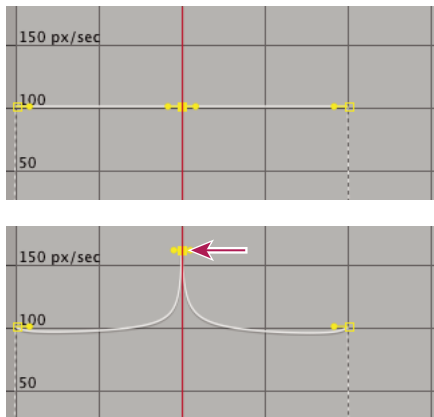

Dragging direction handle to create a peak

Start or stop change gradually

Direction handles can create gradual starts and stops, such as a boat slowing to a stop and then starting again. When you use this technique, the speed graph resembles a smooth U shape.

- 1 In the Timeline panel, expand the outline for the keyframe you want to adjust.
- 2 Click the Graph Editor button and display the speed graph for the property.
- 3 Make sure the interpolation method for the keyframe you want to adjust is set to Continuous Bezier or Bezier.
- 4 At the desired keyframe, drag the direction handle down until it is near the bottom of the graph.
- 5 Drag the direction handles on either side of the keyframe away from the center of the keyframe.

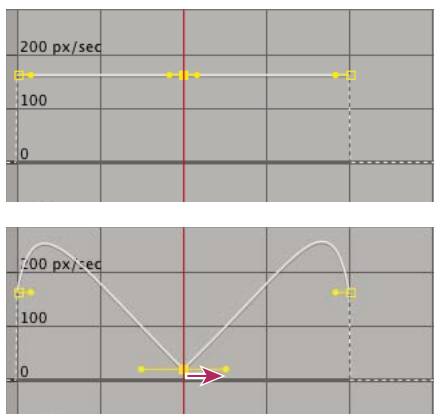

Dragging the direction handle to make a gradual change

Adjust influence of a direction handle on an adjacent keyframe

Along with controlling the level of acceleration and deceleration, you can also extend the *influence* of a keyframe outward or inward in relation to an adjacent keyframe. Influence determines how quickly the speed graph reaches the value you set at the keyframe, giving you an additional degree of control over the shape of the graph. The direction handle increases the influence of a keyframe value in relation to the neighboring keyframe when you drag it toward the neighboring keyframe, and it decreases the influence on the neighboring keyframe when you drag it toward the center of its own keyframe.

- 1 In the Timeline panel, expand the outline for the keyframe you want to adjust.

- 2 Click the Graph Editor button and display the speed graph for the property.
- 3 Using the Selection tool, click a keyframe and drag the direction handle left or right.

Change speed numerically

You may want to specify speed more precisely than you can by dragging keyframes in the speed graph. In such cases, specify speed numerically in the Keyframe Velocity dialog box.

The options and units in the dialog box vary depending on the layer property you are editing and may also vary for plug-ins.

- 1 Display the speed graph for the keyframe you want to adjust.
- 2 Select the keyframe you want to edit, and then choose Animation > Keyframe Velocity.
- 3 Enter values for Speed for Incoming and Outgoing Velocity.
- 4 Enter a value for Influence to specify the amount of influence toward the previous keyframe (for incoming interpolation) or the next keyframe (for outgoing interpolation).
- 5 To create a smooth transition by maintaining equal incoming and outgoing velocities, select Continuous.

Note: By default, the proportions of the current Scale or Mask Feather values are preserved as you edit the values. If you don't want to preserve proportions, click the link icon next to the property values in the Timeline panel to remove the icon.

See also

“Work with the Graph Editor” on page 184

“About animation, keyframes, and expressions” on page 183

Smooth motion with roving keyframes

Using the *roving keyframe* option in After Effects, you can easily create smooth movement across several keyframes at once. Roving keyframes are keyframes that are not linked to a specific time; their speed and timing are determined by adjacent keyframes. When you change the position of a keyframe adjacent to a roving keyframe in a motion path, the timing of the roving keyframe may change.

Roving keyframes are available only for spatial layer properties such as Position. In addition, a keyframe can rove only if it is not the first or last keyframe in a layer, because a roving keyframe must interpolate its speed from the previous and next keyframes.

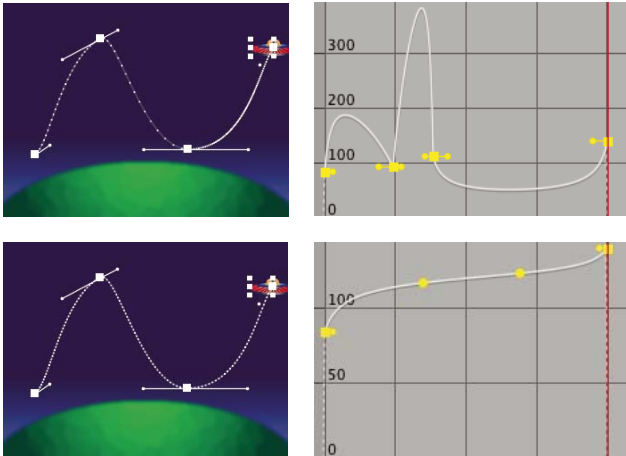

The original motion path (top) shows different velocities between keyframes. After the keyframes are set to rove (bottom), the motion path shows consistent speed over the range of keyframes.

- 1 In layer bar mode or in the Graph Editor, set up the keyframes for the motion you want to smooth.
- 2 Determine the beginning and ending keyframes for the range you want to smooth.
- 3 Do one of the following:
 - For every keyframe in the range (except the beginning and ending keyframes), select Rove Across Time in the keyframe menu .
 - Select the keyframes you want to rove and choose Animation > Keyframe Interpolation. Then choose Rove Across Time from the Roving menu.

The intermediate keyframes adjust their positions on the timeline to smooth the speed curve between the beginning and ending keyframes.

Revert to a nonroving keyframe



- Select the roving keyframe option from the keyframe menu, or drag the roving keyframe left or right.
- Select the keyframes you want to change, and choose Animation > Keyframe Interpolation. Then choose Lock To Time from the Roving menu.

Automatically ease speed

Although you can manually adjust the speed of a keyframe by dragging direction handles, using Easy Ease automates the work.

After you apply Easy Ease, each keyframe has a speed of 0 with an influence of 33.33% on either side. When you ease the speed of an object, for example, the object slows down as it approaches a keyframe, and gradually accelerates as it leaves. You can ease speed when coming into or out of a keyframe, or both.

- 1 In the Graph Editor or in layer bar mode, select a range of keyframes.
- 2 Do one of the following:
 - Choose Animation > Keyframe Assistant > Easy Ease (to ease speed coming both into and out of selected keyframes), Easy Ease In (to ease speed coming into selected keyframes), or Easy Ease Out (to ease speed coming out of selected keyframes).

- Click the Easy Ease , Easy Ease In , or Easy Ease Out  button located at the bottom of the Graph Editor.

Use Exponential Scale

You can simulate a realistic acceleration of a zoom lens when working with 2D layers by using Exponential Scale, which converts linear scaling of a layer to exponential scaling. This is useful for creating a cosmic zoom, for example. Zooming optically with a lens is not linear—the rate of change of scaling increases as you zoom. To simulate this acceleration, Exponential Scale converts the velocity of the scaling to an exponential curve.

- 1 In layer bar mode or in the Graph Editor, hold down the Shift key and select starting and ending keyframes for the scale property.
- 2 Choose Animation > Keyframe Assistant > Exponential Scale.

Note: Exponential Scale replaces any existing keyframes between the selected starting and ending keyframes.

Time-stretching and time-remapping

Time-stretch a layer

Speeding up or slowing down a layer is known as *time-stretching*. When you time-stretch a layer, the audio or the original frames in the footage (and all keyframes that belong to the layer) are redistributed along the new duration. Use this command only when you want the layer and all layer keyframes to change to the new duration.

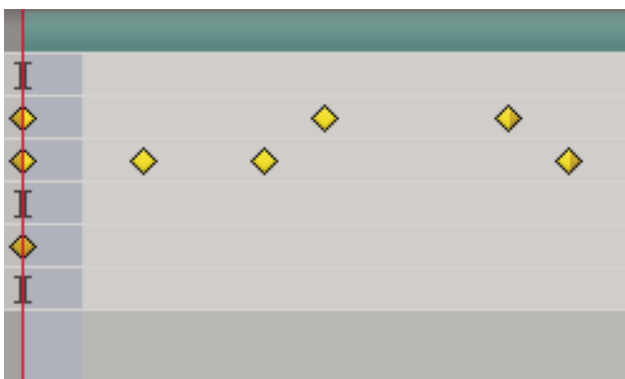
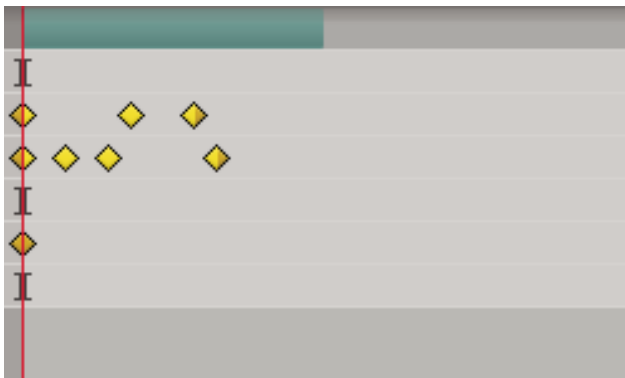

Time-stretching a layer redistributes keyframes along the new duration.

If you time-stretch a layer so that the resulting frame rate is significantly different from the original frame rate, the quality of motion within the layer may suffer. For best results when time-remapping a layer, use the Timewarp effect.

See also

“Apply frame blending to a layer” on page 225

“Timewarp effect” on page 535

Time-stretch a layer from a specific time

- 1 In the Timeline or Composition panel, select the layer.
- 2 Choose Layer > Time > Time Stretch.
- 3 Type a new duration for the layer, or type a Stretch Factor.
- 4 To specify the point in time from which the layer will be time-stretched, click one of the Hold In Place options, and then click OK.

Layer In-point Holds the layer’s current starting time, and time-stretches the layer by moving the Out point.

Current Frame Holds the layer at the position of the current-time indicator (also the frame displayed in the Composition panel), and time-stretches the layer by moving the In and Out points.

Layer Out-point Holds the layer’s current ending time and time-stretches the layer by moving the In point.

Time-stretch a layer to a specific time

- 1 In the Timeline panel, move the current-time indicator to the frame where you want the layer to begin or end.
- 2 Display the In and Out columns by choosing Columns > In and Columns > Out from the Timeline panel menu.
- 3 Do one of the following:
 - To stretch the In point to the current time, press Ctrl (Windows) or Command (Mac OS) as you click the In time for the layer in the In column.
 - To stretch the Out point to the current time, press Ctrl (Windows) or Command (Mac OS) as you click the Out time for the layer in the Out column.

Time-stretch a layer but not its keyframes

When you time-stretch a layer, the positions of its keyframes stretch with it by default. You can circumvent this behavior by cutting and pasting keyframes.

- 1 Make a note of the time at which the first keyframe appears.
- 2 In the Timeline panel, click the name of one or more layer properties containing the keyframes you want to keep at the same times.
- 3 Choose Edit > Cut.
- 4 Move or stretch the layer to its new In and Out points.
- 5 Move the current-time indicator to the time at which the first keyframe appeared before you cut the keyframes.
- 6 Choose Edit > Paste.

Reverse a layer's playback direction

When you reverse a layer's playback direction, all keyframes for all properties on the selected layer also reverse order. The layer itself maintains its original In and Out points relative to the composition.

Note: For best results, precompose the layer and then reverse the layer inside the precomposition. This is the most accurate way to reverse footage. For more information on this process, see "About nesting and precomposing" on page 113.

- 1 In a Timeline panel, select the layer you want to reverse.
- 2 Choose Layer > Time > Time-Reverse Layer, or press Ctrl+Alt+R (Windows) or Command+Option+R (Mac OS).

Reverse keyframes without reversing layer playback

You can select and reverse keyframes across multiple layers and properties, but each set of keyframes for a property is reversed only within its original time range and not that of any other selected property. Markers in the Timeline panel are not reversed, so you might need to move markers after reversing keyframes.

- 1 In the Timeline panel, select a range of keyframes you want to reverse.
- 2 Choose Animation > Keyframe Assistant > Time-Reverse Keyframes.

About time-remapping

You can expand, compress, play backward, or freeze a portion of a layer's duration using a process known as *time-remapping*. For example, if you are using footage of a person walking, you can play footage of the person moving forward, and then play a few frames backward to make the person retreat, and then play forward again to have the person resume walking.

When you apply time-remapping to a layer containing audio and video, the audio and video remain synchronized. You can remap audio files to gradually decrease or increase the pitch, play audio backward, or create a warbled or scratchy sound. Still-image layers cannot be time-remapped.

Aharon Rabinowitz provides a tutorial that shows how to use time-remapping to do lip-synching; this same basic concept can be used for many kinds of character animation: www.adobe.com/go/learn_ae_aharonlipsynch.

You can remap time in either the Layer panel or the Graph Editor. Remapping video in one panel displays the results in both. Each provides a different view of the layer duration:

- The Layer panel provides a visual reference of the frames you change, as well as the frame number. The panel displays the current-time indicator and a remap-time marker, which you move to select the frame you want to play at the current time.

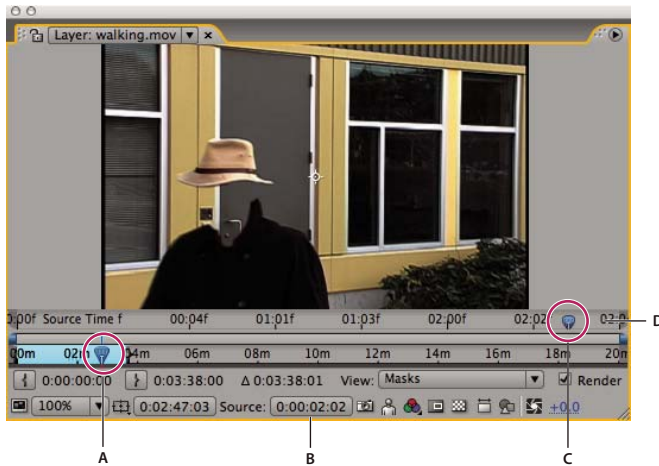

Layer panel for time remapping

A. Current-time indicator B. Time-remap value C. Remap-time marker D. Navigator bar

- The Graph Editor provides a view of the changes you specify over time by marking your changes with keyframes and a graph similar to the one displayed for other layer properties.

When remapping time in the Graph Editor, use the values represented in the Time Remap graph to determine and control which frame of the movie plays at which point in time. Each Time Remap keyframe has a time value associated with it that corresponds to a specific frame in the layer; this value is represented vertically on the Time Remap value graph. When you enable time remapping for a layer, After Effects adds a Time Remap keyframe at the start and end points of the layer. These initial Time Remap keyframes have vertical time values equal to their horizontal position on the timeline.

By setting additional Time Remap keyframes, you can create complex motion results. Each time you add a Time Remap keyframe, you create another point at which you can change the playback speed or direction. As you move the keyframe up or down in the value graph, you adjust which frame of the video is set to play at the current time. After Effects then interpolates intermediate frames and plays the footage forward or backward from that point to the next Time Remap keyframe. In the value graph, reading from left to right, an upward angle indicates forward playback, while a downward angle indicates reverse playback. The amount of the upward or downward angle corresponds to the speed of playback.

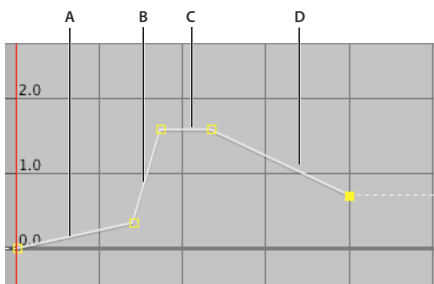

Time-remapping graph

A. No change B. Fast motion C. Freeze frame D. Backward motion

Similarly, the value that appears next to the Time Remap property name indicates which frame plays at the current time. As you drag a value graph marker up or down, this value changes accordingly and a Time Remap keyframe is set, if necessary. You can click this value and type a new one, or click and drag the value to adjust it.

The original duration of the source footage may no longer be valid when remapping time, because parts of the layer no longer play at the original rate. If necessary, set a new duration for the layer before you remap time.

As with other layer properties, you can view the values of the Time Remap graph as either a value graph or a speed graph.

If you remap time and the resulting frame rate is significantly different from the original, the quality of motion within the layer may suffer. Apply frame blending to improve slow- or fast-motion effects.

***Note:** Use the information shown in the Info panel to guide you as you work with time-remapping. The ratio given in the units of seconds/sec indicates the current speed of playback—the number of seconds of the original layer being played for each second after time-remapping.*

See also

“About animation, keyframes, and expressions” on page 183

“Work with the Graph Editor” on page 184

Time-remap a layer

You can time-remap all or part of a layer. For example, you can time-remap a frame at the beginning or end of the layer, creating a freeze-frame result, or you can time-remap frames in the middle of the layer, creating a slow-motion result that only lasts for a few seconds.

See also

“About animation, keyframes, and expressions” on page 183

“Work with the Graph Editor” on page 184

Freeze the first frame without changing the speed

1 In a Composition or Timeline panel, select the layer that you want to remap.

2 Choose Layer > Time > Enable Time Remapping.

This adds two Time Remap keyframes by default, one at the beginning of the layer and one at the end.

3 Move the current-time indicator to where you want the movie to begin.

4 Click the Time Remap property name to select the start and end keyframes.

5 Drag the first keyframe to the current-time indicator, which moves the start and end keyframes. (If you are working in the Graph Editor, drag the bounding box—not the keyframe or a handle—so that both keyframes move.)

Freeze a frame in the middle of a layer's duration

1 In a Composition or Timeline panel, select the layer that you want to remap.

2 Choose Layer > Time > Enable Time Remapping.

This adds two Time Remap keyframes by default, one at the beginning of the layer and one at the end.

3 Move the current-time indicator to the frame that you want to freeze, and set a Time Remap keyframe at the current time by clicking the keyframe navigator diamond for the Time Remap property.

4 Select the last two Time Remap keyframes (the second and third keyframes) and drag them to the right.

5 Press F2 to deselect the keyframes, and then click the second (middle) keyframe to select it.

- 6 Press Ctrl+C (Windows) or Command+C (Mac OS) to copy the keyframe.
- 7 Press Ctrl+V (Windows) or Command+V (Mac OS) to paste the keyframe at the current time. You should not have moved the current-time indicator since step 3.
- 8 (Optional) To extend the layer so that its duration is increased to accommodate the time added by the freeze-frame operation, press the K key twice to move the current-time indicator to the last Time Remap keyframe, and press Alt+] (Windows) or Option+] (Mac OS).

The portion of the layer between the first and second keyframes plays at an unaltered rate (the same as for the non-time-remapped layer), as does the portion of the layer between the third and fourth keyframes. The second and third keyframes are identical, so a single frozen frame plays during the time between those two keyframes.

Remap time using the Graph Editor



To switch between Graph Editor mode and layer bar mode, press Shift+F3.

- 1 In a Composition or Timeline panel, select the layer you want to remap.
- 2 Choose Layer > Time > Enable Time Remapping.
- 3 In the Timeline panel, click the name of the Time Remap property to select it.
- 4 Move the current-time indicator to the time at which to add a keyframe, and click the keyframe button  in the keyframe navigator to add a keyframe.
- 5 In the Graph Editor, drag the keyframe marker up or down, watching the Time Remap value as you drag. To snap to other keyframes, Shift-drag.

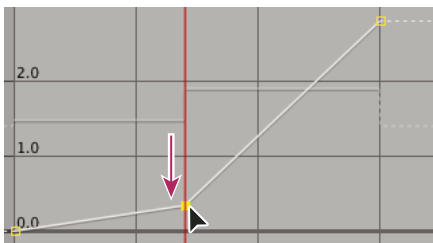
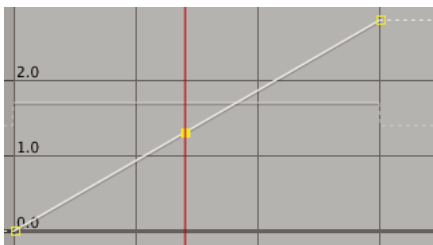

Dragging the keyframe down slows down the layer.

- To slow the layer down, drag the keyframe down. (If the layer is playing in reverse, drag up.)
- To speed the layer up, drag the keyframe up. (If the layer is playing in reverse, drag down.)
- To play frames backward, drag the keyframe down to a value below the previous keyframe value.
- To play frames forward, drag the keyframe up to a value above the previous keyframe value.

- To freeze the previous keyframe, drag the current keyframe marker to a value equal to the previous keyframe value so that the graph line is flat. Another method is to select the keyframe and choose Animation > Toggle Hold Keyframe, and then add another keyframe where you want the motion to start again.

 Before you move a time-remap keyframe, it's a good idea to select all subsequent time-remap keyframes in the layer first. This will preserve the timing of the rest of the layer when you remap time for the current keyframe.

Remap time in a Layer panel

- 1 Open the Layer panel for the layer you want to remap.
- 2 Choose Layer > Time > Enable Time Remapping. A second time ruler appears in the Layer panel above the default time ruler and the navigator bar.
- 3 On the lower time ruler, move the current-time indicator to the first frame where you want the change to occur.
- 4 On the upper time ruler, the remap-time marker indicates the frame currently mapped to the time indicated on the lower time ruler. To display a different frame at the time indicated on the lower time ruler, move the remap-time marker accordingly.

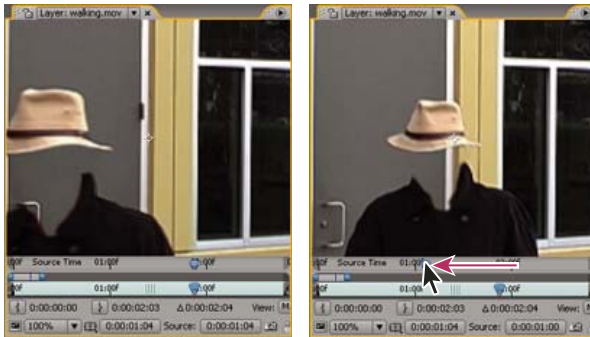

Drag the remap-time marker to replace the frame at the current time marker.

- 5 Move the current-time indicator on the lower time ruler to the last frame where you want change to occur.
- 6 Move the remap-time marker on the upper time ruler to the frame you want to display at the time indicated on the lower time ruler:
 - To move the preceding portion of the layer forward, set the remap-time marker to a later time than the current-time indicator.
 - To move the preceding portion of the layer backward, set the remap-time marker to an earlier time than the current-time indicator.
 - To freeze a frame, set the remap-time marker to the frame you want frozen. Then, move the current-time indicator (lower ruler) to the last point in time where the frame will appear frozen and move the remap-time marker again to the frame you want frozen.

Time-remap audio pitch

The speed graph of the Time Remap property directly relates to the pitch of an audio file. By making subtle changes to the speed graph, you can create a variety of interesting effects. To avoid screeching audio, you may want to keep the Speed value below 200%. When the speed is too high, use the Levels controls, located under the Audio property, to control the volume.

You may hear clicks at the beginning and end of an audio (or an audio and video) layer after setting new In and Out points in the Time Remap graph. Use the Levels controls to remove these clicks.

See also

“Preview video and audio” on page 120

Change the pitch of an audio layer

- 1 In a Composition or Timeline panel, select the layer you want to remap.
- 2 Choose Layer > Time > Enable Time Remapping.
- 3 Click the Graph Editor button in the Timeline panel to display the Graph Editor, if necessary.
- 4 Click the Choose Graph Type And Options button at the bottom of the Graph Editor and choose Edit Speed Graph.
- 5 Move the current-time indicator to the frame where you want change to begin, and then click the Add A Keyframe button.
- 6 On the speed graph below the keyframe, drag a marker, watching the Speed value as you drag.
 - To lower the pitch, drag the speed graph marker down.
 - To increase the pitch, drag the speed graph marker up.

Remove clicks from new In and Out points

- 1 If necessary, choose panel > Audio.
- 2 In the Timeline panel, select the audio (or audio and video) layer to which you applied time-remapping.
- 3 Expand the layer outline to display the Audio property and then the Audio Levels property.
- 4 Move the current-time indicator to the new In point and choose Animation > Add Audio Levels Keyframe.
- 5 In the Audio panel, change the decibel value to 0.0.
- 6 Press the Page Up key on your keyboard to move the current-time indicator to the previous frame.
- 7 In the Audio panel, change the decibel level to -96.0.
- 8 Move the current time to the new Out point and set the decibel level to 0.
- 9 Press the Page Down key to move the current-time indicator to the next frame.
- 10 In the Audio panel, change the decibel level to -96.0.



You can change the decibel Slider Minimum value in the Audio Options dialog box, which is available from the Audio panel menu.

Apply frame blending to a layer

When you time-stretch footage to a slower frame rate or to a rate lower than that of its composition, movement can appear jerky. This jerky appearance results because the layer now has fewer frames per second than the composition. Likewise, the same jerky appearance can occur when you time-stretch or time-remap footage to a frame rate that is faster than that of its composition. To create smoother motion when you slow down or speed up a layer, use frame blending.

After Effects provides two types of frame blending: Frame Mix and Pixel Motion. Frame Mix takes less time to render, but Pixel Motion provides much better results, especially for footage that has been drastically slowed down.

Frame blending slows previewing and rendering. To speed things up, you can apply frame blending without using it to redraw or render.

The Quality setting you select also affects frame blending. When the layer is set to Best quality, frame blending results in smoother motion but may take longer to render than when set to Draft quality.

Note: When working with a frame-blended layer in Draft mode, After Effects will always use Frame Mix interpolation to increase rendering speed.

You can also enable frame blending for all compositions when you render a movie.

Use frame blending to enhance the quality of time-altered motion in a layer that contains live-action footage—video, for example. You can apply frame blending to a sequence of still images, but not to a single still image. If you are animating a layer—for example, moving a text layer across the screen—use motion blur.

1 Select the layer in the Timeline panel.

2 Do one of the following:

- Choose Layer > Frame Blending > Frame Mix.
- Choose Layer > Frame Blending > Pixel Motion.

A check mark by the appropriate Frame Blending command (Frame Mix or Pixel Motion) indicates that it is applied to the selected layer. Also, the Frame Blending switch  appears in the Switches column for the layer in the Timeline panel. Remove frame blending either by clicking the Frame Blending switch or by choosing the appropriate Frame Blending command again.

Regardless of the state of the layer switches, if frame blending is off for the composition, it is off for all layers in the composition. You set frame blending for the composition by choosing Enable Frame Blending from the Timeline panel menu, or clicking the Enable Frame Blending button  at the top of the Timeline panel.

See also

“About animation, keyframes, and expressions” on page 183

“Layer image quality” on page 150

“Timewarp effect” on page 535

Animating with Puppet tools

About the Puppet tools

Use the Puppet tools to quickly add natural motion to raster images and vector graphics, including still images, shapes, and text characters.

To see a video tutorial on using the Puppet tools, visit the Adobe website at www.adobe.com/go/vid0274.

Note: Though the Puppet tools work within an effect (the Puppet effect), you will seldom need to apply the effect using the Effect menu or the Effects & Presets panel. Use the Puppet tools in the Tools panel to directly apply and work with the effect in the Layer panel or Composition panel.

The Puppet effect works by deforming part of an image according to the positions of pins that you place and move. These pins define what parts of the image should move, what parts should remain rigid, and what parts should be in front when parts overlap.

Each Puppet tool is used to place and modify a specific kind of pin:

Puppet Pin tool  Use this tool to place and move Deform pins.

Puppet Overlap tool  Use this tool to place Overlap pins, which indicate which parts of an image should appear in front of others when distortion causes parts of the image to overlap one another.

Puppet Starch tool  Use this tool to place Starch pins, which stiffen parts of the image so that they are distorted less.

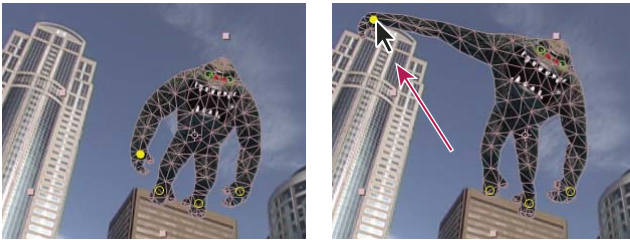

Puppet mesh created by placing Deform pins (left), and result of dragging a Deform pin

When you place the first pin, the area within an outline is automatically divided into a mesh of triangles. An outline is only visible when the Puppet effect has been applied and a Puppet tool pointer is over the area that the outline defines. (See “How the Puppet effect creates outlines” on page 230.) Each part of the mesh is also associated with the pixels of the image, so the image’s pixels move with the mesh.

Note: To show the mesh, select *Show in the Tools panel*.

When you move one or more Deform pins, the mesh changes shape to accommodate this movement, while keeping the overall mesh as rigid as possible. The result is that a movement in one part of the image causes natural, life-like movement in other parts of the image.

For example, if you place Deform pins in a person’s feet and hands and then move one of the hands to make it wave, the motion in the attached arm will be large, but the motion in the waist will be small, just as in the real world.

If a single animated Deform pin is selected, its Position keyframes are visible in the Composition panel and Layer panel as a motion path. You can work with these motion paths as you work with other motion paths, including setting keyframes to rove across time. (See “Smooth motion with roving keyframes” on page 216.)

You can have multiple meshes on one layer. This is useful for deforming several parts of an image individually—such as text characters—as well as for deforming multiple instances of the same part of an image, each with a different deformation.

The original, undistorted mesh is calculated at the current frame at the time at which you apply the effect. The mesh does not change to accommodate motion in a layer based on motion footage, nor does the mesh update if you replace a layer’s source footage item.

Note: Because the render order for continuously rasterized layers—such as shape layers and text layers—is different than the render order for raster layers, you should not animate the position or scale of a continuously rasterized layer with layer transformations if you are also animating the layer with the Puppet tools. You can precompose the shape layer and use the Puppet tools on the precomposition layer, or you can use the Puppet tools to transform the shapes within the layer. (See “Render order and collapsing transformations” on page 115 and “Continuously rasterize a layer containing vector graphics” on page 151.)

The motion created by the Puppet tools is sampled by motion blur if motion blur is enabled for the layer and the composition, though the number of samples used is half of the value specified by the Samples Per Frame value. (See “Use motion blur” on page 200.)

 You can use expressions to link the positions of Deform pins to motion tracking data, audio amplitude keyframes, or any other properties.

Aharon Rabinowitz provides a tutorial that shows a creative way to use the Puppet tools with a particle generator to simulate airflow over a car: www.adobe.com/go/learn_ae_aharonpuppetparticles.

See also

“Creating and modifying motion paths” on page 197

Manually animate an image with the Puppet tools

The stopwatch switch  is automatically set for the Position property of a Deform pin as soon as the pin is created. This means that a keyframe is set or modified each time that you change the position of a Deform pin. This is unlike most properties in After Effects, for which you must explicitly set the stopwatch switch by adding a keyframe or an expression to animate each property. The auto-animation of Deform pins makes it convenient to add them and animate them in the Composition panel or Layer panel, without manipulating the properties in the Timeline panel.

- 1 Select the layer that contains the image to animate.
- 2 Using the Puppet Pin tool , do one of the following in the Composition panel or the Layer panel:
 - Click any nontransparent pixel of a raster layer to apply the Puppet effect and create a mesh for the outline created by auto-tracing the layer's alpha channel.
 - Click within a closed path on a vector layer to apply the Puppet effect and create a mesh for the outline defined by that path.
 - Click within a closed, unlocked mask to apply the Puppet effect and create a mesh for the outline defined by the mask path.
 - Click outside all closed paths on a vector layer to apply the Puppet effect without creating a mesh. Outlines are created for paths on the layer, though an outline is only visible when a Puppet tool pointer is over the area that the outline defines. Place the pointer over the area enclosed by a path to see the outline in which a mesh will be created if you click that point. (See “How the Puppet effect creates outlines” on page 230.) Click within an outline to create a mesh.

A Deform pin is placed where you clicked to create the mesh.

Note: If an image is too complex for the Puppet effect to generate a mesh with the current Triangle value, a “Mesh Generation Failed” message appears in the Info panel. Increase the Triangle value in the Tools panel and try again.

- 3 Click in one or more places within the outline to add more Deform pins.

Use as few pins as possible to achieve your desired result. The natural deformation provided by the Puppet effect can be lost if you over-constrain the image. Just add pins to the parts of the figure that you know that you want to control. For example, when animating a person waving, add a pin to each foot to hold them to the ground, and add a pin to the waving hand.

- 4 Go to another time in the composition, and move the position of one or more of the Deform pins by dragging them in the Composition or Layer panel with the Puppet Pin tool. Repeat this step until you have completed your animation.

You can modify the Deform pins' motion paths as you would any other motion paths.

See also

“Work with pins and the distortion mesh” on page 231

“Creating and modifying motion paths” on page 197

Record animation by sketching motion with the Puppet Pin tool

You can sketch the motion path of one or more Deform pins in real time—or at a speed that you specify—much as you can sketch the motion path of a layer using Motion Sketch.

If your composition contains audio, you can sketch motion in time with the audio.

Before you begin recording motion, you may want to configure settings for recording. To open the Puppet Record Options dialog box, click Record Options in the Tools panel.

Speed The ratio of the speed of the recorded motion to playback speed. If Speed is 100%, the motion is played back at the speed at which it was recorded. If Speed is greater than 100%, the motion plays back slower than it was recorded.

Smoothness Set this value higher to remove more extraneous keyframes from the motion path as it's drawn. Creating fewer keyframes makes motion smoother.

Use Draft Deformation The distorted outline that is shown during recording does not take Starch pins into account. This can improve performance for a complex mesh.

Note: This procedure assumes that you have already placed Deform pins in the object to animate. For information on placing Deform pins, see “Manually animate an image with the Puppet tools” on page 228.

- 1 Select one or more Deform pins.
- 2 Go to the time at which to begin recording motion.
- 3 In the Composition panel or Layer panel, hold the Ctrl (Windows) or Command (Mac OS) key to activate the Puppet Sketch tool. Ctrl-drag (Windows) or Command-drag (Mac OS) the pins to animate.

Recording of motion begins when you click to begin the drag. Recording ends when you release the mouse button.

The color of the outline for the mesh for which motion is being sketched is the same as the color of the pin (yellow). Reference outlines, for other meshes on the same layer, are the color of the layer's label.

The current-time indicator returns to the time at which recording began, so that you can repeat the recording operation with more Deform pins or redo the recording operation with the same pins.

You can modify the Deform pins' motion paths as you would any other motion paths. A pin's motion path is shown only if it is the only pin selected.

 *Try creating several duplicate meshes and sketching motion for each mesh. When you have multiple meshes in the same instance of the Puppet effect, you can sketch motion for one mesh while seeing the reference outlines of the others, allowing you to follow their movements, either roughly or precisely.*

See also

“Work with pins and the distortion mesh” on page 231

“Creating and modifying motion paths” on page 197

How the Puppet effect creates outlines

When a Puppet mesh is created, its boundaries are determined by an outline, which can be defined by any of the following types of closed paths:

- An unlocked mask path
- A shape path on a shape layer
- A text character's outline

If a layer has no unlocked masks, shapes, or text characters on it when you apply the Puppet effect, it will use Auto-trace to create paths from the alpha channel. These paths are only used by the Puppet effect in the determination of outlines and do not appear as masks on the layer. If the layer is a raster layer with no alpha channel, the result is a single rectangular path around the layer's bounds. For a complex image, or to configure Auto-trace settings, use Auto-trace before using the Puppet tools. (See "Create a mask from a channel with Auto-trace" on page 256.)

A text character that consists of multiple disjoint closed paths (such as the letter *i*) is treated as multiple separate paths.

A shape or character's stroke is not used in the determination of outlines; only the path is used. To encompass a stroke within a mesh created from such items, increase the Expansion value. The default value of 3 pixels for Expansion encompasses a stroke that extends 3 pixels or less from its path.

 *Apply paint strokes to a layer using the Brush tool with the Paint On Transparent option. This creates a raster layer with only the paint strokes, defined by an alpha channel. You can then use the Puppet tools to animate the paint strokes. Do not use a mask on the layer.*

If multiple masks, shapes, or characters overlap on the same layer, an outline is created from the union of the overlapping shapes, overlapping characters, or overlapping masks. If a mask overlaps a text character or shape, outlines are created for the entire character or shape, for the portion of the character or shape that is inside the mask, and for the mask itself.

 *To distort multiple disjoint characters or shapes as one object, surround the individual objects with a mask (with mask mode set to None), and use the mask path as the outline with which to create the mesh. You can delete the mask after you have created the mesh.*



If the Puppet effect has already been applied to a layer, outlines appear with a yellow highlight as you move a Puppet tool pointer over them. You can choose the outline in which to place an initial pin to create a mesh. A mesh is created each time that you click within an outline with a Puppet tool.

If the Puppet effect has not already been applied to a layer, outlines for that layer have not yet been calculated. When you click, the Puppet effect calculates outlines and determines whether you have clicked within an outline. If so, it creates a mesh defined by the outline in which you clicked. Otherwise, you can move the pointer around the layer to select the outline in which to place a pin and create a mesh. This is very useful for seeing the outlines of various objects and choosing which outlines to use to create a mesh.



Outline for union of two shape paths, indicated by yellow highlight, visible because Puppet tool pointer is within area defined by outline

Work with pins and the distortion mesh

- To show the mesh for the Puppet effect, select Show in the options section of the Tools panel.
- To select or move a pin, click or drag it with the Move tool . To activate the Move tool, place the pointer on a pin while either the Selection tool  or the corresponding Puppet tool is active.
- To select multiple pins, Shift-click them, or use the marquee-selection tool  to drag a marquee-selection box around them. To activate the marquee-selection tool, place the pointer for a Puppet tool outside all meshes and outlines or hold the Alt (Windows) or Option (Mac OS) key.
- To select all pins of one kind (Deform, Starch, or Overlap), select one pin of that kind and press Ctrl+A (Windows) or Command+A (Mac OS).
- To delete selected pins, press the Delete key. If the pin has multiple keyframes, and only the keyframe at the current time is selected, pressing Delete will delete only that keyframe; pressing Delete again will delete the pin.
- To reset Deform pins to their original locations at the current time, click Reset for the Puppet effect in the Timeline panel or Effect Controls panel. To remove all pins and meshes from an instance of the Puppet effect, click Reset again.

 Sometimes, you want to animate an image from an initial position, through an intermediate position, and back to the initial position. Rather than manually dragging the pins back to their initial positions at the end of the animation, place the current-time indicator at the end time and click Reset. Only the keyframes at the current time are reset.

- To increase or decrease the number of triangles used in a mesh, modify the Triangle value in the options section of the Tools panel or in the Timeline panel. This modifies the value for a selected mesh or, if no mesh is selected, sets the value for meshes created later.

A higher number of triangles gives smoother results but takes longer to render. Small objects, like text characters, usually distort well with only 50 triangles, whereas a large figure may require 500. The number of triangles used may not match the Triangle value exactly; this value is a target only.

- To expand the mesh beyond the original outline, increase the Expansion property in the options section of the Tools panel or in the Timeline panel. This modifies the value for a selected mesh or, if no mesh is selected, sets the value for meshes created later. Expanding the mesh is useful for encompassing a path's stroke.
- To duplicate an object using Puppet Pin tool, click within the original outline. This creates a new mesh, with its own copy of the pixels from within the original outline. You can also duplicate a Mesh group in the Timeline panel to achieve the same result, which is sometimes easier than clicking within the original outline without clicking on the mesh to create a pin.

Puppet Overlap controls

When you are distorting one part of an image, you may want to control which parts of the image appear in front of other parts. For example, you may want to keep an arm in front of the face as you make the arm wave. Use the Puppet Overlap tool to apply Overlap pins to the parts of an object for which you want to control apparent depth.

You apply Puppet Overlap pins to the original outline, not to the deformed image.

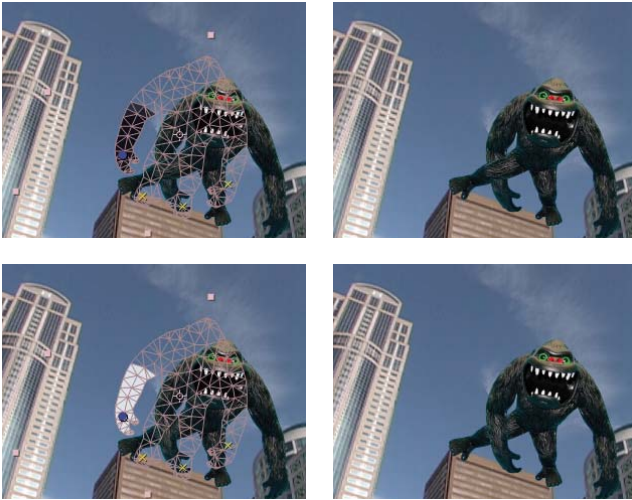

Overlap pin with positive In Front value (top), and Overlap pin with negative In Front value (bottom)

Each Overlap pin has the following properties:

In Front The apparent proximity to the viewer. The influence of Overlap pins is cumulative, meaning that the In Front values are added together for places on the mesh where extents overlap. You can use negative In Front values to cancel out the influence of another Overlap pin at a specific location.

Extent How far from the Overlap pin its influence extends. The influence ends abruptly; it does not decrease gradually with distance from the pin. Extent is indicated visually by a fill in the affected parts of the mesh. The fill is dark if In Front is negative; the fill is light if In Front is positive.

Puppet Starch controls

When you are distorting one part of an image, you may want to prevent other parts from being distorted. For example, you may want to preserve the rigidity of an arm as you move a hand to make it wave. Use the Puppet Starch tool to apply Starch pins to the part of an object that you want to keep rigid.

You apply Puppet Starch pins to the original outline, not to the deformed image.



Unwanted distortion in figure (top left) is prevented with Starch pin (upper right and lower left)

Each Starch pin has the following properties:

Amount The strength of the stiffening agent. The influence of Starch pins is cumulative, meaning that the Amount values are added together for places on the mesh where extents overlap. You can use negative Amount values to cancel out the influence of another Starch pin at a specific location.

 *If you notice image tearing near a Deform pin, use a Starch pin with a very small Amount value (less than 0.1) near the Deform pin. Small Amount values are good for maintaining image integrity without introducing much rigidity.*

Extent How far from the Starch pin its influence extends. The influence ends abruptly; it does not decrease gradually with distance from the pin. Extent is indicated visually by a pale fill in the affected parts of the mesh.

In addition to animating still images, you can use the Puppet effect on a layer with motion footage as its source. For example, you could distort the contents of the entire composition frame to match the motion of an object within the frame. In this case, consider creating a mesh for the entire layer, using the layer boundaries as the outline, and using the Puppet Starch tool around the edges to prevent the edges of the layer from distorting.

Chapter 9: Color

Color basics

Set the color depth

Color depth (or *bit depth*) is the number of bits per channel (bpc) used to represent the color of a pixel. The more bits for each RGB channel (red, green, and blue), the more colors can be represented.

In After Effects, you can work in 8-bpc, 16-bpc, or 32-bpc color.

In addition to bit depth, a separate characteristic of the numbers used to represent pixel values is whether the numbers are integers or floating-point numbers. Floating-point numbers can represent a larger range of numbers with the same number of bits. In After Effects, 32-bpc pixel values are floating-point values.

8-bpc pixels can have values for each color channel from 0 (black) to 255 (pure color). 16-bpc pixels can have values for each color channel from 0 (black) to 32,768 (pure color). If all three color channels have the maximum, pure-color value, the result is white. 32-bpc pixels can have values under 0.0 and values over 1.0 (pure color); this means that 32-bpc color in After Effects is also *high dynamic range* (HDR) color. HDR values can be much brighter than white. (See “High dynamic range color” on page 235.)

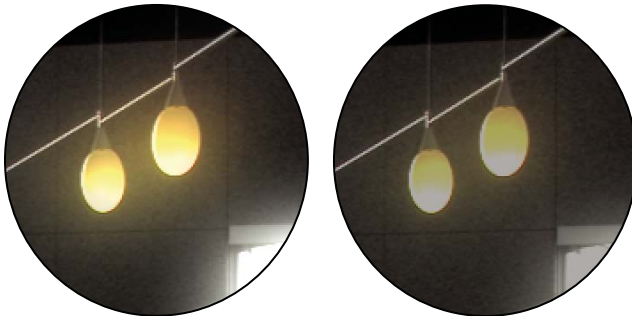

Glow effect and Gaussian Blur effect applied to image in 32-bpc project (left) and 16-bpc project (right)

Set the project color depth to 32 bpc to work with HDR footage or to work with over-range values—values above 1.0 (white) that aren’t supported in 8- or 16-bpc mode. Over-range values preserve the intensity of highlights, which is just as useful for synthetic effects such as lights, blurs, and glows as it is for working with HDR footage. The *headroom* provided by working in 32 bpc prevents many kinds of data loss during operations from color correction to color profile conversion. Even if you’re using 8-bpc footage and are creating movies in 8-bpc formats, you can obtain better results by having the project color depth set to 16 or 32 bpc. Working in a higher bit depth provides higher precision for calculations and greatly reduces quantization artifacts, such as banding in gradients.

Because 16-bpc frames use half the memory of 32-bpc frames, rendering previews in a 16-bpc project is faster, and RAM previews can be longer than in a 32-bpc project. 8-bpc frames use even less memory, but the tradeoff between quality and performance can be quite visible in some images at a project color depth of 8 bpc.

- Alt-click (Windows) or Option-click (Mac OS) the Project Settings button in the Project panel.
- Choose File > Project Settings or click the Project Settings button in the Project panel, and choose a color depth from the Depth menu.

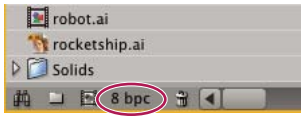

Project Settings button in the Project panel

You can specify a color depth for each render item, which overrides the project color depth when rendering for final output. You can also specify the color depth to use for each output item in the output module settings.

Though many effects can work with all color depths, some effects work only with lower color depths. You can set the Effects & Presets panel to only show effects that work with your current project color depth. (See “Effects & Presets panel overview” on page 350.)

Note: To change the format in which color values are shown in the Info panel and in some effect controls, choose an option such as Percent or Web from the Info panel menu. Choosing Auto Color Display automatically switches between 8 bpc, 16 bpc, and 32 bpc, depending on the project’s color depth.

See also

“Work with render settings” on page 597

“Work with output module settings” on page 599

High dynamic range color

The dynamic range (ratio between dark and bright regions) in the physical world far exceeds the range of human vision and of images that are printed on paper or displayed on a monitor. Low dynamic range 8-bpc and 16-bpc color values can represent RGB levels only from black to white; this represents an extremely small segment of the dynamic range in the real world.

High dynamic range (HDR), 32-bpc floating-point color values can represent brightness levels much greater than white, including objects as bright as a candle flame or the Sun.

Because we can see only a subset of the luminance values in a real-world scene in an HDR image on a monitor, it is sometimes necessary to adjust the *exposure*, or the amount of light captured in an image, when working with an HDR image. Adjusting the exposure of an HDR image is like adjusting the exposure when photographing a scene in the real world, allowing you to bring detail out of very dark areas or very bright areas.

You can use the HDR Comander effect to compress the dynamic range of a layer with an HDR footage item as its source. In this way, you can use tools that don’t support HDR, such as 8-bpc and 16-bit effects. When you’re done, use the HDR Comander to undo the dynamic range compression. The HDR Highlight Compression effect lets you compress the highlight values in an HDR image so that they fall within the value range of a low dynamic range image.

Jonas Hummelstrand’s website provides a collection of resources for understanding and using HDR color in After Effects: www.adobe.com/go/learn_ae_jonas32bpc.

See also

“Adjust exposure for previews” on page 129

“Exposure effect” on page 397

“HDR Comander effect” on page 545

“HDR Highlight Compression effect” on page 546

Select a color or edit a gradient

In many contexts, you can click an eyedropper button  to activate the eyedropper tool, or you can click a color swatch to open a color picker. If you use the Adobe Color Picker, you can also activate the eyedropper from the Adobe Color Picker dialog box.

If you click a gradient swatch for a shape layer's stroke or fill, or click Edit Gradient in the Timeline panel, the Adobe Color Picker opens as the Gradient Editor, with additional controls for editing gradients included at the top of the dialog box.

Note: The `sampleImage` expression samples the color values in a way similar to that of the eyedropper. Use this method to use color values of specific pixels as input into an expression. (See “Layer General attributes and methods” on page 570.)

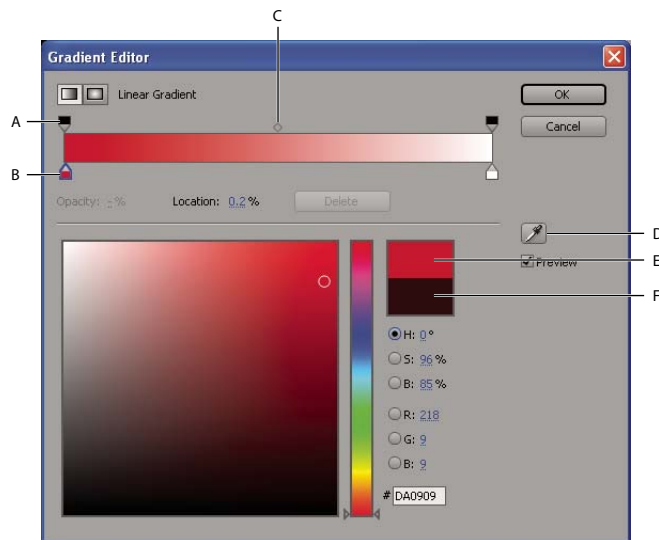

A. Opacity stop B. Color stop C. Opacity midpoint D. Eyedropper E. New-color rectangle F. Original-color rectangle

Choose a color picker

❖ Choose Edit > Preferences > General (Windows) or After Effects > Preferences > General (Mac OS), and do one of the following:

- To use the color picker provided by the operating system, select Use System Color Picker.
- To use the Adobe Color Picker, deselect Use System Color Picker.

Select a color with the eyedropper tool

1 Click the eyedropper button, and move the pointer to the pixel that you want to sample. The color swatch next to the eyedropper button dynamically changes to the color under the eyedropper.

2 Do one of the following:

- To select the color of a single pixel, click the pixel.
- To sample the color average of a 5-pixel-by-5-pixel area, Ctrl-click (Windows) or Command-click (Mac OS) the area.



Press the Escape key to deselect the eyedropper.

Select a color with the Adobe Color Picker

1 Click a color swatch to display the Adobe Color Picker.

2 (Optional) To prevent panels from updating with the results of your color selection until you accept the color by clicking OK, deselect Preview in the Color Picker dialog box. The Preview option is not available in all contexts.

Note: Selecting Preview is convenient for seeing the results of your color selections before you commit them, but it can also decrease performance, as new images are rendered for the preview in the Composition panel or Layer panel.

3 Select the component you want to use to display the color spectrum:

H Displays all hues in the color slider. Selecting a hue in the color slider displays the saturation and brightness range of the selected hue in the color spectrum, with the saturation increasing from left to right and brightness increasing from bottom to top.

S Displays all hues in the color spectrum with their maximum brightness at the top of the color spectrum, decreasing to their minimum at the bottom. The color slider displays the color that's selected in the color spectrum with its maximum saturation at the top of the slider and its minimum saturation at the bottom.

B (in the HSB section) Displays all hues in the color spectrum with their maximum saturation at the top of the color spectrum, decreasing to their minimum saturation at the bottom. The color slider displays the color that's selected in the color spectrum with its maximum brightness at the top of the slider and its minimum brightness at the bottom.

R Displays the red color component in the color slider with its maximum brightness at the top of the slider and its minimum brightness at the bottom. When the color slider is set to minimum brightness, the color spectrum displays colors created by the green and blue color components. Using the color slider to increase the red brightness mixes more red into the colors displayed in the color spectrum.

G Displays the green color component in the color slider with its maximum brightness at the top of the slider and its minimum brightness at the bottom. When the color slider is set to minimum brightness, the color spectrum displays colors created by the red and blue color components. Using the color slider to increase the green brightness mixes more green into the colors displayed in the color spectrum.

B (in the RGB section) Displays the blue color component in the color slider with its maximum brightness at the top of the slider and its minimum brightness at the bottom. When the color slider is set to minimum brightness, the color spectrum displays colors created by the green and red color components. Using the color slider to increase the blue brightness mixes more blue into the colors displayed in the color spectrum.

4 Do any of the following:

- Drag the triangles along the color slider, or click inside the color slider to adjust the colors displayed in the color spectrum.
- Click or drag inside the large square color spectrum to select a color. A circular marker indicates the color's position in the color spectrum.

Note: As you adjust the color using the color slider and color spectrum, the numeric values change to indicate the new color. The top rectangle to the right of the color slider displays the new color; the bottom rectangle displays the original color. Click the bottom rectangle to reset the color to the original color.

- For HSB, specify hue (H) as an angle, from 0° to 360°, that corresponds to a location on the color wheel. Specify saturation (S) and brightness (B) as percentages (0 to 100).
- For RGB, specify component values. You can set colors to under-range and over-range values (outside of the range of 0.0 to 1.0) in an HDR project.
- For #, enter a color value in hexadecimal form. This color format is common in web workflows.

Edit a gradient

A gradient is defined by *color stops* and *opacity stops*. Each stop has a location along the gradient and a value for color or opacity. The values between stops are interpolated. By default, the interpolation is linear, but you can drag the opacity midpoint or color midpoint between two stops to alter the interpolation.

- To add a color stop or opacity stop, click below or above the gradient bar in the Gradient Editor dialog box.
- To remove a stop, drag it away from the gradient bar, or select the stop and click Delete.
- To edit a stop's value, select it and adjust the Opacity value or use the Adobe Color Picker controls beneath the gradient editor controls.
- To choose a gradient type, click the Linear Gradient or Radial Gradient button in the upper-left corner of the Gradient Editor dialog box.

Note: Use the *Style property* to choose a gradient type for the *Gradient Overlay layer style*.

About color correction and adjustment

When you assemble a composition, you often need to adjust the colors of one or more of the layers to correct their colors. Such adjustments can be for any of a number of reasons. Some examples:

- You need to make it seem as if multiple footage items were shot under the same conditions so that they can be composited or edited together.
- You need to adjust the colors of a shot so that it seems to have been shot at dusk instead of noon.
- You need to adjust the exposure of an image to recover detail from the over-exposed highlights.
- You need to enhance one color in a shot because you will be compositing a graphic element over it with that color.
- You need to restrict colors to a particular range, such as the broadcast-safe range.

After Effects includes many built-in effects for color correction. See “Color Correction effects” on page 387.

The Color Finesse plug-in included with After Effects includes excellent color-correction tools. For more information, see the Color Finesse documentation in the following folder: Adobe After Effects CS3/Additional Documentation/Color Finesse 2.

The Camera Raw plug-in can be used to correct and adjust still images in JPEG, TIFF, and various camera raw formats.

John Dickinson provides visual aids on his website that illustrate how to use the Curves and Levels effects for color adjustments: www.adobe.com/go/learn_ae_jdcurves and www.adobe.com/go/learn_ae_jdlevels.

See also

“Introduction to Camera Raw” on page 86

“Broadcast-safe colors” on page 250

About color spaces

A *color model* is a way of describing color using numbers so that computers can operate on them. The color model used within After Effects is the RGB color model, in which each color is described in terms of amounts of red, green, and blue light added together to make the color. Other color models include CMYK, HSB, Y'CbCr, and XYZ.

A *color space* is a variant of a color model. A color space is distinguished by a *gamut* (range of colors), a set of primary colors (*primaries*), a *white point*, and a *tone response*. For example, within the RGB color model are a number of color spaces, including—in decreasing order of gamut size—ProPhoto RGB, Adobe RGB, sRGB IEC61966-2.1, and Apple RGB. Although each of these color spaces defines color using the same three axes (R, G, and B), their gamuts and tone response curves are different.

Harry Frank provides a video tutorial that shows how and why to use color conversion expressions to convert colors from RGB to HSL when randomly varying colors; the specific example that he shows uses the Radio Waves effect: www.adobe.com/go/learn_ae_harryrgb2hsl.

Though many devices use red, green, and blue components to record or express color, the components have different characteristics—for example, one camera's blue is not exactly the same as another camera's blue. Each device that records or expresses color has its own color space. When an image moves from one device to another, image colors may look different because each device interprets the RGB values in its own color space.

Color management uses color profiles to convert colors from one color space to another, so colors look the same from one device to another.

For information on color spaces and color management in After Effects, go to the Adobe website at www.adobe.com/go/learn_ae_colormanagementpaper.

See also

“Color management” on page 241

About gamma and tone response

A color space's *tone response* is the relationship of light intensity to the signal that creates or records (perceives) the light.

The human visual system does not respond linearly to light. In other words, our perception of how bright a light is does not double when twice as many photons hit our eyes. Similarly, a CRT monitor's display elements do not emit light that is twice as bright when a voltage twice as great is applied. The relationship of light intensity to signal intensity for a display device is expressed by a power function. The exponent of this power function is called *gamma*. The relationship of light intensity to signal intensity for an input device is the inverse of the relationship for an output device, though the gamma values may differ for input and output devices to accommodate the difference between scene lighting and lighting of the viewing environment.

Raising any number to the power of 1 gives the original number as a result. A gamma of 1.0 is used to express the behavior of light in the natural world, outside the context of our nonlinear perceptual systems. A system with gamma of 1.0 is sometimes said to operate in *linear light*, whereas a system encoded with a gamma other than 1.0 to match the human visual system is said to be *perceptual*.

Note: Moving the midtone slider (such as the Levels effect's Gamma control) in a color-correction histogram has the same result as modifying gamma, changing the tone response curve without moving the white point. Modifying the curve in the Curves effect also modifies tone response, but not necessarily with a gamma curve.

If you have enabled color management (by specifying a working color space), you can perform all color operations in linear light by linearizing the working color space. A linearized color space uses the same primaries and white point as the nonlinear version; the tone response curve is just made straight.

If you have not enabled color management, you can still perform blending operations using a gamma of 1.0.

The gamma value for an entire system—from capture, through production, to display in the viewing environment—is the product of the gamma values used for each of the phases in the system. This product is not always 1.0, as it would be if the operations performed for encoding exactly matched (inverted) the operations performed for decoding. One reason for a system gamma other than 1.0 is that there is often a difference between the lighting conditions in which a scene is captured and the lighting conditions in which it is viewed. (Consider that you usually watch a movie in a dim environment, but the scenes aren't normally shot in a dim environment.)

For example, the *device gamma* for an HD camera is approximately 1/1.9, and the device gamma for an HD display is approximately 2.2. Multiplying these values gives a *system gamma* of approximately 1.15, which is appropriate for the somewhat dim television viewing conditions of a typical living room. The system gamma for motion picture production is much higher (approximately 1.5–2.5) to accommodate the darker viewing environment of a movie theater. The gamma for the film negative is approximately 1/1.7, and the gamma for the projection film is approximately 3–4.

QuickTime and gamma in non-color-managed projects

After Effects 7.0 and earlier used QuickTime codecs to decode several kinds of media, and the gamma adjustments performed by QuickTime on Windows were different from the gamma adjustments performed on Mac OS. The gamma adjustments performed by After Effects CS3 differ from the gamma adjustments performed by these QuickTime codecs. Gamma adjustments performed by After Effects CS3 on Windows are the same as gamma adjustments performed by After Effects CS3 on Mac OS. Also, by not using QuickTime codecs, After Effects preserves over-range values in 32-bpc projects.

Select Match Legacy After Effects QuickTime Gamma Adjustments in the Project Settings dialog box to accomplish any of the following:

- Avoid color shifts when working with projects created in After Effects 7.0 or earlier
- Match the colors in a project created in After Effects 7.0 or earlier
- Ensure that colors in Composition panel match colors in QuickTime player

The Match Legacy After Effects QuickTime Gamma Adjustments option is selected by default for projects created in After Effects 7.0 or earlier. You should create new projects without this option selected.

Note: On Mac OS running on a PowerPC processor, QuickTime codecs are used for some formats (including DV, 2vuy, and v210), whether or not you select Match Legacy After Effects QuickTime Gamma Adjustments. However, selecting this option does modify the gamma adjustments used so that they match the behavior of After Effects 7.0 and earlier.

Important: Install the most recent updates for After Effects CS3. Versions 8.0.0 and 8.0.1 of After Effects CS3 do not correctly export data for some QuickTime RGB codecs.

For current and detailed information on issues related to QuickTime Player and gamma adjustments, go to the Adobe website at www.adobe.com/go/learn_ae_quicktimegamma.

Mark Christiansen has a blog post about QuickTime and gamma: www.adobe.com/go/learn_ae_markquicktimegamma.

See also

“Linearize working space and enable linear blending” on page 244

Color management

Why you should use color management

To see a video tutorial on color management in After Effects, go to the Adobe website at www.adobe.com/go/vid0260.

For step-by-step instructions on using color management to create movies for Flash, HDTV, motion-picture film, and other common media, go to the Adobe website at www.adobe.com/go/learn_ae_colormanagementpaper.

Color management provides many benefits, including the following:

- The colors in imported images appear as the creators of the images intended.
- You have more control over how colors are blended within your project, for everything from motion blur to anti-aliasing.
- The movies that you create will look as you intend when viewed on devices other than your computer monitor.

If you don't enable color management for your project, then the colors in your composition are dependent on the color characteristics of your monitor: the colors that you see are the colors that your monitor displays based on RGB numbers in your footage items. Because different color spaces use the same RGB numbers to represent different colors, the colors that you see and composite may not be the colors that the creator of the footage intended. In fact, the colors may be very far from the intended colors.

By setting a working color space for the project (which enables color management), you do two things:

- You define a common color space for compositing and other color operations.
- You control the appearance of colors in your composition.

If a footage item has an embedded color profile (for example, the footage item is a Photoshop PSD file), then the colors intended by the person who created the image can be accurately reproduced in your composition. The color profile contains the information that determines how to convert the RGB numbers in the image file into a device-independent color space; the monitor's color profile can then be used to determine which RGB numbers in your monitor's color space represent the colors intended for the footage item. This becomes even more important as you import footage items with many different color profiles, from many different sources.

The color conversion process takes no effort on your part. The colors simply appear on your monitor just like they appeared when the image was created. Your monitor may, of course, have a limited gamut compared to the color space that you choose for the working space, and colors can be clipped when displayed on the monitor. However, you still have the full range of color data in your project, and the colors are not clipped internally.

When you are ready to output your composition, you can use color management to transform your colors into the space appropriate for your output media. At this stage, you are preserving the appearance of colors as you intend them to look.

 *Be sure to read the helpful text in the Interpret Footage, Project Settings, and Output Module Settings dialog boxes. This text helps you to understand the color conversions that will be done as you interpret footage, composite, and output rendered movies.*

See also

“About color spaces” on page 238

Color management and color profiles

Color information is communicated using numbers. Because different devices use different methods to record and display color, the same numbers can be interpreted differently and appear to us as different colors. A color management system keeps track of all of these different ways of interpreting color and translates between them so that images can look the same regardless of the device used to display them.

In general, a color profile is a description of a device-specific color space in terms of the transformations required to convert its color information to a device-independent color space.

In the specific case of working within After Effects, ICC color profiles are used to convert to and from the working color space in the following general workflow:

- 1 An input color profile is used to convert each footage item from its color space into the working color space. A footage item may contain an embedded input color profile, or you can assign the input color profile in the Interpret Footage dialog box or interpretation rules file.
- 2 After Effects performs all of its color operations in the working color space. You assign a working color space in the Project Settings dialog box.
- 3 Colors are converted from the working color space to the color space of your computer monitor through the monitor profile. This means that your composition will look identical on two different monitors, as long as the monitors have been properly profiled. This conversion does not change the data within the composition. You can choose whether to convert colors for your monitor using the View > Use Display Color Management menu command.
- 4 Optionally, After Effects uses a simulation profile to show you on your computer monitor how the composition will look in its final output form on a different device. You control output simulation for each view through the View > Simulate Output menu.
- 5 An output color profile for each output module is used to convert the rendered composition from the working color space to the color space of the output medium. You choose an output color profile in the Output Module Settings dialog box.

The file format for color profiles is standardized by the ICC (International Color Consortium), and the files that contain them usually end with the .icc filename extension. After Effects comes with a large number of color profiles for color spaces for common (and some not so common) input and output types.

For information on color profiles, see the International Color Consortium website at www.color.org.

After Effects loads color profiles from multiple locations, including the following:

- Mac OS: Library/ColorSync/Profiles
- Windows: WINDOWS\system32\spool\drivers\color

When you create or install new profiles, put them in these folders. You can create a custom ICC profile using Adobe Photoshop.

When you choose a profile—for input, output, or simulation—you will not see the motion-picture film profiles unless your footage is Cineon footage or you select Show All Available profiles. If your footage is Cineon footage, you will see only the motion-picture film profiles, unless you select Show All Available Profiles. The DPX Theater Preview and DPX Standard Camera profiles provided by After Effects 7 for use with the Proof Colors command have been replaced by the Kodak 2383 and Kodak 5218 profiles used with the Simulate Output command. Proof Colors has been replaced by Output Simulation. (See “Simulate how colors will appear on a different output device” on page 248.) If you open an After Effects 7 project that uses DPX Scene and DPX Theater color profiles in the Color

Profile Converter effect, After Effects CS3 will not automatically update these profiles to the new equivalent profiles (Kodak 5218/7218 Printing Density and Kodak 2383 Theater Preview). Instead, the profiles will be listed as Embedded. You can convert your project by manually assigning the new profiles in After Effects CS3. However, if the same profiles were assigned to the footage or selected in Proof Colors in After Effects 7, they will be automatically updated to the new profiles in After Effects CS3.

Note: *The NTSC (1953) color profile corresponds to obsolete television equipment and should not be used. For standard-definition NTSC television, use one of the SDTV NTSC color profiles.*

 *Make sure that your work environment provides a consistent light level and color temperature. For example, the color characteristics of sunlight change throughout the day, which can alter the way colors appear on your screen, so keep shades closed or work in a windowless room.*

All color profiles used in a project are saved in the project, so you do not need to manually transfer color profiles from one system to another to open the project on another system.

See also

“Interpret footage items” on page 51

Calibrate and profile your monitor

When you calibrate your monitor, you’re adjusting it so that it conforms to a known specification. After your monitor is calibrated, the profiling utility lets you save a color profile. The profile describes the color behavior of the monitor—what colors can be reproduced on the monitor and how the color values in an image must be converted so that colors are displayed accurately.

Note: *Monitor performance changes and declines over time; recalibrate and profile your monitor every month or so. If you find it difficult or impossible to calibrate your monitor to a standard, it may be too old and faded.*

- 1 Make sure that your monitor has been turned on for at least half an hour. This gives it sufficient time to warm up and produce more consistent output.
- 2 Make sure that your monitor is displaying millions of colors (24 bits per pixel) or higher.
- 3 If you do not have profiling software that uses a hardware measuring device, remove colorful background patterns on your monitor desktop and set your desktop to display neutral grays. Busy patterns or bright colors surrounding a document interfere with accurate color perception.
- 4 Do one of the following to calibrate and profile your monitor:
 - For best results, use third-party software and measuring devices. In general, using a measuring device such as a colorimeter along with software can create more accurate profiles because an instrument can measure the colors displayed on a monitor far more accurately than the human eye can.

Most profiling software automatically assigns the new profile as the default monitor profile. For instructions on how to manually assign the monitor profile, refer to the Help system for your operating system.

- In Mac OS, use the Calibrate utility, located in the System Preferences > Displays > Color tab.

Choose a working color space and enable color management

You turn color management on for a project by choosing a working color space (Working Space) in the Project Settings dialog box. You control color management for each footage item with the Interpret Footage dialog box or interpretation rules file. You control color management for each output item in the Output Module Settings dialog box.

If Working Space is set to None in the Project Settings dialog box, color management is off for the project.

Choosing a working color space is an essential step in managing color in a project. Footage items' colors are converted into the working color space as a common color space for compositing.

For best results, when working with 8-bpc color, match the working color space to the output color space. If you are outputting to more than one output color space, you should set the project color depth to 16 or 32 bpc, at least for rendering for final output. The working color space should match the output color space that has the largest gamut. For example, if you plan to output to Adobe RGB and sRGB, then use Adobe RGB as your working color space, because Adobe RGB has a larger gamut and can therefore represent more saturated colors. To preserve over-range values, work in 32-bpc color for its high dynamic range.

Suggestions for color working space choices:

- SDTV NTSC or SDTV PAL is a good choice if you're making a movie for standard-definition broadcast television, including standard-definition DVD.
- HDTV (Rec. 709) is a good choice if you're making a movie for high-definition television. This color space uses the same primaries as sRGB, but it has a larger gamut, so it makes a good working space for many kinds of work.
- ProPhoto RGB with a linear (1.0) gamma is a good choice for digital cinema work.
- sRGB IEC61966-2.1 is a good choice if you're making a movie for the Web, especially cartoons.

The color spaces available in After Effects vary based on the color profiles installed on your computer.

- 1 Choose File > Project Settings.
- 2 Choose a working color space from the Working Space menu.

Previews sent to an external video monitor are not color managed. The color values sent to the video monitor are from the project's working color space. To preview video colors, choose a value for Working Space in the Project Settings dialog box that matches the color space of the preview device.

Similarly, colors in a composition sent to Adobe Premiere Pro or Encore using Dynamic Link are in the After Effects project's working color space. To manage colors in a dynamically linked composition, create a new composition and nest your composition within it; then apply the Color Profile Converter effect to the containing composition, with Input Profile set to Project Working Space.

See also

"About color spaces" on page 238

"Set the color depth" on page 234

Linearize working space and enable linear blending

If you have enabled color management (by specifying a working color space), you can perform all color operations in linear light by linearizing the working color space. A linearized color space uses the same primaries and white point as the nonlinear version; it just doesn't use a tone response curve. (See "About gamma and tone response" on page 239.)

If you have not enabled color management, you can still perform blending operations using a gamma of 1.0.

By performing operations in a linear color space, you can prevent certain edge and halo artifacts, such as the fringing that appears when high-contrast, saturated colors are blended together. Many color operations benefit from working in a linear color space, including those involved in image re-sampling, blending between layers with blending modes, motion blur, and anti-aliasing.

Stu Maschwitz's blog has several posts that are useful for learning about how, when, and why to work in a linear color space versus a non-linear color space. In this post, he lists several categories of color operations and whether they should be performed in a linear or non-linear working color space: www.adobe.com/go/learn_ae_stuloglin.

If you want to use a linearized working color space, do so when you set up the project, instead of switching later. Otherwise, colors chosen in the color picker will change when you switch to a linear working color space, because colors inside After Effects are interpreted to be in the working color space.

Note: A linearized working color space works best with higher color depths, 16 bpc and 32 bpc, and is not recommended for 8 bpc color.

❖ Choose File > Project Settings, and do one of the following:

- To linearize the working color space, choose Linearize Working Space.
- To blend colors in a linear color space, choose Blend Colors Using 1.0 Gamma. This affects only blending between layers. The result is that opacity fades, motion blur, and other features that rely on blending modes are affected.

See also

“Blending modes” on page 163

Interpret a footage item by assigning an input color profile

You control color management for each footage item using the Interpret Footage dialog box.

You can prevent the conversion of colors into the working color space for a single footage item by selecting Preserve RGB in the Color Management tab of the Interpret Footage dialog box. This option preserves RGB numbers; color appearance is not preserved. Turning off color management for a specific footage item is useful when the footage item is not intended for visual display, but is instead intended for use as a control layer—for example, a displacement map.

The input color profile determines what calculations are performed when converting the footage item's colors into the project's working color space. If a working space has not been set—that is, if color management is not on for the project—then you cannot assign an input color profile.

In some cases, files that you import will have ICC profiles embedded in them. When you import these files, you can be confident that the colors that you see are as the producer of the footage originally intended. After Effects can read and write embedded color profiles for Photoshop (PSD), TIFF, PNG, and JPEG files.

If a footage item does not have an embedded color profile, you can assign an input color profile using the Interpret Footage dialog box or by adding or modifying a rule in the interpretation rules file (interpretation.rules.txt). After Effects interprets the footage item as if the source footage was created using this color profile, so be certain to assign a profile that matches (or at least approximates) that used to create the source footage.

Non-RGB footage items (e.g., CMYK, Y'CbCr, and camera raw images) cannot be assigned an input profile. Their native color space is displayed in the Interpret Footage dialog box. Conversion of non-RGB color values to RGB color values is handled automatically for each format.

If you don't assign an input color profile, and After Effects doesn't have a rule in the interpretation rules file with which to make an interpretation, the footage item's colors are assumed to be in the project's working color space.

When color management is enabled, a footage item's input color profile is shown in the information area at the top of the Project panel.

The Interpret As Linear Light option determines whether the assigned input color profile is interpreted as being linear (gamma equals 1.0). This option also works when color management is turned off for the project. (See “About gamma and tone response” on page 239.)

- 1 Select a footage item in the Project panel.
- 2 Choose File > Interpret Footage > Main.
- 3 In the Color Management tab of the Interpret Footage dialog box, choose a value from the Assign Profile menu. If you don't see the profile that you want in the Assign Profile menu, select Show All Available Profiles.
- 4 Read the information in the Description area of the dialog box to confirm that the conversion is the one that you want, and click OK.

See also

“Interpret footage items” on page 51

“Introduction to Camera Raw” on page 86

Assign an output color profile

You control color management for each output item using the Output Module Settings dialog box.

Important: When you export to Flash SWF format, you use the Export menu, not the Render Queue panel, so the output module settings are not available for this output type. If color management is enabled for the project, After Effects automatically converts colors from the project's working color space to the sRGB IEC61966-2.1 color space when exporting to SWF.

You can prevent the conversion of colors from the working color space for a single output item by selecting Preserve RGB in the Color Management tab of the Output Module Settings dialog box. This option preserves RGB numbers; color appearance is not preserved. Turning off color management for a specific footage item is useful when the footage item is not intended for visual display, but is instead intended for use as a control layer—for example, a displacement map.

The output color profile for a render item determines what calculations are performed when converting a rendered composition's colors from the project's working color space to the color space for the output medium. If a working space has not been set—that is, if color management is not on for the project—then you cannot assign an output color profile.

For example, after creating a movie in an HDTV (Rec. 709) working color space for output to film, you likely want to output to a log-encoded Cineon/DPX color space using a film output color profile. If, on the other hand, you're creating a movie for high-definition television, you should choose an HDTV (Rec. 709) output profile.

A render item's output color profile is part of an output module and is displayed in the output module group in the Render Queue panel. You can assign multiple output modules to one render item, each with its own output color profile, allowing you to create output movies for various media from one rendered movie.

The Convert To Linear Light option determines whether the colors are output to a linear color profile (gamma equals 1.0). It is seldom a good idea to output to linear light for 8-bpc or 16-bpc color, so the default setting for Convert To Linear Light is On For 32 bpc. (See “About gamma and tone response” on page 239.)

Some file formats—such as Photoshop (PSD), PNG, TIFF, and JPEG—allow for the embedding of a color profile. If you embed a color profile in an output file, then you can be more certain that programs that use the file will correctly interpret its color information.

After Effects chooses a rendering intent based on the output color profile that you choose. For most output types, the rendering intent is relative colorimetric (with black point compensation); for output to film negative, the rendering intent is absolute colorimetric.

- 1 Click the underlined text next to the render item's Output Module heading in the Render Queue panel.
- 2 In the Color Management tab of the Output Module Settings dialog box, choose a value from the Output Profile menu:
sRGB IEC61966-2.1 For display in web browsers and other web-based environments.

SDTV NTSC or SDTV PAL For display on standard-definition television. If luma levels are not adjusted by the codec you are using, choose a 16-235 profile to compress luma levels.

Kodak 5218/7218 Printing Density For film-out corresponding to the scene capture of Kodak 5218 camera negative film.

If you don't see the profile that you want in the Output Profile menu, select Show All Available Profiles. This option shows the motion-picture film color profiles.

- 3 Read the information in the Description area of the dialog box to confirm that the conversion is the one that you want, and click OK.

See also

"Work with output module settings" on page 599

"Render and export a movie using the render queue" on page 590

Enable or disable display color management

When color management is on, the default behavior is for RGB pixel values to be converted to your computer monitor's color space from the project's working color space. Color appearance is preserved; RGB numbers are not preserved. This is adequate for most uses, but you sometimes need to see how the colors are actually going to look when viewed through a system that does not use color management. For example, you may need to see how the colors will appear when viewed in a web browser.

When display color management is off, the RGB color values are sent directly to your monitor, without any conversion through the monitor profile. RGB numbers are preserved; color appearance is not preserved.

When display color management is on for a viewer, a yellow plus sign appears in the Show Channel  button at the bottom of the viewer.

For each viewer (Composition, Layer, or Footage panel), you can choose whether to manage display colors, which involves the conversion of colors from the working color space to the monitor's color space.

- 1 Activate a Composition, Layer, or Footage panel.
- 2 Do one of the following to toggle between enabling and disabling display color management:
 - Choose View > Use Display Color Management.
 - Press Shift+/- (on the numeric keypad).

Output simulation settings (including No Output Simulation) are remembered.

See also

"Work with viewers" on page 19

"Previewing" on page 120

Simulate how colors will appear on a different output device

Often, you need to preview how a movie will appear on a device other than your computer monitor. One purpose of color management is to ensure that colors look the same on every device, but color management in After Effects can't overcome scenarios like the following:

- An output device for which you're creating your movie has a smaller gamut than your project's working color space, so the device is unable to represent some colors.
- The colors in your movie are displayed by a device or software that does not use color management to convert colors.

For example, when you are creating a movie on Windows, you may want to see how the movie will look on Mac OS without color management. (Colors tend to look lighter on computer systems running Mac OS.) An even more extreme example: When you are creating a movie using a computer monitor and a high-definition video monitor, you may need to see how the movie will look when transferred to a specific film stock and projected under standard theater viewing conditions.

In situations like these, you'll want to preview how colors will appear when they're displayed on a device other than your computer monitor. Output simulation requires display color management.

During output simulation, colors are converted from the project's working color space to the monitor's color space through the following flow:

1. Colors are converted from project's working color space to output color space. Colors are converted from the working color space to the color space of the output type using the output color profile (the same profile that will be used for rendering to final output).

2. Colors are converted from output color space to simulated playback device's color space. If Preserve RGB is not selected, colors are converted from the output color space to the color space of the presentation medium using the simulation profile. This presumes that the simulated device also performs color management and will convert colors for display. Color appearance is preserved; RGB numbers are not preserved.

If Preserve RGB is selected, the color values are not converted in this step. Instead, the numerical RGB color values are preserved and are re-interpreted to be in the color space of the simulated device. One use of this simulation is to see how a movie will look when played back on a device other than the one for which it was intended or a device that does not perform color management.

Note: Preserve RGB is also used when simulating the combination of a capture film stock and a print film stock.

3. Colors are converted from simulated playback device's color space to your monitor's color space Colors are converted from the presentation device color space to the color space of your computer monitor using the monitor profile.

When you create an output simulation preset, you can choose a profile to use for each of these steps.

 *Even if you're using a preset output simulation, you can choose the Custom option in the View > Simulate Output menu after selecting the preset to see a representation of which color conversions and reinterpretations are occurring for that simulation type.*

Output simulation applies only to a specific viewer (Composition, Layer, or Footage panel) and works only for previews. Color conversions for output simulation are performed when values are sent to the display. Actual color numbers in the project are not changed.

As with all color space conversions, simulating output decreases performance somewhat, so you may not want to simulate output when performing tasks that require real-time interaction.

Note: Merely applying the correct profiles can't compensate for different color gamuts for different devices. For example, common LCD monitors do not have the gamut necessary to fully simulate HDTV output.

You can press Shift+/ (on the numeric keypad) to turn display color management on or off. Turning display color management off also turns output simulation off. Simulation settings (including No Output Simulation) are remembered.

See also

“Previewing” on page 120

“Color Profile Converter effect” on page 543

Simulate output for previews

1 Activate a Composition, Layer, or Footage panel.

2 Choose View > Simulate Output, and choose an output type to simulate.

Note: Output simulation relies on display color management, which is on by default. If display color management is off, choose View > Use Display Color Management.

No Output Simulation Display color management is on, but no conversion is performed to simulate an output type.

Macintosh RGB Show how colors will appear when displayed by a non-color managed application on a Macintosh computer (with a gamma of 1.8). This option is not available if Linearize Working Space is selected.

Windows RGB Show how colors will appear when displayed by a non-color managed application on Windows (with a gamma of 2.2). This option is not available if Linearize Working Space is selected.

Kodak 5218 To Kodak 2383 Show how colors will appear when output to the Kodak 5218 negative film stock and then projected from Kodak 2383 positive film stock in a theater environment.

Note: The DPX Theater Preview and DPX Standard Camera profiles provided by After Effects 7.0 for use with the Proof Colors command have been replaced by the Kodak 2383 and Kodak 5218 profiles used with the Simulate Output command.

Custom If you don't see an entry for the output type that you want to simulate, you can create your own output simulation preset by choosing Custom. You can specify a profile to use for each of the conversion or reinterpretation steps.

- To preview how a movie will look if you output the movie to a device and view it on that device, use the same value for Output Profile and Simulation Profile.
- To preview how a movie will look if you output the movie to one device and then view it on another, color-managed device, use different values for Output Profile and Simulation Profile, and deselect Preserve RGB.
- To preview how a movie will look if you output the movie to one device and view it on another device, use different values for Output Profile and Simulation Profile, and select Preserve RGB.

You can choose an output simulation preset for each view. Custom output simulation settings are shared between all views.

Simulate an output type in a movie rendered for final output

Color management for output simulation is only for previews, but you can render a movie with a look that simulates a particular output type. For example, you can render a movie for HDTV that simulates a film appearance. This is especially useful for creating dailies when doing film work.

- 1 Choose Layer > New > Adjustment Layer to create a new adjustment layer at the top of your composition.
- 2 Choose Effect > Utility > Color Profile Converter to apply the Color Profile Converter to the adjustment layer.
- 3 Choose Edit > Duplicate to duplicate the effect.
- 4 In the Effect Controls panel, set the following options for the first instance of the effect:

Input Profile Project Working Space

Output Profile The type of output to simulate; for example, a film printing density profile, such as Kodak 5218/7218 Printing Density

Intent Absolute Colorimetric

- 5 In the Effect Controls panel, set the following options for the second instance of the effect:

Input Profile The type of playback to simulate; for example, a theater preview profile

Output Profile The color space of the output medium; for example HDTV (Rec. 709)

Intent Relative Colorimetric

To enable and disable this kind of output simulation, you can turn the adjustment layer on and off by selecting and deselecting its Video switch in the Timeline panel.

Broadcast-safe colors

Analog video signal amplitude is expressed in IRE units (or volts in PAL video). Values between 7.5 and 100 IRE units are considered *broadcast-safe*; colors in this range do not cause undesired artifacts such as audio noise and color smearing. (In practice, some spikes over 100 IRE are legal, but for simplicity 100 IRE is considered the legal maximum here.) This range of 7.5-100 IRE is equivalent to a range from black to white of 64-940 in 10-bpc values for Y' in Y'CbCr, which corresponds to 16-235 in 8-bpc values. Therefore, many common video devices and software systems interpret 16 as black and 235 as white, instead of 0 and 255. These numbers don't directly correspond to RGB values.

If you notice that colors of imported footage look wrong—blacks don't look black enough, and whites don't look white enough—make sure that you've assigned the correct input color profile. The common video color profiles included with After Effects include variants that account for these limited ranges, such as the HDTV (Rec. 709) 16-235 color profile, which interprets 16 as black and 235 as white.

Note: Some video cards and encoders assume that output is in the range 0-255, so limiting colors in your composition and rendered movie may be redundant and lead to an undesired compression of the color range. If colors of your output movie look dull, try assigning an output color profile that uses the full range of colors.

You can use the Broadcast Colors effect to reduce luminance or saturation to a safe level, but the best way to limit output colors to the broadcast-safe range is to create your composition to not use colors out of this range. Keep the following guidelines in mind:

- Avoid pure black and pure white values.
- Avoid using highly saturated colors.
- Render a test movie and play it on a video monitor to ensure that colors are represented accurately.

The Color Finesse plug-in included with After Effects includes excellent tools that can help you keep your colors within the broadcast-safe range. For more information, see the Color Finesse documentation in the folder containing the Color Finesse plug-in.

Note: After Effects 7.0 had an Expand ITU-R 601 Luma Levels option in the Interpret Footage dialog box. When opened in After Effects CS3 or later, footage items in projects created with this option will have a corresponding assigned profile.

Working with Cineon footage items

A common part of the motion-picture film production workflow is scanning the film and encoding the frames into the Cineon file format. The DPX (Digital Picture Exchange) format is a standard format closely related to the Cineon format.

Cineon data is stored in a logarithmic format, with each color channel taking up 10 bits.

Stu Maschwitz has a blog post that goes into some of the finer details of what it means to say that Cineon files' color values are in a logarithmic color space: www.adobe.com/go/learn_ae_stucineonlog.

Cineon data has a 10-bit white point of 685 and a 10-bit black point of 95. Values above 685 are retained, but are treated as highlights. Rather than abruptly clipping highlights to white, After Effects interprets highlights using a gradual ramp defined by the Highlight Rolloff value. You can modify the 10-bit white point and 10-bit black point input levels and the output (converted) white point and black point levels to match your specific footage items or creative needs.

Use a project color depth of 32 bpc when working with Cineon footage items so that highlights are preserved, in which case you don't need to roll off the highlights.

There are three basic ways of working with Cineon footage items in After Effects:

- The easiest—and recommended—way is to enable color management and assign an input color profile to a Cineon footage item in the Color Management tab of the Interpret Footage dialog box, corresponding to the film stock on which the footage was recorded. Of course, if creating output for film, you should use the same profile as the output color profile so that the output file matches the film stock. One advantage of using color management features to work with Cineon footage items is that compositing with images from other footage types is made easier. See “Interpret a footage item by assigning an input color profile” on page 245.
- If you need to manually modify the settings for a Cineon footage item, or if you don't want to use color management, then you can use the Cineon Settings dialog box. To open this dialog box, click the Cineon Settings button in the Color Management tab of the Interpret Footage dialog box.
- If you need the settings for the interpretation of the Cineon footage item to change over time, then you can apply the Cineon Converter effect to a layer that uses the Cineon footage item as its source.

See also

“Cineon Converter effect” on page 542

Chapter 10: Masks, transparency, and keying

Transparency overview

Use masks, keying effects, and mattes to determine which parts of a layer are transparent, allowing other layers to show through.

About transparency

Before you can create a composite from multiple images, parts of one or more of the images must be transparent. You can use *alpha channels*, *masks*, *mattes*, or *keying* to define which parts of an image are transparent and which parts of an image can be used to obscure parts of another image. By manipulating transparency and choosing blending modes, you can create a variety of visual effects.

About alpha channels and mattes

Color information is contained in three channels: red, green, and blue. In addition, an image can include an invisible fourth channel, called an *alpha channel*, that contains transparency information.

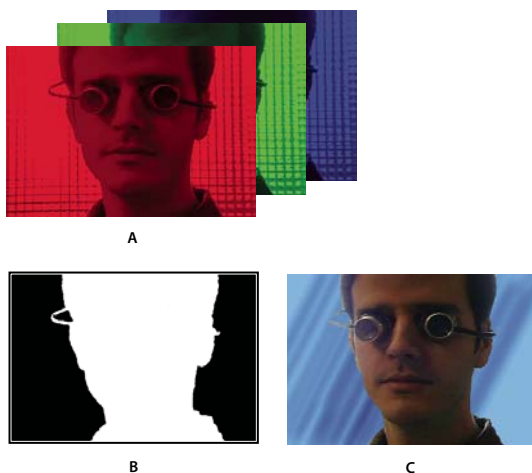

Channels at a glance

A. Separated color channels B. Alpha channel C. All channels viewed together

An alpha channel provides a way to store images and their transparency information in a single file without disturbing the color channels.

When you view an alpha channel in the After Effects Composition panel or an Adobe Premiere Pro Monitor panel, white indicates complete opacity, black indicates complete transparency, and shades of gray indicate partial transparency.

A *matte* is a layer (or any of its channels) that defines the transparent areas of that layer or another layer. White defines opaque areas, and black defines transparent areas. An alpha channel is often used as a matte, but you can use a matte other than the alpha channel if you have a channel or layer that defines the desired area of transparency better than the alpha channel does, or in cases where the source image doesn't include an alpha channel.

Many file formats can include an alpha channel, including Adobe Photoshop, ElectricImage, Adobe Flash Video (FLV), TGA, TIFF, EPS, PDF, and Adobe Illustrator. AVI and QuickTime (saved at a bit depth of Millions Of Colors+), also can contain alpha channels, depending upon the codecs used to generate these file types. For Adobe Illustrator EPS and PDF files, After Effects automatically converts empty areas to an alpha channel.

About straight and premultiplied channels

Alpha channels store transparency information in files in one of two ways: straight or premultiplied. Although the alpha channels are the same, the color channels differ.

With *straight* (or *unmatted*) channels, transparency information is stored only in the alpha channel, not in any of the visible color channels. With straight channels, the effects of transparency aren't visible until the image is displayed in an application that supports straight channels.

With *premultiplied* (or *matted*) channels, transparency information is stored in the alpha channel and also in the visible RGB channels, which are multiplied with a background color. The colors of semitransparent areas, such as feathered edges, are shifted toward the background color in proportion to their degree of transparency.

Some software lets you specify the background color with which the channels are premultiplied; otherwise, the background color is usually black or white.

Straight channels retain more accurate color information than premultiplied channels. Premultiplied channels are compatible with a wider range of programs, such as Apple QuickTime Player. Often, the choice of whether to use images with straight or premultiplied channels has been made before you receive the assets to edit and composite. Adobe Premiere Pro and After Effects recognize both straight and premultiplied channels, but only the first alpha channel they encounter in a file containing multiple alpha channels. Adobe Flash recognizes only premultiplied alpha channels.

About keying

Keying is defining transparency by a particular color value (with a color key or chroma key) or brightness value (with a luminance key) in an image. When you *key out* a value, all pixels that have similar colors or luminance values become transparent.

Keying makes it easy to replace a background of a consistent color or brightness with another image, an especially useful technique when you work with objects too complex to mask easily. The technique of keying out a background of a consistent color is often called *bluescreening* or *greenscreening*, although you don't have to use blue or green; you can use any solid color for a background.

Difference keying defines transparency with respect to a particular baseline background image. Instead of keying out a single-color screen, you can key out an arbitrary background.

About masks

A *mask* in After Effects is a path that is used as a parameter to modify layer effects and properties. The most common use of a mask is the modification of a layer's alpha channel, which determines the layer's transparency at each pixel. Another common use of a mask is as a path along which to animate text. (See "Creating and animating text on a path" on page 293.)

A mask path consists of *segments* and *vertices*. Segments are the lines or curves that connect vertices. Vertices are where each segment of a path starts and ends. For more information on paths, see “About paths” on page 313.

Closed-path masks can create transparent areas for a layer. Open paths cannot create transparent areas for a layer but are useful as parameters for an effect. Some effects can use an open or closed mask path as input; these include Stroke, Path Text, Audio Waveform, Audio Spectrum, and Vegas. Others can use closed masks only; these include Fill, Smear, Reshape, Particle Playground, and Inner/Outer Key.

A mask belongs to a specific layer. Each layer can contain multiple masks.

You can draw masks in common geometric shapes—including polygons, ellipses, and stars—with the shape tools, or you can use the Pen tool to draw an arbitrary path.

In most ways, drawing mask paths is the same as drawing shape paths on shape layers, though the editing and interpolation of mask paths has a few additional features. You can link a mask path to a shape path using expressions, which allows you to bring the benefits of masks into shape layers, and vice versa.

The position of a mask in the stacking order in the Timeline panel affects how it interacts with other masks. You can drag a mask to different positions within the Masks property group in the Timeline panel.

A mask's Mask Opacity property determines the influence that a closed mask has on a layer's alpha channel inside the mask area. A Mask Opacity value of 100% corresponds to an interior area that is completely opaque. The area outside the mask is always completely transparent. To invert what is considered inside and what is considered outside for a specific mask, select Invert next to the mask name in the Timeline panel.



Default behavior for a drawn mask (left); same mask inverted (right)

See also

“Creating shapes and masks” on page 318

Creating and importing masks

Creating masks

You can create one or more masks for each layer in a composition using any of the following methods:

- Draw a path using the shape tools or Pen tool from the Tools panel. Drawing a mask path is very similar to drawing a shape path. (See “Creating shapes and masks” on page 318.)
- Specify the dimensions of the mask shape numerically in the Mask Shape dialog box.
- Convert a shape path to a mask path.
- Convert a motion path to a mask path.
- Trace a color or alpha channel's values to create a mask using the Auto-trace command.

- Paste a path copied from another layer or from Adobe Illustrator, Photoshop, or Fireworks. (See “Copy a path from Illustrator, Photoshop, or Fireworks” on page 324.)
- Convert a text layer to one or more editable masks by using the Create Outlines command and then linking the mask paths to the resulting shape paths.

When you create masks on a layer, the mask names appear in the Timeline panel outline in the order in which you create the masks. To organize and keep track of your masks, rename them.

 To rename a mask, select it and press *Enter* (Windows) or *Return* (Mac OS).

When creating additional masks for one layer in the Layer panel, make sure that the Target menu in the Layer panel is set to None; otherwise, you will replace the targeted mask instead of creating a new mask. You can also lock a mask to prevent changes to it.

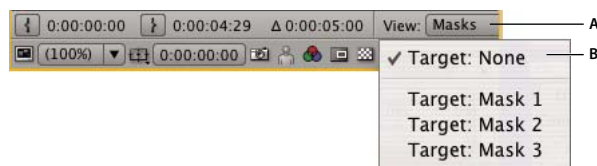

Menu selections to specify a mask to target in the Layer panel
A. View menu B. Target menu

 To create a mask that you can move independently of the primary layer that it's masking, create the mask on a separate white solid layer, and use that solid layer as a track matte for the primary layer. Then use parenting to make the solid layer a child of the primary layer, so that the mask moves with the primary layer as if it were applied directly. Because the solid layer is a child layer, it can also be animated independently of its parent. You can use motion tracking to make the solid layer (and therefore the mask) follow moving objects in the primary layer. (See “Convert a layer into a track matte” on page 264 and “Work with parent and child layers” on page 158.)

Create a rectangular or elliptical mask numerically

- 1 Select a layer in the Composition panel, or display a layer in the Layer panel.
- 2 Choose Layer > Mask > New Mask. A new mask appears in the Composition or Layer panel with its handles at the outer edges of the frame.
- 3 Choose Layer > Mask > Mask Shape.
- 4 Select Rectangle or Ellipse, and specify the size and location of the mask's bounding box.

Create a mask from a motion path

You can copy position keyframes, anchor point keyframes, or an effect control point's position keyframes and paste those keyframes on a selected mask. This is useful for creating animations that follow the edges of a mask. When you create masks from motion paths, make sure that you copy keyframes from a single position property only—do not copy the keyframes of any other property.

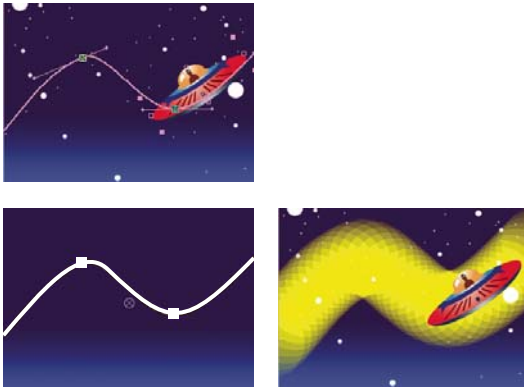

The motion path of the spaceship (top) is copied to the background layer (bottom left) and used by the Vegas effect (bottom right).

- 1 In the Timeline panel, click the name of the Position property or Anchor Point property from which you want to copy the motion path. (This selects all keyframes. To select only some of the motion path's keyframes, Shift-click them.)
- 2 Choose Edit > Copy.
- 3 To create a new mask, select the layer on which to create the mask, and choose Layer > Mask > New Mask.
- 4 In the Timeline panel, click the name of the Mask Path property for the mask to which to paste the motion path keyframes.
- 5 Choose Edit > Paste.

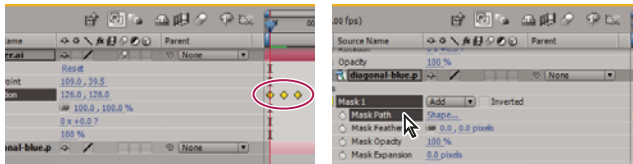

Selecting and copying Position keyframes (left); then pasting them in the selected Mask Path property (right)

See also

“Work with motion paths” on page 197

Create a mask from a channel with Auto-trace

You can convert the alpha, red, green, blue, or luminance channel of a layer to one or more masks by using the Auto-trace command. Auto-trace creates as many Bezier masks as necessary to outline the specified channel values in the layer. Auto-trace creates masks with the smallest number of vertices possible while conforming to the settings that you choose. You can modify a mask created with Auto-trace as you would any other mask, and you can link its path to other path types, such as shape paths on a shape layer, using expressions.

When you apply Auto-trace, affected layers are automatically set to Best Quality to ensure accurate results.



To reduce the number of masks created by Auto-trace, apply a keying effect to the layer to isolate your subject before applying Auto-trace.

- 1 In the Timeline panel, do one of the following:
 - To create mask keyframes at a single frame, drag the current-time indicator to the desired frame.

- To create mask keyframes across a range of frames, set a work area that spans that range.

2 Select one or more layers.

3 Choose Layer > Auto-trace.

4 Select one of the following:

Current Frame Creates mask keyframes at only the current frame.

Work Area Creates mask keyframes for frames within the work area.

5 Set any of the following options:

Invert Inverts the input layer prior to searching for edges.

Blur Blurs the original image before generating the tracing result. Select this option to reduce small artifacts and to smooth jagged edges in the tracing result. Deselect this option to closely trace details in a high-contrast image. Specify the radius, in pixels, of the area used for the blurring operation. Larger values result in more blur.

Tolerance How far, in pixels, the traced path is allowed to deviate from the contours of the channel.

Threshold Specifies, as a percentage, the value that a pixel's channel must have for that pixel to be considered part of an edge. Pixels with channel values over the threshold are mapped to white and are opaque; pixels with values under the threshold are mapped to black and are transparent.

Minimum Area Specifies the smallest feature in the original image that will be traced. For example, a value of 4 removes features smaller than 2 pixels wide by 2 pixels high from the tracing result.

Corner Roundness Specifies the roundness of the mask curve at vertices. Enter a higher value for smoother curves.

Apply To New Layer Applies the mask to a new solid the same size as the selected layer. This control is automatically selected for layers that have Collapse Transformations enabled—it creates a new layer the same size as the composition that contains the layer.

Preview Select to preview the mask results and the results of the Auto-trace command's various options.

See also



“Keying overview and tips” on page 268

“Set the work area” on page 112

“About alpha channels and mattes” on page 252

Working with masks and mattes

View mask paths

- To view mask paths for selected layers in the Timeline panel, press M.
- To view selected masks in the Timeline panel, press SS (press the S key twice).
- To view mask paths in the Composition panel, click the Toggle Mask And Shape Path Visibility button  at the bottom of the Composition panel.
- To view mask paths in the Layer panel, choose Masks from the Layer panel View menu.
- To hide a mask path while showing others, lock the mask by selecting its Lock switch  in the Timeline panel, and then choose Layer > Mask > Hide Locked Masks.

Select masks, segments, and vertices

Unlike layers, masks can have more than one level of selection. You can select a mask as a whole path, which is appropriate when you want to move or resize a mask. However, if you want to change the path of a mask, select one or more points on it. Selected points appear solid, and unselected points appear hollow.

Select or deselect masks in the Layer or Composition panel

- To select a vertex on a mask, click the vertex with the Selection tool . To add vertices to the selection, Shift-click them.
- To select a mask segment, click the segment with the Selection tool. To add segments to the selection, Shift-click them.
- To select an entire mask, Alt-click (Windows) or Option-click (Mac OS) a segment, vertex, or handle of a mask with the Selection tool, or select any portion of the mask and choose Edit > Select All or press Ctrl+A (Windows) or Command+A (Mac OS). To add masks to the selection, Alt+Shift-click (Windows) or Option+Shift-click (Mac OS) them.
- To select masks by dragging, select a mask or portion of a mask to enter mask editing mode and then drag with the Selection tool to draw a marquee-selection box completely around the vertices or masks that you want to select. To add masks or vertices to the selection, hold down the Shift key as you draw additional marquee-selection boxes.
- To select all masks on a layer, select a mask on the layer, and choose Edit > Select All or press Ctrl+A (Windows) or Command+A (Mac OS).
- To deselect all masks, press Ctrl+Shift+A (Windows) or Command+Shift+A (Mac OS).
- To select an adjacent mask on a layer, press Alt+tilde (~) (Windows) or Option+tilde (~) (Mac OS) to select the next mask, or Shift+Alt+tilde (~) (Windows) or Shift+Option+tilde (~) (Mac OS) to select the previous mask.
- To deselect a mask, click anywhere other than on the mask.
- To remove a vertex or segment from a selection, Shift-click the vertex or segment.



To use the Selection tool when the Pen tool is selected, hold down Ctrl (Windows) or Command (Mac OS).

Select masks in the Timeline panel

- 1 Click the right arrow next to a layer name to expand it.
- 2 Click the right arrow next to the Masks heading to expand it, revealing all masks on that layer.
- 3 Do any of the following:
 - To select one mask, click its name.
 - To select a contiguous range of masks, Shift-click the names of the first and last masks in the range.
 - To select discontinuous masks together, Ctrl-click (Windows) or Command-click (Mac OS) the names of any masks you want to include.

Note: You can select only whole masks in the Timeline panel. To select individual vertices on a mask, use the Composition or Layer panel.

Change a mask path numerically

- 1 Select the mask.
- 2 In the Timeline panel, expand the Mask properties.
- 3 Next to the Mask Path property, click the underlined word, and specify the changes in the Mask Path dialog box.

Lock or unlock masks

Locking a mask prevents you from selecting it in the Timeline, Composition, and Layer panels or setting it as a target in the Layer panel. Use this feature to avoid unwanted changes to the mask.

- 1 In the Timeline panel, expand the Masks property group.
- 2 In the A/V Features column, click the box underneath the Lock icon  next to the mask you want to lock or unlock. A mask is locked and cannot be selected when its Lock switch is selected—i.e., when the Lock icon appears in the box.

Note: To unlock multiple masks at one time, select one or more layers and choose **Layer > Mask > Unlock All Masks**.

Copy, cut, save, reuse, and delete masks

You can reuse masks in other layers and compositions—particularly Bezier masks you’ve spent a long time perfecting. Mask paths are stored inside a composition in a project file. It can be useful to create a project with compositions just for storing complex layer masks. When you want to use a mask from another project, import that project into your current project.

Copy, cut, duplicate, or paste a mask

- To copy or cut selected masks to the clipboard, choose **Edit > Copy** or **Edit > Cut**.
- To duplicate selected masks, choose **Edit > Duplicate**.
- To paste a mask onto a layer, select the layer and then choose **Edit > Paste**. If a mask is selected, this replaces the selected mask.

Save a mask

- 1 In the Timeline panel for the composition containing the layer and mask you want to save, expand the layer and its mask properties.
- 2 Do one of the following:
 - To save an animated mask, select the mask keyframes you want to save.
 - To save a nonanimated mask, select the mask.
- 3 Copy the mask or keyframes, and paste the mask or keyframes to a new layer. The new layer can be a simple solid.

Reuse a mask

- 1 Open the composition containing the mask you want to reuse. If you saved the mask in another project, import the project and then open the mask’s composition.
- 2 In the Timeline panel, expand the saved mask’s layer and mask properties.
- 3 Select the mask or keyframes.
- 4 Copy the mask or keyframes, and paste the mask or keyframes to the layer to which you want to apply the mask.

Delete masks

- To delete one mask, select the mask in the Timeline panel and press **Delete**.
- To delete all masks, select the layer containing the masks you want to remove and choose **Layer > Masks > Remove All Masks**.

Control mask path color

To help you identify and work with masks, the Composition and Layer panels outline a mask's path with color, and the Timeline panel displays that same color next to the mask's name. By default, After Effects uses the color yellow for all masks. To make each mask more distinctive, you can manually change a mask's color using the Timeline panel, or you can set After Effects to cycle through mask colors for new masks.

Apply a new color to a mask outline

To make it easier to work with multiple masks in the Composition panel, you can apply different colors to each mask outline.

- 1 Select the mask in the Timeline panel.
- 2 Click the color swatch to the left of the mask name, pick a new color, and click OK.

Set After Effects to cycle through mask colors

- 1 Choose Edit > Preferences > User Interface Colors.
- 2 Select Cycle Mask Colors.

After Effects cycles through different mask colors.

Mask modes

Blending modes for masks (*mask modes*) control how masks within a layer interact with one another. By default, all masks are set to Add, which combines the transparency values of any masks that overlap on the same layer. You can apply a mode to each mask, but you can't animate a mask's mode—that is, you can't change a mask mode over time.

You choose a mask mode for a mask from the menu next to the mask name in the Timeline panel.

The first mask that you create interacts with the layer's alpha channel. If that channel doesn't define the entire image as opaque, then the mask interacts with the layer frame. Each additional mask you create interacts with masks located above it in the stacking order in the Timeline panel. The results of mask modes vary depending on the modes set for the masks higher up in the stacking order. Mask modes only operate between masks on the same layer.

Using mask modes, you can create complex compound masks with multiple transparent areas. For example, you can set a mask mode that combines two masks and sets the opaque area to the areas where the two masks intersect.

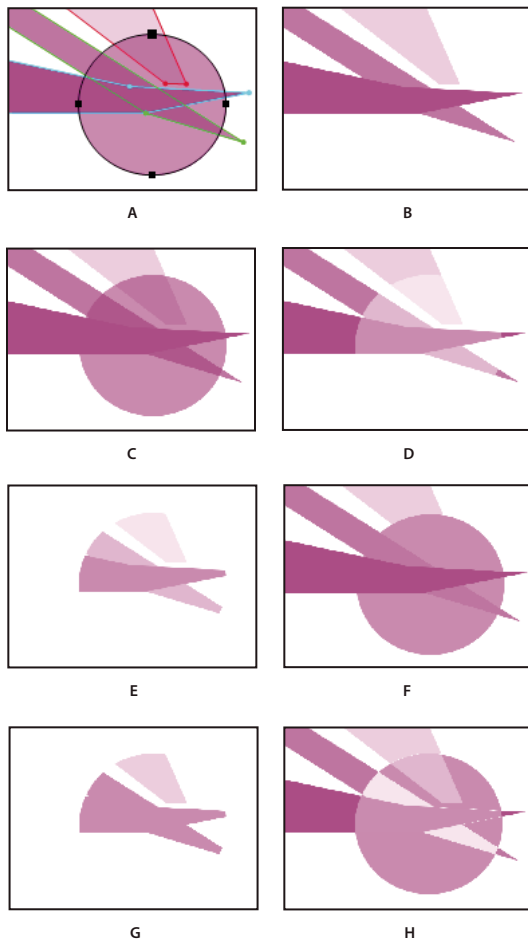

Compound masks that result when different modes are applied to the circle mask. The masks in this illustration have different Mask Opacity values.

A. Original masks B. None C. Add D. Subtract E. Intersect F. Lighten G. Darken H. Difference

None The mask has no direct influence on the alpha channel of the layer. This option is useful when you are only using the mask's path for an effect such as Stroke or Fill, or if you are using the mask path as the basis for a shape path.

Add The mask is added to the masks above it in the stacking order. The influence of the mask is cumulative with the masks above it.

Subtract The influence of the mask is subtracted from the masks above it. This option is useful when you want to create the appearance of a hole in the center of another mask.

Intersect The mask is added to the masks above it in the stacking order. In areas where the mask overlaps the masks above it, the influence of the mask is cumulative with the masks above it. In areas where the mask does not overlap with the masks above it, the result is complete opacity.

Lighten The mask is added to the masks above it in the stacking order. Where multiple masks intersect, the highest transparency value is used.

Darken The mask is added to the masks above it in the stacking order. Where multiple masks intersect, the lowest transparency value is used.

Difference The mask is added to the masks above it in the stacking order. In areas where the mask does not overlap the masks above it, the mask operates as it would alone on the layer. In areas where the mask overlaps the masks above it, the influence of the mask is subtracted from the masks above it.

Adjust the edges of a mask

To finely expand or contract all edges of a mask, use the Mask Expansion property. This property's value represents, in pixels, how far from the original mask edge you are expanding or contracting the adjusted edge.

- 1 In the Timeline panel, expand the Mask properties of the layer you want to adjust.
- 2 Drag the underlined value for Mask Expansion.

Note: To reset a mask to its default boundaries, select the mask in the Timeline panel and choose Layer > Mask > Reset Mask.

Adjust mask feather

Feathering softens the edges of a mask by fading it from more transparent to less transparent over a user-defined distance. Using the Mask Feather property, you make mask edges hard-edged or soft-edged (feathered). By default, the feather width straddles the mask edge, half inside and half outside. For example, if you set the feather width to 25, the feathering extends 12.5 pixels inside the mask edge and 12.5 pixels outside it. You can also extend or contract the mask edges using the Mask Expansion property to control where the mask feathering appears.

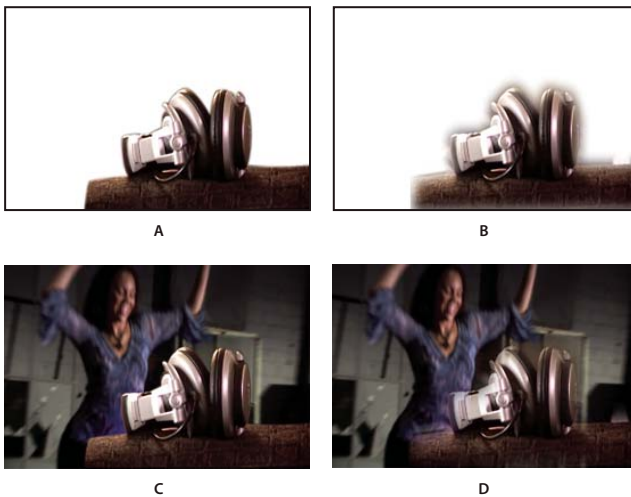

Setting the Mask Feather property

A. Masked layer with 5-pixel feather B. Masked layer with 40-pixel feather C. Result with 5-pixel feather D. Result with 40-pixel feather

Mask feathering takes place only within the dimensions of the layer. Therefore, a feathered mask's path should always be slightly smaller than the layer area and should never move to the very edge of the layer. If a mask feather extends beyond the layer area, the feathered edge ends abruptly.

- 1 To display the Mask Feather property for selected layers, press F.
- 2 (Optional) To constrain horizontal and vertical feather amounts to change proportionally, select the Constrain Proportions switch  next to the Mask Feather property.
- 3 Modify the Mask Feather property as you would any other property—by dragging the underlined value or clicking the underlined value and entering an amount in the text box.

💡 The PV Feather plug-in from RE:Vision Effects provides the ability to control the feather amount for each vertex of a mask path independently. For information, see the RE:Vision Effects website:

www.adobe.com/go/learn_ae_revisionfxpvfeather.

About track mattes and traveling mattes

When you want one layer to show through a hole in another layer, set up a track matte. You'll need two layers—one to act as a matte, and another to fill the hole in the matte. You can animate either the track matte layer or the fill layer. When you animate the track matte layer, you create a *traveling matte*. If you want to animate the track matte and fill layers using identical settings, consider precomposing them.

Define transparency in a track matte using values from either its alpha channel or the luminance of its pixels. Using luminance is useful when you want to create a track matte using a layer without an alpha channel or a layer imported from a program that can't create an alpha channel. In both alpha channel mattes and luminance mattes, pixels with higher values are more transparent. In most cases, you use a high-contrast matte so that areas are either completely transparent or completely opaque. Intermediate shades should appear only where you want partial or gradual transparency, such as along a soft edge.

After Effects preserves the order of a layer and its track matte after you duplicate or split the layer. Within the duplicated or split layers, the track matte layer remains on top of the fill layer. For example, if your composition contains layers A and B, where A is the track matte and B the fill layer, duplicating or splitting both of these layers results in the layer order ABAB.

💡 A track matte only applies to the layer directly beneath it. To apply a track matte to multiple layers, first precompose the multiple layers, and then apply the track matte to the precomposition layer.

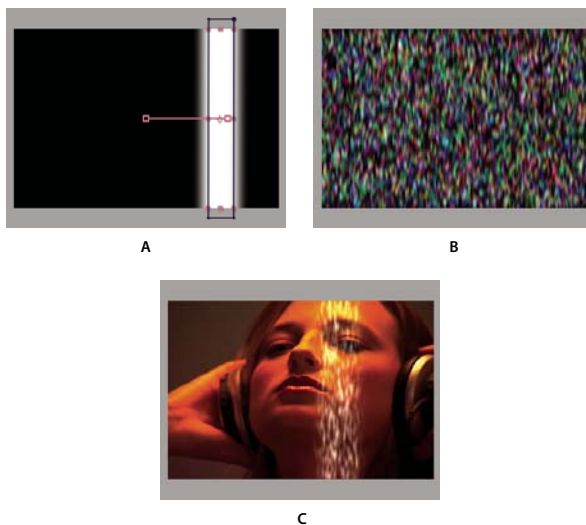

Traveling matte

A. Track matte layer: a solid with a rectangular mask, set to Luma Matte. The mask is animated to travel across the screen. **B.** Fill layer: a solid with a pattern effect. **C.** Result: the pattern is seen in the track matte's shape and added to the image layer, which is below the track matte layer.

💡 To animate a track matte to move with the layer that it's matting, make the track matte a child of the layer that it's matting. (See "Work with parent and child layers" on page 158.)

See also

“About alpha channels and mattes” on page 252

“Split a layer” on page 146

Convert a layer into a track matte

- 1 Drag the layer that will be the track matte directly above the layer that will be the fill layer.
- 2 Define transparency for the track matte by choosing one of the following options from the TrkMat menu for the fill layer:

No Track Matte No transparency created; next layer above acts as a normal layer.

Alpha Matte Opaque when alpha channel pixel value is 100%.

Alpha Inverted Matte Opaque when alpha channel pixel value is 0%.

Luma Matte Opaque when a pixel's luminance value is 100%.

Luma Inverted Matte Opaque when a pixel's luminance value is 0%.

After Effects converts the next layer above into a track matte, turns off the video of the track matte layer, and adds a track matte icon  next to the track matte layer's name in the Timeline panel. The Composition panel displays the fill layer viewed through the alpha channel of the matte layer.

Note: Although the video is turned off for the matte layer, you can still select the layer to reposition, scale, or rotate it. Select the layer in the Timeline panel, and then drag the center (indicated by a circle with an X) of the layer in the Composition panel.

See also

“About alpha channels and mattes” on page 252

Preserve underlying transparency during compositing

The Preserve Underlying Transparency option causes the opaque areas of a layer to appear only when positioned over opaque areas in underlying layers. With this option, you can make a layer visible only when it is positioned over the layer below it. It's useful for creating effects such as glints or light reflecting off a polished surface.

- ❖ Select the T option in the Modes column for the appropriate layer.

Animating masks

Alejandro Pérez provides a script on the AE Enhancers forum with which you can use tracking data to position individual mask vertices: www.adobe.com/go/learn_ae_alejandrotrackmaskvertices.

Scott Squires provides a pair of movies that show how to rotoscope, both painting and masking:

- www.adobe.com/go/learn_ae_scottsquiresrotoscope1
- www.adobe.com/go/learn_ae_scottsquiresrotoscope2

Use Smart Mask Interpolation

Smart Mask Interpolation provides a high level of control for creating mask path keyframes and smooth, realistic animation. After you select the mask path keyframes to interpolate, Smart Mask Interpolation creates intermediate keyframes based on settings you provide. The Info panel displays the progress of the interpolation and the number of keyframes created.

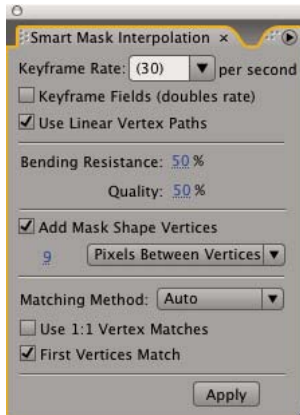

The Smart Mask Interpolation panel

- 1 Choose Window > Smart Mask Interpolation.
- 2 Select at least two adjacent mask path keyframes.
- 3 Set options in the Smart Mask Interpolation panel, and then click Apply.

Note: To interrupt the interpolation process, press Esc. The Info panel indicates that the process has been interrupted and reports the number of keyframes created.

Keyframe Rate Specifies the number of keyframes that Smart Mask Interpolation creates per second between the selected keyframes. For example, a value of 10 creates a new keyframe every 1/10 of a second. Choose Auto to set the keyframe rate equal to the composition frame rate, which appears in parentheses. Create more keyframes for smoother animation; create fewer keyframes to reduce render time.

Note: Regardless of the keyframe rate you choose, Smart Mask Interpolation always adds keyframes at the frame just after the first mask path keyframe and at the frame just before the second mask path keyframe. For example, if you interpolate between keyframes at 0 seconds and 1 second in a 30-fps composition with a keyframe rate of 10 keyframes per second, mask path keyframes are added at frame numbers 1, 3, 6, 9, 12, 15, 18, 21, 24, 27, and 29.

Keyframe Fields Doubles the keyframe rate. When this option is selected, and Keyframe Rate is set to the composition frame rate, a keyframe is added at each video field. Select this option for animated masking for interlaced video. If this option is not selected, the mask may slip off the object that you are attempting to key out. For more information about fields in interlaced video, see “About interlaced and noninterlaced video” on page 70.

Use Linear Vertex Paths Specifies that vertices in the first keyframe move along a straight path to their corresponding vertices in the second keyframe. Leave this option unselected if you want some vertices to interpolate along curved paths; for example, when the desired interpolation involves rotating parts. If this option is not selected, Smart Mask Interpolation creates a natural path for the mask.

Bending Resistance Specifies how susceptible the interpolated mask path is to bending instead of stretching. A value of 0 specifies that, as the mask path animates, it bends more than it stretches; a value of 100 specifies that the mask path stretches more than it bends.

Quality Specifies how strictly Smart Mask Interpolation matches vertices from one keyframe to another. A value of 0 specifies that a particular vertex in the first keyframe matches only the same-numbered vertex in the second keyframe. For example, the tenth vertex in the first keyframe must match the tenth vertex in the second keyframe. A value of 100 means that a vertex in the first keyframe can potentially match any vertex in the second keyframe. Higher values usually yield better interpolations; however, the higher the value, the longer the processing time.

Add Mask Shape Vertices Specifies that Smart Mask Interpolation adds vertices to facilitate quality interpolations. In general, Smart Mask Interpolation works best when the mask paths have dense sets of vertices. Also, a vertex on the first mask path cannot match the middle of a curve or straight-line segment on the second mask path, so sometimes you must add vertices before matching to produce the desired result. Smart Mask Interpolation does not modify the original keyframes. Only the new mask path keyframes computed by Smart Mask Interpolation have additional vertices.

The value you set specifies how finely the input mask paths are subdivided. **Pixels Between Vertices** specifies the distance, in pixels, between vertices on the larger perimeter mask path after subdivision. **Total Vertices** specifies the number of vertices on the interpolated mask paths. **Percentage Of Outline** specifies that a vertex is added at each indicated percent of the mask path outline length. For example, a value of 5 means that a vertex is added at each successive segment of the outline that represents 5% of the total perimeter. To use only the vertices that were on the path at the first frame, do not select this option.

Note: Smart Mask Interpolation may add vertices at existing vertex locations even if Add Mask Shape Vertices is not selected. If two vertices on one mask path match a single vertex on the other, the single vertex is duplicated at the same location so that the segment between the two vertices shrinks to that location.

Matching Method Specifies the algorithm that Smart Mask Interpolation uses to match vertices on one mask path to vertices on the other. **Auto** applies the matching algorithm for curves if either of the two selected keyframes has a curved segment; otherwise, it applies the polylines algorithm. **Curve** applies the algorithm for mask paths that have curved segments. **Polyline** applies the algorithm for mask paths that have only straight segments.

Note: The mask path keyframes added by Smart Mask Interpolation are polylines when Polyline Matching Method is selected, regardless of whether the input mask paths contained curved segments.

Use 1:1 Vertex Matches Specifies that Smart Mask Interpolation creates a vertex on one mask path that matches the same-numbered vertex on the other mask path. On each of the input mask paths, Smart Mask Interpolation matches the first vertices, the second vertices, the third vertices, and so forth. If the two paths have unequal numbers of vertices, this action may produce undesirable results.

First Vertices Match Specifies that Smart Mask Interpolation matches the first vertices in the two mask path keyframes. If not selected, Smart Mask Interpolation searches for the best first-vertex match between the two input mask paths.

Note: To ensure good results, make sure that the first vertices of the input mask paths match, and then select First Vertices Match.

See also

“Interpolation” on page 204

Move a mask or pan a layer behind a mask

You can adjust the area that is visible through a mask by either moving the mask in the Layer or Composition panel or panning (moving) the layer behind the mask in the Composition panel. When you move a mask, the mask layer’s Position values remain constant, and the mask moves in relation to other objects in the Composition panel.

When you use the Pan Behind tool to pan a layer behind a mask, the mask's position remains constant in the Composition panel but changes in the Layer panel. The masked layer's Position values change in relation to the composition. As you pan past the edges of the layer's frame, the layer's Mask Path values also change. Using the Pan Behind tool saves steps; without it, you would have to change the masked layer's Position and Mask Path properties manually. You can animate a layer panning behind another layer by setting keyframes for the masked layer's Position and Mask Path properties.

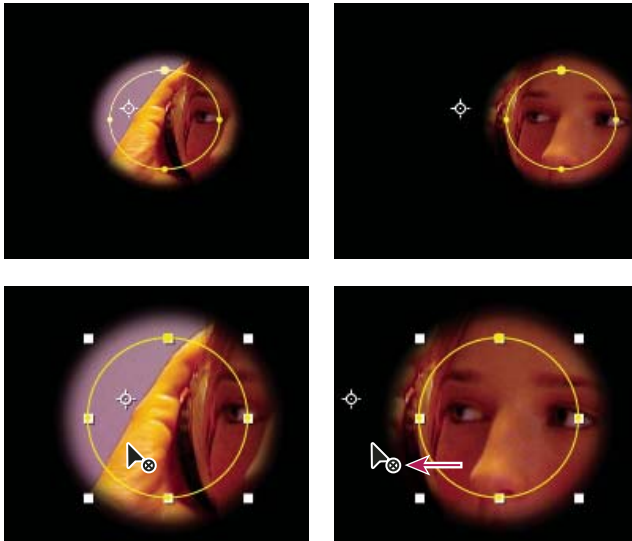

When you use the Pan Behind tool in the Composition panel, After Effects automatically makes two adjustments. In the Layer panel, the mask is moved in relation to its layer (top), and in the Composition panel, the layer is moved in relation to the composition (bottom).

Move a mask

- 1 Select the mask or masks you want to move.
- 2 In the Composition panel, drag the mask or masks to a new location. To constrain the movement of the mask or masks to horizontal or vertical, hold down Shift after you start dragging.

Pan a layer behind its mask

- 1 Select the Pan Behind tool in the Tools panel .
- 2 Click inside the mask area in the Composition panel and drag the layer to a new position.

Apply motion blur to a mask

Motion blur creates a blur based on a mask's movement in the composition. You can apply motion blur to individual masks. The composition's Enable Motion Blur switch must be selected for any layer or any mask within a layer to exhibit motion blur.

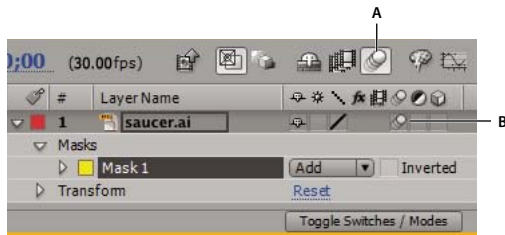

Motion blur settings for a layer and a composition
A. Enable Motion Blur composition switch B. Motion Blur layer switch

- 1 Select one or more masks.
- 2 Choose Layer > Masks > Motion Blur, and choose one of the following options:
 - Same As Layer** The mask will have motion blur only if the layer's Motion Blur switch is selected.
 - On** The mask will have motion blur regardless of the setting of the layer's Motion Blur switch.
 - Off** The mask will not have motion blur.

See also

“Use motion blur” on page 200

Keying

Keying overview and tips

Keying is defining transparency by a particular color value or luminance value in an image. When you *key out* a value, all pixels that have colors or luminance values similar to that value become transparent. Keying makes it easy to replace a background, which is especially useful when you work with objects too complex to mask easily. When you place a keyed layer over another layer, the result forms a composite, in which the background is visible wherever the keyed layer is transparent.

After Effects includes several built-in keying effects, as well as the Academy Award-winning Keylight effect, which excels at professional-quality color keying. For information on the Keylight effect, see its documentation in this folder: Adobe After Effects CS3/Additional Documentation/Keylight.

To see a video tutorial on keying with Keylight, visit the Adobe website at www.adobe.com/go/vid0229.

Adobe® Creative Suite® Production Premium Edition also includes Adobe Ultra®, which can quickly key out a poorly lit background shot with a low-quality webcam. For more information on Adobe Ultra, visit the Adobe website at www.adobe.com/go/learn_ae_ultra.

You often see composites made with keying techniques in movies, for example, when an actor appears to dangle from a helicopter or float in outer space. To create this effect, the actor is filmed in an appropriate position against a solid-color background screen. The background color is then keyed out and the actor's scene is composited over a new background.

The technique of keying out a background of a consistent color is often called *bluescreening* or *greenscreening*, although you don't have to use blue or green; you can use any solid color for a background. Magenta screens have been used for keying work in some very successful feature films. Other common terms for this sort of keying are *color keying* and *chroma keying*.

Difference keying works somewhat differently from color keying. Difference keying defines transparency with respect to a particular baseline background image. Instead of keying out a single-color screen, you can key out an arbitrary background. To use difference keying, you must have at least one frame that contains only the background; other frames are compared to this frame, and the background pixels are made transparent, leaving the foreground objects.

Keep in mind that generating a high-quality key can require the application of multiple keying effects in sequence and careful modification of their properties, especially if the footage was shot without considering the requirements of the compositor.

Here are some tips to help you as you work with keying effects:

- To help you view transparency, temporarily change the background color of the composition, or include a background layer behind the layer you are keying out. As you apply the keying effect to the layer in the foreground, the composition background (or a background layer) shows through, making it easy to view transparent areas. (See “Set composition background color” on page 111.)
- Once you have used a key to create transparency, use Matte effects to remove traces of key color and create clean edges.
- Start with the highest-quality materials you can gather, such as film that you scan and digitize.
- Use uncompressed footage (or, at least, files with the least possible amount of compression). Many compression algorithms, especially those used in DV and Motion JPEG, discard subtle variations in blue—which may be necessary to create a good key from a bluescreen.
- Noise and compression artifacts can cause problems for keying, especially difference keying. Often, applying a slight blur before keying can reduce noise and compression artifacts enough to improve keying results. For example, blurring the blue channel for DV footage can smooth out noise in a bluescreen.

The KeyerforDV animation preset available through the AE Enhancers forum automates the process of blurring the blue and green channels before keying, which can be crucial for keying DV footage:

www.adobe.com/go/learn_ae_aenhancersdvkeyer. This animation preset was written for an earlier version of the Keylight effect, but you can simply drag and drop the Keylight (1.2) effect from the Effects & Presets panel to replace the older effect, which may be reported as missing if you're using After Effects CS3.

- Blurring the alpha channel after keying can soften the edges of the matte, which can improve compositing results.
- Light your greenscreen or bluescreen uniformly, and keep it free of wrinkles.
- Use a garbage matte to roughly outline your subject so that you don't have to waste time keying out parts of the background far from the foreground subject. (See “Use a garbage matte” on page 270.)
- For evenly lit greenscreen or bluescreen footage, adjust keying controls on only one frame. Choose the most intricate frame of the scene, one involving fine detail such as hair and transparent or semitransparent objects, such as smoke or glass. If the lighting is constant, the same settings you apply to the first frame are applied to all subsequent frames. If lighting changes, you may need to adjust keying controls for other frames. Place keyframes for the first set of keying properties at the start of the bluescreen scene. If you are setting keyframes for one property only, use Linear interpolation. For footage that requires keyframes for multiple interacting properties, use Hold interpolation. If you set keyframes for keying properties, you may want to check the results frame by frame. Intermediate keying values may appear, producing unexpected results.
- To key well-lit footage shot against a bluescreen or greenscreen, start with the Color Difference Key. Add the Spill Suppressor to remove traces of the key color, and then use one or more of the other Matte effects, if necessary. If you are not satisfied with the results, try starting again with the Linear Color Key.

- To key well-lit footage shot against multiple colors or unevenly lit footage shot against a bluescreen or greenscreen, start with the Color Range key. Add the Spill Suppressor and other effects to refine the matte. If you are not completely satisfied with the results, try starting with or adding the Linear Color Key.
- To key dark areas or shadows, use the Extract Key on the Luminance channel.
- To make a static background scene transparent, use the Difference Matte Key. Add the Simple Choker and other effects as needed to refine the matte.

For tips on shooting footage so that color keying is easier and more successful, see Jonas Hummelstrand's website: www.adobe.com/go/learn_ae_jonasshootingforcolorkeying.

See also

“Keying effects” on page 440

“Matte effects” on page 450

Use a garbage matte

A *garbage matte* removes unneeded portions of the scene, resulting in a rough area that contains only the subject that you want to keep. When you are working with a poorly lit or uneven bluescreen or greenscreen, sketching a garbage matte around the subject can greatly reduce the amount of work that you have to do in keying out the background. However, if you spend a lot of time making a perfect garbage matte that exactly outlines the subject—essentially rotoscoping—you lose the time-saving advantage of color keying.

- 1 Create a mask to roughly outline a subject.
- 2 Apply one or more keying effects to mask out the remainder of the background.
- 3 Apply Matte effects as necessary to fine-tune the matte.

Aharon Rabinowitz shows how to create a super-tight garbage matte using Auto-trace in this video tutorial: www.adobe.com/go/learn_ae_aharonsupertightmattes.

See also

“Creating and importing masks” on page 254

“Keying overview and tips” on page 268

“Matte effects” on page 450

Use a hold-out matte

Use a *hold-out matte* (also known as a *hold-back matte*) to patch a scene to which a keying effect has been applied.

A hold-out matte is a masked-out portion of a duplicate of a layer that you have keyed. The duplicate is masked to include only the area of the image that contains the key color that you want to preserve as opaque. The hold-out matte is then placed directly on top of the keyed layer.

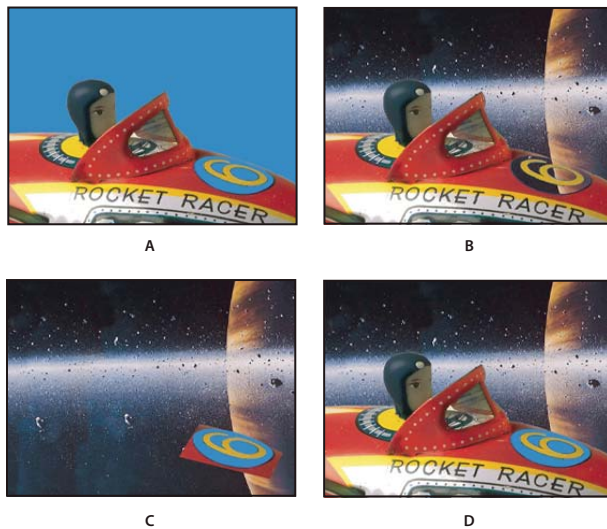

Example of using a hold-out matte

A. Original bluescreen image. The number's background is also blue. **B.** After keying, the number's background is also transparent. **C.** Hold-out matte containing the part of the image you want to remain opaque. **D.** When the hold-out matte is placed on top of the keyed image, the number's background is now opaque.

1 Duplicate the layer containing the color screen.

Note: Don't change Transform properties of only one of the layers after making the duplicate; keep the layers moving together.

2 Apply keying effects and Matte effects to the original layer to create transparency.

3 On the duplicate layer, create masks to mask out everything in the image except the area that you want to preserve.

4 Make sure that the copy (the hold-out matte) is positioned directly on top of the keyed layer and contains exactly the same keyframes with the same values. Then render the movie.

See also

"Creating and importing masks" on page 254

"Keying overview and tips" on page 268

"Matte effects" on page 450

Close a hole in a matte

The sequence of choking and spreading occurs in two stages, each with its own set of identical controls. Typically, stage two does the opposite of stage one. After a specified number of back-and-forth adjustments (which are handled automatically by Matte Choker), the hole is filled and the matte shape is preserved.

1 Select the layer, and choose Effect > Matte > Matte Choker.

2 Set stage-one controls (the first three properties) to spread the matte as far as possible without altering its shape, as follows:

Geometric Softness Specifies (in pixels) the largest spread or choke.

Choke Sets the amount of choke. Negative values spread the matte; positive values choke it.

Gray Level Softness Specifies how soft to make the edges of the matte. At 0%, the matte edges contain only fully opaque and fully transparent values. At 100%, the matte edges have a full range of gray values but may appear blurred.

3 Set stage-two controls (the next three properties) to choke the matte by the same amount as that by which you spread it in stage one.

4 (Optional) Use the Iterations property to specify how many times After Effects repeats the spread-and-choke sequence. You may need to try a few different settings so that the sequence is repeated as many times as necessary to close any unwanted holes.

See also

“Keying overview and tips” on page 268

“Matte effects” on page 450

Chapter 11: Text

Creating and editing text layers

About text layers

You can add text to a composition and animate the properties of entire text layers or individual characters, such as color, size, and position.

After Effects uses two kinds of text: *point text* and *paragraph text*. Point text is useful for entering a single word or a line of characters; paragraph text is useful for entering and formatting the text as one or more paragraphs.



Vertical and horizontal point text (left), and paragraph text in a bounding box (right)

You work with text on text layers, which in many ways are like other layers in After Effects. You can apply effects and expressions to text layers, animate them, designate them as 3D layers, and edit 3D text while viewing it in multiple views. As with shape layers and other vector layers, text layers are continuously rasterized, so when you scale the layer or resize the text, it retains crisp, resolution-independent edges.

To see a video tutorial on animating text, visit the Adobe website at www.adobe.com/go/vid0226.

You cannot open a text layer in its own Layer panel. You animate text using text animator properties and selectors. 3D text layers can optionally contain 3D sublayers, one for each character. (See “Animate text with text animators” on page 286 and “Work with per-character 3D text properties” on page 293.)

You can copy text from other applications such as Adobe Photoshop, Adobe Illustrator, Adobe InDesign, or any text editor, and paste it into a text layer in After Effects. Because After Effects also supports Unicode characters, you can copy and paste these characters between After Effects and any other application that also supports Unicode (which includes all Adobe applications).

Text formatting is included in the Source Text property. Use the Source Text property to animate formatting and to change the characters themselves (for example, change the letter *b* to the letter *c*). Because you can mix and match formatting within a text layer, you can easily create animations that transform every detail of a word or phrase.



Sequential frames in which Source Text has been animated

 When working with text, you may find it useful to hide the layer controls, such as highlights and vertices, while showing grids, guides, and safe zones. (See “Show or hide layer controls in the Composition panel” on page 127 and “Work with safe zones, grids, guides, and rulers” on page 130.)

Paul Tuersley provides a script for importing Substation Alpha (SSA) karaoke files and automatically creating animated text layers from them: www.adobe.com/go/learn_ae_paulssakaraoke.

Aharon Rabinowitz provides a video tutorial that shows a few ways to make 3D extruded text in After Effects, using duplicate layers or the Shatter effect: www.adobe.com/go/learn_ae_aharonextrusionhacks.

See also

“Examples of text animation” on page 295

Best practices for creating text and vector graphics for video

Text that looks good on your computer screen as you are creating it can sometimes look bad when viewed in a final output movie. These differences can arise from the device used to view the movie or from the compression scheme used to encode the movie. The same is true for other vector graphics, such as shapes in shape layers. Keep the following in mind as you create and animate text and vector graphics for video:

- You should always preview your movie on the same sort of device that your audience will use to view it, such as an NTSC video monitor. (See “Preview on an external video monitor” on page 126.)
- Avoid sharp color transitions, especially from one highly saturated color to its complementary color. Sharp color transitions are difficult for many compression schemes—such as those used by MPEG and JPEG standards—to encode. This can cause visual noise near sharp transitions. For analog television, the same sharp transitions can cause spikes outside the allowed range for the signal, also causing noise.
- When text will be over moving images, make sure that the text has a contrasting border (such as a glow or a stroke) so that the text is still readable when something the same color as the fill passes behind the text.
- Avoid thin horizontal elements, which can vanish from the frame if they happen to be on an even scan line during an odd field, or vice versa. The height of the horizontal bar in a capital *H*, for example, should be three pixels or greater. You can thicken horizontal elements by increasing font size, using a bold (or faux bold) style, or applying a stroke. (See “Formatting characters” on page 278.)
- When animating text to move vertically—for scrolling credits, for example—move the text vertically at a rate in pixels per second that is an even multiple of the field rate for the interlaced video format. This prevents a kind of twitter that can come from the text movement being out of phase with the scan lines. For NTSC, good values include 0, 119.88, and 239.76 pixels per second; for PAL, good values include 0, 100, and 200 pixels per second.



Apply the Autoscroll - Vertical animation preset in the Behaviors category to quickly create a vertical text crawl.

Fortunately, many problems with text in video and compressed movie formats can be solved with one simple technique: Apply Fast Blur to the text layer, with a Blurriness setting between 1 and 2. A slight blur can soften color transitions and cause thin horizontal elements to expand.

See also

“Apply an effect or animation preset” on page 351



Enter point text

When you enter point text, each line of text is independent—the length of a line increases or decreases as you edit the text, but it doesn’t wrap to the next line.

The small line through the type tool pointer  marks the position of the text *baseline*. For horizontal text, the baseline marks the line on which the text rests; for vertical text, the baseline marks the center axis of the characters.

When you enter point text, it is created using the properties currently set in the Character panel. You can change these properties later by selecting the text and modifying settings in the Character panel.

1 Do one of the following to create a text layer:

- Choose Layer > New > Text. A new text layer is created and an insertion point for the Horizontal Type tool appears in the center of the Composition panel.
- Select the Horizontal Type tool  or the Vertical Type tool , and then click in the Composition panel to set an insertion point for the text.

2 Enter text characters by typing. Press Enter on the main keyboard (Windows) or Return (Mac OS) to begin a new line.

Note: You can also choose Edit > Paste to paste text that you have copied from any application that uses Unicode characters. Text receives the formatting of the first character in the text layer into which it is pasted.



3 To end text-editing mode, press Enter on the numeric keypad, select another tool, or press Ctrl+Enter (Windows) or Command+Return (Mac OS).

Enter paragraph text

When you enter paragraph text, the lines of text wrap to fit the dimensions of the bounding box. You can enter multiple paragraphs and apply paragraph formatting.

You can resize the bounding box at any time, which causes the text to reflow within the adjusted rectangle.

When you enter paragraph text, it has the properties set in the Character and Paragraph panels. You can change these properties later by selecting the text and modifying settings in the Character and Paragraph panels.

1 Select the Horizontal Type tool  or the Vertical Type tool .

2 Do one of the following in the Composition panel to create a text layer:

- Drag to define a bounding box from a corner.
- Alt-drag (Windows) or Option-drag (Mac OS) to define a bounding box around a center point.

3 Enter text by typing. Press Enter on the main keyboard (Windows) or Return (Mac OS) to begin a new paragraph. Press Shift+Enter on the main keyboard (Windows) or Shift+Return (Mac OS) to create a soft carriage return, which begins a new line without beginning a new paragraph. If you enter more text than can fit in the bounding box, the overflow icon  appears on the bounding box.

Note: You can also choose Edit > Paste to paste text that you have copied from any application that uses Unicode characters. Text receives the formatting of the first character in the text layer into which it is pasted.

4 To end text-editing mode, press Enter on the numeric keypad, select another tool, or press Ctrl+Enter (Windows) or Command+Return (Mac OS).

 *After Effects doesn't have a direct way to enter a non-breaking space between two words, but you can create a non-breaking space in Photoshop and copy it into After Effects. Select the two words in Photoshop (or at least the space and the following character), and then use the Photoshop Character panel's No Break option to prevent the text from breaking after that space. Then copy the text from Photoshop and paste it into After Effects. The two words will be treated as independent words from the point of view of a word-based selector, but they will also stay together on a line of paragraph text.*

Resize a text bounding box

- 1 With a type tool active, select the text layer in the Composition panel to display the bounding box handles.
- 2 Position the pointer over a handle—the pointer turns into a double arrow —and do one of the following:
 - Drag to resize in one direction.
 - Shift-drag to maintain the proportion of the bounding box.
 - Ctrl-drag (Windows) or Command-drag (Mac OS) to scale from the center.

Convert point or paragraph text

Note: When you convert paragraph text to point text, all characters outside the bounding box are deleted. To avoid losing text, resize the bounding box so that all text is visible prior to conversion.

- 1 Using the Selection tool , select the text layer.

Note: You can't convert the text layer if it's in text-editing mode.

- 2 Using a type tool, right-click (Windows) or Control-click (Mac OS) anywhere in the Composition panel, and choose Convert To Paragraph Text or Convert To Point Text.

When you convert from paragraph text to point text, a carriage return is added at the end of each line of text, except the last line.

 To display the bounding box of paragraph text and automatically select a type tool, double-click the text layer in the Timeline panel.

Change the direction of text

Horizontal text flows from left to right; multiple lines of horizontal text lie from top to bottom. Vertical text flows from top to bottom; multiple lines of text lie from right to left.

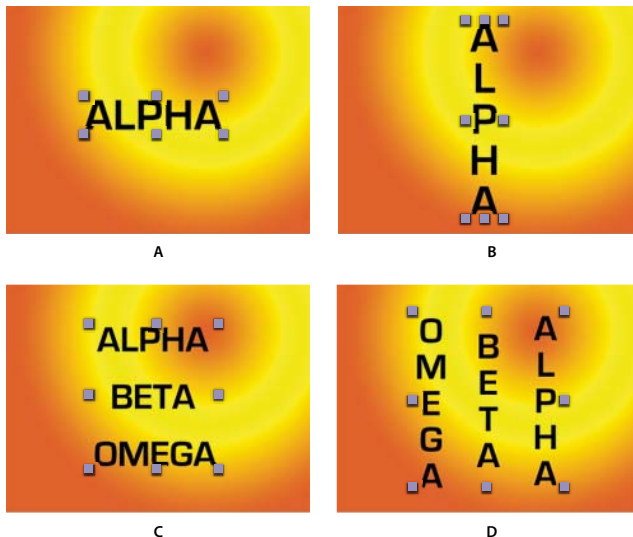

A. Horizontal point text **B.** Horizontal point text converted to vertical **C.** Horizontal paragraph text **D.** Horizontal paragraph text converted to vertical

- 1 Using the Selection tool , select the text layer.

Note: You can't convert text in text-editing mode.

2 Using a type tool, right-click (Windows) or Control-click (Mac OS) anywhere in the Composition panel, and choose Horizontal or Vertical.

Convert text from Photoshop to editable text

Text layers from Photoshop retain their style and remain editable in After Effects.

If you imported the Photoshop document as merged layers, then you must first select the layer and choose Layer > Convert To Layered Comp to decompose the imported Photoshop document into its layers.

1 Add the Photoshop text layer to your composition and select it.

2 Choose Layer > Convert To Editable Text.

The layer becomes an After Effects text layer and no longer uses the Photoshop text layer as its source footage item.

If the layer contains layer styles, the layer styles are converted to editable layer styles as if the Layer > Layer Styles > Convert To Editable Styles command had been used on the layer before converting the text to editable text.

See also

“Preparing and importing Photoshop files” on page 83

“Layer styles” on page 168

Select text



1 Double-click the text layer in the Timeline panel to select all text in the layer.



2 Do one of the following:

- To select text, drag over the text.
- To select a range of text, click, move the pointer, and then Shift-click.
- To select a word, double-click it. To select a line, triple-click it. To select a paragraph, quadruple-click it. To select all text in a layer, quintuple-click anywhere in the text.
- To use the arrow keys to select text, hold down Shift and press the Right Arrow or Left Arrow key. To use the arrow keys to select words, hold down Shift+Ctrl (Windows) or Shift+Command (Mac OS) and press the Right Arrow or Left Arrow key.

Edit and move text in text layers

You can edit text in text layers at any time. If you set the text to follow a path, designate it as a 3D layer, transform it, or animate it, you can still continue to edit it.

The pointer for a type tool changes as you move it around the Composition panel. When it is directly over a text layer, it appears as the edit text pointer ; click to edit the existing text. When the pointer is not directly over a text layer, it appears as a new text pointer ; click to create a new text layer. Shift-click always creates a new layer.

You can drag with the move pointer  in the Composition panel to move text. To activate the move pointer without leaving text editing mode, move the type tool away from the text in the Composition panel; when you see the move pointer , drag to move the text. You can also hold down the Ctrl (Windows) or Command (Mac OS) key to momentarily activate the move pointer.

1 To select the text and activate the type tool, double-click the text layer in the Timeline panel.

2 Edit text.

Formatting characters

Using the Character panel

Use the Character panel to format characters. If text is selected, changes you make in the Character panel affect only the selected text. If no text is selected, changes you make in the Character panel affect the selected text layers and the text layer's selected Source Text keyframes, if any exist. If no text is selected and no text layers are selected, the changes you make in the Character panel become the new defaults for the next text entry.

- To display the Character panel, choose Window > Character; or, with a type tool selected, click the panel button  in the Tools panel.



To open the Character and Paragraph panels automatically when a type tool is active, select Auto-Open Panels in the Tools panel.

- To reset Character panel values to the default values, choose Reset Character from the Character panel menu.

Work with fonts

A font is a complete set of characters—letters, numbers, and symbols—that share a common weight, width, and style. In addition to the fonts installed on your system, After Effects uses font files in this local folder:

Windows Program Files\Common Files\Adobe\Fonts

Mac OS X Library/Application Support/Adobe/Fonts

If you install a Type 1, TrueType, OpenType®, or CID font into the local Fonts folder, the font appears in Adobe applications only.

If the formatting for a character specifies a font that is unavailable on your computer system, another font will be substituted, and the missing font name will appear in brackets. This sometimes occurs when you open a project on Mac OS that was created on Windows, because the set of default fonts differs between the two operating systems.

When you select a font, you can select the font family and its font style independently. The *font family* is a collection of fonts sharing an overall typeface design; for example, Times. A *font style* is a variant version of an individual font in the font family; for example, regular, bold, or italic. The range of available font styles varies with each font. If a font doesn't include the style you want, you can apply *faux* styles—simulated versions of bold, italic, superscript, subscript, all caps, and small caps styles. If more than one copy of a font is installed on your computer, an abbreviation follows the font name: (T1) for Type 1 fonts, (TT) for TrueType fonts, or (OT) for OpenType fonts.

The *font size* determines how large the type appears in the image. In After Effects, the unit of measurement for fonts is pixels. When a text layer is at 100% scale value, the pixel values match composition pixels one-to-one. So if you scale the text layer to 200%, the font size will appear to double; for example, a font size of 10 pixels will look like 20 pixels. Because After Effects continuously rasterizes text, the resolution remains high when you increase the scale values.

Note: When choosing fonts and styles from the menus in the Character panel, press *Enter* (Windows) or *Return* (Mac OS) to accept an entry, or press *Esc* to exit the menu without applying a change.

Choose a font family

- Click in the Font Family menu text box, and begin typing the name. Continue typing until the desired font family name appears.
- To choose the previous or next font family in the menu, place the pointer over the Font Family menu text box and use your mouse scroll wheel; or click in the Font Family menu text box, and press the Up Arrow or Down Arrow.
- Click the arrow to the right of the Font Family menu text box, and press the key for the first letter of the font family name. Press the key again to advance through the font families with names that begin with that letter.

Choose a font style

- Choose from the Font Style menu in the Character panel.
- If the font family you chose does not include a bold or italic style, you can click the Faux Bold button **T** or the Faux Italic button *T* in the Character panel to apply a simulated style.

Choose a font size

- Enter or select a new value for Size **T** in the Character panel.

Use smart quotes

Smart quotes, or *printer's quotation marks*, use a curved left or right quotation mark instead of straight quotation marks.

- ❖ Choose Use Smart Quotes from the Character panel menu.

Specify leading to control spacing between lines

- ❖ In the Character panel, do one of the following:
 - Choose the desired leading from the Leading menu **A**.
 - Select the existing leading value, and enter a new value.
 - Drag the underlined leading value.

Work with text fills and strokes

For text, a *fill* is applied to the area inside the shape of an individual character; a *stroke* is applied to the outline of the character. After Effects applies a stroke to a character by centering the stroke on the character's path; half of the stroke appears on one side of the path, and the other half of the stroke appears on the other side of the path.

The Character panel lets you apply both color fill and color stroke to text, control the stroke width, and control the stacking position of the fill and stroke. You can change these properties for individual, selected characters; selected Source Text keyframes; all text in a layer; or all text across multiple selected layers.

You can also control the compositing order of a text layer's fill and stroke using the All Fills Over All Strokes or All Strokes Over All Fills options, which override the Fill Over Stroke or Stroke Over Fill properties of individual characters.

Note: For text that has per-character 3D properties, you cannot control the order of stroke and fill operations between characters; the Fill & Stroke menu in the More Options property group in the Timeline panel is unavailable, and the All Fills Over All Strokes and All Strokes Over All Fills options in the Character panel do nothing.

Add a stroke (outline) to text





- 1 Select the characters to which you want to add a stroke.
- 2 Set a stroke size with the Stroke Width  property in the Character panel.
- 3 Set the stroke color with the Stroke Color control in the Character panel.
- 4 Choose one of the following in the Character panel to control the stroke's position:

Stroke Over Fill, Fill Over Stroke The stroke of only selected text appears over or behind the fill.

All Strokes Over All Fills, All Fills Over All Strokes Strokes appear over or behind fills in the entire text layer.

Change text fill or stroke color

The text you enter gets its color from the Fill Color and Stroke Color controls in the upper-right corner of the Character panel. Select text to change its color after the text has already been entered.

- To set fill or stroke color using the color picker, click the Fill Color or Stroke Color control. To set fill or stroke color using the eyedropper, click the eyedropper button  and then click anywhere on-screen to sample the color.
- To swap colors for fill and stroke, click the Swap Fill And Stroke button .
- To remove fill or stroke, click the No Fill Color button or No Stroke Button. Only one of these buttons is available, depending on whether the Fill Color or Stroke Color box is forward.
- To set the fill or stroke to black or white, click the Set To Black  or Set To White  button.
- To bring the Fill Color or Stroke Color box forward, click it.

Specify kerning and tracking

Kerning is the process of adding or subtracting space between specific letter pairs. *Tracking* is the process of creating an equal amount of spacing across a range of letters. Positive kerning or tracking values move characters apart (increasing the spacing from the default); negative values move characters closer together (reducing the spacing from the default).

Note: When you open a project that was last saved in After Effects 6.0, text in the project may lie differently than in After Effects 6.0 because of improvements in kerning behavior.

You can automatically kern type using metrics kerning or optical kerning. Metrics kerning uses kern pairs, which are included with most fonts. Kern pairs contain information about the spacing of specific pairs of letters such as *LA*, *To*, *Tr*, *Ta*, *Tu*, *Te*, *Ty*, *Wa*, *WA*, *We*, *Wo*, *Ya*, and *Yo*. After Effects uses metrics kerning by default so that specific pairs are automatically kerned when you import or type text.



Some fonts include robust kern-pair specifications. For other fonts, or for two different typefaces or sizes in a line, you may want to use the optical kerning option. Optical kerning adjusts the spacing between adjacent characters based on their shapes. You can also use manual kerning, which is ideal for adjusting the space between two letters. Tracking and manual kerning are cumulative, so you can first adjust individual pairs of letters and then tighten or loosen a block of text without affecting the relative kerning of the letter pairs.

Note: Values for kerning and tracking affect Japanese text, but normally these options are used to adjust the *aki* (spacing) between Roman characters.

Alan Shisko provides a blog post and video tutorial on kerning: www.adobe.com/go/learn_ae_alankerning.



Tracking set to default value of 0 (left), Tracking set to -50 (center), and Tracking set to 200 (right)

- To use a font's built-in kerning information, choose Metrics from the Kerning menu  in the Character panel.
- To adjust kerning manually, click between two characters with a type tool, and set a numeric value for Kerning  in the Character panel.



Note: If a range of text is selected, you can't manually kern the characters. Instead, use tracking.

- To specify tracking, set a numeric value for Tracking  in the Character panel.

Adjust scale or specify baseline shift

Horizontal scale and *vertical scale* specify the proportion between the height and width of the text. Unscaled characters have a value of 100%. You can adjust scale to compress or expand selected characters in both width and height.



Baseline shift controls the distance that text appears from its baseline, either raising or lowering the selected text to create superscripts or subscripts.

- To adjust scale, enter a new percentage for Horizontal Scale  or Vertical Scale  in the Character panel, or drag the underlined value.
- To specify baseline shift, set a value for Baseline Shift  in the Character panel. A positive value moves horizontal text above and vertical text to the right of the baseline; a negative value moves text below or to the left of the baseline.

Change the case of text



You can enter or format text as uppercase characters, either all caps or small caps. When you format text as small caps, After Effects uses the small caps designed as part of the font, if they are available. If the font does not include small caps, After Effects generates faux small caps.

Note: *Small Caps formatting will not change characters that were originally typed in uppercase.*

- Click the All Caps button  or the Small Caps button  in the Character panel.
- Choose All Caps or Small Caps from the Character panel menu.

Format as superscript or subscript

Superscript characters are reduced in size and shifted above the text baseline; subscript characters are reduced in size and shifted below the text baseline. If the font does not include superscript or subscript characters, After Effects generates faux superscript or subscript characters.

- Click the Superscript button  or the Subscript button  in the Character panel.
- Choose Superscript or Subscript from the Character panel menu.

Blend overlapping characters in a text layer

- 1 In the Timeline panel, expand the text layer and the More Options group.
- 2 Choose a blending mode from the Inter-Character Blending menu.

Note: To blend a text layer with the layers beneath it, specify a blending mode from the Modes column in the Timeline panel.

Inter-character blending is not available for text layers with per-character 3D properties.

See also

“Blending modes” on page 163

“Work with per-character 3D text properties” on page 293

Work with Chinese, Japanese, and Korean text

After Effects provides several options for working with Chinese, Japanese, and Korean (CJK) text. Characters in CJK fonts are often referred to as *double-byte characters* because they require more than one byte of information to express each character.



To display CJK font name in English, choose Show Font Names In English from the Character panel menu.

Adjust tsume

Tsume reduces the space around a character by a specified percentage value. The character itself is not stretched or squeezed as a result. When *tsume* is added to a character, spacing around both sides of the character is reduced by an equal percentage.

- 1 Select the characters you want to adjust.
- 2 In the Character panel, enter or select a percentage for Tsume . The greater the percentage, the tighter the compression between characters. At 100% (the maximum value), there is no space between the character's bounding box and its em box.

Specify how leading is measured

- 1 Select the paragraphs you want to adjust.
- 2 Choose Top-To-Top Leading or Bottom-To-Bottom Leading from the Paragraph panel menu. A check mark indicates which option is selected.

Use tate-chuu-yoko

Tate-chuu-yoko (also called *kumimoji* and *renmoji*) is a block of horizontal text laid out within a vertical text line.

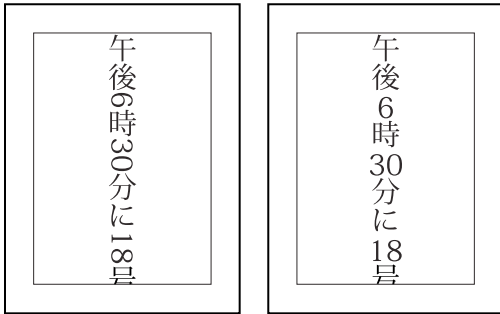

Original layer (left) and after *tate-chuu-yoko* is applied (right)

- 1 Select the characters that you want to rotate.
- 2 Choose *Tate-Chuu-Yoko* from the Character panel menu. (A check mark indicates that the option is turned on. To turn the option off, choose *Tate-Chuu-Yoko* again.)

Using *tate-chuu-yoko* does not prevent you from editing and formatting text; you can edit and apply formatting options to rotated characters as you do to other characters.

Formatting paragraphs

Work with the Paragraph panel

A paragraph is any range of text with a carriage return at the end. Use the Paragraph panel to set options that apply to entire paragraphs, such as the alignment, indentation, and leading (line spacing). For point text, each line is a separate paragraph. For paragraph text, each paragraph can have multiple lines, depending on the dimensions of the bounding box.

If the insertion point is in a paragraph or text is selected, changes you make in the Paragraph panel affect only paragraphs that are at least partially selected. If no text is selected, changes you make in the Paragraph panel affect the selected text layers and the text layer's selected Source Text keyframes, if any exist. If no text is selected and no text layers are selected, the changes you make in the Paragraph panel become the new defaults for the next text entry.



- To display the Paragraph panel, choose **Window > Paragraph**; or, with a type tool selected, click the panel button  in the Tools panel.

 *To open the Character and Paragraph panels automatically when a type tool is active, select **Auto-Open Panels** in the Tools panel.*

- To reset values in the Paragraph panel to the default values, choose **Reset Paragraph** from the Paragraph panel menu.

Align and justify text

You can *align* text to one edge of a paragraph (left, center, or right for horizontal text; top, center, or bottom for vertical text) and *justify* text to both edges of a paragraph. Alignment options are available for both point text and paragraph text; justification options are available only for paragraph text.

- To specify alignment, in the Paragraph panel, click an alignment option:
 -  Aligns horizontal text to the left, leaving the right edge of the paragraph ragged.
 -  Aligns horizontal text to the center, leaving both edges of the paragraph ragged.

- ☰ Aligns horizontal text to the right, leaving the left edge of the paragraph ragged.
- ☰ Aligns vertical text to the top, leaving the bottom edge of the paragraph ragged.
- ☰ Aligns vertical text to the center, leaving both the top and bottom edges of the paragraph ragged.
- ☰ Aligns vertical text to the bottom, leaving the top edge of the paragraph ragged.
- To specify justification for paragraph text, in the Paragraph panel, click a justification option:
 - ☰ Justifies all horizontal lines except the last, which is left-aligned.
 - ☰ Justifies all horizontal lines except the last, which is center-aligned.
 - ☰ Justifies all horizontal lines except the last, which is right-aligned.
 - ☰ Justifies all horizontal lines including the last, which is force-justified.
 - ☰ Justifies all vertical lines except the last, which is top-aligned.
 - ☰ Justifies all vertical lines except the last, which is center-aligned.
 - ☰ Justifies all vertical lines except the last, which is bottom-aligned.
 - ☰ Justifies all vertical lines including the last, which is force-justified.

Indent and space paragraphs

Indentation specifies the amount of space between text and the bounding box or line that contains the text. Indentation affects only the selected paragraph or paragraphs, so you can easily set different indentations for paragraphs.

- To indent paragraphs, enter a value in the Paragraph panel for an indentation option:

Indent Left Margin Indents text from the left edge of the paragraph. For vertical text, this option controls the indentation from the top of the paragraph.

Indent Right Margin Indents text from the right edge of the paragraph. For vertical text, this option controls the indentation from the bottom of the paragraph.

Indent First Line Indents the first line of text in the paragraph. For horizontal text, the first line indent is relative to the left indent; for vertical text, the first line indent is relative to the top indent. To create a first line hanging indentation, enter a negative value.

- To change space above or below paragraphs, enter a value in the Paragraph panel for Space Before ☰ and Space After ☰.

Specify hanging punctuation for Roman fonts

Hanging punctuation controls whether punctuation marks fall inside or outside the margins. If hanging punctuation is turned on for Roman fonts, then periods, commas, single quotation marks, double quotation marks, apostrophes, hyphens, em dashes, en dashes, colons, and semicolons appear outside the margins.

- ❖ Choose Roman Hanging Punctuation from the Paragraph panel menu. A check mark indicates that the option is selected.

Note: When you use Roman Hanging Punctuation, any double-byte punctuation marks available in Chinese, Japanese, and Korean fonts in the selected range will not appear outside the margins.

Text composition methods

The appearance of text on the page depends on a complex interaction of processes called *text composition*. Using the word spacing, letter spacing, and glyph spacing options you've selected, After Effects evaluates possible line breaks and chooses the one that best supports the specified parameters.

After Effects offers two composition methods, which you choose from the Paragraph panel menu:

Adobe Single-line Composer Offers a traditional approach to composing text one line at a time. This option is useful if you prefer to have manual control over how lines break. If spacing must be adjusted, the Single-line Composer first tries to compress, rather than expand text.

Adobe Every-line Composer Considers a network of break points for a range of lines and thus can optimize earlier lines in the paragraph in order to eliminate especially unattractive breaks later on. Working with multiple lines of text results in more even spacing and fewer hyphens. The Every-line Composer approaches composition by identifying possible breakpoints, evaluating them, and assigning a weighted penalty based on these principles:

- Highest importance is given to evenness of letter and word spacing. Possible breakpoints are evaluated and penalized according to how much they deviate from optimal spacing.
- After breakpoint penalty values are identified for a range of lines, they are squared, magnifying the bad breakpoints. The composer then uses the good breakpoints.

Animating text

About text animation

As with other layers in After Effects, you can animate text layers. However, text layers offer additional animation options. You can animate text layers by using any of the following methods:

- Animate the Transform properties, as you would any other layer, to change the entire layer, not its text contents.
- Apply text animation presets.
- Animate the source text of the layer, so that the characters themselves change to different characters or use different character or paragraph formats over time.
- Use text animators and selectors to animate many properties of individual characters or a range of characters.

To see a video tutorial on animating text, visit the Adobe website at www.adobe.com/go/vid0226.



To smooth the edges and movement of animated text, enable motion blur for the text layer. See “Use motion blur” on page 200 for more information.

See also

“About animation, keyframes, and expressions” on page 183

“Apply an effect or animation preset” on page 351

Text animation presets

Browse and apply text animation presets as you would any other animation presets.

The text animation presets were created in an NTSC DV 720 x 480 composition, and each text layer uses 72-point Myriad Pro. Some preset animations move the text on, off, or through the composition. The animation preset position values may not be appropriate for a composition that is much larger or smaller than 720 x 480; for example, an animation that is supposed to start off-screen may start on-screen. You may need to adjust the text animator's position values.

If the text isn't positioned as expected or the text disappears unexpectedly, adjust the text animator's position values in the Timeline panel or Composition panel.

After you apply a 3D Text animation preset, you may need to rotate the layer or add a camera to rotate around the layer to see the results of the 3D animation.

Text animation presets in the Paths category automatically replace the source text with the preset's name, change the font color to white, and may change other character properties.

The Fill And Stroke category of animation presets contains presets that may change the fill color and stroke properties of the preset that you apply. If the animation preset requires a stroke or fill color, the animation works only if you have assigned one to your text.

You can download additional animation presets that take advantage of per-character 3D text animation from the Adobe After Effects Exchange: www.adobe.com/go/learn_ae_cs3additionalanimationpresets.

See also

“About animation presets” on page 347

“Apply an effect or animation preset” on page 351

Animate text with text animators

Animating text with animators and selectors consists of three basic steps:

- Add an animator to specify which properties to animate.
- Use a selector to specify how much each character is affected by the animator.
- Adjust the animator properties.

Note: *To always affect all characters in the layer, delete the default selector. In this case, animating a text layer is not significantly different from animating any other layer.*

Usually, you don't need to set keyframes or expressions for the animator properties. It's common to only set keyframes or expressions for the selector and specify only the ending values for the animator properties.

For example, to animate opacity gradually from the first character to the last, you can add an animator for Opacity, set the Opacity value (in the Animator property group) to 0, and then set keyframes for the default selector's End property to 0% at 0 seconds and 100% at a later time.

 *You may find it easier to think in terms of numbers of characters than percentages for a range selector's Start and End properties. To show these properties in numbers of characters (including spaces), choose Index for Units in the Advanced property group of a range selector.*

You can create elaborate animations using several animators and several selectors, each of which adds its influence to the text animation.

To download a project that demonstrates and explains the use of text animators and selectors, see the After Effects Exchange website: www.adobe.com/go/learn_ae_textanimationproject.

Harry Frank provides a tutorial on animating text with text animators on the Digital Arts Online website:
www.adobe.com/go/learn_ae_harrytextanimators.



Animating the opacity of a text layer using the Opacity animator and the End property

1 Select a text layer in the Timeline panel, or select the specific characters that you want to animate in the Composition panel.

2 Do one of the following:

- Choose Animation > Animate Text and then choose a property from the menu.

Note: The Enable Per-Character 3D menu item does not add an animator. It adds 3D properties to the layer and to the individual characters, for which you can then add animators.

- Choose a property from the Animate menu, located in the Switches/Mode column of the Timeline panel.

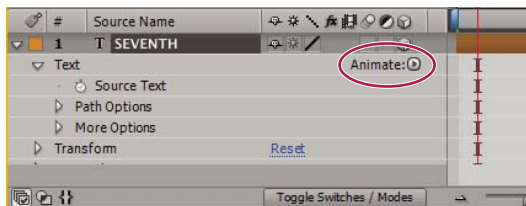

Animate menu

3 In the Timeline panel, adjust the animator property values. Often, you simply set the property that you want to animate to its ending value and then use the selectors to control everything else.

4 Expand the Range Selector property group and set keyframes for Start or End properties by clicking the stopwatch for the property and doing one of the following:

- Set the values for Start and End in the Timeline panel.
- Drag the selector bars in the Composition panel. The pointer changes to the selector movement pointer  when it is over the middle of a selector bar.

5 To refine the selection, expand Advanced and specify options and values as desired.

Work with animator properties

Animator properties work much like other layer properties, except that their values only influence the characters that are selected by the animator group's selectors. Choose **Enable Per-Character 3D** to add 3D properties to a text layer; this does not add properties to an animator group.

- To add an animator group to a text layer, select the text layer in the Timeline panel, and choose a property from the **Animation > Animate Text** menu or from the layer's **Animate** menu in the **Switches/Modes** column in the Timeline panel. A new animator group, along with a default selector and the chosen animator property, appears in the Timeline panel.
- To add a new animator property to an existing animator group, select the animator group in the Timeline panel, and choose the property from **Animation > Animate Text** menu or from the animator group's **Add** menu in the Timeline panel. The new animator property appears within the same group as the existing animator property and shares the existing selectors.
- To delete an animator property or animator group, select it in the Timeline panel and press **Delete**.
- To remove animators from a text layer, select the text layer in the Timeline panel, and choose **Animation > Remove All Text Animators**.
- To copy an animator group, select it in the Timeline panel and choose **Edit > Copy**. To paste the an animator group, select a layer and choose **Edit > Paste**.
- To rename an animator group, make sure that it is the only thing selected, and then press **Enter** (Windows) or **Return** (Mac OS).
- To reorder an animator group, drag it to a new location in the stacking order in the Timeline panel.

Animator properties

Anchor Point Anchor point for the characters. This is the point about which transformations—such as scaling and rotation—are performed.

Position The position of the characters. You can specify values for this property in the Timeline panel, or you can modify it by selecting it in the Timeline panel and then dragging the layer in the Composition panel using the Selection tool, which changes to a move tool  when positioned over text characters. Dragging with the move tool does not affect the z (depth) component of Position.

Scale The scale of the characters. Because scale is relative to the anchor point, changes to the z component of Scale have no apparent result unless the text also has an Anchor Point animator with a non-zero z value.

Skew The slant of the characters. The Skew Axis specifies the axis along which the character is skewed.

Rotation, X Rotation, Y Rotation, Z Rotation If per-character 3D properties are enabled, you can set the rotation about each axis individually. Otherwise, only Rotation (which is the same as Z Rotation) is available.

All Transform Properties All of the Transform properties are added at once to the animator group.

Line Anchor The alignment for the tracking in each line of text. A value of 0% specifies left alignment, 50% specifies center alignment, and 100% specifies right alignment.

Line Spacing The space between lines of text in a multiline text layer.

Character Offset The number of Unicode values to offset selected characters. For example, a value of 5 moves the characters in the word forward five steps alphabetically, so the word *offset* becomes *tkkxjy*.

Character Value The new Unicode value for selected characters, replacing each character with one character represented by the new value. For example, a value of 65 replaces all of the characters in a word with the 65th Unicode character (*A*), so the word *value* becomes *AAAAA*.

Character Range Specifies limits on the character. This property appears whenever you add the Character Offset or Character Value property to a layer. Choose Preserve Case & Digits to keep characters in their respective groups. Groups include uppercase Roman, lowercase Roman, digits, symbols, Japanese katakana, and so forth. Choose Full Unicode to allow for unlimited character changes.

Blur The amount of Gaussian blur to be added to the characters. Horizontal and vertical blur amounts can be specified separately.

Work with selectors

Each animator group includes a default range selector. You can replace the default selector, add additional selectors to an animator group, and remove selectors from a group.

To download a project that demonstrates and explains the use of text animators and selectors, see the After Effects Exchange website: www.adobe.com/go/learn_ae_textanimationproject.

Selectors are a lot like masks: You use selectors to specify which part of a range of text you want to affect, and by how much. You can use multiple selectors and specify a Mode setting for each one to determine how it interacts with the text and with other selectors in the same animator group. If you have only one selector, Mode specifies the interaction between the selector and the text—Add is the default behavior; and Subtract inverts the influence of the selector.

 *If you delete all selectors from an animator group, the values of the animator properties apply to all characters in the layer. This is useful because properties of the text specified by the Character panel cannot otherwise be animated (except by using Hold keyframes on the Source Text property itself).*

Use a Wiggly selector to vary a selection within a specified amount over time. Use expression selectors to use expressions to dynamically specify how much you want characters to be affected by an animator property.

- To add a selector using the Timeline panel, select an animator group in the Timeline panel and choose Selector from the animator group's Add menu, or choose Animation > Add Text Selector. Choose Range, Wiggly, or Expression from the submenu.
- To add a selector using the Composition panel, select a range of characters in the Composition panel, right-click (Windows) or Control-click (Mac OS) the text, and choose Add Text Selector from the context menu. Choose Range, Wiggly, or Expression from the submenu.
- To delete a selector, select it in the Timeline panel and press Delete.
- To rename a selector, make sure that it is the only thing selected, and then press Enter (Windows) or Return (Mac OS).
- To copy a selector, select it in the Timeline panel and choose Edit > Copy. To paste the selector, select a layer and choose Edit > Paste.
- To reorder a selector, drag it to a new location in the stacking order in the Timeline panel.

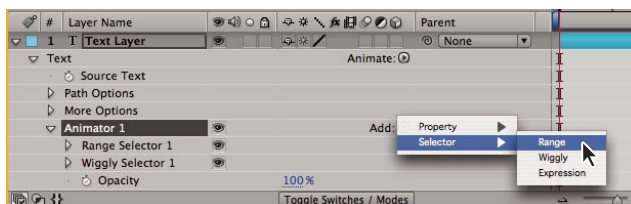

Adding a new range selector to an animator group

See also

“Working with expressions” on page 547

“Mask modes” on page 260

Common selector properties

Mode Specifies how each selector combines with the text and with selector above it, similar to how multiple masks combine when you apply a mask mode. For example, if you want to wiggle only a specific word, use a range selector on that word and then add a Wiggly selector and set it to Intersect mode.

Amount Specifies how much the range of characters is affected by animator properties. At 0%, the animator properties do not affect the characters. At 50%, half of each property value affects the characters. This option is useful for animating the result of animator properties over time. Using an expression selector, you can use expressions to dynamically set this option.

Units and Based On The units for Start, End, and Offset. You can use either the percentage or index units and base the selection on the characters, characters excluding spaces, words, or lines. If you select Characters, After Effects counts spaces and effectively pauses the animation between words as it animates the spaces between words.



Original (left) and with VEN selected by the range selectors, Based On set to Character, Shape set to Triangle, and Scale set to 40% (right)

Range selector properties

Range selectors include the following properties, in addition to properties common with other selectors:

Start and End The beginning and end of the selection. You can modify the Start and End properties by dragging the selector bars in the Composition panel when the selector is selected in the Timeline panel.

Offset The amount to offset the selection from that specified by the Start and End properties. To set Offset in the Composition panel while you edit the Start or End values, Shift-click the Start or End selector bars with the Selection tool.

Shape Controls how characters are selected between the Start and End of the range. Each option modifies the selection by creating transitions between selected characters using the chosen shape. For example, when animating the y Position values of text characters using Ramp Down, the characters gradually move at an angle from bottom left to upper right. You can specify Square, Ramp Up, Ramp Down, Triangle, Round, and Smooth.



Original (left) and after selecting the entire word, setting Based On to Characters, animating the y Position value so that the word is at the bottom of the frame, and setting Shape to Ramp Down (right)

Using different Shape options, you can significantly change the appearance of an animation.

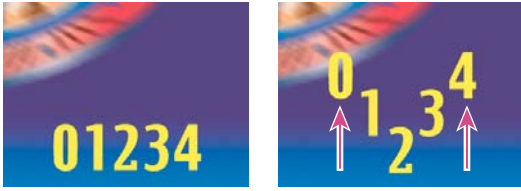

Setting Shape to Triangle

Smoothness Determines the amount of time the animation takes to transition from one character to another when you use the Square shape.

Ease High and Ease Low Determines the speed of change as selection values change from fully included (high) to fully excluded (low). For example, when Ease High is 100%, the character changes more gradually (eases into the change) while it is fully to partially selected. When Ease High is -100%, the character changes quickly while it is fully to partially selected. When Ease Low is 100%, the character changes more gradually (eases into the change) while it is partially selected to unselected. When Ease Low is -100%, the character changes quickly while it is partially selected to unselected.

Randomize Order Randomizes the order in which the property is applied to the characters specified by the Range selector. (By contrast, when you use the Wiggly selector, the value of the animator property is randomized.)

Random Seed Calculates the randomized order of a range selector when the Randomize Order option is set to On. When Random Seed is zero, the seed is based on its animator group. If you want to duplicate an animator group and retain the same randomized order as in the original animator group, set Random Seed to a value other than zero.

Wiggly selector properties

The Wiggly selector includes the following properties, in addition to properties common with other selectors:

Max Amount and Min Amount Specifies the amount of variation from the selection.

Wiggles/Second How many variations from the set selection occur per second.

Correlation Correlation between variations for each character. At 100%, all characters wiggle by the same amount at the same time, and at 0%, all characters wiggle independently.

Temporal and Spatial Phase (revolutions + degrees) The variation of wiggle, based on the phase of your animation in time (temporal) or per character (spatial).

Lock Dimensions Scales the wiggled selection's dimensions by the same value. This is useful when wiggling the Scale property.

Random Seed Changes the starting time for the animation by a specified value. When the seed is left at zero, a default value is derived based on the layer index and stream path.

Expression selector properties

Expand the Expression Selector property group and the Amount property group to reveal the expression field in the Timeline panel. By default, the Amount property begins with the expression `selectorValue * textIndex/textTotal`.

Expression selectors allow you to express the selector values for each character. The expression is evaluated once per character. Each time it is evaluated, the input parameter `textIndex` is updated to match the index of the character.



Apply the Text Bounce or Inch Worm animation preset to a text layer to see how expression selectors can be used. To see all expressions on a layer, select the layer and press EE.

In addition to the expression elements you use elsewhere, you can use the following attributes to animate selections in any number of interesting ways:

textIndex Returns the index of the character, word, or line.

textTotal Returns the total number of characters, words, or lines.

selectorValue Returns the value of the previous selector. Think of this as the input from the selector above the expression selector in the stacking order.

Note: The attributes `textIndex`, `textTotal`, and `selectorValue` can be used only with the expression selector. Using them elsewhere results in a syntax error.

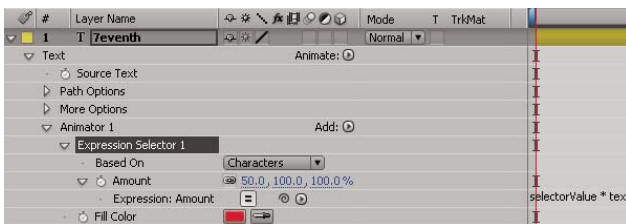

Fill color changes randomly using an expression animator.

Set a text layer's anchor point properties

Text animators animate character position, rotation, and size-related properties relative to an anchor point. You can use the text property, **Anchor Point Grouping**, to specify whether the anchor point used for transformations is that of each character, each word, each line, or the entire text block. In addition, you can control the alignment of the characters' anchor points relative to the anchor point of the group with the **Grouping Alignment** property.



Original text, then rotated and with **Grouping Alignment** set to **Character**, **Word**, and **Line**

- 1 Expand the text layer in the Timeline panel, and expand the **More Options** property group.

2 Do any of the following:

- Choose how to group the text layer's character anchor points from the Anchor Point Grouping menu.
- Lower the Grouping Alignment values to move each anchor point up and to the left.
- Raise the Grouping Alignment values to move each anchor point down and to the right.

 *To center the anchor point in a string of capital letters, try a Grouping Alignment value of 0%, -50%. To center the anchor point in a string of lowercase letters, or if you're using both lowercase and uppercase letters, try 0%, -25%.*

Work with per-character 3D text properties

You can move, scale, and rotate individual characters in three dimensions using 3D animator properties. These properties become available when you enable per-character 3D properties for the layer. Position, Anchor Point, and Scale gain a third dimension; and two additional Rotation properties (X Rotation and Y Rotation) become available. The single Rotation property for 2D layers is renamed to Z Rotation.

Enabling per-character 3D properties causes each character in the text layer to behave like an individual 3D layer within the text layer, which behaves like a precomposition with collapsed transformations. Per-character 3D layers intersect with other 3D layers following the standard rules for 3D precompositions with collapsed transformations.

A text layer itself automatically becomes a 3D layer when you enable 3D properties for its characters; this occurs implicitly whenever a per-character 3D property is added to the layer—whether by copying and pasting the Y Rotation property from another layer or applying a 3D Text animation preset.

A per-character 3D layer is designated by a special icon  in the layer's Switches column.

Inter-character blending and the Fill & Stroke options in the More Options property group are not available for per-character 3D layers.

Per-character 3D layers can decrease rendering performance. When you convert a layer from per-character 3D to 2D, the animator properties and dimensions specific to per-character 3D layers are lost. Re-enabling per-character 3D will not restore values for these properties.

You can download additional animation presets that take advantage of per-character 3D text animation from the Adobe After Effects Exchange: www.adobe.com/go/learn_ae_cs3additionalanimationpresets.

- To enable per-character 3D animator properties for a text layer, select the layer and choose Enable Per-character 3D from the Animation > Animate Text menu or from the layer's Animate menu in the Timeline panel.
- To disable per-character 3D animator properties for a text layer and convert the layer to a 2D layer, click the layer's Per-character 3D switch  in Switches column in the Timeline panel.
- To disable per-character 3D animator properties for a text layer but keep it as a 3D layer, choose Enable Per-character 3D to deselect it.

See also

“Example: Animate characters with per-character 3D properties” on page 295

Creating and animating text on a path

Once you create a mask on a text layer, you can make the text follow the mask as a path. You can then animate the text along that path, or animate the path itself. You can use open or closed masks to create paths for text. After you create the path, you can modify it at any time. When using a closed mask as a text path, make sure to set the mask mode to None.



See also

“Creating and importing masks” on page 254

“Mask modes” on page 260

Position text along a mask’s path

- 1 Create a text layer and enter text.
- 2 With the text layer selected, use the Pen tool or a mask tool to draw a mask in the Composition panel.
- 3 In the Timeline panel, expand the Path Options property group for the text layer and select the mask from the Path menu. The text automatically uses the alignment specified in the Paragraph panel.
- 4 To reposition the text on the path, change the text margins using the First Margin and Last Margin properties in the Timeline panel, or do one of the following in the Composition panel:

- Drag the left margin control , center margin control , or right margin control  to move text along the path.
- Shift-drag any margin control to snap the control to the mask vertices.

Note: Select a property in the Text property group in the Timeline panel to see the margin controls in the Composition panel. The text alignment determines which controls are available.



Changing the Last Margin of path text in the Composition panel

Text path properties

Use the Path Options properties to specify a path and alter the way that individual characters appear on the path—perpendicular to the path, aligned to the left or right, reversed, and so on. Animating Path Options properties is an easy way to animate text along a path.

Reverse Path Reverses the direction of the path.

Perpendicular To Path Rotates each character so that it is perpendicular to the path.

Force Alignment Positions the first character at the beginning of the path (or at the specified First Margin location), positions the last character at the end of the path (or at the specified Last Margin location), and evenly spaces the remaining characters between the first and last characters.

First Margin Specifies the position of the first character in pixels, relative to the start of the path. First Margin is ignored when text is right-aligned and Force Alignment is Off.

Last Margin Specifies the position of the last character in pixels, relative to the end of the path. Last Margin is ignored when text is left-aligned and Force Alignment is Off.

Examples of text animation

For examples of using an expression on the Source Text property to animate text to overcome some of the limitations of the Numbers effect, see these posts by Rick Gerard on the Adobe user-to-user forums:

www.adobe.com/go/learn_ae_rickcountingexpression1 and

www.adobe.com/go/learn_ae_rickcountingexpression2. Colin Brailey provides a tutorial and example project that show how to use an expression on the Source Text property and a null control layer to achieve a similar result:

www.adobe.com/go/learn_ae_colincountingexpression.

Example: Animate characters with per-character 3D properties

This example illustrates how you can easily animate individual characters in 3D so that each character steps out of line and takes a bow.

- 1 Create a new composition.
- 2 Create a new text layer with the word *ovation*.
- 3 Choose Animation > Animate Text > Enable Per-character 3D.
- 4 Choose Animation > Animate Text > Position.
- 5 Choose Animation > Animate Text > Rotation.
- 6 In the Timeline panel, in the Animator group, set the X Rotation property to 45, and set the Position value to (0.0, 0.0, -100.0).
- 7 Expand Range Selector 1.
- 8 Click the stopwatch icon for the Offset property to set an initial keyframe with the value at 0 seconds.
- 9 Set the Offset property value to -15%.
- 10 Set the End property value to 15%.
- 11 Move the current-time indicator to 10 seconds, and set the Offset value to 100%.
- 12 Press the R key to show the Rotation properties for the entire layer.
- 13 Set the Y Rotation value for the layer to -45. This rotates the entire layer so that you can more easily see the 3D motion of the characters.
- 14 Preview the composition.

Example: Offset characters

This example illustrates how you can easily animate random characters so that they gradually form a legible word or phrase. To do this, specify a Character Offset value and animate the range selector.



Animating the offset values for the characters in the word Galaxy

- 1 Create a new composition.
- 2 Create a new text layer with the word *Galaxy*.
- 3 Choose Animation > Animate Text > Character Offset.
- 4 In the Timeline panel, set the Character Offset value to 5.
- 5 Expand Range Selector 1.
- 6 Click the Start stopwatch to set an initial keyframe at 0 seconds and set the value to 0%.
- 7 Move the current-time indicator to 5 seconds and set the Start value to 100%.
- 8 Set Character Alignment to Center.
- 9 Preview the composition.

See also

“Create a composition” on page 108

“Enter point text” on page 274

“Work with selectors” on page 289

“Set keyframes” on page 187

“Preview video and audio” on page 120

Example: Animate characters with the Wiggly selector

This example demonstrates how easy it is to animate the position of individual characters. It also shows how the Wiggly selector can create a dramatic change to the animation simply by adding it to the layer.



Animating the color and position of the characters in the word Galaxy

- 1 Create a new composition.
- 2 Create a new text layer with the word *Galaxy* and set the color to blue in the Character panel.
- 3 Choose Animation > Animate Text > Position.
- 4 In the Timeline panel, drag the Position property's y value to the left until all the characters are off the screen.
- 5 Expand Range Selector 1.
- 6 Click the Start stopwatch and leave it at 0% at 0 seconds; then move the current-time indicator to 5 seconds and set Start to 100%.
- 7 Preview the composition.
- 8 Collapse the Animator 1 group.
- 9 Make sure that nothing is selected except the text layer name in the Timeline panel, and choose Fill Color > Hue from the Animate menu. A new animator group, Animator 2, appears in the Timeline panel.
- 10 Set Fill Hue to $1 \times +0.0$.
- 11 Expand the Range Selector 1 for Animator 2.
- 12 Click the Start stopwatch and leave it at 0% at 0 seconds; then move the current-time indicator to 5 seconds and set Start to 100%.
- 13 Preview the animation. The colors change now as they drop from the top of the screen, but they all use the same color and end up the same, original color.
- 14 With Fill Hue selected, choose Selector > Wiggly from the Add menu.
- 15 Expand the Wiggly Selector 1 property and choose Add from the Mode menu.
- 16 Preview the composition.

Note: If you add the Fill Hue property to Animator 1 and then add the Wiggly selector, both the position and the colors wiggle, instead of just the colors.

See also

“Create a composition” on page 108

“Enter point text” on page 274

“Work with selectors” on page 289

“Set keyframes” on page 187

“Preview video and audio” on page 120

Example: Animate text tracking

This example shows you how easy it is to isolate characters when tracking a line of text. Using the Tracking and Line Anchor animator properties, you can easily move all but one or a few characters.



Animating the tracking values for the characters 3579 (left and center) so that only the 7 in the middle remains (right)

- 1 Create a new composition.
- 2 Create a new text layer and type 3579.
- 3 With the text layer selected, click the Center Text button in the Paragraph panel.
- 4 Choose View > Show Grid.
- 5 In the Timeline panel, select the text layer and choose Animation > Animate Text > Tracking.
- 6 Make sure that Before & After is specified in the Track Type menu.
- 7 Click the Tracking Amount stopwatch and leave the value 0 at 0 seconds.
- 8 Move the current-time indicator to 5 seconds and drag the Tracking Amount value until all characters are off the screen.
- 9 Preview the animation.
- 10 With the current-time indicator at 0, take a snapshot of the Composition panel. You will use this, and the grids, to determine the original location of the number 7 at the end of the animation.
- 11 Move the current-time indicator to 5 seconds.
- 12 Click the Show Last Snapshot button.
- 13 In the Timeline panel, select Animator 1 and choose Line Anchor from the Add menu.
- 14 Drag the Line Anchor value until the 7 is positioned in approximately its original position in the center of the Composition panel.
- 15 Click the Show Last Snapshot button in the Composition panel to see the exact location of the 7 in its original location. Adjust the Line Anchor value to position the character in the original location.
- 16 Preview the animation.

See also

“Create a composition” on page 108

“Enter point text” on page 274

“Work with selectors” on page 289

“Work with snapshots” on page 125

“Set keyframes” on page 187

“Preview video and audio” on page 120

Example: Use selectors to animate specific words

There are many ways to use selectors. This example shows how you can use them to limit an animation to a specific word.



Animating the skew values in the characters in the word Speeding

- 1 Create a new composition.
- 2 Create a new text layer with the words *Speeding Saucer*.
- 3 Choose Animation > Animate Text > Skew.
- 4 In the Timeline panel, set the Skew value to 35.
- 5 Expand Range Selector 1.
- 6 Make sure the current-time indicator is at 0 seconds and click the End stopwatch.
- 7 In the Composition panel, drag both selector bars to the left side of the S in *Speeding*.
- 8 Move the current-time indicator to 2 seconds and drag the right selector bar to the right side of the g in *Speeding*.
- 9 Preview the composition.

See also

“Create a composition” on page 108

“Enter point text” on page 274

“Work with selectors” on page 289

“Set keyframes” on page 187

“Preview video and audio” on page 120

Example: Create a write-on animation

You can easily create the appearance of writing on the screen by using the Opacity animator property.



Writing text on using the Opacity property

- 1 Create a new composition.
- 2 Create a text layer with the characters *01234*.
- 3 Choose Animation > Animate Text > Opacity.
- 4 Set Opacity to 0%.
- 5 Expand the Range Selector 1 and click the stopwatch icon for Start.
- 6 In the Composition panel, drag the start selector to the left edge of the text (the value will be at 0).

7 Move the current-time indicator to 5 seconds and drag the start selector in the Composition panel to the right edge of the text (the value will be 5).

8 Preview the composition.

Note: By default, the Smoothness property is set to 100%. To create a typewriter appearance, expand the Advanced property and set Smoothness to 0%.

See also

“Create a composition” on page 108

“Enter point text” on page 274

“Work with selectors” on page 289

“Set keyframes” on page 187

“Preview video and audio” on page 120

Example: Animate text with multiple selectors

This example uses the `selectorValue` parameter with the Wiggly selector to make a string of characters flash on and off randomly.

1 Create a new composition.

2 Create a new text layer.

3 In the Timeline panel, choose Opacity from the text layer’s Animate menu.

4 Expand the text layer and its animator in the Timeline panel.

5 Select the Range Selector and delete it.

6 Choose Add > Selector > Wiggly next to the text layer’s Animator property group.

7 Choose Add > Selector > Expression. If the Wiggly selector doesn’t come before the Expression selector, drag the Wiggly selector above the Expression selector.

8 Expand the Expression Selector.

9 Expand the Amount property to reveal the expression. The following expression appears by default:

```
selectorValue * textIndex/textTotal
```

10 Replace the default expression text with the following expression:

```
r_val=selectorValue[0];  
if(r_val < 50)r_val=0;  
if(r_val > 50)r_val=100;  
r_val
```

11 Set the opacity to 0%, and preview the composition.

See also

“Create a composition” on page 108

“Enter point text” on page 274

“Work with selectors” on page 289

“Set keyframes” on page 187

“Preview video and audio” on page 120

Example: Animate text position with expressions

This example uses the `textIndex` and `textTotal` attributes with the `wiggle` expression to animate a line of text.

- 1 Create a new composition.
- 2 Create a new text layer.
- 3 Expand the text layer in the Timeline panel to view the text properties. Add a Position animator group from the Animate menu.
- 4 Delete the default Range selector, Range Selector 1.
- 5 Add an Expression selector by selecting the Add menu, then choosing Selector > Expression. Expand the Expression selector to reveal its options.
- 6 Expand the Amount property to reveal the expression. The following expression appears by default:

```
selectorValue * textIndex/textTotal
```

- 7 Replace the default expression with the following expression:

```
seedRandom(textIndex);  
amt=linear(time, 0, 5, 200*textIndex/textTotal, 0);  
wiggle(1, amt);
```

The `linear` method is used in this example to ramp down the maximum wiggle amount over time.

- 8 Set the vertical position value. The greater the value, the more the characters wiggle.
- 9 Preview your composition.

See also

“Create a composition” on page 108

“Enter point text” on page 274

“Work with selectors” on page 289

“Set keyframes” on page 187

“Preview video and audio” on page 120

Example: Animate text as a timecode display

❖ With no layers selected in the Timeline panel, double-click the Current Time Format animation preset in the Effects & Presets panel. (You can locate the animation preset by typing its name in the Contains field in the Effects & Presets panel.)

A new text layer is created, with an expression on the Source Text property that makes the text show the current time in the project’s current time display format.

You can use other expressions in the Global category to display time in another format.



To see the expressions on a layer, select the layer and press EE.

See also

“Global objects” on page 560



Chapter 12: Drawing and painting

Using paint tools

Scott Squires provides a pair of movies that show how to rotoscope, both painting and masking:

- www.adobe.com/go/learn_ae_scottsqquiresrotoscope1
- www.adobe.com/go/learn_ae_scottsqquiresrotoscope2

Work with paint tools and paint strokes

The Brush tool , Clone Stamp tool , and Eraser tool  are all paint tools. You use each in the Layer panel to apply paint strokes to a layer. Each paint stroke's brush marks add or remove pixels from the layer or modify the layer's transparency without modifying the layer source.

Each paint stroke has its own duration bar, Stroke Options properties, and Transform properties, which you can see and modify in the Timeline panel. Each paint stroke is, by default, named for the tool that created it, with a number that indicates the order in which it was drawn.

At any time after you draw a paint stroke, you can modify and animate each of its properties using the same techniques that you use to modify a layer's properties and duration. You can copy paint stroke path properties to and from properties for mask paths, shape layer paths, and motion paths. For even more power and flexibility, you can link these properties using expressions. (See “Creating shapes and masks” on page 318 and “Add, edit, and remove expressions” on page 549.)

Important: *To specify settings for a paint stroke before you apply it, use the Paint and Brush Tips panels. To change and animate properties for a paint stroke after you've applied it, use the stroke's properties in the Timeline panel.*

Individual brush marks are distributed along each paint stroke—though the marks may appear to merge together to form a continuous stroke with the default settings. Brush settings for each brush in the Brush Tips panel determine the shape, spacing, and other properties of brush marks; you can also modify these Stroke Options properties for each stroke in the Timeline panel.

Groups of paint strokes appear in the Timeline panel as instances of the Paint effect. Each instance of the Paint effect has a Paint On Transparent option. If you select this option, the layer source image and all effects that precede this instance of the Paint effect in the effect stacking order are ignored; the paint strokes are applied on a transparent layer.



To see a video tutorial on using the drawing and painting tools, go to the Adobe website at www.adobe.com/go/vid0223.

- To show selected layers' paint strokes in the Timeline panel, press PP.
- To select paint strokes in the Layer panel, use the Selection tool to click a paint stroke or drag a box around portions of multiple paint strokes.



To momentarily activate the Selection tool, press and hold V.

- To show only selected paint strokes in the Timeline panel, select paint strokes and press SS.

- To rename a paint stroke, select the paint stroke in the Timeline panel and press Enter on the main keyboard (Windows) or Return (Mac OS).
- To reorder paint strokes within an instance of the Paint effect, drag a Paint stroke to a new location in the stacking order in the Timeline panel.
- To reorder an instance of the Paint effect to interleave it with other effects, drag the effect to a new location in the stacking order in the Timeline panel.
- To target a specific instance of the Paint effect for the addition of new paint strokes, choose from the View menu at the bottom of the Layer panel.
- To hide a paint stroke from view (and from rendered output), deselect the paint stroke's Video switch .
- To open or close the Paint panel and Brush Tips panel when a paint tool is selected, click the Toggle The Paint Panels button .

 For some painting, drawing, cloning, and retouching tasks, you may want to take advantage of the sophisticated paint tools provided by Adobe Photoshop. See “Working with Photoshop and After Effects” on page 32.

See also

“Blending mode reference” on page 164

“Work with layer properties in the Timeline panel” on page 152

Common paint tool settings in the Paint panel

To use the Paint panel, first select a paint tool from the Tools panel.

Opacity For Brush and Clone strokes, the maximum amount of paint applied. For Eraser strokes, the maximum amount of paint and layer color removed.

Flow For Brush and Clone strokes, how quickly paint is applied. For Eraser strokes, how quickly paint and layer color are removed.

Mode How pixels in the underlying image are blended with the pixels painted on by the Brush or Clone stroke. (See “Blending mode reference” on page 164.)

Channels Which channels of the layer are affected by the Brush stroke or Clone stroke. When you choose Alpha, the stroke only affects opacity, so swatches are grayscale. Painting the alpha channel with pure black has the same result as using the Eraser tool.

Duration The duration of the paint stroke. Constant applies the stroke from the current frame to the end of the layer's duration. Single Frame applies the stroke to the current frame only. Custom applies the stroke to the specified number of frames, beginning with the current frame. Write On applies the stroke from the current frame to the end of the layer's duration and animates the End property of the stroke to match the motion with which the stroke was drawn.

See also

“Work with brushes” on page 303

Work with brushes

To use the Brush Tips panel, first select a paint tool from the Tools panel.

See also



“Work with paint tools and paint strokes” on page 302

“Common paint tool settings in the Paint panel” on page 303

Choose a brush gallery display mode

❖ Choose a display mode from the Brush Tips panel menu: Text Only, Small Thumbnail, Large Thumbnail, Small List, or Large List.

Create and manage preset brushes

- To create a new preset brush, specify the desired settings in the Brush Tips panel, and then choose New Brush from the Brush Tips panel menu or click the Save Current Settings As New Brush button .
- To rename a preset brush, select the brush and choose Rename Brush from the panel menu.
- To delete a preset brush, choose Delete Brush from the panel menu or click the Delete Brush button .
- To restore the default set of preset brushes, choose Reset Brush Tips from the Brush Tips panel menu. To retain the custom brushes you created, click Append when the dialog box prompts you to replace current brushes with the default brushes.

Note: Preset brushes are saved in the preferences file, so they persist between projects.

Brush properties

 *Ctrl-drag (Windows) or Command-drag (Mac OS) the brush in the Layer panel to adjust Diameter; release the key and continue to drag to adjust Hardness.*

Diameter Controls the size of the brush.

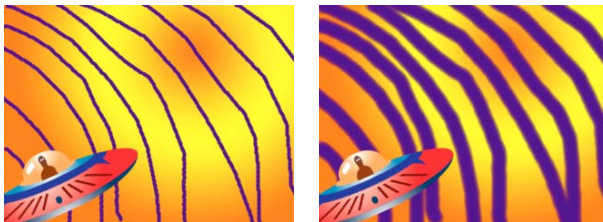

Strokes with low Diameter values (left) and high Diameter values (right)

Angle The angle by which an elliptical brush’s long axis is rotated from horizontal.

Note: Brush angles can be expressed in both positive and negative values. For example, a brush with a 45° angle is equivalent to a brush with a -135° angle.

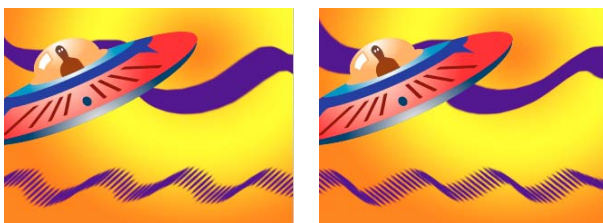

Angled brushes create chiseled strokes: 45-degree brush (left), and -45-degree brush (right).

Roundness The ratio between the brush's short and long axes. A value of 100% indicates a circular brush, a value of 0% indicates a linear brush, and intermediate values indicate elliptical brushes.



Brush strokes using 100% roundness (left) and varying percentages (right)

Hardness Controls the brush stroke's transition from 100% opaque at the center to 100% transparent at the edges. Even with high hardness settings, only the center is fully opaque.

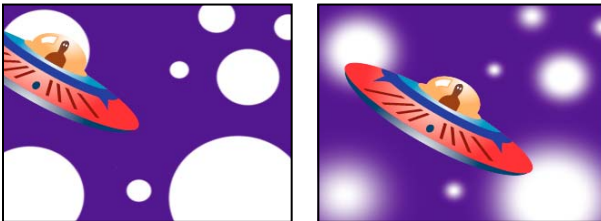

Hardness settings at 100% (left) and 0% hardness (right)

Spacing The distance between the brush marks in a stroke, measured as a percentage of the brush diameter. When this option is deselected, the speed at which you drag to create the stroke determines the spacing.

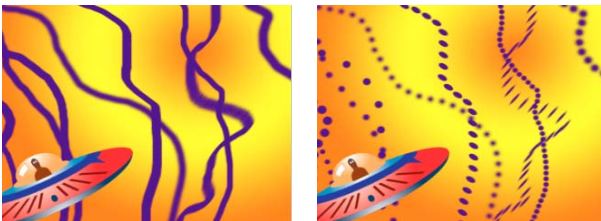

Decrease spacing for continuous strokes (left); increase spacing for dashed strokes (right).

Brush Dynamics These settings determine how brush marks are controlled by the features of a pressure-sensitive digitizing tablet, such as a Wacom pen tablet. For each brush, you can choose Pen Pressure, Pen Tilt, or Stylus Wheel for Size, Angle, Roundness, Opacity, and Flow to indicate what features of the pen tablet you would like to use to control brush marks. For example, you can vary the thickness of brush marks by setting Size to Pen Pressure and pressing more firmly when drawing some portions of the stroke. If Size is not set to Off, Minimum Size specifies the size of the thinnest brush mark.

Paint with the Brush tool

Use the Brush tool to paint on a layer in the Layer panel with the current foreground color.

Important: To specify settings for a paint stroke before you apply it, use the Paint and Brush Tips panels. To change and animate properties for a paint stroke after you've applied it, use the stroke's properties in the Timeline panel.

See also

“Common paint tool settings in the Paint panel” on page 303



“Select a color or edit a gradient” on page 236

“Blending mode reference” on page 164

“Work with layer properties in the Timeline panel” on page 152

Select a color for the Brush tool

Do any of the following with the Brush tool active:

- To select a foreground color with the Color Picker, click the Set Foreground Color button  in the Paint panel.
- To select a foreground color from anywhere on the screen with the eyedropper, select the eyedropper  in the Paint panel and then click to sample the color under the pointer. Ctrl-click (Windows) or Command-click (Mac OS) to sample the average color of a square three pixels on a side.

 You can quickly activate the eyedropper for use within the Layer panel by pressing Alt (Windows) or Option (Mac OS) when the pointer is in the Layer panel.

- To switch the foreground color with the background color, press X or click the Switch Foreground And Background Colors button .
- To reset the foreground color and background color to black and white, press D.

Note: To change or animate the color of a brush stroke after painting, use the Color property in the Stroke Options group in the Timeline panel.

Paint with the Brush tool

- 1 Select the Brush tool .
- 2 Choose settings and a brush in the Paint panel and Brush Tips panel.
- 3 In the Layer panel, drag with the Brush tool to paint on the layer.

Each time you release the mouse button, you stop drawing a stroke. When you drag again, you create a new stroke. Shift-drag to resume drawing the previous stroke.

Paint on individual frames with the Brush tool

You can paint on individual frames over a series of frames to create an animation or to obscure unwanted details in your footage. *Rotoscoping* is a special case of painting or drawing on individual frames in which some item in the frame is being traced.

 If your output will be interlaced, double the frame rate of your composition before painting on individual frames. (See “Change frame rate” on page 53.)

- 1 Select the Brush tool.
- 2 In the Paint panel, choose Custom from the Duration menu, and specify the duration in frames. To paint on each frame, set the Duration value to 1. Set other options in the Paint panel and Brush Tips panel as desired.
- 3 In the Layer panel, drag with the Brush tool to paint on the layer.

Each time you release the mouse button, you stop drawing a stroke. When you drag again, you create a new stroke. Shift-drag to resume drawing the previous stroke.

4 Press 2 on the main keyboard to advance the number of frames specified by the Custom duration setting, and then repeat the previous step.

Note: To move back the Custom number of frames, press 1 on the main keyboard.



If you use a graphics tablet, map the keyboard shortcuts to the buttons on your pen to work more efficiently. Refer to your tablet's documentation for instructions.

Use the Clone Stamp tool

You can use the Clone Stamp tool to copy pixel values from one place and time and apply them at another place and time. For example, you can use the Clone Stamp tool to remove wires by copying from a clear patch of sky, or you can create a herd of cows from one cow in the source footage and offset the copies in time.

The Clone Stamp tool samples the pixels from a *source* layer and applies the sampled pixel values to a *target* layer; the target layer can be the same layer or a different layer in the same composition. If the source layer and target layer are the same, the Clone Stamp tool samples paint strokes and effects in the source layer, in addition to the layer source image.

As with all paint tools, you use the Clone Stamp tool in the Layer panel.



If the source layer and target layer are different layers, open each layer in a different viewer. Press **Ctrl+Alt+Shift+N** (Windows) or **Command+Option+Shift+N** (Mac OS) to split and lock the current viewer.

You can identify what result a stroke will have before you make it by using the clone source overlay, a semi-transparent image of the source layer.

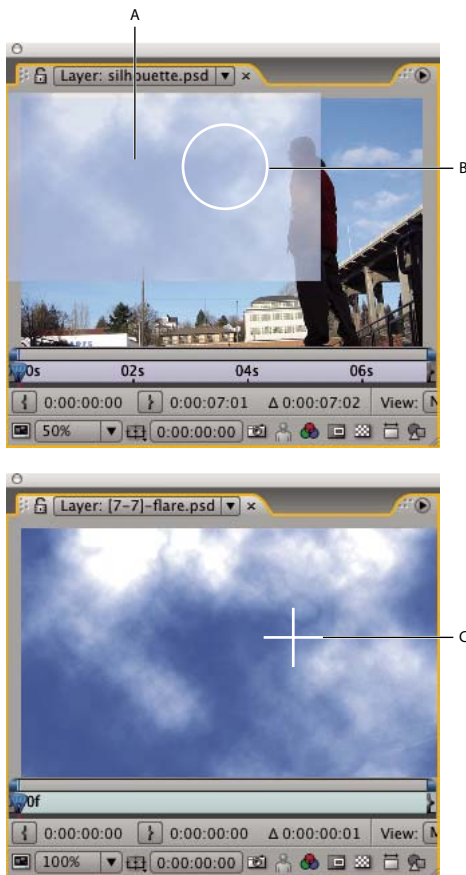

Displaying the clone source overlay while cloning between two different layers
 A. Clone source overlay B. Current stroke point C. Current sample point

Important: To specify settings for a paint stroke before you apply it, use the Paint and Brush Tips panels. To change and animate properties for a paint stroke after you've applied it, use the stroke's properties in the Timeline panel.

Select Aligned in the Paint panel to make the position of the sample point (Clone Position) change for subsequent strokes to match the movement of the Clone Stamp tool in the target Layer panel. In other words, with the Aligned option selected, you can use multiple strokes to paint on one copy of the sampled pixels. In contrast, deselecting the Aligned option causes the sample point to stay the same between strokes, meaning that you begin painting on pixels from the original sample point each time you drag again to create a new clone stroke.

For example, select Aligned to use multiple clone strokes to copy one whole cow—which would be difficult to do in one continuous stroke—and deselect Aligned to copy one flower into dozens of places in the target layer to make a field of flowers, using one clone stroke per copy.

Select Lock Source Time to clone a single source frame (at composition time Source Time); deselect Lock Source Time to clone subsequent frames, with a time offset (Source Time Shift) between the source frame and the target frame. The clone source time automatically loops back to the starting sample point when the current sampling point goes beyond the end of the source layer's duration. This is especially helpful when you have a lot of frames to repair in the target layer but only a few good frames in the source layer.

- 1 Open a composition that contains both the source layer and the target layer.

2 Open the source layer in a Layer panel and move the current-time indicator to the frame from which to begin sampling.



Note: You can manually manipulate the time and coordinates from which sampling begins by modifying the *Offset*, *Source Time Shift*, *Source Position*, or *Source Time* values in the *Paint* panel. You can reset them to zero with the *Reset* button.

3 Alt-click (Windows) or Option-click (Mac OS) with the Clone Stamp tool on the source layer in the Layer panel to set the sampling point.

4 Open the target layer in a Layer panel and move the current-time indicator to the frame to which to begin painting the clone stroke.

5 Drag in the target layer to paint on cloned pixel values from the source layer. To help you identify what the Clone Stamp tool is sampling as you apply clone strokes, a cross-hair identifies the point being sampled.

Each time you release the mouse button, you stop drawing a stroke. When you drag again, you create a new stroke. Shift-drag to resume drawing the previous stroke.

 Click the *Difference Mode* button  next to the *Clone Source Overlay* option in the *Paint* panel or modify the overlay's opacity to help you better line up elements and see the results of your clone strokes. To temporarily show the clone source overlay, press *Alt+Shift* (Windows) or *Option+Shift* (Mac OS). *Alt+Shift-drag* (Windows) or *Option+Shift-drag* (Mac OS) to change the position of the source layer.

Each clone stroke includes properties in the Timeline panel that are unique to the Clone Stamp tool and correspond to settings made in the Paint panel before the clone stroke is created:

Clone Source The sampled layer.

Clone Position The x, y location of the sample point within the source layer.

Clone Time The composition time at which the source layer is sampled. This property appears only when *Lock Source Time* is selected.

Clone Time Shift The time offset between the sampled frame and the target frame. This property appears only when *Lock Source Time* is not selected.

After clone strokes have been created, their properties in the Timeline panel can be modified and animated. For example, you can clone a bird flying across the screen by cloning it in one frame, tracking the bird's motion, and then linking the *Clone Position* property to the tracker's *Attach Point* property with an expression.

See also

"Common paint tool settings in the Paint panel" on page 303

"Work with viewers" on page 19

"Add, edit, and remove expressions" on page 549

"Work with layer properties in the Timeline panel" on page 152

Work with clone presets

Use clone presets to save and reuse clone source settings: Source Layer, Aligned, Lock Source Time, Source Time Shift, Offset, and Source Position values. Clone presets are saved in the preferences file, so they can be reused in other projects. To work with clone presets, you must first select the Clone Stamp tool.

- To select a clone preset, press 3, 4, 5, 6, or 7 on the main keyboard, or click a Clone Preset button  in the Brush Tips panel.
- To modify a clone preset, select it and adjust the Clone Options settings as desired.
- To copy the settings from one clone preset to another, select the clone preset from which to copy, and Alt-click (Windows) or Option-click (Mac OS) the Clone Preset button for the clone preset to which you want to paste the settings.

Use the Eraser tool

If you use the Eraser tool in Layer Source & Paint or Paint Only mode, it creates Eraser strokes that can be modified and animated. In contrast, using the Eraser tool in Last Stroke Only mode only affects the last paint stroke drawn and does not create an Eraser stroke.

 To temporarily use the Eraser tool in Last Stroke Only mode, Ctrl+Shift-drag (Windows) or Command+Shift-drag (Mac OS).

- 1 Select the Eraser tool from the Tools panel.
- 2 Choose settings in the Paint panel.
- 3 Select a brush in the Brush Tips panel, and set brush options.
- 4 Drag through the area you want to erase in the Layer panel.

Each time you release the mouse button, you stop drawing a stroke. When you drag again, you create a new stroke. Shift-drag to resume drawing the previous stroke.

Note: If you use a graphics tablet, pressing the eraser side of the pen to the tablet temporarily activates the Eraser tool.

See also

“Work with layer properties in the Timeline panel” on page 152

Animate paint strokes

You animate a paint stroke by setting keyframes or expressions for its properties. After Effects animates paint stroke properties—even the paint stroke’s Path property—by interpolating values for all frames between keyframes.

By modifying and animating a paint stroke’s Start and End properties, you can control how much of a stroke is shown at any time. For example, by automatically animating the End property from 0% to 100% with the Write On setting, you can make a paint stroke appear to be drawn on over time.

As with all properties, you can link paint stroke properties to other properties using expressions. For example, you can make a paint stroke follow a moving element in your footage by tracking the moving element and then linking the paint stroke’s Position property to the tracker’s Attach Point property.

See also

“Work with layer properties in the Timeline panel” on page 152

“Add, edit, and remove expressions” on page 549

Animate a paint stroke by sketching with Write On

If you choose Write On from the Duration menu in the Paint panel, the End property is automatically animated to match the motion that you used to draw the stroke.

Note: After Effects also includes a Write-on effect. (See “Write-on effect” on page 439.)

- 1 Select a paint tool in the Tools panel.
- 2 In the Paint panel, choose Write On from the Duration menu.
- 3 Drag in the Layer panel to apply a paint stroke to the layer.

As you paint, your movements are recorded in real time and determine the rate at which the resulting stroke is drawn to the screen for output. Recording begins when you click on the layer in Layer panel. When you release the mouse button, the current time returns to the time at which you started painting; this is so that you can record more paint strokes for animated playback starting from the same time.

Animate a paint stroke path

- 1 Select a paint tool in the Tools panel.
- 2 In the Paint panel, choose Single Frame, Constant, or Custom from the Duration menu.
- 3 In the Layer panel, drag to create a paint stroke.
- 4 Using the Selection tool, select the paint stroke.



To momentarily activate the Selection tool, press and hold V.

- 5 Press SS to show the selected paint stroke in the Timeline panel.
- 6 Click the triangle next to the paint stroke name to expand its list of properties.
- 7 Click the stopwatch for the Path property to create an initial Path keyframe.
- 8 Drag the current-time indicator to another time.
- 9 While the stroke is still selected, drag in the Layer panel using a paint tool to create a paint stroke. A second Path keyframe appears in the Timeline panel.

By creating a stroke while a stroke is selected, you replace the selected stroke. This is sometimes referred to as *stroke targeting*.



If you are not satisfied with the way that the path is interpolated, consider creating your path as a mask, using Smart Mask Interpolation to fine-tune the interpolation, and then copying the Mask Path property keyframes to the paint stroke Path property. (See “Use Smart Mask Interpolation” on page 265.)



After Effects interpolates a paint stroke (center) between two different shapes created with the same brush (left and right).

Shape layers overview

About vector graphics and raster images

Vector graphics are made up of lines and curves defined by mathematical objects called *vectors*, which describe an image according to its geometric characteristics. Examples of vector graphics elements within After Effects include mask paths, shapes on shape layers, and text on text layers.

Raster images (sometimes called *bitmap images*) use a rectangular grid of picture elements (pixels) to represent images. Each pixel is assigned a specific location and color value. Video footage, image sequences transferred from film, and many other types of images imported into After Effects are raster images.

Vector graphics maintain crisp edges and lose no detail when resized, because they are resolution-independent. This makes vector graphics a good choice for visual elements, such as logos, that will be used at various sizes.

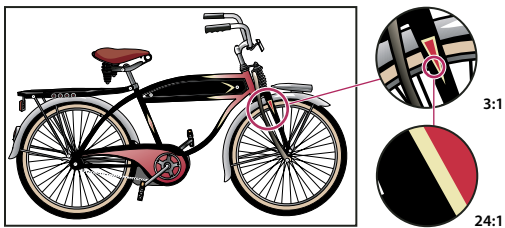

Example of a vector graphic at different levels of magnification

Raster images each consist of a fixed number of pixels, and are therefore resolution-dependent. Raster images can lose detail and appear jagged (*pixelated*) if they are scaled up.



Example of a raster image at different levels of magnification

Some images are created as vector graphics in another application but are converted to pixels (*rasterized*) when they are imported into After Effects. If a layer is continuously rasterized, After Effects reconverts the vector graphics to pixels when the layer is resized, preserving sharp edges. Vector graphics from Flash SWF, PDF, EPS, and Illustrator files can be continuously rasterized.

To see a video tutorial on using the drawing and painting tools, go to the Adobe website at www.adobe.com/go/vid0223.

See also

“Continuously rasterize a layer containing vector graphics” on page 151

About paths

Several features of After Effects, including masks and shapes, rely on the concept of a *path*. A path consists of *segments* and *vertices*. Segments are the lines or curves that connect vertices. Vertices define where each segment of a path starts and ends. Some Adobe applications use the terms *anchor point* and *path point* to refer to a vertex.

You change the shape of a path by dragging its vertices, the *direction handles* at the end of each vertex's *direction lines* (or *tangents*), or the path segment itself.

You can draw paths in common geometric shapes—including polygons, ellipses, and stars—with the shape tools, or you can use the Pen tool to draw an arbitrary path. Paths drawn with the Pen tool are either manual Bezier paths or RotoBezier paths. The main difference between RotoBezier and manual Bezier paths is that direction lines are calculated automatically for RotoBezier paths, making them easier and faster to draw.

As a path exits a vertex, the angle and length of that vertex's outgoing direction line determine the path. As the path approaches the next vertex, the path is less influenced by the previous vertex's direction line and more influenced by the next vertex's incoming direction line.

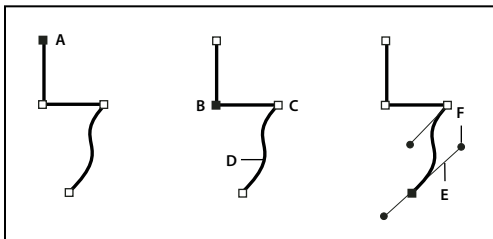

Components of a path

A. Selected vertex B. Selected vertex C. Unselected vertex D. Curved path segment E. Direction line (tangent) F. Direction handle

Paths can have two kinds of vertices: corner points and smooth points. At a *smooth point*, path segments are connected as a smooth curve; the incoming and outgoing direction lines are on the same line. At a *corner point*, a path abruptly changes direction; the incoming and outgoing direction lines are on different lines. You can draw a path using any combination of corner and smooth points. If you draw the wrong kind of point, you can change it later.

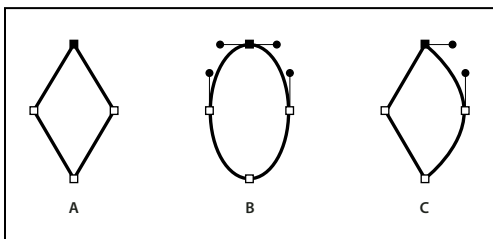

Points on a path

A. Four corner points B. Four smooth points C. Combination of corner and smooth points

When you move a direction line for a smooth point, the curves on both sides of the point adjust simultaneously. By contrast, when you move a direction line on a corner point, only the curve on the same side of the point as the direction line is adjusted.

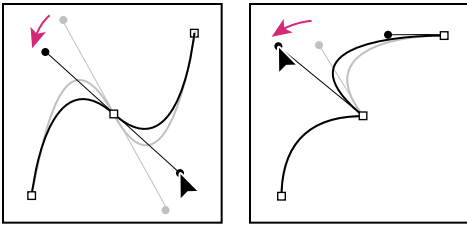

Adjusting the direction lines on a smooth point (left) and a corner point (right)

A path can either be open or closed. An open path has a beginning point that is not the same as its end point; for example, a straight line is an open path. A closed path is continuous and has no beginning or end; for example, a circle is a closed path.

For shape paths, you can use the Merge Paths path operation (similar to the Pathfinder effects in Adobe Illustrator) to combine multiple paths into one path. (See “Merge Paths options” on page 333.)

A path itself has no visual appearance in rendered output; it is essentially a collection of information about how to place or modify other visual elements. To make a path visible, you apply a stroke to it. In the case of a mask path, you can apply the Stroke effect. In the case of a path for a shape layer object, the default is for a path to be created with a stroke property group (attribute) after the path property group in the Timeline panel.

A color or gradient applied to the area inside the area bounded by a path is a *fill*.

When you use the shape tools (Rectangle, Rounded Rectangle, Ellipse, Polygon, or Star) to draw a shape path on a shape layer, you can create one of two kinds of paths: a parametric shape path or a Bezier shape path. (See “About shapes and shape layers” on page 314.)

You can link mask paths, paint stroke paths, and Bezier shape paths using expressions. You can also copy and paste between mask paths, paint stroke paths, Bezier shape paths, motion paths, and paths from Adobe Illustrator, Photoshop, and Adobe Fireworks®. (See “Creating shapes and masks” on page 318.)

See also

“Creating shapes and masks” on page 318

“Add, edit, and remove expressions” on page 549

About shapes and shape layers

Shape layers contain vector graphics objects called *shapes*. By default, a shape consists of a path, a stroke, and a fill.

You create a shape layer by drawing in the Composition panel with the shape tools or the Pen tool.

There are two varieties of shape paths: *parametric* shape paths and *Bezier* shape paths. Parametric shape paths are defined numerically, by properties that you can modify and animate after drawing, in the Timeline panel. Bezier shape paths are defined by a collection of vertices (path points) and segments that you can modify in the Composition panel. You work with Bezier shape paths in the same way that you work with mask paths. All mask paths are Bezier paths.

You can modify a shape path by applying *path operations*, such as Wiggle Paths and Pucker & Bloat. You apply a stroke to a path or fill the area defined by a path with color by applying *paint operations*.

Shape paths, paint operations, and path operations for shapes are collectively called *shape attributes*. You add shape attributes using the Add menu in the Tools panel or in the Timeline panel. Each shape attribute is represented as a property group in the Timeline panel, with properties that you can animate, just as you do with any other layer property. (See “About animation, keyframes, and expressions” on page 183.)

Shape layers are not based on footage items. Layers that are not based on footage items are sometimes called *synthetic* layers. Text layers are also synthetic layers and are also composed of vector graphics objects, so many of the rules and guidelines that apply to text layers also apply to shape layers. For example, you can't open a shape layer in a Layer panel, just as you can't open a text layer in a Layer panel.



You can save your favorite shapes as animation presets. (See “Save an animation preset” on page 353.)

To see a video tutorial introducing shape layers, go to the Adobe website at www.adobe.com/go/vid0224.

To see a video tutorial on animating shapes, go to the Adobe website at www.adobe.com/go/vid0225.

You can download additional animation presets that take advantage of per-character 3D text animation from the Adobe After Effects Exchange: www.adobe.com/go/learn_ae_cs3additionalanimationpresets.

See also

“Creating and importing masks” on page 254

“Best practices for creating text and vector graphics for video” on page 274

“Create a shape or mask by dragging with shape tools” on page 318

About groups and render order for shapes

Though the default is for a shape to consist of a single path, a single stroke, and a single fill—arranged from top to bottom in the Timeline panel—much of the power and flexibility of shape layers arises from your ability to add and reorder shape attributes and create more complex compound shapes.

A *group* is a collection of shape attributes: paths, fills, strokes, path operations, and other groups. Each group has its own blending mode and its own set of transform properties. By assembling shapes into groups, you can work with multiple shapes simultaneously—such as scaling all shapes in the group by the same amount or applying the same stroke to each shape. You can even place individual shapes or individual shape attributes within their own groups to isolate transformations. For example, you can scale a path without scaling its stroke by grouping the path by itself.

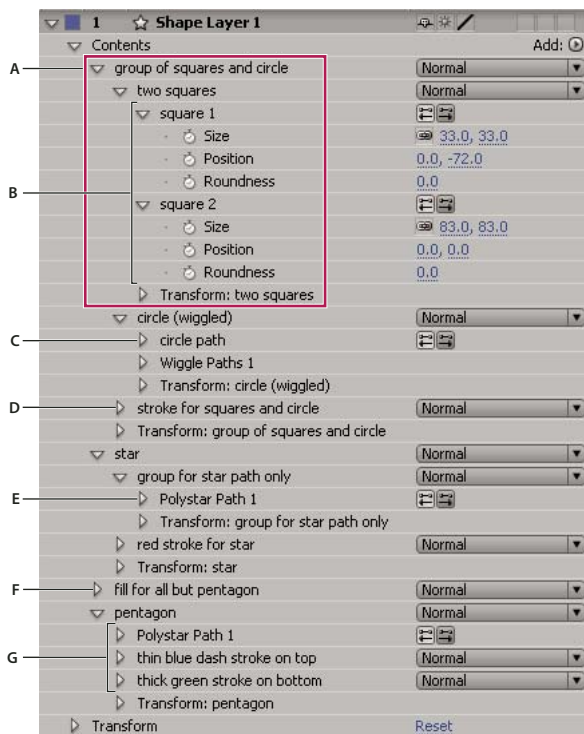
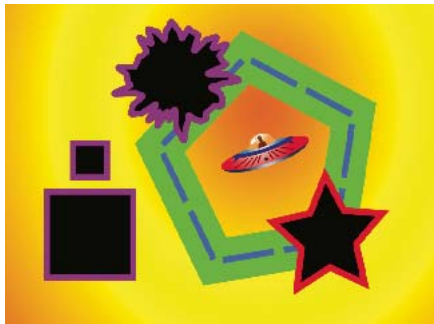

A. Two shapes in a group B. Two paths in a compound shape C. Circle path with Wiggle Paths applied D. One stroke applied to all paths above it E. Star path in a group by itself F. One fill applied to all paths above it G. One path with two strokes

When you add a shape attribute using the Add menu in the Tools panel or Timeline panel, the attribute is added within the group that is selected. You can drag groups and attributes to reorder them in the Timeline panel. By reordering and grouping shapes and shape attributes, you can affect their rendering order with respect to other shapes and shape attributes.

Render order for shapes within a shape layer

The rules for rendering a shape layer are similar to the rules for rendering a composition that contains nested compositions:

- Within a group, the shape at the bottom of the Timeline panel stacking order is rendered first.
- All path operations within a group are performed before paint operations. This means, for example, that the stroke follows the distortions in the path made by the Wiggle Paths path operation. Path operations within a group are performed from top to bottom. (See “Alter shape paths with path operations” on page 332.)

- Paint operations within a group are performed from the bottom to the top in the Timeline panel stacking order. This means, for example, that a stroke is rendered on top of (in front of) a stroke that appears after it in the Timeline panel. To override this default behavior for a specific fill or stroke, choose Above Previous In Same Group for the fill or stroke's Composite property in the Timeline panel. (See "Work with strokes and fills for shapes" on page 328.)

Path operations and paint operations apply to all paths above them in the same group.

Transform properties for shape groups and shape paths

Each group has its own Transform property group. This Transform property group is represented in the Timeline panel with a property group named Transform: *[group name]* and in the Composition panel as a dashed box with handles. You can group a path by itself and transform only the path using its new Transform property group.

Introducing an additional Transform property group for a single path is useful, for example, for creating complex motion—such as spinning about one anchor point while also revolving along an orbit. The transformations of a group affect all shapes within the group; this is the same behavior as that of layer parenting. (See "Work with parent and child layers" on page 158.)

Each shape path also has intrinsic properties that affect the position and shape of the path. For parametric shape paths, these properties (such as Position and Size) are parameters visible in the Timeline panel. For Bezier shape paths, these properties are defined for each vertex but are contained within the Path property. When you modify a Bezier path using the free-transform bounding box, you modify these intrinsic properties for the vertices that constitute that path.

Group and ungroup shapes and shape attributes

You can group shapes or shape attributes that are at the same grouping level within a single shape layer.

See also

"About groups and render order for shapes" on page 315

Group shapes or shape attributes

- ❖ Select one or more shapes or shape attributes, and do one of the following:
 - Choose Layer > Group Shapes.
 - Press Ctrl+G (Windows) or Command+G (Mac OS).

When you group shapes, the anchor point for the group is placed in the center of the group's bounding box.

Ungroup shapes or shape attributes

- ❖ Select a single group, and do one of the following:
 - Choose Layer > Ungroup Shapes.
 - Press Ctrl+Shift+G (Windows) or Command+Shift+G (Mac OS).

Create an empty shape group

- ❖ Choose Group (Empty) from the Add menu in the Tools panel or in the Timeline panel.

Creating shapes and masks

Creating shapes and shape layers

You create a shape layer by drawing in the Composition panel with a shape tool or the Pen tool. You can then add shape attributes to existing shapes or create new shapes within that shape layer. By default, if you draw in the Composition panel when a shape layer is selected, you create a new shape within that shape layer, above the selected shapes or group of shapes. If you draw in the Composition panel using a shape tool or Pen tool when an image layer other than a shape layer is selected, you create a mask.



Press F2 to deselect all layers before drawing in the Composition panel to create a new shape layer.

A new shape has a fill and a stroke that correspond to the Fill and Stroke settings in the Tools panel at the time that the shape is drawn. You can use the same controls in the Tools panel to change these attributes for a selected shape after it has been drawn.

Note: To draw a mask on a shape layer, click the *Tool Creates Mask*  button in the Tools panel with a shape tool or Pen tool active. For more information about creating masks, see “Creating and importing masks” on page 254.





You can create a new, empty shape layer by choosing Layer > New > Shape Layer.

See also

“About shapes and shape layers” on page 314

“About masks” on page 253

Create a shape or mask by dragging with shape tools

The shape tools are the Rectangle , Rounded Rectangle , Ellipse , Polygon , and Star  tools.



To activate and cycle through the shape tools, press Q.

A polygon is a star without an Inner Radius or Inner Roundness property, so the name of the shape created for a polygon or a star is the same: *polystar*.

You can create a mask by dragging with a shape tool on a selected layer in the Composition panel or Layer panel. You can create a shape by dragging with a shape tool on a selected shape layer in the Composition panel. If you drag with a shape tool in the Composition panel with no layer selected, you create a shape on a new shape layer.

Note: To draw a mask on a shape layer, click the *Tool Creates Mask*  button in the Tools panel with a shape tool active.

When you create a shape by dragging with a shape tool in the Composition panel, you create a parametric shape path. To instead create a Bezier shape path, press the Alt (Windows) or Option (Mac OS) key before you click to begin dragging. You can release the key before you complete the drag operation. All mask paths are Bezier paths.

Dragging starts when you click in the Composition panel or Layer panel to begin drawing, and ends when you release the mouse button. Pressing modifier keys at different times during a single dragging operation achieves different results:

- To reposition a shape or mask as you are drawing, hold the spacebar or the middle mouse button while dragging.

- To scale a circle, ellipse, square, rounded square, rectangle, or rounded rectangle around its center while drawing, hold the Ctrl (Windows) or Command (Mac OS) key after you begin dragging. Don't release the key until you have released the mouse button to finish drawing.
- To cancel the drawing operation, press Esc.

Note: Each shape tool retains the settings of the most recent drawing operation with that tool. For example, if you draw a star and modify the number of points to be 10, then the next star that you draw will also have 10 points. To reset a tool's settings and create a shape with the default settings, double-click the tool in the Tools panel. (See "Create a shape or mask the size of the layer" on page 320.)

See also

"Creating and importing masks" on page 254

"Shortcuts for working with shape layers" on page 655

Draw rectangles, rounded rectangles, squares, and rounded squares

1 Select the Rectangle tool  or the Rounded Rectangle tool , and do one of the following:

- To draw a rectangle or rounded rectangle, drag diagonally.
- To draw a square or rounded square, Shift-drag diagonally.

2 (Optional) If drawing a rounded rectangle or rounded square, do the following before releasing the mouse button:

- To increase or decrease the corner roundness, press the Up Arrow key or the Down Arrow key, or roll the mouse wheel forward or backward.
- To set corner roundness to the minimum or maximum, press the Left Arrow key or the Right Arrow key.

3 Release the mouse button to finish drawing. If drawing a square or rounded square, release the Shift key after releasing the mouse button.

Note: Squares are created to be square according to the pixel aspect ratio of the composition. If the composition's pixel aspect ratio is not 1, then squares only appear square in the Composition panel if the Toggle Pixel Aspect Ratio button  is selected at the bottom of the Composition panel.

Draw ellipses and circles

1 Select the Ellipse tool , and do one of the following:

- To draw an ellipse, drag diagonally.
- To draw a circle, Shift-drag diagonally.

2 Release the mouse button to finish drawing. If drawing a circle, release the Shift key after releasing the mouse button.

Note: Circles are created to be circular according to the pixel aspect ratio of the composition. If the composition's pixel aspect ratio is not 1, then circles only appear circular in the Composition panel if the Toggle Pixel Aspect Ratio button  is selected at the bottom of the Composition panel.

Draw polygons and stars

1 Select the Polygon tool  or the Star tool , and do one of the following:

- Drag to scale and rotate the polygon or star as you draw it.
- Shift-drag to scale the polygon or star as you draw it, preventing rotation.

2 (Optional) Do the following before releasing the mouse button:





- To add or remove points, press the Up Arrow key or the Down Arrow key, or roll the mouse wheel forward or backward.
- To increase or decrease the outer roundness, press the Left Arrow key or the Right Arrow key.
- To keep the inner radius of a star constant as you move the mouse to increase the outer radius, hold the Ctrl (Windows) or Command (Mac OS) key.
- To increase or decrease the inner roundness of a star, press the Page Up key or the Page Down key.

3 Release the mouse button to finish drawing. If Shift-dragging to prevent rotation, release the Shift key after releasing the mouse button.

Create a shape or mask the size of the layer

1 Select the destination for the new mask or shape:

- To create a shape on an existing shape layer, select the shape layer.
- To create a shape on a new shape layer with the dimensions of the composition, deselect all layers by pressing F2.
- To create a mask, select a layer in the Timeline panel, Layer panel, or Composition panel. To create a mask on a shape layer, you must also click the Tool Creates Mask  button in the Tools panel with a shape tool active.
- To replace a mask path, select the mask in the Timeline panel, Layer panel, or Composition panel.
- To replace a shape path, select the shape path (not the group) in the Composition panel or Timeline panel.

2 In the Tools panel, double-click the Rectangle , Rounded Rectangle , Ellipse , Polygon , or Star  tool.

Create shapes from text characters

The Create Outlines command extracts the outlines for each character, creates shapes from the outlines, and puts the shapes on a new shape layer. You can then use these shapes as you would any other shape.

The new shape layer is created at the top of the layer stacking order. The new layer contains one shape group for each selected character, plus fill and stroke properties that match those of the text.

For characters that consist of compound paths—such as *i* and *e*—multiple paths are created and combined with the Merge Paths path operation.

Effects, masks, layer styles, and keyframes and expressions for properties in the text layer's Transform property group are copied to the new shape layer. The Video switch  for the text layer is turned off.

 *Some font families, such as Webdings, include characters that are graphical images, rather than text. Converting text from these font families can be a good way to get started with simple graphical elements in shape layers.*

1 Select the text to convert to shapes:

- To create shapes for all characters in a text layer, select the text layer in the Timeline panel or Composition panel.
- To create shapes for specific characters, select the characters in the Composition panel.

2 Choose Layer > Create Outlines.

The Create Outlines menu command in versions of After Effects previous to After Effects CS3 created masks on a solid layer instead of creating shapes. To achieve the same result in After Effects CS3, you can run a script to convert the shapes created by the Create Outlines command to masks on a solid layer. The script is available on Jeff Almasol's website: www.adobe.com/go/learn_ae_jeffshapestomasks.

See also

“About text layers” on page 273

Create a Bezier shape or mask using the Pen tool

You can create a Bezier mask using the Pen tool on a selected layer in the Composition panel or Layer panel. You can create a shape with a Bezier path using the Pen tool on a selected shape layer in the Composition panel. If you draw with the Pen tool in the Composition panel with no layer selected, you create a shape on a new shape layer.

Creating a RotoBezier path is similar to creating a manual Bezier path. The primary difference is that direction lines for vertices and curvature for path segments are automatically calculated.

Create a manual Bezier path using the Pen tool

1 With the Pen tool selected and the RotoBezier option deselected in the Tools panel, click in the Composition panel where you want to place the first vertex.

2 Click where you want to place the next vertex. To create a curved segment, drag the direction line handle to create the curve that you want.

 *To reposition a vertex after you've clicked to place it but before you've released the mouse button, hold the spacebar while dragging.*

The last vertex that you add appears as a solid square, indicating that it is selected. Previously added vertices become hollow, and deselected, as you add more vertices.

3 Repeat step 2 until you are ready to complete the path.

4 Complete the path by doing one of the following:

- To close the path, place the pointer over the first vertex and, when a closed circle icon appears next to the pointer , click the vertex.

Note: You can also close a path by double-clicking the last vertex or choosing *Layer > Mask And Shape Path > Closed*.

- To leave the path open, activate a different tool, or press F2 to deselect the path.

Draw straight manual Bezier path segments with the Pen tool

The simplest path that you can draw with the Pen tool is a straight line, made by clicking with the Pen tool to create two vertices. By continuing to click, you create a path made of straight line segments connected by corner points.

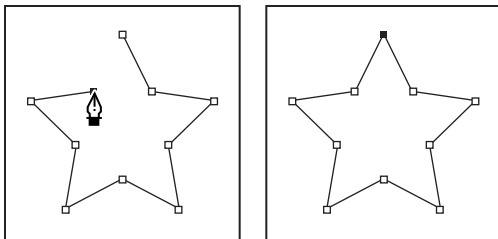

Clicking with Pen tool creates straight segments.

1 Place the Pen tool where you want the straight segment to begin, and click to place a vertex. (Do not drag.)

2 Click again where you want the segment to end. (Shift-click to constrain the angle between segments at the corner point to a whole multiple of 45°.)

3 Continue clicking to set vertices for additional straight segments.

Draw curved manual Bezier path segments with the Pen tool

You create a curved path segment by dragging direction lines. The length and direction of the direction lines determine the shape of the curve.

 *Shift-drag to constrain the angle of the direction lines to whole multiples of 45°. Alt-drag (Windows) or Option-drag (Mac OS) to modify only the outgoing direction line.*

1 Place the Pen tool where you want the curve to begin, and hold the mouse button down.

A vertex appears, and the Pen tool pointer changes to an arrowhead.

2 Drag to modify the length and direction of both direction lines for a vertex, and then release the mouse button.

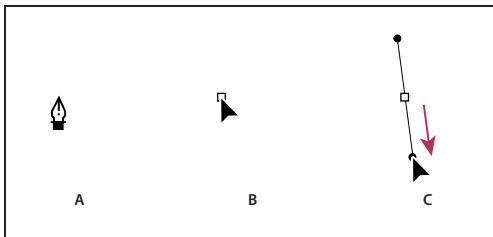

Drawing the first vertex in a curved path

A. Positioning Pen tool B. Starting to drag (mouse button pressed) C. Dragging to extend direction lines

3 Place the Pen tool where you want the curved segment to end, and do one of the following:

- To create a C-shaped curve, drag in the direction opposite from the direction that you dragged the previous direction line, and then release the mouse button.

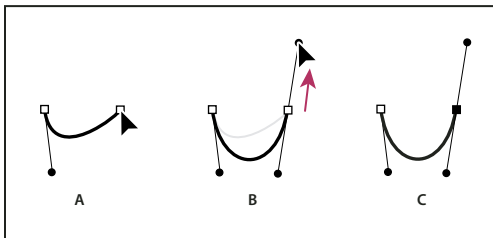

Drawing the second vertex in a curved path

A. Starting to drag B. Dragging away from previous direction line, creating a C curve C. Result after releasing mouse button

- To create an S-shaped curve, drag in the same direction as the previous direction line, and then release the mouse button.

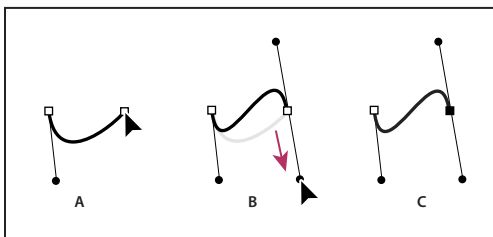

Drawing an S curve

A. Starting to drag B. Dragging in same direction as previous direction line, creating an S curve C. Result after releasing mouse button

4 Continue dragging the Pen tool from different locations to create a series of smooth curves.

Convert a path between manual Bezier and RotoBezier

You can convert any manual Bezier mask path or manual Bezier shape path to a RotoBezier path. If the manual Bezier path has direction handles that have been adjusted, this conversion changes the shape of the path, because After Effects calculates the curvature of RotoBezier segments automatically.

The conversion of a RotoBezier path to a manual Bezier path does not change the shape of the path.

- 1 Select a mask in the Layer, Composition, or Timeline panel, or select a shape path in the Composition or Timeline panel.
- 2 Choose Layer > Mask And Shape Path > RotoBezier.

Modify a Bezier mask path or shape path

You can change a Bezier mask path using the Selection tool and pen tools in the Layer or Composition panel. You can change a Bezier shape path using the Selection tool and pen tools in the Composition panel.

The pen tools—Add Vertex, Delete Vertex, and Convert Vertex tools—are grouped with the Pen tool in the Tools panel. To reveal these tools in the Tools panel, click and hold the Pen tool in the Tools panel.

 *In most cases, the appropriate pen tool becomes active when you place the Pen tool pointer in a particular context. For example, the Delete Vertex tool becomes active when you place the Pen tool pointer over an existing vertex, and the Add Vertex tool becomes active when you place the Pen tool pointer over a path segment. To manually activate and cycle through these tools, press G.*



When modifying a path, make sure that you click only existing vertices or segments; otherwise, you may create a new path instead.

Move, add, or delete a vertex

❖ Do one of the following:

- To move a vertex, drag the vertex with the Selection tool .

 *To temporarily switch from the Pen tool to the Selection tool, press V or Ctrl (Windows) or Command (Mac OS).*

- To add a vertex to a mask, use the Add Vertex tool  to click the segment between two existing vertices.
- To delete a vertex from a mask, use the Delete Vertex tool  to click the vertex.

Adjust a path segment

❖ Do one of the following with the Selection tool:

- Drag a vertex.
- Drag the direction handles extending from an adjoining smooth vertex.
- Drag a curved segment.

 *Dragging a curved segment on a RotoBezier mask also moves the vertices.*

Toggle a vertex between a smooth point and a corner point

❖ Click the vertex with the Convert Vertex tool .

 *To activate the Convert Vertex tool when the Pen tool is selected, hold down Alt (Windows) or Option (Mac OS).*

Adjust the tension of a RotoBezier mask

- 1 If you want to adjust the tension of more than one vertex simultaneously, then select them.
- 2 Using the Convert Vertex tool , drag a vertex.



To activate the Convert Vertex tool when the Pen tool is selected, hold down *Alt* (Windows) or *Option* (Mac OS).

The Adjust Tension pointer  appears as you drag a vertex of the RotoBezier mask.

Clicking a vertex instead of dragging sets the vertex to a corner point (100% tension); clicking again sets the vertex to a smooth point (33% tension). Dragging up or to the right decreases the selection's tension, increasing the curve of adjacent path segments; dragging down or to the left increases the selection's tension, decreasing the curve of adjacent path segments.



To view the tension value of a vertex, look in the Info panel as you adjust the tension.

Copy a path from Illustrator, Photoshop, or Fireworks

You can copy a path from Illustrator, Photoshop, or Fireworks and paste it into After Effects as a mask path or shape path.

To make the data copied from Illustrator compatible with After Effects, the AICB option must be selected in the Files & Clipboard section of the Adobe Illustrator Preferences dialog box.

For a path imported from Photoshop to be scaled correctly, the Photoshop document must have a resolution of 72dpi. This is the Resolution setting of documents created in Photoshop using a Film & Video preset.

- 1 In Illustrator, Photoshop, or Fireworks, select an entire path, and then choose *Edit > Copy*.
- 2 In After Effects, do one of the following to define a target for the paste operation:
 - To create a new mask, select a layer.
 - To replace an existing mask path or shape path, select its Path property.

Note: To paste a path as a shape path, you must select the Path property of an existing shape in a shape layer. This selection tells After Effects what the target of the paste operation is; if the target isn't specified in this way, After Effects assumes that the target is the entire layer and therefore draws a new mask. If there is no Path property—perhaps because the shape layer is empty—then you can draw a placeholder path with the Pen tool and then paste the path from Illustrator into that.

- 3 Choose *Edit > Paste*.

If you paste multiple paths into a shape path, the first path goes into the shape path, and the remaining paths are pasted into new mask paths. This is because the paths other than the first one don't have a clearly defined target, so they are added to the entire layer as masks.

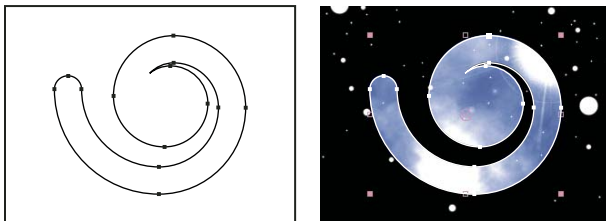

Path drawn in Adobe Illustrator (left) and pasted into After Effects as a mask (right)

Note: You can also use a copied Illustrator, Photoshop, or Fireworks path as an After Effects motion path. See “Create a motion path from a mask, shape, or paint path” on page 199 for more information.

See also

“Preparing and importing Illustrator files” on page 85

Designate the first vertex for a Bezier path

To animate a path, After Effects designates the topmost vertex at the initial keyframe as the *first vertex* and numbers each successive vertex in ascending order from the first vertex. After Effects then assigns the same numbers to the corresponding vertices at all successive keyframes. After Effects interpolates the movement of each vertex from its initial position at one keyframe to the position of the correspondingly numbered vertex at the next keyframe. At any time during an animation, you can designate another vertex as the first vertex; this causes After Effects to renumber the vertices of the path. Renumbering vertices causes path animation to change, because After Effects then maps the new vertex numbers to the corresponding old vertex numbers still saved at successive keyframes.

Some shape path operations, such as Trim Paths, also use the first vertex as input to determine how to modify the path.

Note: By default, when you add a vertex to a path, the new vertex appears on the path throughout the path’s duration but reshapes the path only at the time at which it was added. When you delete a vertex from a path at a specific point in time, the vertex is deleted from the path throughout the path’s duration. Prevent After Effects from adding and deleting vertices throughout the path’s duration by choosing Edit > Preferences > General (Windows) or After Effects > Preferences > General (Mac OS), and deselecting Preserve Constant Vertex Count When Editing Masks.

- 1 Create an animated path.
- 2 In the Timeline panel, move the current-time indicator to the point where you want to designate a new first vertex.
- 3 Select the vertex to designate as the first vertex.
- 4 Choose Layer > Mask And Shape Path > Set First Vertex.

Note: The vertex designated as the first vertex appears slightly larger than the other vertices in the Composition panel.

Managing and editing shapes

Select paths, shapes, and groups

You can select shape layers and their components at any of four levels of selection, referred to as *selection modes*:

Layer selection mode The entire shape layer is selected. Transformations apply to the transform properties for the layer, in the Transform property group that is at the same level as the Contents property group.

Group selection mode An entire shape group is selected. Transformations apply to the transform properties for the group, in the Transform property group within the shape group in the Timeline panel.

Free-transform mode Multiple vertices on one or more Bezier paths are selected. A free-transform bounding box is shown around the vertices in the Composition panel. By operating on this box, you can move multiple vertices with a single transformation. Transformations apply to the vertices themselves, which are contained within the Path property in the Timeline panel.

Path-editing mode Only vertices are selected. In this mode, you can perform path-editing operations, such as adding vertices to a path and moving individual vertices.

When a pen tool is active, path-editing mode is active. To remain in path-editing mode, select the Pen tool; press *V* or *Ctrl* (Windows) or *Command* (Mac OS) to temporarily activate the Selection tool as needed.

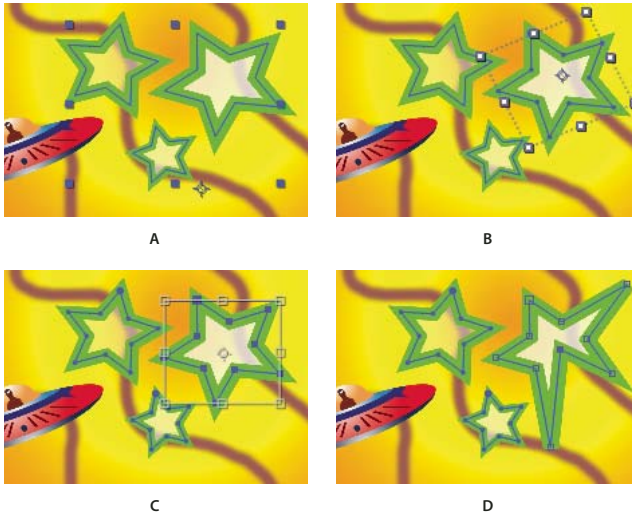

Selection modes for shapes on shape layers
A. Layer selection B. Group selection C. Free-transform D. Path editing

For information on selecting masks, see “Select masks, segments, and vertices” on page 258.

Press *Ctrl+A* (Windows) or *Command+A* (Mac OS) with a shape vertex selected to select all vertices on that path. Press again to select all shapes. Press again to select all layers.

Select a shape layer

- Click the layer name or layer duration bar in the Timeline panel.
- Using the Selection tool, click within the layer’s bounds in the Composition panel.
- To deselect all shapes on a layer but leave the shape layer selected, click within the layer’s bounds but outside all shape paths.

Select a shape group in group selection mode

- Using the Selection tool, double-click a member of the group in the Composition panel. Each time that you double-click, you descend another level in the group hierarchy.
- To activate the Direct Selection tool , hold *Ctrl* (Windows) or *Command* (Mac OS) with the Selection tool selected. Click a shape in the Composition panel with the Direct Selection tool to directly select that shape’s group, regardless of how deeply nested the shape is in the group hierarchy.
- To select a group that is contained within the same group as the group that is already selected, click the group to select.
- To add a group to a selection, Shift-click it. You can combine the Shift key with double-clicking and with the Direct Selection tool to add more deeply nested groups to the selection.

Select paths and vertices in path-editing mode

- To select a vertex, click the vertex with the Selection tool. To add vertices to the selection, Shift-click them.
- To select a path segment, click the segment with the Selection tool. To add segments to the selection, Shift-click them.

- To select an entire path, Alt-click (Windows) or Option-click (Mac OS) a segment or vertex of the path with the Selection tool, or select any portion of the path and press Ctrl+A (Windows) or Command+A (Mac OS).
- To select vertices by dragging, select a path or portion of a path to enter path-editing mode, and then drag with the marquee-selection tool  to draw a marquee-selection box around the vertices to select. To add vertices to the selection, hold down the Shift key as you draw additional marquee-selection boxes.





Select all points on a path and enter free-transform mode

- Double-click a path segment while in path-editing mode or in group selection mode for a single shape.
- Select the Path property in the Timeline panel and press Ctrl+T (Windows) or Command+T (Mac OS).

Move vertices in free-transform mode

You can scale and rotate an entire mask or shape path (or selected vertices in one or more paths) using the Free Transform Points command. When you use this command, a *free-transform bounding box* surrounds the selected vertices, and an anchor point appears in the center of the bounding box to mark the anchor point for the current transformation. You can scale and rotate the selected vertices by dragging the bounding box or its handles. You can also change the reference point from which the vertices are rotated or scaled by moving the bounding box anchor point. The free-transform bounding box handles and anchor point exist independently of the handles and anchor point for the layer.



Note: When you animate rotation using Free Transform Points, the vertices of the mask are interpolated in a straight line from keyframe to keyframe. For this reason, the results may be different from what you expect.

- 1 Display the layer containing the paths that you want to transform in the Composition or Layer panel.
- 2 Using the Selection tool, do one of the following:
 - To transform any number of vertices, select the vertices that you want to transform and choose Layer > Mask And Shape Path > Free Transform Points.
 - To transform an entire mask or shape path, select it in the Timeline panel and choose Layer > Mask And Shape Path > Free Transform Points.
- 3 To move the bounding box's anchor point, position the Selection tool over the bounding box anchor point  until the Selection tool changes to a move anchor point icon . Drag to position the anchor point.
- 4 Do any combination of the following:
 - To move the path or selected vertices, position the pointer inside the bounding box and drag.
 - To scale the path or selected vertices, position the pointer on a bounding box handle and, when the pointer changes to a straight, double-sided arrow , drag to a new size. Hold down Shift as you drag to constrain the scale. Hold down Ctrl (Windows) or Command (Mac OS) as you drag to scale around the bounding box's anchor point.
 - To rotate the path or selected vertices, position the pointer just outside the free-transform bounding box and, when the pointer changes to a curved double-sided arrow , drag to rotate.
- 5 To exit free-transform mode, press Esc, Enter (Windows), or Return (Mac OS).

Duplicate a shape group while transforming

When a shape group is selected in group selection mode, you can duplicate the group while moving, rotating, or scaling it in the Composition panel.

- Hold the Alt (Windows) or Option (Mac OS) key as you drag to transform a group.

The pointer changes to a duplication pointer ( or ) as you hold the key and place the pointer near the group transform box.

Adding attributes to shape layers

After a shape layer has been created, you can add attributes by using the Add menu in the Tools panel or in the Timeline panel.

By default, the new attributes are inserted into the selected shape group or groups according to the following rules:

- New paths are added below existing paths and groups.
- New path operations—such as Zig Zag and Wiggle Paths—are added below existing path operations. If no path operations are present, new path operations are added below existing paths.
- New paint operations—strokes and fills—are added below existing paths and above existing strokes and fills.

To override these rules and place a new attribute at the end of the group, below all attributes, hold the Alt (Windows) or Option (Mac OS) key as you click to choose an item from the Add menu.

The Repeater operation is always added at the end of the group.

See also

“About groups and render order for shapes” on page 315

Work with strokes and fills for shapes

Strokes and fills for shapes are paint operations that add colored pixels to a path or to the area defined by a path. A stroke or a fill can consist of a solid color, or it can use a gradient of colors. Strokes can be continuous, or they can consist of a periodic series of dashes and gaps. Each stroke and fill has its own blending mode, which determines how it interacts with other paint operations in the same group.

By default, paint operations within a group are performed from the bottom to the top in the Timeline panel stacking order. This means, for example, that a stroke is rendered on top of (in front of) a stroke that appears after it in the Timeline panel. To override this default behavior for a specific fill or stroke, choose Above Previous In Same Group for the fill or stroke's Composite property in the Timeline panel.

***Note:** When you add a stroke or fill using the Add menu in the Tools panel or Timeline panel, the paint operation is added below existing paths and above existing strokes and fills. To place a new stroke at the end of the group, hold the Alt (Windows) or Option (Mac OS) key as you click to choose an item from the Add menu.*

New shapes are created with fill and stroke properties depicted by the swatch buttons next to the underlined Fill and Stroke text controls in the Tools panel. You can also modify the fill colors, stroke colors, fill type, and stroke type for selected shapes using these controls. The Fill and Stroke controls are only visible in the Tools panel when a shape layer is selected or a drawing tool is active.

If multiple shapes are selected, with different fill or stroke properties, then the swatch button next to the Fill or Stroke control contains a question mark. You can still modify the fill and stroke properties using these controls, and the corresponding properties for all selected shapes are set to the same value.

Fills and strokes can be any of four types:

None No paint operation is performed.

Solid color The entire fill or stroke consists of one color.

Linear gradient The fill or stroke consists of colors and opacity values defined by a linear gradient and then mapped onto the composition along a single axis from the Start Point to the End Point.

Radial gradient The fill or stroke consists of colors and opacity values defined by a linear gradient, which are mapped onto the composition along a radius extending outward from the Start Point at the center to the End Point at the circumference of a circle. You can offset the starting point by modifying the Highlight Length and Highlight Angle values.

 You can animate and interpolate gradients by adding keyframes to the Colors property and using the Color Picker in Gradient Editor mode to add, modify, and remove color stops and opacity stops. You can also save gradients as animation presets. (See “Save an animation preset” on page 353.)

The colors of strokes and fills for shape layers are not rendered as high-dynamic range colors. Color values under 0.0 or over 1.0 are clipped to fall within the range of 0.0 to 1.0.

See also

“Select a color or edit a gradient” on page 236

Choose stroke or fill type and blending options

- To choose a fill type or stroke type for new shapes, or set the blending mode or opacity for a fill or stroke for new shapes, click the underlined Fill or Stroke text control in the Tools panel. To cycle through fill types or stroke types for existing shapes, select the shapes before using these controls.
- To cycle through fill types or stroke types for new shapes, Alt-click (Windows) or Option-click (Mac OS) the swatch button next to the underlined Fill or Stroke text control in the Tools panel. To choose a fill type or stroke type for existing shapes, select the shapes before using these controls.

Choose a solid color or edit a gradient for a stroke or fill

- To choose a solid color or gradient for fills or strokes for new shapes, click the swatch button next to the underlined Fill or Stroke text control in the Tools panel. To choose a solid color or gradient for fills or strokes for existing shapes, select the shapes before using the controls.

Modify a gradient’s color mapping



A gradient is a range of color and opacity values that you can customize in the Gradient Editor dialog box. You can also customize how those colors are applied to a stroke or fill by modifying the Start Point and End Point, which determine the direction and scale of the gradient. For example, you can modify these points to stretch the colors of a gradient out over a larger area, or orient a linear gradient so that colors fade from top to bottom instead of from left to right. For a radial gradient, you define the center of gradient, its radius, and the offset of a highlight.

By default, when you create a shape path by drawing with the Pen tool, the control points for the gradient are placed in the center of the layer. You can adjust these points after you finish drawing.

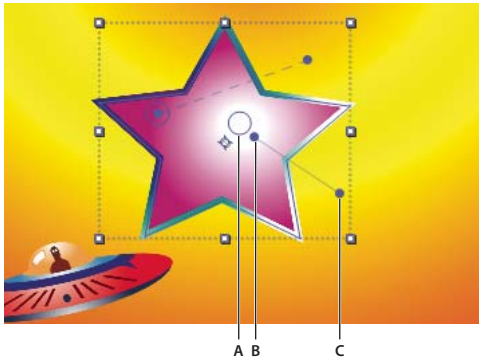
You can modify the Start Point, End Point, Highlight Angle, and Highlight Length properties in the Timeline panel. You can also modify these properties directly in the Composition panel.



Controls for mapping gradient colors in Composition panel
A. Highlight control point B. Start Point C. End Point

- 1 Select the group in which the gradient is contained.
- 2 With the Selection tool active, drag the Start Point, End Point, or Highlight controls in the Composition panel. The Selection tool turns to a gradient control pointer  or  when placed over a gradient control.

Set stroke width

- To set stroke width for new shapes in pixels (px), drag the underlined Stroke Width control (which is located to the right of the Stroke controls in the Tools panel), or click the control and enter a value in the box. To set the stroke width for existing shapes, select them before using the Stroke Width control.

Create a dashed stroke

You create a dashed stroke by adding any number of dashes and gaps to the Dashes property group for the stroke. The dashes and gaps in this property group are repeated as many times as necessary to cover the entire path. The Offset property determines at what point on the path the stroke begins.



Animate the Offset property to create a moving trail of dashes, like the lights on a marquee.

- 1 Expand the stroke's property group in the Timeline panel.
- 2 Click the Add A Dash Or Gap  button to add a dash and gap to one cycle of the dashed-line pattern that you want to create. You can add up to three dashes for each stroke pattern.
- 3 Modify the Dash and Gap properties to make the dashes and gaps the lengths that you want.

Line Cap options for strokes

The Line Cap property for a dashed stroke determines the appearance of the ends of the stroke segments (dashes).

Butt Cap The stroke ends at the end of the path.

Round Cap The stroke extends beyond the end of the path for a number of pixels equal to the stroke's width. The cap is a semicircle.

Projecting Cap The stroke extends beyond the end of the path for a number of pixels equal to the stroke's width. The end is squared off.

Line Join options for strokes

The Line Join property for a stroke determines the appearance of the stroke where the path suddenly changes direction (turns a corner).

Miter Join A pointed connection. The Miter Limit value determines the conditions under which a beveled join is used instead of a miter join. If the miter limit is 4, then when the length of the point reaches four times the stroke weight, a bevel join is used instead. A miter limit of 1 causes a bevel join.

Round Join A rounded connection.

Bevel Join A squared-off connection.

Fill rules for shapes

A fill operation works by painting color in the area defined as inside a path. Determining what is considered *inside* a path is easy when the path is something simple, like a circle. However, when a path intersects itself, or when a compound path consists of paths enclosed by other paths, determining what is considered *inside* is not as easy.

After Effects uses one of two rules to determine what is considered *inside* a path for the purpose of creating fills. Both rules count the number of times that a straight line drawn from a point crosses the path on its way out of the area surrounded by a path. The nonzero winding fill rule considers path direction; the even-odd fill rule does not.

After Effects and Illustrator use the nonzero winding fill rule as the default.

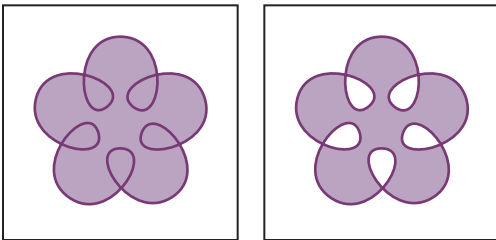

Self-intersecting path with Fill Rule set to Non-Zero Winding Fill Rule (left) compared with Even-Odd Fill Rule (right)

Even-odd fill rule If a line drawn from a point in any direction crosses the path an odd number of times, then the point is inside; otherwise, the point is outside.

Nonzero winding fill rule The crossing count for a line is the total number of times that the line crosses a left-to-right portion of the path minus the total number of times that the line crosses a right-to-left portion of the path. If a line drawn in any direction from the point has a crossing count of zero, then the point is outside; otherwise, the point is inside.

 A more intuitive way to think of the nonzero winding rule is to think of a path as a loop of string. A point is considered outside the path if you can put your finger at that point and then pull the string away without it being caught, wrapped around your finger.

Because the nonzero winding fill rule takes path direction into account, using this fill rule and reversing the direction of one or more paths in a compound path is useful for creating holes in compound paths. To reverse a path's direction, click the Reverse Path Direction On  button for the path in the Timeline panel.

Alter shape paths with path operations

Path operations are live, which means that you can modify or remove them at any time. Path operations apply to all paths above them in the same group; as with all shape attributes, you can reorder path operations by dragging, cutting, copying, and pasting in the Timeline panel.

- 1 In the Composition panel or Timeline panel, select the shape group into which to add the path operation.
- 2 Choose a path operation from the Add menu in the Tools panel or the Timeline panel:

Merge Paths Combines paths into a compound path. (See “Merge Paths options” on page 333.)

Offset Paths Expands or contracts a shape by offsetting the path from the original path. For a closed path, a positive Amount value expands the shape; a negative Amount value contracts it. The Line Join property specifies the appearance of the path where offset path segments come together. A bevel join is a squared-off connection. A miter join is a pointed connection. The miter limit determines the conditions under which a beveled join is used instead of a miter join. If the miter limit is 4, then when the length of the point reaches four times the stroke weight, a bevel join is used instead. A miter limit of 1 causes a bevel join.

Pucker & Bloat Pulls a path’s vertices outward while curving the segments inward (Pucker), or pulls a path’s vertices inward while curving the segments outward (Bloat).

Repeater Creates multiple copies of a shape, applying a specified transformation to each copy. (See “Using the Repeater to replicate shapes” on page 333.)

Round Corners Rounds corners of paths. Higher Radius values cause greater roundness.

Trim Paths Animate the Start, End, and Offset properties to trim a path to create results similar to those achieved with the Write-on effect and the Write On setting for paint strokes. If the Trim Paths path operation is below multiple paths in a group, then you can choose to have the paths trimmed simultaneously or treated as a compound path and trimmed individually.

Twist Rotates a path more sharply in the center than at the edges. Entering a positive value twists clockwise; entering a negative value twists counterclockwise.

Wiggle Paths Turns a path into a series of jagged peaks and valleys of various sizes. The distortion is auto-animated, meaning that it changes over time without the need to set any keyframes or add expressions. Several properties for this path operation behave the same as properties of the same name for the Wiggly selector for text animation. The Correlation property specifies the amount of correlation between a vertex’s movement and that of its neighbors; smaller values create more jagged results, as the position of a vertex depends less on the position of its neighbors. The Correlation property is similar to Correlation for the Wiggly selector, except that the Wiggle Paths version specifies the correlation between neighboring vertices instead of neighboring characters. Set the maximum length for segment paths using an absolute or relative size. Set the density of jagged edges (Detail) and choose between soft edges (Smooth) or sharp edges (Corner).



Animate the Size property to fade the wiggling up or down. To smoothly accelerate or decelerate the wiggling, set Wiggles/Second to a constant value of 0, and animate the Temporal Phase property.

Zig Zag Turns a path into a series of jagged peaks and valleys of uniform size. Set the length between peaks and valleys using an absolute or relative size. Set the number of ridges per path segment, and choose between wavy edges (Smooth) or jagged edges (Corner).

Merge Paths options

The Merge Paths path operation takes all of the paths above it in the same group as input. The output is a single path that combines the input paths. The input paths are still visible in the Timeline panel, but they are essentially removed from the rendering of the shape layer, so they don't appear in the Composition panel. A fill and stroke are added after the Merge Paths property group in the Timeline panel if a fill and stroke are not already present; otherwise, the output path wouldn't be visible.

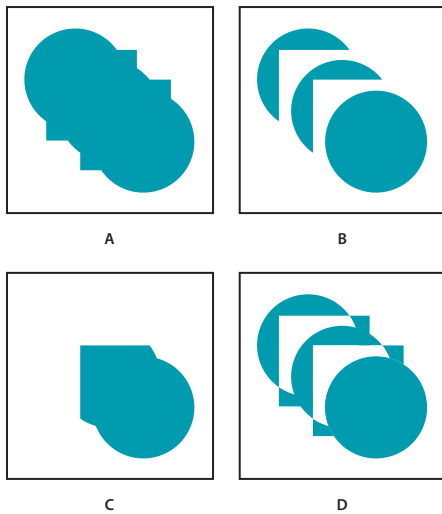

Merge Paths options

A. Add for all shapes B. Subtract for squares C. Intersect for squares D. Exclude Intersections for squares

The Merge Paths path operation has the following options, each of which performs different calculations to determine the output path:

Merge Merges all input paths into a single compound path. This is the default used for shapes created from text characters made up of multiple paths, like the letter *e*, when using the Create Outlines command.

Add Creates a path that encompasses the union of the areas of the input paths.

Subtract Creates a path that encompasses only the areas defined by the topmost path, subtracting the area defined by underlying paths.

Intersect Creates a path that encompasses only the areas defined by intersections between all input paths.

Exclude Intersections Creates a path that is the union of the areas defined by all input paths, minus the areas defined by intersections between all input paths.

Using the Repeater to replicate shapes

The Repeater path operation creates virtual copies of all paths, strokes, and fills above it in the same group. The virtual copies are not represented by separate entries in the Timeline panel, but they are rendered in the Composition panel. Each copy is transformed according to its order in the set of copies and the values of the properties in the Transform property group for that instance of the Repeater.

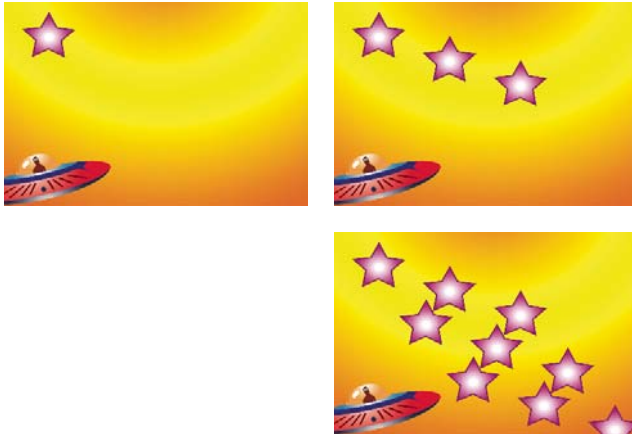

Original shape (top left), one instance of the Repeater operation applied (top right), and two instances of the Repeater operation applied (bottom right)

If the original shape is numbered 0, the next copy is numbered 1, and so on, then the result of the Repeater is to apply each transformation in the Transform property group n times to copy number n .

Consider the example of the Repeater applied to a shape with the Copies value set to 10 and the Position property in the Transform property group for the Repeater set to (0.0, 8.0). The original shape remains in its original position, (0.0, 0.0). The first copy appears at (0.0, 8.0), the second copy appears at (0.0, 16.0), the third copy appears at (0.0, 24.0), and so on until the ninth copy at (0.0, 72.0), for a total of ten shapes.

You can apply multiple instances of the Repeater within the same group. In other words, you can repeat the Repeater. This is an easy way to create a grid of virtual copies of a single shape: just set the Position property for one instance of the Repeater to modify the horizontal values, and another instance to modify vertical values.

The Offset property value is used to offset the transformations by a number of copies. For example, if the Copies value is 10 and the Offset value is 3, then the original shape is transformed by 3 times the amount specified in the Transform property group, and the last copy is transformed by 12 times the amount specified in the Transform property group.



Animating the Offset property is a good way to easily create interesting results.

The Composite option determines whether copies are rendered above (in front of) or below (behind) the copies that precede them.

Use the Start Opacity value to set the opacity of the original shape, and the End Opacity value to set the opacity for the last copy. Opacity values for copies in between are interpolated.

If you place the Repeater after a path, above the fill and stroke property groups for a shape, then the set of virtual copies is filled or stroked as a compound path. If you leave the Repeater below the fill and stroke, then each copy is filled and stroked individually. The difference is most apparent with gradient fills and strokes.

Chapter 13: Motion tracking

Motion tracking overview

About motion tracking

With motion tracking, you can *track* the movement of an object and then apply the tracking data for that movement to another object—such as another layer or an effect control point—to create compositions in which images and effects follow the motion. You can also stabilize motion, in which case the tracking data is used to animate the tracked layer to compensate for movement of an object in that layer. You can link properties to tracking data using expressions, which opens up a wide variety of uses.

After Effects tracks motion by matching image data from a selected area in a frame to image data in each succeeding frame. You can apply the same tracking data to different layers or effects. You can also track multiple objects in the same layer.

Motion tracking has many uses. Here are some examples:

- Combining elements filmed separately, such as adding video to the side of a moving city bus or a star to the end of a sweeping wand.
- Animating a still image to match the motion of action footage, such as making a cartoon bumblebee sit on a swaying flower.
- Animating effects to follow a moving element, such as making a moving ball glow. Michele Yamazaki provides a tutorial on the Toolfarm website that shows how to use motion tracking to obscure a logo in motion footage: www.adobe.com/go/learn_ae_micheletracklogo.
- Linking the tracked object's position to other properties, such as making stereo audio pan from left to right as a car races across the screen.
- Stabilizing footage to hold a moving object stationary in the frame to examine how a moving object changes over time, which can be useful in scientific imaging work.
- Stabilizing footage to remove the jostling of a handheld camera.

 *Depending on the encoder you use, it is possible to decrease the size of your final output file by stabilizing motion footage. Random motion, such as from the jostling of a handheld camera, can make it difficult for many compression algorithms to compress your video.*

You set up, initiate, and apply motion tracking with the Tracker Controls panel.

As with all properties, you can modify, animate, manage, and link tracking properties in the Timeline panel.

You specify areas to track by setting *track points* in the Layer panel. Each track point contains a *feature region*, a *search region*, and an *attach point*. A set of track points is a *tracker*.

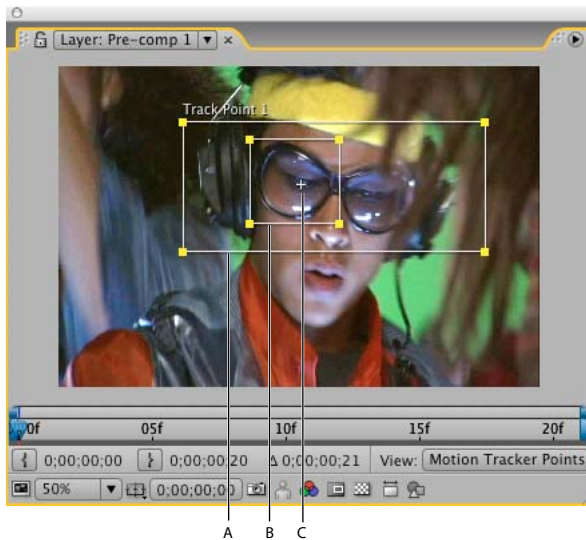

Layer panel with track point
A. Search region B. Feature region C. Attach point

Feature region The feature region defines the element in the layer to be tracked. The feature region should surround a distinct visual element, preferably one object in the real world. After Effects must be able to clearly identify the tracked feature throughout the duration of the track, despite changes in light, background, and angle.

Search region The search region defines the area that After Effects will search to locate the tracked feature. The tracked feature needs to be distinct only within the search region, not within the entire frame. Confining the search to a small search region saves search time and makes the search process easier, but runs the risk of the tracked feature leaving the search region entirely between frames.

Attach point The attach point designates the place of attachment for the *target* —the layer or effect control point to synchronize with the moving feature in the tracked layer.

Note: When you begin tracking, After Effects sets the quality of the motion source layer to Best and the resolution to Full in the Composition and Layer panels, which makes the tracked feature easier to find and enables subpixel processing and positioning.

After Effects uses one track point to track position, two track points to track scale and rotation, and four points to perform tracking using corner pinning.

Motion tracking workflow

The implicit first step of any workflow is to determine the result that you want to achieve before you begin. What sort of motion will you track, and what will you apply the tracking data to?

As with many workflows in the real world, you may have to repeat some of these steps. You can track a layer as many times as desired and apply any combination of tracking results.

1. Set up the shot

For motion tracking to go smoothly, you must have a good feature to track, preferably a distinctive object or region.

For best results, prepare the object or region that you are tracking before you begin shooting. Because After Effects compares image data from one frame to the next to produce an accurate track, attaching high-contrast markers to the object or region lets After Effects more easily follow the motion from frame to frame. Lightweight, brightly colored balls (such as ping-pong balls) placed on the feature work particularly well, in part because their appearance is the same from all angles. The number of markers that you use corresponds to the number of points you are tracking. For example, if you're tracking four points using the Perspective Corner Pinning option, you'll track four features, to correspond to the four corners of the layer to attach. The more markers you add to your subject before shooting, the more features you'll have for tracking—but the more items you might have to remove later from the image with the Clone Stamp tool. You don't need to add a marker for each feature if there is already a distinctive object or region at the appropriate location.

2. Add the appropriate number of track points

When you choose a mode from the Track Type menu in the Tracker Controls panel, After Effects places the appropriate number of track points in the Layer panel for that mode. You can add more track points to track additional features with one tracker.

3. Select features to track, and place feature regions

Before you begin tracking, view the entire duration of the shot to determine the best features to track. What is clearly identifiable in the first frame may later blend into the background because the angle, lighting, or surrounding elements have changed. A tracked feature may disappear off-screen or be obscured by another element at some point in the scene. Though After Effects can extrapolate the feature's motion, your chances for successful tracking are highest if you step through the entire shot to select the best candidates for tracking.

A good tracked feature has these characteristics:

- Visible for the entire shot
- A contrasting color from the surrounding area in the search region
- A distinct shape within the search region
- A consistent shape and color throughout the shot

4. Set the attach point offset

The *attach point* is where the target layer or effect control point will be placed. The default attach point position is in the center of the feature region. You can move the attach point to offset the target's position relative to the tracked feature's position by dragging the attach point in the Layer panel before tracking.

For example, to animate a cloud above a person's head, position the feature region on the head and move the attach point above the head. If you left the attach point centered in the feature region, the cloud would be attached to that point and would obscure the person's head.

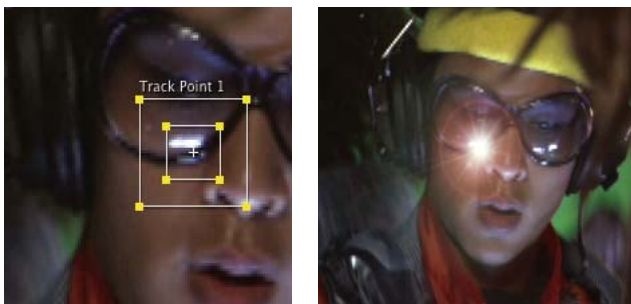

Attach point centered in feature region

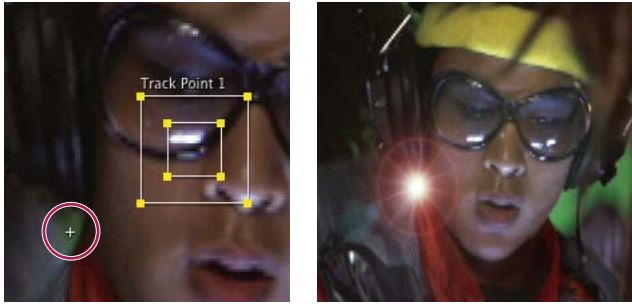

Attach point offset from feature region

5. Adjust the feature region, search region, and tracking options

Place each feature region control tightly around its tracked feature, completely enclosing the tracked feature, but including as little of the surrounding image as possible.

The size and position of the search region depend on the movement of the feature you want to track. The search region must accommodate the movement of the tracked feature, but only the frame-to-frame movement, not its movement throughout the shot. As After Effects locates the tracked feature in a frame, both the feature region and search region move to the new location. Therefore, if the frame-to-frame movement of the tracked feature is gradual, then the search region needs to be only slightly larger than the feature region. If the feature changes position and direction quickly, then the search region needs to be big enough to encompass the largest position and direction change in any pair of frames.

You can also set tracking options that determine such things as which color channels are compared to find a match to the feature region.

6. Analyze

You perform the actual motion tracking step by clicking one of the Analyze buttons in the Tracker Controls panel. When tracking a tricky set of features, you may want to analyze a frame at a time.

7. Repeat as necessary

Because of the changing nature of an image in motion, automatic tracking is rarely perfect. In moving footage, the shape of a feature changes, along with the lighting and surrounding objects. Even with careful preparation, a feature generally changes during a shot and at some point no longer matches the original feature. If the change is too great, After Effects may not be able to track the feature, and the track point will wander or drift.

When the analysis begins to fail, return to the frame where tracking was still accurate and repeat steps 5 and 6 above: adjust and analyze.

8. Apply tracking data

If you're using any Track Type setting other than Raw, you apply tracking data by clicking Apply, after making sure that the correct target is shown for Motion Target. You apply tracking data from a Raw tracking operation by copying keyframes from the trackers to other properties or by linking properties with expressions.

You can also adjust the Attach Point or Attach Point Offset property after tracking in the Timeline panel, which can be useful when applying the same tracking data to multiple targets that you want to distribute around the tracked feature.

Note: If the layer that you're attaching has motion blur enabled, make sure that the Shutter Phase value is set to -1/2 times the Shutter Angle value. This centers the motion blur on the attach point. Otherwise, the attached object may appear to lead or lag the object that it's attached to.

See also

"Use motion blur" on page 200

Motion tracking controls

You set up, initiate, and apply motion tracking with the Tracker Controls panel.

Motion Source The layer that contains the motion to track.

Note: Layers are available in the Motion Source menu if they have source footage items that can contain motion or if they are composition layers. You can precompose a layer to make it available in the Motion Source menu.

Current Track The active tracker. You can modify settings for a tracker at any time by selecting the tracker from this menu.

Track Type The tracking mode to use. The motion tracking itself is the same for each of these modes; they differ in the number of track points and how the tracking data is applied to the target:

- Stabilize tracks position, rotation, and/or scale to compensate for movement in the tracked (source) layer. When tracking position, this mode creates one track point and generates Anchor Point keyframes for the source layer. When tracking rotation, this mode creates two track points and produces Rotation keyframes for the source layer. When tracking scale, this mode creates two track points and produces Scale keyframes for the source layer.
- Transform tracks position, rotation, and/or scale to apply to another layer. When tracking position, this mode creates one track point on the tracked layer and sets Position keyframes for the target. When tracking rotation, this mode creates two track points on the tracked layer and sets Rotation keyframes for the target. When tracking scale, this mode creates two track points and produces Scale keyframes for the target.
- Parallel Corner Pin tracks skew and rotation, but not perspective; parallel lines remain parallel, and relative distances are preserved. This mode uses three track points in the Layer panel—and calculates the position of the fourth—and sets keyframes for four corner points in a Corner Pin effect property group, which is added to the target. The four attach points mark the placement of the four corner points.
- Perspective Corner Pin tracks skew, rotation, and perspective changes in the tracked layer. This mode uses four track points in the Layer panel and sets keyframes for four corner points in a Corner Pin effect property group, which is added to the target. The four attach points mark the placement of the four corner points. This option is useful for attaching an image to an opening door or the side of a bus that's turning a corner.
- Raw tracks position only. Use Raw to generate tracking data that you won't apply using the Apply button. For example, you can copy and paste the keyframes for the Attach Point property to the Position property for a paint stroke; or, you can link effect properties for the Stereo Mixer effect to the x coordinate of the Attach Point property using expressions. Tracking data is stored on the tracked layer. The Edit Target button and the Apply button are not available with this tracking option. You can add track points to a tracker by choosing New Track Point from the Tracker Controls panel menu.

Motion Target The layer or effect control point that the tracking data is applied to. After Effects adds properties and keyframes to the target to move or stabilize it. Change the target by clicking Edit Target. No target is associated with a tracker if Raw is selected for Track Type.

Analyze buttons Begins the frame-to-frame analysis of the track point in the source footage:

- Analyze 1 Frame Backward : Analyze the current frame by moving back to the previous frame.

- Analyze Backward ◀: Analyze from the current-time indicator backward to the beginning of the trimmed layer duration.
- Analyze Forward ▶: Analyze from the current-time indicator to the end of the trimmed layer duration.
- Analyze 1 Frame Forward ▶▶: Analyze the current frame by advancing to the next frame.

Note: While analysis is in progress, the Analyze Backward and Analyze Forward buttons change to a Stop button, with which you can stop analysis when the track drifts or otherwise fails.

Reset Restores the feature region, search region, and attach point to their default positions and deletes the tracking data from the currently selected track. Tracker Control settings and keyframes already applied to the target layer remain unchanged.

Apply Sends the tracking data (in the form of keyframes) to the target layer or effect control point.

See also

“Corner Pin effect” on page 405

Motion tracking options

These settings apply to a tracker, a group of track points that is generated in one tracking session. You can modify these settings by clicking Options in the Tracker Controls panel.

Track Name The name for a tracker. You can also rename a tracker by selecting it in the Timeline panel and pressing Enter on the main keyboard (Windows) or Return (Mac OS).

Tracker Plug-in The plug-in used to perform motion tracking for this tracker. By default, this option displays Built-in, the only tracking plug-in included with After Effects.

Channel The components of the image data to use for comparison when searching for a match for the feature region. Select RGB if the tracked feature is a distinct color. Select Luminance if the tracked feature has a different brightness than the surrounding image (such as a burning candle carried through a room). Select Saturation if the tracked feature has a high concentration of color, surrounded by variations of the same color (such as a bright red scarf against a brick wall).

Process Before Match Temporarily blurs or sharpens an image to improve tracking. Blur reduces noise in the footage. Usually a value of 2 to 3 pixels is enough to produce better tracks in grainy or noisy footage. Enhance exaggerates or refines the edges of an image and makes them easier to track.

Note: After Effects blurs or enhances the layer only for tracking. This does not affect the motion source layer.

Track Fields Temporarily doubles the frame rate of the composition and interpolates each field to a full frame to track motion in both fields of interlaced video.

Subpixel Positioning When selected, keyframes are generated to a precision of a fraction of a pixel. When deselected, the tracker rounds off values to the nearest pixel for generated keyframes.

Adapt Feature On Every Frame Causes After Effects to adapt the tracked feature for each frame. The image data that is searched for within the search region is the image data that was within the feature region in the previous frame, rather than the image data that was in the feature region at the beginning of analysis.

If Confidence Is Below Specifies the action to perform when the Confidence property value is below the percentage value that you specify.

Note: To determine an acceptable confidence threshold, track the motion and then examine the Confidence values for the track point in the Timeline panel for problematic frames. Specify a confidence value that is slightly larger than the largest confidence value for the problematic frames.

- Select Continue Tracking to ignore the Confidence value. This is the default behavior.
- Select Stop Tracking to stop the motion tracking.
- Select Extrapolate Motion to estimate the position of the feature region. Attach-point keyframes aren't created for low-confidence frames, and attach-point keyframes for the low-confidence frames from previous tracks are deleted.
- Select Adapt Feature to use the original tracked feature until the confidence level falls below the specified threshold. At that point, After Effects adapts the tracked feature to be the contents of the feature region in the frame preceding the one that has low confidence and continues tracking. This option isn't available if Adapt Feature On Every Frame is selected in the Motion Tracker Options dialog box; enabling feature adaptiveness causes After Effects to adapt the feature region with every frame regardless of the confidence level.

Options Opens the Tracker Plug-in Options dialog box, which includes options for the AE Original Built-in Tracker. This command is only available if you choose to use the older After Effects tracker plug-in.

Motion tracking properties in the Timeline panel

Each time you click Track Motion or Stabilize Motion in the Tracker Controls panel (or choose Animation > Track Motion or Animation > Stabilize Motion), a new tracker is created for the layer in the Timeline panel. Each tracker contains track points, which are property groups that store the tracking data after tracking has been performed. Trackers are grouped in the Motion Trackers property group for each layer in the Timeline panel.



To show a tracker in the Timeline panel, select the tracker from the Current Track menu in the Tracker Controls panel and press SS.

You can rename trackers and track points and modify and animate their property values in the Timeline panel just as you do for other layer properties and property groups. You must click Apply in the Tracker Controls panel to apply the property changes to the target.

Feature Center Position of the center of the feature region.

Feature Size Width and height of the feature region.

Search Offset Position of the center of the search region relative to the center of the feature region.

Search Size Width and height of the search region.

Confidence Property through which After Effects reports the amount of certainty regarding the match made for each frame. In general, this is not a property that you modify.

Attach Point Position assigned to the target layer or effect control point.

Attach Point Offset Position of the attach point relative to the center of the feature region.

Tracking motion

Track or stabilize motion

Tracking motion and stabilizing motion are essentially the same process, only with a different target and result. Use Track Motion to track motion and apply the results to a different layer or effect control point. Use Stabilize Motion to track motion and apply the results to the tracked layer to compensate for that motion.

To stabilize a layer, After Effects tracks the motion of a feature in the layer that should be stationary in the frame, and then uses the tracking data to set keyframes to perform the opposite motion. You can stabilize to remove any combination of changes in position, rotation, and scale, while leaving desired motion unaffected. For example, if the camera is panning, deselect Position but select Scale and Rotation as the properties to stabilize.

When you select Rotation or Scale in the Tracker Controls panel, you set two track points in the Layer panel. A line connects the attach points; an arrow points from the first attach point (the base) to the second. If possible, place the feature regions on opposite sides of the same object, or at least on objects that are the same distance from the camera. The farther apart the regions, the more accurate the calculations and the better the result.

After Effects calculates rotation by measuring the change of angle of the line between the attach points. When you apply the tracking data to the target, After Effects creates keyframes for the Rotation property.

After Effects calculates scale by comparing the distance between attach points on each frame with the distance between the attach points on the start frame. When you apply the tracking data to the target, After Effects creates keyframes for the Scale property.

When you track motion using either parallel or perspective corner pinning, After Effects applies keyframes for the Corner Pin effect to the layer to scale and skew the target layer as necessary to fit the four-sided area defined by the feature regions. The feature regions should lie in a single plane in the real world—for example, on the side of a bus, on the same wall, or on the floor. The attach points should also all lie in a single plane, but not necessarily the same plane as the feature regions.

***Note:** For parallel corner pinning only: To change which point is inactive, Alt-click (Windows) or Option-click (Mac OS) the feature region of the point to make inactive. (One point must remain inactive to keep the lines parallel.)*

- 1 Select the layer to track in the Timeline panel.
- 2 Do one of the following:
 - Click Track Motion in the Tracker Controls panel (or choose Animation > Track Motion), click Edit Target, and choose the target to apply the tracking data to.
 - Click Stabilize Motion in the Tracker Controls panel (or choose Animation > Stabilize Motion). The target layer is the tracked (source) layer.
- 3 Select Position, Rotation, and/or Scale to specify what kinds of keyframes to generate for the target.
- 4 Move the current-time indicator to the frame from which to begin tracking.
- 5 Using the Selection tool, adjust the feature region, search region, and attach point for each track point.
- 6 In the Tracker Controls panel, click either the Analyze Forward or Analyze Backward button to begin tracking.

If the tracking ceases to be accurate, click the Stop button , correct the problem as described in “Correct a motion track” on page 345, and resume analysis.

- 7 When you are satisfied with the position of the feature region and attach point throughout the track, click the Apply button to apply the motion to the specified target.

After Effects creates keyframes for the target layer.

When tracking position and applying this position data to a target, you can choose to apply only the x (horizontal) or y (vertical) component of motion. For example, you can apply the tracking data to the x axis to make a speech bubble (the motion target) remain at the top of the frame even when the actor's head (the motion source) moves downward.

- X And Y (default) allows motion along both axes.
- X Only restricts the motion target to horizontal movement.
- Y Only restricts the motion target to vertical movement.



To bypass the Motion Tracker Apply Options dialog box and use the previous setting, hold Alt (Windows) or Option (Mac OS) as you click Apply.

When you stabilize a layer, the compensating motion may itself cause the layer to move too far in one direction, exposing the background in the composition or moving action out of the action-safe zone. You can correct this with a small change in scale for the layer. Find the frame where the problem is most severe, and then increase or decrease the scale of the layer until the problem is resolved. This technique adjusts the scale for the duration of the layer; you can also animate scale to correct this problem by zooming in and out at different times.

This post on the AE Enhancers forum describes and links to an animation preset from Donat van Bellinghen for scaling a set of Corner Pin effect points: www.adobe.com/go/learn_ae_donatscalecornerpin.

This post on the AE Enhancers forum describes and links to a script from Paul Tuersley that takes a stabilized layer, precomposes it, and then adds expressions that counter the stabilization: www.adobe.com/go/learn_ae_paulstabilizefortracking.

This post on the AE Enhancers forum describes and links to a script from Paul Tuersley that can make a difficult tracking job easier by averaging multiple sets of tracking data: www.adobe.com/go/learn_ae_paulaveragetracks.

See also

“Motion tracking workflow” on page 336

“Set the work area” on page 112

“Scale a layer” on page 155

Adjust the track point

When you set up motion tracking, it's often necessary to refine your track point by adjusting the feature region, search region, and attach point. You can resize or move these items independently or in groups by dragging using the Selection tool. To help you define the area to be tracked, the image area within the feature region is magnified to 400% while you move the region.

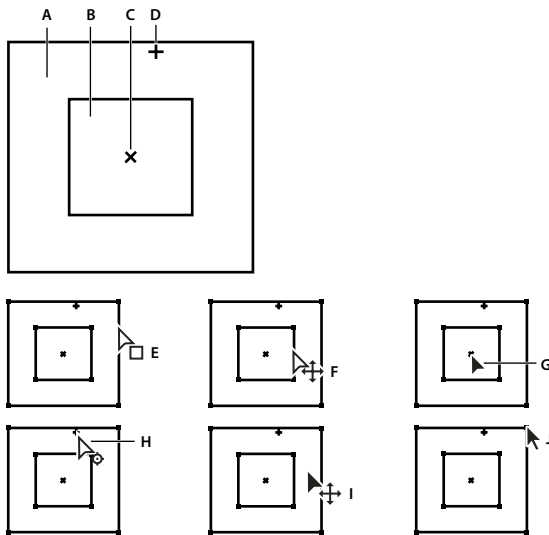

Track point components and Selection tool pointer icons

A. Search region B. Feature region C. Keyframe marker D. Attach point E. Moves search region F. Moves both regions G. Moves entire track point H. Moves attach point I. Moves entire track point J. Resizes region

- To turn on or off feature region magnification, choose Magnify Feature When Dragging from the Tracker Controls panel menu.
- To move the feature region, search region, and attach point together, drag inside the track point area (avoiding the region edges and the attach point), or press the Up, Down, Left, or Right Arrow key. Hold Shift while pressing an arrow key to move by an increment 10 times as large.
- To move only the feature and search regions together, drag the edge of the feature region, or Alt-drag (Windows) or Option-drag (Mac OS) with the Selection tool inside the feature or search region. You can also hold Alt (Windows) or Option (Mac OS) while pressing the Up, Down, Left, or Right Arrow key. Hold Alt+Shift (Windows) or Option+Shift (Mac OS) while pressing an arrow key to move by an increment 10 times as large.
- To move only the search region, drag the edge of the search region.



Offset the search region center from the feature region center in the direction in which the tracked feature is traveling.

- To move only the attach point, drag the attach point.
- To resize the feature or search region, drag a corner handle.
- To make all of the region's sides match the length of the longest side, and to resize the region relative to the original region's center point, Shift-drag a corner handle.
- To make all of the region's sides match the length of the longest side, and to resize the region relative to a particular corner handle, Ctrl+Shift-drag (Windows) or Command+Shift-drag (Mac OS) the opposite corner handle.



To restrict the movement of the track point to the x (horizontal) or y (vertical) axis during tracking, resize the height or width of the search region to match the height or width of the feature region.

Apply tracking data to a new target

After you've tracked a motion source layer, you can apply that layer's stored tracking data to any number of other target layers and effect control points. For example, you can apply the track to a light bulb's position and to the Lens Flare effect's control point.

- 1 In the Tracker Controls panel, choose the tracked layer from the Motion Source menu.
- 2 Choose the track that contains the tracking data you want from the Current Track menu.
- 3 Click Edit Target, and choose the target.
- 4 In the Tracker Controls panel, click the Apply button.

Correct a motion track

As an image moves in a shot, the lighting, surrounding objects, and angle of the object can all change, making the once distinct feature no longer identifiable at the subpixel level. Also, if the search region is too small, the tracked feature may leave its bounds from one frame to the next.

Learning to choose a trackable feature takes time. Even with careful planning and practice, the feature region can drift away from the desired feature. Re-adjusting the feature and search regions, changing the tracking settings, and trying again is a standard part of automatic tracking. It's not necessary to get a single good track in one try. You may need to track the shot in sections, redefining the feature region in places where the feature changes and the region drifts. You may even need to choose a different feature to track, one with movement that closely matches that of the feature to track, and use the attach point offset to place the target.

After you've tracked motion, each track point has a motion path in the Layer panel that shows the position of the center of the feature region. You can fine-tune the motion path's keyframes in the Layer panel as you would any other motion path. This is most useful when you want to manually change the motion tracking data before applying it to a target. In some cases, it may be easier to manually modify the motion path created by the motion tracker than to get a perfect track.

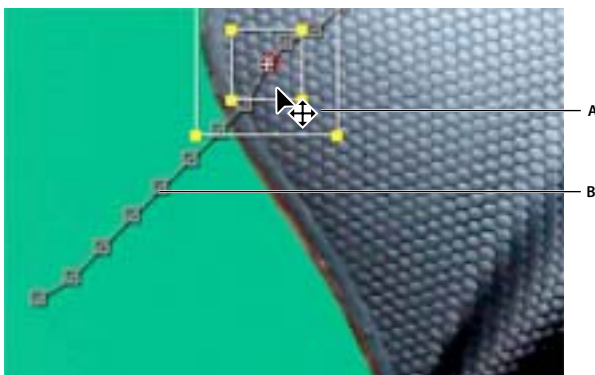

*Motion source and its motion path
A. Moving the feature and search regions B. Keyframe marker*

See also

“Creating and modifying motion paths” on page 197

Correct drifting by adjusting the feature and search regions

- 1 Move the current-time indicator to the last well-tracked frame.

- 2 Alt-drag (Windows) or Option-drag (Mac OS) the feature and search regions only (not the attach point) to the correct location.
- 3 If you are correcting the track for one frame, go to step 4. If you are correcting the track for several contiguous frames, adjust the feature region and search region if necessary, and click Analyze. Watch the tracking to make sure that it is accurate. If the tracking is not accurate, then click the button again to stop tracking, adjust the feature region, and begin again.
- 4 When you are satisfied with the track, click Apply to apply the keyframes to the target layer or effect control point.

Correct drifting by modifying tracking settings

- 1 Move the current-time indicator to the last well-tracked frame.
- 2 In the Tracker Controls panel, click Options.
- 3 Change settings in the Motion Tracker dialog box as appropriate. (See “Motion tracking options” on page 340.)
- 4 In the Tracker Controls panel, click the Analyze Forward or the Analyze Backward button.
- 5 Watch the tracking to make sure that it is accurate. If the tracking is not accurate, then click the button again to stop tracking, adjust the settings, and begin again.
- 6 When you are satisfied with the track, click Apply to apply the keyframes to the target layer or effect control point.

Chapter 14: Effects and animation presets

Effects and animation presets overview

About animation presets

Animation presets let you save and reuse specific configurations of layer properties and animations, including keyframes, effects, and expressions. After Effects includes hundreds of animation presets that you can drop into your projects and then modify to suit your needs.

You can browse and apply animation presets in After Effects using the Effects & Presets panel or Adobe Bridge. To open the Presets folder in Adobe Bridge, choose Browse Presets from the Effects & Presets panel menu or from the Animation menu.

Many animation presets don't contain animation; rather, they contain combinations of effects, transform properties, and so on. A *behavior* animation preset uses expressions instead of keyframes to animate layer properties.

Animation presets can be saved and transferred from one computer to another. The filename extension for an animation preset is `.ffx`.

The animation presets that are installed with After Effects are in the Presets folder located in the Program Files\Adobe\Adobe After Effects CS3\Support Files (Windows) or Applications/Adobe After Effects CS3 (Mac OS) folder. Animation presets that you create are saved by default in the Presets folder located in My Documents\Adobe\After Effects CS3 (Windows) or Documents/Adobe/After Effects CS3.

You can download additional animation presets—including a set of animation presets that make use of shape layers and per-character 3D text animation—from the Adobe After Effects Exchange:
www.adobe.com/go/learn_ae_cs3additionalanimationpresets.

You can also download animation presets from many After Effects community websites, such as the AE Enhancers forum: www.adobe.com/go/learn_ae_aeenhancershome.

You can add a single new animation preset or an entire folder of new animation presets to either of the Presets folders.

When After Effects starts, it searches both of the Presets folders and their subfolders for installed presets and adds them to the Effects & Presets panel. After Effects ignores the contents of folders with names that begin and end in parentheses; for example, the contents of the folder (archived_animation_presets) will not be loaded.

Note: *Animation presets appear in the Effects & Presets panel only if they are located in one of the Presets folders or a subfolder of one of the Presets folders. If you move a preset to a new folder, place a shortcut (Windows) or an alias (Mac OS) of that folder in the Presets folder.*

See also

“Apply an effect or animation preset” on page 351

“Save an animation preset” on page 353

“Use Adobe Bridge with After Effects” on page 28

About effects

After Effects includes a variety of effects, which you apply to layers to add or modify video and audio characteristics. For example, an effect can alter the exposure or color of a layer's image, add new visual elements, manipulate sound, distort images, remove grain, enhance lighting, animate text, or create a transition.

You browse and apply effects using the Effects & Presets panel. You modify effect properties using the Effect Controls panel or Timeline panel or by moving effect control points in the Layer panel or Composition panel.

You can apply multiple instances of the same effect to a layer, rename each instance, and set the properties for each instance separately.

To see a video tutorial on applying and working with effects, visit the Adobe website at www.adobe.com/go/vid0228.

Note: Path operations on shape layers, such as Zig Zag and Pucker & Bloat—which you apply through the shape layer's Add menu—are called effects in Adobe Illustrator, but they function differently from other effects in After Effects.

Because effects are implemented as plug-ins, you can install and use additional effects that parties other than Adobe provide. You can add a single new effect or an entire folder of new effects to the Plug-ins folder, which is located by default in the Program Files\Adobe\Adobe After Effects CS3\Support Files (Windows) or Applications/Adobe After Effects CS3 (Mac OS) folder. When After Effects starts, it searches the Plug-ins folder and its subfolders for all installed effects and adds them to the Effect menu and to the Effects & Presets panel. After Effects ignores the contents of folders with names that begin and end in parentheses; for example, the contents of the folder (archived_effects) will not be loaded.

Adobe provides many third-party effect plug-ins with After Effects. Keylight, Color Finesse, and Cycore FX plug-ins are installed by default with the After Effects application. The installers for some plug-ins install their documentation in the same directory as the plug-ins themselves. Documentation for Cycore FX plug-ins is available on the Cycore website: www.adobe.com/go/learn_ae_cycorefxdocumentation.

For more information on the various categories of After Effects effects, see “Effect reference” on page 355.

Animating effects

You animate effect properties in the same way that you animate any other properties—by adding keyframes or expressions to them. In most cases, even effects that rely on animation for their normal use require that you set some keyframes or expressions. For example, animate the Transition Completion property of a Transition effect or the Evolution setting of the Fractal Noise effect to turn a static effect into a dynamic effect.

Color depth

Many effects support processing of image color and alpha channel data at a depth of 16 or 32 bits per channel (bpc). Using an 8-bpc effect in a 16-bpc or 32-bpc project can result in a loss of color detail. If an effect supports only 8 bpc, and your project is set to 16 or 32 bpc, the Effect Controls panel displays a warning icon  next to the effect name. You can set the Effects & Presets panel to list only the effects that support the color depth of the current project. (See “Set the color depth” on page 234.)

Render order

The order in which After Effects renders masks, effects, layer styles, and transform properties—called the *rendering order*—may affect the final result of an applied effect. By default, effects appear in the Timeline panel and Effect Controls panel in the order in which they were applied. Effects are rendered in order from top to bottom in this list. To change the order in which effects are rendered, drag the effect name to a new position in the list. (See “Render order and collapsing transformations” on page 115.)

An effect applied to an adjustment layer affects all layers below it in the layer stacking order in the Timeline panel. (See “Create an adjustment layer” on page 136.)

Expression Controls effects

Expression Controls effects do not modify existing layer properties; rather, these effects add layer properties that expressions can refer to. (See “Using Expression Controls effects” on page 555.)

Preventing edge clipping with the Grow Bounds effect

Because an effect is applied to a layer, the results of some effects are constrained to the layer’s bounds, which can make the effect appear to end abruptly. You can apply the Grow Bounds effect to a layer to temporarily extend the layer for the purpose of calculating the results of other effects. This process is not necessary for newer effects, which tend to be 32-bit effects.

Managing effects and effect properties with scripts

Paul Tuersley provides a script with which you can search compositions for effects and turn them on or off: www.adobe.com/go/learn_ae_pauleffecttoggle.

Paul Tuersley also provides a script that makes synchronizing changes to effect properties on multiple layers easier: www.adobe.com/go/learn_ae_pauleffectmultiplelayers.

See also

“About plug-ins” on page 44

“Layer switches and columns in the Timeline panel” on page 147

About compound effects and control layers

Several effects rely on a *control layer* as input. These *compound effects* use the pixel values of the control layer to determine how to affect the pixels of the layer that the effect is applied to. For example, the Displacement Map effect uses the color values of a control layer to determine how far to shift pixels of the underlying layer, and in which direction. The compound effect ignores effects, masks, and transformations of a control layer, unless the layer has been precomposed. It is common to use a control layer that is not itself visible—that is, its Video switch  is off.

Most compound effects include a Stretch Map To Fit option (or a similarly named option), which temporarily stretches or shrinks a control layer to the effect layer’s dimensions. This provides a pixel in the control layer corresponding to each pixel in the effect layer. If you deselect this option, the compound effect’s calculations are performed as if the control layer is centered on the effect layer at its original size.

 *For many compound effects, neutral gray pixels in the control layer correspond to null operations. This makes a neutral gray solid layer a good starting point for creating a control layer. Apply the Fractal Noise effect to a layer and precompose it to create a good control layer for turbulent or atmospheric results.*

Effects with a Comp Camera attribute

Some effects can use a composition’s camera and lights. These effects include Card Dance, Card Wipe, and Shatter. Some of these effects always use the composition camera, whereas others include light and camera options in the Effect Controls panel.

When you apply an effect with a Comp Camera attribute to a 2D layer, the effect can track the composition's camera and light positions and render a 3D image on the 2D layer that it is applied to. The effect's results appear 3D; however, the layer with the Comp Camera attribute applied remains a 2D layer and consequently has the following characteristics:

- 3D layers above and below it in the Timeline panel cannot intersect with each other or cast shadows on each other.
- It cannot intersect with 3D layers or cast or accept shadows.

Note: *The image is rendered on the layer, not the composition, so make sure that you apply these effects to layers that are the same size as the composition and are exactly centered in the composition.*

Working with effects and animation presets

Work with effects in the Effect Controls panel

When you apply an effect to a layer, the Effect Controls panel opens, listing the effect you just applied and controls to change the property values for the effect. You can also work with effects and change most effect property values in the Timeline panel. However, the Effect Controls panel has more convenient controls for many kinds of properties, such as sliders, effect control point buttons, and histograms.

The Effect Controls panel is a viewer, which means that you can have Effect Controls panels for multiple layers open at once and can use the viewer menu in the panel's tab to select layers.





- To open or close the Effect Controls panel for the selected layer, press F3.
- To reset all of an effect's properties to their default values, click Reset at the top of the effect's entry.
- To duplicate selected effects, choose Edit > Duplicate, or press Ctrl+D (Windows) or Command+D (Mac OS).
- To move an effect to a different place in the rendering order, drag the effect up or down in the effect stack.
- To set an effect's properties to the properties used in an animation preset, choose from the Animation Presets menu at the top of the effect's entry in the Effect Controls panel.
- To hide the Animation Presets menu in the Effect Controls panel, deselect Show Animation Presets in the panel menu.

See also

"Work with viewers" on page 19

Effects & Presets panel overview

Browse and apply effects and animation presets with the Effects & Presets panel. Each item in the panel is identified by type with an icon:

-  32-bpc effect
-  16-bpc effect
-  8-bpc effect
-  audio effect
-  animation preset

You can scroll through the list of effects and animation presets, or you can search for effects and animation presets by typing any part of the name in the Contains box.

The options that you choose in the Effects & Presets panel menu determine which items are shown:

Show Effects For All Color Depths Shows effects that work with any color depth, not just the effects that work with the depth of the current project.

Show Effects Shows all available effects.

Show Animation Presets Shows all animation presets, including those saved by you in the Presets folder.

The panel organizes effects and animation presets according to the option that you select from the panel menu: Categories, Explorer Folders (Windows) or Finder Folders (Mac OS), or Alphabetical.

Use the following commands in the panel menu to manage your effects and animation presets:

Reveal In Explorer (Windows) or Reveal In Finder (Mac OS) Opens the folder that contains the effect or animation preset selected in the Effects & Presets panel.

Refresh List Updates the list of effects and animation presets.

See also

“Set the color depth” on page 234

Apply an effect or animation preset

- To apply an effect or animation preset to a single layer, drag the effect or animation preset from the Effects & Presets panel to a layer in the Timeline, Composition, or Effect Controls panel.

Note: When you're dragging an effect or animation preset onto a layer in the Composition panel, the name of the layer under the pointer is shown in the Info panel. If you release the mouse button when the pointer is not over a layer, a new layer is created to hold the effect or animation preset.

- To apply an effect or animation preset to one or more layers, select the layers, and then double-click the effect or animation preset in the Effects & Presets panel.
- To apply an effect to one or more layers, select the layers, and then choose Effect > [category] > [effect].
- To apply a recently used or saved animation preset to one or more layers, select the layers, choose Animation > Recent Animation Presets, and then choose the animation preset from the list.
- To apply the most recently applied animation preset to one or more layers, select the layers, and then press Ctrl+Alt+Shift+F (Windows) or Command+Option+Shift+F (Mac OS).
- To apply the most recently applied effect to one or more layers, select the layers, and then press Ctrl+Alt+Shift+E (Windows) or Command+Option+Shift+E (Mac OS).
- To apply an animation preset to one or more layers using Adobe Bridge, select the layers, choose Animation > Browse Presets, navigate to the animation preset, and then double-click it.
- To apply the effect settings from an animation preset to the current instance of an effect, choose the animation preset name from the Animation Presets menu for the effect in the Effect Controls panel.
- To copy a layer's effects to one or more layers, select the effects in the Timeline panel or Effect Controls panel, choose Edit > Copy, select the target layers, and choose Edit > Paste.

Note: Applying an effect or animation preset to a layer selects the layer.

By default, when you apply an effect to a layer, the effect is active for the duration of the layer. However, you can make an effect start and stop at specific times or make the effect more or less intense over time by using keyframes or expressions or by applying the effect to an adjustment layer.

Animation presets are applied at the current time.

See also

“Create an adjustment layer” on page 136



Delete or disable effects and animation presets

After you’ve applied effects to a layer, you can temporarily disable one or all the effects on the layer to concentrate on another aspect of your composition. Effects that are disabled do not appear in the Composition panel and typically are not included when the layer is previewed or rendered. However, in the Render Queue panel, you can specify that the composition is rendered for final output with all effects on, regardless of which effects are rendered for previews in the Composition panel. Disabling an effect does not delete the keyframes created for any of the effect properties; all keyframes remain until the effect is deleted from the layer.

You can’t disable an animation preset or delete it from a layer as a unit. You can, of course, individually delete or disable the effects, keyframes, and expressions that it comprises.

- To delete one effect from a layer, select the effect name in the Effect Controls panel or Timeline panel, and press Delete.
- To delete all effects from one or more layers, select the layers in the Timeline or Composition panel and choose Effect > Remove All or press Ctrl+Shift+E (Windows) or Command+Shift+E (Mac OS).

Note: This command eliminates all keyframes for the deleted effects. If you choose Remove All accidentally, immediately choose Edit > Undo Delete Effect to restore the effects and keyframes.

- To temporarily disable one effect, select the layer in the Effect Controls or Timeline panel, and then click the Effect switch  to the left of the effect name.
- To temporarily disable all effects on a layer, click the Effect switch  in the Switches column for the layer in the Timeline panel.

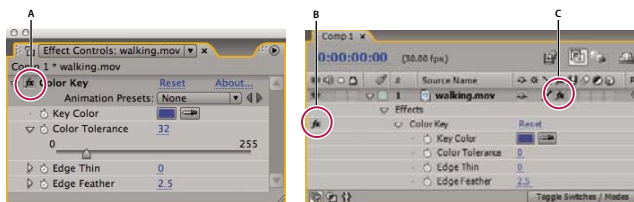

Effect switch in the Effect Controls panel and Effect switch in the Timeline panel

A. The Effect switch in the Effect Controls panel turns a specific effect on or off. **B.** The Effect switch in the Timeline panel also turns a specific effect on or off. **C.** The Effect switch in the Switches column of the Timeline panel turns all effects on a layer on or off.

Remove an effect or animation preset

You can remove an effect or animation preset from the folder in which After Effects searches for these items, preventing it from being loaded and from being shown in the Effects & Presets panel or Effect menu.

- 1 Select the effect or animation preset in the Effects & Presets panel.
- 2 Choose Reveal In Explorer (Windows) or Reveal In Finder (Mac OS) from the panel menu.
- 3 Move the effect (.aex) or animation preset (.afx) file out of the Plug-ins or Presets folder.

- 4 Choose Refresh List from the Effects & Presets panel menu to update the list of animation presets in the panel.

The list of effects is only updated when the application starts.

 *Rather than removing effects or animation presets entirely, consider creating a subfolder in the Plug-ins or Presets folder for effects or animation presets that you seldom use. After Effects ignores the contents of folders with names that begin and end with parentheses, such as (archive_folder).*

Save an animation preset

You can save any combination of properties and their keyframes and expressions as an animation preset. This includes effects and their properties. For example, if you created an explosion using several effects with complex property settings, keyframes, and expressions, you can save all of those settings as a single animation preset. You can then apply that animation preset to any other layer.

Animation presets appear in the Animation Presets category in the Effects & Presets panel.

- 1 Select any combination of properties (e.g., Position and Scale) and property groups (e.g., Paint and Transform). If you are selecting only effects, you can select them in the Effect Controls panel.
- 2 Choose Save Animation Preset from the Animation menu or from the Effects & Presets panel menu.
- 3 Specify a filename and location, and then click Save.

For the animation preset to appear in the Effects & Presets panel, it must be saved in the Presets folder.

Note: *If the animation preset does not appear in the Effects & Presets panel, choose Refresh List from the Effects & Presets panel menu.*

Work with effect control points

Some effects have *effect control points*, which determine how the effect is applied to the layer. For example, the Advanced Lightning effect has two effect control points—Origin and Direction—which specify where the lightning begins and in which direction it points.



The coordinates for effect control points are in the layer's coordinate space (*layer space*), not in the composition's coordinate space (*composition space*). The coordinates shown in the Info panel are in layer space when the Layer panel is active.

View an effect control point

- To view an effect control point in the Layer panel, choose the effect name from the Layer panel's View menu.
- To view an effect control point in the Composition panel, select the effect name in the Timeline panel or Effect Controls panel.

Note: *To view effect control points in the Composition panel, you must have Show Layer Controls selected in the View menu and Effect Controls selected in View Options (View > View Options).*

Move an effect control point

- In the Composition panel or Layer panel, drag the effect control point .
- In the Effect Controls panel, click the effect control point button ; then, in the Composition or Layer panel, click where you want the effect control point.
- In the Timeline or Effect Controls panel, drag or enter values for the x and y coordinates for the effect control point as you would to modify any other property.

About randomness and random seeds

Because true randomness is not repeatable, many effects simulate randomness by using a calculation that generates seemingly random results for each value of a Random Seed property. Multiple instances of the same effect will give the same results if all of their settings—including the Random Seed property values—are the same. This allows you to get predictable, deterministic results, while still achieving the appearance of randomness.

Changing the Random Seed value doesn't make things more or less random; it only makes them seem random in a different way.

You can add randomness to any property with the expressions in the Random Numbers category.

See also

“Random Numbers methods” on page 563

Chapter 15: Effect reference

Adobe provides many third-party effect plug-ins with After Effects. Keylight, Color Finesse, and Cycore FX plug-ins are installed by default with the After Effects application. The installers for some plug-ins install their documentation in the same directory as the plug-ins themselves. Documentation for Cycore FX plug-ins is available on the Cycore website: www.adobe.com/go/learn_ae_cycorefxdocumentation.

Galleries of effects

3D Channel effects gallery

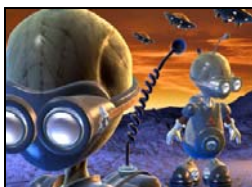

No effect applied

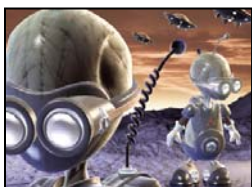

"3D Channel Extract effect" on page 368

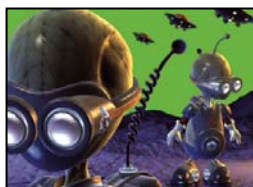

"Depth Matte effect" on page 368



"Depth Of Field effect" on page 369

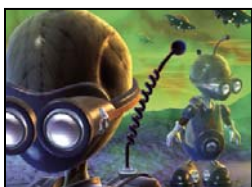

"Fog 3D effect" on page 370

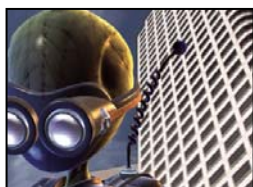

"ID Matte effect" on page 371

Blur & Sharpen effects gallery



No effect applied



"Box Blur effect" on page 376



"Channel Blur effect" on page 376



"Compound Blur effect" on page 376



"Directional Blur effect" on page 377



"Fast Blur effect" on page 377



"Gaussian Blur effect" on page 378



"Lens Blur effect" on page 378



"Radial Blur effect" on page 379



"Sharpen effect" on page 380

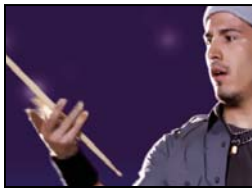

"Smart Blur effect" on page 380



"Unsharp Mask effect" on page 380

Channel effects gallery



No effect applied



"Alpha Levels effect" on page 381



"Arithmetic effect" on page 381



"Blend effect" on page 382



"Calculations effect" on page 383



"Channel Combiner effect" on page 383



"Compound Arithmetic effect" on page 384



"Invert effect" on page 384



"Minimax effect" on page 385



"Remove Color Matting effect" on page 385



"Set Channels effect" on page 386



"Set Matte effect" on page 386



"Shift Channels effect" on page 387



"Solid Composite effect" on page 387

Color Correction effects gallery



No effect applied



"Auto Color and Auto Contrast effects" on page 388



"Auto Levels effect" on page 389



"Brightness & Contrast effect" on page 389

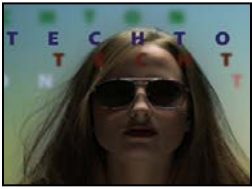

"Broadcast Colors effect" on page 390



"Change Color effect" on page 390



"Change To Color effect" on page 391



"Channel Mixer effect" on page 392



"Color Balance effect" on page 392



"Color Balance (HLS) effect" on page 392



"Color Link effect" on page 392



"Color Stabilizer effect" on page 393



"Colorama effect" on page 393



"Curves effect" on page 396

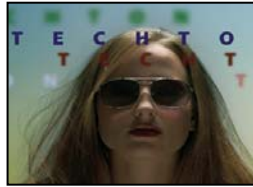

"Equalize effect" on page 396

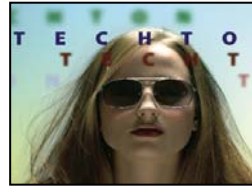

"Exposure effect" on page 397



"Gamma/Pedestal/Gain effect" on page 397



"Hue/Saturation effect" on page 398



"Leave Color effect" on page 399



"Levels effect" on page 399

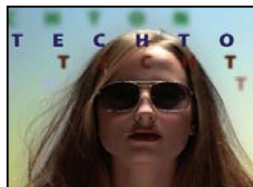

"Levels (Individual Controls) effect" on page 400



"Photo Filter effect" on page 400

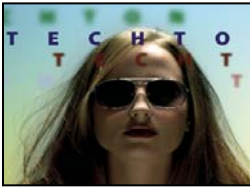

"PS Arbitrary Map effect" on page 401



"Shadow/Highlight effect" on page 402

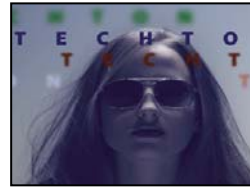

"Tint effect" on page 403



"Tritone effect" on page 403

Distort effects gallery



No effect applied



"Bezier Warp effect" on page 404



"Bulge effect" on page 404



"Corner Pin effect" on page 405



"Displacement Map effect" on page 406



"Liquify effect" on page 406



"Magnify effect" on page 408



"Mesh Warp effect" on page 409



"Mirror effect" on page 410



"Offset effect" on page 410



"Optics Compensation effect" on page 410



"Polar Coordinates effect" on page 411

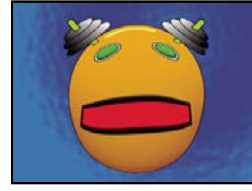

"Reshape effect" on page 412



"Ripple effect" on page 414

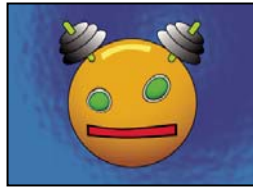

"Smear effect" on page 415



"Spherize effect" on page 416



"Transform effect" on page 417



"Turbulent Displace effect" on page 417



"Twirl effect" on page 418



"Warp effect" on page 418



"Wave Warp effect" on page 419



"Puppet effect" on page 412

Generate effects gallery



No effect applied

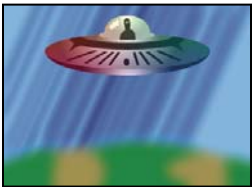

"4-Color Gradient effect" on page 419



"Advanced Lightning effect" on page 420

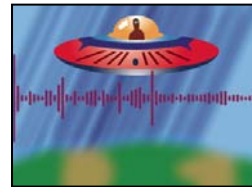

"Audio Spectrum effect" on page 421

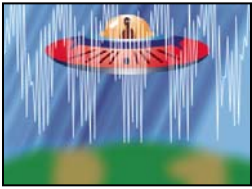

"Audio Waveform effect" on page 423



"Beam effect" on page 423

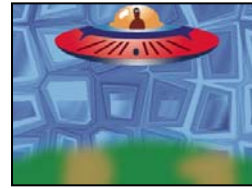

"Cell Pattern effect" on page 424

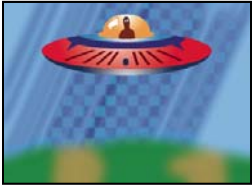

"Checkerboard effect" on page 425



"Circle effect" on page 426

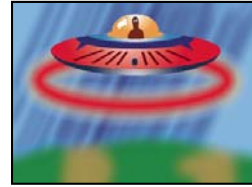

"Ellipse effect" on page 426



"Eyedropper Fill effect" on page 426



"Fill effect" on page 427

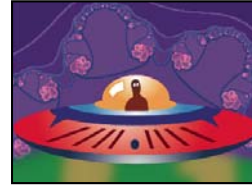

"Fractal effect" on page 427

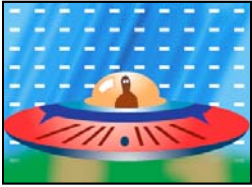

"Grid effect" on page 429

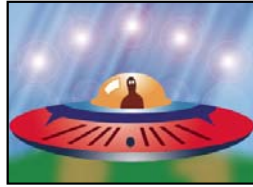

"Lens Flare effect" on page 429



"Lightning effect" on page 430



"Paint Bucket effect" on page 431



"Radio Waves effect" on page 432



"Ramp effect" on page 435

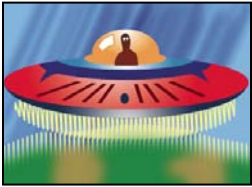

"Scribble effect" on page 435

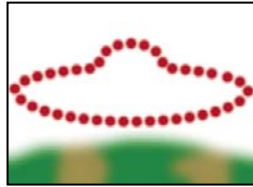

"Stroke effect" on page 437

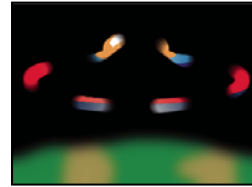

"Vegas effect" on page 438



"Write-on effect" on page 439

Keying effects gallery



"Color Difference Key effect" on page 440



"Color Key effect" on page 442



"Color Range effect" on page 442



"Difference Matte effect" on page 443



"Extract effect" on page 445



"Inner/Outer Key effect" on page 446



"Linear Color Key effect" on page 447

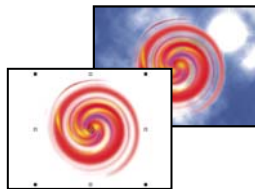

"Luma Key effect" on page 448



"Spill Suppressor effect" on page 449

Matte effects gallery



"Matte Choker effect" on page 450



"Simple Choker effect" on page 451

Noise & Grain effects gallery



No effect applied



"Add Grain effect" on page 459



"Dust & Scratches effect" on page 460



"Fractal Noise effect" on page 461



"Match Grain effect" on page 464



"Median effect" on page 466



"Noise effect" on page 466



"Noise Alpha effect" on page 466



"Noise HLS effect and Noise HLS Auto effect" on page 467



"Remove Grain effect" on page 468

Paint effects gallery



"Paint effect" on page 471



"Vector Paint effect" on page 471

Perspective effects gallery



No effect applied



"3D Glasses effect" on page 481



"Basic 3D effect" on page 483



"Bevel Alpha effect" on page 484



"Bevel Edges effect" on page 484



"Drop Shadow effect" on page 484



"Radial Shadow effect" on page 485

Simulation effects gallery

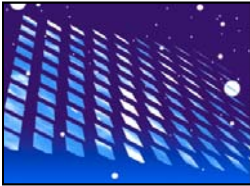

"Card Dance effect" on page 487



"Caustics effect" on page 489



"Foam effect" on page 491

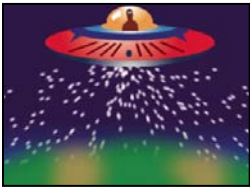

"Particle Playground effect" on page 495

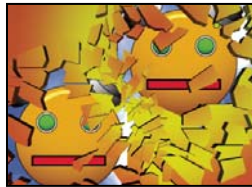

"Shatter effect" on page 508



"Wave World effect" on page 514

Stylize effects gallery



No effect applied



"Brush Strokes effect" on page 517

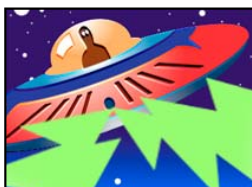

"Color Emboss effect" on page 518



"Emboss effect" on page 518



"Find Edges effect" on page 519



"Glow effect" on page 519



"Mosaic effect" on page 520



"Motion Tile effect" on page 520



"Posterize effect" on page 521



"Roughen Edges effect" on page 521



"Scatter effect" on page 522



"Strobe Light effect" on page 523



"Texturize effect" on page 523



"Threshold effect" on page 524

Text effects gallery



No effect applied



"Basic Text effect" on page 524



"Numbers effect" on page 525



"Path Text effect" on page 526



"Timecode effect" on page 530

Time effects gallery



"Echo effect" on page 531



"Posterize Time effect" on page 532



"Time Difference effect" on page 532



"Time Displacement effect" on page 533



"Timewarp effect" on page 535

Transition effects gallery



No effect applied

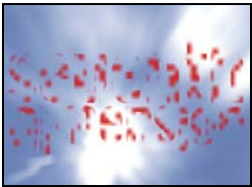

"Block Dissolve effect" on page 537



"Card Wipe effect" on page 537



"Gradient Wipe effect" on page 539



"Iris Wipe effect" on page 540



"Linear Wipe effect" on page 541



"Radial Wipe effect" on page 541



"Venetian Blinds effect" on page 542

Utility effects gallery



“Cineon Converter effect” on page 542



“Color Profile Converter effect” on page 543

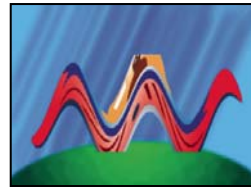

“Grow Bounds effect” on page 544



“HDR Comander effect” on page 545



“HDR Highlight Compression effect” on page 546

3D Channel effects

About 3D Channel effects

The 3D Channel effects work on 2D layers—specifically, 2D layers with 3D information in auxiliary channels. The sources of these 2D layers are 3D scenes that have been rendered out of a 3D application.

Use 3D Channel effects to integrate 3D scenes into 2D composites and to make changes to those 3D scenes. You can import 3D image files saved in RLA, RPF, Softimage PIC/ZPIC, and Electric Image EI/EIZ formats. For PIC and EI files, the 3D channel information is in the ZPIC and EIZ files, respectively. You don't actually import ZPIC and EIZ files, but as long as they're in the same folder with the PIC and EI files, you have access to their 3D channels using the 3D Channel effects. The 3D Channel effects don't affect other types of files.

3D Channel effects read and manipulate the additional channels of information, including z-depth, surface normals, object ID, texture coordinates, background color, unclamped RGB, and material ID. You can layer 3D elements along the z axis, insert other elements in a 3D scene, blur areas in a 3D scene, isolate 3D elements, apply a foggy effect with depth, and extract 3D channel information for use as parameters in other effects.

If you convert a layer to 3D and view it from anywhere but the front and center, it doesn't appear as expected.



To display a pixel's depth and other channel values in the Info panel, apply a 3D Channel effect, and then—with the effect selected—click the pixel in the Composition panel or Layer panel using the Selection tool.

See also

“About 3D layers” on page 171

3D Channel Extract effect

The 3D Channel Extract effect makes auxiliary channels visible as either grayscale or multichannel color images. You can then use the resulting layer as a control layer for other effects. For example, extract the depth information in a 3D channel image file and then use it as an influence map in the Particle Playground effect, or extract values from the unclamped RGB channel to produce a matte that generates glowing highlights.

 To display a pixel's 3D channel values in the Info panel, apply the 3D Channel Extract effect, select the channel in the Effect Controls panel, and then click the pixel in the Composition panel or Layer panel using the Selection tool.

This effect works with 8-bpc color.

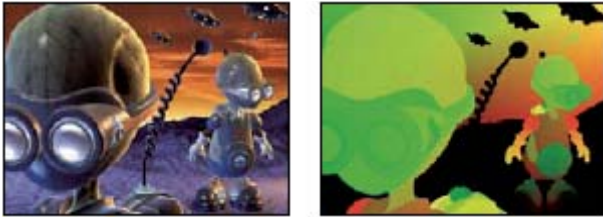

Original (left), with 3D Channel Extract applied using Texture UV (right)

3D Channel The channel to extract from the 3D image.

White Point, Black Point The value that is mapped to white or black.

See also

“About 3D layers” on page 171

Depth Matte effect

The Depth Matte effect reads the depth information in a 3D image and slices the image anywhere along the z axis. For example, you can remove a background in a 3D scene, or you can insert objects into a 3D scene.

 To insert a layer into a 3D scene, apply the Depth Matte effect to the layer containing the 3D scene, set the Depth property to the depth at which you want to insert the new layer, duplicate the 3D scene layer, select Invert for the 3D scene layer on top, and place the new layer between the two 3D scene layers in the layer stacking order in the Timeline panel.

This effect works with 8-bpc color.



Original (top left), with effect applied (bottom left), and with effect applied and Invert Alpha selected (bottom right)

Depth The z axis value at which to slice the image. Everything with a depth value less than this Depth value is matted out.



To determine the depth of an object, click it in the Composition panel or Layer panel using the Selection tool while the effect is selected.

Feather The amount of feather along the matte's edges.

Invert Select to matte out everything with a depth greater than the Depth value. Deselect to matte out everything with a depth less than the Depth value.

See also

“About 3D layers” on page 171

Depth Of Field effect

The Depth Of Field effect simulates a camera that's focusing at one depth (focal plane) in a 3D scene, blurring objects at other depths. This effect uses the depth information from the auxiliary channel of an imported file representing a 3D scene. To use the depth information that After Effects calculates for a camera layer, see “Create a camera layer and change camera settings” on page 176.

This effect works with 8-bpc color.

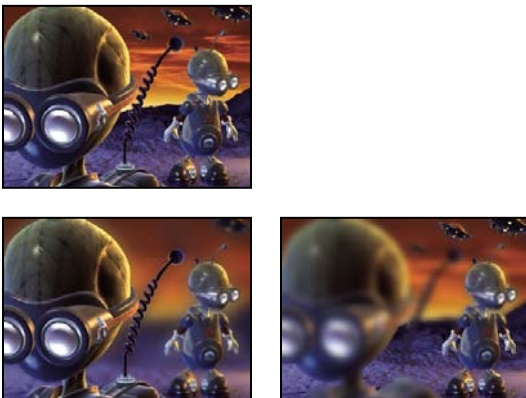

Original (top left), and with Depth Of Field applied using different Focal Plane values (bottom left and bottom right)

Focal Plane The distance along the z axis of the focal plane from the camera.

 To show the depth of an object in the Info panel, click the object in the Composition panel or Layer panel using the Selection tool while the effect is selected.

Maximum Radius How much blur is applied to objects outside the focal plane.

Focal Plane Thickness Determines what depths are in focus on either side of the focal plane.

Focal Bias The higher the value, the more quickly elements drop out of focus with increasing distance from the focal plane.

See also

“About 3D layers” on page 171

Fog 3D effect

The Fog 3D effect simulates fog by behaving as though there is a scattering medium in the air that makes objects look more diffuse as they get more distant along the z axis.

This effect works with 8-bpc color.

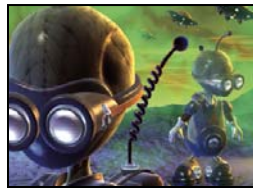
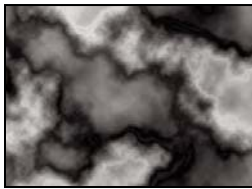

Original (top left), Gradient Layer (bottom left), and with Fog 3D applied (bottom right)

Fog Start Depth Where along the z axis the diffuse scattering begins.

 To determine the depth of an object, click it in the Composition panel or Layer panel using the Selection tool while the effect is selected.

Fog End Depth Where along the z axis the diffusion reaches its maximum.

Scattering Density Determines how quickly the scattering occurs. The higher the value, the more dense the fog appears from its starting point.

Foggy Background Creates a foggy background (default). Deselect to create transparency at the back of the 3D scene for compositing on top of another layer.

Gradient Layer (Optional) A grayscale layer to use as a control layer, the luminance values of which apply to fog density. For example, use the Fractal Noise effect to create a swirling control layer for atmospheric fog. Make sure that the dimensions of the gradient layer are at least as great as the dimensions of the 3D scene layer.

Layer Contribution How much the gradient layer affects the fog density.

See also

“About 3D layers” on page 171

ID Matte effect

Many 3D programs tag each element in a scene with a unique Object ID. The ID Matte effect uses this information to create a matte that excludes everything in the scene except the element you want.



Original (top left), with ID Matte applied using the near alien as the ID Selection (bottom left), and composited over a new background (bottom right)

Aux. Channel Isolate elements based on Object ID or Material ID.

ID Selection The ID value for an object.

 *To determine the ID of an object, select the ID type from the Aux. Channel menu in the Effect Controls panel, and click the object in the Composition panel or Layer panel using the Selection tool while the effect is selected. If Object ID is selected for Aux. Channel, ID Selection automatically updates to the Object ID for the object you click.*

Feather The amount of feather along the matte's edges.

Invert Inverts the selection. Select to matte out the object specified by ID Selection. Deselect to matte out everything but the object (default).

Use Coverage Creates a cleaner matte by removing the colors stored behind the object from the pixels along the edge of the matte. This option works only if the 3D image contains a coverage channel that stores information about the colors behind objects.

See also

“About 3D layers” on page 171

Audio effects

Backwards effect

The Backwards effect reverses a layer's audio by playing it from the last frame to the first frame. The frames remain in their original order in the Timeline panel. Select Swap Channels to swap left and right channels.

See also

“Preview video and audio” on page 120

Bass & Treble effect

The Bass & Treble effect boosts (increases) or cuts (decreases) the low frequencies (bass) or the high frequencies (treble) of the audio. For greater control, use the Parametric EQ effect.

See also

“Preview video and audio” on page 120

Delay effect

The Delay effect repeats audio after a specified amount of time. This effect simulates sound bouncing off a surface, such as a wall.

To simulate the acoustic ambience of a room, use the Reverb effect.

Delay Time Time between the original sound and its echo, in milliseconds.

Delay Amount Volume of the first delayed audio, as a fraction of the original.

Feedback Amount of the echo that is fed back into the delay line to create subsequent echoes.

Dry Out, Wet Out The amounts of the original (dry) sound and delayed (wet) sound in the final output. Values of 50% are commonly used.

See also

“Preview video and audio” on page 120

Flange & Chorus effect

Flange is an audio effect caused by mixing the original audio with a copy that is delayed by a varying amount that cycles over time. The frequency of the copy is also offset by an amount related to the delay. Chorus uses a larger delay, to make one voice or instrument sound like many.

The default settings for the Flange & Chorus effect are for flange. To create a chorus result, use values something like the following: 40 for Voice Separation Time (or higher for a greater chorus result), 4 for Voices, 0.1 for Modulation Rate, 50% for Modulation Depth, and 90 for Voice Phase Change, with Stereo Voices selected.

Voice Separation Time The time in milliseconds that separates each voice. Each voice is a delayed version of the original sound. Use values of 6 or lower for flange, and higher values for chorus.

Voices The number of voices in the processed (wet) audio.

Modulation Rate The rate in Hz at which the modulation cycles.

Modulation Depth The amount of modulation.

Voice Phase Change The modulation phase difference in degrees between each subsequent voice. Divide 360 by the number of voices to find the optimum value.

Invert Phase Inverts the phase of the processed (wet) audio, emphasizing more of the high frequencies; not inverting the phase emphasizes more of the low frequencies.

Stereo Voices Alternates assignment of voices to one of the two channels so that the first voice appears in the left channel, the second in the right channel, the third in the left, and so on. To hear stereo voices, you must preview or render in stereo.

Dry Out, Wet Out The amounts of the original (dry) sound and delayed (wet) sound in the final output. Values of 50% are commonly used.

See also

“Preview video and audio” on page 120

High-Low Pass effect

The High-Low Pass effect sets a limit above or below which frequencies can pass. High Pass allows frequencies above the limit and blocks frequencies below. Conversely, Low Pass allows frequencies below the limit and blocks frequencies above. Use High-Low Pass to do the following:

- Enhance or attenuate (reduce) a sound. For example, using High Pass can reduce traffic noise, which often is concentrated at low frequencies, while minimally affecting a voice recording. Using Low Pass can remove high-frequency sounds, such as static and buzzing.
- Change the focus from one sound to another over time. For example, in audio that contains both music and voice, you can fade out the music while gradually bringing in the voice.
- Protect equipment from potentially damaging frequencies.
- Direct certain frequencies to specific equipment. For example, use Low Pass to isolate sounds intended for a subwoofer.



To check the frequencies that you filter out, switch to the opposite Filter Options value and preview audio.

Cutoff Frequency All frequencies below (High Pass) or above (Low Pass) are removed. If the unwanted sound changes over time, animate this property.



To identify the frequencies of unwanted sound, use the Audio Spectrum effect.

Dry Out, Wet Out The amounts of the original (dry) sound and delayed (wet) sound in the final output. Common values for removing frequencies are 0% for Dry Out and 100% for Wet Out.

See also

“Audio Spectrum effect” on page 421

“Preview video and audio” on page 120

Modulator effect

The Modulator effect adds both vibrato and tremolo to audio by modulating (varying) the frequency and amplitude.

Modulation Type The type of waveform to use. Sine produces smoother modulation. Triangle produces more abrupt modulation.

Modulation Rate The rate in Hz of the modulation.

Modulation Depth The amount of frequency modulation.

Amplitude Modulation The amount of amplitude modulation.

See also

“Preview video and audio” on page 120

Parametric EQ effect

The Parametric EQ effect emphasizes or attenuates specific frequency ranges. Parametric EQ is useful for enhancing music, such as boosting low frequencies to bring up bass.

If you have audio with an unwanted sound (such as a beep from a forklift in the background), you can isolate and cut the frequency range of the beep to attenuate the sound.

Using this effect, you can enhance up to three different bands of audio. As you adjust controls, a frequency-response graph indicates the combined equalization curve you create; band 1 is red, band 2 is green, and band 3 is blue. You may find it easier to specify controls if you determine in advance the frequency-response curve you want.



To identify the frequencies of unwanted sound, use the Audio Spectrum effect.

Band Enabled Activates an equalization band and its controls.

Frequency The center of the frequency band to modify.

Bandwidth The width of the frequency band to modify.

Boost/Cut The amount by which to boost (increase) or cut (decrease) the amplitude of the frequencies inside the specified band. Positive values boost; negative values cut.

See also

“Audio Spectrum effect” on page 421

“Preview video and audio” on page 120

Reverb effect

The Reverb effect simulates a spacious or acoustically live interior by simulating random reflections of a sound off a surface.

Reverb Time The average time, in milliseconds, between the original audio and the reverberated audio.

Diffusion Specifies how much the effect scatters the original audio. More diffusion can make the audio sound farther from the microphone.

Decay Specifies the amount of time it takes for the effect to subside. A higher value simulates a larger space.

Brightness Specifies the amount of detail preserved from the original audio. High brightness simulates a room with live (highly reflective) acoustics.

Dry Out, Wet Out The amounts of the original (dry) sound and delayed (wet) sound in the final output. Values of 50% are commonly used.

See also

“Preview video and audio” on page 120

Stereo Mixer effect

The Stereo Mixer effect mixes the left and right channels of audio and pans the entire signal from one channel to the other.

Invert Phase Inverts the phase of both channels of the stereo signal. Use this control to prevent two sounds at the same frequency from canceling each other out.

See also

“Preview video and audio” on page 120

Tone effect

The Tone effect synthesizes simple audio tones to create sounds, such as the low rumble of a submarine, a telephone ringing in the background, sirens, or a laser blast. You can have up to five tones for each instance of the Tone effect, to create a chord. When you apply this effect to a layer with audio, the dry (original, unprocessed) audio is ignored, and only the tone plays.

You can also apply the Tone effect to a layer that has no audio, such as a solid layer, to synthesize audio.

Note: The Tone effect doesn't generate audio on a placeholder layer; for the effect to generate audio, you must replace the placeholder with a footage item.

Waveform Options Specifies the type of waveform to use. Sine waves produce the purest tones. Square waves produce the most distorted tones. Triangle waves have elements of both sine waves and square waves but are closer to sine waves. Saw waves have elements of both sine waves and square waves but are closer to square waves.

Frequency Frequency in Hz. To turn off a tone, set its frequency to 0.0.

Level Changes the amplitude of all tones in this instance of the effect. To avoid clipping and popping, use a Level value that is no greater than 100 divided by the number of frequencies you use. For example, if you use all five frequencies, specify 20%.

Note: To avoid clicks at the end of a tone, set a keyframe for the desired Level value at the frame just before the end of the tone, and then set a keyframe for a Level value of 0.0 at the end of the tone. This technique works well for any audio that you end abruptly.

See also

“Preview video and audio” on page 120

“Set keyframes” on page 187

Blur & Sharpen effects

About Blur & Sharpen effects

In general, blur effects sample the area around a pixel and assign to the pixel a new value that is the average of the sampled values. Increased blurriness is the result of increasing the size of the sample, whether this is expressed as a radius or a length.

Some blur effects have a Repeat Edge Pixels option. Select this option to make the blur algorithm operate as if the pixel values beyond the edge of the layer are the same as those of the edge pixels. This option keeps edges sharp, preventing them from darkening and becoming more transparent—the result of being averaged with a lot of zeroes. Deselect this option to make the blur algorithm operate as if the pixel values beyond the edge of the layer are zero.

Note: Film grain and noise are removed from an image when you blur it. To make the image look more realistic, you may want to add noise back to the image so that it doesn't look retouched. (See "Noise & Grain effects" on page 452.)

Box Blur effect

Box Blur is similar to Fast Blur and Gaussian Blur, but Box Blur has the added advantage of an Iterations property, which allows you to control the quality of the blur.

This effect works with 8-bpc, 16-bpc, and 32-bpc color.

Iterations How many times the blur is sequentially applied to the image. A value around 3 gives a blur similar in quality to Fast Blur. A higher number of iterations creates smoother transitions between colors and increases the blur, but it also increases the render time. The default value creates boxy results.

Channel Blur effect

The Channel Blur effect blurs a layer's red, green, blue, or alpha channels individually.

Note: If you have noise or artifacts primarily in one color channel—such as MPEG compression artifacts in the blue channel of DV footage—use Channel Blur to clean up the noise in that channel, leaving the other channels sharp.

This effect works with 8-bpc, 16-bpc, and 32-bpc color.

Compound Blur effect

The Compound Blur effect blurs pixels in the effect layer based on the luminance values of a control layer, also known as a *blur layer* or *blurring map*. By default, bright values in the blur layer correspond to more blurring of the effect layer, while dark values correspond to less blurring; select Invert Blur for light values to correspond to less blurring.

This effect is useful for simulating smudges and fingerprints, or changes in visibility caused by atmospheric conditions such as smoke or heat, especially with animated blur layers such as those generated with the Fractal Noise effect.

This effect works with 8-bpc, 16-bpc, and 32-bpc color.

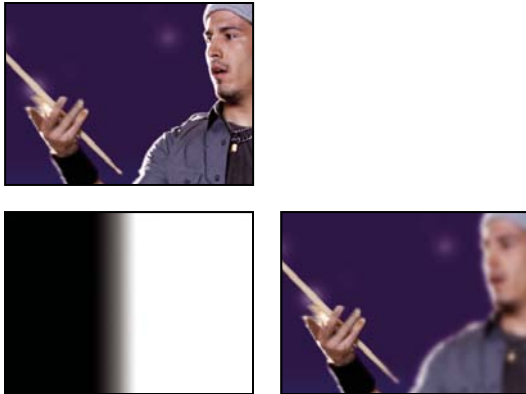

Original (top left), blur layer (bottom left), and result (bottom right)

Maximum Blur The maximum amount, in pixels, that any part of the affected layer can be blurred.

Stretch Map To Fit Stretches the control layer to the dimensions of the layer to which it is applied; otherwise, the control layer is centered on the effect layer.

See also

“About compound effects and control layers” on page 349

Directional Blur effect

The Directional Blur effect gives a layer the illusion of motion.

This effect works with 8-bpc, 16-bpc, and 32-bpc color.



Original (left), and with effect applied (right)

Direction The direction of the blur. The blur is applied equally on either side of a pixel’s center; therefore, a setting of 180° and a setting of 0° produce the same results.

Fast Blur effect

When layer quality is set to Best, Fast Blur is a close approximation of Gaussian Blur, but Fast Blur blurs large areas more quickly.

This effect works with 8-bpc, 16-bpc, and 32-bpc color.

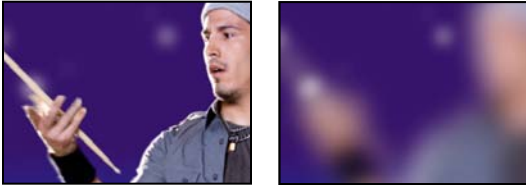

Original (left), and with effect applied (right)

Gaussian Blur effect

The Gaussian Blur effect blurs and softens the image and eliminates noise. The layer's quality setting doesn't affect Gaussian Blur.

This effect works with 8-bpc, 16-bpc, and 32-bpc color.

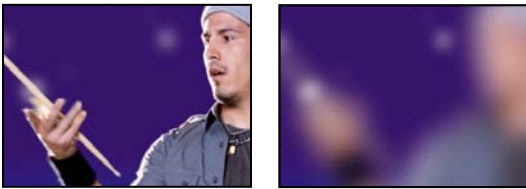

Original (left), and with effect applied (right)

Lens Blur effect

The Lens Blur effect simulates the blurring of objects not in the focal plane of a camera. The appearance of the blur depends on the control layer used as a depth map and the iris settings for the simulated camera aperture.

This effect works with 8-bpc and 16-bpc color.

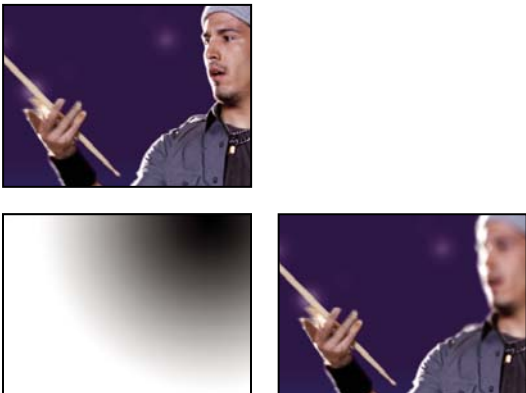

Original (top left), Depth Map layer (bottom left), and result (bottom right)

Depth Map Layer The control layer from which the depth map is taken.

Depth Map Channel The channel of the control layer to use as the depth map. Pixels with low values correspond to low depth (near the camera); pixels with high values correspond to high depth (far from the camera). Select Invert Depth Map to invert this relationship.

Blur Focal Distance Depth of the focal plane, where pixels are in focus.

Iris Shape The polygon to use as the iris shape.

Iris Blade Curvature The roundness of the edges of the iris.

Iris Rotation The rotation of the iris.

Iris Radius The size of the iris. Increase this value for greater blur.

Specular Threshold All pixels with a brightness value greater than Specular Threshold are treated as specular highlights.

Specular Brightness Brightness of specular highlights.

Noise controls Film grain and noise are removed when you blur an image. To make the image look more realistic, you may want to add noise back to the image so that it doesn't look retouched. To add noise, set Noise Amount, and choose a noise type from the Noise Distribution menu. To add noise without affecting the color in your image, choose Monochromatic Noise.

Stretch Map To Fit Stretches the control layer to the dimensions of the layer to which it is applied; otherwise, the control layer is centered on the affected layer.

Radial Blur effect

The Radial Blur effect creates blurs around a point, simulating the result of a zooming or rotating camera.

You can specify the level of anti-aliasing applied at Best quality; no anti-aliasing is applied at Draft quality. At Draft quality, the blur appears somewhat grainy. You may prefer the draft results for special effects, but the grain may flicker on interlaced displays.

This effect works with 8-bpc, 16-bpc, and 32-bpc color.



Original (left), and with effect applied (right)

Type Spin blurs in arcs around the Center point, as if the camera were rotating; Amount specifies degrees of rotation. Zoom blurs radially outward from the center point; Amount specifies the length of the blur.

Reduce Interlace Flicker effect

The Reduce Interlace Flicker effect reduces high vertical frequencies to make images more suitable for use in an interlaced medium (such as NTSC video). For example, images with very thin horizontal lines can flicker when broadcast. Reduce Interlace Flicker softens horizontal edges to reduce the flickering.

This effect works with 8-bpc color.

Note: *Flicker may result from fields that haven't been separated.*

See also

“Separate video fields” on page 71

Sharpen effect

The Sharpen effect increases the contrast where color changes occur. The layer's quality setting doesn't affect Sharpen.

This effect works with 8-bpc and 16-bpc color.

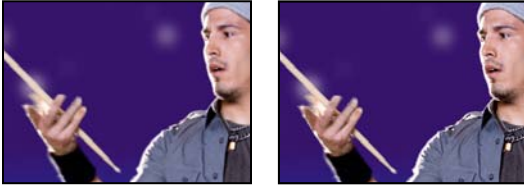

Original (left), and with effect applied (right)

Smart Blur effect

The Smart Blur effect blurs an image while preserving lines and edges within the image. For example, you can use the Smart Blur effect to smoothly blur shaded areas while retaining crisp outlines of text and vector graphics.

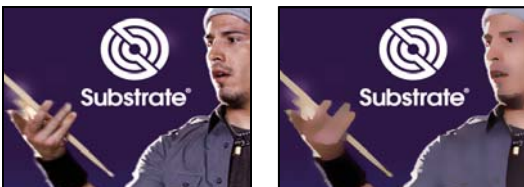

Original (left), and with effect applied (right)

This effect works with 8-bpc and 16-bpc color.

Radius How far the filter searches for dissimilar pixels to blur.

Threshold How different the pixels' values should be before they are eliminated.

Mode What parts of the image receive the blur. Normal specifies that the blur be applied to the entire selection, whereas Edge Only and Overlay Edge specify that the blur be applied only to the edges of color transitions. Where significant contrast occurs, Edge Only applies black-and-white edges, and Overlay Edge applies white.

Unsharp Mask effect

The Unsharp Mask effect increases the contrast between colors that define an edge.

This effect works with 8-bpc and 16-bpc color.

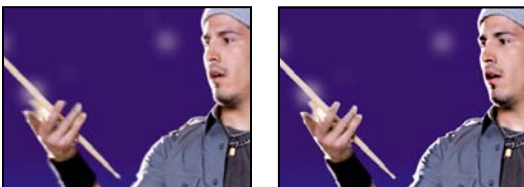

Original (left), and with effect applied (right)

Radius The distance from the edge at which pixels are adjusted for contrast. If you specify a low value, only pixels near the edge are adjusted.

Threshold The greatest difference between adjacent pixels for which contrast isn't adjusted. A lower value produces a greater result. A value that is too low causes contrast for the entire image to be adjusted and can generate noise or cause unexpected results.

Channel effects

Alpha Levels effect

Use Alpha Levels to convert completely opaque or completely transparent areas of a matte to be semitransparent, or to convert semitransparent areas to be completely opaque or completely transparent. Because transparency is based on the monochrome alpha channel, the controls for this effect refer to complete transparency as black and complete opacity as white. This effect is very similar to the Levels effect, which performs the same operations on color channels instead of the alpha channel.

- Use Output Black Level of 0 and Input Black Level greater than 0 to convert a range of semitransparent areas to be completely transparent.
- Use Output White Level of 1.0 and Input White Level less than 1.0 to convert a range of semitransparent areas to be completely opaque.
- Use Output Black Level greater than 0 to convert a range of completely transparent areas to be semitransparent.
- Use Output White Level less than 1.0 to convert a range of completely opaque areas to be semitransparent.

This effect works with 8-bpc and 16-bpc color.

Input Black Level Alpha channel values at this level or lower are mapped to the Output Black Level (maximum transparency).

Input White Level Alpha channel values at this level or higher are mapped to the Output White Level (maximum opacity).

Gamma Determines the distribution of intermediate (gray, semitransparent) values. A Gamma value of 1 produces a linear distribution of gray values. Gamma less than 1 biases the distribution toward darker gray values (more transparency). Gamma greater than 1 biases the distribution toward lighter gray values (less transparency).

See also

“Levels effect” on page 399

Arithmetic effect

The Arithmetic effect performs various simple mathematical operations on an image's red, green, and blue channels.

This effect works with 8-bpc color.

Operator The operation to perform between the value you specify for each channel and the existing value of that channel for each pixel in the image:

- **And, Or, and Xor** Apply bitwise logical operations.
- **Add, Subtract, Multiply, and Difference** Apply basic math functions.
- **Max** Set the pixel's channel value to the greater of the specified value and the pixel's original value.
- **Min** Set the pixel's channel value to the lesser of the specified value and the pixel's original value.

- **Block Above** Set the pixel's channel value to zero if the pixel's original value is greater than the value specified; otherwise, leave the original value.
- **Block Below** Set the pixel's channel value to zero if the pixel's original value is less than the value specified; otherwise, leave the original value.
- **Slice** Set the pixel's channel value to 1.0 if the pixel's original value is above the specified value; otherwise, set the value to zero. In both cases, the values for the other color channels are set to 1.0.

Clip Result Values Prevents all functions from creating color values that exceed the valid range. If this option isn't selected, some color values may wrap around.

Blend effect

The Blend effect blends two layers using one of five modes.

You can blend layers more easily and quickly using blending modes, but you can't animate blending modes. The advantage of using the Blend effect is that you can animate it. (See "Blending modes" on page 163.)

This effect works with 8-bpc and 16-bpc color.



Original (top left), matte created with Fractal Noise effect on a solid layer (bottom left), and result of Blend effect with Mode set to Crossfade (bottom right)

Blend With Layer The layer to blend with (the secondary or control layer).

Note: To use a layer as a control layer for the Blend effect but not show the layer in the rest of the composition, deselect the control layer's Video switch . (See "Layer switches and columns in the Timeline panel" on page 147.)

Mode Blending mode:

- **Color Only** colorizes each pixel in the original image based on the color of each corresponding pixel in the secondary image.
- **Tint Only** is similar to Color Only but tints pixels in the original image only if they're already colored.
- **Darken Only** darkens each pixel in the original image that is lighter than the corresponding pixel in the secondary image.
- **Lighten Only** lightens each pixel in the original image that is darker than the corresponding pixel in the secondary image.
- **Crossfade** causes the original image to fade out while the secondary image fades in.

Note: You can create a crossfade without applying an effect by animating the Opacity property of one layer on top of another. However, this technique doesn't work if the foremost layer has any transparent portions (which allow the other layer to show through, even when at full opacity). The Crossfade mode creates a proper crossfade between two layers, even if both have transparent regions.

Blend With Original The effect's transparency. The result of the effect is blended with the original image, with the effect result composited on top. The higher you set this value, the less the effect affects the layer. For example, if you set this value to 100%, the effect has no visible result on the layer; if you set this value to 0%, the original image doesn't show through.

If Layer Sizes Differ Specifies how to position the control layer. The layer's quality setting affects Blend only if Stretch To Fit is selected and if the layers are of different sizes. Stretching at Best quality is much smoother.

Calculations effect

The Calculations effect combines channels of one layer with the channels of a second layer.

This effect works with 8-bpc and 16-bpc color.

Input Channel The channel to extract and use as input to the blending operation. RGBA displays all channels normally. Gray converts all color channel values for a pixel to the luminance value of the original pixel. Red, Green, or Blue converts all color channel values for a pixel to the value of the selected color channel for the original pixel. Alpha converts all channels to the value of the alpha channel for the original pixel.

Invert Input Inverts the layer (subtracts each channel value from 1.0) before the effect extracts the specified channel information.

Second Layer The control layer with which Calculations blends the original layer.

Second Layer Channel The channel to be blended with the input channels.

Second Layer Opacity The opacity of the second layer. Use a setting of 0% for the second layer to have no influence on the output.

Invert Second Layer Inverts the second layer (subtracts each channel value from 1.0) before the effect extracts the specified channel information.

Stretch Second Layer To Fit Stretches the second layer to the dimensions of the original layer before blending. Deselect to center the second layer on the original layer.

Preserve Transparency Ensures that the original layer's alpha channel isn't modified.

See also

"Blending modes" on page 163

Channel Combiner effect

The Channel Combiner effect extracts, displays, and adjusts channel values for a layer.

Note: You can use this effect to view any channel as a grayscale image by choosing the channel from the From menu and choosing Lightness Only from the To menu.

This effect works with 8-bpc color.

Use 2nd Layer Retrieve values from Source Layer, which can be any layer in the composition.

From Which values to use as input; the first several items in the menu are actually multichannel combinations of input and output options, so they don't require you to set a To value.

- **Saturation Multiplied** uses the saturation value multiplied by the lightness value, where lightness is the minimum distance to black or white. For example, a dark or light blue pixel has a lower value than a bright or *pure* blue pixel. This option represents the most common view of a pixel's saturation value.
- **Min RGB** uses the lowest value among the red, green, and blue channel values.
- **Max RGB** uses the highest value among the red, green, and blue channel values.

To The channels to which to apply the values. Choose **Red Only**, **Green Only**, and **Blue Only** to apply the value to one channel only and set the other color channels to zero. Choose **Alpha Only** to apply the value to the alpha channel and set the color channels to 1.0. When you select **Hue Only**, the applied hue value is combined with 50% lightness and 100% saturation. When you select **Lightness Only**, the applied lightness value is combined with 0% saturation, which then gives the hue no influence. When you select **Saturation Only**, the applied saturation values are combined with 0% hue and 50% lightness.

Invert Inverts (subtracts from 1.0) the output channel values.

Solid Alpha Makes the alpha channel value 1.0 (complete opacity) throughout the layer.

Compound Arithmetic effect

The Compound Arithmetic effect mathematically combines the layer to which it is applied with a control layer. The Compound Arithmetic effect is intended only to provide compatibility with projects created in earlier versions of After Effects that use the Compound Arithmetic effect. Using blending modes is usually more effective than using the Compound Arithmetic effect.

This effect works with 8-bpc color.

Second Source Layer The layer to use with the current layer in the given operation.

Operator The operation to perform between the two layers.

Operate On Channels The channels to which the effect is applied.

Overflow Behavior How the effect remaps values that fall outside the grayscale range of 0-255.

- **Clip** Values above 255 are mapped to 255. Values below 0 are mapped to 0.
- **Wrap** Values above 255 and below 0 are wrapped back around into the 0-255 range. For example, a value of 258 wraps around to 2, a value of 256 wraps around to 0, and a value of -3 wraps around to 253.
- **Scale** The maximum and minimum values are remapped to 255 and 0, and intermediate values are stretched or compressed to fit within this range.

Stretch Second Source To Fit Scales the second layer to match the size (width and height) of the current layer. If this option is deselected, the second layer is placed at its source's current size, aligned with the upper left corner of the source layer.

Blend With Original The effect's transparency. The result of the effect is blended with the original image, with the effect result composited on top. The higher you set this value, the less the effect affects the layer. For example, if you set this value to 100%, the effect has no visible result on the layer; if you set this value to 0%, the original image doesn't show through.

Invert effect

The Invert effect inverts the color information of an image.

This effect works with 8-bpc and 16-bpc color.



Original (left), and with effect applied (right)

Channel Which channel or channels to invert. Each group of items operates in a particular color space, inverting either the entire image in that color space or just a single channel.

- **RGB/Red/Green/Blue** RGB inverts all three of the additive color channels. Red, Green, and Blue each invert an individual color channel.
- **HLS/Hue/Lightness/Saturation** HLS inverts all three of the calculated color channels. Hue, Lightness, and Saturation each invert an individual color channel.
- **YIQ/Luminance/In Phase Chrominance/Quadrature Chrominance** YIQ inverts all three NTSC luminance and chrominance channels. Y (luminance), I (in-phase chrominance), and Q (quadrature chrominance) each invert an individual channel.
- **Alpha** Inverts the alpha channel of the image. The alpha channel isn't a color channel; it specifies transparency.

Blend With Original The effect's transparency. The result of the effect is blended with the original image, with the effect result composited on top. The higher you set this value, the less the effect affects the layer. For example, if you set this value to 100%, the effect has no visible result on the layer; if you set this value to 0%, the original image doesn't show through.

Minimax effect

The Minimax effect assigns each channel of a pixel the minimum or maximum value for that channel found within a specified radius.

This effect can be used to enlarge or reduce a matte. For example, a white solid area surrounded by black shrinks one pixel on each side using Minimum and a radius of 1.

The layer's quality setting doesn't affect Minimax.

This effect works with 8-bpc and 16-bpc color.

Operation Minimum assigns each channel of a pixel the minimum value for the specified channel within the specified radius. Maximum assigns each channel of a pixel the maximum value. Minimum Then Maximum performs the Minimum operation and then the Maximum operation. Maximum Then Minimum performs the Maximum operation and then the Minimum operation.

Direction The axis along which to scan for values. Horizontal & Vertical scans all directions.

Remove Color Matting effect

The Remove Color Matting effect removes color fringes (halos) from layers with premultiplied color channels. Halos often occur when an area of partial transparency retains the color of the original background and is composited into a context with a different background color. Use this effect in conjunction with effects that create transparency—such as keying effects—to achieve more control over the appearance of areas of partial transparency.

Use Background Color to specify the new background color. To allow this effect to generate color values outside of the range 0.0-1.0 when working in 32-bpc color, deselect Clip HDR Values.

This effect works with 8-bpc, 16-bpc, and 32-bpc color.



Original (left), and with Remove Color Matting effect applied (right)

Set Channels effect

The Set Channels effect copies channels from control layers (source layers) to the red, green, blue, and alpha channels of the effect layer. For example, you can take the luminance values of a control layer's pixels and use them as the blue values for the effect layer's pixels.

This effect works with 8-bpc and 16-bpc color.

Set Matte effect

The Set Matte effect replaces the alpha channel (matte) of a layer with a channel from another layer above it for the creation of traveling matte results. The Set Matte effect is intended only to provide compatibility with projects created in earlier versions of After Effects that use the Set Matte effect.

This effect works with 8-bpc and 16-bpc color.



Original (top left), matte layer (bottom left), and result (bottom right)

Although you can use Set Matte for a traveling matte, it's easier and faster to create traveling mattes by using a track matte. (See "About track mattes and traveling mattes" on page 263.)

Take Matte From Layer The layer to use as the replacement matte.

Use For Matte The channel to use for the matte.

Invert Matte Inverts the transparency values of the matte.

Stretch Matte To Fit Scales the selected layer to match the size of the current layer. If Stretch Matte To Fit is deselected, the layer designated as the matte is centered in the first layer.

Composite Matte With Original Composites the new matte with the current layer, rather than replacing it. The resulting matte allows the image to show through only where the current matte and the new matte both have some opacity.

Premultiply Matte Layer Premultiplies the new matte layer with the current layer.

Shift Channels effect

The Shift Channels effect replaces red, green, blue, and alpha channels in the image with other channels.

This effect works with 8-bpc, 16-bpc, and 32-bpc color.

Take Channel From The channel to use as a source.

Solid Composite effect

The Solid Composite effect offers a quick way to create a composite of a new color solid behind the original source layer.

This effect works with 8-bpc, 16-bpc, and 32-bpc color.

Source Opacity The opacity of the source layer.

Color The color of the solid.

Opacity The opacity of the solid.

Blending Mode The blending mode used to combine the layer and the solid color.

Color Correction effects

The Rebel CC animation preset is a simple, telecine-style color-correction tool for coloring or grading a movie. This animation preset uses expressions to control the Levels (Individual Controls) effect. To learn more and download the animation preset, see Stu Maschwitz's blog: www.adobe.com/go/learn_ae_sturebelcc.

John Dickinson provides visual aids on his website that illustrate how to use the Curves and Levels effects for color adjustments: www.adobe.com/go/learn_ae_jdcurves and www.adobe.com/go/learn_ae_jdlevels.

Using histograms to adjust color

A *histogram* is a representation of the number of pixels at each luminance value in an image. A histogram that has nonzero values for each luminance value indicates an image that takes advantage of the full tonal range. A histogram that doesn't use the full tonal range corresponds to a dull image that lacks contrast.

A common color-correction task is adjusting an image to spread out the pixel values more evenly from left to right on the histogram, instead of having them bunched up at one end or the other. Applying the Levels effect and adjusting its Input White and Input Black properties in the histogram is an easy and effective way to accomplish this task for many images.



Histogram for image that does not use full tonal range

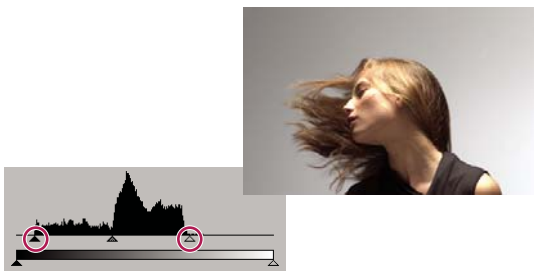

Input sliders moved so that output uses full tonal range



Histogram showing highlight clipping



Histogram showing shadow clipping

Auto Color and Auto Contrast effects

The Auto Color effect adjusts the contrast and color of an image after analyzing the shadows, midtones, and highlights of the image. The Auto Contrast effect adjusts the overall contrast and mixture of colors. Each effect maps the lightest and darkest pixels in the image to white and black, and then redistributes the intermediate pixels. The result is that highlights appear lighter and shadows appear darker.

Because Auto Contrast and Auto Color don't adjust channels individually, they don't introduce or remove color casts.

The Auto Levels effect uses many of the same controls as the Auto Color and Auto Contrast effects.

These effects work with 8-bpc and 16-bpc color.

Temporal Smoothing The range of adjacent frames, in seconds, analyzed to determine the amount of correction needed for each frame, relative to its surrounding frames. If Temporal Smoothing is 0, each frame is analyzed independently, without regard for surrounding frames. Temporal Smoothing can result in smoother looking corrections over time.

Scene Detect If selected, frames beyond a scene change are ignored when surrounding frames are analyzed for temporal smoothing.

Black Clip, White Clip How much of the shadows and highlights are clipped to the new extreme shadow and highlight colors in the image. Note that setting the clipping values too high reduces detail in the shadows or highlights. A value between 0.0% and 1% is recommended. By default, shadow and highlight pixels are clipped by 0.1%—that is, the first 0.1% of either extreme is ignored when the darkest and lightest pixels in the image are identified; these are then mapped to output black and output white. This method ensures that input black and input white values are based on representative rather than extreme pixel values.

Snap Neutral Midtones (Auto Color only) Identifies an average nearly neutral color in the frame and then adjusts the gamma values to make the color neutral.

Blend With Original The effect's transparency. The result of the effect is blended with the original image, with the effect result composited on top. The higher you set this value, the less the effect affects the layer. For example, if you set this value to 100%, the effect has no visible result on the layer; if you set this value to 0%, the original image doesn't show through.

Auto Levels effect

The Auto Levels effect maps the lightest and darkest values in each color channel in the image to white and black, and then redistributes the intermediate values. As a result, highlights appear lighter and shadows appear darker. Because Auto Levels adjusts each color channel individually, it may remove or introduce color casts.

See “Auto Color and Auto Contrast effects” on page 388 for explanations of this effect's controls.

This effect works with 8-bpc and 16-bpc color.

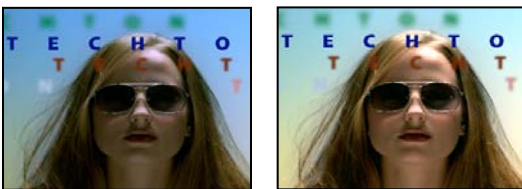

Original (left), and with effect applied (right)

Brightness & Contrast effect

The Brightness & Contrast effect adjusts the brightness and contrast of an entire layer (not individual channels). The default value of 0.0 indicates that no change is made. Using the Brightness & Contrast effect is the easiest way to make simple adjustments to the tonal range of the image. It adjusts all pixel values in the image at once—highlights, shadows, and midtones.

This effect works with 8-bpc, 16-bpc, and 32-bpc color.

Broadcast Colors effect

Note: The Color Finesse plug-in included with After Effects includes excellent tools that can help you keep your colors within the broadcast-safe range. For more information, see the Color Finesse documentation in the following folder: *Adobe After Effects CS3/Additional Documentation/Color Finesse 2.*

The Broadcast Colors effect alters pixel color values to keep signal amplitudes within the range allowed for broadcast television.

Use the Key Out Unsafe and Key Out Safe settings for How To Make Color Safe to determine which portions of the image will be affected by the Broadcast Colors effect at the current settings.

Note: A more reliable way to keep colors within the broadcast-safe range for your output type is to use color management features to set the output color profile accordingly, such as to SDTV (Rec. 601 NTSC). This ensures that color values between 0.0 and 1.0 in your working color space are converted to broadcast-safe values. (See “Broadcast-safe colors” on page 250.)

This effect works with 8-bpc color.

Broadcast Locale The broadcast standard for your intended output. NTSC (National Television Standards Committee) is the North American standard and is also used in Japan. PAL (Phase Alternating Line) is used in most of Western Europe and South America.

How To Make Color Safe How to reduce signal amplitude:

- **Reduce Luminance** Reduces a pixel's brightness by moving it toward black. This setting is the default.
- **Reduce Saturation** Moves the pixel's color toward a gray of similar brightness, making the pixel less colorful. For the same IRE level, reducing saturation alters the image more noticeably than does reducing luminance.

Maximum Signal The maximum amplitude of the signal in IRE units. A pixel with a magnitude above this value is altered. The default is 110. Lower values affect the image more noticeably; higher values are more risky.

Change Color effect

The Change Color effect adjusts the hue, lightness, and saturation of a range of colors.

This effect works with 8-bpc and 16-bpc color.

View Corrected Layer shows the results of the Change Color effect. Color Correction Mask shows a grayscale matte that indicates the areas of the layer that will be changed. White areas in the color correction mask are changed the most, and dark areas are changed the least.

Hue Transform The amount, in degrees, to adjust hue.

Lightness Transform Positive values brighten the matched pixels; negative values darken them.

Saturation Transform Positive values increase saturation of matched pixels (moving toward pure color); negative values decrease saturation of matched pixels (moving toward gray).

Color To Change The central color in the range to be changed.

Matching Tolerance How much colors can differ from Color To Change and still be matched.

Matching Softness The amount that unmatched pixels are affected by the effect, in proportion to their similarity to Color To Change.

Match Colors Determines the color space in which to compare colors to determine similarity. RGB compares colors in an RGB color space. Hue compares the hues of colors, ignoring saturation and brightness—so bright red and light

pink match, for example. Chroma uses the two chrominance components to determine similarity, ignoring luminance (lightness).

Invert Color Correction Mask Inverts the mask that determines which colors to affect.

Change To Color effect

The Change To Color effect (formerly Change Color HLS effect) changes a color you select in an image to another color using hue, lightness, and saturation (HLS) values, leaving other colors unaffected.

Change To Color offers flexibility and options unavailable in the Change Color effect. These options include tolerance sliders for hue, lightness, and saturation for exact color matching, and the ability to select the exact RGB values of the target color that you wish to change to.

This effect works with 8-bpc and 16-bpc color.

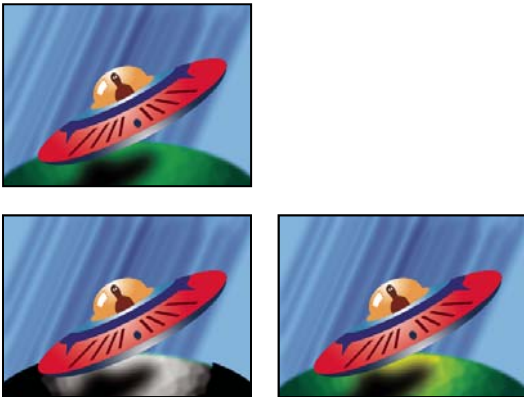

Original image (top left), with saturation removed in the planet (bottom left), and with light green changed to yellow in the planet (bottom right)

From The center of the color range to change.

To The color to change matched pixels to.



To animate a color change, set keyframes or expressions for the To color.

Change Which channels are affected.

Change By How to change colors. Setting To Color performs a direct change of affected pixels to the target color. Transforming To Color transforms affected pixel values toward the target color, using HLS interpolation; the amount of change for each pixel depends on how close the pixel's color is to the From color.

Tolerance How much colors can differ from the From color and still be matched. Expand this control to reveal separate sliders for Hue, Lightness, and Saturation values.

Note: Use the View Correction Matte option to better identify which pixels are matched and affected.

Softness The amount of feather to use for the edges of the correction matte. Higher values create smoother transitions between areas affected by the color change and those unaffected.

View Correction Matte Shows a grayscale matte that indicates the amount to which the effect affects each pixel. White areas are changed the most, and dark areas are changed the least.

Channel Mixer effect

The Channel Mixer effect modifies a color channel using a mix of the current color channels. Use this effect to make creative color adjustments not easily done with the other color adjustment tools: Create high-quality grayscale images by choosing the percentage contribution from each color channel, create high-quality sepia-tone or other tinted images, and swap or duplicate channels.

[output channel]-[input channel] The percentage of the input channel value to add to the output channel value. For example, a Red-Green setting of 10 increases the value of the red channel for each pixel by 10% of the value of the green channel for that pixel. A Blue-Green setting of 100 and a Blue-Blue setting of 0 replaces the blue channel values with the green channel values.

[output channel]-Const The constant value (as a percentage) to add to the output channel value. For example, a Red-Const setting of 100 saturates the red channel for every pixel by adding 100% red.

Monochrome Uses the value of the red output channel for the red, green, and blue output channels, creating a grayscale image.

This effect works with 8-bpc and 16-bpc color.

Color Balance effect

The Color Balance effect changes the amount of red, green, and blue in the shadows, midtones, and highlights of an image.

Preserve Luminosity preserves the average brightness of the image while changing the color. This control maintains the tonal balance in the image.

This effect works with 8-bpc and 16-bpc color.

Color Balance (HLS) effect

The Color Balance (HLS) effect alters an image's levels of hue, lightness, and saturation. It's intended only to provide compatibility with projects created in earlier versions of After Effects that use the Color Balance (HLS) effect. For new projects, use the Hue/Saturation effect, which operates the same as the Hue/Saturation command in Adobe Photoshop. You can convert a movie to grayscale by setting the Saturation to -100.

This effect works with 8-bpc and 16-bpc color.

See also

"Hue/Saturation effect" on page 398

Color Link effect

The Color Link effect colorizes one layer with the average pixel values of another layer. This effect is useful for quickly finding a color that matches the color of a background layer.

This effect works with 8-bpc color.

Source Layer The layer from which to sample colors. If you choose None, the layer to which the effect is applied is used as the source layer, taking into account any masks and other effects applied to the layer. If you choose the layer's name from the menu, the source layer without masks and effects is used.

Sample Specifies what values are sampled and what operation is performed on them.

Clip The percentage of pixels to ignore at the extreme channel values. This clipping is useful for reducing the influence of noise or other nonrepresentative pixels.

Stencil Original Alpha The effect places a stencil of the layer's original alpha channel over the new value.

Opacity The effect's opacity. The result of the effect is blended with the original image, with the effect result composited on top. The lower you set this value, the less the effect affects the layer. For example, if you set this value to 0%, the effect has no visible result on the layer; if you set this value to 100%, the original image doesn't show through.

Blending Mode The blending mode to use to combine the effect result with the original layer. These blending modes aren't available when averaging alpha channel values in the layer.

Color Stabilizer effect

The Color Stabilizer effect samples the color values of a single reference frame, or *pivot frame*, at one, two, or three points; it then adjusts the colors of other frames so that the color values of those points remain constant throughout the layer's duration. This effect is useful for removing flicker from footage and equalizing the exposure of footage with color shifts caused by varying lighting situations.



Use this effect to remove the flicker common to time-lapse photography and stop-frame animation.

You can animate the effect control points that define the sample areas to track objects for which you want to stabilize colors. The greater the difference in color values between the sample points, the better the effect works.

This effect works with 8-bpc and 16-bpc color.

Set Frame Sets the pivot frame. Display the frame that has the area of brightness or color that you want to match, and click Set Frame.

Stabilize What to stabilize:

- **Brightness** Brightness is stabilized using one sample point (Black Point).
- **Levels** Color is stabilized using two sample points (Black Point and White Point).
- **Curves** Color is stabilized using all three sample points (Black Point, White Point, and Mid Point).

Black Point Place this point on a dark area to stabilize.

Mid Point Place this point on a midtone area to stabilize.

White Point Place this point on a bright area to stabilize.

Sample Size Radius, in pixels, of sampled areas.

Colorama effect

The Colorama effect is a very versatile and powerful effect for converting and animating colors in an image. Using the Colorama effect, you can subtly tint an image or radically change its color palette.

Colorama works by first converting a specified color attribute to grayscale and then remapping the grayscale values to one or more cycles of the specified output color palette. One cycle of the output color palette appears on the Output Cycle wheel. Black pixels are mapped to the color at the top of the wheel; increasingly lighter grays are mapped to successive colors going clockwise around the wheel. For example, with the default Hue Cycle palette, pixels corresponding to black become red, while pixels corresponding to 50% gray become cyan.

This effect works with 8-bpc and 16-bpc color.

Guy Chen provides an example of using the Fractal Noise effect to generate the base noise (in this case for the turbulent surface of the Sun) and then colorizing the noise with the Colorama effect:

www.adobe.com/go/learn_ae_guyfractalsun.

Input Phase controls

Get Phase From The color attribute to use as input. Choose Zero to use a color attribute from another layer.

Add Phase The second layer to use as input. To use only this layer as input, select Zero for Get Phase From; otherwise, both the Add Phase layer and the layer to which the effect is applied are used. You can choose the layer to which the effect is applied to add a second input attribute from the same layer.

Add Phase From The color attribute from the second layer to use as input.

Add Mode How input values are combined:

- **Wrap** Adds the values of the two attributes for each pixel. Values above 100% are wrapped around the cycle again. For example, a sum of 125% wraps around to 25%.
- **Clamp** Adds the values of the two attributes for each pixel. Values above 100% are clipped to 100%.
- **Average** Averages the values of the two attributes for each pixel. Because the average of two values that are each in the range 0% to 100% is never over 100%, wrapping and clamping by this operation are never necessary. Average is therefore the safest option for predictable output.
- **Screen** Screens the second layer over the original layer; the brighter areas in the second layer brighten the first layer, and the darker areas in the second layer are discarded. Screen mode is especially useful for compositing fire, lens flares, and other lighting effects.

Phase Shift The point on the Output Cycle wheel at which the mapping of the input colors begins. A positive value moves the starting point clockwise around the Output Cycle wheel.



Animate Phase Shift to cycle colors around the wheel.

Output Cycle controls

Use Preset Palette Presets for the Output Cycle. The top palettes are designed for quick color correction and adjustment tasks. The bottom choices offer a variety of built-in color palettes for creative results.

Output Cycle Customize the output color palette by altering the colors and locations of the triangles on the Output Cycle wheel. The triangles specify the location on the color wheel where a specific color occurs. The color between triangles is smoothly interpolated, unless Interpolate Palette is deselected. Each Output Cycle can have 1-64 triangles.

- To change a triangle's location, drag the triangle. Shift-drag to snap the triangle to 45-degree increments. At the top of the wheel, the triangle snaps to either the start position or end position depending on whether you drag from the left or right.
- To add a triangle, click in or near the wheel, and select a color from the color picker. Click slightly to the left of the top arrows for the end color, and slightly to the right for the start color.
- To duplicate a triangle, Ctrl-drag (Windows) or Command-drag (Mac OS) the triangle.
- To delete a triangle, drag it away from the wheel.
- To change the opacity, select a triangle on the color wheel and then drag the attached triangle above the opacity slider. Make sure that Modify Alpha is selected if you want the opacity information to affect your output.

Note: When you animate the Output Cycle, a triangle's position and color are interpolated between keyframes. For best results, make sure that all keyframes have the same number of Output Cycle triangles.

Cycle Repetitions How many iterations of the Output Cycle the input color range is mapped to. The default value of 1 maps the input range to one iteration of the Output Cycle, from input black at the top of the Output Cycle wheel, clockwise to input white at the top of the Output Cycle wheel. A value of 2 maps the input range to two iterations of the Output Cycle. Use this option to create a simple palette and repeat it many times throughout a gradient.

Interpolate Palette Colors between triangles are interpolated smoothly. When this option is deselected, output colors are posterized.

Modify controls

Modify controls specify which color attributes are modified by the Colorama effect. For subtle refinement of images, choose the same color attribute for Input Phase and Modify. For example, choose Hue from both menus to simply adjust Hue.

Modify The color attribute to modify.

Modify Alpha Modifies alpha channel values.

Note: If you apply Colorama to a layer with an alpha channel, and the Output Cycle doesn't contain alpha information, the anti-aliased edges of the layer may appear pixelated. To smooth the edges, deselect Modify Alpha. If Modify Alpha is selected and the Output Cycle contains alpha information, the output is affected even if you've selected None from the Modify menu. Using this method, you can adjust the levels of just the alpha channel without also changing the RGB information.

Change Empty Pixels The Colorama effect's influence extends to transparent pixels. (This setting works only if Modify Alpha is selected.)

Pixel Selection, Masking, and other controls

These controls determine which pixels are affected. For the Matching controls for Pixel Selection to work, Matching Mode must be set to anything other than Off.

Matching Color The center of the range of colors of pixels to be affected by the Colorama effect. To select a specific color in the image using the eyedropper, turn off the Colorama effect temporarily by clicking its Effect switch  in the Effect Controls panel.

Matching Tolerance How far a color can be from Matching Color and still be affected by the Colorama effect. When Matching Tolerance is 0, only the exact color selected for Matching Color is affected by Colorama. When Matching Tolerance is 1, all colors are matched; this value essentially turns Matching Mode off.

Matching Softness How smoothly the matched pixels blend into the rest of the image. For example, if you have an image of a man wearing a red shirt and blue pants, and you want to change the color of the pants from blue to red, subtly adjust Matching Softness to spread the matching from the blue in the pants into the shadows of the pants folds. If you adjust it too high, the matching spreads to the blue of the sky; if you adjust it even higher, the matching spreads to his red shirt.

Matching Mode What color attributes are compared to determine matching. In general, use RGB for high-contrast graphics and Chroma for photographic images.

Mask Layer The layer to use as a matte. Masking Mode specifies what attribute of the Mask Layer is used to define the matte.

Composite Over Layer Shows modified pixels composited on top of the original layer. Deselect this option to show only modified pixels.

Blend With Original The effect's transparency. The result of the effect is blended with the original image, with the effect result composited on top. The higher you set this value, the less the effect affects the layer. For example, if you set this value to 100%, the effect has no visible result on the layer; if you set this value to 0%, the original image doesn't show through.

Curves effect

The Curves effect adjusts the tonal range of an image. You can also use the Levels effect, but the Curves effect gives you more control. With the Levels effect you make the adjustments using just three controls (highlights, shadows, and midtones), but with the Curves effect you can arbitrarily map input values to output values using a curve defined by 256 points.



You can load and save arbitrary maps and curves to use with the Curves effect.

This effect works with 8-bpc, 16-bpc, and 32-bpc color.



When you apply the Curves effect, After Effects displays a graph in the Effect Controls panel that you use to specify a curve. The horizontal axis of the graph represents the original brightness values of the pixels (input levels); the vertical axis represents the new brightness values (output levels). In the default diagonal line, all pixels have identical input and output values. Curves displays brightness values from 0 to 255 (8 bit) or 32768 (16 bit), with shadows (0) on the left.

John Dickinson provides visual aids on his website that illustrate how to use the Curves effect for color adjustments: www.adobe.com/go/learn_ae_jdcurves.

Use the Curves effect

- 1 Choose Effect > Color Correction > Curves.
- 2 If the image has more than one color channel, choose the channel you want to adjust from the Channel menu. RGB alters all channels using a single curve.
- 3 Use the Bezier tool and the Pencil tool to modify or draw a curve. (To activate a tool, click the Bezier button  or the Pencil button .)



To smooth the curve, click the Smooth  button. To reset the curve to a line, click the Line  button.

The curve type is determined by the last tool used to modify it. You can save arbitrary map curves modified by the Pencil tool as .amp (Photoshop lookup) files. You can save curves modified by the Bezier tool as .acv (Photoshop spline) files.

Equalize effect

The Equalize effect alters an image's pixel values to produce a more consistent brightness or color component distribution. The effect works similarly to the Equalize command in Adobe Photoshop. Pixels with 0 alpha (completely transparent) values aren't considered, so masked layers are equalized based on the mask area.

This effect works with 8-bpc color.

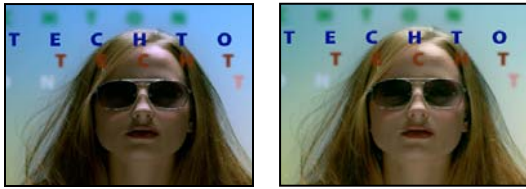

Original (left), and with effect applied (right)

Equalize RGB equalizes the image based on red, green, and blue components. Brightness equalizes the image based on the brightness of each pixel. Photoshop Style equalizes by redistributing the brightness values of the pixels in an image so that they more evenly represent the entire range of brightness levels.

Amount To Equalize How much to redistribute the brightness values. At 100%, the pixel values are spread as evenly as possible; lower percentages redistribute fewer pixel values.

Exposure effect

Use the Exposure effect to make tonal adjustments to footage, either one channel at a time or all channels at once. The Exposure effect simulates the result of modifying the exposure setting (in f-stops) of the camera that captured the image. The Exposure effect works by performing calculations in a linear color space, rather than in the image's current color space. The Exposure effect is designed for making tonal adjustments to high-dynamic range (HDR) images with 32-bpc color, but you can use the effect on 8-bpc and 16-bpc images.

This effect works with 8-bpc, 16-bpc, and 32-bpc color.

Master Adjust all channels simultaneously.

Individual Channels Adjust channels individually.

Exposure Simulates the exposure setting on the camera that captures the image, multiplying all light intensity values by a constant. The units for Exposure are f-stops.

Offset Darkens or brightens the shadows and midtones with minimal change to the highlights.

Gamma Correction The amount of gamma correction to use for adding an additional power-curve adjustment to the image. Higher values make the image lighter; lower values make the image darker. Negative values are mirrored around zero (that is, they remain negative but still get adjusted as if they were positive). The default value is 1.0, which corresponds to no additional adjustment.

Note: In previous versions of After Effects, the Gamma Correction property was the Gamma property, and its behavior was reversed.

Bypass Linear Light Conversion Select to apply the Exposure effect to the raw pixel values. This option can be useful if you manage color manually using the Color Profile Converter effect.

See also

“Adjust exposure for previews” on page 129

“High dynamic range color” on page 235

Gamma/Pedestal/Gain effect

The Gamma/Pedestal/Gain effect adjusts the response curve independently for each channel. For pedestal and gain, a value of 0.0 is completely off, and a value of 1.0 is completely on.

The Black Stretch control remaps the low pixel values of all channels. Large Black Stretch values brighten dark areas. Gamma specifies an exponent describing the shape of the intermediate curve. The Pedestal and Gain controls specify the lowest and highest attainable output value for a channel.

This effect works with 8-bpc color.

Hue/Saturation effect

The Hue/Saturation effect adjusts the hue, saturation, and lightness of individual color components in an image. This effect is based on the color wheel. Adjusting the hue, or color, represents a move around the color wheel. Adjusting the saturation, or purity of the color, represents a move across its radius. Use the Colorize control to add color to a grayscale image converted to RGB, or to add color to an RGB image.

This effect works with 8-bpc, 16-bpc, and 32-bpc color.

Channel Control The color channel you want to adjust. Choose Master to adjust all colors at once.

Channel Range The definition of the color channel chosen from the Channel Control menu. Two color bars represent the colors in their order on the color wheel. The upper color bar shows the color before the adjustment; the lower bar shows how the adjustment affects all of the hues at full saturation. Use the adjustment slider to edit any range of hues.

Master Hue Specifies the overall hue of the channel chosen from the Channel Control menu. Use the dial, which represents the color wheel, to change the overall hue. The underlined value displayed above the dial reflects the number of degrees of rotation around the wheel from the pixel's original color. A positive value indicates clockwise rotation; a negative value indicates counterclockwise rotation. Values range from -180 to $+180$.

Master Saturation, Master Lightness Specify the overall saturation and lightness of the channel chosen from the Channel Control menu. Values range from -100 to $+100$.

Colorize Adds color to a grayscale image converted to RGB, or adds color to an RGB image—for example, to make it look like a duotone image by reducing its color values to one hue.

Colorize Hue, Colorize Saturation, Colorize Lightness Specify the hue, saturation, and lightness of the color range chosen from the Channel Control menu. After Effects displays only the sliders for the Channel Control menu choice.

Adjust colors with the Hue/Saturation effect

- 1 Choose Effect > Color Correction > Hue/Saturation.
- 2 From the Channel Control menu, choose which colors to adjust:
 - Choose Master to adjust all colors at once.
 - Choose a preset color range for the color you want to adjust, and then use the sliders for that color range.
- 3 For Hue, type a value or drag the dial.
- 4 For Saturation, type a value or drag the slider. The color shifts away from or toward the center of the color wheel, relative to the beginning color values of the selected pixels.
- 5 For Lightness, type a value or drag the slider.

Colorize an image or create a monotone result

- 1 Choose Effect > Color Correction > Hue/Saturation.
- 2 Select Colorize. The image is converted to the hue of the current foreground color. The lightness value of each pixel doesn't change.

- 3 Drag the Colorize Hue dial to select a new color if desired.
- 4 Drag the Colorize Saturation and Colorize Lightness sliders.

Modify the range of Hue/Saturation effect adjustments

- 1 From the Channel Control menu, choose an individual color. (By default, the range of color selected when you choose a color component is 30° wide, with 30° of fall-off on either side. Setting the fall-off too low can produce dithering in the image.)
- 2 Do any of the following:
 - Drag one or both of the white triangles to adjust the amount of feather without affecting the range.
 - Drag one or both of the vertical white bars to adjust the range. Increasing the range decreases the fall-off, and vice versa.

Leave Color effect

The Leave Color effect removes all colors from a layer except those similar to the Color To Leave. For example, a movie of a basketball game could be decolorized except for the orange of the ball itself.

This effect works with 8-bpc color.

Amount To Decolor How much color to remove. 100% causes areas of the image dissimilar to the selected color to appear as shades of gray.

Tolerance The flexibility of the color-matching operation. 0% decolors all pixels except those that exactly match Color To Leave. 100% causes no color change.

Edge Softness The softness of the color boundaries. High values smooth the transition from color to gray.

Match Colors Determines whether colors' RGB values or HSB values are compared. Choose Using RGB to perform more strict matching that usually decolors more of the image. For example, to leave dark blue, light blue, and medium blue, choose Using HSB and choose any shade of blue as Color To Leave.

Levels effect

The Levels effect remaps the range of input color levels onto a new range of output color levels, with a distribution of color values determined by the gamma value. This effect functions much the same as the Levels adjustment in Photoshop.

This effect works with 8-bpc, 16-bpc, and 32-bpc color.

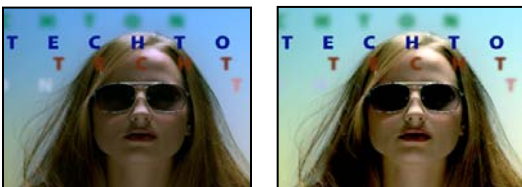

Original (left), and with effect applied (right)

John Dickinson provides visual aids on his website that illustrate how to use the Levels effect for color adjustments: www.adobe.com/go/learn_ae_jdlevels.

Channel The color channels to be modified.

Histogram Shows number of pixels with each luminance value in an image.

Input Black and Output Black Pixels in the input image with a luminance value equal to the Input Black value are given the Output Black value as their new luminance value. The Input Black value is represented by the upper left triangle below the histogram. The Output Black value is represented by the lower left triangle below the histogram.

Input White and Output White Pixels in the input image with a luminance value equal to the Input White value are given the Output White value as their new luminance value. The Input White value is represented by the upper right triangle below the histogram. The Output White value is represented by the lower right triangle below the histogram.

Gamma The exponent of the power curve that determines the distribution of luminance values in the output image. The Gamma value is represented by the middle triangle below the histogram.

Clip To Output Black and Clip To Output White These controls determine the results for pixels with luminance values that are less than the Input Black value or greater than the Input White value. If clipping is on, pixels with luminance values less than the Input Black value are mapped to the Output Black value; pixels with luminance values above the Input White value are mapped to the Output White value. If clipping is off, the resulting pixel values can be less than the Output Black value or greater than the Output White value and are affected by the Gamma value.

Levels (Individual Controls) effect

The Levels (Individual Controls) effect functions like the Levels effect but allows you to adjust the individual color values for each channel. As a result, you can add expressions to individual properties or animate one property independently of the others. To see each control individually, click the arrow next to the channel color to expand it.

This effect works with 8-bpc, 16-bpc, and 32-bpc color.

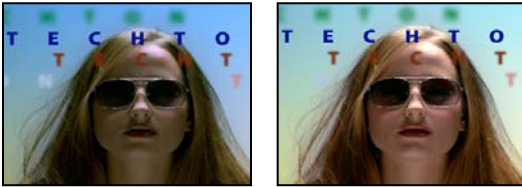

Original (left), and with effect applied (right)

See also

“Levels effect” on page 399

Photo Filter effect

The Photo Filter effect mimics the technique of putting a colored filter in front of the camera lens to adjust the color balance and color temperature of the light transmitted through the lens and exposing the film. You can choose a color preset to apply a hue adjustment to an image, or you can specify a custom color using the Adobe Color Picker or the eyedropper.

You can use the Photo Filter effect controls to do the following:

- To use a color preset for the filter color, choose an option from the Filter pop-up menu.
- To select a custom color for the filter color, click the Color control's color swatch to select a color using the Adobe Color Picker, or click the eyedropper and click a color anywhere on the computer screen.
- To set the amount of color applied to the image, adjust Density.
- To ensure that the image isn't darkened by the effect, select Preserve Luminosity.

 To retain Photo Filter adjustment layers created in Photoshop, import the Photoshop file into your After Effects project as a composition rather than as footage. If you changed your default Photoshop color settings, After Effects may not be able to exactly match the color of the Photo Filter.

This effect works with 8-bpc and 16-bpc color.

Warming Filter (85) and Cooling Filter (80) Color conversion filters that tune the white balance in an image. If an image was photographed with a lower color temperature of light (yellowish), the Cooling Filter (80) makes the image colors bluer to compensate for the lower color temperature of the ambient light. Conversely, if the photo was taken with a higher color temperature of light (bluish), the Warming Filter (85) makes the image colors warmer to compensate for the higher color temperature of the ambient light.

Warming Filter (81) and Cooling Filter (82) Light balancing filters for minor adjustments in the color quality of an image. The Warming Filter (81) makes the image warmer (yellower), and the Cooling Filter (82) makes the image cooler (bluer).

Individual Colors Apply a hue adjustment to the image depending on the color preset you choose. Your choice of color depends on how you use the Photo Filter command. If a photo has a color cast, you can choose a complement color to neutralize the color cast. You can also apply colors for special color effects or enhancements. For example, the Underwater color simulates the greenish-blue color cast common to underwater photography.

PS Arbitrary Map effect

The PS Arbitrary Map effect is intended only to provide compatibility with projects created in earlier versions of After Effects that use the Arbitrary Map effect. For new work, use the Curves effect.

The PS Arbitrary Map effect applies a Photoshop arbitrary map file to a layer. An arbitrary map adjusts the brightness levels of an image, remapping a specified brightness range to darker or brighter tones. In the Curves window in Photoshop, you can create an arbitrary map file for the entire image or for individual channels.

This effect works with 8-bpc and 16-bpc color.

You can import and apply an arbitrary map file with Options in the Effect Controls panel. When loaded into After Effects, the specified arbitrary map is applied to the layer or to one or more channels of the layer, depending on how it was created. If you don't select an arbitrary map, After Effects applies the default map (linear distribution of brightness) to the layer. Although you can't import .acv or Photoshop spline files into the After Effects PS Arbitrary Map effect, you can convert these files in Photoshop to create files that are compatible with the After Effects Curves effect.

 To convert .acv and Photoshop spline files, load the .acv file (Windows) or the Photoshop spline file (Mac OS) in the Curves dialog box, click the Pencil tool, and then save the file as an .amp file (Windows) or Photoshop lookup file (Mac OS).

Phase Cycles through the arbitrary map. Increasing the phase shifts the arbitrary map to the right (as viewed in the Curves dialog box); decreasing the phase shifts the map to the left.

Apply Phase Map To Alpha Applies the specified map and phase to the layer's alpha channel. If the specified map doesn't include an alpha channel, After Effects uses the default map (linear distribution of brightness) for the alpha channel.

See also

"Curves effect" on page 396

Shadow/Highlight effect

The Shadow/Highlight effect brightens shadowed subjects in an image and reduces the highlights in an image. This effect doesn't darken or lighten an entire image; it adjusts the shadows and highlights independently, based on the surrounding pixels. You can also adjust the overall contrast of an image. The default settings are for fixing images with backlighting problems.

This effect works with 8-bpc and 16-bpc color.



Original (left), and with effect applied (right)

Auto Amounts If this option is selected, the Shadow Amount and Highlight Amount values are ignored, and amounts are used that are automatically determined to be appropriate for lightening and restoring detail to the shadows. Selecting this option also activates the Temporal Smoothing control.

Shadow Amount The amount to lighten shadows in the image. This control is active only if you deselect Auto Amounts.

Highlight Amount The amount to darken highlights in the image. This control is active only if you deselect Auto Amounts.

Temporal Smoothing The range of adjacent frames, in seconds, analyzed to determine the amount of correction needed for each frame, relative to its surrounding frames. If Temporal Smoothing is 0, each frame is analyzed independently, without regard for surrounding frames. Temporal Smoothing can result in smoother-looking corrections over time.

Scene Detect If this option is selected, frames beyond a scene change are ignored when surrounding frames are analyzed for temporal smoothing.

Blend With Original The effect's transparency. The result of the effect is blended with the original image, with the effect result composited on top. The higher you set this value, the less the effect affects the clip. For example, if you set this value to 100%, the effect has no visible result on the clip; if you set this value to 0%, the original image doesn't show through.

Expand the More Options category to reveal the following controls:

Shadow Tonal Width and Highlight Tonal Width The range of adjustable tones in the shadows and highlights. Lower values restrict the adjustable range to only the darkest and lightest regions, respectively. Higher values expand the adjustable range. These controls are useful for isolating regions to adjust. For example, to lighten a dark area without affecting the midtones, set a low Shadow Tonal Width value so that when you adjust the Shadow Amount, you're lightening only the darkest areas of an image. Specifying a value that is too large for a given image might introduce halos around strong dark to light edges. The default settings attempt to reduce these artifacts. These halos may occur if the Shadow or Highlight Amount value is too large; they can also be reduced by decreasing these values.

Shadow Radius and Highlight Radius The radius (in pixels) of the area around a pixel that the effect uses to determine whether the pixel resides in a shadow or a highlight. Generally, this value should roughly equal the size of the subject of interest in the image.

Color Correction The amount of color correction that the effect applies to the adjusted shadows and highlights. For example, if you increase the Shadow Amount value, you bring out colors that were dark in the original image; you

may want these colors to be more vivid. The higher the Color Correction value, the more saturated these colors become. The more significant the correction that you make to the shadows and highlights, the greater the range of color correction available.

Note: If you want to change the color over the whole image, use the Hue/Saturation effect after applying the Shadow/Highlight effect.

Midtone Contrast The amount of contrast that the effect applies to the midtones. Higher values increase the contrast in the midtones alone, while concurrently darkening the shadows and lightening the highlights. A negative value reduces contrast.

Black Clip, White Clip How much of the shadows and highlights are clipped to the new extreme shadow and highlight colors in the image. Note that setting the clipping values too high reduces detail in the shadows or highlights. A value between 0.0% and 1% is recommended. By default, shadow and highlight pixels are clipped by 0.1%—that is, the first 0.1% of either extreme is ignored when identifying the darkest and lightest pixels in the image, which are then mapped to output black and output white. This method ensures that input black and input white values are based on representative rather than extreme pixel values.

Tint effect

The Tint effect tints a layer by replacing each pixel's color values with a value between the colors specified by Map Black To and Map White To. Pixels with luminance values between black and white are assigned intermediate values. Amount To Tint specifies the intensity of the effect.

For more complex tinting, use the Colorama effect.

This effect works with 8-bpc, 16-bpc, and 32-bpc color.

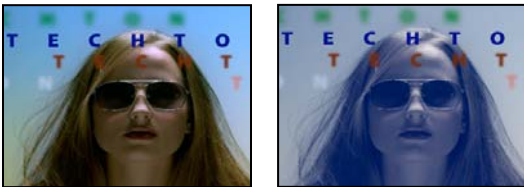

Original (left), and with effect applied (right)

See also

“Colorama effect” on page 393

Tritone effect

The Tritone effect alters a layer's color information by mapping bright, dark, and midtone pixels to colors you select. It's like the Tint effect, except with midtone control.

This effect works with 8-bpc, 16-bpc, and 32-bpc color.

Blend With Original The effect's transparency. The result of the effect is blended with the original image, with the effect result composited on top. The higher you set this value, the less the effect affects the layer. For example, if you set this value to 100%, the effect has no visible result on the layer; if you set this value to 0%, the original image doesn't show through.

Distort effects

Zaxwerks provides a set of 3D Warps effect plug-ins, which can be used to distort layers in 3D space:
www.adobe.com/go/learn_ae_zax3dwarps.

Bezier Warp effect

The Bezier Warp effect shapes an image using a closed Bezier curve along the boundary of a layer. The curve consists of four segments. Each segment has three points (a vertex and two tangents).

This effect works with 8-bpc and 16-bpc color.

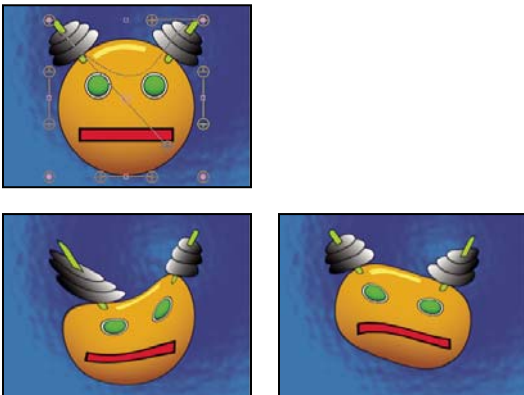

Original (top left) and with variations of Bezier Warp applied (bottom left and right)

The positions of the vertices and tangents determine the size and shape of a curved segment. Dragging these points reshapes the curves that form the edge, thus distorting the image. For example, you can use Bezier Warp to reshape one image to fit another, as in wrapping a label around a jar. Bezier Warp is also useful for correcting lens aberrations, such as the fisheye effect (barrel distortion) that can occur with a wide-angle lens; using Bezier Warp, you can bend the image back to achieve an undistorted look. By animating the effect and choosing a high quality setting, you can create fluid visual effects, such as a jiggling gelatin dessert or a fluttering flag.

Bulge effect

The Bulge effect distorts an image around a specified point, making the image appear to bulge toward or away from the viewer, depending on the options you select.

This effect works with 8-bpc and 16-bpc color.

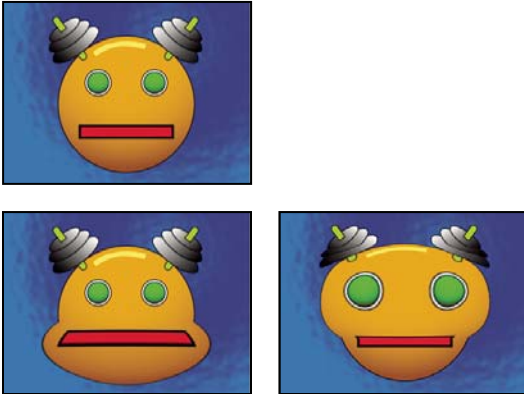

Original (top left), and with variations of Bulge applied (bottom left and right)

Horizontal Radius and Vertical Radius The width and height of the distorted area, in pixels. You can also set the radius values by dragging the selection handles in the layer.

Bulge Height The apparent depth of the bulge. Positive values push the bulge toward the viewer. Negative values pull the bulge away from the viewer.

Taper Radius The shallowness of the sides of the bulge. A taper radius of 0 produces a steep, pronounced bulge.

Antialiasing The amount of edge smoothing (blending of colors) at the boundaries of the bulge. Anti-aliasing is applied only when the layer quality is set to Best.

Pin All Edges Prevents the edges of the layer from bulging.

Corner Pin effect

The Corner Pin effect distorts an image by repositioning each of its four corners. Use it to stretch, shrink, skew, or twist an image or to simulate perspective or movement that pivots from the edge of a layer, such as a door opening. You can also use it to attach a layer to a moving rectangular region tracked by the motion tracker. You can move the corner pins in the Composition panel, the Timeline panel, or the Effect Controls panel.

This effect works with 8-bpc, 16-bpc, and 32-bpc color.

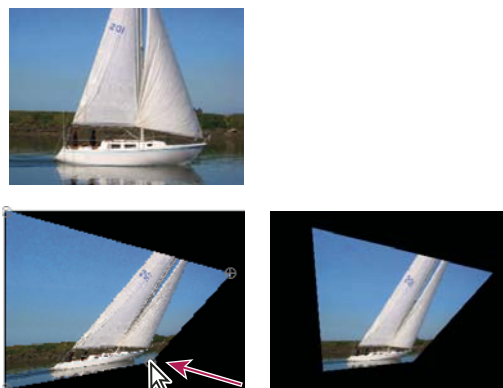

Original image (top left), corner moved (bottom left), and final image (bottom right)

This post on the AE Enhancers forum describes and links to an animation preset from Donat van Bellinghen for scaling a set of Corner Pin effect points: www.adobe.com/go/learn_ae_donatscalecornerpin.

Displacement Map effect

The Displacement Map effect distorts a layer by displacing pixels horizontally and vertically based on the color values of pixels in the control layer specified by the Displacement Map Layer property. The type of distortion created by the Displacement Map effect can vary greatly, depending on the control layer and options you select.

This effect works with 8-bpc, 16-bpc, and 32-bpc color.

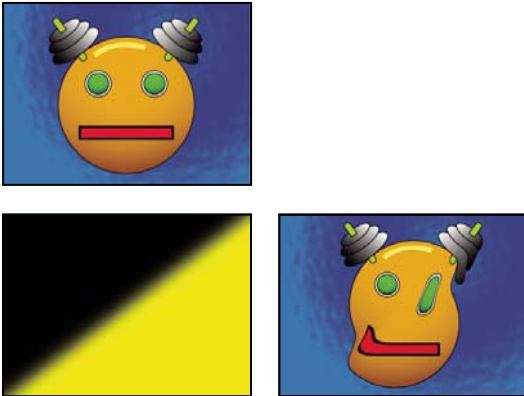

Original (top left), displacement map (bottom left), and displaced image (bottom right)

The displacement is determined from the color values of the displacement map. The color values range from 0 to 255. Each value is converted into a scale ranging from -1 to 1. The displacement amount is calculated by multiplying the converted value by the maximum displacement amount you specify. A color value of 0 produces maximum negative displacement ($-1 * \text{maximum displacement}$). A color value of 255 produces maximum positive displacement. A color value of 128 produces no displacement.

The effect uses the control layer specified by Displacement Map Layer, without considering any effects or masks. If you want to use the control layer with its effects, precompose it. If the control layer isn't the same size as the layer to which the effect is applied, it is centered, stretched, or tiled depending on the setting for Displacement Map Behavior.

Select Expand Output to allow the results of the effect to extend beyond the original boundaries of the layer to which it's applied. Select Wrap Pixels Around to copy pixels displaced outside of the original layer boundaries to the opposite side of the layer; that is, pixels pushed off the right side appear on the left side, and so on.

Rick Gerard provides additional explanation and an example project for the Displacement Map effect on his website: www.adobe.com/go/learn_ae_rickdisplacementmap.

Liquify effect

The Liquify effect lets you push, pull, rotate, enlarge and shrink areas in a layer. Several Liquify tools distort the brush area when you hold down the mouse button or drag. The distortion is concentrated at the center of the brush area, and the effect intensifies as you hold down the mouse button or repeatedly drag over an area.

You can limit the area of a layer you distort by using Freeze Area Mask. Use the Reconstruction mode to lessen or undo distortions you've created.

The Liquify effect can extend beyond the boundaries of the target layer. This extension is useful when the target layer is smaller than the composition.

This effect works with 8-bpc and 16-bpc color.

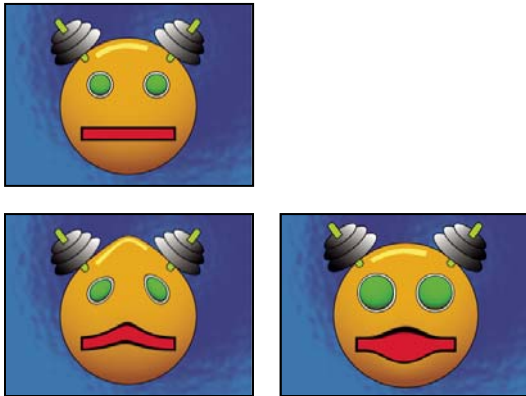

Original (top left), and with variations of Liquify applied (bottom left and right)

Mask properties

Freeze Area Mask Determines the area of the image in which the distortion is affected by mask opacity and feather settings. Areas outside the mask are distorted; areas within the mask are distorted according to Mask Opacity and Mask Feather settings.

Mask Opacity Determines how the area within the mask is affected by the distortion. If Mask Opacity is set to 100%, the area within the mask isn't affected by the distortion; if it's set to 50%, the area within the mask is somewhat affected. If you set Mask Opacity to 100%, make sure to feather the mask to prevent jagged edges on the mask.

Mask Feather The width of the feather used to blend pixels between the masked area and the nonmasked area.

Tools

Warp  Pushes pixels forward as you drag.

Turbulence  Smoothly scrambles pixels. This setting is useful for creating fire, clouds, waves, and similar effects.

Twirl Clockwise  Rotates pixels clockwise as you hold down the mouse button or drag.

Twirl Counterclockwise  Rotates pixels counterclockwise as you hold down the mouse button or drag.

Pucker  Moves pixels toward the center of the brush area as you hold down the mouse button or drag.

Bloat  Moves pixels away from the center of the brush area as you hold down the mouse button or drag.

Shift Pixels  Moves pixels perpendicular to the stroke direction.

Reflection  Copies pixels to the brush area.

Clone  Copies the distortions from around a source location to the current mouse location. Set the source location by Alt-clicking (Windows) or Option-clicking (Mac OS) the source point.

Reconstruction  Reverses distortions or applies them in different ways.

Distort an image with the Liquify effect

- 1 Select the layer, and choose Effect > Distort > Liquify.
- 2 In the Layer panel, create a mask to freeze areas of the image, and then set mask properties.
- 3 In the Effect Controls panel do the following:
 - Choose the mask you created from the Freeze Area Mask pop-up menu.

- Specify a brush size and brush pressure. A low brush pressure makes changes occur more slowly, so it's easier to stop them at exactly the right moment.
 - Specify a turbulent jitter to control how tightly the Turbulence tool scrambles pixels.
 - Select View Mesh under the View Options control.
 - Set a distortion mesh offset if desired.
 - Drag the Distortion Percentage slider to specify the amount of distortion.
- 4 Use the tools to distort the preview of the image.
 - 5 Use the Reconstruction tool  to fully or partially reverse the distortions or to change the image in new ways.

Undo distortions with the Liquify effect

Use the Reconstruction tool and its modes to reverse distortions or redo them in new ways.

- 1 Select the Reconstruction tool, and then choose a mode from the Reconstruction Mode pop-up menu:

Revert Changes unfrozen areas back to their predistorted state.

Displace Reconstructs unfrozen areas to match the displacement at the starting point for the reconstruction. You can use Displace to move all or part of the preview image to a different location.

Amplitwist Reconstructs unfrozen areas to match the displacement, rotation, and overall scaling that exist at the starting point.

Affine Reconstructs unfrozen areas to match all local distortions that exist at the starting point, including displacement, rotation, horizontal and vertical scaling, and skew.

- 2 Drag the area to restore. The restoration occurs more quickly at the brush center.

Magnify effect

The Magnify effect enlarges all or part of an image. This effect can act like a magnifying glass placed over an area of the image, or you can use it to scale the entire image far beyond 100% while maintaining resolution.

This effect works with 8-bpc color.

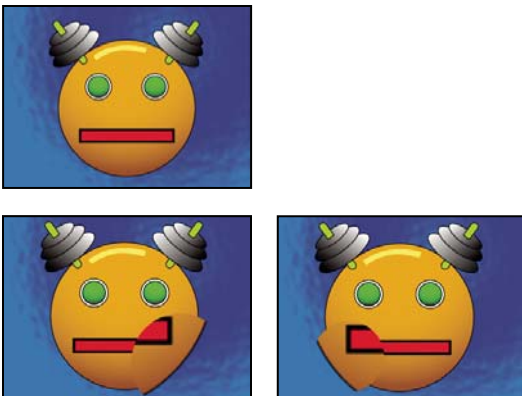

Original (top left), and with variations of Magnify applied (bottom left and right)

Shape The shape of the magnified area.

Center The center point of the magnified area.

Magnification Percentage by which to scale the magnified area.

Link How the size and edge feathering of the magnified area are affected by the Magnification setting. Setting Link to any value other than None disables the Resize Layer option.

- **None** The size and edge feathering of the magnified area don't depend on the Magnification setting.
- **Size To Magnification** The radius of the magnified area is equal to the Magnification value (a percentage) times the Size value.
- **Size & Feather To Magnification** The radius of the magnified area is equal to the Magnification value (a percentage) times the Size value. The thickness of the edge feather is equal to the Magnification value times the Feather value.

Size The radius of the magnified area, in pixels.

Feather The amount of edge feather, in pixels.

Opacity The opacity of the magnified area, as a percentage of the opacity of the original layer.

Scaling The type of scaling used to magnify the image:

- **Standard** This method maintains sharpness in the image but produces pixelated edges at higher values.
- **Soft** Uses spline algorithms. If you scale the image beyond 100%, Soft reduces edge pixelation and maintains image quality. Soft works well at large magnification amounts.
- **Scatter** Creates scatter or noise in the image as the image enlarges.

Blending Mode The blending mode used to combine the magnified area with the original layer. The None option displays transparent pixels around the magnified area.

Resize Layer If Resize Layer is selected, the magnified area can extend beyond the original layer's boundaries.

Mesh Warp effect

The Mesh Warp effect applies a grid of Bezier patches over a layer, which you can manipulate to distort areas of an image. Each corner of a patch includes a vertex and two to four tangents (points that control the curvature of the line segment that makes up the edge of the patch). The number of tangents depends on whether the vertex is in a corner, on an edge, or inside the grid. By moving the vertices and tangents, you can manipulate the shape of the curved line segment. The finer the grid, the tighter the adjustments you can make to the area of the image inside the patch.

This effect works with 8-bpc and 16-bpc color.

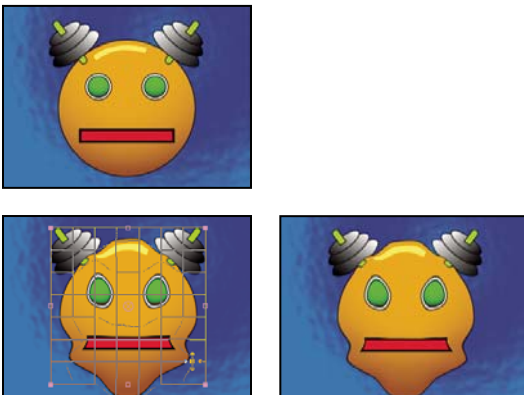

Original (top left), with distortion mesh (bottom left), and with Mesh Warp applied (bottom right)

 To select multiple vertices, Shift-click the vertices.

Rows, Columns Specify up to 31 patches vertically (Rows) or horizontally (Columns). For broader distortion, use fewer patches. For finer control, use more. Drag the vertices and tangents to change the grid shape. The image follows the grid shape according to the elasticity setting and the boundary created by the adjacent patch.

Quality Specifies how closely the image follows the shape defined by the curve. The higher the quality value, the more closely the image follows the shape. Higher quality settings require more rendering time.

Distortion Mesh Click the stopwatch to animate the distortion over time.

Note: Each patch becomes a boundary for the distortion. For example, when you stretch a patch, the area of the image in the patch stretches, squishing the area of the image in the adjacent patch. The boundary of the adjacent patch protects the image inside it from being squished to zero. In other words, you can't push an image out of its patch.

Mirror effect

The Mirror effect splits the image along a line and reflects one side onto the other.

Reflection Center The position of the line about which the reflection occurs.

Reflection Angle The angle of the line about which the reflection occurs. An angle of 0° reflects the left side onto the right. An angle of 90° reflects the top onto the bottom.

This effect works with 8-bpc and 16-bpc color.

Offset effect

The Offset effect pans the image within a layer. Visual information pushed off one side of the image appears on the opposite side. One use of the Offset effect is to create a looping background from a layer. At Best quality, the offset is performed with subpixel precision.

Lloyd Alvarez provides a simple expression for the Offset effect to simulate a poorly timed film projector:
www.adobe.com/go/learn_ae_lloydoffsetprojector.

Shift Center To The new position of the original image's center point.

Blend With Original The effect's transparency. The result of the effect is blended with the original image, with the effect result composited on top. The higher you set this value, the less the effect affects the layer. For example, if you set this value to 100%, the effect has no visible result on the layer; if you set this value to 0%, the original image doesn't show through.

This effect works with 8-bpc and 16-bpc color.

Optics Compensation effect

Use the Optics Compensation effect to add or remove camera lens distortion. Elements composited with mismatched lens distortion cause anomalies in the animation. For example, tracked objects in a distorted scene don't match the scene area because linear objects don't follow the distortion of the scene.

This effect works with 8-bpc, 16-bpc, and 32-bpc color.

Field Of View (FOV) The *field of view (FOV)* of the distorted footage. The FOV is relative to the size of the source layer and the selected FOV Orientation. The distortion amount is relative to FOV. There is no general rule as to what FOV value applies to different lenses. Zooming in reduces the FOV, and zooming out increases it. Consequently, if footage includes different zoom values, you'll need to animate the FOV value.

Reverse Lens Distortion Reverses the lens distortion. For example, to remove wide-angle lens distortion, set Field Of View to 40.0 and select Reverse Lens Distortion. Selecting Reverse Lens Distortion enables the Resize control.

FOV Orientation The axis on which the Field Of View value is based. This setting is useful when matching computer-generated elements to the rendered view angle.

View Center Specifies an alternate center point of view. This setting is useful when using custom lenses that aren't centered. However, in most cases, this control should be left untouched.

Optimal Pixels Maintains as much pixel information as possible through the distortion. When selected, FOV values are no longer reversible.

Resize Resizes the layer when the applied distortion stretches the layer beyond its boundaries. To use this control, first select Reverse Lens Distortion, and then choose an option. Off doesn't resize the layer. Max 2X resizes the layer to a maximum of twice the original width and height. Max 4X resizes the layer to a maximum of four times the original width and height. Unlimited resizes the layer as far as it is stretched. This option may require a large amount of memory.

Add and match lens distortion with Optics Compensation

To match FOV values, layers must be the same size. However, if you select Resize, you can apply Optics Compensation again and reverse the distortion using the same value (reversed). You can then apply another effect between the two instances of Optics Compensation.

If you resize a layer using Optics Compensation and then precompose it into a larger composition, you cannot reverse the distortion using the same value until you enlarge the precomposed layer to accommodate the expanded layer.

- 1 Select the layer with the distortion, and choose Effect > Distort > Optics Compensation.
- 2 In the Effect Controls panel, adjust the FOV until a distorted edge or line appears straight. Note the FOV value.
- 3 Select the computer graphic layer you want to distort, and apply Optics Compensation to it using the FOV value from step 2.
- 4 Select Reverse Lens Distortion.
- 5 Remove Optics Compensation from the footage layer.

Polar Coordinates effect

The Polar Coordinates effect distorts a layer by transposing each pixel in the layer's (x,y) coordinate system to the corresponding position in the polar coordinate system, or the reverse. This effect produces unusual and surprising distortions that can vary greatly depending on the image and the controls you select. The standard coordinate system specifies points by measuring the horizontal distance (x axis) and the vertical distance (y axis) from the origin. Each point is specified as (x,y). The polar coordinate system specifies points by measuring the length of a radius from the origin (r) and its angle from the x axis (θ). Each point is specified as (r, θ).

This effect works with 8-bpc, 16-bpc, and 32-bpc color.

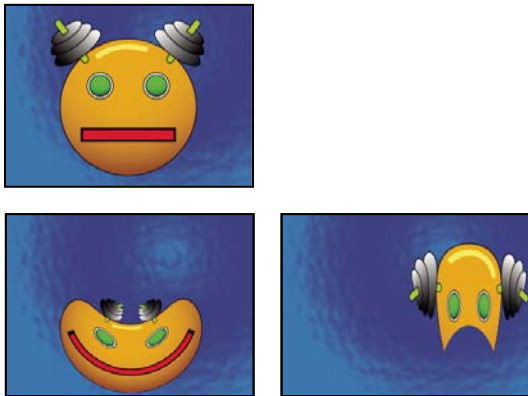

Original (top left), and with variations of Polar Coordinates applied (bottom left and right)

Stu Maschwitz provides an example project that uses the Fractal Noise effect to create the corona of the Sun and then uses the Polar Coordinates effect to wrap the line of noise around into a circle:

www.adobe.com/go/learn_ae_stucorona.

Interpolation Specifies the amount of distortion. At 0%, no distortion occurs.

Type of Conversion The conversion process to use:

- **Rect To Polar** Moves pixels by using (x,y) coordinates from each pixel as (r, θ) coordinates. For example, an (x,y) coordinate of (2,3) becomes a polar coordinate with a radius of 2 and a degree of 3. Horizontal lines distort into circles, and vertical lines into radial lines.
- **Polar To Rect** Moves pixels by using the (r, θ) coordinates from each pixel as the (x,y) coordinates. For example, polar coordinates of radius 10 and 45° become (x,y) coordinates of (10,45).

Puppet effect

Use the Puppet effect to animate distortions of images to produce natural, lifelike motion.

This effect works with 8-bpc, 16-bpc, and 32-bpc color.

See also

“Animating with Puppet tools” on page 226

Reshape effect

The Reshape effect transforms one shape into another shape on the same layer, dragging the underlying image with it. The image is distorted to fit the shape of the new area. You create or import up to three masks to define the area you want to distort: the source mask, the destination mask, and the boundary mask (optional).

This effect works with 8-bpc and 16-bpc color.

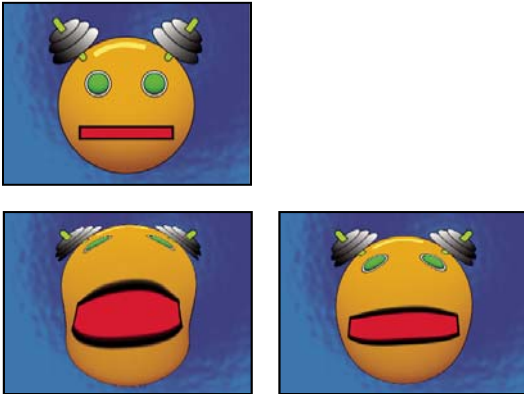

Original including three masks (top left), and with variations of Reshape applied (bottom left and right)

By default, After Effects assigns the masks a function (source, destination, or boundary) based on the order in which you create or import them. You can also specify different masks. Use a closed path for each mask. All three masks must be on the layer to which you apply the Reshape effect, although you can copy masks from another layer.

Source Mask The mask that contains the image area you want to reshape. If not specified, After Effects uses the second mask created as the Source mask. In the Composition and Layer panels, a red outline defines the source mask.

Destination Mask The mask that determines the shape of the final image. If not specified, After Effects uses the third mask created as the Destination mask. In the Composition and Layer panels, a yellow outline defines the destination mask.

Boundary Mask Specifies what part of the image is reshaped. Anything outside the boundary isn't altered. If not specified, After Effects uses the first mask created as the Boundary mask. In the Composition and Layer panels, a blue outline defines the boundary mask.

Percent The amount of reshaping. This value is useful for creating partial distortions that increase over time.

Elasticity Specifies how closely the image follows the shape defined by the curve. Stiff acts like cold rubber, allowing the image to distort the least amount. Super Fluid acts like hot rubber, allowing the image to distort in a fluid fashion. The other settings fall between. The more fluid elasticity settings require more rendering time. If the final image doesn't follow the curve as expected, use the following elasticity guidelines:

- In general, use the stiffest setting possible that doesn't create a polygonal image. Use a higher elasticity setting if the final image looks polygonal but the curves are smooth.
- Use Stiff, Less Stiff, or Below Normal if the source and destination masks are similar in shape and have low curvature (few curved segments that change direction radically).
- Use Normal, Absolutely Normal, or Above Average if the source and destination masks are dissimilar and have mild curvature.
- Use Loose, Liquid, or Super Fluid if the masks are very dissimilar and have extreme curvature.

Correspondence Points Specifies the number of points on the source mask that are associated with, or mapped to, points on the destination mask. These points appear in the Composition panel and control the interpolation of the distortion through space. To control the precision of the effect, you can add, delete, or move the points on either mask. A mask can have an unlimited number of points, but the more points it has, the longer the effect takes to render. If the distortion appears twisted, try adding more correspondence points at distinguishing points along the masks. (If the arc lengths of the curves between correspondence points are too different, twisting may result.)

Interpolation Method Specifies how After Effects determines the distortion of each video or animation frame in the interval between keyframes or if no keyframes exist.

- **Discrete** Requires no keyframes because it calculates the distortion at each frame. Discrete produces the most accurate results but requires more rendering time.
- **Linear** (Default) Requires two or more keyframes and performs a straight-line interpolation between the keyframes. Linear produces steady changes between keyframes and sharp changes at keyframes.
- **Smooth** Requires three or more keyframes and approximates the distortion using cubic curves, producing distortions with graceful motion.

Use the Reshape effect

1 Open the layer in a Layer panel.

2 Create or import the source, destination, and boundary masks into the layer.



Name each mask so that you can easily recognize it in the Mask menu in the Effect Controls panel.

3 In the Timeline panel, choose None from the Mode pop-up menu for each mask.

4 Position the boundary mask to specify the area of the image that will remain unaltered. Areas within the boundary mask will be distorted; areas outside the mask will remain unaltered. Keep the boundary mask as far as possible from the source and destination masks to avoid foldovers.

5 Scale and position the source mask over the image.

6 Scale and position the destination mask to indicate the final shape. Distortions work best if the source and destination masks are in approximately the same location.

7 Make the Composition or Timeline panel active, select the layer, and then choose Effect > Distort > Reshape.

8 From the Mask menus, choose the source, destination, and boundary masks.

9 Adjust the Percent control, and choose an option for Elasticity.

10 In the Composition panel, add, delete, or move correspondence points on the masks to control the distortion:

- To add a point, Alt-click (Windows) or Option-click (Mac OS) the mask.
- To delete a point, Alt-click or Option-click the point.
- To move a point, drag it to a new location.
- To change the interpolation of a pair of points, Shift-click a point. Smooth interpolation works best with round masks, while linear interpolation works best with angular masks. You can combine smooth and linear interpolation in the same composition.

11 Choose an interpolation method, and preview the distortion. If Linear or Smooth produces undesired results, add more keyframes. If Discrete produces undesired results, choose another method.

Ripple effect

The Ripple effect creates the appearance of ripples in a specified layer, moving away from a center point in concentric circles. The effect is similar to dropping a stone in a pond. You can also specify that ripples move toward the center point.

Animate ripples at a constant speed using the Wave Speed control. This control doesn't require keyframes for animation. Animate ripples at varying speeds by creating keyframes for the Ripple Phase control.

This effect works with 8-bpc and 16-bpc color.

Radius Controls the distance the ripples travel from the center point. The Radius value is a percentage of the image size. If the center of the ripple is the center of the layer and the radius is set to 100, the ripples travel to the edge of the image. A value of 0 produces no ripples. Like ripples in water, ripples in the layer become smaller as they travel farther from the center.



To create a single-wave ripple, set Radius to 100, Wave Width between 90 and 100, and Wave Height as desired.

Center Of Ripple Specifies the center of the effect.

Type Of Conversion Specifies how the ripples are created. Asymmetric produces more realistic-looking ripples; asymmetric ripples include lateral motion and produce more distortion. Symmetric produces motion that travels only outward from the center point; symmetric ripples produce less distortion.

Wave Speed Sets the speed at which the ripples travel outward from the center point. When you specify a wave speed, the ripples are automatically animated at a constant speed (without keyframes) across the time range. A negative value makes the ripples move toward the center, and a value of 0 produces no movement. To vary wave speed over time, set this control to 0, and then create a keyframe for the Ripple Phase property of the layer.

Wave Width Specifies the distance, in pixels, between wave peaks. Higher values produce long, undulating ripples, and low values produce many small ripples.

Wave Height Specifies the height of the ripple wave. Taller waves produce greater distortion.

Ripple Phase Specifies the point along the waveform at which a wave cycle begins. The default value of 0° starts the wave at the midpoint of its downward slope; 90° starts it at the lowest point in the trough; 180° starts it at the midpoint of the upward slope, and so on.

Smear effect

Using the Smear effect, you define an area within an image and then move that area to a new location, stretching, or *smearing*, the surrounding part of the image with it. Use masks to define the area you want to distort.

This effect works with 8-bpc and 16-bpc color.

To use Smear, first create or import two masks: the source mask and the boundary mask. You can create masks on the layer in After Effects or use masks created in Adobe Illustrator. To use a mask created in Illustrator, copy the mask and paste it into a layer in After Effects. Masks must be closed to work with Smear; if a mask is an open trace, After Effects closes it when you select it. Both masks must be on the same layer as the footage to which you apply the Smear effect, although you can copy masks from another layer.

When you move the source mask within the image, Smear stretches the portion of the image inside the boundary mask to follow the edges of the source mask. The boundary mask tries to protect the image outside it from being stretched. Both the original position of the source mask (set in the Layer panel) and the offset position of the source mask are displayed in the Composition panel. The first position of the source mask is indicated by a light red outline, and the new position is indicated by a dark outline.

You can animate the position, size, and rotation of the source mask as it moves to its offset position. You can also animate the original position of the source mask in the Layer panel.

Processing can take up to several minutes with certain settings. Computation time increases as the source mask gets closer to the boundary mask. Processing is interrupted when you click a control.

Source Mask Specifies a mask as the source mask. By default, After Effects selects the second mask you create or import for the layer as the source mask.

Note: You must specify both a boundary mask and a source mask to create a distortion.

Boundary Mask Specifies a mask as the boundary mask. By default, After Effects selects the first mask you create or import as the boundary mask.

Mask Offset Specifies a destination position for the source mask. The offset is a position specified by x and y coordinates, which appear to the right of the Offset button. To set an offset location, click the Offset button, and then click the image in the desired location. To set the offset position numerically, type a new value for each axis. When you don't need the precision provided by Mask Offset, you can simply drag the source mask offset in the Composition panel.

Note: Unwanted undulations may occur if the source mask is close to the boundary mask during animation.

Mask Rotation Rotates the source mask around its center point, between 0° and 360°.

Mask Scale Scales the source mask (at its offset position) larger or smaller, in relation to its original position.

Percent Specifies what percentage of the smear is actually performed. For example, when Percent is set to 50%, Smear performs half of the smear you have specified by moving, scaling, and rotating the source mask. This value doesn't affect the location of the original and offset positions of the source mask; it affects only the percentage of the effect that is performed.

Elasticity Specifies how closely the image follows the shape defined by the curve. Stiff distorts the least, while Super Fluid distorts the most. In general, use the stiffest setting possible that doesn't create polygonal images.

Interpolation Method Specifies a method for the interpolation that Smear performs between keyframes. Linear requires two or more keyframes and performs a straight-line interpolation between the keyframes. Discrete produces animations in which the distortions change at keyframes. Smooth requires three or more keyframes and approximates the distortion using cubic curves, producing distortions with graceful motion. If you need further precision in the animation between keyframes, add more keyframes. For example, a distortion representing a 90-degree rotation between two keyframes appears as a folding of the image. To make this distortion more fluid, add a keyframe for every 10°.

Use the Smear effect

- 1 Open the layer in a Layer panel.
- 2 Create or paste the masks to use as the boundary mask and the source mask.
- 3 Position the boundary mask to specify the area of the layer you don't want Smear to affect.
- 4 Scale and position the source mask over the area you want to move.
- 5 Make the Composition panel active, and choose Effect > Distort > Smear.
- 6 Enter a Percent value to specify the amount of smear applied.
- 7 In the Composition panel, move the source mask to its destination position by dragging it or by using the Mask Offset value.
- 8 Use the Mask Rotation control to rotate the source mask, and use the Mask Scale control to scale it.
- 9 Drag the Percent slider as needed, and choose a setting for Elasticity.

Spherize effect

The Spherize effect distorts a layer by wrapping a region of the image onto a sphere. The layer's quality setting influences the Spherize effect. Best quality samples the displaced pixels to subpixel precision; Draft quality samples to the nearest whole pixel.

This effect works with 8-bpc and 16-bpc color.

Transform effect

The Transform effect applies two-dimensional geometric transformations to a layer. This effect supplements the transform properties available for each layer in the Timeline panel. Anchor Point, Position, Rotation, Scale, and Opacity properties function much the same as the layer transform properties in the Timeline panel.

You can specify the shutter angle for motion blur for this layer independently of the composition's shutter angle. (Motion blur must be enabled for the layer and for the composition for this to be relevant.)

Note: This effect is relative to the input layer. Therefore, to make a layer rotate around the upper left corner, open the layer in the Layer panel, choose Transform from the Layer panel menu, and then move the anchor point and the position to the upper left corner.

This effect works with 8-bpc and 16-bpc color.

Skew Skew amount.

Skew Axis The axis about which skew occurs.

See also

“Use motion blur” on page 200

Turbulent Displace effect

The Turbulent Displace effect uses fractal noise to create turbulent distortions in an image. For example, use it to create flowing water, funhouse mirrors, and waving flags.

This effect works with 8-bpc, 16-bpc, and 32-bpc color.

Displacement The type of turbulence used. Turbulent Smoother, Bulge Smoother, and Twist Smoother each perform the same operations as Turbulent, Bulge, and Twist, except that the Smoother options create smoother warps and take longer to render. Vertical Displacement warps the image vertically only. Horizontal Displacement warps the image horizontally only. Cross Displacement warps the image both vertically and horizontally.

Amount Higher values cause more distortion.

Size Higher values cause larger areas of distortion.

Offset (Turbulence) Determines the portion of the fractal shape that is used to create the distortion.

Complexity Determines the level of detail in the turbulence. Lower values cause smoother distortions.

Evolution Animating this setting results in changes of the turbulence over time.

Note: Although the Evolution value is set in units called revolutions, it's important to realize that these revolutions are progressive. The Evolution state continues to progress infinitely at each new value. Use the Cycle Evolution option to return the Evolution setting to its original state at each revolution.

Evolution Options Evolution Options provide controls that render the effect for one short cycle and then loop it for the duration of the layer. Use these controls to prerender turbulence elements into loops, and thus speed up rendering time.

- **Cycle Evolution** Creates a loop that forces the Evolution state to return to its starting point.
- **Cycle** The number of revolutions of the Evolution setting that the fractal cycles through before it repeats. The timing of the Evolution cycles is determined by the amount of time between Evolution keyframes.

Note: The Cycle control affects only the state of the fractal, not geometrics or other controls, so you can get different results with different Size or Offset settings.

- **Random Seed** Specifies a value from which to generate the fractal noise. Animating this property results in flashing from one set of fractal shapes to another within the same fractal type. For smooth transition of the fractal noise, use the Evolution control.

Note: Create new turbulence animations by reusing previously created Evolution cycles and changing only the Random Seed value. Using a new Random Seed value alters the noise pattern without disturbing the Evolution animation.

Pinning Specifies which edges to pin so that the pixels along those edges aren't displaced.

Resize Layer Enables the distorted image to expand past the layer's original bounds.

Create a seamless loop using Turbulent Displace

- 1 Set two keyframes for the Evolution control, using full revolutions only.
- 2 Adjust the time between keyframes, and the number of Evolution revolutions until you're satisfied with the appearance of the displacement.
- 3 Select Cycle Evolution.
- 4 Set a value for Cycle that's evenly divisible by the number of revolutions that you set for Evolution.
- 5 In the Timeline panel, move the current-time indicator to the time where the cycle completes. For example, if the Cycle value is 2, find the frame where the Evolution value is 2 revolutions.
- 6 Move the current-time indicator back one frame, to prevent a duplicate frame in the seamless loop.
- 7 Press the right bracket key (]) to trim the layer Out point to the current time.
- 8 Prerender this layer, and import it into the project.
- 9 Set this prerendered footage item to loop. (See "Loop a footage item" on page 63.)

Note: If you set keyframes for any of the other controls, you must return them to their initial settings at the point on the Timeline panel where the cycle begins to repeat. Otherwise, these properties don't loop.

Twirl effect

The Twirl effect distorts an image by rotating a layer around its center. The image is distorted more sharply in its center than at the edges, causing a whirlpool result at extreme settings. Because distortion in this effect is significant, After Effects uses special anti-aliasing techniques to produce the highest-quality image. As a result, the Twirl effect can be particularly slow to render.

This effect works with 8-bpc, 16-bpc, and 32-bpc color.

Angle How far to twirl the image. Positive angles twirl the image clockwise; negative angles twirl it counterclockwise. For a whirlpool result, animate the angle.

Twirl Radius How far the twirl extends from the twirl center. This value is a percentage of width or height of the layer, whichever is greater. A value of 50, for example, produces a twirl that extends to the edges of the layer.

Warp effect

Use Warp to distort or deform layers. The warp styles work much like the Warp effects in Adobe Illustrator and Warp Text in Adobe Photoshop.

This effect works with 8-bpc and 16-bpc color.

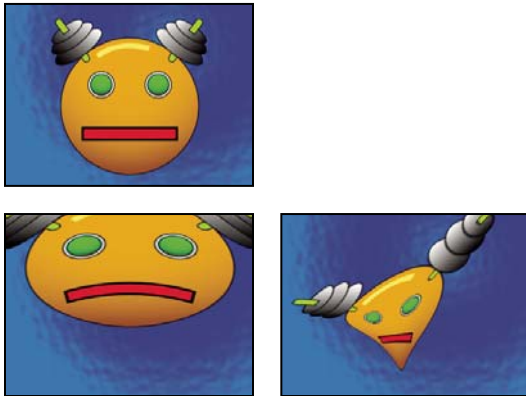

Warping a layer

Wave Warp effect

The Wave Warp effect produces the appearance of a wave traveling across an image. You can produce a variety of different wave shapes, including square, circular, and sine waves. The Wave Warp effect is automatically animated at a constant speed across the time range (without keyframes or expressions). To vary speeds, you need to set keyframes or expressions.

This effect works with 8-bpc and 16-bpc color.

Wave Type The shape of the wave.

Wave Height The distance, in pixels, between wave peaks.

Wave Width The size of the wave in pixels.

Direction The direction the wave travels across the image. For example, a value of 225° makes the waves travel diagonally from upper right to lower left.

Wave Speed The speed (in cycles per second) at which the waves travel. A negative value reverses the wave direction, and a value of 0 produces no movement. To vary wave speed over time, set this control to 0, and then set keyframes or expressions for the Phase property.

Pinning Which edges to pin so that the pixels along those edges aren't displaced.

Phase The point along the waveform at which a wave cycle begins. For example, 0° starts the wave at the midpoint of its downward slope, and 90° starts it at the lowest point in the trough.

Antialiasing Sets the amount of anti-aliasing, or edge smoothing, to perform on the image. In many cases, lower settings produce satisfactory results; a high setting can significantly increase rendering time. Anti-aliasing is performed only if the layer quality setting is Best.

Generate effects

4-Color Gradient effect

The 4-Color Gradient effect produces a four-color gradient. The gradient is defined by four effect points, the positions and colors of which can be animated using the Positions & Colors controls. The gradient is actually composed of four solid-color circles blended together, each with an effect point as its center.

This effect works with 8-bpc and 16-bpc color.

Blend Higher values create more gradual transitions between colors.

Jitter The amount of *jitter* (noise) in the gradient. The jitter, which reduces banding, affects only those areas where banding could occur.

Opacity The opacity of the gradient, as a fraction of the layer's Opacity value.

Blending Mode The blending mode to use in combining the gradient with the layer.

Advanced Lightning effect

The Advanced Lightning effect creates simulations of electrical discharges. Unlike the Lightning effect, Advanced Lightning doesn't self-animate. Animate the Conductivity State or other properties to animate the lightning.

The Advanced Lightning effect includes the Alpha Obstacle feature, with which you can make the lightning go around designated objects.

This effect works with 8-bpc color.

Lightning Type Specifies the characteristics of the lightning.

Note: The type determines the nature of the Direction/Outer Radius contextual control. In the Breaking type, the branches are focused toward the Direction point as the distance between Origin and Direction increases.

Origin Specifies the point of origin for the lightning.

Direction, Outer Radius This control changes depending on the Lightning Type:

- **Not In Use** The Direction or Outer Radius control is not available if Lightning Type is Vertical.
- **Outer Radius** Specifies the distance that the lightning travels from its origin. This control is enabled if Omni or Anywhere is selected as the lightning type. Use it to terminate the lightning at a defined distance from the origin.
- **Direction** Specifies the direction that the lightning will travel. This control is enabled if any of the following lightning types are selected: Direction, Strike, Breaking, Bouncy, and Two-Way Strike.

Conductivity State Changes the path of the lightning.

Core Settings These controls adjust various characteristics of the lightning's core.

Glow Settings These controls adjust the lightning's glow.

Note: To disable the glow, set Glow Opacity to 0. This setting can speed up rendering time significantly.

Alpha Obstacle Specifies the influence of the original layer's alpha channel on the path of the lightning. The lightning attempts to wrap itself around opaque areas of the layer's alpha channel, seeing them as an obstacle.

Note: If Alpha Obstacles is set to a value other than 0, it's not always possible to preview the correct result in less than full resolution; full resolution may reveal new obstacles. Be sure to check the result in full resolution before final rendering.

Turbulence Specifies the amount of turbulence in the lightning path. Higher values result in a more complex strike containing more branches and forks, and lower values produce simpler strikes with fewer branches.

Forking Specifies what percentage of a branch is forked. Its value is influenced by Turbulence and Alpha Obstacle settings.

Decay Specifies the amount of continuous decay or dissipation of the lightning strength and influences where the opacity of the forks begins to fade.

Decay Main Core Decays the main core along with its forks.

Composite On Original Composites the lightning with the original layer using the Add blending mode. When deselected, only the lightning is visible.

Complexity Specifies the complexity of the turbulence in the lightning.

Min. Fork Distance Specifies the minimum pixel distance between new forks. Lower values create more forks in the lightning. Higher values result in fewer forks.

Termination Threshold Specifies the level at which a path terminates, based on resistance in the atmosphere and possible alpha collision. At lower values, the path terminates more easily when encountering resistance or alpha obstacles. At higher values, the path more persistently moves around alpha obstacles.

Note: Increasing Turbulence or Complexity values causes resistance to increase in some areas. These areas change as conductivity changes. Increasing the Alpha Obstacle value causes resistance to increase at alpha edges.

Main Core Collision Only Calculates collisions only on the main core. The forks aren't affected. This control is relevant only if you select Alpha Obstacle.

Fractal Type Specifies the type of fractal turbulence used to create the lightning.

Core Drain Specifies the percentage by which the core strength is drained when creating a new fork. Increasing this value reduces the opacity of the core where new forks appear. Because forks draw their strength from the main core, decreasing this value reduces the opacity of the forks as well.

Fork Strength Specifies the opacity of the new fork. This amount is measured as a percentage of the Core Drain value.

Fork Variation Specifies the amount of variation in the opacity of the fork and determines how much the fork opacity deviates from the amount set for Fork Strength.

Audio Spectrum effect

Apply the Audio Spectrum effect to a video layer to display the audio spectrum of an audio layer. The effect displays the magnitude of frequencies in the range you define using Start Frequency and End Frequency. This effect can display the audio spectrum in a number of different ways, including along a Bezier path of a layer. Apply the effect to a layer that contains a solid or an image, and that may contain audio.

Note: Audio Spectrum uses the audio source footage without time-remapping, effects, stretch, or levels. To display the spectrum with such effects, precompose the audio layer before applying the Audio Spectrum effect.

This effect works with 8-bpc, 16-bpc, and 32-bpc color.

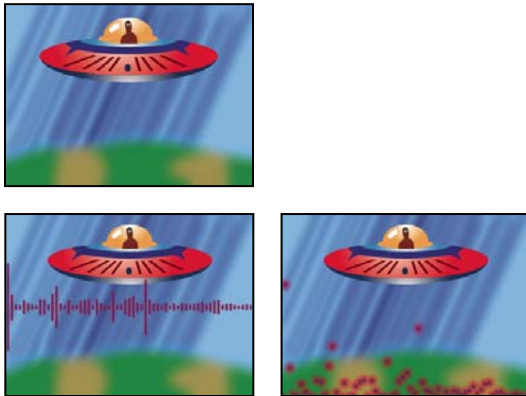

Original (top left), and with effect applied (bottom left and right)

Audio Layer The audio layer you want to use as input.

Start Point, End Point Specifies the position at which the spectrum starts or ends if Path is set to None.

Path The audio spectrum is displayed along the path of the layer, unless None is chosen.

Use Polar Path The path starts from a single point and appears as a radial graph.

Start Frequency, End Frequency The lowest and highest frequencies, in hertz, to display.

Frequency Bands The number of frequency bands into which to divide displayed frequencies.

Maximum Height Maximum height, in pixels, of a displayed frequency.

Audio Duration Duration of audio, in milliseconds, used to calculate the spectrum.

Audio Offset Time offset in milliseconds used to retrieve the audio.

Thickness Thickness of the bands.

Softness How feathered or blurry the bands appear.

Inside Color, Outside Color Inside and outside colors of the bands.

Blend Overlapping Colors Specifies that overlapping spectrums are blended.

Hue Interpolation If the value is greater than 0, the frequencies displayed rotate through the hue color space.

Dynamic Hue Phase If selected, and the Hue Interpolation is greater than 0, the Start color shifts to the maximum frequency in the range of displayed frequencies. This setting allows the hue to follow the fundamental frequency of the spectrum displayed as it changes.

Color Symmetry If selected, and the Hue Interpolation is greater than 0, the start and end colors are the same. This setting allows color continuity on closed paths.

Display Options Specifies whether to display frequency as Digital, Analog Lines, or Analog Dots.

Side Options Specifies whether to display the spectrum above the path (Side A), below the path (Side B), or both (Side A & B).

Duration Averaging Specifies that audio frequencies are averaged to reduce randomness.

Composite On Original If selected, displays the original layer with the effect.

Audio Waveform effect

Apply the Audio Waveform effect to a video layer to display the audio waveform amplitude of an audio layer. You can display the audio waveform in a number of different ways, including along an open or closed mask path.

Note: Audio Waveform uses the audio source footage without time-remapping, effects, stretch, or levels. To display the spectrum with such effects, precompose the audio layer before applying the Audio Waveform effect.

This effect works with 8-bpc, 16-bpc, and 32-bpc color.

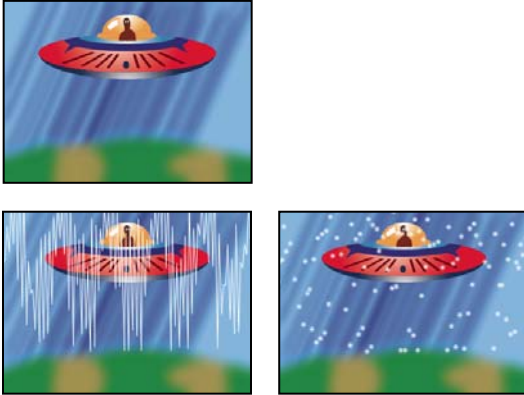

Original (top left), and with effect applied (bottom left and right)

Audio Layer The audio layer you want to display as a waveform.

Start Point, End Point The position at which the waveform starts and ends, if Path is set to None.

Path If set to None, the audio waveform is displayed along the path of the layer.

Displayed Samples Number of samples to display in the waveform.

Maximum Height Maximum height, in pixels, of a displayed frequency.

Audio Duration Duration of audio, in milliseconds, used to calculate the waveform.

Audio Offset Time offset, in milliseconds, used to retrieve the audio.

Thickness The thickness of the waveform.

Softness How feathered or blurry the waveform appears.

Inside Color, Outside Color The inside and outside colors of the waveform.

Waveform Options Mono combines the left and right channels of the audio layer. Nonstereo audio layers play as Mono.

Display Options Digital displays each sample as a single vertical line connecting the minimum and maximum source sample. This option simulates the display used on digital equipment. Analog Lines displays each sample as a line connecting the previous and next sample from either the minimum or maximum audio source sample. This option simulates the retrace seen in the display of an analog oscilloscope. Analog Dots displays each sample as a dot representing either the minimum or maximum audio source sample.

Beam effect

The Beam effect simulates the movement of a beam, such as a laser beam. You can make the beam shoot, or you can create a wandlike beam with stationary start and end points. The beam looks best when motion blur is enabled and the shutter angle is set to 360.

This effect works with 8-bpc, 16-bpc, and 32-bpc color.

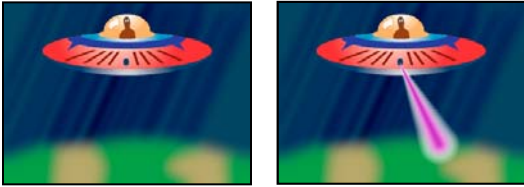

Original (left), and with a simulated beam (right)

The Length control specifies the length of the beam based on a percentage of the Time specified. For example, a setting of 100% means that the visible beam length is at its maximum when the Time control is 50%. Time specifies the time of the beam's travel from start to end as a percentage. The 3D Perspective control uses 3D perspective based on start and end thickness if Time is animated.

Cell Pattern effect

The Cell Pattern effect generates cellular patterns based on cellular noise. Use it to create static or moving background textures and patterns. The patterns can be used in turn as textured mattes, as transition maps, or as a source for displacement maps.

This effect works with 8-bpc color.

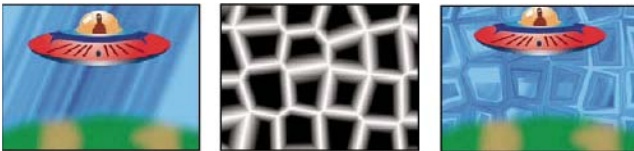

Original image (left); the Cell Pattern effect creates a displacement map (center), which is used as a displacement map for the Displacement Map effect (right).

Cell Pattern The cell pattern to use. *HQ* denotes high-quality patterns that render with more definition than their unmarked counterparts. Mixed Crystals is available only as a high-quality option.

Note: The Static Plates option is identical in appearance to the Plates option. However, when evolving, the static plates retain a uniform lightness value, whereas the plates shift the lightness of the cell pattern.

Invert Inverts the cell pattern. Black areas become white, and white areas become black.

Contrast/Sharpness Specifies the contrast of the cell pattern when you use the Bubbles, Crystals, Pillow, Mixed Crystals, or Tubular cell pattern. The control specifies sharpness for any of the Plate or Crystallize options.

Note: The contrast is affected by the option chosen from the Overflow menu.

Overflow How the effect remaps values that fall outside the grayscale range of 0-255. Overflow isn't available if sharpness-based cell patterns are chosen.

- **Clip** Values above 255 are mapped to 255. Values below 0 are mapped to 0. Contrast amount controls how much of the image falls outside the range 0-255; higher contrast amounts result in a mostly black or white image, with less gray. Therefore, less subtle cellular detail appears at higher contrast settings.

- **Soft Clamp** Remaps grayscale values to fall inside the 0–255 range. Contrast appears reduced; cells are mostly gray with very few areas of pure black or white.

- **Wrap Back** Values above 255 or below 0 are reflected back into the 0-255 range. For example, a value of 258 (255+3) is reflected to 252 (255-3), and a value of -3 is reflected to 3. With this setting, Contrast values above 100 increase complexity and detail.

Disperse How randomly the pattern is drawn. Lower values cause more uniform or gridlike cell patterns.

Note: If you set the Disperse value above 1.0, set the layer to Best quality to avoid artifacts.

Size The size of the cells. The default size is 60.

Offset Determines the portion of the fractal shape used to create the pattern.

Tiling Options Choose Enable Tiling to create a pattern built of repeating tiles. Cells Horizontal and Cells Vertical determine how many cells wide and how many cells high each tile is.

Evolution Animating this setting results in changes of the pattern over time.

Note: Although the Evolution value is set in units called revolutions, it's important to realize that these revolutions are progressive. The Evolution state continues to progress infinitely at each new value. Use the Cycle Evolution option to return the Evolution setting to its original state at each revolution.

Evolution Options Evolution Options provide controls that render the effect for one short cycle and then loop it for the duration of your clip. Use these controls to prerender cell pattern elements into loops, and thus speed up rendering time.

- **Cycle Evolution** Creates a loop that forces the Evolution state to return to its starting point.
- **Cycle** The number of revolutions of the Evolution setting that the cell pattern cycles through before it repeats. The timing of the Evolution cycles is determined by the amount of time between Evolution keyframes.

Note: The Cycle control affects only the state of the cell pattern, not geometrics or other controls, so you can get different results with different Size or Offset settings.

- **Random Seed** Specifies a value from which to generate the cell pattern. Animating this property results in flashing from one cell pattern to another within the same cell pattern type. For smooth transition of the cell pattern, use the Evolution control.

Note: Create new cell pattern animations by reusing previously created Evolution cycles and changing only the Random Seed value. Using a new Random Seed value alters the cell pattern without disturbing the Evolution animation.

Checkerboard effect

The Checkerboard effect creates a checkerboard pattern of rectangles, half of which are transparent.

This effect works with 8-bpc color.

Anchor The point of origin of the checkerboard pattern. Moving this point offsets the pattern.

Size From How the dimensions of the rectangles are determined:

- **Corner Point** Each rectangle's dimensions are those of the rectangle with opposite corners defined by the Anchor and Corner points.
- **Width Slider** A rectangle's height and width are equal to the Width value, meaning that the rectangles are squares.
- **Width & Height Sliders** A rectangle's height is equal to the Height value. A rectangle's width is equal to the Width value.

Feather Thickness of the edge feather within the checkerboard pattern.

Color The color of the nontransparent rectangles.

Opacity The opacity of the colored rectangles.

Blending Mode The blending mode to use to composite the checkerboard pattern on top of the original layer. These blending modes work identically to the ones in the Timeline panel, except for the default None mode, which renders the checkerboard pattern only.

Circle effect

The Circle effect creates a customizable solid disk or ring.

This effect works with 8-bpc color.

Edge None creates a solid disk. The other options all create rings. Each option corresponds to a different set of properties that determine the shape and edge treatment of the ring:

- **Edge Radius** The difference between the Edge Radius property and the Radius property is the thickness of the ring.
- **Thickness** The Thickness property sets the ring's thickness.
- **Thickness * Radius** The product of the Thickness property and the Radius property is the ring's thickness.
- **Thickness & Feather * Radius** The product of the Thickness property and the Radius property is the ring's thickness. The product of the Feather property and the Radius property is the ring's feather.

Feather The thickness of the feather.

Invert Circle Inverts the matte.

Blending Mode The blending mode used to combine the shape and the original layer. These blending modes behave like those in the Timeline panel, except for None, which displays only the shape, without the original layer.

Ellipse effect

The Ellipse effect draws an ellipse.

This effect works with 8-bpc, 16-bpc, and 32-bpc color.

Eyedropper Fill effect

The Eyedropper Fill effect (formerly the Color Picker effect) applies a sampled color to the source layer. This effect is useful for quickly picking a solid color from a sample point on the original layer or picking a color value from one layer and using blending modes to apply this color to a second layer.

This effect works with 8-bpc color.

Sample Point The center of the sampled area.

Sample Radius The radius of the sampled area.

Average Pixel Color Which color values are sampled:

- **Skip Empty** Samples the average RGB color values, excluding those of transparent pixels.
- **All** Samples the average of all RGB color values, including those of transparent pixels.
- **All Premultiplied** Samples the average of all RGB color values, premultiplied with the alpha channel.
- **Including Alpha** Samples the average of all RGB color and alpha channel values. This setting results in the sampled color also containing the average transparency of the sampled pixels.

Maintain Original Alpha Maintains the original layer's alpha channel. If you choose Including Alpha in the Average Pixel Color menu, the original alpha is stenciled over the sampled color.

Blend With Original The effect's transparency. The result of the effect is blended with the original image, with the effect result composited on top. The higher you set this value, the less the effect affects the layer. For example, if you set this value to 100%, the effect has no visible result on the layer; if you set this value to 0%, the original image doesn't show through.

Fill effect

The Fill effect fills specified masks with a specified color. If you want to add both a stroke and a fill to a closed path, the order in which you apply the stroke and fill determines the visible width of the stroke: If the fill is applied before the stroke, the full stroke brush size is visible; if the stroke is applied before the fill, the fill appears on top of the stroke, obscuring the half of the stroke that falls inside the path.

This effect works with 8-bpc color.

See also

"Stroke effect" on page 437

Fractal effect

The Fractal effect renders the Mandelbrot or Julia set, creating colorful textures. When you first apply the effect, the picture you see is the classic sample of the Mandelbrot set; the set is the area that is colored black. Any pixel outside the set is colored, depending on how close it is to the set.

This effect works with 8-bpc and 16-bpc color.

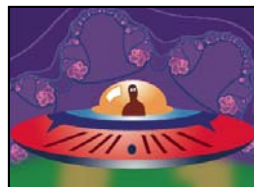
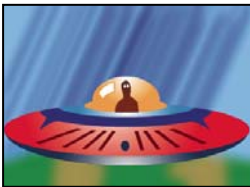

Spaceship layer (top left) composited over layer with Mandelbrot fractal with Lightness Gradient palette (bottom left) and Julia fractal (bottom right)

Set Choice Specifies the set used. Mandelbrot is the typical Mandelbrot set. Mandelbrot Inverse is the Mandelbrot set mathematically inverted. Julia always changes depending on the center point from the Mandelbrot set and can produce the set of all possible Julia sets. Julia Inverse is the inverse of the Julia set. To see a Julia set, you may want to set the magnification to a negative value, because these sets tend to fill up the complex plane outside the normal boundary. Mandelbrot Over Julia is the same as Mandelbrot, except that it does change when the Julia center point changes. Mandelbrot Inverse over Julia is the same as Mandelbrot Inverse, except that it does change when the Julia center point changes.

Mandelbrot, Julia Specify the settings for the specified set. X (Real) and Y (Imaginary) specify the pixels at the center of the image for either the Mandelbrot or Julia set. Magnification specifies the magnification of the effect. Escape Limit specifies how many times the calculation looks for a color for a given pixel before it assigns the color black. It also sets the maximum number of line segments the Selection tool can use when tracing the path of a point. Higher numbers require longer render times.

Color Specifies the color of the effect:

- **Overlay** Displays a ghosted version of the opposite set. For example, when viewing the Julia set, use this control to display a ghosted version of the Mandelbrot set. When you select Overlay, a white cross hair with a black drop shadow appears so you can see the exact point at the center of the opposite set. This control is useful because the Julia set depends on the center point of the Mandelbrot set.
- **Transparency** Specifies whether black pixels are transparent. If you choose Solid Color from the Palette menu, this control specifies whether everything inside or outside the set is transparent.
- **Palette** Specifies the palette to use when drawing the set. Lightness Gradient creates a gradient that ranges from black to white, passing through the hue specified by the Hue control. Then it applies the same gradient eight more times, each time using the hue 45° away on the color wheel. The number of colors in the gradient is specified by the Cycle Steps control. Hue Wheel uses all the color from the Hue color wheel, with maximum brightness and saturation. Black And White uses alternating bands of black and white. Solid Color turns everything transparent except the inside of the set, which uses the color specified by the Hue control. Select Transparent to get the opposite result.
- **Hue** Specifies the hue for solid colors and the starting hue for color gradients. This control works well for creating smooth color changes or for cycling through the palette. Cycle Steps specifies the number of bands of different color that appear before the cycle starts over. Cycle Offset specifies where, other than the beginning, a cycle starts.
- **Edge Highlight** Highlights the edges between color bands. This control requires low-quality mode. If you want to use high-quality edge highlighting, use the Find Edges effect instead.

High Quality Settings Specify the oversampling settings for the effect:

- **Oversample Method** Specifies the method used to oversample the effect: Edge Detect-Fast-May Miss Pixels performs a simple edge detection and oversamples only those pixels. This option is the fastest, especially in areas with a lot of solid color, such as black, and it generally produces results indistinguishable from Brute Force. Brute Force-Slow-Every Pixel oversamples every pixel in the image. It is slow but precise.
- **Oversample Factor** Specifies the amount of oversampling to perform. For example, a value of 4 specifies that each pixel is sampled 16 times ($4 \times 4 = 16$) and that the average color is used. Higher values produce better quality output but require longer render times.

Use tools with the Fractal effect

When the Fractal effect is selected in the Effect Controls panel, you can use After Effects tools in the following way. (If you don't want the Fractal tools active, deselect the effect before using tools.)

- Drag the Selection tool to see if a point's path lies within the set. If the path leads out of the bounded rectangle (-2, -2, 2, 2), it has gone into infinity; in such a case, the starting-point color is based on how many line segments it takes to reach infinity. If the path ends within the rectangle, it's colored black.
- Use the Zoom tool to zoom in or out on a particular point, or hold down Ctrl (Windows) or Command (Mac OS), click and hold the Magnifying tool over the center of the image, and navigate from the center. For example, to zoom straight in, stay in the center; to move up, drag up just a little and then quickly move back to the center.

- Use the Hand tool to pan the image. Press Ctrl (Windows) or Command (Mac OS) to pan the opposite fractal. For example, when viewing the Julia set, press Ctrl (Windows) or Command (Mac OS) to pan the Mandelbrot set and see how the Julia set depends on the center point of the Mandelbrot set.
- Use the arrow keys to pan the center point by 1 pixel. Press Shift as you press an arrow key to adjust the point by 10 pixels. Press Ctrl (Windows) or Command (Mac OS) as you press an arrow key to adjust the center point of the opposite set.

Grid effect

Use the Grid effect to create a customizable grid. Render this grid in a solid color or as a mask in the alpha channel of the source layer. This effect is good for generating design elements and mattes within which other effects can be applied.

This effect works with 8-bpc color.



Use Grid with the Advanced Lightning effect to create lightning forks that follow a grid pattern.

Anchor The point of origin of the grid pattern. Moving this point offsets the pattern.

Size From How the dimensions of the rectangles are determined:

- **Corner Point** Each rectangle's dimensions are those of the rectangle with opposite corners defined by the Anchor and Corner points.
- **Width Slider** A rectangle's height and width are equal to the Width value, meaning that the rectangles are squares.
- **Width & Height Sliders** A rectangle's height is equal to the Height value. A rectangle's width is equal to the Width value.

Border The thickness of the grid lines. A value of 0 causes the grid to disappear.

Note: The anti-aliasing of the grid borders may cause the visible thickness to vary.

Feather The softness of the grid.

Invert Grid Inverts the transparent and opaque areas of the grid.

Color The color of the grid.

Opacity The opacity of the grid.

Blending Mode The blending mode to use to composite the grid on top of the original layer. These blending modes work identically to the ones in the Timeline panel, except for the default None mode, which renders the grid only.

Lens Flare effect

The Lens Flare effect simulates the refraction caused by shining a bright light into the camera lens. Specify a location for the center of the flare by clicking anywhere inside the image thumbnail or by dragging its cross hair.

This effect works with 8-bpc color.

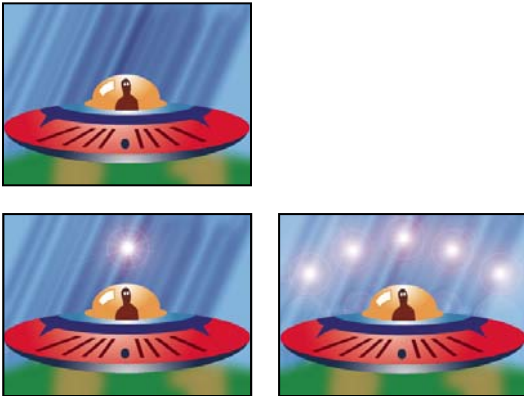

Single lens flare (bottom left) and multiple lens flares (bottom right)

Lightning effect

The Lightning effect creates lightning bolts and other electrical visuals, including a *Jacob's Ladder* result (as seen in old horror movies) between two specified points in a layer. This effect is automatically animated without keyframes or expressions.

This effect works with 8-bpc color.

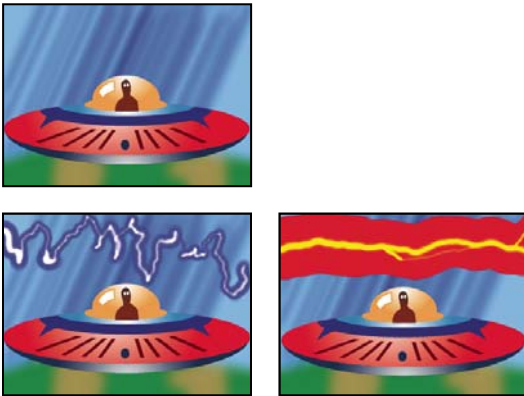

Variations in thickness, color, and number of branches (bottom left and right)

Start Point, End Point Where the lightning begins and ends.

Segments The number of segments that form the main lightning bolt. Higher values produce more detail but reduce the smoothness of motion.

Amplitude The size of undulations in the lightning bolt as a percentage of the layer width.

Detail Level, Detail Amplitude How much detail is added to the lightning bolt and any branches. For Detail Level, typical values are between 2 and 3. For Detail Amplitude, a typical value is 0.3. Higher values for either control are best for still images but tend to obscure animation.

Branching The amount of branching (forking) that appears at the ends of bolt segments. A value of 0 produces no branching; a value of 1.0 produces branching at every segment.

Rebranching The amount of branching from branches. Higher values produce treelike lightning bolts.

Branch Angle The angle between a branch and the main lightning bolt.

Branch Seg. Length The length of each branch segment as a fraction of the average length of the segments in the lightning bolt.

Branch Segments The maximum number of segments for each branch. To produce long branches, specify higher values for both Branch Seg. Length and Branch Segments.

Branch Width The average width of each branch as a fraction of the width of the lightning bolt.

Speed How fast the lightning bolt undulates.

Stability How closely the lightning follows the line defined by the start and end points. Lower values keep the lightning bolt close to the line; higher values create significant bouncing. Use Stability with Pull Force to simulate a Jacob's Ladder effect and cause the lightning bolt to snap back to a position along the start line after it has been pulled in the Pull Force direction. A Stability value that is too low doesn't allow the lightning to be stretched into an arc before it snaps back; a value that is too high lets the lightning bolt bounce around.

Fixed Endpoint Determines whether the end point of the lightning bolt remains fixed in place. If this control isn't selected, the end of the bolt undulates around the end point.

Width, Width Variation The width of the main lightning bolt and how much the width of different segments can vary. Width changes are randomized. A value of 0 produces no width changes; a value of 1 produces the maximum width changes.

Core Width The width of the inner glow, as specified by the Inside Color value. Core Width is relative to the total width of the lightning bolt.

Outside Color, Inside Color The colors used for the lightning bolt's outer and inner glows. Because the Lightning effect adds these colors on top of existing colors in the composition, primary colors often produce the best results. Bright colors often become much lighter, sometimes becoming white, depending on the brightness of colors beneath.

Pull Force, Pull Direction The strength and direction of a force that pulls the lightning bolt. Use the Pull Force value with the Stability value to create a Jacob's Ladder appearance.

Random Seed An input value for the random noise generator that is the basis of the Lightning effect. If the random movement of the lightning interferes with another image or layer, enter a new value for Random Seed until you find one that works for you.

Blending Mode The blending mode to use to composite the lightning on top of the original layer. These blending modes work identically to the ones in the Timeline panel.

Rerun At Each Frame Regenerates the lightning at each frame. To make the lightning behave the same way at the same frame every time you run it, don't select this option. Selecting this option increases rendering time.

Paint Bucket effect

The Paint Bucket effect (formerly Basic Fill effect) is a nondestructive paint effect that fills an area with a solid color. It works much like the Paint Bucket tool in Adobe Photoshop. Use the Paint Bucket effect for colorizing cartoon-type outlined drawings or replacing areas of color in an image.

This effect works with 8-bpc color.

Fill Point The effect fills an area that contains the Fill Point. The area is determined by analyzing pixels that neighbor the Fill Point and expanding the fill area by adding matching pixels. How far the fill color spreads depends upon the Tolerance setting, as well as the option you choose from the Fill Selector menu.

Fill Selector Which values to operate on:

- **Color & Alpha** Specifies that the effect fills the fill point's RGB and alpha channels with the new color.

- **Straight Color** Specifies that the effect fills only the fill point area's RGB channel with the new color.
- **Transparency** Specifies that the effect fills only the transparent areas near the fill point. You must set a fill point in a transparent area for this option to work.
- **Opacity** Specifies that the effect fills only the opaque areas near the fill point. You must set a fill point in an opaque area for this option to work.
- **Alpha Channel** Specifies that the effect fills either the opaque or transparent areas in the whole image, depending upon the alpha channel value at the point you set the fill point.

Tolerance How far a pixel's color values can be from the Fill Point color values and still match. Higher values expand the range of pixels that the effect fills.

View Threshold Shows what pixels match—that is, which pixels are within the Tolerance value of the color values of the Fill Point pixel. This option is especially useful in tracking leaks. If there is a small gap, the color can flow over and fill areas not intended to be filled.

Stroke How the effect treats the edges of the filled area:

- **Antialias** Anti-aliases the edges of the filled area.
- **Feather** Creates a feathered edge for the filled area. Feather Softness values create a more gradually disappearing edge.
- **Spread** Expands the area of the fill color. The Spread Radius value indicates the number of pixels the fill color extends beyond the edge of the fill area.
- **Choke** Contracts the area of the fill color. The Spread Radius value indicates the number of pixels the fill color shrinks from the edge of the fill area.
- **Stroke** Confines the fill to just the border of the selected area. The Stroke Width value indicates the width of the stroke, in pixels.

Color The fill color.

Opacity Opacity of the filled area.

Blending Mode The blending mode to use to composite the result of effect on top of the original layer. All of these blending modes operate like those in the Timeline panel, except for Fill Only. Use Fill Only to show only the fill.

Note: If you apply multiple instances of Paint Bucket to a layer, be sure not to set more than one to use the Fill Only blending mode. If you set more than one instance to use this blending mode, only the first application of the effect is shown.

Radio Waves effect

The Radio Waves effect creates radiating waves from a stationary or animated effect control point. You can use this effect to generate pond ripples, sound waves, or intricate geometric patterns. Use the Reflection control to make the shapes bounce off the sides of the layer. You can also use Radio Waves to create realistic wave displacement maps that work well with the Caustics effect.

This effect works with 8-bpc color.

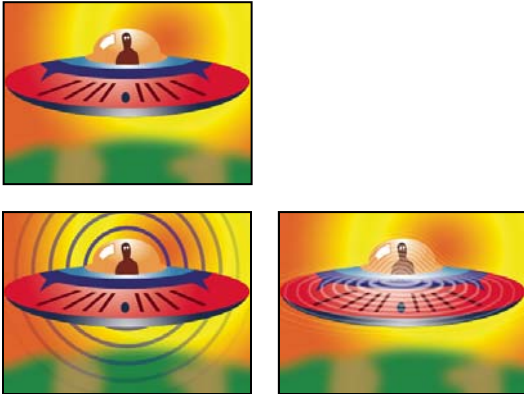

Polygon wave type with square stroke profile (bottom left), and Image Contour wave type with Sine stroke profile (bottom right)

Producer Point The point from which the waves appear.

Parameters Are Set At Specifies whether parameters can be animated for individual waves. Birth specifies that each wave maintains the same parameter settings over time. Each Frame specifies that the waves change as the parameters change. For example, if you create a star wave with an animated rotation property, select Birth to offset each star from the previous one to create a twisting tunnel, or select Each Frame to make all the stars rotate in unison as the rotation property changes.

Render Quality Controls the quality of the output. Radio Waves creates smooth, anti-aliased shapes by rendering high-resolution versions of the shapes and then scaling them down by oversampling. For example, to create a 100x100-pixel image, it may first generate a 400x400-pixel image and then scale it down using 4x oversampling. Oversampling provides high-quality results but results in long render times. This option works only with Best quality mode.

Wave Type What to base the wave shape on.

Polygon What kind of polygon to use for the wave shape. These controls are available if Polygon is chosen for Wave Type.

- **Sides** Three sides create a triangle, four create a square, and so on. Size values above 64 result in a smooth circle. You can also approximate a circle by setting Sides to 3, Curve Size to 1, and Curvyness to about 0.62.
- **Curve Size** Specifies how much of each side is curved at each point.
- **Curvyness** Specifies how extreme the curve is at each point of the wave.
- **Star** Specifies that the polygon is shaped like a star. To change the number of points on the star, change the number of sides.
- **Star Depth** Specifies the star's angles by controlling the distance between inner points and the star's center.

Mask Specifies the mask used to create a wave. This control is available if you choose Mask from the Wave Type pop-up menu.

Image Contour controls

You can base the wave shape on the contours of an image by choosing Image Contours for Wave Type.

Source Layer The layer to use as input for the creation of the image contours. Select an animated layer to emit moving shapes. A well-defined outline, high-contrast grayscale layer, or alpha channel works well as a source. The Radio Waves effect detects edges and converts sources into outlines.

Source Center Specifies the center point of the shape, relative to the source layer. For example, if you isolate a shape that is positioned in the left half of the frame, the shape radiates to the left by default; you can move the source center anywhere on the layer.

Value Channel The color attributes of the source layer used to define the image contours.

Invert Input Inverts the chosen value channel option.

Value Threshold Specifies the threshold for the chosen value channel. It determines the percentage value at which everything below it or above it is mapped to either white or black. This control can make a big difference in the shape of the wave.

Pre-Blur Smooths out the value channel before the value threshold is sampled. If you have a high-contrast image, such as white on black, and you want the wave to follow the edges very closely, set this option to 0.

Tolerance Defines how tightly the wave conforms to the layer. A very high setting results in sharp corners; a very low value can make the wave shape more sensitive to noise.

Contour Specifies the shape in the source layer that you want to use as the emitted wave. Contour numbers the shapes by their order in the frame from top to bottom, left to right. The shape in the top left corner is number 1.

Wave Motion controls

Wave Motion controls specify how the wave emits from the center point.

Frequency Specifies the number of waves per second flowing out of the producer point.

Expansion Specifies the speed at which the wave travels from the producer point once it is born. This option doesn't affect the number of waves per second.

Orientation Specifies the rotation of the shape at birth around its center point. To animate the rotation, use the Spin control.

Direction Specifies the wave's initial direction if Velocity is greater than 0. By default, particles are emitted from the producer point in an expanding radial pattern.

Velocity Specifies the speed at which the wave moves in the specified direction.

Spin Controls the continued rotation of a shape after it is born.

Lifespan (sec) Specifies the time, in seconds (including the fade-in and fade-out times), that the wave exists.



To prevent waves from abruptly disappearing when their lifetime ends, use the Fade Out Time control.

Reflection Specifies whether the waves bounce off the edges of the layer and back into the scene. This option is effective for generating displacement maps for use as water ripples.

Stroke controls

Stroke controls specify the appearance of the wave's stroke.

Profile Controls the appearance of the stroke that defines the shape. The outline of the shape is animated in the wave that emanates from the effect point. The quality of the stroke is defined as a 3D wave type.

Color Specifies the color of the stroke.

Opacity Specifies the maximum possible opacity of the stroke. The actual opacity of the stroke takes into account this setting in conjunction with the Fade-in Time and Fade-out Time controls.

Fade-in Time Specifies the amount of time it takes the wave to fade into view. Fade-in Time is measured in seconds and begins with 0 opacity at birth. For example, if the Lifespan is 3 seconds and Fade-in Time is 1 second, the stroke is completely transparent at birth and fades smoothly to full opacity at 1 second.

Fade-out Time Specifies the amount of time it takes the wave to fade out of view. Fade-out Time is measured backward in time from the end of the Lifespan. If the Lifespan is 3 seconds and Fade-out Time is 1 second, the wave begins to fade out at 2 seconds. If the sum of Fade-in Time and Fade-out Time is greater than the Lifespan value, the intersection point of the two fades is calculated so that the wave doesn't reach full transparency. If either Fade-in Time or Fade-out Time is longer than the Lifespan, that amount is truncated to equal the Lifespan.

Start Width Specifies the width of the shape at its birth. End Width specifies the width of the shape at the end of its lifespan.

Ramp effect

The Ramp effect creates a color gradient. You can create linear or radial ramps, and vary the position and colors of the ramp over time. Use the Start Of Ramp and End Of Ramp properties to specify the start and end positions. Use the Ramp Scatter control to disperse the ramp colors and eliminate banding.

This effect works with 8-bpc, 16-bpc, and 32-bpc color.

Note: Ramps often don't broadcast well; serious banding occurs because the broadcast chrominance signal doesn't contain sufficient resolution to reproduce the ramp smoothly. The Ramp Scatter control dithers the ramp colors, eliminating the banding apparent to the human eye.

Scribble effect

The Scribble effect creates the appearance of hand-drawn artwork by filling or stroking a closed mask.

For example, the Scribble effect can simulate fills that look like marker, cross-hatching, or textiles. It fills a mask with a single zigzagging line that crisscrosses the path. Some paths, because of their geometry, cannot be filled with a single line. The Scribble effect breaks these paths into several simpler paths, each of which it then fills with a zigzagged stroke.

Aharon Rabinowitz provides a tutorial that shows how to use Auto-trace with the Scribble effect to create a stylized animated fill from video footage or from Illustrator graphics: www.adobe.com/go/learn_ae_aharonscribble.

This effect works with 8-bpc color.

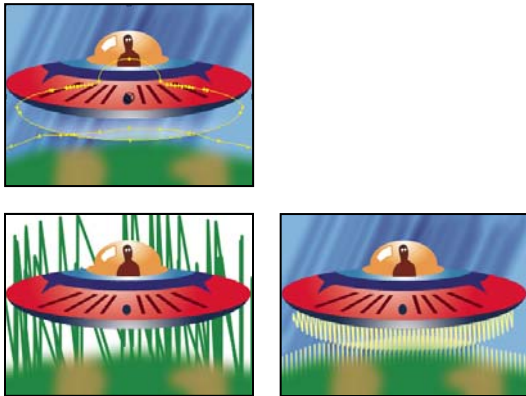

Masks (top left), Scribble applied to outside edges (bottom left), and Scribble applied to inside edges with Composite on Original (bottom right)

Scribble Single Mask scribbles a specified mask on the layer; All Masks scribbles all masks on the layer; All Masks Using Modes combines the masks using their modes and then scribbles the resulting shape.

Mask The mask to use if Scribble is set to Single Mask.

Fill Type Controls whether the fill is drawn inside the path or creates a scribble along the path. Left Edge draws the fill along the path's left edge; Right Edge draws the fill along the path's right edge. The left and right edges of a path are determined by the direction in which the path is drawn. When using the Left Edge or Right Edge fill types on masks that have tight curves, you get best results by making the Edge Width less than the radius of the curve.

Edge Options Options for the edge of the scribble if Fill Type is set to an edge.

- **Edge Width** Controls the width of the edge.
- **End Cap** Controls the ends of scribble lines. Use Round for stroked lines with semicircular ends; use Butt for stroked lines with squared ends; and use Projecting for stroked lines with squared ends that extend half the line width beyond the end of the line, making the weight of the line extend equally in all directions around the line. This option is enabled only if Fill Type is set to Centered Edge.
- **Join** Specifies how the corners of a scribble line appear. Use Round for stroked lines with rounded corners; use Bevel for stroked lines with squared corners; and use Miter for stroked lines with pointed corners.
- **Miter Limit** Controls when the effect switches from a miter (pointed) join to a bevel (squared-off) join. Specify a value between 1 and 500. For example, if the value is set to the default of 4, the effect switches from a miter to a bevel join when the length of the point reaches four times the stroke weight. A miter value of 1 results in a bevel join. It's enabled if Join is set to the Miter option.
- **Start/End Apply To** Specifies how changes to the effect's Start and End options in the Timeline panel are applied; Scribble Result affects the scribble in the order in which it is drawn, and Mask Path follows the path of the mask to create more continuous drawing in or out of the scribble.

Angle Specifies the angle of the scribbled stroke.

Stroke Width Specifies the width of the stroke. Specify a value from 0.1 to 50.

Stroke Options Specify the curviness, spacing, and overlap of the scribbled line.

- **Curviness** Controls the amount of curve at the end of each scribbled stroke. Specify a value between 0° and 100°.
- **Curviness Variation** Determines the amount of variance the curviness values can have at each end point. Specify a value between 0% and 100%. A value of 0 gives the scribble sharp corners, while a value of 100 makes the scribble loopy.

- **Spacing and Spacing Variation** The number of pixels between lines and zigzags. Setting a value equal to the stroke width value makes the lines fall next to each other.

- **Path Overlap** Determines whether the scribble ends at the path, inside the path, or outside the path. Specify 0 to make it end at the path, negative values to make it end inside, and positive values to make it end outside. Path Overlap Variation determines how much each stroke can vary from the value specified for Path Overlap.

Start, End Where the drawn stroke starts and ends, as a percentage of the distance from the beginning of the total stroke.

Fill Paths Sequentially Enabled if Scribble is set to All Masks. If this control is selected, the start and end values apply to the combined length of the scribbles for all masks. If it isn't selected, the start and end values apply independently to the scribble for each mask.

Wiggle Type Specifies an animation style: Static keeps the scribble constant over time; Jumpy changes from one scribble to the next abruptly; and Smooth changes from one scribble to the next smoothly.

Wiggles/Second Controls how frequently a new scribble is generated when the Wiggle Type control is set to Smooth or Jumpy.

Composite On Transparent replaces the original image with the scribble. On Original Image composites the scribble on the original image. Reveal Original Image shows the original image through the scribble.

Stroke effect

The Stroke effect creates a stroke or border around a mask or along a Bezier path. You can also specify stroke color, opacity, and spacing, as well as brush characteristics. Specify whether the stroke appears on top of the image, on a transparent image, or if it reveals the original alpha channel. To use a path created in Illustrator, copy the path and paste it into a layer in After Effects.

This effect works with 8-bpc color.

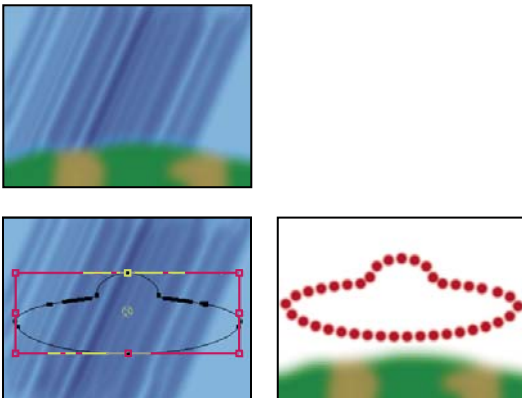

Original (top left), with mask (bottom left), and with effect applied (bottom right)

Brush Hardness Specifies the edge quality of the stroke, between hard and soft.

Spacing Specifies the spacing between stroke segments.

Paint Style Specifies whether the stroke is applied to the original layer or to a transparent layer.

See also

“Fill effect” on page 427

Vegas effect

The Vegas effect generates running lights and other path-based pulse animations around an object. You can outline just about anything, surround it with a number of lights or longer pulses, and then animate it to create the appearance of lights chasing around the object.

This effect works with 8-bpc color.

Stroke What to base the stroke on: Image Contours or Mask/Path.

Image Contours If Image Contours is chosen from the Stroke menu, you specify what layer to take the image contours from and how to interpret the input layer.

- **Input Layer** The layer whose image contours are used. High-contrast, grayscale layers, and alpha channels work well and are easy to work with.
- **Invert Input** Inverts the input layer prior to creating the stroke.
- **If Layer Sizes Differ** Determines how to adjust the layers if the size of the input layer differs from that of the layer to which Vegas is applied. Center centers the input layer in the composition at its original size. Stretch To Fit scales the input layer to match the layer to which Vegas is applied.
- **Channel** The color attribute of the input layer used to define the contours.
- **Threshold** The percentage value at which everything below or above is mapped to either white or black. This property is important in determining the location of the edges that the effect strokes.
- **Pre-Blur** Smooths out the input layer before the threshold is sampled. Set this option to 0 if you have a high-contrast image and want the stroke to follow the edges very closely.
- **Tolerance** Defines how tightly the stroke conforms to the input layer. A very high value results in sharp corners, while very low values can make the stroking sensitive to noise.
- **Render** Specifies whether to apply the effect to a selected contour or to all contours in the layer.
- **Selected Contour** Specifies the contour to use when Selected Contour is selected from the Render menu. Contours are numbered from left top to bottom right; the contour with the highest point is number 1, the second highest point is number 2, and so on.
- **Shorter Contours Have** Specifies whether shorter contours have fewer segments. By default, the effect breaks each contour into the same number of segments. For example, if you apply the effect to the letter R, the outside contour may look fine with 32 segments, but the inside contour may be almost solid. To resolve this issue, select Fewer Segments.

Mask/Path The mask or path to use for the stroke. You can use either closed or open masks.

Segments Specifies the number of segments used to create each stroked contour. For example, if the effect is applied to the word *Vegas* and Segments is set to 10, the outline of each of the letters, plus the inner contours of *e*, *g*, and *a*, are broken into 10 segments.

Length Determines the length of a segment's stroke in relation to its maximum possible length. For example, if Segments is set to 1, the maximum length of a stroke is one complete trip around the object outline. If Segments is set to 3, the maximum length of a segment is 1/3 of the total outline, and so on.

Segment Distribution Determines the spacing of the segments. Bunched puts the segments together like boxcars in a train: The shorter the segment length, the shorter the overall length of the train. Even spaces the segments evenly around the contour.

Rotation Animates the segments around the contour. For example, to create the appearance of running lights, start with a large number of segments set to 50% of their length, and then animate Rotation to move the lights around the shapes.

Random Phase Specifies that the stroke starting point is different for each contour. By default, the effect strokes a contour beginning at its highest point on the screen. In the event of a tie, it starts at the leftmost highest point.

Blend Mode Determines how the stroke is applied to the layer. Transparent creates the effect on a transparent background. Over places the stroke over the existing layer. Under places the stroke behind the existing layer. Stencil uses the stroke as an alpha channel mask, filling the stroke with the pixels of the original layer.

Color Specifies the color of the stroke, unless Stencil is chosen for Blending Mode.

Width Specifies the width of the stroke in pixels. Fractional values are supported.

Hardness Determines how sharp or blurry the edges of the stroke are. A value of 1 creates a slight blur; a value of 0.0 blurs the line so that few solid areas of color remain.

Start, End Opacity Specify the opacity at the beginning or end of the stroke.

Mid-point Opacity Specifies the opacity of the midpoint of the stroke. This control works in terms of relative opacity, not absolute opacity. Setting it to 0 makes the change in opacity smooth from the start point to the end point, as if there were no midpoint at all.

Mid-point Position Specifies the location of the midpoint within a segment: Lower values move the midpoint closer to the beginning; higher values move the midpoint closer to the end. Use this control to move the midpoint opacity from the center of the stroke.

See also

“About randomness and random seeds” on page 354

Write-on effect

The Write-on effect animates strokes on a layer. For example, you can simulate the action of hand-writing of cursive text or signatures.

Note: A convenient way to animate Brush Position is to use Motion Sketch to create Position keyframes on a new solid layer and then use an expression on the Brush Position property to link it to the Position property on the new solid layer. (See “Sketch a motion path with Motion Sketch” on page 199 and “Add, edit, and remove expressions” on page 549.)

This effect works with 8-bpc color.

Other methods of animating paint strokes and text are also available. For example, you can animate text by using the type tools and text animators, and you can animate a paint stroke applied with a paint tool. Paint strokes can have a Write-on Duration setting, which you can use to create similar results as with the Write-on effect. You can also animate shape paths for a similar result with the Trim Paths operation. (See “Animating text” on page 285, “Animate paint strokes” on page 310, and “Managing and editing shapes” on page 325.)

Brush Position The position of the brush. Animate this property to create a stroke.

Stroke Length (secs) The duration, in seconds, of each brush mark. If this value is 0, the brush mark has unlimited duration. Use a single, constant, nonzero value to create a snakelike movement of the stroke. Animate this value to make the stroke expand and contract.

Brush Spacing (secs) The time interval, in seconds, between brush marks. Smaller values produce smoother paint strokes but take more time to render.

Paint Time Properties and Brush Time Properties Specifies whether paint properties and brush properties are applied to each brush mark or to the entire stroke. Choose None to apply values at each time to all brush marks in the stroke. Choose a property name for each brush mark to retain the value for that property at the time that the brush mark was drawn. For example, if you choose Color, then each brush mark keeps the color specified by the Color value at the time that the mark was drawn.

Paint Style How the paint stroke interacts with the original image:

- **On Original Image** Paint stroke appears over original image.
- **On Transparent** Paint stroke appears over transparency; the original image doesn't appear.
- **Reveal Original Image** The original image is revealed by the paint stroke.

Keying effects

After Effects includes several built-in keying effects, as well as the Academy Award winning Keylight effect, which excels at professional-quality color keying. For information on the Keylight effect, see its documentation in this folder: Adobe After Effects CS3/Additional Documentation/Keylight.

To see a video tutorial on keying with Keylight, visit the Adobe website at www.adobe.com/go/vid0229.

Adobe Creative Suite Production Premium Edition also includes Adobe Ultra, which can quickly key out a poorly lit background shot with a low-quality webcam.

See also

“Keying overview and tips” on page 268

Color Difference Key effect

The Color Difference Key effect creates transparency from opposite starting points by dividing an image into two mattes, Matte Partial A and Matte Partial B. Matte Partial B bases the transparency on the specified key color, and Matte Partial A bases transparency on areas of the image that don't contain a second, different color. By combining the two mattes into a third matte, called the alpha α matte, the Color Difference Key creates well-defined transparency values.

The Color Difference Key produces high-quality keying for all well-lit footage items shot against a bluescreen or greenscreen and works especially well with images that contain transparent or semitransparent areas, such as smoke, shadows, or glass.

This effect works with 8-bpc and 16-bpc color.

See also

“Keying overview and tips” on page 268

“Matte Choker effect” on page 450

“Simple Choker effect” on page 451

Use the Color Difference Key effect

1 Select the layer you want to make transparent, and then choose Effect > Keying > Color Difference Key.

Note: To use any of the eyedroppers in the Layer panel, choose Color Difference Key from the View menu in the Layer panel.

2 In the Effect Controls panel, choose Matte Corrected from the View menu. To view and compare the source image, both partial mattes, and the final matte at the same time, choose [A, B, Matte] Corrected, Final from the View menu. Other views available in the View menu are described in step 10.

3 Select the appropriate key color: To key out a bluescreen, use the default blue color. To key out a nonblue screen, select a key color in one of the following ways:

- Thumbnail eyedropper: Select and then click in the Composition panel or the original thumbnail image on an appropriate area.
- Key Color eyedropper: Select and then click in the Composition or Layer panel on an appropriate area.
- Key Color swatch: Click to select a color from the specified color space.

Note: The eyedropper tools move the sliders accordingly. Use the sliders in step 9 to fine-tune the keying results.

4 Click the **α** matte button to display the final combined matte in the matte thumbnail.

5 Select the Black eyedropper, and then click inside the matte thumbnail on the lightest area of black to specify transparent regions. The transparency values in the thumbnail and Composition panel are adjusted.

6 Select the White eyedropper, and then click inside the matte thumbnail on the darkest area of white to specify opaque regions. The opaque values in the thumbnail and the Composition panel are adjusted.



To produce the best possible key, make the black and white areas as different as you can so that the image retains as many shades of gray as possible.

7 Select a matching accuracy from the Color Matching Accuracy menu. Choose Faster unless you use a screen that isn't a primary color (red, blue, or yellow). For those screens, choose More Accurate, which increases rendering time but produces better results.

8 If you need to further adjust transparency values, repeat steps 5 and 6 for one or both of the partial mattes. Click the Partial Matte B button or the Partial Matte A button to select a partial matte, and then repeat the steps.

9 Adjust transparency values for each partial matte and for the final matte by dragging one or more of the following sliders in the Matte Controls section:

- Black sliders adjust the transparency levels of each matte. You can adjust the same levels using the Black eyedropper.
- White sliders adjust the opaque levels of each matte. You can adjust the same levels using the White eyedropper.
- Gamma sliders control how closely the transparency values follow a linear progression. At a value of 1 (the default), the progression is linear. Other values produce nonlinear progressions for particular adjustments or visual effects.

10 When adjusting individual mattes, choose from the View menu to compare the mattes with and without adjustments:

- Choose Uncorrected to view a matte without adjustments.
- Choose Corrected to view a matte with all adjustments.

11 Before closing the Effect Controls panel, select Final Output from the View menu. Final Output must be selected for After Effects to render the transparency.



To remove traces of reflected key color from the image, apply Spill Suppressor using Better For Color Accuracy. If the image still has a lot of color, apply the Simple Choker or Matte Choker effect.

Color Key effect

The Color Key effect keys out all image pixels that are similar to a specified key color. This effect modifies only the alpha channel of a layer.

This effect works with 8-bpc and 16-bpc color.

See also

“Keying overview and tips” on page 268

“Matte Choker effect” on page 450

“Simple Choker effect” on page 451

Key out a single color with the Color Key effect

- 1 Select the layer.
- 2 Choose Effect > Keying > Color Key.
- 3 In the Effect Controls panel, specify a key color in one of two ways:
 - Click the Key Color swatch to open the Color dialog box and specify a color.
 - Click the eyedropper, and then click a color on the screen.
- 4 Drag the Color Tolerance slider to specify the range of color to key out. Lower values key out a smaller range of colors near the key color. Higher values key out a wider range of color.
- 5 Drag the Edge Thin slider to adjust the width of the keyed area’s border. Positive values enlarge the mask, increasing the transparent area. Negative values shrink the mask, decreasing the transparent area.
- 6 Drag the Edge Feather slider to specify the softness of the edge. Higher values create a softer edge but take longer to render.

Color Range effect

The Color Range effect creates transparency by keying out a specified range of colors in either the Lab, YUV, or RGB color space. You can use this key on screens that consist of more than one color or on bluescreens or greenscreens that have been unevenly lit and contain different shades of the same color.

This effect works with 8-bpc color.

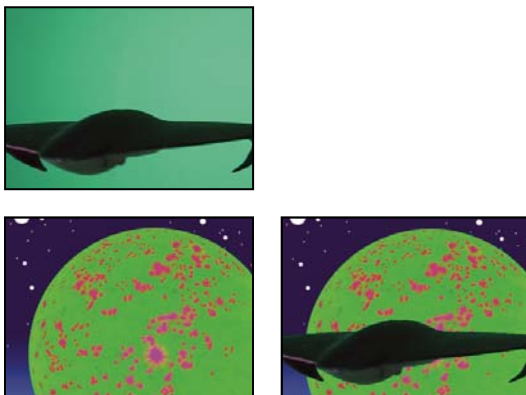

Poorly lit greenscreen (top left) and background layer (bottom left) are combined using Color Range Key (bottom right).

See also

“Keying overview and tips” on page 268

“Matte Choker effect” on page 450

“Simple Choker effect” on page 451

Use the Color Range effect

- 1 Select the layer you want to make transparent, and then choose Effect > Keying > Color Range.
- 2 Choose Lab, YUV, or RGB from the Color Space menu. If you have trouble isolating the subject using one color space, try using a different one.
- 3 Select the Key Color eyedropper, and then click in the matte thumbnail to select the area that corresponds to a color in the Composition panel you want to make transparent. Typically, this first color is the one that covers the largest area of the image.

Note: To use the eyedroppers in the Layer panel, choose Color Range from the View menu in the Layer panel.

- 4 Select the Plus eyedropper, and then click other areas in the matte thumbnail to add other colors or shades to the range of colors keyed out for transparency.
- 5 Select the Minus eyedropper, and then click areas in the matte thumbnail to subtract other colors or shades from the range of colors keyed out.
- 6 Drag the Fuzziness slider to soften the edges between transparent and opaque regions.
- 7 Use the sliders in the Min/Max controls to fine-tune the color range you selected with the Plus and Minus eyedroppers. The L, Y, R sliders control the first component of the specified color space; the a, U, G sliders control the second component; and the b, V, B sliders control the third component. Drag the Min sliders to fine-tune the beginning of the color range. Drag the Max sliders to fine-tune the end of the color range.

Difference Matte effect

The Difference Matte effect creates transparency by comparing a source layer with a difference layer, and then keying out pixels in the source layer that match both the position and color in the difference layer. Typically, it's used to key out a static background behind a moving object, which is then placed on a different background. Often the difference layer is simply a frame of background footage (before the moving object has entered the scene). For this reason, the Difference Matte effect is best used for scenes that have been shot with a stationary camera and an unmoving background.

This effect works with 8-bpc and 16-bpc color.

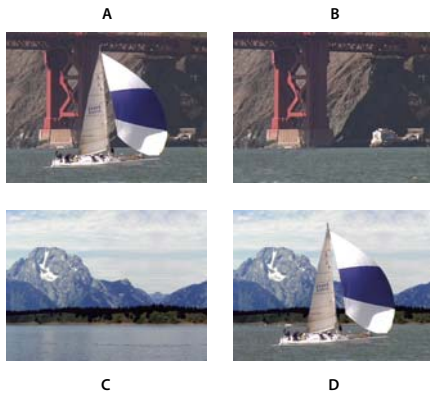

Difference Matte Key effect

A. Original image B. Background image C. New background image D. Final composite image

See also

“Keying overview and tips” on page 268

“Matte Choker effect” on page 450

“Simple Choker effect” on page 451

Use the Difference Matte effect

- 1 Select a motion footage layer as the source layer.
- 2 In the source layer, find a frame that consists only of background, and save the background frame as an image file. (See “Export a single frame of a composition” on page 607.)
- 3 Import the image file into After Effects, and add it to the composition.

The imported image becomes the difference layer. Make sure that its duration is at least as long as that of the source layer.

Note: If the shot doesn't contain a full background frame, you may be able to assemble the full background by combining parts of several frames in After Effects or Photoshop. For example, you can use the Clone Stamp tool to take a sample of the background in one frame, and then paint the sample over part of the background in another frame.

- 4 Turn off the display of the difference layer by clicking the Video switch in the Timeline panel.
- 5 Make sure that the original source layer is selected, and then choose Effect > Keying > Difference Matte.
- 6 In the Effect Controls panel, choose Final Output or Matte Only from the View menu. (Use the Matte Only view to check for holes in the transparency. To fill undesired holes after you complete the keying process, see “Close a hole in a matte” on page 271.)
- 7 Select the background file from the Difference Layer menu.
- 8 If the difference layer isn't the same size as the source layer, choose one of the following controls from the If Layer Sizes Differ menu:

Center Places the difference layer in the center of the source layer. If the difference layer is smaller than the source layer, the rest of the layer fills with black.

Stretch To Fit Stretches or shrinks the difference layer to the size of the source layer. Background images may become distorted.

- 9 Adjust the Matching Tolerance slider to specify the amount of transparency based on how closely colors must match between the layers. Lower values produce less transparency; higher values produce more transparency.
- 10 Adjust the Matching Softness slider to soften the edges between transparent and opaque areas. Higher values make matched pixels more transparent but don't increase the number of matching pixels.
- 11 If the matte still contains extraneous pixels, adjust the Blur Before Difference slider. This slider suppresses noise by slightly blurring both layers before the comparison is made. Note that the blurring occurs only for the comparison and doesn't blur final output.
- 12 Before closing the Effect Controls panel, make sure to select Final Output from the View menu to ensure that After Effects renders the transparency.

Extract effect

The Extract effect creates transparency by keying out a specified brightness range, based on a histogram of a specified channel. It's best used to create transparency in an image shot against a black or white background or against a background that is very dark or bright but consists of more than one color.

Note: The controls for this effect are similar to those of the Extract effect in Adobe Premiere Pro, but the purpose and results of the effect are different.

This effect works with 8-bpc and 16-bpc color.

See also

“Keying overview and tips” on page 268

“Matte Choker effect” on page 450

“Simple Choker effect” on page 451

Use the Extract effect

In the Effect Controls panel, the Extract effect displays a histogram for a channel specified in the Channel menu. The histogram displays a representation of the brightness levels in the layer, showing the relative number of pixels at each level. From left to right, the histogram extends from the darkest (a value of 0) to the lightest (a value of 255).

Using the transparency control bar beneath the histogram, you can adjust the range of pixels that are made transparent. The position and shape of the bar in relation to the histogram determine transparency. Pixels corresponding to the area covered by the bar remain opaque; pixels corresponding to the areas not covered by the bar are made transparent.

- 1 Select the layer you want to make transparent, and then choose Effect > Keying > Extract.
- 2 If you are keying out bright or dark areas, choose Luminance from the Channel menu. To create visual effects, choose Red, Green, Blue, or Alpha.
- 3 Adjust the amount of transparency by dragging the transparency control bar in the following ways:
 - Drag the upper right or upper left selection handles to adjust the length of the bar and to shorten or lengthen the transparency range. You can also adjust the length by moving the White Point and Black Point sliders. Values above the white point and below the black point are made transparent.
 - Drag the lower right or lower left selection handles to taper the bar. Tapering the bar on the left affects the softness of transparency in the darker areas of the image; tapering it on the right affects the softness in the lighter areas. You can also adjust the softness levels by adjusting White Softness (lighter areas) and Black Softness (darker areas).

Note: To taper the edges of the transparency control bar, you must first shorten the transparency bar.

- Drag the entire bar left or right to position it under the histogram.

Inner/Outer Key effect

The Inner/Outer Key effect isolates a foreground object from its background.

This effect works with 8-bpc and 16-bpc color.

See also

“Keying overview and tips” on page 268

Use the Inner/Outer Key effect

To use the Inner/Outer key, create a mask to define the inside and outside edge of the object you want to isolate. The mask can be fairly rough—it doesn’t need to fit exactly around the edges of the object.

In addition to masking a soft-edged object from its background, Inner/Outer Key modifies the colors around the border to remove contaminating background colors. This color decontamination process determines the background’s contribution to the color in each border pixel, and then removes that contribution—thus removing the halo that can appear if a soft-edged object is matted against a new background.

1 Select the border of the object that you want to extract by doing one of the following:

- Draw a single closed mask near the object’s border; then select the mask from the Foreground menu and leave the Background menu set to None. Adjust the Single Mask Highlight Radius to control the size of the border around this mask. (This method works well only on objects with simple edges.)
- Draw two closed masks: an inner mask just inside the object, and an outer mask just outside the object. Make sure that any fuzzy or uncertain areas of the object lie within these two masks. Select the inner mask from the Foreground menu and the outer mask from the Background menu.

Note: Make sure that the mask mode for all masks is set to None.

2 If you want, move the masks around to find the location that provides the best results.

3 To extract more than one object, or to create a hole in an object, draw additional masks and then select them from the Additional Foreground and Additional Background menus. For example, to key out a woman’s hair blowing in the wind against a blue sky, draw the inner mask inside her head, draw the outer mask around the outside edge of her hair, and then draw an additional mask around the gap in her hair where you can see sky. Select the additional mask from the Additional Foreground menu to extract the gap and remove the background image.

4 Create additional open or closed masks to clean up other areas of the image, and then select them from the Cleanup Foreground or Cleanup Background menu. Cleanup Foreground masks increase the opacity along the mask; Cleanup Background masks decrease the opacity along the mask. Use the Brush Radius and Brush Pressure options to control the size and density of each stroke.

Note: You can select the Background (outer) mask as a Cleanup Background mask to clean up noise from the background portions of the image.

5 Set Edge Thin to specify how much of the matte’s border is affected by the key. A positive value moves the edge away from the transparent region, increasing the transparent area; a negative value moves the edge toward the transparent region and increases the size of the foreground area.

6 Increase the Edge Feather values to soften edges of the keyed area. High Edge Feather values take longer to render.

- 7 Specify the Edge Threshold, which is a soft cutoff for removing low-opacity pixels that can cause unwanted noise in the image background.
- 8 Select Invert Extraction to reverse the foreground and background regions.
- 9 Set Blend With Original to specify the degree to which the resulting extracted image blends with the original image.

Linear Color Key effect

Linear keys create a range of transparency across an image. A linear key compares each pixel in the image to the key color you specify. If the color of a pixel closely matches the key color, it becomes completely transparent. Pixels that don't match as well are made less transparent, and pixels that don't match at all remain opaque. The range of transparency values, therefore, forms a linear progression.

The Linear Color Key effect uses RGB, hue, or chroma information to create transparency from a specified key color. This effect works with 8-bpc, 16-bpc, and 32-bpc color.

See also

“Keying overview and tips” on page 268

“Matte Choker effect” on page 450

“Simple Choker effect” on page 451

Apply the Linear Color Key effect

In the Effect Controls panel, the Linear Color Key effect displays two thumbnail images; the left thumbnail image represents the unaltered source image, and the right thumbnail image represents the view you've selected in the View menu.

You can adjust the key color, the matching tolerance, and the matching softness. The matching tolerance specifies how closely pixels must match the key color before they start becoming transparent. The matching softness controls the softness of edges between the image and the key color.

You can also reapply this key to preserve a color that was made transparent by the first application of the key. For example, if you key out a medium-blue screen, you might lose some or all of a light-blue piece of clothing your subject is wearing. You can bring back the light-blue color by applying another instance of the Linear Color Key and choosing Keep This Color from the Key Operation menu.

- 1 Select a layer as the source layer, and then choose Effect > Keying > Linear Color Key.
- 2 In the Effect Controls panel, choose Key Colors from the Key Operation menu.
- 3 Choose a color space from the Match Colors menu. In most cases, use the default RGB setting. If you have trouble isolating the subject using one color space, try using a different color space.
- 4 In the Effect Controls panel, choose Final Output from the View menu. The view you choose appears in the right thumbnail and in the Composition panel. If you need to see other results, work in one of the other views:

Source Only Shows the original image without the key applied.

Matte Only Shows the alpha channel matte. Use this view to check for holes in the transparency. To fill undesired holes after you complete the keying process, see “Close a hole in a matte” on page 271.

5 Select a key color in one of the following ways:

- Select the Thumbnail eyedropper, and then click an appropriate area in the Composition panel or the original thumbnail image.
- Select the Key Color eyedropper, and then click an appropriate area in the Composition or Layer panel.
- To preview transparency for different colors, select the Key Color eyedropper, hold down the Alt key (Windows) or Option key (Mac OS), and move the cursor to different areas in the Composition panel or the original thumbnail image. The transparency of the image in the Composition panel changes as you move the cursor over different colors or shades. Click to select the color.
- Click the Key Color swatch to select a color from the specified color space. The selected color becomes transparent.

Note: The eyedropper tools move the sliders accordingly. Use the sliders in steps 6 and 7 to fine-tune the keying results. To use eyedroppers in the Layer panel, choose Linear Color Key from the View menu in the Layer panel.

6 Adjust matching tolerance in one of the following ways:

- Select the Plus (+) or the Minus (-) eyedropper, and then click a color in the left thumbnail image. The Plus eyedropper adds the specified color to the key color range, increasing the matching tolerance and the level of transparency. The Minus eyedropper subtracts the specified color from the key color range, decreasing the matching tolerance and the level of transparency.
- Drag the matching tolerance slider. A value of 0 makes the entire image opaque; a value of 100 makes the entire image transparent.

7 Drag the Matching Softness slider to soften the matching tolerance by tapering the tolerance value. Typically, values under 20% produce the best results.

8 Before closing the Effect Controls panel, make sure to select Final Output from the View menu to ensure that After Effects renders the transparency.

Preserve a color after applying Linear Color Key

1 In the Effect Controls panel or Timeline panel, turn off any current instances of keys or matte effects by deselecting the Effect option to the left of the key name or tool name. Deselecting the option causes the original image to appear in the Composition panel so that you can select a color to preserve.

2 Choose Effect > Keying > Linear Color Key. A second set of Linear Color Key controls appears in the Effect Controls panel below the first set.

3 In the Effect Controls panel, choose Keep Colors from the Key Operation menu.

4 Select the color you want to keep.

5 In the first application of the Linear Color Key effect, choose Final Output from the View menu in the Effect Controls panel, and then turn other instances of the Linear Color Key effect back on to examine the transparency. You may need to adjust colors or reapply the key a third time to get the results you need.

Luma Key effect

The Luma Key effect keys out all the regions of a layer with a specified luminance or brightness. The layer's quality setting doesn't influence the Luma Key effect.

Use this effect if the object from which you want to create a matte has a greatly different luminance value than its background. For example, if you want to create a matte for musical notes on a white background, you can key out the brighter values; the dark musical notes become the only opaque areas.

This effect works with 8-bpc and 16-bpc color.

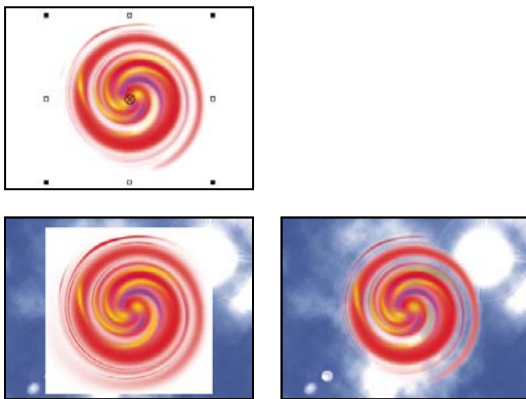

White background of original (top left and bottom left) is removed using Luma Key and composited over underlying layer (bottom right).

See also

“Keying overview and tips” on page 268

“Matte Choker effect” on page 450

“Simple Choker effect” on page 451

Key out a luminance value with the Luma Key effect

- 1 Select the layer, and choose Effect > Keying > Luma Key.
- 2 Select a Key Type to specify the range to be keyed out.
- 3 Drag the Threshold slider in the Effect Controls panel to set the luminance value you want the matte to be based on.
- 4 Drag the Tolerance slider to specify the range of values to be keyed out. Lower values key out a smaller range of values near the threshold. Higher values key out a wider range of values.
- 5 Drag the Edge Thin slider to adjust the width of the keyed area’s border. Positive values make the mask grow, increasing the transparent area. Negative values shrink the mask.
- 6 Drag the Edge Feather slider to specify the softness of the edge. Higher values create a softer edge but take longer to render.

Spill Suppressor effect

The Spill Suppressor effect removes traces of the key color from an image with a screen that’s already been keyed out. Typically, the Spill Suppressor is used to remove key color spills from the edges of an image. Spills are caused by light reflecting off the screen and onto the subject.

 *If you’re not satisfied with the results from using the Spill Suppressor, try applying the Hue/Saturation effect to a layer after keying, and then decrease the saturation value to de-emphasize the key color. (See “Hue/Saturation effect” on page 398.)*

This effect works with 8-bpc and 16-bpc color.

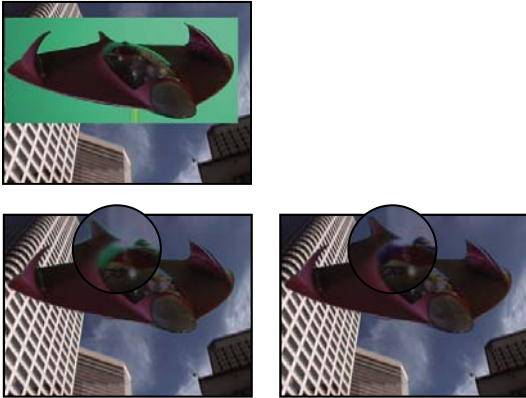

Original greenscreen (top left) leaves green glow when keyed out (bottom left). Spill Suppressor removes glow (bottom right).

See also

“Keying overview and tips” on page 268

“Matte Choker effect” on page 450

“Simple Choker effect” on page 451

Use the Spill Suppressor effect

- 1 Select the layer and choose Effect > Keying > Spill Suppressor.
- 2 Choose the color you want to suppress in one of the following ways:
 - If you already keyed out the color with a key in the Effect Controls panel, click the Color To Suppress eyedropper, and then click the screen color in the key’s Key Color swatch.
 - In Spill Suppressor, click the Key Color swatch and choose a color from the color wheel.

Note: To use the eyedropper in the Layer panel, choose Spill Suppressor from the View menu in the Layer panel.

- 3 From the Color Accuracy menu, choose Faster to suppress blue, green, or red. Choose Better to suppress other colors, because After Effects may need to analyze the colors more carefully to produce accurate transparency. The Better option may increase rendering time.
- 4 Drag the Suppression slider until the color is adequately suppressed.

Matte effects

Matte Choker effect

The Matte Choker effect repeats a sequence of choking and spreading the matte to fill undesired holes (transparent areas) in opaque regions. The repetition is necessary because the entire matte must be choked and spread; the spreading fills the hole, but the edges of the matte must be choked back to preserve the matte shape.

This effect works with 8-bpc and 16-bpc color.

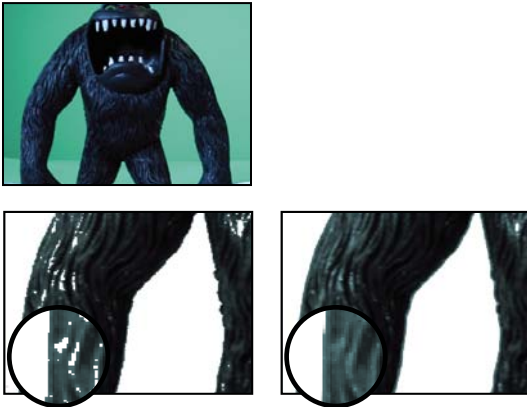

Original (top left) shows areas of unwanted transparency after using Color Key (bottom left) that are removed with Matte Choker (bottom right).

See also

“Keying overview and tips” on page 268

“Close a hole in a matte” on page 271

Simple Choker effect

The Simple Choker effect shrinks or expands the edges of a matte in small increments to create a cleaner matte. The Final Output view displays the image with the effect applied, and the Matte view provides a black-and-white view of the image with black areas indicating transparency and white areas indicating opacity. Choke Matte sets the amount of choke. Negative values spread the matte; positive values choke it.

This effect works with 8-bpc and 16-bpc color.

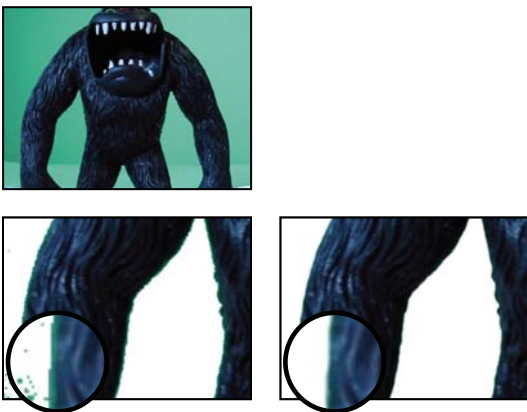

Original (top left) contains unwanted edges after keying (bottom left) that are removed with Simple Choker (bottom right).

See also

“Keying overview and tips” on page 268

Noise & Grain effects

Work with Grain effects

Almost every digital image captured from the real world contains grain or visual noise caused by the recording, encoding, scanning, or reproduction processes and by the equipment used to create the image. Examples include the faint static of analog video, compression artifacts from digital cameras, halftone patterns from scanned prints, CCD noise from digital image sensors, and the characteristic speckle pattern of chemical photography, known as *film grain*.

Noise isn't necessarily bad; it's often added to images to create a mood or tie elements together, such as adding film grain to a computer-generated object to integrate it into a photographed scene. However, noise can be unwanted for aesthetic reasons. Archival footage or high-speed photography may appear unpleasantly grainy; digital compression artifacts or halftone patterns may mar an image; or noise may interfere with technical processes such as bluescreen compositing.

There are also technical reasons to reduce noise. For example, compression algorithms usually achieve smaller file sizes if the input material is less noisy, so noise reduction is a valuable preprocessing step for work such as DVD creation and video streaming.

The Add Grain, Match Grain, and Remove Grain effects allow you to manipulate grain that appears more or less evenly over an entire image. Grain effects can't correct image problems that affect only a few pixels, such as dust, salt and pepper noise, or analog video dropouts.

The Add Grain effect generates new grain from nothing; it doesn't take samples from existing grain. Instead, a number of parameters and presets for different types of film can be used to synthesize different types of grain.

The Remove Grain and Match Grain effects use a two-step process to manipulate grain without affecting the edges, sharpness, or highlights of an image. First, the grain is sampled, either automatically or manually; second, the grain is analyzed and portrayed by a mathematical model, which the effect uses to add, remove, or match the grain.

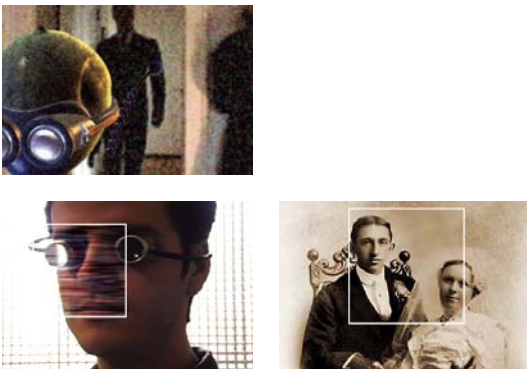

Three types of grain effects: matching (top left), adding (bottom left), and removing (bottom right)

RE:Vision Effects provides the DE:Noise plug-in for removing noise and grain from images:
www.adobe.com/go/learn_ae_revisionfxdenoise.

Neat Video provides the Reduce Noise plug-in for removing noise from digital video:
www.adobe.com/go/learn_ae_neatvideoreducenoise.

Apply a grain effect

Each grain effect is applied with default settings and is displayed in Preview viewing mode, which has a preview region framed by a white border and centered on the image. The preview region displays the results of the grain effect on just a portion of your image, for speed and comparison purposes. The grain effects are almost fully automatic but also offer many controls to achieve precise results. You can also selectively apply the grain effects to portions of your image using the extensive Blend With Original features provided with each effect.

- 1 Select the layer you want to affect.
- 2 Choose Effect > Noise & Grain > *[effect]*.
- 3 Choose a viewing method from the Viewing Mode control in the Effect Controls panel:

Preview Displays the current settings of the applied effect in a 200x200-pixel area.

Blending Matte Shows the current color matte or mask, or the combination of both, which results from the current settings of the Blend With Original controls group.

Final Output Renders the full active frame, using the current settings of the effect.

- 4 Adjust the effect's controls in the Effect Controls panel.

The preview region in the Composition panel reflects any changes you make.

- 5 Choose Final Output from the Viewing Mode control.

Apply a grain effect to a selected area

The Blend With Original controls group lets you precisely apply a grain effect to a particular area of an image or sequence by masking and matting the desired area. You can choose between two selection techniques or use a combination of both:

Color Matching Excludes any area of the image that matches a selected color. By inverting the matte, you can also selectively process such an area.

Masking Layer Uses any layer in the current composition as a mask to selectively process or exclude an area of the current layer or track.

When any grain effect is first applied, the Amount value of the Blend With Original controls group is set to 0%; this value determines the percentage of blending between the original image and the processed version. At 0%, no blending occurs and the selected effect is applied to the entire image at full strength; at 100%, white areas of the blending matte are unchanged from the original image.

Any mask or matte works in a similar way: The white pixels in it exclude that area of the original image from processing by the grain effect; the black pixels process normally. At 100% Amount, the white areas fully blend with the original so that they are completely excluded from the processing. This behavior remains true when the match is inverted. Regardless of the Amount value, the black areas of the matte or mask are always processed. The Amount slider affects only the areas under the white pixels in the matte or mask. It affects only how the white areas of the matte or mask are treated by each grain effect.

- 1 Apply a grain effect to the image.
- 2 Do any of the following in the Effect Controls panel:
 - To create a matte around the area to which you want to apply or exclude the grain effect, use the Color Matching controls in the Blend With Original controls group.
 - To mask the current layer with another layer or track, use the Masking Layer controls.

- 3 Adjust the Blur Matte value to soften the matte and to produce a softer transition between the affected and unaffected areas of the image.
- 4 If you're using both a color matte and a layer mask, choose one of the following from the Combine Match And Mask Using menu:
 - Screen** Makes the matte white wherever either the mask or the color match is white.
 - Multiply** Makes the matte white where both of the inputs are white.
- 5 Reduce the Amount value to let more of the original image show through the grain.
- 6 Choose Final Output from the Viewing Mode control.

Generate a color-matching matte

When a grain effect is first applied, a neutral gray color is used to generate a default color-matching matte, so that in most images a visible matte appears. The Color Matching group of controls uses color matching to precisely define a matte. The matte isolates portions of the image where the layer that uses the grain effect is blended with the input.

- 1 Apply a grain effect to the image.
- 2 To select a color to exclude from or restrict to the effect, do one of the following adjacent to the Matching Color control in the Blend With Original and Color Matching controls groups:
 - Click the color swatch and select a color in the Color Picker dialog box.
 - Click the eyedropper  and click a color anywhere on-screen.
- 3 Do one of the following:
 - To prevent the grain effect from affecting the selected color, make sure that the Invert Match control is deselected.
 - To restrict the grain effect to the selected color, leaving the rest of the image unaffected, select Invert Match.
- 4 If you want to exclude colors that are similar to the matching color, increase the Matching Tolerance value, which sets a threshold for color matching. As the value increases, the matte includes pixels with colors increasingly different from the matching color.
- 5 Choose an option from the Match Color Using control if you want to change the default criterion (RGB) used to determine that a color is similar to the matching color.
- 6 Adjust the Matching Softness controls to determine the width of the transition band between completely matched and completely unmatched pixels or how smoothly the affected areas blend with the original image.
- 7 Select Invert Match if you want to invert the matte so that the white areas become black and the black areas become white. (The matching color will be black in the matte and will be processed by the grain effect regardless of the Amount setting. The inversion doesn't affect any other settings.)
- 8 If you're using both a color matte and a layer mask, choose one of the following from the Combine Match And Mask Using menu:
 - Screen** Makes the matte white wherever either the mask or the color match is white.
 - Multiply** Makes the matte white where both of the inputs are white.
- 9 Choose Final Output from the Viewing Mode control.

Generate a layer matte

In some cases, you may want to use a different layer or track as a mask for the layer that uses a grain effect. This type of mask allows unlimited control over exactly which parts of an image are modified and by how much.

- 1 Apply a grain effect to the image.
- 2 In the Effect Controls panel, choose the layer that you want to use as a mask from the Mask Layer control in the Blend With Original and Masking Layer controls groups.
- 3 Choose a masking mode from one of the standard track matte mode options.
- 4 If the masking layer is a different size than the current layer, choose one of the following from the If Mask Size Differs pop-up menu in the Masking Layer controls:

Center Centers the masking layer over the current layer.

Stretch To Fit Resizes the masking layer to match the dimensions of the current layer.

- 5 If you're using both a color matte and a layer mask, choose one of the following from the Combine Match And Mask Using menu:

Screen Makes the matte white wherever either the mask or the color match is white.

Multiply Makes the matte white where both of the inputs are white.

- 6 Choose Final Output from the Viewing Mode control.

Change the preview region

You can use the Preview Region controls group to change the position or the size of a grain effect's preview region.

Because adding or removing grain can affect sharpness of detail, you may want to preview an area of fine detail, such as a human face or some text. When you remove grain with the Remove Grain effect, a best practice is to preview an area where the grain is most clearly visible or most objectionable, such as a large expanse of solid color.

You'll achieve the best results by experimenting, applying small increments to each of several controls in the Effect Controls panel, and viewing the results in the Composition panel after every adjustment.

- 1 After applying a grain effect, click the Center button  in the Preview Region group of controls in the Effect Controls panel.

A cross hair is centered in the Composition panel.

- 2 In the image, click the desired center of the preview region.

The preview region redraws, centered in the new position.





- 3 To change the dimensions of the preview region, change the Width and Height values in the Effect Controls panel to the desired size, in pixels. (Larger preview regions can result in slower rendering.)

- 4 Select Show Box if you want to outline the preview region in color. If you want to change the outline color, next to Box Color do one of the following:

- Click the color swatch and select a color in the Color Picker dialog box.
- Click the eyedropper button, and click a color anywhere on-screen.

- 5 View the results:

- To view the fine detail of the noise structure, zoom into the preview region.
- To examine the noise in each channel independently, click the corresponding color channel icon in the Composition panel.

- To increase the effect's interaction speed and RAM preview duration, use the Region Of Interest feature in the Composition panel to reduce the area that's processed. (See "Work with the region of interest" on page 111.)
- To retain an image of the current frame in its current state, click Take Snapshot  in the Composition panel. You can subsequently click and hold down Show Last Snapshot  to view the most recent snapshot instead of the active composition, and to toggle between the current and previous states of the preview region. This technique is extremely useful for evaluating subtle adjustments. (See "Work with snapshots" on page 125.)
- To compare the preview region with and without the grain effect, click the Effect switch (small *f* icon) next to the grain effect's name in the Effect Controls panel to temporarily disable the effect. Click Take Snapshot  in the Composition panel, click the Effect switch again to re-enable the effect, and then click and hold down Show Last Snapshot  to display the snapshot of the image without the effect.

Work with noise samples in Grain effects

Noise sampling is the first and most important step in removing noise from an image or in matching the noise of one image in another image. Normally, this process is entirely automatic. For very fine control, you can switch to Manual mode and adjust the samples using the Sampling controls group in the Effect Controls panel.

A noise sample should be a solid block of uniform color that clearly displays the noise pattern present in the image. The objective is to extract samples of pure noise, without any image features that the algorithm could misconstrue as grain. For instance, extract samples from a piece of sky, a background wall, or an area of fleshtone. All samples should be selected from the normal range of the film, DV, or video stock. Avoid underexposed or overexposed areas lacking in information, especially areas where pixel values have been clipped to pure black or white. Within this normal exposure range, it's best to select samples with various RGB values and colors—for example, one sample from a bright area, one from a dark area, and one from an area with midtones.

The number of samples in automatic mode is high to ensure that the algorithm has enough good noise data, even if finding good samples in a particular image is difficult. In addition, automatic mode may override the number of samples you've set if the effect can't find enough good samples. You can vary the size of the samples in either automatic or manual mode; however, increasing sample size doesn't guarantee better results, especially if the resulting samples include more substantial variations in RGB values. Sample size should be reduced if a particular image doesn't contain sufficiently large areas of constant color values. Conversely, increasing the sample size may give better results if the image contains large featureless areas.

Manually reposition noise samples



Automatic grain or sample selection generally gives acceptable results for the Match Grain or Remove Grain effect, but you can choose to manually position and resize each sample or change the sample number. For example, you may want to reposition samples if the automatic sampling selected a uniform area that is underexposed or overexposed and that lacks information about grain structure.

Noise samples for the Match Grain and Remove Grain effects are always extracted from the source layer without regarding any effects or masks already applied to the layer; this method results in more accurate sampling. If you want the samples to include the existing effects, you must precompose or prerender the source layer with the effects and then apply the grain effect to the resulting source layer.

Avoid sample areas with the following characteristics: sharp edges, color gradients, highlights, textures such as grass or water ripples, fine detail such as hair or tree leaves, and overexposed or underexposed areas lacking in information.

1 In the Effect Controls panel, choose Noise Samples from the Viewing Mode menu.

The samples appear as small white squares (24 x 24 pixels) overlaid on the source image.

- 2 Choose Manual from the Sample Selection pop-up menu in the Sampling controls group.
- 3 To remove the least desirable samples from the image, try reducing the Number Of Samples value.
- 4 To move a noise sample, do one of the following:
 - Click the point parameter  for the noise sample in the Noise Sample Points controls group. A cross hair appears in the composition, centered on that sample. Click the desired location in the Composition panel to place the sample.
 - Using the Selection tool , drag the sample point in the Composition panel to the desired location.
 - Enter the desired horizontal and vertical coordinates in the Effect Controls panel.

Note: The number of sample points that are enabled corresponds to the current value of the Number Of Samples.

- 5 Repeat for each sample point you want to move.

Change the sampling source frame

By default, the Remove Grain and Match Grain effects take noise samples from the first frame of the sequence, but you can choose to sample the noise from a different frame. Changing the frame might be useful if large lighting or exposure variations occur between frames within the sequence.

- 1 Decide which frame you want to sample; make sure that the project settings Display Style is set to Frames, numbering from zero. The number of the current frame then appears in blue in the top left corner of the Timeline panel. Enter that frame number as the Source Frame value in the Sampling controls group.
- 2 Choose Noise Samples from the Viewing Mode menu.

The selected frame appears in the Composition panel, and its automatic samples appear on the image.

Change the noise sample box color

You can set the Remove Grain or Match Grain effect's viewing mode to Noise Samples to see the areas sampled by the effect. Sampled areas are automatically framed with a white outline. If you prefer, you can change the color of these noise sample boxes.

- ❖ Next to the Sample Box Color control in the Sampling controls group, do one of the following:
 - Click the color swatch, and select a color in the Color Picker.
 - Click the eyedropper, and click a color anywhere in the application window.

Working with added or matched grain

The Add Grain effect creates new grain or noise in an image by building the grain from nothing or by basing the grain's properties on presets. The Match Grain effect also creates new grain in an image but by matching the grain in a different image. Both effects share several controls in the Effect Controls panel that let you control the new grain's color, tonal range, blending mode, and animation properties.

Adjusting the tones of added or matched grain

The precise grain pattern present in any frame of film isn't uniform throughout the frame but may depend on the tonal values of the content at each pixel. For example, in chemical film grain, the sizes of the silver halide crystals actually vary with the exposure level.

The Add Grain and Match Grain effects let you reproduce these subtle changes in grain patterns across areas of an image or a sequence by using the Shadows, Midtones, Highlights, and Midpoint controls in the Application controls group. These controls let you define how much grain is added to each tonal area and also to each channel in the image. For example, you can add more grain to overexposed areas of the blue channel to give an image of sky a grainier look.

You can use the Application controls group for the Add Grain or Match Grain effect to do the following:

- To define how much grain is added to each tonal area in an image, adjust the Shadows, Midtones, and Highlights values.
- To define the midpoint of the image's tonal range for grain application purposes, adjust the Midpoint slider. By default, this slider is centered at 0.5, which represents the middle of the range of pixel values—127 for 8-bpc images and 16384 for 16-bpc images.
- For even finer control, use the Channel Balance controls to adjust the grain in the shadow, midtone, and highlight areas independently for each channel.

Animating added or matched grain

By default, the grain or noise generated by the Add Grain and Match Grain effects moves at the same speed as the source material to accurately simulate realistic noise. Slowing down the noise processes may be useful for aesthetic effect or to keep the added noise from buzzing and drawing attention to itself. These effects have an internal randomizer that changes the positions of the noise pixels between frames. But you can also change the appearance of the noise between layers on the same frame while keeping every other parameter constant.

You can use the Animation controls group for the Add Grain or Match Grain effect to do the following:

- To determine the frame rate of the added grain, as a multiple of the destination frame rate, adjust the Animation Speed value in the Animation controls group in the Effect Controls panel. At the default 1, the noise moves at the same rate as the frames. At zero, the noise is stationary over time.
- To use interpolation to create smooth transitions between the generated noise frames, select Animate Smoothly. This control matters only if Animation Speed is less than 1.
- To change the appearance of the noise between layers on the same frame, adjust the Random Seed value. Each Random Seed value represents one of 100 possible variations in the appearance; changing the value doesn't make the results more or less random.

Blending and adjusting the color of added or matched grain

You can adjust the color, saturation, and blending behavior of the grain generated by the Add Grain or Match Grain effect.

Several factors can affect the apparent color of the grain that these effects generate, including the following:

- The color value of the underlying pixel in the source image.
- The Saturation value of the noise.
- The Tint Color and Tint Amount values, if you have modified these from the defaults.
- The Blending Mode value in the Application controls group.
- The amount of noise applied, if any, to each channel individually using the Channel Intensities controls group.

Using the Color controls group in the Effect Controls panel, you can adjust any of the following:

Monochromatic Gives the added noise a single tint. By default, the tones are black and white, but you can change the Tint Color to make it a gradient of any color. (The Saturation and Channel Intensities controls aren't available if Monochromatic is selected.)

Tint Amount Controls the depth and intensity of the color shift.

Tint Color Controls the color the added noise shifts toward.

Saturation Controls the amount and vividness of the color.

The Blending Mode in the Application controls determines how the color value of the generated noise combines with the color value of the underlying source layer at each pixel:

Film Makes the generated grain appear embedded in the image. This mode affects darker colors more than lighter ones, just as the grain in a film negative appears.

Multiply Multiplies the color values of the noise and the source. However, the result may be either lighter or darker than the original, because the noise may have either a positive or negative value.

Add Combines the color values of the pixel in the source with the noise. However, the result isn't always lighter than the original because the noise created by grain effects can have either a positive or negative value.

Screen Multiplies the inverse brightness values of the noise and the source. The effect is like printing from a multiple exposure on a negative. The result is always brighter than the original.

Overlay Combines the behavior of Film and Multiply: Both shadows and highlights get less grain, while midtones get a full application of grain.

Add Grain effect

The Add Grain effect generates new noise from nothing and does not take samples from existing noise. Instead, a number of parameters and presets for different types of film can be used to synthesize many different types of noise or grain. You can modify virtually every characteristic of this noise, control its color, apply it to the image in several ways, even animate it or apply it selectively to only a part of your image.

This effect works with 8-bpc and 16-bpc color.

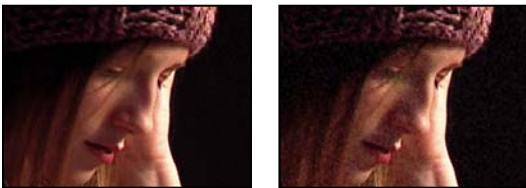

Original (left), and with effect applied (right)

The distribution of the added noise over the color channels does affect the overall color of the resulting image. With a dark background, the noise tends to add to the image visually, so a red tint or more noise in the red channel gives a reddish hue to the image. With a bright background, the noise tends to subtract from the image visually, so a red tint or more noise in the red channel gives a cyan color. The result also depends on the Blending Mode control in the Application controls group.

Note: The actual grain of your image may vary from the film presets, because of factors such as exposure and scanning resolution.

You can use the Add Grain effect's controls to do the following:

- To reproduce the grain of a particular film or photographic stock, choose the film type from the Add Grain effect's Preset menu in the Effect Controls panel.
- To adjust the intensity and size of the applied grain and introduce a blur, adjust the Tweaking controls group for the Add Grain effect in the Effect Controls panel.
- To modify the color of the added noise, adjust the Color controls.
- To define how the color value of the generated noise combines with the color value of the underlying destination layer at each pixel, choose a Blending Mode in the Application controls group.
- To define how much grain is added to each tonal area in your image and the midpoint, adjust the Shadows, Midtones, Highlights and Midpoint values in the Application controls group.
- To animate the added grain, adjust the properties in the Animation controls group.
- To apply the effect to the entire image, choose Final Output from the Viewing Mode menu.

Tweaking controls for Grain effects

The Match Grain and Add Grain effects share a group of Tweaking controls. You can use these controls to modify the intensity and size of the noise and to introduce a blur, all of which can be done across the three channels or individually for each channel. You can also change the aspect ratio of the applied grain.

Note: The values of the Tweaking controls are relative to the noise sampled in the source layer: a value of 1.0 leaves that property of the source noise unchanged, while higher and lower values alter the applied noise.

Adjust any of the following controls in the Tweaking controls group:

Intensity Controls the amount of variation in brightness and color strength between pixels in the generated noise, which determines the visibility of the noise. Increasing the value does not change the position or size of each grain but makes the grain appear to pop more; lower values give a more subtle muted appearance.

Channel Intensities Controls the contrast between pixels in the generated noise separately for each channel. For example, you may want to add more grain to the blue channel to emulate film.

Size Adjusts the size of the generated grain in pixels.

Channel Size Adjusts the size of the generated grain in pixels independently for each channel.

Softness Sets the amount of softness in the grain.

Aspect Ratio Controls the ratio of the width of the generated grain over a constant height of 1; this is useful for emulating the effect of anamorphic lenses or for aesthetic effects. A value higher than 1 stretches the grain horizontally; values smaller than 1 squash it horizontally.

See also

“Working with added or matched grain” on page 457

Dust & Scratches effect

The Dust & Scratches effect reduces noise and defects by changing dissimilar pixels within a specified radius to be more like their neighboring pixels. To achieve a balance between sharpness of the image and hiding defects, try various combinations of Radius and Threshold settings.

This effect works with 8-bpc and 16-bpc color.

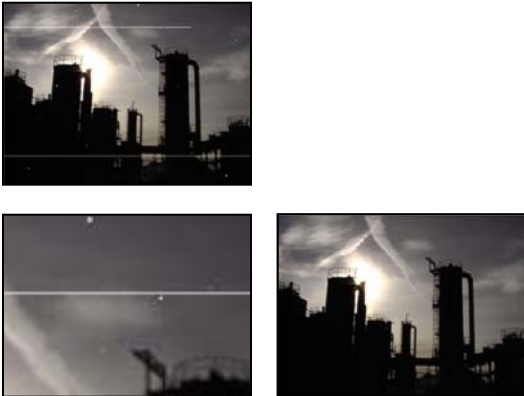

Original image with scratches (top left), enlarged view of scratches (bottom left), and scratches removed with loss of clarity (bottom right)

Radius How far the effect searches for differences among pixels. High values make the image blurry. Use the smallest value that eliminates the defects.

Threshold How different pixels can be from their neighbors without being changed by the effect. Use the highest value that eliminates the defects.

Fractal Noise effect

The Fractal Noise effect uses Perlin noise to create grayscale noise that you can use for organic-looking backgrounds, displacement maps, and textures, or to simulate things like clouds, lava, or vapor.

The Evolution controls create subtle changes in the shape of the fractal noise. Animating these controls results in smooth changes of the noise over time, creating an effect such as passing clouds or flowing water.

This effect works with 8-bpc, 16-bpc, and 32-bpc color.

Stu Maschwitz provides an example project that uses the Fractal Noise effect to create the corona of the Sun:
www.adobe.com/go/learn_ae_stucorona.

Guy Chen provides an example of using the Fractal Noise effect to generate the base noise (in this case for the turbulent surface of the Sun) and then colorizing the noise with the Colorama effect:
www.adobe.com/go/learn_ae_guyfractalsun.

Harry Frank provides an animation preset that uses Fractal Noise to create a star field:
www.adobe.com/go/learn_ae_harryfractalstars.

Controls

Fractal Type The noise is created by generating a grid of random numbers for each noise layer (where the number of noise layers is specified by Complexity). The Fractal Type setting determines the characteristics of this grid.

Noise Type The type of interpolation to use between the random values in the noise layer's grid.

Invert Inverts the noise. Black areas become white, and white areas become black.

Contrast The default value is 100. Higher values create larger, more sharply defined areas of black and white in the noise, generally revealing less subtle detail. Lower values result in more areas of gray, softening or muting the noise.

Overflow Remaps color values that fall outside of the range of 0–1.0, using one of the following options:

- **Clip** Remaps values so that any value above 1.0 is displayed as pure white, and any value below 0 is displayed as pure black. The Contrast value influences how much of the image falls outside of this range. Higher values result in

a mostly black and/or white image with less gray area. Therefore, higher contrast settings display less subtle detail. When used as a luma matte, the layer has sharper, better-defined areas of transparency.

- **Soft Clamp** Remaps values on an infinite curve so that all values stay in the range. This option reduces contrast and makes noise appear gray with few areas of pure black or pure white. When used as a luma matte, the layer contains subtle areas of transparency.
- **Wrap Back** Remaps triangularly, so that values above 1.0 or below 0 fall back into the range. This option reveals subtle detail when Contrast is set above 100. When used as a luma matte, the layer reveals more detailed textured areas of transparency.
- **Allow HDR Results** No remapping is performed. Values outside the range of 0-1.0 are preserved.

Transform Settings to rotate, scale, and position the noise layers. The layers appear as if they are at different depths if you select Perspective Offset.

Complexity The number of noise layers that are combined (according to the Sub Settings) to create the fractal noise. Increasing this number increases the apparent depth and amount of detail in the noise.

Note: Increasing Complexity results in longer rendering times. If appropriate, try reducing the Size rather than increasing Complexity to achieve similar results and avoid longer rendering. A trick to increase apparent complexity without increasing rendering time is to use a negative or very high Contrast or Brightness setting and choose Wrap Back for Overflow.

Sub Settings The fractal noise is generated by combining layers of noise. The Sub Settings control how this combination occurs and how the noise layers' properties are offset from one another. Scaling successive layers down creates finer details.

- **Sub Influence** How much influence each successive layer has on the combined noise. At 100%, all iterations have the same amount of influence. At 50%, each iteration has half as much influence as the previous iteration. A value of 0% makes the effect appear exactly as if Complexity is 1.
- **Sub Scaling, Rotation, and Offset** The scale percentage, angle, and position of a noise layer relative to the previous noise layer.
- **Center Subscale** Calculates each noise layer from the same point as the previous layer. This setting can result in the appearance of duplicated noise layers stacked on top of each other.

Evolution Uses progressive revolutions that continue to change the image with each added revolution. This method is unlike typical revolutions that refer to a setting on the dial control for which the result is the same for every multiple of 360°. For Evolution, the appearance at 0° is different from that at 1 revolution, which is different from that at 2 revolutions, and so on. To return the Evolution setting to its original state (for example, to create a seamless loop), use the Cycle Evolution option.

You can specify how much the noise evolves over a period of time by animating Evolution. The more revolutions within a given amount of time, the more rapidly the noise changes. Large changes in the Evolution value over a short period of time may result in flashing.

To create a seamless loop, use Cycle Evolution, and set Evolution keyframes at full revolutions with no degrees—partially completed revolutions may interrupt the loop.

Evolution Options Options for Evolution.

- **Cycle Evolution** Creates a cycle of Evolution that loops over the set amount of time. This option forces the Evolution state to return to its starting point, creating a smooth progressive cycle, a nonrepeating cycle, or a loop segment.

To ensure that a cycle completes full revolutions, choose a Cycle value that either matches or is evenly divisible by the number of revolutions set for Evolution.

- **Cycle (in Revolutions)** Specifies the number of revolutions that the noise cycles through before it repeats. The speed of these Evolution cycles is determined by the amount of time between Evolution keyframes. This option affects only the evolution of the noise, not Transform or other controls. For example, if you view two identical states of noise with different Size or Offset settings, they don't appear the same.

Note: Cycle is available only if Cycle Evolution is selected.

- **Random Seed** Sets a unique random value from which to generate the noise. Animating the Random Seed results in flashing from one set of noise to another (within that fractal type). For smooth transition of the noise, use the Evolution option.

 You can easily create new fractal noise animations by reusing previously created Evolution cycles and changing only the Random Seed value. Using a new Random Seed value alters the noise pattern without disturbing the Evolution animation.

 Instead of animating Evolution over the entire composition, save rendering time by prerendering and looping one short Evolution cycle for the duration you want.

Opacity Specifies the opacity of the noise.

Blending Mode Specifies an operation between the fractal noise and the original image. These blending modes are identical to the ones in the Modes column in the Timeline panel, with the following three exceptions:

- **None** Renders the fractal noise only and does not composite on the original layer.
- **Hue** Renders the fractal noise as hue values instead of grayscale. The Saturation and Lightness of the original layer are maintained. If the original layer is grayscale, nothing happens.
- **Saturation** Renders the fractal noise as saturation values instead of grayscale. The Hue and Lightness of the original layer are maintained. If the original layer is grayscale, nothing happens.

Create a seamless loop using Fractal Noise

- 1 Select a layer in the Timeline panel, and choose Effect > Noise & Grain > Fractal Noise.
- 2 Set two keyframes for Evolution.
- 3 Adjust the time between keyframes and the number of Evolution revolutions until you are satisfied with the animation of the noise.
- 4 Select Cycle Evolution.
- 5 Set a value for Cycle.

The evolution completes the number of revolutions you specify for Cycle in the amount of time determined by the distance between Evolution keyframes. Determine the Cycle value by considering how much of this cycle you need to render before it repeats. Choose the shortest length appropriate for your project to save rendering time.

Initially, the last frame of a cycle is identical to the first frame. To create a seamless loop, skip the last frame by setting the Out point of the layer one frame before the last frame of the cycle:

- 6 Move the current-time indicator to the time where the cycle completes. For example, if the Cycle is set to 2, locate the frame when the Evolution value is 2.

Note: If you set keyframes for other Fractal Noise controls, return them to their initial settings where the cycle begins to repeat in the timeline, or the controls don't loop.

- 7 Move the current-time indicator back one frame.

- 8 Trim the layer's Out point at this frame.
- 9 Prerender this layer, and import the pre-rendered movie into your project.
- 10 Select the imported footage item in the Project panel, and choose File > Interpret Footage. Then set Loop to the number of loops required for the duration of the layer in the project.

Match Grain effect

The Match Grain effect matches the noise between two images. This is especially useful for compositing and in bluescreen/greenscreen work. The Match Grain effect only adds noise and can't remove it, so if the destination is already noisier than the source, an exact match is not possible. In this case, you can first use the Remove Grain effect to clean up the destination and then apply the Match Grain effect to the result to get a perfect match.

The Match Grain effect uses noise sampling as its starting point. Basically, entire frames of new noise are synthesized to match the noise samples. You can modify the noise in many ways before the effect is applied to the new image, such as duplicating the noise from an image but making the noise larger and redder before applying the noise to another image.

The Match Grain effect shares some controls with the Add Grain effect. (See "Add Grain effect" on page 459.)

Note: The Match Grain effect samples the noise on the frame in the source layer that corresponds to the first frame in the destination layer. If the source layer is not present at that frame, or if the noise samples contain transparent areas, no noise is sampled or applied.

This effect works with 8-bpc and 16-bpc color.



Original images (left), and with effect applied (right)

See also

"Working with added or matched grain" on page 457

Match noise or grain between images

- 1 Make sure that the source and the destination layers are in the same composition.
- 2 Select the destination layer to which you want to add grain.
- 3 Choose Effect > Noise & Grain > Match Grain.
- 4 Choose a layer from the Noise Source Layer control in the Effect Controls panel to specify the source layer from which you want to sample the grain. (The Noise Source Layer control lists only layers that are in the Timeline panel.)

The grain is automatically sampled and applied to the preview region on the destination layer. If you need an automatic match, you can skip the remaining steps.

5 If there already is significant noise in the destination layer before choosing a noise source layer and this causes a grain mismatch, adjust the Compensate For Existing Noise slider to avoid grain build-up.

6 Do any of the following:

- To adjust the intensity and size of the applied grain and to introduce a blur, adjust the Tweaking controls.
- To modify the color of the added noise, adjust the Color controls.
- To determine how the color value of the generated noise combines with the color value of the underlying destination layer at each pixel, choose a Blending Mode in the Application controls group.
- To define how much grain is added to each tonal area in your image and the midpoint, adjust the Shadows, Midtones, Highlights, and Midpoint values in the Application controls group.

7 If you want to change the effect view, choose any of the following from the Viewing Mode menu in the Effect Controls panel:

Noise Samples Shows the areas that have been sampled to extract the current noise model. Selecting the source layer causes it to appear in the Composition panel, with its noise sample squares displayed.

Compensation Samples Shows the noise samples that have been automatically extracted from the destination image.

Preview Displays the current settings of the applied effect in a 200x200 pixel area.

Blending Matte Shows the current color matte or mask, or the combination of both, which results from the current settings of the Blend With Original controls group.

Final Output Renders the full active frame, using the current settings of the effect.

8 Animate the added grain, if desired.

9 Choose Final Output from the Viewing Mode control.

Compensate for existing noise when matching noise

If you're trying to match the grain between images with the Match Grain effect, and your destination layer already has its own visible grain, a grain mismatch or grain build-up may occur. To prevent these problems, the Compensate For Existing Noise control extracts a noise model from both the source and the destination and then modifies the noise from the source to account for the noise already present in the destination, before applying it to the destination.

To use this control automatically, simply set the Compensate For Existing Noise slider to 100%. You can then view the noise samples in the destination layer by choosing Compensation Samples in the Viewing Mode menu. You can also reposition the samples in the destination image by setting Sampling Mode to Manual. This makes the Compensation Sample Points available for manual repositioning.

1 Apply the Match Grain effect to the destination layer.

2 In the Effect Controls panel, adjust the Compensate For Existing Noise value under the Match Grain effect as needed. The noise in the source layer and the noise in the destination layer are sampled, and their difference is calculated, so that only enough noise to match the destination layer to the source layer is applied to the destination.

3 To modify the noise samples, choose Noise Samples from the Viewing Mode menu, change the Sampling > Sample Selection control to Manual, and then expand the Compensation Sample Points. The current value of Number Of Samples determines how many points are available.

4 To reposition each sample point, do any of the following:

- Drag each sample point in the Composition panel to a new location.

- Enter new x and y coordinates adjacent to the sample point under the Compensation Sample Points controls in the Effect Controls panel.
 - Click a Compensation Sample Point's point parameter  in the Effect Controls panel, and then click where you want to move the point in the Composition panel.
- 5 Choose Final Output from the Viewing Mode control.

Median effect

The Median effect replaces each pixel with a pixel that has the median color value of neighboring pixels with the specified Radius. At low Radius values, this effect is useful for reducing some types of noise. At higher Radius values, this effect gives an image a painterly appearance.

This effect works with 8-bpc and 16-bpc color.

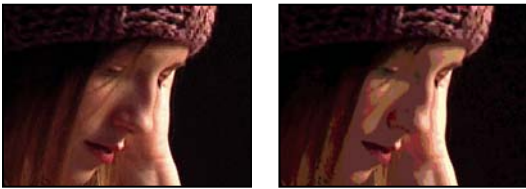

Original (left), and with effect applied (right)

Noise effect

The Noise effect randomly changes pixel values throughout the image.

This effect works with 8-bpc, 16-bpc, and 32-bpc color.

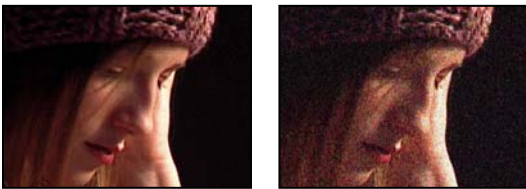

Original (left), and with effect applied (right)

Amount Of Noise The amount of noise to add.

Noise Type Use Color Noise adds random values to the red, green, and blue channels individually. Otherwise, the same random value is added to all channels for each pixel.

Clipping Clips color channel values. Deselecting this option causes more apparent noise. This control does not work in a 32-bpc project.

Noise Alpha effect

The Noise Alpha effect adds noise to the alpha channel.

This effect works with 8-bpc color.

Noise The type of noise. Unique Random creates equal amounts of black and white noise. Squared Random creates high-contrast noise. Uniform Animation creates animated noise, and Squared Animation creates animated high-contrast noise.

Amount The magnitude of the noise.

Original Alpha How to apply the noise to the alpha channel:

- **Add** Produces equal amounts of noise in the transparent and opaque areas of the clip.
- **Clamp** Produces noise in the opaque areas only.
- **Scale** Increases the amount of noise proportionate to the level of opacity and produces no noise in 100% transparent areas.
- **Edges** Produces noise only in partially transparent areas, such as the edge of the alpha channel.

Overflow How the effect remaps values that fall outside the grayscale range of 0-255:

- **Clip** Values above 255 are mapped to 255. Values below 0 are mapped to 0.
- **Wrap Back** Values above 255 or below 0 are reflected back into the 0-255 range. For example, a value of 258 (255+3) is reflected to 252 (255-3), and a value of -3 is reflected to 3.
- **Wrap** Values above 255 and below 0 are wrapped back around into the 0-255 range. For example, a value of 258 wraps around to 2, a value of 256 wraps around to 0, and a value of -3 wraps around to 253.

Random Seed An input value to the random number generator for the noise. This control is active only if you choose Uniform Random or Squared Random.



To produce flashing noise, animate the Random Seed control. To create smoothly animated noise, animate the Noise Phase value.

Noise Phase Specifies the placement of noise. This control is active only if you choose Uniform Animation or Squared Animation.

Noise Options (Animation) How noise is animated.

- **Cycle Noise** Produces a cycle of noise that plays through once in the specified amount of time.
- **Cycle** Specifies the numbers of revolutions of the Noise Phase that the noise cycles through before it repeats (available only when Cycle Noise is selected).

Alter the timing of the Noise Phase keyframes to adjust the speed of the Noise Phase cycles.



To save time animating the Noise Phase value, use the Cycle Noise option to create a seamless noise loop. Then, render the layer, and reimport it as a new source footage item.

Noise HLS effect and Noise HLS Auto effect

The Noise HLS and Noise HLS Auto effects add noise to the hue, lightness, and saturation components of an image. The noise generated by the Noise HLS Auto effect is automatically animated noise; you choose the speed of the animation. To animate the Noise HLS effect, you must use keyframes or expressions. Controls for these effects are the same except for the Noise Phase or Noise Animation Speed control, which controls noise animation.

These effects work with 8-bpc color.

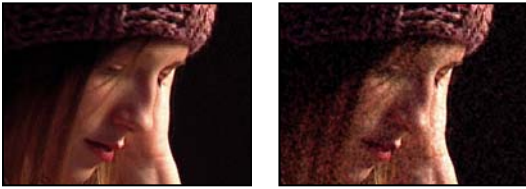

Original (left), and with effect applied (right)

Noise The type of noise. Uniform produces uniform noise. Squared creates high-contrast noise. Grain produces grainlike noise similar to film grain.

Hue The amount of noise added to hue values.

Lightness The amount of noise added to lightness values.

Saturation The amount of noise added to saturation values.

Grain Size This control is active only for the Grain type of noise.

Noise Phase (Noise HLS only) An input value to the random number generator for the noise. When you set keyframes for Noise Phase, the effect cycles through the phases to create animated noise. Greater value differences between keyframes increase the speed of the noise animation.

Noise Animation Speed (Noise HLS Auto only) The speed of the noise animation. To accelerate or decelerate the noise animation, animate this property.

Remove Grain effect

To remove grain or visual noise, use the Remove Grain effect. This effect uses sophisticated signal processing and statistical estimation techniques in an attempt to restore the image to how it would look without the grain or noise. While many techniques, such as applying a mild Gaussian Blur effect or the Median effect, reduce the visibility of noise in an image, the tradeoff is an unavoidable loss of sharpness and highlights. The Remove Grain effect, in contrast, differentiates fine image detail from grain and noise and preserves the image detail as much as possible.

The Remove Grain effect provides several options to precisely balance the reduction in noise and the amount of sharpness retained in the image. Additionally, the Remove Grain effect can analyze the differences between frames to further improve noise reduction and sharpness; since this process operates over time, it is called *temporal filtering*.

Note: *Good degrading depends on good noise sampling. The results of the automatic sampling depend on the image content and noise type. You can also change the number, size, and position of the samples to get the best results for a particular image.*

The Temporal Filtering controls of the Remove Grain effect use a statistical algorithm to blend the current frame with previous and next frames. These controls are particularly effective in removing compression artifacts from DV or video footage. Because temporal filtering works on the basis of differences between frames, it is useful only for sequences.

To properly evaluate the results of this filter, the sequence must be viewed in real time, either with a RAM preview or by viewing a movie rendered to a file.

 *To increase the speed of the Remove Grain effect preview, adjust the Remove Grain controls in order in the Effect Controls panel. Specifically, the most efficient workflow is to find effective degrading settings first and to adjust the last three controls last.*

This effect works with 8-bpc and 16-bpc color.

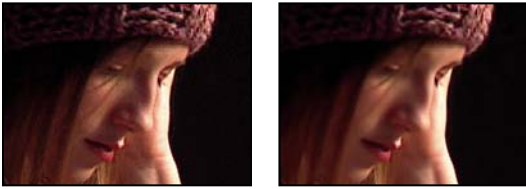

Original (left), and with effect applied (right)

Remove noise or grain from an image

- 1 Select the layer you want to affect.
- 2 Choose Effect > Noise & Grain > Remove Grain.
- 3 Adjust any of the following using the Noise Reduction Settings controls group:

- To adjust the overall amount of noise in the image, adjust the Noise Reduction value.
- To adjust the amount of noise on each channel individually, adjust the Red, Green, and Blue Noise Reduction values in the Channel Noise Reduction controls.



The blue channel often has the most pronounced grain in a chemical film-based image. Try reducing the noise in only the blue channel to retain all image detail in the other two channels.

- 4 Adjust the Passes value to control the maximum noise radius that can be detected:
 - If your grain is large and chunky, try increasing the Passes value. A higher number of passes reduces larger-sized noise.
 - If your render time is longer than desired because your file size is large, try lowering the number of passes to reduce the memory usage and render time.

Note: Once the optimum number of passes is applied, additional passes have no effect.

- 5 Choose one of the following from the Mode pop-up menu:

Multichannel Degrains all channels of a color image together, which generally produces the best results on color images. This mode takes advantage of correlations between channels to improve the accuracy of the denoising process.

Single Channel Degrains each channel independently. Use this mode for a monochromatic image or if Multichannel causes objectionable color artifacts.

- 6 Adjust any of the following in the Fine Tuning controls group to improve the balance between noise reduction and retained sharpness:

Chroma Suppression Suppresses some of the chroma from the noise to clean up the image. If the noise is very colorful, increasing this control can help remove it. Setting the amount too high may strip some chroma from the image itself. (Chroma Suppression has no effect on grayscale images and isn't available if the Noise Reduction Settings Mode is Single Channel.)

Texture Controls the amount of low-level noise that passes through to the output. This is especially useful to reduce objectionable artifacts or to retain finely textured areas such as wood grain, brick, or the like. Lower values result in a smoother, possibly artificial-looking result. Higher values may leave the output unchanged from the input.

Noise Size Bias Controls how the noise reduction process responds to variations in noise size within the same image. The default value of zero treats all sizes equally. Negative values leave larger residual noise and more aggressively remove smaller-sized grain; this leaves larger residual noise after degrading. Positive values leave smaller noise and more aggressively remove noise of larger size.

Clean Solid Areas Controls the extent to which adjacent pixels with low variations in value are smoothed out by the noise reduction process. This is helpful for large areas of solid color that need to be as clean as possible. Settings that are too high can smooth out nearly solid areas of the image, resulting in an artificial appearance.

7 Adjust the Unsharp Mask controls to enhance subtle edge detail that may have been suppressed by the degrading.

8 If you are applying the effect to a sequence of frames, use the Temporal Filtering controls to perform interframe noise reduction.

9 To change the effect view, choose any of the following from the Viewing Mode pop-up menu:

Noise Samples Shows the areas that have been sampled to extract the current noise model.

Preview Displays the current settings of the applied effect in a 200x200 pixel area.

Blending Matte Shows the current color matte or mask, or the combination of both, which results from the current settings of the Blend With Original controls group.

10 Choose Final Output from the Viewing Mode control.

Add temporal filtering to a sequence

1 Apply the Remove Grain effect to your image.

2 Place the Remove Grain preview region over the area of the image that has the most subtle changes from frame to frame or that has the most moving image detail.

3 Select Enable in the Temporal Filtering controls.

4 Adjust the Amount value to 100%.

5 Create a RAM preview of the sequence or render it.

6 If you see unwanted streaking or blurs around moving objects, reduce the Motion Sensitivity value, and then preview or render it again.

7 Try the following techniques if you want to improve the results:

- To quickly reduce the noise of a sequence that has a lot of buzzing noise, set the Noise Reduction value to zero and the Temporal Filtering Amount to 100%, and render the sequence.
- To speed up previews, apply temporal filtering to your sequence after all the settings for a single frame have been adjusted.
- To retain a layer's effects and also apply temporal filtering to it, precompose the selected layer (choose Layer > Precompose), and then apply the Remove Grain effect to that layer.

Sharpen an image with Unsharp Mask controls

The Remove Grain effect contains Unsharp Mask controls, which increase the contrast of edges and fine details to help restore some of the sharpness that may have been lost during the grain reduction process.

❖ Do any of the following:

- Increase the Unsharp Mask controls Amount value to obtain acceptable sharpening without generating undesirable artifacts or bringing back too much grain.
- Increase the Threshold value to remove any unwanted artifacts that resulted from the sharpening.
- Adjust the Radius to change the area over which Unsharp Mask finds details.
- Adjust the Noise Reduction value until the image just begins to lose sharpness; then decrease the value a little, and then apply the Unsharp Mask controls to sharpen the image.

Paint effects

Paint effect

Apply the Paint effect using the paint tools.

This effect works with 8-bpc, 16-bpc, and 32-bpc color.

See also

“Work with paint tools and paint strokes” on page 302

Vector Paint effect

For most drawing and painting tasks, use shape tools and paint tools, not the Vector Paint effect.

For more information, see “Work with paint tools and paint strokes” on page 302 and “Shape layers overview” on page 312.

This effect works with 8-bpc and 16-bpc color.

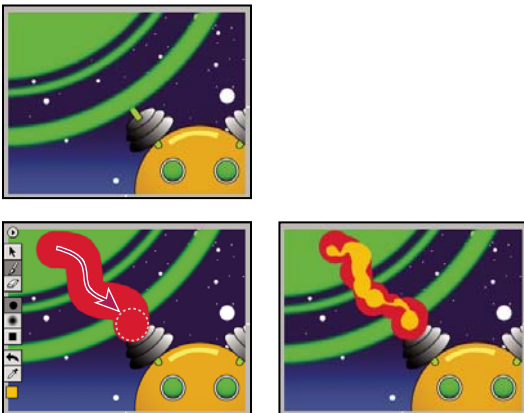

Original (top left), brushstroke with selection spline (bottom left), and second stroke created with Wiggle control (bottom right)

Vector Paint strokes are made up of many tiny points that create the stroke path. You cannot isolate or adjust these individual points, but you can affect them using Vector Paint features such as smoothing and wiggling. The wiggling of a stroke is created by manipulating and displacing these points along the stroke path.

Vector Paint strokes are nondestructive, so painting and erasing actions affect only the appearances on a layer; they don't alter the original source file of any image on the layer. All paint strokes are recorded and stored as they are drawn, so you can make the strokes appear in various sequences, such as animated over time or all at once.

For animated strokes, the exact timing (real time) you used to draw the strokes can be played back and rendered. You can adjust the playback speed to fit the timing you want. You can also create new strokes by blending existing strokes, both in space and in time.

Vector Paint supports the Wacom and Creation Station tablets' pressure-stylus and erase functions.

Note: The Vector Paint options menu contains some unique commands and settings that are otherwise unavailable. Open this menu by clicking the Vector Paint toolbar options button when a Vector Paint painting tool is selected.

 When you use Vector Paint on a layer, you can start over at any time by deleting all strokes or the Vector Paint effect itself. To delete the effect, select Vector Paint in the Effect Controls panel and press Delete or Backspace.

Paint with the Vector Paint effect

- 1 Select the Selection tool  in the Tools panel.
- 2 In either the Composition or Timeline panel, select the layer on which you want to paint.
- 3 Choose Effect > Paint > Vector Paint. The Vector Paint effect appears and is selected in the Effect Controls panel, and the Vector Paint toolbar appears on the left side of the Composition panel.

Note: This toolbar appears only if Vector Paint is selected (highlighted) in the Effect Controls panel. If the rulers in the Composition panel interfere with your view of the Vector Paint toolbar, deselect View > Show Rulers.

- 4 Select the Vector Paint painting tool you want to use from the Vector Paint toolbar.
- 5 In the Effect Controls panel, select the options you want for Brush Settings and Composite Paint.
- 6 In the Timeline panel, move the current-time indicator to the appropriate point in time.
- 7 In the Composition panel, drag to draw strokes on the layer.

 To quickly set your brush Radius and Feather amounts as you paint, press Ctrl (Windows) or Command (Mac OS) and click anywhere in the Composition panel; then drag in or out to resize the brush. When you release the Ctrl or Command key, you can then drag in or out to resize the feather.

Vector Paint tools

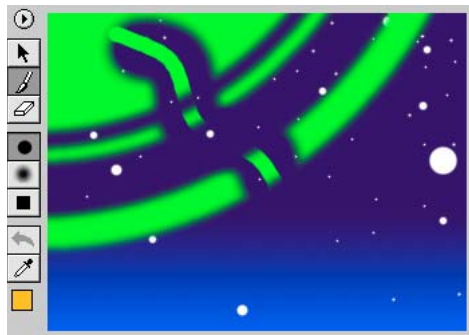



Vector Paint tools in Composition panel

You can use three tools in the Vector Paint toolbar to work with Vector Paint:

Selection tool  Select a stroke by clicking or dragging across it. You can drag across several strokes to select them simultaneously. You select strokes to edit or delete them.

Paint tool  Paint directly on the layer, using settings defined in the Effect Controls panel. When you use the Paint tool, the pointer appears as a circle (or square) in the actual size of the brush.



Eraser tool  Erase areas of the layer, using Brush Type settings defined in the Effect Controls panel. The Eraser pointer appears as a circle with an X through it. If you use an installed tablet with stylus eraser support, Vector Paint automatically switches to eraser mode when you use the stylus eraser.

 Clicking the active tool (Selection, Paint, or Brush) in the Vector Paint toolbar deactivates painting and hides the other buttons in the toolbar. You can then drag and scale the layer. To reactivate the toolbar, reselect one of the three Vector Paint tool buttons.

Work with Vector Paint brushes

Vector Paint includes three brush types: Paint, Air, and Square. These brush types define the shapes and performance of both the Paintbrush tool and the Eraser tool. All brush types but the Air brush include a Feather setting.

❖ Do one of the following:

- In the Vector Paint toolbar, click the Paint , Air , or Square  button.
- In the Effect Controls panel, click the current Brush Type setting (Paint, Air, or Square) repeatedly to cycle through the brushes until the one you want is selected.

With increased Feather and reduced Opacity settings, Paint brushstrokes may resemble Air brushstrokes. However, when you paint a single stroke that crosses itself, the two brush types produce different results. Air brushstrokes build up opacity as the stroke crosses itself. Paint brushstrokes don't build up opacity within the same stroke, whether they cross themselves or not. To increase opacity with Paint brushstrokes, create multiple strokes over the area (like multiple coats of paint).

Note: Each brush type is also available for the Eraser tool. When the Eraser tool is selected in the Vector Paint toolbar, the name appears with “-E” after it in the Effect Controls panel. Also, if a tablet is installed and the stylus has eraser support, Vector Paint automatically switches to eraser mode when you use the stylus eraser.

Brush Settings controls

Radius Controls the size of the brush or eraser.

 If you press *Alt* (Windows) or *Option* (Mac OS) when clicking the question mark representing the Radius value, a *Set Value* dialog box appears. You can then type a *Relative Radius*, reducing the radius of each stroke by that percentage. The default value is 100%, which produces no change in the stroke radii.

Feather Controls the softness of brush or eraser edges (but doesn't affect the airbrush).

 When you drag to change Radius, Feather, or Opacity values, hold down *Ctrl* (Windows) or *Command* (Mac OS) to reduce the size of the increments. To change the value by larger increments, hold down *Shift* as you drag.

Opacity Controls the transparency of the paint or erasures.

Brush Type Shows the brush type you selected in the Vector Paint toolbar in the Composition panel.

Color Represents the paint color used to draw strokes. Select a new color by clicking the Color swatch and then using the Color Picker, or by using the eyedropper to sample a color from the desktop.

When one or more strokes of the same color are selected, this swatch displays the color of those strokes. You can change the color of the selected strokes.

Color Clone When Color Clone is turned on, the brush behaves like a combination eyedropper and brush. The color of the stroke is determined by the pixels at the position where the stroke begins. The Color swatch in the Effect Controls panel's Brush Settings displays the new sampled color. When you begin another stroke, a new group of pixels is sampled and used to color that stroke.

The Color Clone affects strokes only while you draw; it has no effect on an already completed stroke. This brush setting is the only one you can't apply after drawing. Clicking either the eyedropper or Color swatch turns off the Color Clone feature.

Stylus The Radius option affects stylus sensitivity. When you select this option, the pressure of the pen on the tablet changes the weight of the stroke as it is drawn. Lighter pressure decreases the radius (creating a thinner stroke), and increased pressure increases the radius (creating a wider one). The Radius value setting indicates the maximum radius amount. Use the tablet settings to adjust the pressure-width sensitivity for the pen.

Note: You can choose Stylus Radius even if no tablet is installed. This option affects strokes when wiggling is enabled.

The pressure variation of the pen on the tablet alters the opacity of the stroke as you draw. Light pressure results in lower opacity values, while increased pressure creates more opaque strokes. The Opacity value defines the maximum of the Opacity range.

Selecting and editing Vector Paint strokes

When you select a single stroke or strokes with the same Brush Settings, you can edit the enabled Brush Settings in the Effect Controls panel. Your changes to the strokes immediately appear in the Composition panel as you complete them.

When you select multiple strokes that have different Brush Settings, a question mark [-?-] appears next to that Brush Setting in the Effect Controls panel. If you edit that value, all of the selected strokes are reset to the new value.

To edit a specific paint stroke, select it using the Selection tool  on the Vector Paint toolbar and click or drag, or choose Select from the Vector Paint options menu. You can select and then move, revise attributes, or delete either a paint stroke or erasure stroke.

Use the following commands from the Select option in the Vector Paint toolbar option menu to select and edit paint strokes:

Note: Some options are tied to the current position of the current-time indicator in the Timeline panel.

All Selects all strokes on a layer.

None Deselects all strokes on a layer (available only if some strokes are selected).

Visible Selects all strokes visible at the current frame.

Current Time Selects all strokes that were drawn at the current time position. (Playback Speed doesn't affect the original start time of strokes.)

Last Painted Selects the last-painted brush stroke (or erase stroke). If you painted several strokes with the Shift key held down, this command selects that group of strokes.

Similar With one or more strokes selected, this command selects additional strokes with similar Brush Settings properties. If strokes with dissimilar properties are initially selected, this command selects a broader range of strokes.

Inverse Toggles to a selection of all unselected strokes, leaving the previously selected strokes unselected.

After you select one or more strokes, you can transform them, such as by rotating, scaling (vertically, horizontally, or both), or nudging (repositioning one pixel at a time).

Tools for editing paint work with Vector Paint



Use the following tools in the Vector Paint toolbar in the Composition panel to revise your paint work:

Undo button  Click the Undo button to cancel your most recent single painting action, if it can be undone. If the action cannot be undone, this tool is dimmed (not available). You can also undo paint actions by using the Undo command on the Vector Paint options menu or by pressing Ctrl+Z (Windows) or Command+Z (Mac OS).

Note: Don't use the Undo command on the Edit menu to undo Vector Paint actions.

Eyedropper  Use the eyedropper to select a color to paint with from a sampling anywhere on the desktop. Press the Escape key to cancel the eyedropper.

Note: By default, the eyedropper samples a single pixel. Hold down Ctrl (Windows) or Command (Mac OS) and click the eyedropper to sample a 3-x-3-pixel average. Hold down Shift and drag to sample a range of multiple pixels.

Color swatch   Displays the current selection as a solid color. When clicked, it opens the Color Picker dialog box. If the Opacity setting is less than 100%, the Color Swatch icon appears checkered, not solid.

 If Color Clone is enabled in the Effect Controls panel, this swatch represents the sampled color. Shift-click the Color Swatch to open the Set Value dialog box for Opacity without turning off Color Clone.

Smoothing a Vector Paint stroke

The Smoother command in the Vector Paint options menu removes points from a selected stroke or strokes. This action simplifies stroke paths, smoothing out the curves. By eliminating unneeded points, the Smoother command can also dramatically reduce the size of the project file if you have complex drawings composed of many strokes.

When you select a path and choose Smoother, a dialog box appears in which you can type a Max Error value. This value sets the tolerance for the smoothing. Higher values remove more points on the path, resulting in a smoother stroke. Values can range from 0–100. The default value, 1.0, removes only redundant points, maintaining details in the stroke.

After you click OK in the dialog box, the stroke paths immediately reflect the smoothing in the Composition panel.

Smoothing cannot be undone. Removing these points may alter the shape of the path. If you want to preview the results, create a duplicate of the layer and apply Smoothing to test the result. If the results are satisfactory, then apply the command to the original layer.

Configure a stylus for Vector Paint (Windows only)

You can specify preferences for a Wacom or Creation Station tablet in several areas of the After Effects interface.

Note: Using a tablet with the Vector Paint effect isn't supported in Mac OS. You can, however, use a tablet with the standard paint tools and the Paint effect.

❖ In the Vector Paint Preferences dialog box, click Options in the Effects Control panel, and select the following preferences:

Stylus Vendor Tablets aren't supported in Vector Paint on Mac OS. "Unknown" appears.

Use High Res. Coordinates If this option is selected, data is recorded at high resolution (if supported by the stylus). This setting overrides normal mouse coordinates to use the higher resolution of the tablet, recording strokes with greater precision and subpixel precision.

Note: Wacom tablets don't support the High Res. Coordinates option if Proportional mode is selected in the Wacom control panel.

If you experience offset coordinates with the pen, try the following:

- Check that screen resolution and monitor settings haven't changed.
- If using a Wacom tablet, make sure that the tablet-mapping aspect isn't set to Proportional. Select To Fit mode or One To One mode instead.
- Restart the computer.
- If all else fails, deselect Use High Res. Coordinates. Subpixel precision will be lost, but Pressure and Eraser modes will still be available.

Play back your painting with Vector Paint

Use the Playback Mode pop-up menu in the Effect Controls panel to specify when and how quickly your strokes appear in a composition. When you draw strokes, Vector Paint records information for the stroke start time and the drawing time of each stroke (in real time). The playback mode you select determines when a stroke starts and for how long it appears. You can set the speed at which the strokes play back using Playback Speed.

Play back your strokes using standard (spacebar) preview or RAM preview, or by viewing the results of a rendered composition.

Note: Regardless of how you record your strokes and which Playback mode you select when recording, you can always switch to another Playback Mode at any time.

While the playback mode chosen affects what you see during playback, it also determines what you see while you are drawing strokes. Onion Skin mode, for example, is used primarily while drawing strokes, and then another mode is selected before rendering.

Note: Note the position of the current-time indicator when you begin drawing strokes. This position affects the appearance of strokes in all modes except All Strokes.

Adjust the following controls to affect the way that strokes appear in the composition:

All Strokes Displays all strokes for the full duration of the layer, regardless of the position of the current-time indicator when you drew them.

Past Strokes Displays strokes from the time at which they were recorded until the end of the layer (the Out point).

Hold Strokes Displays strokes from the frame on which they were drawn and holds them only until the point at which the next stroke was drawn. This mode treats strokes like Hold keyframes; as a stroke appears, it replaces the next, as in a slide show.

Animate Strokes Begins drawing the stroke at the current time (that is, at the frame where the current-time indicator is when you draw the stroke). The stroke animates in the same way as it was drawn.

Current Frame The default Draw Strokes setting. This mode displays the stroke only at the frame at which it was painted.

Onion Skin Displays strokes drawn on the current frame plus strokes drawn on the surrounding few frames. These additional strokes appear color-coded and at reduced opacity, to distinguish them from the strokes on the current frame. Those strokes actually exist only on the frames in which they are drawn. Onion-skinning is very useful for drawing frame-by-frame animations because it gives you reference points for the stroke positions.

Use the Onion Skinning options in the Vector Paint Preferences dialog box to specify how previous and forward strokes appear when Onion Skin is the active playback mode. (To open Vector Paint Preferences, use the Vector Paint options menu and choose Options.) These options include the following:

- **Frames Backward/Frames Forward** Sets the number of frames backward or forward that are displayed. Both backward and forward frames are displayed unless one or both of these values is set to 0.
- **Color Backward/Color Forward** Sets the color of the display of backward and forward strokes.
- **Skin Opacity** Sets the percentage of opacity for onion skin strokes.

Adjust the playback speed for the Vector Paint effect

The Playback Speed value in the Effect Controls panel can change the timing at which painted strokes appear in previews and rendered compositions. Playback Speed affects the Vector Paint strokes only if you set Playback Mode to Past Strokes, Hold Strokes, or Animate Strokes.

When you create strokes on a layer, the stroke is tied to the location of the current-time indicator in the Timeline panel when you start drawing. Vector Paint also records the amount of time you take to draw the stroke. For example, you might start painting a stroke with the current-time indicator set to 0:00 and use 1.5 seconds to draw the stroke. Then, you might move the current-time indicator to 2:00 and draw a second stroke (leaving 0.5 seconds between the completion of the first stroke and the beginning of the second one). For this example, let's say you use 1.0 second to draw the second stroke. The entire process covers 3.0 seconds on the timeline.

By changing the playback speed, you can change the timing for stroke appearances in previews and rendered compositions.

- 1 In the Effect Controls panel under Vector Paint, make sure that Playback Mode is set to Past Strokes, Hold Strokes, or Animate Strokes.
- 2 In the Effect Controls panel, click the underlined Playback Speed value and type a new value, using a number between 0 and 100.

You can also change the playback speed by dragging the value itself or the slider below it: drag left to decrease the speed; drag right to increase it.

 *For animations, always begin painting strokes at the layer In point, especially when adjusting Playback Speed. This workflow locks the In point (first stroke's start time) to the In point of the layer, making it easier to locate the beginning of the animation. Then, simply place the layer's In point where you want the animation to begin in the composition.*

The results that your changes produce depend on the Playback Mode setting:

Animate Strokes With the Playback Speed at 1.0, each stroke appears as if drawn by an unseen hand, taking the same amount of time as you used to create it. When you increase the Playback Speed value, you reduce the time it takes to draw each stroke and the gaps between strokes. If you decrease Playback Speed, both the time taken to draw the strokes and the length of the gaps between strokes increase. Using the example above, if you increase the Playback Speed value to 2.0 (double the speed), the first stroke would be drawn in 0.75 seconds, the gap between the two strokes would be shortened to 0.25 seconds, and the second stroke would be drawn in 0.5 seconds. The entire animation would be complete after 1.5 seconds of playback.

Past Strokes With the Playback Speed at 1.0, each stroke appears in completed form at the frame in which you started drawing and remains visible for the duration of the layer playtime. When you increase Playback Speed, each stroke appears at an earlier point in time. If you decrease Playback Speed, strokes occur at later points in time.

Hold Strokes Like Past Strokes mode, each stroke appears in completed form at the frame in which it was drawn. However, in Hold Strokes mode, each stroke disappears when the next stroke appears (without any gap between them). Otherwise, the results of changing Playback Speed are similar to those in Past Strokes mode.

Change playback time with the Vector Paint Re-timer

The results from using the Re-timer or changing the Playback Speed value are similar but have important differences:

- You apply the Re-timer to individual strokes you select before choosing the Re-timer option. In comparison, changes in Playback Speed apply to all paint strokes on the layer.
- The Re-timer affects only playbacks that use Animate Strokes mode. Playback Speed changes can also influence Hold Strokes and Past Strokes modes.
- The Re-timer does not affect the start times of strokes. Changing the Re-timer value shortens or lengthens the amount of time previews and rendered versions take to draw the stroke. The strokes begin to appear at the same points in time as before, but they are drawn more quickly or more slowly.
- The values for Re-timer are percentages of the original time required to draw the stroke. The default value is 100%. A higher value causes the drawing time to increase, so that a setting of 200% uses twice the time to draw the selected strokes. A lower value draws the selected strokes more quickly.

- 1 Using the Vector Paint Selection tool , click or drag to select the strokes.
- 2 From the Vector Paint options menu, choose Re-timer.
- 3 In the Set Value dialog box, type a value for Relative Duration (%), and click OK.

Note: You cannot use the Undo command to reverse the Re-timer after you apply it. However, you can apply the Re-timer again, using the inverse of the value you typed previously to revert to the original value. For example, if you changed the Re-timer value to 200% and then wanted to go back to the earlier setting, choose Re-timer again and type a value of 50%.

Paint using QuickPaint mode in Vector Paint

Ordinarily, when you draw strokes with Vector Paint, those strokes are associated with the position of the current-time indicator. After you draw a stroke, you can draw more strokes at the same time setting or at different time settings. The results you see when you preview or render the composition depend on your Playback Mode setting. The Shift-Paint Records controls change the way that strokes associate with time settings, called *QuickPaint* mode. One of the advantages of this feature is that you can create fast continuous recordings of a sequence of strokes without redraw delays after each one.

1 From the Vector Paint options menu, choose Shift-Paint Records, and then choose a Shift-Paint Records option:

Note: You cannot apply a Shift-Paint Records option to strokes you've already created.

To Current Frame Specifies that all strokes start at the current frame (the current-time indicator position when you draw the strokes). The result is similar to ordinary painting mode except that Shift-Paint Records has no redraw delays.

To Sequential Frames Specifies that all stroke start times are offset by one frame. The next frame is calculated according to the composition frame rate at the time of drawing. For example, if the current-time indicator is at 0:00 when you draw three strokes, then the start point is 0:00 for the first stroke, 00:01 for the second stroke, and 00:02 for the third stroke.

In Realtime Specifies that stroke start times are determined by how they are drawn. The strokes are recorded and played back in real time even if you lift the brush while drawing. Strokes play back exactly as they were recorded, including any time that elapsed (gaps) between the creation of the strokes (provided that you continued to hold down Shift during the time gap).

Continuously Specifies that stroke start times follow one another, without any gaps. When one stroke is finished drawing, the next one begins immediately. Otherwise, the result is similar to the In Realtime option.

2 Press Shift as you paint.

When you paint, the Info panel displays the name of the selected Shift-Paint Records option.

Wiggle controls for the Vector Paint effect

Enable Wiggling If selected, all strokes on the layer are set to wiggle using the Wiggle Control values set in the Effect Controls panel.

Wiggles/sec Determines the number of wiggles per second of composition time. Wiggling is spline-based morphing of paint strokes. Wiggles/sec controls the speed at which the morph completely shifts shape. For example, in a 30-fps composition, setting the Wiggles/sec value to 30 creates one wiggle per frame. Lower values result in a smooth animation of morphing strokes. Higher values create more rapid wiggling.

Displacement Variation Determines how far the stroke moves from its original position while wiggling. The greater the value, the greater the deviation in shape.

Displacement Detail Determines how much the original shape of the path is altered while wiggling. Greater values increase the detail of displacement (or change in shape) in the stroke. Lower values produce less displacement, leaving the path closer to its original shape.

When Displacement Detail values are set very high, the stroke may not resemble its original shape at all. This approach is useful in creating randomly animated strokes.

Set the Displacement Detail value by using the slider in the Effect Controls panel (preset to values between 0 and 100) or by clicking the underlined Displacement Detail value and typing a number between 0 and 1000.

Pressure Variation Determines how much the Radius and Opacity values of the stroke vary while wiggling. For strokes that have Stylus Radius enabled, the Radius wiggles. For strokes that have Stylus Opacity enabled, the Opacity wiggles. The amount of variation in either the Radius or Opacity value while wiggling depends on the value specified for Pressure Variation. The Radius and Opacity settings in the Brush Settings act as maximum amounts, not to be exceeded while wiggling.

Note: Strokes that don't have either Stylus Radius or Stylus Opacity options selected aren't affected by the Wiggle Pressure Settings. However, these options can be enabled even if a tablet isn't installed.

In the Effect Controls panel, set the Pressure Variation value by clicking the underlined Pressure Variation value and typing a number between -30,000 and 30,000, or by dragging the Pressure Variation slider.

Pressure Detail Determines how tight the pressure variation appears along the stroke. Higher values create more dense variations.

Individual Stroke Seeds If selected, this option creates a different random wiggle seed for each stroke on a layer.

Because the wiggle controls apply to all strokes on a layer, the wiggle parameters are always the same. To randomize the wiggling of the individual strokes, select the Individual Stroke Seeds option.

If Individual Stroke Seeds isn't selected, all strokes use the same wiggle seed, so they all have the same spatial wiggle values. For example, two strokes exactly on top of each other will wiggle equally. By setting individual seeds for each stroke, you avoid identical strokes wiggling in the same way.

Composite Paint options

Various options control the way Vector Paint composites strokes on a layer. Select the option you want in the Effect Controls panel for a layer, from the Composite Paint pop-up menu under Vector Paint. These options control two things: what you see in the Composition panel as you work, and what aspects of the layer the strokes affect, including what happens when you preview and render the composition.

As you paint and erase, you can either hide or display the footage image. You have similar viewing options when you paint using matte and alpha-channel options.

As you work, painting and erasing can block pixels in an original image, such as a footage file or solid. You can also paint on a virtual layer above or below that image (although the virtual layer doesn't appear as a separate layer in the Timeline panel). You can paint and erase to adjust mattes and alpha channels for the original image. You can restrict Vector Paint strokes to the areas inside or outside the original alpha channel.

Each Composite Paint option specifies a unique combination of work view, layer type (image, matte, or alpha channel), and placement of strokes relative to the original image. You can select strokes later and change the Composite Paint option, but it's a good idea to understand what results each option produces before you start painting.

The following illustrations use the same basic example of an imported image. A paint stroke has been applied, followed by an erasure stroke. The original image is the green layer, including an alpha channel that reveals the background layer.

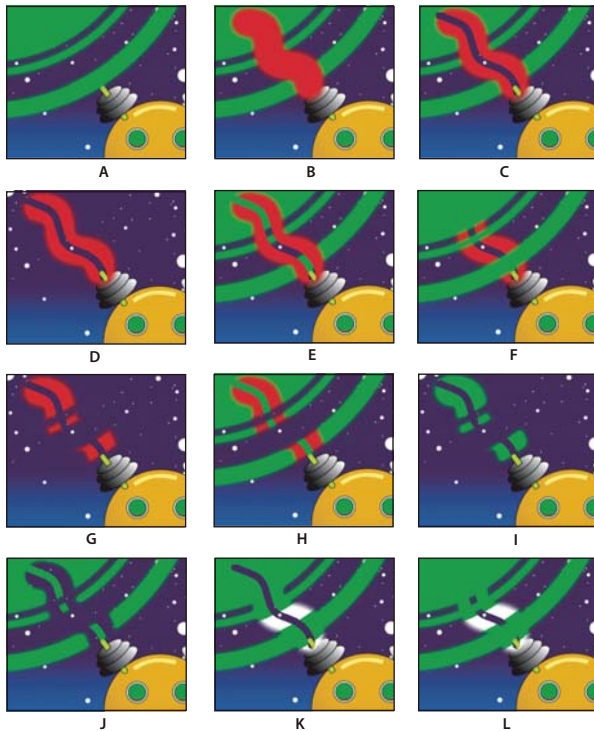

Composite Paint options

A. In Original (default setting), before painting The imported image is visible.

B. In Original, with paint stroke The paint strokes appear above the original image.

C. In Original, with paint stroke and erasure stroke An erasure stroke removes underlying portions of both the paint stroke and the original image.

D. Only The original image on the layer doesn't appear in the working view; only paint strokes are shown. Erasures remove only paint, not the original image.

E. Over Original The original image is visible in the working view, similar to the In Original option. Painting and erasing occur as with the Only option: Erasing removes pixels from underlying paint strokes but doesn't alter the original image.

F. Under Original The layer image is visible in the working view. Painting doesn't alter the original image; it affects only areas of the layer that are outside the original image. Erasures remove only paint pixels, not the original image.

G. Track Original Matte The original image isn't visible in the working view. Paint strokes are visible. Painting affects only the area within the original image alpha channel (that is, paint applied within the original circle area). Erasures remove only existing paint pixels.

H. Track Original Matte Visible The original image is visible in the working view. Otherwise, Vector Paint strokes behave exactly as with Track Original Matte, so erasures don't affect the original image.

I. As Matte Before you paint, nothing is visible in working view. Paint strokes affect only the matte, revealing the underlying original image. Erasures add back areas of opacity, so that they appear to erase the underlying image again. Both types of strokes are restricted to the area of the original alpha channel.

J. As Inverse Matte Before you paint, the original image is visible in the working view. Painting affects only areas within the original image alpha channel. Paint strokes block (rather than reveal) the original image, appearing to erase the original image. Erasures remove only painting strokes; that is, they re-reveal the underlying image within the alpha channel.

K. In Original Alpha Only The original image appears within its alpha channel in working view. Strokes affect the alpha channel itself. Painting adds areas of opacity. Erasures add areas of transparency.

Note: You don't need to switch colors when you paint in the alpha channel, even if you paint with gray. The changes to the opacity of the painted area are determined by the values shown for Opacity and Feather under Brush Settings in the Effect Controls panel, not by the color of paint.

L. Under Original Alpha Only The original image appears within its alpha channel in working view. Strokes don't affect the original image alpha channel, only areas outside of it. Painting adds areas of opacity; erasing restores transparency to painted areas only.

Note: The difference between using Under Original and Under Original Alpha Only is that in the latter, strokes affect only the alpha channel; RGB is unchanged.

Select Vector Paint preferences

Use the Vector Paint Preferences dialog box to customize the way you view your work in Vector Paint. Unlike most other effects, the options you select as Vector Paint preferences apply to all your Vector Paint work, both on the current layer and on other layers. Your current preferences are also used for subsequent sessions of Vector Paint.

1 Select Vector Paint in the Effect Controls panel and open the Vector Paint Preferences dialog box in any of the following ways:

- Click the menu button  in the Vector Paint toolbar in the Composition panel, and choose Options.
- Right-click (Windows) or Control-click (Mac OS) anywhere in the Composition panel, and choose Options.
- In the Effect Controls panel, click Options to Vector Paint.

2 Choose the appropriate options.

Note: Better Preview While Drawing is temporarily disabled in low-memory situations, and Draft quality is used instead. Also, if the preview doesn't draw correctly, you may have an incompatible graphics card.

Perspective effects

3D Glasses effect

The 3D Glasses effect creates a single 3D image by combining a left and right 3D view. You can use images from 3D programs or stereoscopic cameras as sources for each view.

The method you use to create the combined images dictates how you view them. For example, you can use 3D Glasses to create an anaglyphic image, which is an image containing two slightly different perspectives of the same subject that are tinted contrasting colors and superimposed on each other. To create an anaglyphic image, first combine views and tint each one a different color. Then, use 3D glasses that have either red and green lenses or red and blue lenses to view the resulting image stereoscopically.

This effect works with 8-bpc color.



Original (left), and with effect applied (right)

To avoid problems with flipped views, keep in mind the following guidelines:

- Use the same vertical dimensions for the composition and source images. A one-pixel difference produces the same result as moving the position one pixel vertically.
- Make sure that the layer's Position values are whole numbers (such as 240 instead of 239.7).
- If the left and right view images are interlaced, deinterlace them before using 3D Glasses to avoid field mismatch.
- Because 3D Glasses creates interlaced frames, don't select an interlace option in the Render Settings dialog box.

Ghost effects occur if the luminance values of one color exceed those of another color to such an extent that you can see the first color through the wrong lens of anaglyph glasses. For example, an excessive red luminance value becomes visible through the blue lens. If you adjust the Balance value, test the results on the final output media. If you set the Balance value too high, a reversed shadow may appear.

When you work with red and blue images, the blue color in glasses with red and blue lenses is actually cyan, not blue. Red and cyan are complementary colors, producing the best separation because they filter each other out more efficiently. When you work with red and green images, it may appear that the green isn't as bright as the red. However, viewing the images with red and green lenses produces an even result because green has a higher luminance value than red.

Left View, Right View The layer to use as the left or right view. You need to apply 3D Glasses to only one layer in a composition. If you use a second layer, make sure that the two layers are the same size. The second layer doesn't need to be visible in the composition.

Convergence Offset The amount that the two views are offset. Use this control to realign uncalibrated camera views of rendered material. Photos or images rendered from 3D programs are generally misaligned and require a negative Convergence Offset value. If the original footage was shot with correct convergence, changing this value isn't necessary. Keyframing this value may result in erratic animation.

Swap Left-Right Swaps the left and right views.

3D View How the views are combined.

- **Stereo Pair** Scales both layers to fit side by side within the effect layer's bounding box. Select Swap Left-Right to create cross-eyed vision. Selecting Stereo Pair disables Convergence Offset.
- **Interlace Upper L Lower R** Takes the upper (first) field from the Left View layer, and the lower (second) field from the Right View layer, and combines them into a sequence of interlaced frames. Use this option if you want to view the results with polarized or LCD shutter glasses. Select Swap Left-Right to switch fields.
- **Red Green LR** Tints the Right View layer red, and the Left View layer green using the luminance values of each layer.
- **Red Blue LR** Tints the Right View layer red and the Left View layer blue (cyan) using the luminance values of each layer.

- **Balanced Red Green LR** Performs the same operation as Red Green LR but also balances the colors to reduce shadows or ghosting effects caused by one view showing through the other. Setting a high value reduces the overall contrast.
- **Balanced Red Blue LR** Performs the same operation as Red Blue LR but also balances the colors to reduce shadows or ghosting effects.
- **Balanced Colored Red Blue** Converts the layer into a 3D view using the original layer's RGB channels. This option maintains the layer's original colors but may produce shadows and ghosting effects. To reduce these effects, adjust the balance or desaturate the image, and then apply 3D Glasses. If you use CG images, raise the black level of both views before applying the effect.

Balance Specifies the level of balance in a balanced 3D view option. Use this control to reduce shadows and ghost effects. The default balance that 3D Glasses sets when you select the Balanced Colored Red Blue option is the ideal value: If you set Balance to 0.0, 3D Glasses creates no 3D depth, and if you set Balance too high, 3D Glasses produces a highly saturated output.

Basic 3D effect

If you are working on a project that was created in an older version of After Effects and the Basic 3D effect is applied to one or more layers, you can continue to use the Basic 3D effect; otherwise, use the 3D layer switch instead.

This effect works with 8-bpc color.

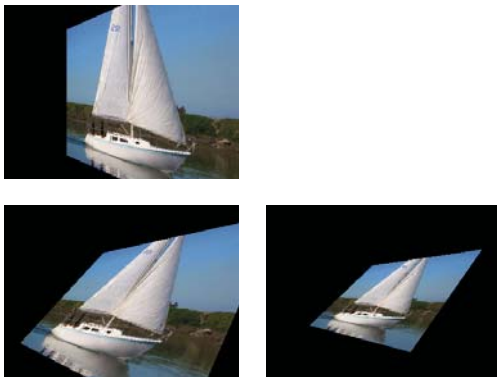

Basic 3D effect: Swivel (top left); Swivel and Tilt (bottom left); and Swivel, Tilt, and Distance (bottom right)

The Basic 3D effect manipulates a layer in 3D space. You can rotate an image around horizontal and vertical axes and move it toward or away from you. With Basic 3D, you can also create a specular highlight to give the appearance of light reflecting off a rotated surface. The light source for the specular highlight is always above, behind, and to the left of the viewer. Because the light comes from above, the image must be tilted backward to see this reflection. Specular highlights can enhance the realism of the 3D appearance. The specular highlight can be viewed only at Best quality.

The layer's quality setting affects Basic 3D. Draft quality calculates pixel location to the nearest integer value; Best quality calculates pixel location to the subpixel level.

Swivel Controls horizontal rotation (rotation around a vertical axis). You can rotate past 90° to see the back side of the image, which is the mirror image of the front.

Tilt Controls vertical rotation (rotation around a horizontal axis).

Distance To Image Specifies the image's distance from the viewer. As the distance gets larger, the image recedes.

Specular Highlight Adds a glint of light that reflects off the surface of the layer, as if an overhead light were shining on the surface. When Draw Preview Wireframe is selected, the specular highlight is indicated by a red plus sign (+) if it isn't visible on the layer (that is, if the center of the highlight doesn't intersect the layer) and a green plus sign (+) if the highlight is visible.

Preview Draws a wireframe outline of the 3D image. The wireframe outline renders quickly. To see the final results, deselect Draw Preview Wireframe when you finish manipulating the wireframe image. The preview wireframe is drawn only at Draft quality; when you switch to Best quality, the image content is drawn. This way, you won't accidentally render a Best quality movie in Preview mode.

Bevel Alpha effect

The Bevel Alpha effect gives a chiseled and lighted appearance to the alpha boundaries of an image, often giving 2D elements a 3D appearance. If the layer is completely opaque, then the effect is applied to the bounding box of the layer. The edge created by this effect is somewhat softer than that created by the Bevel Edges effect. This effect works especially well for elements with text in the alpha channel.

This effect works with 8-bpc and 16-bpc color.



Original (left), and with effect applied (right)

Bevel Edges effect

The Bevel Edges effect gives a chiseled and lighted 3D appearance to the edges of an image. Edge locations are determined by the alpha channel of the source image. Unlike Bevel Alpha, the edges created with this effect are always rectangular, so images with nonrectangular alpha channels don't produce the proper appearance. All edges have the same thickness. At Best quality, edge thickness is interpolated for smooth visual results.

This effect works with 8-bpc color.



Original (left), and with effect applied (right)

Drop Shadow effect

The Drop Shadow effect adds a shadow that appears behind the layer. The shape of the shadow is determined by the layer's alpha channel.

When you add a drop shadow to a layer, a soft-edged outline of the layer's alpha channel appears behind it, as if a shadow is cast on the background or underlying objects.

Drop Shadow can create a shadow outside the bounds of the layer. The layer's quality setting affects the subpixel positioning of the shadow and the smoothness of the shadow's soft edges.

This effect works with 8-bpc and 16-bpc color.



Original (left), and with effect applied (right)

To render the shadow without the image, select Shadow Only.

Note: To apply a drop shadow to a layer that rotates, rotate the layer using the Transform effect and then apply the Drop Shadow effect. You can also use nesting, precomposing, or an adjustment layer to achieve this result. If you don't use one of these methods, the shadow rotates with the layer.

Radial Shadow effect

The Radial Shadow effect creates a shadow from a point light source over the layer it's applied to, rather than from an infinite light source (as with the Drop Shadow effect). The shadow is cast from the alpha channel of the source layer, allowing the color of that layer to influence the color of the shadow as light passes through semitransparent areas. You can use this effect to make a 3D layer appear to cast a shadow onto a 2D layer.

This effect works with 8-bpc color.



Original (left), and with effect applied (right)

Shadow Color The color of the shadow.

Note: The colors of the layer may override this option if you choose Glass Edges from the Render control menu. See the Render and Color Influence controls for more information.

Opacity The opacity of the shadow.

Light Source The location of the point light source.



Copy and paste position keyframes or expressions from another effect's control point (for example, Lens Flare) to quickly create a shadow that matches another effect's light source.

Projection Distance The distance from the layer to the surface on which the shadow falls. The shadow appears larger as this value increases.

Softness The softness of the shadow's edges.

Render The type of shadow:

- **Regular** Creates a shadow based on the Shadow Color and Opacity values, regardless of semitransparent pixels in the layer. (If Regular is chosen, the Color Influence control is disabled.)

- **Glass Edge** Creates a colored shadow based on the color and opacity of the layer. If the layer contains semitransparent pixels, the shadow uses both the color and transparency of the layer. This option creates the appearance, for example, of sun shining through stained glass.

The more transparent the pixels in the layer are, the closer the shadow color matches the colors of the layer. If the layer contains no semitransparent pixels, Glass Edge has little result.

Note: Anti-aliased edges produce colors in a shadow edge when you choose Glass Edge, even if the layer is fully opaque. The layer's colors shine through these anti-aliased edges, and the Shadow Color fills the center of the shadow.

Color Influence The fraction of the layer's color values that appear in the shadow. At 100%, the shadow takes on the color of any semitransparent pixels in the layer. If the layer contains no semitransparent pixels, Color Influence has little result, and the Shadow Color value determines the shadow's color. Decreasing the Color Influence value blends the colors of the layer in the shadow with the Shadow Color. Increasing Color Influence reduces the influence of the Shadow Color.

Shadow Only Select to render only the shadow.

Resize Layer Select to allow the shadow to extend beyond the layer's original boundaries.

Simulation effects

Common Lighting controls and Material controls

Several of the Simulation effects have some common controls. The Card Wipe effect also shares many controls with the Card Dance effect.

Lighting controls

Light Type Specifies which type of light you want to use. Distant Source simulates sunlight and casts shadows in one direction, where all the light rays strike the object from virtually the same angle. Point Source is similar to a light bulb and casts shadows in all directions. First Comp Light uses the composition's first light layer, which can use a variety of settings.

Light Intensity Specifies the power of the light. The higher the value, the brighter the layer. Other lighting settings affect the overall light intensity as well.

Light Color Specifies the color of light.

Light Position Specifies the position of the light in x,y space. To position the light interactively, Alt-drag (Windows) or Option-drag (Mac OS) the light's effect point.

Light Depth Specifies the position of the light in z space. Negative numbers move the light behind the layer.

Ambient Light Distributes light over the layer. Increasing this value adds an even illumination to all objects and prevents shadows from being totally black. Setting Ambient Light to pure white and setting all other light controls to 0 makes the object fully lit and eliminates any 3D shading from the scene.

Material controls

The Material controls specify reflection values.

Diffuse Reflection Gives objects form-defining shading. Shading depends on the angle at which the light strikes the surface and is independent of the viewer's position.

Specular Reflection Takes into account the position of the viewer. It models the reflection of the light source back to the viewer. It can create the illusion of shininess. For realistic effects, you can animate this control by using higher and higher values to mask the transition from filtered to nonfiltered versions of the layer.

Highlight Sharpness Controls shininess. Very shiny surfaces produce small, tight reflections, while duller surfaces spread the highlight out into a larger region. Specular highlights are the color of the incoming light. Because light is typically white or off-white, broad highlights can desaturate an image by adding white to the surface color.

💡 *In general, use the following process to adjust lighting: Set Light Position and Diffuse Reflection to control the overall light level and shading in a scene. Then adjust Specular Reflection and Highlight Sharpness to control the strength and spread of highlights. Finally, adjust Ambient Light to fill in the shadows.*

Card Dance effect

This effect creates the appearance of card choreography by dividing layers into numerous cards and then controlling all geometric aspects of the cards by using a second layer. For example, Card Dance can simulate an extruded pin sculpture, a crowd doing the wave, or letters floating on the surface of a pond.

This effect works with 8-bpc color.

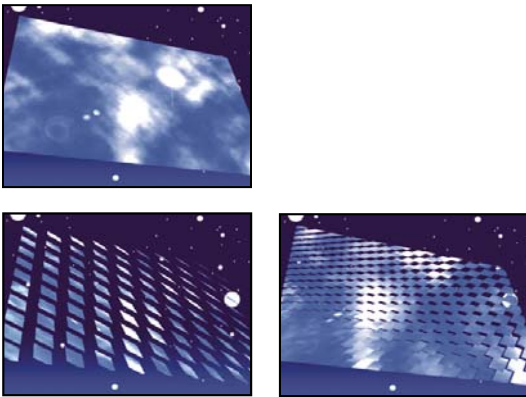

Original (top left), and with rotation adjusted using Camera Position controls (bottom left) and Corner Pin controls (bottom right)

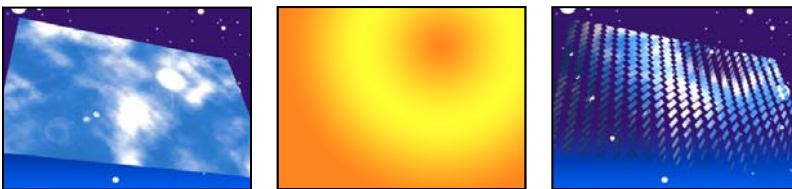

Original (left), gradient layer (center), and with Card Dance applied (right)

Apply Card Dance to the layer to use for the front of the cards. To set the view, use the rotation or perspective controls, or match the perspective of the effect in any scene by corner-pinning.

For example, select a vertical grayscale gradient layer (black on top, white on bottom) from the Gradient Layer 1 menu, and then select Intensity 1 from the X Rotation Source menu. Card Dance uses the intensity of the gradient to animate the x-axis rotation of the cards. It assigns a numeric value to the center pixel of each card on the gradient layer, based on the pixel's intensity. Pure white equals 1, pure black equals -1, and 50% gray equals 0. Card Dance then multiplies that value by the X Rotation Multiplier value and rotates each card that amount. If X Rotation Multiplier is set to 90, the cards in the top row rotate almost 90° backward, the cards in the bottom row rotate almost 90° forward, and cards in middle rows rotate by lesser amounts. Cards in the 50% gray area don't rotate at all.

If you want half of the cards in a layer to come in from the right, and the other half to come in from the left, create a gradient layer that is half black and half white. Set the gradient as the source for X Position, and set X Position Multiplier to 5, and animate it to 0. The cards in the black area initially appear at the left, and the cards in the white area initially appear at the right.

See also

“Common Lighting controls and Material controls” on page 486

Rows, Columns, Layer, and Order controls

Rows & Columns Specifies the interaction of the numbers of rows and columns. Independent makes both the Rows and Columns sliders active. Columns Follows Rows makes only the Rows slider active. If you choose this option, the number of columns is always the same as the number of rows.

Rows The number of rows, up to 1000.

Columns The number of columns, up to 1000, unless Columns Follows Rows is selected.

Note: Rows and columns are always evenly distributed across a layer, so unusually shaped rectangular tiles don't appear along the edges of a layer—unless you use an alpha channel.

Back Layer The layer that appears in segments on the backs of the cards. You can use any layer in the composition; its Video switch  can even be turned off. If the layer has effects or masks, precompose the layer first.

Gradient Layer 1 The first control layer to use to make the cards dance. You can use any layer. Grayscale layers produce the most predictable results. The gradient layer acts as a displacement map for animating the cards.

Gradient Layer 2 The second control layer.

Rotation Order The order in which the cards rotate around multiple axes when using more than one axis for rotation.

Transformation Order The order in which the transformations (scale, rotation, and position) are performed.

Position, Rotation, and Scale controls

Position (X, Y, Z), Rotation (X, Y, Z), and Scale (X, Y) specify the transformation properties you want to adjust. Because Card Dance is a 3D effect, you can control these properties separately for each axis of the cards. However, because the cards themselves are still 2D, they have no inherent depth—hence the absence of z scaling.

Source Specifies the gradient layer channel you want to use to control the transformation. For example, select Intensity 2 to use the intensity from Gradient Layer 2.

Multiplier The amount of transformation applied to the cards.

Offset The base value from which the transformation begins. It is added to the transformation value (a card's center pixel value times the Multiplier amount) so that you can start the transformation from some place other than 0.

Camera System and Camera Position controls

Camera System Specifies whether to use the effect's Camera Position properties, the effect's Corner Pins properties, or the default composition camera and light positions to render 3D images of the cards.

X Rotation, Y Rotation, Z Rotation Rotate the camera around the corresponding axis. Use these controls to look at the cards from the top, side, back, or any other angle.

X, Y Position Where the camera is positioned along the x and y axes.

Z Position Where the camera is positioned along the z axis. Smaller numbers move the camera closer to the cards, and larger numbers move the camera away from the cards.

Focal Length The zoom factor. Smaller numbers zoom in.

Transform Order The order in which the camera rotates around its three axes, and whether the camera rotates before or after it is positioned using the other Camera Position controls.

Corner Pins controls

Corner Pinning is an alternative camera control system. Use it as an aid for compositing the result of the effect into a scene on a flat surface that is tilted with respect to the frame.

Upper Left Corner, Upper Right Corner, Lower Left Corner, Lower Right Corner Where to attach each of the corners of the layer.

Auto Focal Length Controls the perspective of the effect during the animation. When Auto Focal Length is deselected, the focal length you specify is used to find a camera position and orientation that positions the corners of the layer at the corner pins. If this isn't possible, the layer is replaced by its outline, drawn between the pins. When Auto Focal Length is selected, the focal length required to match the corner points is used, if possible. If not, it interpolates the correct value from nearby frames.

Focal Length Overrides the other settings if the results you've obtained aren't what you need. If you set the Focal Length to something that doesn't correspond to what the focal length would be if the pins were actually in that configuration, the image may look unusual (strangely sheared, for example). But if you know the focal length that you are trying to match, this is the easiest way to get correct results.

Caustics effect

This effect simulates caustics—reflections of light at the bottom of a body of water, created by light refracting through the water's surface. The Caustics effect generates this reflection and creates realistic water surfaces when used with Wave World and Radio Waves.

This effect works with 8-bpc color.



Original (top left), and with Bottom set to the text layer (bottom left) and Water Surface set to the whirl layer with Surface Opacity set to 0% (bottom right)

 To get the most realistic results from Caustics, render the Bottom layer separately, with Render Caustics enabled and Surface Opacity at 0. Then precompose, and use the resulting layer as the Bottom layer for another Caustics effect with Render Caustics off. With this process you can offset, scale, or otherwise manipulate the Bottom layer in the precomposed composition, and thus simulate lighting that doesn't come from straight overhead.

See also

“Common Lighting controls and Material controls” on page 486

Bottom controls

The Bottom controls specify the appearance of the bottom of the body of water:

Bottom Specifies the layer at the bottom of the body of water. This layer is the image that is distorted by the effect, unless Surface Opacity is 100%.

Scaling Makes the bottom layer larger or smaller. If the edges of the bottom layer show, because of the refraction of the light through the waves, scale up the bottom layer. Scaling down is useful for tiling a layer to make a complex pattern.

Repeat Mode Specifies how a scaled-down bottom layer is tiled. Once uses only one tile, basically turning tiling off. Tiles uses the traditional tiling method of abutting the right edge of one bottom layer tile to the left edge of another bottom layer tile. This option works well if the bottom layer contains a repeating pattern, like a logo, that needs to read a certain way. Reflected abuts each edge of a bottom layer tile to a mirrored copy of the tile. This option can eliminate a hard edge where the two tiles meet.

If Layer Size Differs Specifies how to handle the bottom layer when it is smaller than the composition.

Blur Specifies the amount of blur applied to the bottom layer. To make the bottom totally sharp, set this control to 0. Higher values make the bottom appear increasingly blurry, especially where the water is deeper.

Water controls

Water Surface Specifies the layer to use as the water's surface. Caustics uses the luminance of this layer as a height map for generating a 3D water surface. Light pixels are high, and dark pixels are low. You can use a layer created by using the Wave World or Radio Waves effect; precompose the layer before using it with Caustics.

Wave Height Adjusts the relative height of the waves. Higher values make the waves steeper and the surface displacement more dramatic. Lower values smooth the Caustics surface.

Smoothing Specifies the roundness of the waves by blurring the water surface layer. Very high values eliminate detail. Very low values show imperfections in the water surface layer.

Water Depth Specifies depth. A small disturbance in shallow water moderately distorts the view of the bottom, but the same disturbance in deep water distorts the view significantly.

Refractive Index Affects the way the light bends as it passes through the liquid. A value of 1 does not distort the bottom. The default value of 1.2 accurately simulates water. To add distortion, increase the value.

Surface Color Specifies the color of the water.

Surface Opacity Controls how much of the bottom layer is visible through the water. If you want a milky effect, increase the Surface Opacity and Light Intensity values; a value of 0 results in a clear liquid.



Set Surface Opacity to 1.0 to perfectly reflect a sky later. With a suitable texture map, you can use this technique to create the effect of liquid mercury.

Caustics Strength Displays the caustics, the concentrations of light on the bottom surface, caused by the lensing effect of the water waves. This control changes the way everything looks: The waves' dark spots get much darker, and the light spots get much lighter. If you don't set a value for this control, the effect distorts the bottom layer when the waves pass over it, but it doesn't render the lighting effect.

Sky controls

Sky Specifies the layer above the water. Scaling makes the sky layer larger or smaller. If the edges of the sky layer show, scale the layer up. Scaling down is useful for tiling a layer to make a complex pattern.

Repeat Mode Specifies how a scaled-down sky layer is tiled. Once uses only one tile, basically turning tiling off. Tiles uses the traditional tiling method of abutting the right edge of one layer tile to the left edge of another layer tile. This option works well if the layer contains a repeating pattern, like a logo, that needs to read a certain way. Reflected abuts each edge of a layer tile to a mirrored copy of the tile. This option can eliminate a hard edge where the two tiles meet.

If Layer Size Differs Specifies how to handle the layer when it is smaller than the composition. Intensity specifies the opacity of the sky layer. Convergence specifies how close the sky and the bottom or water layer appear, controlling the extent to which the waves distort the sky.

Foam effect

This effect generates bubbles that flow, cling, and pop. Use the effect's controls to adjust attributes for the bubbles such as stickiness, viscosity, life span, and bubble strength. You can control exactly how the foam particles interact with each other and with their environment, and specify a separate layer to act as a map, controlling precisely where the foam flows. For example, you can have particles flow around a logo or fill a logo with bubbles.

This effect works with 8-bpc color.

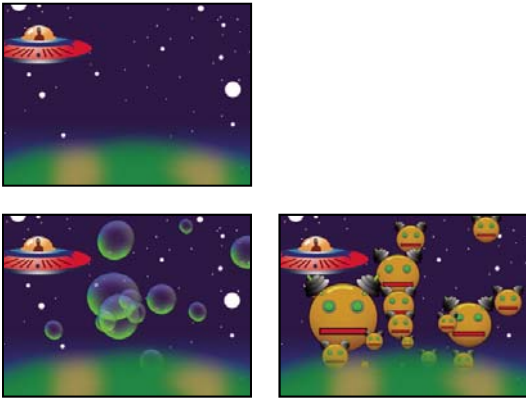

Original (top left), with Foam applied (bottom left), and with a robot layer used as the Bubble Texture Layer (bottom right)

You can also substitute any image or movie for bubbles. For example, you can create swarms of ants, flocks of birds, or crowds of people.

Note: On a frame-by-frame basis, Foam renders quickly, but the slightest adjustment in the initial settings is likely to result in very different output a few seconds into the simulation. When making adjustments to Physics controls, the farther into the simulation you are, the longer the adjustments take to render, because each adjustment results in the simulation being recalculated all the way back to the beginning. Not every frame takes this long to calculate; once Foam adjusts to the change, rendering speeds up again.

See also

“About randomness and random seeds” on page 354

View controls

Draft Displays the bubbles without fully rendering them. This is a fast way to preview the behavior of the bubbles. Draft mode is the only way to preview the universe edges, the Flow Map alignment, and the Producer location, orientation, and size. Bubbles are represented by blue ellipses. The Producer Point is represented by a red ellipse. The bubble universe is represented by a red rectangle.

Draft + Flow Map Displays the Draft view wireframe superimposed over a grayscale representation of the flow map, if selected.

Rendered Displays the final output of the animation.

Producer controls

The Producer controls specify the location where the bubbles originate, as well as the speed at which they are generated:

Producer Point The center of the area from which the bubbles can be produced.

Producer X Size, Producer Y Size Adjust the width and height of the area from which the bubbles can be produced.

Producer Orientation Adjusts the rotation (orientation) of the area from which the bubbles can be produced. Producer Orientation has no noticeable effect when Producer X Size and Producer Y Size are identical.

Zoom Producer Point Specifies whether the producer point and all of its associated keyframes remain relative to the universe (selected) or to the screen (unselected) when you zoom in or out on it. For example, if you set a position for Producer Point in the upper-left corner of the layer and then zoom out on that layer, the producer point stays in the

upper-left corner of the screen if you don't select Zoom Producer Point. If you select Zoom Producer Point, the point moves with the universe as it is zoomed out, and the point ends up closer to the center of the screen.

Production Rate Determines the rate at which bubbles are generated. This control does not affect the number of bubbles per frame. Rather, the rate is the average number of bubbles generated every 30th of a second. Higher numbers yield more bubbles.

 *If a large number of bubbles appear in the same point at the same time, some may pop. If you want a lot of foam, increase the values for Producer X Size and Producer Y Size so that the bubbles don't immediately pop each other.*

Bubbles controls

Size Specifies the average size for adult bubbles. Size Variance, Bubble Growth Speed, and Random Seed also affect the size of a bubble in any particular frame.

Size Variance Specifies the range of possible bubble sizes. This control uses the Size value as the average and creates smaller-than-average and larger-than-average-bubbles by using the range you specify here. For example, a default bubble Size of 0.5 and default Size Variance of 0.5 generate bubble sizes ranging from 0 to 1 ($0.5 - .5 = 0$ and $0.5 + 0.5 = 1$).

Lifespan Specifies the maximum life of a bubble. This value is not absolute; if it were, the bubbles would all pop after the same lifespan, as if they were hitting a wall. Rather, this value is a target lifespan; some bubbles pop early, and others may last until the end.

Bubble Growth Speed Specifies how fast a bubble reaches full size. When a bubble is released from the producer point, it generally starts out rather small. If you set this value too high and you specify a small producer area, the bubbles pop each other, and the effect generates fewer bubbles than expected.

Strength Influences how likely a bubble is to pop before it reaches its Lifespan limit. Lowering a bubble's Strength makes it more likely to pop early in its life, when forces like wind and flow maps act upon it. Lower values are good for soap bubbles. The highest value is recommended for flocking animations.

 *Set this value low, and set Pop Velocity high to create chain reactions of popping bubbles.*

Physics controls

The Physics controls specify the motion and behavior of the bubbles:

Initial Speed Sets the speed of the bubble as it is emitted by the producer point. This speed is affected by the other Physics parameters.

 *Low Initial Speed values in conjunction with the default producer size don't affect the results much because the bubbles bounce off each other. For more control over initial speed, increase the values for Producer X Size and Producer Y Size.*

Initial Direction Sets the initial direction in which the bubble moves as it emerges from the producer point. This is affected by other bubbles and other Physics controls.

Wind Speed Sets the speed of the wind that pushes the bubbles in the direction specified by Wind Direction.

Wind Direction Sets the direction in which the bubbles blow. Animate this control to create turbulent wind effects. Bubbles are affected by wind as long as Wind Speed is greater than 0.

Turbulence Applies small random forces to the bubbles, making them behave chaotically.

Wobble Amount Randomly changes the shape of bubbles from perfectly round to a more natural elliptical shape.

Repulsion Controls whether bubbles bounce off each other, stick to each other, or pass through each other. At a value of 0, bubbles don't collide; they pass through each other. The higher the Repulsion value, the more likely bubbles are to interact with each other when they collide.

Pop Velocity Controls how popping bubbles affect each other. When a bubble pops, it affects other bubbles around it by leaving a hole that other bubbles can fill, pushing other bubbles away, or popping other bubbles. The higher the value, the more popping bubbles affect one another.

Viscosity Specifies the rate at which bubbles decelerate after being released from the producer point, and controls the speed of the flow of the bubbles. A high Viscosity value creates resistance as the bubbles get farther away from the producer point, causing them to slow down. If Viscosity is set high enough, the bubbles stop. The thicker the substance, the higher the Viscosity. For example, if you want to create the effect of bubbles traveling through oil, set Viscosity fairly high, so that the bubbles meet resistance as they travel. To create the effect of bubbles floating in air, set Viscosity fairly low.

Stickiness Causes bubbles to clump together and makes them less vulnerable to other Physics controls like Wind Direction. The higher the Stickiness, the more likely the bubbles are to form clusters and cling. Use Stickiness and Viscosity to create a bubble cluster.

Zoom and Universe Size controls

Zoom Zooms in or out around the center of the bubble universe. To create really large bubbles, increase the Zoom value instead of the Size value because large bubble sizes can be unstable.

Universe Size Sets the boundaries of the bubble universe. When bubbles completely leave the universe, they pop and are gone forever. By default, the universe is the size of the layer. Values greater than 1 create a universe that stretches beyond the borders of the layer. Use higher values to make bubbles flow in from off-screen, or make it possible to zoom out and bring them back into the picture. Using a value lower than 1 clips the bubbles before they reach the edge of the layer. For example, when you want to confine bubbles to a specific area, such as inside a mask shape, set Universe Size a little larger than the mask size to remove all the extra bubbles and speed up the rendering process.

Rendering controls

The Rendering controls specify the appearance of the bubbles, including their texture and reflection:

Blend Mode Specifies the relative transparency of bubbles as they intersect. Transparent blends the bubbles smoothly together, allowing you to see the bubbles through each other. Solid Old On Top makes a younger bubble appear to be underneath an older bubble and eliminates transparency. Use this setting to simulate bubbles flowing toward you. Solid New On Top makes younger bubbles appear to be on top of older bubbles and also eliminates transparency. Use this setting to make bubbles appear as if they are flowing downhill.

Bubble Texture Specifies the bubble texture. Use a preset texture, or create your own. To see the texture, make sure that View is set to Rendered. To create your own texture, select User Defined, and from the Bubble Texture Layer menu, choose the layer you want to use as the bubble.

Note: The preset bubble textures are prerendered 64 x 64 images. If you zoom in above 64 x 64, the bubble appears blurry. To avoid this, use a higher-resolution custom bubble.

Bubble Texture Layer Specifies the layer you want to use as the bubble image. To use this control, choose User Defined from the Bubble Texture menu. If you want the layer to appear only as a bubble, turn off the video switch for the layer in the Timeline panel.

Note: You can use any file type that After Effects supports. If you plan on zooming in or using a large bubble size, make sure that the resolution of the layer is high enough to avoid blurring. Remember, this doesn't have to be a normal bubble. You can make blood cells, starfish, bugs, space aliens, or flying monkeys. If it's a layer in your composition, it can be a bubble.

Bubble Orientation Determines the direction that the bubble rotates. Fixed releases the bubble from the producer right side up and keeps it that way. Use this control if the bubble has built-in highlights and shading, as all of the preset bubbles do. Physical Orientation buffets and spins bubbles around by the forces on them, creating a chaotic scene. Bubble Velocity faces the bubble in the direction of its motion. This is the most useful setting for flocking-style animations.

Environment Map Specifies the layer that is reflected in the bubbles. If you want to use this layer only for the reflection, turn off the layer's video switch.

Reflection Strength Controls how much of the selected Environment Map is reflected in the bubbles. The higher the value, the more the reflection obscures the original bubble texture. Reflections appear only on opaque pixels, so bubbles with high amounts of transparency, such as the Spit preset, don't reflect much.

Reflection Convergence Controls how much your Environment Map is distorted as it is mapped onto the bubbles. A value of 0 projects the map flat on top of all of the bubbles in the scene. As the value increases, the reflection distorts to account for the spherical shape of each bubble.

Flow Map controls

The Flow Map controls specify the map that the flow of the foam follows:

Flow Map Specifies the layer used to control the direction and speed of the bubbles. Use a still image layer; if you select a movie as the flow map layer, only the first frame is used. A flow map is a height map based on luminance: White is high, and black is low. White is not infinitely high; if a bubble travels fast enough, it can travel past a white obstacle. Make sure that the map is a little blurry; sharp edges can create unpredictable results. For example, to make bubbles flow through a canyon, create a flow map with a white canyon rim, a black canyon, and blurry gray walls. Use wind to blow the bubbles in the direction you want them to flow, and the walls of the canyon contain them. You can also use a gentle gradient on the floor of the canyon to control the flow direction, but this is somewhat more difficult to set up.

Note: If the bubbles don't follow the map, use the Simulation Quality control. Also, try blurring the flow map a little to make sure that it does not have excessively abrupt edges.

Flow Map Steepness Controls the difference between white and black as they are used to determine steepness. If the bubbles are ricocheting randomly off the flow map, decrease this value.

Flow Map Fits Specifies whether the flow map is relative to the layer or to the universe. The flow map resizes itself to fit whichever you specify. This control is useful when you want to enlarge the universe but the flow map is designed for a particular layer, or when you want the bubbles to start off-screen and be affected by the flow map as they arrive onscreen.

Simulation Quality Increases the precision, and therefore the realism, of the simulation. However, the higher the value, the longer the composition takes to render. Normal generally produces good results and takes the least amount of time to render. High returns better results but takes longer to render. Intense increases the rendering time but produces more predictable bubble behavior. Use this option if the bubbles aren't following the flow map. It often solves problems of erratic behavior that can occur with small bubbles, high bubble speeds, and steep slopes.

Particle Playground effect

The Particle Playground effect lets you animate a large number of similar objects independently, such as a swarm of bees or a snow storm. Use the Cannon to create a stream of particles from a specific point on the layer, or use the Grid to generate a plane of particles. The Layer Exploder and Particle Exploder can create new particles from existing layers or particles. You can use any combination of particle generators on the same layer.

This effect works with 8-bpc color.

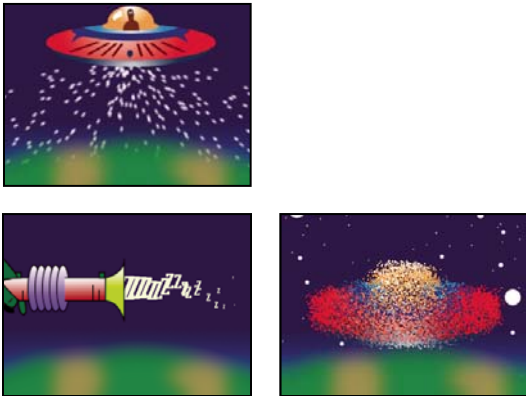

Particles shooting out of the spacecraft layer (top left), text characters used as particles shooting out of a ray gun (bottom left), and Layer Exploder used on spacecraft layer (bottom right)

Start by creating a stream or plane of particles, or by exploding an existing layer into particles. Once you have a layer of particles, you can control their properties, such as speed, size, and color. You can replace the default dot particles with images from an existing layer to create, for example, an entire snowstorm from a single snowflake layer. You can also use text characters as particles. For example, you can shoot words across the screen, or you can create a sea of text in which a few letters change color, revealing a message.

Use Cannon, Grid, Layer Exploder, and Particle Exploder controls to generate particles. Use Layer Map control to specify a layer in place of each default dot particle. Use Gravity, Repel, and Wall controls to influence overall particle behavior. Use Property Mapper controls to influence particle properties. Use Options to set options, including those for substituting text characters in place of dots.

Note: Because of the complexity of Particle Playground, you may experience long computation, preview, and render times.

Use Particle Playground

- 1** Select the layer on which you want particles to exist, or create a new solid layer.
- 2** Choose Effect > Simulation > Particle Playground. The layer becomes an invisible layer in which only the particles are visible. Animating the layer in the Timeline panel animates the entire layer of particles.
- 3** Set up a particle generator to determine how particles are created. You can shoot a stream of particles from the Cannon, generate a flat plane full of particles from the Grid, or use the Layer Exploder to create particles from an existing layer. If you've already created particles, you can apply the Particle Exploder to explode them into more new particles.
- 4** Select your particles. By default, Particle Playground creates dot particles. You can replace the dots with a layer already in the composition or with text characters you specify.
- 5** Specify the overall behavior of some or all particles. Use Gravity to pull particles in a specified direction, Repel to push particles apart from or toward one another, or Wall to contain or exclude particles from a certain area.
- 6** Use an image to specify the behavior of individual particles. You can modify controls that change particle motion, such as speed and force, and controls that change particle appearance, such as color, opacity, and size.

The Particle Playground effect renders with anti-aliasing when the layer to which it is applied is set to Best quality. It also applies motion blur to moving particles when both the Motion Blur layer switch and the Enable Motion Blur composition switch are on.

When you use another layer as a source for particles, Particle Playground ignores any changes you made to that layer within that composition, such as changing the Position values. Instead it uses the layer in its original state. To keep changes for a layer when you use it as a particle source, precompose the layer.

Particle content and particle generators

Particle Playground can generate three kinds of particles: dots, a layer, or text characters. You can specify only one kind of particle per particle generator.

Create particles by using the Cannon, the Grid, the Layer Exploder, and the Particle Exploder. The Grid creates particles in an organized grid format with straight rows and columns. The exploders create particles randomly, like firecracker sparks.

The particle generators set the attributes of particles at the moment they are created. After that, particle behavior is influenced by the Gravity, Repel, Wall, Exploder, and Property Mapper controls. For example, if you want particles to stick to grid intersections, you might use the Static Friction option in the Persistent Property Mapper to hold particles in place. Otherwise, as soon as particles are created, they begin moving away from their original grid positions.

Cannon controls

The Cannon is on by default; to use a different method to create particles, first turn the Cannon off by setting Particles Per Second to zero. The Cannon creates particles in a continuous stream.

Position Specifies the (x,y) coordinates from which particles are created.

Barrel Radius Sets the size of the Cannon's barrel radius. Negative values create a circular barrel, and positive values create a square barrel. For a narrow source, such as a ray gun, specify a low value. For a wide source, such as a school of fish, specify a high value.

Particles Per Second Specifies how often particles are created. A value of 0 creates no particles. A high value increases the density of the particle stream. If you don't want the Cannon to fire continuously, set keyframes for this control so that the value is 0 at the times when you don't want to create any particles.

Direction Sets the angle at which particles are fired.

Direction Random Spread Specifies how much each particle's direction deviates randomly from the cannon direction. For example, specifying a 10-degree spread sprays particles in random directions within $\pm 5^\circ$ of the cannon direction. For a highly focused stream, such as a ray gun, specify a low value. For a stream that widens quickly, specify a high value. You can specify up to 360° .

Velocity Specifies the initial speed of particles in pixels per second as they emanate from the Cannon.

Velocity Random Spread Specifies the amount of random velocity of particles. A higher value results in more variation in the velocity of particles. For example, if you set Velocity to 20 and Velocity Random Spread to 10, particles leave the Cannon at velocities ranging from 15 to 25 pixels per second.

Color Sets the color of dots or text characters. This control has no effect if you use a layer as the particle source.

Particle Radius Sets the radius of dots, in pixels, or the size of text characters in points. This control has no effect if you use a layer as the particle source.

Grid controls

The Grid creates a continuous plane of particles from a set of grid intersections. The movement of Grid particles is completely determined by the Gravity, Repel, Wall, and Property Mapper settings. By default, the Force control of Gravity is on, so Grid particles fall toward the bottom of the frame.

With the Grid, a new particle appears on every frame at each grid intersection. You can't adjust this frequency, but if you want to turn off the Grid or make the Grid stop generating particles at specific times, set the Particle Radius/Font Size control to 0, or use keyframes to animate the value of the Particles Across and Particles Down controls. To make more particles appear in each frame, increase the values for Particles Across and Particles Down.

Note: By default, the Cannon is on and the Grid is off. If you are using the Grid and want to stop the Cannon from generating particles, turn off the Cannon by setting its Particles Per Second value to 0.

Position Specifies the (x,y) coordinates of the grid center. When a grid particle is created, it is centered over its grid intersection, regardless of whether it is a dot, a layer, or a text character. If you're using text characters as particles, the Use Grid option in the Edit Grid Text dialog box is on by default, placing each character on its own grid intersection, so normal character spacing, word spacing, and kerning do not apply. If you want text characters to appear at the grid position with normal spacing, use a text alignment other than the Use Grid option.

Width, Height Specify the dimensions of the grid, in pixels.

Particles Across, Particles Down Specify the number of particles to distribute horizontally and vertically across the grid area. Particles are generated only when the value is 1 or more.

Note: If the Width, Height, Particles Across, and Particles Down controls are not available, the Use Grid option has been turned off in the Edit Grid Text dialog box.

Color Sets the color of dots or text characters. This control has no effect if you use a layer as the particle source.

Particle Radius/Font Size Sets the radius of dots in pixels or the size of text characters in points. This control has no effect if you use a layer as the particle source.

Layer Exploder and Particle Exploder

The Layer Exploder explodes a layer into new particles, and the Particle Exploder explodes a particle into more new particles. In addition to explosion effects, the exploders are also handy for simulating fireworks or for rapidly increasing the number of particles.

The following guidelines can help you control particles resulting from an explosion:

- A layer is exploded once for each frame. By default, this creates a continuous shower of particles for the duration of the composition. If you want to start or stop a layer explosion, animate the Radius of New Particles control by using keyframes so that its value is zero at times when you don't want particles to be created.
- If the source of the layer is a nested composition, you can set different Opacity values or In and Out points for the layers within the nested composition to make the exploding layer transparent at different points in time. The Layer Exploder does not create particles where the source of the layer is transparent.
- To change the position of the exploding layer, precompose the layer with its new position (use the Move All Attributes Into The New Composition option), and then use the precomposed layer as the exploding layer.
- When you explode particles, the new particles inherit the position, velocity, opacity, scale, and rotation of the original particles.
- After you explode layers or particles, the movement of particles is influenced by the Gravity, Repel, Wall, and Property Mapper controls.

 *Some Persistent Property Mapper and Ephemeral Property Mapper options can make explosions more realistic. For example, change Opacity to make the resulting particles fade out, or change the Red, Green, and Blue color channels to make resulting particles change color as they appear to cool.*

Explode Layer (Layer Exploder only) Specifies the layer you want to explode. To make the video disappear the moment the particles appear, either turn off the video for the layer or trim the layer's Out point.

Radius Of New Particles Specifies the radius of the particles resulting from the explosion. This value must be smaller than the radius of the original layer or particle.

Velocity Dispersion Specifies, in pixels per second, the maximum speed of the range within which Particle Playground varies the velocity of the resulting particles. High values create a more dispersed or cloudlike explosion. Low values keep the new particles closer together and can make the exploded particles resemble a halo or shockwave.

Affects Specifies which particles are affected by the Layer Exploder and Particle Exploder.

Layer Map controls

By default, the Cannon, Grid, Layer Exploder, and Particle Exploder create dot particles. To replace the dots with a layer in the composition, use the Layer Map. For example, if you use a movie of a single bird flapping its wings as a particle source layer, After Effects replaces all dots with an instance of the bird movie, creating a flock of birds. A particle source layer can be a still image, a solid, or a nested After Effects composition.

A *multiframe layer* is any layer with a source that varies over time, such as a movie or a composition. When you map new particles to a multiframe layer, use the Time Offset Type control to specify how you want to use the layer's frames. For example, use Absolute to map an unchanging image onto a particle, or use Relative to map an animating sequence of frames onto a particle. You can randomize both Absolute and Relative across particles.

Note: When you choose a layer for Layer Map, Particle Playground ignores any changes that you made to that layer within that composition. Instead, it uses the layer in its original state. To keep transformations, effects, masks, rasterization options, expressions, or keyframe changes for a layer when you use it as a particle source, precompose the layer.

Use Layer Specifies the layer you want to use as the particles.

Time Offset Type Specifies how you want to use a multiframe layer's frames. For example, if you are using a layer of a bird flapping its wings and you choose Relative for Time Offset Type with a Time Offset of 0, the flapping wings for all the instances of the bird are synchronized. While this might be realistic for a marching band, it is not realistic for a flock of birds. To make each bird start flapping its wings from a different frame in the layer, use Relative Random.

- **Relative** Starts playing the layer at a frame based on the Time Offset you specify, relative to the effect layer's current time; then advances in step with the Particle Playground layer's current time. If you specify a Time Offset of 0, all particles show the frame that corresponds to the effect layer's current time. If you choose a Time Offset of 0.1 (and your composition is set to 30 fps), each new particle displays the frame that is 0.1 seconds after the previous particle's frame. Regardless of the Time Offset you specify, the first particle always displays the frame of the source layer that corresponds to the effect layer's current time.
- **Absolute** Displays a frame from the layer based on the Time Offset you specify, regardless of the current time. Choose Absolute when you want a particle to show the same frame of a multiframe source layer for its entire lifespan, instead of cycling through different frames as the effect layer advances in time. For example, if you choose Absolute and specify a Time Offset of 0, every particle shows the first frame of the source layer for its entire lifespan. If you want to show a frame other than the first frame, move the layer earlier in time until the frame you want to show corresponds to the In point of the Particle Playground layer. If you specify a Time Offset of 0.1, for example, each new particle displays a frame that is 0.1 second after that of the previous particle (or every third frame of a 30-fps animation).
- **Relative Random** Starts playing the layer from a frame chosen at random, within the range between the effect layer's current time and the Random Time Max you specify. For example, if you choose Relative Random and specify a Random Time Max of 1, each particle starts playing from a layer frame chosen at random from between the current time and 1 second after the current time. If, for another example, you specify a negative Random Time Max value of - 1, the Random Time Max is before the current time, so that the range within which new particles start playing

advances as the current time advances. However, the range is always between the current time and one second earlier than the current time.

- **Absolute Random** Takes a frame at random from the layer, by using a time between 0 and the Random Time Max you specify. Choose Absolute Random when you want each particle to represent a different single frame of a multi-frame layer. For example, if you choose Absolute Random and specify a Random Time Max of 1, each particle shows a layer frame from a random time between 0 and 1 second into the layer's duration.

Time Offset Specifies the frame from which to start playing sequential frames from the layer.

Affects Specifies which particles are affected by the Layer Map controls.

Replace default Cannon particles with text

You can use text characters as particles. For example, you can type a message that the Cannon shoots across the frame. You can also change the attributes of any three sets of characters. For example, you can make some of the characters larger or brighter than others.

- 1 In the Effect Controls panel, click Options.
- 2 Click Edit Cannon Text.
- 3 Type text in the text box, and then set the following options:
 - For Font/Style, choose the font and style for Cannon characters.
 - For Order, click to specify the sequence in which characters exit the Cannon. The sequence is relative to the character order typed in the text box. For example, if the Cannon Direction is set to 90° (making it point to the right), English text must exit the Cannon last letter first to be in readable order. Therefore, select Right to Left.
 - For Loop Text, select to continuously generate the characters you typed. Deselect to generate only one instance of the characters.
- 4 Click OK to close the Edit Cannon Text dialog box, and then click OK to close the Particle Playground dialog box.
- 5 Click the right-facing triangle next to Cannon so that it points downward.
- 6 Click the Font Size value, type a value of 10 or greater, and press Enter (Windows) or Return (Mac OS).

If you want to stop replacing default particles with text, delete all text from the text box in the Edit Cannon Text dialog box.

Replace default Grid particles with text

- 1 In the Effect Controls panel, click Options, and then click Edit Grid Text.
- 2 Set the following options:
 - For Font/Style, choose the font and style for Grid characters.
 - For Alignment, click Left, Center, or Right to position text in the text box at the Position specified in the Grid control, or click Use Grid to position each letter in the text on consecutive grid intersections.
 - For Loop Text, select to repeat the characters you typed until all the grid intersections contain one character. Grid intersections are specified by the Particle Across and Particle Down controls. Deselect to generate only one instance of the text. (This option is available only if you select Use Grid alignment.)
- 3 Type text in the text box. If Use Grid alignment is selected and you want to skip a grid intersection, type a space. To force the next character down to the next grid row, press Enter (Windows) or Return (Mac OS).
- 4 Click OK to close Edit Grid Text, and then click OK to close the Particle Playground dialog box.
- 5 Click the right-facing triangle next to Grid so that it points downward.

6 Click the Font Size value, type a value of 10 or greater, and press Enter (Windows) or Return (Mac OS).

If you want to stop replacing default particles with text, delete all text from the text box in the Edit Grid Text dialog box.

Changing a particle over its lifespan

Some controls affect the particle from birth: Cannon, Grid, Layer Exploder, and Particle Exploder. Others affect the particle after birth and over the course of its lifespan: Gravity, Repel, Wall, Persistent Property Mapper, and Ephemeral Property Mapper. To have full control over particle movement and appearance, you must balance these controls.

For example, if you want to use the Cannon to shoot sparks that fade over time, it may seem that you need only animate the Cannon's Color control. However, using this method, you change only the color of each new particle as it's created. To control the color for the lifespan of particles, you must create a layer map and use one of the Property Mappers to alter the particles' color channels.

The following list covers common particle behavior and how you can influence it.

Speed At particle creation, particle velocity is set by the Cannon and the exploders; Grid particles have no initial speed. After particle creation, use the Force control in the Gravity and Repel control groups. You can also influence the speed of individual particles by using a layer map to set values for the Speed, Kinetic Friction, Force, and Mass properties in the Property Mappers.

Direction At particle creation, the Cannon includes particle direction; the Layer Exploder and Particle Exploder send new particles in all directions; and Grid particles have no initial direction. After particle creation, direction can be influenced by the Direction control in the Gravity control group or by specifying a Boundary (mask) in the Wall control group. You can also influence the direction of individual particles by using a layer map to set values for the Gradient Force, X Speed, and Y Speed properties in the Property Mappers.

Area Use a Wall mask to contain particles to a different area or to remove all barriers. You can also restrict particles to an area by using a layer map to set values for the Gradient Force property in the Property Mappers.

Appearance At particle creation, the Cannon, Grid, Layer Exploder, and Particle Exploder set particle size unless you replace the default dots with a layer map. The Cannon and Grid set the initial color, while the Layer Exploder and Particle Exploder take color from the exploded dot, layer, or character. The Options dialog box affects the initial appearance of text. After particle creation, you can use the Property Mappers to set values for Red, Green, Blue, Scale, Opacity, and Font Size.

Rotation At particle creation, the Cannon and Grid set no rotation; the Particle Exploder takes rotation from the exploded dot, layer, or character. Use Auto-Orient Rotation to make particles rotate automatically along their respective trajectories. For instance, a particle can point up as it climbs an arc, and point down as it descends. Rotation isn't easily visible for a dot particle. It is easier to observe only when you replace the dot particle with text characters or a layer. After particle creation, use a layer map to set values for the Angle, Angular Velocity, and Torque property in the Property Mappers.

Note: *The appearance and rotation of a layer map particle changes in relation to the mapped layer's original appearance and rotation. For instance, if you replace the default dot particles with a movie of a spinning wheel, the spinning-wheel particles appear to spin when no particle rotation is applied.*

Gravity controls

Use Gravity controls to pull existing particles in a direction you specify. Particles accelerate in the direction of gravity. Apply in a vertical direction to create falling particles, such as rain or snow, or rising particles, such as champagne bubbles. Apply in a horizontal direction to simulate wind.

Force Specifies the force of gravity. Positive values increase the force, pulling particles more strongly. Negative values reduce the force.

Force Random Spread Specifies a range of randomness for the Force. At zero, all particles fall at the same rate. At a higher value, particles fall at slightly different rates. Although pure gravity accelerates all objects equally, increasing the Force Random Spread value can produce more realistic results with subjects such as leaves falling through air, where there is enough air resistance to vary the leaves' rates of descent.

Direction Specifies the angle along which gravity pulls. The default is 180°, which simulates the real world by pulling particles toward the bottom of the frame.

Affects Specifies a subset of the layer's particles to which Gravity applies.

Repel controls

Repel controls specify how nearby particles repel or attract each other. This feature simulates adding a positive or negative magnetic charge to each particle. You can specify which particles, layers, or characters are the repelling force and which are repelled.

Note: If you want to repel an entire layer of particles away from a specific area, use the Property Mapper controls, Wall or Gradient Force.

Force Specifies the repel force. Greater values repel particles with more force. Negative values result in particle attraction.

Force Radius Specifies the radius (measured in pixels) within which particles are repelled. Another particle must be within this radius to be repelled.

Repeller Specifies which particles act as the repellers or attractors to another subset you specify by using the Affects control.

Affects Specifies a subset of the layer's particles to which repulsion or attraction applies.

Wall controls

Wall controls contain particles, limiting the area within which particles can move. A wall is a closed mask that you create by using a mask tool, such as the Pen tool. When a particle hits the wall, it bounces off at a velocity based on the force with which it hit.

Boundary Specifies the mask to use as the wall. You can create a new mask by drawing one on the effect layer.

Affects controls

Many Particle Playground controls include Affects controls. Affects controls specify which particles are affected by the encompassing control. For example, the Affects controls within the Particle Exploder controls specify which particles the Particle Exploder affects.

Particles From Specifies the particle generator or combination of particle generators whose particles you want to affect.

Selection Map Specifies the layer map that influences which particles are affected.

Note: The simulation space is not bounded by the dimensions of the layer to which Particle Playground is applied. You may need to use a selection map that is larger than the Particle Playground layer so that dots that are not visible are still affected by Selection Map.

Characters Specifies the characters you want to affect. This control applies only if you are using text characters as the particle type.

Older/Younger Than Specifies the age threshold, in seconds, above or below which you want to affect a particle. Positive values affect older particles, and negative values affect younger particles. For example, a value of 10 means that as soon as a particle reaches 10 seconds, it changes to the new value.

Age Feather Specifies the age range in seconds within which the Older/Younger Than value is feathered, or softened. Feathering creates a gradual, rather than abrupt, change. For example, if you set Older/Younger Than to 10 and Age Feather to 4, about 20% of particles start changing when they're 8 seconds old, 50% change when they're 10 seconds old (the Older/Younger Than value), and the remainder change by the time they're 12 seconds old.

Use Particle Playground Property Mapper controls

You can control specific properties of individual particles by using a layer map and either the Persistent Property Mapper or the Ephemeral Property Mapper. You can't alter a specific particle directly, but you can use a layer map to specify what happens to any particle that passes over a specific pixel in the layer. Particle Playground interprets the brightness of each layer map pixel as a specific value. The Property Mapper associates a specific layer map channel (Red, Green, or Blue) with a specific property, so that as a particle passes over a certain pixel, the brightness value at that pixel modifies the property.

A particle property can be modified in either a persistent or an ephemeral way:

- A *persistent* change to a particle property retains the most recent value set by a layer map for the remaining lifespan of the particle, unless the particle is modified by another control such as Repel, Gravity, or Wall. For example, if you use a layer map to modify particle size and you animate the layer map so it exits the frame, the particles keep the last size value set by the layer map after it exits the frame.
- An *ephemeral* change to a particle property causes the property to revert to its original value after each frame. For example, if you use a layer map to modify particle size and you animate the layer map so that it exits the frame, each particle returns to its original size value as soon as no layer map pixels correspond to it. Similarly, if you apply an operator such as Add, each time a particle passes over a different layer map pixel, the value of the layer map pixel is added to the original value of the particle.

In both the Persistent and Ephemeral Property Mappers, you can control up to three particle properties independently by using a single RGB image as a layer map. Particle Playground achieves this by extracting brightness values separately from the red, green, and blue channels in the image. You don't have to use all three channels if you want to modify just one property. To change just one property or change up to three properties using the same values, use a grayscale image as the layer map because the RGB channels are identical.

In combination with keyframes or expressions, the Property Mappers provide complete control over individual particle properties in space and time. Using layer maps, you can change particle properties at any location within a frame. By applying keyframes or expressions to Property Mapper options and animating a layer map, you can control how particle properties change.

- 1 For Use Layer As Map, choose a layer map to use as the source for values that modify particle values. The layer map must be part of the composition.
- 2 To apply the effect to a subset of particles, specify the Affects controls as necessary.

3 Choose a property for each of the Map Red To, Map Green To, and Map Blue To controls. You don't have to map properties to all of the color channels. For example, if you want to change scale over an image map, you can map the color red to scale without setting other properties.

4 Specify the minimum and maximum values you want the layer map to produce for each Map To group. Min is the value to which a black pixel is mapped, and Max is the value to which a white pixel is mapped. The complete tonal distribution between Min and Max is then scaled proportionally.

5 If using the Ephemeral Property Mapper, you can apply an operator to the value of a particle property and the value of the corresponding layer map pixel.

Note: Because particle properties use many kinds of units, such as pixels, degrees, and seconds, you may want to compress or expand the range of values from the layer map so that all the resulting values are usable in the measurement system of a specific particle property. First, use the Min and Max controls, which define the range of values to use from the layer map. If further adjustment is necessary and you're using the Ephemeral Property Mapper, use the Operator control and choose a mathematical operator to amplify, attenuate, or limit the effect of a layer map.

In both the Persistent and Ephemeral Property Mappers, you can use a layer map's alpha channel to make more subtle changes to the value of a particle property. For example, particles over a layer-map pixel in which the alpha channel value is 255 are fully affected, while lower values affect particles less. Layer-map pixels that are completely transparent have no effect on particle properties.

When you choose any of the following properties, Particle Playground copies the value from the layer map (that is, the layer selected in the Use Layer as a Map menu) and applies it to the particle.

None Modifies no particle property.

Red, Green, Blue Copy the value of the particle's red, green, or blue channel within a range of 0.0–1.0.

Kinetic Friction Copies the amount of resisting force against a moving object, typically within a range of 0.0–1.0. Increase this value to slow down or stop moving particles, as if braking.

Static Friction Copies the amount of inertia that holds a stationary particle in place, typically within a range of 0.0–1.0. At zero, a particle moves when any other force, such as gravity, is present. If you increase this value, a stationary particle requires more of another force to start moving.

Angle Copies the direction in which the particle points, in degrees relative to the particle's original angle. The angle is easily observable when a particle is a text character or a layer without radial symmetry.

Angular Velocity Copies the velocity of particle rotation in degrees per second. This determines how fast a particle rotates around its own axis.

Torque Copies the force of particle rotation. The angular velocity of a particle is increased by a positive torque and is increased more slowly for particles of greater mass. Brighter pixels affect angular velocity more forcefully; if enough torque is applied against angular velocity, the particle starts spinning in the opposite direction.

Scale Copies the scale value of a particle along both the x and y axes. Use this to stretch a particle proportionally. A value of 1.0 scales the particle to its full size; a value of 2.0 scales it 200%, and so on.

X Scale, Y Scale Copy the scale value of a particle along the x or y axis. Use these to stretch a particle horizontally or vertically.

X, Y Copy the position of a particle along the x or y axis in the frame, in pixels. A value of zero specifies a position at the left of the frame (for X) or at the top of the frame (for Y).

Gradient Velocity Copies the velocity adjustment based on areas of a layer map on both the x and y planes of motion.

X Speed, Y Speed Copy the horizontal speed (x-axis velocity) or vertical speed (y-axis velocity) of a particle in pixels per second.

Gradient Force Copies the force adjustment based on areas of a layer map on both the x and y planes of motion. The pixel brightness values in the color channel define the resistance to particle force at each pixel, so the color channel acts like a layer map of hills and valleys that decrease or increase particle force. In the layer map, areas of equal brightness result in no adjustment, similar to flat land. Lower pixel values represent less resistance to a particle's force, similar to a downhill grade. Higher pixel values represent more resistance to a particle's force, similar to an uphill grade. For best results, use a soft-edged layer map image.

 *If you are using a layer map for Gradient Force where flat areas equal no adjustment, and you are using the Min and Max controls (not the Min or Max operators) to set the range of values for Gradient Force, set them to positive and negative values of the same number (for example, -30 and +30). This ensures that the middle of the range remains centered at zero.*

X Force Copies the coercion along the x axis of motion. Positive values push a particle to the right.

Y Force Copies the coercion along the y axis of motion. Positive values push a particle down.

Opacity Copies the transparency of a particle, where zero is invisible, and 1 is solid. Adjust this value to fade particles in or out.

Mass Copies the particle mass, which interacts with all properties that adjust force, such as Gravity, Static Friction, Kinetic Friction, Torque, and Angular Velocity. It takes greater force to move particles with a larger mass.

Lifespan Copies the elapsed length of time a particle exists, in seconds. At the end of its lifespan, the particle is removed from the layer. The default lifespan is effectively immortal.

Character Copies the value that corresponds to an ASCII text character, making it replace the current particle. Applies only if you're using text characters as particles. You can specify which text characters appear by painting or drawing shades of gray on the layer map that correspond to the ASCII characters you want. A value of zero produces no character. For US English characters, use values between 32 and 127. The range of possible values can accommodate Japanese characters. For more information about the ASCII character values for a font you're using, see the documentation for the font, use a utility such as Character Map (Windows), or contact the font manufacturer.

Note: If you simply want to make certain characters spell a message, it's much easier to type the text directly in the Options dialog box. The Character property is more useful as a secret message effect in which you scramble text characters.

Font Size Copies the point size of characters. Applies only if you're using text characters as particles. Increase this value to make characters larger.

Time Offset Copies the Time Offset value used by the Layer Map. Applies only if you used the Layer Map control to specify a multiframe layer (such as a movie) as a particle source.

Scale Speed Copies the scale of a particle. Positive values expand the particle, and negative values shrink the particle. Particles expand or shrink by a percentage per second.

Min and Max controls for Property Mappers

When the overall range of layer map brightness values is too wide or narrow, use Min and Max to stretch, compress, or shift the range of values produced by the layer map. The following examples describe when you might want to adjust Min and Max:

- You want to set the smallest font size for your text to 10 points and the largest size to 96 points. Set the Min value to 10 and the Max value to 96.
- You set the initial color of a particle and then use a layer map to change particle colors. If you find that the color changes aren't dramatic enough, you can lower the Min value and raise the Max value to increase the contrast of the color changes.

- You set the initial velocity of a particle and then use a layer map to affect the X Speed value. However, you find that the difference between the fastest and slowest particles is too great. By raising the Min value and lowering the Max value for the layer map channel that is mapped to the X Speed value, you narrow the resulting range of particle speeds.
- You use a layer map to affect the Scale property of particles and find that the smallest particles aren't small enough while the largest resulting particles are too large. In this case, the entire output range needs to be shifted down; lower both the Min and Max values.
- You have a layer map that modifies particles in the opposite direction from the one you want. Swap the Min and Max values, which has the same result as inverting the layer map.

Note: *The alpha channel of the layer map is used as the selection map for the Persistent and Ephemeral Property Mappers.*

Operator controls for the Ephemeral Property Mapper

When you use the Ephemeral Property Mapper controls, Particle Playground replaces the value of a particle's property with the value represented by the layer map pixel at the particle's current location. You can also amplify, attenuate, or limit the resulting values by specifying a mathematical operator and then using both the value of a particle's property and its corresponding layer map pixel value.

Set Replaces the value of a particle property by the value of the corresponding layer map pixel. For example, to simply replace the value of a particle property with the brightness value of the corresponding pixel on the layer map, use Set. This is the most predictable operator and is the default.

Add Uses the sum of the value of a particle property and the value of the corresponding layer map pixel.

Difference Uses the absolute value of the difference of the value of a particle property and the brightness value of the corresponding pixel on the layer map. Because it takes the absolute value of the difference, the resulting value is always positive. This operator is useful when you want to limit values to only positive values. If you're trying to model realistic behavior, the Difference operator may not be ideal.

Subtract Starts with the value of a particle property and subtracts the value of the brightness value of the corresponding pixel on the layer map.

Multiply Multiplies the value of a particle property by the brightness value of the corresponding pixel on the layer map and uses the result.

Min Compares the brightness value of the layer map to the value of the particle property and uses the lower value. To limit a particle property so that it is less than or equal to a value, use the Min operator and set both the Min and Max controls to that value. If you use a white solid as a layer map, you need only set the Max control to that value.

Max Compares the brightness value of the layer map to the value of the particle property and uses the higher value.

 *To amplify existing values of properties, try applying the Add operator with positive values or the Multiply operator with values above 1.0. To attenuate (tone down) property value changes, try applying the Multiply operator using values between 0 and 1.0.*

Layer maps for Particle Playground

A *layer map* is an image in which each pixel's brightness value is used by an effect in a calculation. Particle Playground uses a layer map to exercise precise control of a particle property such as opacity. In this way, After Effects doesn't use a layer map as a picture but as a matrix of numbers. In many cases, you never see the actual layer map in the final movie—you see only the result of an effect applying the layer map's pixel values to the corresponding pixels in a destination layer.

Regardless of the color depth of the image that you use as a layer map, After Effects always uses its red, green, and blue channels as if each were an 8-bit grayscale image. If you create a layer map using colors, the Property Mappers in Particle Playground can extract the brightness values from each RGB color channel separately.

A layer map is often used as a stationary layer of the same dimensions as its destination layer. The value of each pixel in the layer map applies only to one specific pixel at the corresponding position in the destination layer. However, when you animate a layer, the appearance of the pixels in the destination layer changes depending on which layer-map pixel corresponds to it at a particular point in time. Layer maps are often animated so that the layer map effect appears to sweep through the destination layer.

Layer maps are often created by painting in an image-editing program, such as Adobe Photoshop, although you can use any program that can save an image compatible with After Effects. The key to creating a good layer map is to remember that the brightness value of each pixel influences an effect property. Here are some hints and tips for creating layer maps:

- If you want a layer map to match the shape of an image that already exists, simply use that image. For best results, create a layer map that has the same dimensions as the layer containing the image.
- You can create a layer map by precomposing a white solid layer, a black solid layer, and a mask on the top layer that determines which areas are white and black. Increasing the mask's feather softens the transition between black and white values.
- In Photoshop, an easy way to create a layer map is to create a layer with a black or white background, draw a selection, and fill the selection with the opposite color. Blurring the entire layer softens the transition between black and white values.
- You can set layer map values more precisely by painting shades of gray within a range from 0 (black) to 255 (white). This is the tonal range of an 8-bit channel. To simplify painting or drawing, see if your image-editing program provides or allows you to create a palette of 256 gray shades.

Note: While images created for use as displacement maps (in other effects or programs) often map tones to values on a scale from -127 to +127, Particle Playground interprets tones of gray as values on a scale from 0.0 (black) to 1.0 (white). If you're using images created as displacement maps, use the Min and Max controls to modify the range of tones produced by the layer map.

- The alpha channel in a layer map modifies the value before it's applied to the destination layer. Areas where the alpha channel is completely off (transparent areas of a layer map) don't affect on particle values. Areas where the alpha channel has a partial value (semitransparent areas of a layer map) partially affect the particle value. For example, if a layer-map pixel has a value of 10 and the layer-map alpha channel has a value of 127 (50%), the layer-map pixel is affected by 50%, and its true value is 5. When you use the Persistent and Ephemeral Property Mappers, the actual value applied to a particle is also affected by the range set for the Min and Max controls.
- If you want to change any of the layer map's layer properties (Masks, Effects, or Transform), change them, precompose the layer, and then use the resulting composition as the layer map. Otherwise, Particle Playground ignores any property settings.
- The contrast between adjacent pixel values determines how smoothly the values change across the surface of the layer map. To create smooth changes, paint using a soft or anti-aliased brush, or apply gradients. To create abrupt changes, avoid intermediate shades, using just a few widely spaced shades, such as 50% gray, black, and white.
- You can adjust overall edge contrast with blur or sharpen filters, if your painting or drawing program provides them.

Note: If you want to edit individual pixels, open the layer map in the program you used to create it and make the change.

Before you apply a layer map to a particle layer, they must be in the same composition, in a stacking order that produces the results you want. If you want particles to be visible in front of the layer map, make sure that the layer with Particle Playground applied is in front of the layer map. If you don't want the layer map to be visible, hide it by clicking the layer's eye icon  in the Timeline panel.

RGB layer maps

Particle Playground can extract brightness values separately from the red, green, and blue channels in an image. If you want to create different layer maps for each channel, use a program that can edit individual color channels, such as Adobe Photoshop, and then paint or paste each layer map into its own channel. Save the layer map as an RGB image in a format After Effects can import. The image may look unusual when viewed in RGB mode because it's intended to be used as a single hidden layer containing three different layer maps, not as a visible color layer.

When you apply an effect that can use each color channel as a separate layer map, you can still use a grayscale image; the RGB channels will be identical.

 *If you already have three separate images, you can combine them into a single RGB file by using the Set Channels effect. Set Channels can load each image into its own channel in a combined file, making it suitable for use as an RGB layer map.*

Improving performance with Particle Playground

Keep the following in mind when working with the Particle Playground effect:

- When you're generating a Particle Playground effect, keep an eye on the Info panel to see how many particles are being produced. If an effect contains more than 10,000 particles, it can significantly slow rendering. If you notice performance problems, set Particles Per Second and/or Particles Down to relatively low values (between 1 and 100).
- The Grid and Layer Exploder generate particles on every frame, which may generate too many particles for the effect you're creating and slow down rendering. To avoid continuous particle generation, animate these controls to decline to zero over time: Layer Exploder, Radius of New Particles, Grid Width and Height, Particle Radius, and Font Size. Then Particle Playground generates new particles only at the start of a sequence.
- When you apply a Particle Playground effect to a layer, the particle positions aren't limited to the bounds of that layer. To control particles that you can't see or that appear near the edge of the image, use a Selection or Property Map that's larger than the area of the Particle Playground layer. Also, note that After Effects takes an image map's alpha channel into account. If you want transparent areas of your map to affect the particles, precompose the map layer with a black solid behind it.

To specify field rendering with a Particle Playground effect, select Enable Field Rendering in the Particle Playground options dialog box. Then Particle Playground calculates the simulation at double the frame rate of the current composition, which is what field rendering requires.

Shatter effect

The Shatter effect explodes graphic images. Use the effect's controls to set explosion points and adjust the strength and radius. Anything outside the radius doesn't explode, leaving portions of the layer unaltered. You can choose from a variety of shapes for the shattered pieces and extrude the pieces to give them bulk and depth. You can even use a gradient layer to precisely control the order of an explosion. For example, you can import a logo and use Shatter to blow a logo-shaped hole in a layer.

Note: *To reverse the temporal direction of the Shatter effect (i.e., have the pieces come together instead of fly apart), apply the effect, precompose the layer, and then time-reverse the precomposition layer.*

This effect works with 8-bpc color.

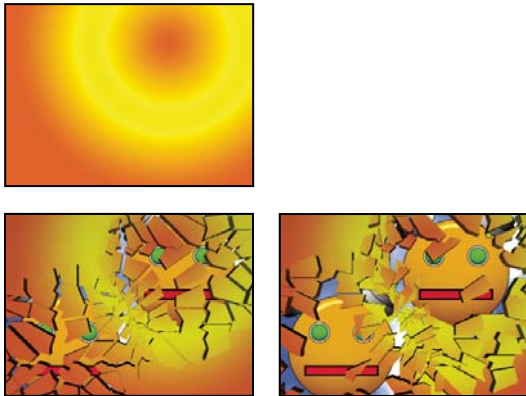

Original (top left), and as Shatter is applied over time to reveal another layer (bottom left and right)

Aharon Rabinowitz provides a video tutorial that shows how to make 3D extruded text in After Effects using the Shatter effect: www.adobe.com/go/learn_ae_aharonextrusionhacks.

See also

“Common Lighting controls and Material controls” on page 486

“Precompose layers” on page 114

“Reverse a layer’s playback direction” on page 220

View controls

The View control specifies exactly how a scene appears in the Composition panel by using the following views:

Rendered Displays the pieces with textures and lighting—as they will look at final output. Use this view when rendering the animation.

Wireframe Front View Displays the layer from a full-screen, straight-on camera angle with no perspective. Use this view to adjust effect points and other parameters that are hard to see from an angle. In addition, the outlines of the shatter map are visible so you can precisely position, rotate, and scale the shatter pattern. It’s handy to toggle between this view and the perspective view you use for the scene.

Wireframe Displays the correct perspective of the scene, so you can quickly set up the camera the way you like it and fine-tune the Extrusion Depth.

Wireframe Front View + Forces Displays the wireframe front-view representation of the layer, plus a blue representation of each force sphere.

Wireframe + Forces Displays the wireframe view, plus a blue representation of the force spheres. This view includes camera controls, so you can position everything precisely in 3D space.

Render control

The Render control renders the whole scene (the default), the unshattered layer, or the shattered pieces independently. For example, if you want to apply the Glow effect only to shattered pieces and not to the portions of the layer that remain intact, create the explosion and duplicate the layer. Next, for the back layer, choose Layer from the Render menu, and for the front layer, choose Pieces. Then apply the Glow effect to the front layer.

Shape controls

Shape controls specify the shape and appearance of the shattered pieces.

Pattern Specifies the preset pattern to use for the exploded pieces.

Custom Shatter Map Specifies the layer you want to use as the shape of the exploded pieces.

White Tiles Fixed Prevents pure white tiles in a custom shatter map from being exploded. You can use this control to force certain parts of a layer to remain intact.



Use this control when your shatter map uses images or letters such as O: Set the portion you don't want to blow out, such as the centers of the O and the background, to pure white and set the rest to another pure color.

Repetitions Specifies the scale of the tile pattern. This control works only in conjunction with the preset shatter maps, which all seamlessly tile. Increasing this value increases the number of pieces on the screen by scaling down the size of the shatter map. Consequently, the layer breaks into more and smaller pieces. Animating this control is not recommended, as it can cause sudden jumps in the number and size of shatter pieces.

Direction Rotates the orientation of a preset shatter map, relative to the layer. As with Repetitions, animating this control results in sudden jumps in the animation and is not recommended.

Origin Precisely positions a preset shatter map on the layer. This is useful if you want to line up portions of an image with specific shattered pieces. Animating this control results in sudden jumps in the animation and is not recommended.

Extrusion Depth Adds a third dimension to the exploded pieces. The higher the value, the thicker the pieces. In Rendered view, this effect isn't visible until you start the shatter or rotate the camera. As you set this control higher, the pieces may actually pass through each other. While this is generally not a problem in full-speed animations, it may become visible when the pieces grow very thick and move slower.

Force 1 and Force 2 controls

Force 1 and Force 2 controls define the blast areas by using two different Forces.

Position Specifies the current center point of the blast in (x,y) space.

Depth Specifies the current center point in z space, or how far in front of or behind the layer the blast point is. Adjust Depth to determine how much of the blast radius is applied to the layer. The blast radius is a sphere, and the layer is basically a plane; therefore, only a circular slice of the sphere intersects the plane. The farther away the layer is from the center of the blast, the smaller the circular slice. When pieces explode, they fly away from the force center. Depth determines which way the pieces fly: Positive values cause the pieces to explode forward, toward the camera (assuming the default camera settings of 0, 0, 0); negative values cause pieces to blow backward, away from the camera. To see the result of the Depth setting, use the Wireframe + Force Sphere view.

Radius Defines the size of the blast sphere. The radius is the distance from the center of a circle (or sphere) to the edge. By adjusting this value, you can fine-tune exactly which pieces explode. Changing this value can vary the speed and completeness of the explosion. Animating it from small to large generates an expanding, shockwave explosion.

Note: *To begin the shattering at a time other than layer time zero, animate the Radius property, not the Strength property. Pieces inside the force sphere defined by the Radius property are pulled off-screen by gravity even if Strength is set to 0. Use Hold keyframes on the Radius property with the value 0 until the time when you want the shattering to start.*

Strength Specifies the speed at which the exploded pieces travel—how hard they are blown away from or sucked back into the blast point. A positive value blows the pieces away from the blast point; a negative value sucks the pieces into the blast point. The greater the positive value, the faster and farther they fly away from the center point. The greater the negative value, the faster the pieces launch themselves toward the center of the force sphere. Once the pieces are launched, however, they are no longer affected by the force sphere; the Physics settings take over. A

negative Strength value does not suck the pieces into a black hole; instead, the pieces fly through each other and back out the other side of the sphere. Setting Strength very low causes the pieces to break up into shapes, creating cracks in the layer, but it doesn't actually blow the pieces apart. If gravity is set to anything other than 0, the pieces are pulled in the direction of gravity after they break up.

Note: A shatter piece is made up of vertices (points or dots that define the corners of the shape), edges (lines that connect the dots), and planes (walls of the shape). Shatter determines when a shape has come in contact with a force sphere based on when a vertex comes in contact with the sphere.

Gradient controls

Gradient controls specify the gradient layer used to control the timing of an explosion and the pieces that are affected by the blast.

Shatter Threshold Specifies which pieces in the force sphere shatter according to the corresponding luminance of the specified gradient layer. If Shatter Threshold is set to 0%, no pieces in the force sphere shatter. If it is set to 1%, only the pieces in the force sphere corresponding to white (or very nearly white) areas on the gradient layer shatter. If it is set to 50%, all the pieces in the force sphere corresponding to white-to-50%-gray areas on the gradient layer shatter. If it is set to 100%, all pieces in the force sphere shatter. Because there are 256 shades of gray (including black and white), each percentage point represents approximately 2.5 shades of gray.

Animating Shatter Threshold influences the timing of the explosion. If you leave it set to 0%, the layer never explodes. However, if you set a Shatter Threshold keyframe at 50%, the pieces of your layer in the force field that correspond to areas of your gradient layer that range from white to 50% gray explode. If you then animate Shatter Threshold up to 100%, the remaining pieces in the force sphere explode.

Gradient Layer Specifies the layer to use to determine when specific areas of the target layer shatter. White areas shatter first; black areas shatter last. Shatter determines which pixels correspond to which pieces by subdividing the layer into pieces, each with a center point or balance point. If you superimpose the shatter map over the gradient layer, the gradient layer pixels that are precisely under each balance point control the explosion.

Note: Some shapes have a balance point that falls outside the actual area of the shape—for example, the letters C and U. When designing a gradient layer in such a situation, avoid using grayscale versions of letters. Instead, use larger shapes that cover the balance point of each character.

Invert Gradient Inverts the pixel values in the gradient. White becomes black, and black becomes white.

Physics controls

Physics controls specify the way the pieces move and fall through space.

Rotation Speed Specifies the speed at which pieces rotate around the axis set by the Tumble Axis control, allowing you to simulate different rotation speeds for different materials. In nature, similarly shaped pieces spin at different speeds based on their mass and air friction. For example, a brick spins faster than Styrofoam.

Tumble Axis Specifies the axis that the pieces spin around. Free spins the pieces in any direction. None eliminates all rotation. X, Y, and Z spin the pieces only around the selected axis. XY, XZ, and YZ spin the pieces only around the selected combination of axes.

Note: Any application of z-axis rotation appears only when a second force hits the layer. The pieces do not rotate from the first blast if only z-axis rotation is selected.

Randomness Affects the initial velocities and spins generated by the force sphere. When this control is set to 0, pieces fly directly away from the center point of a blast (assuming a positive force). Since real explosions are rarely this orderly, Randomness allows you to vary things a little bit.

Viscosity Specifies how fast pieces decelerate after being blown apart. The higher the Viscosity value, the more resistance the pieces encounter as they move and spin. If Viscosity is set high enough, the pieces quickly come to a stop. To replicate an explosion in water or sludge, set Viscosity to a high value. In air, set it to a medium value, and for an explosion in space, set it very low, or to 0.

Mass Variance Specifies the theoretical weight of the pieces as they explode. For example, a large piece is heavier than a small piece and therefore does not fly as far or as fast when it encounters the blast. Mass Variance's default setting of 30% gives a realistic approximation of this law of physics. Setting Mass Variance to 100% greatly exaggerates the difference between the behavior of large versus small pieces. Setting it to 0% makes all pieces behave the same, regardless of their size.

Gravity Determines what happens to the pieces after they break up and blow apart. The higher the gravity setting, the faster the pieces are sucked in the direction set by Gravity Direction and Gravity Inclination.

Gravity Direction Defines the direction in (x,y) space that the pieces travel when affected by gravity. The direction is relative to the layer. If Gravity Inclination is set to -90 or 90, Gravity Direction has no effect.

Gravity Inclination Determines the direction in z space that the pieces travel once they explode. A value of 90 explodes the pieces forward, relative to the layer. A value of -90 explodes them backward, relative to the layer.

Textures controls

Textures controls specify the texture of the pieces.

Color Specifies the color of the piece as defined by the Front Mode, Side Mode, and Back Mode menus. This color may or may not be visible depending on the Mode settings: When a Mode setting is Color, Tinted Layer, Color + Opacity, or Tinted Layer + Opacity, the selected color is factored into the appearance of the piece.

Opacity Controls the opacity of the corresponding Mode setting. A Mode setting must be Color + Opacity, Layer + Opacity, or Tinted Layer + Opacity for the opacity to affect the appearance of the piece. You can use the Opacity control in conjunction with texture maps to create the look of semitransparent materials.

Front Mode, Side Mode, Back Mode Determine the appearance of the front, sides, and back of the pieces. Color applies the selected color to the applicable side of the piece. Layer takes the layer chosen in the corresponding Layer menu and maps it to the applicable side of the piece. Tinted Layer blends the chosen layer with the selected color; the effect is similar to viewing the layer through a colored filter. Color + Opacity combines the selected color and the Opacity amount. With Opacity at 1, the applicable side is given the selected color. With Opacity at 0, the applicable side is transparent. Layer + Opacity combines the chosen layer and the Opacity amount. With Opacity at 1, the chosen layer is mapped to the applicable side. With Opacity at 0, the applicable side is transparent. Tinted Layer + Opacity combines the tinted chosen layer and the Opacity amount. With Opacity at 1, the tinted chosen layer is mapped to the applicable side. With Opacity at 0, the applicable side is transparent.

Note: If you apply Shatter to a layer containing an alpha channel that you want to use for transparency, use the same texture (or at least another layer with an identical alpha channel) for the front, sides, and back of the pieces to make all sides transparent.

Front Layer, Side Layer, Back Layer Specify the layer to be mapped onto the corresponding side of the piece. Front Layer maps the chosen layer to the front of the piece. Back Layer maps the chosen layer backward to the layer. If Layer is chosen for both Front Mode and Back Mode, and the same layer is specified for each, each shattered piece has the same pixel information on both sides. Side Layer maps an extrusion of the chosen layer to the extruded sides of the piece, as if the chosen layer is also mapped to the front and back, and the layer has been sliced through.

Note: If you choose a layer with an effect applied, the effect does not show up in the texture unless you precompose the layer. However, if you select None, the layer to which you have applied Shatter, along with any effects that occur before Shatter, is used as the texture map, with no precomposing required.

Camera System and Camera Position controls

Camera System Whether to use the effect's Camera Position properties, the effect's Corner Pins properties, or the default composition camera and light positions to render 3D images.

X Rotation, Y Rotation, Z Rotation Rotate the camera around the corresponding axis. Use these controls to look at the cards from the top, side, back, or any other angle.

X, Y Position Where the camera is positioned in (x,y) space.

Z Position Where the camera is positioned along the z axis. Smaller numbers move the camera closer to the cards, and larger numbers move the camera away from the cards.

Focal Length The zoom factor. Smaller numbers zoom in.

Transform Order The order in which the camera rotates around its three axes, and whether the camera rotates before or after it is positioned using the other Camera Position controls.

Corner Pins controls

Corner pinning is an alternative camera control system. Use it as an aid for compositing the result of the effect into a scene on a flat surface that is tilted with respect to the frame.

Upper Left Corner, Upper Right Corner, Lower Left Corner, Lower Right Corner Where to attach each of the corners of the layer.

Auto Focal Length Controls the perspective of the effect during the animation. If this option is deselected, the focal length you specify is used to find a camera position and orientation that positions the corners of the layer at the corner pins, if possible. If not, the layer is replaced by its outline, drawn between the pins. If this option is selected, the focal length required to match the corner points is used, if possible. If not, the correct value is interpolated from nearby frames.

Focal Length Overrides the other settings if the results you've obtained aren't what you need. If you set the Focal Length to something that doesn't correspond to what the focal length would be if the pins were actually in that configuration, the image may look unusual (strangely sheared, for example). But if you know the focal length that you are trying to match, this option is the easiest way to get correct results.

Creating a custom shatter map

All layers in After Effects are represented as an RGBA image, including black-and-white images. The Shatter effect calculates the luminance threshold of each channel to create a custom shatter map. Shatter calculates the 50% luminance threshold of each channel, creating an image composed of only eight colors: red, green, blue, yellow, magenta, cyan, white, and black. These eight colors become possible combinations of the channels set either all the way on (255) or all the way off (0). The shatter layer splits along the edges of these different colored sections.

When designing custom shatter maps, you can find it useful to manually set a threshold for each channel of the image at 50% (you can use the Curves effect to do so). When you set the threshold, you can see how the image will be broken into pieces. Alternatively, you can create custom shatter maps by drawing an image using only the eight colors listed above, with no intermediate shades or anti-aliasing.

***Note:** Use the Colorama effect to posterize the colors of an image to these eight colors. Turn off Interpolate Palette in the Colorama effect controls. See "Colorama effect" on page 393.*

The alpha channel determines whether or not a shattered piece exists. A white alpha channel value results in a shattered piece, and a black alpha channel value results in no piece. Using an alpha channel, you can make a tile map with holes in it or generate simple 3D models like extruded text.

Note: The custom shatter map determines the shapes of the pieces a layer shatters into, but not when the pieces shatter. The timing is determined by the Force controls and can be further controlled by a gradient layer.

Wave World effect

Use this effect to create a grayscale displacement map for use with other effects such as Caustics or Colorama. This effect creates waves based on a simulation of the physics of liquids. Waves emanate from an effect point, interact with each other, and realistically reflect off their environment. Use Wave World to create a top-down view of a logo, with waves reflecting off the logo and the sides of the layer.

This effect works with 8-bpc color.

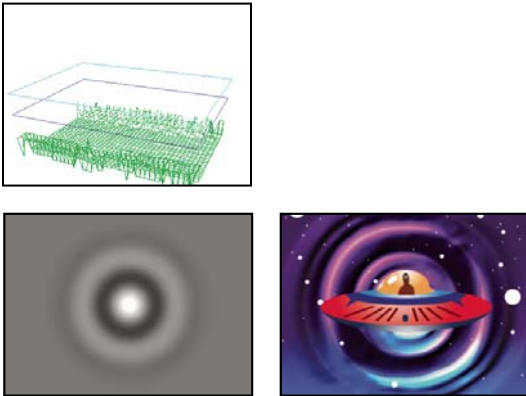

Wireframe view (top left), Height Map view (bottom left), and resulting image (bottom right). Result is used as Water Surface source for Caustics effect example.

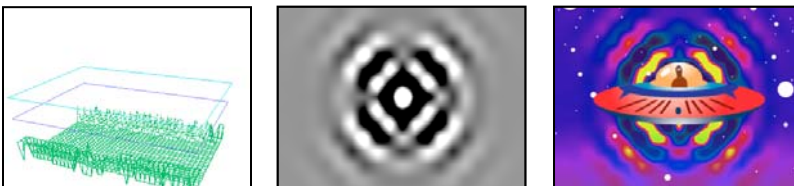

Wireframe view (left), Height Map view (center), and resulting image (right). Result is used as Input Phase for Colorama effect example.

To understand how this effect works, consider the following information about the physics of waves: A wave consists of a peak and a trough. The amplitude of a wave is the height, or distance, between the peak and trough. The wavelength is the distance from one peak to the next. Frequency is the number of waves per second passing a fixed point.

View controls

View controls specify the method used to preview the Wave World effect. Choose one of the following views:

Height Map Displays the highest points as bright pixels and the lowest points as dark pixels. Use this view when creating a displacement map.

Wireframe Preview Provides a visual depiction of how the wave is being created. The grayscale output represents a height map: White represents the highest possible wave, and black represents the lowest. The two rectangular outlines represent these two extremes: The cyan rectangle represents pure white, and the violet rectangle represents pure black. The green grid represents the ground layer; it is flat by default but can be distorted by using a grayscale image. The white grid represents the surface of the water.

Wireframe controls

Wireframe controls fine-tune the appearance of the wireframe model. These controls don't affect the grayscale output.

Horizontal Rotation Rotates the wireframe preview around the horizontal axis (right and left). As you adjust this control, the distortion of the wireframe model keeps the entire wireframe model in full view.

Vertical Rotation Rotates the wireframe preview around the vertical axis (up and down).

Vertical Scale Distorts the wireframe preview vertically so that you can see heights more easily. It doesn't affect the grayscale output.

Height Map controls

Height Map controls specify the appearance of the height map.

Note: While adjusting Brightness and Contrast, keep the wave surface layer between the cyan and violet rectangles. If a peak pokes through the cyan rectangle, it clips at pure white. If a trough pokes through the bottom of the violet rectangle, it clips at pure black. If you want to create a displacement map, try to avoid clipping because it shows up as flat peaks and valleys, which look unnatural.

Brightness Adjusts the overall height of the water surface. Adjusting it brightens or darkens the overall grayscale output. If you use Wave World for displacement, this control moves the surface of the water up or down.

Contrast Changes the difference between the grays of the peaks and troughs, making the difference more or less extreme. Lower values even out the grays, and higher values create a wider range from black to white (until clipping occurs).

Gamma Adjustment Controls the slope of the waves in relation to the Brightness. Results are visible only in Height Map view. Higher values result in rounder peaks and narrower valleys, while lower values result in smoother valleys and pointier peaks.

Render Dry Areas As Specifies how the water surface is rendered when a dry area exists. Dry areas are created when a portion of the ground layer rises above the surface of the water. You can manipulate the dry area by using the Steepness control.

This control is useful for compositing a Wave World effect into a scene. For example, you can use a precomposed Wave World scene with transparency as a displacement map for the Caustics effect, and as a track matte for the effect layer.

Transparency Controls the clarity of the water by adjusting how opaque the alpha channel is in shallower areas. For example, you can easily see to the bottom of a pool filled with fresh water, but you can see only an inch or two into a pool filled with coffee. This control is most useful when compositing a Wave World effect into another scene. For example, you can use a Wave World composition as a source layer for Caustics, and also as a track matte for the effect layer.

Simulation controls

The Simulation controls specify the resolution of the water surface and ground grids.

Grid Resolution Specifies the number of horizontal and vertical divisions that make up the wave surface and ground grids. Higher values greatly increase the precision of the simulation but require more memory and increase rendering time.

Grid Res Downsamples Reduces the internal simulation resolution when the output resolution decreases, increasing the rendering speed. However, the result may cause the output to look significantly different.

Wave Speed Specifies how fast waves travel away from their starting point.

Damping Specifies how quickly a wave's energy is absorbed by the liquid it travels through. The higher the value, the quicker the wave energy is absorbed, and the shorter the distance the wave travels.

Wave Speed, Damping Specify the apparent viscosity of the liquid, and the apparent size of the body of liquid. For example, waves in water move faster and farther than waves in honey; waves in a sink move much faster and fade out much more quickly than waves in a lake.

Note: Wave World is optimized for small- to medium-sized bodies of water—anything from a teacup to a small lake. Large bodies of water, like an ocean, include swells or wide, stable waves with no apparent slowdown. Even at the lowest settings, Wave World cannot generate swells because the waves fade out relatively quickly.

Reflect Edges Specifies how waves bounce off the edges of the layer and back into the scene.

Pre-roll (seconds) Specifies when the waves start moving. By default, the effect starts with a still surface without waves or ripples. Use this control to start the waves moving before the layer begins. The settings at the first frame of the effect are applied to the layer during the pre-roll.

Ground controls

The Ground controls specify the appearance of the ground layer.

Ground Specifies the layer that appears at the bottom of the water. If you use an animated layer for the ground, Wave World samples only the first frame. Wave World determines the intersection of the water's surface with the edge of the ground, computes the waves bouncing off the shore, and properly adjusts the speed of the waves depending on the depth. The ground surface is determined by the layer's brightness: White represents higher elevation, and black represents lower elevation.

Steepness Adjusts the steepness of the ground by expanding and contracting the height of the displaced wireframe. The mesh is locked at the black level, so it always grows up from the bottom. In other words, you cannot adjust the bottom of a canyon to be deeper; instead, you can adjust the rim to be higher. To make the canyon deeper, combine a higher Steepness setting with a lower Height setting.

Height Controls the distance between the water surface and the ground's deepest possible point. Use this control to make the body of water deeper or shallower. When you change the depth of the water, the waves behave accordingly: They move faster in deep water and slower in shallow water. (Adjusting the Height control when using the wireframe preview may appear to lower the ground level, but the wireframe camera always moves with the water level.)

Wave Strength Controls how big the resulting waves are when the ground height or steepness is animated. A value of 0 results in no waves.

Note: You can create a pulsing wave effect by animating the ground's steepness so that the ground pokes through the water, producing waves. Then use the Wave Strength control to intensify the effect.

Producer 1 and Producer 2 controls

The Producer controls specify the point at which the waves begin.

Type Specifies the type of producer. Ring creates a wave as if a stone were dropped into a pond; waves radiate outward in circles (or ellipses, depending on the size settings of the effect point). Line creates waves that emanate from the producer's position in a line instead of an ellipse. This setting is useful for creating waves that look as though they were generated from much farther away. The waves are produced perpendicular to the edges of the line. The length of the line is based on the Height/Length setting.

Position Specifies the location of the center of the wave producer.

Height/Length Specifies the (vertical) height of a Ring producer and adjusts the length of a Line producer.

Width Specifies the (horizontal) width of the producer area.

Angle Specifies the angle of the wave producer area for the Line and Ring types. This control sets the orientation of the line and thus controls the initial direction of the waves, which emanate from either side of the line, perpendicular to its length.

Amplitude Controls the height of the produced wave. Higher values create more dramatic waves but may result in clipping, which you can repair by using the Brightness and Contrast controls.

Frequency Controls how many waves are produced per second. A value of 1 has the effect of waves surfacing once every second.

Phase Specifies where in the wave phase the wave actually begins. For example, with the default setting of 0°, the first disturbance in the liquid is a convex wave (projecting upward from the surface of the water). With Phase set to 180°, the first disturbance in the liquid is a concave wave.

Stylize effects

Brush Strokes effect

The Brush Strokes effect applies a rough painted look to an image. You can also use this effect to achieve a pointillist style by setting the length of the brush strokes to 0 and increasing the stroke density. Although you specify the direction of strokes, they're scattered randomly by a small amount to give a more natural result. This effect alters the alpha channel, as well as the color channels; if you masked out a portion of the image, the brush strokes paint over the edges of the mask.

This effect works with 8-bpc color.

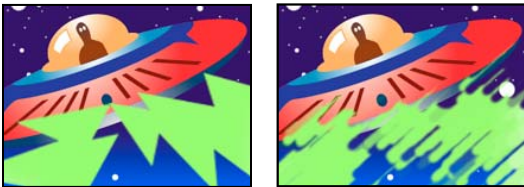

Original (left), and with effect applied (right)

Stroke Angle The direction in which the strokes are made. The image is effectively shifted in this direction, potentially causing some clipping at the layer boundaries.

Brush Size The size of the brush in pixels.

Stroke Length The maximum length of each stroke, in pixels.

Stroke Density Higher densities result in overlapping brush strokes.

Stroke Randomness Creates nonuniform strokes. The more randomness, the more the strokes vary from the brush and stroke settings you've specified.

Paint Surface Specifies where brush strokes are applied:

- **Paint On Original Image** Puts the strokes on top of the unmodified layer. This setting is the default.
- **Paint On Transparent** Causes only the strokes themselves to appear, leaving the layer transparent between the strokes.
- **Paint On White/Paint On Black** Applies strokes over a white or black background.

Blend With Original The effect's transparency. The result of the effect is blended with the original image, with the effect result composited on top. The higher you set this value, the less the effect affects the layer. For example, if you set this value to 100%, the effect has no visible result on the layer; if you set this value to 0%, the original image doesn't show through.

Color Emboss effect

The Color Emboss effect works like the Emboss effect, without suppressing the image's original colors.

This effect works with 8-bpc and 16-bpc color.

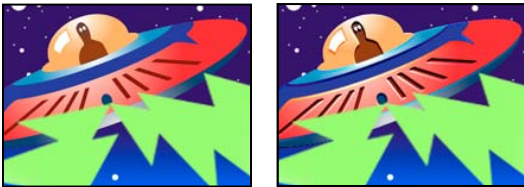

Original (left), and with effect applied (right)

See also

“Emboss effect” on page 518

Emboss effect

The Emboss effect sharpens the edges of objects in an image and suppresses colors. The effect also highlights the edges from a specified angle. The layer's quality setting influences the Emboss effect by controlling the Relief setting. Relief is calculated at the subpixel level in Best quality and rounded off to the pixel level in Draft quality.

This effect works with 8-bpc and 16-bpc color.

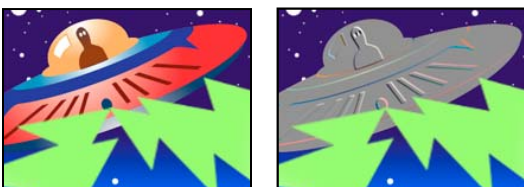

Original (left), and with effect applied (right)

Direction The direction from which the highlight source shines.

Relief The apparent height of the embossing, in pixels. The Relief setting actually controls the maximum width of highlighted edges.

Contrast Determines the sharpness of the image.

Blend With Original The effect's transparency. The result of the effect is blended with the original image, with the effect result composited on top. The higher you set this value, the less the effect affects the clip. For example, if you set this value to 100%, the effect has no visible result on the clip; if you set this value to 0%, the original image doesn't show through.

Find Edges effect

The Find Edges effect identifies the areas of an image that have significant transitions and emphasizes the edges. Edges can appear as dark lines against a white background or colored lines against a black background. If the Find Edges effect is applied, images often look like sketches or photographic negatives of the original.

Invert Inverts the image after the edges are found. If Invert isn't selected, edges appear as dark lines on a white background. If selected, edges appear as bright lines on a black background.

This effect works with 8-bpc color.

Glow effect

The Glow effect finds the brighter parts of an image and then brightens those and surrounding pixels to create a diffuse, glowing aura. The Glow effect can also simulate overexposure of brightly lit objects. You can base the glow on either the original colors of the image or on its alpha channel. Glows based on alpha channels produce diffuse brightness only at the edges of the image, between the opaque and transparent regions. You can also use the Glow effect to create a gradient glow between two colors (A and B colors) and to create multicolor effects with looping.

Rendering the Glow effect at Best quality can change the appearance of the layer. This change is especially true if you use Adobe Photoshop arbitrary maps to color the glows. Be sure to preview at Best quality before you render the effect.



Glows tend to be brighter and more realistic in 32-bpc projects. Consider working in 32-bpc color for this reason, even if footage items don't contain high-dynamic range color values.

This effect works with 8-bpc, 16-bpc, and 32-bpc color.

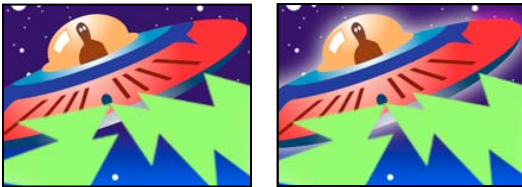

Original (left), and with effect applied (right)

Glow Based On Determines whether glow is based on color values or transparency values.

Glow Threshold Sets a threshold as a percentage brightness to which the glow isn't applied. A lower percentage produces more glow; a higher percentage produces less.

Glow Radius The distance, in pixels, that the glow extends out from the bright areas of the image. Larger values produce diffuse glows; smaller values produce glows with sharp edges.

Glow Intensity The brightness of the glow.

Composite Original Specifies how to composite the effect results with the layer. On Top places the glow on top of the image, using the blending method selected for Glow Operation. Behind places the glow behind the image, creating a backlighting result. None separates the glow from the image.



To reduce the layer to the glow only, choose None for Composite Original and None for Glow Operation. To achieve a glow effect for text that knocks out (blocks) all layers below it, choose Silhouette Alpha for Glow Operation. These glow effects are more noticeable if the image has a feathered edge.

Glow Colors The colors of the glow. A & B Colors creates a gradient glow using the colors specified by Color A and Color B controls.

Color Looping The shape of the gradient curve to use if A & B Colors is selected for Glow Colors.

Color Loops Creates multicolor ringing in the glow, if you select two or more loops. A single loop cycles through the gradient (or arbitrary map) specified for Glow Colors.

Color Phase Where in the color cycle to begin color loops. By default, color loops begin at the origin of the first loop.

A & B Midpoint The midpoint specifies the balance between the two colors used in the gradient. Lower percentages use less of the A color. Higher percentages use less of the B color.

Color A, Color B The color of the glow if you choose A & B Colors for Glow Colors.

Glow Dimensions Specifies whether the glow is horizontal, vertical, or both.

Mosaic effect

The Mosaic effect fills a layer with solid-color rectangles, pixelating the original image. This effect is useful for simulating low-resolution displays and for obscuring faces. You can also animate it for a transition. At Best quality, the edges of the rectangles are anti-aliased.

This effect works with 8-bpc and 16-bpc color.



Original (left), and with effect applied (right)

Horizontal/Vertical Blocks The number of blocks in each row and column.

Sharp Colors Gives each tile the color of the pixel in the center of the corresponding region in the original image. Otherwise, each tile is given the average color of the corresponding region in the original image.

Motion Tile effect

The Motion Tile effect replicates the source image across the output image. When you change the placement of the tiles, it uses motion blur to accentuate the movement if motion blur is enabled.

This effect works with 8-bpc color.

Tile Center The center of the main tile.

Tile Width, Tile Height Dimensions of tiles as a percentage of the input layer dimensions.

Output Width, Output Height Dimensions of the output image as a percentage of the input layer dimensions.

Mirror Edges Flips adjacent tiles to form mirror images. If Phase is set to 0, selecting this option causes the edges of the layer to be mirrored with the surrounding tiles.

Phase The horizontal or vertical offset of the tiles.

Horizontal Phase Shift Offsets tiles horizontally instead of vertically.

Posterize effect

The Posterize effect lets you specify the number of tonal levels (or brightness values) for each channel in an image. The Posterize effect then maps pixels to the closest matching level. For example, choosing two tonal levels in an RGB image gives you two tones for red, two tones for green, and two tones for blue. Values range from 2 to 255.

Note: Another way to accomplish much the same result as the applying the Posterize Time effect to a layer is to precompose the layer, change the frame rate for the precomposition in the Composition Settings dialog box, and set Preserve Frame Rate When Nested Or In Render Queue for the precomposition on the Advanced tab. This causes the precomposition to retain its own frame rate, and not inherit those settings from the containing composition.

Level The number of tonal levels for each channel.

This effect works with 8-bpc and 16-bpc color.



Original (left), and with effect applied (right)

See also

“Nesting, precomposing, and pre-rendering” on page 113

“Work with composition settings” on page 110

Roughen Edges effect

The Roughen Edges effect makes an alpha channel rough and can add color to simulate rust and other kinds of corrosion. This effect gives rasterized text or graphics a naturally rough look, like that of old typewriter text.

This effect works with 8-bpc color.

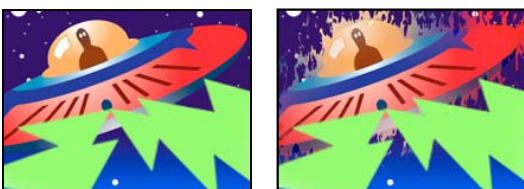

Original (left), and with effect applied (right)

Edge Type What kind of roughening to use.

Edge Color The color to apply to the edge for Rusty Color or Roughen Color, or to the fill for Photocopy Color.

Border How far, in pixels, the effect extends inward from the edge of the alpha channel.

Edge Sharpness Low values create softer edges. High values create sharper edges.

Fractal Influence The amount of roughening.

Scale The scale of the fractal used to calculate the roughness.

Stretch Width or Height The width or height of the fractal used to calculate the roughness.

Offset (Turbulence) Determines the portion of the fractal shape that is used to create the roughness.

Complexity Determines the level of detail in the roughness.

Note: Increasing complexity results in longer rendering times. Reduce the Scale value rather than increasing Complexity to achieve similar results.

Evolution Animating this setting results in changes of the roughness over time.

Note: Although the Evolution value is set in units called revolutions, it's important to realize that these revolutions are progressive. The Evolution state continues to progress infinitely at each new value. Use the Cycle Evolution option to return the Evolution setting to its original state at each revolution.

Evolution Options Evolution Options provide controls that render the effect for one short cycle and then loop it for the duration of your layer. Use these controls to prerender your roughen elements into loops, and thus speed up rendering time. Use the following controls to create a smooth, progressive, nonrepeating loop:

- **Cycle Evolution** Creates a loop that forces the Evolution state to return to its starting point.
- **Cycle** The number of revolutions of the Evolution setting that the fractal cycles through before it repeats. The timing of the Evolution cycles is determined by the amount of time between Evolution keyframes.

Note: The Cycle control affects only the state of the fractal, not geometrics or other controls, so you can get different results with different Size or Offset settings.

- **Random Seed** Specifies a value from which to generate the roughness texture. Animating this property results in flashing from one set of fractal shapes to another within the same fractal type. For smooth transition of the roughness, use the Evolution control.

Note: Create new roughness animations by reusing previously created Evolution cycles and changing only the Random Seed value. Using a new Random Seed value alters the noise pattern without disturbing the Evolution animation.

Scatter effect

The Scatter effect scatters the pixels in a layer, creating a blurry or smeared appearance. Without changing the color of each individual pixel, the Scatter effect redistributes the pixels randomly, but in the same general area as their original positions.

This effect works with 8-bpc and 16-bpc color.

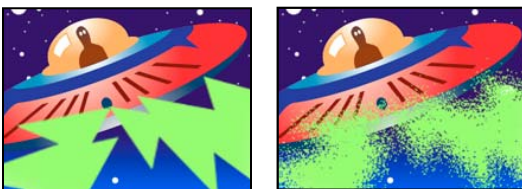

Original (left), and with effect applied (right)

Grain The direction in which to scatter the pixels—horizontally or vertically. Select None to scatter pixels in all directions.

Scatter Randomness Specifies whether scattering changes at each frame. To animate scattering without keyframes or expressions, select the Randomize Every Frame option.

Strobe Light effect

The Strobe Light effect performs an arithmetic operation on a layer or makes the layer transparent at periodic or random intervals. For example, every five seconds the layer could become completely transparent for one-tenth of a second, or a layer's colors could invert at random intervals.

This effect works with 8-bpc color.

Strobe Color The color of the strobe light.

Blend With Original The effect's transparency. The result of the effect is blended with the original image, with the effect result composited on top. The higher you set this value, the less the effect affects the layer. For example, if you set this value to 100%, the effect has no visible result on the layer; if you set this value to 0%, the original image doesn't show through.

Strobe Duration (secs) How long, in seconds, each strobe lasts.

Strobe Period (secs) The time, in seconds, between the start of subsequent strobes.

Random Strobe Probability The probability that the strobe operation will apply to any given frame.

Strobe Choose Makes Layer Transparent for each strobe to make the layer transparent. Choose Operates On Color Only to use the operation specified by Strobe Operator.

Strobe Operator The operation to use for each strobe.

Texturize effect

The Texturize effect gives a layer the appearance of having the texture of another layer. For example, you could make the image of a tree appear as if it had the texture of bricks, and control the depth of the texture and the apparent light source. At Best quality, the texture layer is positioned and scaled with subpixel precision.

This effect works with 8-bpc color.



Original layers (left), and with whirl layer applied as the texture (bottom right)

Texture Layer The source of the texture.

Light Direction The angle at which light hits the texture.

Texture Contrast The magnitude of the result.

Texture Placement How the texture layer is applied to the effect layer:

- **Tile Texture** Applies the texture repeatedly.

- **Center Texture** Positions the texture in the middle.
- **Stretch Texture To Fit** Stretches the texture to the dimensions of the effect layer.

Threshold effect

The Threshold effect converts grayscale or color images to high-contrast, black-and-white images. Specify a certain level as a threshold; all pixels lighter than the threshold convert to white and all pixels darker convert to black.

This effect works with 8-bpc and 16-bpc color.



Effect applied with threshold settings of 44 (left), 70 (center), and 200 (right)

Text effects

Basic Text effect

The Basic Text effect places text on an existing layer—unlike text created on text layers or imported text created in Adobe Photoshop or Adobe Illustrator, either of which becomes its own layer. Use text layers for greater control over text formatting and text animation. (See Text.)

This effect works with 8-bpc color.



Original (top left) and after applying Basic Text (bottom left) and selecting Composite On Original (bottom right)

After Effects creates an alpha channel for text it creates. You can use a text effect's alpha channel with features such as track matte.

Note: The width and height of text aren't constrained by the dimensions of the layer; the layer dimensions merely define the visible region of the text. This feature makes it simple to scroll text over a layer.

Position The position of the text on the layer.

Note: The behavior of the Position point is affected by the Alignment setting in the Basic Text dialog box. The point always positions the vertical center of the text relative to the layer. However, if the text is left aligned, the point positions the left edge; if the text is center aligned, the point positions the center; and if the text is right aligned, the point positions the right edge.

Numbers effect

The Numbers effect generates random or sequential numbers in different formats, such as decimal number, dates, and timecode—even the current date and time (at render time). The maximum offset for sequential numbers is 30,000.

Use text layers for greater control over text formatting and text animation. (See “Examples of text animation” on page 295.)

 Apply the Current Time Format animation preset to a text layer to show the current time in the format corresponding to the project’s time display style.

This effect works with 8-bpc color.



Original (top left); after applying the Numbers effect (bottom left); and after setting Type to Numbers, Time, and Hexadecimal on three different layers (bottom right)

The following options and values are available in the Font Style dialog box: Font, Style, Direction, and Alignment. To open this dialog box again, click Options at the top of the effect’s entry in the Effect Controls panel.

Type The numbering system:

- **Number** Decimal numbers.
- **Number [Leading Zeros]** Decimal numbers with five digits to the left of the decimal point.
- **Timecode [30], Timecode [25], and Timecode [24]** Standard non-drop-frame timecode formats (XX:XX:XX:XX) using the stated frame rate. The timecode types use the layer’s current time as the base.
- **Time** Hours and minutes. If you also select Current Time/Date, the Value/Offset/Random Max value is ignored. If you select Random, the time is bounded by 0 (12:00 AM) and the slider value.
- **Numerical Date, Short Date, and Long Date** If you don’t also select Current Time/Date, the Value/Offset/Random Max is the number of days since January 1, 1995 (0 on the slider corresponds to January 1, 1995). If you do select Current Time/Date, Value/Offset/Random Max is the number of days since the current date (0 on the slider corresponds to the current date). If you select Random, the date is bounded by 0 (either the current date or January 1, 1995) and the slider value.

Note: Leap years are taken into consideration. Note that on some Mac operating systems, the clock starts on January 1, 1904, and doesn't go beyond February 6, 2040.

- **Hexadecimal** Base-16 numbers (digits from 0 to F). Hexadecimal numbers increment by 0x1 for every 0.0000125 that the Value/Offset/Random Max value increases, and increments by 0x10000 for every 1.0 that the Value/Offset/Random Max value increases. If you select Random, the number is bounded by 0 and the Value/Offset/Random Max value.

Random Values Random values limited by the Value/Offset/Random Max value. If Value/Offset/Random Max is 0, values are random across their maximum possible range.

Value/Offset/Random Max Varies based on the chosen type and whether or not Random Values is selected.

Decimal Places Specifies the number of places to the right of the decimal point.

Current Time/Date Select for time and date numbers to be based on the current time and date.

Position The position of the numbers on the layer.

Display Options Specifies the use of a fill or stroke or a combination of both on the text. Fill Only fills the characters with a color. Stroke Only strokes the edges of the characters with a color. Fill Over Stroke overlaps the fill color onto the stroke color. Stroke Over Fill overlaps the stroke color onto the fill color.

Size Size of the characters.

Tracking Average distance between characters.

Proportional Spacing Numbers use proportional spacing instead of monospacing.

Composite On Original Text is composited on top of the original image. If Composite On Original isn't selected, the original image isn't visible.

Path Text effect

The Path Text effect lets you animate text along a path. You can define a path as a straight line, a circle of any diameter, or a Bezier curve. You can also import a path created in another application, such as Adobe Photoshop or Adobe Illustrator. The Path Text effect can work with nonsquare pixels, adjusting both character shape and path shape accordingly.

Use text layers for greater control over text formatting and text animation. (See Text.)

This effect works with 8-bpc color.



Original (top left), after Path Text effect is applied (bottom left), and with Shape Type set to Bezier and Baseline Jitter and Scale Jitter values increased (bottom right)

Note: If you use Adobe Type Manager (ATM) and large text looks blocky or doesn't otherwise render properly, increase the Character Cache Size in the ATM control column.

When changing the shape of a Bezier path over time, make sure to create initial keyframes for all four path control points; moving a control point without an initial keyframe doesn't move it over time. You may find it easier to animate a path by modifying the motion paths of individual control points in the Layer panel.

Note: Handles appear in the Composition panel only if the effect is selected in the Effect Controls panel and if you aren't animating text along a mask or path.

If you want to move a Bezier path across the composition, and you don't want to change its shape, animate the layer rather than the path. If you want to stretch, shrink, or wag one side of the Bezier path while keeping the other half in the same position, move a tangent-vertex pair together. To do so, create keyframes for both by dragging the outer circle of the appropriate vertex.

Note: When animating the control points of a Bezier path, don't confuse the Bezier path shape with the Bezier spatial interpolation of the keyframes. Like keyframes for other position controls, those for the vertex or tangent of a Bezier path can be set to either linear or Bezier. The default spatial interpolation is specified in General Preferences. Spatial interpolation can be selected for individual keyframes by choosing Animation > Keyframe Interpolation.

You can apply motion blur to motion that you create with the Path Text effect. Blurring occurs on each character. Like motion blur for layers, blurring for characters is more visible when movement is quick. For example, blurring is quite pronounced when you choose negative jitter values, which produce jumpy motion.

Path Options controls

Shape Type Defines the shape of the path. The Path Text effect name must be selected in the Effect Controls panel to make the path visible in the Composition panel.

- **Bezier** Shapes text along a Bezier curve, defined by four control points (Vertex 1/Circle Center, Tangent 1/Circle Point, Tangent 2, and Vertex 2). Characters that don't fit on the path are placed off the end in a straight line.
- **Circle** Shapes text around the circumference of a circle, defined by two control points (Tangent 1/Circle Point, and Vertex 1/Circle Center). If the text is longer than the circumference of the circle, the text overlaps itself. If an arbitrary path is chosen and if the path is closed, this property forms the text around the path, as opposed to looping it.
- **Loop** Shapes text around the circumference of the circle, defined by two control points (Vertex 1/Circle Center, and Tangent 1/Circle Point). If text is longer than the circumference of the circle, it flows off the Tangent 1 point in a straight line. You can also use margin controls to make text enter or exit a circle in a straight line.
- **Line** Shapes text in a straight line, defined by two control points (Vertex 1/Circle Center, and Vertex 2). Note that, as with the Bezier path, the distance between the two control points doesn't affect the spacing of the text, unless alignment is set to Force.

Control Points Specify the points on the path.

- **Tangent 1/Circle Point** Specifies the following points: starting tangent for a Bezier curve, diameter of a circle and starting or ending point of text (depending on the specified alignment), and diameter of a loop and the point where text enters.
- **Vertex 1/Circle Center** Specifies the starting vertex for a Bezier curve, center of a circle or loop, and starting or ending point for text on a line (depending on the specified alignment).
- **Tangent 2** Specifies the ending tangent of the Bezier curve. The line between Tangent 2 and Vertex 2 specifies the slope of the curve at its ending point. For circles or loops, Tangent 2 is ignored.

- **Vertex 2** Specifies the ending vertex of a Bezier curve and the angle of a line. For circles or loops, Vertex 2 is ignored.

Custom Path Specifies an arbitrary path. You can use a mask created in the Layer panel or in Adobe Illustrator.

Reverse Path Reverses the path.

Character controls

Size Size of the characters.

Tracking Average distance between characters.

Kerning Controls the horizontal distance between two characters. If you change the text, specified kerning is preserved for all unchanged character pairs. You cannot use the Undo command to undo kerning changes. To change horizontal spacing between characters over time, use Kerning Jitter Max or create keyframes for Tracking.

- **Kerning Pair** Specifies the pair of characters to kern. Click the arrow to move among the pairs.
- **Kerning Value** The amount of kerning to apply.

Orientation Specifies the orientation or rotation values of each character.

- **Character Rotation** Each character is rotated by the specified number of degrees from its current angle. The center of rotation is on the point where the character intersects the path. Note that Perpendicular To Path changes the initial angle of the characters.
- **Perpendicular To Path** Rotates each character so that it's perpendicular to the path. If Perpendicular To Path is deselected, characters always remain upright (unless rotated by Character Rotation).
- **Vertical Writing** Rotates each character so it's vertical along the path.
- **Rotate Roman Characters** Rotates Roman characters vertically along the path; if Rotate Roman Characters isn't selected, only non-Roman characters are rotated.

Horizontal Shear Slants characters left or right, similar to italics. The slant is based on the point where the character intersects the path. To slant characters from their centers, set Baseline Shift to make the path go through the centers of the characters.

Horizontal Scale, Vertical Scale Resize the characters by the specified percentage in the horizontal and vertical directions. Text is scaled from the initial rasterization size, specified for Size. Setting the scaling percentage greater than 100 may result in blurred edges. For best results, set Size to a point size that doesn't require scaling beyond 100% to achieve the largest desired text size. For example, to increase the size text from 48 to 88 points, set Size to 88 and specify a starting value for both Vertical and Horizontal Scale at 55%; then increase both scale values to 100% if you want the text displayed at 88 points.

Paragraph controls

Alignment Specifies the horizontal alignment of the text on the specified path.

- **Left** Places the first character at the position specified by Left Margin; all other characters are drawn relative to it. Right Margin is ignored.
- **Right** Places the last character at the position specified by Right Margin; all other characters are drawn relative to it. Left Margin is ignored.
- **Center** Centers the text between Left Margin and Right Margin.
- **Force** Places the first character at the position specified by Left Margin and the last character at the position specified by Right Margin, spacing all other characters evenly between. Tracking is ignored.

Left Margin, Right Margin Specify the margins. Left Margin specifies the position of the first character in pixels, relative to the starting point; Right Margin specifies the position of the last character, relative to the ending point. In path shapes, the starting point for Bezier curves and lines is Vertex 1, and the starting point for circles and loops is Tangent 1. The ending point for Bezier curves and lines is Vertex 2, and the ending point for circles and loops is Tangent 1. To move text across the path shape that you've defined, create keyframes or expressions for the Left or Right margins (depending on the specified alignment). Positive values move the text to the right; negative values move it to the left.

Line Spacing Specifies the space between lines of characters.

Baseline Shift Specifies the distance in pixels between the path and the bottom of the characters. Depending on the path shape, text may appear to be better spaced if the path passes through the centers of the characters. You can set Baseline Shift to a negative value so that the centers of characters lie on the path.

Advanced controls

Visible Characters The number of characters that appear at the current time. Animate Visible Characters to display one or more characters at a time to create the appearance of typing characters. Positive values specify the number of visible characters from the beginning of the text to the end. Negative values specify the number of visible characters from the end of the text to the beginning. Remember that spaces are characters, too.

You can also use this control with Fade Time to fade in characters. When Fade Time is 0, the next character appears when the value of Visible Characters is halfway to the next whole number. For example, the second character appears when the value of Visible Characters is 1.5, the third character appears when the value is 2.5, and so on. A Fade Time value of 0 produces the appearance of typing characters.

Note: Visible Characters doesn't alter the positions of characters defined by the path and other controls.

Fade Time Specifies a range of time over which a particular character is partially visible. Fade Time works in conjunction with Visible Characters. If Fade Time is 0, each letter appears fully opaque at the appropriate Visible Characters value. If Fade Time is 100%, a particular character is displayed with greater and greater opacity as the value of Visible Characters increases between whole numbers. The exact opacity of the character is equal to the fractional part of the Visible Characters value. For example, the eighth character is displayed at 10% opacity if the value of Visible Characters is 7.10 and Fade Time is 100%; the same character is displayed at 60% opacity if the value of Visible Characters is 7.60, and so on.

For Fade Time values between 0 and 100%, the opacity of the character is defined as a range across the halfway point between whole-number values of Visible Characters. For example, if Fade Time is 20%, the eighth character begins to appear at a Visible Character value of 7.40 and is fully opaque at 7.60. If Fade Time is set to 60%, the same character begins to appear at a value of 7.20 and is fully opaque at 7.80.

Mode The blending mode used if characters overlap.

Jitter Settings Specify the maximum amount of deviation added randomly to baseline, kerning, rotation, or scale. Higher values produce greater deviations. Positive values produce smooth motion; negative values produce jumpy motion. Movement is created without keyframes or expressions, although you can use keyframes or expressions to change the maximum values.

A specific jitter value generates the same seemingly random motion for identical text and settings. If a composition contains duplicate animated text, you can generate different motion for each instance of the text by changing a setting but making the change invisible. For example, you could add a space to a second instance of text, and then adjust the kerning so that the space isn't visible. This method creates an invisible change that will generate different motion.

You can specify the following Jitter options:

- **Baseline Jitter Max** Sets a maximum distance, in pixels, that characters are randomly moved above or below the path after Baseline Shift is applied.
- **Kerning Jitter Max** Sets a maximum distance, in pixels, that characters are randomly moved apart from one another along the horizontal axis after kerning and tracking are applied.
- **Rotation Jitter Max** Sets a maximum amount, in degrees, that characters are randomly rotated after Character Rotation is applied.
- **Scale Jitter Max** Sets a maximum amount, as a percentage, that characters are randomly scaled after Horizontal Scale and Vertical Scale are applied. For best results, characters should not scale greater than 100%.

Move vertices, circle centers, and tangents

- To move the Vertex 1/Circle Center and the Tangent 1/Circle Point together, drag the outer circle of the Vertex 1/Circle Center.
- To move only the Vertex 1/Circle Center, drag its cross hair.
- To automatically snap the Tangent 1/Circle Point on top of the Vertex 1/Circle Center, select the Pen tool and then click the outer circle of Tangent 1 (Windows) or Command-click the outer circle (not the cross hair) of Tangent 1 (Mac OS).
- To snap the Tangent 1/Circle Point to increments of 45° from the Vertex 1/Circle Center, Shift-drag the outer circle of Tangent 1.
- To move Vertex 2 and Tangent 2 together, drag the outer circle of Vertex 2.
- To move only Vertex 2, drag its cross hair.

Timecode effect

The Timecode effect creates a text overlay that displays timecode or frame number information on a layer. This effect doesn't modify timecode embedded from external sources, such as QuickTime.

Use text layers for greater control over text formatting and text animation. (See Text.)



Apply the Current Time Format animation preset to a text layer to show the current time in the format corresponding to the project's time display style.

This effect works with 8-bpc color.

Display Format Specifies whether timecode is displayed in the SMPTE format, in frame numbers, or in feet and frames of 35mm or 16mm film.

Time Units Frame rate in frames per second (fps) to be used by this instance of the Timecode effect. This setting affects only the numbers displayed by the Timecode effect; it has no influence on composition frame rate or the frame rate of the layer's source footage item.

Drop Frame Select Drop Frame to generate drop-frame timecode or deselect it to generate non-drop-frame timecode.

Starting Frame The frame number assigned to the first frame of the layer.

Text Position The position of the text overlay, in composition space.

Text Size The size of text, in points.

Time effects

Echo effect

The Echo effect combines frames from different times in a layer. The Echo effect has a variety of uses, from a simple visual echo to streaking and smearing effects. The results of this effect are visible only if there is change across time in the layer, such as motion.

Note: A layer's masks and any previously applied effects are ignored by the Echo effect. To echo the frames of a layer with its masks and effects, precompose the layer before applying the Echo effect.

This effect works with 8-bpc, 16-bpc, and 32-bpc color.



Echo effect

David Van Brink provides a blog post and sample project that show how to use the Echo effect, the Particle Playground effect, and the loopOut expression to animate a swarm of stylized swimming bacteria:
www.adobe.com/go/learn_ae_ominosalmonella.

Echo Time (seconds) The time, in seconds, between echoes. Negative values create echoes from previous frames; positive values create echoes from upcoming frames.

Number of Echoes The number of echoes. For example, if the value is 2, the result is a combination of three frames: the current time, the current time + Echo Time, and the current time + (2 * Echo Time).

Starting Intensity The opacity of the first image in the echo sequence.

Decay The ratio of the opacity of an echo to the opacity of the echo preceding it in the echo sequence. For example, if Decay is 0.5, then the opacity of the first echo is half of the Starting Intensity; the second echo is half of that, or one quarter of the Starting Intensity.

Echo Operator The blending operation used to combine the echoes.

- **Add** Combines the echoes by adding their pixel values. If the starting intensity is too high, this mode can quickly overload and produce streaks of white.
- **Maximum** Combines the echoes by taking the maximum pixel values from all of the echoes.
- **Minimum** Combines the echoes by taking the minimum pixel values from all of the echoes.
- **Screen** Emulates combining the echoes by sandwiching them optically. This mode is similar to Add, but it won't overload as quickly.
- **Composite In Back** Causes the image from the current time to appear in back, with each echo appearing successively farther forward in the composite.
- **Composite In Front** Causes the image from the current time to appear in front, with each echo appearing successively farther back in the composite.
- **Blend** Averages the echoes.

See also

“Precompose layers” on page 114

Posterize Time effect

The Posterize Time effect locks a layer to a specific frame rate. It's useful on its own as a special effect, but it also has more subtle uses. For example, 60-field-per-second video footage can be locked to 24 frames per second (and then field rendered at 60 fields per second) to give a filmlike look. Also, nested compositions can be locked to a given frame rate. This effect is sometimes called *Strobe* in hardware devices.

Note: *A layer's masks and any previously applied effects are ignored by the Posterize Time effect. To posterize the time of a layer with its masks and effects, precompose the layer before applying the Posterize Time effect.*

Animating the value of the Frame Rate slider can give unpredictable results. For this reason, the only interpolation method allowed for the frame rate is Hold.

This effect works with 8-bpc and 16-bpc color.



Posterize Time effect

See also

“Precompose layers” on page 114

Time Difference effect

The Time Difference effect calculates the color difference between two layers and is a useful aid in color correction; use it to extract color differences when matching a clean background plate with foreground footage. It's also good for creating mattes to be used to apply trails of smoke, fire, or echoing effects. Once you've applied Time Difference to locate color differences in footage, use color and levels controls to apply the color corrections.

This effect works with 8-bpc color.



Time Difference effect



Use Time Difference with Particle Playground to shed particles only from moving sections.

Target Specifies the layer to be compared to the effect layer. The comparison layer's Video switch doesn't need to be on (unless you select the source layer as the Target).

Time Offset The relative time in the comparison layer, in seconds, where the layers are compared. If this control is set to 0.00, the comparison occurs at the current time. To compare the effect layer to a point 3 seconds into the comparison layer, for example, change the Time Offset value to 3. When you select the underlined offset value, you can enter the specific frame offset value in the format *frames/frame rate*. After Effects automatically calculates the value. For example, enter 3/30 to offset three frames forward in a 30-fps composition. The calculated value is 0.1, or 10% of the total time.

Contrast Adjusts the comparison result. This control can be especially helpful in fine-tuning color corrections.

Absolute Difference Displays the result of the comparison as an absolute value. Any area of the comparison layer that isn't different from the effect layer is represented by black, and any amount of difference is represented as brighter than black. If this option is unselected, compared areas with no difference are represented as gray.

Alpha Channel Specifies how the alpha channel is calculated.

- **Original** Uses the effect layer's alpha channel.
- **Target** Uses the target layer's alpha channel.
- **Blend** Blends the effect and target layers' alpha channels.
- **Max** Uses the most opaque of the original source and Target layers' alpha channels.
- **Full On** Sets the alpha channel to completely opaque.
- **Lightness Of Result** Uses the lightness of the RGB difference as alpha.
- **Max Of Result** Uses the highest values of the RGB difference as alpha.
- **Alpha Difference** Calculates differences in the effect and target layers' alpha channels the same way RGB difference is calculated.
- **Alpha Difference Only** Calculates only the differences in the alpha channels. RGB is set to white.

Time Displacement effect

The Time Displacement effect distorts the image by shifting pixels across time, producing a wide variety of effects. For example, the traditional slit-scan technique, which captures different stages of a moving image across time, can be simulated using the Time Displacement effect.

This effect works with 8-bpc and 16-bpc color.



Time Displacement effect

Like the Displacement Map effect, the Time Displacement effect uses a displacement map, but it bases the movement of pixels in the layer on luminance values in the map. Pixels in the layer that correspond to bright areas in the displacement map are replaced by pixels in the same position but at a specified number of seconds forward in time. Likewise, pixels in the layer that correspond to dark areas in the displacement map are replaced by pixels at a specified number of seconds backward in time. You can use any layer as a displacement map, though using a grayscale image lets you more easily see brightness levels and predict how pixels will be displaced.

The Time Displacement effect automatically replaces pixels across time without keyframes or expressions. However, you can animate other properties to vary the effect over time.

To better understand how pixels are displaced in time, think of the displacement occurring in steps, as follows:

- 1 After Effects overlays the displacement map layer on top of the effect layer (the layer you're distorting). If the dimensions of the displacement map are different from those of the effect layer, you can specify whether the map is centered or stretched to fit.
- 2 You specify a maximum displacement amount, in seconds.
- 3 After Effect uses the luminance value of each pixel in the displacement map to calculate the displacement of the corresponding pixel in the effect layer, based on the maximum displacement amount.

In grayscale images, the luminance value range extends from 0 to 255, and it's converted to a scale ranging from -1 to 1. A luminance value of 0 produces maximum backward displacement, meaning that pixels at the current time are replaced by pixels from a previous time. A luminance value of 255 produces maximum positive displacement, meaning that pixels at the current time are replaced by those at a future time. A luminance value of 128 produces no displacement. For other values in grayscale displacement maps, you can calculate the displacement amount, in seconds, using the following equation:

Displacement amount in seconds = maximum_displacement_time * (2 * (luminance_value - 128) / 256)

- 4 After Effects displaces each pixel in the image by replacing a pixel in the image at the current time with the pixel in the same position at another time. The other time is the displacement amount in seconds for the pixel, calculated in step 3.

Suppose you specified 2 seconds as the maximum time displacement. After Effects finds the luminance value of each pixel in the displacement map, and then it replaces the corresponding pixels at the current time with pixels from another time based on the maximum time of 2 seconds. A luminance value of 255 in the displacement map replaces that pixel with the pixel 2 seconds ahead in the same position. A luminance value of 42 replaces that pixel with the pixel 1.34 seconds behind in the same position.

Time Displacement Layer Specifies the layer to use as the displacement map.

Max Displacement Time (sec) Sets the maximum time, in seconds, from which pixels are replaced, before or after the current time. Note that only luminance values of 0 or 255 (maximum darkness and maximum brightness) produce the maximum time. All other luminance values produce times less than the maximum time.

Time Resolution (fps) Sets the number of frames per second in which to replace pixels. Typically, this value shouldn't be greater than the frame rate of the affected layer. Increasing Time Resolution can significantly increase rendering time.

Stretch Map To Fit Resizes the Time Displacement Layer to match the dimensions of the layer you're distorting. If this option isn't selected, the time displacement layer is centered in the composition.

Apply the Time Displacement effect

- 1 In the Composition panel, display both the layer you want to distort and the displacement map layer.
- 2 Hide the displacement map layer by clicking the Video switch in the Timeline panel.
- 3 In the Composition panel, select the layer you want to distort.
- 4 Choose Effect > Time > Time Displacement.
- 5 Choose a displacement map from the Time Displacement Layer menu, which lists all layers in the composition. Grayscale maps are recommended.

Note: After Effects uses the layer you select in its original form, without any masking, effects, or transformations you may have applied. If you want to use the layer with those alterations included in the displacement map, precompose that layer using the Move All Attributes into the New Composition option. (See “Precompose layers” on page 114.)

6 Adjust the Time Displacement controls.

Timewarp effect

The Timewarp effect gives you precise control over a wide range of parameters when changing the playback speed of a layer, including interpolation methods, motion blur, and source cropping to eliminate unwanted artifacts. The Timewarp effect works independently of the Frame Blending switch in the Timeline panel.

Note: The Timewarp effect does not work on fields for interlaced footage. To use the Timewarp effect on a layer with an interlaced footage item as its source, double the frame rate in the composition settings. When you render to final output, modify your render settings in the Render Queue panel to set the frame rate appropriate for the output type.

This effect works with 8-bpc and 16-bpc color.



Timewarp effect

Method options

These options determine how interpolated frames are generated:

Whole Frames Duplicates the last frame shown.

Frame Mix Creates a new frame by blending existing frames.

Pixel Motion Creates a new frame by analyzing the pixel movement in nearby frames and creating motion vectors.

Adjust Time By controls

Choose Speed to specify a time adjustment as a percentage. Choose Source Frame to specify a time adjustment by identifying which source frame is to play at which time. If you choose Source Frame for Adjust Time By, then you must animate the Source Frame property to do anything other than freeze on one frame.

Tuning controls for Pixel Motion interpolation

Vector Details Determines how many motion vectors are used during interpolation. The more vectors used, the longer the rendering time. A value of 100 produces one vector per pixel. If the layer has fast-moving motion, it may look better with a lower Vector Details setting.

Smoothing These controls affect the sharpness of the image:

- **Build From One Image** Generates the final output from the closest single frame, as opposed to the closest two frames. The result is a sharper image, but jerkier motion.
- **Correct Luminance Changes** Equalizes the luminance between frames before calculating motion.
- **Filtering** The quality of the filtering used to build the interpolated image. Extreme greatly increases rendering time. The Filtering option affects only the sharpness of the final image; use Normal until you're ready for final rendering.

Error Threshold Determines the precision of pixel matching from one frame to the next. A higher value results in fewer motion vectors and more blending.

Note: If you see edge tearing in the image, try increasing the Error Threshold for more blending. If the image has heavy grain, try decreasing the Error Threshold so the low-level motion of the grain is ignored.

Block Size Adjusts the size of the blocks used to calculate the vectors.

Weighting Controls the weighting of the red, green, and blue channels in calculations used to analyze the image. For example, setting Red Weight and Green Weight to zero means that only the blue channel is analyzed for motion.

Motion Blur controls

Shutter Angle Determines the intensity of motion blur. The shutter angle is measured in degrees, simulating the exposure caused by a rotating shutter. Simulated exposure time is determined by dividing the shutter angle by the frame rate times 360°. For example, a shutter angle of 90° causes an exposure of 1/96 of a second per frame: $90^\circ / (360^\circ * 24 \text{ fps})$.

Shutter Samples Controls the quality of the motion blur. A higher value results in a smoother motion blur.

Matte, warp, and crop controls

Matte Layer The layer to use as a matte for defining the foreground and background areas of the image. White areas in the matte represent the foreground, black areas represent the background, and gray attenuates between foreground and background.

Matte Channel The channel to use as a matte.

Warp Layer Allows you to warp the layer to which the effect is applied by applying the motion vectors from the layer that you choose.

Show Controls the portion of the layer to be time-remapped.

Source Crops If the image contains unwanted pixels or artifacts at the edges, use Source Crops controls to specify image boundaries. Pixels from the boundaries are repeated to fill the area beyond the boundaries to the layer's edges.

See also

“Work with composition settings” on page 110

“Work with render settings” on page 597

Transition effects

About Transition effects

All Transition effects but the Iris Wipe effect have a Transition Completion property. When this property is 100%, the transition is complete, and the underlying layers show through; the layer to which the effect is applied is entirely transparent. You typically animate this property from 0% to 100% over the time of the transition.

For an example of how to use animation presets to create custom transitions, see this entry in Stu Maschwitz's blog: www.adobe.com/go/learn_ae_stufilmburn. From this page, you can download the Film Burn animation preset, which adds film-like flicker to layers and adds a film burn transition to the ends of layers' durations.

See also

“About animation, keyframes, and expressions” on page 183

Block Dissolve effect

The Block Dissolve effect makes a layer disappear in random blocks. The width and height of the blocks, in pixels, can be set independently. At Draft quality, the blocks are placed with pixel precision and have sharply defined edges; at Best quality, the blocks can be positioned with subpixel precision and have soft edges.

This effect works with 8-bpc and 16-bpc color.

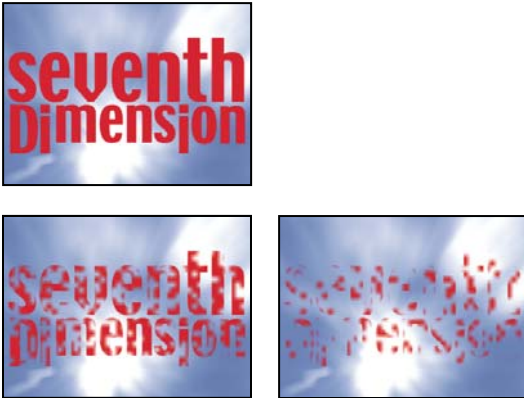

Original (top left), and with effect applied (bottom left and right)

Card Wipe effect

This effect simulates a group of cards displaying a picture and then flipping to display another picture. Card Wipe provides control over the number of rows and columns of cards, the flip direction, and the transition direction (including the ability to use a gradient to determine flip order). You can also control randomness and jitter to make the effect appear more realistic. By varying the rows and columns, you can also create venetian blind and Chinese lantern effects.

The Card Wipe effect shares many controls with the Card Dance effect.

This effect works with 8-bpc color.



Original (top left), and with effect applied (bottom left and right)

See also

“About randomness and random seeds” on page 354

“Common Lighting controls and Material controls” on page 486

Basic controls

Transition Width The width of the area that actively changes from the original to the new image.

Back Layer The layer that appears in segments on the backs of the cards. You can use any layer in the composition; its Video switch  can even be turned off. If the layer has effects or masks, precompose the layer first.

Rows & Columns Specifies the interaction of the numbers of rows and columns. Independent makes both the Rows and Columns sliders active. Columns Follows Rows makes only the Rows slider active. If you choose this option, the number of columns is always the same as the number of rows.

Rows The number of rows, up to 1000.

Columns The number of columns, up to 1000, unless Columns Follows Rows is selected.

Note: Rows and columns are always evenly distributed across a layer, so unusually shaped rectangular tiles don't appear along the edges of a layer, unless you're using an alpha channel.

Card Scale The size of the cards. A value smaller than 1 scales the cards down, revealing the underlying layer in the gaps. A value greater than 1 scales the cards up, creating a blocky mosaic as they overlap each other.

Flip Axis The axis around which each card flips.

Flip Direction The direction in which the cards flip around their axes.

Flip Order The direction in which the transition occurs. You can also use a gradient to define a custom flip order: Cards flip first where the gradient is black and last where the gradient is white.

Gradient Layer The gradient layer to use for the Flip Order. You can use any layer in the composition.

Timing Randomness Randomizes the timing of the transition. If this control is set to 0, the cards flip in order. The higher the value, the more random the order in which the cards flip.

Camera System Whether to use the effect's Camera Position properties, the effect's Corner Pins properties, or the default composition camera and light positions to render 3D images of the cards.

Camera Position controls

X Rotation, Y Rotation, Z Rotation Rotate the camera around the corresponding axis. Use these controls to look at the cards from the top, side, back, or any other angle.

X, Y Position Where the camera is positioned in x,y space.

Z Position Where the camera is positioned along the z axis. Smaller numbers move the camera closer to the cards, and larger numbers move the camera away from the cards.

Focal Length The zoom factor. Smaller numbers zoom in.

Transform Order The order in which the camera rotates around its three axes, and whether the camera rotates before or after it's positioned using the other Camera Position controls.

Corner Pins controls

Corner Pinning is an alternative camera control system. Use it as an aid for compositing the result of the effect into a scene on a flat surface that is tilted with respect to the frame.

Upper Left Corner, Upper Right Corner, Lower Left Corner, Lower Right Corner Where to attach each of the corners of the layer.

Auto Focal Length Controls the perspective of the effect during the animation. If Auto Focal Length is unselected, the focal length you specify is used to find a camera position and orientation that positions the corners of the layer at the corner pins, if possible. If not, the layer is replaced by its outline, drawn between the pins. If Auto Focal Length is selected, the focal length required to match the corner points is used, if possible. If not, it interpolates the correct value from nearby frames.

Focal Length Overrides the other settings if the results you've obtained aren't what you need. If you set the Focal Length to something that doesn't correspond to what the focal length would be if the pins were actually in that configuration, the image may look unusual (strangely sheared, for example). But if you know the focal length that you are trying to match, this control is the easiest way to get correct results.

Jitter controls

Adding jitter (Position Jitter and Rotation Jitter) makes this transition more realistic. Jitter works on the cards before, during, and after the transition occurs. If you want the jitter to happen only during the transition, start with the Jitter Amount at 0, animate it up to the desired amount during the transition, and then animate it back down to 0 at the completion of the transition.

Position Jitter Specifies the amount and speed of jitter at the x, y, and z axes. X, Y, and Z Jitter Amount specify the amount of extraneous movement. The X, Y, and Z Jitter Speed values specify the speed of jitter for each Jitter Amount option.

Rotation Jitter Specifies the amount and speed of rotation jitter around the x, y, and z axes. X, Y, and Z Rotation Jitter Amount specify the amount of rotational jitter along an axis. A value of 90° makes it possible for a card to rotate up to 90° in either direction. The X, Y, and Z Rot Jitter Speed values specify the speed of rotational jitter.

Gradient Wipe effect

The Gradient Wipe effect causes pixels in the layer to become transparent based on the luminance values of corresponding pixels in another layer, called the *gradient layer*. Dark pixels in the gradient layer cause the corresponding pixels to become transparent at a lower Transition Completion value. For example, a simple grayscale gradient layer that goes from black on the left to white on the right causes the underlying layer to be revealed from left to right as Transition Completion increases.

This effect works with 8-bpc and 16-bpc color.



Original (top left), and with effect applied (bottom left and right)

The gradient layer can be a still image or a moving image. The gradient layer must be in the same composition as the layer to which you apply Gradient Wipe.

You can create gradient layers in many ways, such as using the Ramp effect or creating them in Photoshop or Illustrator.

Transition Softness The degree to which the transition is gradual for each pixel. If this value is 0%, pixels in the layer to which the effect is applied are either completely opaque or completely transparent. If this value is greater than 0%, pixels are semitransparent at the intermediate stages of the transition.

Gradient Placement How the gradient layer's pixels are mapped to the pixels of the layer to which the effect is applied:

- **Tile Gradient** Uses multiple tiled copies of the gradient layer.
- **Center Gradient** Uses a single instance of the gradient layer in the center of the layer.
- **Stretch Gradient To Fit** Resizes the gradient layer horizontally and vertically to fit the entire area of the layer.

Invert Gradient Inverts the gradient layer's influence; lighter pixels in the gradient layer create transparency at a lower Transition Completion value than do darker pixels.

Iris Wipe effect

The Iris Wipe effect creates a radial transition that reveals an underlying layer. Specify the number of points used to create the iris using a range of 6 to 32 points, and specify whether an inner radius is used. If Use Inner Radius is selected, you can specify values for both Inner Radius and Outer Radius; the iris isn't visible if Outer Radius, Inner Radius, or both are set to 0. The iris is roundest if both Outer Radius and Inner Radius are set to the same value.

The Iris Wipe effect is the only Transition effect that doesn't have a Transition Completion property. To animate the Iris Wipe effect to expose the underlying layers, animate the Radius properties.

This effect works with 8-bpc and 16-bpc color.



Original (top left), and with effect applied (bottom left and right)

Linear Wipe effect

The Linear Wipe effect performs a simple linear wipe of a layer in a specified direction. At Draft quality, the edge of the wipe isn't anti-aliased; at Best quality, the edge of the wipe is anti-aliased and the feather is smooth.

Wipe Angle The direction that the wipe travels. For example, at 90° the wipe travels from left to right.

This effect works with 8-bpc and 16-bpc color.



Original (top left), and with effect applied (bottom left and right)

Radial Wipe effect

The Radial Wipe effect reveals an underlying layer using a wipe that circles around a specified point. At Best quality, the edges of the wipe are anti-aliased.

Start Angle The angle at which the transition starts. With a start angle of 0°, the transition starts at the top.

Wipe Specifies whether the transition moves clockwise or counterclockwise, or alternates between the two.

This effect works with 8-bpc and 16-bpc color.



Original (top left), and with effect applied (bottom left and right)

Venetian Blinds effect

The Venetian Blinds effect reveals an underlying layer using strips of specified direction and width. At Draft quality, the strips are animated with pixel precision; at Best quality, the strips are animated with subpixel precision.

This effect works with 8-bpc and 16-bpc color.



Original (top left), and with effect applied (bottom left and right)

Utility effects

Cineon Converter effect

The Cineon Converter effect provides a high degree of control over color conversions of Cineon frames, but in most cases you should convert the colors in a Cineon file using color management features. (See “Working with Cineon footage items” on page 251.)

To use the Cineon Converter effect, import a Cineon file and leave it in its default state; After Effects either condenses the colors to 8 bpc or expands them to 16 bpc, depending on the mode you work in. You can then apply the Cineon Converter effect to the file and precisely adjust the colors while interactively viewing the results in the Composition panel. You can set keyframes or expressions to adjust for changes in tone over time—use keyframe interpolation and ease handles to precisely match the most irregular lighting changes. Consider using other Color Correction effects to perform these corrections instead. (See “Color Correction effects” on page 387.)

The 10 bits of data available in each Cineon channel for each pixel make it easier to enhance an important range of tones while preserving overall tonal balance. By carefully specifying the range, you can create a version of the image that faithfully resembles the original.

***Note:** Each computer monitor has unique display characteristics that affect your perception of color on-screen. For best results when evaluating tonal balance, use the Info panel in After Effects to see the true color values of pixels as you move the pointer over them.*

Conversion Type How the Cineon file is converted. Log To Linear converts an 8-bpc logarithmic non-Cineon layer that you plan to render as a Cineon sequence. Linear To Log converts a layer containing an 8-bpc linear proxy of a Cineon file into an 8-bpc logarithmic file so that its display characteristics are consistent with the original Cineon file. Log To Log detects an 8-bpc or 10-bpc logarithmic Cineon file when you plan to render it as an 8-bpc logarithmic proxy.

***Note:** For compatibility, obsolete versions of each option appear if you open a project that uses an earlier version of the Cineon Converter effect.*

10 Bit Black Point The black point (minimum density) for converting a 10-bpc logarithmic Cineon layer.

Internal Black Point The black point used for the layer in After Effects.

10 Bit White Point The white point (maximum density) for converting a 10-bpc logarithmic Cineon layer.

Internal White Point The white point used for the layer in After Effects.

Gamma Increase or decrease Gamma to lighten or darken midtones, respectively.

Highlight Rolloff The rolloff value used to correct bright highlights. If adjusting the brightest areas makes the rest of the image appear too dark, use Highlight Rolloff to adjust these bright highlights. If highlights appear as white blotches, increase Highlight Rolloff until details are visible. An image with high contrast may require a high rolloff value.

See also

“Importing Cineon sequences” on page 85

“Set the color depth” on page 234

Color Profile Converter effect

The Color Profile Converter effect converts a layer from one color space to another by specifying input and output profiles.

In most cases, you should use automatic color management features to convert from one color space to another, rather than using the Color Profile Converter to manually do the conversions.

***Important:** In general, you should either work with color management features or use the Color Profile Converter—not both.*

The profiles you select are embedded in the project, so you can use them even if you transfer the project to a computer that doesn't have the same profiles. When converting from one color space to another, you can specify how After Effects handles the color conversion by selecting a rendering intent. You can also choose whether to linearize the input or output profile.

This effect works with 8-bpc, 16-bpc, and 32-bpc color.

To convert the color profile of the layer, select a color profile from the Input Profile menu. Select Project Working Space to use the profile specified in the project settings (File > Project Settings). To linearize the input profile, select the Linearize Input Profile option. Then select an output profile from the Output Profile menu. To linearize the output profile, select the Linearize Output Profile. In the Intent menu, select a rendering intent.

Rendering intent options determine how source colors are adjusted. For example, colors that fall inside the destination gamut may remain unchanged, or they may be adjusted to preserve the original range of visual relationships when translated to a smaller destination gamut.

The result of choosing a rendering intent depends on the graphical content of an image and on the profiles used to specify color spaces. Some profiles produce identical results for different rendering intents.

When specifying a rendering intent, you can choose to use black point compression. Black point compression ensures that the shadow detail in the image is preserved by simulating the full dynamic range of the output device.

The following rendering intents are available for the Color Profile Converter effect:

Perceptual Attempts to preserve the visual relationship between colors so it's perceived as natural to the human eye, even though the color values themselves may change. This intent is suitable for images with many of out-of-gamut colors.

Saturation Attempts to produce vivid colors in an image at the expense of color accuracy. This rendering intent is suitable for images, such as graphic logos, in which bright saturated colors are more important than the exact relationship between colors.

Relative Colorimetric Compares the extreme highlight of the source color space to that of the destination color space and shifts all colors accordingly. Out-of-gamut colors are shifted to the closest reproducible color in the destination color space. This rendering intent preserves more of the original colors in an image than Perceptual. This rendering intent is used by default throughout After Effects.

Absolute Colorimetric Leaves colors that fall inside the destination gamut unchanged. Out-of-gamut colors are clipped. No scaling of colors to the destination white point is performed. This intent aims to maintain color accuracy at the expense of preserving relationships between colors.

***Note:** If you open an After Effects 7 project that uses DPX Scene and DPX Theater color profiles in the Color Profile Converter effect, After Effects CS3 will not automatically update these profiles to the new equivalent profiles (Kodak 5218/7218 Printing Density and Kodak 2383 Theater Preview). Instead, the profiles will be listed as Embedded. You can convert your project by manually assigning the new profiles in After Effects CS3. However, if the same profiles were assigned to the footage or selected in Proof Colors in After Effects 7, they will be automatically updated to the new profiles in After Effects CS3. (Proof Colors has been replaced by Output Simulation.)*

See also

“Color management” on page 241

Grow Bounds effect

The Grow Bounds effect increases the layer size for the effect that directly follows it. This effect is most useful with layers that have Collapse Transformations/Continuously Rasterize enabled, because they render using a buffer that's the size of the composition. For example, if you apply Drop Shadow to a text layer that's partially out of the composition frame, the shadow will be clipped because only the portion of the text that's in the composition frame will cast a shadow. Applying the Grow Bounds effect before the Drop Shadow effect prevents the shadow from being cut off. The number of pixels you specify increases the height and width of the layer's buffer.

Note: You should not need to use this effect when working with effects that work with 32-bpc color, because these effects have been updated to automatically compensate for layer size.

This effect works with 8-bpc, 16-bpc, and 32-bpc color.

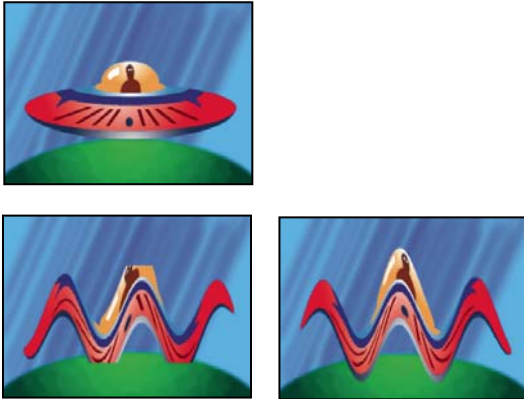

Original (top left); the Wave Warp effect is constrained by dimensions of layer (bottom left); Grow Bounds effect fixes problem (bottom right).

HDR Componder effect

The HDR Componder (compressor/expander) effect gives you a way to work with tools that don't support high-dynamic range color—such as 8-bpc and 16-bpc effects—without sacrificing the high dynamic range of footage.

The HDR Componder effect works by first compressing the highlight values in the HDR image so that they fall within the range of an 8-bpc or 16-bpc image, and then expanding the values back to the 32-bpc range.

Apply the HDR Componder effect to a layer once before working with low-dynamic-range tools and effects. Then, when you're finished, use the HDR Componder effect to expand the dynamic range back to 32 bpc.

Because the first instance of the HDR Componder effect compresses the range of values through sampling, some precision is lost. For this reason, use the HDR Componder effect only if you're willing to trade off some precision in values for the sake of high dynamic range.

This effect works with 8-bpc, 16-bpc, and 32-bpc color.

See also

“High dynamic range color” on page 235

“Set the color depth” on page 234

Apply the HDR Componder effect

- 1 Apply the HDR Componder effect to a layer in a 32-bpc project.
- 2 Select Compress Range for Mode.
- 3 Set Gain to the maximum value to be represented in the compressed range—that is, the highest white value in the image. Don't set Gain too high; the more of the 16-bpc value that you use for highlights, the more compressed the midtones (the majority of the pixels) will be, and the more data will be lost in this process.
- 4 Set Gamma. Gamma affects the distribution of values in the range, allowing more precision in specific areas of the range.
- 5 Apply whatever low-dynamic-range effects you choose to the layer.

- 6 Apply another instance of the HDR Compander effect to the layer. Make sure that the second instance of HDR Compander is ordered after (below) any 8-bpc or 16-bpc effects you've applied.
- 7 Select Expand Range for Mode for the second instance of the HDR Compander effect.
- 8 Set Gain and Gamma to the same values as set in the first instance of the HDR Compander effect.

 A more convenient way to use the HDR Compander effect is to apply the Compress-Expand Dynamic Range animation preset. This animation preset consists of an expression and two instances of the HDR Compander effect: The first instance has Compress Range selected, and the second has Expand Range selected. The expression automatically sets the Gain and Gamma for the second instance to be the same as that which you set for the first instance. Insert whatever low-dynamic-range effects you choose between these two instances of the HDR Compander effect.

HDR Highlight Compression effect

The HDR Highlight Compression effect compresses the highlight values in a high-dynamic range image so that they fall within the value range of a low-dynamic-range image. Adjust the amount of compression by setting the effect's Amount property.

See also

“High dynamic range color” on page 235

“Set the color depth” on page 234

Chapter 16: Expressions

Working with expressions

Many of the examples in this section are based on examples provided by Dan Ebberts. Dan Ebberts also has an excellent collection of example expressions and tutorials for learning how to work with expressions on his website: www.adobe.com/go/learn_ae_motionscripthome.

The AE Enhancers forum provides lots of examples and useful information about expressions, as well as scripts and animation presets: www.adobe.com/go/learn_ae_aeenhancershome.

About expressions

When you want to create and link complex animations, but would like to avoid creating tens or hundreds of keyframes by hand, try using *expressions*. With expressions, you can create relationships between layer properties and use one property's keyframes to dynamically animate other layers. For example, if you set Rotation keyframes for a layer and then apply the Drop Shadow effect, you can use an expression to link the Rotation property's values with the Drop Shadow effect's Direction values; that way, the drop shadow changes accordingly as the layer rotates. You can even use the pick whip to link path properties, so a mask can take its path from a brush stroke or a shape layer object.

Expressions are based on the standard JavaScript language, but you do not need to know JavaScript to use expressions. You can create expressions by using the pick whip or by copying simple examples and modifying them to suit your needs.

Note: Two great sources of example expressions are the Expression Sampler template project (File > Browse Template Projects) and the animation presets in the Behaviors category (Animation > Browse Presets).

You can do all of your work with expressions in the Timeline panel, though it is sometimes more convenient to drag the pick whip to a property in the Effect Controls panel. You can use the pick whip to create expressions, or you can enter and edit expressions manually in the *expression field*, a resizable text field in the time graph. The expression field appears alongside the property in layer bar mode; the expression field appears at the bottom of the Graph Editor in Graph Editor mode. You can write an expression in a text editor and then copy it into the expression field. When you add an expression to a layer property, a default expression appears in the expression field. The default expression essentially does nothing—it sets the property value to itself.

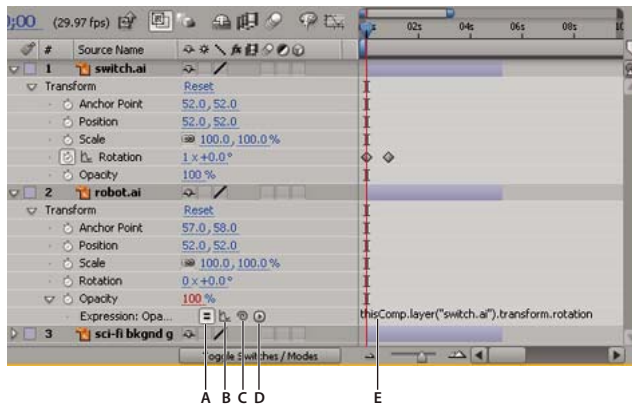

Expression interface in the Timeline panel in layer bar mode

A. Enable Expression switch B. Show Post-Expression Graph button C. Pick whip D. Expression Language menu E. Expression field

While you are editing an expression, previews of all sorts are suspended; a red bar appears at the bottom of panels that are waiting for you to exit text-editing mode.

The values for a property that contains an expression appear in red or pink type.

Animation presets can include expressions, or even consist entirely of an expression. Animation presets that use expressions instead of keyframes are sometimes called *behaviors*.

After you add an expression to a property, you can continue to add or edit keyframes for the property. An expression can take the value of a property as determined by its keyframes and use that as input to generate new, modified values. For example, the following expression on a layer's Position property preserves the layer's keyframed motion and causes it to wiggle a little:

```
transform.position.wiggle(10, 10)
```

Note: Using the *wiggle* expression is often much faster and easier than using the *Wiggler*.

If an expression cannot be processed, After Effects displays a message explaining the error and automatically disables the expression. A yellow warning icon ⚠ appears next to the expression; click the warning icon to view the error message again.



To show expressions that have errors, select one or more layers, right-click (Windows) or Control-click (Mac OS) a selected layer in the Timeline panel, and choose *Reveal Expression Errors* from the context menu.

Some expressions rely on the names of layers or properties in your project; if you change the name of a layer or property that is involved in an expression, After Effects will attempt to update the expression to use the new name. However, in some complex cases, After Effects will be unable to automatically update the expression, in which case the expression may produce an error message, and you must update the expression yourself.

Important: If you are running After Effects in a language other than the one for which an expression was written, or if you have changed the names of items (such as layers, effects, or other property groups), then the expression may not work until you modify the expression to use the new names or the strings that match the language in which you are running After Effects. Because the examples in this document were created for the default state of After Effects running in English, some examples in this document will not work without such modification.

Precomposing multiple layers will also cause expressions that refer to one of the layers' properties to produce an error, requiring you to update these expressions to refer to the layer within the new composition. (See "About nesting and precomposing" on page 113.)

Note: The arguments for some After Effects effects have changed from those in previous versions. If you have existing expressions that use argument index references rather than argument names, you may need to update the expressions to use argument names.

When you are animating text, you can use the Expression selector to dynamically specify how much you want characters to be affected by an animator property through the use of expressions. You can add one or more Expression selectors to an animator group, and that animator group can contain one or more properties.

See also

“Save an animation preset” on page 353

“About animation, keyframes, and expressions” on page 183

“Work with selectors” on page 289

Add, edit, and remove expressions

You can enter entire expressions yourself, by manually typing them or by using the Expression Language menu; or you can create an expression with the pick whip or paste it from an example or other property.

A good way to begin working with expressions is to create a simple expression with the pick whip and then adjust the expression's behavior using simple math operations, such as those listed in the following table:

Symbol	Function
+	add
-	subtract
/	divide
*	multiply
*-1	perform opposite of original, such as counterclockwise instead of clockwise

For example, you can double the result by typing `*2` at the end of the expression; or you can halve the result by typing `/2` at the end of the expression.

As you develop comfort editing expressions, you can combine these simple operations—and more. For example, you can add `/360*100` to the end of an expression to change its range from 0-360 to 0-100. This would be useful if you wanted to convert the values of a 360-degree dial to a slider that is measured in percentages.

The Expression Language menu in the Timeline panel contains language elements specific to After Effects that you can use in an expression. This menu is helpful for determining valid elements and their correct syntax; use it as a reference for available elements. When you choose any object, attribute, or method from the menu, After Effects automatically inserts it in the expression field at the insertion point. If text is selected in the expression field, that text is replaced by the new expression text. If the insertion point is not in the expression field, all text in the field is replaced by the new expression text.



The Expression Language menu lists arguments and default values. This makes it easy to remember which elements you can control when you write an expression. For example, in the language menu, the wiggle method in the Property category appears as `wiggle(freq, amp, octaves=1, amp_mult=.5, t=time)`. There are five arguments listed in the parentheses following `wiggle`. The `=` in the last three arguments indicates that using those arguments is optional. If you specify no values for them, they default to 1, .5, and the current time, respectively.

Important: You must replace the argument names written by the Expression Language menu with actual values.

See also

“About animation, keyframes, and expressions” on page 183

Add, disable, or remove an expression

- To add an expression to a property, select the property in the Timeline panel and choose Animation > Add Expression or press Alt+Shift+= (Windows) or Option+Shift+= (Mac OS); or Alt-click (Windows) or Option-click (Mac OS) the stopwatch button  next to the property name in the Timeline panel or Effect Controls panel.
- To temporarily disable an expression, click the Enable Expression switch . When an expression is disabled, a slash appears through the switch .
- To remove an expression from a property, select the property in the Timeline panel and choose Animation > Remove Expression, or Alt-click (Windows) or Option-click (Mac OS) the stopwatch button next to the property name in the Timeline panel or Effect Controls panel.

Edit an expression with the pick whip

If you are not familiar with JavaScript or the After Effects expression language, you can still take advantage of the power of expressions by using the pick whip. You simply drag the pick whip  from one property to another to link the properties with an expression, and the expression text is entered in the expression field at the insertion point. If text is selected in the expression field, that text is replaced by the new expression text. If the insertion point is not in the expression field, all text in the field is replaced by the new expression text.

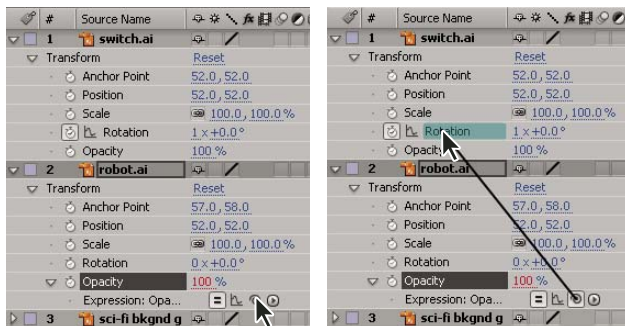

Drag the pick whip to a property to create a link to the property's value.

You can drag the pick whip to a property's name or to its values. If you drag to the property's name, the resulting expression displays all the values as one. For example, if you drag the pick whip to the Position property's name, an expression like the following appears:

```
thisComp.layer("Layer 1").transform.position
```

If you drag the pick whip to one of the Position property's values (such as the y value), an expression like the following appears, in which both the x and y coordinates of the property are linked to the Position property's y value:

```
temp = thisComp.layer("Layer 1").transform.position[1];
[temp, temp]
```

If the layer, mask, or effect that you drag the pick whip to does not have a unique name in its local context, After Effects renames it. For example, if you have two or more masks named “Mask” on the same layer, and you drag the pick whip to one of them, After Effects renames it “Mask 2”.

The format of expressions created by the pick whip is determined by the Expression Pick Whip Writes Compact English preference (Edit > Preferences > General (Windows) or After Effects > Preferences > General (Mac OS)). By default, the pick whip creates compact English expressions, which use the Timeline panel's name for the properties within an expression. Because these names are coded into the application and never change, these expressions can work when After Effects is running in another language. Any property names that you can change are enclosed in double quotation marks and remain the same in any language. If you don't plan on sharing your projects across languages, you can deselect this preference. This preference does not affect effect names or effect properties.

Here is an example in compact English:

```
thisComp.layer("Layer 1").transform.position
```

Here is the same expression, not in compact English:

```
thisComp.layer("Layer 1")("Transform")("Position")
```

Note: Because the default is to use compact English, this document uses compact English in most examples and illustrations.

- 1 Drag the pick whip to another property in the Timeline panel or Effect Controls panel.
- 2 Optionally, modify the default expression in the expression field.

Edit an expression manually

- 1 Click in the expression field to enter text-editing mode.

Note: When you enter text-editing mode, the entire expression is selected. To add to the expression, click within the expression to place the insertion point; otherwise, you will replace the entire expression.

- 2 Type and edit text in the expression field, optionally using the Expression Language menu.



To see more of a multiline expression, drag the bottom or top of the expression field to resize it.

- 3 To exit text-editing mode and activate the expression, do one of the following:

- Press Enter on the numeric keypad.
- Click outside the expression field.

Example: Use the expression language reference to write an expression

Follow along with this example to learn how to use the After Effects expression language reference to write expressions. The expression created in this example copies position values from one layer to another.

- 1 Create two solid layers: Solid 1 and Solid 2.
- 2 Animate the Position property values for Solid 1 using keyframes. (See “About animation, keyframes, and expressions” on page 183.)
- 3 Select the Position property for Solid 2 and choose Animation > Add Expression or Alt-click (Windows) or Option-click the property's stopwatch  button. The following expression appears by default:

```
transform.position
```

- 4 Type the following directly over `transform.position`:

```
thisComp
```

5 The element `thisComp` is a global attribute whose value is a Comp object representing the current composition. To determine what can follow `thisComp` in your expression, look up the return value for `thisComp` under “Global objects” on page 560.

Note that `thisComp` returns a Comp. Next, look at “Comp attributes and methods” on page 567 to see which attributes and methods you can use with a Comp. One option is `layer(index)`. The index, or number, inside the parentheses specifies the layer that you want to use. For this example, we assume that Solid 1 is the first layer in your composition. To retrieve values from the first layer in the active composition, type `.layer(1)` at the end of the expression, to get the following:

```
thisComp.layer(1)
```

6 Again, look at the expression elements reference to see that `layer(index)` returns a Layer. Look at “Layer General attributes and methods” on page 570, and find the element you want to use. For example, if you want to access the Position property’s values for the layer, type `.position` at the end of the expression to get the following:

```
thisComp.layer(1).position
```

7 From “Layer General attributes and methods” on page 570, you can see that the `position` attribute returns a property. Look up “Property attributes and methods” on page 576 and notice that you can add a time factor to the expression. To add a specific time, such as current time plus 2 seconds, type `.valueAtTime(time+2)` at the end of the expression to get the following:

```
thisComp.layer(1).position.valueAtTime(time+2)
```

8 From “Property attributes and methods” on page 576, notice that the `valueAtTime` method returns a number or Array. When an expression returns a Number, Array, or Boolean (true or false), you cannot add further attributes or methods to the expression (if you want, however, you can add arithmetic operators, such as +, -, *, and /).

See also

“Using the expression elements reference” on page 559

Show expressions and the expression graph

In Graph Editor mode, the single expression field appears as a resizable text box at the bottom of the Graph Editor and shows only the expression for the selected property. To show multiple expression fields simultaneously, the Timeline panel must be in layer bar mode.



To toggle between layer bar mode and Graph Editor mode, press Shift+F3.

- To show only properties with expressions, select one or more layers, and then press **EE**.
- To show the expression field in the Graph Editor, choose Show Expression Editor from the Choose Graph Type And Options  menu at the bottom of the Graph Editor. When you add a new expression to a property, the expression editor is shown, regardless of this setting.



To resize the expression field, drag its bottom edge up or down.

- To see how an expression changes the value or velocity graph, click the Show Post-Expression Graph button  while showing the value or velocity graph in the Graph Editor.

The dimly colored graph displays the value or velocity before the expression is applied, and the brightly colored graph displays the value or velocity after the expression is applied. Turning on the graph overlay for the Position property also changes the motion path display in the Composition panel so that you can see the expression-affected path.

See also

“Work with the Graph Editor” on page 184

“Creating and modifying motion paths” on page 197

Writing expressions for source text

The Source Text property of a text layer is interpreted by expressions as a JavaScript String. You can use the pick whip to retrieve the source text from another text layer; however, only the style of the first character of the destination layer is used.

For more information on the String object, consult a JavaScript guide.

You can use “\r” in a string expression to start a new line of text. For example, to copy the original text from one layer onto the same layer and repeat it in all uppercase characters on a new line, use the following expression:

```
text.sourceText + "\r" + text.sourceText.toUpperCase()
```

Adding a text layer to a composition and adding an expression to its Source Text property can be a great way to examine the property values of other layers. For example, the following expression on a Source Text property reports the name and value of the Opacity property for the next layer in the layer stacking order:

```
thisComp.layer(index + 1).name + "\rOpacity = " + thisComp.layer(index + 1).opacity.value
```

The following example reports the name of the footage item used as the source of the topmost image layer in the stacking order at the current time that has its Video switch set.

```
source_footage_name = "";
for (i = 1; i <= thisComp.numLayers; i++){
  if (i == index) continue;
  my_layer = thisComp.layer(i);
  if (!(my_layer.hasVideo && my_layer.active)) continue;
  if (time >= my_layer.inPoint && time < my_layer.outPoint){
    try{
      source_footage_name = my_layer.source.name;
    }catch(err1){
      source_footage_name = my_layer.name
    }
    break;
  }
}
source_footage_name
```

See also

“Creating and editing text layers” on page 273

Add comments to an expression

If you write a complex expression and intend to reuse it later, you should add comments that explain what the expression does and how its pieces work.

- Type // at the beginning of the comment. Any text between // and the end of the line is ignored. For example:

```
// This is a comment.
```

- Type `/*` at the beginning of the comment and `*/` at the end of the comment. Any text between `/*` and `*/` is ignored. For example:

```
/* This is a  
   multiline comment. */
```

Save and reuse expressions

Once you have written an expression, you can save it for future use by copying and pasting it into a text-editing application or by saving it in an animation preset or template project. However, because expressions are written in relation to other layers in a project and may use specific layer names, you must sometimes modify an expression to transfer it between projects.

You can define your own functions within expressions using normal JavaScript function syntax. In this example, a function is defined that calculates the average of two values, and the last line uses this function:

```
function average(a, b)  
{  
  return (a + b) / 2;  
}  
average(position, thisComp.layer(1).position);
```

Note that you must define each function fully within each expression in which it is used; there is no global library of functions that you can add to.

If you want to save an expression for use in another project, you should add comments to the expression. You should also use variables so that you can change a value in one place rather than having to change it in several places.

For example, this expression has a multiline comment at the beginning that explains what the expression does and a short comment after a variable is declared and initialized that tells what the variable is for:

```
/* This expression on a Source Text property reports the name  
   of a layer and the value of its Opacity property. */  
  
var myLayerIndex = 1; // layer to inspect, initialized to 1, for top layer  
  
thisComp.layer(myLayerIndex).name + ": \rOpacity = " +  
thisComp.layer(myLayerIndex).opacity.value
```

You can save an animation preset that includes an expression and reuse it in other projects, as long as the expression does not refer to properties that don't exist in the other projects. When you save a preset in which a property has an expression but no keyframes, only the expression is saved. If the property has one or more keyframes, the saved preset will contain the expression along with all keyframe values.

You can copy an expression from a layer property, with or without the property's keyframes. Copying an expression without keyframes is particularly useful when you want to simultaneously copy multiple expressions and paste them onto one or more new layers, or when you want to copy one expression and paste it onto more than one layer.

- To copy an expression and keyframes from one property to other properties, select the source layer property in the Timeline panel, copy the layer property, select the target layer properties, and paste.
- To copy an expression from one property to other properties without copying keyframes, select the source property, choose `Edit > Copy Expression Only`, select the target properties, and paste.

Note: As with pasting keyframes and other items, you can often paste the item into the target layer and rely on After Effects to determine which property should be the target of the paste operation. For example, this works for copying Position properties from one layer to another, but you must select the target property yourself if you are pasting an expression from a Position property into a Scale property.

See also

“Save an animation preset” on page 353

“Work with layer properties in the Timeline panel” on page 152

Using Expression Controls effects

Use Expression Controls effects to add a control that you can use to manipulate one or many properties' values by linking the property to the control using expressions. A single control can affect several properties at once.

You can apply Expression Controls effects to any layer; however, it is useful to apply them to a null layer, which you can simply use as a controlling layer. You then add expressions to properties on other layers to take input from that control.

For example, you can add the Slider Control effect to a null layer (Null 1), and then apply this expression to the Position properties of multiple layers:

```
position+[0,10*(index-1)*thisComp.layer("Null 1").effect("Slider Control")("Slider")]
```

In this example, as you drag the slider, each layer with this expression will move. The layers with greater index numbers (layers toward the bottom in the Timeline panel) will be shifted more than the layers with lower index numbers, at 10-pixel intervals. You can set keyframes for the slider on the null layer, and all of the other layers will animate accordingly.

You apply Expression Controls effects to a layer in the same ways that you apply other effects, such as dragging the effect onto the layer from the Effects & Presets panel.



To modify the range of a control, right-click (Windows) or Control-click (Mac OS) the control's underlined property value and choose Edit Value from the context menu.

Harry Frank shows how to use an Expression Controls effect (the Slider Control effect) as part of his video tutorial about converting from RGB to HSL using expressions: www.adobe.com/go/learn_ae_harryrgb2hsl.

See also

“Create a null object” on page 159

“Apply an effect or animation preset” on page 351

Convert an expression to keyframes

In some situations, it may be useful to convert an expression to keyframes. For example, if you want to freeze the values in an expression, you can convert the expression to keyframes and then adjust the keyframes accordingly; or, if an expression takes a long time to evaluate, you can convert it to keyframes so that it renders more quickly. When you convert an expression to keyframes, After Effects evaluates the expression, creating a keyframe at every frame, and then disables the expression.

❖ In the Timeline panel, select the property on which the expression is written and choose Animation > Keyframe Assistant > Convert Expression To Keyframes.

The expression language

About the expression language

The After Effects expression language is based on JavaScript 1.2, with an extended set of built-in objects. After Effects uses only the core standard JavaScript 1.2 language, not the web browser-specific extensions. After Effects contains its own set of extension objects—such as Layer, Comp, Footage, and Camera—that you can use to access most of the values in an After Effects project.

For more information about JavaScript, see a JavaScript reference manual.

When creating expressions, keep the following in mind:

- JavaScript is case-sensitive.
- Semicolons are required to separate statements or lines.
- Spaces between words are ignored, except within a string.

In JavaScript, a value stored in an object is called a *property*. However, After Effects uses the term *property* to refer to layer attributes as defined in the Timeline panel. Consequently, for clarity, After Effects documentation refers to a JavaScript property as a *method* when the property takes arguments, or an *attribute* when it does not.

The value of an expression is the value of the last statement evaluated.

Accessing attributes and methods

You use the expression language to access attributes and methods of layer properties. To access a value, use a chain of object references separated by the period (.) operator. To chain object references past the layer level (for example, to chain effect properties, masks, or text animators), you can also use parentheses. For example, to link the Opacity property in Layer A to the Gaussian Blur effect's Blurriness property in Layer B, type the following expression in the expression field for Layer A's Opacity property:

```
thisComp.layer("Layer B").effect("Gaussian Blur")("Blurriness")
```

The default object for an expression is the property on which the expression is written, followed by the layer containing the expression; therefore, you do not need to specify the property. For example, a wiggle expression written on a layer's Position property can be either of the following:

```
wiggle(5, 10)  
position.wiggle(5, 10)
```

You do need to include the layer and property when retrieving them from outside the layer and property on which the expression is written. For example, an expression written on Layer B's Opacity property, linking it to Layer A's Rotation property would look like this:

```
thisComp.layer("Layer A").rotation
```



To see more examples of how this works, use the pick whip to link one layer property to another, and look at the expressions it creates.

Arrays and multidimensional properties

An *Array* is a type of object that stores an ordered set of numbers. An Array is represented as a list of numbers separated by commas and surrounded by brackets, as in this example:

```
[10, 23]
```

You can assign an Array to a variable, making it easy to refer to Array values in other areas of the expression. For example:

```
myArray = [10, 23]
```

The *dimension* of an Array is the number of elements in the Array. The dimension of `myArray` is 2. Different properties in After Effects have different dimensions depending on the number of value arguments they have. In the expression language, properties' values are either single values (Numbers) or Arrays.

The following table provides examples of some properties and their dimensions:

Dimension	Property
1	Rotation ° Opacity %
2	Scale [x=width, y=height] Position [x, y] Anchor Point [x, y]
3	Scale [width, height, depth] 3D Position [x, y, z] 3D Anchor Point [x, y, z]
4	Color [red, green, blue, alpha]

You can access the individual elements of an Array by using brackets and an index number to indicate which element you want. The elements in an Array are indexed starting from 0. Using the previous example, `myArray[0]` is 10 and `myArray[1]` is 23.

The following two expressions are equivalent:

```
[myArray[0], 5]
[10, 5]
```

The Position property arrays are indexed as follows:

- `position[0]` is the x coordinate of position.
- `position[1]` is the y coordinate of position.
- `position[2]` is the z coordinate of position.

Colors are represented as four-dimensional arrays [*red, green, blue, alpha*]. In projects with a color depth of 8 or 16 bpc, each value in a color array ranges from 0 (black) to 1 (white). For example, *red* can range from 0 (no color) to 1 (red). So, [0,0,0,0] is black and transparent, and [1,1,1,1] is white and completely opaque. In projects with a color depth of 32 bpc, values under 0 and over 1 are allowed.

If you use an index that is greater than the index of the highest-dimension component in an Array, After Effects returns an error. For example, `myArray[2]` causes an error, but `position[2]` returns the z coordinate of Position.

Many of the properties and methods in the After Effects expression language take Array objects as arguments or return them as values. For example, `thisLayer.position` is an Array that is either two-dimensional or three-dimensional depending on whether your layer is 2D or 3D.

If you want to write an expression that keeps the y value of an object's animation but fixes the x value at 9, you would use the following:

```
y = position[1];  
[9, y]
```

The following is even more succinct:

```
[9, position[1]]
```

This is an important point, so let's look at one more example. If you want to combine the x position value from Layer A with the y position value from Layer B, you would use the following:

```
x = thisComp.layer("Layer A").position[0];  
y = thisComp.layer("Layer B").position[1];  
[x, y]
```

You can create an expression that refers to just one value within the Array of a 2D or 3D property. By default, the first value is used, unless you specify otherwise. For example, if you drag the pick whip from Layer A's Rotation property to Layer B's Scale property, the following expression appears:

```
thisComp.layer("Layer B").scale[0]
```

By default, the above expression uses the first value of the Scale property, which is width. If you prefer to use the height value instead, drag the pick whip directly to the second value instead of the property name, or change the expression as follows:

```
thisComp.layer("Layer B").scale[1]
```

Conversely, if you drag the pick whip from Layer B's Scale property to Layer A's Rotation property, After Effects automatically creates a variable, assigns the one-dimensional Rotation property's value to it, and then uses that variable for both dimensions of the Scale property:

```
temp = thisComp.layer(1).transform.rotation;  
[temp, temp]
```

See also

“High dynamic range color” on page 235

Vectors

In After Effects, many properties and methods take or return *vectors*. After Effects refers to an Array as a *vector* if it represents either a point or direction in space. For example, After Effects describes `position` as returning a vector.

However, though a function like `audioLevels` does return a two-dimensional value (the left and right channel levels), it is not called a *vector* because it does not represent a point or direction. Some functions in After Effects accept vector arguments, but they are generally only useful when the values passed represent a direction. For example, `cross(vec1, vec2)` computes a third vector that is at right angles to the input vectors. This is useful when `vec1` and `vec2` are two vectors representing directions in space, but not if they just represent two arbitrary collections of numbers.

Indices and labels

Indexing for Layer, Effect, and Mask elements in After Effects starts from 1. For example, the first layer in the Timeline panel is `layer(1)`.

Generally, it is best to use the name of a layer, effect, or a mask instead of a number to avoid confusion and errors if the layer, effect, or mask is moved, or if the arguments are changed during product updates and upgrades. When you use a name, always enclose it in straight quotes. For example, the first expression below is easier to understand than the second expression, and the first expression will continue to work even if you change the order of effects:

```
effect("Colorama").param("Get Phase From")  
effect(1).param(2)
```

Expression time

Time within an expression is always in composition time (not layer time) and is measured in seconds. The default time for any expression is the current composition time at which the expression is being evaluated. The following expressions both use the default composition time and return the same values:

```
thisComp.layer(1).position  
thisComp.layer(1).position.valueAtTime(time)
```

To use a relative time, add an incremental time value to the `time` argument. For example, to get the Position value 5 seconds before the current time, use the following expression:

```
thisComp.layer(1).position.valueAtTime(time-5)
```

Default time references to properties in nested compositions use the original default composition time, not remapped time. However, if you use the `source` function to retrieve a property, the remapped time is used.

For example, if the source of a layer in the parent composition is a nested composition, and in the parent composition you have remapped time, when you access the position values of a layer in the nested composition with the following expression, the position values use the composition's default time:

```
comp("nested composition").layer(1).position
```

However, if you access layer 1 using the `source` function, the position values use the remapped time:

```
thisComp.layer("nested composition").source.layer(1).position
```

Note: *If you use a specific time in an expression, After Effects ignores the remapped time.*

After Effects expression elements reference

Using the expression elements reference

Use the After Effects expression elements along with standard JavaScript elements to write your expressions. You can use the Expression Language menu at any time to insert methods and attributes into an expression, and you can use the pick whip at any time to insert properties.

If an argument description contains an equal sign (=) and a value (such as `t=time` or `width=.2`), then the argument uses the included default value if you don't specify a different value.

Some argument descriptions include a number in square brackets—this number indicates the dimension of the expected property or Array.

Some return-value descriptions include a number in square brackets—this number specifies the dimension of the returned property or Array. If a specific dimension is not included, the dimension of the returned Array depends on the dimension of the input.

- “Global objects” on page 560

- “Time conversion methods” on page 561
- “Vector Math methods” on page 562
- “Random Numbers methods” on page 563
- “Interpolation methods” on page 565
- “Color Conversion methods” on page 566
- “Other Math methods” on page 566
- “Comp attributes and methods” on page 567
- “Footage attributes and methods” on page 569
- “Layer Sub-objects attributes and methods” on page 569
- “Layer General attributes and methods” on page 570
- “Layer Properties attributes and methods” on page 571
- “Layer 3D attributes and methods” on page 572
- “Layer Space Transforms methods” on page 573
- “Camera attributes and methods” on page 574
- “Light attributes and methods” on page 575
- “Effect attributes and methods” on page 576
- “Mask attributes and methods” on page 576
- “Property attributes and methods” on page 576
- “Key attributes and methods” on page 580
- “MarkerKey attributes” on page 581

See also

“About expressions” on page 547

“Add, edit, and remove expressions” on page 549

Global objects

comp(name) Return type: Comp.

Argument type: *name* is a String.

Retrieves another composition by name.

footage(name) Return type: Footage.

Argument type: *name* is a String.

Retrieves a footage item by name.

thisComp Return type: Comp.

Represents the composition containing the expression.

thisLayer Return type: Layer, Light, or Camera.

Represents the layer containing the expression. Because `thisLayer` is the default object, its use is optional. For example, you can start an expression with `thisLayer.width` or `width` and get the same result.

thisProperty Return type: Property.

Represents the property containing the expression. For example, if you write an expression on the Rotation property, you can start an expression with `thisProperty` to refer to the Rotation property.

time Return type: Number.

Represents the composition time, in seconds, at which the expression is being evaluated.

colorDepth Return type: Number.

Returns the project's color depth value. For example, `colorDepth` returns 16 when the project's color depth is 16 bits per channel.

posterizeTime(framesPerSecond) Return type: Number.

Argument type: *framesPerSecond* is a Number.

The *framesPerSecond* value becomes the frame rate from which the rest of the expression operates. This allows you to set the expression to a frame rate lower than that of the composition. For example, the following expression updates the property value with a random value once per second:

```
posterizeTime(1);
random()
```

value Return type: Number, Array, or String.

Represents the value at the current time for the property containing the expression.

Time conversion methods

timeToFrames(t = time + thisComp.displayStartTime, fps = 1.0 / thisComp.frameDuration, isDuration = false)

Return type: Number.

Argument type: *t* and *fps* are Numbers; *isDuration* is a Boolean.

Converts the value of *t*, which defaults to the current composition time, to an integer number of frames. The number of frames per second is specified in the *fps* argument, which defaults to the frame rate of the current composition ($1.0 / \text{thisComp.frameDuration}$). The *isDuration* argument, which defaults to false, should be true if the *t* value represents a difference between two times instead of an absolute time. Absolute times are rounded down towards negative infinity; durations are rounded away from zero (up for positive values).

framesToTime(frames, fps = 1.0 / thisComp.frameDuration) Return type: Number.

Argument type: *frames* and *fps* are Numbers.

The inverse of `timeToFrames`. Returns the time corresponding to the *frames* argument, which is required. It doesn't have to be an integer. See `timeToFrames` for explanation of the *fps* argument.

timeToTimecode(t = time + thisComp.displayStartTime, timecodeBase = 30, isDuration = false) Return type: String.

Argument type: *t* and *timecodeBase* are Numbers; *isDuration* is a Boolean.

Converts the value of *t* to a String representing timecode. See `timeToFrames` for an explanation of the *t* and *isDuration* arguments. The *timecodeBase* value, which defaults to 30, specifies the number of frames in one second.

timeToNTSCTimecode(t = time + thisComp.displayStartTime, ntscDropFrame = false, isDuration = false) Return type: String.

Argument type: *t* is a Number, *ntscDropFrame* and *isDuration* are Booleans.

Converts *t* to a String representing NTSC timecode. See `timeToFrames` for an explanation of the *t* and *isDuration* arguments. If *ntscDropFrame* is false (the default), the result String is NTSC non-drop-frame timecode. If *ntscDropFrame* is true, the result String is NTSC drop-frame timecode.

timeToFeetAndFrames(*t* = time + thisComp.displayStartTime, fps = 1.0 / thisComp.frameDuration, framesPerFoot = 16, isDuration = false) Return type: String.

Argument type: *t*, *fps*, and *framesPerFoot* are Numbers; *isDuration* is a Boolean.

Converts the value of *t* to a String representing feet of film and frames. See `timeToFrames` for an explanation of the *t*, *fps*, and *isDuration* arguments. The *framesPerFoot* argument specifies the number of frames in one foot of film. It defaults to 16, which is the most common rate for 35mm footage.

timeToCurrentFormat(*t* = time + thisComp.displayStartTime, fps = 1.0 / thisComp.frameDuration, isDuration = false)
Return type: String.

Argument type: *t* and *fps* are Numbers; *isDuration* is a Boolean.

Converts the value of *t* to a String representing time in the current Project Settings display format. See `timeToFrames` for a definition of all of the arguments.

 If you want more control over the look of timecode in your footage, use the `timeToCurrentFormat` method or other `timeTo` methods to generate the timecode instead of using the Timecode or Numbers effect. Create a text layer, add an expression to the Source Text property, and enter `timeToCurrentFormat()` in the expression field. This method enables you to format and animate the timecode text. In addition, the timecode uses the same display style defined by the current project settings.

See also

“Change time display units” on page 131

Vector Math methods

Vector Math functions are global methods that perform operations on arrays, treating them as mathematical vectors. Unlike built-in JavaScript methods, such as `Math.sin`, these methods are not used with the `Math` prefix. Unless otherwise specified, Vector Math methods are lenient about dimensions and return a value that is the dimension of the largest Array, filling in missing elements with zeros. For example, the expression `add([10, 20], [1, 2, 3])` returns `[11, 22, 3]`.

add(*vec1*, *vec2*) Return type: Array.

Argument type: *vec1* and *vec2* are Arrays.

Adds two vectors.

sub(*vec1*, *vec2*) Return type: Array.

Argument type: *vec1* and *vec2* are Arrays.

Subtracts two vectors.

mul(*vec*, *amount*) Return type: Array.

Argument type: *vec* is an Array, *amount* is a Number.

Multiplies every element of the vector by the amount.

div(vec, amount) Return type: Array.

Argument type: *vec* is an Array, *amount* is a Number.

Divides every element of the vector by the amount.

clamp(value, limit1, limit2) Return type: Number or Array.

Argument type: *value*, *limit1*, and *limit2* are Numbers or Arrays.

The value of each component of *value* is constrained to fall between the values of the corresponding values of *limit1* and *limit2*.

dot(vec1, vec2) Return type: Number.

Argument type: *vec1* and *vec2* are Arrays.

Returns the dot (inner) product of the vector arguments.

cross(vec1, vec2) Return type: Array [2 or 3].

Argument type: *vec1* and *vec2* are Arrays [2 or 3].

Returns the vector cross product of *vec1* and *vec2*. Refer to a math reference or JavaScript guide for more information.

normalize(vec) Return type: Array.

Argument type: *vec* is an Array.

Normalizes the vector so that its length is 1.0. This is a short way of writing `div(vec, length(vec))`.

length(vec) Return type: Number.

Argument type: *vec* is an Array.

Returns the length of vector *vec*.

length(point1, point2) Return type: Number.

Argument type: *point1* and *point2* are Arrays.

Returns the distance between two points. The *point2* argument is optional. For example, `length(point1, point2)` is the same as `length(sub(point1, point2))`.

lookAt(fromPoint, atPoint) Return type: Array [3].

Argument type: *fromPoint* and *atPoint* are Arrays [3].

The argument *fromPoint* is the location in world space of the layer you want to orient. The argument *atPoint* is the point in world space you want to point the layer at. The return value can be used as an expression for the Orientation property, making the layer's z-axis point at *atPoint*. This method is especially useful for cameras and lights. If you use this on a camera, turn off auto-orientation. For example, this expression on the Orientation property of a spot light makes the light point at the anchor point of layer number 1 in the same composition: `lookAt(position, thisComp.layer(1).position)`

Random Numbers methods

seedRandom(offset, timeless=false) Return type: none.

Argument type: *offset* is a Number, *timeless* is a Boolean.

The `random` and `gaussRandom` methods use a seed value that controls the sequence of numbers. By default, the seed is computed as a function of a unique layer identifier, the property within the layer, the current time, and an offset value of 0. Call `seedRandom` to set the offset to something other than 0 to create a different random sequence. Use `true` for the `timeless` argument to not use the current time as input to the random seed; this allows you to generate a random number that doesn't vary depending on the time of evaluation. The `offset` value, but not the `timeless` value, is also used to control the initial value of the `wiggle` function.

For example this expression on the Opacity property sets the Opacity value to a random value that does not vary with time:

```
seedRandom(123456, true);  
random()*100
```

The multiplication by 100 in this example converts the value between 0 and 1 returned by the `random` method into a number between 0 and 100; this range is more typically useful for the Opacity property, which has values from 0% to 100%.

random() Return type: Number.

Returns a random number between 0 and 1.

random(maxValOrArray) Return type: Number or Array.

Argument type: *maxValOrArray* is a Number or Array.

If *maxValOrArray* is a Number, this method returns a number between 0 and *maxValOrArray*. If *maxValOrArray* is an Array, this method returns an Array with the same dimension as *maxValOrArray*, with each component ranging between 0 and the corresponding component of *maxValOrArray*.

random(minValOrArray, maxValOrArray) Return type: Number or Array.

Argument type: *minValOrArray* and *maxValOrArray* are Numbers or Arrays.

If *minValOrArray* and *maxValOrArray* are Numbers, this method returns a number between *minValOrArray* and *maxValOrArray*. If the arguments are Arrays, this method returns an Array with the same dimension as the argument with the greater dimension, with each component between the corresponding components of *minValOrArray* and *maxValOrArray*. For example, the expression `random([100, 200], [300, 400])` returns an Array whose first value is between 100 and 300 and whose second value is between 200 and 400. If the dimensions of the two input Arrays don't match, higher-dimension values of the shorter Array are filled out with zeros.

gaussRandom() Return type: Number.

Returns a random number. The results have a Gaussian (bell-shaped) distribution. Approximately 90% of the results are between 0 and 1, and the remaining 10% are outside this range.

gaussRandom(maxValOrArray) Return type: Number or Array.

Argument type: *maxValOrArray* is a Number or Array.

When *maxValOrArray* is a Number, this method returns a random number. Approximately 90% of the results are in the 0 to *maxValOrArray* range, and the remaining 10% are outside of this range. When *maxValOrArray* is an Array, this method returns an Array of random values, with the same dimension as *maxValOrArray*. Ninety percent of the values range between 0 and the value in *maxValOrArray*, and the remaining 10% are outside of this range. The results have a Gaussian (bell-shaped) distribution.

gaussRandom(minValOrArray, maxValOrArray) Return type: Number or Array.

Argument type: *minValOrArray* and *maxValOrArray* are Numbers or Arrays.

If *minValOrArray* and *maxValOrArray* are Numbers, this method returns a random number. Approximately 90% of the results are between *minValOrArray* and *maxValOrArray*, and the remaining 10% are outside of this range. If the arguments are Arrays, this method returns an Array of random numbers with the same dimension as the argument with the greater dimension. For each component, approximately 90% of the results are between the corresponding components of *minValOrArray* and *maxValOrArray*, and the remaining 10% are outside of this range. The results have a Gaussian (bell-shaped) distribution.

noise(valOrArray) Return type: Number.

Argument type: *valOrArray* is a Number or an Array [2 or 3].

Returns a number between -1 and 1. The noise is not actually random; it is based on Perlin noise, which means that the return values for two input values that are near one another will also tend to be near one another. This kind of noise is useful when you want a sequence of seemingly random numbers that don't vary wildly from one to the other—as is usually the case when animating any sort of apparently random natural motion. Example: `rotation + 360*noise(time)`

Interpolation methods

For all of the Interpolation methods, the argument *t* is often `time` or `value`, though it can have other values, instead. If *t* is `time`, the interpolation between values happens over a duration. If *t* is `value`, then the expression maps one range of values to a new range of values.

linear(t, tMin, tMax, value1, value2) Return type: Number or Array.

Argument type: *t*, *tMin*, and *tMax* are Numbers, and *value1* and *value2* are Numbers or Arrays.

Returns *value1* when $t \leq tMin$. Returns *value2* when $t \geq tMax$. Returns a linear interpolation between *value1* and *value2* when $tMin < t < tMax$.

For example this expression on the Opacity property causes Opacity values to ramp linearly from 20% to 80% over the time from 0 to 6 seconds:

```
linear(time, 0, 6, 20, 80)
```

This method—like all of the Interpolation methods—can also be used to convert from one range of values to another. For example this expression on the Opacity property converts the Opacity values from the range 0%-100% to the range 20%-80%:

```
linear(value, 0, 100, 20, 80)
```

linear(t, value1, value2) Return type: Number or Array.

Argument type: *t* is a Number, and *value1* and *value2* are Numbers or Arrays.

Returns a value that linearly interpolates from *value1* to *value2* as *t* ranges from 0 to 1. Returns *value1* when $t \leq 0$. Returns *value2* when $t \geq 1$.

ease(t, value1, value2) Return type: Number or Array.

Argument type: *t* is a Number, and *value1* and *value2* are Numbers or Arrays.

Similar to `linear` with the same arguments, except that the interpolation eases in and out so that the velocity is 0 at the start and end points. This method results in a very smooth animation.

ease(t, tMin, tMax, value1, value2) Return type: Number or Array.

Argument type: *t*, *tMin*, and *tMax* are Numbers, and *value1* and *value2* are Numbers or Arrays.

Similar to `linear` with the same arguments, except that the interpolation eases in and out so that the velocity is 0 at the start and end points. This method results in a very smooth animation.

`easeIn(t, value1, value2)` Return type: Number or Array.

Argument type: *t* is a Number, and *value1* and *value2* are Numbers or Arrays.

Similar to `ease`, except that the tangent is 0 only on the *value1* side and interpolation is linear on the *value2* side.

`easeIn(t, tMin, tMax, value1, value2)` Return type: Number or Array.

Argument type: *t*, *tMin*, and *tMax* are Numbers, and *value1* and *value2* are Numbers or Arrays.

Similar to `ease`, except that the tangent is 0 only on the *tMin* side and interpolation is linear on the *tMax* side.

`easeOut(t, value1, value2)` Return type: Number or Array.

Argument type: *t* is a Number, and *value1* and *value2* are Numbers or Arrays.

Similar to `ease`, except that the tangent is 0 only on the *value2* side and interpolation is linear on the *value1* side.

`easeOut(t, tMin, tMax, value1, value2)` Return type: Number or Array.

Argument type: *t*, *tMin*, and *tMax* are Numbers, and *value1* and *value2* are Numbers or Arrays.

Similar to `ease`, except that the tangent is 0 only on the *tMax* side and interpolation is linear on the *tMin* side.

See also

“Interpolation” on page 204

“Automatically ease speed” on page 217

Color Conversion methods

Harry Frank provides a video tutorial that shows how to use these color conversion methods to change the color of the waves produced by the Radio Waves effect: www.adobe.com/go/learn_ae_harryrgb2hsl.

`rgbToHsl(rgbaArray)` Return type: Array [4].

Argument type: *rgbaArray* is an Array [4].

Converts a color in RGBA space to HSLA space. The input is an Array of normalized red, green, blue, and alpha channel values, all in the range of 0.0 to 1.0. The resulting value is an Array of hue, saturation, lightness, and alpha channel values, also in the range of 0.0 to 1.0. Example:

```
rgbToHsl.effect("Change Color")("Color To Change")
```

`hslToRgb(hslaArray)` Return type: Array [4].

Argument type: *hslaArray* is an Array [4].

Converts a color in HSLA space to RGBA space. This is the opposite of `rgbToHsl`.

Other Math methods

`degreesToRadians(degrees)` Return type: Number.

Argument type: *degrees* is a Number.

Converts degrees to radians.

radiansToDegrees(radians) Return type: Number.

Argument type: *radians* is a Number.

Converts radians to degrees.

Comp attributes and methods

layer(index) Return type: Layer, Light, or Camera.

Argument type: *index* is a Number.

Retrieves the layer by number (order in the Timeline panel). Example: `thisComp.layer(3)`

layer(name) Return type: Layer, Light, or Camera.

Argument type: *name* is a String.

Retrieves the layer by name. Names are matched by layer name, or source name if there is no layer name. If duplicate names exist, After Effects uses the first (topmost) one in the Timeline panel. Example:

```
thisComp.layer("Solid 1")
```

layer(otherLayer, relIndex) Return type: Layer, Light, or Camera.

Argument type: *otherLayer* is a Layer object, and *relIndex* is a Number.

Retrieves the layer that is *relIndex* layers above or below *otherLayer*. For example, `thisComp.layer(thisLayer, 1).active` returns true if the next layer down in the Timeline panel is active.

marker Return type: MarkerProperty.

Important: You cannot access a composition-time marker by marker number. If you have a project created in a previous version of After Effects that uses composition marker numbers in expressions, you must change those calls to use `marker.key(name)` instead. Because the default name of a composition-time marker is a number, this is often just a matter of surrounding the number with quotation marks.

marker.key(index) Return type: MarkerKey.

Argument type: *index* is a Number.

Returns the MarkerKey object of the marker with the specified index. The index refers to the order of the marker in composition time, not to the name of the marker. For example, this expression returns the time of the first composition-time marker:

```
thisComp.marker.key(1).time
```

marker.key(name) Return type: MarkerKey.

Argument type: *name* is a String.

Returns the MarkerKey object of the marker with the specified name. The *name* value is the name of the marker, as typed in the comment field in the marker dialog box, for example, `marker.key("1")`. For a composition-time marker, the default name is a number. If more than one marker in the composition has the same name, this method returns the marker that occurs first in time (in composition time). The value for a marker key is a String, not a Number. For example, this expression returns the time of the composition-time marker with the name "0":

```
thisComp.marker.key("0").time
```

marker.nearestKey(t) Return type: MarkerKey.

Argument type: *t* is a Number.

Returns the marker that is nearest in time to *t*. For example, this expression returns the time of the composition-time marker nearest to the time of 1 second:

```
thisComp.marker.nearestKey(1).time
```

This expression returns the time of the composition-time marker nearest to the current time:

```
thisComp.marker.nearestKey(time).time
```

marker.numKeys Return type: Number.

Returns the total number of composition-time markers in the composition.

numLayers Return type: Number.

Returns the number of layers in the composition.

activeCamera Return type: Camera.

Returns the Camera object for the camera through which the composition is rendered at the current frame. This is not necessarily the camera through which you are looking in the Composition panel.

width Return type: Number.

Returns the composition's width, in pixels.

height Return type: Number.

Returns the composition's height, in pixels.

duration Return type: Number.

Returns the composition's duration, in seconds.

displayStartTime Return type: Number.

Returns the composition start time, in seconds.

frameDuration Return type: Number.

Returns the duration of a frame, in seconds.

shutterAngle Return type: Number.

Returns the shutter-angle value of the composition, in degrees.

shutterPhase Return type: Number.

Returns the shutter phase of the composition, in degrees.

bgColor Return type: Array [4].

Returns the background color of the composition.

pixelAspect Return type: Number.

Returns the pixel aspect ratio of the composition.

name Return type: String.

Returns the name of the composition.

Footage attributes and methods

To use a footage item from the Project panel as an object in an expression, use the global `footage` method, as in `footage("file_name")`, and then use any of the attributes below. You can also access a footage object using the `source` attribute on a layer whose source is a footage item.

width Return type: Number.

Returns the width of the footage item, in pixels.

height Return type: Number.

Returns the height of the footage item, in pixels.

duration Return type: Number.

Returns the duration of the footage item, in seconds.

frameDuration Return type: Number.

Returns the duration of a frame in the footage item, in seconds.

pixelAspect Return type: Number.

Returns the pixel aspect ratio of the footage item.

name Return type: String.

Returns the name of the footage item as shown in the Project panel.

Layer Sub-objects attributes and methods

source Return type: Comp or Footage.

Returns the source Comp or source Footage object for the layer. Default time is adjusted to the time in the source.

Example: `source.layer(1).position`

effect(name) Return type: Effect.

Argument type: *name* is a String.

After Effects finds the effect by its name in the Effect Controls panel. The name can be the default name or a user-defined name. If there is more than one effect with the same name, the effect closest to the top of the Effect Controls panel is used. Example:

```
effect("Fast Blur")("Blurriness")
```

effect(index) Return type: Effect.

Argument type: *index* is a Number.

After Effects finds the effect by its index in the Effect Controls panel, starting at 1 and counting from the top.

mask(name) Return type: Mask.

Argument type: *name* is a String.

The name can be the default name or a user-defined name. If there is more than one mask with the same name, the first (topmost) mask is used. Example:

```
mask("Mask 1")
```

mask(index) Return type: Mask.

Argument type: *index* is a Number.

After Effects finds the mask by its index in the Timeline panel, starting at 1 and counting from the top.

Layer General attributes and methods

width Return type: Number.

Returns the width of the layer, in pixels. It is the same as `source.width`.

height Return type: Number.

Returns the height of the layer, in pixels. It is the same as `source.height`.

index Return type: Number.

Returns the index number of the layer in the composition.

parent Return type: Layer, Light, or Camera.

Returns the parent Layer object of the layer, if there is one. Example: `position[0] + parent.width`

hasParent Return type: Boolean.

Returns true if the layer has a parent or false if it doesn't.

Use the `hasParent` attribute to determine if a layer has a parent. You can use this attribute even if there isn't a parent layer at present. For example, the following expression indicates that the layer to which you apply it will wiggle based on the position of the layer's parent. If the layer has no parent, then it will wiggle based on its own position. If the layer is given a parent later, then the layer's behavior will change accordingly:

```
idx = index;
if (hasParent) {
    idx = parent.index;
}
thisComp.layer(idx).position.wiggle(5,20)
```

inPoint Return type: Number.

Returns the In point of the layer, in seconds.

Note: In general, the value of `outPoint` is greater than the value of `inPoint`. However, if a layer is reversed in time, the value of `inPoint` is greater than the value of `outPoint`. Similarly, the value of `startTime` can be greater than the value of `inPoint`.

outPoint Return type: Number.

Returns the Out point of the layer, in seconds.

startTime Return type: Number.

Returns the start time of the layer, in seconds.

hasVideo Return type: Boolean.

Returns true if the layer has video, or false if it doesn't.

hasAudio Return type: Boolean.

Returns true if the layer has audio or false if it doesn't.

active Return type: Boolean.

Returns true if the layer's Video switch  is on and the current time is between the layer's In point and Out point; false otherwise.

audioActive Return type: Boolean.

Returns true if the layer's Audio switch  is on and the current time is between the layer's In point and Out point; false otherwise.

sampleImage(point, radius = [.5, .5], postEffect=true, t=time) Return type: Array [4].

Argument type: *point* is an Array [2], *radius* is an Array [2], *postEffect* is a Boolean, and *t* is a Number.

Samples the color and alpha channel values of a layer and returns the average alpha-weighted value of the pixels within the specified distance of the point as an array: *[red, green, blue, alpha]*. If *postEffect* is true, the sampled values are for the layer after masks and effects on that layer have been rendered; if *postEffect* is false, the sampled values are for the layer before masks and effects have been rendered. The input value *point* is in layer space; the point [0,0] is the center of the top-left pixel in the layer. The input value *radius* specifies the horizontal and vertical distance from the sample center to the edges of the sampled rectangle. The default value samples one pixel.

Note: The *postEffect* parameter refers to effects applied directly to the layer, not to effects applied indirectly, such as with an adjustment layer.

This example samples a rectangle 4 pixels wide and 3 pixels high, centered around a point 100 pixels down and to the right of the upper-left corner of the layer:

```
thisComp.layer(1).sampleImage([100, 100], [2, 1.5])
```

Dan Ebberts has an example of how to use the `sampleImage` method on his website:
www.adobe.com/go/learn_ae_danobscuration.

Layer Properties attributes and methods

When you add masks, effects, paint, or text to a layer, After Effects adds new properties to the Timeline panel. There are too many of these properties to list here, so use the pick whip to learn the syntax for referring to them in your expressions.

anchorPoint Return type: Property [2 or 3].

Returns the anchor point value of the layer in the layer's space.

position Return type: Property [2 or 3].

Returns the position value of the layer, in world space if the layer has no parent or in the parent's layer space if there is a parent.

scale Return type: Property [2 or 3].

Returns the scale value of the layer, expressed as a percentage.

rotation Return type: Property.

Returns the rotation value of the layer in degrees. For a 3D layer, it returns the z rotation value in degrees.

opacity Return type: Property.

Returns the opacity value for the layer, expressed as a percentage.

audioLevels Return type: Property [2].

Returns the value of the Audio Levels property of the layer, in decibels. This is a 2D value; the first value represents the left audio channel, and the second value represents the right. The value is not the amplitude of the source material's audio track; instead, it is the value of the Audio Levels property, which may be affected by keyframes.

timeRemap Return type: Property.

Returns the value of the Time Remap property, in seconds, if Time Remap is enabled.

marker.key(index) Return type: MarkerKey.

Argument type: *index* is a Number.

Returns the MarkerKey object of the layer-time marker with the specified index.

marker.key(name) Return type: MarkerKey.

Argument type: *name* is a String.

Returns the MarkerKey object of the layer-time marker with the specified name. The *name* value is the name of the marker, as typed in the comment field in the marker dialog box, for example, `marker.key("ch1")`. If more than one marker on the layer has the same name, this method returns the marker that occurs first in time (in layer time). The value for a marker key is a String, not a Number.

This expression on a property ramps the property's value from 0 to 100 between two markers identified by name:

```
m1 = marker.key("Start").time;  
m2 = marker.key("End").time;  
linear(time, m1, m2, 0, 100);
```

marker.nearestKey(t) Return type: MarkerKey.

Argument type: *t* is a Number.

Returns the layer-time marker that is nearest in time to *t*. For example, this expression returns the time of the marker on the layer nearest to the time of 1 second:

```
marker.nearestKey(1).time
```

This expression returns the time of the marker on the layer nearest to the current time:

```
marker.nearestKey(time).time
```

marker.numKeys Return type: Number.

Returns the total number of markers on the layer.

name Return type: String.

Returns the name of the layer.

Layer 3D attributes and methods

orientation Return type: Property [3].

Returns the 3D orientation value, in degrees, for a 3D layer.

rotationX Return type: Property.

Returns the x rotation value, in degrees, for a 3D layer.

rotationY Return type: Property.

Returns the y rotation value, in degrees, for a 3D layer.

rotationZ Return type: Property.

Returns the z rotation value, in degrees, for a 3D layer.

lightTransmission Return type: Property.

Returns the value of the Light Transmission property for a 3D layer.

castsShadows Return type: Property.

Returns a value of 1.0 if the layer casts shadows.

acceptsShadows Return type: Property.

Returns a value of 1.0 if the layer accepts shadows.

acceptsLights Return type: Property.

Returns a value of 1.0 if the layer accepts lights.

ambient Return type: Property.

Returns the ambient component value as a percentage.

diffuse Return type: Property.

Returns the diffuse component value as a percentage.

specular Return type: Property.

Returns the specular component value as a percentage.

shininess Return type: Property.

Returns the shininess component value as a percentage.

metal Return type: Property.

Returns the metal component value as a percentage.

Layer Space Transforms methods

Use layer space transform methods to transform values from one space to another, such as from layer space to world space. The “from” methods transform values from the layer’s space to the named space (composition or world). The “to” methods transform values from the named space (composition or world) to the layer space. Each transform method takes an optional argument to determine the time at which the layer’s transform is computed; however, you can almost always use the current (default) time.

Use “Vec” transform methods when transforming a direction vector, such as the difference between two position values. Use the plain (non-”Vec”) transform methods when transforming a point, such as position. Composition (comp) and world space are the same for 2D layers. For 3D layers, however, composition space is relative to the active camera, and world space is independent of the camera.

toComp(point, t=time) Return type: Array [2 or 3].

Argument type: *point* is an Array [2 or 3], and *t* is a Number.

Transforms a point from layer space to composition space.

fromComp(point, t=time) Return type: Array [2 or 3].

Argument type: *point* is an Array [2 or 3], and *t* is a Number.

Transforms a point from composition space to layer space. The resulting point in a 3D layer may have a nonzero value even though it is in layer space. Example: `fromComp(thisComp.layer(2).position)`

toWorld(point, t=time) Return type: Array [2 or 3].

Argument type: *point* is an Array [2 or 3], and *t* is a Number.

Transforms a point from layer space to view-independent world space. Example:

```
toWorld.effect("Bulge")("Bulge Center")
```

fromWorld(point, t=time) Return type: Array [2 or 3].

Argument type: *point* is an Array [2 or 3], and *t* is a Number.

Transforms a point from world space to layer space. Example: `fromWorld(thisComp.layer(2).position)`

toCompVec(vec, t=time) Return type: Array [2 or 3].

Argument type: *vec* is an Array [2 or 3], and *t* is a Number.

Transforms a vector from layer space to composition space. Example: `toCompVec([1, 0])`

fromCompVec(vec, t=time) Return type: Array [2 or 3].

Argument type: *vec* is an Array [2 or 3], and *t* is a Number.

Transforms a vector from composition space to layer space. Example (2D layer):

```
dir=sub(position, thisComp.layer(2).position);
fromCompVec(dir)
```

toWorldVec(vec, t=time) Return type: Array [2 or 3].

Argument type: *vec* is an Array [2 or 3], and *t* is a Number.

Transforms a vector from layer space to world space. Example:

```
p1 = effect("Eye Bulge 1")("Bulge Center");
p2 = effect("Eye Bulge 2")("Bulge Center");
toWorld(sub(p1, p2))
```

fromWorldVec(vec, t=time) Return type: Array [2 or 3].

Argument type: *vec* is an Array [2 or 3], and *t* is a Number.

Transforms a vector from world space to layer space. Example: `fromWorld(thisComp.layer(2).position)`

fromCompToSurface(point, t=time) Return type: Array [2].

Argument type: *point* is an Array [2 or 3], and *t* is a Number.

Projects a point located in composition space to a point on the surface of the layer (zero z-value) at the location where it appears when viewed from the active camera. This is useful for setting effect control points. Use with 3D layers only.

Camera attributes and methods

Camera objects have the same attributes and methods as Layer objects, except for `source`, `effect`, `mask`, `width`, `height`, `anchorPoint`, `scale`, `opacity`, `audioLevels`, `timeRemap`, and all of the material properties.

pointOfInterest Return type: Property [3].

Returns the camera's point of interest values in world space.

zoom Return type: Property.

Returns the camera's zoom values in pixels.

Here's an expression for the Scale property of a layer that maintains the relative size of the layer in frame while changing the layer's z position (depth) or the camera's Zoom value:

```
cam = thisComp.activeCamera;  
distance = length(sub(position, cam.position));  
scale * distance / cam.zoom;
```

depthOfField Return type: Property.

Returns 1 if the camera's Depth Of Field property is on, or returns 0 if it is off.

focusDistance Return type: Property.

Returns the camera's focus distance value, in pixels.

aperture Return type: Property.

Returns the camera's aperture value, in pixels.

blurLevel Return type: Property.

Returns the camera's blur level value as a percentage.

active Return type: Boolean.

Returns true if the camera is the active camera for the composition at the current time: the camera's Video switch  is on, the current time is between the camera's In and Out points, and it is the first (topmost) such camera listed in the Timeline panel. Returns false otherwise.

See also

“Cameras, lights, and points of interest” on page 176

Light attributes and methods

Light objects have the same attributes and methods as Layer objects, except for `source`, `effect`, `mask`, `width`, `height`, `anchorPoint`, `scale`, `opacity`, `audioLevels`, `timeRemap`, and all of the material properties.

pointOfInterest Return type: Property [3].

Returns the light's point of interest values in world space.

intensity Return type: Property.

Returns the light's intensity values as a percentage.

color Return type: Property [4].

Returns the light's color value.

coneAngle Return type: Property.

Returns the light's cone angle, in degrees.

coneFeather Return type: Property.

Returns the light's cone feather value as a percentage.

shadowDarkness Return type: Property.

Returns the light's shadow darkness value as a percentage.

shadowDiffusion Return type: Property.

Returns the light's shadow diffusion value, in pixels.

David Van Brink provides an instructional blog post and sample project that show how to use expressions with lights:
www.adobe.com/go/learn_ae_ominoflashing.

See also

“Cameras, lights, and points of interest” on page 176

Effect attributes and methods

active Return type: Boolean.

Returns true if the effect is turned on (the Effect switch  is selected).

param(name) Return type: Property.

Argument type: *name* is a String.

Returns a property within an effect. Effect control points are always in layer space. Example:

```
effect("Bulge").param("Bulge Height")
```

param(index) Return type: Property.

Argument type: *index* is a Number.

Returns a property within an effect. Effect control points are always in layer space. For example, `effect("Bulge").param(4)` returns the Bulge Height property.

Mask attributes and methods

Note: You can link Mask Path properties to other path properties (paths in a shape layer and brush strokes), but the properties are not accessible for direct numerical manipulation through expressions.

maskOpacity Return type: Property.

Returns the mask's opacity value as a percentage.

maskFeather Return type: Property.

Returns the mask's feather value, in pixels.

maskExpansion Return type: Property.

Returns the mask's expansion value, in pixels.

invert Return type: Boolean.

Returns true if the mask is inverted or false if it is not.

Property attributes and methods

value Return type: Number, Array, or String.

Returns the property's value at the current time.

valueAtTime(t) Return type: Number or Array.

Argument type: *t* is a Number.

Returns the property's value at the specified time, in seconds.

For example, to have a property's value for each frame be chosen randomly from a set of four values, set your four values as keyframes at 0, 1, 2, and 3 seconds, and then apply the following expression to the property:

```
valueAtTime(random(4))
```

velocity Return type: Number or Array.

Returns the temporal velocity value at the current time. For spatial properties, such as Position, it returns the tangent vector value. The result is the same dimension as the property.

velocityAtTime(t) Return type: Number or Array.

Argument type: *t* is a Number.

Returns the temporal velocity value at the specified time.

speed Return type: Number.

Returns a 1D, positive speed value equal to the speed at which the property is changing at the default time. This element can be used only for spatial properties.

speedAtTime(t) Return type: Number.

Argument type: *t* is a Number.

Returns the spatial speed value at the specified time.

wiggle(freq, amp, octaves=1, amp_mult=.5, t=time) Return type: Number or Array.

Argument type: *freq*, *amp*, *octaves*, *amp_mult*, and *t* are Numbers.

Randomly shakes (wiggles) the value of the property.

freq value is the frequency in wiggles per second.

amp value is the amplitude in units of the property to which it is applied.

octaves is the number of octaves of noise to add together. This value controls how much detail there is in the wiggle. Make this value higher than the default of 1 to include higher frequencies or lower to include amplitude harmonics in the wiggle.

amp_mult is the amount that *amp* is multiplied by for each octave. This value controls how fast the harmonics drop off. The default is 0.5; make it closer to 1 to have the harmonics added at the same amplitude as the base frequency, or closer to 0 to add in less detail.

t is the base start time. This value defaults to the current time. Use this parameter if you want the output to be a wiggle of the property value sampled at a different time.

Example: `position.wiggle(5, 20, 3, .5)` will produce about 5 wiggles per second with an average size of about 20 pixels. In addition to the main wiggle, two more levels of detailed wiggles will occur with a frequency of 10 and 20 wiggles per second, and sizes of 10 and 5 pixels, respectively.

This example, on a two-dimensional property such as Scale, wiggles both dimensions by the same amount:

```
v = wiggle(5, 10);  
[v[0], v[0]]
```

This example, on a two-dimensional property, wiggles only along the y axis:

```

freq = 3;
amp = 50;
w = wiggle(freq,amp);
[value[0],w[1]];

```

temporalWiggle(freq, amp, octaves=1, amp_mult=.5, t=time) Return type: Number or Array.

Argument type: *freq*, *amp*, *octaves*, *amp_mult*, and *t* are Numbers.

Samples the property at a wiggled time. The *freq* value is the frequency in wiggles per second, *amp* is the amplitude in units of the property to which it is applied, *octaves* is the number of octaves of noise to add together, *amp_mult* is the amount that *amp* is multiplied by for each octave, and *t* is the base start time. For this function to be meaningful, the property it samples must be animated, because the function alters only the time of sampling, not the value.

Example: `scale.temporalWiggle(5, .2)`

smooth(width=.2, samples=5, t=time) Return type: Number or Array.

Argument type: *width*, *samples*, and *t* are Numbers.

Smooths the property's values over time, converting large, brief deviations in the value to smaller, more evenly distributed deviations. This is accomplished by applying a box filter to the value of the property at the specified time. The *width* value is the range of time (in seconds) over which the filter is averaged. The *samples* value is the number of discrete samples evenly spaced over time; use a larger value for greater smoothness (but decreased performance). Generally, you'll want *samples* to be an odd number so that the value at the current time is included in the average.

Example: `position.smooth(.1, 5)`

loopIn(type="cycle", numKeyframes=0) Return type: Number or Array.

Loops a segment of time that is measured from the first keyframe on the layer forward toward the layer's Out point. The loop plays from the layer's In point. The *numKeyframes* value determines what segment is looped: The segment looped is the portion of the layer from the first keyframe to the *numKeyframes*+1 keyframe. For example, `loopIn("cycle", 3)` loops the segment bounded by the first and fourth keyframes. The default value of 0 means that all keyframes will loop.

You can use keyframe-looping methods to repeat a series of keyframes. You can use these methods on any property except a marker or Source Text property. Keyframes or duration values that are too large are clipped to the maximum allowable value. Values that are too small result in a constant loop.

Loop type	Result
cycle	(default) Repeats the specified segment.
pingpong	Repeats the specified segment, alternating between forward and backward.
offset	Repeats the specified segment, but offsets each cycle by the difference in the value of the property at the start and end of the segment, multiplied by the number of times the segment has looped.
continue	Does not repeat the specified segment, but continues to animate a property based on the velocity at the first or last keyframe. For example, if the last keyframe of a layer's Scale property is 100%, the layer continues to scale from 100% to the Out point, instead of looping directly back to the Out point. This type does not accept a <i>keyframes</i> or <i>duration</i> argument.

loopOut(type="cycle", numKeyframes=0) Return type: Number or Array.

Loops a segment of time that is measured from the last keyframe on the layer back toward the layer's In point. The loop plays until the layer's Out point. The segment to loop is determined by the specified number of keyframes. The *numKeyframes* value sets the number of keyframe segments to loop; the specified range is measured backward from

the last keyframe. For example, `loopOut("cycle", 1)` loops the segment bounded by the last keyframe and second-to-last keyframe. The default value of 0 means that all keyframes will loop. See the entry for `loopIn` for more information.

David Van Brink provides a blog post and sample project that show how to use the Echo effect, the Particle Playground effect, and the `loopOut` expression to animate a swarm of stylized swimming bacteria: www.adobe.com/go/learn_ae_ominosalmonella.

loopInDuration(type="cycle", duration=0) Return type: Number or Array.

Loops a segment of time that is measured from the first keyframe on the layer forward toward the layer's Out point. The loop plays from the layer's In point. The segment to loop is determined by the specified duration. The *duration* value sets the number of composition seconds in a segment to loop; the specified range is measured from the first keyframe. For example, `loopInDuration("cycle", 1)` loops the first second of the entire animation. The default of 0 means that the segment to loop begins at the layer Out point. See the entry for `loopIn` for more information.

loopOutDuration(type="cycle", duration=0) Return type: Number or Array.

Loops a segment of time that is measured from the last keyframe on the layer back toward the layer's In point. The loop plays until the layer's Out point. The segment to loop is determined by the specified duration. The *duration* value sets the number of composition seconds in a segment to loop; the specified range is measured backward from the last keyframe. For example, `loopOutDuration("cycle", 1)` loops the last second of the entire animation. The default of 0 means that the segment to loop begins at the layer In point. See the entry for `loopIn` for more information.

key(index) Return type: Key or MarkerKey.

Argument type: *index* is a Number.

Returns the Key or MarkerKey object by number. For example, `key(1)` returns the first keyframe.

key(markerName) Return type: MarkerKey.

Argument type: *markerName* is a String.

Returns the MarkerKey object with this name. Use only on marker properties.

nearestKey(t) Return type: Key or MarkerKey.

Returns the Key or MarkerKey object nearest to a designated time.

numKeys Return type: Number.

Returns the number of keyframes on a property. Returns the number of markers on a marker property.

propertyGroup(countUp = 1) Return type: Group.

Returns a group of properties relative to the property on which the expression is written. For example, if you add the `propertyGroup(1)` expression to a Brush stroke's Rotation property, the expression targets the Transform property group, which contains the Rotation property. If you add `propertyGroup(2)` instead, the expression targets the Brush property group. This lets you establish name-independent relationships in the property hierarchy. This is especially useful when duplicating properties that contain expressions.

propertyIndex Return type: Number.

Returns the index of a property relative to other properties in its property group, including property groups within masks, effects, text animators, selectors, shapes, trackers, and track points.

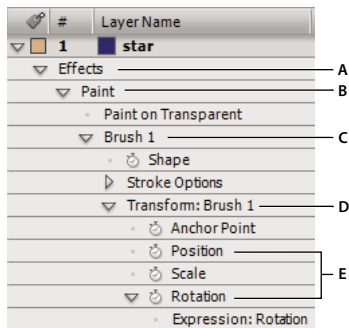
Example: Animating with the propertyGroup method and propertyIndex attribute

Values of `propertyGroup` relative to brush stroke's `Position` property

A. `propertyGroup(4)` B. `propertyGroup(3)` C. `propertyGroup(2)` D. `propertyGroup(1)` E. `Position`'s `propertyIndex` value is 2; `Rotation`'s `propertyIndex` value is 4.

In this example, each brush stroke's `propertyGroup` method targets the Brush property group because that group is two property groups up from the `Rotation` property. The `propertyIndex` attribute in each Brush stroke then returns a unique value for each Brush stroke. The resulting value is then multiplied by the time and 200 and applied to each rotation value, rotating each brush stroke differently, creating swirling paint strokes:

```
propertyGroup(2).propertyIndex * time * 200
```

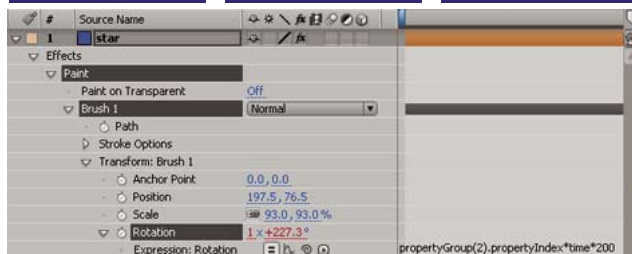

Animating a brush stroke with an expression

Key attributes and methods

When you access a Key object, you can get `time`, `index`, and `value` properties from it. For example, the following expression gives you the value of the third `Position` keyframe: `position.key(3).value`.

The following expression, when written on an `Opacity` property with keyframes, ignores the keyframe values and uses only the keyframes' placement in time to determine where a flash should occur:

```
d = Math.abs(time - nearestKey(time).time);
easeOut(d, 0, .1, 100, 0)
```

value Return type: Number or Array.

Returns the value of the keyframe.

time Return type: Number.

Returns the time of the keyframe.

index Return type: Number.

Returns the index of the keyframe.

MarkerKey attributes

You can access values for composition-time markers and layer-time markers using the same methods. Access layer-time markers through the `thisLayer.marker` object; access composition-time markers through the `thisComp.marker` object.

For the purpose of expressions, markers are a special kind of Key object, so you can use methods such as `nearestKey(time)` to access markers, and markers also have `time` and `index` attributes. The `index` attribute is not the number (name) of the marker; it is the keyframe index number, representing the marker's order in the time ruler.

Expressions have access to all of the values for a marker that you can set in the Composition Marker or Layer Marker dialog box. This expression on a text layer's Source Text property displays the time, index, comment (name), chapter, URL, frame target, and cue point name for the layer marker nearest the current time, and whether the marker is for an event cue point:

```
m = thisLayer.marker.nearestKey(time);
s = "time:" + timeToCurrentFormat(m.time) + "\r" +
    "key index: " + m.index + "\r" +
    "comment:" + m.comment + "\r" +
    "chapter:" + m.chapter + "\r" +
    "URL:" + m.url + "\r" +
    "frame target: " + m.frameTarget + "\r" +
    "cue point name: " + m.cuePointName + "\r" +
    "Event cue point? " + m.eventCuePoint + "\r";
for (param in m.parameters){
    s += "parameter: " + param + " value: " + m.parameters[param] + "\r";
}
s
```

comment Return type: String.

Contents of Comment field in marker dialog box.

chapter Return type: String.

Contents of Chapter field in marker dialog box.

url Return type: String.

Contents of URL field in marker dialog box.

frameTarget Return type: String.

Contents of Frame Target field in marker dialog box.

eventCuePoint Return type: Boolean.

Setting for cue point type in marker dialog box. True for Event; false for Navigation.

cuePointName Return type: String.

Contents of cue point Name field in marker dialog box.

parameters Return type: associative array of String values.

Contents of Parameter Name and Parameter Value fields in marker dialog box.

For example, if you have a parameter named “background color”, then you can use the following expression to access its value at the nearest marker:

```
thisComp.marker.nearestKey(time).parameters["background color"]
```

Expression examples

Many of the examples in this section are based on expressions provided by Dan Ebberts. Dan Ebberts also has an excellent collection of example expressions and tutorials for learning how to work with expressions on his website: www.adobe.com/go/learn_ae_motionscripthome.

Colin Brailey provides a tutorial and example project that show how to use expressions to make one layer repel others in a natural-seeming manner: www.adobe.com/go/learn_ae_colinrepelexpression.

The AE Enhancers forum provides lots of examples and useful information about expressions, as well as scripts and animation presets. In this post, Paul Tuersley provides a tutorial and example project that show how to use expressions to animate several layers in a swarm: www.adobe.com/go/learn_ae_paulswarmexpression.

Rick Gerard provides an example that demonstrates rolling a square object along a floor so that the sides stayed in contact with the floor plane: www.adobe.com/go/learn_ae_ricksquarewheels.

Example: Make a layer revolve in a circle

You can create an expression without using properties from other layers. For example, you can make a layer revolve in a perfect circle.

- 1 Select a layer, press P to reveal its Position property in the Timeline panel, and Alt-click (Windows) or Option-click (Mac OS) the stopwatch to the left of the property name.
- 2 Enter the following in the expression field:

```
[(thisComp.width/2), (thisComp.height/2)] + [Math.sin(time)*50, -Math.cos(time)*50]
```

Example: Rotate the hands of a clock

You can use the pick whip to link rotation values between layers to animate the hands on a clock—as the hour hand moves from hour to hour, the minute hand rotates the full circumference of the clock face. This type of animation would take a long time to create if you had to set each keyframe for both hand layers, but with the pick whip, you can do it in a matter of minutes.

- 1 Import or create two long, narrow solid-color layers: an hour hand and a minute hand. (See “Create or modify a solid-color layer” on page 136.)
- 2 Set the anchor points at the ends of the layers. (See “Work with layer anchor points” on page 154.)
- 3 Move the layers so that the anchor points are at the center of the composition. (See “Move layers in space” on page 139.)
- 4 Set Rotation keyframes for the hour hand. (See “Set keyframes” on page 187.)
- 5 Select the Rotation property for the minute hand and choose Animation > Add Expression.
- 6 Drag the pick whip to the hour hand’s Rotation property. The following expression appears:

```
thisComp.layer("hour hand").rotation
```

- 7 To make the minute hand rotate 12 times as fast as the hour hand, add *12 at the end of the expression as follows:

```
thisComp.layer("hour hand").rotation*12
```

Guy Chen provides a simple project that takes this idea further, connecting a clock's minute hand and hour hand's rotation to the rotation of the second hand: www.adobe.com/go/learn_ae_guyclockexpression.

Example: Position one layer between two others

This example expression positions and maintains one layer at a balanced distance between two other layers.

- 1 Start with three layers. (See “Creating layers” on page 133.)
- 2 Animate the positions of the first two layers in the Timeline panel. (See “Creating and modifying motion paths” on page 197.)
- 3 Select the third layer, press P to reveal the Position property, and Alt-click (Windows) or Option-click (Mac OS) the stopwatch  button to the left of the property name.
- 4 Enter the following in the expression field:

```
(thisComp.layer(1).position + thisComp.layer(2).position)/2
```

Example: Create a trail of images

This example expression instructs a layer to be at the same position as the next higher layer in the Timeline panel, but delayed by a specified amount of time (in this case, 0.5 seconds). You can set similar expressions for the other geometric properties.

- 1 Start with two solid-color layers that are scaled to approximately 30% of the composition size. (See “Create or modify a solid-color layer” on page 136.)
- 2 Animate the position of the first layer. (See “Creating and modifying motion paths” on page 197.)
- 3 Select the second layer, press P to reveal the Position property, and Alt-click (Windows) or Option-click (Mac OS) the stopwatch  button to the left of the property name.
- 4 Enter the following in the expression field:

```
thisComp.layer(thisLayer, -1).position.valueAtTime(time - .5)
```

- 5 Duplicate the last layer five times by selecting it and pressing Ctrl+D (Windows) or Command+D (Mac OS) five times.

All layers follow the same path, and each is delayed 0.5 seconds from the previous.

Example: Create a bulge between two layers

This example expression synchronizes the Bulge Center argument of the Bulge effect in one layer with the position of another layer. For example, you can create an effect that looks like a magnifying glass moving over a layer, with the contents under the magnifying glass bulging as the lens (that is, the overlying layer) moves. This expression uses the `fromWorld` method, which makes the expression work correctly regardless of whether you move the magnifying glass layer or the underlying layer. You can rotate or scale the underlying layer, and the expression stays intact.

You can also use other effects, such as Ripple, with this expression.

- 1 Start with two layers. Make one layer a magnifying glass or similar object with a hole in the middle and name it Magnifier. (See “Creating layers” on page 133.)
- 2 Animate the position of the magnifying glass layer. (See “Creating and modifying motion paths” on page 197.)
- 3 Apply the Bulge effect to the other layer. (See “Apply an effect or animation preset” on page 351.)

4 Select the Bulge effect's Bulge Center property in the Timeline panel and choose Animation > Add Expression, or Alt-click (Windows) or Option-click (Mac OS) the property's stopwatch  button.

5 Select the default expression text and type the following:

```
fromWorld(thisComp.layer("Magnifier").position)
```

Example: Fade a 3D layer's opacity based on distance from camera

❖ Apply the following expression to a 3D layer's Opacity property:

```
startFade = 500; // Start fade 500 pixels from camera.
endFade = 1500; // End fade 1500 pixels from camera.
try{ // Check whether there's a camera.
    C = thisComp.activeCamera.toWorld([0,0,0]);
}catch(err){ // No camera, so assume 50mm.
    w = thisComp.width * thisComp.pixelAspect;
    z = (w/2)/Math.tan(degreesToRadians(19.799));
    C = [0,0,-z];
}
P = toWorld(anchorPoint);
d = length(C,P);
linear(d,startFade,endFade,100,0)
```

The fade starts at a distance of 500 pixels from the camera and is complete at 1500 pixels from the camera. The `linear` interpolation method is used to map distance values to opacity values.

See also

“Add, edit, and remove expressions” on page 549

“Create a camera layer and change camera settings” on page 176

Example: Make a 3D layer invisible if facing away from camera

❖ Apply the following expression to a 3D layer's Opacity property:

```
if (toCompVec([0, 0, 1])[2] > 0 ) value else 0
```

See also

“Add, edit, and remove expressions” on page 549

“Create a camera layer and change camera settings” on page 176

Example: Flip layer horizontally if facing away from camera

❖ Apply the following expression to a 3D layer's Scale property:

```
if (toCompVec([0, 0, 1])[2] > 0 ) value else [-value[0], value[1], value[2]]
```

See also

“Add, edit, and remove expressions” on page 549

“Create a camera layer and change camera settings” on page 176

Example: Animate scale at each layer-time marker

- ❖ Apply the following expression to a Scale property to make a layer wobble at each marker:

```
n = 0;
t = 0;
if (marker.numKeys > 0){
    n = marker.nearestKey(time).index;
    if (marker.key(n).time > time) n--;
}
if (n > 0) t = time - marker.key(n).time;

amp = 15;
freq = 5;
decay = 3.0;

angle = freq * 2 * Math.PI * t;
scaleFact = (100 + amp * Math.sin(angle) / Math.exp(decay * t)) / 100;
[value[0] * scaleFact, value[1] / scaleFact];
```

See also

“Add, edit, and remove expressions” on page 549

Example: Start or stop wiggle at specific time

You can use any expression in place of the `wiggle` expression used here, to begin and end any expression’s influence at a specific time.

- Apply the following expression to a property to wiggle it beginning at time 2 seconds:

```
timeToStart = 2;
if (time > timeToStart){
    wiggle(3,25);
}else{
    value;
}
```

- Apply the following expression to a property to stop wiggling it at time 4 seconds:

```
timeToStop = 4;
if (time > timeToStop){
    value;
}else{
    wiggle(3,25);
}
```

- Apply the following expression to a property to start wiggling it at time 2 seconds and stop wiggling it at time 4 seconds:

```
timeToStart = 2;
timeToStop = 4;

if ((time > timeToStart) && (time < timeToStop)){
    wiggle(3,25);
}else{
    value;
}
```

See also

“Add, edit, and remove expressions” on page 549

Example: Match camera’s focal plane to another layer

❖ Apply the following expression to a camera layer’s Focus Distance property to have its focus distance match the distance to the anchor point of a layer named “target”:

```
target = thisComp.layer("target");  
V1 = target.toWorld(target.anchorPoint) - toWorld([0,0,0]);  
V2 = toWorldVec([0,0,1]);  
dot(V1,V2);
```

See also

“Add, edit, and remove expressions” on page 549

“Create a camera layer and change camera settings” on page 176

Chapter 17: Rendering and exporting

Basics of rendering and exporting

About rendering and exporting

Rendering is the creation of the finished frames of a movie from a composition. The rendering of a frame is the creation of a composited two-dimensional image from all of the layers, settings, and other information in a composition that make up the model for that image. The rendering of a movie is the frame-by-frame rendering of each of the frames that make up the movie. For more information on how each frame is rendered, see “Render order and collapsing transformations” on page 115.

After a composition is rendered for final output, it is processed by one or more output modules that encode the rendered frames into one or more output files.

A movie can be made into a single output file (such as a Flash Video movie) that contains all of the rendered frames, or it can be made into a sequence of still images (as you would do when creating output for a film recorder).

Though it is common to speak of *rendering* as if this term only applies to final output, the processes of creating previews to show in the Footage, Layer, and Composition panels are also kinds of rendering. In fact, it is possible to save a RAM preview as a movie and use that as your final output. (See “Preview video and audio” on page 120.)

Note: *Some kinds of exporting don't involve rendering and are for intermediate stages in a workflow, not for final output. For example, you can export a project as an Adobe Premiere Pro project by choosing File > Export > Adobe Premiere Pro Project. The project information is saved without rendering.*

To see a video tutorial on rendering and exporting, visit the Adobe website at www.adobe.com/go/vid0262.

After Effects provides a variety of formats and compression options for output. Which format and compression options you choose depends on how your output will be used. For example, if the movie that you render from After Effects is the final product that will be played directly to an audience, then you need to consider the medium from which you'll play the movie and what limitations you have on file size and data rate. By contrast, if the movie that you create from After Effects is an intermediate product that will be used as input to a video editing system, then you should output without compression to a format compatible with the video editing system.

Aharon Rabinowitz has an article on the Creative COW website about planning your project and deciding what formats and settings to use for final output: www.adobe.com/go/learn_ae_aharonplanning.

Keep in mind the fact that you can use different encoding and compression schemes for different phases of your workflow. For example, you may choose to export a small number of frames as full-resolution still images (e.g., TIFF files) when you need approval from a customer about the colors in a shot; whereas you may export the movie using a lossy encoding scheme (e.g., H.264) when you need approval for the timing of the animation.

Important: *You do not need to render a movie multiple times to export it to multiple formats with the same render settings. You can export multiple versions of the same rendered movie by adding output modules to a render item in the Render Queue panel.*

In the Render Queue panel, you can manage several render items at once, each with its own render settings and output module settings. Render settings determine such characteristics as output frame rate, duration, resolution, and layer quality. Output module settings—which are applied after render settings—determine such post-rendering characteristics as output format, compression options, cropping, and whether to embed a link to the project in the output file. You can create templates that contain commonly used render settings and output module settings. Using the Render Queue panel, you can render the same composition to different formats or with different settings, all with one click of the Render button:

- You can output to a sequence of still images, such as a Cineon sequence, which you can then transfer to film for cinema projection.
- You can output using lossless compression (or no compression) to a QuickTime container for transfer to a non-linear editing (NLE) system for video editing.
- You can output to H.264 or another highly compressed format for playback on mobile devices such as cellular phones or the Apple iPod.
- You can output to MPEG-2 for playback from DVD.

Note: To transfer the output rendered from After Effects to film or video, you must have the proper hardware for film or video transfer, or have access to a service bureau that can provide transfer services.

If you output your movie in the H.264 format for mobile devices, then you can use Adobe Device Central to view your movie as it will appear on any of a large number of mobile devices. Adobe Device Central emulates cellular phones, portable media players (such as the Apple iPod), and many other common viewing devices. (See “Preview a movie on a virtual mobile device using After Effects” on page 618.)

Rendering a composition into a movie can take a few seconds or many hours, depending on the composition’s frame size, quality, complexity, and compression method. As After Effects renders the item, you are unable to work in the program. An audio alert indicates when rendering is complete.

 A chime plays when all items in the render queue have been rendered and exported; a different noise plays if a render operation fails. You can replace the render-complete sounds on Windows by placing files named `rnd_okay.wav` and `rnd_fail.wav` in this folder: `C:\Documents and Settings\[user_name]\Application Data\Adobe\After Effects\8.0`.

GridIron Software provides Nucleo Pro 2, which improves rendering performance in After Effects in several ways: www.adobe.com/go/learn_ae_gridironnucleopro.

Lloyd Alvarez provides a script that takes items that are ready to render in the render queue and sends them to render in the background using `aerender`: www.adobe.com/go/learn_ae_lloydbgrenderer.

See also

“Work with render settings” on page 597

“Work with output module settings” on page 599

Supported output formats

Unless otherwise noted, all image file formats are exported at 8 bits per channel (bpc).

Additional output formats may be available in the File > Export menu, depending on which QuickTime components and codecs you have installed. To export to some image sequence formats, choose File > Export > Image Sequence.

You can add the ability to export other kinds of data by installing plug-ins or scripts provided by parties other than Adobe. For example, Paul Tuersley provides a script with which you export After Effects composition data as Cinema 4D project data: www.adobe.com/go/learn_ae_paulaftereffectstocinema4d.

Video and animation formats

- 3GPP (3GP, 3G2, AMC; requires QuickTime 6.5 or later)
- Adobe Clip Notes (PDF containing rendered movie)
- Animated GIF (GIF)
- Cineon (CIN, DPX; 16 and 32 bpc converted to 10 bpc)
- ElectricImage (IMG, EIZ)
- Filmstrip (FLM)
- Flash (SWF)
- Flash Video (FLV)
- H.264 and H.264 Blu-ray
- MPEG-2 (Windows and Mac OS on Intel-based Mac only)
- MPEG-2 DVD (Windows and Mac OS on Intel-based Mac only)
- MPEG-2 Blu-ray (Windows and Mac OS on Intel-based Mac only)
- MPEG-4
- OMF (media [essence] only, Windows only)
- QuickTime (MOV, DV; requires QuickTime for 8 bpc and codec support for 16 bpc)
- RealMedia (RAM, RM; Windows only)
- Video for Windows (AVI)
- Windows Media (Windows only)

 *After Effects can read and render QuickTime files in 16-bpc color depth. When you select a QuickTime codec that supports 16-bpc color depth in the Output Module dialog box, such as the None16 codec, Trillions Of Colors is available. For information on the None16 and Microcosm codecs, see the Digital Anarchy website: www.adobe.com/go/learn_ae_digitalanarchynone16. To find out whether your video codec supports 16-bpc color depth, contact the manufacturer directly.*

Video project formats

- Adobe Premiere Pro project (PRPROJ; Windows and Mac OS on Intel-based Mac only)

Still-image formats

- Adobe Photoshop (PSD; 8, 16, and 32 bpc)
- Bitmap (BMP, RLE)
- CompuServe GIF (GIF)
- Maya IFF (IFF; 16 bpc)
- JPEG (JPG, JPE)
- Open EXR (EXR)
- Pict (PCT, PIC)
- PNG (PNG; 16 bpc)
- Radiance (HDR, RGBE, XYZE)
- RLE (RLE)

- SGI (SGI, BW, RGB, 16 bpc)
- Targa (TGA, VBA, ICB, VST)
- TIFF (TIF; 8, 16, and 32 bpc)

Audio-only formats

- AU audio file (AU)
- Audio Interchange File Format (AIFF)
- MP3 (MP3)
- WAV

See also

“Supported import formats” on page 48

Render and export a movie using the render queue

1 Select the composition from which to make a movie in the Project panel, and then do one of the following to add the composition to the render queue:

- Choose Composition > Make Movie. Specify a name and location for the output file, and click Save.
- Choose Composition > Add To Render Queue.
- Drag the composition to the Render Queue panel.

2 Click the triangle next to the Output To heading in the Render Queue panel to choose a name for the output file based on a naming convention, and then choose a location; or click the text next to the Output To heading to enter any name. If you used Make Movie to add the composition to the render queue, then you can skip this step. (See “Specify file names and locations for rendered output” on page 595.)

3 Click the triangle to the right of the Render Settings heading to choose a render settings template, or click the underlined text to the right of the Render Settings heading to customize the settings. (See “Work with render settings” on page 597.)

4 Choose a Log type from the Log menu.

5 Click the triangle to the right of the Output Module heading to choose an output module settings template, or click the underlined text to the right of the Output Module heading to customize the settings. You use the output module settings to specify the file format of the output movie. In some cases, a format-specific dialog box opens after you choose a format, in which you can specify format-specific settings. (See “Work with output module settings” on page 599 and “Encoding and compression options for movies” on page 612.)

When an output name and location have been set, and render settings and an output module have been selected, the entry in the Render column will automatically become selected (shown by a check mark) and the status will change to Queued. This means that the render item is in the render queue.

 *Press the Caps Lock key before you start rendering to prevent the Composition panel from displaying rendered frames. By not updating the Composition panel, After Effects requires less time to process simple render items with a lot of frames.*

6 Click the Render button in the upper-right corner of the Render Queue panel.

 To create a new composition from a footage item and add that composition to the render queue, drag the footage item from the Project panel to the Render Queue panel. This is a convenient way to convert a footage item from one format to another.

Work in the Render Queue panel

Use the Render Queue panel to render compositions, apply render settings and output module settings, and obtain information on the rendering process.

When you place a composition into the Render Queue panel, it becomes a *render item*. You can add many render items to the render queue, and After Effects can render multiple items in a batch, unattended. When you click the Render button in the upper-right corner of the Render Queue panel, all items with the status of Queued are rendered and output in the order in which they are listed in the Render Queue panel.

When rendering of a render item is complete, it remains in the Render Queue panel with its status changed to Done until you remove the item from the Render Queue panel. You cannot re-render a completed item, but you can duplicate it to create a new item in the queue with the same settings or with new settings.

 When working with multiple render items, it is often useful to add comments in the Comments column in the Render Queue panel. If the Comments column is not visible, right-click (Windows) or Control-click (Mac OS) a column heading, and choose Columns > Comments.

See also

“Render and export a movie using the render queue” on page 590

Render item statuses

Each render item has a status, which appears in the Status column in the Render Queue panel:

Unqueued The render item is listed in the Render Queue panel but is not ready to render. Confirm that you have selected the desired render settings and output module settings, and then select the Render option to queue the render item.

Queued The render item is ready to render.

Needs Output An output file name has not been specified. Choose a value from the Output To menu, or click the underlined Not Yet Specified text next to the Output To heading to specify a file name and path.

Failed After Effects was unsuccessful in rendering the render item. Use a text editor to view the log file for specific information on why the rendering was unsuccessful.

User Stopped The rendering process was stopped.

Done The rendering process for the item is complete.

Manage render items and change render statuses

- To remove a render item from the render queue (change its status from Queued to Unqueued), deselect its entry in the Render column. The item remains in the Render Queue panel.
- To change a render item’s status from Unqueued to Queued, select its entry in the Render column.
- To remove a render item from the Render Queue panel, select the item and press Delete, or choose Edit > Clear.
- To rearrange items in the Render Queue panel, drag an item up or down the queue. A heavy black line appears between render items, indicating where the item will be placed.

Pause or stop rendering

- To pause rendering, click Pause. To resume rendering, click Continue.

While rendering is paused, you cannot change settings or use After Effects in any other way.

- To stop rendering with the purpose of starting the same render over again, Alt-click (Windows) or Option-click (Mac OS) Stop.

The render item for which rendering was stopped is assigned the status User Stopped, and a new item with the status of Queued is added to the Render Queue panel. The new item uses the same output file name and has the same duration as the original render item.

- To stop rendering with the purpose of resuming the same render, click Stop.

The render item for which rendering was stopped is assigned the status User Stopped, and a new item with the status of Unqueued is added to the Render Queue panel. The new item uses an incremented output file name and resumes rendering at the frame at which rendering was stopped.

Information shown for current render operations

Basic information about the current batch of renders is shown at the top of the Render Queue panel:

Message A status message.

RAM Memory available for the rendering process.

Renders Started The time at which the current batch of renders was started.

Total Time Elapsed The rendering time elapsed (not counting pauses) since the current batch of renders was started.

Log File The name and location of the file to which rendering status messages have been written (None if no log information has been written). Use the Log menu for each render item to choose which information is written to the log file.

 *To view more information about the current render operation, click the triangle to the left of Current Render Details. The Current Render Details pane will collapse (close) after a short time. To expand the pane so that it does not collapse after a time-out period, Alt-click (Windows) or Option-click (Mac OS) the triangle next to Current Render Details. To view details of a completed render, review the log file.*

Re-render a previously rendered item

1 Select the render item.

2 Do one of the following:

- To render with the same file name, choose Edit > Duplicate With File Name.
- To render with a new file name, choose Edit > Duplicate, click the underlined file name next to Output To, enter a new file name, and click Save.

3 Click Render.

Rendering and exporting movies using QuickTime components

If you have QuickTime installed, you can export a movie using components provided by QuickTime, without using the Render Queue panel. Compositions exported using QuickTime components are rendered using the Composition panel's current quality and resolution settings. Only the work area is rendered.

Note: *You can also export movies to QuickTime using the Render Queue panel. However, some QuickTime options, such as Fast Start and Hinted Streaming, are available only through the File > Export menu.*

The specific file formats that you can export to using QuickTime depend on how you've configured QuickTime. If you install new export modules as they become available from Apple or other parties, those modules appear in the File > Export menu in After Effects.

For more information about QuickTime effects and file formats supported by QuickTime, see QuickTime Help.

See also

“Render and export a movie using the render queue” on page 590

“Set the work area” on page 112

Render with OpenGL

OpenGL is a set of standards for high-performance processing of 2D and 3D graphics for a wide variety of applications. For After Effects users, OpenGL provides fast, high-quality rendering for previews and final output by moving rendering from the CPU to the OpenGL hardware (GPU).

To use OpenGL in After Effects, you'll need an OpenGL card that supports OpenGL 2.0 and has Shader support and support for NPOT (Non Power of Two) textures.

Note: After Effects provides limited support for OpenGL 1.5 on Macintosh computers with PowerPC processors.

Feature support in After Effects is dependent on the OpenGL hardware; contact the hardware manufacturer for details. When you first start After Effects, it attempts to determine if your OpenGL card meets the requirements, and then enables or disables OpenGL as appropriate.

For information regarding specific OpenGL hardware, visit the After Effects section of the Adobe website at www.adobe.com/go/learn_ae_openglsupport.

OpenGL in After Effects supports the following features:

- Shadows, except point light shadows (Colored shadows appear gray.)
- Lights (eight maximum)
- Masks
- Alpha channels
- Track mattes
- Intersecting layers
- Transformations for 2D and 3D layers
- GPU-accelerated effects, including Alpha Levels, Bevel Alpha, Box Blur, Brightness & Contrast, Channel Blur, Color Balance, Color Balance (HLS), Curves, Directional Blur, Drop Shadow, Fast Blur, Find Edges, Gaussian Blur, Hue/Saturation, Invert, Noise, Radial Blur, Ramp, Sharpen, and Tint.
- All blending modes except Dissolve and Dancing Dissolve
- Metal property settings for 3D layers
- Cone feather settings for light layers
- 2D motion blur
- Adjustment layers
- Anti-aliasing

Important: Use caution when enabling the OpenGL renderer in a network rendering environment. Inconsistencies may arise if the sets of features supported by the OpenGL cards in the network aren't the same.

When OpenGL does not support a feature, it simply renders without using that feature. For example, if your layers contain shadows and your OpenGL hardware does not support shadows, the output will not contain shadows.

- To enable OpenGL for rendering final output, click the underlined text next to Render Settings in the Render Queue panel, and select Use OpenGL Renderer.
- To enable OpenGL for rendering previews, choose Edit > Preferences > Previews (Windows) or After Effects > Preferences > Previews (Mac OS), and select Enable OpenGL.
- To see what features your OpenGL card supports, choose Edit > Preferences > Previews (Windows) or After Effects > Preferences > Previews (Mac OS), and click OpenGL Info.
- To modify the amount of texture memory, choose Edit > Preferences > Previews (Windows) or After Effects > Preferences > Previews (Mac OS), click OpenGL Info, and enter a value for Texture Memory of no more than 80% of the installed video RAM (VRAM) on your video card.

Note: Mac OS provides the total amount of Texture Memory available on the display card in the OpenGL Info panel; Windows does not.

See also

“Work with render settings” on page 597

“Preview video and audio” on page 120

Collect files in one location

The Collect Files command gathers copies of all of the files in a project or composition into a single location. This is useful as a step before rendering, for archiving, or for moving a project to a different computer system or user account.

When you use the Collect Files command, After Effects creates a new folder in which it saves a new copy of the project, copies of the footage files, proxy files as specified, and a report describing the files, effects, and fonts necessary to recreate the project and render the compositions.

After you collect files, you can continue making changes to a project, but be aware that those changes are stored with the original project and not with the newly collected version.

1 Choose File > Collect Files.

2 In the Collect Files dialog box, choose an appropriate option for Collect Source Files.

All Collects all footage files, including unused footage and proxies.

For All Comps Collects all footage files and proxies used in any composition in the project.

For Selected Comps Collects all footage files and proxies used in compositions currently selected in the Project panel.

For Queued Comps Collects all footage files and proxies used directly or indirectly in any of the compositions with a Queued status in the Render Queue panel.

None (Project Only) Copies the project to a new location without collecting any source footage.

3 Select other options, as appropriate:

Generate Report Only Selecting this option does not copy the files and proxies.

Obey Proxy Settings Use this option with compositions that include proxies to specify whether you want the copy to include the current proxy settings. If this is selected, only the files used in the composition are copied. If this is not selected, the copy contains both proxies and source files, so you can later change proxy settings in the collected version.

Note: If you choose For Queued Comps in the Collect Source Files dialog box, After Effects uses the proxy settings from the render settings, not the composition.

Reduce Project Removes all unused footage items and compositions from the collected files when the following options are chosen in the Collect Source Files menu: For All Comps, For Selected Comps, and For Queued Comps.

Change Render Output To Use to redirect the output modules to render files to a named folder in the collected files folder. This option ensures that you have access to your rendered files when you're rendering the project from another computer. Note that the rendering status must be valid (Queued, Unqueued, or Will Continue) for the output modules to render files to this folder.

Enable 'Watch Folder' Render You can use the Collect Files command to save projects to a specified watch folder and then initiate watch-folder rendering over a network. After Effects also includes a render control file called *[project name]_RCF.txt*, which signals to watching computers that the project is available for rendering. After Effects and any installed render engines can then render the project together across a network. (See "Set up watch-folder rendering" on page 626.)

Maximum Number Of Machines Use to specify the number of render engines or licensed copies of After Effects that you want to allocate to render the collected project. Below this option, After Effects reports how many items in the project will be rendered using more than one computer.

Note: If rendering time is unusually long, you may have set Maximum Number Of Machines too high, and the network overhead required to track rendering progress among all computers is out of proportion to the time spent actually rendering frames. The optimal number depends on many variables related to the network configuration and the computers on it; experiment to determine the optimal number for your network.

4 To add your own information to the report that will be generated, click Comments, type your notes, and click OK. The comments appear at the end of the report.

5 Click Collect. Name the folder and specify a location for your collected files.

Once you start the file collection, After Effects creates the folder and copies the specified files to it. The folder hierarchy is the same as the hierarchy of folders and footage items in your project. The new folder includes a (Footage) folder and may include an output folder (if you selected Change Render Output To).

The names of these folders appear in parentheses to signal to any attending render engines that they should not search these folders for projects.

Specify file names and locations for rendered output



You can locate a previously rendered item or check the destination of a queued render item by expanding the Output Module group in the Render Queue panel and clicking the underlined file path, or by right-clicking (Windows) or Control-clicking (Mac OS) the Output Module heading.

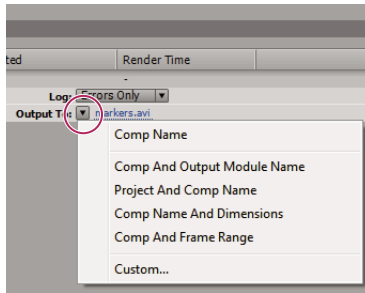

Click the triangle to open the Output To menu, or click the underlined text to enter a destination.

Specify the file name and location for a single render item

- To manually enter a file name and destination folder, click the underlined text next to the Output To heading.
- To name a file using a file naming template, click the triangle next to the Output To heading, and choose a template from the menu.

Change the destination for multiple queued render items

- 1 In the Render Queue panel, Ctrl-click (Windows) or Command-click (Mac OS) multiple queued render items to select them.
- 2 Click the underlined file name next to Output To for any item.
- 3 Choose the folder in which you want to place the rendered files. The destinations for all selected items change to the new destination folder.

Create and use a custom file naming template

You can use custom templates to name the output according to properties of the composition and project.



To make a file naming template the default template, hold down Ctrl (Windows) or Command (Mac OS) as you choose the template from the Output To menu.

- 1 In the Render Queue panel, choose Custom from the Output To menu.
- 2 If you want to base the new file naming template on an existing template, choose the existing template from the Preset menu.
- 3 Click in the Template box where you want to insert a file naming rule, and do any of the following:
 - To add a preset property to the file name, choose the property from the Add Property menu.
 - Type text in the Template box.

Note: Make sure that the insertion point is outside the square brackets ([]) of preset properties.

- 4 Do any of the following:
 - To save the file naming template as a preset for future use in the Output To menu, click the Save button . In the Choose Name dialog box, enter a name for the file naming template, and click OK.
 - To always use the selected file naming template, select Default.
 - To apply the selected file naming template to the current Output Module, click OK.

Name output files automatically

The Use Default File Name And Folder preference ensures that all compositions added to the render queue are automatically assigned a unique output file name (except for files created by saving RAM previews, which still use the composition name). When this option is selected, each render item is assigned the same folder name as the previous render item until you change the path. If a composition is rendered more than once, After Effects adds a number to the file name (for example, composition_name_1).

Note: Avoid using high-ASCII or other extended characters in file names for projects to be used on different platforms or rendered using a watch folder.

1 Choose Edit > Preferences > Output (Windows) or After Effects > Preferences > Output (Mac OS).

2 Select Use Default File Name And Folder.

Work with render settings

Render settings apply to each render item and determine how the composition is rendered for that specific render item. By default, the render settings for a render item are based on the current project settings, composition settings, and switch settings for the composition on which the render item is based. However, you can modify the render settings for each render item to override some of these settings.

Render settings apply to the root composition for a render item, as well as all nested compositions.

Important: Render settings only affect the output of the render item with which they're associated; the composition itself is not affected.

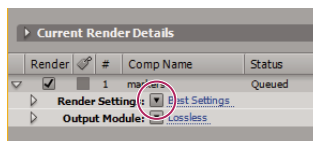

Click the triangle to open the Render Settings menu, or click the underlined text to open the Render Settings dialog box.

See also

“Work with composition settings” on page 110

“Layer switches and columns in the Timeline panel” on page 147

Change render settings

- To change render settings for a render item, click the underlined render settings template name next to the Render Settings heading in the Render Queue panel, and choose settings in the Render Settings dialog box.
- To apply a render settings template to selected render items, click the triangle next to the Render Settings heading in the Render Queue panel, and choose a template from the menu. You can choose a custom render settings template or one of the preset render settings templates:

Best Settings Often used for rendering to final output.

Draft Settings Often appropriate for reviewing or testing motion.

DV Settings Similar to Best Settings, but with Field Rendering turned on, set to Lower Field First.

Multi-machine Settings Similar to Best Settings, but with Storage Overflow set to Off.

Note: The default render settings template is assigned to a render item when it is created. To change which render settings template is the default, hold down **Ctrl** (Windows) or **Command** (Mac OS) as you choose a render settings template from the menu.

Create, edit, and manage render settings templates

You perform the following tasks in the Render Settings Templates dialog box. To open the Render Settings Templates dialog box, choose **Edit > Templates > Render Settings**, or click the triangle next to the Render Settings heading in the Render Queue panel and choose **Make Template**.

- To make a new render settings template, click **New**, specify render settings, and click **OK**. Enter a name for the new template.
- To edit an existing render settings template, choose a template from the **Settings Name** menu, click **Edit**, and specify render settings.

Note: Changes to an existing template do not affect render items that are already in the render queue.

- To specify a default render settings template to be used when rendering movies, individual frames, pre-rendered movies, or proxies, choose a template from a menu in the **Defaults** area of the Render Settings Templates dialog box.
- To save all currently loaded render settings templates to a file, click **Save All**.
- To load a saved render settings template file, click **Load**, select the render settings template file, and then click **Open**.

Render settings

Each of these settings overrides composition settings, project settings, or layer switch settings.

Quality The quality setting to use for all layers. (See “Layer image quality” on page 150.)

Resolution Resolution of the rendered composition, relative to the original composition dimensions. (See “Resolution” on page 128.)

Note: If you render at reduced resolution, set the **Quality** option to **Draft**. Rendering at **Best quality** when reducing resolution produces an unclear image and takes longer than **Draft quality**.

Disk Cache Determines whether the disk cache preferences are used during rendering. **Read Only** writes no new frames to the disk cache while After Effects renders. **Current Settings** (default) uses the disk cache settings defined in the **Memory & Cache** preferences. (See “Memory, storage, and performance” on page 37.)

Use OpenGL Renderer Determines whether OpenGL is used for rendering. (See “Render with OpenGL” on page 593.)

Proxy Use Determines whether to use proxies when rendering. **Current Settings** uses the settings for each footage item. (See “Work with placeholders and proxies” on page 61.)

Effects **Current Settings** (default) uses the current settings for Effect switches . **All On** renders all applied effects. **All Off** renders no effects.

Solo Switches **Current Settings** (default) uses the current settings for Solo switches  for each layer. **All Off** renders as if all Solo switches are off. (See “Solo a layer” on page 149.)

Guide Layers **Current Settings** renders guide layers in the top-level composition. **All Off** (the default setting) does not render guide layers. Guide layers in nested compositions are never rendered. (See “Work with guide layers” on page 159.)

Color Depth **Current Settings** (default) uses the project bit depth. (See “Set the color depth” on page 234.)

Frame Blending On For Checked Layers renders frame blending only for layers with the Frame Blending switch  set, regardless of the composition's Enable Frame Blending setting. (See “Apply frame blending to a layer” on page 225.)

Field Render Determines the field-rendering technique used for the rendered composition. Choose Off if you are rendering for film or for display on a computer screen. (See “Separate video fields” on page 71.)

3:2 Pulldown Specifies the phase of 3:2 pulldown. (See “Introduce 3:2 pulldown” on page 633.)

Motion Blur Current Settings uses the current settings for the Motion Blur layer switch  and the Enable Motion Blur composition switch. On For Checked Layers renders motion blur only for layers with the Motion Blur layer switch set, regardless of the composition's Enable Motion Blur setting. Off For All Layers renders all layers without motion blur regardless of the layer switch and composition switch settings. (See “Use motion blur” on page 200.)

Time Span How much of the composition to render. To render the entire composition, choose Length Of Comp. To render only the part of the composition indicated by the work-area markers, choose Work Area Only. To render a custom time span, choose Custom. (See “Set the work area” on page 112.)

Frame Rate The sampling frame rate to use when rendering the movie. Select Use Comp's Frame Rate to use the frame rate specified in the Composition Settings dialog box, or select Use This Frame Rate to use a different frame rate. The actual frame rate of the composition is unchanged. The frame rate of the final encoded movie is determined by the output module settings. (See “Change frame rate” on page 53.)

Use Storage Overflow Determines whether rendering continues when the first assigned storage volume overflows. If this option isn't selected, rendering stops when the first assigned volume reaches capacity. (See “Overflow volumes and segment settings” on page 629.)

Skip Existing Files Lets you re-render part of a sequence of files without wasting time on previously rendered frames. When rendering a sequence of files, After Effects locates files that are part of the current sequence, identifies the missing frames, and then renders only those frames, inserting them where they belong in the sequence. You can also use this option to render an image sequence on multiple computers. (See “Render a still-image sequence with multiple computers” on page 628.)

Note: The current image sequence must have the same name as the existing image sequence, and the starting frame number, frame rate, and time span must be the same. You must render to the folder that contains the previously rendered frames.

Work with output module settings

Output module settings apply to each render item and determine how the rendered movie is processed for final output. Use output module settings to specify file format, output color profile, compression options, and other encoding options for final output.

You can also use output module settings to crop or stretch a rendered movie; doing this after rendering is often useful when you are generating multiple kinds of output from a single composition.

Output module settings are applied to the rendered output that is generated according to the render settings.

For some formats, an additional dialog box opens when you choose the format in the Output Module Settings dialog box. You can modify these settings and use settings presets to specify format-specific options, such as compression options.

You can apply more than one output module to each render item. This is useful when you want to make more than one version of a movie at the same time. For example, you can automate the creation of a movie and its alpha matte, or you can create high-resolution and low-resolution versions of a movie.

 To duplicate an output module, select it and press **Ctrl+D** (Windows) or **Command+D** (Mac OS).

Note: Before rendering, check the Audio Output settings in the Output Module Settings dialog box to ensure that they are correct. To render audio, Audio Output must be selected. If your composition does not include audio, do not select Audio Output, so that the size of the rendered file will not increase needlessly.

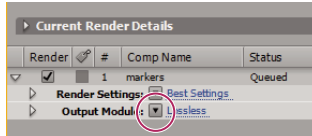

Click the triangle to open the Output Module Settings menu, or click the underlined text to open the Output Module Settings dialog box.

See also

“Encoding and compression options for movies” on page 612

Change output module settings

- To change output module settings for a render item, click the underlined output module settings template name next to the Output Module heading in the Render Queue panel, and choose settings in the Output Module Settings dialog box.
- To apply an output module settings template to selected render items, click the triangle next to the Output Module heading in the Render Queue panel, and choose a template from the menu.

You can choose a custom output module settings template or one of the preset output module settings templates. Several templates are provided, including the Lossless template for creating movies for transfer to video, film, or an NLE system.

Note: The default output module settings template is assigned to a render item when it is created. To change which output module template is the default, hold down **Ctrl** (Windows) or **Command** (Mac OS) as you choose an output module template from the menu.

Create, manage, and edit output module templates

You perform the following tasks in the Output Module Templates dialog box. To open the Output Module Templates dialog box, choose **Edit > Templates > Output Module**, or click the triangle next to the Output Module heading in the Render Queue panel and choose **Make Template**.

- To make a new output module settings template, click **New**, specify output module settings, and click **OK**. Enter a name for the new template.
- To edit an existing output module settings template, choose a template from the Settings Name menu, click **Edit**, and specify output module settings.

Note: Changes to an existing template do not affect render items that are already in the render queue.

- To specify a default output module settings template to be used when processing movies, individual frames, RAM previews, pre-rendered movies, or proxies, choose a template from a menu in the Defaults area of the Output Module Templates dialog box.
- To save all currently loaded output module templates to a file, click **Save All**.
- To load a saved output module template file, click **Load**, select the output module template file, and then click **Open**.

Add an output module to selected render items

- Choose Composition > Add Output Module

Output module settings

For information on using controls in the Color Management area of the Output Module Settings dialog box, see “Assign an output color profile” on page 246.

Format Specifies the format for the output file or sequence of files.

Embed Specifies whether to include information in the output file that links to the source project in After Effects. When you open the output file in another application, such as Adobe Premiere Pro, you can use the Edit Original command to edit the source project in After Effects. Selecting Project Link creates a link between the output file and the source project. Selecting Project Link And Copy creates a link and adds an embedded copy of the linked project to the output file; if the project is missing or updated when you choose Edit Original in another application, you can choose whether to open the source project or the saved copy of the project.

Post-Render Action Specifies an action for After Effects to perform after the composition is rendered. (See “Use a post-render action” on page 602.)

Format Options Opens a dialog box in which you specify format-specific options.

Channels The output channels contained in the output movie. After Effects creates a movie with an alpha channel if you choose RGB+Alpha, implying a depth of Millions of Colors+. Not all codecs support alpha channels.

Note: All files created with a color depth of Millions of Colors+, Trillions of Colors+, or Floating Point + have labeled alpha channels; information describing the alpha channel is stored in the file. Therefore, you do not have to specify an alpha interpretation each time you import an item created in After Effects.

Depth Specifies the color depth of the output movie. Choose from color or grayscale options. Certain formats may limit depth and color settings.

Color Specifies how colors are created with the alpha channel. Choose from either Premultiplied (Matted) or Straight (Unmatted). (See “About straight and premultiplied channels” on page 253.)

Note: PNG files don't support premultiplied alpha.

Starting # Specifies the number for the starting frame of a sequence. For example, if this option is set to 38, After Effects names the first frame `[file_name]_00038`. The Use Comp Frame Number option adds the starting frame number in the work area to the starting frame of the sequence.

Stretch Specifies the size of your output movie. Select Lock Aspect Ratio To if you want to retain the existing frame aspect ratio when stretching the frame size. Select Low Stretch Quality when rendering tests, and select High Stretch Quality when creating a final movie. (See “Scaling a movie down” on page 631 and “Scaling a movie up” on page 632.)

Crop Used to subtract or add rows or columns of pixels to the edges of the output movie. You can specify the number of rows or columns of pixels to be added or subtracted from the top, left, bottom, and right sides of the movie. Use positive values to crop, and use negative values to add rows or columns of pixels. Select Region Of Interest to render only the region of interest selected in the Composition or Layer panel.



By adding one row of pixels to the top and subtracting one row from the bottom of a movie, you can change the field order.

Audio Output Specifies the sample rate, sample depth (8 Bits or 16 Bits), and playback format (Mono or Stereo). Choose a sample rate that corresponds to the capability of the output format. Choose an 8-bit sample depth for

playback on the computer, and a 16-bit sample depth for CD and digital audio playback or for hardware that supports 16-bit playback.

Use a post-render action

You can use post-render actions to automate simple tasks that occur after a composition is rendered.

A common example of the use of post-render actions is with pre-rendering: Choosing Composition > Pre-render adds the selected composition to the render queue and sets the Post-Render Action option to Import & Replace Usage.

Note: You choose Post-Render Action options in the Output Module group, so be aware that changing the Output Module template could also change the Post-Render Action option. (See “Work with output module settings” on page 599.)

1 Expand the Output Module group in the Render Queue panel by clicking the arrow to the left of the Output Module heading.

2 Choose one of the following from the Post-Render Action menu:

None Performs no post-render action. This option is the default.

Import Imports the rendered file into the project as a footage item when the rendering is complete.

Import & Replace Usage Imports the rendered file into the project and substitutes it for the specified item. Drag the pick whip to the item to replace in the Project panel to specify it.

 Use the Import & Replace Usage option to create a chain of dependent render items. For example, you can set one render item to use a watch folder and multiple computers to create a still-image sequence, and then the next render item can render a single movie file from that still-image sequence. (See “Network rendering with watch folders” on page 625.)

Set Proxy Sets the rendered file as a proxy for the specified item. Drag the pick whip to the item in the Project panel item to specify it.

See also

“Work with placeholders and proxies” on page 61

“Pre-render a nested composition” on page 114

Rendering and exporting to Flash formats

About render and export of Flash formats

You can render and export movies from After Effects as Adobe Flash (SWF) files or Flash Video (FLV) files. Incorporating these movies into web pages and adding interactivity is typically accomplished using the Flash authoring application.

To see a video tutorial on rendering and exporting to Flash formats, visit the Adobe website at www.adobe.com/go/vid0261.

Flash (SWF)

SWF files are small files that are often used to deliver animated vector graphics (such as cartoons), audio, and other data types over the Internet. SWF files also allow viewer interaction, such as following a web link or controlling animation. To play SWF files, you need Adobe Flash Player, a plug-in for your web browser. SWF files exported from After Effects can be played by Flash Player or imported into the Flash authoring application for additional editing.

Flash Video (FLV)

FLV files contain only pixel-based (rasterized) video, not vector graphics, and they aren't interactive. To play a movie in the FLV format, you must import the FLV file into Flash and publish it in a SWF file.

 *After Effects markers can be included as cue points in an output FLV file. To transfer keyframes or global property values into Flash from After Effects, run the `Convert Selected Properties To Markers.jsx` script before rendering and exporting an FLV file.*

You render and export a movie to the FLV format using the render queue, just as you do with other formats. (See “Render and export a movie using the render queue” on page 590.)

Important: *Some applications install a QuickTime export component for Flash Video that appears as an entry in the File > Export menu for Flash Video (FLV). Adobe recommends that you not use this command, but instead render and export Flash Video files using the Render Queue panel. Some features, such as export of cue points from After Effects, only work for render and export through the Render Queue panel.*

To include the alpha channel in the FLV output, use the On2 VP6 codec and select Encode Alpha Channel in the Video tab of the Adobe Flash Video export settings dialog box.

See also

“Working with Flash and After Effects” on page 33

“Encoding and compression options for movies” on page 612

Render and export a composition as a Flash (SWF) file

While rendering to SWF, After Effects maintains vectors as much as possible. However, raster images, blending modes, motion blur, some effects, and the contents of nested compositions cannot be represented as vectors in the SWF file and are rasterized.

You can choose to ignore these unsupported items so that the SWF file includes only those After Effects features that can be converted into native SWF elements, or you can choose to rasterize frames that contain unsupported features and add them to the SWF file as JPEG-compressed bitmap images, which may reduce the efficiency of the SWF file.

Audio is encoded in MP3 format and added to the SWF file as an audio stream.

When After Effects creates a SWF file, it also saves a report (`[SWF file_name]R.htm`) to the same folder as the SWF file. The report also contains a link to the SWF file so that you can preview the output using the Flash Player plug-in. Open the report in a browser to view the SWF file and see which items in the composition are unsupported.

The exported SWF file includes each unchanged item in the After Effects composition once, and then references it for each use. If a layer is used in multiple frames, each use refers to the same object, even if the layer's transform properties (such as Position) are animated. However, if the content of the layer changes—for example, if a mask on the layer is animated or if the layer's source footage item is video—a new object is created for each frame in which the layer is visible. If multiple layers in the composition share the same source footage item, the source is added once and is then referenced for every additional layer that shares the source. If the source is an Illustrator file, a SWF movie clip is created and referenced. Text characters are added as vectors once and then referenced on all subsequent frames, unless you choose Fill Over Stroke from the Fill And Stroke options menu; in that case, the characters are added as vectors on every frame.

Note: If color management is enabled for the project, then colors are converted from the project's working color space to the sRGB IEC61966-2.1 color space for output. This output color space is appropriate for movies shown in a web browser. (See "Color management" on page 241.)

- 1 Select the composition you want to export, and then choose File > Export > Adobe Flash (SWF).
- 2 Type a file name (making sure to include the .swf extension) and location, and then click Save.
- 3 Specify options as appropriate, and then click OK.

SWF export settings

JPEG Quality Specifies the image quality of rasterized. The higher the quality, the larger the file. (If you select Rasterize for Unsupported Features, the JPEG Quality setting is used for all JPEG-compressed bitmap images exported to the SWF file, including bitmap images generated from composition frames or Adobe Illustrator files.)

Unsupported Features Specifies whether to rasterize features that SWF format doesn't support. Choose Ignore to exclude unsupported features, or choose Rasterize to render all frames that contain unsupported features as JPEG-compressed bitmap images and include them in the SWF file. If you choose Rasterize, the SWF Exporter rasterizes source files for each layer in the composition (except layers that use Illustrator files or solids as the source footage) and nested compositions with Collapse Transformations enabled.

Audio Bit Rate The bit rate of the exported audio. Choose Auto to get the lowest bit rate available for the specified Sample Rate and Channels settings. Higher bit rates increase file size. Flash audio is in MP3 format.

Loop Continuously Specifies that the exported SWF file loops continuously during playback. If you plan to specify looping by writing HTML code to control the Flash Player, deselect Loop Continuously.

Prevent Import Creates a SWF file that digital image or video-editing programs can't import.

Include Object Names Includes layer, mask, and effect names in the file, for use as input to ActionScript programs. Selecting this option increases file size. Rasterized objects are not named.

Each mask is exported as a separate SWF object, the name of which is the layer name followed by the mask name. If all masks use Difference mode, all masks are exported as one SWF object, and the name is the layer name. Each text character is exported as a separate SWF object.

Flatten Illustrator Artwork Splits all overlapping objects into non-overlapping pieces. When you select this option, you don't need to convert Illustrator text to outlines before exporting. (This option supports source files from Illustrator 9.0 or later.)

There are advantages and disadvantages to flattening Illustrator artwork. When you flatten Illustrator artwork, text is exported to SWF properly, so you don't need to convert text to outlines. Overlapping objects are removed, so composited layers appear the same in both After Effects and the SWF file. End caps, joins, and transparency groups are exported properly, and artwork outside crop marks, which is not visible in the SWF file, is not included. However, SWF files don't necessarily become smaller. In addition, the flattening process may introduce unsupported objects

that are then ignored or rasterized, and white fringes may appear around some objects. The process can be slow, memory-intensive, and possibly ineffective for complex Illustrator artwork.

Include Layer Marker Web Links Makes layer-time markers behave as web links. The Include Layer Marker Web Links option adds web links and a Get URL action to the SWF file by using information from layer-time markers. This option also adds a frame label to each SWF frame that has a layer-time marker. You can specify how the browser opens the web link with standard target commands (for example, `_blank`). (See “Create a web link, chapter link, or cue point from a marker” on page 118.)

Target commands for web links in a SWF file

`_blank` Loads the web link into a new browser window.

`_parent` Loads the web link into the parent frame of the frame in which the current file is playing.

`_self` Loads the web link into the current frame.

`_top` Loads the web link into the top frame in the current window.

`_level0` Loads another SWF file into level 0. The current file typically plays at level 0; another file loaded into level 0 usually replaces the current file. Note that the URL must refer to another SWF file.

`_level1` Loads another SWF file into level 1 if the URL refers to another SWF file.

Supported features for SWF export

Layers After Effects text layers are exported to SWF as vector graphics. The following layer types and layer switches aren't supported: track mattes, 3D layers, 3D cameras, 3D lights, adjustment layers, shape layers, Preserve Transparency, Collapse Transformations, and motion blur. The Fill Over Stroke character option and the Blur animator property aren't supported, and only Normal blending mode is supported. Nested compositions aren't supported and are rasterized.

Masks Only masks with Add mask mode or Difference mask mode are supported; multiple masks in a layer must use the same mask mode. If Add mode is specified, partial opacity and the Inverted option are also supported. Mask feather is not supported. The result of overlapping masks with Add mode and partial opacity may appear differently in the SWF file than in After Effects. (See “Mask modes” on page 260.)

Effects Path Text, Audio Waveform, and Audio Spectrum are supported for output to SWF.

All Path Text options are supported, except the following: Composite On Original, Fill Over Stroke, and Difference mode.

Lines drawn by the Audio Spectrum and Audio Waveform effects are converted to vectors. The following unsupported features are ignored: Outside Color (only Inside Color is used), Softness, and Composite On Original. In addition, only uniformly thick lines are included in the SWF file. For example, if you select the Use Polar Path option in Audio Spectrum, lines become thicker farther from the center in After Effects, but in the SWF file the lines remain at the same thickness.

The waveforms may increase the SWF file size, so decrease the Displayed Samples value in the Audio Waveform effect or the Frequency Bands value in the Audio Spectrum effect, or decrease the frame rate to make the SWF file smaller.

Resolution SWF files are always created at full resolution (size of composition); JPEG-compressed bitmap images are rendered at full resolution.

Adobe Illustrator files Only stroked paths and filled paths in CMYK or RGB color spaces are supported.

Layers that have Illustrator source files are converted to corresponding SWF items if the layer does not contain masks or have Collapse Transformations enabled. Illustrator layers that contain masks or have Collapse Transformations

enabled are rasterized. The SWF file maintains the Illustrator crop marks. Artwork outside the crop marks is included in the SWF file even though it's not visible, thereby increasing the file size.

The SWF export report lists information for unsupported features in Illustrator files for the first frame in which the Illustrator file is visible. Unsupported features are ignored or rasterized (depending on whether you've selected Ignore or Rasterize Unsupported Features) on all frames in which the footage is visible.

Rendering and exporting still images and still-image sequences

Creating motion-picture film

If you intend to display your finished project on motion picture film, you should plan your workflow carefully. You may employ a *matchback* process, in which you shoot on film, transfer to video, and then conform the film negative to your edits. On the other hand, you may choose to shoot and edit using a video format (ideally, a high-definition format, and perhaps shoot at 24 fps to match theatrical film frame-rate) and transfer the finished project to film. In any case, you'll need to consider the important ways film and video formats differ—such as in their image resolutions, aspect ratios, and frame rates—and how to reconcile those differences.

For the production phase, you'll need to consider the acquisition format that best suits your needs. During post-production, you may need to transfer the source footage to the appropriate format for editing, effects, and sound design (using programs such as Adobe Premiere Pro, After Effects, and Soundbooth). When exporting from post-production software, you must determine the file settings appropriate to the film stock you'll use, or you'll need to decide how to best translate your editing decisions to film. If you choose to transfer video to film, it's likely you'll employ a facility that can accomplish the transfer using a *film recorder*, a device that prints video frames to motion picture film frames. To determine the best course, consult the production and post-production facilities before you begin.

Rendering and exporting a sequence of still images

You can export a rendered movie as a sequence of still images, in which case each frame of the movie is output as a separate still-image file. When you render one movie using multiple computers on a network, the movie is always output as a still-image sequence. Many 3D animation programs accept sequences of still images. Sequences of PNG files are often a good choice for transfer of visual elements from After Effects to Flash.

If you are creating a movie for transfer to film, you will need to create a sequence of still images that you can then transfer to film using a film recorder.

Creating a sequence of PSD files is a good way to transfer frames to Photoshop for touchup and editing. You can then import the image sequence back into After Effects.

When specifying the output file name for a still-image sequence, you actually specify a file-naming template. The name that you specify must contain pound signs surrounded by square brackets ([#####]). As each frame is rendered and a file name created for it, After Effects replaces the [#####] portion of the name with a number indicating the order of the frame in the sequence. For example, specifying **mymovie_[#####].tga** would cause output files to be named **mymovie_00001.tga**, **filmout_00002.tga**, and so on.

The maximum number of frames in a still-image sequence is 32,766.

See also

“Render and export a movie using the render queue” on page 590

Export a single frame of a composition

You can export a single frame from a composition, either as an Adobe Photoshop (PSD) file with layers intact or as a rendered image. This is useful for editing files in Adobe Photoshop, preparing files for Adobe Encore, creating a proxy, or exporting an image from a movie for posters or storyboards.

The Photoshop Layers command preserves all layers from a single frame of an After Effects composition in the resulting Photoshop file. Nested compositions up to five levels deep are preserved in the PSD file as layer groups. The PSD file inherits the color bit depth from the After Effects project.

In addition, the layered Photoshop file contains an embedded composite (flattened) image of all the layers. This ensures that the file is compatible with applications that don't support Photoshop layers; such applications display the composited image and ignore the layers.

A layered Photoshop file saved from After Effects may look different from the frame viewed in After Effects if the frame uses features that aren't supported by Photoshop. For example, if the frame contains a blending mode that isn't available in Photoshop, a blending mode that most resembles it is substituted in the layer, but the embedded composite image (viewable only by applications that don't support Photoshop layers) looks the same. Alternatively, you can render the frame using the Composition > Save Frame As > File command to export a flattened and rendered version of the file to the PSD format.

- 1 Go to the frame that you want to export so that it is shown in the Composition panel.
- 2 Do one of the following:
 - To render a single frame, choose Composition > Save Frame As > File. Adjust settings in the Render Queue panel if necessary, and then click Render.
 - To export a single frame as an Adobe Photoshop file with layers, choose Composition > Save Frame As > Photoshop Layers.



To copy the frame in the active Composition, Layer, or Footage panel to the clipboard so that you can paste it into another application, you can use the Copy Image plug-in, from ObviousFX:

www.adobe.com/go/learn_ae_obviousfxcopyimage.

See also

“Work in the Render Queue panel” on page 591

About Filmstrip format

In Adobe Photoshop, you can edit video frames, or even paint directly on them—a process known as *rotoscoping*. One method is to first export the video frames from your video application in filmstrip format.

Note: You can also use the video layers feature in Adobe Photoshop Extended to edit video files not in filmstrip format, and you can rotoscope with paint tools in After Effects without using the filmstrip format. For help in choosing whether to use filmstrip format, or whether to use Photoshop or After Effects for a given task, see Photoshop Help.

From some video editing and compositing applications such as Adobe Premiere Pro (Windows only) and After Effects, you can export part or all of a composition, sequence, or clip as a single filmstrip file. Because video compression isn't used in creating filmstrip files, they can be large. If your computer doesn't have enough memory for Photoshop to load the filmstrip file, you can break the file into any number of smaller files by setting the work area to a different portion of the composition or sequence before rendering or exporting each portion, or you can export the composition, clip, or sequence as numbered still images so that you can edit each frame as a separate file.

Note: If you simply want to export a single frame, you don't need to use Filmstrip format.

A filmstrip opens in Adobe Photoshop as a series of frames in a column, with each frame labeled by number, reel name, and timecode. If the column created by the filmstrip frames is more than 30,000 pixels tall, the frames continue in a second column. The number of frames displayed depends on the duration of the footage or clip and the frame rate selected when you render the filmstrip.

When editing a filmstrip in Adobe Photoshop, use the following guidelines for best results:

- After Effects and Adobe Premiere Pro display only the part of each frame that lies within the frame border; however, you can paint on the gray lines dividing the frames of the filmstrip without damaging the file.
- You can edit the red, green, blue, and alpha channels in the filmstrip file. Use only channel 4 as the alpha channel; other alpha channels aren't recognized.
- Don't resize or crop the filmstrip.
- Flatten any layers you add in Adobe Photoshop.

Exporting project information to other Adobe applications

Export an After Effects project to Adobe Premiere Pro

You can export an After Effects project as an Adobe Premiere Pro project without rendering.

Note: After Effects CS3 projects saved as Premiere Pro projects cannot be opened by Premiere Pro 2.0 or earlier.

When you export an After Effects project as an Adobe Premiere Pro project, Adobe Premiere Pro uses the settings from the first composition in the After Effects project for all subsequent sequences. Keyframes, effects, and other properties are converted in the same way as when you paste an After Effects layer into an Adobe Premiere Pro sequence.

- 1 Choose File > Export > Adobe Premiere Pro Project.
- 2 Specify a file name and location for the project, and click Save.

Note: You can also import Adobe Premiere Pro projects into After Effects.

See also

“Importing from After Effects and Adobe Premiere Pro” on page 63

About Dynamic Link (Production Premium only)

In the past, sharing media assets among post-production applications has required you to render your work in one application before importing it into another—an inefficient and time-consuming workflow. If you wanted to make changes in the original application, you had to re-render the asset. Multiple rendered versions of an asset consume disk space and can lead to file-management challenges.

Adobe Dynamic Link, a feature of Adobe Creative Suite Production Premium, offers an alternative to this workflow: the ability to create dynamic links, without rendering, between new or existing compositions in Adobe After Effects and either Adobe Premiere Pro or Adobe Encore. Creating a dynamic link is as simple as importing any other type of asset, and dynamically linked compositions appear with unique icons and label colors to help you identify them. Dynamic links are saved as part of the Adobe Premiere Pro or Encore project.

Changes you make to a dynamically linked composition in After Effects appear immediately in the linked files in Adobe Premiere Pro or Encore; you don't have to render the composition or even save changes first.

When you link to an After Effects composition, it appears in the target component's Project panel. You can use the linked composition as you would any other asset. When you insert a linked composition into the target component's timeline, a linked clip, which is simply a reference to the linked composition in the Project panel, appears in the Timeline panel. After Effects renders the linked composition on a frame-by-frame basis during playback in the target application.

- In Adobe Premiere Pro, you can preview the linked composition in the Source Monitor, set In and Out points, add it to a sequence, and use any of the Adobe Premiere Pro tools to edit it. When you add a linked composition that contains both footage and audio layers to a sequence, Adobe Premiere Pro inserts linked video and audio clips in the timeline. (You can unlink these to edit them separately; search for “Unlink video and audio” in Adobe Premiere Pro Help.)
- In Encore, you can use the linked composition to create a motion menu or insert it into a timeline, and use any of the Adobe Encore tools to edit it. When you add a linked composition that contains both video and audio layers to an Encore timeline, Encore inserts separate video and audio clips in the timeline.

 *Other ways to share content among Production Premium components include copying and pasting between After Effects and Adobe Premiere Pro, exporting After Effects projects to Adobe Premiere Pro, using the Capture In Adobe Premiere Pro command in After Effects, creating After Effects compositions from Encore menus, or importing Adobe Premiere Pro projects into After Effects. For more information, see the relevant component's Help.*

For a tutorial on Adobe Dynamic Link, see www.adobe.com/go/learn_dv_tutorial_dynlink.

Saving and Dynamic Link (Production Premium only)

You must save your After Effects project at least once before you can create a dynamic link from Adobe Premiere Pro or Encore to a composition within it. However, you don't have to subsequently save changes to an After Effects project to see changes to a linked composition in Adobe Premiere Pro or Encore.

If you use the Save As command to copy an After Effects project that contains compositions referenced by Adobe Dynamic Link, Adobe Premiere Pro or Encore uses the original composition—not the new copy—as its source for the linked composition. You can relink a composition to the new copy at any time.

Managing performance and Dynamic Link (Production Premium only)

Because a linked composition may reference a complex source composition, actions you perform on a linked composition may require additional processing time as After Effects applies the actions and makes the final data available to Adobe Premiere Pro or Encore. In some cases, the additional processing time may delay preview or playback.

If you're working with complex source compositions and experiencing playback delays, you can take the composition offline or disable a linked clip to temporarily stop referencing a dynamically linked composition, or render the composition and replace the dynamically linked composition with the rendered file. If you commonly work with complex source compositions, try adding RAM or using a faster processor.

Color and Dynamic Link (Production Premium only)

Adobe After Effects works in the RGB (red, green, blue) color space. Adobe Premiere Pro, however, works in the YUV color space. When you work with a dynamically linked composition, Adobe Premiere Pro either converts it to YUV or retains the RGB color space, depending on the output format.

Dynamically linked compositions are rendered in the color depth of the After Effects project (8-, 16-, or 32-bpc, depending on project settings). Set the After Effects project color depth to 32-bpc if you're working with HDR (high dynamic range) assets.

 *In Adobe Premiere Pro, choose Project > Project Settings > Video Rendering, and select Maximum Bit Depth to have Adobe Premiere Pro process at the highest possible quality. This option may slow processing.*

Link to a new composition with Dynamic Link (Production Premium only)

When you link to a new composition from Adobe Premiere Pro or Encore, After Effects starts and creates a new project and composition with the dimensions, pixel aspect ratio, frame rate, and audio sample rate of your Adobe Premiere Pro or Encore project. (If After Effects is already running, it creates a new composition in the current project.) The new composition name is based on the Adobe Premiere Pro or Encore project name, followed by "Linked Comp [x]."

- 1 In Adobe Premiere Pro or Adobe Encore, choose File > Adobe Dynamic Link > New After Effects Composition.
- 2 If the After Effects Save As dialog box appears, enter a name and location for the After Effects project, and click Save.

 *When you link to a new After Effects composition, the composition duration is set to 30 seconds. To change the duration, select the composition in After Effects and choose Composition > Composition Settings. Click the Basic tab, and specify a new value for Duration.*

Link to an existing composition with Dynamic Link (Production Premium only)

For best results, composition settings (such as dimensions, pixel aspect ratio, frame rate, and audio sample rate) should match those used in the Adobe Premiere Pro or Adobe Encore project.

❖ Do one of the following:

- In Adobe Premiere Pro or Encore, choose File > Adobe Dynamic Link > Import After Effects Composition. Choose an After Effects project file (.aep), and then choose one or more compositions.
- Drag one or more compositions from the After Effects Project panel to the Adobe Premiere Pro or the Encore Project panel.
- In Adobe Premiere Pro, choose File > Import. Choose an After Effects project file and click Open, and then choose a composition in the Import Composition dialog box and click OK.
- In Adobe Premiere Pro, drag an After Effects project file into the Project panel. If the After Effects project file contains multiple compositions, Adobe Premiere Pro displays the Import Composition dialog box.

Note: *You can link to a single After Effects composition multiple times in a single Adobe Premiere Pro project. In an Adobe Encore project, however, you can link to an After Effects composition only once.*

Encore and After Effects: If you are linking to Dynamic Link compositions that were created using Create After Effects Composition from Encore, turn off subpicture highlight layers in After Effects so that you can control their display in Encore. For more information, search for “subpicture” in Adobe Encore DVD Help or Adobe After Effects Help.

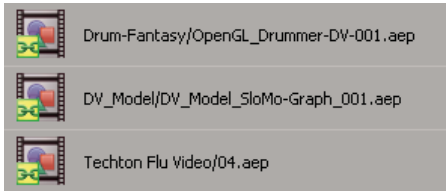

Dynamically linked After Effects compositions

Delete a dynamically linked composition or clip (Production Premium only)

You can delete a linked composition from an Encore project if the composition isn't used in the project. You can delete a linked composition from an Adobe Premiere Pro project at any time, even if the composition is used in a project.

You can delete linked clips, which are simply references to the linked composition in the Project panel, from the timeline of an Adobe Premiere Pro sequence or from an Encore menu or timeline at any time.

❖ In Adobe Premiere Pro or Encore, select the linked composition or clip and press the Delete key.

Edit a dynamically linked composition in After Effects (Production Premium only)

Use the Edit Original command in Adobe Premiere Pro or Encore to edit a linked After Effects composition. Once After Effects is open, you can make edits without having to use the Edit Original command again.

1 Select the After Effects composition in the Adobe Premiere Pro or Encore Project panel, or choose a linked clip in the Timeline, and choose Edit > Edit Original.

2 Make edits in After Effects, and then switch back to Adobe Premiere Pro or Encore to view your changes.

The changes made in After Effects will appear in Adobe Premiere Pro, but any preview files Adobe Premiere Pro may have rendered for the clip prior to the changes will be invalidated.

***Note:** If you change the name of the composition in After Effects after you've created a dynamic link to it from Adobe Premiere Pro, Adobe Premiere Pro doesn't update the linked composition name in the Project panel, but retains the dynamic link.*

Offline compositions and Dynamic Link (Production Premium only)

Adobe Premiere Pro and Encore display dynamically linked compositions as offline in any of the following circumstances:

- You've renamed, moved, or deleted the After Effects project that contains the composition.
- You've purposely taken the composition offline.
- You've opened the project that contains the composition on a system on which Production Premium isn't installed.
- You're working with a project trimmed by the Adobe Premiere Pro Project Manager. Project Manager does not move the After Effects source compositions to the trimmed project folder. You must do this manually.

Offline compositions appear with an Offline icon  in the Adobe Premiere Pro Project panel. In Encore, the thumbnail preview displays the Offline icon when an offline asset is selected in the Project panel. If you're working with an offline composition, you can relink it to the original After Effects composition. You can also choose to relink a linked composition to a different source composition.

Take a dynamically linked composition offline (Production Premium only)

You can take a dynamically linked composition offline if system resources are low, preventing you from smoothly playing back or previewing, or if you want to share your project without having to open it on a system with Production Premium installed. When you take a composition offline, you sever the dynamic link with After Effects, and the linked composition is replaced in the Project panel with an offline composition.

 You can temporarily suppress a linked clip in Adobe Premiere Pro by selecting the clip and choosing **Clip > Enable**. To relink the clip, choose **Clip > Enable** again (a check mark next to the command indicates that the clip is enabled). For more information about disabling clips, see *Adobe Premiere Pro Help*.

- 1 In Adobe Premiere Pro, select the composition in the Project panel.
- 2 Choose **Project > Make Offline**.

Relink a dynamically linked composition (Production Premium only)

❖ Do one of the following:

- In Adobe Premiere Pro, select the composition and choose **Project > Link Media**. In the Import Composition dialog box, choose an After Effects project, and then choose a composition.
- In Encore, right-click the composition and choose **Locate Asset**. In the Locate Asset dialog box, locate the composition you want to link to and then click **Select (Windows)** or **Open (Mac OS)**.

Encoding and compression options for movies

Format options and export settings

After Effects uses the Adobe Media Encoder to encode most movie formats through the Render Queue panel. You can use QuickTime to encode other movie formats (such as raw DV streams) through the **File > Export** menu.

For most output formats, you can specify format-specific encoding and compression options. In many cases, a dialog box opens and presents these options when you choose a format to export to, either in the Output Module Settings dialog box or from the **File > Export** menu.

Formats encoded by the Adobe Media Encoder share a similar export settings dialog box, which you can open by clicking the **Format Options** button in the Output Module Settings dialog box.

When exporting with the Adobe Media Encoder, choosing a format automatically makes available a list of associated presets designed for particular delivery scenarios (for example, the Apple iPod Video Small preset for the H.264 format). Choosing a preset activates the appropriate options in the various settings panels (Video, Audio, and so on).

Note: It is possible in some cases to specify a setting in an export settings dialog box that conflicts with a setting made in the Render Settings or Output Module Settings dialog box. In such cases, After Effects warns you of the mismatch so that you can correct it before continuing.

See also

“Render and export a movie using the render queue” on page 590

“Work with output module settings” on page 599

About the Adobe Media Encoder

The Adobe Media Encoder is an encoding mechanism employed by programs such as Adobe Premiere Pro, After Effects, Soundbooth, and Encore for output to certain media formats. Depending on the program, the Adobe Media Encoder provides a specialized Export Settings dialog box that accommodates the numerous settings associated with certain export formats, such as MPEG-2, Adobe Flash Video, and H.264. For each format, the Export Settings dialog box includes a number of presets that are tailored for particular delivery media. You can also save custom presets, which you can share with others or reload as needed.

Although the Export Settings dialog box’s appearance varies slightly and is accessed differently in different software, its general form and function are consistent. The Export Settings dialog box always contains a section for general export settings (such as Format and Preset) and one or more tabbed sections. The sections available depend on the format and preset you specify. The tab menu also contains commands specific to the selected format.

When you export a movie file for delivery media other than full-screen, full frame-rate television, you usually need to deinterlace the frames, crop the image, or apply certain filters. Through the Export Settings dialog box, the Adobe Media Encoder offers these tasks as pre-encoding options, because it’s best to perform them prior to encoding the file. You can also specify post-encoding tasks, which include generating a log file or uploading the exported file to a specified server automatically.

About MPEG

MPEG is the name of a family of file formats specified by the ISO/IEC Moving Picture Experts Group. MPEG formats include several compression methods. It requires significant processing power and time to generate these keyframe-based file formats from other video formats.

MPEG-1 Generally used for the Internet and CD-ROM, providing picture quality comparable with VHS quality at quarter-screen frame size.

MPEG-2 Delivers higher quality video than MPEG-1. A specific form of MPEG-2 was chosen as the standard for compressing video for DVD video. This is called *DVD-compliant MPEG-2*. MPEG-2 compression is also used in HDV, and supported in the HD-DVD, and Blu-ray formats.

MPEG-4 Includes many of the features of MPEG-1 and MPEG-2, and adds support for interactivity. It offers better compression and reduces file size while maintaining the same perceptual quality level as MPEG-2. MPEG-4 part 10 (H.264, AVC) is the supported by the Blu-ray and HD-DVD formats.

After Effects and Adobe Premiere Pro offer a number of MPEG presets to optimize the output quality for various project types. If you’re experienced with MPEG encoding, you can further fine-tune projects for specific playback situations by customizing the presets in the Export Settings dialog box.

In After Effects, you can create MPEG-2 and MPEG-2 DVD video. In Adobe Premiere Pro, you can create various types of MPEG video by using the File > Export > Adobe Media Encoder command or export directly to DVD-compliant video by using the Export To Encore command (any video you export to DVD is automatically transcoded to MPEG-2 if it isn’t already in that format).

 *After Effects and Adobe Premiere Pro add metadata to MPEG-2 files that Encore can read for aid in authoring and building DVDs. This metadata contains information that enables Encore to multiplex audio and video, automatically generate DVD chapter points, and open clips in the applications from which they were rendered. For more information, see Encore Help.*

Filter options for encoding

Noise, grain, and similar artifacts can interfere with the efficient compression of images. For this reason, the size of the final output file may in some cases be reduced by applying a noise reduction filter to an image or movie before compression takes place.

In the Export Settings dialog box, you can specify whether to apply a noise reduction filter before compression, and you can also set the amount of noise filtering to apply.

If you intend to remove noise and grain from a project for reasons other than reduction of compressed file size, consider using the Noise & Grain effects in Adobe Premiere Pro or After Effects.

Video options for encoding

In the Export Settings dialog box, the options available in the Video tab depend on the format you've specified. Video settings include some or all of the following options:

Codec Specifies the codec used to encode the video from those available on your system.

Quality Specifies the encoding quality. Generally, higher values increase rendering time and file size.

Encode Alpha Channel Enables encoding of an alpha channel into the exported file for formats, such as Adobe Flash Video, that support alpha channels.

TV Standard Conforms the output to the NTSC or PAL standard.

Frame Width Scales the output frame's horizontal aspect to the specified width.

Frame Height Scales the output frame's vertical aspect to the specified height.

Frame Rate The output frame rate for either NTSC or PAL formats.

Field Order Specifies whether the output file's frames are interlaced, and if so, whether the upper or lower field is first in the scanning order.

Pixel Aspect Ratio Specifies the ratio of each pixel's width to height, which determines the number of pixels required to achieve a given image aspect ratio. Some formats use square pixels, while others use nonsquare pixels.

Bitrate Encoding Specifies whether the codec achieves a constant or variable bitrate in the exported file:

- **Constant Bit Rate (CBR)** Compresses each frame in the source video to the fixed limit you specify, producing a file with a fixed data rate. Therefore, frames containing more complex data are compressed more, while less complex frames are compressed less.

- **Variable Bit Rate (VBR)** Allows the exported file's data rate to vary within a range you specify. Because a given amount of compression degrades the quality of a complex image more than it degrades the quality of a simple image, VBR encoding compresses complex frames less and compresses simple frames more.

In general, an image is complex and more difficult to compress efficiently if it contains great detail or if it differs significantly from previous frames, as it would in a scene containing motion.

Note: When comparing CBR and VBR files of the same content and file size, you can make the following generalizations: A CBR file may play back more reliably over a wider range of systems, because a fixed data rate is less demanding on a media player and computer processor. However, a VBR file tends to have a higher image quality, because VBR tailors the amount of compression to the image content.

Bitrate Specifies the number of megabits per second of playback for the encoded file. (This setting is available only if you select CBR as the Bitrate Encoding option.)

The following options appear only if you select VBR as the Bitrate Encoding option:

Encoding Passes Specifies the number of times the encoder will analyze the clip before encoding. Multiple passes increase the time it takes to encode the file, but generally result in more efficient compression and higher image quality. (Adobe After Effects doesn't support multiple encoding passes.)

Target Bitrate Specifies the number of megabits per second of playback for the encoded file.

Maximum Bitrate Specifies the maximum number of megabits per second of playback you want the encoder to allow.

Minimum Bitrate Specifies the minimum number of megabits per second of playback you want the encoder to allow. The minimum bitrate differs according to the format. For MPEG-2-DVD, the minimum bitrate must be at least 1.5 Mbps.

M frames Specifies the number of B frames (Bi-directional frames) between consecutive I frames (Intra-frames) and P frames (Predicted frames).

N frames Specifies the number of frames between I frames (Intra-frames). This value must be a multiple of the M frames value.

Closed GOP Every Specifies the frequency of each Closed Group of Pictures (Closed GOP), which cannot reference frames outside of the closed GOP. A GOP consists of a sequence of I, B, and P frames. (This option is available if you choose MPEG-1 or MPEG-2 as the format.)

Automatic GOP Placement When selected, sets the placement of Group of Pictures (GOP) automatically. (This option is available if you choose MPEG-1 as the format.)

Note: MPEG-1 and MPEG-2 formats include numerous advanced options not listed here. In most cases, selecting a format or preset designed for your target output sets the appropriate options automatically. For detailed information on options not listed, consult the specifications for the MPEG-1 (ISO/IEC 11172) and MPEG-2 (ISO/IEC 13818) formats.

Audio options for encoding

In the Export Settings dialog box, the options available in the Audio tab depend on the format you've specified. Some common audio options include the following:

Codec Specifies the codec used to encode the audio:

- **AAC (Advanced Audio Coding)** A high-quality encoding format supported by many mobile devices. This codec is the default for the H.264 format.
- **SurCode for Dolby Digital 5.1** A high-quality encoding format developed for multichannel digital sound and the most common encoder for DVD-video. (This codec is available only in Adobe Premiere Pro.)
- **MainConcept MPEG Audio** A high-quality encoder developed by MainConcept media technologies, and included with Adobe Premiere Pro, After Effects, and Soundbooth.
- **PCM (pulse-code modulation) Audio** A lossless audio format. Files of this format tend to be larger than files of the other formats.

Audio Format Determines the audio type.

Bit Rate Specifies the output bit rate of the audio. Generally, higher bit rates increase both quality and file size. This option is available for Dolby® Digital, MainConcept MPEG, and some Windows Media audio codecs.

Note: Options not documented here are specific to the selected format. For detailed information, consult the specifications for the selected format.

Alternates and Audiences options for encoding

In the Export Settings dialog box, specifying a streaming media codec in RealMedia or Windows Media formats enables Audiences options, while QuickTime streaming media codecs enable a similar set of Alternates options. Both allow you to output variations of a movie suited to different network speeds. The player software associated with the format detects and selects the most appropriate version to ensure smooth playback. For example, Windows Media includes Audiences such as Dial-up Modems (56 Kbps) and Broadband Or Cable Modem/DSL (384 Kbps). Whereas QuickTime generates individual movies suited for each export type, RealMedia and Windows Media generate a single movie that stores the variations.

Note: Some codec-specific settings are not documented here. For more detailed information regarding a particular codec, check the documentation provided by its developer.

Add Alternates or Audiences

- 1 Choose a format that supports streaming media (QuickTime, RealMedia, or Windows Media).
- 2 From the Preset menu in the Export Settings dialog box, choose a streaming option.
- 3 Select the Filters, Video, Audio, and Others tabs and specify the options you want.
- 4 Do either of the following:
 - For RealMedia or Windows Media output, select Audiences and specify options.
 - For QuickTime output, select Alternates and specify options.
- 5 With any tab selected, choose Add/Remove Audiences (or Add/Remove Alternates) from the tab menu.
- 6 In the Select Audiences (or Select Alternates) dialog box, click Add.
- 7 In the System Audiences (or System Alternates) dialog box, select the options appropriate for your intended viewers, and click OK.
- 8 Click OK to close the Select Audiences (or Select Alternates) dialog box.

Note: You can't have more than ten alternates or audiences. If necessary, you can delete the ones you don't want, and add the ones you want.

Copy or delete an Alternate or Audience

- 1 Choose a format that supports streaming media (QuickTime, RealMedia, or Windows Media).
- 2 From the Preset menu in the Export Settings dialog box, choose a streaming option.
- 3 Select the Filters, Video, Audio, and Others tabs and specify options.
- 4 Do either of the following:
 - For RealMedia or Windows Media output, select Audiences and specify options.
 - For QuickTime output, select Alternates and specify options.
- 5 With any tab selected, choose Add/Remove Audiences (or Add/Remove Alternates) from the tab menu.

6 In the Select Audience (or Select Alternate) dialog box, select the item you want to copy or delete, and click Duplicate or Remove.

7 If copying, double-click the name of the duplicate item, type a new name, and then click OK.

8 When you finish, click OK.

Note: Removing an item from the Alternates or Audiences list can't be undone.

Others options for encoding

The Others tab of the Export Settings dialog box allows you to upload the exported file to an FTP (File Transfer Protocol) server that has storage space allocated for file sharing. FTP is a common method for transferring files over a network and is especially useful for sharing relatively large files using an Internet connection. The server's administrator can provide you with the correct information to connect to the server.

The Others tab includes the following options:

Server Name Enter the DNS or IP address of the server on which the FTP site is located.

Port Specify the number assigned to the FTP server's command port, which is 21 by default.

Remote Directory Enter the location on the FTP server to access, expressed as a file path.

User Login Enter the user's identity, as designated by the server's administrator.

Password Enter the password to a password-protected server.

Retries Specify the number of attempts to contact the server if a connection isn't established.

Send Local File To Recycle Bin (Windows) or Send Local File to Trash (Mac OS) Deletes the local copy of the exported file once it's been uploaded to the FTP server.

Test Verifies the connection with the FTP server.

Log File Details Specify whether to generate a log file, and select the information that the log file includes (errors, warnings, settings, and render frame time). (Not supported for Windows Media, QuickTime, or Adobe Flash Video).

Media Encoder MPEG multiplexer preset options

Multiplexer preset options control how After Effects and Adobe Premiere Pro merge MPEG video and audio data into a single stream. The exact options available depend on the MPEG format you choose.

When you choose the MPEG-2 format, all Multiplexer options provided by the MPEG standard are available for manual control. In most cases, it's better to select an MPEG format specifically targeted to your output medium (such as MPEG-2 DVD).

MPEG format	ISO/IEC standard
MPEG-4	ISO/IEC 14496
MPEG-2	ISO/IEC 13818
MPEG-1	ISO/IEC 11172

For more information on the options available, see the official web site of the MPEG organization at www.chiariglione.org/mpeg/.

Add XMP metadata to an exported file

Metadata is descriptive file information that can be searched and processed by a computer. Adobe's eXtensible Metadata Platform (XMP) lets you include metadata with a file to provide information about the contents of the file. Applications that support XMP can read, edit, and share this information across databases, file formats, and platforms. Some Adobe software, such as Adobe Bridge, can use or write XMP information.

You can specify XMP metadata to be included with files you export using the Adobe Media Encoder.

❖ In the Export Settings dialog box, select XMP Info on the settings tab menu, and then enter information in the appropriate fields.

Preview a movie on a virtual mobile device using After Effects

Using Adobe Device Central, you can preview movies formatted for mobile devices in emulations of those devices. This option is available for most of the H.264 formats listed in the Adobe Media Encoder.

- 1 Start After Effects.
- 2 In the Project panel, select the composition to preview.
- 3 Choose Composition > Add to Render Queue.
- 4 In the Render Queue panel, click the underlined text to the right of Output Module, or select Custom from the Output Module menu.
- 5 In the Output Modules Settings dialog box, choose H.264 from the Format menu.
- 6 In the Export Settings section of the H.264 dialog box, select Open in Device Central.
- 7 Modify other settings as desired and click OK.
- 8 Click OK to close the Output Module Settings dialog box.
- 9 In the Render Queue panel, click Render.

Rendering may take a few minutes, depending on the size of the file. When rendering is complete, a temporary file is displayed in the Adobe Device Central Emulator tab. To continue testing, double-click the name of a different device in the Device Sets or Available Devices lists.

About compression of movie files

Compression is essential to reducing the size of movies so that they can be stored, transmitted, and played back effectively. When exporting or rendering a movie file for playback on a specific type of device at a certain bandwidth, you choose a compressor/decompressor (also known as an encoder/decoder, or *codec*), to compress the information and generate a file readable by that type of device at that bandwidth.

A wide range of codecs is available; no single codec is best for all situations. For example, the best codec for compressing cartoon animation is generally not efficient for compressing live-action video. When compressing a movie file, you can fine-tune it for the best-quality playback on a computer, a mobile device, the web, or a DVD player. Depending on which encoder you use, you may be able to reduce the size of compressed files by removing artifacts that interfere with compression, such as random camera motion and excessive film grain.

The codec you use must be available to your entire audience. For instance, if you use a hardware codec on a capture card, your audience must have the same hardware codec installed, or a software codec that emulates it.

For more information about compression, see www.adobe.com/go/learn_dv_primer_compression.

About data rate

With some video and audio codecs, you can specify the *data rate*, also called the *bit rate*, which controls the amount of video information that must be processed each second during playback. Specifying a data rate actually sets the maximum data rate, because the actual data rate varies depending on the visual content of each frame.

To maximize the quality of encoded video, set the data rate as high as the target delivery medium can support. If you plan to stream video to an audience using dial-up Internet access, this may be as low as 20 kilobits per second; however, if you plan to distribute video on DVD, it may be as high as 7 megabits per second. The data rate you specify depends on the purpose of the video. The following list describes data rate guidelines for some uses:

DVD production The data rate should maximize quality while fitting the entire program within the space available on the DVD.

Non-DV videotape production The data rate should fall within the capabilities of the computer and hard disk that perform the final playback to tape.

Hard-disk playback If the final video will be played back from hard disks, determine the typical data transfer rate of your audience's hard disks and set the data rate accordingly. If you're exporting video to be used in another editing system or to be imported into a compositing application, you'll want to export at the maximum quality. Use a lossless codec or the codec supported by your video capture card, and specify the data rate that the editing system supports for video capture and editing.

CD-ROM playback The data rate for video played from a CD-ROM depends on the speed of the drive. For example, if you're preparing a final video file for a quad-speed CD-ROM drive (600 kilobytes per second), you might specify between 300 and 500 kilobytes per second to account for both the data rate of the drive and for the system overhead required to move the data.

Intranet playback The data rate can be 1 megabit per second or faster, depending on the speed of the intranet.

Streaming video over the web The data rate should account for real-world performance at the target data rate. For example, the data rate for streaming video designed for a 56-kilobit-per-second connection is often set to 40 kilobits per second. The difference accounts for factors such as data volume and line quality that often prevent telephone-based Internet connections from consistently achieving their stated data rate. For broadband connections, set the data rate for streaming video to 128 kilobits per second.

Downloading a video file over the web The data rate is less important than the size of the video file on disk, because the main concern is how long it takes to download the file. However, it still may be desirable to reduce the data rate for downloaded video because doing so reduces the size of the video file, making it download faster.



In Adobe Premiere Pro, use the File > Get Properties For command to analyze the data rate of files you export.

Specify QuickTime compression settings

- 1 In the Render Queue panel, click the underlined name of the output module.
- 2 For Format, choose QuickTime.
- 3 Click Format Options in the Video Output section.
- 4 In the Compression Settings dialog box, choose a compressor.

Note: Set the color depth in the Compression Settings dialog box instead of in the Output Module Settings dialog box. This ensures that non-Adobe plug-ins receive color depth information from After Effects. See step 8.

- 5 Select a Quality level from Least to Best.

Note: (Mac OS only) If you intend to use key frames in the movie, hold down Option and adjust the Quality slider to control the temporal compression of the movie. Temporal compression compresses a movie by comparing successive frames and keeping only changed data. High temporal quality maintains smoothness of motion. Low temporal quality tends to produce jerkiness of motion because a pixel doesn't change unless the difference between frames is great.

6 If you want the smallest possible files, and your compressor choice allows for a key frame rate, select the box and type a number in the Key Frame Every box. Generally, you should type a number equal to the frame rate. For example, if you set a frame rate of 30 fps, type 30 in the Key Frame box. This sets one key frame every 30 frames of your movie.

Note: If you are going to use the resulting movie in another After Effects composition, type a small value (less than 5) in the Key Frame Every box or deselect the Key Frame Every option. The presence of key frames greatly increases the memory required to edit and render a movie.

7 Click OK.

8 If your compressor choice supports different image color depths, choose the appropriate color depth in the Output Module Settings dialog box:

- Choose Millions Of Colors+ if you want 24-bit color quality and you want your composition background to be transparent (to include an alpha channel). The composition's background color is disregarded. Only Animation and None can support the Millions Of Colors+ color depth.
- Choose Millions Of Colors if you want 24-bit color quality but want to include your composition background color (no alpha channel).

Note: Color depth settings of Thousands Of Colors or lower may cause banding and dithered images.

9 Specify other settings in the Output Module Settings dialog box, and then click OK.

See also

“Work in the Render Queue panel” on page 591

“Work with output module settings” on page 599

QuickTime compression options

Choices you make in the Compression Settings dialog box require tradeoffs between file size and movie quality. The higher the visual quality of your movie, the larger the file size.

Quality The Quality control specifies the spatial compression of the movie, which compresses the data in each frame of a composition. Higher quality produces better image quality but results in a bigger movie file. Note that this quality is unrelated to each layer's quality setting in After Effects.

Key Frame Every In QuickTime terminology, the term *key frames* is different from the change-over-time keyframes placed in the After Effects Timeline panel. In QuickTime, key frames are frames that occur at regular intervals in the movie. During compression they are stored as complete frames. Each intermediate frame that separates them is compared to the previous frame, and only changed data is stored. This greatly reduces movie size. Shorter intervals between key frames enable faster seeking and reverse playback, but can significantly increase the size of the file.

Specify Video for Windows compression options

- 1** In the Render Queue panel, click the underlined name of the output module.
- 2** Choose Video For Windows from the Format menu.
- 3** Click Format Options in the Video Output section.

4 In the Video Compression dialog box, choose a compressor from the first menu in the Compressor section. Choose a compressor based on the type of original images you have and the purpose of the rendered movie (available compressors depend on the Video for Windows codecs installed on your computer).



You can render with 10-bpc YUV compression to create 10-bpc AVI files for use with HD footage in Adobe Premiere Pro: choose 10-bit YUV (4:2:2 YUV) from the Compressor menu.

5 Select a Compression Quality level.

6 If you selected either Cinepak or Microsoft Video 1 in step 4, click the Configure button to set other options:

- For Cinepak, choose whether the movie is compressed to color or to black and white.
- For Microsoft Video 1, choose a level for the temporal compression quality of the movie. Temporal compression compresses a movie by comparing successive frames and keeping only changed data. High temporal quality maintains smoothness of motion. Lower temporal quality tends to produce jerkiness of motion because a pixel doesn't change unless the difference between frames is great.

7 If you want the smallest possible files, and your compressor choice allows for a key frame rate, select the Key Frame Every option and type a number of frames. Generally, you should type a number equal to the frame rate. For example, if you set a frame rate of 30 fps, type 30 in the Key Frame box. This sets one key frame every 30 frames of your movie.

***Note:** If you are going to use the resulting movie in another After Effects composition, type a small value (less than 5) in the Key Frame Every field or deselect the Key Frame Every option. The presence of keyframes greatly increases the memory required to edit and render a movie.*

8 Click OK.

9 If your compressor choice supports different image color depths, choose the appropriate color depth in the Output Module Settings dialog box.

10 Specify other settings in the Output Module Settings dialog box, and then click OK.

See also

“Work in the Render Queue panel” on page 591

“Work with output module settings” on page 599

Video for Windows compression options

Microsoft RLE Use for lossless compression limited to 256 colors.

Microsoft DV Use for digital video camcorders.

No Compression Use for a depth setting of Millions Of Colors+ when an alpha channel is required.

Intel Indeo/Microsoft Video Use when compressing video for playback from CD.

Cinepak Use when compressing 16-bit and 24-bit video for playback from CD or for desktop presentations. For best results, use the Cinepak compressor on raw source data that has not been previously compressed with a highly lossy compressor. Note that this is a slow compression method. With Cinepak, decompression is much faster than compression, and the data rate for playback can be defined by the user. However, you cannot save an alpha channel using the Cinepak compressor.

Render a composition to OMF (Windows only)

You can render a composition to the OMF (Open Media Framework Interchange) format to generate Avid media (or essence) files; these files contain only media —not metadata or project data. Each OMF codec has a fixed frame size and frame rate, depending on the output resolution you choose. Make sure that the composition or render settings are set appropriately: If you use an unsuitable frame size or frame rate, After Effects doesn't render the file and returns an error displaying the expected frame size or frame rate.

The OMF file format doesn't support audio, so any audio tracks aren't exported, but you can output audio tracks separately, if desired.

- 1 In the Render Queue panel, click the Output Module template name to open the Output Module Settings dialog box.
- 2 From the Format menu, select OMF.
- 3 Click Format Options.
- 4 Choose a format (NTSC or PAL), an AVR (Avid Video Resolution) codec, and an OMF version.

Note: OMF version 1.0 is supported for backward compatibility with older Avid systems.

AVR codec	NTSC	PAL
1:1	720 x 480 (interlaced), 29.97 fps	720 x 576 (interlaced), 25 fps
1:1 (24p/25p)	720 x 486 (progressive), 24 fps	720 x 576 (progressive), 25 fps
DV	720 x 480 (interlaced), 29.97 fps	720 x 576 (interlaced), 25 fps

See also

“Work in the Render Queue panel” on page 591

“Work with output module settings” on page 599

Automated rendering and network rendering

Automating rendering with `aerender`

The executable file `aerender` (`aerender.exe` on Windows) is a program with a command-line interface with which you can automate rendering. The executable file is located in the same folder as the primary After Effects application. The default locations:

- Windows: \Program Files\Adobe\Adobe After Effects CS3\Support Files
- Mac OS: /Applications/Adobe After Effects CS3

You use the program by entering the command `aerender` on the command line (or in a batch script), followed by a series of optional arguments. Some of the arguments are simple options that take no arguments of their own (e.g., `-reuse`), whereas others take arguments of their own (e.g., `-project project_path`).



Enter the command `aerender -help` to show some of the usage information in this section.

The render may be performed either by an already running instance of After Effects or by a newly invoked instance. By default, `aerender` invokes a new instance of After Effects, even if one is already running. To instead use the currently running instance, use the `-reuse` argument.

This example command tells After Effects to render frames 1 through 10 of Composition_1 in project_1.aep to a numbered sequence of Photoshop files using a multi-machine render:

```
aerender -project c:\projects\project_1.aep -comp "Composition_1" -s 1 -e 10
-RStemplate "Multi-Machine Settings" -OMtemplate "Multi-Machine Sequence"
-output c:\output\project_1\frames[####].psd
```

To render just Composition_1 to a specified file, enter this command:

```
aerender -project c:\projects\project_1.aep -comp "Composition_1" -output c
:\output\project_1\project_1.avi
```

To render everything in the render queue with current settings in the project file, enter this command:

```
aerender -project c:\projects\project_1.aep
```

Argument	Description
-help	Print usage message.
-version	Display the version number of aerender to the console. Does not render.
-v <i>verbose_flag</i>	<i>verbose_flag</i> specifies the type of messages reported: ERRORS : Reports only fatal and problem errors. ERRORS_AND_PROGRESS : (default) Reports errors and progress of rendering.
-reuse	Reuse the currently running instance of After Effects (if found) to perform the render. When an already running instance is used, aerender saves preferences to disk when rendering has completed, but does not quit After Effects. If this argument is not used, aerender starts a new instance of After Effects, even if one is already running. It quits that instance when rendering has completed, and does not save preferences.
-mem_usage <i>image_cache_percent</i> <i>max_mem_percent</i> <i>mem_percent</i>	<i>image_cache_percent</i> specifies the maximum percentage of memory used to cache already rendered images and footage. <i>max_mem_percent</i> specifies the total percentage of memory that can be used by After Effects. For both values, if installed RAM is less than a given amount (<i>n</i> gigabytes), the value is a percentage of the installed RAM, and is otherwise a percentage of <i>n</i> . The value of <i>n</i> is 2 GB for 32-bit Windows, 4 GB for 64-bit Windows, and 3.5 GB for Mac OS.
-project <i>project_path</i>	<i>project_path</i> is a file path or URI specifying a project file to open. If this argument is not used, aerender works with the currently open project. If no project is specified and no project is open, the result is an error.
-comp <i>comp_name</i>	<i>comp_name</i> specifies a composition to be rendered. If the composition is in the render queue already, then the first instance of that composition in the render queue is rendered. If the composition is in the project but not in the render queue, then it is added to the render queue and rendered. If this argument is not used, aerender renders the entire render queue; in this case, only the -project, -log, -output, -v, -mem_usage, and -close arguments are used, and all other arguments are ignored.
-s <i>start_frame</i>	<i>start_frame</i> is the first frame to render. If this argument is not used, aerender uses the start frame in the file.
-e <i>end_frame</i>	<i>end_frame</i> is the last frame to render. If this argument is not provided, aerender uses the end frame in the file.

Argument	Description
<code>-i increment</code>	<i>increment</i> is the number of frames to advance before rendering a new frame. A value of 1 (the default) causes normal rendering of all frames. Higher values render a frame and use it <i>increment</i> times in output, and then skip ahead <i>increment</i> frames to begin the cycle again. Higher values result in faster renders but choppier motion.
<code>-OMtemplate output_module_template</code>	<i>output_module_template</i> is the name of a template to apply to the output module. If the template does not exist, this causes an error. If this argument is not used, <code>aerender</code> uses the template already defined for the output module.
<code>-RStemplate render_settings_template</code>	<i>render_settings_template</i> is the name of a template to apply to the render item. If the template does not exist, this causes an error. If this argument is not used, <code>aerender</code> uses the render template already defined for the item.
<code>-output output_path</code>	<i>output_path</i> is a file path or URI specifying the destination for the final output file. If this argument is not used, <code>aerender</code> uses the path defined in the project file.
<code>-log log_file_path</code>	<i>log_file_path</i> is a file path or URI specifying the location of the log file. If this argument is not used, <code>aerender</code> uses standard output (stdout).
<code>-sound sound_flag</code>	If <i>sound_flag</i> is ON, a sound is played when rendering is complete. Default is OFF.
<code>-close close_flag</code>	<i>close_flag</i> specifies whether or not to close the project when rendering is complete, and whether or not to save changes: DO_NOT_SAVE_CHANGES : (default) The project is closed without saving changes. SAVE_CHANGES : The project is closed and changes are saved. DO_NOT_CLOSE : The project is left open if using an already-running instance of After Effects. (New instances of After Effects must always quit when done.)
<code>-rqindex index_in_render_queue</code>	<code>-rqindex</code> works just like <code>-comp</code> , except that it won't create a render item from the composition automatically.
<code>-mp enable_flag</code>	If <i>enable_flag</i> is 0, additional processes will not be created to render multiple frames simultaneously. If <i>enable_flag</i> is 1, additional processes may be created to render multiple frames simultaneously, depending on system configuration and preference settings. (See "Render multiple frames simultaneously" on page 40.)

Lloyd Alvarez provides a script that takes items that are ready to render in the render queue and sends them to render in the background using `aerender`: www.adobe.com/go/learn_ae_lloydbgrenderer.

See also

"Basics of rendering and exporting" on page 587

"Memory & Cache preferences" on page 39

Network rendering with watch folders

You can render one or more compositions from a project using multiple computers over a network in a fraction of the time that a single computer would require. Network rendering involves copying the project and source files to a networked folder, and then rendering the project.

If you have a full licensed copy of After Effects, you can set it up to work with render-only versions of After Effects called *render engines*. Your license entitles you to install as many copies of the render engine as you want on your network, as long as one activated copy of After Effects is installed on that network.

You install render engines in the same manner as the full version of the application, but you do not activate them. You run the render engine using the Adobe After Effects Render Engine shortcut in the Adobe After Effects CS3 folder. (See “Installation” on page 1.)

Note: For more information, see the Read Me file on the installation DVD or visit the Adobe After Effects support website at www.adobe.com/go/learn_ae_support.

You cannot use a watch folder and multiple render engines to simultaneously render a single movie file. However, you can use multiple render engines to render a movie as a sequence of still-image files. You can then use a post-render action to create a single movie file from that still-image sequence. (See “Use a post-render action” on page 602.)

When you have multiple render engines on multiple computers monitoring a watch folder, they cooperate to achieve optimal efficiency. If your queued render items are set to Skip Existing Files (a Render Settings option), the render engines all work on a single render item at once—no render engine renders any frame another render engine has already worked on. If this option is not selected, each render engine handles a render item itself.

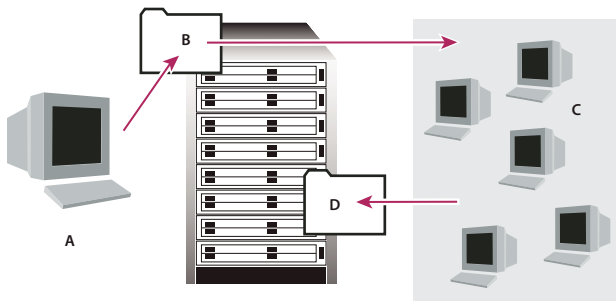

Computer with full version of After Effects (A) saves a project and all source files to a folder (B) on a server. Computers with the render engine installed (C) open the project and render a still-frame sequence to a designated output folder (D) on the server.

Network considerations

When working with multiple render engines on multiple computers, keep the following guidelines in mind:

- When possible, identify folders using absolute file paths so that the paths are correctly identified for all render engines. This may mean mapping network drives to a particular drive letter on all machines (for example, H:\renders\watch\). Avoid using relative paths (for example, \\renders\watch).
- Each Macintosh computer monitoring the watch folder must have a unique name. This means that you should rename your computers to not use the default name.
- Make sure that all servers and clients (computers monitoring the watch folder) have hard disks with unique names.
- Do not use the same computer to serve a watch folder and to run After Effects in Watch Folder mode. Use a dedicated server that's accessible to all render engines to serve your watch folder.

- Do not render to or initiate Watch Folder mode on the root of a volume or a shared folder that appears as the root when viewed from another computer. Specify a subfolder instead. Also, avoid using high-ASCII or other extended characters and slashes in file names. For multiple-computer rendering, After Effects includes the Multi-Machine sample template that you can use as a starting point.

 *When rendering across a network that includes volumes using different network or operating systems, such as Windows, Mac OS, Novell, and UNIX, make sure that you specify output files using a file-naming convention that's compatible with all rendering or destination volumes.*

Project considerations

Make sure that you install all fonts, effects, and encoders (compressors) used in the project on all computers monitoring the watch folder. If a computer monitoring the watch folder can't find fonts, effects, or encoders used in a project, the render fails.

When you install an After Effects render engine on a computer, it contains all the plug-ins included with After Effects. If a composition uses a plug-in from another manufacturer, that plug-in must be present on all computers that will render the composition. However, support for network rendering varies among plug-in manufacturers. Before you set up a network to render effects created by third-party plug-ins, see your plug-in's documentation or contact the plug-in manufacturer and get answers to the following questions:

- Does the plug-in's license agreement allow installing multiple copies on a network for the purposes of rendering?
- Are there any other limitations or tips that apply to using that plug-in for network rendering?

Collect Files folder considerations

When you use the File > Collect Files command, files relevant to a project are copied to a single folder. This folder includes a copy of the project file, a *render control file* (RCF), and other files, depending on the options you choose in the Collect Files dialog box. If you save the Collect Files folder to a networked computer other than a server, don't run a render engine on that computer. Avoid saving the Collect Files folder to a local disk, the root level of a disk (such as C: in Windows or the Macintosh HD in Mac OS), or a shared folder, all of which can signify different locations to each render engine. All render engines must interpret the path in the same way.

 *Once the collected files appear in the watch folder, all monitoring render engines start rendering automatically. If you prefer, you can use the Collect Files command to store compositions and their source footage to a specified location and then initiate the watch-folder rendering process later. Doing so renders the projects in alphabetical order, rather than the order in which they were saved to the location.*

See also

“Basics of rendering and exporting” on page 587

Set up watch-folder rendering

1 Install the After Effects render engine on as many computers as you want to involve in network rendering. (For information on installing After Effects as a render engine, see “Installation” on page 1.)

***Note:** If rendering time is unusually slow, you may be rendering to too many computers, and the network overhead required to track rendering progress among all computers is out of proportion to the time spent actually rendering frames. The optimal number depends on many variables related to the network configuration and the computers on it; experiment to determine the optimal number for your network.*

2 Create a watch folder called AE Watch Folder on a computer that's accessible to all of the After Effects render engines on your network.

- 3 In each render engine, choose File > Watch Folder, and select the watch folder that you've created.
 - 4 Create your projects and compositions, and set them up in the render queue with the render settings and output modules you want to use. (All render items in the project must have output names; otherwise the Enable Watch Folder Render option in the Collect Files dialog box isn't available.)
 - 5 Choose File > Collect Files to copy completed projects to your specified watch folder. Once you choose Collect Files, After Effects copies the project or composition and all source files to the watch folder.
- Note: After Effects can't copy source files that are larger than 2 GB using the Collect Files command: you must copy them manually to the (Footage) folder in the Collect Files folder.*
- 6 Choose For Queued Comps from the Collect Source Files menu (unless you're manually moving source files), and then select Change Render Output To. This option creates a folder on the networked server for rendered files—all of the render engines need access to this folder to complete their rendering tasks.
 - 7 Select Enable Watch Folder Render, click Collect, and name the Collect Files folder.
 - 8 Save the Collect Files folder to a networked computer, preferably to a networked server.
 - 9 Monitor the progress of the render engines by using a web browser to view HTML pages saved in the watch folder. After Effects generates these pages automatically when the rendering begins. Click the Reload button in your browser to see the updated status. These HTML pages will describe any errors that occur.

After Effects renders the item to the specified destination folder and, if necessary, to the overflow volumes you have specified in the Output preferences (see “Overflow volumes and segment settings” on page 629). When After Effects finishes rendering all of the queued items in a given project, it closes that project without saving it and then scans the watch folder for new projects to render. Because it doesn't save the project, After Effects ignores any Post-Render Actions in the Output Module settings dialog box that specify to import the item when it is rendered.

See also

“Basics of rendering and exporting” on page 587

Track dependencies of a watch-folder render

You can track render dependencies when you render over a network by setting Post-Render Action options. When you set these options, After Effects confirms that all of the items that it needs to render are ready and available. For example, if one item depends on another to render, and the first has not finished rendering or has received an error, the second does not render.

You can use this process to render a single QuickTime or AVI movie from a watch-folder render. The movie is actually created on only one computer.

Note: This procedure assumes that you have already created a multiple-computer watch-folder. (See “Set up watch-folder rendering” on page 626.)

- 1 In the Render Queue panel, drag the output module to the Project panel. After Effects creates a placeholder for that item's output.
- 2 Drag the placeholder back to the Render Queue panel.
- 3 Set the render settings and output module settings for the placeholder, and click Render.

Start in watch-folder mode

Watch-folder mode applies only to rendering from a folder on your local computer.

- To start After Effects in watch-folder mode automatically, save a project with the file name Watch This Folder.aep. After Effects watches the folder containing the project if you open that project.
- To start After Effects in watch-folder mode when you start your computer, create a shortcut (Windows) or alias (Mac OS) to the Watch This Folder.aep project and move it to your Startup folder (Windows) or your Startup Items folder (Mac OS). After Effects watches the folder containing the project if you open that project.
- (Windows only) To start After Effects in watch-folder mode from the command line, choose Start > Run, and then enter the following, modifying the application path to the exact name of the folder in which you installed After Effects, and replacing C:[temp] with the path to your watch folder: **"C:\Program Files\Adobe\Adobe After Effects CS3\Support Files\afterfx.exe" -wf C:[temp]**

Note: You can also use this command line in batch files.

See also

"Network rendering with watch folders" on page 625

Render a still-image sequence with multiple computers

Although the preferred method of rendering for multiple computers is using the Watch Folder feature, you can also use multiple computers and multiple copies of After Effects to render a composition across a network. You can use multiple computers to render only still-image sequences; you cannot use multiple computers to render a single movie.

When you render a still-image sequence with multiple computers, rendering in each copy of After Effects starts at approximately the same time. By specifying that each copy skip existing frames or frames in progress, multiple computers can render the project simultaneously, writing the still-image sequence to a single folder.

There is no limit to the number of computers that you can use for rendering; in general, the more computers, the faster the rendering. However, if too many computers are used across a busy network, network traffic may slow down the entire process. You can detect network slowdown by observing the time spent in the Compressing & Writing stage in the Current Render Details section of the Render Queue panel.

Note: Adobe does not provide technical support for general network configuration; consult your network administrator.

Aharon Rabinowitz goes through and explains the steps for rendering a still-image sequence with multiple computers in this video tutorial: www.adobe.com/go/learn_ae_aharonmultimachinerender.

1 Install After Effects on each computer that will be used to render the project. Make sure that you have the same fonts installed on each computer.

Note: Do not share plug-ins across a network. Make sure that you have a copy of the plug-ins folder on each computer that is running After Effects. When using third-party plug-ins, also be sure that the same plug-ins are available on all computers and that you have sufficient licenses for the plug-ins.

2 Open the project on one computer, select the composition, and then choose Composition > Add To Render Queue.

3 Specify a sequence format in the Output Module area, and specify a folder in the Output To area. This folder must be available for all the computers that are rendering.

- 4 In the Render Queue panel, select Skip Existing Files in the Render Settings section so that multiple computers do not render the same frames. Make sure that Use Storage Overflow is not selected. Do not use multiple output modules for one render item when using Skip Existing Files.
- 5 Save the project on the computer where you opened it in step 2.
- 6 On each computer that will be rendering, open and save the project. This ensures that After Effects records the new relative paths to each computer in the following step.
- 7 Unless the network can handle large file transfers rapidly, copy the project file and all its source footage to each rendering computer.
- 8 Open the Render Queue panel on each computer and click Render. You do not need to start rendering on each computer simultaneously, but to ensure equal workloads, start them at approximately the same time. As each computer finishes rendering a frame, After Effects searches the Output folder for the next unrendered frame and starts rendering again.
- 9 You can stop and start any computer at any time. However, if you stop a computer without starting it again, the frame that it was rendering may not be finished. If one or more computers stop during rendering, starting any one computer will ensure that all frames in the sequence get rendered.

See also

“Network rendering with watch folders” on page 625

“Work in the Render Queue panel” on page 591

Overflow volumes and segment settings

Overflow volume and segment settings are in the Output Preferences category.



Choose *Edit > Preferences > Output (Windows)* or *After Effects > Preferences > Output (Mac OS)*.

When the disk volume to which After Effects is writing files is full, it can continue writing files to an *overflow volume*. You can set preferences to make After Effects render to up to six different disk volumes, as specified in the Overflow Volumes list. You can change the amount of disk space remaining on a volume before After Effects considers it an overflow by modifying the Minimum Diskspace Before Overflowing value.

Note: *The log file reports when a render overflows.*

After Effects can also render sequences and movie files into segments that are limited to a specified number of files or by file size; this is useful when preparing a movie for a medium such as CD-ROM, for which file or folder size may need to be limited to chunks of 650 MB or less. Use the Segment Movie Files At value to set the maximum size for segments in megabytes. Use the Segment Sequences At value to set the maximum number of still-image files in a folder.

If you are exporting a movie that is larger than the maximum file size for your hard disk formatting scheme, then you can set the Segment Movie Files At value to a value under this maximum. Hard disks formatted for Windows can be formatted using the FAT, FAT32, or NTFS scheme. The maximum file size in the FAT scheme is 2GB, and the maximum file size in the FAT32 scheme is 4GB. The maximum size for a file for NTFS is very large (approximately 16 terabytes), so you are unlikely to hit this limit with a single movie.

Audio is also rendered in segments, the length of which is set by the Audio Block Duration value. If you hear pops in audio, you may be hearing a faulty transition between segments; if you have enough memory, increase the Audio Block Duration to be longer than your output to avoid this problem.

Converting movies

Convert footage items between video formats

You can use After Effects to convert one type of video to another. When converting video, keep the following in mind:

- Changes in resolution may result in a loss of picture clarity, especially when up-converting from a standard-definition format to a high-definition format.
- Changes in frame rate may require the use of frame blending to smooth out the interpolated frames. For longer footage items, this can result in very long render times.

1 Import the footage you're converting into a composition using the preset of the format you're converting to.

Example: if you're converting NTSC to PAL, add your NTSC footage item to a composition with the appropriate PAL composition settings preset.

2 Select the layer with the footage to be converted and choose Layer > Transform > Fit To Comp Width (or Fit To Comp Height).

Note: For converting between two formats with the same frame aspect ratio, either of these two Fit commands will do the same thing; if the frame aspect ratios differ (e.g., going from 4:3 to 16:9), fitting to width or height will choose between cropping or letterboxing the resulting image.

3 Do one of the following:

- If there are no scene cuts in your footage, choose Layer > Frame Blending > Pixel Motion. This will provide the best results for interpolation of frames, but may require long rendering times.
- If there are scene cuts in your footage, or if you want to sacrifice quality for shorter rendering times, choose Layer > Frame Blending > Frame Mix.

4 Select Composition > Make Movie.

5 In the Render Queue panel, next to Render Settings, select the appropriate preset from the menu. For example, if you're converting to DV footage, select DV Settings from the menu.

6 In the Render Queue panel, next to Output Module, select the appropriate output module preset from the menu, or select Custom to enter custom settings. For example, if you're converting to DV PAL, select the D1/DV-PAL output module preset with the audio sampling rate that you require.

7 Click the name of the output module preset that you chose in step 6 to select additional Format Options.

8 Click the Render button to render your movie.

See also

“Work with output module settings” on page 599

“Work in the Render Queue panel” on page 591

Convert DV footage from PAL to NTSC using pulldown

Because After Effects can easily convert film (24 fps) to video (29.97 fps) using 3:2 pulldown, you can perform a clean PAL-to-NTSC transfer by setting up 25-fps PAL video to act like 24-fps film. This lets you apply 3:2 pulldown to the footage when converting to 29.97 fps. This technique works particularly well for progressive (noninterlaced) PAL video.

1 Create a new composition with the DV NTSC or DV NTSC Widescreen preset.

- 2 Import your DV PAL footage into the new composition.
- 3 Select the layer with the DV PAL footage, and choose Layer > Transform > Fit To Comp Width (or Fit To Comp Height).
- 4 Do one of the following:
 - To preserve audio synchronization but slightly lower the pitch, choose Layer > Time > Time Stretch, and then enter **95.904** in the Stretch Factor box.
 - To preserve audio pitch but not synchronization, or for clips without audio, right-click (Windows) or Control-click (Mac OS) the footage item in the Project panel, select Interpret Footage > Main, select Conform To Frame Rate, and then enter **23.976** in the Conform To Frame Rate box.
- 5 Select Composition > Make Movie.
- 6 Choose Custom from the Render Settings menu.
- 7 In the Render Settings pane, enable Field Rendering (choose the field order required by your output type), select any option from the 3:2 Pulldown menu, and then click OK.
- 8 Choose the output type from the Render Queue Output Module menu (for example, Microsoft DV NTSC 32kHz).
- 9 Click the Render button to render your movie.

See also

“Work with output module settings” on page 599

“Work in the Render Queue panel” on page 591

Scaling a movie down

There are several methods for producing a reduced-size movie from your composition, each with tradeoffs between speed and quality:

Nest the composition Create a new composition at the smaller dimensions, and nest the large composition inside it. For example, if you create a 640 x 480 composition, place it in a 320 x 240 composition. Use the Fit To Comp command to scale the composition to fit the new smaller composition size: Press Ctrl+Alt+F (Windows) or Command+Option+F (Mac OS), and then collapse transformations by choosing Layer > Switches > Collapse. The resulting composition rendered at full resolution and best quality will have excellent image quality, better than if you had rendered using a reduced resolution.

Stretch the composition This method produces the highest quality reduced-size movie but is slower than nesting. For example, if you create a 640 x 480 composition and render it at full resolution, you can set the stretch value in the Output Module Settings dialog box to 50% to create a 320 x 240 movie. For a composition rendered at full resolution, the image quality is excellent when the Stretch Quality is set to High.

***Note:** Do not use stretching to change the vertical dimensions of a movie when field rendering is on. Stretching vertically mixes the field order, which distorts motion. Use either cropping or composition nesting if you need to vertically resize a field-rendered movie.*

Crop the composition This method is ideal for reducing the size of a movie by a few pixels. Use the Crop options in the Output Module Settings dialog box. Remember that cropping cuts off part of the movie, so objects centered in the composition may not appear centered unless the movie is cropped evenly on opposite edges.

Crop to a region of interest To render just a portion of the composition frame, define a region of interest in the Composition panel. Then, select the Region Of Interest option in the Output Module Settings dialog box before rendering. (See “Work with the region of interest” on page 111.)

Note: Cropping an odd number of pixels from the top of a field-rendered movie reverses the field order. For example, if you crop one row of pixels from the top of a movie with Upper Field First field rendering, the field-rendering order then becomes Lower Field First. Remember that if you crop pixels from the top of the movie, you need to add to the bottom row of the movie to maintain the original size. If you are willing to lose one scan line, this gives you a way to output two movies from one render, each with a different field order.

Render the composition at a reduced resolution This is the fastest method to create reduced-size movies. For example, if you create a 640 x 480 composition, you can set the composition resolution to one half, reducing the size of the rendered composition to 320 x 240. You can then create movies or images at this size. Note that the reduced resolution reduces the sharpness of the image and is best used for creating preview or draft movies.

Note: When rendering at reduced resolution, set the quality of the composition to Draft. Rendering at Best quality while reducing resolution does not produce a clean image and takes longer to render than rendering at Draft quality.

See also

“Work with output module settings” on page 599

“Work in the Render Queue panel” on page 591

Scaling a movie up

Increasing the size of the output from a rendered composition reduces the image quality of a movie and is not recommended. If you must enlarge a movie, to maintain highest image quality, enlarge a composition that was rendered at full resolution and highest quality using one of the following methods:

Nest the composition Create a new composition at the larger dimensions and nest the smaller composition inside it. For example, if you create a 320 x 240 composition, you can place it in a 640 x 480 composition. Stretch the composition to fit the new larger composition size, and then collapse transformations by choosing Layers > Switches > Collapse. The resulting composition rendered at full resolution and best quality will have better image quality than if you had stretched the movie. However, this method also renders slower than if you created a composition and stretched it.

Note: To create a draft movie with specific dimensions, use both the Stretch option and reduced resolution in the rendered composition.

Stretch the composition For example, if you create a 320 x 240 composition and render it at full resolution, you can set the stretch value in the Output Module Settings dialog box to 200% to create a 640 x 480 movie. For a composition rendered at full resolution, the image quality will usually be acceptable.

Note: Do not use stretching to change the vertical dimensions of a movie with field rendering. Stretching vertically mixes the field order, which distorts any motion. Use either cropping or composition nesting if you need to vertically resize a field-rendered movie.

Crop the composition To enlarge a movie by a few pixels, increase the size using negative values for the Crop options in the Output Module Settings dialog box. For example, to increase the size of a movie by 2 pixels, type **-2** in the Cropping section of the Output Module Settings dialog box. Remember that negative cropping adds to one side of a movie, so objects originally centered in the composition may not appear centered when the movie is cropped.

Note: Adding an odd number of pixels to the top of a field-rendered movie reverses the field order. For example, if you add one row of pixels to the top of a movie with Upper Field First field rendering, the field-rendering order then becomes Lower Field First. Remember that if you add pixels to the top of the movie, you need to crop from the bottom row of the movie to maintain the original size.

See also

“Work with output module settings” on page 599

“Work in the Render Queue panel” on page 591

Create a composition and render source footage items simultaneously

You can simultaneously create a composition from source footage and prepare it for rendering. This process is useful when you want to change some characteristic of the source footage, such as frame rate or compression method, and have that rendered version available in your project.

- 1 Drag one or more footage items from the Project panel to the Render Queue panel, or select the footage items in the Project panel and press Ctrl+Shift+/ (Windows) or Command+Shift+/ (Mac OS). After Effects creates both a new item in the render queue and a new composition in the Project panel for each footage item.
- 2 Adjust the render settings as desired, and click Render.

See also

“Work with render settings” on page 597

“Work in the Render Queue panel” on page 591

Introduce 3:2 pulldown

If you are creating output for film that's been transferred to video, or if you want to simulate a film look for animation, use 3:2 pulldown. Footage items that were originally film transferred to video and had 3:2 pulldown removed when imported into After Effects can be rendered back to video with 3:2 pulldown reintroduced. You can introduce 3:2 pulldown by choosing one of five different phases. (See “Remove 3:2 or 24Pa pulldown from video” on page 72.)

Note: It is important to match the phase of a segment that had 3:2 pulldown removed if it will be edited back into the video footage it came from.

- 1 In the Render Queue panel, select the render item and then click the underlined text next to the Render Settings heading.
- 2 For Field Render, choose a field order.
- 3 For 3:2 Pulldown, choose a phase.
- 4 Select other settings as appropriate, and then click Render.

See also

“Work with render settings” on page 597

“Work in the Render Queue panel” on page 591

Test field-rendering order

When you render a composition containing separated footage, set the Field Rendering option to the same field order as your video equipment. If you field-render with the incorrect settings, the final movie may appear too soft, jerky, or distorted. A simple test can determine the order in which your video equipment requires fields.

Note: The field order might get altered if you change the hardware or software of your production setup. For example, changing your device control software or VCR after setting the field order can reverse your fields. Therefore, any time you make a change to your setup, test the field-rendering order.

The test takes about 15 to 20 minutes and involves creating two movie versions of the same composition (one rendered with Upper Field First and one with Lower Field First), and then playing the movies to see which choice looks right.

- 1 Create a simple composition with the correct frame size and frame rate. Choose an NTSC or PAL preset in the Composition Settings dialog box, and make the composition at least 3 seconds long.
- 2 Within the composition, make a layer that is a small rectangular solid. The layer can be any color as long as it contrasts sharply with the composition background. You may want to add a title (such as “Upper Field First”) to the solid to make identification of the movie easier.
- 3 Apply some fast movement to the solid using keyframes in its Position property. Set keyframes from the upper left of the Composition panel to the lower right for 1 second.
- 4 Save the project, and then drag the composition to the Render Queue panel.
- 5 Click the underlined Render Settings name, and then choose Upper Field First from the Field Render menu.
- 6 Click OK, and then click Render to make the movie.
- 7 In the composition, change the color of the solid in the Composition panel, and add a new title, such as “Lower Field First,” to identify it.
- 8 Render the composition again, choosing Lower Field First from the Field Render menu in the Render Settings dialog box.
- 9 Record both movies to the same device.
- 10 Play both movies.

One movie will look distorted and have jumpy horizontal motion or shape distortion during vertical motion. The other movie will play back smoothly, with sharply defined edges. Use the field order for the smooth-playing movie whenever you render movies with that particular hardware configuration.

See also

“Work with render settings” on page 597

“Work in the Render Queue panel” on page 591

Reviewing movies with Clip Notes comments

About Clip Notes comments

Use Clip Notes to submit a movie to reviewers for comments. When you render a movie for Clip Notes comments, a copy of the movie or a link to the movie is included in an Adobe PDF file. The movie can be in Windows Media (Windows only) or QuickTime format.

Composition-time markers (After Effects) and sequence markers (Adobe Premiere Pro) are included with the movie as comments, so you can submit questions to reviewers or solicit comments about specific parts of the movie.

Note: When you create a Clip Notes review movie, you can specify FTP settings in the Others tab of the export settings dialog box to automatically place the PDF file on an FTP server for convenient exchange of files and comments.

When your reviewers open the PDF, they can play the movie and enter comments. Each comment is associated with a specific time in the movie.

A reviewer then exports the comments to a file and sends the file back to you. When you import the comments, the reviewer's comments appear in the comments field of markers placed in the Timeline panel.

To view the PDF, a reviewer must have Adobe Acrobat Standard, Acrobat Professional, or Adobe Reader (version 7.0.5 or later). Adobe Reader is available as a free download from www.adobe.com/go/learn_dv_download_adobereader.

Note: To keep comments from being associated with the wrong part of a movie, avoid changing the sequence or composition until you have imported all Clip Notes comments related to it.

Rendering and exporting a movie for Clip Notes comments

You render and export a movie for Clip Notes comments using the render queue in the same way that you render other kinds of movies, though the export options are more limited than for most formats intended for final output.

Note: You can also use the File > Export menu to add a composition to the render queue to create a movie for Clip Notes comments.

When you create a Clip Notes review movie, you can specify FTP settings in the Others tab of the export settings dialog box to automatically place the PDF file on an FTP server for convenient exchange of files and comments.

Before you render and export a composition's work area for review with Clip Notes, make sure that the work area is not set to begin at a frame other than the first frame of the composition. When you import Clip Notes comments into the composition, After Effects assumes that the first frame of the Clip Notes movie matches the first frame of the composition. If the work area is set to begin at a later frame, then the imported comments will be offset in time. (See "Set the work area" on page 112.)

See also

"Render and export a movie using the render queue" on page 590

"Work in the Render Queue panel" on page 591

Clip Notes export settings

Export settings

Format QuickTime movie or Windows Media movie.

Preset Preset based on broadcast standard, data rate, aspect ratio, and quality.

Settings in the Clip Notes tab

Embed Video Embeds the rendered movie into the PDF.

Stream Video Posts the rendered movie to an FTP (File Transfer Protocol) server and includes a link to the movie in the PDF. The size of the PDF is smaller than it would be if you embedded the movie, but you and your reviewers must have access to an FTP server that is also a web server.

Password Requires the reviewer to enter the password to open the PDF.

Instructions Instructions to reviewers. You can edit this field. The contents of this field will be presented to reviewers in an Instructions dialog box when they open the Clip Notes PDF. If you leave this field empty, then the Instructions dialog box will not be presented to reviewers.

Return Comments To E-mail address to which reviewers' comments are sent upon export.

Add Clip Notes comments





1 Open the Clip Notes PDF file in Adobe Acrobat Standard, Acrobat Professional, or Adobe Reader (version 7.0.5 or later).

2 If prompted, specify your preference in the Manage Trust For Multimedia Content dialog box. If prompted for a password, enter the password and click OK. If prompted with an Instructions dialog box, read the instructions and click OK.

Note: You can view the instructions at any time by clicking the View Instructions button .

3 Enter your name in the Reviewer Name field. This name will appear in your comments.

4 Navigate to frames and add comments to them:

- To navigate to a specific frame, use the media player's playback controls.
- To move to another comment, choose it in the Go To menu, or click the Go To Previous Comment button  or Go To Next Comment button .
- To add a comment, click the Add Comment button  and enter your comment.
- To save your comments, click the Save Comment button .
- To delete a comment, go to the comment and then click the Delete Comment button .

Clip Notes prefixes your comment with the current reviewer name and timecode automatically. You can add your own comment at the same frame as other reviewers; this is especially useful for responding to questions entered in the comment field of a marker.

5 When you finish adding comments, click the Export button. The comment file is an XFDF file. (When this file is imported into After Effects or Premiere Pro by the person who initiated the review, the comments appear as markers.)

6 If prompted by your e-mail client software (such as Microsoft Outlook), edit and send the e-mail message that has your Clip Notes comments file attached.

Note: You are prompted by your e-mail client software if an e-mail address was specified in the Return Comments To field, when the Clip Notes PDF was created.

Import Clip Notes comments

1 Select the composition into which to import the Clip Notes comments.

This should be the composition from which you rendered the movie that was sent for comments. If you have modified the composition since you rendered the movie for comments, the imported comments may not be associated with the appropriate parts of the composition.

2 Choose File > Import > Adobe Clip Notes.

3 Select the XFDF file that contains the comments, and click Open.

Clip Notes comments appear as composition-time markers. Double-click a marker to read its comment.

See also

“Work with composition-time markers” on page 117

Chapter 18: Keyboard shortcuts

Using and modifying keyboard shortcuts

Use keyboard shortcuts to speed up common tasks.

Note: On Mac OS, some keyboard commands for interacting with the operating system conflict with keyboard commands for interacting with After Effects. Select *Use System Shortcut Keys* in the General preferences to override the After Effects keyboard command in cases in which there's a conflict with the Mac OS keyboard command.

To modify keyboard shortcuts, use the KeyEd Up script from Jeff Almasol, which is available on the Adobe After Effects Exchange website: www.adobe.com/go/learn_ae_jeffscriptswithkeyedup.

For information on remapping keyboard shortcuts for keyboard layouts other than the standard US English layout, see Jonas Hummelstrand's website: www.adobe.com/go/learn_ae_jonaskeyboardmapping.

Shortcuts, general

Result	Windows	Mac OS
Select all	Ctrl+A	Command+A
Deselect all	F2 or Ctrl+Shift+A	F2 or Command+Shift+A
Rename selected layer, composition, folder, effect, group, or mask	Enter on main keyboard	Return
Open selected layer, composition, or footage item	Enter on numeric keypad	Enter on numeric keypad
Move selected layers, masks, or effects down (back) or up (forward) in stacking order	Ctrl+Alt+Down Arrow or Ctrl+Alt+Up Arrow	Command+Option+Down Arrow or Command+Option+Up Arrow
Move selected layers, masks, or effects to bottom (back) or top (front) of stacking order	Ctrl+Alt+Shift+Down Arrow or Ctrl+Alt+Shift+Up Arrow	Command+Option+Shift+Down Arrow or Command+Option+Shift+Up Arrow
Extend selection to next item in Project panel or Effect Controls panel	Shift+Down Arrow	Shift+Down Arrow
Extend selection to previous item in Project panel or Effect Controls panel	Shift+Up Arrow	Shift+Up Arrow
Duplicate selected layers, masks, effects, text selectors, animators, puppet meshes, shapes, or compositions	Ctrl+D	Command+D
Quit	Ctrl+Q	Command+Q

Result	Windows	Mac OS
Undo	Ctrl+Z	Command+Z
Redo	Ctrl+Shift+Z	Command+Shift+Z
Purge all	Ctrl+Alt+/ (on numeric keypad)	Command+Option+/ (on numeric keypad)

Shortcuts for working with projects

Result	Windows	Mac OS
New project	Ctrl+Alt+N	Command+Option+N
Open project	Ctrl+O	Command+O
Open most recent project	Ctrl+Alt+Shift+P	Command+Option+Shift+P
New folder in Project panel	Ctrl+Alt+Shift+N	Command+Option+Shift+N
Open Project Settings dialog box	Ctrl+Alt+Shift+K	Command+Option+Shift+K
Find in Project panel	Ctrl+Alt+G	Command+Option+G
Find again in Project panel	Alt+Shift+G	Option+Shift+G
Cycle through color bit depths for project	Alt-click bit-depth button at bottom of Project panel	Option-click bit-depth button at bottom of Project panel
Open Project Settings dialog box	Click bit-depth button at bottom of Project panel	Click bit-depth button at bottom of Project panel

Shortcuts for working with preferences

Result	Windows	Mac OS
Open Preferences dialog box	Ctrl+Alt+; (semicolon)	Command+Option+; (semicolon)
Restore default preferences settings	Hold down Ctrl+Alt+Shift while starting After Effects	Hold down Command+Option+Shift while starting After Effects

Shortcuts for panels, viewers, workspaces, and windows

Note: (Mac OS) Shortcuts involving function keys F9-F12 may conflict with shortcuts used by the operating system. See Mac OS Help for instructions to reassign Dashboard & Expose shortcuts.

Result	Windows	Mac OS
Open or close Project panel	Ctrl+0	Command+0
Open or close Render Queue panel	Ctrl+Alt+0	Command+Option+0
Open or close Tools panel	Ctrl+1	Command+1
Open or close Info panel	Ctrl+2	Command+2
Open or close Time Controls panel	Ctrl+3	Command+3

Result	Windows	Mac OS
Open or close Audio panel	Ctrl+4	Command+4
Open or close Effects & Presets panel	Ctrl+5	Command+5
Open or close Character panel	Ctrl+6	Command+6
Open or close Paragraph panel	Ctrl+7	Command+7
Open or close Paint panel	Ctrl+8	Command+8
Open or close Brush Tips panel	Ctrl+9	Command+9
Open or close Effect Controls panel for selected layer	F3 or Ctrl+Shift+T	F3 or Command+Shift+T
Open Flowchart panel for project flowchart	Ctrl+F11	Command+F11
Switch to workspace	Shift+F10, Shift+F11, or Shift+F12	Shift+F10, Shift+F11, or Shift+F12
Close active viewer or panel (closes content first)	Ctrl+W	Command+W
Close active panel or all viewers of type of active viewer (closes content first). E.g., if a Timeline panel is active, this closes all Timeline panels.	Ctrl+Shift+W	Command+Shift+W
Split the frame containing the active viewer and create a new viewer with opposite locked/unlocked state	Ctrl+Alt+Shift+N	Command+Option+Shift+N
Maximize or restore panel under pointer	` (accent grave)	` (accent grave)
Resize application window or floating window to fit screen. (Press again to resize window so that contents fill the screen.)	Ctrl+\ (backslash)	Command+\ (backslash)
Move application window or floating window to main monitor; resize window to fit screen. (Press again to resize window so that contents fill the screen.)	Ctrl+Alt+\ (backslash)	Command+Option+\ (backslash)
Toggle activation between Composition panel and Timeline panel for current composition	\ (backslash)	\ (backslash)
Cycle to previous or next item in active viewer	Shift+, (comma) or Shift+. (period)	Shift+, (comma) or Shift+. (period)
Cycle to previous or next panel in active frame	Alt+Shift+, (comma) or Alt+Shift+. (period)	Option+Shift+, (comma) or Option+Shift+. (period)

Shortcuts for activating tools

Note: You can activate some tools only under certain circumstances. For example, you can activate a camera tool only when the active composition contains a camera layer.

 To momentarily activate a tool with a single-letter keyboard shortcut, hold down the shortcut key; release the shortcut key to return to the previously active tool. To activate a tool and keep it active, press the shortcut key and immediately release it.

Result	Windows	Mac OS
Cycle through tools	Alt-click tool button in Tools panel	Option-click tool button in Tools panel
Activate Selection tool	V	V
Activate Hand tool	H	H
Temporarily activate Hand tool	Hold down spacebar.	Hold down spacebar.
Activate Zoom In tool	Z	Z
Activate Zoom Out tool	Alt (when Zoom In tool is active)	Option (when Zoom In tool is active)
Activate Rotation tool	W	W
Activate and cycle through Camera tools (Orbit, Track XY, and Track Z)	C	C
Activate Pan Behind tool	Y	Y
Activate and cycle through mask and shape tools (Rectangle, Rounded Rectangle, Ellipse, Polygon, Star)	Q	Q
Activate and cycle through Type tools (Horizontal and Vertical)	Ctrl+T	Command+T
Activate and cycle through pen tools (Pen, Add Vertex, Delete Vertex, and Convert Vertex)	G	G
Temporarily activate Selection tool when a pen tool is selected	Ctrl	Command
Temporarily activate pen tool when the Selection tool is selected and pointer is over a path (Add Vertex tool when pointer is over a segment; Convert Vertex tool when pointer is over a vertex)	Ctrl+Alt	Command+Option
Activate and cycle through Brush, Clone Stamp, and Eraser tools	Ctrl+B	Command+B
Activate and cycle through Puppet tools	Ctrl+P	Command+P
Temporarily convert Selection tool to Shape Duplication tool	Alt (in shape layer)	Option (in shape layer)
Temporarily convert Selection tool to Direct Selection tool	Ctrl (in shape layer)	Command (in shape layer)

See also

“Activate a tool” on page 20

Shortcuts for working with compositions and the work area

Result	Windows	Mac OS
New composition	Ctrl+N	Command+N
Open Composition Settings dialog box for selected composition	Ctrl+K	Command+K
Set composition background color	Ctrl+Shift+B	Command+Shift+B
Set beginning or end of work area to current time	B or N	B or N
Set work area to duration of selected layers or, if no layers are selected, set work area to composition duration	Ctrl+Alt+B	Command+Option+B

Shortcuts for working with previews

Result	Windows	Mac OS
Start or stop standard preview	spacebar	spacebar
RAM preview	0 on numeric keypad*	0 on numeric keypad*
RAM preview with alternate settings	Shift+0 on numeric keypad*	Shift+0 on numeric keypad*
Save RAM preview	Ctrl-click RAM Preview button or press Ctrl+0 on numeric keypad*	Command-click RAM Preview button or press Command+0 on numeric keypad*
Save RAM preview with alternate settings	Ctrl+Shift-click RAM Preview button or press Ctrl+Shift+0 on numeric keypad*	Command+Shift-click RAM Preview button or press Command+Shift+0 on numeric keypad*
Preview only audio, from current time	. (decimal point) on numeric keypad*	. (decimal point) on numeric keypad*
Preview only audio, in work area	Alt+. (decimal point) on numeric keypad*	Option+. (decimal point) on numeric keypad*
Manually preview (scrub) video	Drag or Alt-drag current-time indicator, depending on Live Update setting	Drag or Option-drag current-time indicator, depending on Live Update setting
Manually preview (scrub) audio	Ctrl-drag current-time indicator	Command-drag current-time indicator
Wireframe preview	Alt+0 on numeric keypad*	Option+0 on numeric keypad*
Wireframe preview, leaving panel contents	Alt+Shift+0 on numeric keypad*	Option+Shift+0 on numeric keypad*
Show current frame on video preview device	/ (on numeric keypad)	/ (on numeric keypad)
Turn display color management on or off for active view	Shift+ / (on numeric keypad)	Shift+ / (on numeric keypad)

Result	Windows	Mac OS
Toggle Output Device preference between Desktop Only and video preview device	Ctrl+ / (on numeric keypad)	Command+ / (on numeric keypad)
Take snapshot	Shift+F5, Shift+F6, Shift+F7, or Shift+F8	Shift+F5, Shift+F6, Shift+F7, or Shift+F8
Display snapshot in active panel	F5, F6, F7, or F8	F5, F6, F7, or F8
Purge snapshot	Ctrl+Shift+F5, Ctrl+Shift+F6, Ctrl+Shift+F7, or Ctrl+Shift+F8	Command+Shift+F5, Command+Shift+F6, Command+Shift+F7, or Command+Shift+F8

Note: Some shortcuts are marked with an asterisk () to remind you to make sure that Num Lock is on when you use the numeric keypad.*

Shortcuts for time navigation

Result	Windows	Mac OS
Go to specific time	Alt+Shift+J	Option+Shift+J
Go to beginning or end of work area	Shift+Home or Shift+End	Shift+Home or Shift+End
Go to previous or next visible item in time ruler (keyframe, marker, work area beginning or end)	J or K	J or K
Go to beginning of composition, layer, or footage item	Home or Ctrl+Alt+Left Arrow	Home or Command+Option+Left Arrow
Go to end of composition, layer, or footage item	End or Ctrl+Alt+Right Arrow	End or Command+Option+Right Arrow
Go forward 1 frame	Page Down or Ctrl+Right Arrow	Page Down or Command+Right Arrow
Go forward 10 frames	Shift+Page Down or Ctrl+Shift+Right Arrow	Shift+Page Down or Command+Shift+Right Arrow
Go backward 1 frame	Page Up or Ctrl+Left Arrow	Page Up or Command+Left Arrow
Go backward 10 frames	Shift+Page Up or Ctrl+Shift+Left Arrow	Shift+Page Up or Command+Shift+Left Arrow
Go to layer In point	I	I
Go to layer Out point	O	O
Go to previous In point or Out point	Ctrl+Alt+Shift+Left Arrow	Command+Option+Shift+Left Arrow
Go to next In point or Out point	Ctrl+Alt+Shift+Right Arrow	Command+Option+Shift+Right Arrow
Scroll to current time in Timeline panel	D	D

Shortcuts for working with footage

Result	Windows	Mac OS
Import one file or image sequence	Ctrl+I	Command+I
Import multiple files or image sequences	Ctrl+Alt+I	Command+Option+I
Open movie in an After Effects Footage panel	Alt-double-click	Option-double-click
Add selected items to most recently activated composition	Ctrl+/, (on main keyboard)	Command+/, (on main keyboard)
Replace selected layers' source footage with footage item selected in Project panel	Ctrl+Alt+/, (on main keyboard)	Command+Option+/, (on main keyboard)
Replace a selected layer's source	Alt-drag footage item from Project panel onto selected layer	Option-drag footage item from Project panel onto selected layer
Delete a footage item without a warning	Ctrl+Backspace	Command+Delete
Open Interpret Footage dialog box for selected footage item	Ctrl+F	Command+F
Remember footage interpretation	Ctrl+Alt+C	Command+Option+C
Edit selected footage item in application with which it's associated (Edit Original)	Ctrl+E	Command+E
Replace selected footage item	Ctrl+H	Command+H
Reload selected footage items	Ctrl+Alt+L	Command+Option+L
Set proxy for selected footage item	Ctrl+Alt+P	Command+Option+P
Scan for changed footage	Ctrl+Alt+Shift+Q	Command+Option+Shift+Control+Q

Shortcuts for using and modifying views

Result	Windows	Mac OS
Show red, green, blue, or alpha channel as grayscale	Alt+1, Alt+2, Alt+3, Alt+4	Option+1, Option+2, Option+3, Option+4
Show colorized red, green, or blue channel	Alt+Shift+1, Alt+Shift+2, Alt+Shift+3	Option+Shift+1, Option+Shift+2, Option+Shift+3
Toggle showing straight RGB color	Alt+Shift+4	Option+Shift+4
Reset view in the Composition panel to 100% and center composition in the panel	Double-click Hand tool	Double-click Hand tool
Zoom in in Composition, Layer, or Footage panel	. (period) on main keyboard	. (period) on main keyboard
Zoom out in Composition, Layer, or Footage panel	, (comma)	, (comma)

Result	Windows	Mac OS
Zoom to 100% in Composition, Layer, or Footage panel	/ (on main keyboard)	/ (on main keyboard)
Zoom to fit in Composition, Layer, or Footage panel	Shift+/ (on main keyboard)	Shift+/ (on main keyboard)
Zoom up to 100% to fit in Composition, Layer, or Footage panel	Alt+/ (on main keyboard)	Option+/ (on main keyboard)
Set resolution to Full, Half, or Custom in Composition panel	Ctrl+J, Ctrl+Shift+J, Ctrl+Alt+J	Command+J, Command+Shift+J, Command+Option+J
Open View Options dialog box for active Composition panel	Ctrl+Alt+U	Command+Option+U
Zoom in Timeline panel to single-frame units	; (semicolon)	; (semicolon)
Zoom in time	= (equals sign) on main keyboard	= (equals sign) on main keyboard
Zoom out time	- (hyphen) on main keyboard	- (hyphen) on main keyboard
Suspend image updates	Caps Lock	Caps Lock
Show or hide safe zones	' (apostrophe)	' (apostrophe)
Show or hide grid	Ctrl+' (apostrophe)	Command+' (apostrophe)
Show or hide proportional grid	Alt+' (apostrophe)	Option+' (apostrophe)
Show or hide rulers	Ctrl+R	Command+R
Show or hide guides	Ctrl+; (semicolon)	Command+; (semicolon)
Turn snapping to grid on or off	Ctrl+Shift+' (apostrophe)	Command+Shift+' (apostrophe)
Turn snapping to guides on or off	Ctrl+Shift+; (semicolon)	Command+Shift+; (semicolon)
Lock or unlock guides	Ctrl+Alt+Shift+; (semicolon)	Command+Option+Shift+; (semicolon)
Show or hide layer controls	Ctrl+Shift+H	Command+Shift+H

Shortcuts for effects and animation presets

Result	Windows	Mac OS
Delete all effects from selected layers.	Ctrl+Shift+E	Command+Shift+E
Apply most recently applied effect to selected layers.	Ctrl+Alt+Shift+E	Command+Option+Shift+E
Apply most recently applied animation preset to selected layers.	Ctrl+Alt+Shift+F	Command+Option+Shift+F

Shortcuts for working with layers

Note: Some operations do not affect shy layers.

Result	Windows	Mac OS
New solid layer	Ctrl+Y	Command+Y
New null layer	Ctrl+Alt+Shift+Y	Command+Option+Shift+Y
Select layer (1-999) by its number (enter digits rapidly for two-digit and three-digit numbers)	0-9 on numeric keypad*	0-9 on numeric keypad*
Toggle selection of layer (1-999) by its number (enter digits rapidly for two-digit and three-digit numbers)	Shift+0-9 on numeric keypad*	Shift+0-9 on numeric keypad*
Select next layer in stacking order	Ctrl+Down Arrow	Command+Down Arrow
Select previous layer in stacking order	Ctrl+Up Arrow	Command+Up Arrow
Extend selection to next layer in stacking order	Ctrl+Shift+Down Arrow	Command+Shift+Down Arrow
Extend selection to previous layer in stacking order	Ctrl+Shift+Up Arrow	Command+Shift+Up Arrow
Deselect all layers	Ctrl+Shift+A	Command+Shift+A
Scroll topmost selected layer to top of Timeline panel	X	X
Show or hide Parent column	Shift+F4	Shift+F4
Show or hide Layer Switches and Modes columns	F4	F4
Turn off all other solo switches	Alt-click solo switch	Option-click solo switch
Turn Video switch on or off for selected layers	Ctrl+Alt+Shift+V	Command+Option+Shift+V
Turn off Video switch for all video layers other than selected layers	Ctrl+Shift+V	Command+Shift+V
Open settings dialog box for selected solid, light, camera, null, or adjustment layer	Ctrl+Shift+Y	Command+Shift+Y
Paste layers at current time	Ctrl+Alt+V	Command+Option+V
Split selected layers (If no layers are selected, split all layers.)	Ctrl+Shift+D	Command+Shift+D
Precompose selected layers	Ctrl+Shift+C	Command+Shift+C
Open Effect Controls panel for selected layers	Ctrl+Shift+T	Command+Shift+T
Open source of a layer in Footage panel	Alt-double-click a layer	Option-double-click a layer
Reverse selected layers in time	Ctrl+Alt+R	Command+Option+R
Enable time remapping for selected layers	Ctrl+Alt+T	Command+Option+T

Result	Windows	Mac OS
Move In point or Out point of selected layers to current time	[(left bracket) or] (right bracket)	[(left bracket) or] (right bracket)
Trim In point or Out point of selected layers to current time	Alt+[(left bracket) or Alt+] (right bracket)	Option+[(left bracket) or Option+] (right bracket)
Add or remove expression for a property	Alt-click stopwatch	Option-click stopwatch
Add an effect (or multiple selected effects) to selected layers	Double-click effect selection in Effects & Presets panel	Double-click effect selection in Effects & Presets panel
Set In point or Out point by time-stretching	Ctrl+Shift+, (comma) or Ctrl+Alt+, (comma)	Command+Shift+, (comma) or Command+Option+, (comma)
Move In point of selected layers to beginning of composition	Alt+Home	Option+Home
Move Out point of selected layers to end of composition	Alt+End	Option+End
Lock selected layers	Ctrl+L	Command+L
Unlock all layers	Ctrl+Shift+L	Command+Shift+L
Set Quality to Best, Draft, or Wireframe for selected layers	Ctrl+U, Ctrl+Shift+U, or Ctrl+Alt+Shift+U	Command+U, Command+Shift+U, Command+Option+Shift+U
Cycle forward or backward through blending modes for selected layers	Shift+ - (hyphen) or Shift+= (equals sign) on the main keyboard	Shift+ - (hyphen) or Shift+= (equals sign) on the main keyboard

Note: Some shortcuts are marked with an asterisk (*) to remind you to make sure that Num Lock is on when you use the numeric keypad.

Shortcuts for showing properties in the Timeline panel

Note: This table contains double-letter shortcuts (for example, LL). To use these shortcuts, press the letters in quick succession.

Result	Windows	Mac OS
Toggle expansion of selected layers to show all properties	Ctrl+` (accent grave)	Command+` (accent grave)
Toggle expansion of property group and all child property groups to show all properties	Ctrl-click triangle to the left of the property group name	Command-click triangle to the left of the property group name
Show only Anchor Point property (for lights and cameras, Point Of Interest)	A	A
Show only Audio Levels property	L	L
Show only Mask Feather property	F	F
Show only Mask Path property	M	M
Show only Mask Opacity property	TT	TT

Result	Windows	Mac OS
Show only Opacity property (for lights, Intensity)	T	T
Show only Position property	P	P
Show only Rotation and Orientation properties	R	R
Show only Time Remap property	RR	RR
Show only Scale property	S	S
Show only Effects property group	E	E
Show only mask property groups	MM	MM
Show only Material Options property group (3D)	AA	AA
Show only expressions	EE	EE
Show only modified properties	UU	UU
Show only paint strokes and Puppet pins	PP	PP
Show only audio waveform	LL	LL
Show only properties with keyframes or expressions	U	U
Show only selected properties and groups	SS	SS
Hide property or group	Alt+Shift-click property or group name	Option+Shift-click property or group name
Add or remove property or group from set that is shown	Shift+property or group shortcut	Shift+property or group shortcut
Add or remove keyframe at current time	Alt+Shift+property shortcut	Option+Shift+property shortcut

Shortcuts for modifying properties

Result	Windows	Mac OS
Modify property value by default increments	Drag property value	Drag property value
Modify property value by 10x default increments	Shift-drag property value	Shift-drag property value
Modify property value by 1/10 default increments	Ctrl-drag property value	Command-drag property value
Open Auto-Orientation dialog box for selected layers	Ctrl+Alt+O	Command+Alt+O
Open Opacity dialog box for selected layers	Ctrl+Shift+O	Command+Shift+O

Result	Windows	Mac OS
Open Rotation dialog box for selected layers	Ctrl+Shift+R	Command+Shift+R
Open Position dialog box for selected layers	Ctrl+Shift+P	Command+Shift+P
Move selected layers 1 pixel at current magnification (Position)	arrow key	arrow key
Move selected layers 10 pixels at current magnification (Position)	Shift+arrow key	Shift+arrow key
Move selected layers 1 frame earlier or later	Alt+Page Up or Alt+Page Down	Option+Page Up or Option+Page Down
Move selected layers 10 frames earlier or later	Alt+Shift+Page Up or Alt+Shift+Page Down	Option+Shift+Page Up or Option+Shift+Page Down
Increase or decrease Rotation (Z Rotation) of selected layers by 1°	+ (plus) or - (minus) on numeric keypad	+ (plus) or - (minus) on numeric keypad
Increase or decrease Rotation (Z Rotation) of selected layers by 10°	Shift++ (plus) or Shift+- (minus) on numeric keypad	Shift++ (plus) or Shift+- (minus) on numeric keypad
Increase Scale of selected layers by 1%	Ctrl++ (plus) or Alt++ (plus) on numeric keypad	Command++ (plus) or Option++ (plus) on numeric keypad
Decrease Scale of selected layers by 1%	Ctrl+- (minus) or Alt+- (minus) on numeric keypad	Command+- (minus) or Option+- (minus) on numeric keypad
Increase Scale of selected layers by 10%	Ctrl+Shift++ (plus) or Alt+Shift++ (plus) on numeric keypad	Command+Shift++ (plus) or Option+Shift++ (plus) on numeric keypad
Decrease Scale of selected layers by 10%	Ctrl+Shift+- (minus) or Alt+Shift+- (minus) on numeric keypad	Command+Shift+- (minus) or Option+Shift+- (minus) on numeric keypad
Modify Rotation or Orientation in 45° increments	Shift-drag with Rotation tool	Shift-drag with Rotation tool
Modify Scale, constrained to footage frame aspect ratio	Shift-drag layer handle with Selection tool	Shift-drag layer handle with Selection tool
Reset Rotation to 0°	Double-click Rotation tool	Double-click Rotation tool
Reset Scale to 100%	Double-click Selection tool	Double-click Selection tool
Scale and reposition selected layers to fit composition	Ctrl+Alt+F	Command+Option+F
Scale and reposition selected layers to fit composition width, preserving aspect ratio	Ctrl+Alt+Shift+H	Command+Option+Shift+H
Scale and reposition selected layers to fit composition height, preserving aspect ratio	Ctrl+Alt+Shift+G	Command+Option+Shift+G

Shortcuts for 3D layers

Note: (Mac OS) Shortcuts involving function keys F9-F12 may conflict with shortcuts used by the operating system. See Mac OS Help for instructions to reassign Dashboard & Expose shortcuts.

Result	Windows	Mac OS
Switch to 3D view 1 (defaults to Front)	F10	F10
Switch to 3D view 2 (defaults to Custom View 2)	F11	F11
Switch to 3D view 3 (defaults to Active Camera)	F12	F12
Return to previous view	Esc	Esc
New light	Ctrl+Alt+Shift+L	Command+Option+Shift+L
New camera	Ctrl+Alt+Shift+C	Command+Option+Shift+C
Move the camera and its point of interest to look at selected 3D objects	Ctrl+Alt+Shift+\	Command+Option+Shift+\
Turn Casts Shadows property on or off for selected 3D layers	Alt+Shift+C	Option+Shift+C

See also

“Shortcuts for showing properties in the Timeline panel” on page 647

Shortcuts for keyframes

Note: (Mac OS) Shortcuts involving function keys F9-F12 may conflict with shortcuts used by the operating system. See Mac OS Help for instructions to reassign Dashboard & Expose shortcuts.

Result	Windows	Mac OS
Toggle between Graph Editor and layer bar modes	Shift+F3	Shift+F3
Select all keyframes for a property	Click property name	Click property name
Select all visible keyframes and properties	Ctrl+Alt+A	Command+Option+A
Deselect all keyframes, properties, and property groups	Shift+F2 or Ctrl+Alt+Shift+A	Shift+F2 or Command+Option+Shift+A
Move keyframe 1 frame later or earlier	Alt+Right Arrow or Alt+Left Arrow	Option+Right Arrow or Option+Left Arrow
Move keyframe 10 frames later or earlier	Alt+Shift+Right Arrow or Alt+Shift+Left Arrow	Option+Shift+Right Arrow or Option+Shift+Left Arrow
Set interpolation for selected keyframes (layer bar mode)	Ctrl+Alt+K	Command+Option+K
Set keyframe interpolation method to hold or Auto Bezier	Ctrl+Alt+H	Command+Option+H
Set keyframe interpolation method to linear or Auto Bezier	Ctrl-click in layer bar mode	Command-click in layer bar mode
Set keyframe interpolation method to linear or hold	Ctrl+Alt-click in layer bar mode	Command+Option-click in layer bar mode

Result	Windows	Mac OS
Easy ease selected keyframes	F9	F9
Easy ease selected keyframes in	Shift+F9	Shift+F9
Easy ease selected keyframes out	Ctrl+Shift+F9	Command+Shift+F9
Set velocity for selected keyframes	Ctrl+Shift+K	Command+Shift+K
Add or remove keyframe at current time (For property shortcuts, see "Shortcuts for showing properties in the Timeline panel" on page 647.)	Alt+Shift+property shortcut	Option+Shift+property shortcut

Shortcuts for working with text

Result	Windows	Mac OS
New text layer	Ctrl+Alt+Shift+T	Command+Option+Shift+T
Align selected horizontal text left, center, or right	Ctrl+Shift+L, C, or R	Command+Shift+L, C, or R
Align selected vertical text top, center, or bottom	Ctrl+Shift+L, C, or R	Command+Shift+L, C, or R
Extend or reduce selection by one character to right or left in horizontal text	Shift+Right Arrow or Shift+Left Arrow	Shift+Right Arrow or Shift+Left Arrow
Extend or reduce selection by one word to right or left in horizontal text	Ctrl+Shift+Right Arrow or Ctrl+Shift+Left Arrow	Command+Shift+Right Arrow or Command+Shift+Left Arrow
Extend or reduce selection by one line up or down in horizontal text	Shift+Up Arrow or Shift+Down Arrow	Shift+Up Arrow or Shift+Down Arrow
Extend or reduce selection by one line to right or left in vertical text	Shift+Right Arrow or Shift+Left Arrow	Shift+Right Arrow or Shift+Left Arrow
Extend or reduce selection one word up or down in vertical text	Ctrl+Shift+Up Arrow or Ctrl+Shift+Down Arrow	Command+Shift+Up Arrow or Command+Shift+Down Arrow
Extend or reduce selection by one character up or down in vertical text	Shift+Up Arrow or Shift+Down Arrow	Shift+Up Arrow or Shift+Down Arrow
Select text from insertion point to beginning or end of line	Shift+Home or Shift+End	Shift+Home or Shift+End
Move insertion point to beginning or end of line	Home or End	Home or End
Select all text on a layer	Double-click text layer	Double-click text layer
Select text from insertion point to beginning or end of text frame	Ctrl+Shift+Home or Ctrl+Shift+End	Command+Shift+Home or Command+Shift+End
Select text from insertion point to mouse click point	Shift-click	Shift-click

Result	Windows	Mac OS
In horizontal text, move insertion point one character left or right; one line up or down; one word left or right; or one paragraph up or down	Left Arrow or Right Arrow; Up Arrow or Down Arrow; Ctrl+Left Arrow or Ctrl+Right Arrow; or Ctrl+Up Arrow or Ctrl+Down Arrow	Left Arrow or Right Arrow; Up Arrow or Down Arrow; Command+Left Arrow or Command+Right Arrow; or Command+Up Arrow or Command+Down Arrow
In vertical text, move insertion point one character up or down; one left or right; one word up or down; or one paragraph left or right	Up Arrow or Down Arrow; Left Arrow or Right Arrow; Ctrl+Up Arrow or Ctrl+Down Arrow; or Ctrl+Left Arrow or Ctrl+Right Arrow	Up Arrow or Down Arrow; Left Arrow or Right Arrow; Command+Up Arrow or Command+Down Arrow; or Command+Left Arrow or Command+Right Arrow
Select word, line, paragraph, or entire text frame	Double-click, triple-click, quadruple-click, or quintuple-click with Type tool	Double-click, triple-click, quadruple-click, or quintuple-click with Type tool
Turn All Caps on or off for selected text	Ctrl+Shift+K	Command+Shift+K
Turn Small Caps on or off for selected text	Ctrl+Alt+Shift+K	Command+Option+Shift+K
Turn Superscript on or off for selected text	Ctrl+Shift+= (equals)	Command+Shift+= (equals)
Turn Subscript on or off for selected text	Ctrl+Alt+Shift+= (equals)	Command+Option+Shift+= (equals)
Set horizontal scale to 100% for selected text	Ctrl+Shift+X	Command+Shift+X
Set vertical scale to 100% for selected text	Ctrl+Alt+Shift+X	Command+Option+Shift+X
Auto leading for selected text	Ctrl+Alt+Shift+A	Command+Option+Shift+A
Reset tracking to 0 for selected text	Ctrl+Shift+Q	Command+Shift+Control+Q
Justify paragraph; left align last line	Ctrl+Shift+J	Command+Shift+J
Justify paragraph; right align last line	Ctrl+Alt+Shift+J	Command+Option+Shift+J
Justify paragraph; force last line	Ctrl+Shift+F	Command+Shift+F
Decrease or increase type size of selected text by 2 units	Ctrl+Shift+, (comma) or Ctrl+Shift+. (period)	Command+Shift+, (comma) or Command+Shift+. (period)
Decrease or increase type size of selected text by 10 units	Ctrl+Alt+Shift+, (comma) or Ctrl+Alt+Shift+. (period)	Command+Option+Shift+, (comma) or Command+Option+Shift+. (period)
Increase or decrease leading by 2 units	Alt+Down Arrow or Alt+Up Arrow	Option+Down Arrow or Option+Up Arrow
Increase or decrease leading by 10 units	Ctrl+Alt+Down Arrow or Ctrl+Alt+Up Arrow	Command+Option+Down Arrow or Command+Option+Up Arrow

Result	Windows	Mac OS
Decrease or increase baseline shift by 2 units	Alt+Shift+Down Arrow or Alt+Shift+Up Arrow	Option+Shift+Down Arrow or Option+Shift+Up Arrow
Decrease or increase baseline shift by 10 units	Ctrl+Alt+Shift+Down Arrow or Ctrl+Alt+Shift+Up Arrow	Command+Option+Shift+Down Arrow or Command+Option+Shift+Up Arrow
Decrease or increase kerning or tracking 20 units (20/1000 ems)	Alt+Left Arrow or Alt+Right Arrow	Option+Left Arrow or Option+Right Arrow
Decrease or increase kerning or tracking 100 units (100/1000 ems)	Ctrl+Alt+Left Arrow or Ctrl+Alt+Right Arrow	Command+Option+Left Arrow or Command+Option+Right Arrow
Toggle paragraph composer	Ctrl+Alt+Shift+T	Command+Option+Shift+T

Shortcuts for working with masks

Result	Windows	Mac OS
New mask	Ctrl+Shift+N	Command+Shift+N
Select all points in a mask	Alt-click mask	Option-click mask
Select next or previous mask	Alt+` (grave accent) or Alt+Shift+` (grave accent)	Option+` (grave accent) or Option+Shift+` (grave accent)
Enter free-transform mask editing mode	Double-click mask with Selection tool or select mask in Timeline panel and press Ctrl+T	Double-click mask with Selection tool or select mask in Timeline panel and press Command+T
Exit free-transform mask editing mode	Esc	Esc
Scale around center point in Free Transform mode	Ctrl-drag	Command-drag
Move selected path points 1 pixel at current magnification	arrow key	arrow key
Move selected path points 10 pixels at current magnification	Shift+arrow key	Shift+arrow key
Toggle between smooth and corner points	Ctrl+Alt-click vertex	Command+Option-click vertex
Redraw Bezier handles	Ctrl+Alt-drag vertex	Command+Option-drag vertex
Invert selected mask	Ctrl+Shift+I	Command+Shift+I
Open Mask Feather dialog box for selected mask	Ctrl+Shift+F	Command+Shift+F
Open Mask Shape dialog box for selected mask	Ctrl+Shift+M	Command+Shift+M

Shortcuts for working with paint tools

Result	Windows	Mac OS
Swap paint background color and foreground colors	X	X
Set paint foreground color to black and background color to white	D	D
Set foreground color to the color currently under any paint tool pointer	Alt-click	Option-click
Set foreground color to the average color of a 4-pixel x 4-pixel area under any paint tool pointer	Ctrl+Alt-click	Command+Option-click
Set a paint tool's brush size	Ctrl-drag	Command-drag
Set a paint tool's brush hardness	Ctrl-drag, then release Ctrl while dragging	Command-drag, then release Command while dragging
Join current paint stroke to the previous stroke	Hold Shift while beginning stroke	Hold Shift while beginning stroke
Set starting sample point to point currently under Clone Stamp tool pointer	Alt-click	Option-click
Momentarily activate Eraser tool with Last Stroke Only option	Ctrl+Shift	Command+Shift
Show and move overlay. (Change <i>aligned</i> Clone Stamp tool's Offset value or change <i>unaligned</i> Clone Stamp tool's Source Position value.)	Alt+Shift-drag with Clone Stamp tool	Option+Shift-drag with Clone Stamp tool
Duplicate a Clone Stamp tool preset in Paint panel	Alt-click the preset	Option-click the preset
Set a paint tool's opacity	Digit on numeric keypad (e.g., 9=90%, 1=10%)*	Digit on numeric keypad (e.g., 9=90%, 1=10%)*
Set a paint tool's opacity to 100%	. (decimal) on numeric keypad*	. (decimal) on numeric keypad*
Set a paint tool's flow	Shift+a digit on numeric keypad (e.g., 9=90%, 1=10%)*	Shift+a digit on numeric keypad (e.g., 9=90%, 1=10%)*
Set a paint tool's flow to 100%	Shift+. (decimal) on numeric keypad*	Shift+. (decimal) on numeric keypad*
Move earlier or later by number of frames specified for stroke Duration	Ctrl+Page Up or Ctrl+Page Down	Command+Page Up or Command+Page Down

Note: Some shortcuts are marked with an asterisk (*) to remind you to make sure that Num Lock is on when you use the numeric keypad.

Shortcuts for working with shape layers

Result	Windows	Mac OS
Group selected shapes	Ctrl+G	Command+G
Ungroup selected shapes	Ctrl+Shift+G	Command+Shift+G
Enter free-transform path editing mode	Select Path property in Timeline panel and press Ctrl+T	Select Path property in Timeline panel and press Command+T
Increase star inner roundness	Page Up when dragging to create shape	Page Up when dragging to create shape
Decrease star inner roundness	Page Down when dragging to create shape	Page Down when dragging to create shape
Increase number of points for star or polygon; increase roundness for rounded rectangle	Up Arrow when dragging to create shape	Up Arrow when dragging to create shape
Decrease number of points for star or polygon; decrease roundness for rounded rectangle	Down Arrow when dragging to create shape	Down Arrow when dragging to create shape
Reposition shape during creation	Hold spacebar when dragging to create shape	Hold spacebar when dragging to create shape
Set rounded rectangle roundness to 0 (sharp corners); decrease polygon and star outer roundness	Left Arrow when dragging to create shape	Left Arrow when dragging to create shape
Set rounded rectangle roundness to maximum; increase polygon and star outer roundness	Right Arrow when dragging to create shape	Right Arrow when dragging to create shape
Constrain rectangles to squares; constrain ellipses to circles; constrain polygons and stars to zero rotation	Shift when dragging to create shape	Shift when dragging to create shape
Change outer radius of star	Ctrl when dragging to create shape	Command when dragging to create shape

Shortcuts for working with markers

Result	Windows	Mac OS
Set layer-time marker at current time (works during RAM preview and audio-only preview)	* (multiply) on numeric keypad	* (multiply) on numeric keypad
Set layer-time marker at current time and open marker dialog box	Alt+* (multiply) on numeric keypad	Option+* (multiply) on numeric keypad
Set and number a composition-time marker (0-9) at the current time	Shift+0-9 on main keyboard	Shift+0-9 on main keyboard

Result	Windows	Mac OS
Go to a composition-time marker (0-9)	0-9 on main keyboard	0-9 on main keyboard
See the duration between two layer-time markers or keyframes in the Info panel	Alt-click the markers or keyframes	Option-click the markers or keyframes
Remove marker	Ctrl-click marker	Command-click marker

Shortcuts for motion tracking

Result	Windows	Mac OS
Move feature region, search region, and attach point 1 pixel at current magnification	arrow key	arrow key
Move feature region, search region, and attach point 10 pixels at current magnification	Shift+arrow key	Shift+arrow key
Move feature region and search region 1 pixel at current magnification	Alt+arrow key	Option+arrow key
Move feature region and search region 10 pixels at current magnification	Alt+Shift+arrow key	Option+Shift+arrow key

Shortcuts for saving, exporting, and rendering

Result	Windows	Mac OS
Save project	Ctrl+S	Command+S
Increment and save project	Ctrl+Alt+Shift+S	Command+Option+Shift+S
Save As	Ctrl+Shift+S	Command+Shift+S
Add active composition or selected items to render queue	Ctrl+Shift+/ (on main keyboard)	Command+Shift+/ (on main keyboard)
Add active or selected composition to render queue and specify name of output file (Make Movie)	Ctrl+M	Command+M
Add current frame to render queue	Ctrl+Alt+S	Command+Option+S
Duplicate render item with same output file name as original	Ctrl+Shift+D	Command+Shift+D

Index

Numerics

16-bpc color 234
 24Pa pulldown 72
 3:2 pulldown
 adding 633
 removing 72
 32-bpc color 234
 3D Channel effects
 3D Channel Extract effect 368
 about 367
 Depth Matte effect 368
 Depth Of Field effect 369
 Fog 3D effect 370
 ID Matte effect 371
 3D files, importing 77, 78, 79
 Photoshop and Illustrator 78
 Vanishing Point exchange 78
 3D Glasses effect 481
 3D layers
 about 171
 auto-orientation 146
 axes 173
 axis modes 174
 effects and masks 175
 expression elements 572
 nesting 116, 175
 render order 116, 175
 text 293
 views 127
 3D properties 171
 3D text properties 293
 3D views 127
 4-Color Gradient effect 419
 8-bpc color 234

A

AAF (Advanced Authoring Format) 75
 acceptsLights (expression element) 573
 acceptsShadows (expression element) 573
 accessibility
 of Help 4
 action-safe zone 130

activation of software 1
 active (expression element) 570, 575, 576
 activeCamera (expression element) 568
 Adaptive Resolution preview mode 125
 add (expression element) 562
 Add Grain effect 455, 457, 459
 Add Vertex command 323
 adjusting exposure 129
 adjustment layers
 about 136
 lights 178
 Adobe After Effects
 conversion of layers in Adobe Premiere Pro 65
 integration with Adobe Bridge 28
 integration with Adobe Encore 35
 integration with Adobe Premiere Pro 35
 integration with Flash 33
 integration with Photoshop 32
 testing mobile content created in 618
 Adobe Audition 76
 Adobe Bridge 28
 Adobe Design Center 9
 Adobe Dynamic Link
 about 609
 and color spaces 610
 deleting links 611
 editing linked compositions 611
 Import After Effects Composition command 610
 Link Media command 612
 linking to compositions 610
 managing performance 609
 New After Effects Composition command 610
 offline compositions 611
 relinking compositions 612
 Save As command, behavior 609
 saving projects 609
 suppressing linked clips in Adobe Premiere Pro 612
 unlinking compositions 612

Adobe Encore
 chapter markers 118
 creating buttons in After Effects 35
 Adobe Fireworks
 copying paths 324
 Adobe Flash
 integration with After Effects 33
 Adobe Help 2
 Adobe Illustrator
 continuous rasterization 151
 copying paths 85, 324
 preparing and importing files 85
 text from 273
 Adobe InDesign
 text from 273
 Adobe Media Encoder 612
 about 613
 Audio options 615
 command 613
 Filters options 614
 Video options 614
 Adobe Photoshop
 3D files 78
 copying paths 324
 creating new files 137
 integration with After Effects 32
 layer styles 168
 preparing and importing files 83
 rendering a frame to 607
 text from 273
 transparency 83
 Adobe Premiere 6.0 and 6.5 35
 Adobe Premiere Pro
 capture 64
 conversion of assets in After Effects 66
 exporting projects to 608
 projects, importing 64
 working with After Effects 35
 Adobe Soundbooth
 using in After Effects 76
 Adobe Video Workshop 5
 Advanced 3D rendering plug-in 181
 Advanced composition settings 110
 Advanced Lightning effect 420

- aerender 622
- aeselflink 40
- After Effects. *See* Adobe After Effects
- aligning
 - layers 140
 - text 283, 294
- alpha channels
 - about 252
 - copying channels to 386
 - creating masks from 256
 - interpretation methods 52
 - matted and unmatted 253
 - matted with color 385
 - premultiplied and straight 253
 - track mattes and 263
 - viewing 129
- Alpha Levels effect 381
- alpha matte 440
- ambient (expression element) 573
- analog film 68
- analog video 68
- Anamorphic 2:1 setting 57
- anchor points
 - layer 154
 - text layers 292
- anchorPoint (expression element) 571
- angles, conversion 566
- animated GIF 36
- animating
 - 3D rotation 173
 - about 183
 - anchor point 154
 - deformation 226
 - with expressions 547
 - paint strokes 310
 - paths 325
 - scale 155
 - text 285
 - text, examples 295, 296, 297, 298, 299, 300, 301
- animation presets
 - about 347
 - expressions 548
 - saving 353
 - text 285
- animator groups, text 286
- anti-aliasing 151
- aperture (expression element) 575
- aperture, camera setting 178
- Arithmetic effect 381
- arrays (expressions) 556
- Asian text. *See* CJK text
- aspect ratio 55
 - frame 55
 - pixel 55, 57
- attach point 335
- attributes (expressions) 556
- Audiences encoding settings 616
- audio
 - changing pitch 224
 - conforming 67
 - displaying spectrum 421
 - editing in Adobe Audition 76
 - editing in Adobe Soundbooth 76
 - layers 157
 - output options 601
 - previewing 122
 - reversing 371
- Audio effects
 - Backwards effect 371
 - Bass & Treble effect 372
 - Delay effect 372
 - Flange & Chorus effect 372
 - High-Low Pass effect 373
 - Modulator effect 373
 - Parametric EQ effect 374
 - Reverb effect 374
 - Stereo Mixer effect 375
 - Tone effect 375
- Audio Spectrum effect 421
- audio tracks
 - conversion in After Effects 67
- audio transitions
 - conversion in After Effects 67
- audio volume 157
 - conversion in Adobe Premiere Pro 66
- Audio Waveform effect 423
- audioActive (expression element) 571
- audioLevels (expression element) 571
- Audition. *See* Adobe Audition
- Auto Bezier interpolation 207
- Auto Color effect 388
- Auto Contrast effect 388
- Auto Levels effect 389
- automation
 - post-render actions 602
 - rendering 622
 - scripts 45
- Auto-Orient options 146
- Auto-trace command 256
- Avid formats
 - output 622
- AVR codec options 622
- B**
- background color 111
- Backwards effect 371
- baking Maya data 79
- baseline 274
- baseline shift 281
- Basic 3D effect 483
- Basic Fill effect. *See* Paint Bucket effect
- Basic Text effect 524
- Bass & Treble effect 372
- batch scripts 622
- Beam effect 423
- behaviors 347, 548
- Best layer quality 150
- Bevel Alpha effect 484
- Bevel And Emboss layer style 169
- Bevel Edges effect 484
- Bezier paths 321
- Bezier Warp effect 404
- bgColor (expression element) 568
- bit depth, color 234
- bit rate 614, 619
- bitmap images 312
- bits per channel (bpc) 234
- Blend effect 382
- blending modes
 - about 163
 - Calculations effect 383
 - Checkerboard effect 426
 - Circle effect and 426
 - Color Link effect 393
 - with Eyedropper Fill effect 426
 - 4-Color Gradient effect 419
 - Fractal Noise 463
 - Lightning effect 431
 - Magnify effect and 409
 - for overlapping text 282
 - Paint Bucket effect and 432

- reference 164
 - Solid Composite effect 387
 - Blending Options properties 171
 - blending, linear 244
 - blending, restricting to channels 171
 - Block Dissolve effect 537
 - bluescreen. *See* keying
 - blur
 - camera (depth of field) 177
 - masks 267
 - motion 200
 - Blur & Sharpen effects
 - Box Blur effect 376
 - Channel Blur effect 376
 - Compound Blur effect 377, 379
 - Directional Blur effect 377
 - Fast Blur effect 377
 - Gaussian Blur effect 378
 - Lens Blur effect 378
 - Radial Blur effect 379
 - Reduce Interlace Flicker effect 379
 - Sharpen effect 380
 - Smart Blur effect 380
 - Unsharp Mask effect 380
 - blurLevel (expression element) 575
 - bounding box
 - free-transform 327
 - text 276
 - Box Blur effect 376
 - bpc (bits per channel) 234
 - Brainstorm 160
 - Bridge Home 8
 - Bridge. *See* Adobe Bridge
 - Brightness & Contrast effect 389
 - Bring Layer Forward command 138
 - Broadcast Colors effect 390
 - broadcast-safe colors 250
 - brush dynamics 305
 - brush strokes 302
 - Brush Strokes effect 517
 - Brush tool 302, 305
 - See also* paint tools
 - brushes 303, 305
 - bubbles, creating with Cell Pattern effect 424
 - Bulge effect 404
 - buttons for Adobe Encore 35
- C**
- caches
 - media 67
 - RAM and disk 39
 - Calculations effect 383
 - calibrating monitors 243
 - Camera Raw
 - See also* camera raw files
 - about 88
 - database 104
 - preview controls 91
 - profile adjustments 99
 - XMP files 104
 - camera raw files
 - about 86
 - cache in Adobe Bridge 88, 91
 - chromatic aberration 100
 - copying and pasting settings in Adobe Bridge 105
 - correcting a color cast 99
 - cropping and straightening images 101
 - database for settings 105
 - export settings 106
 - histogram and RGB values 94
 - importing 89
 - non-neutral colors in 99
 - preview controls 91
 - profile adjustments 99
 - reducing noise 103
 - saving and restoring settings 104
 - saving to other file formats 93
 - sharpening 103
 - sidecar XMP files 105
 - tonal adjustment controls for 97
 - view controls 91
 - vignetting 101
 - white balance in 95
 - camera raw images
 - color management 245
 - cameras
 - about 176
 - Comp Camera attribute 349
 - expression elements 574
 - point of interest 179
 - settings 177
 - tools 180
 - capital letters 281
 - Caps Lock, preventing panel updates 43
 - capturing video 64
 - Card Dance effect 487
 - Card Wipe effect 537
 - case, text 281
 - castsShadows (expression element) 573
 - Caustics effect 489
 - CBR encoding 614
 - CD-ROM
 - setup 30
 - Cell Pattern effect 424
 - Change Color effect 390
 - Change To Color effect 391
 - Channel Blur effect 376
 - Channel Combiner effect 383
 - Channel effects
 - Alpha Levels effect 381
 - Arithmetic effect 382
 - Blend effect 382
 - Calculations effect 383
 - Channel Combiner effect 383
 - Compound Arithmetic effect 384
 - Invert effect 384
 - Minimax effect 385
 - Remove Color Matting effect 386
 - Set Channels effect 386
 - Set Matte effect 386
 - Shift Channels effect 387
 - Solid Composite effect 387
 - Channel Mixer effect 392
 - Channel Volume effect
 - conversion in After Effects 67
 - channels
 - copying 386
 - creating masks from 256
 - viewing 129
 - chapter (expression element) 581
 - character offset 288, 295
 - Character panel 278
 - character value 288
 - Checkerboard effect 425
 - child layers 158
 - choker, matte 450, 451
 - chroma keying. *See* keying
 - Cineon Converter effect 542
 - Cineon footage 85, 251
 - Circle effect 426
 - CJK text 282
 - formatting exceptions 284

- clamp (expression element) 563
- clip markers, conversion in After Effects 67
- Clip Notes 635, 636
- Clone Stamp tool 302, 307
 - See also* paint tools
- codecs
 - about 618
- Collapse Transformations switch 115
- Collect Files command 594, 627
- color (expression element) 575
- Color Balance (HLS) effect 392
- Color Balance effect 392
- Color Conversion methods (expressions) 566
- color correction 238
- Color Correction effects
 - Auto Color effect 389
 - Auto Contrast effect 388
 - Auto Levels effect 389
 - Brightness & Contrast effect 389
 - Broadcast Colors effect 390
 - Change Color effect 390
 - Change To Color effect 391
 - Channel Mixer effect 392
 - Color Balance (HLS) effect 392
 - Color Balance effect 392
 - Color Link effect 392
 - Color Stabilizer effect 393
 - Colorama effect 393
 - common controls 389
 - Curves effect 396
 - Exposure effect 397
 - Gamma/Pedestal/Gain effect 398
 - Hue/Saturation effect 398
 - Leave Color effect 399
 - Levels (Individual Controls) effect 400
 - Levels effect 399
 - Photo Filter effect 400
 - PS Arbitrary Map effect 401
 - Shadow/Highlight effect 402
 - Tint effect 403
 - Tritone effect 403
- color depth 234
- Color Difference Key effect 440
- Color Emboss effect 518
- Color Finesse 238, 250
- Color Key effect 442
- color keying. *See* keying
- Color Link effect 392
- color management
 - about 241
 - camera raw 245
 - color profiles 242
 - enabling 243
 - input color profile 245
 - linear working space 244
 - monitor profile 247
 - output color profile 246
 - simulation profile 248
 - working color space 243
- color models 238
- Color Overlay layer style 169
- Color Picker 237
- Color Picker effect. *See* Eyedropper Fill effect
- Color Profile Converter effect 543
- color profiles
 - about 242
 - embedded 245
 - embedding 246
 - input 245
 - monitor 243, 247
 - output 246
 - simulation 248
- Color Range effect 442, 443
- color spaces 238
- Color Stabilizer effect 393
- Colorama effect 393
- colorDepth (expression element) 561
- Colorize control, Hue/Saturation effect 398
- columns 18
- command line 622
- comment (expression element) 581
- comments, Clip Notes 635, 636
- comp (expression element) 560
- Comp Camera attribute 349
- Comp expression elements 567
- compositing
 - about 252
- composition method for text 285
- Composition panel
 - about 107
 - background color 111
- composition settings 30, 110
- compositions
 - creating 108
 - importing layered files as 83
 - offline, with Adobe Dynamic Link 612
 - resolution 128
 - thumbnail images 111
- Compound Arithmetic effect 384
- Compound Blur effect 376
- compression
 - about 618
 - Adobe Media Encoder 612
 - QuickTime 620
 - Video for Windows 621
- compressor/decompressor. *See* codecs
- coneAngle (expression element) 575
- coneFeather (expression element) 575
- conforming audio 67
- Consolidate All Footage command 60
- Constant Bit Rate. *See* CBR encoding
- continue, keyframe looping argument 578
- Continuous Bezier interpolation 207
- continuous rasterization 115, 151
- conversion, angles 566
- Convert Audio To Keyframes keyframe assistant 203
- Convert Expression To Keyframes keyframe assistant 555
- Convert To Paragraph Text command 276
- Convert To Point Text command 276
- Convert Vertex tool 323
- converting movies 630
- copying and pasting
 - between Adobe Premiere Pro and After Effects 65
- Corner Pin effect 405
- corner points 313, 323
- Create Layers At Composition Start Time preference 134
- Create Outlines command 320
- Crop effect
 - conversion in After Effects 67
- cropping movies 631
- cross (expression element) 563
- cross-platform projects 36, 63

- crystals, creating with Cell Pattern 424
- cue points 118
- cuePointName (expression element) 581
- current-time display 132
- current-time indicator 109
 - moving 123
 - moving to keyframe 188
- Curves effect 396
- cycle, keyframe looping argument 578

- D**
- D1/DV pixel aspect ratio 57
- dashed lines 328
- data rate 619
- degreesToRadians (expression element) 566
- Delay effect 372
- Delete Vertex tool 323
- depth (3D) 171
- Depth Matte effect 368
- depth of field 177
- Depth Of Field effect 369
- depth, color 234
- depthOfField (expression element) 575
- Design Center 9
- difference keying 443
- difference keying. *See* keying
- Difference Matte effect 443
- diffuse (expression element) 573
- digital disk recorders (DDRs) 76
- Digital Picture Exchange (DPX) files 85
- digital video 68
- direction handles and lines 321
 - Graph Editor 209
- direction handles and lines.path 313
- Directional Blur effect 377
- disk cache 39
- disk space 38
- Displacement Map effect 406
- displayStartTime (expression element) 568
- Distort effects
 - Bezier Warp effect 404
 - Bulge effect 404
 - Corner Pin effect 405
 - Displacement Map effect 406
 - Liquify effect 406
 - Magnify effect 408
 - Mesh Warp effect 409
 - Mirror effect 410
 - Offset effect 410
 - Optics Compensation effect 410
 - Polar Coordinates effect 411
 - Reshape effect 413
 - Ripple effect 414
 - Smear effect 415
 - Spherize effect 416
 - Transform effect 417
 - Turbulent Displace effect 417
 - Twirl effect 418
 - Warp effect 418
 - Wave Warp effect 419
- distributing layers 140
- div (expression element) 563
- docking panels 14
- dot (expression element) 563
- double-byte text. *See* CJK text
- downloads
 - updates, plug-ins, and tryouts 10
- Draft 3D preview mode 124
- Draft layer quality 150
- Drop Shadow effect 484
- Drop Shadow layer style 169
- drop-frame timecode 132
- duplicating layers 145
- duration
 - about 131
 - time-stretching 218
- duration (expression element) 568, 569
- Dust & Scratches effect 460
- DVCPRO
 - HD 69
 - pixel aspect ratio 57
- DVD
 - setup 30
- Dynamic Link. *See* Adobe Dynamic Link

- E**
- ease (expression element) 565
- easeIn (expression element) 566
- easeOut (expression element) 566
- Easy Ease keyframe assistant 213, 217
- Echo effect 531
- Edit Original command 60
- editing mode, text 277
- effect (expression element) 569
- effect control points 353
- Effect Controls panel 350
- effect properties 152
- effect properties, conversion in Adobe Premiere Pro 66
- effects
 - about 348
 - applying to masks 254
 - cameras and lights 349
 - Expression Controls 349, 555
 - expression elements 576
 - expression example 583
 - positioning 353
 - properties 350
 - removing 352
 - turning off and on 352
- Effects & Presets panel 348, 350
- EI format, importing 77
- Ellipse effect 426
- Ellipse tool 319
- Emboss effect 518
- Enable Per-character 3D command 293
- Enable Time Remapping command 222, 225
- encoders 618
- Equalize effect 396
- Eraser tool 302, 310
 - See also* paint tools
- error messages, for expressions 548
- eventCuePoint (expression element) 581
- Every-line Composer 285
- examples
 - expressions 551, 582, 583, 584, 585, 586
 - expressions, pick whip 582
 - text animation 295, 296, 297, 298, 299, 300, 301
- experimenting with property values 160
- exploding a layer or particle 498
- Exponential Scale keyframe assistant 218
- Export command 592
- Export To DVD command 613

- exporting
 - about 587
 - After Effects project to Adobe Premiere Pro 608
 - Clip Notes 634
 - output module settings 599
 - render queue 590, 591
 - supported formats 588
 - to film 606
 - using preset settings 612
 - using QuickTime components 592
- Exposure effect 397
- exposure, adjusting 129
- Expression Controls effects 349, 555
- expression field 552
- Expression Language menu 549
- Expression Sampler template project 547
- Expression selector 300, 301
- expressions
 - about 547
 - animating at markers 585
 - animation presets 548
 - arrays 556
 - attributes 556
 - behaviors 548
 - converting to keyframes 555
 - copying 554
 - creating and modifying 549
 - disabling 550
 - error messages 548
 - examples 551, 582, 583, 584, 585, 586
 - examples with pick whip 582
 - examples, text animation 300, 301
 - global objects 560
 - indices 558
 - Interpolation methods 565
 - language 556
 - Mask Path property 576
 - math methods 566
 - methods 556
 - pick whip 550
 - random number methods 563
 - reference 559
 - saving 554
 - Source Text property 553
 - start or stop at specific time 585
 - time 559
 - time conversion 562
 - vectors 558
 - viewing 552
- extending layers 141
- extensions, filename 37
- Extract effect 445
- Extras 7
- Eyedropper Fill effect 426
- eyedropper tool 236, 441
- F**
- Fast Blur effect 377
- fast motion. *See* time-stretching
- Fast Previews 124
- favorites. *See* animation presets
- feathering mask edges 262
- feature region 335
- Feet + Frames time display 132
- field order 72, 634
- field rendering 71, 599
- field separation 71
- fields
 - in interlaced frames 70
- file formats. *See* formats
- file systems 36
- filenames
 - conventions 37
 - for output 595
- Fill effect 427
- fill layers 263
- fill rules 331
- fills 328
- film 30, 68
- film size, camera setting 178
- Filmstrip (FLM) format
 - guidelines for editing 608
- filters. *See* effects
- Find Edges effect 519
- first vertex 325
- Flange & Chorus effect 372
- Flash (SWF)
 - rendering and exporting 603
- Flash Video (FLV)
 - cue points 118
 - rendering and exporting 603
- Flash. *See* Adobe Flash
- flipping layers 156
- FLM format
 - guidelines for editing 608
- floating windows 14
- Flowchart panel 24
- FLV. *See* Flash Video (FLV)
- Foam effect 491
- focal length, camera setting 178
- focal plane, specifying 369
- focus distance, camera setting 177
- focusDistance (expression element) 575
- Fog 3D effect 370
- folders
 - project hierarchy 36
 - Project panel 58
- font installation 2
- font size 278
- footage
 - editing source in original application 60
 - preparing before importing 47
- footage (expression element) 560, 569
- footage items
 - about 47
 - Adobe Photoshop files 137
 - importing and interpreting 50
 - looping 63
 - managing 58
 - placeholders 61
 - proxies 61
 - replacing 47
- Footage panel 59
- formats
 - See also individual formats*
 - for export 588
 - for import 48
- formatting text
 - characters 278
 - paragraphs 283
- Fractal effect 427
- Fractal Noise effect 461
- frame aspect ratio 55
- frame blending 225
- Frame Hold, conversion in After Effects 67
- Frame Mix 225
- frame rate 53, 83
- frameDuration (expression element) 568, 569
- frames
 - freezing 208, 222
 - in interlaced video 70

- framesToTime (expression element) 561
 - frameTarget (expression element) 581
 - Free Transform Points command 327
 - freeze frame 208, 222
 - fromComp (expression element) 573
 - fromCompToSurface (expression element) 574
 - fromCompVec (expression element) 574
 - fromWorld (expression element) 574
 - fromWorldVec (expression element) 574
 - f-stops, camera setting 178
- G**
- gamma
 - about 239
 - Gamma/Pedestal/Gain effect 397
 - garbage mattes 270
 - Gaussian Blur effect 378
 - gaussRandom (expression element) 564
 - Generate effects
 - Advanced Lightning effect 420
 - Audio Spectrum effect 421
 - Audio Waveform effect 423
 - Beam effect 424
 - Cell Pattern effect 424
 - Checkerboard effect 425
 - Circle effect 426
 - Ellipse effect 426
 - Eyedropper Fill effect 426
 - Fill effect 427
 - 4-Color Gradient effect 419
 - Fractal effect 427
 - Grid effect 429
 - Lens Flare effect 429
 - Lightning effect 430
 - Paint Bucket effect 431
 - Radio Waves effect 432
 - Ramp effect 435
 - Scribble effect 435
 - Stroke effect 437
 - Vegas effect 438
 - Write-on effect 439
 - Get Properties For command 619
 - GIF, animated 36
 - global expression objects 560
 - Glow effect 519
 - GPU 593
 - Gradient Overlay layer style 169
 - Gradient Wipe effect 539
 - gradients
 - creating with Ramp effect 435
 - editing 236
 - gradients (shape layers) 328
 - grain 452
 - Graph Editor 184
 - graphics tablets and paint tools 305
 - grayscale images
 - colorizing 99
 - converting to black and white 524
 - creating 392
 - greenscreen. *See* keying
 - Grid effect 429
 - grids 131
 - grouping shapes 315, 317
 - Grow Bounds effect 544
 - guide layers 159
 - guides 131
- H**
- H.264 69
 - halos 52, 385
 - handheld cameras 342
 - hand-tinted images 392
 - hanging punctuation 284
 - hard disk cache 39
 - hard disk space 38
 - hasAudio (expression element) 570
 - hasParent (expression element) 570
 - hasVideo (expression element) 570
 - HD
 - pixel aspect ratio 57
 - HDR (high dynamic range) images 235, 545
 - HDR Comander effect 545
 - HDR Highlight Compression effect 546
 - HDV 69
 - pixel aspect ratio 57
 - height (expression element) 568, 569, 570
 - Help
 - about 2
 - Hide Layer Controls command 173
 - high-definition video 69
 - highlight clipping 387
 - highlights, adjusting 402
 - High-Low Pass effect 373
 - histograms
 - adjusting color with 387
 - History command 25
 - Hold interpolation 207
 - hold-out matte 270
 - horizontal scale of text 281
 - horizontal scan lines 70
 - horizontal text, converting to vertical 276
 - HSL/Color/Grayscale panel 99
 - hslToRgb (expression element) 566
 - Hue/Saturation effect 398
- I**
- ICC (International Color Consortium) 242
 - ID Matte effect 371
 - Illustrator. *See* Adobe Illustrator
 - image noise, defined 103
 - importing
 - 3D files 77, 78, 79, 171
 - See also individual formats*
 - about 47
 - Adobe Illustrator files 85
 - Adobe Photoshop files 83
 - Adobe Premiere 6.0 and 6.5 projects 64
 - Adobe Premiere Pro projects 64
 - After Effects projects 63
 - camera raw files 89
 - Cineon files 85
 - Digital Picture Exchange (DPX) files 85
 - formats 48
 - methods 50
 - still images and sequences 80
 - Vanishing Point exchange (.vpe) 78
 - In point 141
 - indenting paragraphs 284
 - InDesign. *See* Adobe InDesign
 - index (expression element) 570, 581
 - indices (expressions) 558
 - influence, keyframe direction handles 213
 - Inner Glow layer style 169
 - Inner Shadow layer style 169
 - Inner/Outer Key effect 446

- inPoint (expression element) 570
 - input color profiles 245
 - installation 1
 - intensity (expression element) 575
 - inter-character blending 282
 - interlaced video 70, 71
 - International Press
Telecommunications Council.
See IPTC
 - interpolation
 - about 204
 - acceleration 213
 - applying and changing 208
 - expressions 565
 - motion paths 204
 - Smart Mask Interpolation 265
 - types 207
 - Interpolation methods
(expressions) 565
 - interpretation rules 52
 - interpreting footage items
 - about 51
 - alpha channel 52
 - field order 72
 - frame rate 83
 - separating fields 71
 - invert (expression element) 576
 - Invert effect 384
 - IPTC 105
 - Iris Wipe effect 540
 - ITPC 105
- J**
- JavaScript, as expression
language 556
 - justifying text 284
- K**
- kerning 280
 - key (expression element) 567, 572,
579
 - keyboard shortcuts 20
 - 3D 650
 - animation presets 645
 - compositions 642
 - effects 645
 - exporting 656
 - footage 644
 - general 638
 - in Help 4
 - keyframe 650
 - layers 646
 - markers 655, 656
 - masks 653
 - paint 654
 - preferences 639
 - previews 642
 - projects 639
 - properties, modifying 648
 - properties, showing 647
 - rendering 656
 - saving 656
 - shape layers 655
 - text 651
 - time navigation 643
 - tools 641
 - views 644
 - workspaces 639
- Keyframe Interpolation
command 217
- keyframe menu 189
 - keyframe navigator 188
 - Keyframe Velocity dialog box 216
 - keyframe-looping methods 578
 - keyframes
 - about 183
 - adding to a motion path 198
 - controlling speed between 212
 - copying and pasting 191
 - creating from expressions 555
 - deleting 190
 - editing with spreadsheets 192
 - expression elements 580
 - influence 215
 - modifying multiple 195
 - moving 193
 - roving 216
 - smoothing 202
 - time-stretching 218
 - value graph 191
 - values 195
 - keying 253
 - color 269
 - difference 443
 - effects 268
 - for a single frame 269
 - Keylight 268
 - linear keys 447
 - matte tools 269
 - removing traces of key color 449
 - static background 443
 - Ultra 268
- Keying effects
- Color Difference Key effect 440
 - Color Key effect 442
 - Color Range effect 442
 - Difference Matte effect 443
 - Extract effect 445
 - Inner/Outer Key effect 446
 - Linear Color Key effect 447
 - Luma Key effect 448
 - Spill Suppressor effect 449
- Keylight effect 268
- keys
 - about 253
- kumimoji text 282
- L**
- layer (expression element) 567
 - layer bar mode 184
 - layer expression elements 569, 570,
572
 - layer modes. *See* blending modes
 - layer outline 152
 - layer properties
 - about 152
 - animating 184
 - expression elements 571
 - layer stacking order 115
 - layer styles 168, 169, 170
 - layers
 - about 133
 - adjustment layers 136
 - Adobe Photoshop files 137
 - aligning and distributing 140
 - animating 183
 - child 158
 - color labels 149
 - copying and pasting 145
 - creating 135
 - creating from Adobe Premiere
Pro 65
 - guide 159
 - image quality 150
 - locking and unlocking 149
 - parent 158
 - placing in time 143
 - renaming 147

- rotating 157
 - selecting 138
 - sequencing 144
 - solid-color 136
 - splitting 146
 - stacking and render order 138
 - trimming and extending 141
 - layer-time markers, conversion in Adobe Premiere Pro 66
 - leading 279, 282
 - Leave All Attributes In option 114
 - Leave Color effect 399
 - length (expression element) 563
 - Lens Blur effect 378
 - Lens Flare effect 429
 - Levels (Individual Controls) effect 400
 - Levels effect 399
 - levels, adjusting with Auto Levels effect 389
 - Lightning effect 430
 - lights (3D) 178, 179
 - lights, expression elements 575
 - lightTransmission (expression element) 573
 - Line Anchor animator 297
 - linear (expression element) 565, 584
 - linear blending 239, 244
 - Linear Color Key effect 447
 - linear keys 447
 - Linear Wipe effect 541
 - links, web 118
 - lip-synching 220
 - Liquify effect 406
 - Live Update preview mode 124
 - LiveDocs 2
 - Local Axis mode 174
 - locking
 - layers 149
 - masks 259
 - lookAt (expression element) 563
 - loopIn (expression element) 578
 - loopInDuration (expression element) 579
 - looping
 - footage items 63
 - Fractal Noise effect 463
 - previews 122
 - loopOut (expression element) 578
 - using with grain effects 453
 - viewing 257
 - masks, conversion in Adobe Premiere Pro 66
 - masks, creating
 - about 254
 - from channels 256
 - from motion paths 255
 - Match Grain effect 455, 457, 458, 460, 464
 - material options (3D) 181
 - math, expressions 566
 - Matte Choker effect 271, 450
 - Matte effects
 - Matte Choker effect 450
 - Simple Choker effect 451
 - matted alpha channels 253
 - matted channels 53
 - mattes
 - about 253
 - closing holes 271
 - refining 269
 - removing 385
 - spreading and choking 450, 451
 - track and traveling 263
 - using with grain effects 453, 454
 - mattes, conversion in Adobe Premiere Pro 66
 - Maya format
 - importing 77, 79
 - media cache 67
 - Media Encoder. *See* Adobe Media Encoder
 - media player setup 30
 - Median effect 466
 - Memory & Cache preferences 39
 - memory requirements 37
 - memory, caches 39
 - menus 19
 - Merge Paths 333
 - Mesh Warp effect 409
 - mesh, Puppet 231
 - metadata
 - about 618
 - in MPEG-2 files 613
 - metal (expression element) 573
 - methods (expressions) 556
 - Metrics kerning 281
 - Microsoft RLE compression 621
 - Minimax effect 385
 - loopOutDuration (expression element) 579
 - lower-field first field order 72
 - luma expansion 250
 - Luma Key effect 448
 - luminance keying. *See* keying
- M**
- Magnify effect 408
 - magnifying. *See* zooming
 - Make Movie command 590
 - manual preview 123
 - margins, safe-zone 130
 - marker (expression element) 567
 - MarkerKey (expression element) 581
 - markers
 - about 116
 - chapter links 118
 - composition 117
 - cue points 118
 - layer 118
 - synchronizing to audio 119
 - mask (expression element) 569
 - Mask Expansion property 262
 - Mask Path property 576
 - maskExpansion (expression element) 576
 - maskFeather (expression element) 576
 - maskOpacity (expression element) 576
 - masks
 - 3D layers 175
 - about 253
 - adjusting and expanding edges 262
 - applying effects to 254
 - color 260
 - creating 318, 320, 321
 - creating motion paths from 199
 - deleting 259
 - expression elements 576
 - feathering 262
 - locking and unlocking 259
 - modes, blending 260
 - modifying 323
 - motion blur 267
 - moving 267
 - Pan Behind tool 267
 - saving and reusing 259
 - selecting 258

- Mirror effect 410
 - mixing audio 375
 - mobile devices
 - setup 30
 - Modulator effect 373
 - monitors
 - profiling 243
 - Monochrome control, Channel Mixer effect 392
 - Mosaic effect 520
 - motion blur 200, 267
 - motion paths
 - auto-orientation 146
 - changing speed numerically 216
 - creating 197
 - creating from masks 199
 - Motion Sketch 199
 - smoothing 202
 - spatial interpolation and 204
 - speed 210
 - Motion Sketch 199
 - Motion Tile effect 520
 - motion tracking
 - about 335
 - applying to another layer 345
 - attach point 335
 - correcting drift 345
 - feature region 335
 - search region 335
 - stabilizing motion 342
 - track points 335, 343
 - tracking data 341
 - tracking rotation 342
 - tracking scale 342
 - workflow 336
 - Motion values, conversion in After Effects 67
 - motion-picture film 69, 606
 - Move All Attributes Into The New Composition option 114
 - movies, making from compositions 590
 - MPEG formats
 - about 613
 - multiplexer preset options 617
 - presets 613
 - MPEG indexing 67
 - mul (expression element) 562
 - multiple monitors 17
 - multiplexing 617
 - multiprocessing 40
 - mutation 160
 - MXF 49
 - importing 74
- N**
- name (expression element) 568, 569, 572
 - names
 - footage files 37
 - project files 37
 - navigation shortcuts, in Adobe Help 4
 - nearestKey (expression element) 567, 572, 579
 - nested compositions
 - 3D layers 116
 - about 113
 - prerendering 114
 - network rendering 625, 626, 627, 628
 - noise
 - in camera raw images 103
 - Noise & Grain effects
 - Add Grain effect 459
 - Dust & Scratches effect 460
 - Fractal Noise effect 461
 - Match Grain effect 464
 - Median effect 466
 - Noise Alpha effect 466
 - Noise effect 466
 - Noise HLS Auto effect 468
 - Noise HLS effect 467
 - Remove Grain effect 468
 - noise (expression element) 565
 - Noise Alpha effect 466
 - Noise effect 466
 - Noise HLS Auto effect 467
 - Noise HLS effect 467
 - noise sampling, grain effects 456, 464
 - non-drop-frame timecode 132
 - noninterlaced video 70
 - normalize (expression element) 563
 - NTSC to PAL 630
 - null objects
 - about 159
 - using with Expression Controls effects 555
 - Numbers effect 525
 - numKeys (expression element) 568, 572, 579
 - numLayers (expression element) 568
- O**
- offline compositions 611
 - Offset effect 410
 - offset, keyframe-looping argument 578
 - OMF (Open Media Framework) format
 - importing 75
 - rendering and exporting 622
 - online resources 7
 - opacity (expression element) 571
 - Opacity values, conversion in After Effects 67
 - OpenGL 125, 593
 - OpenType fonts 278
 - operating system considerations 36
 - optical kerning 280
 - Optics Compensation effect 410
 - Orbit Camera tool 180
 - orientation (expression element) 572
 - orthogonal views 127
 - Out point 141
 - Outer Glow layer style 169
 - out-of-memory alert 38
 - outPoint (expression element) 570
 - output color profiles 246
 - output module settings 599
 - overflow volumes 629
 - Overlap controls, Puppet 231
 - overscan 130
- P**
- P2 media
 - importing 74
 - Paint Bucket effect 431
 - Paint effect 471
 - paint operations, shape layers 314, 328
 - Paint panel 302
 - paint strokes 302, 310
 - paint tools 302
 - PAL to NTSC 630
 - Pan Behind tool 154, 267
 - Panasonic P2 49

- panels
 - docking and grouping 14
 - opening and closing 17
 - resizing 16
- panning
 - anchor point 154
 - audio 375
 - masks 266
- Paragraph panel 283
- paragraph text
 - See also* text
 - converting to point 276
- param (expression element) 576
- parameters (expression element) 581
- Parametric EQ effect 374
- parametric shape paths 314
- parent (expression element) 570
- parent layers 158
- Particle Playground effect 499
- patches, Mesh Warp 409
- path names 36
- path operations, shape layers 314, 332
- Path Options property, text 294
- Path Text effect 526
- Pathfinder effects 333
- paths
 - about 313
 - animating 325
 - converting to RotoBezier 323
 - creating 318, 320, 321
 - direction handles 209
 - modifying 258, 323, 327
 - placing text along 293
- PDF files
 - exporting Clip Notes comments as 634
- Pen tool
 - drawing paths 321
 - editing paths 323
 - keyframes and motion paths 198
- per-character 3D text properties 293
- performance, improving 41
- Perspective effects
 - 3D Glasses effect 482
 - Basic 3D effect 483
 - Bevel Alpha effect 484
 - Bevel Edges effect 484
 - Drop Shadow effect 484
 - Radial Shadow effect 485
- Photo Filter effect 400
- Photoshop. *See* Adobe Photoshop
- PIC format, importing 77
- pick whip, creating expressions with 550
- pingpong, keyframe looping argument 578
- pins, Puppet 226, 231
- pitch
 - changing 224
- pixel aspect ratio 55, 57
- Pixel Motion 225
- pixelAspect (expression element) 568, 569
- pixels 312
- placeholders 61
- planning 28
- platforms and importing 63
- playback. *See* previews
- plug-ins 7, 44
 - in Adobe Store 10
- point of interest 179
- point text
 - See also* text
 - converting to paragraph 276
- pointOfInterest (expression element) 574, 575
- Polar Coordinates effect 411
- Polygon tool 319
- Portable Document Format. *See* PDF files
- position
 - expression example 583
 - Pan Behind tool 266
- position (expression element) 571
- Posterize effect 521
- Posterize Time effect 532
- posterizeTime (expression element) 561
- post-render actions 602
- precomposing 113, 114
- preferences
 - resetting 21
- Premiere Pro. *See* Adobe Premiere Pro
- premultiplied channels 53, 253
- preparing source footage 47
- prerendering 114
- Preserve Underlying Transparency option 264
- preset export settings 612
- presets. *See* animation presets
- pressure setting 305
- previews
 - about 120
 - alpha and color channels 129
 - choosing a viewer 124
 - color management 247, 248
 - external video monitors 126
 - grain effects 455
 - memory requirements 38
 - methods 120
 - modes 124
 - performance 41
 - viewers 19
 - work area 112
- profiling a monitor 243
- progressive scanning 70
- Project panel 58
- project settings 29
- project templates 23
- projects 23, 60, 63
- properties
 - effects 350
 - expression elements 576
 - layers 152
- properties and property groups 152
- propertyGroup (expression element) 579, 580
- propertyIndex (expression element) 579, 580
- proxies 61
- PS Arbitrary Map effect
 - about 401
- Pucker & Bloat path operation 332
- pulldown
 - adding 633
 - removing 72
- punctuation, hanging 284
- Puppet tools
 - about 226
 - automatically animating 229
 - manually animating 228
 - mesh and pins 231
 - outlines and paths 230
 - Overlap controls 231
 - Starch controls 232
- purge 38

Q

quality, layer image 150
 QuickTime
 compression settings 619
 encoding presets 616
 QuickTime (MOV) format
 exporting 592
 QuickTime video
 exporting 33
 quotation marks 279

R

Radial Blur effect 379
 Radial Shadow effect 485
 Radial Wipe effect 541
 radiansToDegrees (expression element) 567
 Radio Waves effect 432
 RAM (random access memory) 38, 39
 RAM previews 121
 Ramp effect 435
 random (expression element) 564
 Random Numbers methods (expressions) 563
 random seed 354
 Randomness (Brainstorm) 160
 Range selector 289, 295, 298
 raster images 312
 rasterization, continuous 151
 read me file 2
 RealMedia files, exporting 616
 Reduce Interlace Flicker effect 379
 Reduce Project command 60
 reflectivity, 3D layers 181
 region of interest 111
 registration of software 1
 reloading footage items 60
 remap-time marker 220
 Remove Color Matting effect 385
 Remove Grain effect 468
 Remove Unused Footage command 60
 renaming 147
 Render Multiple Frames
 Simultaneously preference 40
 render order 115, 138

Render Queue panel

 about 591
 output module settings 599
 render settings 597
 render settings 597
 rendering
 about 587
 audio 601
 command-line 622
 field order 72
 file naming 595
 frame blending 225
 log file 592
 memory requirements 38
 network 625, 626, 627
 OpenGL 593
 output module settings 599
 overflow and segment settings 629
 pausing and stopping 591
 performance 41
 post-render actions 602
 render queue 590, 591
 render settings 597
 re-rendering 591, 592
 still-image sequences 606
 watch folders 625, 626
 work area 112
 rendering intent, Color Profile Converter effect 543
 renmoji text 282
 Repeater 333
 replicating shapes 333
 requirements, system 1
 Reshape effect 412
 resizing
 movies 631, 632
 resolution
 compositions 128
 revealing footage items 60
 Reverb effect 374
 reversing audio 371
 reversing paths 331
 Revert command 25
 reviewing with Clip Notes 635, 636
 RGB 238
 rgbToHsl (expression element) 566
 Ripple effect 414
 RLA format, importing 77, 78
 rotating layers 157

rotation

 3D layers 173
 expression example 582
 selected paths 327
 rotation (expression element) 571
 rotationX (expression element) 572
 rotationY (expression element) 572
 rotationZ (expression element) 573
 RotoBezier paths
 adjusting tension 324
 converting 323
 creating 313
 rotoscoping 306
 See also paint tools, paint strokes
 Roughen Edges effect 521
 roving keyframes 216
 RPF Camera Import keyframe assistant 78
 RPF format, importing 77, 78
 rulers 130

S

safe zones 130
 sampleImage (expression element) 571
 Satin layer style 169
 saturation
 adjusting a specific color range 99
 Save Animation Preset 353
 Save Frame As command 607
 Save RAM Preview command 121
 scale
 exponential 218
 paths and points 327
 tracking 342
 scale (expression element) 571
 scaling
 layers 155
 movies 631, 632
 scan lines 70
 Scatter effect 522
 Scribble effect 435
 scripts 45
 scrolling 18
 scrubbing. *See* previews
 search region 335
 seedRandom (expression element) 563
 segment settings 629

- selecting
 - layers 138
- selectors
 - adding 289
 - Expression 300, 301
 - Range 289, 295, 298
 - Wiggly 289, 296, 300
- selflink 40
- Send Layer Backward command 138
- separating fields 71
- Sequence Layers keyframe assistant 144
- sequence markers, conversion in After Effects 67
- sequences of still images 81, 606
- Set Channels effect 386
- Set First Vertex command 325
- Set Matte effect 386
- setting up projects 28
- shadow clipping 387
- Shadow Map Resolution 181
- Shadow/Highlight effect 402
- shadowDarkness (expression element) 575
- shadowDiffusion (expression element) 576
- shadows (3D) 175, 178
- shaky footage, stabilizing 342
- shape groups 315, 317
- shape layers 314, 318
- shapes
 - adding attributes 328
 - creating 318, 320, 321
 - duplicating 328
 - modifying 323
 - replicating 333
 - selecting 325
 - strokes and fills 328
- Sharpen effect 380
- Shatter effect 508
- Shift Channels effect 387
- shininess (expression element) 573
- shortcuts, keyboard. *See* keyboard shortcuts
- Show Layer Controls 173
- showing and hiding
 - axes (layer controls) 173
 - expressions 552
 - layers 149
 - safe zones and grids 131
- shutterAngle (expression element) 568
- shutterPhase (expression element) 568
- shy layers 150
- sidecar files 104, 105
- silhouette blending modes 166
- Simple Choker effect 451
- Simulation effects
 - Card Dance effect 488
 - Caustics effect 490
 - Foam effect 492
 - Particle Playground effect 496
 - Shatter effect 509
 - Wave World effect 514
- single frame, rendering and exporting 607
- Single-line Composer 285
- slip edit 142
- slow motion. *See* time-stretching *and* Timewarp
- Smart Blur effect 380
- Smart Mask Interpolation 265
- Smear effect 415
- smooth (expression element) 578
- smooth points 313, 323
- Smoother, The 202
- smoothing motion 217
- SMPTE timecode 132
- snapshots 125
- software
 - activation 1
 - downloads 10
 - registration 1
- Solid Composite effect 387
- solid-color layers 136
- solo layers 149
- Soundbooth. *See* Adobe Soundbooth
- source (expression element) 569
- source footage
 - See also individual formats.*
 - supported formats for import 48
- Source Text property 273, 553
- spacebar play 120
- spatial interpolation and motion paths 204
- spatial properties 152
- specular (expression element) 573
- speed
 - about 213
 - easing 217
 - gradual starts and stops 215
 - graphs 210
 - motion paths 210
- speed (expression element) 577
- Speed property, conversion in After Effects 67
- speedAtTime (expression element) 577
- Spherize effect 416
- Spill Suppressor effect 449, 450
- Split tone 99
- splitting layers 146
- Spread (Brainstorm) 160
- spreading mattes 451
- spreadsheets 192
- square pixels 57
- stabilizing motion 342
- stacking order 115, 138
- standard preview 120
- Starch controls, Puppet 232
- startTime (expression element) 570
- stencil blending modes 166
- Stereo Mixer effect 375
- Stereo Mixer effect, conversion in Adobe Premiere Pro 66
- still images
 - changing duration 141
 - formats for export 588
 - preparing and importing 80
- stopwatch 184
- storage 38
- straight channels 53, 253
- stretching a layer in time 219
- Strobe Light effect 523
- Stroke effect 437
- Stroke layer style 169
- strokes 328
 - See also* paint strokes
- Stylize effects
 - Brush Strokes effect 517
 - Color Emboss effect 518
 - Emboss effect 518
 - Find Edges effect 519
 - Glow effect 519
 - Mosaic effect 520
 - Motion Tile effect 520
 - Roughen Edges effect 521

- Scatter effect 522
 - Strobe Light effect 523
 - Texturize effect 523
 - Threshold effect 524
 - sub (expression element) 562
 - subscript text 281
 - superscript text 281
 - super-slow motion 535
 - SWF. *See* Flash (SWF)
 - Switch 3D View command 127
 - switches
 - about 147
 - Continuously Rasterize 151
 - Lock 149
 - Quality 150
 - Shy 150
 - Solo 149
 - Video 148
 - synthetic layers 314
 - system requirements 1
- T**
- tablets, graphics 305
 - tate-chuu-yoko text 282
 - technical support 1
 - telecine transfer 69
 - template projects 23
 - templates
 - for output module settings 599
 - for render settings 597
 - Temporal Filtering, Remove Grain effect 468
 - temporal properties 152
 - temporalWiggle (expression element) 578
 - text
 - aligning on a path 294
 - baseline 274
 - baseline shift 281
 - bounding box 276
 - case 281
 - changing direction 276
 - color 280
 - composition 285
 - conversion, paragraph and point 276
 - creating 273
 - creating shapes from 320
 - editing 277
 - fill and stroke 279
 - formatting 278, 283
 - from other applications 273
 - from version 6.0 project 280
 - justified 284
 - kerning and tracking 280
 - leading 279, 282
 - offsetting character values 288
 - paragraph text 273, 275, 276
 - as particles 500
 - Path Options 294
 - point text 273, 274, 276
 - scaling 281
 - selecting 277, 289
 - superscript and subscript 281
 - text animation presets 285
 - text animator groups 288
 - Text effects
 - Basic Text effect 524
 - Numbers effect 526
 - Path Text effect 526
 - Timecode effect 530
 - text, animating
 - about 285
 - effects 527
 - examples 295, 297, 298, 299, 300, 301
 - on a path 293
 - with animator groups 286
 - Texturize effect 523
 - thisComp (expression element) 560
 - thisLayer (expression element) 560
 - thisProperty (expression element) 561
 - Threshold effect 524
 - thumbnail images 111
 - time
 - display style 132
 - in expressions 559
 - time (expression element) 561, 580
 - time conversion, with expressions 562
 - Time Difference effect 532
 - Time Displacement effect 533
 - Time effects
 - Echo effect 531
 - Posterize Time effect 532
 - Time Difference effect 532
 - Time Displacement effect 533
 - Timewarp effect 535
 - time graph 109, 112
 - time ruler 123
 - Time Stretch property, conversion in Adobe Premiere Pro 66
 - timecode 132
 - Timecode effect 530
 - Timeline panel 109
 - timeRemap (expression element) 572
 - time-remapping 220, 223, 224
 - time-remapping (expressions) 559
 - Time-Reverse Keyframes keyframe assistant 220
 - time-stretching 219
 - timeToCurrentFormat (expression element) 562
 - timeToFeetAndFrames (expression element) 562
 - timeToFrames (expression element) 561
 - timeToNTSCTimecode (expression element) 561
 - timeToTimecode (expression element) 561
 - time-vary stopwatch 184
 - Timewarp effect 535
 - Tint effect 403
 - title-safe zones 130
 - toComp (expression element) 573
 - toCompVec (expression element) 574
 - Toggle Hold Keyframe 208
 - tonal adjustments 397
 - tonal levels, posterizing 399, 400
 - tonal range
 - adjusting 387
 - tonal range, adjusting 396, 402
 - Tone effect 375
 - tone response 239
 - tool tips 20
 - tools 20
 - toWorld (expression element) 574
 - toWorldVec (expression element) 574
 - tracing channels 256
 - track mattes 263
 - track points 335, 343
 - Track XY Camera tool 180
 - Track Z Camera tool 180
 - Tracker Controls panel 339
 - tracking data 341
 - tracking motion. *See* motion tracking.

- tracking, text 280
 - transfer modes, conversion in Adobe Premiere Pro 66
 - transfer modes. *See* blending modes
 - Transform effect 417
 - Transform properties, conversion in Adobe Premiere Pro 66
 - transformations, collapsing 115
 - Transition Completion property 536
 - Transition effects 536
 - Block Dissolve effect 537
 - Card Wipe effect 537
 - Iris Wipe effect 540
 - Linear Wipe effect 541
 - Venetian Blinds effect 542
 - transparency
 - Adobe Photoshop files 83
 - alpha channels 252
 - keying 252
 - paint strokes 303
 - preserving during compositing 264
 - traveling mattes 263, 386
 - trimming
 - footage items 59
 - layers 141
 - Tritone effect 403
 - TrueType fonts 278
 - tryouts 10
 - tsume text 282
 - Turbulent Displace effect 417
 - Tweaking controls, Grain effects 460
 - tweening. *See* keyframes
 - Twirl effect 418
 - Twist path operation 332
 - twitter 379
 - Type 1 fonts 278
 - type. *See* text
- U**
- Ultra 268
 - uncompressed high-definition video 69
 - Undo command 25
 - Unicode characters 288
 - unlocking layers 149
 - unmatted channels 53, 253
 - Unsharp Mask controls, Remove Grain effect 470
 - Unsharp Mask effect 380
 - updates 10
 - upper-field first field order 72
 - url (expression element) 581
 - user interface brightness 18
 - Utility effects
 - Cineon Converter effect 543
 - Color Profile Converter effects 543
 - Grow Bounds effect 544
 - HDR Compander effect 545
 - HDR Highlight Compression effect 546
- V**
- value (expression element) 561, 576, 580
 - value graphs 191, 206, 222
 - valueAtTime (expression element) 576
 - Vanishing Point exchange 78
 - vector graphics 151, 312
 - Vector Math methods (expressions) 562
 - Vector Paint effect 471
 - vectors 562
 - vectors (expressions) 558
 - Vegas effect 438
 - velocity
 - easing 216
 - time-remapping 220
 - velocity (expression element) 577
 - velocityAtTime (expression element) 577
 - Venetian Blinds effect 542
 - vertical scale of text 281
 - vertical text
 - converting to horizontal 276
 - vertices, path 323
 - vertices.path 313
 - video
 - capturing 64
 - exporting QuickTime 33
 - fields and frames 70
 - high-definition 69
 - importing from Premiere Pro 65
 - interlacing 70
 - progressive scanning 70
 - removing pulldown 72
 - video fields, separating 71
 - Video filter properties, conversion in After Effects 67
 - Video for Windows format
 - compression 621
 - video formats
 - analog 68
 - converting 630
 - digital 68
 - Video switch 148
 - video transitions, conversion in After Effects 67
 - Video Workshop 5
 - videotape
 - setup 30
 - View Axis mode 174
 - viewers 19
 - views
 - orthogonal 127
 - 3D 127
 - vignetting, correcting in camera raw files 101
 - Volume audio filter, conversion in After Effects 67
 - volume, audio 157
- W**
- Wacom tablets 305
 - Warp effect 418
 - warping images 404, 410
 - Watch Folder command 627
 - watch folders 625, 626, 627, 628
 - Wave Warp effect 419
 - Wave World effect 514
 - waveforms
 - animating with Audio Spectrum 421
 - animating with Audio Waveform 423
 - web links 118
 - web video, setup 30
 - white balance for camera raw files 95
 - wide-angle lens 177
 - width (expression element) 568, 569
 - wiggle (expression element) 577
 - Wiggler, The 202
 - Wiggly selector 289, 291, 296, 300
 - windows
 - floating 14
 - opening and closing 17
 - Windows Media format
 - specifying codecs 616
 - Wireframe layer quality 150

- Wireframe preview mode 124
- WM9 HDTV 69
- work area 112
- workflow 26
- working color space 244
- workspaces
 - about 13
 - choosing 14
 - deleting 18
 - docking and grouping 14
 - drop zones 14
 - floating windows 14
 - multiple monitors 17
 - resetting 18
 - resizing panel groups 16
 - saving custom layouts 17
- World Axis mode 174
- Write On option 310
- Write-on effect 439

X

- XMP (Extensible Metadata Platform)
 - exporting 618
- XMP sidecar files
 - in Camera Raw 104
 - viewing in Adobe Bridge 105

Z

- z axis 171, 173
- Zig Zag path operation 332
- zoom (expression element) 575
- zoom lens 218
- zooming 18, 128
- zooming in time 112
- ZPIC format, importing 77