

# Autodesk® 3ds Max®

2008

Help: Volume 1



Autodesk®

© 2007 Autodesk, Inc. All rights reserved. Except as otherwise permitted by Autodesk, Inc., this publication, or parts thereof, may not be reproduced in any form, by any method, for any purpose.  
Certain materials included in this publication are reprinted with the permission of the copyright holder.  
Portions Copyrighted © 2005 Microsoft Corporation. All rights reserved.  
Portions Copyrighted mental images GmbH 1989-2005.  
This software contains source code provided by mental images GmbH.  
Portions Copyright Max HTR created 2003-2005 by Motion Analysis.  
Portions zlib © 2007 TinyXml.  
REALVIZ Copyright © 2006 REALVIZ S.A. All rights reserved.  
JPEG software is copyright © 1991-1998, Thomas G. Lane. All Rights Reserved. This software is based in part on the work of the Independent JPEG Group.  
Portions Copyrighted © 2005 Blur Studio, Inc.  
Portions Copyrighted © 1989-2005 Joseph Alter, Inc. Credit to Joe Alter, Gonzalo Rueda, and Dean Edmonds.  
Certain patents licensed from Viewpoint Corporation.  
This product includes Radiance software (<http://radsite.lbl.gov/radiance>) developed by the Lawrence Berkeley National Laboratory (<http://www.lbl.gov>). Copyright © 1990-2005. The Regents of the University of California through Lawrence Berkeley National Laboratory. All rights reserved.  
OpenEXR Bitmap I/O Plugin © 2003-2005 SplutterFish, LLC.  
OpenEXR © 2003 Industrial Light and Magic a division of Lucas Digital Ltd. LLC.  
Zlib © 1995-2003 Jean-loup Gailly and Mark Alder  
Portions Copyrighted © 2000-2005 Size8 Software, Inc.  
Portions Copyrighted © 2006 IntegrityWare, Inc.  
Portions © Copyrighted 1999-2005 Havok.com Inc. (or its licensors). All Rights Reserved.  
Portions Copyright 1998-2003 by Neil Hodgson. All Rights Reserved.  
Portions of this software Point Cache 2 © 2005-2006 Blizzard Entertainment, Inc.  
Portions Copyrighted © 2003 ATI Technologies, Inc. All Rights Reserved. Permission to use, copy, modify, and distribute this software and its documentation for any purpose and without fee is hereby granted, provided that the above copyright notice appear in all copies and that both that copyright notice and this permission notice appear in supporting documentation.  
Portions Copyrighted © 1991, 1999 Free Software Foundation, Inc. Refer to GNU Lesser General Public License at <http://www.gnu.org/licenses/lgpl.html>.  
Copyright © 1991-1994 by Arthur D. Applegate. All Rights Reserved. No part of this source code may be copied, modified or reproduced in any form without retaining the above copyright notice. This source code, or source code derived from it, may not be redistributed without express written permission of the author.  
Portions Copyrighted © 1999, 2000 NVIDIA Corporation. This file is provided without support, instructions or implied warranty of any kind. NVIDIA makes no guarantee of its fitness for a particular purpose and is not liable under any circumstances for any damages or loss whatsoever arising from the use or inability to use this file or items derived from it.  
Portions Copyrighted © 2006 NVIDIA Corporation.  
The following are registered trademarks or trademarks of Autodesk, Inc., in the USA and other countries: 3DEC (design/logo), 3December, 3December.com, 3ds Max, ActiveShapes, Actrix, ADI, Alias, Alias (swirl design/logo), AliasStudio, Alias/Wavefront (design/logo), ATC, AUGI, AutoCAD, AutoCAD Learning Assistance, AutoCAD LT, AutoCAD Simulator, AutoCAD SQL Extension, AutoCAD SQL Interface, Autodesk, Autodesk Envision, Autodesk Insight, Autodesk Intent, Autodesk Inventor, Autodesk Map, Autodesk MapGuide, Autodesk Streamline, AutoLISP, AutoSnap, AutoSketch, AutoTrack, Backdraft, Built with ObjectARX (logo), Burn, Buzzsaw, CaiCE, Can You Imagine, Character Studio, Cinestream, Civil 3D, Cleaner, Cleaner Central, ClearScale, Colour Warper, Combustion, Communication Specification, Constructware, Content Explorer, Create>what's-Next> (design/logo), Dancing Baby (image), DesignCenter, Design Doctor, Designer's Toolkit, DesignKids, DesignProf, DesignServer, DesignStudio, DesignStudio (design/logo), Design Your World, Design Your World (design/logo), DWF, DWG, DWG (logo), DWG TrueConvert, DWG TrueView, DXF, EditDV, Education by Design, Extending the Design Team, FBX, Filmbox, FMDesktop, Freewheel, GDX Driver, Gmax, Heads-up Design, Heidi, HOOPS, HumanIK, i-drop, iMOUT, Incinerator, IntroDV, Inventor, Inventor LT, Kaydara, Kaydara (design/logo), LocationLogic, Lustre, Maya, Mechanical Desktop, MotionBuilder, ObjectARX, ObjectDBX, Open Reality, PolarSnap, PortfolioWall, Powered with Autodesk Technology, Productstream, ProjectPoint, Reactor, RealDWG, Real-time Roto, Render Queue, Revit, Showcase, SketchBook, StudioTools, Topobase, Toxik, Visual, Visual Bridge, Visual Construction, Visual Drainage, Visual Hydro, Visual Landscape, Visual Roads, Visual Survey, Visual Syllabus, Visual Toolbox, Visual Tugboat, Visual LISP, Voice Reality, Volo, and Wiretap.  
The following are registered trademarks or trademarks of Autodesk Canada Co. in the USA and/or Canada and other countries: Backburner, Discreet, Fire, Flame, Flint, Frost, Inferno, Multi-Master Editing, River, Smoke, Sparks, Stone, Wire.  
mental images is a registered trademarks of mental images GmbH in the U.S.A. and/or other countries. clothfx™ is a trademark of Size8 Software, Inc. Havok.com™ is a trademark or registered trademark of Havok.com Inc. or its licensors. Intel is a registered trademark of Intel Corporation. All other brand names, product names or trademarks belong to their respective holders.

### Disclaimer

THIS PUBLICATION AND THE INFORMATION CONTAINED HEREIN IS MADE AVAILABLE BY AUTODESK, INC. "AS IS." AUTODESK, INC., DISCLAIMS ALL WARRANTIES, EITHER EXPRESS OR IMPLIED, INCLUDING BUT NOT LIMITED TO ANY IMPLIED WARRANTIES OF MERCHANTABILITY OR FITNESS FOR A PARTICULAR PURPOSE REGARDING THESE MATERIALS.

Published by:

Autodesk, Inc.

111 McInnis Parkway

San Rafael, CA 94903, USA

# Contents

<b>Chapter 1</b>	<b>Introduction</b> . . . . .	<b>1</b>
	What's New in Autodesk 3ds Max 2008 . . . . .	1
	What Was New in 3ds Max 9 Extension 1 . . . . .	8
	3ds Max Documentation Set . . . . .	11
	About MAXScript . . . . .	14
<b>Chapter 2</b>	<b>Getting Started with 3ds Max</b> . . . . .	<b>17</b>
	Project Workflow . . . . .	19
	Setting Up Your Scene . . . . .	25
	Modeling Objects . . . . .	26
	Using Materials . . . . .	27
	Placing Lights and Cameras . . . . .	30
	Animating Your Scene . . . . .	33
	Rendering Your Scene . . . . .	34
	The 3ds Max Window . . . . .	35
	Special Controls . . . . .	38
	Managing Files . . . . .	44
	Importing, Merging, Replacing, and Externally Referencing Scenes . . . . .	46
	Using the Asset Browser . . . . .	49
	Startup Files and Defaults . . . . .	50
	3dsmax .ini File . . . . .	51
	Backing Up and Archiving Scenes . . . . .	53

	Crash Recovery System . . . . .	53
<b>Chapter 3</b>	<b>Viewing and Navigating 3D Space . . . . .</b>	<b>55</b>
	General Viewport Concepts . . . . .	56
	Home Grid: Views Based on the World Coordinate Axes . . . . .	58
	Understanding Views . . . . .	61
	Setting Viewport Layout . . . . .	65
	Controlling Viewport Rendering . . . . .	68
	Controlling Display Performance . . . . .	70
	Using Standard View Navigation . . . . .	71
	Zooming, Panning, and Rotating Views . . . . .	72
	Using Walkthrough Navigation . . . . .	75
	Navigating Camera and Light Views . . . . .	79
	Adaptive Degradation . . . . .	83
	Grab Viewport . . . . .	85
	View-Handling Commands . . . . .	86
	Undo View Change / Redo View Change . . . . .	87
	Save Active View . . . . .	88
	Restore Active View . . . . .	88
	Viewport Background Dialog . . . . .	89
	Select Background Image Dialog . . . . .	97
	Update Background Image . . . . .	102
	Reset Background Transform . . . . .	103
	Show Transform Gizmo . . . . .	103
	Show Ghosting . . . . .	104
	Show Key Times . . . . .	105
	Shade Selected . . . . .	107
	Show Dependencies . . . . .	108
	Create Camera From View . . . . .	109
	Add Default Lights to Scene . . . . .	111
	Redraw All Views . . . . .	113
	Global Viewport Rendering Setting . . . . .	114
	Update During Spinner Drag . . . . .	115
	Diagnose Video Hardware . . . . .	115
	Expert Mode . . . . .	116
	Controlling Object Display . . . . .	117
	Display Color Rollout . . . . .	117
	Hide By Category Rollout . . . . .	118
	Hide Rollout . . . . .	120
	Freeze Rollout . . . . .	122
	Display Properties Rollout . . . . .	124
	Link Display Rollout . . . . .	129
<b>Chapter 4</b>	<b>Selecting Objects . . . . .</b>	<b>131</b>
	Introducing Object Selection . . . . .	132

Basics of Selecting Objects . . . . .	139
Selecting by Region . . . . .	143
Using Select By Name . . . . .	146
Using Named Selection Sets . . . . .	146
Using Selection Filters . . . . .	148
Selecting with Track View . . . . .	150
Selecting with Schematic View . . . . .	151
Freezing and Unfreezing Objects . . . . .	152
Hiding and Unhiding Objects by Selection . . . . .	154
Hiding and Unhiding Objects by Category . . . . .	156
Isolate Selection . . . . .	159
Introduction to Sub-Object Selection . . . . .	160
Selection Commands . . . . .	165
Select Object . . . . .	167
Select From Scene . . . . .	168
Selection Floater . . . . .	171
Selection Region Flyout . . . . .	174
Selection Filter List . . . . .	176
Filter Combinations Dialog . . . . .	177
Named Selection Sets . . . . .	179
Named Selection Sets Dialog . . . . .	181
Edit Named Selections Dialog . . . . .	186
Select All . . . . .	189
Select None . . . . .	189
Select Invert . . . . .	190
Select Similar . . . . .	190
Select By . . . . .	191
Select By Color . . . . .	191
Select By Name (Edit Menu) . . . . .	191
Select By Layer . . . . .	192
Region Selection . . . . .	192
Selection Region . . . . .	192
Rectangular Selection Region . . . . .	192
Circular Selection Region . . . . .	193
Fence Selection Region . . . . .	194
Lasso Selection Region . . . . .	195
Paint Selection Region . . . . .	196
Region . . . . .	197
Select Region Window . . . . .	198
Select Region Crossing . . . . .	200
Window/Crossing Selection Toggle . . . . .	201
Edit Commands . . . . .	202
Undo/Redo . . . . .	202
Hold/Fetch . . . . .	204
Delete . . . . .	205
Groups and Assemblies . . . . .	205

Using Groups . . . . .	206
Using Assemblies . . . . .	209
Character Assembly . . . . .	217
Group Commands . . . . .	221
Group . . . . .	222
Open Group . . . . .	223
Close Group . . . . .	223
Ungroup . . . . .	224
Explode Group . . . . .	225
Detach Group . . . . .	225
Attach Group . . . . .	226
Assembly Commands . . . . .	226
Assemble . . . . .	227
Open Assembly . . . . .	231
Close Assembly . . . . .	232
Disassemble . . . . .	233
Explode Assembly . . . . .	233
Detach Assembly . . . . .	234
Attach Assembly . . . . .	234
Assembly Head Helper Objects . . . . .	234
Assembly Head Helper Object . . . . .	234
Luminaire Helper Object . . . . .	235
Character Assembly Commands . . . . .	237
Create Character . . . . .	238
Destroy Character . . . . .	242
Lock/Unlock Character . . . . .	242
Insert Character . . . . .	243
Save Character . . . . .	243
Skin Pose Commands . . . . .	244

<b>Chapter 5</b>	<b>Object Properties . . . . .</b>	<b>245</b>
	Object Properties Dialog Panels . . . . .	245
	General Panel (Object Properties Dialog) . . . . .	245
	Advanced Lighting Panel (Object Properties Dialog) . . . . .	256
	mental ray Panel (Object Properties Dialog) . . . . .	262
	User Defined Panel (Object Properties Dialog) . . . . .	264
	Rename Objects Tool . . . . .	266
	Custom Attributes . . . . .	267
	Parameter Collector . . . . .	285
	Parameter Collector Menu Bar . . . . .	294
	Notes Dialog (Parameter Collector) . . . . .	297
	Expression Techniques . . . . .	299
	Trigonometric Functions . . . . .	309
	Vectors . . . . .	312

<b>Chapter 6</b>	<b>Creating Geometry</b>	<b>317</b>
	Basics of Creating and Modifying Objects	317
	Using the Create Panel	319
	Identifying the Basic Building Blocks	321
	Creating an Object	323
	Assigning Colors to Objects	327
	Object Color Dialog	327
	Color Selector Dialog	331
	Color Clipboard Utility	337
	Adjusting Normals and Smoothing	339
	Viewing and Changing Normals	340
	Viewing and Changing Smoothing	343
	Geometric Primitives	345
	Creating Primitives from the Keyboard	346
	Standard Primitives	348
	Box Primitive	350
	Cone Primitive	353
	Sphere Primitive	356
	GeoSphere Primitive	361
	Cylinder Primitive	364
	Tube Primitive	367
	Torus Primitive	370
	Pyramid Primitive	374
	Teapot Primitive	377
	Plane Primitive	380
	Extended Primitives	383
	Hedra Extended Primitive	385
	Torus Knot Extended Primitive	389
	ChamferBox Extended Primitive	393
	ChamferCyl Extended Primitive	396
	OilTank Extended Primitive	399
	Capsule Extended Primitive	402
	Spindle Extended Primitive	405
	L-Ext Extended Primitive	409
	Gengon Extended Primitive	411
	C-Ext Extended Primitive	414
	RingWave Extended Primitive	417
	Prism Extended Primitive	423
	Hose Extended Primitive	425
	Architectural Objects	432
	AEC Extended Objects	433
	Working with AEC Design Elements	433
	Foliage	439
	Railing	447
	Wall	456
	Editing Wall Objects	466

Stairs	471
L-Type Stair	473
Spiral Stair	480
Straight Stair	488
U-Type Stair	495
Doors	502
Pivot Door	510
Sliding Door	512
BiFold Door	514
Windows	516
Awning Window	523
Casement Window	526
Fixed Window	528
Pivoted Window	530
Projected Window	532
Sliding Window	534
Shapes	536
Shape Check Utility	541
Splines and Extended Splines	542
Line Spline	551
Rectangle Spline	555
Circle Spline	557
Ellipse Spline	559
Arc Spline	560
Donut Spline	564
NGon Spline	565
Star Spline	567
Text Spline	569
Helix Spline	574
Section Spline	576
Extended Splines	580
WRectangle Spline	580
Channel Spline	583
Angle Spline	585
Tee Spline	587
Wide Flange Spline	588
Editable Spline	590
Editable Spline (Object)	602
Editable Spline (Vertex)	606
Editable Spline (Segment)	618
Editable Spline (Spline)	627
Compound Objects	638
Morph Compound Object	639
Scatter Compound Object	647
Conform Compound Object	660
Connect Compound Object	668



BlobMesh Compound Object . . . . .	674
ShapeMerge Compound Object . . . . .	681
Boolean Compound Object . . . . .	686
Material Attach Options Dialog . . . . .	701
Terrain Compound Object . . . . .	703
Loft Compound Object . . . . .	715
Creation Method Rollout . . . . .	718
Surface Parameters Rollout . . . . .	719
Path Parameters Rollout . . . . .	724
Skin Parameters Rollout . . . . .	727
Deformations . . . . .	744
Deform Scale . . . . .	745
Deform Twist . . . . .	747
Deform Teeter . . . . .	749
Deform Bevel . . . . .	752
Deform Fit . . . . .	754
Deformation Dialog . . . . .	756
Path Commands . . . . .	763
Shape Commands . . . . .	764
Compare Dialog . . . . .	765
Mesher Compound Object . . . . .	767
ProBoolean/ProCutter Compound Objects . . . . .	772
ProBoolean Compound Object . . . . .	774
ProCutter Compound Object . . . . .	792
Quad Meshing and Smoothing . . . . .	799
Dynamics Objects . . . . .	810
Damper Dynamics Object . . . . .	811
Spring Dynamics Object . . . . .	820
Systems . . . . .	829
Bones System . . . . .	831
Using Objects as Bones . . . . .	843
Bone Tools . . . . .	845
Bone Tools Rollouts . . . . .	845
Ring Array System . . . . .	853
<b>Chapter 7 Moving, Rotating, and Scaling Objects . . . . .</b>	<b>859</b>
Axis Tripod and World Axis . . . . .	860
Using Transforms . . . . .	862
Using Transform Gizmos . . . . .	865
Transform Type-In . . . . .	874
Animating Transforms . . . . .	877
Transform Managers . . . . .	879
Specifying a Reference Coordinate System . . . . .	881
Choosing a Transform Center . . . . .	882
Using the Axis Constraints . . . . .	884
Reset Transform Utility . . . . .	886

Transform Commands . . . . .	887
Select and Move . . . . .	888
Select and Rotate . . . . .	889
Select and Scale . . . . .	891
Select and Uniform Scale . . . . .	892
Select and Non-Uniform Scale . . . . .	893
Select and Squash . . . . .	894
Transform Coordinates and Coordinate Center . . . . .	896
Reference Coordinate System . . . . .	896
Use Center Flyout . . . . .	904
Use Pivot Point Center . . . . .	905
Use Selection Center . . . . .	907
Use Transform Coordinate Center . . . . .	908
Transform Tools . . . . .	909
Array Flyout . . . . .	911
Mirror Selected Objects . . . . .	911
Array . . . . .	915
Snapshot . . . . .	921
Spacing Tool . . . . .	925
Clone and Align Tool . . . . .	933
Align Flyout . . . . .	938
Align . . . . .	938
Quick Align . . . . .	944
Normal Align . . . . .	945
Place Highlight . . . . .	948
Align Camera . . . . .	950
Align to View . . . . .	951

**Chapter 8    Creating Copies and Arrays . . . . . 953**

Overview of Copies, Instances, and References . . . . .	955
Techniques for Cloning Objects . . . . .	958
Clone . . . . .	965
Clone Options Dialog . . . . .	965
Using Shift+Clone . . . . .	968
Cloning with Shift+Move . . . . .	970
Cloning with Shift+Rotate . . . . .	972
Cloning with Shift+Scale . . . . .	975
Animating Shift+Rotate and Shift+Scale . . . . .	977
Cloning Objects Over Time with Snapshot . . . . .	979
Arraying Objects . . . . .	981
Using the Array Dialog . . . . .	983
Creating Linear Arrays . . . . .	989
Creating Circular and Spiral Arrays . . . . .	993
Mirroring Objects . . . . .	996
Using the Spacing Tool . . . . .	998

<b>Chapter 9</b>	<b>Modifiers</b>	<b>1001</b>
	Transforms, Modifiers, and Object Data Flow	1004
	List of Available Modifiers	1011
	Using Modifiers	1015
	Using the Modify Panel	1016
	Using the Modifier Stack	1020
	Editing the Stack	1023
	Edit Modifiers and Editable Objects	1027
	Modifying at the Sub-Object Level	1029
	Using the Stack at the Sub-Object Level	1032
	Modifying Multiple Objects	1034
	How Instanced Modifiers Work	1040
	World-Space Modifiers (WSMs)	1043
	Camera Map Modifier (World Space)	1043
	Displace Mesh Modifier (World Space)	1045
	Displace NURBS Modifier (World Space)	1047
	Hair And Fur Modifier	1049
	Selection Rollout (Hair and Fur)	1059
	Tools Rollout (Hair and Fur)	1061
	Styling Rollout (Hair and Fur)	1070
	Quad Menu for Hair Styling	1082
	General Parameters Rollout (Hair and Fur)	1084
	Material Parameters Rollout (Hair and Fur)	1091
	mr Parameters Rollout (Hair and Fur)	1098
	Frizz Parameters Rollout (Hair and Fur)	1099
	Kink Parameters Rollout (Hair and Fur)	1104
	Multi Strand Parameters Rollout (Hair and Fur)	1107
	Dynamics Rollout (Hair and Fur)	1109
	Display Rollout (Hair and Fur)	1116
	LS Colors Modifier (World Space)	1118
	MapScaler Modifier (World Space)	1120
	PatchDeform Modifier (World Space)	1123
	PathDeform Modifier (World Space)	1123
	Point Cache Modifier (World Space)	1129
	Subdivide Modifier (World Space)	1129
	Surface Mapper Modifier (World Space)	1129
	SurfDeform Modifier (World Space)	1132
	Object-Space Modifiers	1132
	Affect Region Modifier	1133
	Attribute Holder Modifier	1136
	Bend Modifier	1139
	Bevel Modifier	1142
	Bevel Profile Modifier	1150
	Camera Map Modifier (Object Space)	1154
	Cap Holes Modifier	1159
	Cloth and Garment Maker Modifiers	1162

Cloth Overview . . . . .	1163
Cloth Modifier . . . . .	1178
Object Properties Dialog (Cloth) . . . . .	1219
Garment Maker Modifier . . . . .	1228
Troubleshooting and Error Codes in Garment Maker . . . . .	1258
CrossSection Modifier . . . . .	1259
Delete Mesh Modifier . . . . .	1266
Delete Patch Modifier . . . . .	1267
Delete Spline Modifier . . . . .	1269
Disp Approx Modifier . . . . .	1270
Displace Modifier . . . . .	1274
Edit Mesh Modifier . . . . .	1283
Edit Normals Modifier . . . . .	1284
Edit Patch Modifier . . . . .	1290
Edit Poly Modifier . . . . .	1293
Selection Rollout (Edit Poly Modifier) . . . . .	1307
Edit Poly (Object) . . . . .	1319
Edit Poly (Vertex) . . . . .	1321
Edit Poly (Edge) . . . . .	1330
Edit Poly (Border) . . . . .	1343
Edit Poly (Polygon/Element) . . . . .	1350
Edit Geometry Rollout (Edit Poly Modifier) . . . . .	1363
Align Geometry Dialog . . . . .	1375
Detach Dialog . . . . .	1375
Edit Spline Modifier . . . . .	1376
Extrude Modifier . . . . .	1377
Face Extrude Modifier . . . . .	1381
FFD (Free-Form Deformation) Modifiers . . . . .	1383
FFD (Box/Cylinder) Modifiers . . . . .	1389
FFD (Free-Form Deformation) Select Modifier . . . . .	1395
Fillet/Chamfer Modifier . . . . .	1396
Flex Modifier . . . . .	1400
Spring Option Dialog . . . . .	1418
HSDS Modifier . . . . .	1420
Adaptive Subdivision Dialog . . . . .	1428
Lathe Modifier . . . . .	1430
Lattice Modifier . . . . .	1435
Linked XForm Modifier . . . . .	1440
LS Mesh Modifier . . . . .	1442
MapScaler Modifier (Object Space) . . . . .	1443
Material Modifier . . . . .	1445
MaterialByElement Modifier . . . . .	1448
Melt Modifier . . . . .	1451
Mesh Select Modifier . . . . .	1455
MeshSmooth Modifier . . . . .	1460
Mirror Modifier . . . . .	1471

Morpher Modifier . . . . .	1473
MultiRes Modifier . . . . .	1493
Noise Modifier . . . . .	1501
Normal Modifier . . . . .	1509
Normalize Spline Modifier . . . . .	1511
NSurf Sel Modifier . . . . .	1513
Optimize Modifier . . . . .	1515
Patch Select Modifier . . . . .	1520
PatchDeform Modifier . . . . .	1525
PathDeform Modifier . . . . .	1528
Point Cache Modifier . . . . .	1533
Poly Select Modifier . . . . .	1541
Preserve Modifier . . . . .	1550
Projection Modifier . . . . .	1556
Selection Rollout (Projection Modifier) . . . . .	1558
Reference Geometry Rollout (Projection Modifier) . . . . .	1560
Cage Rollout (Projection Modifier) . . . . .	1563
Selection Check Rollout (Projection Modifier) . . . . .	1567
Projection Rollout (Projection Modifier) . . . . .	1568
Project Mapping Rollout (Projection Modifier) . . . . .	1570
Projection Holder Modifier . . . . .	1574
Push Modifier . . . . .	1574
Relax Modifier . . . . .	1575
Renderable Spline Modifier . . . . .	1580
Ripple Modifier . . . . .	1583
Select By Channel Modifier . . . . .	1587
Shell Modifier . . . . .	1588
Skew Modifier . . . . .	1596
Skin Modifier . . . . .	1600
Load Envelopes Dialog (Skin Modifier) . . . . .	1624
Weight Tool Dialog . . . . .	1627
Weight Table (Skin Modifier) . . . . .	1633
Skin Morph Modifier . . . . .	1636
Skin Wrap Modifier . . . . .	1648
Skin Wrap Patch Modifier . . . . .	1657
Slice Modifier . . . . .	1658
Smooth Modifier . . . . .	1665
Spherify Modifier . . . . .	1668
Spline IK Control Modifier . . . . .	1670
Spline Select Modifier . . . . .	1673
Squeeze Modifier . . . . .	1676
STL Check Modifier . . . . .	1678
Stretch Modifier . . . . .	1681
Subdivide Modifier . . . . .	1688
Substitute Modifier . . . . .	1691
Surface Modifier . . . . .	1695

SurfDeform Modifier . . . . .	1707
Sweep Modifier . . . . .	1709
Pick Shape Dialog . . . . .	1728
Extract Shape Dialog . . . . .	1730
Merge File (Sweep Modifier) . . . . .	1731
Symmetry Modifier . . . . .	1735
Taper Modifier . . . . .	1739
Tessellate Modifier . . . . .	1743
Trim/Extend Modifier . . . . .	1746
TurboSmooth Modifier . . . . .	1750
Turn To Mesh Modifier . . . . .	1756
Turn To Patch Modifier . . . . .	1758
Turn To Poly Modifier . . . . .	1761
Twist Modifier . . . . .	1765
Unwrap UVW Modifier . . . . .	1769
Edit UVWs Dialog . . . . .	1788
Edit UVWs Dialog Menu Bar . . . . .	1799
Unwrap UVW Shortcuts . . . . .	1807
UVW Editor Dialogs . . . . .	1821
UVW Map Modifier . . . . .	1849
UVW Mapping Add Modifier . . . . .	1871
UVW Mapping Clear Modifier . . . . .	1871
UVW Mapping Paste Modifier . . . . .	1872
UVW XForm Modifier . . . . .	1872
Vertex Weld Modifier . . . . .	1874
VertexPaint Modifier . . . . .	1876
VertexPaint Paintbox . . . . .	1886
Adjust Color Dialog (VertexPaint Modifier) . . . . .	1900
Color Palette (VertexPaint Modifier) . . . . .	1902
Painter Options Dialog . . . . .	1907
Volume Select Modifier . . . . .	1910
Wave Modifier . . . . .	1918
XForm Modifier . . . . .	1922

**Chapter 10 Surface Modeling . . . . . 1925**

Subdivision Surfaces . . . . .	1926
Soft Selection Rollout . . . . .	1926
Collapse Utility . . . . .	1931
Editable Patch Surface . . . . .	1934
Selection Rollout (Editable Patch) . . . . .	1940
Editable Patch (Object) . . . . .	1944
Editable Patch (Vertex) . . . . .	1947
Editable Patch (Handle) . . . . .	1954
Editable Patch (Edge) . . . . .	1956
Editable Patch (Patch) . . . . .	1959
Editable Patch (Element) . . . . .	1965

Geometry Rollout (Patch) . . . . .	1968
Patch Grids . . . . .	1982
Quad Patch . . . . .	1984
Tri Patch . . . . .	1987
Editable Mesh Surface . . . . .	1990
Working with Mesh Sub-Objects . . . . .	1993
Selection Rollout (Editable Mesh) . . . . .	1995
Editable Mesh (Object) . . . . .	1998
Editable Mesh (Vertex) . . . . .	2001
Editable Mesh (Edge) . . . . .	2007
Editable Mesh (Face/Polygon/Element) . . . . .	2014
Edit Geometry Rollout (Mesh) . . . . .	2018
Attach Options Dialog . . . . .	2031
Cut and Slice . . . . .	2033
Editable Poly Surface . . . . .	2038
Selection Rollout (Polymesh) . . . . .	2043
Editable Poly (Object) . . . . .	2053
Editable Poly (Vertex) . . . . .	2055
Editable Poly (Edge) . . . . .	2066
Editable Poly (Border) . . . . .	2085
Editable Poly (Polygon/Element) . . . . .	2091
Edit Geometry Rollout (Polymesh) . . . . .	2105
Subdivision Surface Rollout (Polymesh) . . . . .	2118
Subdivision Displacement Rollout (Polymesh) . . . . .	2123
Paint Deformation Rollout . . . . .	2125
Editable Poly Settings Dialogs . . . . .	2129
Bevel Polygons Dialog . . . . .	2129
Bridge Borders/Polygons Dialog . . . . .	2131
Bridge Edges Dialog . . . . .	2133
Chamfer Vertices/Edges/Borders Dialog . . . . .	2136
Connect Edges Dialog . . . . .	2137
Extrude Polygons Along Spline Dialog . . . . .	2139
Extrude Polygons Dialog . . . . .	2141
Extrude Vertices/Edges Dialog . . . . .	2142
Hinge Polygons From Edge Dialog . . . . .	2143
Inset Polygons Dialog . . . . .	2144
MeshSmooth Selection Dialog . . . . .	2145
Preserve Map Channels Dialog . . . . .	2146
Relax Dialog . . . . .	2148
Tessellate Selection Dialog . . . . .	2149
Weld Vertices/Edges Dialog . . . . .	2150
NURBS Modeling . . . . .	2152
NURBS Models: Objects and Sub-Objects . . . . .	2153
Creating NURBS Models . . . . .	2154
Working with NURBS Models . . . . .	2155
Surface Trimming . . . . .	2156

Modifying NURBS Models and Creating Sub-Objects . . . . .	2159
Quad Menu for NURBS Objects . . . . .	2160
Using the NURBS Toolbox to Create Sub-Objects . . . . .	2162
Sub-Object Selection . . . . .	2164
CV Sub-Objects and Point Sub-Objects . . . . .	2165
Dependent Sub-Objects . . . . .	2169
Rigid Surfaces . . . . .	2172
NURBS and Modifiers . . . . .	2172
NURBS and Animation . . . . .	2175
NURBS Concepts . . . . .	2176
NURBS Tips and Techniques . . . . .	2180
NURBS Surfaces . . . . .	2190
Point Surface . . . . .	2192
CV Surface . . . . .	2195
NURBS Curves . . . . .	2199
Point Curve . . . . .	2201
CV Curve . . . . .	2208
Creating NURBS Curve and Surface Objects . . . . .	2216
Creating Independent Surfaces from NURBS Curve Objects . . . . .	2216
Creating NURBS Curves from Splines . . . . .	2216
Creating NURBS Surfaces from Geometric Primitives . . . . .	2218
Nonrelational NURBS Surfaces . . . . .	2219
Display Controls for NURBS Models . . . . .	2221
Display Line Parameters for NURBS Surfaces . . . . .	2224
Creating and Editing NURBS Sub-Objects . . . . .	2225
Attaching and Importing 3ds Max Objects . . . . .	2225
Common Sub-Object Controls . . . . .	2229
Editing Point Sub-Objects . . . . .	2231
Editing Curve CV Sub-Objects . . . . .	2238
Editing Surface CV Sub-Objects . . . . .	2244
Editing Curve Sub-Objects . . . . .	2252
Editing Surface Sub-Objects . . . . .	2264
Soft Selection Rollout (NURBS) . . . . .	2275
Material Properties Rollout . . . . .	2278
Creating Curve Sub-Objects . . . . .	2283
Creating Surface Sub-Objects . . . . .	2337
Creating and Editing Point Sub-Objects . . . . .	2428
NURBS Editing Dialogs . . . . .	2442
Curve and Surface Approximation . . . . .	2468
Curve Approximation . . . . .	2468
Surface Approximation . . . . .	2469
Advanced Surface Approximation Dialog . . . . .	2478
Surface Approximation Utility . . . . .	2480
Tools for Low-Polygon Modeling . . . . .	2492
Show Statistics . . . . .	2493



	Level of Detail Utility . . . . .	2494
<b>Chapter 11</b>	<b>Precision and Drawing Aids . . . . .</b>	<b>2501</b>
	Tools for Precision . . . . .	2502
	Helpers . . . . .	2503
	Using Units . . . . .	2504
	Using Grids . . . . .	2506
	Using the Home Grid . . . . .	2507
	Using Grid Objects . . . . .	2510
	Viewing Grid Objects . . . . .	2511
	AutoGrid . . . . .	2513
	Aligning Objects . . . . .	2516
	Aligning Normals . . . . .	2520
	Setting Standard Snaps . . . . .	2521
	Setting Snap Options . . . . .	2523
	Measuring Distances . . . . .	2526
	Measure Distance Tool . . . . .	2529
	Select And Manipulate . . . . .	2529
	Standard Helper Objects . . . . .	2530
	Dummy Helper . . . . .	2531
	Expose Transform Helper . . . . .	2532
	Grid Helper . . . . .	2538
	Point Helper . . . . .	2544
	Tape Helper . . . . .	2546
	Protractor Helper . . . . .	2549
	Compass Helper . . . . .	2551
	Manipulator Helper Objects . . . . .	2552
	Cone Angle Manipulator . . . . .	2552
	Plane Angle Manipulator . . . . .	2556
	Slider Manipulator . . . . .	2559
	Grid Commands . . . . .	2564
	Show Home Grid . . . . .	2564
	Activate Home Grid . . . . .	2565
	Activate Grid Object . . . . .	2566
	Align Grid to View . . . . .	2566
	Snap Commands . . . . .	2567
	2D Snap, 2.5D Snap, 3D Snap . . . . .	2568
	Angle Snap Toggle . . . . .	2570
	Percent Snap Toggle . . . . .	2571
	Spinner Snap Toggle . . . . .	2572
	Ortho Snapping Mode . . . . .	2573
	Polar Snapping Mode . . . . .	2575
	Grid and Snap Settings . . . . .	2577
	Snap Settings . . . . .	2578
	Snap Override . . . . .	2585
	Snap Options . . . . .	2587

Home Grid Settings . . . . .	2592
User Grids Settings . . . . .	2595
Drawing Aid Utilities . . . . .	2596
Measure Utility . . . . .	2597
Rescale World Units Utility . . . . .	2599
<b>Chapter 12 Space Warps and Particle Systems . . . . .</b>	<b>2603</b>
Space Warp Objects . . . . .	2603
Bind to Space Warp . . . . .	2609
Forces . . . . .	2609
Push Space Warp . . . . .	2609
Motor Space Warp . . . . .	2614
Vortex Space Warp . . . . .	2619
Drag Space Warp . . . . .	2624
PBomb Space Warp . . . . .	2629
Path Follow Space Warp . . . . .	2635
Gravity Space Warp . . . . .	2639
Wind Space Warp . . . . .	2642
Displace Space Warp . . . . .	2645
Deflectors . . . . .	2650
POmniFlect Space Warp . . . . .	2650
PDynaFlect Space Warp . . . . .	2656
SOmniFlect Space Warp . . . . .	2661
SDynaFlect Space Warp . . . . .	2663
UOmniFlect Space Warp . . . . .	2664
UDynaFlect Space Warp . . . . .	2666
SDeflector Space Warp . . . . .	2669
UDeflector Space Warp . . . . .	2672
Deflector Space Warp . . . . .	2675
Geometric/Deformable . . . . .	2678
FFD(Box) Space Warp . . . . .	2678
FFD(Cyl) Space Warp . . . . .	2685
Wave Space Warp . . . . .	2695
Ripple Space Warp . . . . .	2699
Conform Space Warp . . . . .	2703
Bomb Space Warp . . . . .	2707
Modifier-Based Space Warps . . . . .	2711
Introduction to Particle Systems . . . . .	2713
Particle Flow . . . . .	2713
How Particle Flow Works . . . . .	2714
Particle Flow User Interface . . . . .	2730
Actions . . . . .	2758
Non-Event-Driven Particle Systems . . . . .	2923
Particle System Usage . . . . .	2926
Spray Particle System . . . . .	2938
Snow Particle System . . . . .	2942

	Super Spray Particle System . . . . .	2947
	Blizzard Particle System . . . . .	2951
	PCloud Particle System . . . . .	2956
	PArray Particle System . . . . .	2964
<b>Chapter 13</b>	<b>Animation . . . . .</b>	<b>3001</b>
	Animation Concepts and Methods . . . . .	3002
	Animation Concepts . . . . .	3003
	Using Auto Key Mode . . . . .	3007
	Using Set Key Mode . . . . .	3010
	Spinner Right-Click Menu . . . . .	3014
	Viewing and Copying Transform Keys . . . . .	3016
	Controlling Time . . . . .	3019
	Setting Time Segments . . . . .	3021
	Moving Through Time . . . . .	3023
	Choosing a Frame Rate and Playback Speed . . . . .	3024
	Working with Controllers . . . . .	3025
	Understanding Controllers . . . . .	3027
	Changing Controller Properties . . . . .	3029
	Assigning Controllers . . . . .	3031
	Specifying Default Controllers . . . . .	3034
	General-Purpose Controllers . . . . .	3035
	Special-Purpose Controllers . . . . .	3037
	Explicit Axis Keys . . . . .	3038
	Float Controllers . . . . .	3039
	Controlling Transforms . . . . .	3040
	Controlling Position . . . . .	3041
	Controlling Rotation . . . . .	3042
	Controlling Colors . . . . .	3043
	Morph Controllers . . . . .	3044
	Motion Panel Commands . . . . .	3045
	Trajectories . . . . .	3045
	PRS Parameters Rollout . . . . .	3050
	Key Info (Basic) Rollout/Dialog . . . . .	3052
	Tangent Types . . . . .	3054
	Key Info (Advanced) Rollout/Dialog . . . . .	3056
	Animation Controllers . . . . .	3058
	Audio Controller . . . . .	3060
	Barycentric Morph Controller . . . . .	3061
	Bezier Controllers . . . . .	3063
	Block Controller . . . . .	3066
	Boolean Controller . . . . .	3072
	Color RGB Controller (Point3 XYZ Controller) . . . . .	3074
	Euler XYZ Rotation Controller . . . . .	3076
	Expression Controller . . . . .	3079
	Expression Controller Techniques . . . . .	3086

Layer Controller . . . . .	3087
Animation Layers . . . . .	3089
Layer Properties Dialog . . . . .	3104
Create New Animation Layer Dialog . . . . .	3105
Limit Controller . . . . .	3106
Linear Controller . . . . .	3118
List Controller . . . . .	3119
Local Euler XYZ Rotation Controller . . . . .	3123
Look At Controller . . . . .	3124
Master Point Controller . . . . .	3126
Motion Capture Controller . . . . .	3128
Noise Controller . . . . .	3139
On/Off Controller . . . . .	3142
Position XYZ Controller . . . . .	3144
PRS Controller . . . . .	3145
Reaction Controllers . . . . .	3147
Reaction Manager Dialog . . . . .	3153
Using Manipulators with Reaction Controllers . . . . .	3169
Scale XYZ Controller . . . . .	3171
Script Controller . . . . .	3173
Smooth Rotation Controller . . . . .	3178
Spring Controller . . . . .	3178
TCB Controllers . . . . .	3183
Transform Script Controller . . . . .	3186
Waveform Controller . . . . .	3190
XRef Controller . . . . .	3194
Controller Subdialogs . . . . .	3198
Audio Controller Dialog . . . . .	3198
Attach Controls Dialog (Block Controller) . . . . .	3201
Barycentric Morph Controller Key Info Dialog . . . . .	3203
Block Parameters Dialog (Block Controller) . . . . .	3204
Master Block Parameters Dialog (Block Controller) . . . . .	3205
Master Track Key Info Dialog (Master Point Controller) . . . . .	3207
Slave Parameters Dialog (Block Controller) . . . . .	3209
Track View Pick Dialog (Block Controller) . . . . .	3211
Animation Constraints . . . . .	3212
Attachment Constraint . . . . .	3213
Surface Constraint . . . . .	3218
Path Constraint . . . . .	3222
Position Constraint . . . . .	3228
Link Constraint . . . . .	3233
LookAt Constraint . . . . .	3237
Orientation Constraint . . . . .	3244
Wire Parameters . . . . .	3247
Parameter Wiring Dialog . . . . .	3249

Hierarchies and Kinematics . . . . .	3255
Hierarchies . . . . .	3256
Linking Strategy . . . . .	3260
Linking and Unlinking Objects . . . . .	3267
Adjusting Pivots . . . . .	3270
Viewing and Selecting Hierarchies . . . . .	3275
Animating with Forward Kinematics . . . . .	3279
Using Dummy Objects . . . . .	3288
Animating Links . . . . .	3290
Adjusting Object Transforms . . . . .	3293
Locking Object Transforms . . . . .	3294
Animating Attachment . . . . .	3295
Changing Link Inheritance . . . . .	3296
Link Inheritance (Selected) Utility . . . . .	3297
Inverse Kinematics (IK) . . . . .	3299
IK Terminology . . . . .	3302
Inverse Kinematics Methods . . . . .	3305
Joint Controls . . . . .	3390
Hierarchy Panel Commands . . . . .	3397
Pivot . . . . .	3398
IK . . . . .	3409
Link Info . . . . .	3424
Track View . . . . .	3426
Working with Track View . . . . .	3431
Track View Workspace . . . . .	3433
Curve Editor . . . . .	3441
Dope Sheet . . . . .	3442
Time Ruler . . . . .	3446
Track View Shortcuts . . . . .	3447
Track View Hierarchy . . . . .	3454
Hierarchy Right-Click Menu . . . . .	3461
Properties (Track View Hierarchy) . . . . .	3466
Sound Options Dialog . . . . .	3468
Track View Menu Bar . . . . .	3470
Modes Menu . . . . .	3470
Controller Menu . . . . .	3471
Tracks Menu . . . . .	3475
Keys Menu . . . . .	3475
Curves Menu . . . . .	3477
Time Menu . . . . .	3478
Options Menu . . . . .	3479
Display Menu . . . . .	3485
View Menu . . . . .	3488
Utilities Menu . . . . .	3489
Track View Quad Menu . . . . .	3492
Track View Toolbars . . . . .	3495

Curve Editor Toolbars . . . . .	3495
Dope Sheet Toolbars . . . . .	3500
Controller Toolbar . . . . .	3505
Ranges: Dope Sheet Toolbar . . . . .	3506
Extras: Dope Sheet Toolbar . . . . .	3507
Filters . . . . .	3507
Filters Dialog (Track View) . . . . .	3508
Copy Controller . . . . .	3513
Paste Controller . . . . .	3514
Assign Controller . . . . .	3515
Delete Controller . . . . .	3520
Ignore Animation Range . . . . .	3520
Respect Animation Range . . . . .	3521
Make Controller Unique . . . . .	3522
Parameter Curve Out-of-Range Types . . . . .	3523
Add Note Track . . . . .	3526
Remove Note Track . . . . .	3528
Editing Keys . . . . .	3529
Edit Keys . . . . .	3529
Snap Frames . . . . .	3530
Lock Selection . . . . .	3532
Align to Cursor . . . . .	3532
Add Visibility Track . . . . .	3533
Move Keys (Dope Sheet) . . . . .	3536
Slide Keys . . . . .	3536
Scale Keys - Time . . . . .	3538
Add Keys (Dope Sheet) . . . . .	3539
Properties (Track View Key Window) . . . . .	3541
Track View Utilities . . . . .	3542
Randomize Keys Utility . . . . .	3543
Create Out of Range Keys Utility . . . . .	3544
Select Keys By Time Utility . . . . .	3547
Euler Filter . . . . .	3548
Current Value Editor . . . . .	3549
Edit Time . . . . .	3551
Select Time . . . . .	3552
Delete Time . . . . .	3553
Cut Time . . . . .	3554
Copy Time . . . . .	3555
Paste Time . . . . .	3555
Reverse Time . . . . .	3557
Insert Time . . . . .	3558
Scale Time . . . . .	3559
Exclude Left End Point . . . . .	3560
Exclude Right End Point . . . . .	3561
Reduce Keys . . . . .	3562

Edit Ranges . . . . .	3564
Position Ranges . . . . .	3565
Recouple Ranges . . . . .	3566
Editing Tracks: Copying, Pasting, and Handling Instances and References . . . . .	3567
Copying and Pasting Items . . . . .	3567
Copying and Pasting Objects . . . . .	3570
Making Instance and Reference Controllers and Objects Unique . . . . .	3571
Curve Editor . . . . .	3572
Move Keys (Curve Editor) . . . . .	3575
Scale Keys . . . . .	3576
Scale Values . . . . .	3577
Add Keys (Curve Editor) . . . . .	3578
Draw Curves . . . . .	3579
Show Tangents . . . . .	3580
Lock Tangents . . . . .	3582
Apply Ease Curve / Apply Multiplier Curve . . . . .	3583
Remove Ease/Multiplier Curve . . . . .	3584
On/Off (Curves) . . . . .	3585
Ease Curve Out-of-Range Types . . . . .	3585
Multiplier Curve Out-of-Range Types . . . . .	3587
Freeze Non-Selected Curves . . . . .	3589
Status Bar/View Controls . . . . .	3590
Zoom Selected Object . . . . .	3591
Select By Name (Track View) . . . . .	3592
Track Sets List . . . . .	3594
Track Sets Editor Dialog . . . . .	3596
Key Time Display . . . . .	3601
Value Display . . . . .	3602
Show Selected Key Statistics . . . . .	3603
Pan (Track View) . . . . .	3603
Zoom Horizontal Extents . . . . .	3604
Zoom Value Extents . . . . .	3605
Zoom Track View Key Window . . . . .	3606
Zoom Region (Track View) . . . . .	3607
Managing Track View Windows . . . . .	3608
New Track View . . . . .	3608
Delete Track View . . . . .	3609
Delete Track View Dialog . . . . .	3609
Saved Track Views . . . . .	3610
Track View Customization . . . . .	3611
Track View Toolbar Right-Click Menu . . . . .	3618
Motion Mixer . . . . .	3620
Using the Motion Mixer . . . . .	3621
Adding Tracks to the Mixer . . . . .	3626

Importing Clips to the Mixer . . . . .	3630
Working with Clips in the Mixer . . . . .	3635
Filtering Mixer Tracks . . . . .	3637
Adjusting Clip Timing . . . . .	3644
Working with Transitions . . . . .	3646
Adjusting Track Weight . . . . .	3652
Adding Time Warps . . . . .	3655
Adjusting Biped Balance in the Mixer . . . . .	3659
Exporting Animation to the Biped . . . . .	3663
Using the Reservoir . . . . .	3667
Motion Mixer Interface . . . . .	3671
Motion Mixer Menus . . . . .	3672
Motion Mixer Dialogs . . . . .	3681
Motion Mixer Toolbar . . . . .	3698
Trackgroup Filter Dialog (Biped Object) . . . . .	3702
Trackgroup Filter Dialog (Non-Biped Object) . . . . .	3704
Motion Mixer Editor . . . . .	3706
Reservoir . . . . .	3710
Mixer Preferences Dialog . . . . .	3714
Mixer Rollout . . . . .	3717
Animation Utilities . . . . .	3718
Follow/Bank Utility . . . . .	3719
Motion Capture Utility . . . . .	3721
MACUtilities Utility . . . . .	3740
Camera Tracker Utility . . . . .	3742
Requirements for Camera Tracking . . . . .	3748
Camera Tracker: Movie Rollout . . . . .	3748
Camera Tracker: Movie Window . . . . .	3750
Camera Tracker: Motion Trackers Rollout . . . . .	3753
Camera Tracker: Movie Stepper Rollout . . . . .	3758
Camera Tracker: Error Thresholds Rollout . . . . .	3760
Camera Tracker: Batch Track Rollout . . . . .	3761
Camera Tracker: Position Data Rollout . . . . .	3764
Camera Tracker: Match Move Rollout . . . . .	3765
Camera Tracker: Move Smoothing Rollout . . . . .	3768
Camera Tracker: Object Pinning Rollout . . . . .	3770
Camera Tracker: Troubleshooting . . . . .	3774
Dynamics Utility . . . . .	3775
Edit Object Dialog . . . . .	3790
Edit Object List Dialog . . . . .	3796
Skin Utilities . . . . .	3798

<b>Chapter 14 reactor . . . . .</b>	<b>3803</b>
Introducing Dynamics Simulation . . . . .	3811
Special Features in reactor . . . . .	3819
reactor Helpers . . . . .	3830



Rigid Bodies . . . . .	3832
Rigid Body Basics . . . . .	3833
Rigid Body Properties . . . . .	3834
Compound Rigid Bodies . . . . .	3843
Rigid Body Collection . . . . .	3845
Constraints . . . . .	3848
Constraint Concepts . . . . .	3849
Simple Constraints . . . . .	3853
Cooperative Constraints . . . . .	3867
reactor Objects . . . . .	3922
Plane . . . . .	3922
Motor . . . . .	3924
Toy Car . . . . .	3926
Fracture . . . . .	3933
Fracture Tips . . . . .	3940
Storing and Accessing Collisions . . . . .	3942
Deformable Bodies . . . . .	3947
Cloth . . . . .	3949
Cloth Modifier . . . . .	3950
Cloth Collection . . . . .	3957
Soft Bodies . . . . .	3960
Soft Body Modifier . . . . .	3961
FFD Soft Bodies . . . . .	3966
Soft Body Collection . . . . .	3969
Rope . . . . .	3971
Rope Modifier . . . . .	3972
Rope Collection . . . . .	3977
Deforming Meshes (Skin) . . . . .	3980
Deforming Mesh Collection . . . . .	3981
Constraining Deformable Bodies . . . . .	3983
Fixing Vertices in World Space . . . . .	3986
Keyframing Vertices . . . . .	3987
Attaching Vertices to a Rigid Body . . . . .	3989
Attaching Vertices to Deforming Meshes (Skin) . . . . .	3991
Soft Selection . . . . .	3993
Water Simulation . . . . .	3996
Water Space Warp . . . . .	3997
Rendering Water . . . . .	3999
Wind . . . . .	4001
The reactor Utility . . . . .	4005
Preview & Animation Rollout . . . . .	4007
Havok 1 World/Havok 3 World Rollout . . . . .	4009
Collisions Rollout . . . . .	4013
Display Rollout . . . . .	4015
reactor Utilities . . . . .	4018
Properties Rollout . . . . .	4021

The Real-Time Preview . . . . .	4021
Scripts . . . . .	4026
Frequently Asked Questions . . . . .	4033
Troubleshooting . . . . .	4037
<b>Chapter 15 character studio . . . . .</b>	<b>4049</b>
What is character studio? . . . . .	4050
What You Should Know to Use character studio . . . . .	4051
Understanding Biped . . . . .	4052
Understanding Physique . . . . .	4054
Understanding Track Editing . . . . .	4057
Understanding the Workbench . . . . .	4058
Understanding Motion Flow . . . . .	4059
Understanding Crowds . . . . .	4061
Understanding character studio Workflow . . . . .	4063
Biped . . . . .	4069
Creating a Biped . . . . .	4073
Understanding Biped Anatomy . . . . .	4075
Changing Initial Biped Anatomy . . . . .	4077
Naming the Biped . . . . .	4077
Posing the Biped . . . . .	4079
Scaling Links . . . . .	4088
Rubber-Banding Arms and Legs . . . . .	4090
Biped Display Options . . . . .	4093
Deleting a Biped . . . . .	4093
Linking Character Body Parts to the Biped . . . . .	4094
Saving and Loading FIG Files . . . . .	4096
Footstep Animation . . . . .	4098
Creating Footsteps . . . . .	4105
Editing Footstep Motion . . . . .	4120
Footstep and Freeform Animation . . . . .	4148
Freeform Animation . . . . .	4154
Creating Freeform Animation . . . . .	4158
Freeform and IK . . . . .	4181
Editing Freeform Animation . . . . .	4202
Working with Biped Animation . . . . .	4215
Working with Euler Curves on Biped Animation . . . . .	4215
Working with XRef Biped . . . . .	4219
Loading, Saving, and Displaying Biped Motion . . . . .	4220
Working with Biped Motion Files . . . . .	4220
Loading and Saving BIP Animation . . . . .	4222
Importing and Exporting Animation Data . . . . .	4224
Motion Mapping: Retargeting Biped Motion . . . . .	4224
Merging and Cloning a Character . . . . .	4226
Combining BIP Motions . . . . .	4229
Loading and Saving STP Files . . . . .	4230

Using Motion-Capture Data . . . . .	4231
Correcting Posture . . . . .	4232
Copying and Pasting Tracks . . . . .	4233
Repositioning the Biped . . . . .	4235
Previewing Biped Motion . . . . .	4238
In Place Mode . . . . .	4240
Trajectory Display . . . . .	4241
Display Preferences . . . . .	4243
Biped User Interface . . . . .	4245
Motion Panel (Biped) . . . . .	4246
Center of Mass . . . . .	4247
Motion Panel Rollouts (Biped) . . . . .	4250
Track View (Biped) . . . . .	4379
Biped Color-coded Keys and Trajectories . . . . .	4385
Biped Shortcuts . . . . .	4389
Working with the Workbench . . . . .	4394
Navigating the Workbench . . . . .	4397
Selecting Workbench Tracks . . . . .	4399
Analyzing Curves . . . . .	4400
Fixing Curves . . . . .	4401
Animation Workbench . . . . .	4401
Select Panel . . . . .	4407
Analyze Panel . . . . .	4410
Fix Panel . . . . .	4416
Filters Panel . . . . .	4421
Working with Motion Flow . . . . .	4426
Placing Motions on the Motion Flow Graph . . . . .	4427
Creating Transitions . . . . .	4431
Creating a Motion Flow Script . . . . .	4436
Saving, Loading, and Appending Motion Flow Graphs . . . . .	4439
Customizing Transitions . . . . .	4444
Creating Random Motion . . . . .	4447
Unifying Motion . . . . .	4452
Sharing Motion Flow . . . . .	4455
Setting Up Paths for Motion Flow Files . . . . .	4461
Motion Flow Mode . . . . .	4464
Motion Flow Rollout . . . . .	4467
Motion Flow Graph Dialog . . . . .	4468
Motion Flow Scripts Group . . . . .	4473
Transition Editor . . . . .	4477
Create Random Motion Dialog . . . . .	4484
Shared Motion Flow Dialog . . . . .	4486
Transition Optimization Dialog . . . . .	4490
Clip Properties Dialog . . . . .	4491
Working with Motion-Capture Data . . . . .	4493

Importing Motion-Capture Data . . . . .	4495
Filtering Motion-Capture and Marker Data . . . . .	4496
Sliding Footsteps . . . . .	4500
Prop Bone . . . . .	4502
Motion Capture Rollout . . . . .	4503
Motion Capture Conversion Parameters Dialog . . . . .	4511
Motion Capture Batch File Conversion Dialog . . . . .	4520
Marker Display Dialog . . . . .	4520
Physique . . . . .	4522
Using Physique . . . . .	4524
Creating a Skin . . . . .	4524
Using Physique with a Biped . . . . .	4533
Using Physique with 3ds Max Bones . . . . .	4535
Using Physique with 3ds Max Objects . . . . .	4540
Applying and Initializing Physique . . . . .	4544
Previewing Motion . . . . .	4545
Envelopes and Vertex Assignments . . . . .	4547
Bulges . . . . .	4566
Tendons . . . . .	4571
Saving and Loading Physique Data . . . . .	4574
Reinitializing Physique Settings . . . . .	4574
Working with an Initial Pose . . . . .	4576
Improving Interactive Performance . . . . .	4577
Scaling a Character . . . . .	4579
Facial Animation . . . . .	4579
Physique and Modifiers . . . . .	4586
Physique User Interface . . . . .	4589
Physique Rollout . . . . .	4590
Physique Level of Detail Rollout . . . . .	4594
Floating Bones Rollout . . . . .	4597
Physique Shortcuts . . . . .	4598
Physique Dialogs . . . . .	4600
Physique Modifier Sub-Object Levels . . . . .	4635
Crowd Animation . . . . .	4680
Creating a Crowd System . . . . .	4681
Creating Crowd Helpers . . . . .	4686
Adjusting Delegate Parameters . . . . .	4691
Assigning Behaviors . . . . .	4691
Directing Delegates . . . . .	4696
Obstacle Avoidance . . . . .	4699
Changing Delegate Orientation and Speed . . . . .	4704
Solving the Simulation . . . . .	4705
Linking Objects to Delegates . . . . .	4706
Cognitive Controllers . . . . .	4708
Using Motion Synthesis . . . . .	4712
Biped Crowds . . . . .	4712

Non-Biped Crowds . . . . .	4724
Crowd Animation User Interface . . . . .	4729
Crowd Shortcuts . . . . .	4730
Delegate Helper Object . . . . .	4730
Crowd Helper Object . . . . .	4738
Vector Field Space Warp . . . . .	4837
Motion Synthesis . . . . .	4845
File Formats and Index of Procedures . . . . .	4876
character studio File Formats . . . . .	4876
Procedures . . . . .	4877
<b>Chapter 16 Lights and Cameras . . . . .</b>	<b>4889</b>
Lights . . . . .	4890
Name and Color Rollout (Lights) . . . . .	4892
Using Lights . . . . .	4894
Working with Lights . . . . .	4895
Properties of Light . . . . .	4898
Lighting in 3ds Max . . . . .	4904
Guidelines for Lighting . . . . .	4906
Positioning Light Objects . . . . .	4910
Previewing Shadows in Viewports . . . . .	4911
Animating Lights . . . . .	4916
Light Include/Exclude Tool . . . . .	4917
Light Lister . . . . .	4920
Standard Lights . . . . .	4925
Target Spotlight . . . . .	4927
Free Spotlight . . . . .	4930
Target Directional Light . . . . .	4932
Free Directional Light . . . . .	4935
Omni Light . . . . .	4938
Skylight . . . . .	4940
mr Area Omni Light . . . . .	4945
mr Area Spotlight . . . . .	4948
Photometric Lights . . . . .	4951
Photometric Lights: Preset Lights . . . . .	4953
Target Point Light (Photometric) . . . . .	4955
Free Point Light (Photometric) . . . . .	4958
Target Linear Light (Photometric) . . . . .	4960
Free Linear Light (Photometric) . . . . .	4963
Target Area Light (Photometric) . . . . .	4964
Free Area Light (Photometric) . . . . .	4967
IES Sun Light (Photometric) . . . . .	4969
IES Sky Light (Photometric) . . . . .	4973
mental ray Sun & Sky . . . . .	4977
mr Sky Portal . . . . .	4999
Using Photometric Lights . . . . .	5007

Sunlight and Daylight Systems . . . . .	5024
Geographic Location Dialog . . . . .	5033
Common Lighting Rollouts . . . . .	5035
General Lighting Parameters . . . . .	5035
Exclude/Include Dialog . . . . .	5043
Shadow Parameters . . . . .	5046
Spotlight Parameters . . . . .	5051
Advanced Effects Rollout . . . . .	5055
mental ray Indirect Illumination Rollout (for Lights) . . . . .	5060
mental ray Light Shader Rollout . . . . .	5063
Additional Rollouts for Standard Lights . . . . .	5065
Intensity/Color/Attenuation Parameters . . . . .	5065
Directional Parameters . . . . .	5069
Atmospheres and Effects for Lights . . . . .	5072
Add Atmosphere or Effect Dialog . . . . .	5074
Hair Light Attr(ributes) Rollout . . . . .	5076
Additional Rollouts for Photometric Lights . . . . .	5077
Intensity/Color/Distribution Rollout . . . . .	5077
Linear Light Parameters Rollout . . . . .	5081
Area Light Parameters Rollout . . . . .	5081
Area Light Sampling Rollout . . . . .	5082
Web Parameters Rollout . . . . .	5083
Rollouts for Specific Shadow Types . . . . .	5085
Advanced Ray-Traced Parameters Rollout . . . . .	5085
Area Shadows Rollout . . . . .	5089
mental ray Shadow Map Rollout . . . . .	5095
Optimizations Rollout . . . . .	5097
Ray-Traced Shadow Parameters Rollout . . . . .	5100
Shadow Map Parameters Rollout . . . . .	5102
Cameras . . . . .	5106
Free Camera . . . . .	5116
Target Camera . . . . .	5118
Using Cameras . . . . .	5120
Characteristics of Cameras . . . . .	5120
Common Camera Parameters . . . . .	5123
Using Transforms to Aim a Camera . . . . .	5134
Using Clipping Planes to Exclude Geometry . . . . .	5135
Using the Horizon to Match Perspective . . . . .	5136
Animating Cameras . . . . .	5138
Multi-Pass Rendering Effects . . . . .	5140
Depth of Field Parameter (mental ray Renderer) . . . . .	5142
Multi-Pass Depth of Field Parameters for Cameras . . . . .	5143
Multi-Pass Motion Blur Parameters for Cameras . . . . .	5147
Camera Match Utility . . . . .	5152
Camera Match Helper Objects . . . . .	5157
Two-Point Perspective . . . . .	5160

Camera Correction Modifier . . . . .	5160
<b>Chapter 17 Material Editor, Materials, and Maps . . . . .</b>	<b>5163</b>
Designing Materials . . . . .	5164
Sample Slots and Material Name . . . . .	5166
Material Type . . . . .	5168
Shading Type . . . . .	5169
Material Components . . . . .	5171
Lights and Shading . . . . .	5172
Choosing Colors for Realism . . . . .	5174
Using Maps to Enhance a Material . . . . .	5178
Applying a Material to an Object . . . . .	5182
Mapping Coordinates . . . . .	5183
Saving a Material . . . . .	5184
Material XML Exporter Utility . . . . .	5185
UVW Remove Utility . . . . .	5188
Material Editor . . . . .	5188
Material/Map Browser . . . . .	5194
Copying and Pasting: Right-Click Menu for Materials, Maps, Bitmaps, and Colors . . . . .	5205
Sample Slots . . . . .	5208
Sample Slot Right-Click Menu . . . . .	5212
Dragging and Dropping Maps and Materials . . . . .	5214
Drag and Drop Sub-Object Material Assignment . . . . .	5216
Creating a Custom Sample Object . . . . .	5218
Material Editor Tools . . . . .	5221
Material Editor Menu Bar . . . . .	5225
Reflectance and Transmittance Display . . . . .	5228
Sample Type . . . . .	5232
Propagate Materials to Instances . . . . .	5232
Backlight . . . . .	5233
Sample Slot Background . . . . .	5233
Sample UV Tiling . . . . .	5234
Video Color Check . . . . .	5236
Make Preview, Play Preview, Save Preview . . . . .	5237
Material Editor Options . . . . .	5239
Select By Material . . . . .	5244
Get Material . . . . .	5245
Put Material to Scene . . . . .	5247
Assign Material to Selection . . . . .	5248
Reset Map/Mtl to Default Settings . . . . .	5249
Make Material Copy . . . . .	5250
Make Unique (Material Editor) . . . . .	5250
Put to Library . . . . .	5252
Material ID Channel . . . . .	5252
Material ID Channel Flyout . . . . .	5254

Show Standard/Hardware Map in Viewport . . . . .	5254
Show End Result . . . . .	5260
Go to Parent . . . . .	5260
Go Forward to Sibling . . . . .	5261
Material/Map Navigator . . . . .	5261
Pick Material From Object (Eyedropper) . . . . .	5264
Name Field (Materials and Maps) . . . . .	5264
Type Button (Materials and Maps) . . . . .	5265
Animating Materials . . . . .	5265
Creating and Playing Animated Material Previews . . . . .	5266
Synchronizing an Animated Bitmap with the Scene . . . . .	5267
Material Editor Subdialogs . . . . .	5269
Copy (Instance) Map Dialog . . . . .	5269
Copy or Swap Colors Dialog . . . . .	5270
Create Material Preview Dialog . . . . .	5270
Duplicate Name Dialog (Material Library) . . . . .	5272
Merge Dialog (Material Library) . . . . .	5274
Merge Material Library Dialog . . . . .	5275
Put to Library Dialog . . . . .	5276
Render Map Dialog . . . . .	5277
Replace Map Dialog . . . . .	5280
Replace Material Dialog . . . . .	5280
Update Scene Materials Dialog . . . . .	5281
Types of Materials . . . . .	5283
SuperSampling Rollout . . . . .	5285
mental ray Connection Rollout . . . . .	5289
DirectX Manager Rollout . . . . .	5297
Standard Material . . . . .	5298
Shader Basic Parameters Rollout . . . . .	5301
Understanding Shaders . . . . .	5303
Basic Parameters Rollout (Standard Material) . . . . .	5310
Extended Parameters Rollout (Standard Material) . . . . .	5312
Maps Rollout (Standard Material) . . . . .	5318
Dynamics Properties Rollout . . . . .	5327
Basic Material Shaders . . . . .	5328
Basic Parameters for Standard Materials . . . . .	5341
Specular Highlight Controls . . . . .	5353
Mapping Standard Material Components . . . . .	5362
Raytrace Material . . . . .	5394
Raytrace Basic Parameters Rollout . . . . .	5397
Raytrace Extended Parameters Rollout . . . . .	5406
Raytracer Controls Rollout . . . . .	5411
Raytrace Maps Rollout . . . . .	5414
Raytrace Dynamics Properties Rollout . . . . .	5421
Raytracing Acceleration Parameters Dialog . . . . .	5423
Raytrace Exclude/Include Dialog . . . . .	5424



Raytrace Antialiaser Dialog: Fast Adaptive Antialiaser . . .	5427
Raytrace Antialiaser Dialog: Multiresolution Adaptive Antialiaser . . . . .	5429
Architectural Material . . . . .	5431
Templates Rollout . . . . .	5432
Physical Qualities Rollout . . . . .	5434
Special Effects Rollout . . . . .	5438
Advanced Lighting Override Rollout . . . . .	5441
Cutout Mapping . . . . .	5446
mental ray Materials . . . . .	5448
mental ray Material . . . . .	5449
Arch & Design Material (mental ray) . . . . .	5458
Car Paint Material/Shader (mental ray) . . . . .	5521
DGS Material (mental ray) . . . . .	5529
Glass Material (mental ray) . . . . .	5533
Subsurface Scattering (SSS) Materials . . . . .	5536
Matte/Shadow Material . . . . .	5538
Compound Materials . . . . .	5544
Blend Material . . . . .	5546
Composite Material . . . . .	5549
Double-Sided Material . . . . .	5551
Morpher Material . . . . .	5554
Multi/Sub-Object Material . . . . .	5558
Shellac Material . . . . .	5565
Top/Bottom Material . . . . .	5567
Shell Material . . . . .	5570
Advanced Lighting Override Material . . . . .	5572
Lightscape Material . . . . .	5579
Ink 'n Paint Material . . . . .	5580
DirectX 9 Shader Material . . . . .	5596
DirectX Viewport Shaders . . . . .	5598
LightMap Shader Rollout . . . . .	5598
Metal Bump Shader Rollout . . . . .	5599
XRef Material . . . . .	5603
Types of Maps . . . . .	5605
Real-World Mapping . . . . .	5609
Output Rollout . . . . .	5612
Missing Map Coordinates Dialog . . . . .	5618
2D Maps . . . . .	5619
Coordinates Rollout (2D) . . . . .	5620
Noise Rollout (2D) . . . . .	5631
Bitmap 2D Map . . . . .	5633
Select Bitmap Image File Dialog . . . . .	5642
Checker Map . . . . .	5646
Combustion Map . . . . .	5649
Gradient Map . . . . .	5673

Gradient Ramp Map . . . . .	5678
Flag Properties Dialog . . . . .	5684
Swirl Map . . . . .	5686
Tiles Map . . . . .	5689
3D Maps . . . . .	5698
Coordinates Rollout (3D) . . . . .	5699
Cellular Map . . . . .	5700
Dent Map . . . . .	5707
Falloff Map . . . . .	5715
Marble Map . . . . .	5721
Noise Map . . . . .	5724
Particle Age Map . . . . .	5727
Particle MBlur Map . . . . .	5729
Perlin Marble Map . . . . .	5731
Planet Map . . . . .	5734
Smoke Map . . . . .	5736
Speckle Map . . . . .	5739
Splat Map . . . . .	5740
Stucco Map . . . . .	5742
Waves Map . . . . .	5745
Wood Map . . . . .	5747
Compositor Maps . . . . .	5756
Composite Map . . . . .	5756
Mask Map . . . . .	5759
Mix Map . . . . .	5760
RGB Multiply Map . . . . .	5764
Color Modifier Maps . . . . .	5766
Output Map . . . . .	5767
RGB Tint Map . . . . .	5769
Vertex Color Map . . . . .	5770
Reflection and Refraction Maps . . . . .	5773
Flat Mirror Map . . . . .	5773
Raytrace Map . . . . .	5779
Reflect/Refract Map . . . . .	5791
Thin Wall Refraction Map . . . . .	5798
mental ray Shaders . . . . .	5801
Custom Shaders for 3ds Max . . . . .	5804
mental images Shader Libraries . . . . .	5805
Shaders in the LumeTools Collection . . . . .	5807
Connect Parameter to Shader Dialog (mental ray) . . . . .	5808
3ds Max Custom Shaders . . . . .	5810
Normal Bump Map . . . . .	5844
Camera Map Per Pixel Map . . . . .	5846
Material, Mapping, and Vertex Color Utilities . . . . .	5849
Assign Vertex Colors Utility . . . . .	5849
Channel Info Utility . . . . .	5858

	Clean MultiMaterial Utility . . . . .	5864
	Instance Duplicate Maps Utility . . . . .	5869
<b>Chapter 18</b>	<b>Rendering . . . . .</b>	<b>5877</b>
	Render Scene Dialog . . . . .	5878
	Rendered Frame Window . . . . .	5885
	Render Output File Dialog . . . . .	5892
	Rendering Commands . . . . .	5897
	Render Scene . . . . .	5898
	Render Type . . . . .	5900
	Render Bounding Box/Selected Dialog . . . . .	5907
	Quick Render Flyout . . . . .	5908
	Quick Render (Production) . . . . .	5909
	Quick Render (ActiveShade) . . . . .	5909
	ActiveShade . . . . .	5910
	ActiveShade Floater . . . . .	5917
	ActiveShade Viewport . . . . .	5918
	ActiveShade Commands (Quad Menu) . . . . .	5919
	Preset Rendering Options . . . . .	5922
	Show Last Rendering . . . . .	5924
	Render Last . . . . .	5924
	Print Size Wizard . . . . .	5925
	Common Rendering Parameters . . . . .	5929
	Common Panel (Render Scene Dialog) . . . . .	5929
	Common Parameters Rollout (Render Scene Dialog) . . . . .	5929
	Configure Preset Dialog . . . . .	5938
	Email Notifications Rollout . . . . .	5939
	Scripts Rollout (Render Scene Dialog) . . . . .	5941
	Assign Renderer Rollout . . . . .	5943
	Choose Renderer Dialog . . . . .	5944
	Renderers . . . . .	5946
	Renderer Panel (Render Scene Dialog) . . . . .	5946
	Default Scanline Renderer Rollout . . . . .	5949
	Advanced Lighting Panel . . . . .	5962
	Raytracer Panel . . . . .	6030
	Using Multi-Pass Rendering Effects . . . . .	6036
	mental ray Renderer . . . . .	6039
	Rendering with the mental ray Renderer . . . . .	6042
	Getting Good Results with mental ray Rendering . . . . .	6044
	3ds Max Materials in mental ray Renderings . . . . .	6048
	Enhancements to Standard Features . . . . .	6050
	Processing Panel (mental ray Renderer) . . . . .	6053
	mental ray Messages Window . . . . .	6054
	mental ray Concepts . . . . .	6056
	mental ray Renderer Rollouts . . . . .	6083
	VUE File Renderer . . . . .	6143

Rendering Elements Separately . . . . .	6144
Render Elements Panel and Rollout . . . . .	6144
Render Elements Dialog . . . . .	6157
Render Element Output File Dialog . . . . .	6158
Blend Element Parameters Rollout . . . . .	6162
Hair and Fur Render Element . . . . .	6163
Lighting Texture Element Rollout . . . . .	6163
Matte Texture Element Rollout . . . . .	6164
Velocity Element Parameters Rollout . . . . .	6165
Z Element Parameters Rollout . . . . .	6167
Diffuse Texture Element Rollout . . . . .	6168
Render to Texture . . . . .	6169
Baked Texture Elements . . . . .	6174
Target Map Slot Assignments . . . . .	6181
Creating and Using Normal Bump Maps . . . . .	6182
Troubleshooting Normal Bump Maps . . . . .	6184
Render to Texture Dialog . . . . .	6195
Render to Texture: General Settings Rollout . . . . .	6197
Render to Texture: Objects to Bake Rollout . . . . .	6199
Render to Texture: Output Rollout . . . . .	6204
Render to Texture: Baked Material Rollout . . . . .	6208
Render to Texture: Automatic Mapping Rollout . . . . .	6211
Render to Texture: Add Texture Elements Dialog . . . . .	6213
Render to Texture: Projection Options Dialog . . . . .	6214
Rendering Previews . . . . .	6220
Make Preview . . . . .	6220
View Preview . . . . .	6224
Rename Preview . . . . .	6224
Panorama Exporter Utility . . . . .	6225
Panorama Exporter Render Setup Dialog . . . . .	6226
Panorama Exporter Viewer . . . . .	6229
Network Rendering . . . . .	6231
Basic Procedures for Network Rendering . . . . .	6233
How Network Rendering Works . . . . .	6246
Starting Network Rendering . . . . .	6248
Troubleshooting Guide . . . . .	6253
System Setup . . . . .	6259
Checking Requirements . . . . .	6259
Setting Up for Network Rendering . . . . .	6261
Setting Up TCP/IP . . . . .	6261
Configuring TCP/IP . . . . .	6264
Creating a Special User Account . . . . .	6270
Setting Up Rendering Software . . . . .	6272
Setting Up Directories . . . . .	6273
Sharing a Directory . . . . .	6275
Mounting a Directory . . . . .	6276

Using Configure User Paths . . . . .	6277
Network Job Assignment Dialog . . . . .	6279
Job Dependencies Dialog . . . . .	6289
Notifications Dialog . . . . .	6291
Strips Setup Dialog . . . . .	6293
Advanced Settings Dialog . . . . .	6296
Manager and Server . . . . .	6300
Initial Setup for Manager and Server Programs . . . . .	6300
Installing Network Services . . . . .	6302
Logging Properties Dialog . . . . .	6304
The backburner.xml File . . . . .	6307
Network Rendering Manager . . . . .	6308
Network Rendering Server . . . . .	6315
Queue Monitor . . . . .	6321
The Queue Monitor Application . . . . .	6321
Module Info Report Dialog . . . . .	6332
Queue Monitor: Job Settings Dialog . . . . .	6334
Viewing Jobs and Servers with the Queue Monitor . . . . .	6339
Job Report Dialog . . . . .	6340
Job Archives Dialog . . . . .	6342
Activating and Deactivating Jobs in the Queue . . . . .	6343
Activating and Deactivating Servers in the Queue . . . . .	6344
Managing Jobs in the Queue . . . . .	6345
Week Schedule Dialog . . . . .	6345
Batch Rendering . . . . .	6347
Quick Start Batch Rendering . . . . .	6348
Using Backburner for Batch Rendering . . . . .	6349
Batch Rendering - Batch Render Dialog . . . . .	6352
Batch Render Tool - Batch Render Warning Dialog . . . . .	6359
Command-Line Rendering . . . . .	6361
Command-Line Rendering Switches . . . . .	6365
Backburner Command Line Control . . . . .	6378

**Chapter 19 Effects and Environments . . . . . 6379**

Environment and Effects Dialog . . . . .	6380
Rendering Effects . . . . .	6381
Rendering Effects Command . . . . .	6382
Effects Panel and Rollout . . . . .	6383
Merging Effects . . . . .	6385
Hair and Fur Render Effect . . . . .	6386
Lens Effects Rendering Effects . . . . .	6391
Glow Lens Effect . . . . .	6397
Ring Lens Effect . . . . .	6404
Ray Lens Effect . . . . .	6414
Auto Secondary Lens Effect . . . . .	6421
Manual Secondary Lens Effect . . . . .	6429

Star Lens Effect . . . . .	6436
Streak Lens Effect . . . . .	6443
Lens Effects Dialogs . . . . .	6450
Blur Rendering Effect . . . . .	6461
Brightness and Contrast Rendering Effect . . . . .	6470
Color Balance Rendering Effect . . . . .	6472
File Output Rendering Effect . . . . .	6473
Film Grain Rendering Effect . . . . .	6476
Motion Blur Rendering Effect . . . . .	6478
Depth of Field Rendering Effect . . . . .	6480
Environment and Atmosphere Effects . . . . .	6484
Environment Panel . . . . .	6486
Fire Environment Effect . . . . .	6493
Fog Environment Effect . . . . .	6506
Volume Fog Environment Effect . . . . .	6512
Volume Light Environment Effect . . . . .	6520
Exposure Controls . . . . .	6531
Automatic Exposure Control . . . . .	6534
Linear Exposure Control . . . . .	6537
Logarithmic Exposure Control . . . . .	6540
mr Photographic Exposure Control . . . . .	6544
Pseudo Color Exposure Control . . . . .	6552
Lighting Data Exporter Utility . . . . .	6559
Atmospheric Apparatus . . . . .	6560
Add Atmosphere Dialog . . . . .	6560
BoxGizmo Helper . . . . .	6561
CylGizmo Helper . . . . .	6564
SphereGizmo Helper . . . . .	6567

**Chapter 20 Video Post . . . . . 6571**

Video Post Queue . . . . .	6573
Video Post Status Bar / View Controls . . . . .	6575
Troubleshooting Video Post . . . . .	6577
Useful Video Post Procedures . . . . .	6580
Video Post Toolbar . . . . .	6596
New Sequence . . . . .	6596
Open Sequence . . . . .	6597
Save Sequence . . . . .	6598
Edit Current Event . . . . .	6598
Delete Current Event . . . . .	6599
Swap Events . . . . .	6600
Execute Sequence . . . . .	6601
Configure Presets . . . . .	6603
Edit Range Bar . . . . .	6604
Align Selected Left . . . . .	6605
Align Selected Right . . . . .	6606

Make Selected Same Size . . . . .	6606
Abut Selected . . . . .	6607
Add Scene Event . . . . .	6607
Add Image Input Event . . . . .	6613
Image Input Options . . . . .	6617
Add Image Filter Event . . . . .	6620
Add Image Layer Event . . . . .	6623
Add Image Output Event . . . . .	6627
Add External Event . . . . .	6630
Add Loop Event . . . . .	6633
Filter Events . . . . .	6636
Contrast Filter . . . . .	6636
Fade Filter . . . . .	6637
Image Alpha Filter . . . . .	6638
Lens Effects Filters . . . . .	6639
Negative Filter . . . . .	6640
Pseudo Alpha Filter . . . . .	6641
Simple Wipe Filter . . . . .	6642
Starfield Filter . . . . .	6643
Lens Effects Filters . . . . .	6647
Animating Lens Effects Properties . . . . .	6647
Lens Effects Flare Filter . . . . .	6648
Lens Effects Focus Filter . . . . .	6670
Lens Effects Glow Filter . . . . .	6673
Lens Effects Highlight Filter . . . . .	6685
Lens Effects Gradients . . . . .	6699
Layer Events . . . . .	6707
Alpha Compositor . . . . .	6707
Cross Fade Compositor . . . . .	6708
Pseudo Alpha Compositor . . . . .	6709
Simple Additive Compositor . . . . .	6710
Simple Wipe Compositor . . . . .	6711

**Chapter 21 Managing Scenes and Projects . . . . . 6713**

File-Handling Commands . . . . .	6715
New . . . . .	6716
Reset . . . . .	6717
Open . . . . .	6718
Open from Vault . . . . .	6721
Open Recent . . . . .	6723
Save . . . . .	6723
Save As . . . . .	6724
Save Copy As . . . . .	6726
Save Selected . . . . .	6727
Set Project Folder . . . . .	6728
External References (XRefs) . . . . .	6729

XRef Objects . . . . .	6732
XRef Objects Dialog . . . . .	6737
XRef Record List Right-Click Menu . . . . .	6747
XRef Entities List Right-Click Menu . . . . .	6750
XRef Merge Dialog . . . . .	6752
XRef Scene . . . . .	6755
XRef Scenes Dialog . . . . .	6763
XRef Object Rollout . . . . .	6769
Proxy Object Rollout . . . . .	6770
Missing XRef Paths Dialog . . . . .	6772
File Link . . . . .	6772
Working with Drawing Files . . . . .	6774
File Link Tips . . . . .	6777
Interpreting Layer Data from AutoCAD, AutoCAD Architecture, and Revit . . . . .	6782
Scale Synchronization . . . . .	6783
File Link Manager Utility . . . . .	6783
Working with AutoCAD, AutoCAD Architecture, and Revit Files . . . . .	6817
Instanced Objects, Elements, Blocks and Styles . . . . .	6842
Merge . . . . .	6854
Merge File Dialog . . . . .	6858
Merge Animation . . . . .	6859
Replace . . . . .	6866
Saving and Loading Animation . . . . .	6870
Load Animation . . . . .	6873
Save Animation . . . . .	6876
Map Animation Dialog . . . . .	6879
Motion Mapping Parameters Rollout . . . . .	6882
Map Track to Track Rollout . . . . .	6885
Retargeting Rollout . . . . .	6886
Import . . . . .	6892
Export . . . . .	6894
Export Selected . . . . .	6895
Asset Tracking . . . . .	6896
Asset Tracking Dialog . . . . .	6897
Global Settings and Defaults for Bitmap Proxies Dialog . . . . .	6912
Prompts Dialog . . . . .	6914
Asset Tracking Dialog Icons . . . . .	6916
Archive . . . . .	6918
Summary Info . . . . .	6919
File Properties . . . . .	6920
View Image File . . . . .	6923
Exit . . . . .	6926
Missing External Files Dialog . . . . .	6926



File-Handling Utilities . . . . .	6928
Asset Browser Utility . . . . .	6928
Bitmap/Photometric Path Editor Utility . . . . .	6938
MAX File Finder Utility . . . . .	6939
Resource Collector Utility . . . . .	6942
Fix Ambient Utility . . . . .	6944
Bitmap Pager Statistics Dialog . . . . .	6947
Asset Browser Subdialogs . . . . .	6948
Preferences Dialog (Asset Browser) . . . . .	6948
Internet Download Dialog . . . . .	6950
Favorite Location Dialog . . . . .	6952
Bitmap Path Editor Subdialogs . . . . .	6953
Bitmap / Photometric Path Editor Dialog . . . . .	6953
Resource Information Dialog . . . . .	6955
Internet Access . . . . .	6956
i-drop Indicator . . . . .	6957
Geometry File Formats . . . . .	6958
Importing Geometry . . . . .	6960
Working with MAX Files from Autodesk VIZ . . . . .	6961
VIZ Render (DRF) Files . . . . .	6964
Working with DRF Files in 3ds Max . . . . .	6967
3D Studio Mesh (3DS, PRJ) Files . . . . .	6969
Importing 3DS Files . . . . .	6969
Importing PRJ Files . . . . .	6971
Exporting to 3DS . . . . .	6972
Importing SHP Files . . . . .	6974
Importing Adobe Illustrator 88 Files . . . . .	6975
Exporting to Adobe Illustrator . . . . .	6976
Exporting to ASCII . . . . .	6977
AutoCAD (DWG) Files . . . . .	6979
Importing AutoCAD Drawing Files . . . . .	6979
DWG/DXF Import: Geometry Panel . . . . .	6984
DWG/DXF Import: Layers Panel . . . . .	6993
DWG/DXF Import: Spline Rendering Panel . . . . .	6995
Legacy AutoCAD Import . . . . .	6998
Exporting AutoCAD DWG Files . . . . .	7003
AutoCAD Interchange (DXF) Files . . . . .	7006
Importing DXF Files . . . . .	7006
Exporting to DXF Files . . . . .	7006
Autodesk Inventor Files . . . . .	7008
Importing Autodesk Inventor Files . . . . .	7008
DWF Files . . . . .	7013
Exporting 3D DWF Files . . . . .	7013
FBX Files . . . . .	7019
IGES Files . . . . .	7020
Overview of IGES in 3ds Max . . . . .	7020

IGES Log Files . . . . .	7022
Importing IGES Files . . . . .	7023
IGES to 3ds Max Import Table . . . . .	7025
Exporting IGES Files . . . . .	7027
3ds Max to IGES Export Table . . . . .	7028
JSR-184 Files . . . . .	7030
JSR-184 Object Parameters . . . . .	7033
JSR-184 Texture Tool . . . . .	7038
JSR-184 Log Files . . . . .	7040
JSR-184 Standalone Player . . . . .	7042
LandXML (XML, DEM) Files . . . . .	7044
Importing LandXML/DEM Models . . . . .	7044
LandXML/DEM Model Import Dialog . . . . .	7046
Exporting Lightscape Files . . . . .	7048
Importing Lightscape Files . . . . .	7050
Lightscape Materials Utility . . . . .	7051
Motion Analysis Files (HTR/HTR2, TRC) . . . . .	7054
Importing HTR/HTR2 Files . . . . .	7054
Importing TRC Files . . . . .	7056
Exporting HTR/HTR2 Files . . . . .	7058
Exporting to Shockwave 3D . . . . .	7061
Shockwave 3D Scene Export Options Dialog . . . . .	7062
Shockwave 3D Export Preview . . . . .	7069
Shockwave 3D File Analysis Window . . . . .	7071
Stereolithography (STL) Files . . . . .	7073
Importing STL Files . . . . .	7073
Exporting to STL . . . . .	7076
Wavefront (OBJ, MTL) Files . . . . .	7077
Exporting Wavefront Material (MTL) Files . . . . .	7078
Exporting Wavefront Object (OBJ) Files . . . . .	7079
VRML Files . . . . .	7082
Importing VRML Files . . . . .	7082
Exporting to VRML97 . . . . .	7083
VRML97 Export . . . . .	7089
Image File Formats . . . . .	7116
AVI Files . . . . .	7118
BMP Files . . . . .	7120
CIN (Kodak Cineon) Files . . . . .	7120
CWS (Combustion Workspace) Files . . . . .	7121
DDS Files . . . . .	7122
EPS and PS (Encapsulated PostScript) Files . . . . .	7124
GIF Files . . . . .	7126
HDRI Files . . . . .	7126
IFL Files . . . . .	7131
Image File List Control Dialog . . . . .	7134
IFL Manager Utility . . . . .	7136

IMSQ Files . . . . .	7138
JPEG Files . . . . .	7139
MOV (QuickTime Movie) Files . . . . .	7140
MPEG Files . . . . .	7140
OpenEXR Files . . . . .	7141
Saving OpenEXR Files . . . . .	7142
Opening OpenEXR Files . . . . .	7147
PIC Files . . . . .	7151
PNG Files . . . . .	7152
PSD Files . . . . .	7153
RLA Files . . . . .	7156
RPF Files . . . . .	7159
RGB (SGI Image) Files . . . . .	7161
TGA (Targa) Files . . . . .	7162
TIFF Files . . . . .	7164
YUV Files . . . . .	7166
RAM Player . . . . .	7166
RAM Player Configuration Dialog . . . . .	7170
Scene Explorer . . . . .	7171
Using Scene Explorer . . . . .	7173
Scene Explorer Menus . . . . .	7178
Scene Explorer Toolbars . . . . .	7179
Manage Scene Explorer . . . . .	7182
Advanced Search Dialog . . . . .	7183
Scene States . . . . .	7185
Manage Scene States Dialog . . . . .	7188
Schematic View . . . . .	7193
Using Schematic View . . . . .	7197
Schematic View Menus . . . . .	7201
Schematic View List Views . . . . .	7205
Schematic View Preferences Dialog . . . . .	7207
Schematic View Toolbars . . . . .	7213
Schematic View Display Floater . . . . .	7217
Schematic View Commands . . . . .	7219
New Schematic View . . . . .	7219
Delete Schematic View . . . . .	7220
Saved Schematic Views . . . . .	7220
Schematic View Selection Right-Click Menu . . . . .	7220
Using Layers to Organize a Scene . . . . .	7224
Layer Manager . . . . .	7227
Layer Properties Dialog . . . . .	7237
Layer List . . . . .	7245
Create New Layer . . . . .	7246
Add Selection to Current Layer . . . . .	7247
Select Objects in Current Layer . . . . .	7247
Set Current Layer to Selection's Layer . . . . .	7247

<b>Chapter 22</b>	<b>Utilities</b>	<b>7249</b>
	List of Available Utilities	7249
<b>Chapter 23</b>	<b>User Interface</b>	<b>7251</b>
	Additional Keyboard Commands	7251
	Toggling Dialogs	7253
	Starting 3ds Max from the Command Line	7254
	Menu Bar	7257
	File Menu	7259
	Edit Menu	7260
	Tools Menu	7260
	Group Menu	7262
	Views Menu	7262
	Create Menu	7263
	Modifiers Menu	7270
	reactor Menu	7275
	Animation Menu	7275
	Graph Editors Menu	7278
	Rendering Menu	7278
	Customize Menu	7279
	MAXScript Interface	7280
	Help Menu	7281
	Toolbars	7283
	Main Toolbar	7284
	Axis Constraints Toolbar	7288
	Layers Toolbar	7289
	reactor Toolbar	7290
	Extras Toolbar	7290
	Render Shortcuts Toolbar	7291
	Snaps Toolbar	7292
	Animation Layers Toolbar	7293
	Brush Presets Toolbar	7293
	Brush Preset Manager	7296
	Right-Click Menu for Scripted Toolbar Buttons	7300
	Quad Menu	7300
	Additional Quad Menus	7304
	Animation Quad Menu	7306
	Status Bar Controls	7308
	Prompt Line	7309
	MAXScript Mini Listener	7309
	Status Line	7312
	Time Slider	7312
	Track Bar	7315
	Selection Lock Toggle	7324
	Coordinate Display	7325

Grid Setting Display . . . . .	7327
Time Tag . . . . .	7328
Add Time Tag Dialog . . . . .	7329
Edit Time Tag Dialog . . . . .	7331
Communication Center . . . . .	7333
Using Communication Center . . . . .	7335
Configuring Communication Center . . . . .	7336
Refreshing the Content . . . . .	7341
Receive New Information Notifications . . . . .	7342
Animation and Time Controls . . . . .	7342
Auto Key Animation Mode . . . . .	7344
Set Key Animation Mode . . . . .	7347
Default In/Out Tangents For New Keys . . . . .	7351
Go To Start . . . . .	7354
Previous Frame/Key . . . . .	7355
Play/Stop . . . . .	7355
Next Frame/Key . . . . .	7357
Go To End . . . . .	7357
Current Frame (Go To Frame) . . . . .	7358
Key Mode . . . . .	7358
Time Configuration . . . . .	7359
Viewport Controls . . . . .	7366
Viewport Right-Click Menu . . . . .	7370
Viewport Navigation . . . . .	7378
Controls Available in All Viewports . . . . .	7381
Walkthrough Controls for Perspective and Camera Viewports . . . . .	7383
Perspective and Orthographic Viewport Controls . . . . .	7384
Camera Viewport Controls . . . . .	7397
Light Viewport Controls . . . . .	7407
Command Panel . . . . .	7422
Object Name and Wireframe Color . . . . .	7423
Create Panel . . . . .	7423
Modify Panel . . . . .	7425
Modifier Stack Controls . . . . .	7427
Modifier Stack Right-Click Menu . . . . .	7440
Make Unique . . . . .	7446
Modifier Sets Menu . . . . .	7449
Configure Modifier Sets Dialog . . . . .	7450
Hierarchy Panel . . . . .	7453
Motion Panel . . . . .	7455
Assign Controller Rollout . . . . .	7456
Display Panel . . . . .	7457
Display Floater . . . . .	7458
Utilities Panel . . . . .	7463
Utilities Dialog . . . . .	7465

Configure Button Sets Dialog . . . . .	7465
MAXScript Interface . . . . .	7468
New Script . . . . .	7468
Open Script . . . . .	7469
Run Script . . . . .	7469
MAXScript Listener . . . . .	7469
Macro Recorder . . . . .	7470
Visual MAXScript Utility (See MAXScript Reference) . . . . .	7471
MAXScript Debugger Dialog . . . . .	7472
Running Scripts from the Command Line . . . . .	7472
<b>Chapter 24 Customizing the User Interface . . . . .</b>	<b>7475</b>
Useful Customization Techniques . . . . .	7475
Customize Display Right-Click Menu . . . . .	7479
Show UI . . . . .	7480
Lock UI Layout . . . . .	7481
Plug-In Manager . . . . .	7482
Custom UI and Defaults Switcher . . . . .	7483
Market-Specific Defaults . . . . .	7486
COM/DCOM Server Control Utility . . . . .	7488
Customize User Interface Dialog . . . . .	7489
Keyboard Panel . . . . .	7489
Toolbars Panel . . . . .	7492
Quads Panel . . . . .	7496
Menus Panel . . . . .	7501
Colors Panel . . . . .	7505
Advanced Quad Menu Options . . . . .	7507
Edit Button Appearance Dialog . . . . .	7511
Saving and Loading Custom User Interfaces . . . . .	7513
Load Custom UI Scheme . . . . .	7515
Save Custom UI Scheme . . . . .	7516
Revert to Startup Layout . . . . .	7519
Configure Paths . . . . .	7519
Configure User Paths . . . . .	7520
Configure System Paths . . . . .	7523
File I/O Path Configuration . . . . .	7524
External Path Configuration . . . . .	7526
XRefs Path Configuration . . . . .	7529
System Paths . . . . .	7531
3rd Party Plug-Ins Path Configuration . . . . .	7532
Network Plug-In Configuration . . . . .	7533
Preferences . . . . .	7534
General Preferences . . . . .	7536
File Preferences . . . . .	7541
Viewport Preferences . . . . .	7545
Gamma and LUT Preferences . . . . .	7550

	Rendering Preferences . . . . .	7560
	Animation Preferences . . . . .	7564
	Inverse Kinematics Preferences . . . . .	7568
	Gizmos Preferences . . . . .	7570
	MAXScript Preferences . . . . .	7574
	Radiosity Preferences . . . . .	7578
	mental ray Preferences . . . . .	7579
	Graphics Driver Setup Dialog . . . . .	7582
	Configure Driver . . . . .	7585
	Configure Software Display Driver Dialog . . . . .	7586
	Configure OpenGL Dialog . . . . .	7588
	Direct3D Driver Setup Dialog . . . . .	7592
	Configure Direct3D Dialog . . . . .	7594
	MIDI Time Slider Control Setup Dialog . . . . .	7600
	Units Setup Dialog . . . . .	7601
	System Unit Setup Dialog . . . . .	7605
	File Load: Units Mismatch Dialog . . . . .	7608
	Viewport Configuration . . . . .	7610
	Rendering Method . . . . .	7611
	Viewport Layout . . . . .	7617
	Safe Frames . . . . .	7618
	Adaptive Degradation Options . . . . .	7622
	Regions . . . . .	7626
	Statistics . . . . .	7628
	Lighting and Shadows . . . . .	7630
	Strokes . . . . .	7631
	Defining Strokes . . . . .	7634
	Reviewing and Editing Strokes . . . . .	7638
	Stroke Preferences Dialog . . . . .	7640
	Strokes Utility . . . . .	7643
<b>Chapter 25</b>	<b>Keyboard Shortcuts . . . . .</b>	<b>7645</b>
	Keyboard Shortcut Override Toggle . . . . .	7646
<b>Chapter 26</b>	<b>Using the 3ds Max Help . . . . .</b>	<b>7647</b>
	Finding Information Fast . . . . .	7648
	Using the HTML Help Viewer . . . . .	7650
	Searching for Help Topics . . . . .	7652
	Favorites Tab . . . . .	7657
	HTML Help Viewer Toolbar . . . . .	7658
	HTML Help Viewer Right-Click Menus . . . . .	7659
	Keyboard Shortcuts in the Help Viewer . . . . .	7659
<b>Chapter 27</b>	<b>Troubleshooting 3ds Max . . . . .</b>	<b>7663</b>

Handling File Corruptions . . . . .	7663
Fixing Boolean Problems . . . . .	7667
Performance Issues While Running 3ds Max . . . . .	7677
Problems Caused by Unit Settings . . . . .	7681
User Interface Problems and Recovery . . . . .	7683
Video Driver and Display Problems . . . . .	7690
<b>Glossary . . . . .</b>	<b>7697</b>
2-Sided (Double Sided) . . . . .	7697
2D Map . . . . .	7698
3D DWF . . . . .	7698
3D Map . . . . .	7698
3DS and PRJ Files . . . . .	7698
Action . . . . .	7701
Active Link . . . . .	7701
Active Time Segment . . . . .	7702
Active/Inactive Footsteps . . . . .	7702
ActiveShade Initialize and Update . . . . .	7703
Adapt Locks . . . . .	7704
Adaptation . . . . .	7704
Adaptive Degradation . . . . .	7704
Additive Opacity . . . . .	7705
Adjust Talent Pose . . . . .	7707
Affine Transformation . . . . .	7707
Airborne Period . . . . .	7707
Aliasing/Antialiasing . . . . .	7708
Alpha Channel . . . . .	7709
Ambient Color . . . . .	7710
Ambient Light . . . . .	7710
Animated Texture . . . . .	7711
Animation . . . . .	7711
Animation Controllers / Transform Controllers . . . . .	7712
Animation Layers . . . . .	7713
Applied IK . . . . .	7713
Area Lights (mental ray Renderer) . . . . .	7713
Area Shadows . . . . .	7717
Aspect Ratio . . . . .	7718
Attachments (IK) . . . . .	7719
Attenuation . . . . .	7719
AutoGrid . . . . .	7720
Avoid Behavior . . . . .	7721
Avoidance Behavior . . . . .	7721
Axonometric View . . . . .	7722
B-Spline . . . . .	7722
Balance Factor . . . . .	7723
Balance Track . . . . .	7723



Ballistic Gait . . . . .	7723
Ballistic Tension . . . . .	7723
Barycentric Coordinates . . . . .	7724
Behaviors . . . . .	7724
Bend Links . . . . .	7725
Bezier Curve . . . . .	7726
BioVision Files . . . . .	7726
BIP Files . . . . .	7727
Biped . . . . .	7727
Biped Dynamics . . . . .	7727
Biped Playback . . . . .	7728
Birth Event . . . . .	7728
Bitmap . . . . .	7730
Blend Object . . . . .	7731
Block Reference . . . . .	7731
Block/Style Parent . . . . .	7732
Blur / Blur Offset . . . . .	7732
Body Space . . . . .	7733
Boolean Operation . . . . .	7734
Bound Vertex . . . . .	7735
Bounding Box . . . . .	7736
Bulge . . . . .	7736
Bulge Angle . . . . .	7737
BVH Files . . . . .	7737
By Layer . . . . .	7737
Center of Mass (COM) . . . . .	7737
Chamfer . . . . .	7738
character studio Marker Files . . . . .	7738
CIBSE Files . . . . .	7739
Clip Controller . . . . .	7739
Clipping Planes . . . . .	7739
Codec . . . . .	7740
Cognitive Controller . . . . .	7740
Composite . . . . .	7741
Compound Materials . . . . .	7742
Constrained Point . . . . .	7743
Contact Object . . . . .	7743
Containers . . . . .	7743
Continuity . . . . .	7743
Continuity Level . . . . .	7744
Control Lattice . . . . .	7745
Control Point . . . . .	7745
Control Vertex (CV) . . . . .	7746
Controller . . . . .	7746
Convex Hull Property . . . . .	7747
Cool . . . . .	7747

Coordinate Space . . . . .	7747
CPY Files . . . . .	7748
Creation Parameters . . . . .	7748
Cross Section . . . . .	7748
Crowd . . . . .	7748
Crowd System . . . . .	7749
CSM Files . . . . .	7749
Curve View . . . . .	7749
CV . . . . .	7750
CV Curve . . . . .	7751
CV Surface . . . . .	7752
Deformable Envelope . . . . .	7752
Deformation . . . . .	7753
Deformation Spline . . . . .	7753
Degree . . . . .	7755
Delegates . . . . .	7755
Dependent . . . . .	7755
Dependent (NURBS) . . . . .	7756
Depot . . . . .	7756
Description Panel . . . . .	7757
Diagonal . . . . .	7757
Diffuse Color . . . . .	7759
Dithering . . . . .	7760
Dock and Float . . . . .	7761
Double Support Period . . . . .	7761
Dummy Object . . . . .	7761
DWG Files . . . . .	7762
DXF Files . . . . .	7762
Dynalector . . . . .	7763
Dynamics . . . . .	7763
Dynamics Blend . . . . .	7763
Ease Curve . . . . .	7764
Edge . . . . .	7765
Editable Mesh . . . . .	7765
Editable Poly . . . . .	7765
Element . . . . .	7766
Emitter . . . . .	7766
End Effector . . . . .	7767
Envelopes . . . . .	7767
Environment Map . . . . .	7768
Event . . . . .	7770
Event Display . . . . .	7772
Event Level . . . . .	7773
Extents . . . . .	7773
Face/Polygon . . . . .	7774
Faceted . . . . .	7774

FFD	7775
FGM File	7775
Field of View	7776
Fields	7777
Figure Mode	7778
Fillet	7779
Filter Color / Filter Opacity	7780
Filtering (Antialiasing)	7781
Filtering (Character Animation)	7781
Final Gathering (mental ray Renderer)	7782
First Vertex	7785
Flat Mirror	7786
Flow	7787
Fluorescence	7788
Flyout	7789
Follow Object	7789
Foot States	7790
Footstep Animation	7790
Footsteps Method	7790
Forward Kinematics	7791
Forward Kinematics (Bipeds)	7791
Frame Rate	7791
Freeform Animation	7792
Freeform Method	7792
Freeze/Unfreeze	7793
Function Curve	7794
Fusing	7794
FX File	7794
G-Buffer	7795
Gait Pattern	7797
Gait Type	7797
Gamma Correction	7798
Geometric Primitives	7799
Gizmo/Center	7800
Global Event	7801
Global Motion Clip Controller	7803
Glossiness and Specular Level Settings	7803
GravAccel	7804
Gravity	7804
Grid Object	7805
Head Object	7806
Helper Object	7806
Hide/Unhide	7806
Hierarchical Linkage	7806
Home Grid	7808
Horizon	7809

Hot	7810
Hotspot/Falloff	7811
IGES (Initial Graphics Exchange Specification)	7812
IK Blend	7812
IK Goal	7812
IK Solution	7813
Illuminance	7813
Image Motion Blur	7814
In Place Mode	7816
Independent	7816
Influence	7816
Initial Pose	7817
Initialize	7817
Inputs: Event	7817
Instance	7818
Instance (Motion Mixer)	7819
Interactive Renderer	7820
Interpolation	7820
Inverse Kinematics	7820
Inverse Kinematics (Biped)	7821
Iso Line	7822
Isometric View	7823
Keyframe Mode	7823
Keyframes/Keys	7824
Kinematic Chain	7825
Knot	7825
Launch Script	7825
Layer Track	7825
Layers	7826
Layers (Biped)	7826
Layout Mode	7826
Lift	7827
Light Map	7827
Linked Geometry	7828
Links	7829
Listener Window	7829
Local Coordinate System	7830
Local Event	7831
Lofting	7831
Log File (mental ray Renderer)	7832
Look At Object	7832
LTLI Files	7833
Luminance	7833
Luminous Flux	7833
Luminous Intensity	7833
LZF Files	7833

LZG Files . . . . .	7834
LZH Files . . . . .	7834
LZO Files . . . . .	7834
LZV Files . . . . .	7834
Map Bias . . . . .	7835
Map Channel . . . . .	7836
Mapped Material . . . . .	7837
Mapping Coordinates . . . . .	7838
Maps . . . . .	7840
Marker Data . . . . .	7841
Marker Files . . . . .	7841
Markers . . . . .	7841
Master Motion Clip Controller . . . . .	7841
Match Frame . . . . .	7841
Material ID . . . . .	7842
Material/Map Hierarchy . . . . .	7844
Materials . . . . .	7845
Matte Object . . . . .	7846
MAXScript . . . . .	7847
Mesh . . . . .	7847
Metaballs . . . . .	7847
MFE Files . . . . .	7848
MI Files . . . . .	7848
Mirroring . . . . .	7848
Mix . . . . .	7848
MIX Files . . . . .	7849
Mixdown . . . . .	7849
MNM Files . . . . .	7849
Modal/Modeless . . . . .	7849
Modifier Stack . . . . .	7850
Modifiers . . . . .	7852
Morphing . . . . .	7853
Motion Blending . . . . .	7853
Motion Blur . . . . .	7854
Motion Capture . . . . .	7855
Motion Clip . . . . .	7855
Motion Files . . . . .	7856
Motion Flow . . . . .	7856
Motion Flow Editor . . . . .	7856
Motion Flow Scripts . . . . .	7856
Motion Mixer . . . . .	7856
Motion Synthesis . . . . .	7857
MSP (MAXScript Package) Files . . . . .	7858
Multiplicity . . . . .	7858
Multiplier . . . . .	7859
Multiplier Curve . . . . .	7860

N Links . . . . .	7860
Network Manager . . . . .	7861
Network Rendering . . . . .	7861
Network Rendering Server . . . . .	7862
Newton . . . . .	7862
Node . . . . .	7862
Normal . . . . .	7863
NTSC . . . . .	7863
NURBS . . . . .	7864
NURBS Curve . . . . .	7864
NURBS Model . . . . .	7865
NURBS Surface . . . . .	7865
Object . . . . .	7866
Object Instance . . . . .	7866
Object Motion Blur . . . . .	7867
Object Space . . . . .	7868
Object Space (Biped) . . . . .	7869
Obstacle-Avoidance Behavior . . . . .	7869
Object-Space Modifiers . . . . .	7870
Omnidirectional Light . . . . .	7870
Omniflector . . . . .	7871
Opacity Falloff . . . . .	7872
Operand . . . . .	7873
Operator . . . . .	7873
Operator Icon . . . . .	7874
Optical Markers . . . . .	7875
Orientation Behavior . . . . .	7875
Origin . . . . .	7876
Orthographic View . . . . .	7877
Out-of-Range Types . . . . .	7878
Outputs: Source / Test . . . . .	7879
Overshoot . . . . .	7881
PAL . . . . .	7882
Parameter Space . . . . .	7882
Parameters Panel . . . . .	7882
Parameter/Parametric . . . . .	7884
Parent Particle . . . . .	7885
Particle Diagram . . . . .	7885
Particle Level . . . . .	7886
Particle System . . . . .	7887
Particle System (Particle Flow) . . . . .	7887
PASS File . . . . .	7887
Patch . . . . .	7888
Patch-Based Objects . . . . .	7888
Path . . . . .	7888
Path Follow Behavior . . . . .	7890

Period . . . . .	7890
Perspective View . . . . .	7891
Phases of Leg Motion . . . . .	7892
Photometry . . . . .	7892
Photon Map . . . . .	7894
PHY Files . . . . .	7894
Physique . . . . .	7895
Pivot Point . . . . .	7895
Pixel . . . . .	7896
Plant . . . . .	7896
Plug-Ins . . . . .	7896
PMAP File . . . . .	7897
Point . . . . .	7897
Point Curve . . . . .	7898
Point Surface . . . . .	7899
Poses . . . . .	7899
Positional Markers . . . . .	7899
Posture . . . . .	7900
Precedence . . . . .	7900
Premultiplied Alpha . . . . .	7900
Procedural Maps . . . . .	7901
Projector Light . . . . .	7903
Prop Bone . . . . .	7904
Quadtree . . . . .	7904
Queue Monitor . . . . .	7905
Radiosity . . . . .	7905
Radiosity Solution . . . . .	7905
Ray-Trace Acceleration (mental ray Renderer) . . . . .	7905
Ray-Trace Bias . . . . .	7906
Ray-Traced Shadows . . . . .	7907
RAYHOSTS File . . . . .	7907
Real Time . . . . .	7908
Red, Green, Blue / Hue, Saturation, Value . . . . .	7908
Reference . . . . .	7910
Reference Object . . . . .	7910
Refine . . . . .	7910
Reinitialize . . . . .	7911
Repel Behavior . . . . .	7911
Reservoir . . . . .	7911
Resolution . . . . .	7911
Rotoscoping . . . . .	7912
Rubber-Band Mode . . . . .	7912
RVT Link . . . . .	7913
Sample Range . . . . .	7913
Sampling (mental ray Renderer) . . . . .	7914
Scale Stride . . . . .	7918

Scanline Renderer . . . . .	7918
Scene Extents . . . . .	7919
Scene Motion Blur . . . . .	7919
Schematic View . . . . .	7921
Script . . . . .	7921
Script Editor Window . . . . .	7921
Scripted Behavior . . . . .	7922
Scripted Utility Panel . . . . .	7922
Scripts (Motion Flow) . . . . .	7922
Scripting . . . . .	7922
Seed Value . . . . .	7922
Seek Behavior . . . . .	7923
Segment . . . . .	7923
Self-Illumination . . . . .	7924
Shaders (mental ray Renderer) . . . . .	7925
Shaders (Standard Materials) . . . . .	7925
Shadow Maps (Light Objects) . . . . .	7927
Shadow Map (mental ray Renderer) . . . . .	7928
Shapes and Splines . . . . .	7929
SHP Files . . . . .	7931
Skylight . . . . .	7931
Sliding Footstep . . . . .	7932
Smoothing Groups . . . . .	7932
SMPTE . . . . .	7933
Space Warp Behavior . . . . .	7933
Space Warps . . . . .	7934
Spawn Particles . . . . .	7934
Specular Color . . . . .	7935
Speed Vary Behavior . . . . .	7936
Splice . . . . .	7936
Spline . . . . .	7937
Spline Dynamics . . . . .	7937
Startup Script . . . . .	7938
Sub-Object . . . . .	7939
Sub-Object Level . . . . .	7940
Subtractive Opacity . . . . .	7941
Sunlight . . . . .	7942
Super Black . . . . .	7942
Supersampling . . . . .	7942
Support Period . . . . .	7943
Surface Arrive Behavior . . . . .	7943
Surface Follow Behavior . . . . .	7943
Synthesis, Synthesize . . . . .	7943
Talent Figure Mode . . . . .	7944
Tangents . . . . .	7944
TCB (Biped) . . . . .	7944



TCB (Tension, Continuity, Bias)	7945
Tendons	7946
Tension, Continuity, Bias (Biped)	7946
Terrain	7947
Test	7948
Texel	7948
Ticks	7948
Tile/Mirror	7949
Topology	7950
Topology-Dependent Modifier	7951
Touch	7951
Track	7951
Track View	7952
Trackgroup	7952
Track View Hierarchy Icons	7952
Tracks	7954
Trajectory	7955
Trajectory (Biped)	7956
Transform Gizmo	7956
Transforms	7958
Transition	7958
Transition Track	7959
Translucency	7959
Truecolor	7960
Twist Links	7960
Universal Naming Convention (UNC)	7961
UVW Coordinates	7962
Vector Field	7963
Vector Field Space Warp	7963
Vectors and Vector Handles	7964
Velocity Interpolation	7965
Vertex	7965
Video Safe Frame	7965
Viewport (Interactive) Renderer	7966
VIZBlock	7967
VPX Files	7967
VUE File	7967
Walking Gait	7970
Wall Repel Behavior	7970
Wall Seek Behavior	7970
Wander Behavior	7971
Weight Curve	7971
Wire	7971
Wireframe Mode	7973
Workbench	7974
Workflow	7974

World Coordinate System . . . . .	7975
World Space . . . . .	7976
World Space (Biped) . . . . .	7977
World-Space Modifiers (WSM) . . . . .	7977
xref (AutoCAD External Reference) . . . . .	7977
XRef (3ds Max Externally Referenced File) . . . . .	7978
ZT File . . . . .	7978
<b>Index . . . . .</b>	<b>7979</b>

# Introduction



## What's New in Autodesk 3ds Max 2008

Autodesk 3ds Max 2008 software dramatically improves artist productivity by streamlining the process of working with complex scenes. This is achieved through performance improvements areas such as viewport interaction, interactive transformation, and material assignment, as well as through the addition of new, artist-friendly UI and scene-management features.

This release also marks the launch of new tools that deliver interactive previewing of shadows, the 3ds Max sun/sky environment, and Arch & Design material settings. In addition, Autodesk 3ds Max 2008 delivers enhanced support for complex pipelines and workflows: The new, integrated ProEditor makes it easier to use MAXScript to extend and customize the software, and enhanced DWG file-linking and data support strengthen interoperability with applications such as AutoCAD® 2008 and Revit® 2008 software products. Finally, character animation is enhanced by numerous Biped improvements, including new ways of layering character motion and exporting it to game engines, as well as tools that give animators new levels of flexibility with regard to their Biped rigs.

---

**NOTE** This topic doesn't comprehensively list all the changes in 3ds Max. As you proceed through the documentation, keep an eye out for the  icon, which designates a new feature. You can also use the index in this reference to identify topics that contain information about new features in the program. For topics that describe new program features, check the index entry "new feature". For changes in existing features, check the index entry "changed feature".

---

Following is a list of major new features with brief descriptions and links to the relevant reference topic:

## New Feature Movies

For introductory movies to the new features in Autodesk 3ds Max 2008, click the following links:

- *Modeling*
- *Viewport Rendering*
- *mental ray® rendering*
- *Data Scene Management*
- *Animation*

---

**NOTE** When you click a link, the movie opens in a Web browser. You will need to click once to activate the window and then, to watch the movie, click the Play button.

---

## General Improvements

- **Enhanced Point Cache Support** Improved file I/O capabilities let you move [Point Cache](#) on page 1533 files seamlessly between 3ds Max and Autodesk Maya software.
- **Enhanced FBX Support** The integrated FBX translator now includes improved support for animation, mesh, material and lighting data.
- **Enhanced Selection Performance** Optimizations and new viewport technology make the selecting of hundreds and thousands of objects more than 10 times faster, boosting user productivity, particularly for those working with large data sets.
- **Improved Transform Performance** Transforming 5,000 or more objects in Autodesk 3ds Max 2008 is up to 60 times faster, thanks to optimizations and new viewport technology.
- **General Performance Improvements** Optimizations and new viewport technology make grouping and cloning operations, as well as array functions, perform significantly faster.
- **Windows Vista Support** Autodesk 3ds Max 2008 now supports the latest Microsoft operating system release, giving you more OS options.
- **DirectX 10 Support** A new integrated DirectX 10 driver lets game developers view shaders that access the Microsoft latest DirectX library.

Autodesk 3ds Max 2008 is the only 3D animation package that ships with an integrated DirectX 10 driver, along with a driver for DirectX 9.

- **Customer Involvement Program** This new, optional Autodesk [program](#) on page 7281 enables you to help shape the future development of the product. This feature lets you automatically provide valuable information to Autodesk regarding frequently used workflows. It does not, however, extract sensitive information from your files.

## Materials and Mapping

- **Improved Material Assignment** Material assignment in Autodesk 3ds Max 2008 is now up to 10 times faster for scenes with 10,000 nodes, or more, significantly improving the productivity of those working with large, object-intensive scenes.
- **Multiple UVW Unwrap** Users can now perform an [Unwrap](#) on page 1769 operation on the texture coordinates of multiple objects simultaneously. This makes it significantly easier to organize the mapping of multiple objects with one texture. For example, in the case of a car model comprising various parts, all the parts can be quickly be mapped with the same texture, with suitable UVW mapping for each part.
- **Auto-reset for Projection Modifier** The [Projection modifier](#) on page 1556 now performs an auto-reset of the cage, preventing shrink-wrap behavior that can lead to inaccurate results.

## Viewport Rendering

- **Adaptive Degradation** The integration of new technology into the software's [adaptive degradation system](#) on page 7622 improves interactive performance by automatically simplifying scene display to meet a user-defined target frame rate. You specify how the software adjusts the scene display, including whether small objects are hidden, distant objects have less detail, etc., and 3ds Max calculates how best to achieve it. When combined with the new Direct3D mesh caching that groups objects by materials, the result is that a scene containing tens of thousands of objects can be just as interactive as one with 10 objects.

---

**NOTE** This functionality supplants the legacy Object Display Culling command and utility, which have therefore been removed from the program.

---

- **Graphics Processing Unit (GPU)-based shadow support** The [viewports now support real-time shadows](#) on page 4911 , including self-shadowing and up to 64 lights simultaneously. All standard lights are supported along with a simple UI to choose which lights are on. Users can choose between high-quality per-pixel shadowing and fast shadowing (i.e., good and best modes).
- **Sun/Sky Viewport Preview** The mental ray Sun & Sky system lets you create an accurate depiction of the sun and the sky at a specific time and location. With this release, architectural and design visualization professionals working with the Sun & Sky system can now interactively preview their settings in the viewports prior to rendering. Reflections are derived from the Sun & Sky system and automatically mapped onto the surface of shiny objects. For a detailed procedure, see [this procedure](#) on page 4983 .
- **Hardware-based Material Rendering in Viewports** Architectural and design visualization professionals can now get immediate feedback on common mental ray Arch & Design and Standard materials settings, allowing them to achieve their desired look by way of a fast, efficient, iterative process. For details, see [Show Standard/Hardware Map in Viewport](#) on page 5254 .

## Rendering

- **Ambient Occlusion Enhancements (Architectural & Design Material)** The Arch & Design material for mental ray now delivers greater physical accuracy in the light-occluded areas near objects so that the coloring of nearby objects can affect the occlusion, resulting in more accurate, true-to-life rendered images. See [Use Color From Other Materials](#) on page 5479 .
- **Self-Illumination (Architectural & Design Material)** Also new for the Arch & Design material is the ability to produce a realistic self-illumination effect, with the added option of acting as a light source when using Final Gather. See [Self Illumination \(Glow\) rollout](#) on page 5473 .
- **Sky Portal** For mental ray users, the new [mr Sky Portal](#) on page 4999 area light simplifies the process of illuminating indoor scenes with outdoor lighting. You can now create an object that defines precisely where external light enters the indoor scene, via skylights, windows, open doors, etc. Using this technique dramatically reduces render times and improves image quality for these lighting situations. HDRI-based lighting effects are also supported.

- **Photographic Exposure UI** The new [mr Photographic Exposure Control](#) on page 6544 with its camera-based interface for managing exposure settings (tone mapping) greatly simplifies the process of achieving a photographic rendering effect with physically accurate lighting. You can define the film speed, shutter speed, etc., as with a real camera.
- **Glare Shader** The new mental ray [Glare shader](#) on page 5825 creates a realistic halo around very bright areas in the rendered image.
- **Support for DDS Floating-Point Formats** When rendering to [DirectDraw Surface \(DDS\) format](#) on page 7122, you can now choose for the 64-bit and 128-bit floating-point options.
- **Output Path Dialog Box Improvements** Autodesk 3ds Max 2008 streamlines the render output workflow. The Setup button on the Render Output File dialog is now enabled as soon as you enter a file name and type, so changing settings for the file format no longer requires closing the dialog box, reopening it and changing the file type.
- **Presets for RTT** Autodesk 3ds Max 2008 now lets game artists [define presets](#) on page 6201 to use with Render to Texture, making this popular mapping workflow feature even more flexible than in previous versions.

## Scene and Project Management

- **Scene Explorer** Autodesk 3ds Max 2008 delivers [Scene Explorer](#) on page 7171, a powerful tool that provides a hierarchical view of scene data and fast scene analysis and editing tools that facilitate working with even the most complex, object-heavy scenes. Scene Explorer, which takes the form of a modeless dialog, gives artists the ability to sort, filter, and search a scene by any object type or property (including metadata), with stackable filtering, sorting, and searching criteria. You can save and store multiple explorer instances and link, unlink, rename, hide, freeze, and delete objects, regardless of what objects are currently selected in the scene. Users can also configure columns to display and edit any object property, and because this feature is scriptable and SDK extendable, callbacks can be used to add custom column definitions. The legacy Select Objects dialog has been replaced by [Select From Scene](#) on page 168, a modal, read-only version of Scene Explorer.
- **Memory Management Optimization** Significantly improved memory management enables the import of large and complex scenes with multiple objects, in significantly less time.

- **Normals Management** DWG scenes imported from Revit 2008 products now maintain their original normal positioning: greater data fidelity equaling improved user-productivity.
- **Material Assignment and Naming** DWG scenes imported from Revit 2008 now maintain the correct material assignment. Materials also maintain their original names.
- **Sun/Sky Import** Geographic location (including time of day and time zone) as well as sun and sky parameters are now imported along with DWG files. This streamlines workflows in which this data plays a role.
- **UV Coordinate Enhancements** DWG UV import is now more complete thanks to added support for Box, spherical and cylindrical mapping as well as support for mirror texture tiling.

### General Animation Improvements

- **Improved Skin Load Weights Dialog** The Skin Load Weights dialog box is now resizable.
- **New Default for Bones/IK Goals** Bones and IK goals now default to a size of two inches. The size of subsequent objects defaults to the last value set by the user - saving set up time.
- **Improved Controller Assignment** The Controllers menu now allows users to assign controllers to multiple selected objects simultaneously.
- **Edit Trajectories CUI Item** A new custom UI shortcut for edit trajectories streamlines workflows for those using a custom UI.

### Character Animation Improvements

- **Layers as Assets** Autodesk 3ds Max 2008 now enables Biped users to [save and load Biped layers as BIP files](#) on page 4333 , so you can isolate character motion and save each layer as its own asset for export into a game. You can use MAXScript to customize Biped layer export.
- **Xtras** You can now extend biped characters with the new [Xtras feature](#) on page 4349 . This tool, an FK chain attachable anywhere and parentable to any Biped object, lets animators create and animate extraneous Biped features such as wings, or additional facial bones, and save these as BIP files. Like other BIP files, Xtras animation is supported in Mixer and Motion Flow as well as Copy, Paste, and Layers.



- **Head Relocation** Biped users can now [move a character's head away from its neck](#) on page 4340 , which helps in fitting the biped to its character mesh.

## Modeling Improvements

- **Hotkeys as Temporary Overrides** Existing modeling hotkeys can now be made to act as temporary overrides, called [press/release](#) on page 2039 keyboard shortcuts, enabling modelers to quickly move back and forth between modes using hotkeys.
- **Working Pivot** You can now override an object's own pivot with a global, ["working" pivot](#) on page 3402 in order to simplify the rotating of objects without affecting the original pivot. This helps modelers quickly pick arbitrary points around which to rotate.
- **Sub-object Previewing** The ability to [preview](#) on page 2051 [sub-objects](#) on page 1318 streamlines the modeling workflow: Not only does it enable you to preview and select sub-objects in one fluid motion, but it also gives you an intuitive, natural way to switch among sub-object levels in the viewport.
- **Constrain to Normal** This [new](#) on page ? [operation](#) on page ? lets you transform sub-object geometry along the normals of selections: the result is a localized geometry push-and-pull operation.

## Scripting Improvements

- **MAXScript ProEditor** Autodesk 3ds Max 2008 marks the debut of the new MAXScript ProEditor. This new, intelligent interface for working with MAXScript includes multilevel undo functionality; fast, high-quality code colorization; rapid opening of large documents; line-number display; regular expressions in search/replace; folding of sections of the script; support for user-customization, and many other features.
- **AVG\_DLX** The integration of the publicly available avg\_dlx MAXScript extension into 3ds Max reduces dependency on third-party tools while exposing more than 100 new methods, properties, and classes to 3ds Max. These include methods for accessing registry, the clipboard, and IK properties on transform controllers, as well as for combining bitmaps, and more.

See also:

- [What Was New in 3ds Max 9 Extension 1](#) on page 8

## What Was New in 3ds Max 9 Extension 1

This topic is intended primarily for non-subscribers who are coming to Autodesk 3ds Max 2008 from a version of the software earlier than the most recent release prior to this one: 3ds Max 9 Extension 1. It covers new features as of that subscriber-only version, which was released in the fall of 2006. Note that these features are not indicated by the  icon or the “new feature” index entry in the body of this document.

Following is a list of major new features as of 3ds Max 9 Extension 1, with brief descriptions and links to the relevant reference topics:

### General Improvements

- Core performance enhancements help maximize your productivity and accelerate your creative workflow. For example, enjoy greater viewport interactivity when working with dense meshes.
- Also useful for interactivity is the [viewport statistics](#) on page 2493 feature, which displays in the viewport information about the current rate and number of polys, faces, edges, and vertices, both for the entire scene and for the current selection. The display updates in real time.
- The Hidden Line [rendering method](#) on page 7611 improves visual feedback by simplifying wireframe viewport display.
- You can set any viewport to display the Track View interface.
- The Sample function in the [Color Selector dialog](#) on page 331 lets you grab colors from anywhere on the screen.
- [Parameter wiring](#) on page 3249 is made easier with the dialog's new ability to list only nodes that are selected in the scene.
- You can search the drop-down Modifier list on the Modify panel for a particular modifier more easily by typing a sequence of characters, not just single characters. For details, see [To apply a modifier to an object:Select the object.Do one of the following:Choose a modifier from th...](#) on page ?

## Rendering Improvements

- Getting a rendered image into a bitmap editor is a snap with the [Rendered Frame Window's](#) on page 5885 new Copy Bitmap function.
- When rendering an Ambient Occlusion element with Render To Texture, you can choose whether or not to exclude the low-res object in a Projection modifier from the Ambient Occlusion pass. See [this note](#) on page 6179 .

## Scene and Project Management

- The [Configure User Paths](#) on page 7520 dialog lets you set individual paths to be absolute or relative to the current project folder.
- Many enhancements have been made to [XRefs](#) on page 6729 . You can reference all aspects of systems, including geometry and materials. You can also reference [controllers](#) on page 3194 and can maintain dependencies between XRef items. The XRef system's dependency handling lets you preview object relationships in both merge and XRef operations, providing more control over how external objects are used.
- 3ds Max supports multiple materials per object in DWG files exported as ACIS solids from Revit Architecture/Structure/MEP 2008 and later, as well as solid primitives created in AutoCAD Architecture 2008 (formerly ADT) and later. See [Support of Multiple Materials on Imported ACIS Solids](#) on page 6980 .
- [DWF Export](#) on page 7013 supports named camera views, so you can choose different views by name in the Autodesk Design Review program.
- [Reloading XRef items](#) on page 6739 works correctly even when an object in the source scene has been renamed, or deleted and then re-created with the same name.
- The [Select Similar](#) on page 190 command lets you select all items in an imported or linked DWG file with the same [style\(s\)](#) on page 6850 , as defined in AutoCAD Architecture. Select Similar also supports 3ds Max-native objects with similar characteristics.
- Thanks to a revamped interface, the [DWG Import](#) on page 6984 toolset for geometry is significantly easier to use.

## Animation Improvements

- If you enable animation layers for an object that has animation loaded in the Motion Mixer, 3ds Max can [automatically create new map files](#) on page 3101 for you.
- New Biped quadrants on the quad menu provide quick access to many commonly used Biped tools. Just select any biped part and then right-click the biped.
- You can assign the same type of controller or constraint to several different objects at once. Just select the objects and then choose the controller or constraint from the Animation menu.
- Visualizing and editing biped IK animation is easier thanks to color-coded keys and trajectories in the viewports, and color-coded keys on the track bar. Trajectories use gradients to depict transitions between FK and IK periods. See [Biped Color-coded Keys and Trajectories](#) on page 4385 .
- You can view and edit controller properties simply by double-clicking the controller label anywhere it appears.
- The [Euler Filter utility](#) on page 3548 in Track View can automatically correct rotation anomalies caused by gimbal flipping.
- [Track View filtering options](#) on page 3508 let you show or hide global tracks, display only animated tracks with full hierarchies, and assign filters to hotkeys and other custom UI elements.
- Switch pivot points on biped hands and feet faster and more easily with the new [Pivot Selection Dialog](#) on page 4296 feature.
- Remapping an XAF animation file when loading it onto an object whose animation layers status has changed is easier thanks to the new [Load Into Active Layer switch](#) on page 6874 .
- Animate an effect such as a curling finger with ease with [Use Pivot Point Center's](#) on page 905 new support for accumulated rotation of linked objects such as bones.
- New [CUI shortcuts for selecting hierarchy siblings](#) on page 3277 make it easier to navigate a character hierarchy when setting up animation.
- Zooming in Track View now focuses in on the current mouse position, rather than the center of the view.

## Modeling Improvements

- Users of normal bump mapping can take advantage of export/import functionality available on the Projection modifier > [Cage rollout](#) on page 1563 . You can convert the cage into standard geometry of the same type and topology as the cage and modified object, which you can edit using standard methods and then use to define a new shape for the cage. This provides access to the full range of mesh-editing tools available in 3ds Max for shaping the cage to your precise requirements.
- Automatically round off [chamfered edges](#) on page 2136 of poly meshes with the Segments parameter.

# 3ds Max Documentation Set

The documentation set for 3ds Max® comprises online material only.

- **Autodesk 3ds Max 2008 Installation Guide:** Contains complete installation , configuration, and troubleshooting instructions, including system requirements. Also includes information on uninstalling and maintaining the software, as well as descriptions of the full install documentation set.
- **Autodesk 3ds Max 2008 Readme (3ds\_Max\_Readme.rtf):** Contains the latest information about 3ds Max. You can access this file by clicking View Readme in the Autodesk 3ds Max 2008 Installation Wizard.
- **Autodesk 3ds Max 2008 Help:** This document covers fundamental concepts and strategies for using the product, as well as details about the features of 3ds Max.  
Access the reference by choosing Help > 3ds Max Help.
- **Autodesk 3ds Max 2008 Tutorials:** Contains tutorial information and detailed procedures to walk you through increasingly complex operations. This is the best source for learning 3ds Max.  
Access the tutorials by choosing Help > Tutorials.

---

**NOTE** All the sample files required to do the tutorials are found on DVD 1 of 2: Software, Documentation, Videos, & Tutorials. None of these files are installed automatically.

---

- **MAXScript Reference:** Describes the [MAXScript scripting language](#) on page 14 . Check out the “Learning MAXScript” chapter there if you're new to MAXScript.

Access the *MAXScript Reference* by choosing Help > MAXScript Reference.

- **Additional mental ray® Help File:** Documentation from mental images® is available from Help menu > Additional Help. There, you'll find the *mental ray Reference*, comprising the *mental ray Manual*, *mental ray Shader Reference*, and *LumeTools Collection*.

---

**NOTE** The *Autodesk 3ds Max 2008 Help* documents all other mental ray components available in the 3ds Max user interface. This includes documentation for lights for mental ray and specific shadow types, controls for adding mental ray shaders to lights and cameras, mental ray materials, custom shaders for 3ds Max, and the mental ray renderer controls.

---

- **Additional Backburner Files:** Procedures for using Backburner from inside 3ds Max are documented in this *Autodesk 3ds Max Help File*. For further information on using and configuring Backburner, refer to the additional Backburner documentation available from Start menu > Programs > Autodesk 3ds Max 2008 [32- or 64-bit] > Help. The two documents related to Autodesk Backburner are called:

- *Backburner 2007.1 Installation Guide*
- *Backburner 2007.1 User's Guide*

---

**NOTE** For information on installing Autodesk Backburner see the *Autodesk 3ds Max 2008 Installation Guide*.

---

## How to Print from the Online Documentation Files

If your computer is connected to a printer, you can print single help topics or entire chapters.

To print a topic or chapter, highlight the topic or chapter title and click the Print button at the top of the help display. A dialog appears.

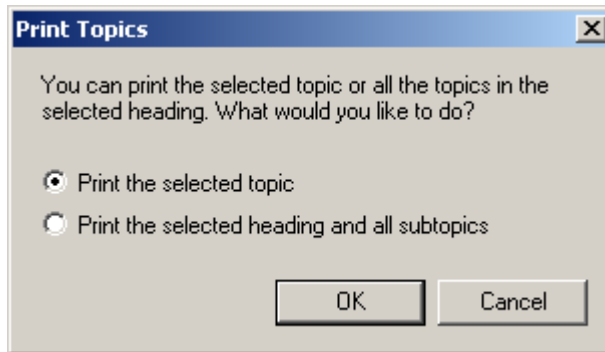

Choose to print only the selected topic, or to print all topics in that chapter. After you make your selection, another dialog appears where you can choose your printer and other options.

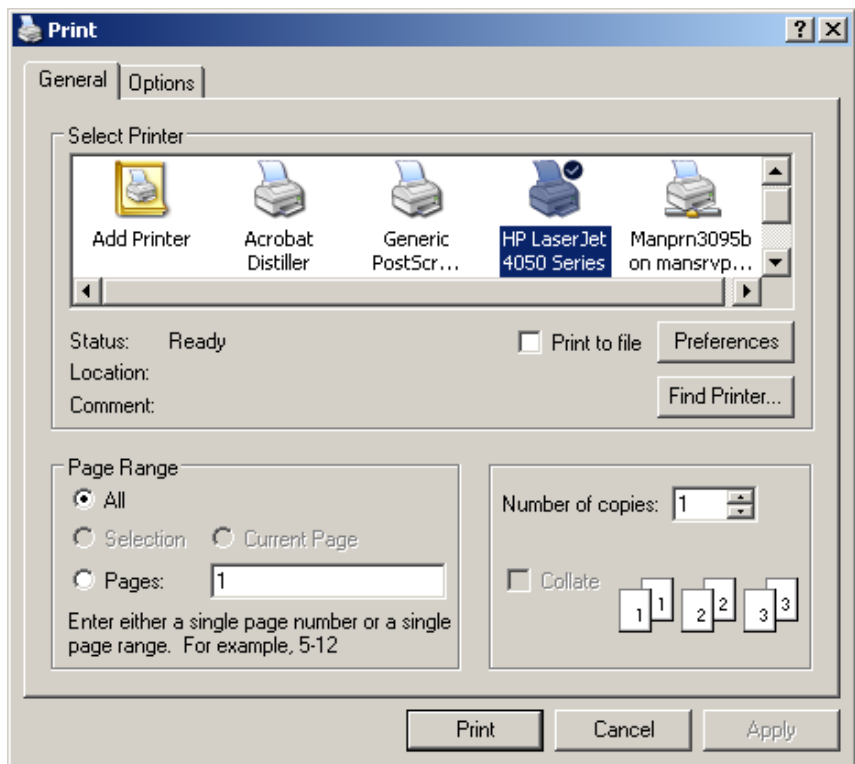

The tabs available at the top of the dialog depend on the selected printer. Choose options for the print job, and click OK to begin printing.

## How to Contact Us

We are also interested in hearing your views about 3ds Max. We'd like to hear ways you think we can improve our program, features you're interested in, as well as your views on the documentation set.

Please send us email about the documentation set at:  
*me.documentation@autodesk.com*

# About MAXScript

MAXScript is the built-in scripting language for 3ds Max. It provides users with the ability to:

- Script all aspects of 3ds Max use, such as modeling, animation, materials, rendering, and so on.
- Control 3ds Max interactively through a command-line shell window.
- Package scripts within custom utility panel rollouts or modeless windows, giving them a standard 3ds Max user interface.
- Build custom import/export tools using the built-in file I/O.
- Write procedural controllers that can access the entire state of the scene. Build batch-processing tools, such as batch-rendering scripts.
- Set up live interfaces to external system using OLE Automation.

The MAXScript language is specifically designed to complement 3ds Max. It is object-oriented, and has several special features and constructs that mirror high-level concepts in the 3ds Max user interface. These include coordinate-system contexts, an animation mode with automatic keyframing, and access to scene objects using hierarchical path names that match the 3ds Max object hierarchy.

The syntax is simple enough for non-programmers to use, with minimal punctuation and formatting rules.

## Visual MAXScript

Visual MAXScript is a powerful addition to MAXScript, making the MAXScript feature easier to learn and use. With Visual MAXScript, you can quickly create UI elements and layouts for scripting.



For detailed information about Visual MAXScript, open the MAXScript Reference, available from Help menu > MAXScript Reference.

**See also:**

- [MAXScript Interface](#) on page 7280

**Procedures**

**To access MAXScript, do one of the following:**

- 1 On the menu bar, choose MAXScript. The MAXScript menu appears.
- 2 Choose Utilities panel > MAXScript.

From here, you can either write new scripts, edit or run existing scripts, open the MAXScript Listener, or use the Macro Recorder.

To access the MAXScript Listener, you can also right-click in the Mini Listener and choose Open Listener Window from the right-click menu.

For detailed information about the MAXScript utility, open the MAXScript Reference, available from Help menu > MAXScript Reference.



# Getting Started with 3ds Max

# 2

You use 3ds Max to quickly create professional-quality 3D models, photorealistic still images, and film-quality animation on your PC.



Image by Michael McCarthy

Before using this reference material, we highly recommend you get to know 3ds Max firsthand by following the included tutorials. You can access the tutorials using the Help menu > Tutorials command.

This section presents these brief topics designed to help you quickly start using 3ds Max.

- [Project Workflow](#) on page 19
- [Working with AutoCAD, AutoCAD Architecture, and Revit Files](#) on page 6817
- [Setting Up Your Scene](#) on page 25
- [Modeling Objects](#) on page 26
- [Using Materials](#) on page 27
- [Placing Lights and Cameras](#) on page 30
- [Animating Your Scene](#) on page 33
- [Rendering Your Scene](#) on page 34

[The 3ds Max Window](#) on page 35

- [Special Controls](#) on page 38
- [Quad Menu](#) on page 7300
- [Customize Display Right-Click Menu](#) on page 7479

[Managing Files](#) on page 44

- [VIZ Render \(DRF\) Files](#) on page 6964
- [Importing, Merging, and Replacing Scenes](#) on page 46
- [Using the Browser](#) on page 49
- [Startup Files and Defaults](#) on page 50
- [3dsmax.ini File](#) on page 51
- [3dsviz.ini File](#) on page 51
- [vizr.ini File](#) on page 51
- [Backing Up and Archiving Scenes](#) on page 53
- [Crash Recovery System](#) on page 53

# Project Workflow

Once you've installed 3ds Max (see the *Installation Guide* included with your software package), you open it from the Start menu, or use any other Windows method. The figure below shows the application window with a scene file loaded.

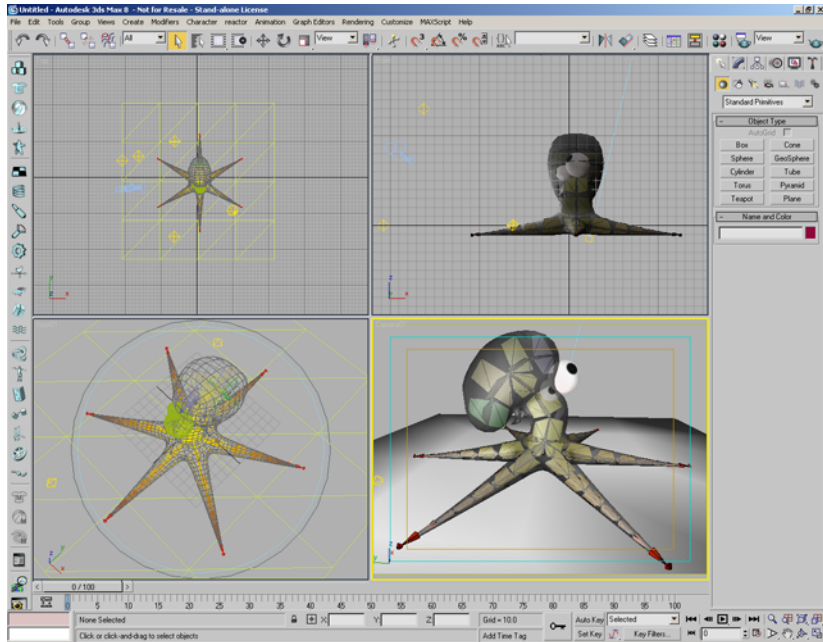

Main program window

---

**NOTE** If you open 3ds Max from a Command Prompt window or batch file, you can add command-line switches. See [Starting 3ds Max from the Command Line](#) on page 7254 .

---

**NOTE** 3ds Max is a single-document application, meaning you can work on only one scene at a time. However, you can open more than one copy of 3ds Max and open a different scene in each copy. Opening additional copies of 3ds Max requires a lot of RAM. For the best performance, you should plan to open one copy and work on one scene at a time.

---

Opening multiple copies of 3ds Max is not supported in Windows ME.

## Modeling Objects

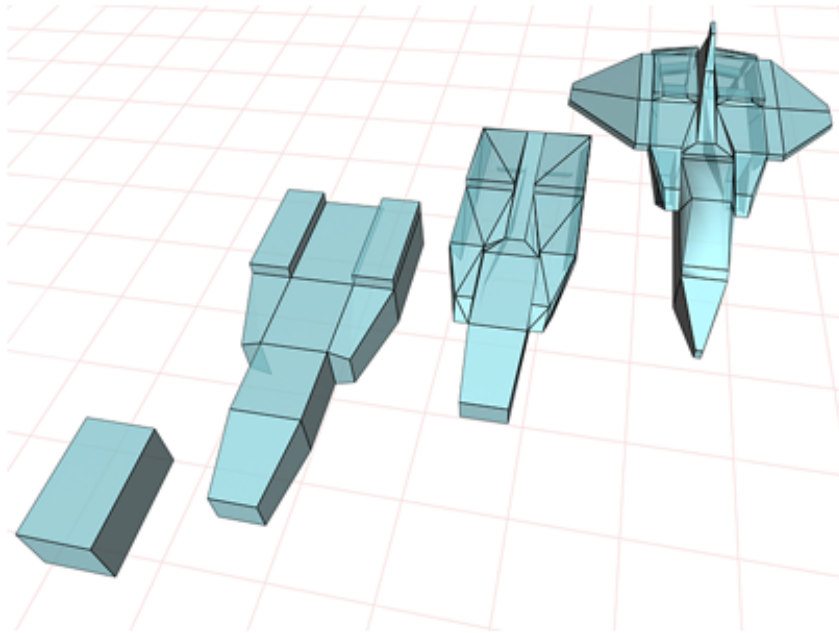

You model and animate objects in the viewports, whose layout is configurable. You can start with a variety of 3D geometric primitives. You can also use 2D shapes as the basis for lofted or extruded objects. You can convert objects to a variety of editable surface types, which you can then model further by pulling vertices and using other tools.

Another modeling tool is to apply modifiers to objects. Modifiers can change object geometry. Bend and Twist are examples of modifiers.

Modeling, editing, and animation tools are available in the command panels and toolbar. See [Modeling Objects](#) on page 26 . Also, you can learn a good deal about modeling from the tutorials available from Help menu > Tutorials.

## Material Design

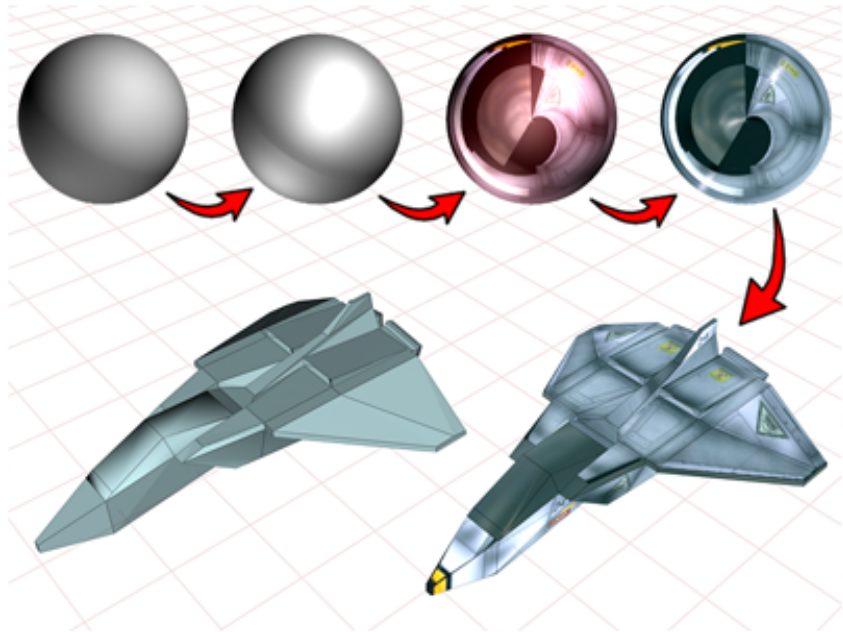

You design materials using the Material Editor, which appears in its own window. You use the Material Editor to create realistic materials by defining hierarchies of surface characteristics. The surface characteristics can represent static materials, or be animated. See [Material Editor](#) on page 5188 . Tutorials especially helpful for learning about materials include "Overview of Creating a Scene: Still Life" and "Using Materials."

## Lights and Cameras

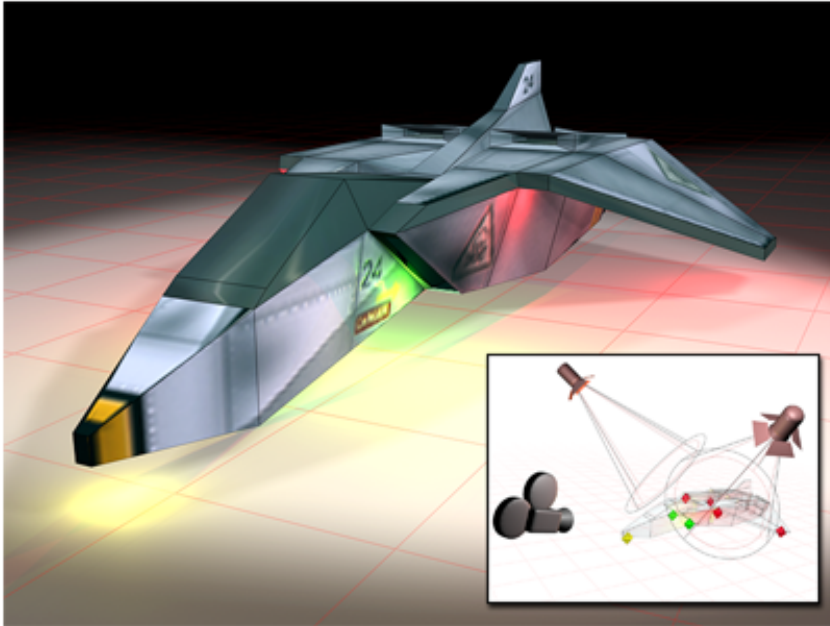

You create lights with various properties to illuminate your scene. The lights can cast shadows, project images, and create volumetric effects for atmospheric lighting. Physically-based lights let you use real-world lighting data in your scenes and [Radiosity](#) on page 5976 provides incredibly accurate light simulation in renderings. See [Lights](#) on page 4890 . You can learn more about lighting by following the Introduction to Lighting tutorial.

The cameras you create have real-world controls for lens length, field of view, and motion control such as truck, dolly, and pan. See [Cameras](#) on page 5106 .



## Animation

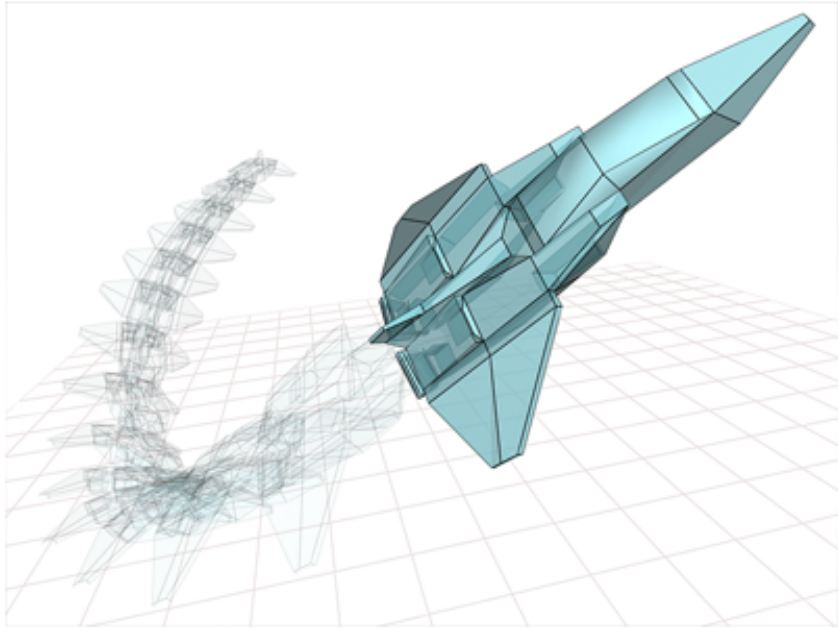

You can begin animating your scene at any time by turning on the Auto Key button. Turn the button off to return to modeling. You can also perform animated modeling effects by animating the parameters of objects in your scene. You can learn more about animating in the [Animating Your Scene topic](#) on page 33 and from most of the tutorials.

When the Auto Key button is on, 3ds Max automatically records the movement, rotation, and scale changes you make, not as changes to a static scene, but as *keys* on certain *frames* that represent time. You can also animate many parameters to make lights and cameras change over time, and preview your animation directly in the 3ds Max viewports.

You use [Track View](#) on page 3426 to control animation. Track View is a floating window where you edit animation keys, set up animation controllers, or edit motion curves for your animated effects. The Lip Sync tutorial covers Track View usage.

## Rendering

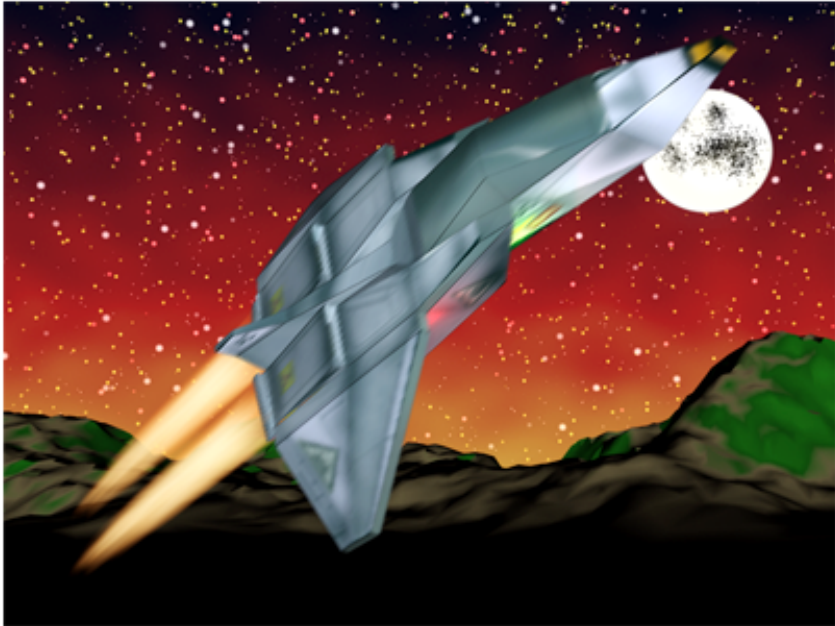

Rendering adds color and shading to your scene. The renderers available with 3ds Max include features such as selective ray tracing, analytical antialiasing, motion blur, volumetric lighting, and environmental effects. See [Rendering Your Scene](#) on page 34 . The tutorials can help you learn about rendering.

When you use the default scanline renderer, a [radiosity solution](#) on page 5976 can provide accurate light simulation in renderings, including the ambient lighting that results from reflected light. When you use the mental ray renderer, a comparable effect is provided by [global illumination](#) on page 6072 .

If your workstation is part of a network, network rendering can distribute rendering jobs over multiple workstations. See [Network Rendering](#) on page 6231 .

With [Video Post](#) on page 6571 , you can also composite the scene with animations stored on disk.

### **A Typical Project Workflow**

These topics explain the basic procedures for creating scenes:

[Setting Up Your Scene](#) on page 25

[Modeling Objects](#) on page 26

[Using Materials](#) on page 27

[Placing Lights and Cameras](#) on page 30

[Animating Your Scene](#) on page 33

[Rendering Your Scene](#) on page 34

## Setting Up Your Scene

You start with a new unnamed scene when you open the program. You can also start a new scene at any time by choosing New or Reset from the File menu.

### Choosing a Unit Display

You choose a system of unit display on the [Units Setup dialog](#) on page 7601 . Choose from Metric, Standard US, and Generic methods, or design a custom measuring system. You can switch between different systems of unit display at any time.

---

**NOTE** For best results, use consistent units when you are going to:

- [Merge scenes and objects](#) on page 6854 .
- Use [XRef objects](#) on page 6732 or [XRef scenes](#) on page 6755 .

---

### Setting the System Unit

The System Unit setting, in the [Units Setup dialog](#) on page 7601 , determines how 3ds Max relates to distance information you input to your scene. The setting also determines the range for round-off error. Consider changing the system unit value only when you model very large or very small scenes.

### Setting Grid Spacing

Set spacing for the visible grid in the Grid And Snap Settings dialog > [Home Grid panel](#) on page 2592 . You can change grid spacing at any time.

See [Precision and Drawing Aids](#) on page 2501 for information about the system unit, unit display, and grid spacing.

## Setting the Viewport Display

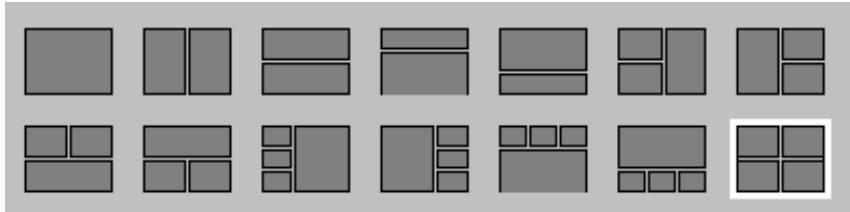

Viewport layout options

The default four viewports in 3ds Max represent an efficient and popular screen layout. Set options in the [Viewport Configuration dialog](#) on page 7610 to change viewport layout and display properties.

See [Viewing and Navigating 3D Space](#) on page 55 for more information.

## Saving Scenes

Save your scene frequently to protect yourself from mistakes and loss of work.

See [Backing Up and Archiving Scenes](#) on page 53 .

# Modeling Objects



1. Modify panel
2. Create panel
3. Object categories

You model objects in your scene by creating standard objects, such as 3D geometry and 2D shapes, and then applying modifiers to those objects. The program includes a wide range of standard objects and modifiers.

## Creating Objects

You create objects by clicking an object category and type on the Create panel and then clicking or dragging in a viewport to define the object's creation parameters. The program organizes the Create panel into these basic categories: Geometry, Shapes, Lights, Cameras, Helpers, Space Warps, and Systems. Each category contains multiple subcategories from which you can choose.

You can also create objects from the Create menu by choosing an object category and type and then clicking or dragging in a viewport to define the object's creation parameters. The program organizes the Create menu into these basic categories: Standard Primitives, Extended Primitives, AEC Objects, Compound, Particles, Patch Grids, NURBS, Dynamics, Shapes, Lights, Cameras, Helpers, Space Warps, and Systems.

See [Basics of Creating and Modifying Objects](#) on page 317 .

## Selecting and Positioning Objects

You select objects by clicking or dragging a region around them. You can also select objects by name or other properties such as color or object category.

After selecting objects, you position them in your scene using the transform tools Move, Rotate, and Scale. Use alignment tools to precisely position objects.

See [Selecting Objects](#) on page 131 , [Moving, Rotating, and Scaling Objects](#) on page 859 , and [Precision and Drawing Aids](#) on page 2501 .

## Modifying Objects

You sculpt and edit objects into their final form by applying modifiers from the Modify panel. The modifiers you apply to an object are stored in a stack. You can go back at any time and change the effect of the modifier, or remove it from the object.

See [Basics of Creating and Modifying Objects](#) on page 317 .

# Using Materials

You use the Material Editor to design materials and maps to control the appearance of object surfaces. Maps can also be used to control the appearance of environmental effects such as lighting, fog, and the background.

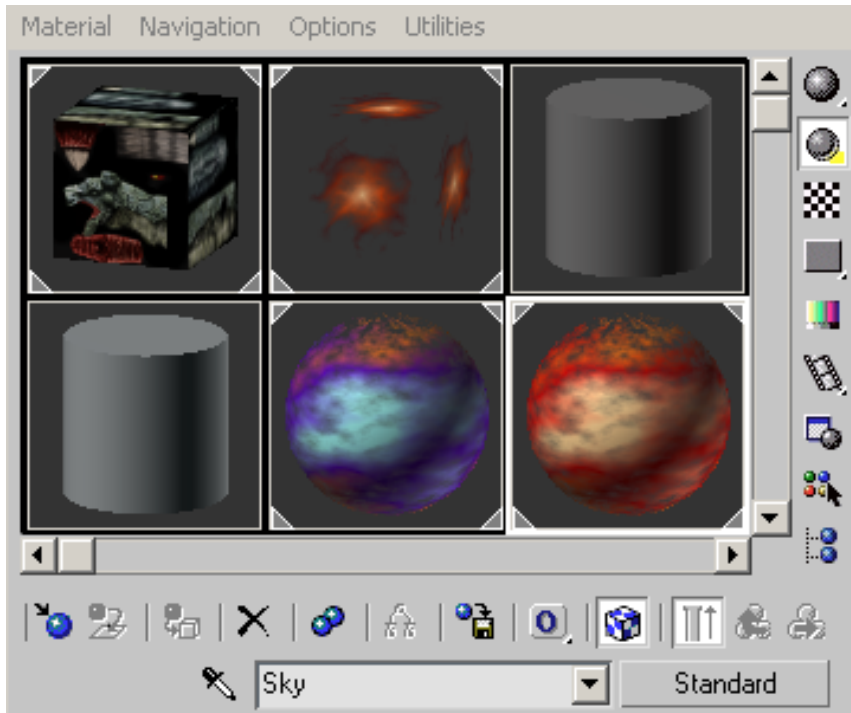

A variety of materials in the Material Editor's sample slots

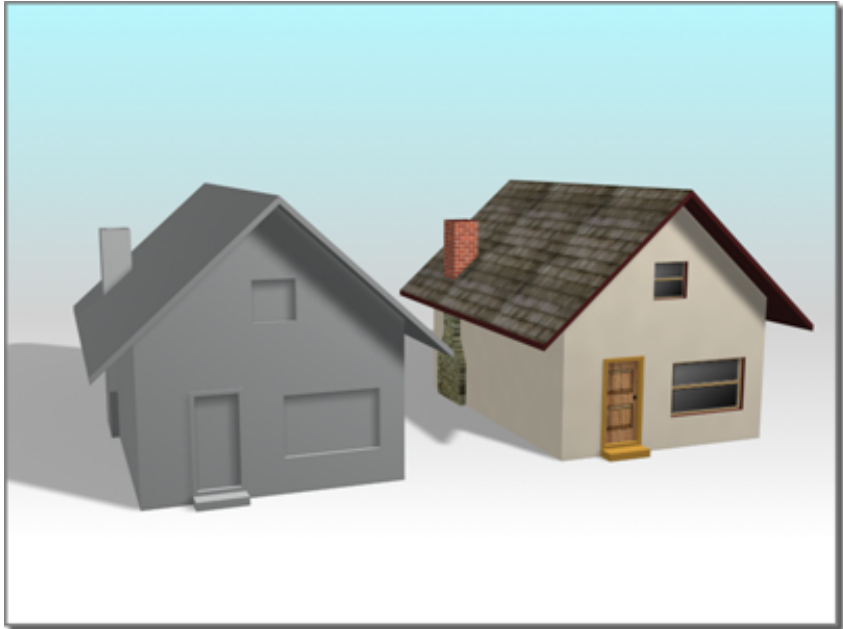

House on left uses the default standard material.

House on right uses a compound material.

### **Basic Material Properties**

You set basic material properties to control such surface characteristics as default color, shininess, and level of opacity. You can create realistic, single-color materials using just the basic properties.

### **Using Maps**

You extend the realism of materials by applying maps to control surface properties such as texture, bumpiness, opacity, and reflection. Most of the basic properties can be enhanced with a map. Any image file, such as one you might create in a paint program, can be used as a map, or you can choose procedural maps that create patterns based on parameters you set.

The program also includes a raytrace material and map for creating accurate reflections and refraction.

## Viewing Materials in the Scene

You can view the effect of materials on objects in a shaded viewport, but the display is just an approximation of the final effect. Render your scene to view materials accurately.

See [Designing Materials](#) on page 5164 .

## Placing Lights and Cameras

You place lights and cameras to complete your scene in much the same way lights and cameras are placed on a movie set prior to filming.



Lights and cameras placed to compose a scene





The resulting scene

### **Default Lighting**

Default lighting evenly illuminates the entire scene. Such lighting is useful while modeling, but it is not especially artistic or realistic.

### **Placing Lights**

You create and place lights from the Lights category of the Create panel or menu when you are ready to get more specific about the lighting in your scene.

The program includes the following standard light types: omni, spot, and directional lights. You can set a light to any color and even animate the color to simulate dimming or color-shifting lights. All of these lights can cast shadows, project maps, and use volumetric effects.

See [Guidelines for Lighting](#) on page 4906 .

## Photometric Lights

[Photometric lights](#) on page 4951 provide you with the ability to work more accurately and intuitively using real-world lighting units (lumens and candelas). Photometric lights also support industry-standard photometric file formats ( [IES](#) on page 5017 , [CIBSE](#) on page 7739 , [LTLI](#) on page 7833 ) so that you can model the characteristics of real-world manufactured luminaires, or even drag ready-to-use luminaires from the Web. Used in conjunction with the [3ds Max radiosity solution](#) on page 5976 , photometric lights let you evaluate more accurately (both physically and quantitatively) the lighting performance of your scene.

Photometric lights are available from the Create panel > Lights drop-down list.

## Daylight System

The [Daylight system](#) on page 5024 combines [sunlight](#) on page 7942 and [skylight](#) on page 7931 to create a unified system that follows the geographically correct angle and movement of the sun over the earth at a given location. You can choose location, date, time, and compass orientation. You can also animate the date and time. This system is suitable for shadow studies of proposed and existing structures.

## Viewing Lighting Effects in the Scene

When you place lights in a scene, the default lighting turns off and the scene is illuminated only by the lights you create. The illumination you see in a viewport is just an approximation of the true lighting. Render your scene to view lighting accurately.

---

**TIP** If the Daylight system appears to wash out the scene, try using the [Logarithmic exposure control](#) on page 6540 .

---

## Placing Cameras

You create and place cameras from the Cameras category of the Create panel. Cameras define viewpoints for rendering, and you can animate cameras to produce cinematic effects such as dollies and truck shots.

You can also create a camera automatically from a Perspective viewport by using the [Create Camera from View command](#) on page 109 found on the Views menu. Just adjust your Perspective viewport until you like it, and then choose Views > Create Camera From View. 3ds Max creates a camera and

replaces the Perspective viewport with a Camera viewport showing the same perspective.

See [Common Camera Parameters](#) on page 5123 .

## Animating Your Scene



You can animate almost anything in your scene. Click the Auto Key button to enable automatic animation creation, drag the time slider, and make changes in your scene to create animated effects.

### Controlling Time

The program starts each new scene with 100 frames for animation. Frames are a way of measuring time, and you move through time by dragging the [time slider](#) on page 7312 . You can also open the [Time Configuration dialog](#) on page 7359 to set the number of frames used by your scene and the speed at which the frames are displayed.

### Animating Transforms and Parameters

While the Auto Key button is on, the program creates an [animation key](#) on page 7824 whenever you transform an object or change a parameter. To animate a parameter over a range of frames, specify the values at the first and last frames of the range. The program calculates the values for all of the frames in between.

See [Animation Concepts and Methods](#) on page 3002 .

### Editing Animation

You edit your animation by opening the Track View window or by changing options on the Motion panel. Track View is like a spreadsheet that displays animation keys along a time line. You edit the animation by changing the keys.

Track View has two modes. You can display the animation as a series of function curves that graphically show how a value changes over time in the Curve Editor mode. Alternatively, you can display your animation as a sequence of keys or ranges on a grid in the Dope Sheet mode.

See [Track View](#) on page 3426 .

## Rendering Your Scene

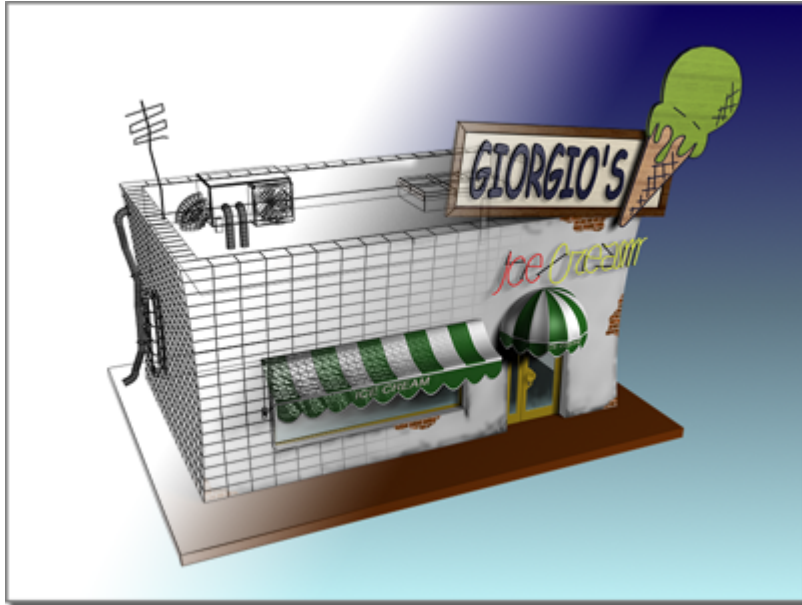

Rendering "fills in" geometry with color, shadow, lighting effects, and so on.

Use the rendering features to define an environment and to produce the final output from your scene.

### Defining Environments and Backgrounds

Rarely do you want to render your scene against the default background color. Open the Environment And Effects dialog > [Environment panel](#) on page 6486 to define a background for your scene, or to set up effects such as fog.

### Setting Rendering Options

To set the size and quality of your final output, you can choose from many options on the [Render Scene dialog](#) on page 5878 . You have full control over professional grade film and video properties as well as effects such as reflection, antialiasing, shadow properties, and motion blur.

## Rendering Images and Animation

You render a single image by setting the renderer to render a single frame of your animation. You specify what type of image file to produce and where the program stores the file.

Rendering an animation is the same as rendering a single image except that you set the renderer to render a sequence of frames. You can choose to render an animation to multiple single frame files or to popular animation formats such as AVI or MOV.

See [Render Scene Dialog](#) on page 5878 .

## The 3ds Max Window

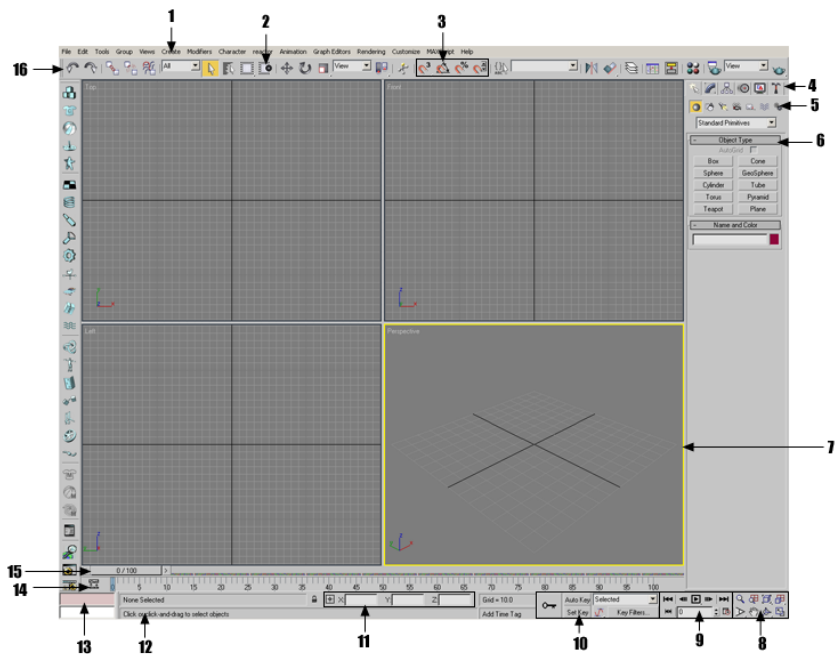

1. Menu bar
2. Window/Crossing selection toggle
3. Snap tools
4. Command panels
5. Object categories

6. Rollout
7. Active viewport
8. Viewport navigation controls
9. Animation playback controls
10. Animation keying controls
11. Absolute/Relative coordinate toggle and coordinate display
12. Prompt line and status bar
13. MAXScript mini-listener
14. Track bar
15. Time slider
16. Main toolbar

Most of the main window is occupied by the viewports, where you view and work with your scene. The remaining areas of the window hold controls and show status information.

One of the most important aspects of using 3ds Max is its versatility. Many program functions are available from multiple user-interface elements. For example, you can open Track View for animation control from the Main toolbar as well as the Graph Editors menu, but the easiest way to get to a specific object's track in Track View is to right-click the object, and then choose Track View Selected from the quad menu.

You can customize the user interface in a variety of ways: by adding keyboard shortcuts, moving toolbars and command panels around, creating new toolbars and tool buttons, and even recording scripts into toolbar buttons.

MAXScript lets you create and use custom commands in the built-in scripting language. For more information, access the MAXScript Reference from the Help menu.

## Menu Bar

A standard Windows menu bar with typical [File](#) on page 7259 , [Edit](#) on page 7260 , and [Help](#) on page 7281 menus. Special menus include:

- [Tools](#) on page 7260 contains duplicates of many of the Main toolbar commands.
- [Tools](#) on page 7260 contains many important program functions, including precision functions.
- [Group](#) on page 7262 contains commands for managing combined objects.

- [Views](#) on page 7262 contains commands for setting up and controlling the viewports.
- [Create](#) on page 7263 contains commands for creating objects.
- [Modifiers](#) on page 7270 contains commands for modifying objects.
- [Animation](#) on page 7275 contains commands for animating and constraining objects, plus commands such as Bone Tools for setting up animated characters.
- [Graph Editors](#) on page 7278 provides graphical access to editing objects and animation: Track View lets you open and manage animation tracks in [Track View](#) on page 3426 windows, and [Schematic View](#) on page 7197 gives you an alternate way to work with the objects in your scene and navigate to them.
- [Rendering](#) on page 7278 contains commands for rendering, Video Post, [radiosity](#), on page 5976 and the environment.
- [Rendering](#) on page 7278 contains commands for rendering, using [radiosity](#) on page 5976 , and changing the environment.
- [Customize](#) on page 7279 gives you access to controls that let you customize the user interface.
- [MAXScript](#) on page 7280 has commands for working with MAXScript, the built-in scripting language.

For more information about the 3ds Max menus, see [Menu Bar](#) on page 7257 .

## **Time Controls**

The [Auto Key button](#) on page 3007 turns on animation mode. The other controls navigate through time and play back an animation.

## **Command Panel**

This collection of six panels provides handy access to most of the modeling and animation commands.

You can "tear off" the command panel and place it anywhere you like.

By default, the command panel is docked at the right of your screen. You can access a menu that lets you [float](#) on page 7761 or dismiss the command panel by right-clicking just above it. If it is not displayed, or you want to change its

location and docking or floating status, right-click in a blank area of any toolbar, and choose from the shortcut menu.

- [Create](#) on page 7423 holds all object creation tools.
- [Modify](#) on page 7425 holds modifiers and editing tools.
- [Hierarchy](#) on page 7453 holds linking and inverse kinematics parameters.
- [Motion](#) on page 7455 holds animation controllers and trajectories.
- [Display](#) on page 7457 holds object display controls.
- [Utilities](#) on page 7463 holds miscellaneous utilities.

### **Status Bar and Prompt Line**

These two lines display prompts and information about your scene and the active command. They also contain system toggles controlling selections, precision, and display properties. See [Status Bar Controls](#) on page 7308 .

### **Viewports**

You can display from one to four viewports. These can show multiple views of the same geometry, as well as the Track View, Schematic View, and other informational displays . See [Viewports](#) on page 7366 .

### **Viewport Navigation Buttons**

The button cluster at the lower-right corner of the main window contains controls for zooming, panning, and navigating within the viewports. See [Viewport Controls](#) on page 7366 .

## **Special Controls**

3ds Max uses some special user interface controls, which are described in this topic.

- [Right-click menus](#) on page 39
- [Flyouts](#) on page 39
- [Rollouts](#) on page 40
- [Scrolling panels and toolbars](#) on page 40



- [Spinners](#) on page 41
- [Numerical Expression Evaluator](#) on page 41
- [Entering numbers](#) on page 42
- [Controls and color](#) on page 42
- [Undoing actions](#) on page 43

## Right-Click Menus

The program uses several different types of right-click menus.

For object editing and [ActiveShade control](#) on page 5919 , you use the [quad menu](#) on page 7300 . Commands on the quad menu vary depending on the kind of object you are editing and the mode you are in.

Right-clicking a viewport label displays the [viewport right-click menu](#) on page 7370 , which lets you change viewport display settings, choose which view appears in the viewport, and so on.

Also, the command panel and the Material Editor have right-click menus that let you manage rollouts and navigate the panel quickly. And most other windows, including Schematic View and Track View, have right-click menus that provide fast access to commonly used functions.

## Flyouts

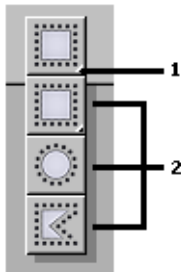

1. Flyout arrow
2. Flyout buttons

A [flyout](#) on page 7789 is similar to a menu, except that its items are buttons. A flyout button is indicated by a small arrow in the lower-right corner. To display the flyout, click and hold the button for a moment, then choose a button by dragging the cursor to it and then releasing the mouse button.

---

**NOTE** You can define customized text annotations for flyouts by editing the *maxstart.cui* file. See [Customize Menu](#) on page 7279 .

---

## Rollouts



Rollouts are areas in the command panels and dialogs that you can expand (roll out) or collapse (roll in) to manage screen space. In the illustration above, the Keyboard entry rollout is collapsed, as indicated by the + sign, and the Parameters rollout is expanded, as indicated by the – sign.

### To open and close a rollout:

- Click the rollout title bar to toggle between expanded and collapsed.

### To move a rollout:

- You can move a rollout in the expanded or collapsed state. To move the rollout, drag the rollout title bar to another location on the command panel or dialog. As you drag, a semi-transparent image of the rollout title bar follows the mouse cursor. When the mouse is positioned over or near a qualifying position for the rollout, a blue, horizontal line appears at the position where the rollout will drop when you release the mouse button.

## Scrolling Panels and Toolbars

Sometimes a command panel or dialog is not large enough to display all of its rollouts. In this case, a pan ("hand") cursor appears over the inactive parts of the panel. You can scroll command panels and dialogs vertically, and you can scroll a toolbar along its major axis.

### To scroll a panel:

- 1 Place the pointer over an empty area of a panel to display the pan cursor.
- 2 When the pointer icon changes to a hand, drag the panel up or down.  
A thin scroll bar also appears on the right side of the scrolling panel. You can use the pointer to drag the scroll bar as well.

### To scroll a toolbar:

You can scroll a toolbar only when some tool buttons are not visible. This typically occurs when the program window is smaller than full screen.

- 1 First, follow either of the procedures below:
  - Place the pointer over an empty area of a toolbar to display the pan cursor.
  - Place the pointer over any part of a toolbar, then press and hold the middle mouse button.
- 2 When the pointer icon changes to a hand, drag the toolbar horizontally.

### Spinners

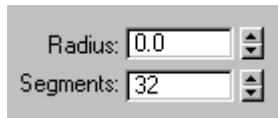

A spinner is a mouse-based control for numeric fields. You can click or drag the spinner arrows to change the value in the field.

#### To change a value using a spinner, do any of the following:

- 1 Click the spinner's up arrow to increment the value; click the down arrow to decrement the value. Click and hold for continuous change.
- 2 Drag upward to increase the value, or drag downward to decrease it.
- 3 Press Ctrl while you drag to increase the rate at which the value changes.
- 4 Press Alt while you drag to decrease the rate at which the value changes.
- 5 Right-click a spinner to reset the field to its minimum value.

### Numerical Expression Evaluator

While a numeric field is active, you can display a calculator called the Numerical Expression Evaluator. To display the calculator, press Ctrl+N.

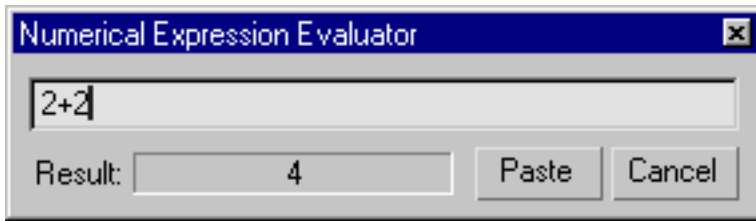

The expression you enter is evaluated, and its result is displayed in the Result field. Click Paste to replace the field value with the result of the calculation. Click Cancel to exit the Expression Evaluator.

The expressions you can enter are described in [Expression Techniques](#) on page 299 . You can't use variables in the Expression Evaluator, but you can enter the constants pi (circular ratio), e (natural logarithm base), and TPS (ticks per second). These constants are case-sensitive: the Expression Evaluator does not recognize PI, E, or tps.

You can also enter a vector expression or an Expression Controller function call, but the result of the expression or function *must* be a scalar value. Otherwise, the Expression Evaluator won't evaluate it.

### Entering Numbers

You can change a numeric value by a relative offset by highlighting the contents of a numeric field (not in the Numerical Expression Evaluator) and typing R or r followed by the offset amount.

For example, a Radius field shows 70 and you highlight it:

- If you enter **R30**, 30 is added to the radius and the value changes to 100.
- If you enter **R-30**, 30 is subtracted from the radius and the value changes to 40.

### Controls and Color

The user interface uses color cues to remind you what state the program is in.

---

**NOTE** You can customize most of these colors by using the [Colors panel](#) on page 7505 of the [Customize User Interface dialog](#) on page 7489 .

---

- **Red for animation:** The Auto Key button, the time slider background, and the border of the active viewport turn red when you are in Animate mode.

- **Yellow for modal function buttons:** When you turn on a button that puts you in a generic creation or editing mode, the button turns yellow.
- **Yellow for special action modes:** When you turn on a button that alters the normal behavior of other functions, the button is highlighted in yellow. Common examples of this behavior include sub-object selection and locking your current selection set.

You can exit a functional mode by clicking another modal button. Other exit methods supported by some buttons include right-clicking in a viewport, or clicking the modal button a second time.

## Undoing Actions

You can easily undo changes you make to your scene and your viewports. There are separate Undo buffers for both the scene objects and each viewport.



Use the toolbar [Undo and Redo buttons](#) on page 202 or the Edit menu > Undo and Redo commands to reverse the effects of most scene operations. You can also use Ctrl+Z for Undo and Ctrl+Y for Redo. Most things you do in the program can be undone.

Use the Views menu > [Undo and Redo commands](#) on page 87 to reverse the effects of most viewport operations, such as zooming and panning. You can also use Shift+Z for Undo View Change and Shift+Y for Redo View Change.

You can also undo actions by using the Hold and Fetch commands on the Edit menu. Choose Edit menu > Hold to save a copy of your scene in a temporary file. Then choose Edit menu > Fetch to discard your current scene and revert to the held scene at any time.

# Managing Files

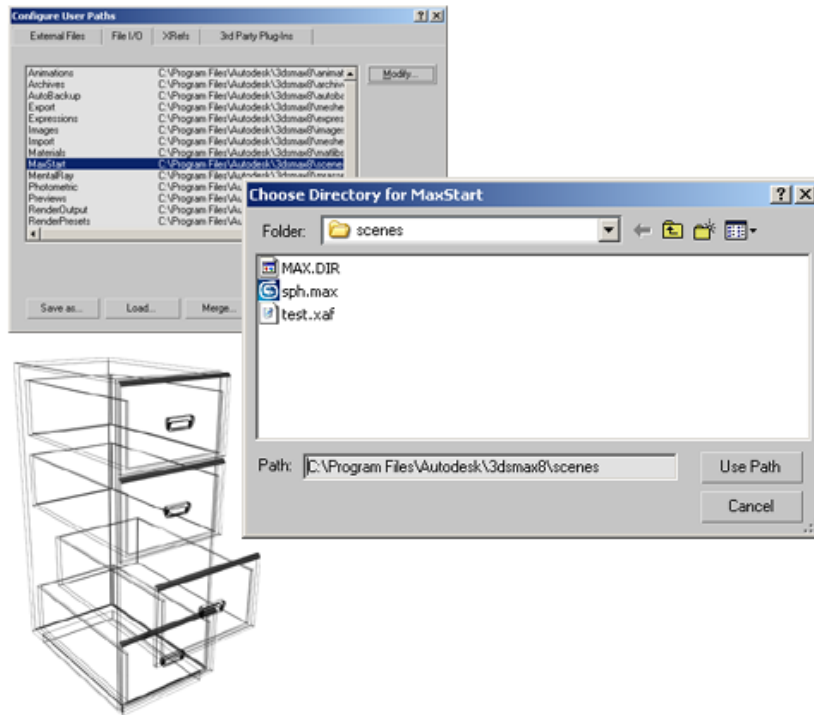

## File-management dialogs

3ds Max supports many types of files for working with plug-ins, image maps, models from other programs, rendering images and animations, and of course saving and opening your scene files.

File dialogs (such as Open, Save, Save As) uniformly remember the previous path you used, and default to that location.

## Configuring File Paths

The locations that 3ds Max searches to locate all file types are specified on the Customize menu > [Configure Paths dialogs](#) on page 7519 .

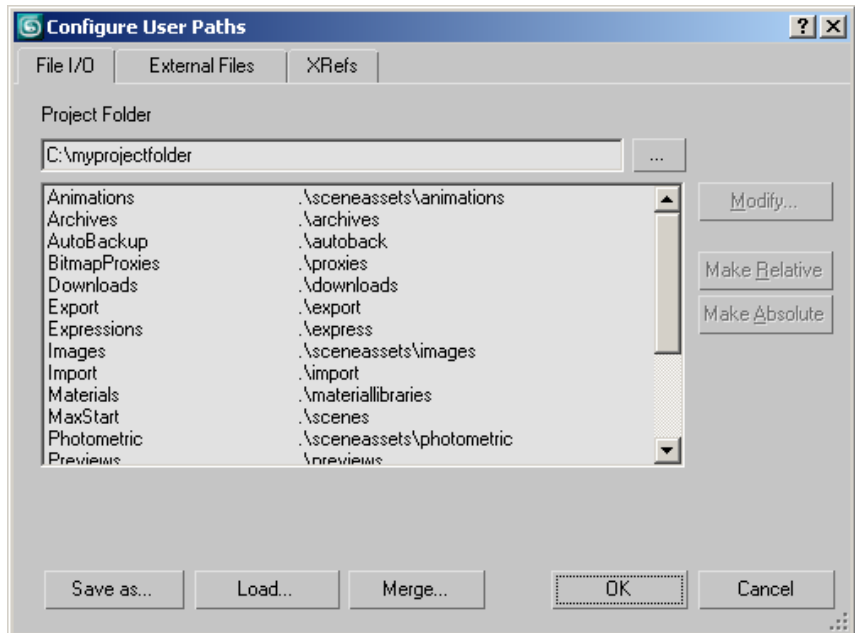

You can choose to open and save files in any path location. The Configure Paths dialog contains four panels for the general categories of support files.

### Setting General File Paths

The [File I/O panel](#) on page 7524 contains paths for most of the standard support files. You can specify one path for each of file types 3ds Max uses.

### Setting Plug-In File Paths

Many features of 3ds Max are implemented as plug-ins. This means you can change and extend 3ds Max functionality by adding new plug-ins from Autodesk Media and Entertainment or from third-party developers.

You tell 3ds Max where to find additional plug-in files by adding path entries on the [3rd Party Plug-Ins panel](#) on page 7532. If you place all of your plug-ins in a single directory, plug-in file management can become messy. That's why the program supports multiple entries on the 3rd Party Plug-Ins panel.

### Setting Bitmap, FX, and Download File Paths

The [External Files panel](#) on page 7526 contains multiple path entries that the program searches for [image files](#) on page 7116, downloaded files (via [i-drop](#)

on page 6957 ), and [FX files](#) on page 7794 . Image files are used for many purposes, such as material and map definition, light projections, and environment effects.

### Setting XRefs File Paths

The [XRefs panel](#) on page 7529 contains multiple path entries that the program uses to search for externally referenced files. These are used for sharing files in a workgroup situation.

## Importing, Merging, Replacing, and Externally Referencing Scenes

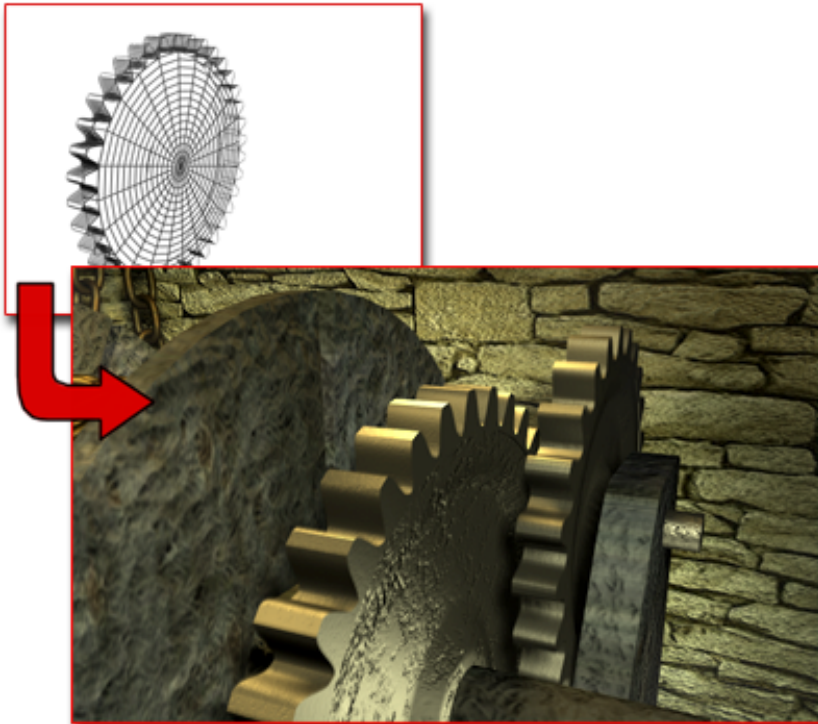

Gear model imported to become part of another scene



You can realize great productivity gains when you reuse work by combining geometry from scenes or other programs. 3ds Max supports this technique with the Import, Merge, and Replace commands. You can also share scenes and objects with others working on the same project using XRef functionality.

### Importing Geometry from Other Programs

Use File menu > [Import](#) on page 6892 to bring objects from other programs into a scene. The types of files that you can import are listed in the Files Of Type list in the Select File To Import dialog.

Depending on the file type you choose, you might have options available for that import plug-in.

### Merging Scenes Together



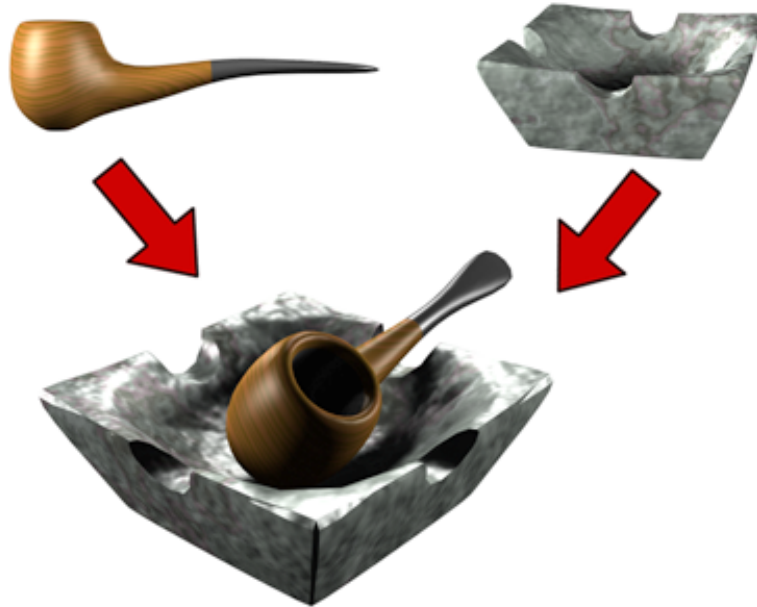

#### **Pipe and ashtray models merged into one scene**

Use [Merge](#) on page 6854 to combine multiple scenes into a single large scene. When you merge a file, you can select which objects to merge. If objects being merged have the same name as objects in your scene, you have the option to rename or skip over the merged objects.

#### **Merging Animation into Scenes**

Use [Merge Animation](#) on page 6859 to merge the animation from one scene into another with the same (or similar) geometry.

#### **Replacing Scene Objects**

Use [Replace](#) on page 6866 to replace objects in your scene with objects in another scene that have duplicate names. Replace is useful when you want to set up and animate your scene with simplified objects, and then replace the simple objects with detailed objects before rendering.

The Replace dialog looks and functions the same as Merge, except that it lists only objects that have the same name as objects in your current scene.

## Using External References

Use [XRef Objects](#) on page 6732 and [XRef Scenes](#) on page 6755 to use objects and scene setups in your scene that are actually referenced from external MAX files. These functions allow sharing files with others in your workgroup, with options for updating and protecting external files.

## Using the Asset Browser

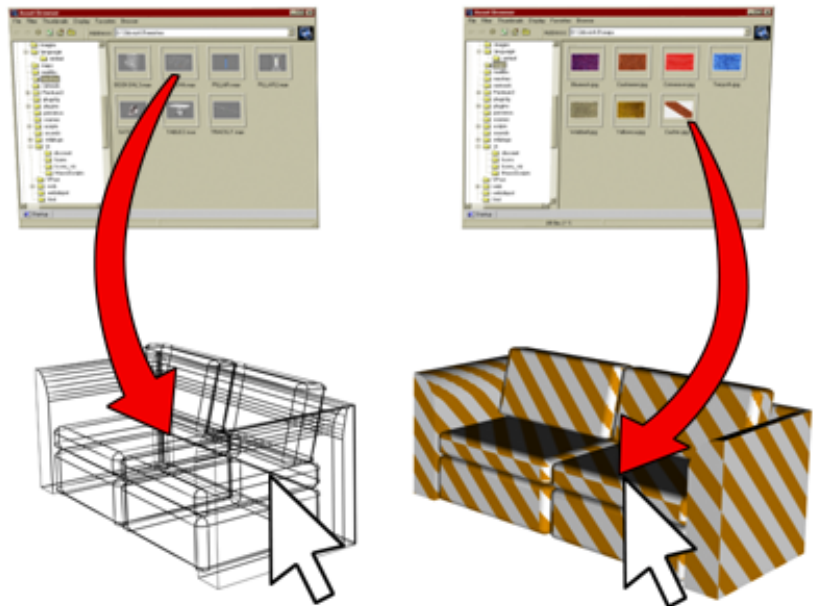

**Left:** Dragging geometry into the scene

**Right:** Dragging a bitmap onto the geometry

The Asset Browser provides access from your desktop to design content on the World Wide Web. From within 3ds Max you can browse the Internet for texture samples and product models. This includes bitmap textures (BMP, JPG, GIF, TIF, and TGA) and geometry files (MAX, 3DS, and so on).

You can drag these samples and models into your scene for immediate visualization and presentation. You can snap geometry into predefined locations, or drag and drop them interactively in your scene.

You can also use the Asset Browser to browse thumbnail displays of bitmap textures and geometry files on your hard disk or shared network drives. Then you can either view them or drag and drop them into your scene or into valid map buttons or slots.

---

**NOTE** The thumbnail display of a geometry file is a bitmap representation of a view of the geometry. Since the thumbnail display is not a vector-based representation, you can't rotate it or perform zooms on it.

---

You can drag and drop most graphic images that are embedded in a Web page into your scene. The exception is images or regions of a Web page that are tagged as hyperlinks or other HTML controls (such as when a bitmap is tagged as a button).

---

**IMPORTANT** Downloaded content might be subject to use restrictions or the license of the site owner. You are responsible for obtaining all content license rights.

---

For complete details, see [Asset Browser](#) on page 6928 .

## Startup Files and Defaults

When you start 3ds Max, several auxiliary files load, setting things like program defaults and UI layout. You can even create a scene, named *maxstart.max* , that automatically loads when you start or reset the program. In some cases, the program updates files when you change settings and when you quit the program.

---

**NOTE** 3ds Max comes with several different [market-specific defaults](#) on page 7486 . These set different program defaults on startup, based on the type of files you expect to work on most often. You can load the preset defaults that come with 3ds Max, or you can create your own.

---

In general, you don't need to work directly with the auxiliary files, but it's good to know about them. Among the auxiliary files the program uses are:

- **3dsmax.ini on page 51** : This file gets updated when you start and exit 3ds Max, as well as when you change most Preferences settings. It contains values relating to program defaults, including the graphics driver, directories used to access external files such as sounds and images, preset render sizes, dialog positions, snap settings, and other preferences and default settings. If you edit this file, be sure to make a copy first, so you can return to the original if anything goes wrong.

---

**NOTE** Many program defaults are set in *currentdefaults.ini*, found within the *\defaults* directory. For more information on this file, see [Market-Specific Defaults](#) on page 7486 .

---

- **maxstart.max** : At startup and when you reset the program, 3ds Max looks for this file in the *MaxStart* folder specified in Configure User Paths > [File I/O panel](#) on page 7524 , and if found, loads it. This allows you to specify the default state of the workspace whenever you start or reset the program. For example, if you always use a ground plane, you can make it the default setup by creating one, and then saving it as *maxstart.max* . If you save a different file over *maxstart.max* , you can return to program defaults by deleting the *maxstart.max* file, and then resetting the program .
- **maxstart.cui** : This is the default custom user interface file. You can load and save CUI files, and set the program to use a different default CUI file. See [Customize Menu](#) on page 7279 .
- **plugin.ini**: This file contains directory paths for plug-ins. Most other paths are kept in the program INI file, but *plugin.ini* is maintained as a separate file because third-party plug-ins often add entries to the list at installation.

---

**NOTE** It is possible to use multiple plug-in configuration files by nesting additional paths in your *plugin.ini* file. This can be very useful for allowing an entire network of users to share one *plugin.ini* file, making the system easier to maintain for the network administrator. For more information, see [Network Plug-In Configuration](#) on page 7533 .

---

- **startup.ms**: A MAXScript file that automatically executes at startup time. For more information, see [Startup Script](#) on page 7938 .
- **splash.bmp**: To substitute a custom splash screen (startup screen) for the default image, copy any Windows Bitmap (*.bmp*) file into the program root directory and rename it *splash.bmp*. The program will thereafter use this image at startup.

## 3dsmax .ini File

The file 3ds Max uses to store settings between sessions is named *3dsmax.ini* . By default, you can find it in the location indicated by the MaxData setting on the [Configure System Paths dialog](#) on page 7523 .

You can make changes to 3ds Max startup conditions by editing the *3dsmax.ini* file in a text editor such as Notepad. If you do edit the file, be sure to maintain the structure and syntax of the original file.

---

**TIP** If you encounter unusual and unexplained user-interface problems using 3ds Max, try deleting the *3dsmax.ini* file and restarting. 3ds Max writes a new INI file to replace the deleted one. Often this fixes problems related to the state of the user interface.

---

**NOTE** Startup scene conditions are defined by the *maxstart.max* file. To save a particular startup condition, such as a Plane object representing the ground, create a scene file with the condition present and then save it as *maxstart.max*. 3ds Max automatically opens this file when you start 3ds Max.

---

The *3dsmax.ini* file includes the following categories of settings:

- [Directories]** Defines the default paths for various file operations.
- [Performance]** Controls that speed up viewport performance.
- [PlugInKeys]** Turns on or off the keyboard shortcuts for plug-ins.
- [Renderer]** Controls for rendering alpha and filter backgrounds.
- [RenderPresets]** Defines the paths for Rendering Preset files.
- [BitmapDirs]** Defines the default map paths for bitmaps used by materials.
- [Modstack]** Controls modifier stack button sets and icon display.
- [WindowState]** Settings for software display, OpenGL, or Direct3D drivers.
- [CustomMenus]** Defines path for the **.mnu** file.
- [CustomColors]** Defines the path for the *.clr* file.
- [KeyboardFile]** Defines the path for the *.kbd* file.
- [Material Editor]** Material Editor settings.
- [ObjectSnapSettings]** Settings associated with snaps.
- [CommandPanel]** Sets number of columns, and controls rollout display in multiple columns.

# Backing Up and Archiving Scenes

You should regularly back up and archive your work. One convenient method is to save incremental copies of your scenes. This method creates a history of your work process.

## Saving Incremental Files

If you turn on the Increment On Save option on the [Files panel](#) on page 7541 of the Preferences dialog, the current scene is renamed by appending a two-digit number to the end of the file and incrementing the number each time you save. For example, if you open a file named *myfile.max* and then save it, the saved file is named *myfile01.max*. Each time you save the file its name is incremented, producing the files *myfile02.max*, *myfile03.max*, and so on.

You can also use [Save As](#) on page 6724 to increment the file name manually with a two-digit number by clicking the increment button (+) on the Save As dialog.

## Using Auto Backup

You can automatically save backup files at regular intervals by setting the [Auto Backup options](#) on page 7544 on the Preferences dialog (see [File Preferences](#) on page 7541 ). The backup files are named *AutoBackupN.max*, where N is a number from 1 to 99, and stored, by default, in the *\autoback* folder. You can load a backup file like any other scene file.

## Archiving a Scene

3ds Max scenes can make use of many different files. When you want to exchange scenes with other users or store scenes for archival purposes, you often need to save more than just the scene file.

Use the File menu > [Archive command](#) on page 6918 to pass the scene file and any bitmap files used in the scene to an archiving program compatible with PKZIP® software.

# Crash Recovery System

If 3ds Max encounters an unexpected crash, it attempts to recover and save the file currently in memory. This is fairly reliable, but it does not always work: the recovered scene could be damaged during the crash.

The recovered file is stored in the configured Auto Backup path. It is saved as "*<filename>\_recover.max*" in this path. It is also placed in the INI file as the most recently used file in the File menu. This makes it easy to return to the file, if you choose to do so.

The crash recovery system identifies when something in an object's modifier stack is corrupt. In these cases, the corrupt object is replaced with a red dummy object to maintain the object's position and any linked object hierarchy.

---

**NOTE** We recommend that you not rely on this file-recovery mechanism as an alternative to good data backup practices:

- Save your work frequently.
  - Take advantage of automatic incremental file naming: Go to Customize menu > Preferences > [Files panel](#) on page 7541 > File Handling group, and turn on Increment On Save.
  - Use File menu > Save As, and click the Increment button (+) to save incremental copies of work in progress.
  - If you are forgetful about saving, use the Auto Backup feature. Go to Customize menu > Preferences > Files tab > Auto Backup group, and turn on Enable.
-



# Viewing and Navigating 3D Space

# 3

Everything in 3ds Max is located in a three-dimensional world. You have a variety of options for viewing this enormous stage-like space, from the tiniest details to the full extent of your scene.

Using the view options discussed in this section you move from one view to another, as your work and imagination require. You can fill your screen with a single, large viewport, or set multiple viewports to track various aspects of your scene. For exact positioning, flat drawing views are available, as are [3D perspective](#) on page 7891 and [axonometric views](#) on page 7722 .

You navigate 3D space by adjusting the position, rotation and magnification of your views. You have full control over how objects are rendered and displayed on the screen.

You can also use the [Grab Viewport command](#) on page 85 to create snapshots of your work as you go.

This section presents these brief topics designed to help you quickly start learning how to organize viewports and navigate through 3D space:

[General Viewport Concepts](#) on page 56

[Home Grid: Views Based on the World Coordinate Axes](#) on page 58

[Understanding Views](#) on page 61

[Setting Viewport Layout](#) on page 65

[Controlling Viewport Rendering](#) on page 68

[Controlling Display Performance](#) on page 70

[Using Standard View Navigation](#) on page 71

[Zooming, Panning, and Rotating Views](#) on page 72

[Navigating Camera and Light Views](#) on page 79

[Grab Viewport](#) on page 85

For details about viewport commands, see [Viewport Controls](#) on page 7366 .

# General Viewport Concepts

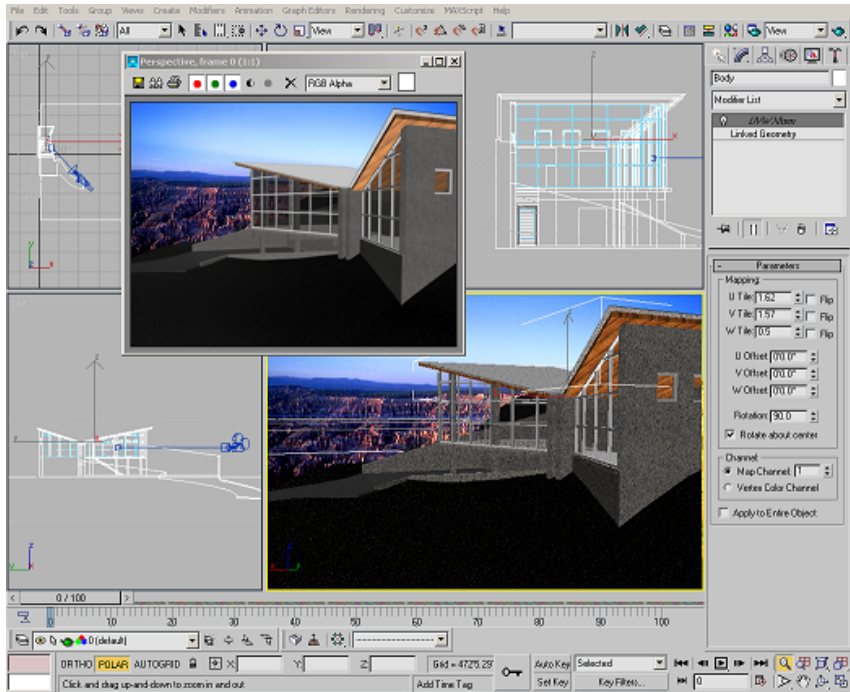

The 3ds Max main window, with a docked toolbar and viewport layout displaying multiple views.

Viewports are openings into the three-dimensional space of your scene, like windows looking into an enclosed garden or atrium. But viewports are more than passive observation points. While creating a scene, you can use them as dynamic and flexible tools to understand the 3D relationships among objects.

At times you might want to look at your scene through a large, undivided viewport, giving you a "picture-window" view of the world you're creating. Often you use multiple viewports, each set to a different orientation.

If you want to move an object horizontally in the world space, you might do this in a top viewport, looking directly down on the object as you move it. At the same time, you could be watching a shaded perspective viewport to see

when the object you're moving slides behind another. Using the two windows together, you can get exactly the position and alignment you want.

You also have pan and zoom features available in either view, as well as grid alignment. With a few mouse clicks or keystrokes, you can reach any level of detail you need for the next step in your work.

Another way to use viewports is to place a camera in your scene and set a viewport to look through its lens. When you move the camera, the viewport tracks the change. You can do the same thing with spotlights.

In addition to geometry, viewports can display other views such as Track View and Schematic View, which display the structure of the scene and the animation. Viewports can be extended to display other tools such as the MAXScript Listener and the Asset Browser. For interactive rendering, the viewport can display the ActiveShade window.

### **Active Viewport**

One viewport, marked with a highlighted border, is always active. The active viewport is where commands and other actions take effect. Only one viewport can be in the active state at a time. If other viewports are visible, they are set for observation only; unless disabled, they simultaneously track actions taken in the active viewport.

### **Saving the Active Viewport**

You can save the view in any active viewport and later restore it with the Views menu's [Save Active View](#) on page 88 and [Restore Active View](#) on page 88 commands. One view can be saved for each of the following view types: Top, Bottom, Left, Right, Front, Back, User, Perspective.

For example, while in the Front view, you choose Save Active Front View, and then zoom and pan that view. You then activate the Top viewport, choose Save Active Top View, and then click Zoom Extents. You return to the Front view, and choose Restore Active Front View to return to its original zoom and pan. At any time, you can activate the Top viewport, and then choose Restore Active Top View to restore its saved view.

# Home Grid: Views Based on the World Coordinate Axes

The grid you see in each viewport represents one of three planes that intersect at right angles to one another at a common point called the origin. Intersection occurs along three lines (the world coordinate axes: X, Y, and Z) familiar from geometry as the basis of the Cartesian coordinate system.

## Home Grid

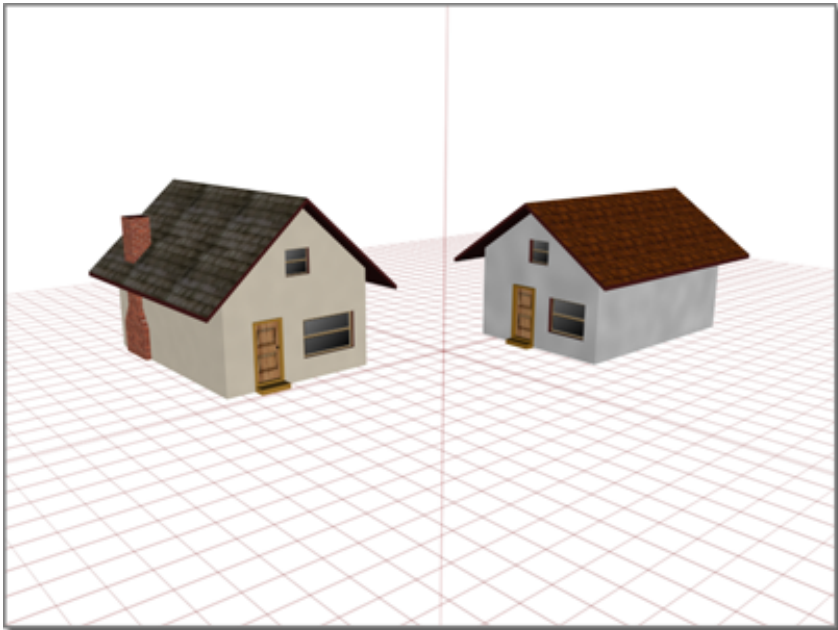

### Using the home grid to position houses

The three planes based on the world coordinate axes are called the home grid; this is the basic reference system of the 3D world.

To simplify the positioning of objects, only one plane of the home grid is visible in each viewport. The figure shows all three planes as they would appear if you could see them in a single perspective viewport.

## Axes, Planes, and Views

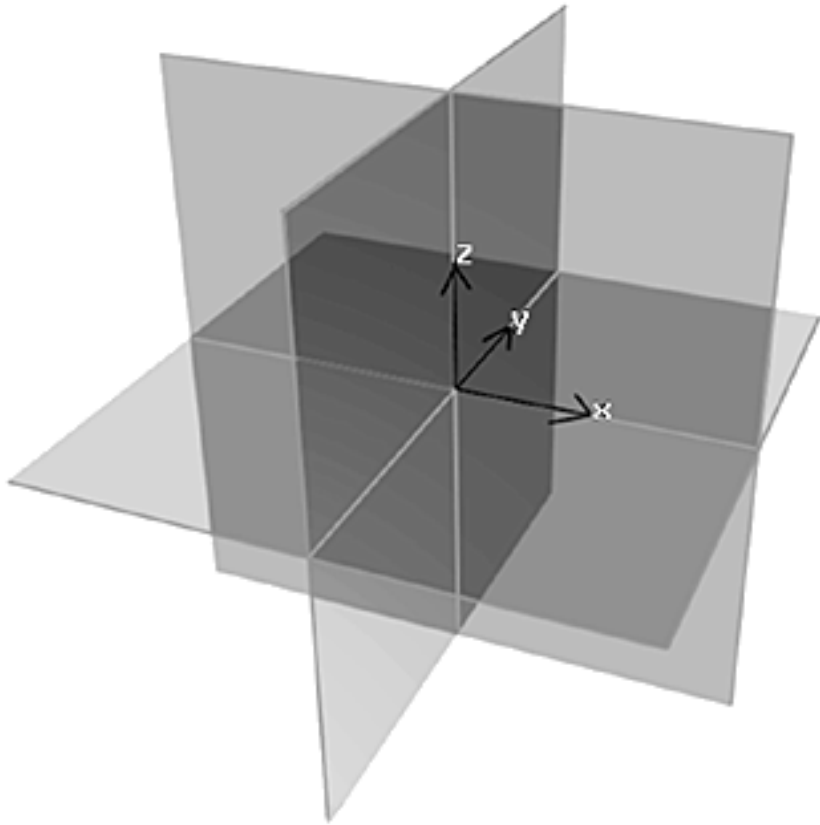

### Home grid axes and planes

Two axes define each plane of the home grid. In the default Perspective viewport, you are looking across the XY plane (ground plane), with the X axis running left-to-right, and the Y axis running front-to-back. The third axis, Z, runs vertically through this plane at the origin.

## Home Grid and Grid Objects

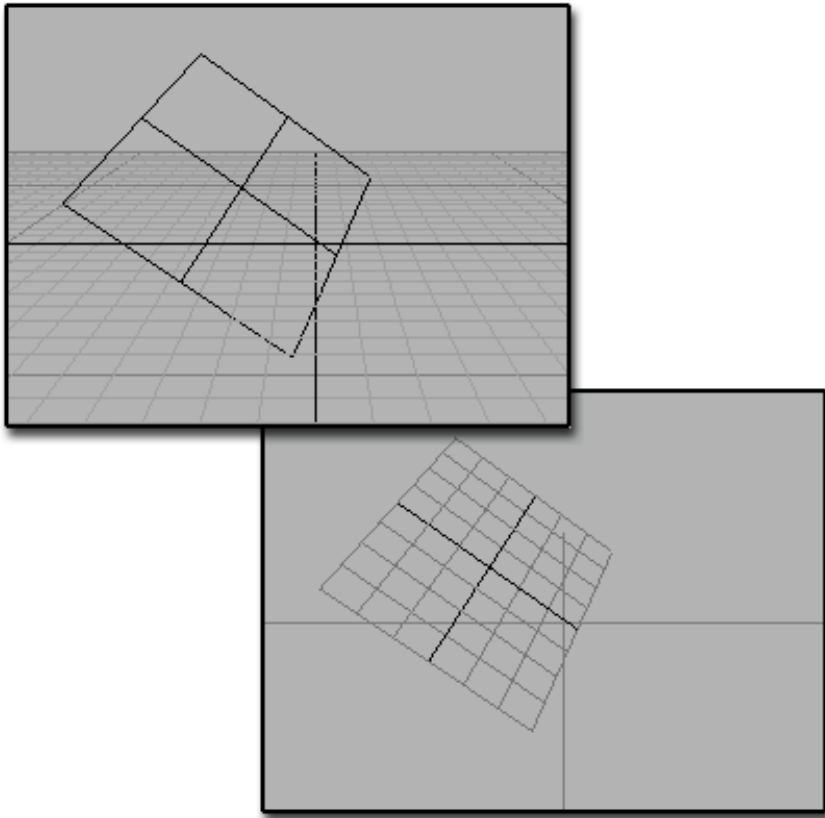

**Above: Inactive grid object in a scene**

**Below: Activated grid object**

The home grid is aligned with the world coordinate axes. You can turn it on and off for any viewport, but you can't change its orientation.

For flexibility, the home grid is supplemented by grid objects: independent grids you can place anywhere, at any angle, aligned with any object or surface. They function as "construction planes" you can use once and discard or save for reuse. See [Precision and Drawing Aids](#) on page 2501 .



## AutoGrid

The AutoGrid feature lets you create and activate temporary grid objects on the fly. This lets you create geometry off the face of any object by first creating the temporary grid, then the object. You also have the option to make the temporary grids permanent. See [AutoGrid](#) on page 2513 .

# Understanding Views

There are two types of views visible in viewports:

- [Axonometric views](#) on page 7722 show the scene without perspective. All lines in the model are parallel to one another. The Top, Front, Left, and User viewports are axonometric views.

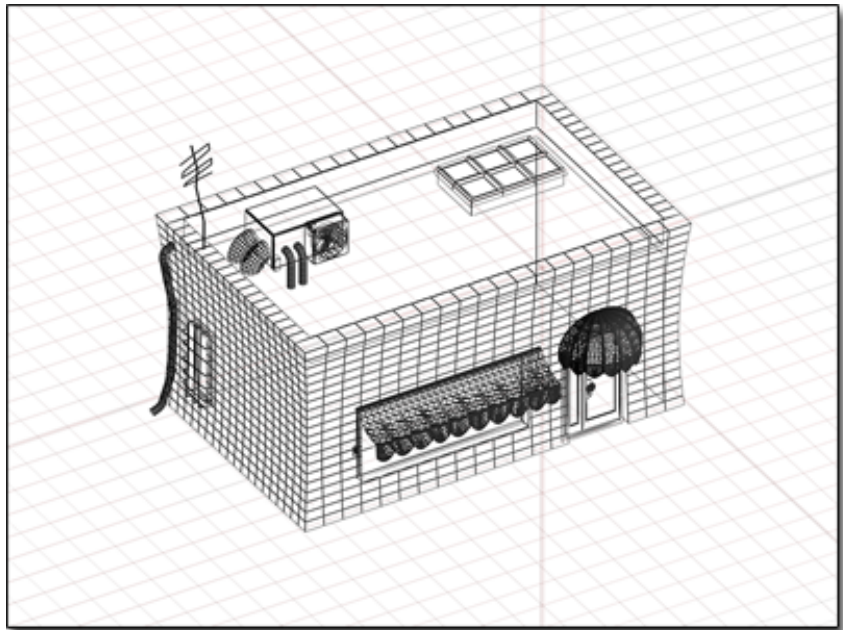

Axonometric view of a scene

- [Perspective views](#) on page 7891 show the scene with lines that converge at the horizon. The Perspective and Camera viewports are examples of perspective views.

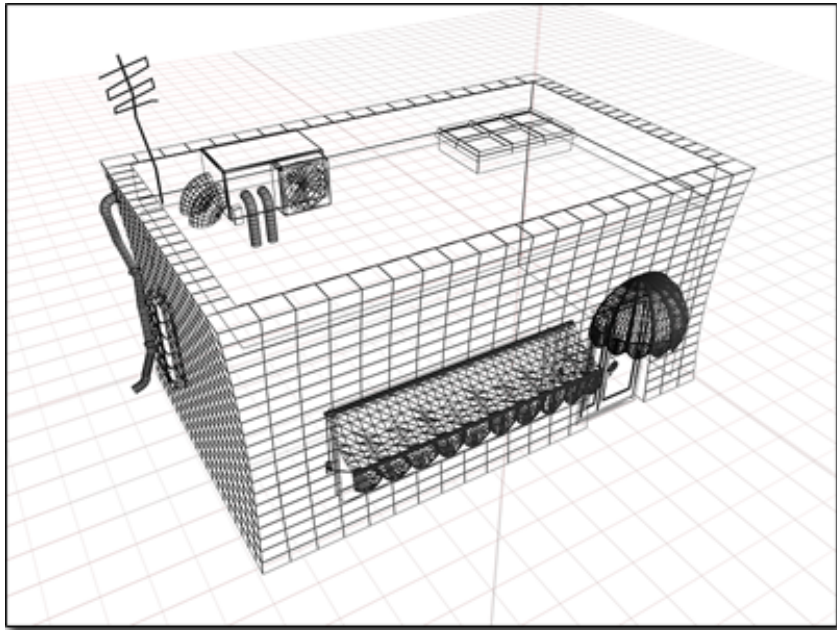

Perspective view of the same model

Perspective views most closely resemble human vision, where objects appear to recede into the distance, creating a sense of depth and space. Axonometric views provide an undistorted view of the scene for accurate scaling and placement. A common workflow is to use axonometric views to create the scene, then use a perspective view to render the final output.

### **Axonometric Views**

There are two types of axonometric views you can use in viewports: orthographic and rotated.

An [orthographic view](#) on page 7877 is a straight-on view of the scene, such as the view shown in the Top, Front, and Left viewports. You can set a viewport to a specific orthographic view using the [viewport right-click menu](#) on page 7370 or [keyboard shortcuts](#) on page 7645. For example, to set an active viewport to Left view, press L.



You can also rotate an orthographic view to see the scene from an angle while retaining parallel projection. This type of view is represented by a User viewport.

### **Perspective Views**

A perspective viewport, labeled Perspective, is one of the startup viewports in 3ds Max. You can change any active viewport to this "eye-like" point of view by pressing P.

### **Camera View**

Once you create a camera object in your scene, you can change the active viewport to a camera view by pressing C and then selecting from a list of cameras in your scene. You can also create a camera view directly from a perspective viewport, using the [Create Camera from View](#) on page 109 command.

A camera viewport tracks the view through the lens of the selected camera. As you move the camera (or target) in another viewport, you see the scene move accordingly. This is the advantage of the Camera view over the Perspective view, which can't be animated over time.

If you turn on Orthographic Projection on a camera's Parameters rollout, that camera produces an axonometric view like a User view. See [Cameras](#) on page 5106 .

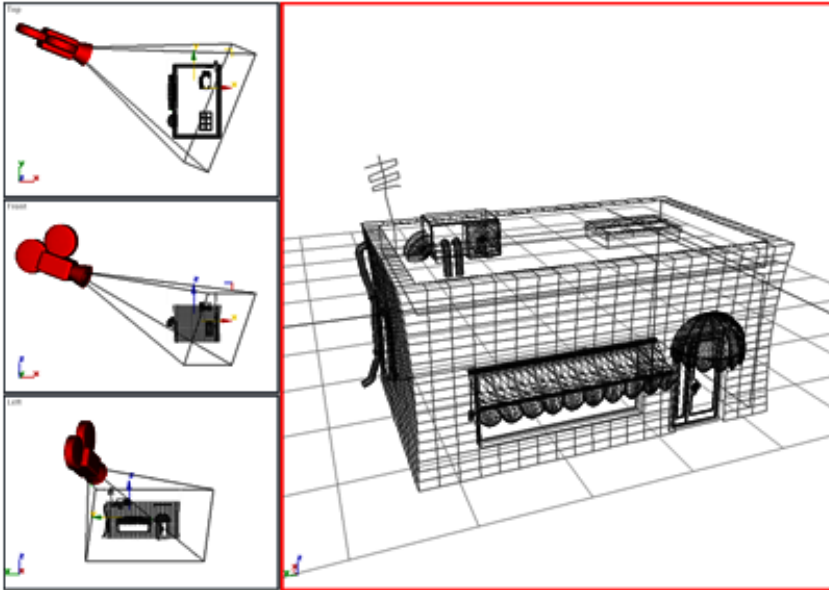

The viewport on the right is seen through a camera in the scene.

### **Two and Three-Point Perspective and the Camera Correction Modifier**

By default, camera views use three-point perspective, in which vertical lines appear to converge with height (in traditional photography this is known as *keystoning*). The [Camera Correction modifier](#) on page 5160 applies two-point perspective to a camera view. In two-point perspective, vertical lines remain vertical. A similar effect can be attained by putting a [Skew modifier](#) on a camera.

### **Light View**

Light view works much like a targeted camera view. You first create a spotlight or directional light and then set the active viewport to that spotlight. The easiest way is to press the keyboard shortcut `$`. See [Lights](#) on page 4890.

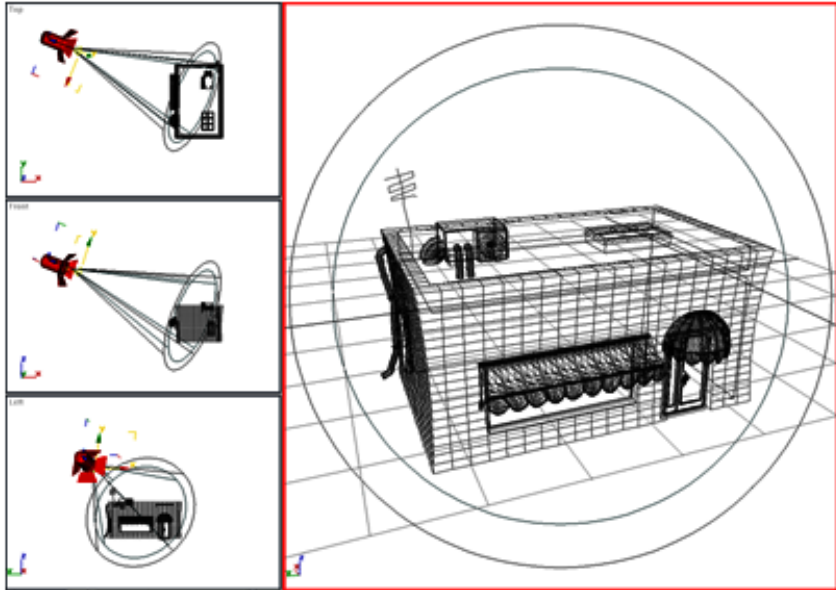

The viewport on the right looks through the lens of a spotlight in the scene.

## Setting Viewport Layout

3ds Max defaults to a two-over-two arrangement of viewports. Thirteen other layouts are possible, but the maximum number of viewports on the screen remains four.

Using the [Layout panel](#) on page 7617 of the Viewport Configuration dialog, you can pick from the different layouts and customize the viewports in each. Your viewport configuration is saved with your work.

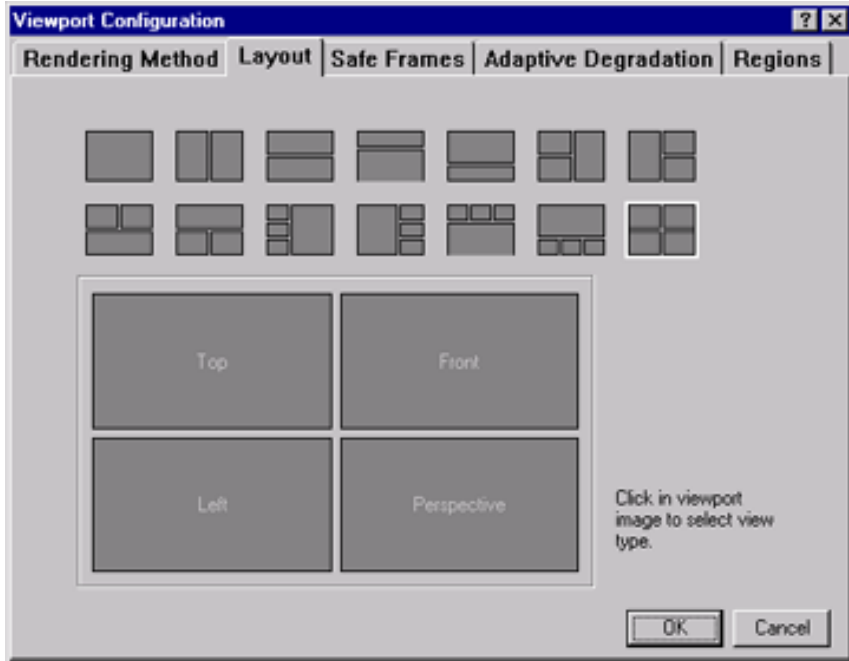

### Resizing the Viewport

After choosing a layout you can resize the viewports so they have different proportions by moving the splitter bars that separate the viewports. This is only available when multiple viewports are displayed.



Resized viewport

## Changing the View Type

As you work, you can quickly change the view in any viewport. For example, you can switch from front view to back view. You can use either of two methods: menu or keyboard shortcut.

- Right-click the label of the viewport you want to change and click Views. Then, click the view type that you want.
- Click the viewport you want to change, and then press one of the keyboard shortcuts in the following table.

Key	View type
T	Top view
B	Bottom view
F	Front view
L	Left view
C	Camera view. If your scene has only one camera, or you select a camera before using this keyboard shortcut, that camera supplies the view. If your scene has more than one camera, and none are selected, a list of cameras appears.
P	Perspective view. Retains viewing angle of previous view.
U	User (axonometric) view. Retains viewing angle of previous view. Allows use of <a href="#">page 7392</a> .
none	Right view. Use viewport right-click menu.
none	Shape view. Use viewport right-click menu. Automatically aligns view to the extents of a selected shape and its local XY axes.

See also:

- [Viewport Layout](#) on page 7617
- [Camera Viewport Controls](#) on page 7397
- [Spotlight Parameters](#) on page 5051
- [Precision and Drawing Aids](#) on page 2501
- [Track View](#) on page 3426

## Controlling Viewport Rendering

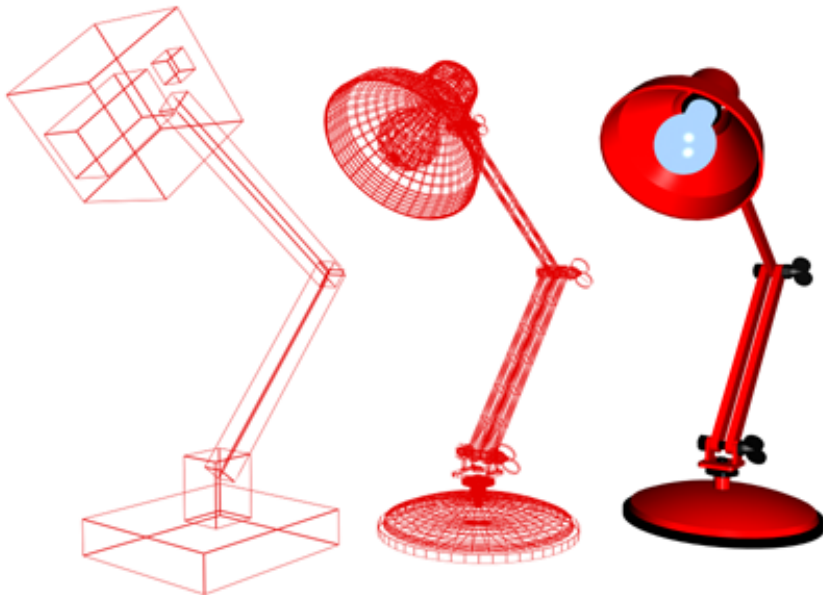

**Box display, wireframe display, and smooth shading**

You can choose from multiple options to display your scene. You can display objects as simple boxes, or render them with smooth shading and texture mapping. If you want, you can choose a different display method for each viewport.

---

**TIP** If you want to display individual objects as wireframe, you can use Wireframe materials. If you want individual objects to display as boxes, you can select the object and choose Display as Box on the Display properties rollout on the display panel.

---

## Using Viewport Rendering Controls

Viewport rendering options are found on the [Rendering Method panel](#) on page 7611 of the Viewport Configuration dialog. Using this panel you choose a rendering level and any options associated with that level. You can then choose whether to apply those settings to the active viewport or all viewports, or to all but the active viewport.

The rendering level you choose is determined by your need for realistic display, accuracy, and speed. For example, Box Mode display is much faster than Smooth Shading with Highlights. The more realistic the rendering level, the slower the display speed.

After choosing a rendering level, you can set rendering options. Different options are available for different rendering levels.

You can also use [ActiveShade](#) on page 5918 in a viewport. This feature helps you quickly preview changes you make to lighting and materials.

Viewport rendering has no effect on final renderings produced by clicking Render Scene.

## Rendering Methods and Display Speed

The rendering methods not only affect the quality of your view display, they can also have a profound effect on display performance. Using higher quality rendering levels and realistic options slows display performance.

After setting a rendering method, you can choose additional options that adjust display performance. One of these controls, Adaptive Degradation, speeds up display performance when you use realistic rendering levels.

---

**TIP** If your scene mysteriously disappears and only displays as boxes when you rotate your viewport, you have pressed the “o” key on the keyboard, and unintentionally turned on Adaptive Degradation.

---

See [Rendering Method](#) on page 7611 .

# Controlling Display Performance

3ds Max contains controls to help you adjust display performance: the balance between quality and time in displaying objects.

Depending on your needs, you might give up some display speed to work at higher levels of rendering quality, or you might choose to maximize display speed by using Wireframe or Bounding Box display. Which method you choose depends on your preferences and the requirements of your work.

## Display Performance Controls

You use display performance controls to determine how objects are rendered and displayed.

## Viewport Preferences

The Customize > Preferences dialog's Viewports panel contains options for fine-tuning the performance of the viewport display software. See [Viewport Preferences](#) on page 7545 .

## How Objects Are Displayed

To see and modify an object's display properties, right-click the object, select Properties, and go to the Display Properties group box; see [Object Properties](#) on page 245 . These options affect display performance much the same way as viewport rendering options. For example, turning on Vertex Ticks for an object with a lot of vertices will slow performance.

---

**NOTE** Display Properties are only available when the By Object/By Layer toggle is set to By Object.

---

To see and modify how objects are displayed, you can use [layers](#) on page 7224 . You can then quickly control the visibility and editability of similar objects from the quad menu.

## Which Objects Are Displayed

One way to increase display speed is not to display something. You can use the Hide and Freeze functions on the Display panel, quad menu, [Layer Manager](#) on page 7227 , and [Scene Explorer](#) on page 7171 to change the display state of objects in your scene. The Hide and Freeze features also affect final



Rendering and Video Post output. See [Hide Rollout](#) on page 120 and [Freeze Rollout](#) on page 122 .

### Setting Adaptive Degradation

Adaptive Degradation dynamically adjusts viewport rendering levels to maintain a desired level of display speed. You have direct control over how much "degradation" occurs and when it occurs.

The active levels determine which rendering levels 3ds Max falls back to when it cannot maintain the desired display speed. You can choose as many levels as you want but you are advised to choose only one or two levels for each type of degradation.

See [Adaptive Degradation](#) on page 7704 .

## Using Standard View Navigation

To navigate through your scene, use the view navigation buttons located at the lower-right corner of the program window. All view types, except Camera and Light views, use a standard set of view navigation buttons.



The standard navigation controls

### Button Operation

Clicking standard view navigation buttons produces one of two results:

- Executes the command and returns to your previous action.
- Activates a view navigation mode.

You can tell that you are in a navigation mode because the button remains highlighted (orange background). This mode remains active until you right-click or choose another command.

While in a navigation mode, you can activate other viewports of the same type, without exiting the mode, by clicking in any viewport. See [Viewport Controls](#) on page 7366 .

## Undoing Standard View Navigation Commands

Use the [Undo View Change](#) and [Redo View Change](#) commands on page 87 on the Views menu to reset standard view navigation commands without affecting other viewports or the geometry in your scene. These commands are also found in the menu displayed when you right-click a viewport label. Or you can use the keyboard shortcuts: Shift+Z for Undo View Change and Shift+Y for Redo View Change.

Views menu > Undo View Change and Views menu > Redo View Change are different from Undo and Redo commands on the Edit menu and main toolbar. 3ds Max maintains separate Undo/Redo buffers for scene editing and for each viewport.

The View Change Undo/Redo buffer stores your last 20 view navigation commands for each viewport. You can step back through the Undo View/Redo View buffer until you have undone all of the stored view-navigation commands.

## Zooming, Panning, and Rotating Views

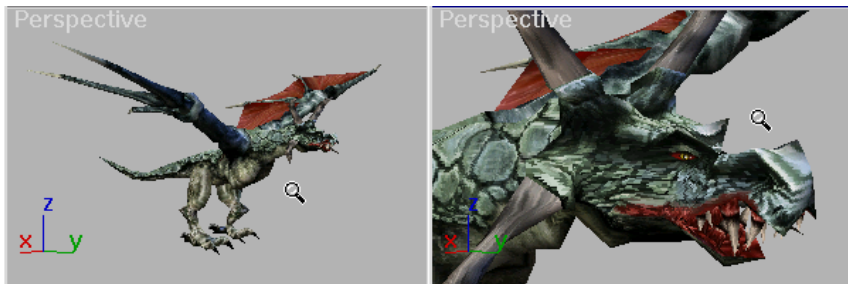

Before and after zooming a viewport

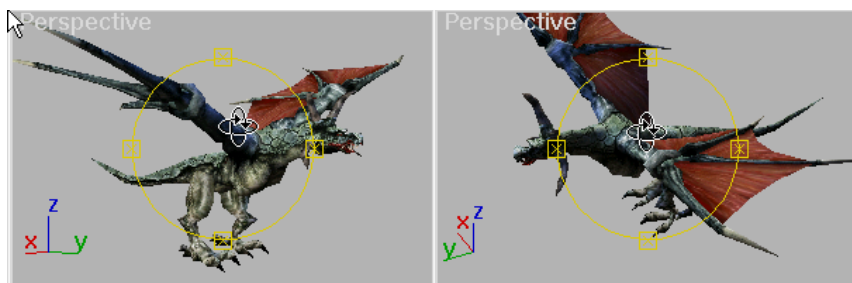

Before and after rotating a viewport

When you click one of the view navigation buttons, you can change these basic view properties:



**View magnification** Controls zooming in and out.



**View position** Controls panning in any direction.



**View rotation** Controls rotating in any direction

## Zooming a View



Click [Zoom](#) on page 7385 or [Zoom All](#) on page 7386 and drag in a viewport to change the view magnification. Zoom changes only the active view, while Zoom All simultaneously changes all non-camera views.



If a perspective view is active, you can also click [Field of View \(FOV\)](#) on page 7389 . The effect of changing FOV is similar to changing the lens on a camera. As FOV gets larger you see more of your scene and perspective becomes distorted, similar to using a wide-angle lens. As FOV gets smaller you see less of your scene and the perspective flattens, similar to using a telephoto lens.

---

**WARNING** Be cautious using extreme Field of View settings. These can produce unexpected results.

---

## Zooming a Region



Click [Zoom Region](#) on page 7392 to drag a rectangular region within the active viewport and magnify that region to fill the viewport. Zoom Region is available for all standard views.





In a perspective viewport, Zoom Region mode is available from the [Field of View flyout](#) on page 7389 .

## Zooming to Extents



Click the Zoom Extents or Zoom Extents All flyout buttons to change the magnification and position of your view to display the extents of objects in your scene. Your view is centered on the objects and the magnification changed so the objects fill the viewport.

-  The [Zoom Extents](#), [Zoom Extents Selected](#) buttons on page 7381 zoom the active viewport to the extents of all visible or selected objects in the scene.
-  The [Zoom Extents All](#), [Zoom Extents All Selected](#) buttons on page 7381 zoom all viewports to the extents of all objects or the current selection.

## Panning a View



Click [Pan View](#) on page 7393 and drag in a viewport to move your view parallel to the viewport plane. You can also pan a viewport by dragging with the middle mouse button held down while any tool is active.

## Rotating a View



Click [Arc Rotate](#), [Arc Rotate on Selection](#), or [Arc Rotate Sub-Object](#) on page 7395 to rotate your view around the view center, the selection, or the current sub-object selection respectively. When you rotate an orthogonal view, such as a Top view, it is converted to a User view.

With Arc Rotate, if objects are near the edges of the viewport they might rotate out of view.



With Arc Rotate Selected, selected objects remain at the same position in the viewport while the view rotates around them. If no objects are selected, the function reverts to the standard Arc Rotate.



With Arc Rotate Sub-Object, selected sub-objects or objects remain at the same position in the viewport while the view rotates around them.

---

**NOTE** You can rotate a view by holding down the Alt key while you drag in a viewport using middle-button. This uses the current Arc Rotate mode, whether or not the Arc Rotate button is active. You can also activate Arc Rotate by pressing Ctrl+R.

---

## Using Walkthrough Navigation

Walkthrough navigation lets you move through a viewport by pressing a set of shortcut keys, including the arrow keys, much as you can navigate a 3D world in many video games.

When you enter the walkthrough navigation mode, the cursor changes to a hollow circle that shows a directional arrow while you are pressing one of the directional keys (forward, back, left, or right).

This feature is available for perspective and camera viewports. It is not available for orthographic views or for spotlight viewports.

### Animating a Walkthrough

When you use walkthrough navigation in a Camera viewport, you can animate the camera walkthrough using either [Auto Key](#) on page 7344 or [Set Key](#) on page 3010 . In either case, to get an animated camera you have to change the frame number manually (the easiest way is to use the [Time Slider](#) on page 7312 ), and in the case of Set Key, you have to change the frame number *and* click Set Keys.

---

**TIP** Select the camera before you animate it. If the camera isn't selected, its keys won't appear in the [Track Bar](#) on page 7315 .

---

### Procedures

To begin using walkthrough navigation, do one of the following:

- 1 Press the Up Arrow key.

- 2 . Click the [Walk Through button](#) on page 7383 to turn it on.

This button is found on the [Pan/Truck And Walkthrough flyout](#) on page 7383 .

To stop using walkthrough navigation, do one of the following:

- 1 Right-click.
- 2 Activate a different viewport.
- 3 Change the active viewport to a different type.
- 4 Turn on a different viewport navigation tool (such as Zoom or Pan).
- 5 Turn on Select Object or one of the transform tools.

---

**NOTE** You *do not* exit walkthrough mode when you select an object or change the viewport shading type (between shaded and wireframe, for example).

---

### Interface

The Walk Through button is the only graphical element of the interface to walkthrough navigation. The other features are provided by mouse actions or by keyboard shortcuts. The following table shows the keyboard actions:

Command	Shortcut
Accelerate Toggle	Q
Back	S, Down Arrow
Decelerate Toggle	Z
Decrease Rotation Sensitivity	
Decrease Step Size	[
Down	C, Shift+Down Arrow
Forward	W, Up Arrow
Increase Rotation Sensitivity	
Increase Step Size	]

Command	Shortcut
Invert Vertical Rotation Toggle	
Left	A, Left Arrow
Level	Shift+Spacebar
Lock Horizontal Rotation	
Lock Vertical Rotation	Spacebar
Reset Step Size	Alt+[
Right	D, Right Arrow
Up	E, Shift+Up Arrow

If nothing appears in the Shortcut column, no default key is assigned to this command. You can set custom keystrokes using the [Keyboard panel](#) on page 7489 of the Customize User Interface dialog.

### Forward, Backward, and Sideways Movement

For movement, you can use either the arrow keys, or letters at the left of the keyboard pad.

**TIP** When you are in a Perspective viewport, you can use Undo View Change and Redo View Change (Shift+Z, Shift+Y) to undo or redo your navigation. However, when you are in a Camera viewport, walkthrough animation transforms the camera object, so you must use Edit > Undo and Edit > Redo (Ctrl+Z and Ctrl+Y).

Holding down any of these keys causes the motion to be continuous.

**Forward** W or the Up Arrow. Moves the camera or the viewpoint forward.

**NOTE** If you are not already in walkthrough navigation mode, pressing Up Arrow enters it.

**Back** S or Down Arrow. Moves the camera or the viewpoint backward.

When you are in a camera viewport, Forward and Back are equivalent to dollying in or out.

**Left** A or Left Arrow. Moves the camera or the viewpoint to the left.

**Right** D or Right Arrow. Moves the camera or the viewpoint to the right.

When you are in a camera viewport, Left and Right are equivalent to trucking left or right.

**Up** E or Shift+Up Arrow. Moves the camera or the viewpoint up.

**Down** C or Shift+Down Arrow. Moves the camera or the viewpoint down.

## **Acceleration and Deceleration**

**Accelerate Toggle and Decelerate Toggle** Pressing Accelerate (Q) causes motion to be quicker. Pressing Decelerate (Z) causes movement to be slower. These controls are toggles: pressing the key a second time restores the default motion rate (and pressing the alternate key turns off the first). They are especially useful when you are navigating by holding down keys.

The acceleration and deceleration toggles are independent of the step size.

## **Adjusting Step Size**

**Increase Step Size and Decrease Step Size** Pressing Increase Step Size (J) increases the motion increments when you move the camera or viewpoint. Pressing Decrease Step Size (I) reduces them. You can press either of these shortcuts repeatedly, to increase the effect. Changing the step size is apparent when you navigate either by single clicks, or by holding down keys. Step size changes are useful for adjusting movement to the scale of the scene. They are saved with the MAX file.

**Reset Step Size** Pressing Reset Step Size (Alt+I) restores the step size to its default value.

The step size is independent of acceleration or deceleration.

## **Rotation (Tilting)**

**Tilt View** Click+drag to tilt the camera or viewpoint.

When you are in a camera viewport, Tilt View is equivalent to panning the camera.

**Increase Rotation Sensitivity and Decrease Rotation Sensitivity** Pressing Increase Rotation Sensitivity (no default key) increases the motion increments



when you use Tilt View. Pressing Decrease Rotation Sensitivity (no default key) decreases them. You can press either of these shortcuts repeatedly, to increase the effect. They are useful for adjusting movement to the scale of the scene. They are saved with the MAX file.

**Lock Horizontal Rotation** Pressing Lock Horizontal Rotation (no default key) locks the horizontal axis, so the camera or viewpoint tilts only vertically.

**Lock Vertical Rotation** Pressing Lock Vertical Rotation (Spacebar) locks the vertical axis, so the camera or viewpoint tilts only horizontally.

**Invert Vertical Rotation Toggle** Pressing Invert Vertical Rotation (no default key) inverts the tilt direction when you drag the mouse. When this toggle is off, dragging up causes scene objects to descend in the view, and dragging down causes them to rise (this is like tilting a physical camera). When this toggle is on, objects in the view move in the same direction you are dragging the mouse.

**Level** Pressing Level (Shift+Spacebar) removes any tilt or roll the camera or viewpoint might have, making the view both level and vertical.

## Navigating Camera and Light Views



The camera navigation buttons

The Camera and Light view navigation buttons are the same with a few exceptions. The buttons are visible when a viewport with a Camera or Light view is active. The Camera and Light view navigation buttons do more than adjust your view. They transform and change the parameters of the associated camera or light object.

Light views treat the light (spotlight or directional light) as if it were a camera. The light falloff is treated the same as the camera field of view.

Keep in mind the following:

- Using the Camera and Light viewport navigation buttons is the same as moving or rotating the camera or Light, or changing their base parameters.

- Changes made with Camera or Light view navigation buttons can be animated the same as other object changes.

### Zooming a Camera or Light View

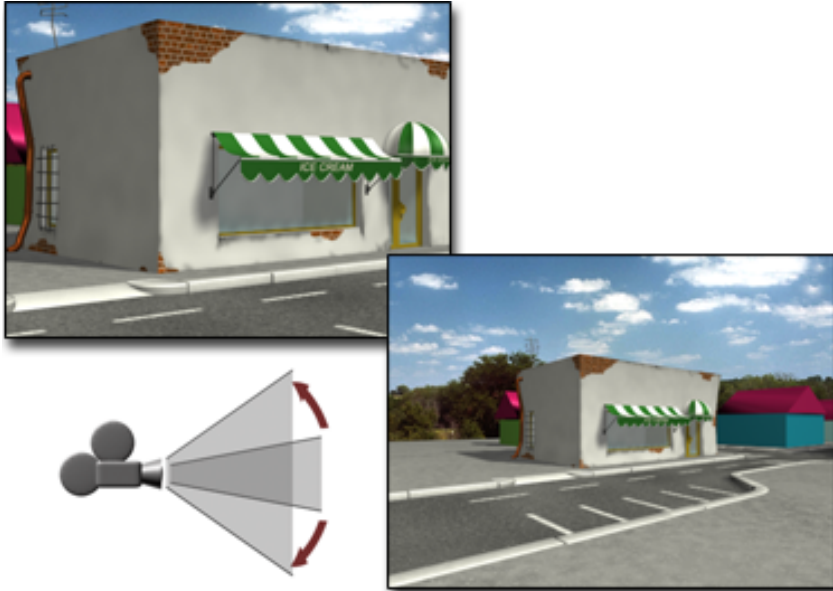

#### Zooming a camera



You zoom a camera view by clicking [FOV](#) on page 7389 and then dragging in the Camera viewport.

The field of view defines the width of your view as an angle with its apex at eye level and the ends at the sides of the view. The effect of changing FOV is exactly like changing the lens on a camera. As the FOV gets larger you see more of your scene and the perspective becomes distorted, similar to using a wide-angle lens. As the FOV gets smaller you see less of your scene and the perspective flattens, similar to using a telephoto lens. See [Cameras](#) on page 5106 .







Click [Light Hotspot](#) on page 7411 for a light viewport to achieve the same effect as zooming.

The hotspot is the inner of the two circles or rectangles visible in a light viewport. Objects inside the hotspot are illuminated with the full intensity of the light. Objects between the hotspot and falloff are illuminated with decreasing intensity as objects approach the falloff boundary. See [Using Lights](#) on page 4894 .

### **Moving a Camera or Light View**

You move a camera or light view by clicking one of the following buttons and dragging in the camera or light viewport.

-  [Dolly](#) on page 7398 moves the camera or light along its line of sight.
-  [Truck](#) on page 7403 moves the camera or light and its target parallel to the view plane.
-  [Pan](#) on page 7404 moves the target in a circle around the camera or light. This button is a flyout that shares the same location with Orbit.
-  [Orbit](#) on page 7404 moves the camera or light in a circle around the target. The effect is similar to Arc Rotate for non-camera viewports.

## Rolling a Camera or Light View

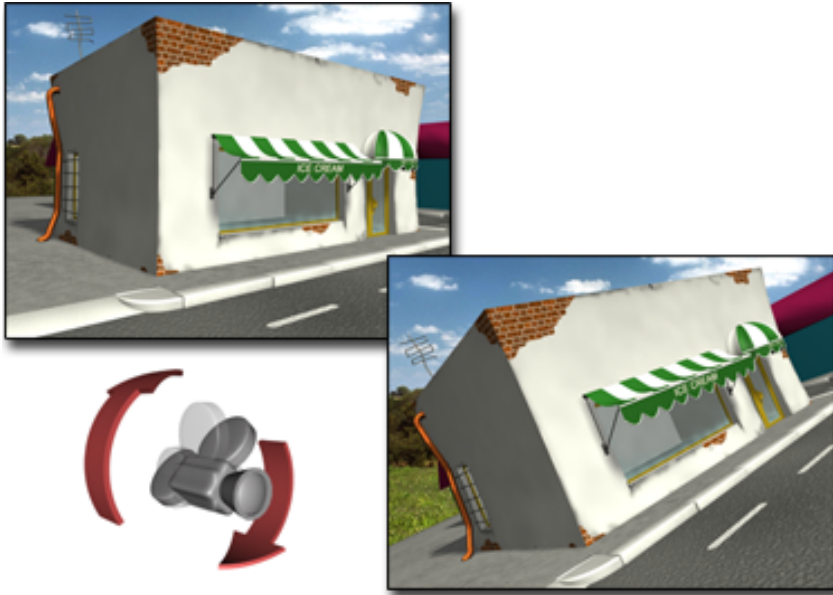

### Rolling a camera



Click [Roll](#) on page 7401 , and drag in a camera or a light viewport to rotate the camera or light about its line of sight. The line of sight is defined as the line drawn from the camera or light to its target. The line of sight is also the same as the camera's or the light's local Z axis.

## Changing Camera Perspective

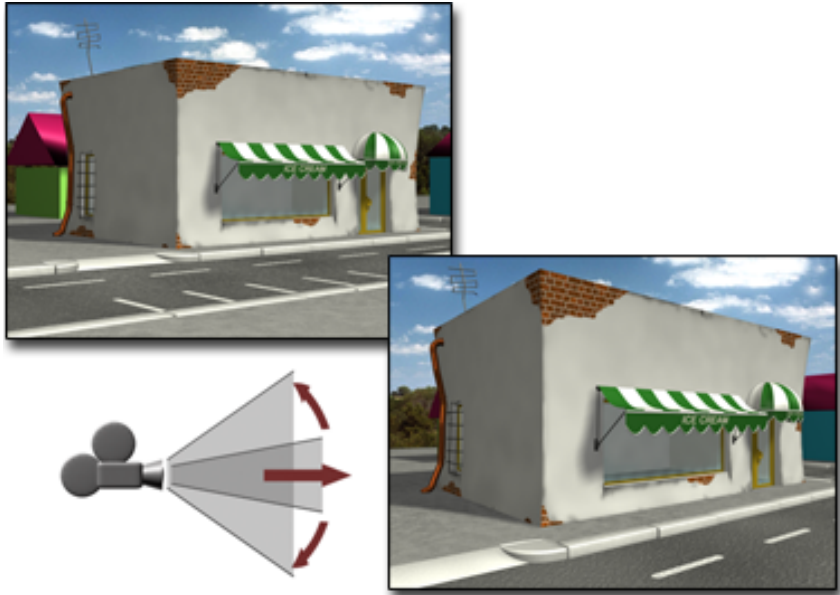

### Changing perspective



Click [Perspective](#) on page 7400 , and drag in a camera viewport to change the Field of View (FOV) and dolly the camera simultaneously. The effect is to change the amount of perspective flare while maintaining the composition of the view.

## Adaptive Degradation



status bar > Adaptive Degradation button

Views menu > Adaptive Degradation



Keyboard > O (the letter O)

Adaptive degradation can improve viewport performance when you transform geometry, change the view, or play back an animation. It does so by decreasing the visual fidelity of certain objects temporarily; for example, by drawing

larger objects or those closer to the camera as bounding boxes instead of wireframes. Without adaptive degradation, the geometry is displayed as usual, even if that slows down viewport display and animation playback. Animation playback might drop frames if the graphics card cannot display the animation in real time.

Turn on adaptive degradation if you have large models you need to navigate around and if you are finding performance sluggish.

The Adaptive Degradation button on the status bar has three states:

-  **Off:** No degradation occurs.
-  **On:** Degradation can occur under the specified conditions. This is the default setting.
-  **Active:** Degradation is being applied currently.

You can change the display options and set other adaptive degradation parameters, on the Viewport Configuration dialog (Customize menu > Viewport Configuration > [Adaptive Degradation panel](#) on page 7622 ). Also, you can toggle adaptive degradation for individual objects with the Object Properties > [Never Degrade setting](#) on page 252 .

## Procedures

**To toggle adaptive degradation, do one of the following:**

- Choose Views menu > Adaptive Degradation.
- Press O (the letter O).

**To change the level of adaptive degradation in the viewports:**

- 1 Right-click the viewport label and choose Configure, or choose Customize > Viewport Configuration.
- 2 On the Viewport Configuration dialog, open the Adaptive Degradation panel and adjust the settings.

# Grab Viewport

Tools menu > Grab Viewport

Grab Viewport creates a snapshot of the active viewport in the [Rendered Frame Window](#) on page 5885 , where you can save it as an [Image file](#) on page 7116 .

## Procedures

To create a snapshot of a viewport:

- 1 Activate the viewport you want to capture.
- 2 Choose Tools menu > Grab Viewport.  
A dialog appears that allows you to add a label to your snapshot.
- 3 Enter a label for your snapshot, if desired.  
The label appears in the lower-right corner of the image as you enter it into the dialog.
- 4 Click Grab.  
The Rendered Frame Window opens to display a snapshot of your viewport.
- 5 Use the controls in the Rendered Frame Window to save your image.

## Interface

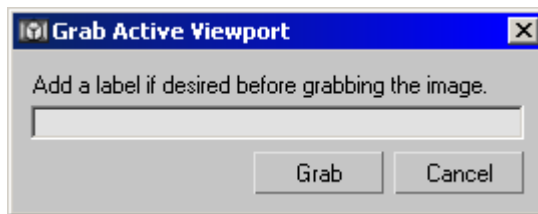

**Label** Enter text here to add a label to your screenshot. The text you enter is displayed in the lower-right corner of your screenshot.

**Grab** Opens the Rendered Frame Window with a snapshot of the active viewport.

**Cancel** Cancels the Grab Viewport command.

# View-Handling Commands

Menu bar > Views menu

These viewport-handling commands are provided on the default main menu:

[Views Menu](#) on page 7262

[Undo View Change / Redo View Change](#) on page 87

[Save Active View](#) on page 88

[Restore Active View](#) on page 88

[Grid Commands](#) on page 2564

[Viewport Background](#) on page 89

[Select Background Image Dialog](#) on page 97

[Update Background Image](#) on page 102

[Reset Background Transform](#) on page 103

[Show Transform Gizmo](#) on page 103

[Show Ghosting](#) on page 104

[Show Key Times](#) on page 105

[Shade Selected](#) on page 107

[Show Dependencies](#) on page 108

[Create Camera From View](#) on page 109

[Add Default Lights to Scene](#) on page 111

[Redraw All Views](#) on page 113

[Global Viewport Rendering Setting](#) on page 114

[Update During Spinner Drag](#) on page 115

[Adaptive Degradation](#) on page 83

[Diagnose Video Hardware](#) on page 115

[Expert Mode](#) on page 116

**See also:**

■ [Viewing and Navigating 3D Space](#) on page 55



- [Views Menu](#) on page 7262
- [Quad Menu](#) on page 7300

## Undo View Change / Redo View Change

Views menu > Undo View Change or Redo View Change

Keyboard > Shift+Z (Undo) or Shift+Y (Redo)

Undo View Change cancels the last change made to the current viewport.  
Redo View Change cancels the last Undo in the current viewport.

These commands act like Undo and Redo on the main toolbar and Edit menu, but operate on a different list of events. They affect changes made *to* the viewport, rather than changes made to *objects in* the viewport.

Use Undo View Change and Redo View Change when you have inadvertently made a view unusable by zooming in too close, or rotating the wrong way. You can keep stepping back until a useful view appears. The keyboard shortcuts are handy for multiple commands.

You can also access Undo View Change and Redo View Change of view changes by right-clicking the viewport label and choosing Undo View or Redo View. The last change made in that viewport will be indicated (for example, "Undo View Zoom"). Each viewport has its own independent undo/redo stack.

Camera and Spotlight viewports use object-based Undo and Redo, because the viewport change is actually a change to the camera or spotlight object. In these viewports, use Edit > Undo (Ctrl+Z) or Edit > Redo ( Ctrl+Y ).

### Interface

**Undo View Change** Cancels viewport changes. The name of the change you're undoing is displayed in the View menu beside the command.

Undo is useful when you are working with a background image in the viewport. You can zoom into the geometry to adjust it, then use Undo Viewport Zoom to restore the original alignment of the geometry with the background.

**Redo View Change** Cancels the previous Undo View Change. The name of the change you're redoing appears in the View menu beside the command.

## Save Active View

Views menu > Save Active View (the name of the active viewport is part of the command)

Save Active View stores the active view to an internal buffer. If you have framed a shot in any view other than a camera, use Save Active View to preserve the viewport's appearance. The saved active view is saved with the scene file. Once saved, you can retrieve it using [Restore Active View](#) on page 88 .

The viewport that will be restored is displayed in the menu item (for example, "Save Active Perspective View"). You can save and restore up to eight different views (Top, Bottom, Left, Right, Front, Back, User, Perspective).

Viewport changes that are saved include viewport type, zoom and rotations, and field-of-view (FOV).

The options available on the [viewport right-click menu](#) on page 7370 , such as Show Safe Frame and Viewport Clipping, are not saved. If these settings are important to the view, make a note of what they are so you can reset them after restoring the view.

### Procedures

#### To save an active view:

- 1 Activate the viewport with the view you want to save.
- 2 Choose Views menu > Save Active View. The view is now saved and can be recalled using Restore Active View.

## Restore Active View

Views menu > Restore Active View (the name of the active viewport is part of the command.)

Restore Active View displays the view previously stored with [Save Active View](#) on page 88 .

The viewport to be restored is displayed in the menu item (for example, "Restore Active Perspective View").

The active view is restored if the same viewport and layout are active.

If an active view won't restore with this command, check the following:

- Be sure the viewport is active.
- Make sure the layout is the same as before. Use Viewport Configuration (right-click any viewport label and choose Configure) and choose Layout.
- If the layout and active viewport are the same, be sure Viewport Clipping on the [Viewport Right-Click Menu](#) on page 7370 is set the same as it was when the viewport was saved.

## Procedures

**To restore a saved view:**

- 1 Activate the viewport where you saved the view.
- 2 Choose Views menu > Restore Active View. This option is available only in a viewport with a saved view.
- 3 The viewport returns to the saved view.

If you're not sure whether a viewport has a saved view, check the Views menu. Restore Active View is unavailable unless a view is saved in the active viewport.

# Viewport Background Dialog

Views menu > Viewport Background > Viewport Background dialog

Keyboard > Alt+B

The Viewport Background dialog controls display of an image or animation as the background for one or all viewports. You can use this for modeling, for example, by placing front, top or side view sketches in the corresponding viewports. Or use Viewport background to match 3D elements with digitized camera footage, or for [rotoscoping](#) on page 7912 .

You select the image or animation to display in the active viewport, set the frame synchronization between the animated image file and the current scene, and turn the assigned image on and off. These changes do not affect the rendered scene.

To place an image in the background of the rendered scene, use the Environment And Effects dialog > [Environment panel](#) on page 6484 , accessed from the Rendering menu.

---

**NOTE** When safe frames are displayed in a viewport, and the Aspect Ratio options are set to either Match Viewport or Match Rendering Output, the assigned viewport background image is confined to the Live area of the safe frames and will correctly match the rendered background bitmap.

---

**TIP** If you are using a viewport driver with hardware acceleration (OpenGL or Direct3D), the viewport background might not appear. If this happens, choose Customize > Preferences. In the [Viewports preferences](#) on page 7545, click Configure Driver. Then in the [Configure OpenGL dialog](#) on page 7588 or the [Configure Direct3D dialog](#) on page 7594, go to the Background Texture Size group and turn on Match Bitmap Size As Closely As Possible ( *do not change* the numeric setting). Click OK in both dialogs to accept your change.

---

**See also:**

- [Select Background Image Dialog](#) on page 97
- [Update Background Image](#) on page 102
- [Reset Background Transform](#) on page 103

## Procedures

**To assign an image to one or all viewports:**

- 1 Activate the viewport that is to display the background image.
- 2 Choose Views menu > Viewport Background or press Alt+B.  
This opens the Viewport Background dialog.
- 3 In the Background Source group, click the Files button.  
This opens the Select Background Image dialog.
- 4 Use the dialog to open the image or animation to use.
- 5 To display the image in all viewports, choose All Views in the Apply Source And Display To group.

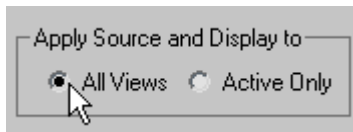

- 6 Click OK.

The image is displayed in a single viewport or all viewports.

**To update the image or map in the viewport:**

Because of the time it takes to render the image or map in the viewport, the map is not automatically updated when you alter the bitmap or assign a new bitmap.

- Choose Views menu > Update Background Image.  
The revised image or map is displayed in the viewport.

**To display the environment map in a viewport:**

- 1 In the Environment dialog, assign an environment map. (See the procedure [“To choose an environment map.”](#) on page 6486 )
- 2 In the Environment dialog > Background group, be sure Use Map is turned on (the default).
- 3 Activate the viewport where you want the map displayed.
- 4 Choose Views menu > Background Image.
- 5 In the Viewport Background dialog > Background Source group, turn on Use Environment Background.
- 6 Click OK.  
The map is displayed in the viewport.

**To display an animated background:**

- 1 Assign an animation file (AVI, MOV, or IFL file) as the viewport background.
- 2 Turn on Animate Background.
- 3 Choose Customize > Preferences. On the Viewports panel, turn on Update Background While Playing.  
Now the background plays when you click Play, or when you drag the time slider.

---

**TIP** If you follow these steps and the background still doesn't appear to animate, open the [Time Configuration dialog](#) on page 7359 and in the Playback group, turn off Real Time.

---

### To use the environment map with animation controls:

This procedure is useful if you've assigned an animated environment map and want access to the animation controls on the Viewport Background dialog.

- 1 In the Viewport Background dialog > Background Source group, turn off Use Environment Background.
- 2 In the same group, click File.
- 3 Choose the same map you're using as the environment map.
- 4 Set parameters in the Animation Synchronization group.
- 5 Click OK.  
The environment map appears in the viewport. The image is renderable.

### To match the viewport background with the rendered background:

- 1 Activate the viewport to render.
- 2 Right-click the viewport label and choose Show Safe Frame.  
This turns on [Safe Frames](#) on page 7618 in the viewport.

---

**NOTE** You can also use Views menu > Configure > Safe Frame tab. In the Application group, turn on Show Safe Frames In Active View.

---

- 3 In the Material Editor, create a material that contains the bitmap for your rendered background.
- 4 At the bitmap level of the Material Editor, on the Coordinates rollout, choose Environ.  
The Mapping control is automatically set to Screen. This is the only mapping type that works for this purpose.
- 5 On the main menu, choose Rendering > Environment.
- 6 Drag the map from the Material Editor > Maps rollout to the Environment Map button on the Environment dialog. Click OK on the Instance (Copy) Map dialog.
- 7 In the Viewport Background dialog > Background Source group, click Files to assign the same bitmap.
- 8 In the Aspect Ratio group, turn on either Match Viewport or Match Rendering Output. Click OK.

**9** Render the viewport.

The background displayed in the rendered scene should exactly match the background displayed in the Live area of the safe frames.

---

**NOTE** When you use the Match Bitmap option, the bitmap reverts to its original aspect ratio and does not match the rendered scene, unless you're rendering to the same aspect ratio.

---

**To remove a background image:**

- 1** Activate the viewport in which the background image is visible.
- 2** On the Views menu, choose Viewport Background.  
Notice the name and path of the background file is displayed in the Current field in the Background Source group
- 3** In the Background Source group, click Devices.
- 4** On the Select Image Input Device dialog, choose No I/O Handlers from the drop-down list, then click OK.
- 5** On the Bitmap Manager Error dialog, click OK.  
The current field no longer displays the background file name. Instead No I/O Handler is listed in the Current field.
- 6** Click OK to close the Viewport Background dialog.  
Next time you open up the Viewport Background dialog, no file name will be displayed in the Current field.

---

**TIP** This technique will work only on systems that don't have any other Image Input Devices installed.

---

## Interface

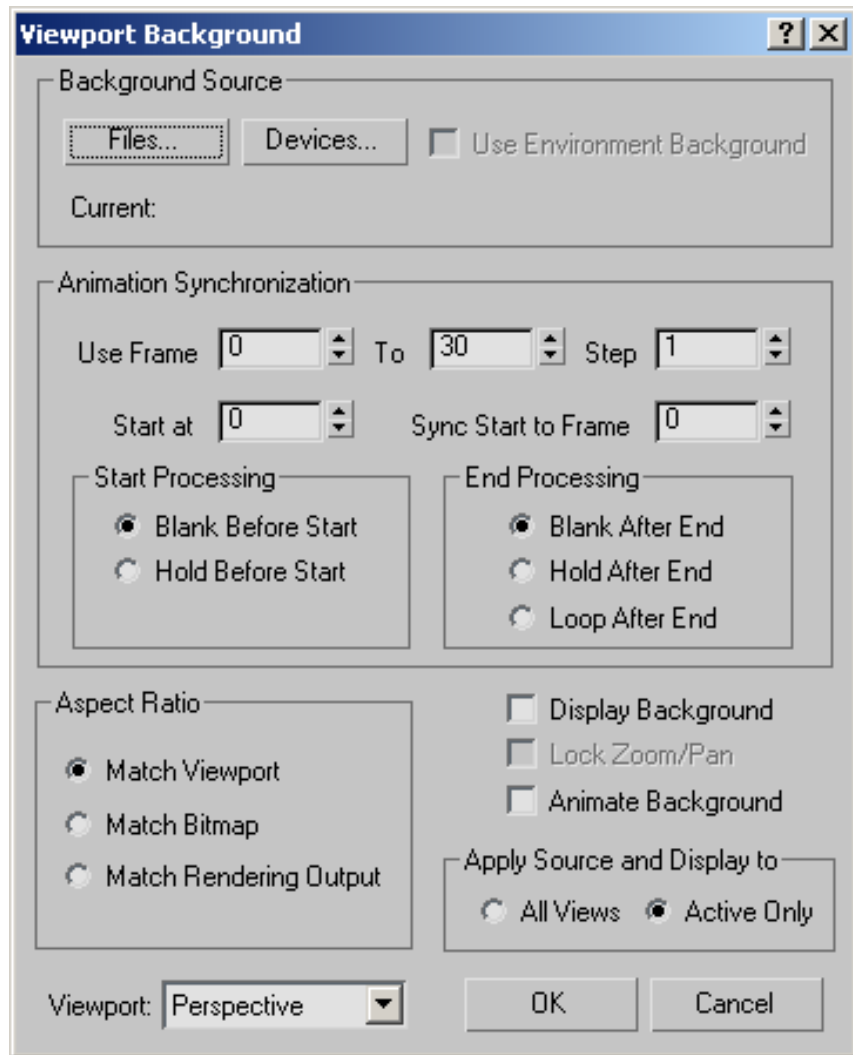

### Background Source group

Options let you select the background image, either from a [bitmap image file](#) on page 7730 , a video file, or from a device such as a video recorder.

**Files** Displays the [Select Background Image dialog](#) on page 97 , which lets you select a file or sequence of files for your background.



**Devices** Displays the Select Image Input Device dialog. This lets you use a background from a digital device. (No device is supported by the default 3ds Max installation.)

**Use Environment Background** Lets you display in the viewports the map you've assigned as your environment background. If no environment map has been assigned in the Environment dialog, or Use Map in that dialog is off, then the Use Environment Background check box is not available.

### **Animation Synchronization group**

Controls how sequences of images (for example, from [IFL](#) on page 7131 , [AVI](#) on page 7118 , or [MOV](#) on page 7140 files) are synchronized to the viewport for [rotoscoping](#) on page 7912 .

**Use Frame** The first field sets the first frame of the incoming sequence that you want to use, and the second field sets the last one.

**Step** Sets the interval between the frames you want to use. For example, if this spinner is set to 7, 3ds Max uses every seventh frame.

**Start At** Specifies the frame number at which you want the first input frame to appear. What happens in the viewport before the start frame depends on the option you choose for "Start Processing," below.

**Sync Start To Frame** Determines which frame from your incoming sequence is displayed at the Start At frame. For example, you could have a 30-frame IFL sequence that starts in your scene at frame 10, but you could use the 5th frame from the IFL on frame 10 by setting Sync Start to 5.

### **Start Processing group**

Determines what happens in the viewport background before the start frame.

**Blank Before Start** Makes the viewport background blank before the start frame.

**Hold Before Start** Specifies that the viewport background will contain the start frame.

### **End Processing group**

Determines what happens in the viewport background after the last input frame.

**Blank After End** Makes the viewport background blank after the last input frame.

**Hold After End** Specifies that the viewport background will contain the last input frame until the last frame in the animation.

**Loop After End** Specifies that the viewport background will loop from the end frame back to the start frame, ad infinitum.

### **Aspect Ratio group**

Controls the proportions of the viewport background by matching it to the bitmap, rendering output, or to the viewport itself.

**Match Viewport** Changes the [aspect ratio](#) on page 7718 of the image to match the aspect ratio of the viewport.

**Match Bitmap** Locks the aspect ratio of the image to the native aspect ratio of the bitmap.

**Match Rendering Output** Changes the aspect ratio of the image to match the aspect ratio of the currently chosen rendering output device.

---

**NOTE** When the Match Bitmap or Match Rendering Output option is chosen, 3ds Max centers the image and clears the edges of the viewport to the background color.

---

### **Display Background**

Turns on display of the background image or animation in the viewport.

### **Lock Zoom/Pan**

Locks the background to the geometry during zoom and pan operations in orthographic or user viewports. When you Zoom or Pan the viewport, the background zooms and pans along with it. When Lock Zoom/Pan is turned off, the background stays where it is, and the geometry moves independently of it. Use Match Bitmap or Match Rendering Output to enable Lock Zoom/Pan. This control is disabled if you choose Match Viewport.

Keyboard shortcut: Ctrl+Alt+B

---

**WARNING** If you zoom in too far, you can exceed the limit of virtual memory, and crash 3ds Max. When you perform a zoom that requires more than 16 megabytes of virtual memory, an alert asks if you want to display the background during the zoom. Choose No to perform the zoom and turn off the background. Choose Yes to zoom with the background image. Your machine might run out of memory as a result.

---

## **Animate Background**

Turns on animation of the background. Shows the appropriate frame of the background video in the scene.

## **Apply Source And Display To group**

**All Views** Assigns the background image to all viewports.

**Active Only** Assigns the background image to only the active viewport.

## **Viewport**

The name of the currently active viewport appears in a list to the left of the OK and Cancel buttons. This reminds you which viewport you're working with and lets you change the active viewport by selecting its name from the list.

---

**NOTE** When you use different images for different viewports, the settings for each viewport are stored separately. Each time you display the Viewport Background dialog, the settings of the currently active viewport are displayed. If you switch the viewport using the list, the settings remain the same. This is useful for copying settings from one viewport to another.

---

# **Select Background Image Dialog**

Views menu > Viewport Background > Background Source group > Files > Select Background Image dialog



**UFO model rendered against a background**

The Select Background Image dialog allows you to choose a file or sequence of files for a viewport background.

You can also convert a set of sequentially numbered files to an [Image File List \(IFL\)](#) on page 7131 . This is the same process used by the [IFL Manager Utility](#) on page 7136 .

### **Procedures**

**To select a background image for a viewport:**

- 1 Activate the viewport where you want the image.
- 2 Choose Views menu > Viewport Background.
- 3 Under Background Source in the dialog that displays, click Files.
- 4 In the Look In field, navigate to the directory containing the file you want to use for the background.

---

**NOTE** The Select Background Image File dialog uses the last location where a bitmap was chosen, rather than the default bitmap path defined on the [Configure User Paths dialog](#) on page 7520 .

---

- 5 Highlight the file name in the file list window.
- 6 Click Open to select the image and close the dialog.
- 7 Click OK to close the Viewport Background dialog and display the background image.

**To select a set of still images as a viewport background:**

- 1 Activate the viewport where you want the image.
- 2 Choose Views menu > Viewport Background.
- 3 Under Background Source, click Files.
- 4 In the Look In field, navigate to the directory containing the sequence of files.

The files must be sequentially numbered (for example, *image01.bmp*, *image02.bmp*, *image03.bmp*).

---

**TIP** If necessary, change Files Of Type to match the file extension of the sequence, or choose All Formats.

---

- 5 Turn on Sequence, and choose the name of the first sequential file (for example, *image01.bmp*).

---

**TIP** Click the Setup button to display the [Image File List Control dialog](#) on page 7134 .

---

- 6 In the Image File List Control dialog, use the Browse button to set the Target Path to a directory on your hard disk. Do not set this path to a CD-ROM drive, because you cannot save the file there.
- 7 Choose the options you want, and then click OK.  
The Image File List (IFL) file is saved to the target directory.

## Interface

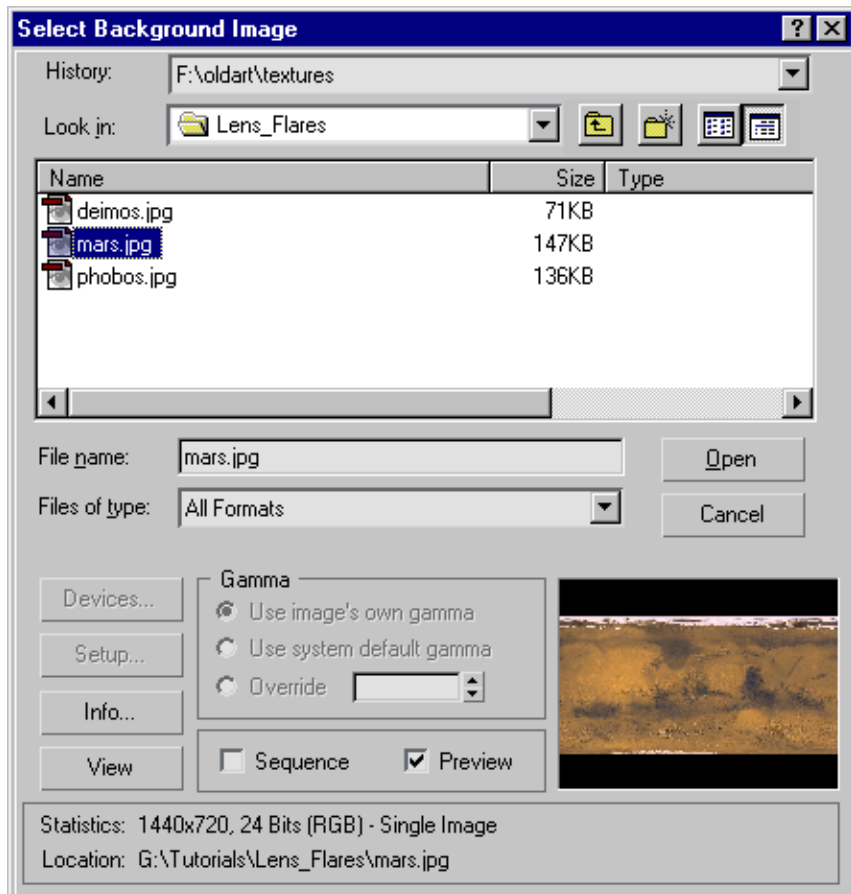

**History** Displays a list of the directories most recently searched.

**Look In** Opens a navigation window to move to other directories or drives.



**Up One Level** Move up a level in the directory structure.



**Create New Folder** Lets you create a new folder while in this dialog.



**List** Displays the contents of a directory by file name.



**Details** Displays the contents of a directory including all the file details.

**List Window** When Details is on, the contents of the directory are displayed with Name, Size, Type, Date Modified, and Attributes. You can sort the files by clicking the label of each parameter.

**File Name** Displays the name of the file selected in the list.

**Files of Type** Displays all the file types that can be displayed. This serves as a filter for the list.

**Open** Selects the highlighted file and closes the dialog.

**Cancel** Cancels the selection and closes the dialog.

**Devices** Lets you select a background image from a digital device. (No device is supported by the default 3ds Max installation.)

**Setup** Displays the [Image File List Control dialog](#) on page 7134 to create an IFL file. Available only when Sequence is on and there are sequentially numbered files in the displayed directory.

**Info** Displays expanded information about the file, such as frame rate, compression quality, file size, and resolution. The information here is dependent on the type of information that is saved with the file type.

**View** Displays the file at its actual resolution. If the file is a movie, the Media Player is opened to play the file.

## **Gamma group**

Selects the type of gamma to be used for the selected file. Available only when Enable Gamma Selection is turned on in the [Gamma panel](#) on page 7550 .

**Use Image's Own Gamma** Uses the gamma of the incoming bitmap.

**Use System Default Gamma** Ignores the image's own gamma and uses the system default gamma instead, as set in the [Gamma panel](#) on page 7550 .

**Override** Defines a new gamma for the bitmap that is neither the image's own, nor the system default.

**Sequence** Creates an "Image File List" to your specifications. Each selected image is checked to see if a valid IFL sequence can be created. If the selected image doesn't yield a list, this option is still available, but doesn't do anything.

**Preview** Displays the image as a thumbnail in the Image Window.

**Image Window** Displays a thumbnail of the selected file if Preview is on.

**Statistics** Displays the resolution, color depth, file type and number of frames of the selected file.

**Location** Displays the full path for the file. With this information at the bottom of the dialog, you always know exactly where you are.

## Update Background Image

Views menu > Update Background Image (available only when a viewport background is displayed)

This command updates the background image displayed in the active viewport. If the active viewport is not displaying a background image, this command is unavailable.

Use this command to update the background for changes that are not updated automatically, such as the following:

- Reassigning the map, or changing any parameters affecting the map in the Materials Editor, the Environment dialog, or the Viewport Background dialog.
- Changing the rendering resolution and aspect ratio.  
The following changes update the viewport background image automatically:
  - Changing the camera view.
  - Undo (for views).
  - Undo (for objects).
  - Assigning a different view type.
  - Toggling Safe Frames display on or off.
  - Changing the rendering parameters.
  - Moving the time slider when the viewport contains an animated background image.

---

**NOTE** Viewports can use the current Environment Map (set on the [Environment panel](#) on page 6486 of the Environment and Effects dialog) as the background image.

---



## Procedures

To update the background image displayed in a viewport:

- 1 Activate a viewport that contains a background image.
- 2 Choose Views menu > Update Background Image.

# Reset Background Transform

Views menu > Reset Background Transform (available only when a viewport background image is displayed and Lock Zoom/Pan is turned on)

Reset Background Transform rescales and recenters the current background to fit an orthographic or user viewport. Use this command when you want to reset the background to the new position of your geometry. See Procedure for detailed requirements.

## Procedures

To reset the background to fit the viewport:

- 1 Activate an orthographic or user viewport that has a background image.
- 2 Press Alt+B.
- 3 Turn on either Match Bitmap or Match Rendering Output, and then turn on Lock Zoom/Pan.
- 4 Click OK.
- 5 Choose Views menu > Reset Background Transform.  
The background image readjusts in the viewport.

# Show Transform Gizmo

Views menu > Show Transform Gizmo

Keyboard > X

Show Transform Gizmo toggles the display of the Transform gizmo [axis tripod](#) on page 860 for all viewports when objects are selected and a transform is active.

Additional controls for the Transform gizmo are found on the [Gizmo Preferences settings](#) on page 7570 .

When the Transform gizmo is turned off, Show Transform Gizmo controls the display of the axis tripod on selected objects.

The state of Transform gizmo is saved in `3dsmax.ini` , so it's maintained between scenes and sessions.

The related entries in the `3dsmax.ini` file are:

- INI: Transformgizmo=1 (for Transform Gizmo visibility, controlled by Preferences)
- INI: ShowAxisIcon=1 (for Axis Icon visibility, controlled in Views menu)

The visibility of the Axis tripod overrides the visibility of the Transform Gizmo. If you turn off the Transform Gizmo in Preferences, the Axis tripod remains on the selected object. If you then turn off the Show Transform Gizmo in the Views menu, it actually turns off the Axis tripod. When the Axis tripod is disabled, the Transform Gizmo is also hidden.

---

**TIP** The converse is not true. If the transform gizmo is turned off, turning on the axis tripod visibility does not display the transform gizmo.

---

## Procedures

**To scale the transform gizmo, do one of the following:**

- 1 Press – (hyphen) to shrink the Transform gizmo.
- 2 Press = (equal sign) to enlarge the Transform gizmo.

## Show Ghosting

Views menu > Show Ghosting

Ghosting is a method of displaying wireframe "ghost copies" of an animated object at a number of frames before or after the current frame. Use it to analyze and adjust your animation. Ghosts that overlap indicate slower motion; ghosts that are spread further apart show faster motion.

When this command is active, ghosting is displayed for selected objects in the scene. Only currently selected objects display the ghosting.

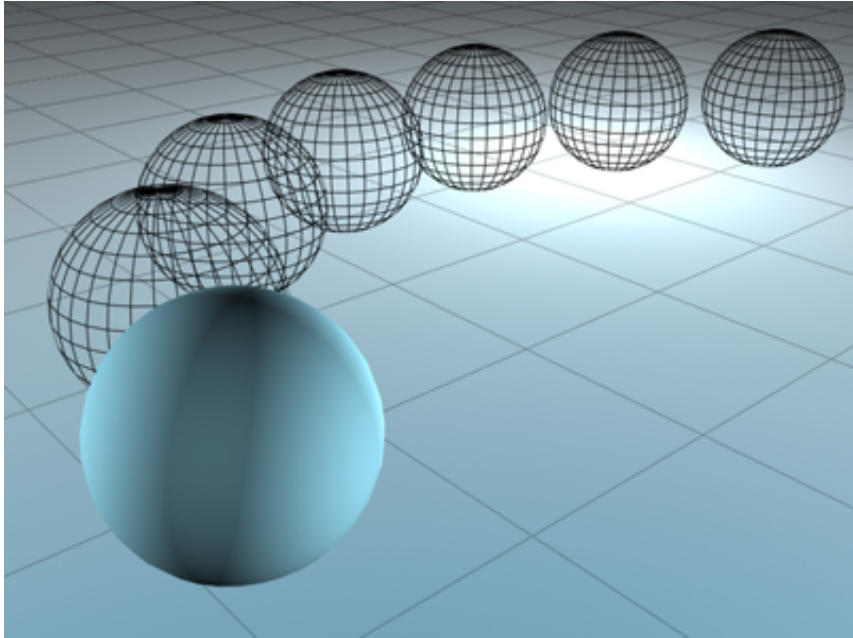

**Ghosting helps to visualize animation.**

To change Ghosting parameters choose **Customize > Preferences**. On the Viewport panel of the Preferences dialog you can determine the number of ghosting frames, whether to ghost before or after the current frame, or both, and you can also show frame numbers with the ghosts.

### **Procedures**

**To show wireframe ghost copies of an animated object:**

- Choose **Views menu > Show Ghosting**.

## **Show Key Times**

Select an object with animation. > **Views menu > Show Key Times**

Key Times shows the frame numbers along a displayed animation [trajectory](#) on page 3045 . Key times correspond to the settings in [Time Configuration](#) on page 7359 for **Frames** or [SMPTE](#) on page 7933 . By default, key times are shown as frame numbers.

## Procedures

To display trajectory time values in the viewport:

- 1 Select an object with animation.



- 2 On the Display panel > Display Properties rollout, turn on Trajectory.

---

**TIP** If the rollout controls are unavailable, right-click the object in the active viewport, choose Properties, and in the Display Properties group, click By Layer to change to By Object. This will make the Trajectory option become available.

---

- 3 Choose Views menu > Show Key Times.

The time values are displayed as white numbers along the trajectory. They remain displayed in red when the animated object is deselected.

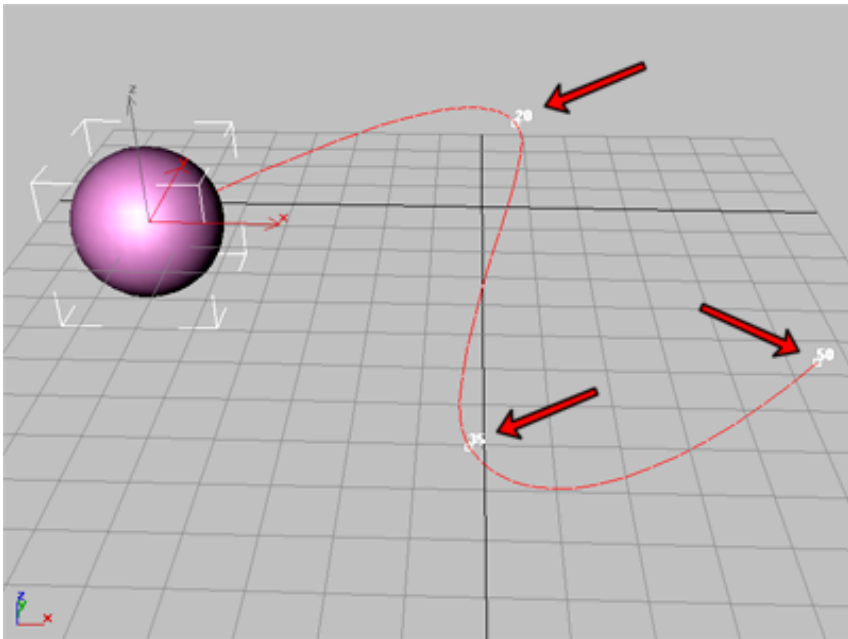

Keyframes with frame number shown on a trajectory.

# Shade Selected

Select an object to be shaded. > Views menu > Shade Selected

Shade Selected shades only the selected objects in the scene when the viewport is set to Wireframe or Other. When Smooth + Highlights is on, all objects are shaded whether they are selected or not.

Shade Selected lets you work with a wireframe scene and shade only the selected objects when you want to visualize them more clearly. All other objects in the scene will appear in wireframe.

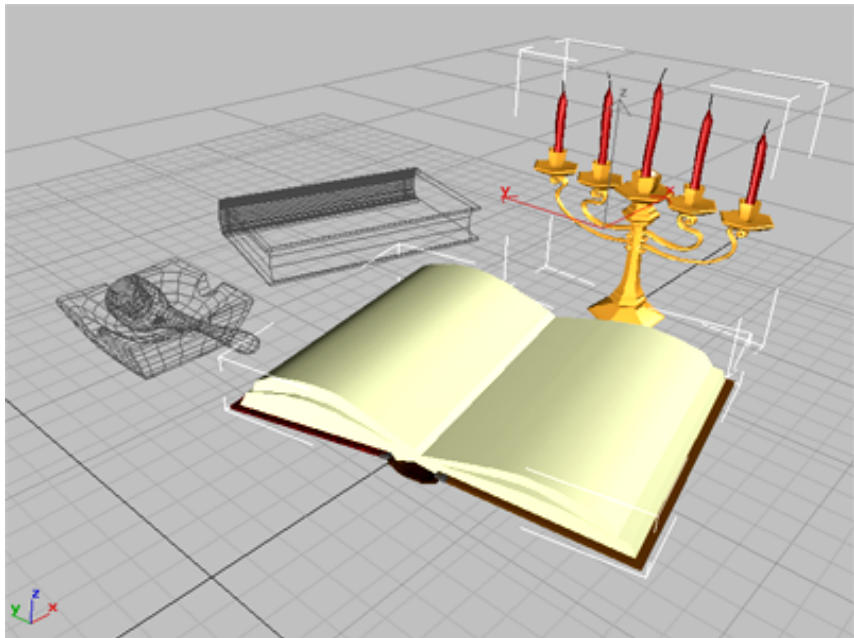

Selected objects shaded in a wireframe viewport.

## Procedures

To shade only selected objects in a scene:

- 1 Choose Views menu > Shade Selected.
- 2 Right-click the viewport label and choose Wireframe.
- 3 Select the object.

Only the selected object is shaded.

## Show Dependencies

Views menu > Show Dependencies

While you are using the Modify panel, this command toggles viewport highlighting of objects dependent on the currently selected object.

When Show Dependencies is on and the Modify panel is active, any object that is dependent upon the currently selected object in any way appears magenta. This includes [instances](#) on page 7818 , [references](#) on page 7910 , and shared [modifiers](#) on page 7852 . Default=off.

You can also see similar dependencies in [Schematic View](#) on page 7193 .

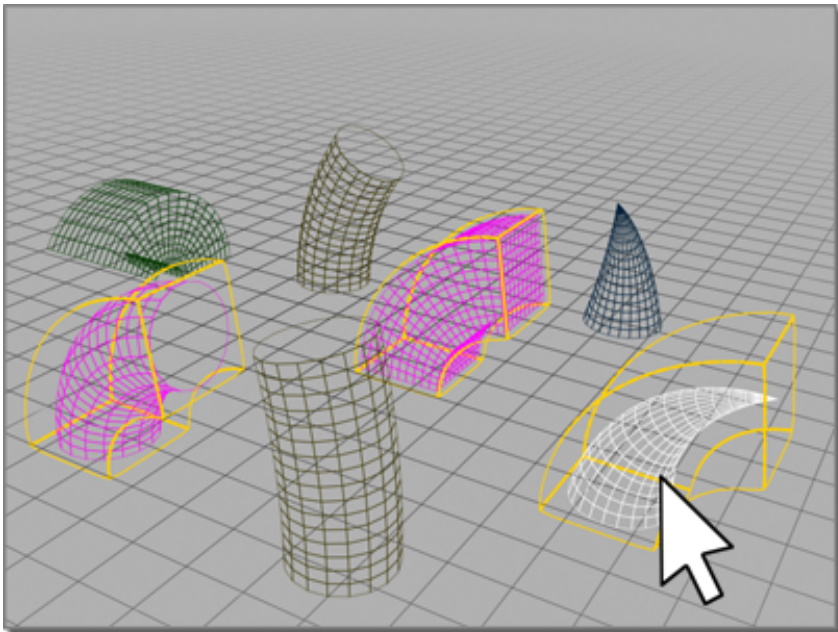

### Procedures

To show dependencies between objects:

- 1 Select an object with an [instanced modifier](#) on page 1040 .

- 2  On the Modify panel, choose the instanced modifier in the modifier stack.
- 3 Choose Views menu > Show Dependencies  
Other objects with instances of the same modifier appear in a different color.

**Example: To use Show Dependencies when animating with Linked XForm:**

- 1 Select the sub-object geometry you want to animate, and apply a [Linked XForm modifier](#) on page 1440 .
- 2 On the Parameters rollout, click Pick Control Object.
- 3 Click an object to be the control object. Choose a dummy object if you want to keep the control hidden in final rendering.
- 4 The chosen object is now linked as parent to the sub-object selection and its name is listed on the Parameters rollout.
- 5 Choose Views menu > Show Dependencies to make the link visible when the control object is selected.
- 6 Use any of the transforms to animate the control object.  
The selection is animated in parallel with the control object.

## Create Camera From View

Activate a Perspective viewport. > Views menu > Create Camera From View

Activate a Perspective viewport. > Create menu > Cameras > Create Camera From View

Activate a Perspective viewport. > Keyboard > Ctrl+C

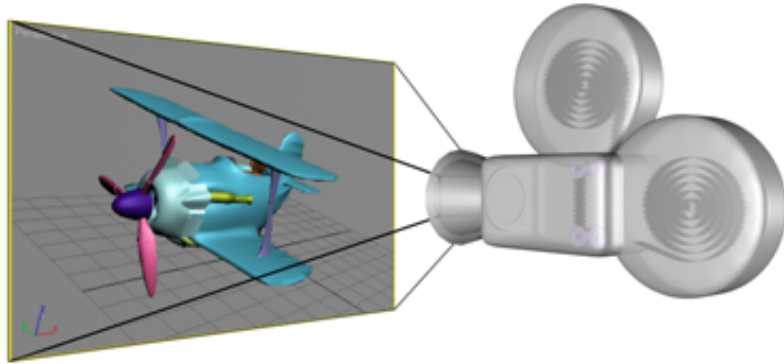

Create Camera From View creates a [Target camera](#) on page 5118 whose field of view matches an active Perspective viewport. At the same time, it changes the viewport to a [Camera viewport](#) on page 7397 for the new camera object, and makes the new camera the current selection.

Alternatively, if the scene already contains a camera and the camera is selected, then Create Camera From View does not create a new camera from the view. Instead, it simply matches the selected camera to the active, Perspective viewport. This functionality was adopted from the Match Camera to View command, which is now available only as an assignable main user interface shortcut (see [Keyboard Shortcuts](#) on page 7645).

---

**NOTE** Create Camera From View is available only when a Perspective viewport is active.

---

**To create a camera from a view, assuming any existing cameras are unselected:**

- 1 Activate a Perspective viewport.
- 2 If necessary, adjust the viewport using Pan, Zoom and Arc Rotate until you have a view you like.



- 3 Leaving the viewport active, on the Views menu choose Create Camera From View or press Ctrl+C.

3ds Max creates a new camera, matching its view to that of the Perspective viewport, and then switches the Perspective viewport to a Camera viewport, showing the view from the new camera.

## Add Default Lights to Scene

Right-click a viewport label. > Configure > Viewport Configuration dialog > Rendering Method tab > Rendering Options group > Turn on Default Lighting and choose 2 Lights (to activate the Add Default Lights To Scene menu item) > Views menu > Add Default Lights To Scene

This command displays the Add Default Lights To Scene dialog, which provides options that let you convert the default scene lighting into actual [light objects](#) on page 4890 .

The default lighting for viewports consists of a *key* light, positioned in front and to the left of the scene, which behaves as an [omni light](#) on page 4938 . .

This command is unavailable unless you use the [Viewport Configuration dialog](#) on page 7610 to configure the active viewport to use two lights . When viewports use two lights, and you invoke this command, the lights are added to the scene as omni lights. You can add either the key light, the fill light, or both.

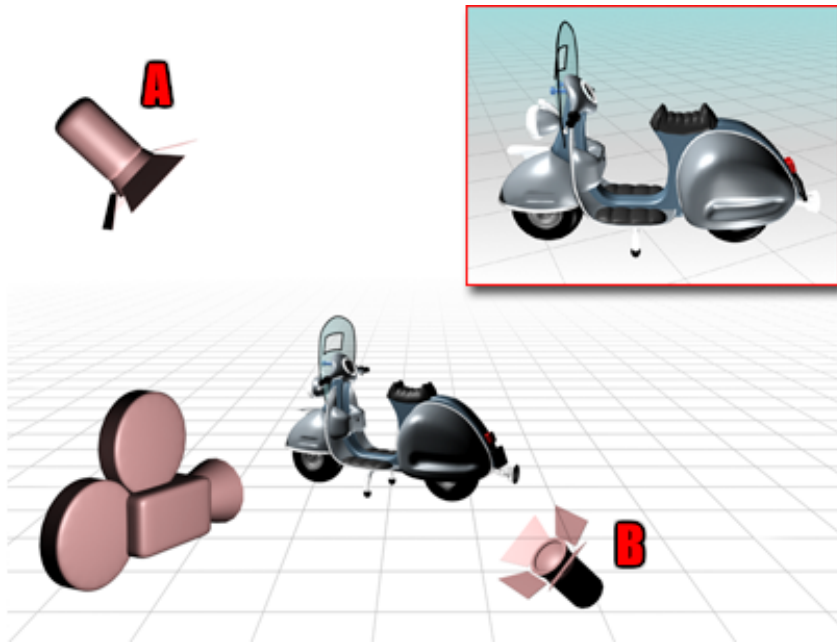

Two default lights are placed opposite to each other.

A, the key light is in front of the object, on the upper left side, while B, the fill light is behind on the lower right side.

You can add either the key light, the fill light, or both. The omni light objects have the names *DefaultKeyLight* and *DefaultFillLight*.

If you have already added one or both default lights, a warning prompts you to rename or delete the previous default light object before you add another.

## Procedures

To add the default lights as objects:

- 1 Right-click a viewport label, and click Configure.
- 2 On the Viewport Configuration dialog > Rendering Method tab, in the Rendering Options group, turn on Default Lighting and choose 2 Lights. Click OK to close the dialog.
- 3 Choose Views menu > Add Default Lights To Scene.
- 4 On the Add Default Lights To Scene dialog, choose Key Light, Fill Light, or both.

- 5  Activate the Top viewport, and on the status bar, click Zoom Extents.

The lights are now visible in the viewport.

### Interface

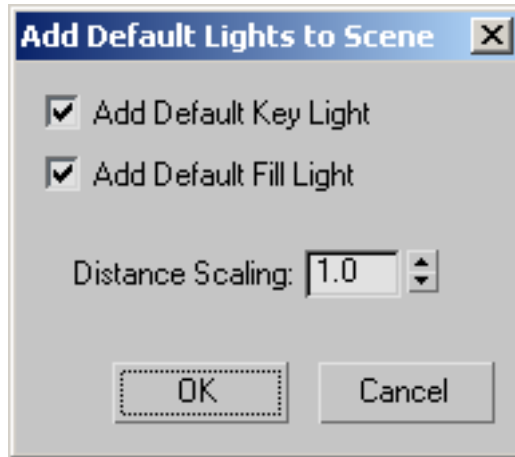

**Add Default Key Light** When on, adds the default key light to the scene. The key light is in front of the scene and to the left. The key light becomes an [omni light](#) on page 4938 with the name, DefaultKeyLight. Default=on.

**Add Default Fill Light** When on, adds the default fill light to the scene. The fill light is behind the scene and to the right. The fill light becomes an [omni light](#) on page 4938 with the name, DefaultFillLight. Default=on.

**Distance Scaling** Affects how far the lights are placed from the origin (0,0,0). The default value leaves the scene's lighting unchanged. Larger values move the lights farther away, dimming the scene, and smaller values move them closer, brightening the scene. Default=1.0. Range=0.0 to 1000.0.

## Redraw All Views

Views menu > Redraw All Views

Keyboard > ` (accent grave)

Redraw All Views refreshes the display in all viewports. When you move, rotate, scale, or otherwise manipulate geometry, the viewports may display the scene with some irregularities, or with objects or parts of objects missing. Use Redraw All Views to redisplay your scene with all lines and shading restored.



## Global Viewport Rendering Setting

Views menu > Global Viewport Rendering Setting > Standard Display

Views menu > Global Viewport Rendering Setting > Standard Display with Maps

Views menu > Global Viewport Rendering Setting > Hardware Display

Views menu > Global Viewport Rendering Setting > Hardware Display with Maps

These commands turn on and off display of all maps in the viewports, using software or hardware rendering. Software rendering applies to all maps and materials, but tends to be less accurate. Hardware rendering is highly accurate, showing highlights very close to the way they render, but applies primarily to the [Arch & Design material](#) on page 5458 , although it also supports the [Standard material](#) on page 5298 .

---

**NOTE** Hardware viewport rendering is not available on computers with older graphics systems. Also, hardware viewport rendering is supported only by the [Direct3D display driver](#) on page 7594 .

---

**NOTE** These commands do not apply to [XRef materials](#) on page 5603 , including materials from [XRef objects](#) on page 6732 and [XRef scenes](#) on page 6755 .

---

**See also:**

- [Show Standard/Hardware Map in Viewport](#) on page 5254

### Interface

**Standard Display** Uses the legacy software shader, which works on a per-face basis, and turns off viewport display of all maps at the material level. This applies only to materials used in the scene.

**Standard Display with Maps** Uses the legacy software shader, which works on a per-face basis, and turns on viewport display of all maps.

**Hardware Display** Uses the hardware viewport shader, which works on a per-pixel basis, and turns off viewport display of all maps at the material level.

The hardware shader applies only to the [Standard](#) on page 5298 and [Arch & Design](#) on page 5458 materials; when it's active, 3ds Max still uses the software shader to display all other materials.

**Hardware Display with Maps** Uses the hardware viewport shader, which works on a per-pixel basis, and turns on viewport display of all maps at the material level.

This switch applies only to the [Standard](#) on page 5298 and [Arch & Design](#) on page 5458 materials; when it's active, 3ds Max still uses the software shader to display all other materials. Also, it doesn't affect viewport display of maps for materials other than those two.

## Update During Spinner Drag

Views menu > Update During Spinner Drag

When Update During Spinner Drag is on, dragging a spinner (such as a Radius spinner for a sphere) updates the effects in real time in the viewports. Default=on.

When Update During Spinner Drag is off, the effect is updated after the drag, when you release the mouse. Use this option when you're adjusting processor-intensive controls.



## Diagnose Video Hardware

Views menu > Diagnose Video Hardware

This command runs a MAXScript script that displays information about your system's graphic display configuration. This can be useful for telling you whether some interactive viewport features such as [shadows](#) on page 4911 are supported.

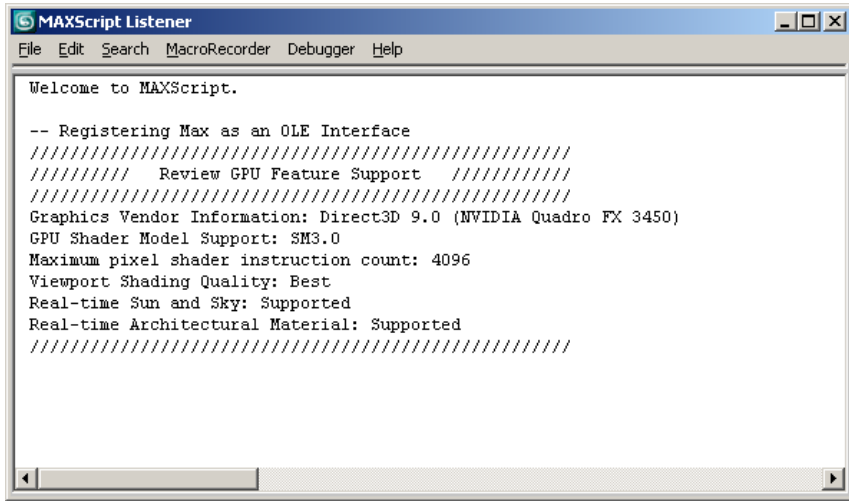

## Expert Mode

Views menu > Expert Mode

Keyboard > Ctrl+X

When Expert mode is on, the title bar, toolbar, command panel, status bar, and all of the viewport navigation buttons are removed from the display, leaving only the menu bar, time slider, and viewports. Use Expert mode when you need to view your composition alone without the rest of the interface.

With the ability to customize the user interface in 3ds Max, you can create your own versions of Expert mode by hiding whatever you want item-by-item. Expert mode is only a quick way to hide everything that can be hidden at once.

You can assign keyboard shortcuts to hide and unhide the command panel, toolbars, and so on and then use these while in Expert mode. You can also use the quad menu to access tools quickly in Expert mode as well.

### Procedures

To turn on Expert mode, do one of the following:

- Choose Views menu > Expert Mode.
- Press Ctrl+X.

To turn off Expert mode and return to full display, do one of the following:

- Click the Cancel Expert Mode button to the right of the time slider.
- Press Ctrl+X.
- Choose Views menu > Expert Mode.

## Controlling Object Display

You use the Display panel, [layers](#) on page 7224 , and [Scene Explorer](#) on page 7171 to control how objects are displayed in viewports, and to hide or freeze objects. This section covers usage of the Display panel controls.

---

**TIP** You can also use the [Isolate Selection command](#) on page 159 to hide everything except your selection set.

---

[Display Color Rollout](#) on page 117

[Hide By Category Rollout](#) on page 118

[Hide Rollout](#) on page 120

[Freeze Rollout](#) on page 122

[Display Properties Rollout](#) on page 124

[Link Display Rollout](#) on page 129

**See also:**

- [Object Display Properties](#) on page 249

## Display Color Rollout

Display panel > Display Color rollout

The Display Color rollout specifies whether 3ds Max displays objects using their object colors or their [diffuse material colors](#) on page 7759 , when the objects have their [display properties](#) on page 245 set to By Object. If the display properties of an object is set to By Layer, the layer color will be used for the display. You can choose one method for wireframe display and a different

one for shaded display. In each shading mode you can specify whether the material or the object color is used.

As a default, all new objects have their display properties set to By Layer. The default can be changed in Customize > Preferences > Preferences dialog > General panel > Layer Defaults group. If you turn off Default To By Layer For New Nodes, all new objects created in 3ds Max will display in the viewports based on the settings in the Display Color rollout. You can switch individual objects between By Object and By Layer by setting the Display Properties in the [Object Properties dialog](#) on page 245, accessible by right-clicking any selected object.

If the object color box displays black and white rectangles, this indicates that the object has its display properties set to By Layer.

### Interface

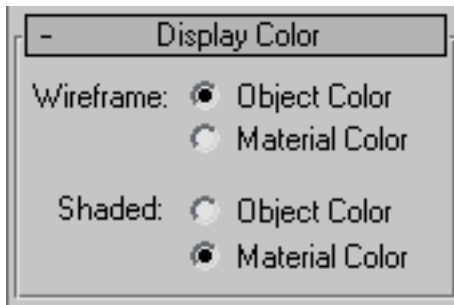

**Wireframe** Controls the color of objects when the viewport is in wireframe display mode.

**Object Color** Displays the wireframes in object color.

**Material Color** Displays the wireframes using the material color.

**Shaded** Controls the color of the object when the viewport is in any shaded display mode.

**Object Color** Displays the shaded objects using the object color.

**Material Color** Displays the shaded objects using the material color.

## Hide By Category Rollout

Display panel > Hide By Category rollout



The Hide By Category rollout toggles the display of objects by category (objects, cameras, lights, and so on).

By default, 3ds Max displays all objects in the scene. Objects hidden by category aren't evaluated in the scene, so hiding objects by category improves performance.

You can use any of the default display filters provided, or add new display filters for fast selection of objects to hide.

## Interface

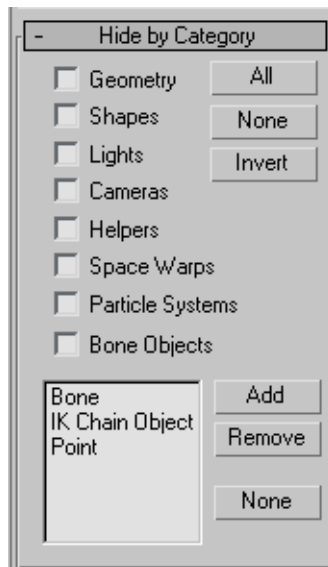

Turn on the check boxes to hide objects of that category. You can use the All, None, and Invert buttons to quickly change the settings of the check boxes.

The Display Filter box gives you finer control in creating categories to hide. Click the Add button to display a list of display filters. Hold down the Ctrl key and click the filter name to select whatever category you'd like to hide.

**Geometry** Hides all geometry in the scene.

**Shapes** Hides all shapes in the scene.

**Lights** Hides all lights in the scene.

**Cameras** Hides all cameras in the scene.

**Helpers** Hides all helpers in the scene.

**Space Warps** Hides all space warps in the scene.

**Particle Systems** Hides all particle systems in the scene.

**Bone Objects** Hides all bones in the scene.

**Bones** Hides all bones in the scene.

**IK Chain** Hides all IK chains in the scene.

**Point** Hides all points in the scene.

**All** Hides everything in the scene.

**None** Unhides everything in the scene

**Invert** Hides everything that is visible and unhides everything currently hidden.

**Add** Adds a display filter category to the list.

**Remove** Removes a display filter category.

**None** Deselects all highlighted display filters in the list.

## Hide Rollout

Display panel > Hide rollout

The Hide rollout provides controls that let you hide and unhide individual objects by selecting them, regardless of their category.

You can also hide and unhide objects using the [Display Floater](#) on page 7458 .

**See also:**

- [Hide By Category Rollout](#) on page 118

## Interface



**Hide Selected** Hides the selected objects.

**Hide Unselected** Hides all visible objects except the selected ones. Use this to hide all objects except the one you're working on. Objects hidden by category aren't affected.

**Hide by Name** Displays a dialog you use to hide objects you choose from a list. See [Select From Scene](#) on page 168 , which describes nearly identical controls.

**Hide by Hit** Hides any object you click in the viewport. If you hold the Ctrl key while selecting an object, that object and all of its children are hidden. To exit Hide by Hit mode, right-click, press Esc, or select a different function. This mode is automatically turned off if you hide all objects in the scene.

**Unhide All** Unhides all hidden objects. The unhide buttons are available only when you have specifically hidden one or more objects. They won't unhide objects hidden by category.

---

**NOTE** If you click Unhide All in a scene with hidden layers, a dialog will pop up prompting you to unhide all layers. You cannot unhide an object on a hidden layer.

---

**Unhide by Name** Displays a dialog you use to unhide objects you choose from a list. See [Select From Scene](#) on page 168 , which describes nearly identical controls.

---

**NOTE** If you select an object on a hidden layer, a dialog will pop up prompting you to unhide the object's layer. You cannot unhide an object on a hidden layer.

---

**Hide Frozen Objects** Hides any frozen objects. Turn it off to display hidden frozen objects.

## Freeze Rollout

Display panel > Freeze rollout

The Freeze rollout provides controls that let you [freeze or unfreeze](#) on page 7793 individual objects by selecting them, regardless of their category.

Frozen objects remain on the screen, but you can't select, transform, or modify them. By default, frozen objects turn dark gray. Frozen lights and cameras, and their associated viewports, continue to work as they normally do.

You can choose to have frozen objects retain their usual color or texture in viewports. Use the Show Frozen In Gray toggle in the [Object Properties dialog](#) on page 245 .

## Interface



**Freeze Selected** Freezes the selected object(s).

**Freeze Unselected** Freezes all visible objects except the selected ones. Use this to quickly freeze all the objects except the one you're working on.

**Freeze by Name** Displays a dialog that lets you choose objects to freeze from a list. See [Select From Scene](#) on page 168 , which describes nearly identical controls.

**Freeze by Hit** Freezes any object you click in a viewport. If you press Ctrl while selecting an object, that object and all of its children are frozen. To exit Freeze by Hit mode, right-click, press Esc, or select a different function. This mode is automatically turned off if you freeze all objects in the scene.

**Unfreeze All** Unfreezes all frozen objects.

---

**NOTE** If you click Unfreeze All in a scene with frozen layers, a dialog opens prompting you to unfreeze all layers. You cannot unfreeze an object on a frozen layer.

---

**Unfreeze by Name** Displays a dialog that lets you choose objects to unfreeze from a list. See [Select From Scene](#) on page 168 , which describes nearly identical controls.

---

**NOTE** If you unfreeze by name an object on a frozen layer, a dialog opens prompting you to unfreeze the object's layer. You cannot unfreeze an object on a frozen layer.

---

**Unfreeze by Hit** Unfreezes any object you click in the viewport. If you press Ctrl while selecting an object, that object and all of its children are unfrozen.

If you select an object on a frozen layer, a dialog will pop up prompting you to unfreeze the object's layer. You cannot unfreeze an object on a frozen layer.

## Display Properties Rollout

Display panel > Display Properties rollout

The Display Properties rollout provides controls for altering the display of selected objects.

See also:

- [Link Display Rollout](#) on page 129

### Procedures

**To display trajectories using the Display panel:**

- 1 Select one or more animated objects.
- 2 Right-click the selection, and choose Properties.
- 3 In the Display properties group, click By Layer to change it to By Object, and then click OK.
- 4 Expand the Display Properties rollout in the Display panel.
- 5 Turn on Trajectory.

By default, object trajectories appear with the following properties:

- The trajectory curve is drawn in red.
- Frame increments display as white dots on the curve.
- Position keys display as red boxes surrounding the appropriate frame dot on the curve. The boxes are white when the object is selected.
- If Views > Show Key Times is turned on, the keyframe numbers are displayed along side the keys on the trajectory.

Trajectories can also be displayed through Object Properties. Right-click any object and choose Properties, then in the Display properties group change By Layer to By Object. Turn on Trajectories when it becomes available in the Display Properties group.

You can change the colors for these items on the [Colors panel](#) on page 7505 of the Customize User Interface dialog.

You can also use object properties to display trajectories: right-click any object and choose Properties, then turn on Trajectory.

### Interface

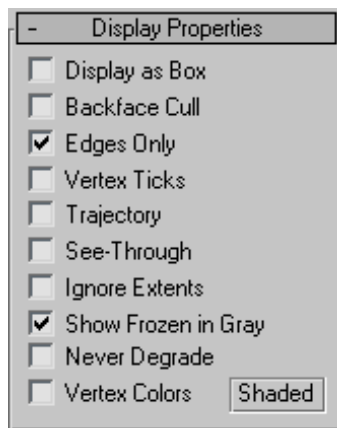

The first three options reduce the displayed geometric complexity of selected objects in a scene, resulting in faster response time because the computer has less to calculate. These options are also available in the Display Properties group of the Object Properties dialog > [General panel](#) on page 245 and the [Display floater](#) on page 7458 .

**Display as Box** Toggles the display of selected objects, including 3D objects and 2D shapes, as [bounding boxes](#) on page 7736 . Produces minimum geometric complexity.

Particle systems appear as bounding boxes when adaptive degradation takes effect. Because particle systems naturally exist in world space, their bounding box is always oriented parallel to the world planes.

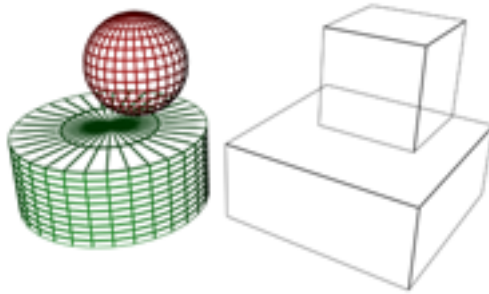

**Backface Cull** Toggles the display of faces, edges, and vertices with [normals](#) on page 7863 pointing away from the point of view. When off, all entities are visible. Default=off.

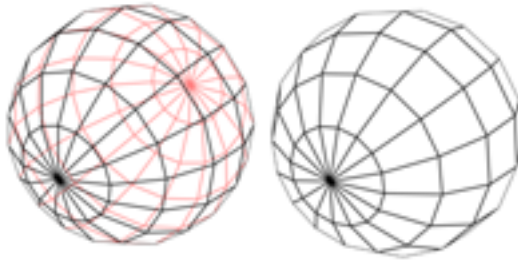

**Edges Only** Toggles the display of hidden edges and polygon [diagonals](#) on page 7757. When on, only outside edges appear. When off, all mesh geometry appears. Applies to Wireframe viewport display mode, as well as other modes with Edged Faces turned on.



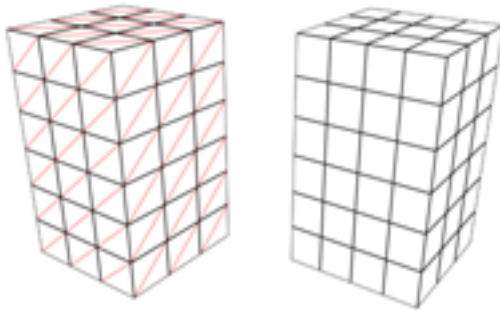

**Vertex Ticks** Displays the vertices in the selected geometry as tick marks.

If the current selection has no displayed tick marks, the check box is clear. If some of the vertices in the current selection display tick marks, the check box contains a gray X. If all vertices in the current selection display tick marks, the check box contains a black X.

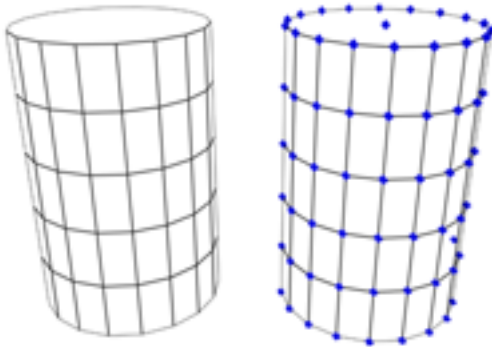

**Trajectory** Toggles [trajectory](#) on page 7955 display for the selected object so its trajectory is visible in viewports.

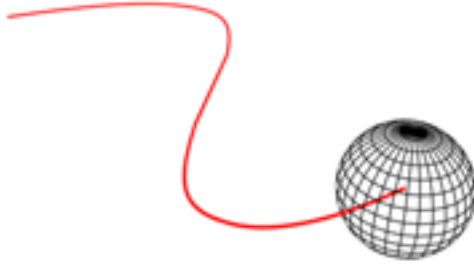

**See-Through** Makes the object or selection translucent in viewports. This setting has no effect on rendering: it simply lets you see what's behind or inside an object in a crowded scene, and is especially useful in adjusting the position of objects behind or inside the See-Through object. This is very handy when you have objects within other objects in your scene.

This option is also available from [Object Properties dialog](#) on page 245 and the Tools > [Display Floater](#) on page 7458 .

You can customize the color of see-through objects by using the [Colors panel](#) on page 7505 of the Customize > [Customize User Interface dialog](#) on page 7489 .

Keyboard shortcut (default): Alt+X

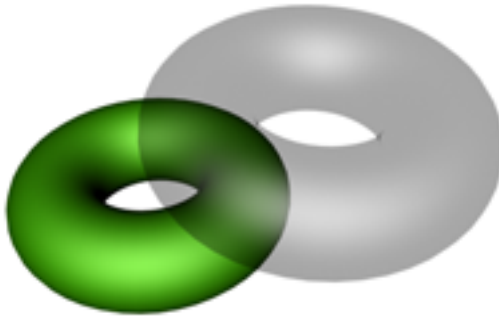

**Ignore Extents** When turned on, the object is ignored when you use the display control Zoom Extents. Use this on distant lights.

**Show Frozen in Gray** When on, the object turns gray in viewports when you freeze it. When off, viewports display the object with its usual color or texture even when it is frozen. Default=on.



**Never Degrade** When on, the object is not subject to [adaptive degradation](#) on page 7704 .

**Vertex Colors** Displays the effect of assigned vertex colors. You assign vertex colors using the Assign Vertex Color utility, or the VertexPaint modifier. Once vertex colors have been assigned they can also be edited in the Vertex Properties rollout in the editable mesh or editable poly in vertex or face sub-object level.

The Shaded button determines whether the object with the assigned vertex colors appears shaded in the viewport. When this button is off, the colors are unshaded and appear in their pure RGB values, looking a little like self-illuminated materials. When the Shaded button is on, the colors appear like any other assigned color in the viewports.

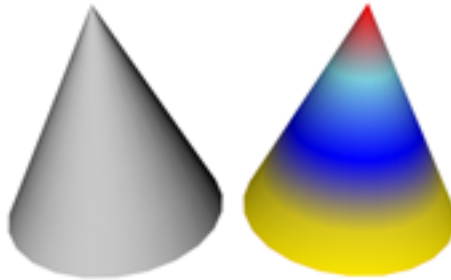

## Link Display Rollout

Display panel > Link Display rollout

The Link Display rollout provides controls that alter the display of [hierarchical linkages](#) on page 7806 .

### Interface

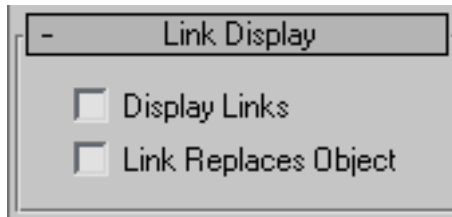

**Display Links** Displays a wireframe representation of any hierarchical links affecting the selected object.

---

**NOTE** Display Links must be turned on in order to see Joint Limits on a inverse kinematics chain.

---

**Link Replaces Object** Replaces the selected object with the wireframe representation of the hierarchical link. This option offers another way to reduce the geometric complexity of selected objects in a scene. See also [Display Properties rollout](#) on page 124 .

The Draw Links As Lines option on the [Viewports panel](#) on page 7545 of the Preference Settings dialog further reduces the display of links to a single line.

# Selecting Objects

# 4

In most cases, before you can perform an action on an object or objects in your scene, you must first *select* them. Thus, the act of selection is an essential part of the modeling and animation process.

3ds Max provides you with a variety of selection tools, which are covered in this chapter. Besides the basic techniques of selecting single and multiple objects using mouse and keyboard, the topics here discuss the use of named selection sets and other features that help you manage object selection, such as hiding and freezing objects and layers. Also included is an introduction to sub-object selection, essential to working with an object's underlying geometry.

Lastly, a technique for grouping objects is presented. Grouping lets you create more permanent selections that have many of the characteristics of independent objects.

This section presents the following topics:

[Introducing Object Selection](#) on page 132

[Basics of Selecting Objects](#) on page 139

[Selecting by Region](#) on page 143

[Using Select By Name](#) on page 146

[Using Named Selection Sets](#) on page 146

[Using Selection Filters](#) on page 148

[Selecting with Track View](#) on page 150

[Selecting with Schematic View](#) on page 151

[Freezing and Unfreezing Objects](#) on page 152

[Hiding and Unhiding Objects by Selection](#) on page 154

[Hiding and Unhiding Objects by Category](#) on page 156

[Isolate Selection](#) on page 159

[Introduction to Sub-Object Selection](#) on page 160

[Using Assemblies](#) on page 209

## Introducing Object Selection

3ds Max is an object-oriented program. This means that each object in the 3D scene carries instructions that tell the program what you can do with it. These instructions vary with the type of object.

Because each object can respond to a different set of commands, you apply commands by first selecting the object and then selecting the command. This is known as a noun-verb interface, because you first select the object (the noun) and then select the command (the verb).

### Identifying the Selection Interface

In the user interface, selection commands or functions appear in the following areas:

- Main toolbar
- Edit menu
- Quad menu (while objects are selected)
- Tools menu
- Track View
- Display panel
- Schematic View

The buttons on the main toolbar provide a direct means of selection. The [Select From Scene dialog](#) on page 168 is easy to use, while the Edit menu provides more general selection commands, plus methods of selecting objects by property. Perhaps the most powerful selection tool is [Scene Explorer](#) on page 7171, which lets you select objects by various methods, and also edit object hierarchies and properties. Track View and Schematic View let you select objects from a hierarchical list.

## Selecting From the Quad Menu

The quickest way to select an object is from the Transform quadrant of the quad menu, where you can easily switch among the Move, Rotate, Scale, and Select modes. Choose any of these and click the object you want to select in the viewport.

## Selecting by Name

Another quick way to select an object is to use the keyboard shortcut for the Select By Name command. Press H on the keyboard to open the [Select From Scene dialog](#) on page 168 and then select the object by name from the list. This is a foolproof way to ensure you select the correct object when the scene contains many overlapping objects.

## Selection Buttons

Another way to select an object is to click one of these buttons, and then click the object.



Select Object



Select by Name



Select And Move



Select And Rotate



Select And Scale



Select And Manipulate

The main toolbar has several selection-mode buttons. When any of the selection buttons is active, the program is in a state where you can select objects by clicking them.

Of the selection buttons, you use Select Object when you want selection only. The remaining buttons let you both select and transform or manipulate your

selection. Use transforms to move, rotate, and scale your selection. See [Moving, Rotating, and Scaling Objects](#) on page 859 and [Select and Manipulate](#) on page 2529 .



## Crossing Versus Window Selection

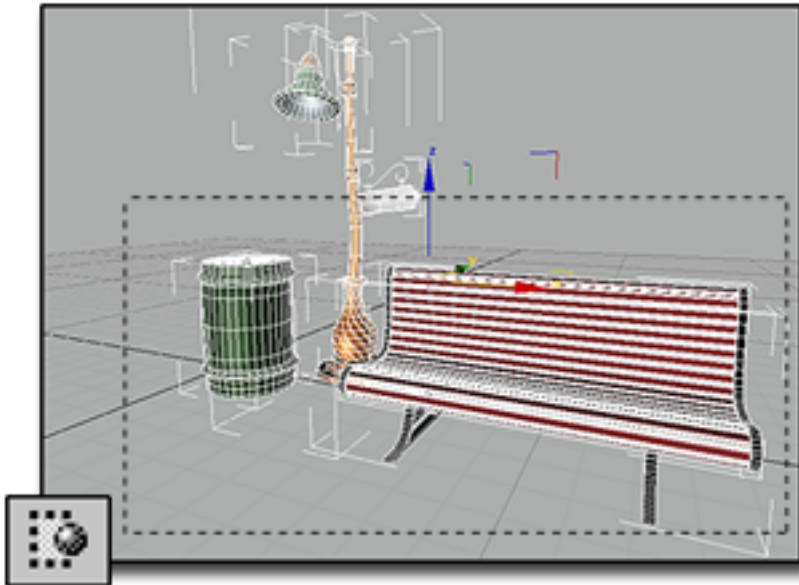
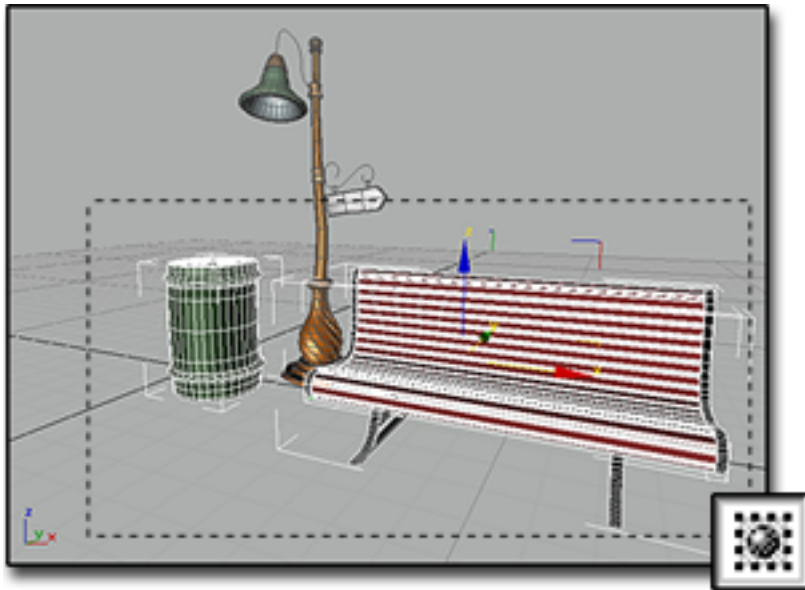

Above: Window selection selects the trash can and bench, but not the streetlight.

**Below: Crossing selection selects all three: trash can, bench, and streetlight.**



One way to select multiple objects simultaneously is to drag a region, such as a rectangle, around them. The Window/Crossing toggle, available from the main toolbar, switches between Window and Crossing modes when you select by region. In Window mode, you select only the objects within the selection. In Crossing mode, you select all objects within the region, plus any objects crossing the boundaries of the region.

## **Edit Menu Commands**

The Edit menu contains selection commands that operate globally on your objects.

Edit menu selection commands include:

[Select All](#) on page 189

[Select None](#) on page 189

[Select Invert](#) on page 190

[Select Similar](#) on page 190

[Select By > Color](#) on page 191

[Select By > Name](#) on page 191 (also a toolbar button)

[Select By > Layer](#) on page 192

[Selection Region > Rectangular Region](#) on page 192

[Selection Region > Circular Region](#) on page 193

[Selection Region > Fence Region](#) on page 194

[Selection Region > Lasso Region](#) on page 195

[Selection Region > Paint Selection Region](#) on page 196

[Selection Region > Window](#) on page 198 (also a toolbar button)

[Selection Region > Crossing](#) on page 200 (also a toolbar button)

[Edit Named Selection Sets](#) on page 181

## **Tools Menu Commands**

The Tools menu provides the Scene Explorer commands as well as access to [modeless](#) on page 7849 selection dialogs or "floaters." You can place them

anywhere on the screen, or minimize them by right-clicking the title bar and choosing Minimize:

- **New Scene Explorer (and related commands)** See [Scene Explorer](#) on page 137 .
- **Display Floater** Provides options for hiding and freezing selections as well as some display options. See [Display Floater](#) on page 7458 .
- **Layer Manager** This modeless dialog lets you select objects individually and by layer, and change display properties such as Hide and Freeze. See [Layer Manager](#) on page 7227 .



### **Scene Explorer**

[Scene Explorer](#) on page 7171 gives you a modeless dialog for selecting and linking objects as well as changing object properties such as the name and display characteristics. You can manipulate hierarchical relationships via drag-and-drop techniques, and use various search methods including a powerful Boolean editor to fine-tune your selection. You can also edit properties for multiple objects at once simply by selecting them and then changing one of them.

### **Track/Schematic View Selection**

[Track View](#) on page 3426 is primarily designed as an animation tool, but you can also use its Hierarchy List window as an alternative method of selecting objects by name and hierarchy. This works in both the Curve Editor and Dope Sheet modes of Track View.

[Schematic View](#) on page 7193 is specifically designed to let you navigate your scene efficiently, presenting a hierarchical view and letting you select objects and their properties by name.

## Display Panel Selection

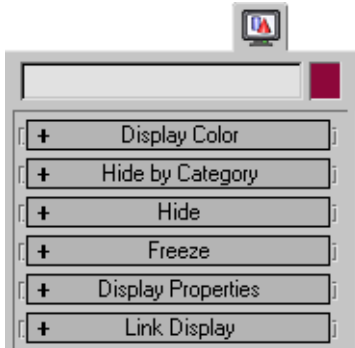

The Display panel provides options for hiding and freezing objects. These techniques exclude objects from other selection methods, and are useful in simplifying complex scenes. Frozen objects are still visible, but hidden objects are not.

# Basics of Selecting Objects

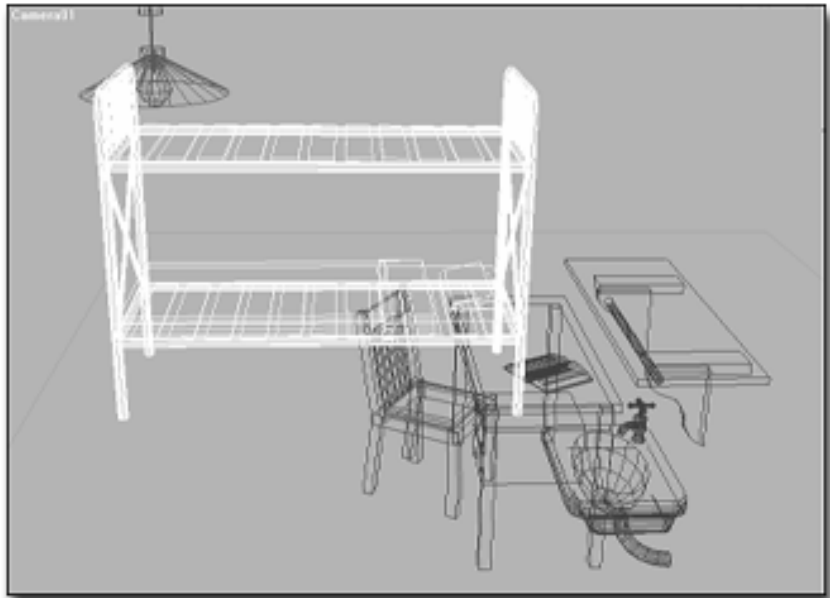

Bed selected in wireframe

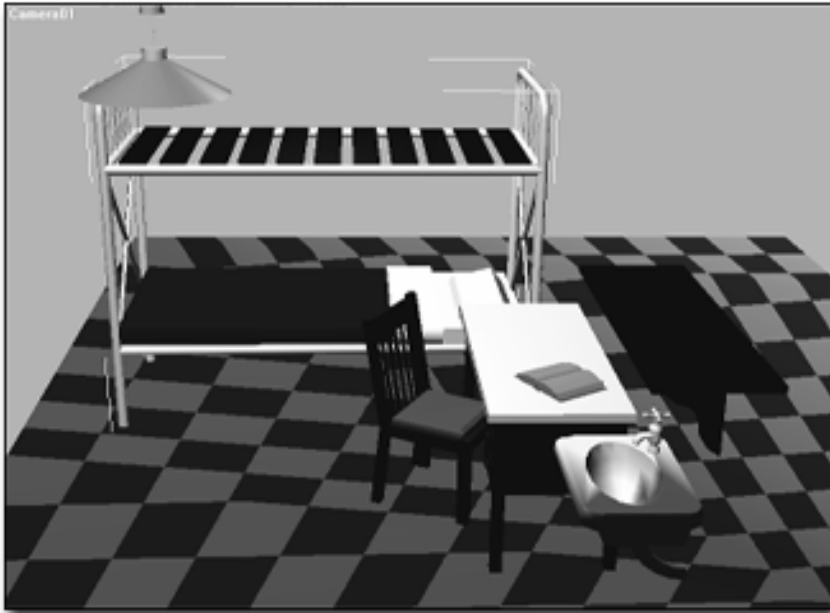

**Bed selected in smooth and shaded view**

The most basic selection techniques use either the mouse, or the mouse in conjunction with a keystroke.

## **Procedures**

### **To select an object in the viewport:**

- 1** Click one of the selection buttons on the toolbar: Select Object, Select And Move, Select And Rotate, Select And Scale, or Select And Manipulate. Alternatively, right-click in a viewport to open the quad menu, and from the Transform menu choose Move, Rotate, Scale, or Select.
- 2** In any viewport, move the cursor over the object you want to select. The cursor changes to a small cross when it's positioned over an object that can be selected.

The valid selection zones of an object depend on the type of object and the display mode in the viewport. In shaded mode, any visible surface of an object is valid. In wireframe mode, any edge or segment of an object is valid, including hidden lines.

- 3 While the cursor displays the selection cross, click to select the object (and to deselect any previously selected object).  
A selected wireframe object turns white. A selected shaded object displays white brackets at the corners of its bounding box.

**To select all objects do one of the following:**

- Choose Edit menu > Select All.  
This selects all objects in your scene.
- On the keyboard press Ctrl+A.

**To invert the current selection do one of the following:**

- Choose Edit menu > Select Invert.  
This reverses the current selection pattern. For example, assume you begin with five objects in your scene, and two of them are selected. After choosing Invert, the two are deselected, and the remaining objects are selected.
- On the keyboard press Ctrl+I.

**To extend or reduce a selection:**

- Hold down Ctrl while you click to make selections.  
This toggles the selection state of the objects you select. Use this method to select or deselect objects. For example, if you have two objects selected and Ctrl+click to select a third, the third object is added to the selection. If you now Ctrl+click any of the three selected objects, that object is deselected.

---

**TIP** You can also hold down Alt while you click to remove objects from selections.

---

**To lock a selection:**

- 1 Select an object.



- 2 Click the [Selection Lock Toggle](#) on page 7324 on the status bar to turn on locked selection mode.

While your selection is locked, you can drag the mouse anywhere on the screen without losing the selection. The cursor displays the current selection icon. When you want to deselect or alter your selection, click

the Lock button again to turn off locked selection mode. The keyboard toggle for locked selection mode is Spacebar.

**To deselect an object, do any of the following:**

- Hold down the Alt key, and either click an object, or drag a region around the object to deselect it.
- Hold down the Ctrl key and click to deselect a selected object. This is a toggle; it also selects non-selected objects.
- To deselect all objects in the scene, choose Edit menu > Select None, or click an empty area of a viewport anywhere outside the current selection.



# Selecting by Region

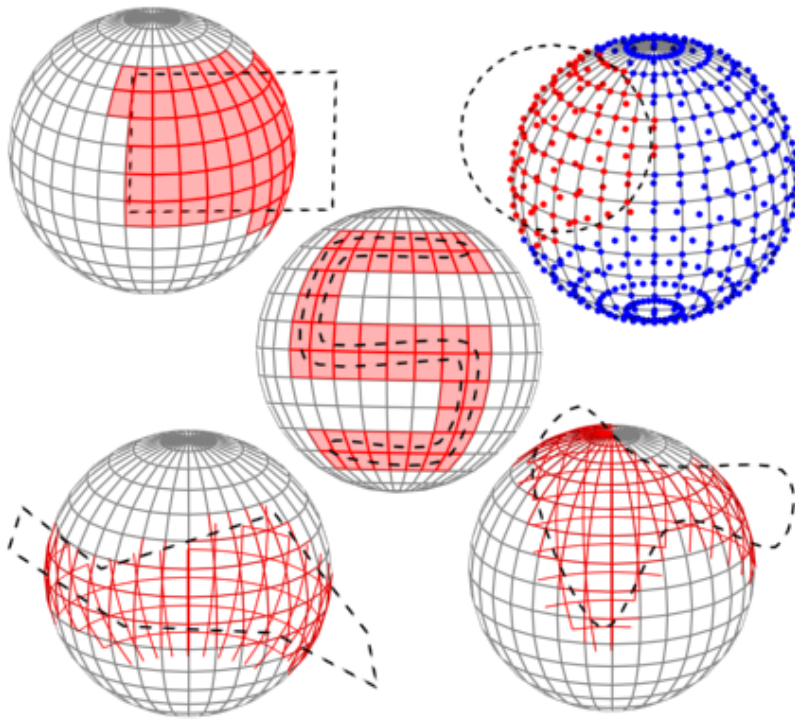

**Top Left:** Selecting face sub-objects with a rectangular region

**Top Right:** Selecting vertex sub-objects with a circular region

**Center:** Selecting face sub-objects with a painted region

**Bottom Left:** Selecting edge sub-objects with a fence region

**Bottom Right:** Selecting edge sub-objects with a lasso region

The region-selection tools let you use the mouse to select one or more objects by defining an outline or area.

## **Region Selection**

By default, when you drag the mouse a rectangular region is created. When you release the mouse all objects within and touched by the region are selected.

The remainder of this topic describes how you can change each of these settings.

---

**NOTE** If you hold down Ctrl while specifying a region, the affected objects are added to the current selection. Conversely, if you hold down Alt while specifying a region, the affected objects are removed from the current selection.

---

### Setting Region Type



The type of region you define when you drag the mouse is set by the Region flyout button to the right of the Select By Name button. You can use any of five types of region selection:

- **Rectangular Region** Dragging the mouse selects a rectangular region. See [Rectangular Selection Region](#) on page 192 .
- **Circular Region** Dragging the mouse selects a circular region. See [Circular Selection Region](#) on page 193 .
- **Fence Region** Draw an irregular selection-region outline by alternating between moving the mouse and clicking (begin with a drag). See [Fence Selection Region](#) on page 194 .
- **Lasso Region** Dragging the mouse outlines an irregular selection region. See [Lasso Selection Region](#) on page 195 .
- **Paint Region** Drag the mouse over objects or sub-objects to be included in the selection. See [Paint Selection Region](#) on page 196 .

## Setting Region Inclusion

This option lets you specify whether to include objects touched by the region border. It applies to all region methods.

Choose Edit menu > Region to display a submenu of the following two items. Only one can be active at a time. The option is also available on the main toolbar.

- **Window** Selects only objects that are completely within the region. See [Select Region Window](#) on page 198 .
- **Crossing** Selects all objects that are within the region and crossing the boundaries of the region. This is the default region. See [Select Region Crossing](#) on page 200 .

The [Window/Crossing toggle](#) on page 201 on the main toolbar also switches between these two modes.

You can set up a preference to switch automatically between Window and crossing based on the direction of your cursor movement. See [Auto Window/Crossing by Direction](#) on page 7539 in General Preferences.

## Procedures

To make a region selection using defaults:



- 1 Click [Select Object](#) on page 167 .
- 2 Drag the mouse to define a region.  
A rubber-band rectangle appears.
- 3 Release the mouse button to select all objects within or touching the region.  
The selected objects turn white.

You can also use the Select and Transform buttons on the main toolbar to select by region. You must start defining the region over an unselectable area of the viewport. Otherwise, you'll transform the object beneath your mouse when you begin to drag.

# Using Select By Name

The Select By Name command opens the Select From Scene dialog, which lets you select objects by their assigned names without having to click in the viewports.

## Procedures

To select objects by name:

- 1 Do one of the following:



- On the main toolbar, click Select By Name.

- Choose Edit menu > Select By > Name.

- Press H.

The Select From Scene dialog opens. By default, this dialog lists all objects in the scene. Any selected objects are highlighted in the list.

- 2 Choose one or more objects in the list. To select multiple objects, drag vertically in the list or use Ctrl to add to the selection.
- 3 Click Select to make the selection.  
The dialog closes and the objects are selected.
- 4 Alternatively, to select a single object and close the dialog at the same time, double-click the object name.

For more information, see [Select From Scene](#) on page 168 .

# Using Named Selection Sets

You can assign a name to the current selection, and then later reselect those objects by choosing their selection name from a list.



Named Selection Sets



You can also edit the contents of named sets from the [Named Selection Sets dialog](#) on page 181 .

## Editing Named Selections

As you model and create a scene, you're likely to rearrange the objects making up your named selection sets. If you do, you'll need to edit the contents of those sets.

### Procedures

#### To assign a name to a selection set:

- 1 Select one or more objects or sub-objects using any combination of selection methods.
- 2 Click in the Named Selection field on the main toolbar.
- 3 Enter a name for your set. The name can contain any standard ASCII characters, including letters, numerals, symbols, punctuation, and spaces.

---

**NOTE** Names are case-sensitive.

---

- 4 Press Enter to complete the selection set.

You can now select another combination of objects or sub-objects and repeat the process to create another named selection set.

#### To retrieve a named selection set:

- 1 In the Named Selection field, click the arrow.

---

**NOTE** If you're working with a sub-object selection set, you must be at the same level at which you created the selection set (for example, editable mesh > vertex) for it to appear on the list.

---

- 2 On the list, click a name.

To edit named selection sets:



- On the main toolbar, click Named Selection Sets to display the Named Selection Sets dialog.

## Using Selection Filters



You can use the Selection Filter list on the main toolbar to deactivate selection for all but a specific category of object. By default, all categories can be selected, but you can set the Selection Filter so that only one category, such as lights, can be selected. You can also create combinations of filters to add to the list.

For greater ease of use while working with animations, you can choose filters that let you select only Bones, objects in IK chains, or Points.

### Using Combos

The Combos feature allows you to combine two or more categories into a single filter category.

### Procedures

To use the selection filter:

- Click the Selection Filter arrow and click a category from the Selection Filter list.

Selection is now limited to objects defined in this category. The category remains in effect until you change it.

The following categories are available:

**All** All categories can be selected. This is the default setting.

**Geometry** Only geometric objects can be selected. This includes meshes, patches, and other kinds of objects not specifically included in this list.

**Shapes** Only shapes can be selected.

**Lights** Only lights (and their targets) can be selected.

**Cameras** Only cameras (and their targets) can be selected.

**Helpers** Only helper objects can be selected.

**Warps** Only space warps can be selected.

**Combos** Displays a [Filter Combinations dialog](#) on page 177 that lets you create custom filters.

**Bone** Only bones objects can be selected.

**IK Chain** Only objects in IK chains can be selected.

**Point** Only point objects can be selected.

#### To create a combination category:

- 1 From the drop-down list, choose Combos to display the [Filter Combinations dialog](#) on page 177 .  
All single categories are listed.

- 2 Select the categories you want to combine.

- 3 Click Add.

The combination appears in a list to the right, abbreviated by the first letter of each category. Click OK.

For example, if you selected Geometry, Lights, and Cameras, the Combo would be named GLC. This name appears below Combo on the drop-down list. For more information, see [Selection Filters List](#) on page 176 .

# Selecting with Track View

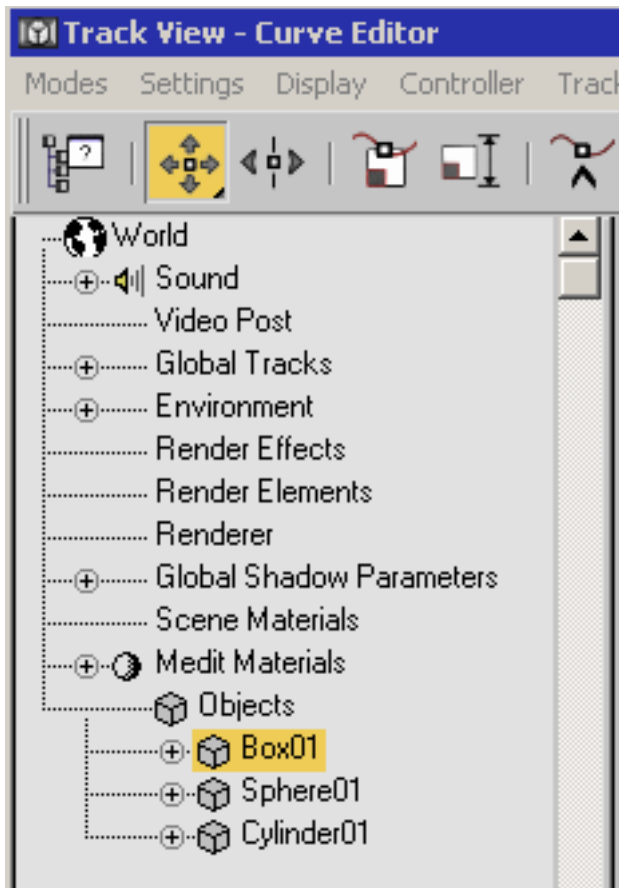

Track View provides sophisticated methods to edit your animation tracks. In addition, its Hierarchy list displays all objects in the scene by name and hierarchy. Using Track View, you can select any object in the scene by clicking its object icon in the Hierarchy list.

## Procedures

You can use Track View selection functionality in both the [Curve Editor](#) on page 3441 and the [Dope Sheet](#) on page 3442. This procedure illustrates usage of the Curve Editor; the same methods work in the Dope Sheet.



**To open Track View and display and select objects:**



- 1 On the main toolbar, click Curve Editor (Open).
- 2 Click any cube icon in the list to select the named object.

You can make the following kinds of selections:

- Select several adjacent objects in the list. Click the first object, hold down Shift, and click another object elsewhere in the list.
- Modify the selection by pressing Ctrl while clicking. Ctrl lets you toggle individual items on and off without deselecting others in the list.
- Select an object and all its descendants. Press and hold Alt, right-click the object's cube icon (keep the right mouse button held down), and choose Select Children from the menu.

You can open a Track View window for the sole purpose of selecting objects by name. Shrink the window until only a portion of the Hierarchy appears, and then move the window to a convenient area on your screen.

## Selecting with Schematic View

Schematic view is a window that displays the objects in your scene in a hierarchical view. It gives you an alternate way to select and choose the objects in your scene and navigate to them.

When the Modify panel is open, double-clicking an object modifier in Schematic view navigates the modifier stack to that modifier for quick access to its parameters.

### Procedures

**To open Schematic View and display and select objects:**



- 1 Click Open Schematic View on the main toolbar.
- 2 Click the rectangle containing the name of your object.

You can select any number of objects in Schematic View using standard methods, including dragging a region. For more information, see [Using Schematic View](#) on page 7197 .

## Freezing and Unfreezing Objects

You can freeze any selection of objects in your scene. By default, frozen objects, whether wireframe or rendered, turn a dark gray. They remain visible, but can't be selected, and therefore can't be directly transformed or modified. Freezing lets you protect objects from accidental editing and speeds up redraws.

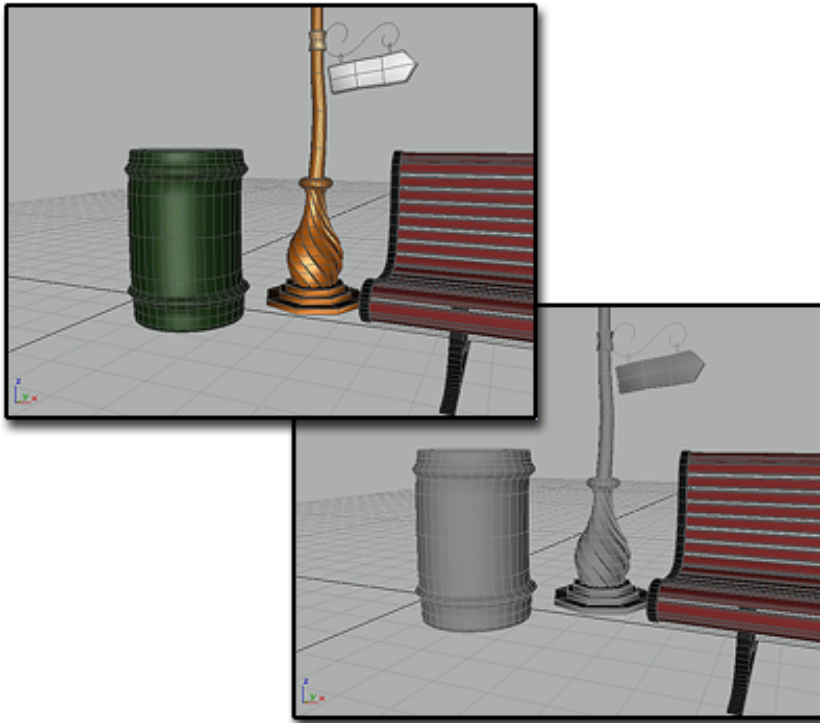

**Above: No layers frozen**

**Below: Trash can and streetlight are frozen, and displayed in gray**

You can choose to have frozen objects retain their usual color or texture in viewports. Use the Object Properties dialog > General panel > Display Properties > [Show Frozen In Gray](#) toggle on page 252 .

Frozen objects are similar to hidden objects. Linked, instanced, and referenced objects behave when frozen just as they would if unfrozen. Frozen lights and cameras and any associated viewports continue to work as they normally do.

For more information, see [Freeze Rollout](#) on page 122 .

## Freezing Objects

You can freeze one or more selected objects. This is the usual method to put objects "on hold."

You can also freeze all objects that are not selected. This method lets you keep only the selected object active, useful in a cluttered scene, for example, where you want to be sure no other objects are affected.

---

**IMPORTANT** Objects on a frozen layer cannot be unfrozen. If you try to unfreeze an object on a frozen layer (with Unfreeze All or Unfreeze By Name), you are prompted ( [by default](#) on page 7541 ) to unfreeze the object's layer.

---

## Procedures

**To access Freeze options, select one or more objects and then do one of the following:**

- Open a [scene explorer](#) on page 7171 and use the check boxes in the Frozen column to freeze and unfreeze objects.



- Open the Display panel and then expand the Freeze rollout.
- Choose Tools menu > Display Floater. This modeless dialog has the same options as the Freeze rollout. It also contains Hide options.
- Access the [Object Properties dialog](#) on page 245 from either the right-click (quad) menu or the Edit menu. Turn on Hide and/or Freeze.
- In the Layer Manager, click in the Freeze column to freeze/unfreeze each layer in the list.
- Right-click in the active viewport and choose a Freeze or Unfreeze command from the quad menu > Display quadrant.

# Hiding and Unhiding Objects by Selection

You can hide any selection of individual objects in your scene. They disappear from view, making it easier to select remaining objects. Hiding objects also speeds up redraws. You can then unhide all objects at once or by individual object name. You can also filter the list contents by category, so only hidden objects of a certain type are listed.

---

**NOTE** Hiding a light source doesn't alter its effect; it still illuminates the scene.

---

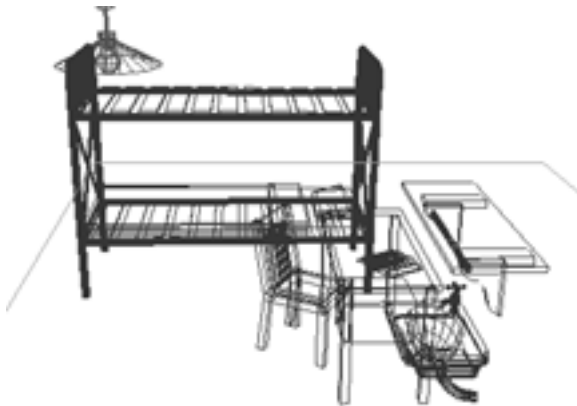

Original scene



Scene with bed hidden

Hiding objects is similar to freezing objects. Linked, instanced, and referenced objects behave when hidden just as they would if unhidden. Hidden lights and cameras and any associated viewports continue to work normally.

For more information, see [Hide Rollout](#) on page 120 .

## Hiding Objects

Hiding objects is similar to freezing objects. See [Freezing and Unfreezing Objects](#) on page 152 . You can hide one or more selected objects. You can also hide all objects that are not selected.

Another option is to hide objects by category. See [Hiding and Unhiding Objects by Category](#) on page 156 .

## Unhiding Objects

You can unhide objects in either of two ways:

- Use Unhide All to unhide all objects at the same time.
- Use All On to display all objects at the same time.
- Use Unhide By Name to unhide object selectively. When you click Unhide By Name, the same dialog is displayed as for hiding, now called Unhide Objects.

The Unhide buttons are unavailable when no object in the scene is hidden.

Objects that were first hidden by selection and then hidden by category do not reappear. Although they are unhidden at the selection level, they are still hidden at the category level. For details, see [Hiding and Unhiding Objects by Category](#) on page 156 .

---

**IMPORTANT** Objects on a hidden layer cannot be unhidden. If you try to unhide an object on a hidden layer (with Unhide All or Unhide By Name), you are prompted ( [by default](#) on page 7541 ) to unhide the object's layer.

---

## Procedures

To access Hide options, do one of the following:

- Open a [scene explorer](#) on page 7171 and use the check boxes in the Hidden column to hide and unhide objects.
- Open the [Layer Manager](#) on page 7227 .

In the Layer Manager, you can easily hide groups of objects or layers.

-  Open the Display panel. Click Hide, if necessary, to expand the rollout.
- Choose Tools menu > Display Floater. This modeless dialog has the same options as the Hide rollout. It also contains Freeze options.
- Access the [Object Properties dialog](#) on page 245 from either the right-click (quad) menu or the Edit menu. Turn on Hide, Freeze, or both. If the button is unavailable because By Layer is turned on, click By Layer to change it to By Object.
- Right-click in the active viewport and choose a Hide or Unhide command from the quad menu > Display quadrant.

## Hiding and Unhiding Objects by Category

You can hide objects by category, the basic types of objects. For example, you can hide all lights in your scene at one time, or all shapes, or any combination of categories. By hiding all categories, your scene appears empty. Hidden objects, while not displayed, continue to exist as part of the geometry of your scene but cannot be selected.

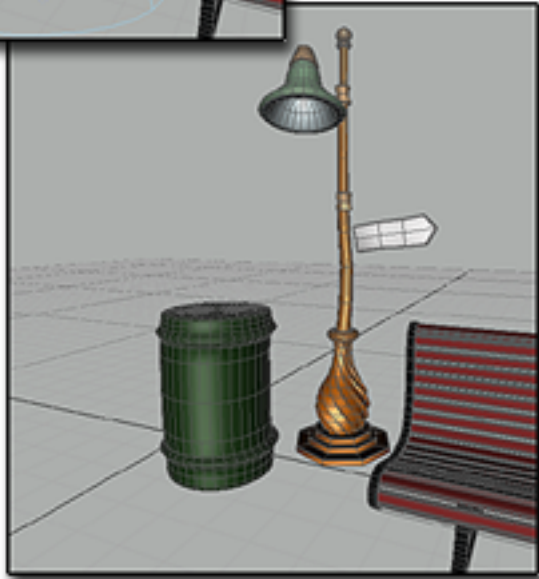
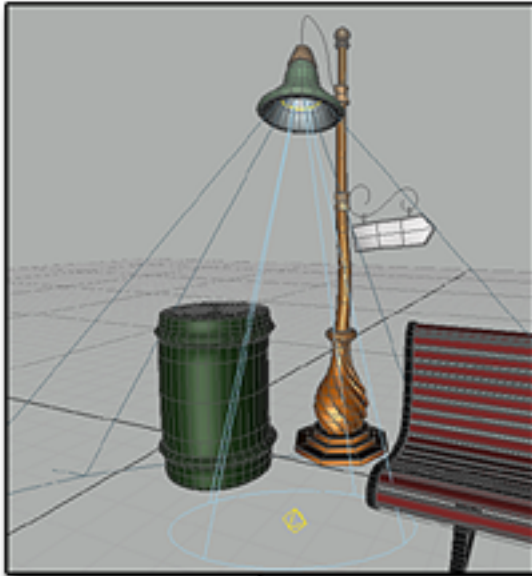

Above: All objects displayed

Below: Lights and shapes are hidden

## Hiding Geometry and Particle Systems

Geometry and particle systems have separate categories, even though particle systems are also geometry.

- Selecting Geometry hides all geometry in the scene, including particle systems. The option for particle systems becomes unavailable.
- Selecting Particle Systems hides only these objects, leaving the other geometry unaffected.

## Effects of Hiding by Category

- If you create an object in a category that is hidden, the software turns off hiding for that category and unhides the objects within the category.
- Unhiding by category has no effect on objects hidden with the controls on the Hide rollout (see [Hiding and Unhiding Objects by Selection](#) on page 154 ). These objects remain hidden. You need to use the controls on that rollout to unhide them.
- Unhiding by category has no effect on objects that are on a layer that is turned off. These objects remain invisible. You need to turn on their layer to display them.
- Unhiding by selection does not return a hidden object to the scene if the category of the object is hidden. The Unhide All and Unhide By Name controls continue to work, but the effect is not seen until the category is cleared.
- Lights hidden by category continue to shine. Views through cameras and targeted lights are still active.
- Linked, instanced, and referenced objects behave when hidden just as they would if visible.

## Procedures

To hide a category of objects:

- 1  Open the Display panel.
- 2 Click Hide by Category, if necessary, to expand the rollout. By default, all categories are off (unhidden) on this rollout.



- 3 Choose the category you want to hide. All objects of that category disappear from your scene as soon as you make the choice.

The same Hide By Category options appear on the Object Level panel of the Display Floater (Tools menu > Display Floater).

**To unhide a category of objects:**

- Deselect the category.  
All objects in the category reappear, unless some have been hidden by selection. See “Effects of Hiding by Category”.

## Isolate Selection

Tools menu > Isolate Selection

Right-click to open the quad menu. > Display (upper-right) quadrant > Isolate Selection

Keyboard > Alt + Q

The Isolate Selection tool lets you edit a single object or selection set of objects while hiding the rest of the scene on a temporary basis. This guards against selecting other objects while working on a single selection. It allows you to focus on the objects you need to see, without the visual distraction of the surroundings. It also reduces the performance overhead that can come from displaying other objects in the viewports.

When you turn on Isolate Selection, the active viewport (Perspective and [axonometric](#) on page 7722 only) performs the [Zoom Extents](#) on page 7381 action on the isolated objects. When you exit Isolate Selection mode, Perspective viewports return to the previous zoom level, but axonometric viewports do not.

When an isolated selection includes multiple objects, you can select a subset of these, and choose Isolate Selection once again. This isolates the subset. However, clicking Exit Isolation unhides the entire scene. You can’t “step back” through individual levels of isolation.

---

**NOTE** Isolate Selection works only at the object level. You can’t choose it while at the sub-object level. If you go to a sub-object level while working with an isolated object, you can click Exit Isolation, but you can’t isolate sub-objects.

---

## Interface

While the Isolate tool is active, a dialog labeled Warning: Isolated Selection appears.

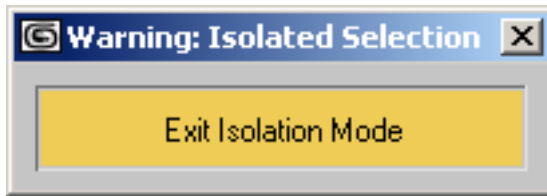

**Exit Isolation Mode** Click to end isolation, close the dialog, and unhide the rest of the scene.

The views are restored to what they showed before you chose Isolate Selection.

## Introduction to Sub-Object Selection

This is a general introduction to sub-object selection. For specific information, see [Editable Mesh](#) on page 1990, [Editable Patch](#) on page 1934, [Editable Poly](#) on page 2038, and [Editable Spline](#) on page 590; for a discussion of NURBS sub-object selection, see [Sub-Object Selection](#) on page 2164.

When you model an object, often you edit a portion of its underlying geometry, such as a set of its faces or vertices. Or when you are working with a model, you may want to apply mapping coordinates to a portion of its underlying geometry. Use the methods described in this topic to make sub-object selections.

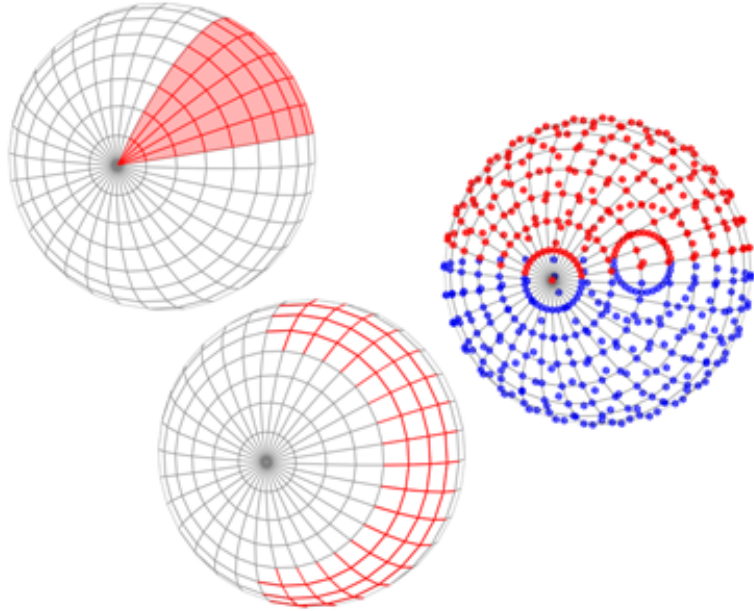

**Left: A selection of face sub-objects**

**Middle: A selection of edge sub-objects**

**Right: A selection of vertex sub-objects**

You can access sub-object geometry through a variety of methods. The most common technique is to convert an object into "editable" geometry such as a mesh, spline, patch, NURBS, or poly object. These object types let you select and edit geometry at the sub-object level.

If you have a primitive object and want to retain control of its creation parameters, you can apply a modifier such as [Edit Mesh](#) on page 1283 , [Edit Poly](#) on page 1293 , [Edit Spline](#) on page 1376 , [Edit Patch](#) on page 1290 , or [Mesh Select](#) on page 1455 .

The [Line Spline](#) on page 551 and NURBS curves and surfaces are the exception: you can edit their sub-objects as soon as you create these kinds of objects.

 You choose a sub-object level in the stack display. Click the plus sign that appears next to the name of an object that has sub-objects. This expands the hierarchy, showing the available sub-object levels. Click a level to choose it. The name of the sub-object level highlights in yellow, and the icon for that

sub-object level appears to the right of both its name and the name of the top-level object.

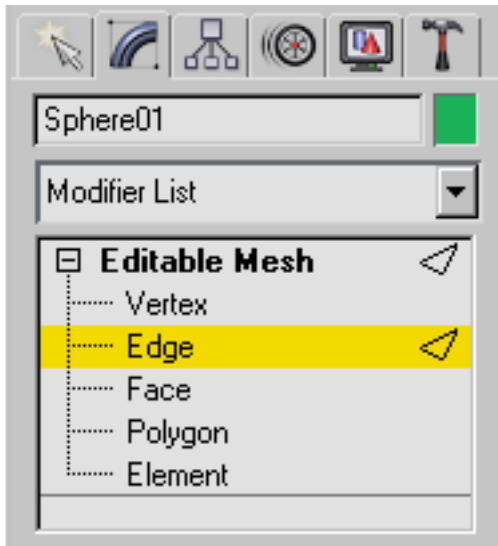

Stack display shows the sub-object hierarchy, letting you choose a sub-object level.

### Editing at the Sub-Object Level

When you edit an object at the sub-object level, you can select only components at that level, such as vertex, edge, face sub-objects, and so on. You can't deselect the current object, nor can you select other objects. To leave sub-object editing and return to object-level editing, click the top-level name of the object in the modifier stack, or click the highlighted sub-object level.

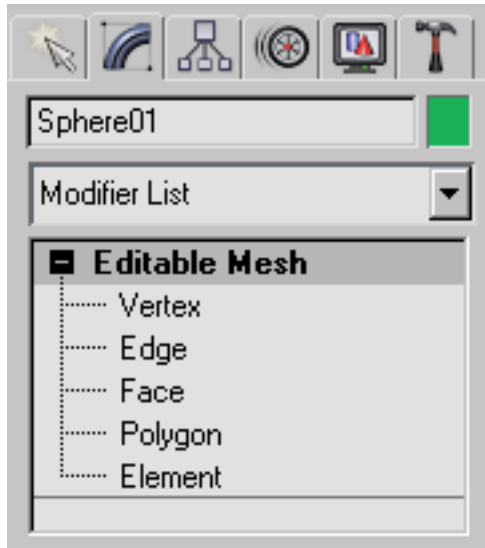

Click the top-level object name to exit sub-object editing.

---



**TIP** You can also access sub-object levels from the buttons at the top of the Selection rollout on the Modify panel.

---

## Procedures

### To make a sub-object selection:

These methods assume the object has sub-object levels. If the object has no sub-object levels (for example, a primitive such as a sphere), the + icon is not present. In that case, you need to collapse the object or apply an Edit modifier before you can edit its sub-object geometry.

- 1 Select the object you want to edit.
- 2 If the object doesn't already have sub-object levels, apply an Edit ... modifier such as Edit Mesh.
- 3  Open the Modify panel.
- 4  On the modifier stack display, click the + icon to expand the object's hierarchy.

- 5 On the stack display, click a sub-object level such as Vertex, Edge, or Face.

---

**TIP** For some kinds of objects, such as editable meshes, shaded viewports don't display sub-object selections. If this is the case, right-click the viewport label and choose Wireframe or Edged Faces view.

---



---

**TIP** For a detailed selection, you might want to zoom in on the object.

---

- 6 Click one of the toolbar selection buttons, and then use the same selection methods you'd use on objects to select the sub-object components. Or from the quad menu > Transform quadrant, choose one of the selection methods and select the sub-object components.

There are two alternative ways to go to a sub-object level:

-  Select the object and go to the Modify panel. Then right-click the object, and use the quad menu > Tools 1 (upper-left) quadrant > Sub-objects submenu.
-  Choose the selection level using buttons on the Modify panel's Selection rollout, if one is present for the type of object you're editing.

---

**TIP** Once you're at a sub-object level, the Insert key cycles through the levels of other kinds of sub-objects.

---

**To exit a sub-object level, do one of the following:**

- In the stack display, click the highlighted sub-object name or the top-level name of the object.
- If the object has a Selection rollout, click the button of the active sub-object level to turn it off.
- Right-click the object, and then in the Tools 1 (upper-left) quadrant of the quad menu, choose Top-level.
- Access a different command panel. This turns off sub-object editing.

If you think you've turned off sub-object editing but top-level object selection is still not restored, it might be due to the following reasons:



- Your selection is locked. Click the Lock Selection Set button on the prompt line to turn it off.
- You've set the [Selection Filter](#) on page 148 on the main toolbar to a specific category of object, so you can't select any of the other categories. To fix this, select All in the Selection Filter list.

## Selection Commands

Selection commands appear on the quad menu, on the main toolbar, on the Edit menu, and on the status bar.

The simplest method of selection is to turn on [Select Object mode](#) on page 167 , and then click an object in a viewport (or drag to surround the object). While the method is simple, it is not effective for selecting multiple objects, especially in a crowded scene. Other tools let you select objects by name, filter out the kinds of objects you want to select, and to create named selection sets you can select repeatedly.

### See also:

- [Introducing Object Selection](#) on page 132
- [Basics of Selecting Objects](#) on page 139
- [Isolate Selection](#) on page 159
- [Scene Explorer](#) on page 7171
- [Select From Scene](#) on page 168

### Selection Commands on the Main Toolbar

The following selection commands appear by default on the Main toolbar.

[Select Object](#) on page 167

[Select From Scene](#) on page 168

[Rectangular Selection Region](#) on page 192

[Circular Selection Region](#) on page 193

[Fence Selection Region](#) on page 194

[Lasso Selection Region](#) on page 195

[Paint Selection Region](#) on page 196

[Selection Filter List](#) on page 176

[Window/Crossing Selection Toggle](#) on page 201

[Named Selection Sets](#) on page 179

The Window/Crossing toggle determines how the region selection options (on the toolbars) behave.

### **Selection Commands on the Edit Menu**

The Edit menu contains selection commands that operate globally on your objects.

Edit menu selection commands include:

[Select All](#) on page 189

[Select None](#) on page 189

[Select Invert](#) on page 190

[Select Similar](#) on page 190

[Select By > Color](#) on page 191

[Select By > Name](#) on page 191 (also a toolbar button)

[Select By > Layer](#) on page 192

[Selection Region > Rectangular Region](#) on page 192

[Selection Region > Circular Region](#) on page 193

[Selection Region > Fence Region](#) on page 194

[Selection Region > Lasso Region](#) on page 195

[Selection Region > Paint Selection Region](#) on page 196

[Selection Region > Window](#) on page 198 (also a toolbar button)

[Selection Region > Crossing](#) on page 200 (also a toolbar button)

[Edit Named Selection Sets](#) on page 181



## Selection Command on the Status Bar

The [Selection Lock Toggle](#) on page 7324 is located on the status bar. Locking a selection is useful when you are doing a lot of editing on a selection, and don't want to select something else by mistake.

## Select Object

Main toolbar > Select Object

Right-click to open quad menu. > Transform quadrant > Select

Select Object lets you select an objects and sub-objects for manipulation.

Object selection is affected by several other controls:

- The active Selection Region type: [Rectangular](#) on page 192 , [Circular](#) on page 193 , [Fence](#) on page 194 , [Lasso](#) on page 195 , or [Paint](#) on page 196 .
- The active [selection filter](#) on page 176 (All, Geometry, Shapes, Lights, and so forth).
- The state of the crossing selection tool (which determines whether completely surrounded objects or surrounded and crossing objects are selected).

You can also select objects by name with the Select From Scene dialog [Select From Scene](#) on page 168 list; press the H key to access the dialog.

A number of objects selected together is called a [selection set](#) on page 146 . You can name selection sets in the Named Selection Sets field on the main toolbar and then recall them for later use.

---

**NOTE** The Smart Select command activates the Select Object function and, with repeated invocations, cycles through the available Selection Region methods. By default, Smart Select is assigned to the Q key; you can use [Customize User Interface](#) on page 7489 to assign it to a different keyboard shortcut, a menu, etc.

---

### Procedures

**To add or remove individual objects from a selection set:**

- 1 Hold down the Ctrl key and select the objects to add or remove.

- 2 Hold down the Alt key and select objects to remove from the current selection set.

---



**NOTE** Adding and removing objects doesn't change a named selection set.

---

**To toggle the selected/deselected state of multiple objects in the selection set:**

- Hold down the Shift key and drag to region-select the objects to toggle.

**To select objects *and* move, rotate, or scale them:**

-   Use the Select And Move, Select And Rotate, or Select And Scale tools, available from the main toolbar and the quad menu > Transform quadrant. When you rotate a selection set, the pivot of rotation depends on which option is selected on the [Use Center flyout](#) on page 904 on the toolbar. These tools are restricted to a specific axis or plane, which you can choose from the [Axis Constraints toolbar](#) on page 7288 or specify with the [transform gizmo](#) on page 865 .



## Select From Scene



main toolbar > Select By Name

Keyboard > H

Edit menu > Select By > Name

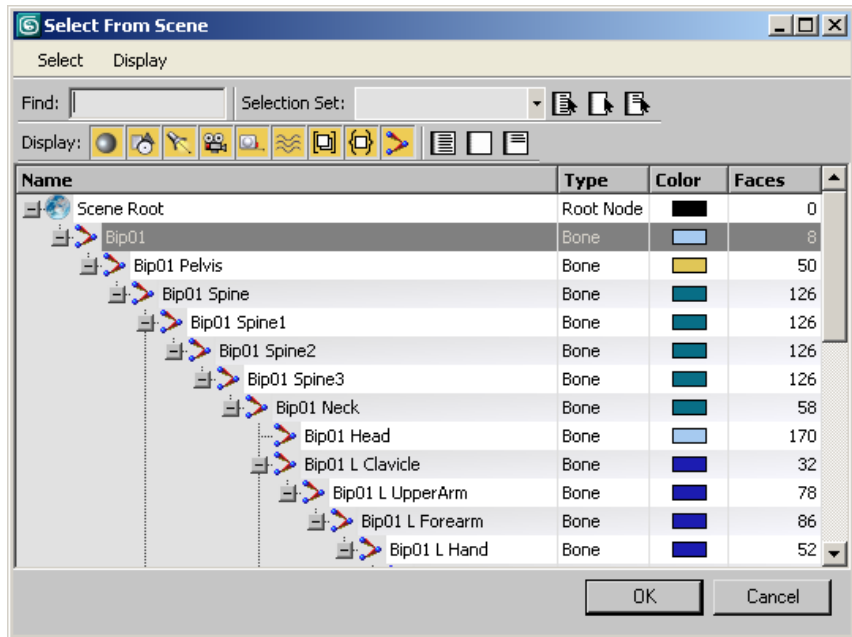

This dialog, named **Select From Scene** or **Select Objects** in most contexts, lets you select or designate objects by choosing them from a list of all objects currently in the scene. **Select From Scene** is a [modal](#) on page 7849, read-only version of [Scene Explorer](#) on page 7171; you can't use it to change object properties such as name and color. Other differences between **Select From Scene** and **Scene Explorer** include:

- No hierarchy manipulation; you can't link or unlink objects
- Hidden and frozen objects don't appear in the list.
- Because the dialog is modal, you must close it before continuing.
- To select an object and close the dialog, double-click the object's list entry.
- All toggle settings such as **Select Dependents**, **Display > Children**, and the **Display** buttons persist. That means they survive **Reset** operations and even quitting and restarting the software. This also applies to the position and size of the dialog. To return all dialog settings to their defaults, delete `[program folder]\plugcfg\DefaultModalSceneExplorer.ini`.

---

**NOTE** The Select From Scene dialog name and functionality are context dependent. When a transform such as Select And Move is active, the dialog lets you choose from all objects in the scene. But when certain modes are active, the choices in the dialog are more limited. For example, when [Select and Link](#) on page 3268 is active, the dialog is entitled Select Parent, and shows linkable objects but not the child object already selected. Similarly, if Group > Attach is active, the dialog is named Attach To Group and lists groups but not solitary objects.

---

**TIP** If you prefer to use the legacy Select Objects dialog instead of Select From Scene, it's available as an option. Open the *CurrentDefaults.ini* file (see [Market-Specific Defaults](#) on page 7486 ), find the [Scene Explorer] section, and change SelectByNameUsesSceneExplorer setting. If set to 1, then Select By Name and related commands use the Select From Scene dialog. If set to 0, then Select By Name and related commands use the legacy Select Objects dialog. The latter's functionality is essentially the same as the [Selection Floater](#) on page 171 , except that it's modal, not modeless.

---

**See also:**

- [Selection Floater](#) on page 171

## Procedures

**To select objects by name:**

- 1 Do one of the following:



- Click the Select By Name button on the main toolbar.
  - Choose Edit menu > Select By > Name.
  - Press H.  
The Select From Scene dialog opens. By default, it lists all objects in the scene, displaying any hierarchies as collapsible branches. Currently selected objects are highlighted in the list.
- 2 Choose one or more objects in the list by doing one of the following:
    - To select a single object and close the dialog, double-click the object name.
    - Drag, or click and then Shift+click to select a contiguous range of objects and Ctrl+click to select noncontiguous objects.

- In the field above the list, type a search phrase. As you type, all matches for the current phrase are highlighted in the list. To highlight only objects whose case matches the search phrase exactly, turn on Find Case Sensitive (from the Select menu) .

---

**NOTE** In some cases, such as when linking objects, you can select only one object.

---

3 Click Select.

The selection is made as the dialog closes.

**To highlight a single item from among multiple highlighted items:**

Clicking one list item among several highlighted items does not unhighlight the rest. When several items are highlighted, but you want to highlight only one of them, do either of the following:

- If any items are not highlighted, click one of them to remove highlighting from the rest, and then highlight the one you want.



- If all items are highlighted, the preceding method isn't practical. In that case, on the upper toolbar click Select None, and then highlight the one you want.

## Selection Floater

[Available only as a CUI action]

This modeless dialog lets you select objects in the scene. You can keep the dialog open while you work in your scene, making it easier to select objects.

---

**IMPORTANT** The Selection Floater command is available only as a [Customize User Interface](#) on page 7489 action; to use it you must first add it explicitly to the user interface.

---

**See also:**

- [Scene Explorer](#) on page 7171

## Interface

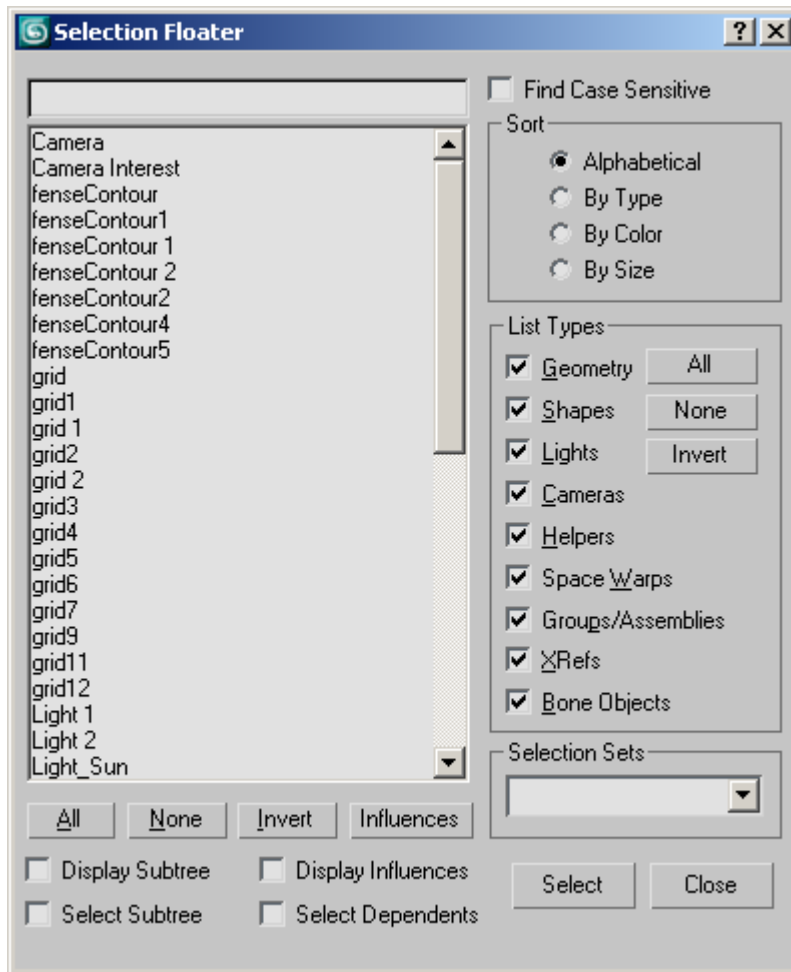

**[select objects field]** Enter a name to highlight objects in the list whose names begin with the text you specify.

**Find Case Sensitive** When on, the select objects field above the list is case-sensitive. For example, if the list contains objects named **apple** and **Apple** and Find Case Sensitive is on, typing “a” will highlight only the **apple** entry. Also, sorts the list so uppercase names come before lowercase.

**[objects list]** Lists objects according to the current Sort and List Types choices. Does not display hidden and frozen objects.

To highlight an object name in the list, click with the mouse. To highlight multiple object names, drag, or click and then Ctrl+click or Shift+click, or use the search field above the list. To select highlighted objects, click the Select button.

Alternatively, you can highlight and select a single object in the list by double-clicking its name.

After selecting objects, the dialog remains open until you close it explicitly.

**All/None/Invert** These buttons alter the pattern of selection in the list window.

**Influences** When you highlight an object in the list window and then click the Influences button, the selected object's [influences](#) on page 7816 are highlighted as well.

**Display Subtree** Displays each item in the list so that its [hierarchical branch](#) on page 7806 is included (for example, Thigh/Shin/Foot). Hierarchical branches are indented.

**Display Influences** When this is on and you select an item in the list window, all of its influences are shown in blue. If you want to highlight these influences, click Influences.

**Select Subtree** When this is on and you select an item in the list window, all of its hierarchical children are selected as well.

**Select Dependents** When this is on and you select an item in the list window, all of its [dependent](#) on page 7755 objects are selected as well. Dependents include instances, references, and objects sharing a common modifier (the same objects that appear green when Show Dependencies is on in the View menu).

When both Select Subtree and Select Dependents are on, the subtree of any newly selected node is first selected, and then the dependents are selected. In other words, dependents of the subtree are selected, but not the subtrees of all dependents.

## Sort group

Lets you choose the sort order of the items displayed in the list. This option is unavailable when Display Subtree is on; in that case, sorting is always alphabetical.

- **Alphabetical** Sorts from numeric characters at the top, then A to Z at the bottom. When Find Case Sensitive is on, all upper-case names come before lower-case names.

- **By Type** Sorts by category, using the same order as the check boxes in the List Types group.
- **By Color** Sorts by object wireframe color. The sorting order is arbitrary; the value of this option is that objects of the same color are grouped together.
- **By Size** Sorts based on the number of faces in each object. The object with the least number of faces is listed first, followed by objects with successively greater number of faces.

### List Types group

Determines the types of objects to display in the list.

**All/None/Invert** These buttons alter the pattern of activation of the List Types options.

### Selection Sets group

Lists any [named selection sets](#) on page 179 that you have defined in the scene. When you choose a selection set from the drop-down list, 3ds Max highlights its component objects in the main list.

## Selection Region Flyout

Main toolbar > Selection Region flyout





### Selection Region flyout

The Selection Region flyout provides access to five methods you can use to select objects by region. Clicking the Selection Region button displays a flyout containing the [Rectangle](#) on page 192 , [Circular](#) on page 193 , [Fence](#) on page 194 , [Lasso](#) on page 195 , and [Paint](#) on page 196 Selection Region buttons.

For the first four methods, you can select either objects that are completely within the selection region (window method), or objects that are within or touched by the selection shape (crossing method). Toggle between the window and crossing selection methods by using the [Window/Crossing Selection button](#) on page 200 on the main toolbar.

---

**NOTE** If you hold down Ctrl while specifying a region, the affected objects are added to the current selection. Conversely, if you hold down Alt while specifying a region, the affected objects are removed from the current selection.

---

**NOTE** The Smart Select command activates the [Select Object](#) on page 167 function and, with repeated invocations, cycles through the available Selection Region methods. By default, Smart Select is assigned to the Q key; you can use [Customize User Interface](#) on page 7489 to assign it to a different keyboard shortcut, a menu, etc.

---

## Procedures

### To select using a region (general method):

- 1 Choose a Selection Region method from the flyout.
- 2 Drag in a viewport, then release the mouse. The first location you click is one corner of the rectangle, and where you release the mouse is the opposite corner.

---

**IMPORTANT** If you're using [Select Object](#) on page 167 , you can start dragging anywhere to select a region: on an object or off. However, if you're using one of the transform tools, such as [Select and Move](#) on page 888 , start the drag operation away from an object; that is, in an empty part of the viewport. Otherwise, if you start dragging on an object, most likely the software will assume you intend to select where you click and will begin the transform operation immediately.

---

To cancel the selection, right-click before you release the mouse.

## Selection Filter List

Main toolbar > Selection Filter

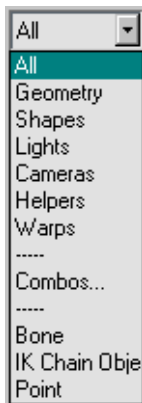

The Selection Filter list lets you restrict to specific types and combinations of objects that can be selected by the selection tools. For example, if you choose Cameras, you can select only cameras with the selection tools. Other objects do not respond. When you need to select objects of a certain type, this is useful as a quick method of freezing all other objects.

Use the drop-down list to select a single filter. Choose Combos from the drop-down list to use multiple filters from the [Filter Combinations dialog](#) on page 177 .

## Filter Combinations Dialog

Main toolbar > Selection Filter list > Combos > Filter Combinations dialog

Use the Filter Combinations dialog to create your own custom combinations of categories to add to the [Selection Filters list](#) on page 176 .

You can also add specific types of objects, or Class IDs, to the list. For example, you can set a filter that lets you select only Sphere primitives.

### Procedures

#### To create a combination filter:

- 1 Open the Selection Filter list and choose Combos.  
The Filter Combinations dialog appears.
- 2 Turn on one or more of the check boxes in the Create Combination group.
- 3 Click the Add button.  
The specified combination appears in the Current Combinations list to the right as a combination of the first letters of each selected category.
- 4 Click OK.  
The new combo item appears at the bottom of the Select Filter list.  
Combos are stored in the [3dsmax.ini](#) on page 51 file, so they remain in effect for all scenes through all sessions.

#### To delete a combination filter:

- 1 Open the Selection Filter list and choose Combos.  
The Filter Combinations dialog appears.
- 2 Choose one or more of the combos in the Current Combinations list.
- 3 Click the Delete button.
- 4 Click OK.

## Interface

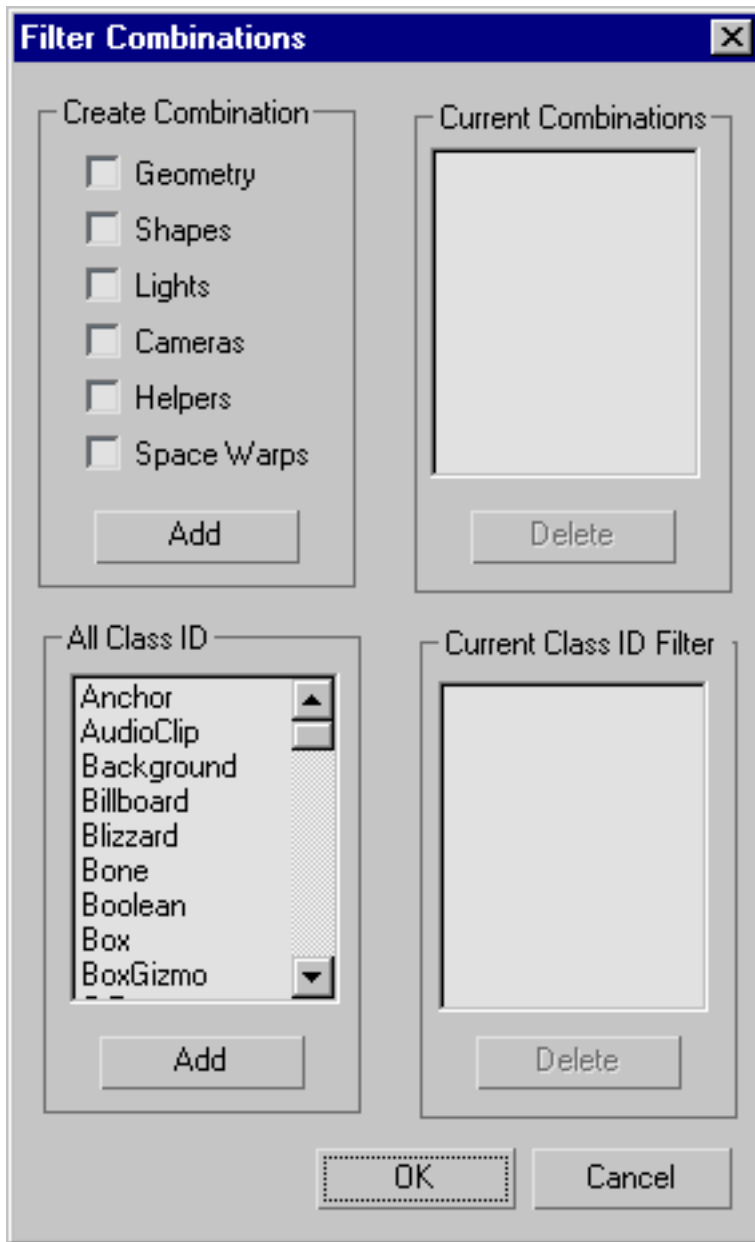

## Create Combination group

**Geometry, Shapes, Lights, Cameras, Helpers, Space Warps** Choose the category or categories you want included in the combination.

**Add** After choosing the categories to include in a combination, click this button to place the categories, labeled with the categories' initials, in the Current Combinations list, as well as at the bottom of the Selection Filter list.

## Current Combinations group

**Current Combinations list** Lists current combinations. To delete one or more combinations, choose them, and then click Delete.

**Delete** After choosing one or more combinations in the Current Combinations list, click this button to delete them.

## All Class ID group

**Class ID list** Lists all the available categories that can be added to custom filters for display and selection. Highlight a category to add, then click Add.

**Add** After choosing a class to include in the filter list, click this button to place the class in the Current Class ID Filter list, as well as at the bottom of the Selection Filter list.

## Current Class ID Filter group

**Class ID list** Lists current classes to filter. To delete a class, choose it, and then click Delete.

**Delete** After choosing a class in the Current Class ID Filter list, click this button to delete the class.

# Named Selection Sets

Main toolbar > Named Selection Sets



The Named Selection Sets list allows you to name a selection set and recall the selection for later use. It supports selection sets both at the object level and at sub-object levels. You edit named object-level selection sets with the [Named Selections Sets dialog](#) on page 181 and sub-object level sets with the [Edit Named Selections dialog](#) on page 186 .

A named selection set is removed from the list if all of its objects have been deleted from the scene, or if all of its objects have been removed from the named set in the Named Selections Sets dialog.

Selection set names are case sensitive at both the object level and at sub-object levels.

You can transfer sub-object named selections from one level in the stack to another. The Copy and Paste buttons let you copy named selections from one modifier to another.

While at a specific sub-object level, such as Vertex, you can make selections and name those selections in the Named Selection Sets field of the toolbar. The named sets are specific to both the selection level and the level on the stack.

Keep in mind the following restrictions:

- You can transfer named selections only between the same type of sub-object level. In other words, you can transfer named selections from vertex sub-object to another vertex sub-object, but you can't transfer it to face or edge sub-object level.
- You must transfer the selection between modifiers that handle like geometry. You can copy and paste between an editable mesh and a mesh select modifier, but you can't copy and paste between a mesh select modifier and an editable spline.
- You can copy and paste between two modifiers in two different objects, as long as you're at the same level and both modifiers handle the same type of geometry.
- If you change the topology of a mesh after creating a named selection (such as deleting some vertices), the named selections will probably no longer select the same geometry.

## **Procedures**

**To create a named selection set:**

- 1 Select the objects you want to be in a set.

- 2 Type the name of the set in the Named Selection Set field and press Enter.
- 3 Whenever you want to access the selection, choose its name from the Named Selection Sets list.

To select a named selection set, do one of the following:

- 1 To select a single item, click it in the list.
- 2 To select more than one item in the list, select one, and then select others while holding down the Ctrl key.
- 3 To deselect single items after you've selected multiple items, hold down the Alt key.

## Named Selection Sets Dialog



Edit menu > Edit Named Selections

Main toolbar > Named Selection Sets

The Named Selection Sets dialog, available from the Edit menu, is a [modeless dialog](#) on page 7849 that lets you create named selection sets or select objects to add to (or remove from) a selection set, directly from the viewport. The dialog also lets you organize your current named selection sets, browse their members, delete or create new sets, or identify which named selection sets a particular object belongs to.

---

**NOTE** This dialog applies to *objects* only. For editing *sub-object* named selection sets, see [Edit Named Selections Dialog](#) on page 186 .

---

See also:

- [Named Selection Sets](#) on page 179
- [Using Named Selection Sets](#) on page 146
- [Edit Named Selections Dialog](#) on page 186

## Procedures

### To create a named selection:

- 1 In the viewport, select the objects you want to gather as a selection set.



- 2 Click the toolbar Named Selection Sets button or choose Edit > Edit Named Selections.



- 3 On the Named Selection Sets dialog, click Create New Set.
- 4 Enter a name for the new selection set.

### To add objects to a named selection set:



- 1 Click the toolbar Named Selection Sets button or choose Edit > Edit Named Selections.

- 2 Choose the named selection set in the dialog.
- 3 Select one or more objects in the viewport.



- 4 In the dialog, click Add Selected Objects.

### To remove objects from a named selection set:



- 1 Click the toolbar Named Selection Sets button or choose Edit > Edit Named Selections.

- 2 Choose the named selection set in the dialog.
- 3 In the viewport, select the objects you want to remove.



- 4 In the dialog, click Subtract Selected Objects.





Note: You can also remove objects by selecting them in the Named Selection Sets dialog, then clicking Remove or pressing Delete.

#### To move an object from one set to another:



- 1 Click the toolbar Named Selection Sets button or choose Edit > Edit Named Selections.
- 2 In the Named Selection Sets dialog, expand the selection sets.
- 3 Drag an object from one set to another.  
The object is moved into the second set. If you use Ctrl+drag, the object will be *copied* into the second set.

---

**TIP** You can also copy the contents of an entire set into another, by dragging them into the desired selection set.

---

#### To select objects in a set:

- 1 Highlight the set in the Named Selection Sets dialog.



- 2 Click Select Objects In Set to select all of the objects in the highlighted set.

## Interface

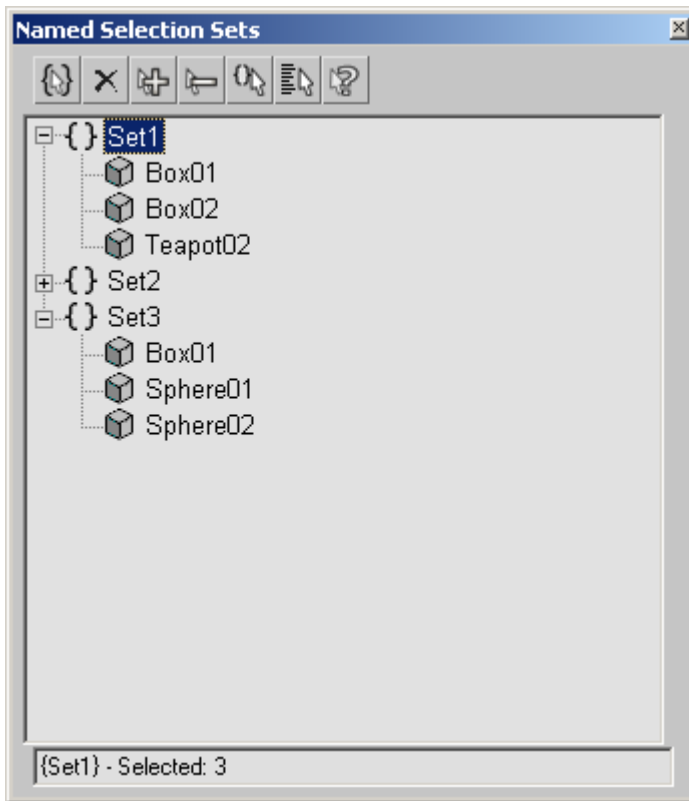

In the Named Selection Sets dialog, all of the current named selection sets are displayed. By clicking the plus (+) or minus (-) icon, you can expand or collapse (respectively) the object list for each set.

The buttons along the top of the dialog let you create or delete sets, add or remove objects from a set, select objects (independently or as a selection set), and see which named selection set(s) a particular object belongs to.



**Create New Set** Creates a new selection set, including any currently selected objects as members.

---

**NOTE** If no objects are selected, an empty set is created.

---



**Remove** Removes the selected object or selection set.

---

**NOTE** Deleting an object or its selection set does not delete the object; it only destroys the named set.

---



**Add Selected Objects** Adds the currently selected objects to the selected named selection set.



**Subtract Selected Objects** Removes currently selected objects from the selected named selection set.



**Select Objects in Set** Selects all members of the current named selection.



**Select Objects by Name** Opens the [Select Objects dialog](#) on page 168, where you can select a group of objects. The selected objects can then be added to or removed from any named selection set.



**Highlight Selected Objects** Highlights all of the named selection sets that contain the current scene selection.

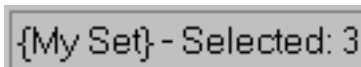

**Status Bar** Displays the current named selection set, as well as what's currently selected in the scene. If more than one object is selected, the number of selected objects is displayed.

### Right-click menu

Additional commands are available when you right-click in the Named Selection Sets dialog.

**Rename** Lets you rename the selected set or object.

---

**TIP** You can rename objects or sets by pressing F2.

---

**Cut** Removes the selected object or set and stores it in a buffer for reuse with the Paste command, similar to the Cut command in Windows.

---

**TIP** You can cut an object or set by pressing Ctrl+X.

---

**Copy** Copies the selected object or set and stores it in a buffer for reuse with the Paste command, similar to the Copy command in Windows.

---

**TIP** You can copy an object or set by pressing Ctrl+C.

---

**Paste** Adds a Cut or Copied object or set into another set.

---

**TIP** You can paste an object or set by pressing Ctrl+V.

---

**Collapse All** Collapses all expanded selection sets.

**Expand All** Expands all collapsed selection sets.

**Create New Set** Creates a new selection set, including any currently selected objects as members.

**Remove** Removes the selected object or selection set.

**Add Selected Objects** Adds currently selected objects to the selected named selection set.

**Subtract Selected Objects** Removes currently selected objects from the selected named selection set.

**Select Objects in Set** Selects all members of the current named selection.

**Select Objects by Name** Opens the [Select Objects dialog](#) on page 168 , and adds all objects selected there to the current named selection set.

**Highlight Selected Objects** Highlights all of the named selection sets that contain the current scene selection.

**Find Next** Toggles through selection sets containing the selected object, when used in collaboration with the Highlight Selected Objects command.

---

**TIP** You can use Ctrl+G to toggle through the sets.

---

## Edit Named Selections Dialog

Make a sub-object selection. > Edit menu > Edit Named Selections

Make a sub-object selection. > Main toolbar > Named Selection Sets

Edit Named Selections displays the Edit Named Selections dialog, letting you manage named selection sets of [sub-objects on page 160](#) . Unlike the [Named](#)

[Selection Sets dialog](#) on page 181 , which applies to *objects only*, it is a modal dialog, which means that you must close it in order to work in other areas of 3ds Max. Also, you can work only with existing named sub-object selections; you cannot use the dialog to create new selections.

## Procedures

### To edit named sub-object selections:

- 1 At a sub-object level, create one or more [named selection sets](#) on page 179 .



- 2 Click the toolbar Named Selection Sets button or choose Edit > Edit Named Selections.

The Edit Named Selections dialog opens, listing all named selection sets for the current sub-object level.

- 3 Use the dialog controls to edit the named selection sets.

## Interface



The dialog window lists all named selections at the current sub-object level. The buttons beneath the windows let you delete, merge, and edit the listed items. Use standard mouse-plus-keyboard methods (using Ctrl or Shift) to highlight list items and designate them for subsequent operations.

To rename a set, click it in the list, and then edit its name in the one-line window immediately below the list.

**Combine** Merges all objects from the highlighted selection sets into a single, new selection set. Select two or more selection sets, and then click Combine and enter a new name for the selection set. Use Delete to delete the original sets.

**Delete** Deletes all highlighted items from the Named Selections window. This affects only selection sets, not the sub-objects they refer to.

**Subtract (A-B)** Removes the sub-objects contained in one selection set from another. Select one item in the Named Selections window, and then select the other. The top highlighted item in the window is operand A, and the bottom is operand B (regardless of the order of their selection). Click Subtract (A-B) to subtract the sub-objects in the bottom item from those in the top item. There must be some overlap between the two selection sets for this command to have any effect.

**Subtract (B-A)** Subtracts the sub-objects in the top selected item from those in the bottom item.

**Intersection** Creates a selection set that consists only of sub-objects that all highlighted selection sets have in common. Highlight two or more items in the Named Selections window, and then click Intersection. In the dialog that appears, enter a new set name and click OK.

## Select All

Edit menu > Select All

Keyboard > Ctrl+A

This command selects all objects in the scene matching the current [selection filter type](#) on page 176 on the main toolbar.

## Select None

Edit menu > Select None

Keyboard > Ctrl+D

This command deselects all objects in the scene conforming to the current [selection filter type](#) on page 176 on the main toolbar.

## Select Invert

Edit menu > Select Invert

Keyboard > Ctrl+I

This command inverts the current selection set. All objects not currently selected are selected, and all objects currently selected are deselected, respecting the current [selection filter type](#) on page 176 on the main toolbar.

## Select Similar

Edit menu > Select Similar

Select one or more objects. > Right-click > quad menu > Transform quadrant > Select Similar

Select Similar automatically selects all items that are “similar” to the current selection. The specific functionality depends on the objects’ source:

- Selects all items imported in the DWG format in the selected object's or objects' layer that have the same [style\(s\)](#) on page 6850 or categories as defined in AutoCAD Architecture (formerly known as ADT, or Architectural Desktop), or the same families or types as defined in Revit. For example, if you've imported or linked to a DWG file that contains walls in several different styles, such as CMU-8, Concrete-8, and Stud-4, you could select all CMU-8 wall segments in the same layer by selecting one and then invoking Select Similar.

If you start by selecting multiple objects with different styles, Select Similar will select all objects with those styles.

- This command also applies to objects native to 3ds Max. It selects all objects of the same type, with the same material (or with no material), and on the same layer as the current selection. This includes primitives and editable object types. For example, if you add some boxes and cylinders, select one of the cylinders, and then invoke Select Similar, all of the cylinders will be selected, but not the boxes. If you then convert all of the objects to Editable Poly format and repeat the test, all of the objects will be selected. If you then apply a material to one of the objects or move it to a different layer, it's no longer “similar” to the rest and won't be selected by Select Similar.



# Select By

Edit menu > Select By

The Select By submenu on the Edit menu provides commands for selecting objects in the scene by color, name, and other characteristics. It also gives quick access to the various Region selection options.

[Select By Color](#) on page 191

[Select By Name \(Edit Menu\)](#) on page 191

[Select By Layer](#) on page 192

## Select By Color

Edit menu > Select By > Color

Select By Color lets you select all objects having the same color as the selected object. Selection is made by wireframe color (see [Object Color Dialog](#) on page 327 ), rather than by any materials associated with the objects.

After you choose this command, click any object in the scene to determine the color for the selection set.

---

**TIP** To select objects by material, use [Schematic View](#) on page 7197 .

---

## Select By Name (Edit Menu)

Edit menu > Select By > Name

Keyboard > H

Select By Name lets you select objects by choosing them from a list of all objects in the scene.

For a full description of the Select By Name function, see [Select From Scene](#) on page 168 .

---

**TIP** To select objects by material, use [Select By Material](#) on page 5244 .

---

## Select By Layer

Edit menu > Select By > Select By Layer

Select By Layer lets you select all objects in one or more layers by picking them from a list of all layers in the scene. Choosing this command opens the Select By Layer dialog; use standard methods to highlight one or more layers, and then click OK. The dialog closes, and all objects in the highlighted layer or layers are selected.

## Region Selection

### Selection Region

Edit Menu > Selection Region

The Selection Region submenu on the Edit menu provides quick access to the various [Region selection](#) on page 143 options.

[Rectangular Selection Region](#) on page 192

[Circular Selection Region](#) on page 193

[Fence Selection Region](#) on page 194

[Lasso Selection Region](#) on page 195

[Paint Selection Region](#) on page 196

[Window](#) on page 198

[Crossing](#) on page 200

### Rectangular Selection Region



main toolbar > Rectangular Selection Region (Selection Region flyout)

Edit menu > Selection Region > Rectangular Region

The Rectangular Selection Region option, available from the [Selection Region flyout](#) on page 174 and the Edit menu, provides one of five methods you can

use to select objects by region. The other methods are [Circular](#) on page 193 , [Fence](#) on page 194 , [Lasso](#) on page 195 , and [Paint](#) on page 196 .

You can use Rectangular to select either objects that are completely within the selection region (window method), or objects that are either within or touched by the selection shape (crossing method). Toggle between the window and crossing selection methods by using the [Window/Crossing Selection button](#) on page 200 on the main toolbar.

---

**NOTE** If you hold down Ctrl while specifying a region, the affected objects are added to the current selection. Conversely, if you hold down Alt while specifying a region, the affected objects are removed from the current selection.

---

## Procedures

To select using a rectangle:

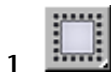

- 1 Click the Rectangular Selection Region button.
- 2 Drag in a viewport, then release the mouse. The first location you click is one corner of the rectangle, and where you release the mouse is the opposite corner.

To cancel the selection, right-click before you release the mouse.

## Circular Selection Region



main toolbar > Circular Selection Region (Selection Region flyout)

Edit menu > Selection Region > Circular Region

The Circular Selection Region option, available from the [Selection Region flyout](#) on page 174 and the Edit menu, provides one of five methods you can use to select objects by region. The other methods are [Rectangular](#) on page 192 , [Fence](#) on page 194 , [Lasso](#) on page 195 , and [Paint](#) on page 196 .

You can use Circular to select either objects that are completely within the selection region (window method), or objects that are either within or touched by the selection shape (crossing method). Toggle between the window and crossing selection methods by using the [Crossing Selection button](#) on page 200 on the main toolbar.

---

**NOTE** If you hold down Ctrl while specifying a region, the affected objects are added to the current selection. Conversely, if you hold down Alt while specifying a region, the affected objects are removed from the current selection.

---

## Procedures

To select using a circle:

- 1  Click the Circular Selection Region button.
- 2 Drag in a viewport, then release the mouse. The first location you click is the center of the circle, where you release the mouse defines the circle's radius.  
To cancel the selection, right-click before you release the mouse.

## Fence Selection Region

main toolbar > Fence Selection Region (Selection Region flyout)

Edit menu > Select By > Fence Region

The Fence Selection Region option, available from the [Selection Region flyout](#) on page 174 and the Edit menu, provides one of five methods you can use to select objects by region. The other methods are [Rectangular](#) on page 192 , [Circular](#) on page 193 , [Lasso](#) on page 195 , and [Paint](#) on page 196 .

You can use Fence to select either objects that are completely within the selection region (window method), or objects that are either within or touched by the selection shape (crossing method). Toggle between the window and crossing selection methods by using the [Window/Crossing button](#) on page 201 on the main toolbar.

---

**NOTE** If you hold down Ctrl while specifying a region, the affected objects are added to the current selection. Conversely, if you hold down Alt while specifying a region, the affected objects are removed from the current selection.

---

## Procedures

### To select using a fence:



- 1 Click the Fence Selection Region button.
- 2 Drag to draw the first segment of a polygon, then release the mouse button.  
A "rubber-band line" is now attached to the cursor, anchored at the point of release.
- 3 Move the mouse and click to define the next segment of the fence. You can make as many steps as you want.
- 4 To complete the fence, either click the first point, or double-click.  
A pair of cross hairs appears when you're near enough to click the first point. This creates a closed fence.  
Double-clicking creates an open fence, which can select objects only by the crossing method.  
To cancel the selection, right-click before you release the mouse.

## Lasso Selection Region



main toolbar > Lasso Selection Region (Selection Region flyout)

Edit menu > Selection Region > Lasso Region

The Lasso Selection method lets you select multiple objects within a complex or irregular region with a single mouse action.

The Lasso Selection Region option, available from the [Selection Region flyout](#) on page 174 and the Edit menu, provides one of five methods you can use to select objects by region. The other methods are [Rectangular](#) on page 192, [Circular](#) on page 193, [Fence](#) on page 194, and [Paint](#) on page 196.

You can use Lasso to select either objects that are completely within the selection region (window method), or objects that are either within or touched by the selection shape (crossing method). Toggle between the window and crossing selection methods by using the [Window/Crossing button](#) on page 201 on the main toolbar.

---

**NOTE** If you hold down Ctrl while specifying a region, the affected objects are added to the current selection. Conversely, if you hold down Alt while specifying a region, the affected objects are removed from the current selection.

---

## Procedures

To select using a lasso:



- 1 Click the Lasso Selection Region button.
- 2 Drag to draw a shape around the object(s) that should be selected, then release the mouse button.

---

**NOTE** To cancel the selection, right-click before you release the mouse.

---

## Paint Selection Region



main toolbar > Paint Selection Region (Selection Region flyout)

Edit menu > Selection Region > Paint Region

The Paint Selection method lets you select multiple objects or sub-objects by dragging the mouse over them. To change the brush size, right-click the Paint Selection Region button, and then, on the Preference Settings dialog > General tab > Scene Selection group, change the [Paint Selection Brush Size value](#) on page 7540 .

If you hold down Ctrl while specifying a region, the affected objects are added to the current selection. Conversely, if you hold down Alt while specifying a region, the affected objects are removed from the current selection.

---

**TIP** You can also create custom tools for changing the brush size; choose Customize menu > Customize User Interface and set keyboard shortcuts or other user interface items for the actions Paint Selection Size Up and Paint Selection Size Down.

---

---

**NOTE** Paint Selection Region respects the [Window/Crossing selection toggle](#) on page 201 setting. If the toggle is set to [Select Region Window](#) on page 198 and the brush is smaller than an object or sub-object to be selected, you won't be able to select the item. To resolve this, enlarge the brush or choose [Select Region Crossing](#) on page 200 .

---

**NOTE** With [editable poly](#) on page 2038 and [Edit Poly](#) on page 1293 objects, you can also paint [soft selections](#) on page 1930 and [deformation](#) on page 2043 .

---

The Paint Selection Region button, available from the [Selection Region flyout](#) on page 174 , provides one of five methods you can use to select objects by region. The other methods are [Rectangular](#) on page 192 , [Circular](#) on page 193 , [Lasso](#) on page 195 , and [Fence](#) on page 194 .

## Procedures

To select by painting a region:



- 1 Choose Paint Selection Region from the flyout.
- 2 Drag over the object(s) to select, then release the mouse button. As you drag, a circle showing the brush radius appears attached to the mouse.

---

**NOTE** To cancel the selection, right-click before you release the mouse.

---

- 3 To change the brush size, right-click the Paint Selection Region button, and then, on the Preference Settings dialog > General tab > Scene Selection group, change the [Paint Selection Brush Size value](#) on page 7540 .  
You can also set keyboard shortcuts for changing the brush size. To do so, use the Paint Selection Size Up and Paint Selection Size Down action items. See [Keyboard Panel](#) on page 7489 .

## Region



Edit menu > Region

main toolbar > Window Selection or Crossing Selection

When dragging the mouse to select one or more objects, the Region options let you switch between selecting objects within, or crossed by, a window region that you draw with the mouse. Choose the appropriate Selection Region submenu command, or use the [Window/Crossing Selection Toggle](#) on page 201 on the main toolbar.

You can automatically switch between Window and Crossing Region Selection based on cursor movement direction. To set this up, choose [Customize > Preferences](#) and on the General tab in the Scene Selection group turn on [Auto Window/Crossing Selection by Direction](#).

**See also:**

- [Select Region Window](#) on page 198
- [Select Region Crossing](#) on page 200

## Select Region Window



Edit menu > Selection Region > Window  
main toolbar > Window/Crossing Selection



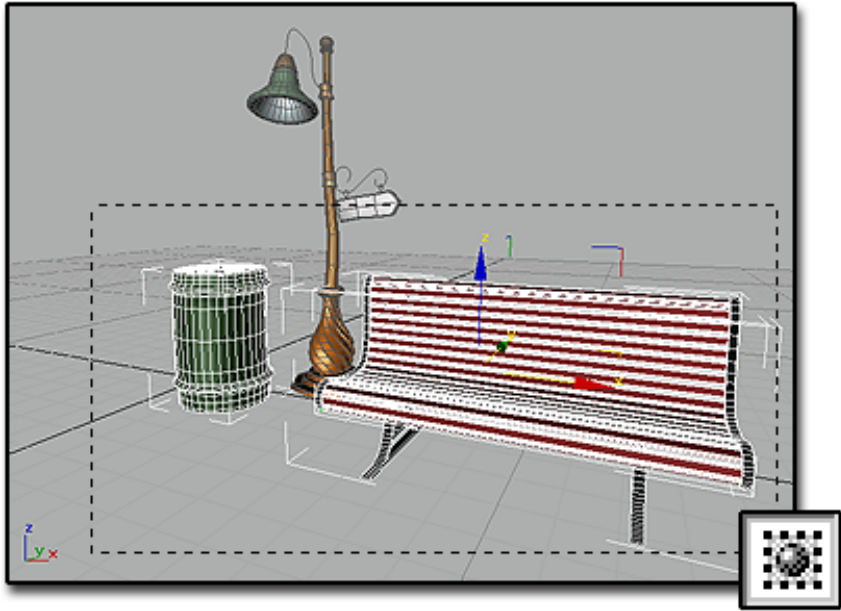

**Select Region Window** selects only those objects completely inside the window: the trash can and bench.

Select Region Window selects objects within a [selection region](#) on page 174 . After you choose this command, draw a selection region around any objects in the scene. Only those objects that are entirely inside the region boundary are selected.

## Procedures

**To select objects within a selection region:**

- 1 Do one of the following:
  - Choose Edit > Selection Region > Window.
  - Click the [Window/Crossing Selection Toggle](#) on page 201 to display the Window icon.
- 2 On the main toolbar, click the [Selection Region flyout](#) on page 174 and choose a method: Rectangular, Circular, Fence, or Lasso Selection region.

---

**NOTE** This setting also applies to Paint Selection Region, but in this case the boundary is that of the brush, not the region. In other words, when painting a selection region, the brush must completely encompass an object or sub-object to select it.

---

- 3 Drag to specify the region and select the objects.

## Select Region Crossing



Edit menu > Region > Crossing

main toolbar > Crossing Selection

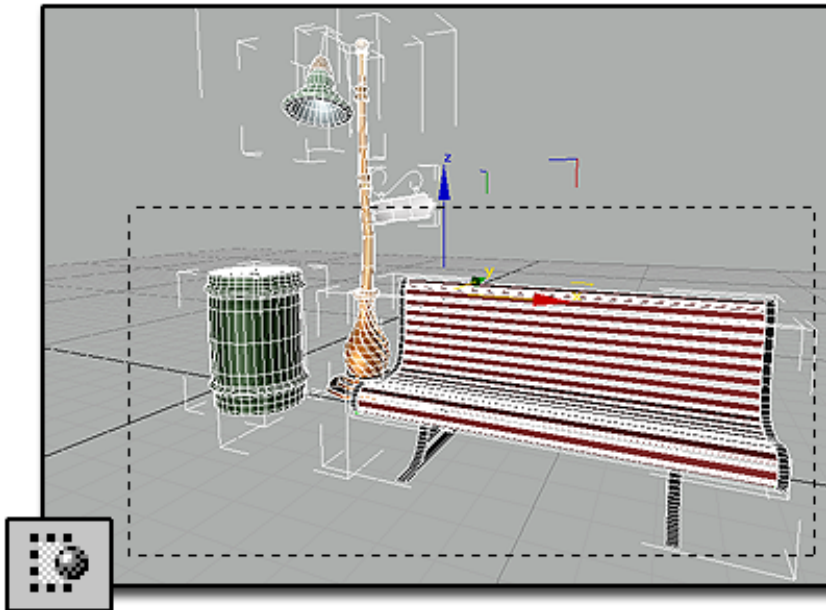

Select Region Crossing selects objects within the window and also objects it crosses: the trash can, bench, and streetlight.

Select Region Crossing selects objects within and crossed by a [selection region](#) on page 174 boundary.

After you choose this command, draw a selection region around or crossing objects in the scene. Objects within the region boundary as well as those that intersect the boundary are selected.

## Procedures

### To select objects within and crossed by a selection region:

- 1 Do one of the following:
  - Choose Edit > Selection Region > Crossing.
  - Click the [Window/Crossing Selection Toggle](#) on page 201 to display the Crossing icon.
- 2 From the main toolbar, click the [Selection Region flyout](#) on page 174 and choose a method: Rectangular, Circular, Fence or Lasso Selection region.

---

**NOTE** This setting also applies to Paint Selection Region, but in this case the boundary is that of the brush, not the region. In other words, when painting a region in Crossing mode, the brush selects every object or sub-object it touches or encompasses.

---

- 3 Drag to specify the region and select the objects.

## Window/Crossing Selection Toggle



main toolbar > Crossing Selection or Window Selection from the Window/Crossing toggle

Edit menu > Region > Window or Crossing

The Window/Crossing Selection toggle switches between window and crossing modes when you select by region.

- In [Window mode](#) on page 198, you select only the objects or sub-objects *within* the selection.
- In [Crossing mode](#) on page 200, you select all objects or sub-objects within the region, plus any objects or sub-objects *crossing* the boundaries of the region.

---

**TIP** If you're making sub-object selections of faces and you select more faces than you want, make sure you're in Window mode.

---

The [Selection Region flyout](#) on page 174 on the toolbar allows you to create different-shaped boundaries.

3ds Max automatically saves the Window/Crossing setting in the [3dsmax.ini](#) on page 51 file.

## Edit Commands

These commands on the [Edit menu](#) on page 7260 are for basic edit manipulations of selections.

Undo and Redo work as in standard Windows applications. These commands are available on the default main toolbar as well. 3ds Max also provides a history of commands. Right-clicking the Undo or Redo buttons displays a list of commands you can undo or redo. Not all operations are reversible using Undo.

---

**NOTE** Viewport changes such as panning and zooming have a separate Undo and Redo. See [View-Handling Commands](#) on page 86 .

---

The Hold and Fetch command pair serves as an alternative to Undo and Redo. Hold saves the current state of the scene. After using Hold, you can restore that state at a later point by using Fetch. Sometimes, when you are about to perform a risky operation, an alert prompts you to first use Hold.

3ds Max does not have the Cut or Paste functions found in many Windows applications. The Delete command simply removes the selection from the scene.

[Undo/Redo](#) on page 202

[Hold/Fetch](#) on page 204

[Delete](#) on page 205

## Undo/Redo

Edit menu > Undo or Redo

Main toolbar > Undo or Redo

Keyboard > Ctrl+Z (Undo) or Ctrl+Y (Redo)

The Undo command reverses the last operation, including selection actions and those performed on selected objects. Redo reverses the last Undo operation.

Some actions cannot be undone: for example, applying the Collapse utility or Reset Transform utility, or saving a file, which overwrites the previous version. When you know something cannot be undone, use [Hold](#) on page 204 first. Then if you want to undo it, use Fetch. Hold and Fetch are also commands on the [Edit menu](#) on page 7260 .

Afer you perform an action that is undoable, the Undo command on the Edit menu shows the name of the function to be undone. After you undo an action, the Redo command Edit menu shows the name of the function you can redo.

Undo and Redo are also available as buttons on the main toolbar. You can right-click the Undo or Redo button to display a box that lists the last operations performed. You can highlight and reverse any number of these operations in sequence with the respective Undo or Redo command. By default, there are 20 levels of Undo. You can change the number of levels with the Customize > Preferences > [General tab](#) on page 7536 > Scene Undo group.

## Undo/Redo and Object Creation

When you create an object, the Create operation is recorded by 3ds Max and displayed next to the activated Undo command in the Edit menu. If you undo the Create operation, the Create operation appears next to the activated Redo command in the Edit menu. The Undo and Redo commands in the Edit menu are unavailable when no valid operation was performed or recorded.

## Procedures

### To undo the most recent action:

Do one of the following:

-  Click Undo..
- Choose Edit menu > Undo.
- Press Ctrl+Z.

### To undo several actions:

- 1  Right-click Undo.
- 2 From the list, select the level where you want to return. You must choose a continuous selection; you can't skip over items in the list.
- 3 Click the Undo button.  
To exit the list without performing an action, click the Cancel button, or click somewhere outside of the list.

### To redo an action, do one of the following:

- 1  Click Redo.
- 2 Edit menu > Redo.
- 3 Press `Ctrl+Y` .

### To redo several actions:

- 1  Right-click Redo.
- 2 From the list, click the action to return to.  
Your selection must be continuous: you can't skip over any items in the list.
- 3 Click the Redo button.  
To exit the list without performing an action, click the Cancel button or click somewhere outside of the list.

## Hold/Fetch

Edit menu > Hold or Fetch

Hold saves the scene and its settings to a disk-based buffer. Fetch restores the contents of the buffer stored by the previous Hold command. The information stored includes geometry, lights, cameras, the viewport configuration, and selection sets.

Use Hold before you perform an operation that might not work as expected, that is new or unfamiliar to you, or that cannot be undone. If the results aren't as expected, you can use Fetch to return to the point where you chose Hold.

---

**TIP** Also use Save or Save As before you perform an operation that cannot be undone: for example, applying the Reset Transform utility.

---

If you experience an unexpected end of operation or crash after you perform Hold, you can retrieve your scene from the buffer with the Fetch command after you restart 3ds Max.

### **Additional Details**

- The Hold buffer is a temporary file (*maxhold.mx*) in the directory specified by the AutoBackup path on the Configure User Paths dialog > [File I/O panel](#) on page 7524 .
- Fetch also deletes all operations recorded in the Undo and Redo History lists.

## **Delete**

Make a selection. > Edit menu > Delete

Make a selection. > Keyboard > Delete

The Delete command deletes the current selection from the model.

The [Undo command](#) on page 202 can restore the deleted selection to the model. (The Undo command is also available as a button on the main toolbar.)

## **Groups and Assemblies**

You use groups and assemblies in 3ds Max to combine arbitrary sets of scene entities into a single, non-hierarchical object that you can then manipulate as one. Grouping works with all objects, while assemblies are best used for light fixtures and characters.

For more information about groups, see [Using Groups](#) on page 206 and [Group Commands](#) on page 221 .

For more information about assemblies, see [Using Assemblies](#) on page 209 and [Assembly Commands](#) on page 226

For more information about character assemblies, see [Character Assembly](#) on page 217 and [Character Assembly Commands](#) on page 237

## Using Groups

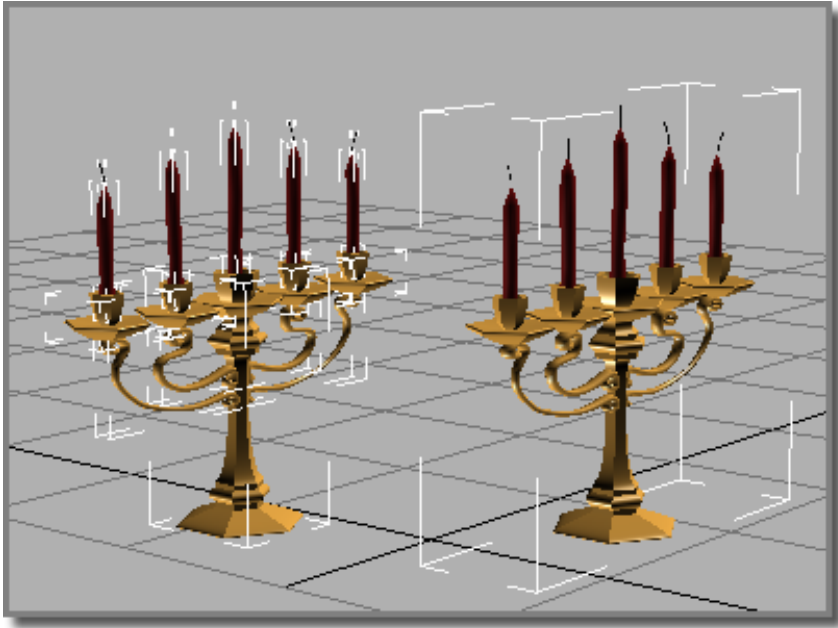

**Object on the right is a group and treated as a single entity.**

Grouping lets you combine two or more objects into a single grouped object. The grouped object is given a name, and then treated much like any other object.

Group names are similar to object names, except that they're carried by the group object. In lists like the one in the [Selection Floater](#) on page 171 , group names appear in square brackets. For example: [Group01]. In [Scene Explorer](#) on page 7171 and related dialogs, the square brackets enclose the group object icon instead.

The commands to manage groups are on the default [Group menu](#) on page 7262 .



## General Features of Groups

Once you group objects, you can treat them as a single object in your scene. You can click any object in the group to select the group object.

When you create a group, all of its member objects are rigidly linked to an invisible dummy object. The group object uses the pivot point and the local transform coordinate system of this dummy object.

Groups can be nested. That is, groups can contain other groups, up to any level.

## Transforming and Modifying a Group

You can transform or modify a group as if it were a single object, and you can animate the transforms and the modifiers.

When you apply a modifier to the group, this applies an instance of the modifier to each object in the group. A grouped object retains its modifier instance, even if you later remove it from the group.

When you apply a transform to the group, on the other hand, this applies only to the group as a whole. More precisely, 3ds Max applies transforms to the dummy object that represents the group.

You can transform and animate individual objects within a group independently from the group itself. However, when you transform the group itself, the transform affects all grouped objects equally. The group transform is uniformly added to objects that have independent motions. An analogy is a cage of birds, each flying around on its own, while the cage itself is being moved. In the case of groups, the "cage" (the dummy object) expands to surround all objects in the group, wherever the objects' independent transforms take them.

## Accessing Objects in a Group

You can open and close groups to access the individual objects contained in them without dissolving the group. These commands maintain the integrity of the group.

- **Open** on page 223 : Temporarily opens the group so that you can access its member objects. While a group is open, you can treat the objects (or nested groups) as individuals. You can transform them, apply modifiers, and access their modifier stacks.

- [Close](#) on page 223 : Restores the group when you're finished working with the individual objects.

## Dissolving Groups

You can permanently dissolve groups by either ungrouping or exploding them. Both commands dissolve groups, but to different levels.

- [Ungroup](#) on page 224 : Goes one level deep in the group hierarchy. It separates the current group into its component objects (or groups), and deletes the group dummy object.
- [Explode](#) on page 225 : Similar to Ungroup, but dissolves all nested groups as well, leaving independent objects.

When you Ungroup or Explode a group, the objects within the group lose all group transforms not on the current frame. However, objects retain any individual animation.

To transform or modify the objects within a group, you must first remove them from the group, either temporarily or permanently. The Open command lets you do this.

## Comparing Groups with Other Selection Methods

Compared to the other methods you can use to combine objects in 3ds Max, grouping is more permanent than selection sets, but less permanent than attaching objects.

- [Selection sets](#) on page 139 : Form a temporary collection of objects to which you apply the current commands. As soon as you select another object, the selection set is gone.
- [Named selection sets](#) on page 146 : Let you reselect the same pattern of objects, but the positional relationship between those objects (their transforms) might be different each time you recall the named set.
- **Grouped objects:** Maintain their positional relationships unless you open the group and rearrange them. A group also keeps its identity as an individual object.  
Each object in a group retains its modifier stack, including its base parameters. At any time, you can open the group to edit an object, and then close the group to restore the group identity.

- Attached objects (see [Editable Mesh \(Object\)](#) on page 1998 ): Attached objects form a single object. The modifier stacks of the original objects are lost, including their base parameters. You can regain the form of the original objects by detaching them, but they become plain meshes.
- [Assemblies](#) on page 209 are useful for creating combinations of geometry and light objects that act as lighting fixtures.

## Using Assemblies

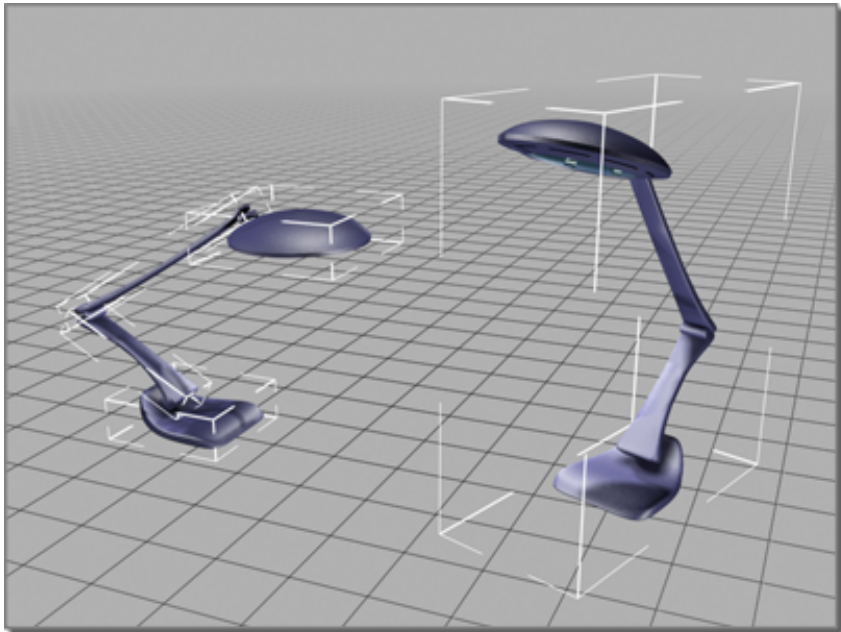

Object on the right is an assembly and is treated as a single entity.

Assemblies are useful for creating combinations of geometry and light objects that act as lighting fixtures; you use them to represent the housing of a lamp and its light source or sources. You can use assemblies to represent lighting fixtures such as simple desk lamps, lighting strips, track systems, wall sconces with fluorescent or incandescent lights, chandelier systems, line voltage cable systems, and so on.

When you create light assemblies, first you create your objects and build a hierarchy, then set joint parameters and assign [inverse kinematics \(IK\)](#) on

page 3299 . As a final step, you assemble the object hierarchy. The lights you use in the assembly have light-multiplier and filter color controls. You [wire](#) on page 3247 the Dimmer and Filter Color parameters of the Luminaire helper object to the parameters of the light sources that are members of the light assembly.

---

**NOTE** In order to wire the Luminaire controls to the light parameters, you must first [open](#) on page 231 the assembly; then, after wiring, you [close](#) on page 232 it.

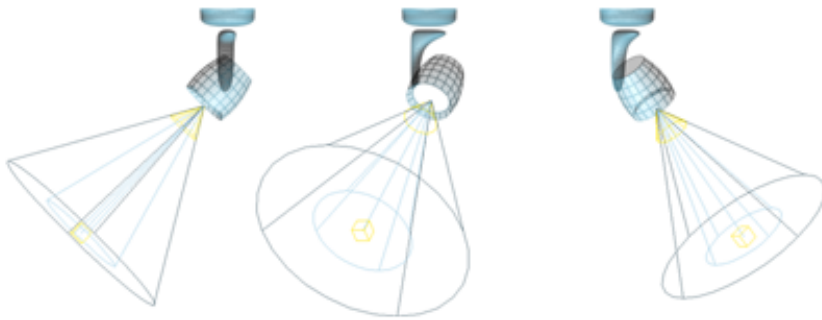

You can use IK to point a luminaire's beam by simply moving the light's target object.

---

## Assemblies and Groups

Assembly functionality is a superset of [grouping](#) on page 206 . Like grouping, creating an assembly lets you combine two or more objects and treat them as a single object. The assembled object is given a name, and then treated much like any other object.

The main difference with assemblies is that, when you [assemble](#) on page 227 the member objects, you specify a [head object](#) on page 234 : a [Luminaire helper object](#) on page 235 . The head object acts as a front end for the assembly, and its parameters appear in the Modify panel when the assembly is selected. You can use these parameters to control the light sources in the assembly via [parameter wiring](#) on page 3247 . You can create other types of head objects with MAXScript; for further information, open the *MAXScript Reference*, available from the Help menu, and look in Creating MAXScript Tools > Scripted Plug-ins > Scripted Helper Plug-ins.

Assembly names are similar to object names, except that they're carried by the assembly. In lists like the one in the [Selection Floater](#) on page 171, assembly names appear in square brackets; for example: [Assembly01]. In [Scene Explorer](#) on page 7171 and related dialogs, the square brackets enclose the assembly object icon instead.

---

**TIP** After you've created one fixture and assembled the parts, use [instancing](#) on page 7818 to [copy](#) on page 953 the fixture, and then distribute them in your scene. That way, if you change the attributes for a light source in an assembly, the change will be reflected in all the instanced light sources. For example, in the early design stages, you might use shadow maps, but later you might want to switch to advanced ray-trace shadows for greater accuracy in rendering. Using instancing makes it easier to change such settings globally.

---

### **General Features of Assemblies**

Once you assemble objects, you can treat them as a single object in your scene. You can click any object in the assembly to select the entire assembly.

When you create an assembly, all of its member objects are rigidly linked to an invisible Luminaire helper object. The assembly uses the pivot point and the local transform coordinate system of this helper object.

You can nest assemblies. That is, assemblies can contain other assemblies (or groups), up to any level.

The head object parameters appear in the Modify panel when the assembly is selected. You can use the 3ds Max [Wire Parameters](#) on page 3247 functionality to connect these parameters to those of light objects in the assembly. For a step-by-step procedure, see [To wire a head object to a light source](#) on page ? .

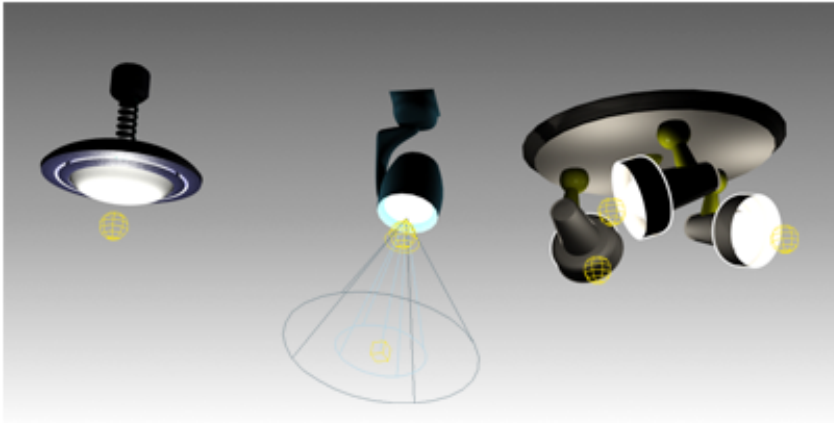

### Luminaire types

Left: Fixed

Middle: Orientable

Right: Multiple lights

### Transforming and Modifying an Assembly

You can transform or modify an assembly as if it were a single object, and you can animate the transforms.

Unlike a group, when you apply a modifier to the assembly, only the luminaire receives the modifier. Thus, deforming modifiers such as Bend don't have any effect on assemblies.

When you apply a transform to the assembly, it applies to the assembly as a whole. More precisely, 3ds Max applies transforms to the dummy object that represents the assembly. To modify member objects, you must first open the assembly, select the objects, and then apply modifiers. Such modifiers do not appear in the modifier stack when the assembly is closed.

You can transform and animate individual objects within an assembly independently from the assembly itself. However, when you transform the assembly itself, the transform affects all assembled objects equally. The assembly transform is uniformly added to objects that have independent motions. An analogy is a cage of birds, each flying around on its own, while the cage itself is being moved. In the case of assemblies, the "cage" (the dummy object) expands to surround all objects in the assembly, wherever the objects' independent transforms take them.

## Accessing Objects in an Assembly

You can *open* and *close* assemblies to access the individual objects contained in them without dissolving the assembly. These commands maintain the integrity of the assembly.

- **Open** on page 231 : Temporarily opens the assembly so that you can access its member objects. While an assembly is open, you can treat the objects (or nested assemblies/groups) as individuals. You can transform them, apply modifiers, and access their modifier stacks.
- **Close** on page 232 : Restores the assembly when you're finished working with the individual objects.

## Using Make Unique with Assemblies

When you clone assemblies using instancing, and then make the clones unique, it's important to consider how this affects parameter wiring. Consider the following typical usage case:

- 1 Drag an assembly, such as a light fixture, into the scene.
- 2 Clone the assembly several times using the Instance option and position the instances in the scene.
- 3 To make the scene look more realistic, giving the appearance of randomness to the objects in the scene, make some of the assembly instances unique and adjust their parameters to differ from the rest of the instances.

When you clone-instance an assembly, all objects in the assembly, along with all the parameter wires, are instanced. So if you change a wired luminaire parameter, all instanced assemblies are affected.

When the modifier stack displays an assembly head that is an instance or reference, the **Make Unique** on page 7446 button is active. By clicking it, the assembly head object is made unique with respect to its instances and all the assembly members are also made unique.

The parameter wiring between the unique assembly head and its members is de-coupled from the other instances of the assembly. Changing the parameters of the unique assembly head object affects only the parameters of its own members, not the members of the other instances of the assembly.

When multiple assembly instances are selected, the Make Unique command works the same as when multiple instances of an object are selected. You're

asked whether you want to make the selected assemblies unique one with respect to each other.

- If you answer Yes, 3ds Max makes the assemblies unique one with respect to another and parameter wires are reconnected inside each unique assembly. That is, the parameters of each unique assembly head drives only the parameters of its own members, not that of the members in any other assembly instances.
- If you answer No, then the selected assemblies are made unique only with respect to the other assembly instances. The parameters of unique assembly heads drive only the parameters of their members, not the members of the other assembly instances.

---

**NOTE** If you chose to instance the controllers when you instanced the assembly, the Modify panel > Make Unique command does not make the controllers unique. You can make them unique by doing the following: Open Track View, select the Transform track for object whose controller you want to make unique, and click the Make Unique button in the Track View toolbar.

---

## Dissolving Assemblies

You can permanently dissolve assemblies by either *disassembling* or *exploding* them. Both commands dissolve assemblies, but to different levels.

- [Disassemble](#) on page 233 : Goes one level deep in the assembly hierarchy. It separates the current assembly into its component objects (or assemblies/groups), and deletes the assembly head object.
- [Explode](#) on page 233 : Similar to Disassemble, but dissolves all nested assemblies and groups as well, leaving independent objects.

When you disassemble or explode an assembly, any transform animation applied to the assembly is lost, and objects remain as they were in the frame at which the dissolution is performed. However, objects retain any individual animation.

To transform or modify the objects within an assembly, you must first remove them from the assembly, either temporarily or permanently. The Open command lets you do this.



## Comparing Assemblies with Other Selection Methods

Compared to the other methods you can use to combine objects in 3ds Max, assembling is more permanent than selection sets, but less permanent than attaching objects.

- [Selection sets](#) on page 139 : Form a temporary collection of objects to which you apply the current commands. As soon as you select another object, the selection set is gone.
- [Named selection sets](#) on page 179 : Let you reselect the same pattern of objects, but the positional relationship between those objects (their transforms) might be different each time you recall the named set.
- Assembled and [grouped](#) on page 206 objects: Maintain their positional relationships unless you open the assembly and rearrange them. An assembly also keeps its identity as an individual object. Each object in an assembly retains its modifier stack, including its base parameters. At any time, you can open the assembly to edit an object, and then close the assembly to restore the assembly identity.
- Attached objects (see [Editable Mesh \(Object\)](#) on page 1998 ): Attached objects form a single object. The modifier stacks of the original objects are lost, including their base parameters. You can regain the form of the original objects by detaching them, but they become plain meshes.

See also:

- [Lights](#) on page 4890

## Procedures

To insert and place an existing assembly:

- 1 Turn on [AutoGrid](#) on page 2513 .
- 2 Drag the assembly from a Web page (if it's an [i-drop object](#) on page 6957 ) or from your local disk and drop it into your scene, placing it on any existing surface.



- 3 On the main toolbar, click [Use Pivot Point Center](#) on page 905 .
- 4 Position the assembly as you would any other object to aim it in a specific direction.

- 5 If necessary, [wire](#) on page ? the assembly luminaire to its light source or sources.
- 6 Select the assembly, and then use the Modify panel settings to adjust the intensity of the light with the Dimmer control.

#### To create your own luminaire:

- 1 Create the geometry of the lighting fixture.
- 2 Create a [light source](#) on page 4894 or on the Create panel, click Lights to add a standard or photometric light to the geometry of the lighting fixture you just made.
- 3 Select all the objects in the assembly, including geometrical objects and lights.

---

**NOTE** If using IK, leave the light targets out of the assembly so that you can manipulate them independently.

---

- 4 Choose Assembly menu > Assemble.  
A dialog appears requesting a name for the assembly and that you specify a head object. The only head object type available by default is [Luminaire](#) on page 235 .
- 5 Enter a name for the assembly and click OK.
- 6 [Wire](#) on page ? the assembly luminaire to its light source or sources.  
More information on parameter wiring is available at the link in this step.  
If more than one light source is present inside the assembly, create a chain of wired parameters. Then enter the desired relationship expression in the expression text box.

#### To adjust the pivot location of an assembly:

- When you adjust the pivot point of a closed group or assembly, the pivot point of all group and assembly members are affected, not only the pivot point of the group or assembly head object. Therefore, we recommend that you open the assembly, adjust the pivot of the head object, and then close the assembly.

**To use an assembly with radiosity:**

- Right-click the Luminaire, choose Properties, and on the [Object Properties dialog](#) on page 245 choose the Radiosity tab. You can exclude and control radiosity parameters of the geometry and lights independently.

**To adjust the properties of an assembly:**

- 1 After wiring the Dimmer and Filter Color parameters, select the Luminaire, and then go to Modify panel to display the luminaire parameters.
- 2 Adjust the parameters.  
The effect is visible in the viewport.

## Character Assembly

A *character assembly* is a special type of group for objects particular to a character setup: the character mesh, bones, IK chains, helper objects, controllers, and other objects used to animate characters. Once the objects are grouped (assembled), you can perform various functions on the group as a whole, such as saving and loading animation for the entire bone/mesh set.

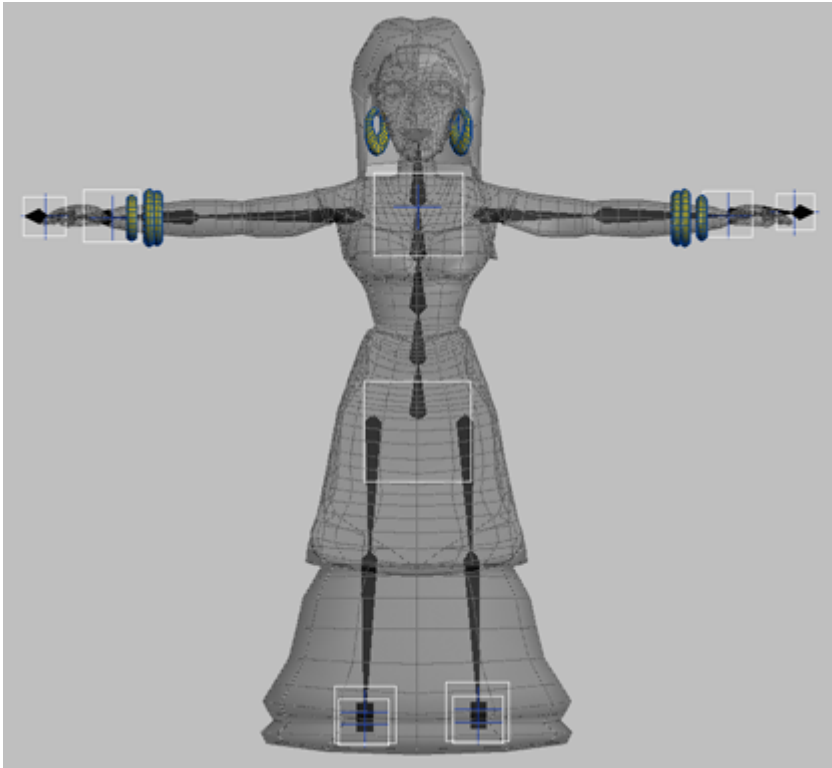

**The objects that make up a typical character assembly**

Unlike an ordinary group, there is no need to open a character assembly to work with its individual members.

When a character assembly is created, it is designated by a placeholder object called a *node*, placed near the bottom of the character assembly. Selecting the node gives access to special tools for working with character models and animation.

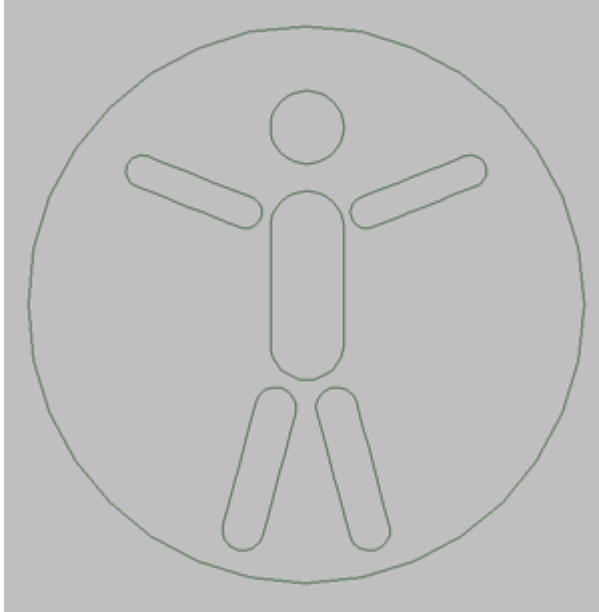

### Character assembly node

A character assembly will not create a character mesh or bone structure for you. The character assembly tool is designed for use on character structures that have already been set up using other tools.

Although the character assembly feature was designed for use with character structures, it will work equally well with any type of hierarchy or related set of objects.

### Adding Character Assembly Commands to the UI

By default, the character-assembly commands described here are not part of the 3ds Max user interface. To add them, choose **Customize menu > Customize User Interface**, click the tab representing the part of the UI to which you'll add the commands (Keyboard, Toolbars, etc.) and then, from the **Category** drop-down list, choose **Characters**. Use standard [CUI functionality](#) on page 7489 to add the commands.

---

**TIP** To add a fully populated Character menu to the menu bar, on the **Customize User Interface** dialog, scroll the **Menus** list to **Character**, and then drag the **Character** item over to the **Main Menu Bar** list on the right side of the dialog.

---

## Creating a Character Assembly

To create a character assembly, first select the objects that will make up the assembly. Next, you need to add any character-assembly commands you wish to use to the user interface; see [Adding Character Assembly Commands to the UI](#) on page 219 . Last, choose the Create Character command.

All selected objects become members of the assembly, and the character assembly node is created. Other objects can be manually added to the assembly after it has been created.

Once the character assembly has been created, you can work with it in a variety of ways. For information about the Modify panel options available after a character assembly is created, see [Create Character](#) on page 238 .

## Linked Objects in Character Assemblies

Any or all members of the character assembly can be linked to a single object outside the assembly, but no more than one. For example, ThighLeft and ThighRight, which are both part of the assembly, can both be linked to Pelvis, which is not part of the assembly. However, if ThighLeft and ThighRight are each linked to different objects outside the assembly, the creation of the assembly will fail, and will show the following error message:

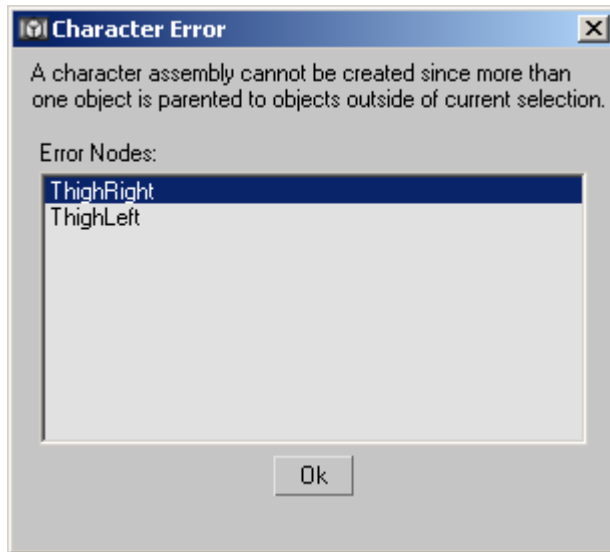

## Parameter Wiring and Animation

If you plan to wire parameters between two objects, create the assembly first and then set up the wiring. Be sure to include both objects in the assembly.

Because wiring should be done after the assembly is created, you will probably find it easiest to create the character assembly before animating the character.

### See also:

- [Create Character](#) on page 238
- [Destroy Character](#) on page 242
- [Lock/Unlock Character](#) on page 242
- [Save Character](#) on page 243
- [Insert Character](#) on page 243
- [Skin Pose Commands](#) on page 244
- [Merge Animation](#) on page 6859

## Group Commands

The commands to manage groups are on the [Group menu](#) on page 7262 .

[Group](#) on page 222

[Open Group](#) on page 223

[Close Group](#) on page 223

[Ungroup](#) on page 224

[Attach Group](#) on page 226

[Detach Group](#) on page 225

[Explode Group](#) on page 225

### See also:

- [Using Groups](#) on page 206

# Group

Group menu > Group

The Group command combines a selection set of objects or groups into a single group.

Once you group objects, you can treat them as a single object in your scene. You can click any object in the group to select the group object. You can transform the group as a single object, and you can apply modifiers as if it were a single object.

Groups can contain other groups, up to any level.

Group names are similar to object names, except that they're carried by the group object. In lists like the one in the [Selection Floater](#) on page 171, group names appear in square brackets. For example: [Group01]. In [Scene Explorer](#) on page 7171 and related dialogs, the square brackets enclose the group object icon instead.

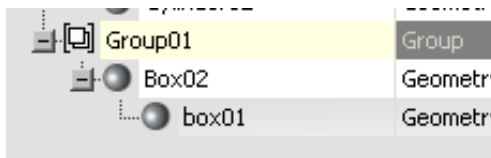

**A group in Scene Explorer**

If a group is selected, its name will appear in “bolded” text in the Name And Color rollout.

All members of a group inherit the visibility of the parent when a visibility controller is assigned to the parent.

Groups are considered whole objects in the Light Exclude/Include dialog, so you can exclude (or include) all objects in a group by selecting the group in the list. If a group is nested within another group, only the "outer" group is available in the list. To exclude only certain objects in a group, open the group before displaying the Exclude/Include dialog.

## Procedures

### To define a group:

- 1 Select two or more objects.
- 2 Choose Group menu > Group.



A dialog appears requesting a name for the group.

- 3 Enter a name for the group and click OK.

**To define a nested group:**

- 1 Select two or more groups or any combination of groups and objects.
- 2 Choose Group > Group.  
A dialog appears requesting a name for the group.
- 3 Enter a name for the new group object and click OK.

## Open Group

Select one or more groups. > Group menu > Open

The Open command lets you ungroup a group temporarily, and access objects within a group.

You can transform and modify the objects within the group independently from the rest of the group, then restore the original group using the Close command.

### Procedures

**To open a group:**

- 1 Select one or more groups.
- 2 Choose Group > Open. A pink bounding box appears, and the objects in the group are now accessible.

**To open nested groups:**

- 1 Select the group within the opened group.
- 2 Choose Group > Open.

## Close Group

Select the pink dummy object of an opened group. > Group menu > Close

The Close command regroups an opened group. For nested groups, closing the outermost group object closes all open inner groups.

When you link an object to a closed group, the object becomes a child of the group parent rather than of any member of the group. The entire group flashes to show that you've linked to the group.

### **Procedures**

#### **To close all opened groups nested within a main group:**

- 1 Select the pink bounding box representing the main group.
- 2 Choose Group > Close.

#### **To close a nested group:**

- 1 Select any object in the nested group or its dummy.
- 2 Choose Group > Close.

## **Ungroup**

Select one or more groups. > Group menu > Ungroup

Ungroup separates the current group into its component objects or groups.

The Ungroup command ungroups one level, unlike [Explode](#) on page 225 , which ungroups all levels of nested groups.

When you Ungroup a group, the objects within the group lose all group transforms that were applied on nonzero frames, but they retain any individual animation.

All ungrouped entities remain in the current selection set.

### **Procedures**

#### **To ungroup a group:**

- 1 Select one or more groups.
- 2 Choose Group > Ungroup.

All components of the group remain selected, but are no longer part of the group. The group dummy is deleted.

## Explode Group

Select one or more groups. > Group menu > Explode

The Explode command ungroups all objects in a group, regardless of the number of nested groups, unlike [Ungroup](#) on page 224 , which ungroups one level only.

As with the Ungroup command, all exploded entities remain in the current selection set.

---

**WARNING** Ungroup and Explode remove all transform animations that have been applied to the group as a whole. As with the Ungroup command, all exploded entities remain in the current selection set.

---

### Procedures

**To explode a group:**

- 1 Select one or more groups.
- 2 Choose Group > Explode.  
All objects in the groups remain selected but no longer belong to groups. All nested groups are exploded. All group dummies in the selection are deleted.

## Detach Group

Select a group. > Group menu > Open > Select one or more objects detach. > Group menu > Detach

The Detach command detaches the selected object from its group.

This command becomes active when you open the group by choosing the Open command from the Group menu.

### Procedures

**To detach an object from a group:**

- 1 Open the group.
- 2 Choose Group > Detach.

The selected objects are now separate, independent objects, no longer members of the group.

## Attach Group

Select one or more objects. > Group menu > Attach

The Attach command makes the selected object part of an existing group.

With an object selected, choose this command, and then click a group in the scene.

### Procedures

**To attach an object to a group:**

- 1 Select one or more objects to attach.
- 2 Choose Group > Attach.
- 3 Click any member of a closed group.  
The selected objects become part of the group, which is now selected.

---

**NOTE** To attach an object to an open group, click the pink bounding box.

---

## Assembly Commands

The commands to manage assemblies are available from the Group > Assembly submenu.

[Assemble](#) on page 227

[Disassemble](#) on page 233

[Open Assembly](#) on page 231

[Close Assembly](#) on page 232

[Attach Assembly](#) on page 234

[Detach Assembly](#) on page 234

[Explode Assembly](#) on page 233

**See also:**

- [Using Assemblies](#) on page 209

## Assemble

Select the objects to assemble. > Group menu > Assembly > Assemble

The Assemble command combines a selection set of objects, assemblies, and/or groups into a single assembly, and adds a [Luminaire helper object](#) on page 235 as a [head object](#) on page 234 .

Once you assemble objects, you can treat them as a single object in your scene. You can click any object in the group to select the entire assembly. You can transform the assembly as a single object, and you can apply modifiers as if it were a single object.

Assemblies can contain other assemblies and/or groups, up to any level.

Assembly names are similar to object names, except that they're carried by the assembly. In lists like the one in the [Selection Floater](#) on page 171 , assembly names appear in square brackets; for example: [Assembly01]. In [Scene Explorer](#) on page 7171 and related dialogs, the square brackets enclose the assembly object icon instead.

Each member of an assembly inherits the visibility of the parent when a visibility controller is assigned to the parent, providing its Object Properties > Rendering Control group > Inherit Visibility check box is turned on, or if its Rendering Control is set to By Layer and Inherit Visibility is turned on for its layer.

Assemblies are considered whole objects in the Light Exclude/Include dialog, so you can exclude (or include) all objects in an assembly by selecting the assembly in the list. If an assembly is nested within another assembly, only the "outer" assembly is available in the list. To exclude only certain objects in an assembly, open the assembly before displaying the Exclude/Include dialog.

**See also:**

- [Using Assemblies](#) on page 209

## Procedures

### To define an assembly:

- 1 Select two or more objects.
- 2 Choose Group menu > Assembly > Assemble.  
The Create Assembly dialog appears. It requests you to specify a name for the assembly and a [head object](#) on page 234 . The default head object type is [Luminaire](#) on page 235 .
- 3 Enter a name for the assembly, choose [Luminaire](#) on page 235 from the list, and click OK.  
The selected objects are assembled. The assembly head object position and orientation is determined as follows:
  - If there are multiple immediate children of the assembly head (for example, you're assembling several non-hierarchical objects), the head object is aligned with center of bottom face of the assembly bounding box.
  - If there's only one immediate child of the assembly head, the assembly head pivot point is aligned with that object's pivot point. For example, if you're assembling a single hierarchy, the topmost object in the hierarchy would be the single immediate child of the assembly head.

### To define a nested assembly:

- 1 Select two or more assemblies or any combination of assemblies and objects.
- 2 Choose Group menu > Assembly > Assemble.  
The Create Assembly dialog appears. It requests a name for the assembly, and a head object.
- 3 Enter a name for the new assembly object and click OK.

### To wire a head object to a light source:

- 1 Create a hierarchy of lights and geometrical objects that models a lighting fixture. Sets up all the necessary IK chains and other constraints that make the model behave properly when the user interacts with it (orients, positions, aims, etc.).

---

**IMPORTANT** For any photometric lights that you want to control with the head object, be sure to turn on the Multiplier check box on the Intensity/Color/Distribution rollout.

---

- 2 Select all objects in the fixture and define them as an assembly.  
When the assembly is selected, the luminaire parameters Dimmer and Filter Color appear in the Modify panel.
- 3 From the Animation menu, choose Wire Parameters > Parameter Wire Dialog.
- 4 The Parameter Wiring dialog appears.
- 5 On one side of the dialog, find the assembly and expand the branch titled Object (LuminaireHelper). Click the Dimmer item to highlight it.
- 6 On the other side, find the assembly and expand its hierarchy branch (click the + symbol in the square box). Find and expand the branch for the light source, and then expand its Object branch. Click the Multiplier item to highlight it.
- 7 Between the two hierarchy lists, click the Control Direction arrow button that points from the selected Dimmer item to the selected Multiplier item.

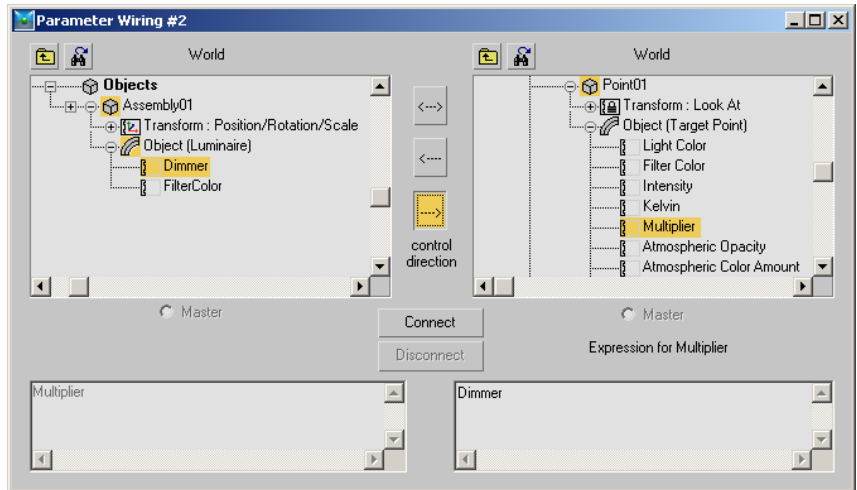

- 8 If you're wiring a photometric light, skip this step. If you're wiring a standard light, or any light whose default Multiplier setting is 1.0, do this:
  - The Expression box below the selected Multiplier item contains the word "Dimmer." Edit this to read "Dimmer/100". This divides the Dimmer value by 100, giving a 1:1 value ratio between it and the Multiplier setting.
- 9 Click the Connect button.

Now, when you change the luminaire's Dimmer setting, the light source intensity changes as well.
- 10 If you like, use the same method to wire the luminaire to any additional light sources in the light fixture.

You can also use this method to wire the luminaire's Filter Color parameter to any light sources' color settings.



## Interface



**Name** Specifies the name of the new assembly. The default name is "Assembly" followed by a two-place number starting with 01 and incremented by one for each new assembly.

**Choose Head Object** Lets you choose the type of object to serve as the assembly head object.

## Open Assembly

Select one or more assemblies. > Group menu > Assembly > Open

The Open command lets you temporarily disassemble an assembly and access its head and member objects individually.

You can transform and modify the head and member objects within the assembly independently from the rest of the assembly, then restore the original assembly using the [Close command](#) on page 232 .

## Procedures

### To open nested assemblies:

- 1 Select an assembly within the opened assembly.
- 2 Choose Group menu > Assembly > Open.

## Close Assembly

Select the luminaire. > Group menu > Assembly > Close

The Close command reassembles an opened assembly. For nested assemblies, closing the outermost assembly object closes all open inner assemblies.

When you link an object to a closed assembly, the object becomes a child of the assembly parent rather than of any member of the assembly. The entire assembly flashes to show that you've linked to the assembly.

## Procedures

### To close all opened assemblies nested within a main assembly:

- 1 Select any object in the main assembly or its luminaire head object.

---

**NOTE** If you select an object within an opened inner assembly, using Close will close only that assembly.

---

- 2 Choose Group menu > Assembly > Close.

### To close a nested assembly:

- 1 Select any object in the nested assembly or its luminaire.
- 2 Choose Group menu > Assembly > Close.

## Disassemble

Select one or more assemblies. > Group menu > Assembly > Disassemble

Disassemble separates the current assembly into its component objects or assemblies.

The Disassemble command separates one level, unlike [Explode](#) on page 233 , which separates all levels of nested assemblies.

When you disassemble an assembly, all components of the assembly remain selected, but are no longer part of the assembly. Any transform animation applied to the assembly is lost, and objects remain as they were in the frame at which the dissolution is performed. However, objects retain any individual animation.

All disassembled entities remain in the current selection set.

---

**NOTE** If you have wired the luminaire head to any other parameters, those parameters are still controlled by the wiring setup after disassembly and are not adjustable until you apply a standard controller, such as Bezier Float. Use Track View to do this.

---

## Explode Assembly

Select one or more assemblies. > Group menu > Assembly > Explode

The Explode command separates all objects in an assembly, regardless of the number of nested assemblies and/or groups, unlike [Disassemble](#) on page 233 , which separates one level only.

When you explode an assembly, all components of the assembly remain selected, but are no longer part of the assembly. Any transform animation applied to the assembly is lost, and objects remain as they were in the frame at which the dissolution is performed. However, objects retain any individual animation.

---

**NOTE** If you have wired the luminaire head to any other parameters, those parameters are still controlled by the wiring setup after exploding and are not adjustable until you apply a standard controller, such as Bezier Float. Use Track View to do this.

---

## Detach Assembly

Select an assembly. > Group menu > Assembly > Open > Select one or more objects to detach. > Assembly > Detach

Select one or more objects to detach in an open assembly. > Group menu > Assembly > Detach

The Detach command detaches the selected object from its assembly. If the object is a member of a nested assembly, after you detach it, it is no longer a member of any assembly.

This command becomes active when you open the assembly by choosing [Open](#) on page 231 from the Assembly menu.

## Attach Assembly

Select one or more objects. > Group menu > Assembly > Attach

The Attach command makes the selected object part of an existing assembly.

With an object selected, choose this command, and then click either a closed assembly in the scene, or the head object of an open assembly.

### Procedures

**To attach an object to an assembly:**

- 1 Select one or more objects to attach.
- 2 Choose Group menu > Assembly > Attach.
- 3 Click any member of an assembly.

The selected objects become part of the assembly, which is now selected.

## Assembly Head Helper Objects

### Assembly Head Helper Object

When you create an [assembly](#) on page 209 in 3ds Max, the program automatically adds a special type of helper object called a head object, or

assembly head. This object serves as the fulcrum of the assembly and also exposes parameters, available in the Modify panel when the assembly is selected, that you can wire to properties of objects inside the assembly. Thus, you can change and animate parameters of assembly member objects without having to open the assembly, as you would with a group.

## Luminaire Helper Object

Create panel > Helpers > Assembly Heads > Object Type rollout > Luminaire

The Luminaire helper object serves primarily as a head, or control, object for light fixtures. When you [assemble](#) on page 227 a set of objects into a light fixture, you specify that a new luminaire object should be used as the assembly head object. The luminaire's parameters, available from the Modify panel, let you control the light sources in the fixture. See [Using Assemblies](#) on page 209 for more information.

You can also add a Luminaire object separately from the Create panel, but in general it's not necessary.

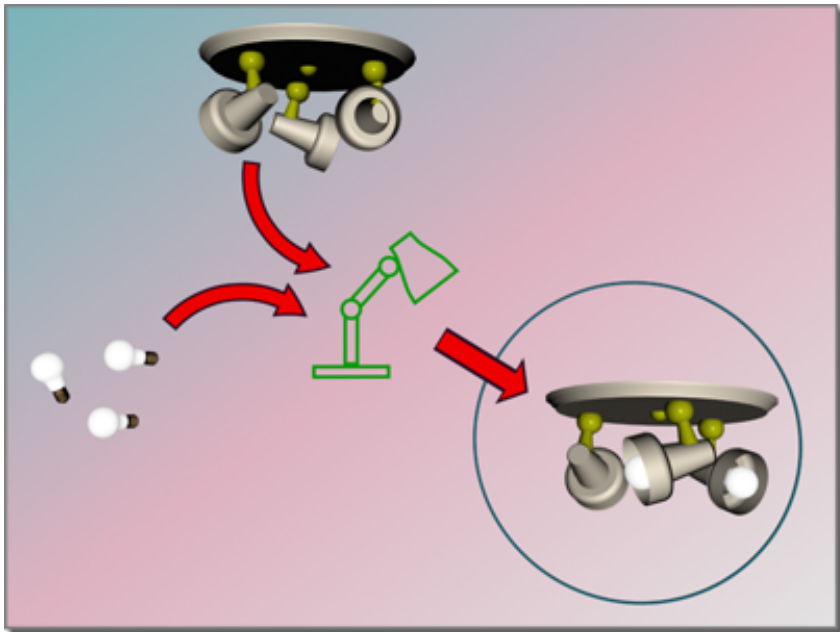

A luminaire object groups and manages the components as a whole.

## Interface

When a selected assembly is closed, the Modify panel displays the Luminaire parameters. However, when you open an assembly, 3ds Max shows you the parameters of the whichever object is selected. The Luminaire object provides Dimmer and Filter Color parameters. You wire these to the light objects that are part of the assembly.

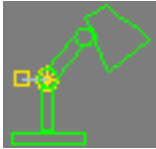

**Luminaire icon  
in the viewport**

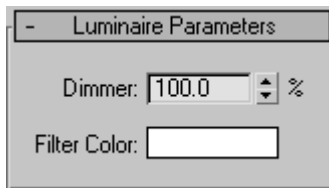

### Luminaire rollout

**Dimmer** Emulates the dimmer switch of a real-world lighting fixture. The setting determines the percentage of the default light intensity is emitted by the light source of a lighting fixture. You wire this parameter to one or more light sources' Multiplier settings.

**Filter Color** An RGB color parameter that you link to a light source's color or filter color.

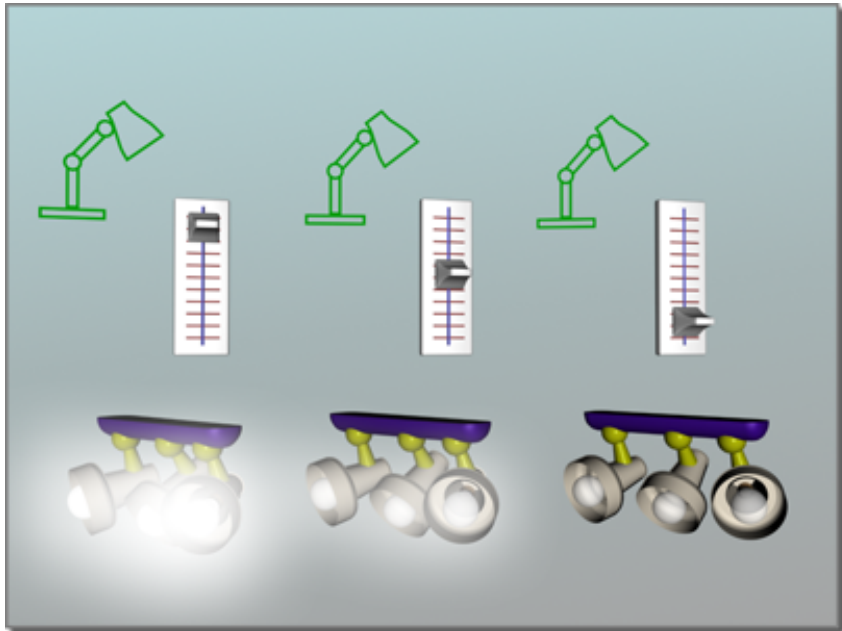

The Dimmer option can control the intensity of all the lights in the luminaire

## Character Assembly Commands

By default, the character-assembly commands listed here are not part of the 3ds Max user interface. To add them, choose **Customize** menu > **Customize User Interface**, click the tab representing the part of the UI to which you'll add the commands (Keyboard, Toolbars, etc.) and then, from the **Category** drop-down list, choose **Characters**. Use standard [CUI functionality](#) on page 7489 to add the commands.

---

**TIP** To add a fully populated **Character** menu to the menu bar, on the **Customize User Interface** dialog, scroll the **Menus** list to **Character**, and then drag the **Character** item over to the **Main Menu Bar** list on the right side of the dialog.

---

[Create Character](#) on page 238

[Destroy Character](#) on page 242

[Lock/Unlock Character](#) on page 242

[Save Character](#) on page 243

[Insert Character](#) on page 243

[Skin Pose Commands](#) on page 244

[Merge Animation](#) on page 6859

## Create Character

See [Adding Character Assembly Commands to the UI](#) on page 219 .

This command creates a [character assembly](#) on page 217 .

### See also:

- [Destroy Character](#) on page 242
- [Lock/Unlock Character](#) on page 242
- [Save Character](#) on page 243
- [Merge Animation](#) on page 6859

### Procedures

#### To create a character assembly:

- 1 Create a linked structure of bones or other objects. The structure can have several chains. You can also use the linked structure with the Skin modifier, and/or set up character rigs and controllers as needed.
- 2 Select all objects that will become members of the assembly.
- 3 Use [this method](#) on page 219 to add the character-assembly commands to the user interface, and then choose the Create Character command.  
The character-assembly node is created at the bottom of the entire selection, as viewed in the Front viewport.



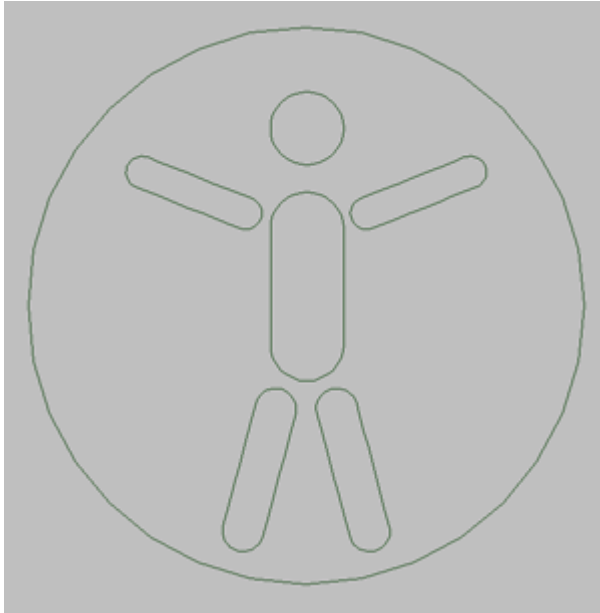

- 4 On the Modify panel, use the character assembly tools to work with the character structure.

The character assembly is given the default name of Character01, which can be changed. All members of the assembly are listed in the Character Members rollout.

### **Interface**

To work with the character assembly, select the character assembly node and work with the parameters on the Modify panel.

## Character Assembly rollout

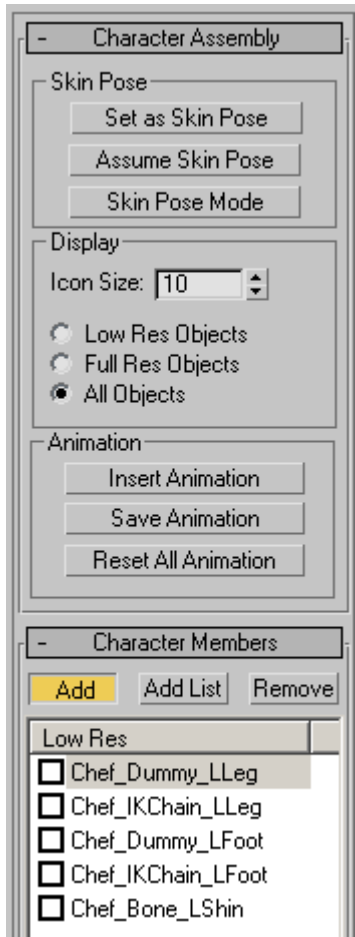

### Skin Pose group

The *Skin pose* is the bone structure pose used by the Skin modifier for associating bones with the mesh. When the Skin modifier is first applied, the current bone structure pose is used as the Skin pose. The Skin pose can sometimes be accidentally altered by animating the bone structure on frame 0. If this occurs, you can use these options to fix the Skin pose.

You can use these options both before and after applying the Skin modifier. You can also invoke these options when any member of the character assembly is selected.

**Set as Skin Pose** Sets the Skin pose to the current bone structure's pose. The Skin modifier's envelopes and vertex weighting are automatically recalculated to work with the new pose.

**Assume Skin Pose** Causes the bone structure to take on the Skin pose. This feature can be useful during the animation phase. For example, if you have animated the character on various keyframes and want the character to animate back to its Skin pose at frame 50, you can turn on Auto Key at frame 50 and click Assume Skin Pose.

**Skin Pose Mode** Poses the character in its Skin pose and allows the Skin pose to be refined. Changes to the bone structure when Skin Pose Mode is on will affect only the Skin pose and not the animation. When Skin Pose Mode is turned off, the bone structure returns to its pose at the current frame.

## Display group

When a high resolution character model is animated, redraw time can slow the animation process. To speed up your work, a low resolution version of the model can be used for the animation process, then switched for the full resolution version at render time. Character assembly objects can be designated as Full Res or Low Res on the Character Members rollout.

**Low Res Objects** Displays only the objects checked in the Low Res display in the Character Members rollout.

**Full Res Objects** Displays only the objects not checked in the Low Res display in the Character Members rollout.

**All Objects** Displays all objects in the character assembly.

## Animation group

Animation for the character assembly can be saved or reset in this group. Previously saved animation from another character can also be inserted to the current character assembly.

**Insert Animation** Displays the [Merge Animation dialog](#) on page 6859 , and prompts for a previously saved animation file.

**Save Animation** Saves the character assembly animation in an ANM or XML file. Both file types contain the character assembly and its animation. An ANM file is a proprietary format that can be read and saved only by 3ds Max. An

XML file formats the information as XML code, and can be edited with a text editor.

Animation saved as an ANM file loads and saves faster than an XML file. Saving and editing an XML animation file is recommended only for users who are familiar with the XML language, and who have a specific need for editing the file.

**Reset All Animation** Removes all animation from the character assembly.

### **Character Members rollout**

**Add** Allows you to select individual objects to add to the character assembly.

**Add List** Displays the Pick Character Members dialog, where you can select multiple objects from a list and add them to the character assembly.

**Remove** Removes highlighted object(s) from the assembly. Bones and objects upon which other assembly objects depend, cannot be removed.

**Low Res** All members of the character assembly are displayed on this list. By default, all members are designated as Full Res objects. To designate a member as Low Res, check the object on the list. The Full Res and Low Res designations are used in conjunction with the Display group selection in the Character Assembly rollout.

## **Destroy Character**

See [Adding Character Assembly Commands to the UI](#) on page 219 .

Destroying a character deletes the character assembly node.

This command is available only when a character assembly node is selected.

**See also:**

- [Character Assembly](#) on page 217
- [Lock/Unlock Character](#) on page 242

## **Lock/Unlock Character**

See [Adding Character Assembly Commands to the UI](#) on page 219 .

Locking a character assembly prevents the character from being animated. Use these commands when you want to prevent accidental animation of the character, such as when the animation process is complete.

Unlocking a locked character assembly allows you to animate the character.

These commands are available only when a character-assembly node is selected.

**See also:**

- [Character Assembly](#) on page 217

## Insert Character

See [Adding Character Assembly Commands to the UI](#) on page 219 .

Choose this command to insert a previously saved character into the current scene.

You save a character assembly as a CHR file with [Save Character](#) on page 243 . A CHR file contains the character assembly node, all members of the assembly and any animation on the members.

When a character is inserted into the scene, it is placed at the same world-space location it had when saved.

**See also:**

- [Character Assembly](#) on page 217
- [Save Character](#) on page 243

## Save Character

See [Adding Character Assembly Commands to the UI](#) on page 219 .

Saving a character saves a [character assembly](#) on page 217 at its current location, including its node, all members, and any animation on its members. Use this command for storing a character assembly to disk prior to inserting it into another scene.

Saving a character with this command saves the assembly as a CHR file. You can then insert the CHR file into a scene with [Insert Character](#) on page 243 .

This option is available only when a character assembly node is selected.

## Skin Pose Commands

Animation menu > Set as Skin Pose

Animation menu > Assume Skin Pose

Animation menu > Skin Pose Mode

When the Skin modifier is first applied to a mesh, the bone structure's current pose is used as the skin pose. Subsequent animation of the bone structure on frame 0 can cause the skin pose to be altered. The skin pose commands allow you to change and set the skin pose either before or after you apply the Skin modifier.

The *skin pose* stores a specific position, rotation and scale for an object. Its intended use is for storing a character assembly's pose for the Skin modifier. However, a skin pose can be used for any object to store its current transforms for later retrieval.

These commands work on any object, regardless of whether the structure is part of a character assembly, or whether the bones have been assigned to a mesh with the Skin modifier.

**Set as Skin Pose** Stores the selected objects' current position, rotation and scale as the skin pose. If the selected objects are assigned as bones for the Skin modifier, the envelopes and vertex weighting are automatically recalculated to work with the new pose.

**Assume Skin Pose** Causes the selected objects to take on the stored skin pose. This feature can be useful during the animation phase. For example, if you have animated the character on various keyframes and want the character to animate back to its skin pose at frame 50, you can turn on Auto Key at frame 50 and click Assume Skin Pose.

**Skin Pose Mode** Poses the character in its skin pose and allows the skin pose to be refined. Changes to the objects when Skin Pose Mode is on will affect only the skin pose and not the animation. When Skin Pose Mode is turned off, the structure returns to its pose at the current frame.

**See also:**

- [Character Assembly](#) on page 217

# Object Properties

# 5

The Object Properties dialog, available from the Edit and right-click menus, lets you view and edit parameters for how selected objects behave in viewports and renderings. Note that you cannot necessarily edit all properties; parameters that apply to renderable geometry are unavailable for non-renderable objects. However, parameters that apply to any object, such as Hide/Unhide, Freeze/Unfreeze, Trajectory, and so on, remain available for these non-renderable objects.

With the Object Properties dialog you can specify settings per object or [by layer](#) on page 7737 . Object settings affect only the object or objects selected. When an object is set to By Layer, it inherits its properties from the layer settings, which you set with the [Layer Properties dialog](#) on page 7237 .

The Object Properties dialog panels are:

- [General Panel \(Object Properties Dialog\)](#) on page 245
- [Advanced Lighting Panel \(Object Properties Dialog\)](#) on page 256
- [mental ray Panel \(Object Properties Dialog\)](#) on page 262
- [User Defined Panel \(Object Properties Dialog\)](#) on page 264

## Object Properties Dialog Panels

### General Panel (Object Properties Dialog)

Edit menu > Object Properties > Object Properties dialog > General panel

Select object or objects. > Right-click. > Transform (lower-right) quadrant of the quad menu > Properties > Object Properties dialog > General panel

Layer manager > Click the icon next to an object's name. > Object Properties dialog > General panel

This panel of the Object Properties dialog displays general object information, as well as controls for rendering the object and displaying it in viewports.



## Interface

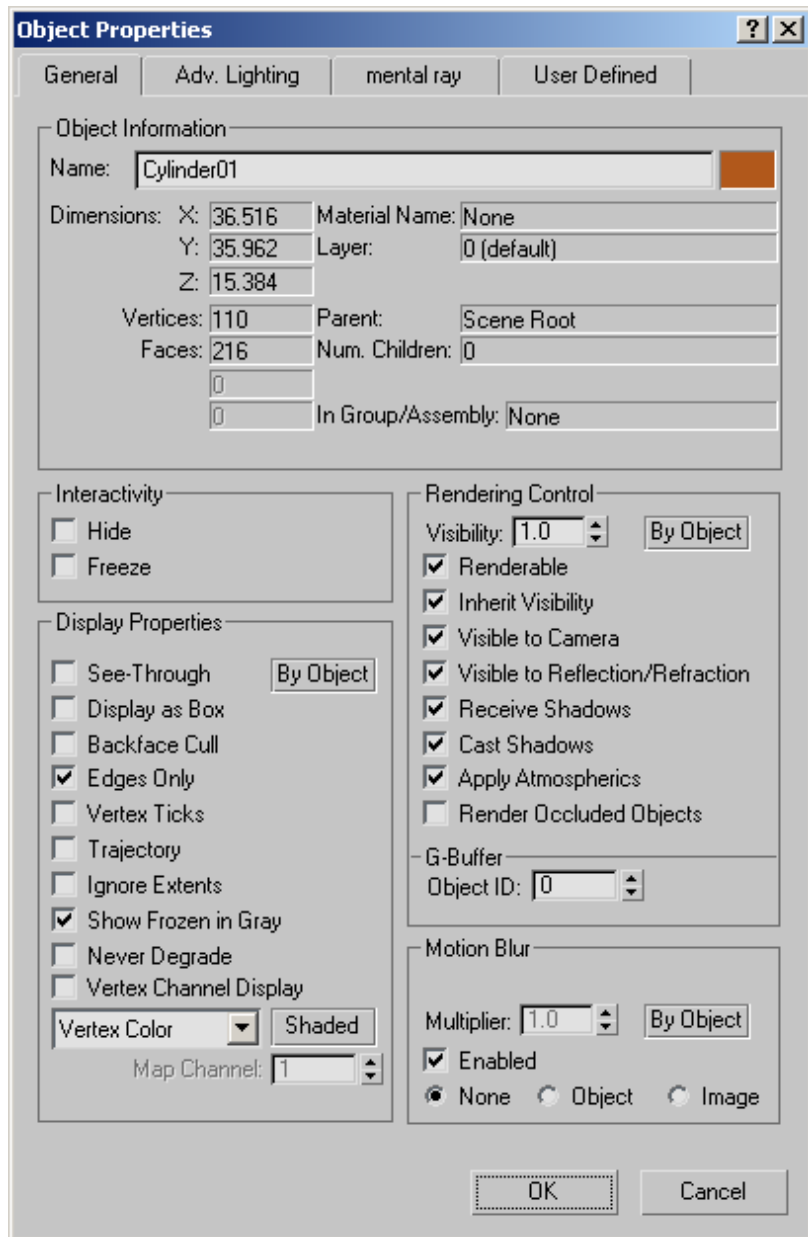

## Object Information group

This group displays information about the selected object, including the following:

**Name** Shows the name of the object. When a single object is selected, you can edit this field to give the object a new name. When multiple objects are selected, this field shows "Multiple Selected," and cannot be edited.

**Color** The color swatch shows the object's color. You can click it to display the [Object Color dialog](#) on page 327 and select a different color.

**Dimensions** Displays the X, Y, and Z dimensions of the object's [extents](#) on page 7773 .

**Vertices and Faces** Display the number of vertices and faces in the object. For [shapes](#) on page 536 , these values are the values used if you have made the shape renderable. Faces for renderable shapes are generated only at rendering time.

**Shape Vertices and Shape Curves** Appear only for shape objects. Shape Vertices is the number of vertices in the shape, and Shape Curves is the number of polygons. (Shape Curves is the value that appeared as "Polygons" in previous releases.)

These values can change over time: they are valid only for the current frame and the current view.

**Parent** Displays the name of the object's parent in a hierarchy. Shows "Scene Root" if the object has no hierarchical parent.

**Material Name** Displays the name of the material assigned to the object. Displays "None" if no material is assigned.

**Num. Children** Displays the number of children hierarchically linked to the object.

**In Group/Assembly** Displays the name of the group or assembly to which the object belongs. Displays "None" if the object is not part of a group.

**Layer** Displays the name of the layer which the object is assigned to.

## Interactivity Group

**Hide** Hides the selected object or objects.

Hidden objects exist in the scene, but do not appear in the viewports or rendered images. To unhide hidden objects, use the [Display panel](#) on page 7457 or choose Tools > [Display Floater](#) on page 7458 .

---

**NOTE** Objects residing on a hidden layer are automatically hidden, regardless of this setting.

---

**TIP** The [Layer Manager](#) on page 7227 is the easiest way to hide groups of objects or layers.

---

**Freeze** Freezes the selected object or objects.

Frozen objects appear in the viewports, but cannot be manipulated. To unfreeze frozen objects, use the [Display panel](#) on page 7457 or choose Tools > [Display Floater](#) on page 7458 .

---

**NOTE** Objects residing on a frozen layer are automatically frozen, regardless of this setting.

---

**TIP** The [Layer Manager](#) on page 7227 is the easiest way to freeze groups of objects or layers.

---

## Display Properties group

---

**NOTE** Most of these options are also available on the [Display panel](#) on page 7457 and by choosing Tools > [Display Floater](#) on page 7458 .

---

**By Object/By Layer** Toggles between setting display properties on a per-object basis and at the layer level. When set to By Layer, the object display properties are unavailable; set the layer properties on the [Layer Properties dialog](#) on page 7237 .

---

**NOTE** If multiple objects are selected and have different values for this setting, this button reads “Mixed.”

---

**See-Through** Makes the object or selection translucent in viewports. This setting has no effect on rendering; it simply lets you see what is behind an object in a crowded scene, and especially to adjust the position of objects behind the see-through object. Default=off.

You can customize the color of see-through objects by using the [Colors panel](#) on page 7505 of the Customize > [Customize User Interface dialog](#) on page 7489 .

Keyboard shortcut (default): Alt+X

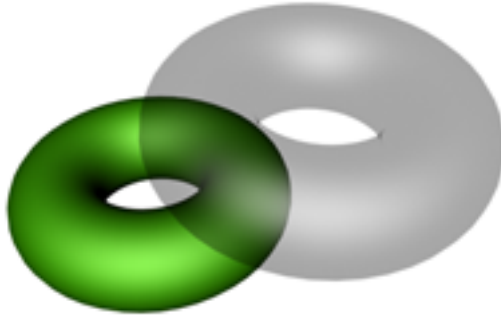

**Display as Box** Toggles the display of selected objects, both 3D objects and 2D shapes, as [bounding boxes](#) on page 7736 . Produces minimum geometric complexity for rapid display in viewports. Default=off.

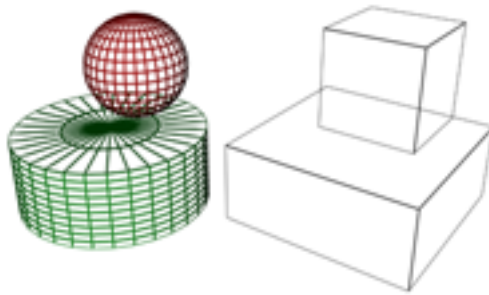

**Backface Cull** Toggles the display of faces with [normals](#) on page 7863 that point away from the view. When on, you see through the wireframe to the backfaces. Applies only to wireframe viewports. Default=on.

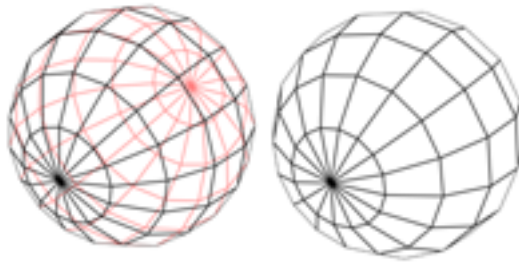

**Edges Only** Toggles the display of hidden edges and polygon [diagonals](#) on page 7757 . When on, only outside edges appear. When off, all mesh geometry appears. Applies to Wireframe viewport display mode, as well as other modes with Edged Faces turned on.

---

**NOTE** This option is also available in the [Display panel](#) on page 7457 and by choosing Tools > [Display Floater](#) on page 7458 .

---

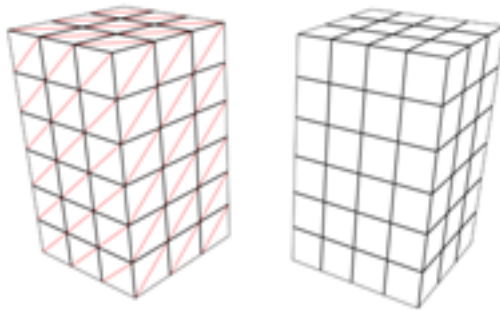

**Vertex Ticks** Displays the object's vertices as tick marks. Default=off.

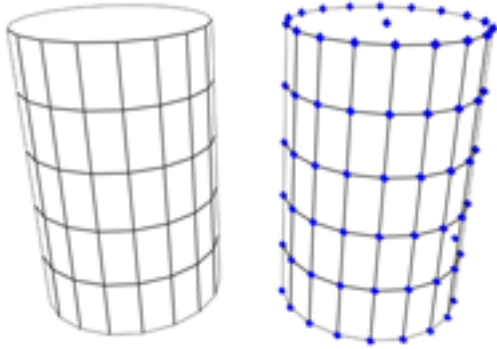

**Trajectory** Displays the object's [trajectory](#) on page 7955 . Default=off.

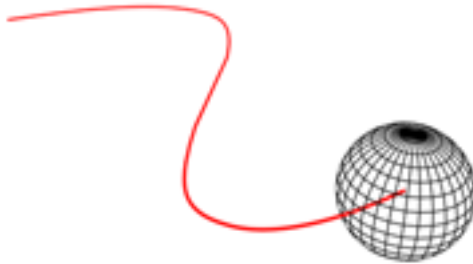

**Ignore Extents** When on, this object is ignored when you use the display controls [Zoom Extents](#) on page 7387 and [Zoom Extents All](#) on page 7381 .

Keyboard shortcut: No default, but you can customize it using the [Keyboard panel](#) on page 7489 of the Customize > [Customize User Interface dialog](#) on page 7489 .

**Show Frozen in Gray** When on, the object turns gray in viewports when you freeze it. When off, viewports display the object with its usual color or texture even when it is frozen. Default=on.



**Never Degrade** When on, the object is not subject to [adaptive degradation](#) on page 7704 .

**Vertex Channel Display** For [editable mesh](#) on page 1990 , [editable poly](#) on page 2038 , and [editable patch](#) on page 1934 objects, displays the assigned vertex colors in viewports. The drop-down list lets you choose to display Vertex

Color, Vertex Illumination, Vertex Alpha, Map Channel Color, or Soft Selection Color. Default=off.

You can assign vertex colors at all sub-object levels except Edge.

**Map Channel** Sets the map channel for the vertex color. Available only when the Map Channel Color option is active.

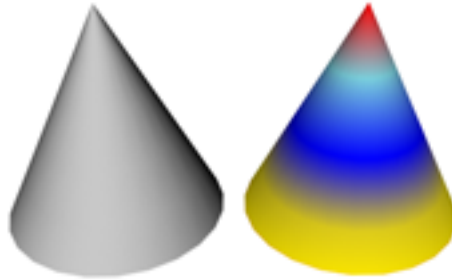

**Shaded** When on, shaded viewports add shading to the vertex coloring. When off, colors are unshaded. Default=off.

### Rendering Control group

**By Object/By Layer** Toggles between setting rendering controls on a per-object basis and at the layer level. When set to By Layer, the object rendering control settings are unavailable; set the layer properties on the [Layer Properties dialog](#) on page 7237 .

---

**NOTE** If multiple objects are selected and have different values for this setting, this button reads “Mixed.”

---

**Visibility** Controls the rendered visibility of the object. At 1.0, the object is fully visible. At 0.0, the object is completely invisible when rendered. Default=1.0.

You can animate this parameter. Animating Visibility assigns a visibility controller to the object. By default this is a [Bezier float controller](#) on page 3063 .

**Renderable** Makes an object or selected objects appear or disappear from rendered output. Nonrenderable objects don't cast shadows or affect the visual component of the rendered scene. Like dummy objects, nonrenderable objects can manipulate other objects in the scene.

For lights, this is the only available control in the Rendering Controls group. Making a light non-renderable effectively turns it off.

[Shape](#) on page 536 objects have the Renderable option turned on by default. In addition, each shape has an Enable In Renderer parameter. When both check boxes are on, the shape appears in rendered output. If the Renderable object properties setting is off, the shape is not renderable, regardless of the state of its local Enable In Renderer check box.

If you apply a modifier that converts the shape into a mesh object, such as a [Lathe modifier](#) on page 1430 or [Extrude modifier](#) on page 1377, the shape automatically becomes renderable regardless of the state of its local Enable In Renderer setting.

**Inherit Visibility** Causes the object to inherit a percentage of the visibility of its parent (as determined by the parent's Visibility track in Track View). When a group parent is assigned a visibility track, Inherit Visibility is automatically turned on for all children in the group. The children will have the maximum visibility of the parent. Transparent materials and hidden objects have no effect on this function.

**Visible to Camera** When on, the object is visible to cameras in the scene. When off, cameras do not view this object; however, its shadows and reflections are rendered. Default=on.

**Visible to Reflection/Refraction** When on, the object has “secondary” visibility: it appears in rendered reflections and refractions. When off, the object does not appear in rendered reflections or refractions. Default=on.

---

**NOTE** An object can have Visible To Camera on but Visible To Reflection/Refraction off, in which case the object renders in the scene but does not appear in reflections or refractions.

---

**Receive Shadows** When on, the object can receive shadows. Default=on.

**Cast Shadows** When on, the object can cast shadows. Default=on.

**Apply Atmospheric** When on, atmospheric effects are applied to the object. When off, atmospheric effects do not change the rendered appearance of this object. Default=on.

**Render Occluded Objects** Allows special effects to affect objects in the scene that are occluded by this object. The special effects, typically applied by [plug-ins](#) on page 7896 such as [Glow](#) on page 6397, use [G-buffer](#) on page 7795 layers to access occluded objects. Turning on this control makes the object transparent for the purposes of special effects. This makes no difference when you render to most image files. When you render to either the [RLA](#) on page



7156 or [RPF](#) on page 7159 file format, however, occluded objects appear with the effect applied on their designated G-buffer layer. Default=off.

### **G-Buffer group**

Allows you to tag an object as a target for a [render effect](#) on page 6381 based on the [G-buffer](#) on page 7795 channel. Assigning the object a nonzero ID creates a G-buffer channel that can be associated with a render effect.

---

**WARNING** The [mental ray renderer](#) on page 6039 does not recognize Z-depth with G-buffers. G-buffer data is saved on a single layer. Also, the mental ray renderer does not support the following effects:

---

- [Glow lens effect](#) on page 6397 (rendering effect)
- [Ring lens effect](#) on page 6404 (rendering effect)
- [Lens effects Focus filter](#) on page 6670 (Video Post)

**Object Channel** Setting this spinner to a nonzero number means that the object will receive the rendering effects associated with that channel in Render Effects and the post-processing effects associated with that channel in Video Post.

To save the channel data with the rendering, render to either the [RLA](#) on page 7156 or [RPF](#) on page 7159 file format.

### **Motion Blur group**

**By Object/By Layer** Toggles between setting motion blur properties on a per-object basis and at the layer level. When set to By Layer, the motion blur settings are unavailable; set the layer properties on the [Layer Properties dialog](#) on page 7237 .

---

**NOTE** If multiple objects are selected and have different values for this setting, this button reads “Mixed.”

---

**Multiplier** Affects the length of the motion-blur streak.

If you choose either form of motion blur here in the Object Properties dialog, you must also choose to apply that type of blur in the [Render Scene dialog](#) on page 5878 .

The rendering speed of object motion blur depends on the complexity of the geometry to which it's assigned. The rendering speed of image motion blur depends on the amount of rendered screen space taken up by the blurring

object. In most cases image motion blur renders more quickly. Object motion blur renders more quickly when applied to very simple objects, and image motion blur renders more slowly when the object takes up a lot of screen space, and moves all the way across the screen in a single frame.



Changing the Object Blur Multiplier value.

**Enabled** When on, enables motion blur for this object. When off, motion blur is disabled regardless of the other blur settings. Default=on.

You can animate the Enabled check box. The main use of animating Enable is to apply motion blur over only a limited range of frames. This can save a tremendous amount of time when you are rendering an animation.

You can enable motion blur for lights and cameras. With the mental ray renderer, moving lights and cameras can generate motion blur. However, they do not generate motion blur with the default scanline renderer.

- **None** Turns off the state of motion blur for the object.
- **Object** [Object motion blur](#) on page 7867 provides a time-slice blur effect.
- **Image** [Image motion blur](#) on page 7814 blurs the object's image based on the velocity of each pixel.

## Advanced Lighting Panel (Object Properties Dialog)

Select object or objects. > Edit menu > Object Properties > Object Properties dialog > Advanced Lighting panel

Select object or objects. > Right-click. > Transform (lower-right) quadrant of the quad menu > Properties > Object Properties dialog > Advanced Lighting panel

Layer manager > Click the icon next to an object's name. > Object Properties dialog > Advanced Lighting panel

This panel of the Object Properties dialog lets you customize how objects behave under advanced lighting (the [Light Tracer](#) on page 5963 or [radiosity](#) on page 5976 ).

## Interface

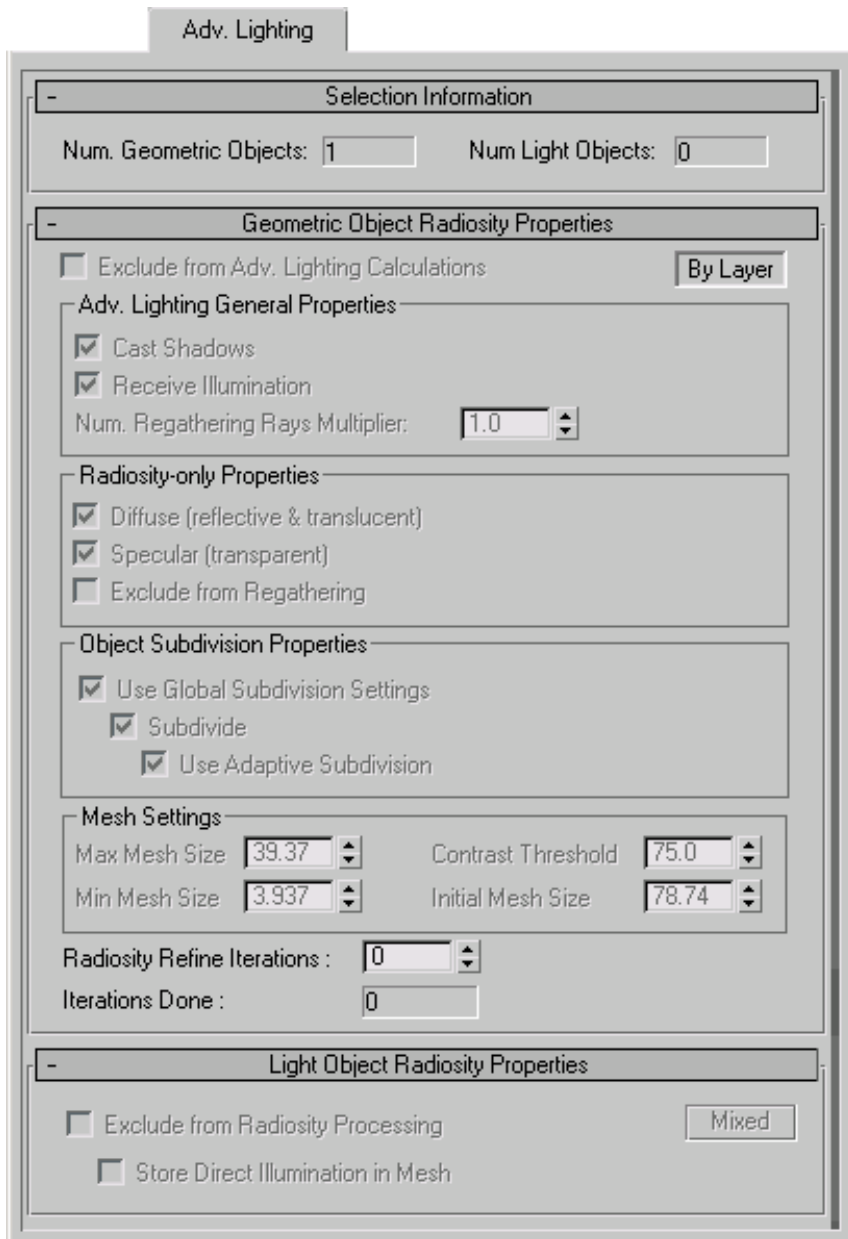

## **Selection Information rollout**

**Num. Geometric Objects** The number of geometric objects present in the current selection.

**Num. Light Objects** The number of lights present in the current selection.

## **Geometric Object Radiosity Properties rollout**

**Exclude from Adv. Lighting Calculations** When on, the current selection is excluded from advanced lighting (radiosity or light tracing). Objects excluded from advanced lighting will not contribute to indirect illumination.

**By Object/By Layer** Toggles between object settings and object layer settings. Object settings affect only the object or objects selected. Object layer settings affect all objects on the same layer as the selected object. Most settings on this rollout are available only when this toggle is set to By Object. Default=By Object .

---

**NOTE** If multiple objects with different settings are selected, this button will read "Mixed."

---

## **Adv. Lighting General Properties group**

**Cast Shadows** Determines whether objects will cast shadows in the radiosity solution.

---

**NOTE** When disabling Cast Shadows, you should also turn off *Diffuse (reflective & translucent)* and *Specular (transparent)* in the Radiosity-only Properties group. If these switches are left turned on, objects will still generate light that can produce artifacts in the solution.

---

**Receive Illumination** Determines whether objects will receive indirect illumination.

**Num. Regathering Rays Multiplier** Lets you adjust the number of rays cast by this object, per pixel. If an object looks "blotchy" after rendering, Increasing this value can improve its appearance. Default=1.0.

---

**TIP** Increasing this setting is most useful for objects with large, smooth surfaces. More complex geometry tends not to show advanced lighting artifacts as much as smooth surfaces do.

---

## Radiosity-only Properties group

**Diffuse (reflective & translucent)** When on, the radiosity solution will process diffuse reflection and [translucency](#) on page 7959 of the selected objects.

**Specular (transparent)** When on, radiosity will process transparency of the selected objects.

**Exclude from Regathering** When on, objects are excluded from the regathering process when rendering.

For more information on the Radiosity-only Properties group, see [Radiosity Control Panel](#) on page 5995 .

## Object Subdivision Properties group

**Use Global Subdivision Settings** When on, the object's meshing settings correspond to the global subdivision settings on the Radiosity Control Panel. When off, you can change the meshing settings for each object. Default=on.

- **Subdivide** When on, a radiosity mesh is created for the objects regardless of the global meshing state. The subdivision that is performed is determined by the Use Adaptive Subdivision switch. When off, the settings in the Mesh Settings group are unavailable. Default=on.
- **Use Adaptive Subdivision** Toggles adaptive subdivision. Default=on.

---

**TIP** Adaptive meshing is computed for an object only if *Shoot Direct Lights* is turned on in the [Radiosity Meshing Parameters rollout](#) on page 6008 .

---

**NOTE** The Mesh Settings group parameters Contrast Threshold, Min Mesh Size, and Initial Mesh Size are available only when Use Adaptive Subdivision is turned on.

---

## Mesh Settings group

**Max Mesh Size** The size of the largest faces after adaptive subdivision. Default=36" for imperial units and 100cm for metric units.

When Use Adaptive Subdivision is off, Max Mesh Size sets the size of the radiosity mesh in world units.

**Min Mesh Size** Faces are not divided smaller than the minimum mesh size. Default=3 inches for Imperial units and 10cm for metric units.

**Contrast Threshold** Faces that have vertex illuminations that differ by more than the Contrast Threshold setting are subdivided. Default=75.0.

**Initial Mesh Size** When improving the face shape, faces that are smaller than the Initial Mesh Size are not subdivided. The threshold for deciding whether a face is poorly shaped also gets larger as the face size is closer to the Initial Mesh Size. Default=12 inches for Imperial units and 30cm for metric units.

**Radiosity Refine Iterations** The number of refine iterations in the radiosity process for the current selection.

**Iterations Done** The number of refine iterations performed on the current selection.

### **Light Object Radiosity Properties rollout**

These options are available only for light objects.

**Exclude from Radiosity Processing** When on, the current selection is excluded from the radiosity solution. When lights are excluded from radiosity, their direct contribution is only used for rendering. This option is available only when By Object is selected.

**By Object/By Layer** Toggles between object settings or object layer settings. Object settings affect only the object or objects selected. Object layer settings affect all objects on the same layer as the selected object.

---

**NOTE** If multiple objects are selected and have different settings, this button reads "Mixed."

---

**Store Direct Illumination in Mesh** When on, the light's direct illumination is added to the radiosity mesh, even if the global rendering mode is Render Direct Illumination. This is comparable to the Re-Use Direct Illumination option when rendering radiosity, but only for this particular light.

When off, the light's direct illumination is used only when you render the scene. This is comparable to the Render Direct Illumination option.

for more information about the Re-Use Direct Illumination and Render Direct Illumination options, see [Rendering Parameters Rollout \(Radiosity\)](#) on page 6016 . In general, re-using direct illumination stored in the radiosity mesh improves render time, but shadows appear coarse and inaccurate unless the mesh is very fine. Rendering direct illumination and shadows (using the radiosity mesh to provide only indirect light) takes more time but gives you a more finished and accurate image.

## mental ray Panel (Object Properties Dialog)

Edit menu > Object Properties > Object Properties dialog > mental ray panel

Select object or objects. > Right-click. > Transform (lower-right) quadrant of the quad menu > Properties > Object Properties dialog > mental ray panel

Layer manager > Click the icon next to an object's name. > Object Properties dialog > mental ray panel

This panel of the Object Properties dialog supports mental ray rendering; specifically, the indirect illumination features [caustics](#) on page 6066 and [global illumination](#) on page 6072 . They control whether objects generate or receive caustics or global illumination.

These settings are ignored where they aren't appropriate. For example, lights can be set to generate caustics, but for a light, the Receive Caustics setting has no effect, as lights aren't renderable. Similarly, these settings have no meaning for cameras.

Also available on this panel are controls for setting displacement parameters on a per-object basis.

### Interface

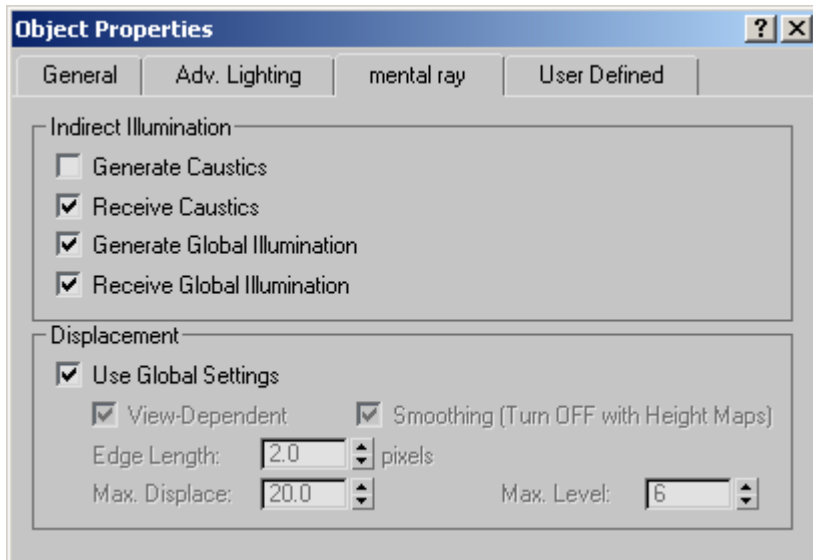

The mental ray panel contains parameters for the mental ray renderer.



## Indirect Illumination group

**Generate Caustics** When on, the object can generate caustics. (For this to happen, Caustics must also be enabled using the Render Scene dialog's [Caustics And Global Illumination rollout](#) on page 6096 .) When off, the object does not generate caustics. Default=off.

**Receive Caustics** When on, the object can receive caustics. That is, caustic effects are cast onto this object. (For this to happen, Caustics must also be enabled using the Caustics And Global Illumination rollout.) When off, the object does not receive caustics. Default=on.

**Generate Global Illumination** When on, the object can generate global illumination. (For this to happen, Global Illumination must also be enabled using the Caustics And Global Illumination rollout.) When off, the object does not generate global illumination. Default=off.

**Receive Global Illumination** When on, the object can receive global illumination. That is, reflected light is cast onto this object. (For this to happen, Global must also be enabled using the Caustics And Global Illumination rollout.) When off, the object does not receive global illumination. Default=on.

## Displacement group

These settings let you apply displacement parameters on a per-object basis.

**Use Global Settings** When on, applies to all objects the Displacement settings on the Render Scene dialog > Renderer panel > [Shadows and Displacement rollout](#) on page 6114 . Turn off to make settings on a per-object basis. Default=on.

**View-Dependent** Defines the space for displacement. When View-Dependent is on, the Edge Length setting specifies the length in pixels. When off, Edge Length is specified in world-space units. Default=on.

**Smoothing** Turn off to have the mental ray renderer correctly render height maps. Height maps can be generated by normal mapping; see [Creating and Using Normal Bump Maps](#) on page 6182 .

When on, mental ray simply smooths the geometry using the interpolated normals, making the geometry look better. This result, however, cannot be used for height map displacement because smoothing affects geometry in a way that is incompatible with height mapping.

**Edge Length** Defines the smallest allowable edge length. The mental ray renderer will stop subdividing an edge once it reaches this size. Default=2.0 pixels.

**Max. Displace** Controls the maximum offset, in world units, that can be given to a vertex when displacing it. This value can affect the bounding box of an object. Default=20.0.

---

**TIP** If displaced geometry appears to be “clipped,” try increasing the value of Maximum Displace.

---

**NOTE** When using placeholders (see the [Translator Options rollout](#) on page 6122), if this value is larger than it needs to be, it can reduce performance. If you experience slow times while displaced objects when Use Placeholder Objects is on, try lowering the Max. Displace value.

---

**Max. Level** Controls how many times a triangle can be subdivided. Default=6.

## User Defined Panel (Object Properties Dialog)

Edit menu > Object Properties > Object Properties dialog > User Defined panel

Select object or objects. > Right-click. > Transform (lower-right) quadrant of the quad menu > Properties > Object Properties dialog > User Defined panel

Layer manager > Click the icon next to an object's name. > Object Properties dialog > User Defined panel

This panel of the Object Properties dialog lets you enter properties or comments that you define yourself.

## Interface



**User Defined Properties** In this text box, you can enter properties for the object, or comments about it, that you define yourself. 3ds Max doesn't use these properties, but it saves them with the scene, and they reappear whenever you view the Object Properties dialog for the object.

## Rename Objects Tool

Tools menu > Rename Objects

The Rename Objects tool helps you rename several objects at once.

### Interface

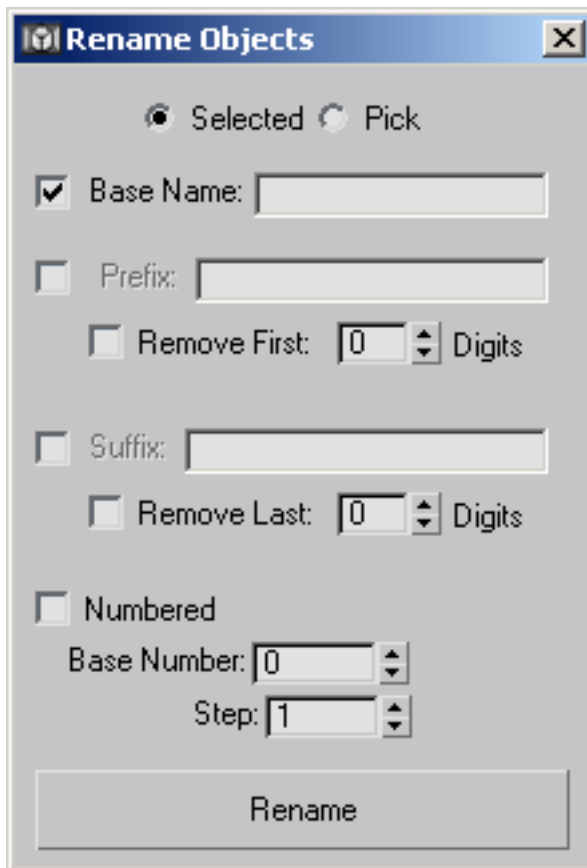

**Selected** When chosen, renaming affects currently selected objects.

**Pick** Click to open the Pick Objects To Rename dialog, which lets you choose the objects to rename. This dialog has the same controls as [Select From Scene](#) on page 168 .

**Base Name** Enter a base name for all objects. The toggle enables or disables this name.

**Prefix** When on, lets you enter a string that will be a prefix to the name of all renamed objects.

**Remove First N Digits** When on, the first N characters in the base name are removed from object names. The spinner sets the value of N.

**Suffix** When on, lets you enter a string that will be a suffix to the name of all renamed objects.

**Remove Last N Digits** When on, the last N characters in the base name are removed from object names. The spinner sets the value of N.

**Numbered** When on, lets you number object names incrementally.

- **Base Number** The base number appended to the name of the first renamed object.

- **Step** The step by which the base number is incremented in succeeding renamed objects.

**Rename** Click to rename the affected objects and have your changes take effect.

## Custom Attributes

Animation menu > Parameter Editor

Keyboard > Alt+1

Use the Parameter Editor to assign custom attributes to objects, modifiers, materials, and animation tracks. A custom attribute is an additional, abstract parameter; abstract in the sense that it does not directly extend the functionality of the object by default. It affects an object only after [wire parameters](#) on page 3247 , [reaction controllers](#) on page 3147 , or [expression controllers](#) on page 3079 are set up to connect the custom attribute to another parameter in the scene. You can also use custom attributes to store job-specific notes and data.

Custom attributes behave like other object parameters in several ways:

- They are saved and loaded in the scene file along with the object.
- They can be animated and keyframed.
- They are displayed in Track View along with the base parameters.

Each custom attribute parameter can be one of a number of different data types, including integers, floating numbers, Booleans, arrays, nodes, colors, and texture maps. Parameters added to an object or modifier appear on a Custom Attributes rollout on the Modify panel. For each custom attribute parameter you create, you can specify the name, layout, value range, default value, and UI type: spinner or slider for floats and integers, check box for Booleans, etc.

As you customize an attribute, the result is displayed on the Testing Attribute rollout at the bottom of the dialog.

**See also:**

- [Parameter Collector](#) on page 285
- [Attribute Holder Modifier](#) on page 1136

### **Custom Attributes Special Features**

The Custom Attributes feature offers an array of workflow-enhancing functionality, including:

- the ability to add custom attributes to specific animation tracks.
- the ability to edit existing custom attributes.
- 13 available data types.
- a variety of available UI options, such as ComboBox and ListBox for the Array data type.
- the ability to position UI elements precisely with X and Y Offset controls.
- the ability to [preserve custom attributes](#) on page 7445 when collapsing the stack.
- A special [Attribute Holder modifier](#) on page 1136 that lets you collect attributes from different entities and access them in one place on the Modify panel.

## Procedures

### To add a parameter to an object:

- 1 Select the object.
- 2 Choose Animation menu > Parameter Editor.  
The Parameter Editor opens.
- 3 Change settings as desired.
- 4 Click Add.

The parameter is added to the level specified in the Add To Type list. If an object has no custom attributes, Parameter Editor first adds a Custom Attributes entry to the current Add To Type level, and then adds the parameter to the Custom Attributes entry. If an object has more than one Custom Attributes entry as a result of collapsing its stack, the parameter is added to the first Custom Attributes entry.

If a custom attribute parameter is assigned to an object or modifier, you can see and edit its value on the Modify panel after adding it by activating the entity to which the attribute is assigned. If the custom attribute is assigned to a material, it's available for that material in the Material Editor, on the Custom Attributes rollout. To access a parameter that's assigned to an animation track, open Track View, highlight the track's Custom Attributes entry, and then right-click and choose View Attribute Dialog.

### To edit a parameter or custom attribute:

- 1 Select the object.
- 2 Choose Animation menu > Parameter Editor.  
The Parameter Editor opens.

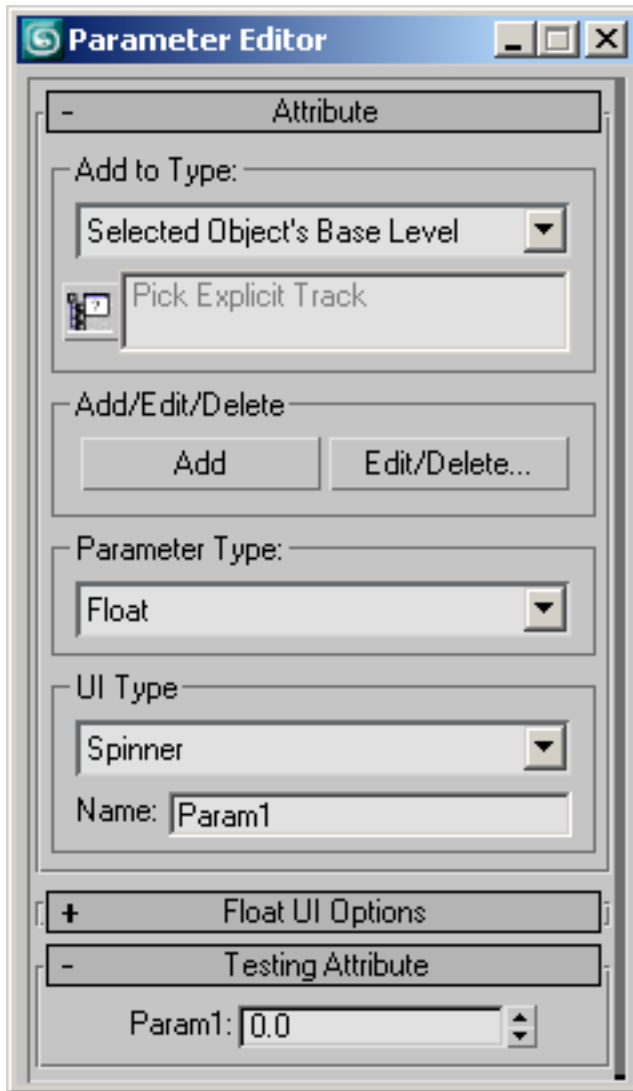

- 3 From the Add To Type drop-down list, choose the type of parameter to edit, and then click Edit/Delete.  
The Edit Attributes/Parameters dialog opens.



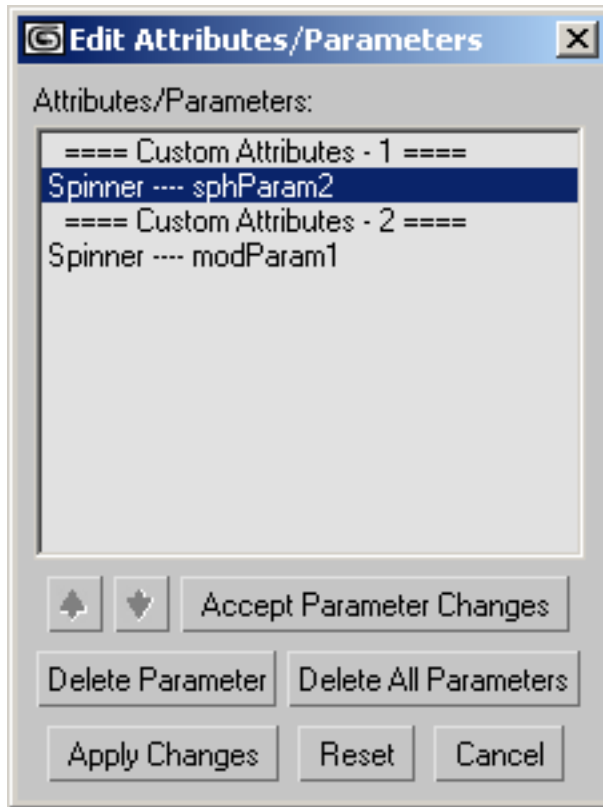

---

**NOTE** If you chose Add To Type > Picked Track, the Track View Pick dialog might open first to prompt you to choose the animation track whose attribute to edit.

---

- 4 In the Edit Attributes/Parameters dialog, highlight the parameter to edit. Its settings appear in the Parameter Editor.
- 5 Change the settings in the Parameter editor, and then click Accept Parameter changes.
- 6 With multiple parameters or custom attributes, to change the ordering, click the entity to move, and then use the up and down arrow buttons to move the entity in the list. Moving a Custom Attributes entry also moves its parameters.

---

**NOTE** You cannot rename a Custom Attributes entry.

---

- 7 When finished editing, click Apply Changes, and then exit the dialog by clicking the Close or Cancel button.

**To delete a custom attribute or parameter:**

- 1 Select the object.
- 2 Choose Animation menu > Parameter Editor.  
The Parameter Editor opens.
- 3 From the Add To Type drop-down list, choose the type of parameter to delete, and then click Edit/Delete.  
The Edit Attributes/Parameters dialog opens.

---

**NOTE** If you chose Add To Type > Picked Track, the Track View Pick dialog might open first to prompt you to choose the animation track from which to delete the attribute.

---

- 4 In the Edit Attributes/Parameters dialog, highlight the parameter to delete, and then click Delete Parameter. Alternatively, to delete all parameters under the same Custom Attributes heading as the highlighted parameter, click Delete All Parameters.  
To delete one or more custom attributes instead, click a Custom Attributes heading, and then click Delete Attribute or Delete All Attributes. Multiple attributes can result from collapsing an object's stack with Preserve Custom Attributes on. For example, one set of custom attributes might be applied to an object and a second set of attributes assigned to one of its modifiers. Collapsing such an object results in two sets of custom attributes.
- 5 Click Apply Changes, and then close the dialog by clicking its Close box or the Cancel button.

**Interface**

The Parameter Editor takes the form of a dialog with several rollouts: The first rollout sets general options for the attribute; the central rollout sets options for the current parameter type; and the third lets you preview the attribute user interface (UI).

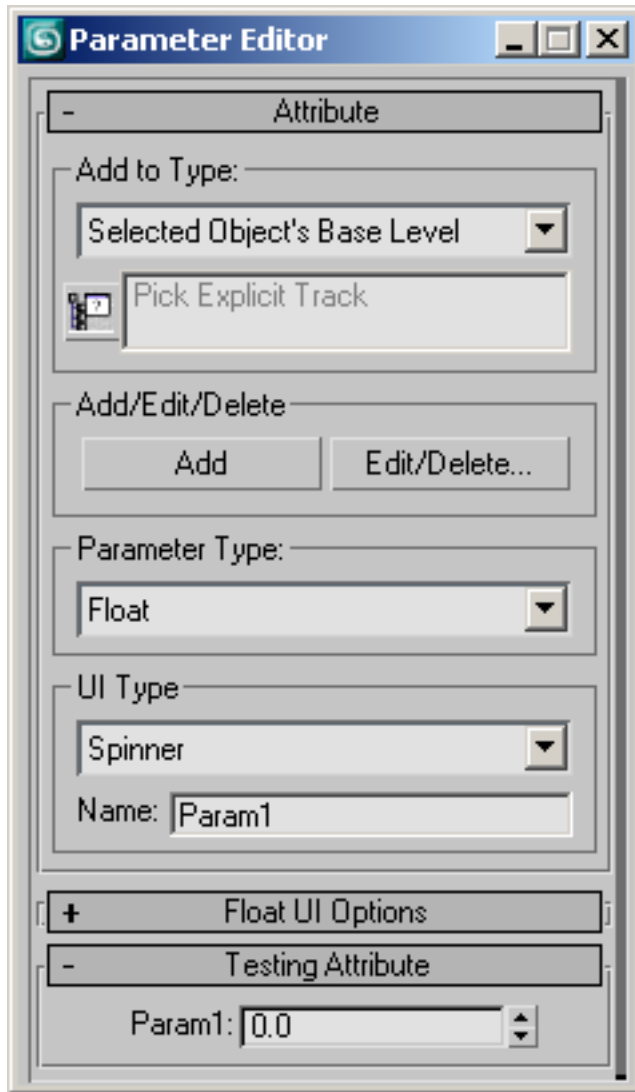

Attribute rollout

### Add to Type group

**Add to Type list** Choose whether the custom attribute is assigned to the selected object, its active modifier (as highlighted in the modifier stack), its

material, or a picked track. Also use this drop-down list to choose the attribute type to delete or edit.

If the text “Pick Explicit Track” appears in the box below the drop-down list before you choose Picked Track, the Track View Pick dialog appears showing the Track View hierarchy. Expand the hierarchy as necessary, click the track to add the attribute to, and then click OK.

---

**NOTE** If you choose Selected Object's Current Modifier and multiple modifiers are highlighted in the stack when you click Add, Parameter Editor applies the custom attribute to the first modifier you highlighted and removes the highlighting from the other modifiers.

---



**[pick explicit track]** Click this button to open a Track View hierarchy window from which to choose an animation track. Navigate the hierarchy to find the desired track, highlight the track, and then click OK. The controller information for the track then appears in the text box to the right of the button, and the Parameter Editor will then use this track for adding or editing custom attributes and parameters.

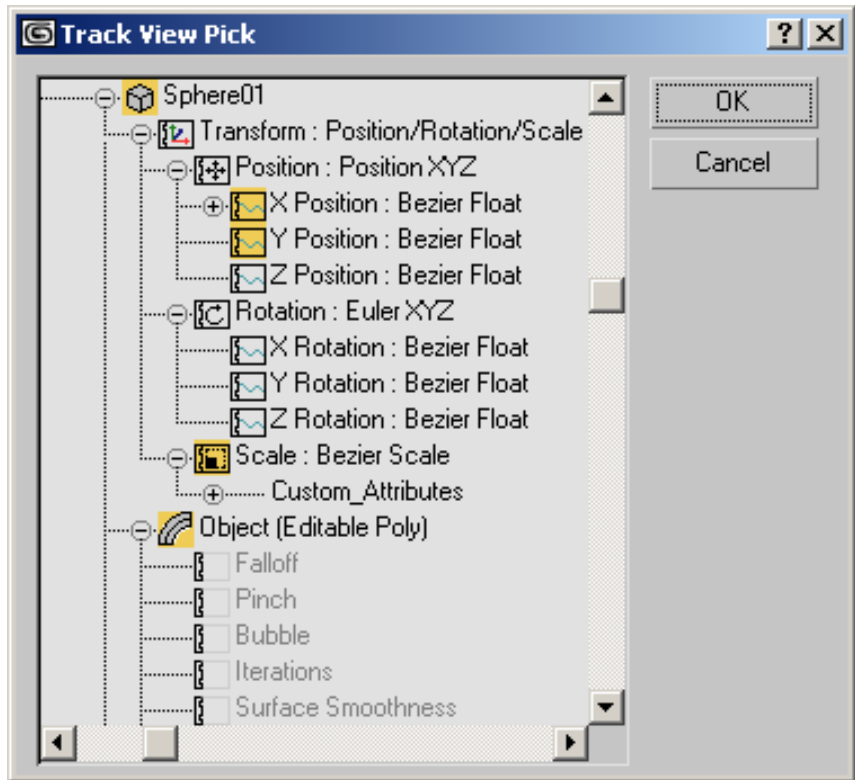

### Add/Edit/Delete group

**Add** Applies the custom attribute parameter to the current object, modifier, material, or track, depending on the current choice in the Add To Type list.

If a custom attribute parameter is assigned to an object or modifier, you can see and edit its value on the Modify panel after adding it by activating the entity to which the attribute is assigned. If the custom attribute is assigned to a material, it's available for that material in the Material Editor. To access a parameter that's assigned to an animation track, open Track View, highlight the track's Custom Attributes entry, and then right-click and choose View Attribute Dialog.

**Edit/Delete** Opens the Edit Attributes/Parameters dialog.

This dialog displays a list of all of the custom attribute parameters assigned to the currently object at the current level. Dialog behavior is described in

these two procedures: [To edit a parameter or custom attribute](#): on page 269 and [To delete a custom attribute or parameter](#): on page 272 .

## Parameter Type group

**Parameter Type** Use the drop-down list to choose the data type for the current parameter. The following list includes links to the sections describing the UI settings for each parameter's data type:

- Angle: [Spinner](#) on page 277 or [Slider](#) on page 278
- [Array](#) on page 280
- Boolean: [CheckBox](#) on page 279 or [CheckButton](#) on page 279
- [Color](#) on page 282
- Float: [Spinner](#) on page 277 or [Slider](#) on page 278
- [fRGBA](#) on page 282
- Integer: [Spinner](#) on page 277 or [Slider](#) on page 278
- [Material](#) on page 283
- [Node](#) on page 282
- Percent: [Spinner](#) on page 277 or [Slider](#) on page 278
- [String](#) on page 284
- [TextureMap](#) on page 283
- WorldUnits: [Spinner](#) on page 277 or [Slider](#) on page 278

## UI Type group

**UI Type** Selects the type of UI element that controls the parameter.

The UI types available depend on which parameter type you specify. For example, float and integer values are controlled by spinners or sliders, and Boolean values by check boxes or check buttons. Array values are always controlled by drop-down lists, node values by pick buttons, color values by color pickers, and texture map values by map buttons.

Full descriptions of each UI Options rollout follow, and the list of parameter types, above, includes links to the respective UI Options rollout descriptions.

**Name** The name of the parameter. Parameter Editor gives the parameter the default name Param#, with # being a number. Change the name by editing this field.

### **Angle/Float/Integer/Percent/WorldUnits UI Options rollout: Spinner**

This is a numeric value that the user can set with a standard 3ds Max spinner.

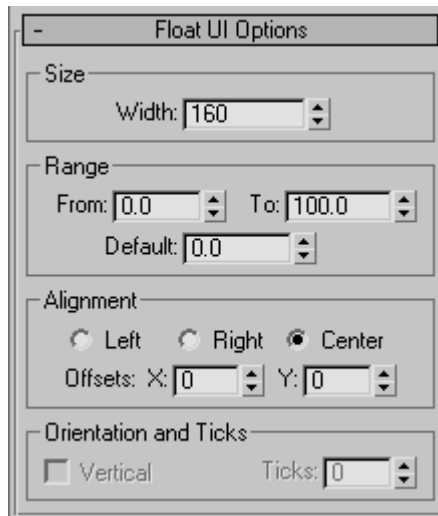

#### **Size group**

**Width** Sets the width of the spinner.

#### **Range group**

**From** Sets the minimum value of the spinner.

**To** Sets the maximum value of the spinner.

**Default** Sets the default value of the spinner.

#### **Alignment group**

**Left/Right/Center** Sets the alignment of the spinner in the rollout.

**Offsets X/Y** Fine-tune the position of the spinner on the horizontal and vertical axes.

## Angle/Float/Integer/Percent/WorldUnits UI Options rollout: Slider

This is a numeric value that the user can set with a standard 3ds Max slider.

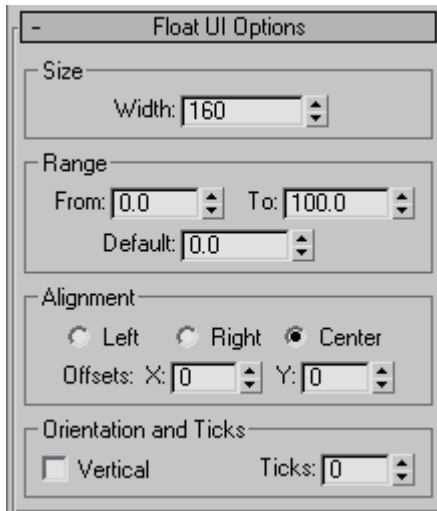

### Size group

**Width** Sets the width of the slider.

### Range group

**From** Sets the minimum value of the slider.

**To** Sets the maximum value of the slider.

**Default** Sets the default value of the slider.

### Alignment group

**Left/Right/Center** Sets the alignment of the slider in the rollout.

**Offsets X/Y** Fine-tune the position of the slider on the horizontal and vertical axes.

### Orientation And Ticks group

**Vertical** When on, the slider will be displayed vertically. When off, the slider is displayed horizontally.



**Ticks** Sets the number of ticks along the slider. The ticks are distributed evenly along the length of the slider.

### **Boolean UI Options rollout: Check Box**

This is a standard 3ds Max check box that the user can turn on and off by clicking it with the mouse.

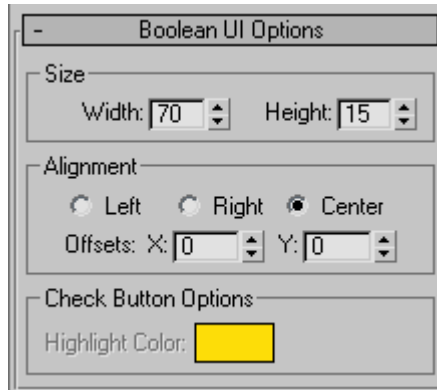

#### **Size group**

**Width** Sets the width of the check box.

**Height** Sets the height of the check box.

#### **Alignment group**

**Left/Right/Center** Sets the alignment of the check box in the rollout.

**Offsets X/Y** Fine-tune the position of the check box on the horizontal and vertical axes.

### **Boolean UI Options rollout: Check Button**

This is a standard 3ds Max check button that the user can turn on and off by clicking it with the mouse.

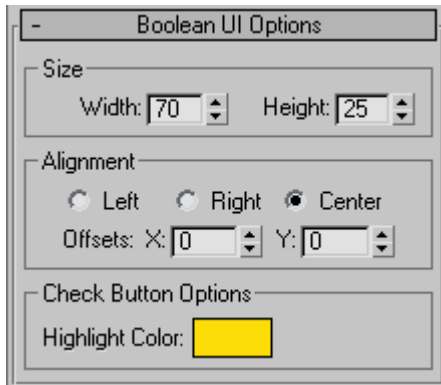

### Size group

**Width** Sets the width of the check button.

**Height** Sets the height of the check button.

### Alignment group

**Left/Right/Center** Sets the alignment of the check button in the rollout.

**Offsets X/Y** Fine-tune the position of the check button on the horizontal and vertical axes.

### Check Button Options group

**Highlight Color** Sets the color of the button when it is pressed.

### Array UI Options rollout: Drop-Down List/ComboBox/ListBox

This lets the user of the custom attribute choose a named option from a list. The options for the three Array UI types are the same; they differ in how they appear on the Custom Attributes rollout. The types are:

- **Drop-Down List:** Only the current choice is visible by default. The user clicks the field to open the list and then clicks to choose a different item.
- **ComboBox:** Displays an editable field above a list box. The user clicks to choose from the list, or edits the field.
- **ListBox:** Displays a list. The user clicks the desired item; the highlighting indicates the current choice.

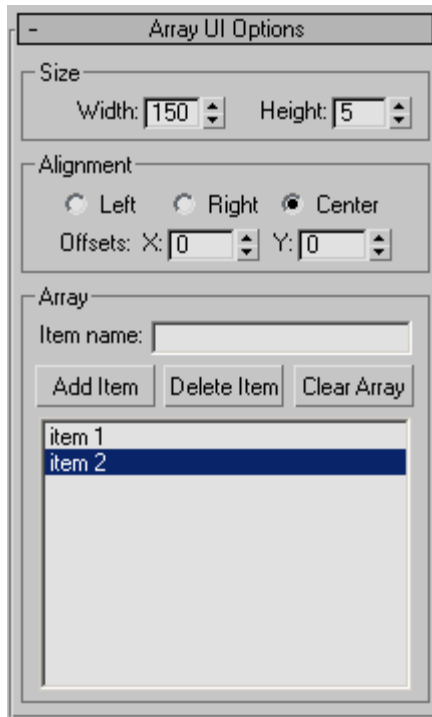

### **Size group**

**Width** Sets the width of the list.

**Height** Sets the height of the list.

### **Alignment group**

**Left/Right/Center** Sets the alignment of the drop-down list in the rollout.

**Offsets X/Y** Fine-tune the position of the array list on the horizontal and vertical axes.

### **Array group**

**Item name** Lets you enter a name into the list.

Click Add Item to add the name to the array list. To remove an item, highlight its name and click Delete Item. Click Clear Array to remove all items from the list.

**[array list]** Displays the contents of the list.

The item at the top of the array list is the default selection.

### **Node UI Options rollout: Pick Button**

A node is any object in the 3ds Max scene. The Node UI element creates a button that, when clicked, lets the user pick a scene node other than the one to which the attribute is attached. After selecting the node, its name appears on the button.

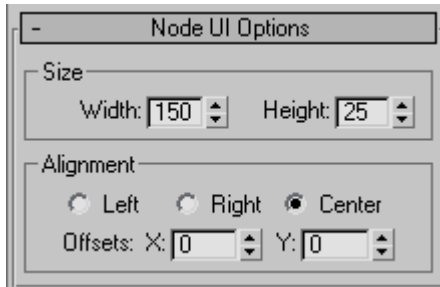

#### **Size group**

**Width** Sets the width of the pick button.

**Height** Sets the height of the pick button.

#### **Alignment group**

**Left/Right/Center** Sets the alignment of the pick button in the rollout.

**Offsets X/Y** Fine-tune the position of the pick button on the horizontal and vertical axes.

### **Color UI Options rollout: Color Picker**

This creates a color swatch that displays the current color and lets the user click it to choose a new color with the Color Selector dialog.

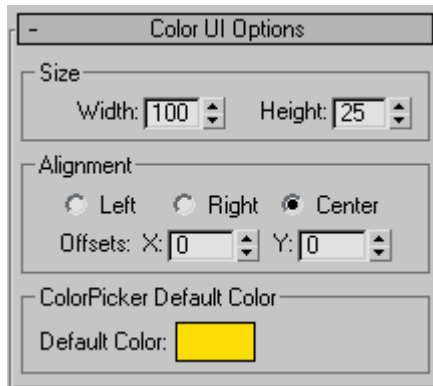

### Size group

**Width** Sets the width of the color picker.

**Height** Sets the height of the color picker.

### Alignment group

**Left/Right/Center** Sets the alignment of color picker in the rollout.

**Offsets X/Y** Fine-tune the position of the color picker on the horizontal and vertical axes.

### ColorPicker Default Color group

**Default Color** Sets the default color of the color picker.

### Material/TextureMap Options rollout: MaterialButton/MapButton

The options for the Material UI type (MaterialButton) and TextureMap UI type (MapButton) are the same. The difference is that, when the user clicks the resulting button to open the Material/Map Browser, the former displays only materials and the latter displays only maps.

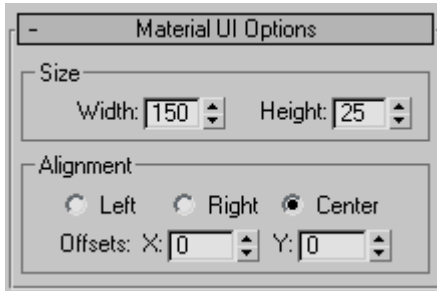

### Size group

**Width** Sets the width of the material/map button.

**Height** Sets the height of the material/map button.

### Alignment group

**Left/Right/Center** Sets the alignment of the material/map button in the rollout.

**Offsets X/Y** Fine-tune the position of the material/map button on the horizontal and vertical axes.

### String Options rollout: EditText

The String parameter type creates a text box that the user can edit with the keyboard, with optional default text.

### Size group

**Width** Sets the width of the material/map button.

**Height** Sets the height of the material/map button.

### Alignment group

**Left/Right/Center** Sets the alignment of the text box in the rollout.

**Offsets X/Y** Fine-tune the position of the text box on the horizontal and vertical axes.

## Label group

**Label above text box** When off, the label (parameter name) appears to the left of the text box. When on, the label appears above the text box.

## EditText Default Text group

**Default Text** Enter any default text that should appear in the box before the user edits it.

## Testing Attribute rollout

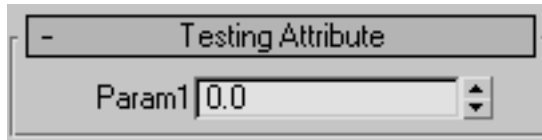

This rollout displays the UI layout for the custom attribute that you are working on. It updates continuously so that you can see how different settings in the various rollouts affect the UI display of the attribute.

The UI element is operational in this rollout in the sense that it can be moved, clicked, toggled, and so on.

# Parameter Collector

Animation menu > Parameter Collector

Keyboard > Alt+2

Parameter Collector lets you sort and present animatable parameters so that you can access and key selected parameter sets with a click or two. It takes the form of a resizable dialog that regenerates dynamically as parameters change. The dialog supports drag-and-drop rollout reordering. Collections are saved with their scenes and can be merged into other scenes.

One of Parameter Collector's most powerful features is the ability to change all parameters in a collection simultaneously, in an absolute or relative mode. For example, if you're animating a character's hand, you can use Parameter Collector to easily make all the fingers curl up together to form a fist.

---

**NOTE** Parameter Collector does not support parameters of [externally referenced objects](#) on page 6732 or objects in [externally referenced scenes](#) on page 6755 .

---

See also:

- [Custom Attributes](#) on page 267
- [Attribute Holder Modifier](#) on page 1136

## Menu Bar

The menu bar provides a range of functions for using Parameter Collector. See [Parameter Collector Menu Bar](#) on page 294 for details. Also, you can open the [Spinner Right-Click menu](#) on page 3014 by right-clicking a numeric field in Parameter Collector.

## Toolbar

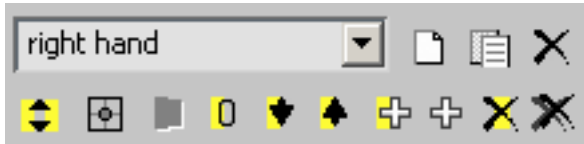

The Parameter Collector toolbar provides button access to the most commonly used functions.

**[collection name]** If empty, enter a name for the current collection, or choose a different collection from the drop-down list. If a name appears and you edit it, pressing Enter duplicates the current collection with the new name.



**New Collection** Creates a new, empty collection, clearing the current collection name and the rollout area. You can restore any existing collection by choosing it from the drop-down list.



**Duplicate Collection** Creates a new, unnamed collection containing the same data as the current collection. Enter a name for the duplicate selection in the editable field.

You can also duplicate a collection and name it at the same time by editing the name of an existing collection and pressing Enter.



**Delete Collection** Removes the current collection from memory.





**Multiple Edits** Enables multiple editing, in which changing the value of any selected parameter simultaneously changes all selected parameters of the same type by the same amount. This applies to both Absolute and Relative modes (see following).



**Absolute/Relative** Works the same way as the Absolute/Offset mode toggle on the [Coordinate Display](#) on page 7325 . When Absolute is chosen, modifying a value changes it to the exact amount you specify. When Relative is chosen, the displayed value is 0, and modifying the parameter adds the specified change to the original value. The actual value appears only in Absolute mode.

This applies to numeric values only; any changes to other values, such as color, are always absolute.

---

**NOTE** With multiple parameters selected, and Multiple Edits on, changing the value of a selected parameter changes the other selected parameter values *by* the same amount, not *to* the same amount. This happens in both Absolute and Relative modes.

---



**Key Selected** Sets [keys](#) on page 7824 for selected parameters only at the current frame. Available only when [Auto Key](#) on page 7344 is on.



**Reset Selected** Sets all selected numeric parameters to 0. Has no effect on other parameter types.



**Move Parameters Down** Moves each selected parameter down one position within its rollout, if possible.



**Move Parameters Up** Moves each selected parameter up one position within its rollout, if possible.



**Add to Selected Rollout** Lets you add new parameters to the selected rollout. Click this button to open the Track View Pick dialog, and then choose the parameters from the dialog.

---

**NOTE** You can add several parameters at once by highlighting them in the dialog before clicking OK.

---



**Add to New Rollout** Lets you add new parameters to a new rollout. Click this button to open the Track View Pick dialog, and then choose the parameter from the dialog. Parameter Collector creates a new rollout to hold the parameters.

---

**NOTE** You can add several parameters at once by highlighting them in the dialog before clicking OK.

---



**Delete Selected** Deletes all selected parameters.



**Delete All** Deletes all parameters and rollouts.

## Rollouts

Rollouts work the same way in Parameter Collector as they do [on the command panel](#) on page 40 . You can expand and collapse a rollout by clicking its title bar, and move it to another location by dragging the title bar. You can resize the dialog to be able to see all rollouts at once.

Only one rollout can be selected at a time. You select a rollout by clicking the horizontal bar beneath the title; when selected, this bar is orange-yellow in color, and angle brackets surround the rollout title (for example, "> Hand Parameters <").

The interface for each parameter on a rollout is as follows:

**[Select Parameter]** A small check button on the left side of the rollout. Click it to toggle the parameter's selection status. When selected, the button appears pressed in and is colored yellow-orange.

**[parameter name]** By default, the parameter has the same name as is shown in Track View, but you can change it with the Edit menu > Edit Notes command. You can see the default name for a parameter as well as the object it controls, if any, by hovering the mouse over the parameter name; the information appears on a tooltip.

**[parameter value]** Shows the current value of the parameter. The parameter type determines how this appears: numeric field/spinner, color swatch, etc. You can edit the value the same way as on the command panel or a dialog.

If a key exists for the value at the current frame, the spinner or swatch appears with red brackets at the corners.



**[Properties]** Opens a [Key Info dialog](#) on page 3052 for the parameter. Available only if the parameter has an animation controller.

Use the Key Info dialog to edit an animation key's value, time, and interpolation methods.

## Procedures

### Example: To use Parameter Collector:

This exercise demonstrates some basic Parameter Collector functions.

In general, start with a scene containing one or more objects whose parameters you'll collect. Ideally, they should be animated, but it's not absolutely necessary.

- 1 For this example, reset 3ds Max and then add a sphere.
- 2 Open Parameter Collector from the Animation menu, or press Alt+2.
- 3  On the Parameter Collector toolbar, click the Add To New Rollout button.  
The Track View Pick dialog opens. This lets you specify parameters to collect.
- 4 On the Track View Pick dialog, expand Objects > Sphere01 > Transform: Position/Rotation/Scale > Position: Position XYZ.
- 5 Click X Position: Bezier Float.  
The parameter highlights.
- 6 Click OK to close the dialog.  
A new rollout named Parameters 1 appears, containing the X Position parameter.

---



**NOTE** A parameter in Parameter Collector can contain only a single value (e.g., float, integer, color), so the software doesn't let you add parameters such as Position: Position XYZ, which contains three distinct values.

---

- 7  Click Add To Selected Rollout and then use the same method to add the Y Position and Z Position parameters: Highlight both parameters on the Track View Pick dialog and then click Add To Selected Rollout to add both at once to the Parameters 1 rollout.

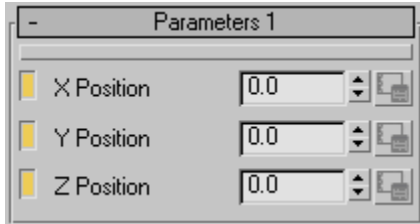
- 8 Drag each spinner in turn to move the sphere on the respective axis.  
As you change each parameter value, the sphere moves in real time in the viewports.
- 9 Set all three parameters to **0.0**.
- 10 Click the check button next to each parameter to select all three.



- 11  On the toolbar, turn on Multiple Edits.
- 12 Drag one of the spinners.  
All three change by the same amount, so that the sphere moves diagonally in the scene.
- 13 Use the keyboard to change the Y Position value to **30.0**.  
Again, the other two change.
- 14  Click the Absolute/Relative button to turn on Relative mode.  
All the values display 0.0, as with Offset mode on the status bar coordinate display.
- 15 Use the spinner to set Y Position to **0.65**.  
The three change in unison, and then reset back to 0.0 when you release the mouse button. This has added the value you set to each of the three positions, as you'll see in the next step.
- 16 Click the Absolute/Relative button to return to Absolute mode.  
The values are all set to 30.65, reflecting the relative change that you made.  
Next, you'll try a few Edit commands.
- 17 Click the Y Position check button to deselect the parameter.
- 18 From the Edit menu, choose Select Invert.

The Y Position parameter is now selected, and the other two are deselected.

- 19  Click the Move Parameters Up button.  
The Y Position parameter now sits above the X Position parameter.

- 20  Click the Move Parameters Down button.  
The Y Position returns to its position below the X Position parameter.

- 21 Choose Edit > Edit Notes.

The Notes dialog opens. Here you can change the parameter name, set a URL or file location with further information about the parameter, and enter comments.

- 22 In the box below Parameter Name, type **Sphere Y Loc.**, and then press Enter.

The new name replaces the old one on the rollout. You can see the original name by hovering the mouse cursor over the parameter name; it appears on a tooltip.

To conclude this exercise, you'll use Parameter Collector to set and edit animation keyframes.

- 23 On the Collection menu, turn on Show Keys In Track Bar if necessary.

- 24  On the 3ds Max status bar, turn on Auto Key.

- 25 Change the Sphere Y Loc. (the old Y Position) parameter value to **20.0**. Because you're at frame 0, no key is set. This is the same way Auto Key works normally.

- 26 Go to frame 20 and then set Sphere Y Loc. to **30.0**.

This sets animation keys at frames 0 and 20.

- 27 Right-click the key at frame 20.

The menu shows that a key exists at frame 20 only for Y Position.

Normally, 3ds Max would create keys for all three axes, even if you moved the sphere only on one axis.

Parameter Collector can set keys for unselected objects as well.

**28** Click in an empty area of the active viewport to deselect the sphere, and then go to frame 30 and change the Sphere Y Loc. value to **40.0**. This sets another key for Y Position at frame 30.



**29** In Parameter Collector, select the X Position and Z Position parameters, and then click Key Selected. This button is available only when Auto Key is on.

**30** Check the track bar key again. Now there are keys for all three parameters, as demonstrated by the red brackets on the spinners in Parameter Collector.



**31** Click the Properties button to the right of the Sphere Y Loc. parameter.

This opens a [Key Info dialog](#) on page 3052 for the parameter, with the ability to edit the key time and value as well as interpolation with other keys. The dialog is also available from the track bar right-click menu, but it's much easier to access the data for a specific key from Parameter Collector.

## Interface

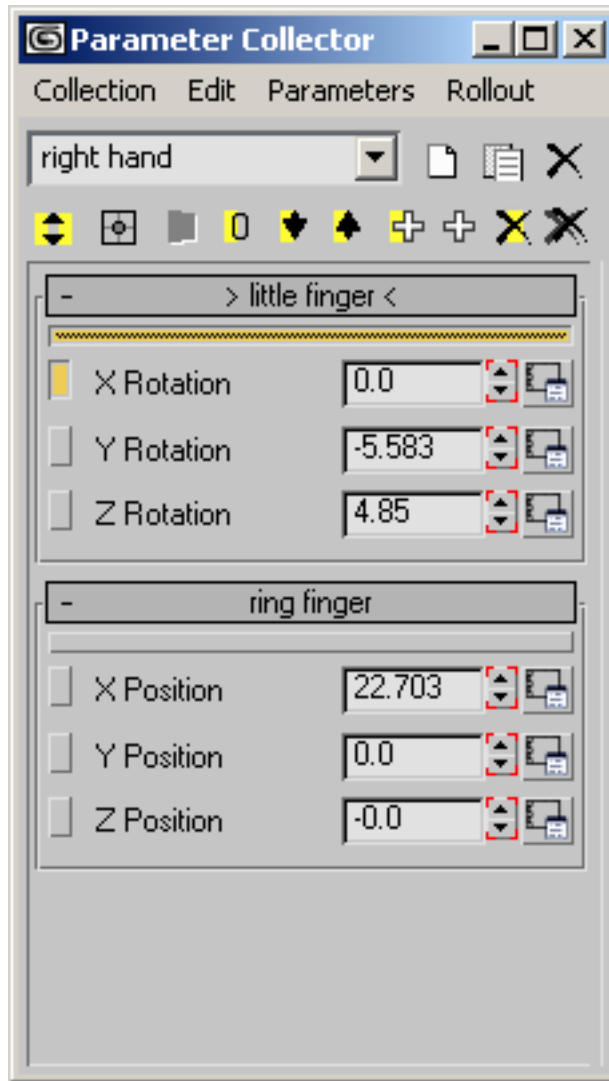

Parameter Collector takes the form of a dialog with a menu bar, a toolbar, and rollouts that you create and modify using the dialog tools. You can resize the dialog horizontally and vertically; expanding it lets you see all rollouts simultaneously.

# Parameter Collector Menu Bar

Animation menu > Parameter Collector > Parameter Collector menu bar

Keyboard > Alt+2 > Parameter Collector menu bar

The Parameter Collector dialog menu bar provides access to a number of important commands. Some of these commands are replicated on the dialog toolbar; others, such as the Select tools, are available only from the menus. Also, you can open the [Spinner Right-Click menu](#) on page 3014 by right-clicking a numeric field in Parameter Collector.

## Interface

### Collection menu

The first three items in this menu are unavailable until you enter a name for the current collection in the editable field (drop-down list) just below the menu bar.

**New Collection** Creates a new, empty collection, clearing the current collection name and the rollout area. You can restore any existing collection by choosing it from the drop-down list.

**Duplicate Collection** Creates a new, unnamed collection containing the same data as the current collection. Enter a name for the duplicate selection in the editable field.

**Delete Collection** Removes the current collection from memory.

**Show Keys in Track Bar** Displays in the [track bar](#) on page 7315 animation keys for all objects with parameters in the current collection, whether or not the objects are selected in the scene.

**Isolate Keys in Track Bar** The track bar displays only keys for parameters in the Parameter Collector.

**Show Selected Keys in Track Bar** Displays in the [track bar](#) on page 7315 animation keys for all objects with selected parameters in the current collection, whether or not the objects are selected in the scene.

**Isolate Selected Keys in Track Bar** The track bar displays only keys for selected parameters in the Parameter Collector.

**Put to Object** Stores the current collection as part of an object in the scene. Opens the Put To Object dialog; highlight an object in the list, and then click Pick.



Although parameter collections are stored with the scene in which they're created, you can use this function to transfer a collection to a different scene. After putting the collection to an object, save the scene. Open or create another scene, merge the object from the saved scene to the new one, and then use Get from Object.

You can also back up, organize and streamline parameter collections by putting and getting different collections to and from various objects in your scene. Just remember that if you add, reorder, or remove parameters or rollouts to a collection that has been put to an object, you must then put it to the object again so the changes are saved to the collection.

**Link to Object** Stores the current collection *using a live link* as part of an object in the scene. Any change to the collection instantly updates the version of the collection stored in the object. Opens the Link To Object dialog; highlight an object in the list, and then click Pick.

Link to Object has basically the same function as Put To Object (see previous entry), except that it guarantees an up-to-date stored version of the collection, especially when merging the object into another scene that is a common production workflow.

---

**NOTE** Only one “linked-to” object can be active in a scene, but you can use Put To Object on any number of objects at a time.

---

**Get from Object** Retrieves a collection that you stored with Put To Object or Link To Object.

**Remove from Object** Deletes a collection that you stored with Put To Object or Link To Object.

### **Edit menu**

Parameter Collector lets you select parameters in any combination, but you can select no more than one rollout at a time. To select or deselect a parameter, click the small button on its left side. To select or deselect a rollout, click the wide horizontal button just below the rollout title. Selecting a rollout deselects any other selected rollout.

**Select All** Selects all parameters and rollouts.

**Select All Rollout** Selects all parameters on the current rollout. Unavailable if no rollout is selected.

**Select None** Deselects all parameters.

**Select Invert** Inverts the current selection of parameters.

**Delete Selected** Deletes all selected parameters.

**Delete All** Deletes all parameters and rollouts.

**Multiple Edits** Enables multiple editing, in which changing any parameter simultaneously changes all selected parameters of the same or similar type.

---

**NOTE** The changed parameter need not be selected.

---

**Absolute/Relative** This works the same as the Absolute/Offset mode toggle on the [Coordinate Display](#) on page 7325 . When Absolute is chosen, modifying a value changes it to the exact amount you specify. When Relative is chosen, the displayed value shows 0, and modifying the parameter adds the specified change to the original value. This applies to numeric values only; changes to any other value types such as color are always absolute.

**Edit Notes** Opens a single [Notes dialog](#) on page 297 for all selected parameters.

You can open the Notes dialog for a single parameter by right-clicking its Select Parameter button.

### Parameters menu

**Add to Selected** Lets you add new parameters to the selected rollout.

**Add to New Rollout** Lets you add new parameters to a new rollout.

**Move Up** Moves selected parameters up one position within their rollout, if possible.

**Move Down** Moves selected parameters down one position within their rollout, if possible.

**Move Up By Rollout** Moves selected parameters to the rollout above, if possible. If the same parameter already exists in the rollout above, the selected parameter is simply deleted.

**Move Down By Rollout** Moves selected parameters to the next rollout, if possible. If the same parameter already exists in the next rollout, the selected parameter is simply deleted.

**Key All** Sets [keys](#) on page 7824 for all parameters at the current frame. Available only when [Auto Key](#) on page 7344 is on.

**Key Selected** Sets [keys](#) on page 7824 for selected parameters only at the current frame. Available only when [Auto Key](#) on page 7344 is on.

**Reset All** Sets all numeric parameters to 0. Has no effect on other parameter types.

**Reset Selected** Sets all selected numeric parameters to 0. Has no effect on other parameter types.

### **Rollout menu**

---

**NOTE** While there are no menu commands for moving rollouts, you can do so simply by dragging the rollout title bar to a new location.

---

**New Rollout** Creates a new, empty rollout.

**New Rollout Selected Parameters** Creates a new rollout and populates it with copies of any selected parameters.

**Rename Rollout** Opens a small dialog that lets you rename the selected rollout.

**Delete Rollout** Deletes the selected rollout.

**Delete Rollout Move Up** Deletes the selected rollout and moves its parameters to the rollout above.

**Delete Rollout Move Down** Deletes the selected rollout and moves its parameters to the rollout below.

## **Notes Dialog (Parameter Collector)**

Parameter Collector > Select one or more parameters. > Parameter Collector menu bar > Edit menu > Notes

Parameter Collector > Right-click a Parameter Select button.

The Notes dialog lets you enter a name, URL, and comments for one or more selected parameters in Parameter Collector.

Choosing Notes from the Edit menu with multiple parameters selected opens a single dialog common to all selected parameters. Right-clicking a Parameter Select button opens a dialog for that parameter only.

When you open Notes from the Edit menu with multiple parameters selected, if the text contents for a box in all selected parameters are the same (or null), its check box is on, indicating that changes to the text will apply to all selected parameters. If a text box has different contents for different selected parameters, the check box is off, and the corresponding text box is empty and unavailable,

preventing any changes. If you turn on a check box, you can edit the text, and changes will be applied to all selected parameters.

### Interface

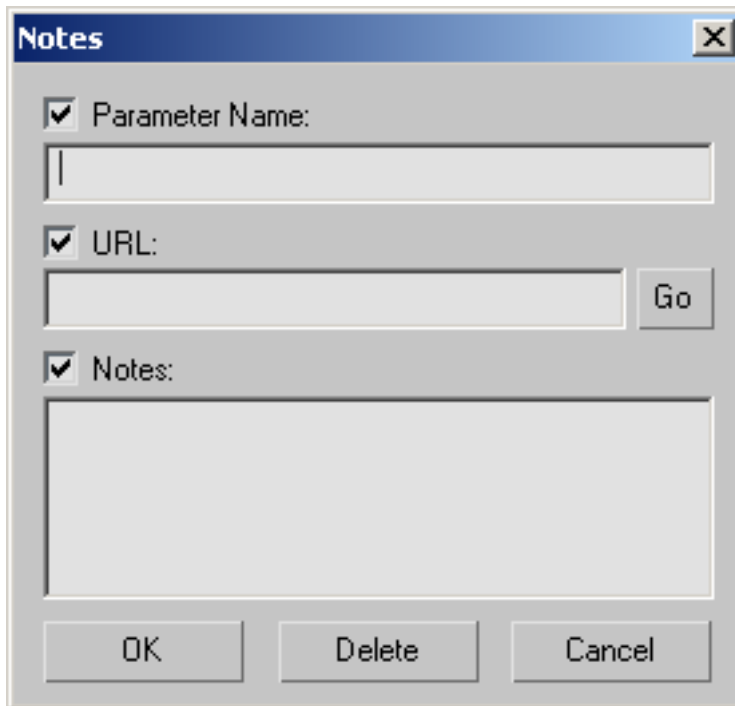

The Notes dialog interface comprises three text boxes, each with its respective check box, and a button. By default, the text boxes are empty; you can enter any text into each box, although each has a specific purpose, as described below.

**Parameter Name** Lets you change the parameter name shown in Parameter Collector.

By default, the parameter name displayed in Parameter Collector is the same as the name that appeared in the Track View Pick dialog when you added it to Parameter Collector. If you enter a different name in the Notes dialog, Parameter Collector then displays that name. The changed name is used only in Parameter Collector; elsewhere, such as the Modify panel, it remains the same as before.

You can see the original parameter name, as well as the object to which it's attached, by hovering the mouse over the parameter name in Parameter Collector; the information appears in a tooltip.

**URL** Lets you enter a URL, such as [www.discreet.com](http://www.discreet.com).

This could be a link to a Web or intranet page, or even a network location or file pertaining to the selected parameter. To access the link, click the Go button.

**Go** If the URL text box contains a valid URL, clicking Go opens the URL in a separate browser window.

**Notes** Contains any comments on the parameters. This field is strictly for informational purposes.

## Expression Techniques

In 3ds Max, you can use mathematical expressions (rather than constant numbers) to express parameter values. For example, you could use the expression  $24*6$  to represent the number 144.

You can use mathematical expressions to control the following object properties:

- Object parameters, such as length, width, and height
- Transform and modifier values, such as an object's position coordinates

[Parameter wiring](#) on page 3247, the [expression controller](#) on page 3079, and the [numerical expression evaluator](#) on page 41 all use expressions, which are described in this topic.

An expression is a mathematical function that returns a value. You can use expressions to control the following scene elements:

Scene element	Calculatable property
Creation parameters	Any numeric creation parameter
Transforms	Position [X, Y, Z] X Rotation Y Rotation Z Rotation

Scene element	Calculatable property
	Scale [X%, Y%, Z%]
Modifiers	Any numeric modifier parameter (including creation parameters)
Materials	Colors [R, G, B] Any numeric material parameter

**NOTE** Expressions only work with the individual XYZ components of Euler rotation. You can't assign an expression to TCB rotation or other kinds of rotation controllers.

The links below are to the sections that follow in this topic.

[Expression Return Types](#) on page 300

[Operators](#) on page 301

[Variables](#) on page 303

[Functions](#) on page 306

**See also:**

- [Trigonometric Functions](#) on page 309
- [Vectors](#) on page 312
- [Expression Controller Techniques](#) on page 3086

## Expression Return Types

The type of value returned by an expression depends on the kind of controller:

- Float expressions return a floating-point scalar value (For example, 5.617). Scalars are used in the animation controllers of numeric parameters. If the parameter has an integer value, the expression rounds the float value to the nearest integer.
- Position, Scale, and Point3 expressions return a three-component vector. For example, [5, 18, 24]. The vector can represent an object's X,Y,Z location, percent scaling in X, Y, and Z, or a color (RGB values) in a material.

## Operators

In the following tables,  $p$  and  $q$  are any scalar value or expression,  $V$  and  $W$  are any vector value or expression. (The character "x" is used as the vector cross-product operator.)

### Scalar Operators

These are the arithmetic operators for scalar values:

Operator	Use	Meaning
+	$p+q$	Addition
-	$p-q$	Subtraction
-	$-p$	Additive inverse
*	$p*q$	Multiplication
/	$p/q$	Division
^	$p^q$	power ( $p$ to the power of $q$ )
**	$p**q$	^ and ** are the same operation

You can also use logical (Boolean) operators with scalar values. These operators all return 1 if true, 0 otherwise:

Operator	Use	Meaning
=	$p=q$	equal to
<	$p<q$	less than
>	$p>q$	Greater than
<=	$p<=q$	less than or equal to

Operator	Use	Meaning
$\geq$	$p \geq q$	Greater than or equal to
	$p   q$	Logical OR, returns 1 if either p or q is nonzero; otherwise, returns 0
&	$p \& q$	Logical AND, returns 1 if p and q are both nonzero; otherwise, returns 0

---

**TIP** Logical operators are useful with the "if" function.

---

### Vector Operators

For vectors that have a variable name, you can use a special component operator (.) to refer to the three scalar components of the vector:

Use	Meaning
$V.x$	first component (X)
$V.y$	second component (Y)
$V.z$	third component (Z)

These are the operators for vector arithmetic:

Operator	Use	Meaning
+	$V+W$	Addition
-	$V-W$	subtraction
*	$p*V$	scalar multiplication
*	$V*p$	scalar multiplication
*	$V*W$	dot product



Operator	Use	Meaning
X	VxW	cross product
/	V/p	scalar division

### Operator Precedence

Expressions have eight levels of precedence. The higher the operator is on the list, the earlier it is evaluated.

Operator	Level of Precedence
- +	as unary operators, as in -8, +25
.	the component operator, as in V.x
** ^	
X	cross product
* /	
+ -	
= < > <=	
>=	
&	

Parentheses are a special case. They are a grouping or subexpression operator that is provided so you can override the precedence order of the other operators.

### Variables

In expressions you write for [expression controllers](#) on page 3079 , variables are represented by symbolic names. You create them to contain constant or

variable values in your expressions. Several predefined variables are also provided. Some of these have a constant value, others can vary.

In expressions used for [parameter wiring](#) on page 3247 and the [numerical expression evaluator](#) on page 41, you can use predefined variables with constant values.

### Predefined Variables with Constant Values

These are the predefined variables that have a constant value (variable names are case-sensitive):

Variable Name	Constant Value	Use
pi	3.14159	Ratio of a circle's circumference to its diameter.
e	2.71828	Base of natural logarithms.
TPS	4800	Ticks per second. The tick is the basic time unit of 3ds Max animation.

### Predefined Variables with Variable Values

These are the predefined variables that have a variable, time-based value (variable names are case-sensitive).

Variable Name	Meaning
F	Frame number. For each frame, F equals the current frame number, counting from zero. The range of frames can vary depending on the number of frames in the active time segment.
NT	Normalized time. By definition, normalized time (NT) ranges from 0 to 1 over the active time segment, regardless of how many frames are in the segment.

Variable Name	Meaning
	<p>If you base an expression on NT, its effect happens exactly once over the range. You can also multiply NT by a factor for the expression's effect to occur a certain number of times (for example, 2*NT causes the expression's effect to occur twice). Expressions based on NT speed up or slow down if you change the length of the time segment.</p>
S	<p>Seconds (elapsed time in seconds). Elapsed time is measured from the first frame to the current frame. The range of seconds can vary depending on the total time of the active time segment.</p>
T	<p>Ticks (elapsed time in ticks). There are 4800 ticks per second. Elapsed time is measured from the first frame to the current frame. The range of ticks can vary depending on the total time of the active time segment.</p>

### Rules for Variable Names

- Variable names can contain as many alphanumeric characters as you like. Their length is not limited.
- Variable names cannot contain spaces.
- The variable name must begin with a letter. Numbers are valid within a variable name (as in "Pos1" or "M23").
- Variable names are case-sensitive. For example, "pos", "Pos", and "POS" designate three different variables.
- You can't create a variable with a name that duplicates another name, including the variable names that are predefined.

## Functions

Following is a list of the functions provided for expressions. In this list,  $p$ ,  $q$ , and  $r$  represent scalar values or scalar expressions.  $V$  and  $W$  represent vector values or vector expressions.

To use a function in an expression, enter the name of the function and appropriate arguments to it.

## Trigonometric Functions

The sine, cosine, and tangent functions take an angle in degrees and return a floating-point value. The arc functions take a floating-point value and return a value in degrees.

Function	Meaning
$\sin(p)$	sine
$\cos(p)$	cosine
$\tan(p)$	tangent
$\text{asin}(p)$	arc sine
$\text{acos}(p)$	arc cosine
$\text{atan}(p)$	arc tangent

## Hyperbolic Functions

Hyperbolic functions take a floating-point value and return a floating-point value.

Function	Meaning
$\sinh(p)$	hyperbolic sine
$\cosh(p)$	hyperbolic cosine

Function	Meaning
$\tanh(p)$	hyperbolic tangent

### Conversion Between Radians and Degrees

Function	Meaning
$\text{radToDeg}(p)$	takes $p$ in radians and returns the same angle in degrees
$\text{degToRad}(p)$	takes $p$ in degrees and returns the same angle in radians

### Rounding Functions

Function	Meaning
$\text{ceil}(p)$	smallest integer greater than or equal to $p$
$\text{floor}(p)$	largest integer less than or equal to $p$

### Standard Calculations

Function	Meaning
$\ln(p)$	natural (base $e$ ) logarithm
$\log(p)$	common (base 10) logarithm
$\exp(p)$	exponential function $\exp(p)=e^p$
$\text{pow}(p,q)$	$p$ to the power of $q$ ( $p^q$ )
$\text{sqrt}(p)$	square root
$\text{abs}(p)$	absolute value

Function	Meaning
<code>min(p,q)</code>	minimum returns p or q, depending on which is smaller
<code>max(p,q)</code>	maximum returns p or q, depending on which is greater
<code>mod(p,q)</code>	remainder of p divided by q

### Conditional Functions

Function	Meaning
<code>if(p,q,r)</code>	works like the common spreadsheet "if" (If p is nonzero then "if" returns q, otherwise "if" returns r.)
<code>vif(c,V1,V2)</code>	"Vector If" (Value is V1 if c is true, else V2.)

### Vector Handling Functions

Function	Meaning
<code>length(V)</code>	length of V
<code>comp(V,i)</code>	i'th component (i=0,1,2): <code>comp([5,6,7],1)=6</code>
<code>unit(V)</code>	returns a unit vector in the same direction as V

**NOTE** The `comp` function is an alternative to the notation  $V_x$ ,  $V_y$ ,  $V_z$ .

## Special Animation Function

Function	Meaning
noise(p,q,r)	3D noise: returns a randomly generated position

The arbitrary values  $p$ ,  $q$  and  $r$ , are used as a random-generation seed. You can reuse these values to ensure that `noise()` returns the same value.

## Trigonometric Functions

This topic is a quick review for readers who need a reminder about this area of mathematics. If you're familiar with trigonometry, you can skip this topic. If you find this topic difficult to follow, you might consult a more basic reference on mathematics.

Trigonometric functions are principally used to model or describe:

- The relation between angles in a triangle (hence the name).
- Rotations about a circle, including locations given in polar coordinates.
- Cyclical or periodic values, such as sound waves.

The three basic trigonometric functions are derived from an angle rotating about a unit circle.

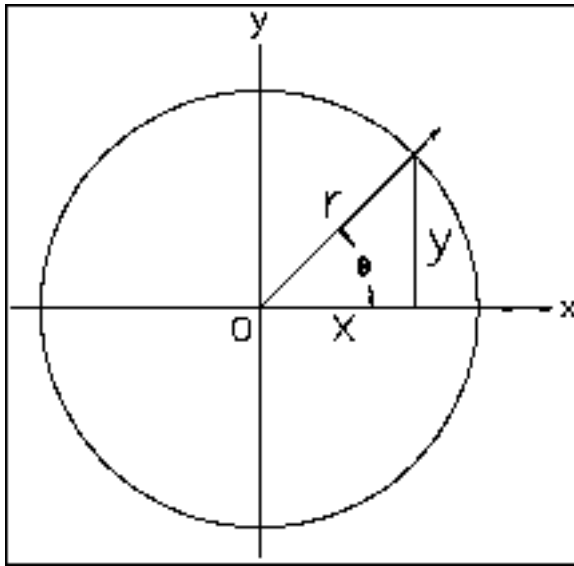

Trigonometric functions based on the unit circle

$$\sin \theta = \frac{y}{r} \quad \cos \theta = \frac{x}{r} \quad \tan \theta = \frac{y}{x}$$

The tangent function is undefined for  $x=0$ . Another way to define the tangent is:

$$\tan \theta = \frac{\sin \theta}{\cos \theta}$$

Because  $XYR$  defines a right-angled triangle, the relation between the sine and cosine is:

$$(\cos \theta)^2 + (\sin \theta)^2 = 1$$

The graphs of the basic trigonometric functions illustrate their cyclical nature.



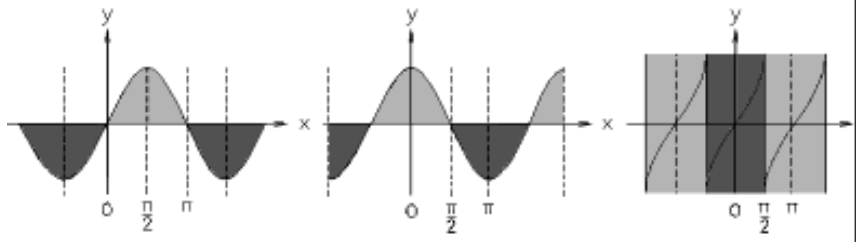

**Graphs of basic trigonometric functions**

The sine and cosine functions yield the same values, but the phase differs along the X axis by  $\pi/2$ : in other words, 90 degrees.

The inverse functions for the trigonometric functions are the arc functions; the inverse only applies to values of  $x$  restricted by  $-\pi/2 \leq x \leq \pi/2$ . The graphs for these functions appear like the basic trigonometric function graphs, but turned on their sides.

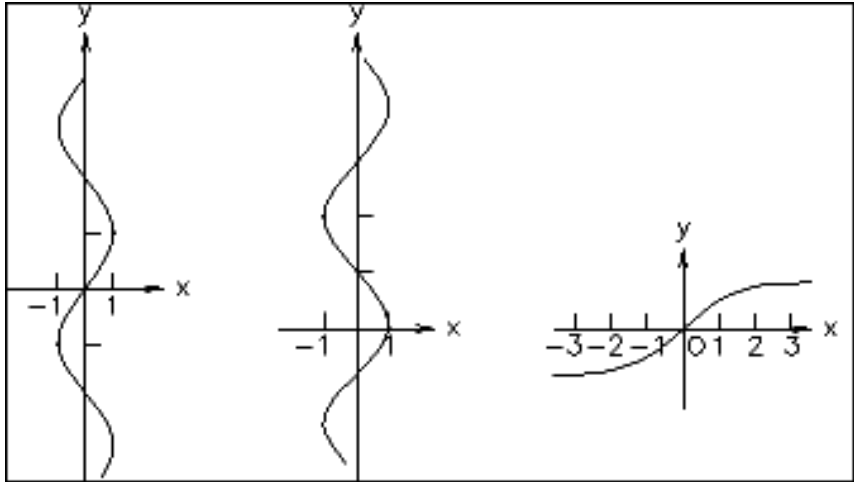

**Graphs of basic arc functions**

The hyperbolic functions are based on the exponential constant  $e$  instead of on circular measurement. However, they behave similarly to the trigonometric functions and are named for them. The basic hyperbolic functions are:

$$\sinh x = \frac{e^x - e^{-x}}{2}$$

$$\cosh x = \frac{e^x + e^{-x}}{2}$$

$$\tanh x = \frac{e^x - e^{-x}}{e^x + e^{-x}} = \frac{\sinh x}{\cosh x}$$

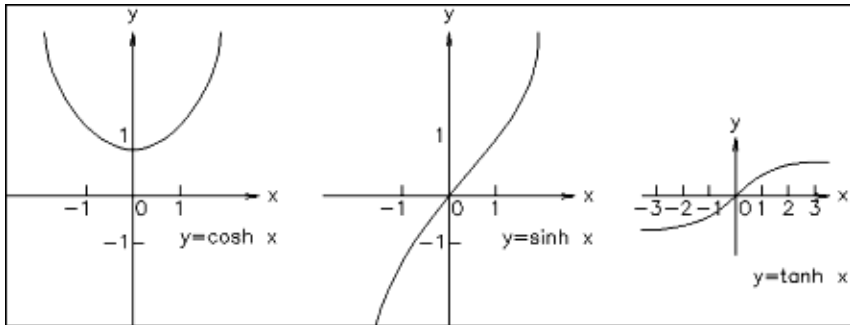

Graphs of basic hyperbolic functions

## Vectors

This topic is a quick review for readers who need a reminder about vector arithmetic. If you're familiar with vectors and vector calculations, you can skip this topic. If this topic is difficult to follow, you might consult a more basic reference on mathematics.

A vector expresses a length and a direction in a particular space. The vector is expressed as a point; for example, [5, 5, 7]. The length is the distance from the origin to that point, and the direction is similarly from the origin to (and through) the point.

In 3ds Max, vectors have three values and describe positions in three-dimensional space. They can also represent percent scaling in X, Y, and Z; and (more abstractly) describe locations in RGB color space.

## Unit Vectors and Basic Vectors

A unit vector has a length of one. Unit vectors are often used to express direction only. The three basic vectors are unit vectors that describe the three axes (X, Y, and Z) of 3D space.

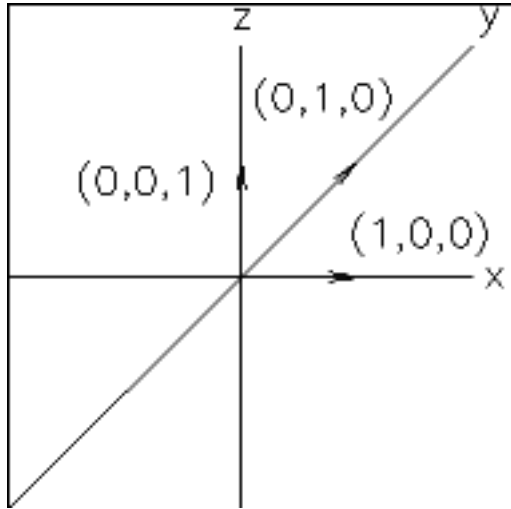

Basic vectors and the XYZ axes

## Adding and Subtracting Vectors

Adding two vectors creates a new vector that combines the length and direction of the original two. Vector addition is commutative:  $V+W=W+V$ .

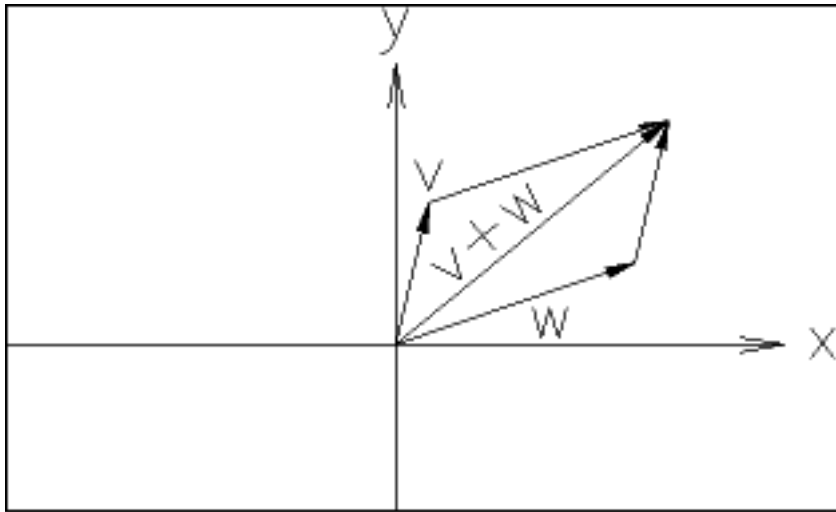

Adding two vectors

$$V + W = [v_1 + w_1, v_2 + w_2, v_3 + w_3]$$

Subtracting two vectors gives the vector between the two points.

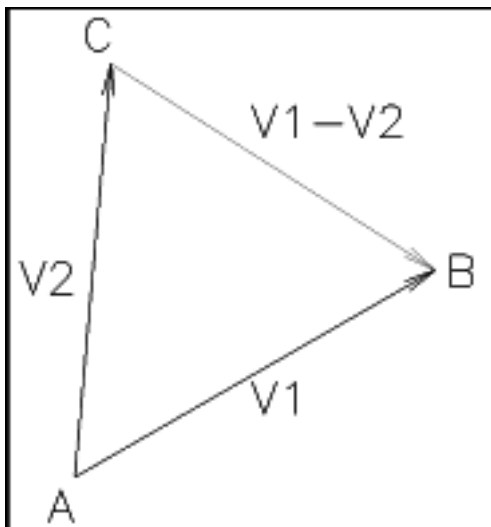

Subtracting two vectors

$$\mathbf{V} - \mathbf{W} = [v_1 - w_1, v_2 - w_2, v_3 - w_3]$$

### Scalar Multiplication and Division

Multiplying a vector by a scalar changes the vector's length, as does dividing the vector by a scalar.

$$y\mathbf{V} = \mathbf{V}y = [yv_1, yv_2, yv_3]$$

$$\mathbf{V}/y = [v_1/y, v_2/y, v_3/y]$$

### Vector Length and Direction

The length of a vector is obtained from the Pythagorean theorem.

$$|\mathbf{V}| = \sqrt{v_1^2 + v_2^2 + v_3^2}$$

In 3ds Max expressions, the `length()` function returns this value.

The direction of the vector is the vector divided by its length; this gives you a unit vector with the same direction.

$$\frac{\mathbf{V}}{|\mathbf{V}|}$$

The distance between two points is the length of the vector between them.

$$|\mathbf{V}\mathbf{W}| = |\mathbf{W} - \mathbf{V}|$$

**Subtracting vectors to obtain a distance**



# Creating Geometry

# 6

The solid 3D objects in the scene, and the objects used to create them, are known as *geometry*. Usually, geometry comprises the subject of your scene and the objects that you render.

This section describes the types of geometry you can create using the [Create panel](#) on page 7423 .

[Basics of Creating and Modifying Objects](#) on page 317

[Geometric Primitives](#) on page 345

[Shapes](#) on page 536

[Compound Objects](#) on page 638

[Dynamics Objects](#) on page 810

[Systems](#) on page 829

**See also:**

- [Surface Modeling](#) on page 1925
- [Space Warps and Particle Systems](#) on page 2603

## Basics of Creating and Modifying Objects

This section provides an introduction to techniques for creating and modeling objects.

The [Create panel](#) on page 7423 contains controls for creating new objects, the first step in building a scene. Despite the variety of object types, the creation process is consistent for most objects.

The [Modify panel](#) on page 7425 provides controls to complete the modeling process. Any object can be reworked, from its creation parameters to its internal geometry. Both object-space and world-space modifiers let you apply a wide range of effects to objects in your scene. The modifier stack allows editing of the modifier sequence.

In 3ds Max, you model basic [parametric](#) on page 7884 objects into more complex ones by:

- Changing [parameters](#) on page 7884
- Applying modifiers
- Directly manipulating sub-object geometry

These topics will help you start creating and modifying objects:

[Using the Create Panel](#) on page 319

[Creating an Object](#) on page 323

[Using the Modify Panel](#) on page 1016

[Using the Modifier Stack](#) on page 1020

[Editing the Stack](#) on page 1023

[Modifying at the Sub-Object Level](#) on page 1029

[Using the Stack at the Sub-Object Level](#) on page 1032

[Modifying Multiple Objects](#) on page 1034

[How Instanced Modifiers Work](#) on page 1040

[Transforms, Modifiers, and Object Data Flow](#) on page 1004

### **Varying the Parameters**

Unlike physical objects, with a fixed shape and size, you can change the creation parameters of objects and shapes to dramatically alter topology. Here are some examples of changes you can make:

- Turn a cone into a four-sided pyramid by reducing the number of sides and turning the Smooth option off.
- Slice any circular object as if it were a pie.
- Animate almost all creation parameters, and interactively change their settings during animation playback.



- Render splines directly at any assigned width.
- Break, detach, and divide wall segments.
- Change the number of risers without affecting the overall rise of the stairs.

## Collapsing Primitives to Base Geometry

You can collapse a geometric primitive or shape to one of a variety of base geometric types once you no longer need access to its creation parameters. For example, you can convert any standard primitive to an [editable mesh](#) on page 1990 , [editable poly](#) on page 2038 , [editable patch](#) on page 1934 , or [NURBS](#) on page 2176 object, and you can convert a spline shape to an editable mesh, [editable spline](#) on page 590 , or NURBS object. The easiest way to collapse an object is to select it, right-click it, and choose a "Convert to" option from the quad menu > Transform quadrant. This lets you use explicit editing methods with the object, such as transforming vertices. You can also use the Modify panel to collapse a primitive.

## Mapping Coordinates

Most Geometry objects have an option for generating mapping coordinates. Objects need these mapping coordinates if you plan to apply a mapped material to them. Mapped materials include a wide range of rendered effects, from 2D bitmaps to reflections and refractions. See [Mapping Coordinates](#) on page 5183 and [Using Maps to Enhance a Material](#) on page 5178 . If mapping coordinates have already been applied to an object, the check box for this feature is turned on.

# Using the Create Panel

The Create panel provides the controls for creating objects and adjusting their parameters.

To access the Create panel:



- 1 Click the Create tab in the [command panels](#) on page 7422 .

By default, this panel is open when you start the program. If the command panel isn't visible, choose it from the [Customize Display right-click menu](#) on page 7479 .

- 2 Click an object type to display its Parameters rollout.

## The Creation Process

The actual creation of objects is accomplished with a single click of the mouse, a drag, or some combination, depending on the object type. This is the general sequence:

- Choose an object type.
- Click or drag in a viewport to create an object of approximate size and location.
- Adjust the object's parameters and position, either immediately or later.

See [Creating an Object](#) on page 323 .

## Create Panel Interface

Controls in the Create panel vary depending on the kind of object you are creating. However, certain controls are always present, and others are shared by nearly all object types.

**Category** Buttons at the top of the panel access the seven main categories of objects. Geometry is the default category.

**Subcategory** A list lets you select subcategories. For example, subcategories under Geometry include Standard Primitives, Extended Primitives, Compound Objects, Particle Systems, Patch Grids, NURBS Surfaces, and Dynamics Objects.

Each subcategory contains one or more object types. If you've installed plug-in components for additional object types, these might be grouped as a single subcategory.

**Object Type** A rollout contains labeled buttons for creating objects in a particular subcategory, plus the [AutoGrid](#) on page 2513 check box.

**Name and Color** The Name shows the automatically assigned name of the object. You can edit this name or replace it with another. (Different objects can have the same name, though this is not recommended.) Clicking the square color swatch brings up an [Object Color dialog](#) on page 327 to change the color of the object as it appears in viewports (the wireframe color).

**Creation Method** This rollout provides a choice of how you use the mouse to create an object. For example, you can use either the center (radius) or edge (diameter) to define the size of a Circle shape.

A default creation method is always selected when you access the tool. If you want to use an alternate method, choose the option before you create the object. The creation method has no effect on a finished object; the options are for your convenience during creation.

**Keyboard Entry** This rollout lets you enter creation parameters from the keyboard for geometric primitive and shape objects.

**Parameters** This rollout shows creation parameters: the defining values for an object. Some parameters can be preset, while others are only for adjustment after an object has been created.

**Other rollouts** Additional rollouts can appear on the Create panel, depending on what kind of object you create.

## Identifying the Basic Building Blocks

On the Create panel, the categories for Geometry and Shapes supply the "building blocks" to combine and modify into more sophisticated objects. These [parametric](#) on page 7884 objects are ready to use. By adjusting values and turning some buttons on or off, you can create dozens of "new" building blocks from the ones listed here.

You can choose these types from the sub-categories list on the Create panel.

### Geometry Types

**Standard Primitives** Relatively simple 3D objects such as Box, Sphere, and Cylinder, as well as Torus, Plane, Cone, GeoSphere, Tube, Teapot, and Pyramid.

**Extended Primitives** More complex 3D objects such as Capsule, OilTank, Spindle, Hedra, Torus Knot, and Prism.

**Compound Objects** Compound objects include Scatter, Connect, ShapeMerge, Booleans, Morph, BlobMesh, Terrain, and Loft. Booleans combine the geometry of two objects using union, intersection, and difference operations. Morphs are animated objects that change one geometric shape into other shapes over time. ShapeMerge lets you embed a spline shape into a geometric mesh. [Loft](#) on page 715 uses shapes as cross sections along a path to produce a 3D object.

**Particle Systems** Animated objects that simulate spray, snow, blizzard, and similar collections of small objects.

**Patch Grids** Simple 2D surfaces ready for modeling or repairing existing meshes.

**NURBS Surfaces** Analytically generated surfaces especially suited for modeling surfaces with complicated curves.

**AEC Extended** Elements useful for AEC design, including Terrain, Foliage (plants and trees), Railing, for creating custom railings, and Wall, for the production of Wall objects.

**Stairs** Four types of stairs: Spiral, L-Type, Straight, and U-Type.

**Doors** Parametric door styles include Pivot, BiFold, and Sliding.

**Windows** Parametric window styles include Awning, Fixed, Projected, Casement, Pivoted, and Sliding.

---

**NOTE** Default materials are automatically applied to Foliage, as well as to the following object types: Railing, Stairs, Doors, and Windows.

---

**Dynamics Objects** Objects designed for use in dynamics simulations.

## Shape Types

**Splines** Common 2D shapes such as a Line, Rectangle, Circle, Ellipse, Arc, Donut, NGon, and Star. Text shapes support TrueType fonts. Section creates a spline from the cross-section of an object. Helix is a 3D shape.

**NURBS Curves** A Point Curve and CV Curve provide the starting points for complex surfaces. See [Introduction to NURBS Modeling](#) on page 2152 .

**Extended Splines** More complex 2D shapes including Walled Rectangle, Channel Spline, Angle Spline, Tee Spline, and Wide Flange Spline. Extended splines can be used in architectural and similar applications.

## Varying the Parameters

Unlike physical building blocks, with fixed shape and size, you can change the parameters of objects and shapes to dramatically alter topology. Here are some examples of changes you can make:

- Turn a cone into a four-sided pyramid by reducing the number of sides and turning the Smooth option off.
- Slice any circular object as if it were a pie.
- Animate almost all creation parameters, and interactively change their settings during animation playback.
- Render splines directly at any assigned width.

- Break, detach, and divide wall segments.
- Change the number of risers without affecting the overall rise of the stairs.

### **Collapsing Primitives to Base Geometry**

You can collapse a building-block object to one of a variety of base geometric types once you no longer need access to its creation parameters. For example, you can convert any standard primitive to an [editable mesh](#) on page 1990 , [editable poly](#) on page 2038 , [editable patch](#) on page 1934 , or [NURBS](#) on page 2176 object, and you can convert a spline shape to an editable mesh, [editable spline](#) on page 590 , or NURBS object. The easiest way to collapse an object is to select it, right-click it, and choose a "Convert to" option from the quad menu > Transform quadrant. This lets you use explicit editing methods with the object, such as transforming vertices. You can also use the Modify panel to collapse a primitive.

### **Mapping Coordinates**

Most Geometry objects have an option for generating mapping coordinates. Objects need these mapping coordinates if you plan to apply a mapped material to them. Mapped materials include a wide range of rendered effects, from 2D bitmaps to reflections and refractions. See [Mapping Coordinates](#) on page 5183 and [Using Maps to Enhance a Material](#) on page 5178 . If mapping coordinates have already been applied to an object, the check box for this feature is turned on.

## **Creating an Object**

With some variations, the steps shown in the following images apply to creating any type of object on the Create panel. For specific examples, see the Procedures section in any object's topic.

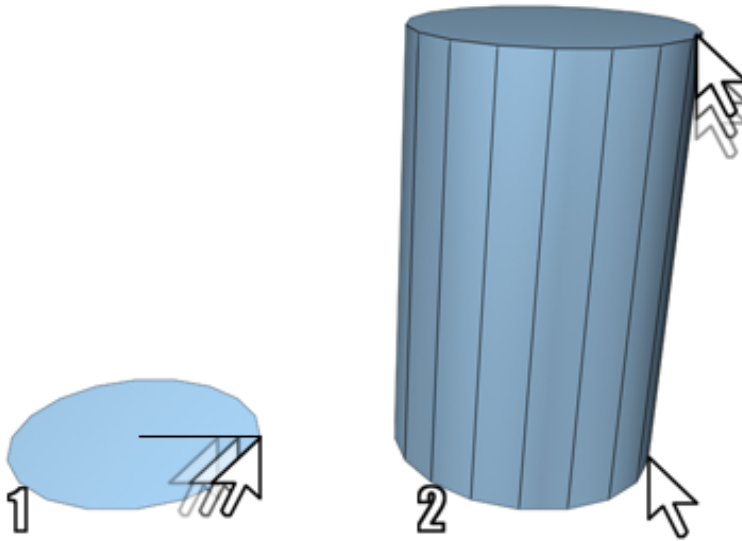

1. Radius defined
2. Height defined

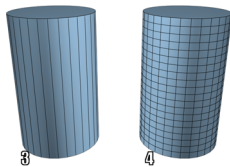

3. Sides increased
4. Height Segments increased

To choose an object category:

- 1  Click the Create tab to view the Create panel.
- 2 Click one of the buttons at the top of the Create panel. For example, Geometry.
- 3 Choose the subcategory Standard Primitives from the list.

A number of buttons appear on the Object Type rollout.

**To choose an object type:**

- Click the button for the type of object you want to create. The button highlights, showing that it is active. Four rollouts appear: Name and Color, Creation Method, Keyboard Entry, and Parameters.

**To choose a creation method (optional):**

You can accept the default method and skip this step.

- Choose a method in the Creation Method rollout.

**To preset the creation parameters (optional):**

You can adjust *all* creation parameters after you create an object. Skip this step if you prefer.

- In the Parameters rollout, you can set parameters before you create an object. However, the values of parameters you set by dragging the mouse (for example, the Radius and Height of a cylinder) have no effect until after you create the object.

**To create the object:**

- 1 Put the cursor at a point in any viewport where you want to place the object, and hold the mouse button down (do not release the button).
- 2 Drag the mouse to define the first parameter of the object; for example, the circular base of a cylinder.
- 3 Release the mouse button. The first parameter is set with this release.
- 4 Move up or down without touching the mouse button. This sets the next parameter; for example, the height of a cylinder.  
*If you want to cancel:* Until you complete the next step, you can cancel the creation process with a right-click.
- 5 Click when the second parameter has the value you want, and so on.  
The number of times you press or release the mouse button depends on how many spatial dimensions are required to define the object. (For some kinds of objects, such as Line and Bones, the number is open-ended.)

When the object is complete, it is in a selected state and ready for adjustments.

### To name the object (optional):

- Highlight the default object name in the Name and Color rollout, and then enter a name. This option is available only when a single object is selected.

Naming objects is a good practice for organizing your scenes. To name a set of selected objects, see [Named Selection Sets](#) on page 146 .

### To change the object's display color (optional):

- The color swatch next to the object name field displays the selected object's color and lets you select a new one. The color is the one used to display the object in viewports. Click the color swatch to display the [Object Color dialog](#) on page 327 .

You can also change object colors with [Layers](#) on page 7227 .

### To adjust the object's parameters:

- You can change the creation parameters immediately after you complete an object, while it's still selected. Or, you can select the object later and adjust its creation parameters on the Modify panel.

While making adjustments, you can use viewport navigation controls like Zoom, Pan, and Arc Rotate to change your view of the selected object. You can also adjust the time slider.

### To end the creation process:

While the object type button remains active, you can continue creating objects of the same type until you do one of the following:

- 1 Select an object other than the one you created most recently.
- 2 Transform an object.
- 3 Change to another command panel.
- 4 Use commands other than viewport navigation or the time slider.

After you end the creation process, changing parameters on the Create panel will have no effect on the object; you must go to the Modify panel to adjust the object's parameters. See [Using the Modify Panel](#) on page 1016 .



# Assigning Colors to Objects

3ds Max is a [truecolor](#) on page 7960 program. When you pick a color in the program, you are specifying 24 bits of color data, which provide a range of over 16 million colors.

Object wireframe colors are used primarily as an organizational tool. Object naming strategies, named selection sets, and object wireframe color strategies provide a rich set of tools for organizing even the most complex scenes.

You can use two dialogs to specify colors:

- The [Object Color dialog](#) on page 327 contains two preset palettes of colors that you use to set an object's wireframe color. This is also the surface color you see in a rendered viewport. The two color palettes are Default palette and AutoCAD ACI palette.
- The [Color Selector](#) on page 331 is a generic dialog that you use to define any color in the 24-bit color range. For the purpose of defining colors to assign to objects, it is available only through the Default palette.

The Layers functionality lets you organize your scene and can also be used for assigning object colors. For more information, see [Layer Manager](#) on page 7227 .

## Object Color Dialog

Click the color swatch by the object's name in any command panel.

The Object Color dialog contains two preset palettes of colors that you use to set an object's wireframe color. This is also the surface color you see in a shaded viewport.

### Using Random Color Assignment

By default, 3ds Max assigns colors randomly as objects are created. The colors are chosen from the current palette in the Object Color dialog. If you turn on Customize > Preferences > [General panel](#) on page 7536 > Default to By Layer for New Nodes, new objects are assigned the color set by the layer.

For individual objects, you can click the By Layer/By Object button on the Object Color dialog to change the method used to set the object color.

## Defining Custom Colors

When using the 3ds Max palette, the Object Color dialog contains a palette of 16 custom color swatches. You can define any color for each of the 16 color swatches by selecting a swatch from the Custom Colors group, then clicking Add Custom Colors.

## Switching Between Palettes

You can alternate between two versions of the Object Color dialog at any time by clicking the appropriate Basic Colors toggle:

- **3ds Max palette:** Contains a fixed palette of 64 colors, plus a custom palette of 16 user-defined custom colors.  
Use this version when you want to work with a smaller palette of colors or when you want to define custom object wireframe colors.
- **AutoCAD-compatible version:** Contains a fixed palette of 256 colors matching the colors in the AutoCAD Color Index (ACI).  
Use this version when you want to assign object colors that match the AutoCAD Color Index. Using ACI colors is useful if you plan to export objects to AutoCAD and want to organize them by object color, or when you want a wide selection of colors to choose from.

## Procedures

### To set object color:

This is the general procedure for selecting object color.

- 1 Select one or more objects.
- 2 On any command panel, click the color swatch to the right of the Object Name field to display the Object Color dialog.
- 3 On the Object Color dialog, click the By Layer / By Object toggle to set it to By Object.
- 4 Click a color swatch from the palette, and then click OK to apply the color to the selection.

### To create objects of the same color:

- Choose the color you want to use and turn off Assign Random Colors.  
Newly created objects appear in this color until you change the setting.

### To define a custom color:

- 1 With the 3ds Max palette option active, click one of the 16 custom color swatches.
- 2 Click Add Custom Colors to display the [Color Selector](#) on page 331 .
- 3 Define a custom color and click Add Color.  
The custom color is stored in the selected color swatch of the Object Color dialog and is set as the current color.

### To copy a custom color from an object in your scene to one of your custom color swatches:

- Drag the Active Color swatch up to one of the custom color swatches. The Active Color swatch is in the Object Color dialog, to the left of the OK button.

### To select objects by color:

-  Click Select By Color. This displays the [Select Objects dialog](#) on page 168 . All objects that have the same color as the current object are highlighted in the list. Click Select.

## Interface

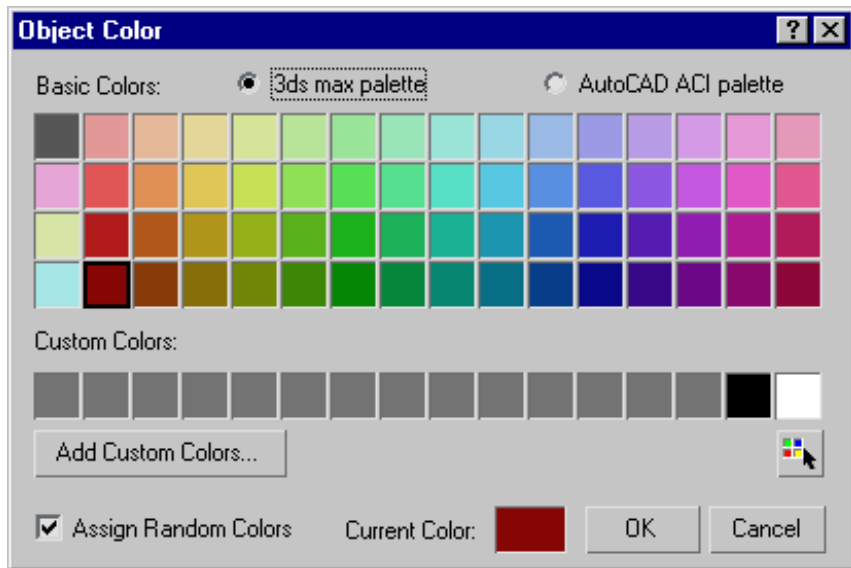

**Palette** Choose one of these:

- **3ds Max palette** When chosen, the dialog displays Basic Colors and Custom Colors groups, and you have the option to add custom colors.
- **AutoCAD ACI palette** When chosen, the AutoCAD ACI palette is shown. When you click a color, its ACI# is displayed at the bottom of the dialog.

**Basic Colors** A set of 64 default colors, available only when 3ds Max Palette is active.

**Custom Colors** Displays 16 custom colors when 3ds Max Palette is active. To choose a custom color, click its swatch. To define or change a custom color, click its swatch and then click Add Custom Colors.

**Add Custom Colors** Available only when 3ds Max Palette is active. Clicking this option displays the [Color Selector](#) on page 331, which allows you to modify the currently selected custom color. If you click Add Custom Colors with a basic color chosen, the dialog switches to the first custom color before opening the Color Selector.

**By Layer/By Object** Sets the object's color by layer or by object. If color is set by object, choosing a new color on the Object Color dialog changes the object's wireframe color in viewports.

**ACI#** Displays the ACI number for the selected color. Available only when AutoCAD ACI palette is active.



**Select by Color** Opens the [Select Objects dialog](#) on page 168 listing all objects that use the current color as their wireframe color.

---

**NOTE** This button is available only if at least one object in the scene has the Current Color as its wireframe color.

---

**Assign Random Colors** When on, 3ds Max will assign a random color to each object created. When off, 3ds Max will assign the same color to every object created until the color swatch is changed. This setting affects wireframe colors only when By Object is turned on as the color method.

**Active/Current Color** Displays the active color (if no object is selected) or current color. When you click the color swatch, the [Color Selector dialog](#) on page 331 opens, where you can mix a custom color.

## Color Selector Dialog

Any command panel > Name and Color fields > Click color swatch. > Object Color dialog > Add Custom Colors button or Current Color swatch.

Material Editor > Click any color swatch.

Select or add a light object. > Modify panel > Intensity/Color/(Distribution/Attenuation) rollout > Click color or Filter Color swatch.

Rendering menu > Environment > Environment and Effects dialog > Click color swatch for Background, Tint, and Ambient components of Global Lighting, and various components of atmospheric effects such as Fire, Fog, and so on..

The Color Selector dialog lets you specify a custom color parameter in 3ds Max. You can work simultaneously with three different color models to help you zero in on the exact color you want.

You can use the Color Selector to specify many color parameters, such as light colors, material colors, background colors, and custom object colors. (Another way to choose an object's viewport color is to use the predefined colors in the [Object Color dialog](#) on page 327 .)

In most contexts, the Color Selector is [modeless](#) on page 7849 ; that is, it remains on the screen until you dismiss it, and you can use other controls or work in

a viewport while the dialog is still visible. In other contexts, the Color Selector is modal, and you must close the dialog before proceeding.

The dialog is divided into three different color selection models. You can use the controls for any model to define a color. The three color models are:

- Hue/Blackness/Whiteness (HBW)

The most prominently displayed and intuitive color model is the HBW model. This model represents a natural, pigment-based way of mixing color by starting with a pure color (hue) and then making it darker by adding black, or lighter by adding white.

The main feature of the HBW model is a large square box displaying the color spectrum. Across the top of this box you have the spectrum of pure colors, or hue. Down the side of the box you see increasing levels of blackness, making the color dark as you approach the bottom.

To the right of the color spectrum box is the Whiteness box, which controls the amount of white in the color. Use higher positions to decrease the whiteness, or lower positions to increase the whiteness.

- Red/Blue/Green (RGB)

The RGB model adjusts the mix of Red, Green, and Blue to define a color. This model represents the way colored light can be mixed. This is additive color mixing, as opposed to the subtractive color mixing for paint and other pigments. You can adjust values using the color sliders, the numeric fields to their right (via the keyboard), or the spinners to the right of the numeric fields.

- Hue/Saturation/Value (HSV)

The HSV color model adjusts Hue, Saturation, and Value. Hue sets the color; Saturation (labeled "Sat") sets the color's purity; and Value sets the color's brightness, or intensity. You can adjust values using the color sliders, the numeric fields to their right (via the keyboard), or the spinners to the right of the numeric fields.

As you adjust the controls of one color model, the controls of the other two models change to match. The color defined by the color model is displayed in the right half of the Color Output box. The original color, before you began making changes, is displayed in the left half.

## Procedures

### To display the Color Selector:

- 1 Click the color swatch of a color parameter such as the color of a light or of a material component.

---

**NOTE** The object color displayed next to an object's name on command panels uses the [Object Color dialog](#) on page 327 . On the Object Color dialog, clicking the Active (or Current) Color swatch or the Add Custom Colors button displays a Color Selector.

---

- 2 Make a color selection and click OK or Cancel, or the Close button (X).  
If using the Add Color version of the Color Selector, be sure to click Add Color first.
- 3 To revert to the original color, click Reset.

### To choose the hue of a color, do one of the following:

- 1 Click anywhere in the Hue rainbow (the large, multicolored square).
- 2 Drag the Hue slider at the top of the rainbow.
- 3 Drag the Red, Green, and Blue sliders.
- 4 Drag the Hue slider.
- 5 Use the Red, Green, Blue, or Hue spinners.

### To make a color lighter, do one of the following:

- 1 Drag the vertical Whiteness slider (at the right of the Hue rainbow) downward.
- 2 Drag the vertical Blackness slider (at the left of the Hue rainbow) upward.
- 3 Drag the Saturation (Sat.) slider to the left.
- 4 Use the Saturation spinner to decrease saturation.
- 5 Drag the Value slider to the right.
- 6 Use the Value spinner to increase the value.

**To make a color darker, do one of the following:**

- 1 Drag the vertical Whiteness slider (at the right of the Hue rainbow) upward.
- 2 Drag the vertical Blackness slider (at the left of the Hue rainbow) downward.
- 3 Drag the Saturation (Sat.) slider to the right.
- 4 Use the Saturation spinner to increase saturation.
- 5 Drag the Value slider to the left.
- 6 Use the Value spinner to decrease the value.

**To return to the original color:**

- Click Reset.  
The new color is replaced by the original color, and all parameter values are reset.

**To dismiss the Color Selector, do one of the following:**

- 1 Click Close.
- 2 Click OK or Cancel.
- 3 Click the dialog's Close (X) button.

## Interface

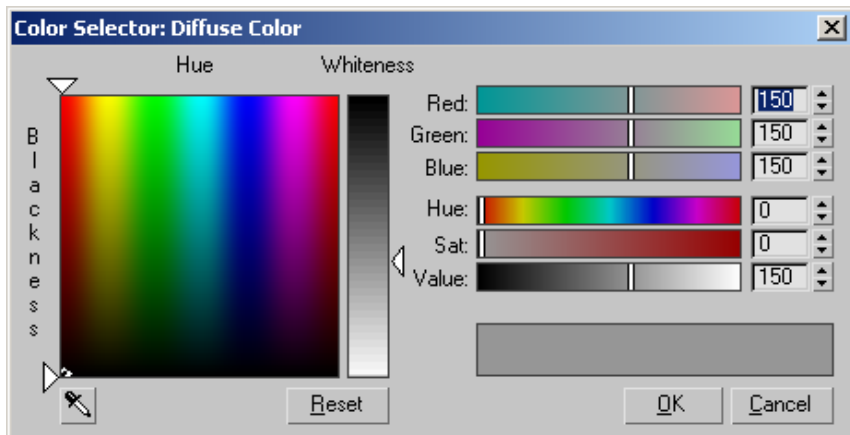



**Hue** Define a pure color by dragging the hue pointer across the top of the box.

**Blackness** Drag the blackness pointer down the side to darken the pure color by adding black. You can also click or drag inside the box to change hue and blackness at the same time.

**Whiteness** The vertical bar to the right controls the amount of whiteness. The color set by the hue and blackness pointers is displayed at the top of the bar and pure white at the bottom. Drag the whiteness pointer down to lighten the color by adding white.

**Red, Green, and Blue** When a red, green, or blue slider is all the way to the left, its numeric field contains 0; none of the color controlled by that slider is used. If the slider is all the way to the right, the field reads 255; the maximum amount of that color is being used.

The spinners to the right of each slider are another way of setting the red, blue, or green component.

The colors in the sliders change to show an approximation of what the color result will be if you move the slider to that location, without adjusting any other color parameter.

**Hue** Sets the pure color. Locating the slider all the way to the left gives you pure red. As you drag the slider to the right you move through the spectrum of Red, Yellow, Green, Cyan, Blue, Magenta, and back to Red again. Hue is more accurately represented as a color wheel rather than a linear slider. That is why the Hue slider is red at both ends. Think of the hue range from 0 to 255 as being points on a circle where the numbers 0 and 255 are right next to each other.

**Saturation ("Sat")** Sets the purity or strength of the color. A weak color, with a saturation near 0, is dull and gray. A strong color, with a saturation near 255 is very bright and pure.

**Value** Sets the lightness or darkness of a color. Low values darken the color toward black. High values lighten the color toward white. A value in the middle, at a setting of 127, gives you the color defined only by hue and saturation.

**Color Output** This pair of color swatches, below the Value slider, lets you compare the new color, shown on the right, to the original color, shown on the left.



**Sample Screen Color** Lets you pick a new color from anywhere on the screen. After clicking this button, the mouse cursor changes to the eyedropper icon shown on the button. While this cursor appears, use any of these methods:

- Click anywhere on the screen to replace the current color with the color of the pixel under the lower-right corner of the cursor.
- Drag to continually update the current color with the color of the pixel under the lower-right corner of the cursor. This makes it easier to make sure you get the right color if the desired color area is small (say, a one-pixel-thick line).
- At any time, press and hold Shift to *average* the current color with colors the cursor moves over. Instead of replacing the current color with the new sampled color, smoothed sampling gradually mixes the sampled color with the current color, giving a smoothed color transition during sampling. This is useful for sampling noisy areas, where the variations in colors are accumulated to provide a representative general color.

Unlike the other methods, releasing the left mouse button only does not exit the sampler mode; you can move the mouse elsewhere (without sampling) and then start dragging again to continue smoothed sampling in other areas. Releasing Shift only returns to regular sampling. Releasing both Shift and the left mouse button exits the sampler mode, returning the mouse cursor and behavior to normal.

Sampling can occur under any conditions anywhere within any windows that belong to the current instance of 3ds Max. To sample anywhere outside of 3ds Max (for example, the desktop), drag the mouse from within one of these 3ds Max windows.

The color sampler tool compensates for any gamma applied to the color selector using the Customize > Preferences > [Gamma And LUT](#) on page 7550 > Affect Color Selectors option. This means that the color-corrected, displayed sampled visual color in the color selector always matches the on-screen visual color of the sampled location. If the gamma of the color selector does not match the gamma of the sampled location, the true color values (RGB/HSV) of the sampled color will differ from the true color values of the sampled location. This behavior applies to both regular gamma and Autodesk LUT gamma correction modes.

**Reset** Click to restore color settings to the original color.

**OK** Accepts any changes and closes the dialog.

---

**NOTE** If you opened the dialog by clicking Add Custom Colors on the Object Color dialog, the button label reads “Add Color.”

---

**Cancel** Restores the original color and closes the dialog.

## Color Selector for mental ray Materials and Shaders

When you click a color swatch in the interface for a [mental ray material](#) on page 5448 or [mental ray shader](#) on page 5801 , or a [DirectX material](#) on page 5596 , you see a variant of the Color Selector.

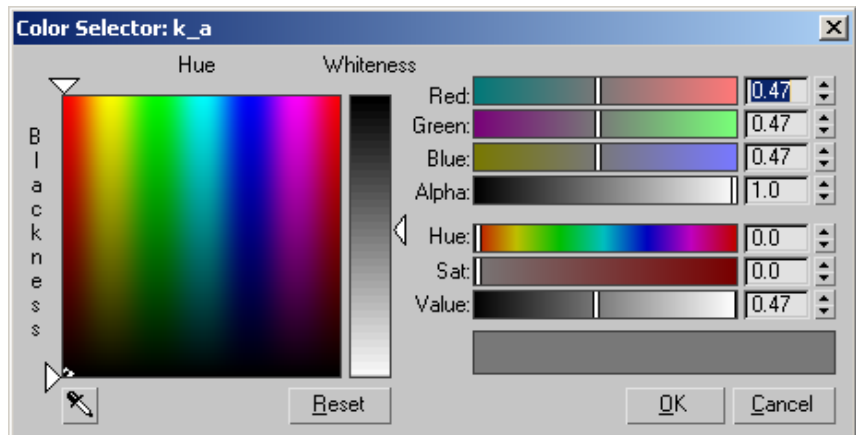

This dialog differs from the standard Color Selector in two ways:

- The RGB and HSV values appear as normalized values between 0.0 and 1.0, rather than as 8-bit integers (0–255).
- An additional Alpha slider and spinner let you explicitly set the alpha value for this color. This value is also normalized, where 0.0 represents fully transparent, and 1.0 represents fully opaque.

This version of the Color Selector also appears when you use the [DirectX 9 Shader material](#) on page 5596 and the mental ray renderer's [Sampling Quality rollout](#) on page 6083 .

## Color Clipboard Utility

Tools menu > Color Clipboard

Utilities panel > Utilities rollout > More button > Utilities dialog > Color Clipboard button

The Color Clipboard utility stores color swatches for copying from one map or material to another.

For example, if in the Material Editor, you want to copy a color from a swatch in one level of a material to a swatch in another level (or from another material), there would be no way to do it with drag and drop. This is because you can't have two materials/maps visible at the same time. However, you can drag the color from one material to the color clipboard, switch to the other material, and then drag the color from the clipboard to the swatch in the new material.

You can save and load color clipboard files. The saved file, which is given a *.ccb* (color clip board) extension, is an ASCII file that contains a palette description. The first 12 lines of the file consist of three RGB numbers, so you can easily edit or create your own clipboard files. This file format is also used by the [VertexPaint modifier](#) on page 1876 .

## **Procedures**

### **To copy a color from a swatch to the color clipboard:**

- 1 On the Utilities panel, click Color Clipboard.
- 2 Open the Material Editor.
- 3 Select a color from any swatch in a material.
- 4 Drag the color to a swatch in the color clipboard.
- 5 A dialog appears asking if you want to copy or swap the material. Choose copy to replace the swatch in the color clipboard with the swatch from the material you selected. Choose swap to swap colors on the Color Clipboard swatch and material swatch.

## Interface

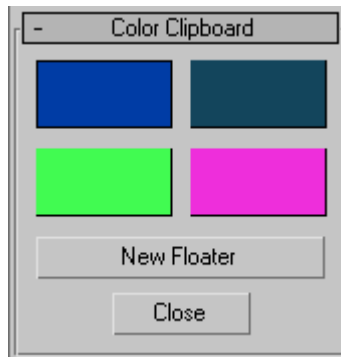

**Color swatches** Click a color swatch to edit its value with the Color Selector.

---

**NOTE** The Color Selector invoked by this utility uses decimal numbers in the range 0.0 to 1.0, instead of integers in the range 0 to 255 as with other color-selection dialogs in 3ds Max.

---

**New Floater** Displays a floating clipboard with 12 slots, plus buttons for opening and saving color clipboard files. You can open up as many of these floaters as you want and you can minimize them. If you exit the Utilities panel or select the Close button to exit the Color Clipboard utility, any visible floaters remain open. When you close a floater, any changed values are lost.



**Close** Exits the Clipboard utility.

## Adjusting Normals and Smoothing

In general, you adjust normals and smoothing to prepare objects for rendering.

A [normal](#) on page 7863 is a unit vector that defines which way a face or vertex is pointing. The direction in which the normal points represents the front, or outer surface of the face or vertex, which is the side of the surface that is normally displayed and rendered.

You can manually flip or unify *face* normals to fix surface errors caused by modeling operations or by importing meshes from other programs.

*Smoothing groups* define whether a surface is rendered with sharp edges or smooth surfaces. Smoothing groups are numbers assigned to the faces of an object. Each face can carry any number of smoothing groups up to the maximum of 32. If two faces share an edge and share the same smoothing group, they render as a smooth surface. If they don't share the same smoothing group, the edge between them renders as a corner. You can change and animate smoothing group assignments manually. Changing smoothing groups does not alter geometry in any way; it simply changes the way faces and edges are shaded.

**See also:**

- [Viewing and Changing Normals](#) on page 340
- [Viewing and Changing Smoothing](#) on page 343

## Viewing and Changing Normals

When you create an object, [normals](#) on page 7863 are generated automatically. Usually objects render correctly using these default normals. Sometimes, however, you need to adjust the normals.

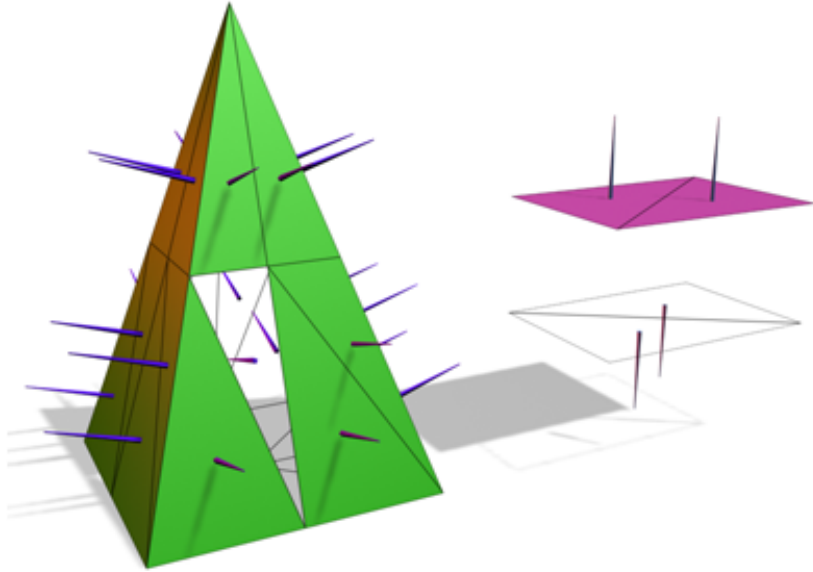

**Left:** The normals shown as spikes indicate the orientation of faces on the pyramid.

**Right:** Flipping normals can make faces invisible (or visible) in shaded viewports and renderings.

Undesired normals can appear in these objects:

- Meshes imported from other applications.
- Geometry generated by complex operations such as Boolean objects, lathe objects, or lofts.

Normals are used to define which side of a face or vertex is considered the "out" side. The out side of a face or vertex is the side that gets rendered unless you are using two-sided materials, or turn on the Force 2-Sided option in the Render Scene dialog > Common panel > [Common Parameters rollout](#) on page 5929 .

Do one of the following to view or change *face normals*:

- Apply a [Normal modifier](#) on page 1509 . If a Face sub-object selection is active, Normal applies to the selected faces. If no faces are selected, Normal applies to the entire object.

- Apply an [Edit Mesh modifier](#) on page 1283 , enable Face, Polygon or Element sub-object mode, and then use the features on the Surface Properties rollout to change the directions in which normals point.
- Convert the object to an [editable mesh](#) on page 1990 , enable Face, Polygon or Element sub-object mode, and use the features on the Surface Properties rollout

## Viewing Normals

The easiest way to view normals is to look at an object in a shaded viewport. In this case, you are not viewing the normal arrows themselves, but rather their effects on the shaded surface. If the object looks as if it is inside-out, or has holes, then some of the normals might be pointing in the wrong direction.

You can display the normal vectors for selected faces or vertices by enabling Show Normals on the Selection rollout of an editable mesh object or the Edit Mesh modifier.

## Unifying Normals

Use Unify Normals to make normals point in a consistent direction. If an object has normals that are inconsistent (some point outward and others inward) the object will appear to have holes in its surface.

Unify Normals is found on the Surface Properties rollout and on the Normal modifier.

If you are animating the creation of a complex object such as a nested Boolean or a loft, and you think the operation might result in inconsistent faces, apply a [Normal modifier](#) on page 1509 to the result, and turn on Unify Normals.

## Flipping Normals

Use Flip Normals to reverse the direction of all selected faces. Flipping the normals of an object turns it inside-out.

Flip Normals is found on the Surface Properties rollout and on the Normal modifier.

The [Lathe modifier](#) on page 1430 sometimes creates an object with normals pointing inward. Use the Flip Normals check box on the Lathe modifier's Parameters rollout to adjust the normals. You can also use the Normal modifier with both Unify and Flip turned on to fix inside-out lathed objects.



## Viewing and Changing Smoothing

Smoothing blends the shading at the edges between faces to produce the appearance of a smooth, curved surface. You can control how smoothing is applied to a surface so your objects can have both smooth surfaces and sharp, faceted edges where appropriate.

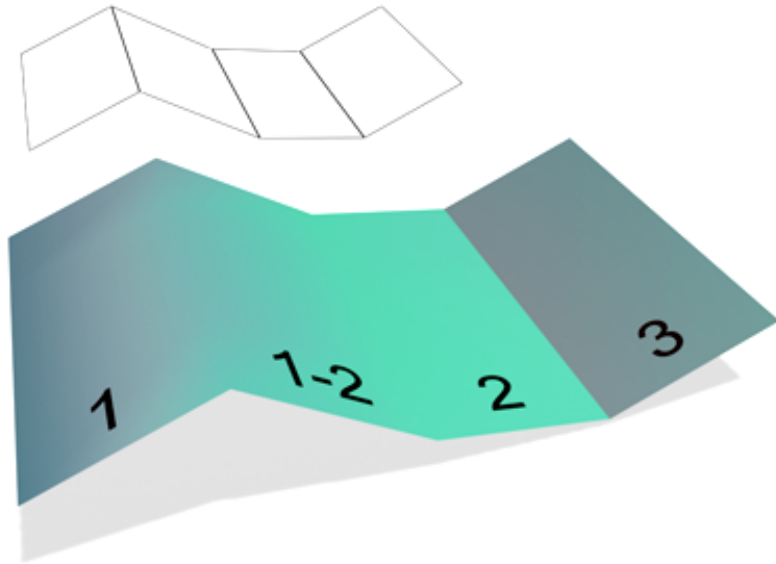

The face labeled "1-2" shares smoothing groups with adjacent faces, so the edges between them are smoothed over in renderings.

The face labeled "3" does not share a smoothing group, so its edge is visible in renderings.

Smoothing does not affect geometry. It affects only the way geometry is colored when rendered.

Smoothing is controlled by smoothing groups, which are numbered groups ranging from 1 to 32. Each face is assigned to one or more smoothing groups. When a scene is rendered, the renderer checks each adjacent pair of faces to see if they share a smoothing group, and renders the object as follows:

- If faces have no smoothing groups in common, the faces are rendered with a sharp edge between them.

- If faces have at least one smoothing group in common, the edge between the faces is “smoothed”, meaning it is shaded in such a way that the area where the faces meet appears smooth.

Because each face has three edges, only three smoothing groups can be in effect for any face. Extra smoothing groups assigned to a face are ignored.

Do one of the following to view or change smoothing group assignments:

- Turn on the Smooth check box on the Parameters rollout of a parametric object to set default smoothing for the object.
- Turn on the Auto Smooth check box on the Rendering rollout of a spline shape to turn on smoothing.
- Apply a [Smooth modifier](#) on page 1665 . If a Face sub-object selection is active, Smooth applies to the selected faces. If no faces are selected, Smooth applies to the entire object.
- Apply an [Edit Mesh modifier](#) on page 1283 , enable Face (or Polygon or Element) sub-object mode, then use the features on the Surface Properties rollout.
- Convert the object to an [editable mesh](#) on page 1990 , enable Face (or Polygon or Element) sub-object mode, then use the features on the Surface Properties rollout.

## Viewing Smoothing Groups

The easiest way to view smoothing is to look at an object in a shaded viewport. In this case, you are not viewing the smoothing groups themselves but rather their effects on the shaded surface.

You can see the smoothing group numbers for selected faces of an editable mesh object or the Edit Mesh modifier by looking at the Smoothing Group buttons on the Surface Properties rollout, or of an editable poly object on the Polygon Properties rollout.

Smoothing Group buttons appear as follows:

- Group numbers not used by any face in the selection, appear normal.
- Group numbers used by all faces in the selection, appear selected.
- Group numbers used by some, but not all, faces in the selection, appear blank.

## Automatically Smoothing an Object

Click Auto Smooth to assign smoothing automatically. You set a Threshold angle to determine whether to smooth adjacent faces.

- If the angle between face normals is less than or equal to the threshold, the faces are assigned to a common smoothing group.
- If the angle between face normals is greater than the threshold, the faces are assigned to separate groups.

Auto Smooth is found on the Surface Properties rollout and on the Smooth modifier.

## Manually Applying Smoothing Groups

You manually assign smoothing groups to a selection of faces by clicking Smoothing Group buttons on the Surface Properties rollout or the Smooth modifier. The smoothing group of each button you click is assigned to the selection.

## Selecting Faces by Smoothing Group

You can also select faces according to the assigned smoothing groups. Click Select By SG on the Surface Properties rollout (editable mesh) or Polygon Properties rollout (editable poly) and then click the smoothing group of the faces to select.

This is a convenient way to examine smoothing groups on an object someone else created.

# Geometric Primitives

Geometric primitives are basic shapes that 3ds Max provides as [parametric objects](#) on page 7884 . Primitives are divided into two categories:

[Standard Primitives](#) on page 348

[Extended Primitives](#) on page 383

**See also:**

- [Basics of Creating and Modifying Objects](#) on page 317

- [Creating an Object](#) on page 323
- [Creating Primitives from the Keyboard](#) on page 346

## Creating Primitives from the Keyboard

Create panel > Geometry > Standard or Extended Primitives > Keyboard Entry rollout

You can create most geometric primitives from your keyboard using the Keyboard Entry rollout. In a single operation, you define both the initial size of an object and its three-dimensional position. The software automatically assigns the object's name and color. See [Object Name and Wireframe Color](#) on page 7423 .

This method is generally the same for all primitives; differences occur in the type and number of parameters. The Hedra primitive, a complex and highly visual family of objects, is unsuited to this method and has no keyboard entry.

### Procedures

**To open the Keyboard Entry rollout:**

- 1 On the Create panel for Standard or Extended Primitives, click any of the primitive Object Type rollout buttons, except Hedra or RingWave.
- 2 Click the Keyboard Entry rollout to open it. This rollout is closed by default.

---

**NOTE** The buttons on the Creation Method rollout have no effect on keyboard entry.

---

**To create a primitive from the keyboard:**

- 1 On the Keyboard Entry rollout, select a numeric field with the mouse and then enter a number.
- 2 Press **Tab** to move to the next field. You do not have to press **Enter** after entering a value. Press **Shift+Tab** to reverse direction.
- 3 When you have all fields set, press **Tab** to move the focus to the Create button. Press **Enter**.
- 4 The object appears in the active viewport.

Once created, a new primitive is unaffected by the numeric fields in the Keyboard Entry rollout. You can adjust parameter values on the Parameters rollout, either immediately after creation or on the Modify panel.

### Interface

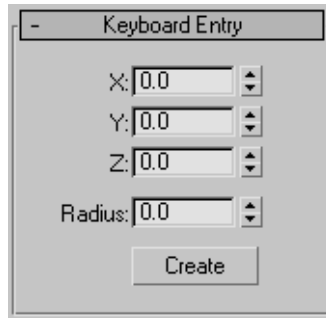

The Keyboard Entry rollout contains a common set of position fields, labeled X, Y, and Z. The numbers you enter are offsets along the axes of the active construction plane; either the home grid or a grid object. Plus and minus values correspond to positive and negative directions for these axes. Defaults=0,0,0; the center of the active grid.

The location set by X,Y is equivalent to the first mouse-down position in the standard method of creating objects.

Each standard primitive has the following parameters on its Keyboard Entry rollout.

Primitive	Parameters	XYZ point
Box	Length, Width, Height	Center of base
Cone	Radius 1, Radius 2, Height	Center of base
Sphere	Radius	Center
GeoSphere	Radius	Center
Cylinder	Radius, Height	Center of base
Tube	Radius 1, Radius 2, Height	Center of base

Primitive	Parameters	XYZ point
Torus	Radius 1, Radius 2	Center
Pyramid	Width, Depth, Height	Center of base
Teapot	Radius	Center of base
Plane	Length, Width	Center

## Standard Primitives

Geometric primitives are familiar as objects in the real world such as beach balls, pipes, boxes, doughnuts, and ice cream cones. In 3ds Max, you can model many such objects using a single primitive. You can also combine primitives into more complex objects, and further refine them with modifiers.

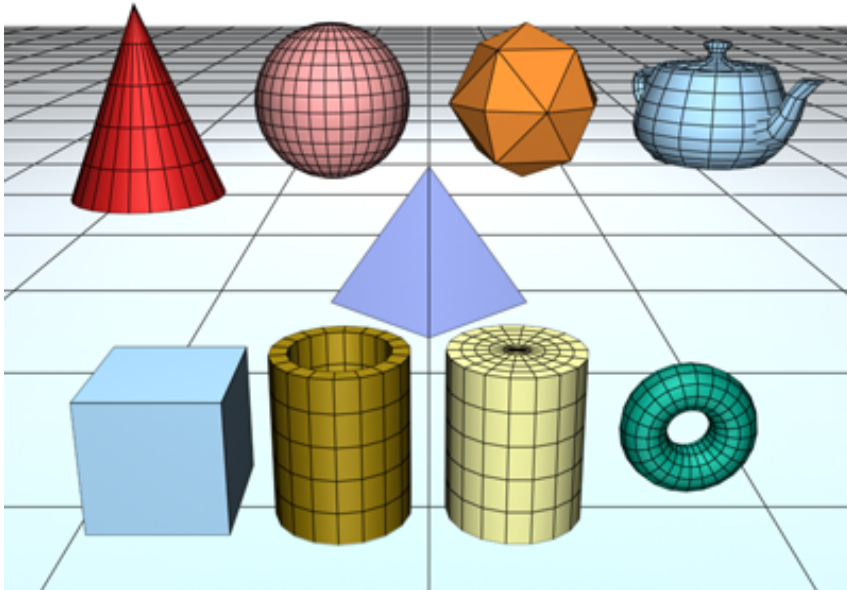

A collection of standard primitive objects

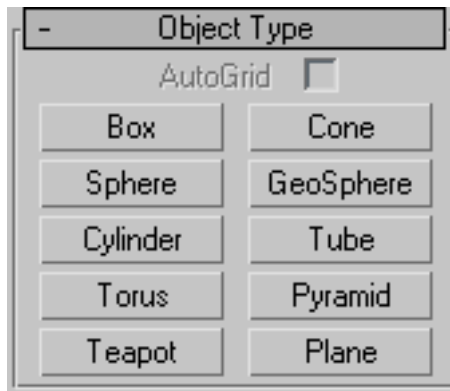

3ds Max includes a set of 10 basic primitives. You can easily create the primitives with the mouse in the viewport, and most can be generated from the keyboard as well.

These primitives are listed in the Object Type rollout and on the Create menu:

[Box Primitive](#) on page 350

[Cone Primitive](#) on page 353

[Sphere Primitive](#) on page 356

[GeoSphere Primitive](#) on page 361

[Cylinder Primitive](#) on page 364

[Tube Primitive](#) on page 367

[Torus Primitive](#) on page 370

[Pyramid Primitive](#) on page 374

[Teapot Primitive](#) on page 377

[Plane Primitive](#) on page 380

Also available from the Object Type rollout is the [AutoGrid option](#) on page 2513 .

You can convert standard primitive objects to [editable mesh objects](#) on page 1990 , [editable poly objects](#) on page 2038 , and [NURBS surfaces](#) on page 2218 You can also convert primitives to patch objects; see the path annotation at [Editable Patch](#) on page 1934 (the information at the start of the topic that tells you how to create this type of object).

All primitives have name and color controls, and allow you to enter initial values from the keyboard. See these topics:

[Object Name and Wireframe Color](#) on page 7423

[Creating Primitives from the Keyboard](#) on page 346

The remaining rollouts are covered in the topic for each primitive.

## Box Primitive

Create panel > Geometry button > Standard Primitives > Object Type rollout > Box button

Create menu > Standard Primitives > Box

Box produces the simplest of the primitives. Cube is the only variation of Box. However, you can vary the scale and proportion to make many different kinds of rectangular objects, from large, flat panels and slabs to tall columns and small blocks.

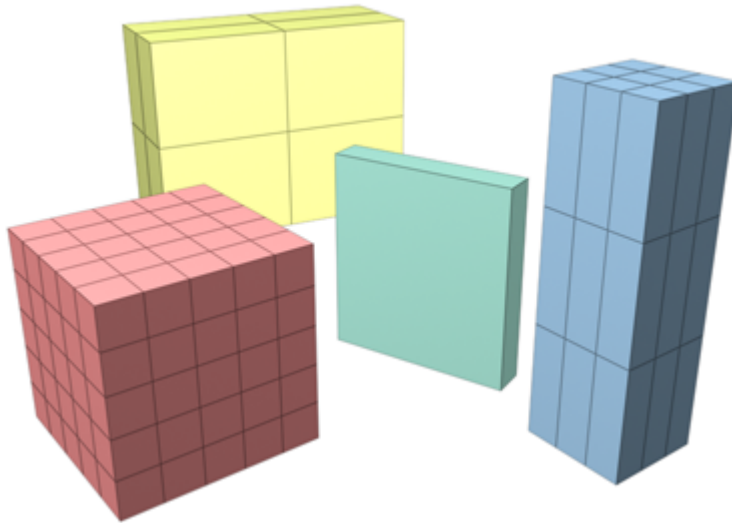

Examples of boxes



## Procedures

### To create a box:

- 1 On the Object Type rollout, click Box.
- 2 In any viewport, drag to define a rectangular base, then release to set length and width.
- 3 Move the mouse up or down to define the height.
- 4 Click to set the finished height and create the box.

### To create a box with a square base:

- Hold down Ctrl as you drag the base of the box. This keeps length and width the same. Holding the Ctrl key has no effect on height.

### To create a cube:

- 1 On the Creation Method rollout, choose Cube.
- 2 In any viewport, drag to define the size of the cube.
- 3 As you drag, a cube emerges with the pivot point at the center of its base.
- 4 Release to set the dimensions of all sides.

## Interface

### Creation Method rollout

**Cube** Forces length, width, and height to be equal. Creating a cube is a one-step operation. Starting at the center of the cube, drag in a viewport to set all three dimensions simultaneously. You can change a cube's individual dimensions in the Parameters rollout.

**Box** Creates a standard box primitive from one corner to the diagonally opposite corner, with different settings for length, width, and height.

## Parameters rollout

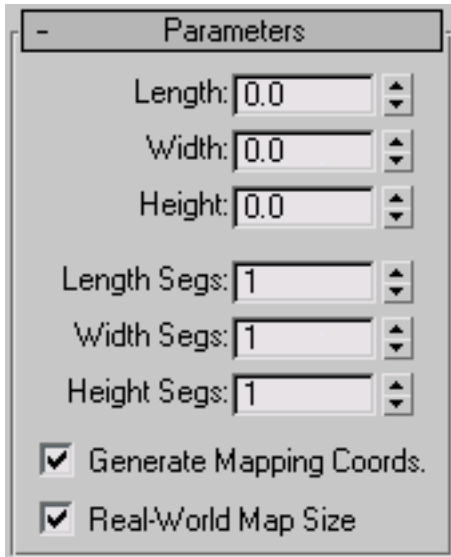

The defaults produce a box with one segment on each side.

**Length, Width, Height** Sets the length, width, and height of the Box object. These fields also act as readouts while you drag the sides of the box. Default=0,0,0.

**Length, Width, Height Segments** Sets the number of divisions along each axis of the object. Can be set before or after creation. By default, each side of the box is a single segment. When you reset these values, the new values become the default during a session. Default=1,1,1.

---

**TIP** Increase the Segments settings to give objects extra resolution for being affected by modifiers. For example, if you're going to [bend](#) on page 1139 a box on the Z axis, you might want to set its Height Segments parameter to 4 or more.

---

**Generate Mapping Coords** Generates coordinates for applying mapped materials to the box. Default=on.

**Real-World Map Size** Controls the scaling method used for texture mapped materials that are applied to the object. The scaling values are controlled by the Use Real-World Scale settings found in the applied material's [Coordinates rollout](#) on page 5620 . Default=off.

## Cone Primitive

Create panel > Geometry button > Standard Primitives > Object Type rollout > Cone button

Create menu > Standard Primitives > Cone

The Cone button on the Creation command panel lets you produce round cones, either upright or inverted.

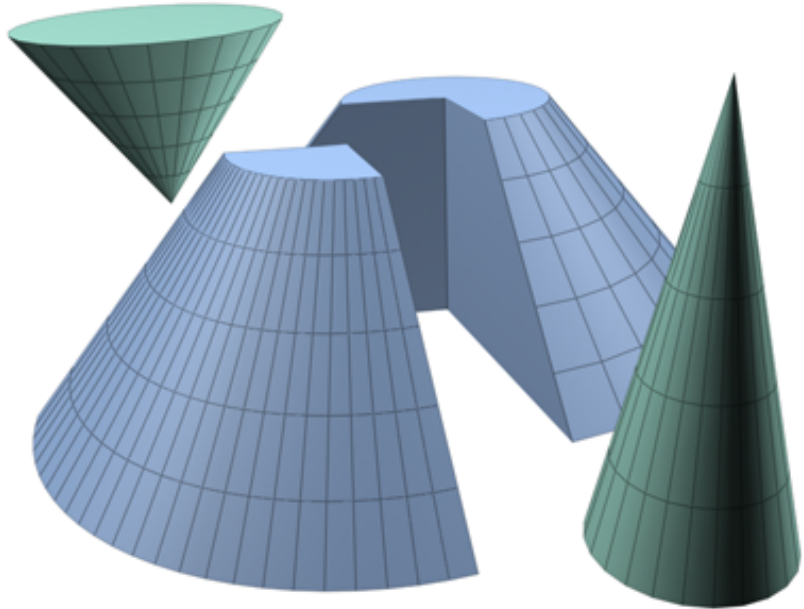

Examples of cones

### Procedures

To create a cone:

- 1 On the Create menu choose Standard Primitives > Cone.
- 2 In any viewport, drag to define a radius for the base of the cone, then release to set it.
- 3 Move to up or down to define a height, either positive or negative, then click to set it.

- 4 Move to define a radius for the other end of the cone. Decrease this radius to 0 for a pointed cone.
- 5 Click to set the second radius and create the cone.

## Interface

### Creation Method rollout

**Edge** Draws a cone from edge to edge. You can change the center location by moving the mouse.

**Center** Draws a cone from the center out.

### Parameters rollout

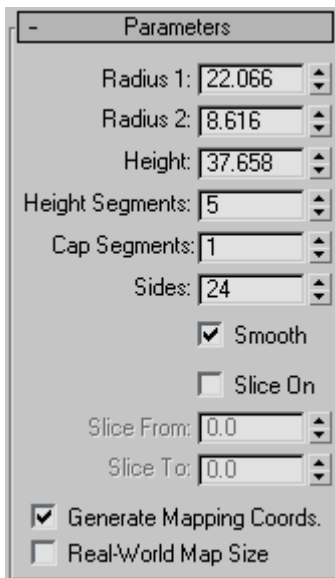

The defaults produce a smooth, round cone of 24 sides with five height segments, one cap segment, and the pivot point at the center of the base. For improved rendering of smoothly shaded cones, particularly those with pointed tips, increase the number of height segments.

**Radius 1, Radius 2** Set the first and second radii for the cone. The minimum value for both is 0.0. If you enter a negative value, the software converts it to

0.0. You can combine these settings to create pointed and flat-topped cones, upright or inverted. The following combinations assume a positive height:

Radius Combinations	Effect
Radius 2 is 0	Creates a pointed cone
Radius 1 is 0	Creates an inverted pointed cone
Radius 1 is larger than Radius 2	Creates a flat-topped cone
Radius 2 is larger than Radius 1	Creates an inverted flat-topped cone

If Radius 1 and 2 are the same, a cylinder is created. If the two radius settings are close in size, the effect is similar to applying a Taper modifier to a cylinder.



#### Effect of Radius settings

**Height** Sets dimension along the central axis. Negative values create the cone below the construction plane.

**Height Segments** Sets the number of divisions along the cone's major axis.

**Cap Segments** Sets the number of concentric divisions around the center of the cone's top and bottom.

**Sides** Sets the number of sides around the cone. Higher numbers shade and render as true circles with Smooth selected. Lower numbers create regular polygonal objects with Smooth off.

**Smooth** Blends the faces of the cone, creating a smooth appearance in rendered views.

**Slice On** Enables the Slice function. Default=off.

When you create a slice and then turn off Slice On, the complete cone reappears. You can use this check box to switch between the two topologies.

**Slice From, Slice To** Sets the number of degrees around the local Z axis from a zero point at the local X axis.

For both settings, positive values move the end of the slice counterclockwise; negative values move it clockwise. Either setting can be made first. When the ends meet, the whole cone reappears.

**Generate Mapping Coords** Generates coordinates for applying mapped materials to the cone. Default=on.

**Real-World Map Size** Controls the scaling method used for texture mapped materials that are applied to the object. The scaling values are controlled by the Use Real-World Scale settings found in the applied material's [Coordinates rollout](#) on page 5620 . Default=off .

## Sphere Primitive

Create panel > Geometry button > Standard Primitives > Object Type rollout > Sphere button

Create menu > Standard Primitives > Sphere

Sphere produces a full sphere, or a hemisphere or other portion of a sphere. You can also "slice" a sphere about its vertical axis.

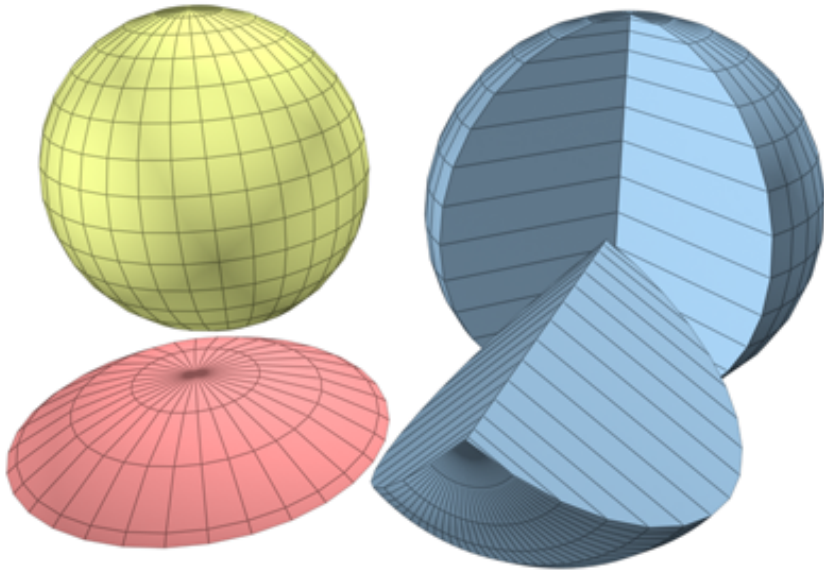

### Examples of spheres

### Procedures

#### To create a sphere:

- 1 On the Create menu choose Standard Primitives > Sphere.
- 2 In any viewport, drag to define a radius.  
As you drag, a sphere emerges with its center at the pivot point.
- 3 Release the mouse to set the radius and create the sphere.

#### To create a hemisphere:

You can reverse the order of the following steps, if you like.

- 1 Create a sphere of desired radius.
- 2 Type **0.5** in the Hemisphere field.  
The sphere is reduced to exactly the upper half, a hemisphere. If you use the spinner, the sphere changes in size.

## Interface

### Creation Method rollout

**Edge** Draws a sphere from edge to edge. You can change the center location by moving the mouse.

**Center** Draws a sphere from the center out.

### Parameters rollout

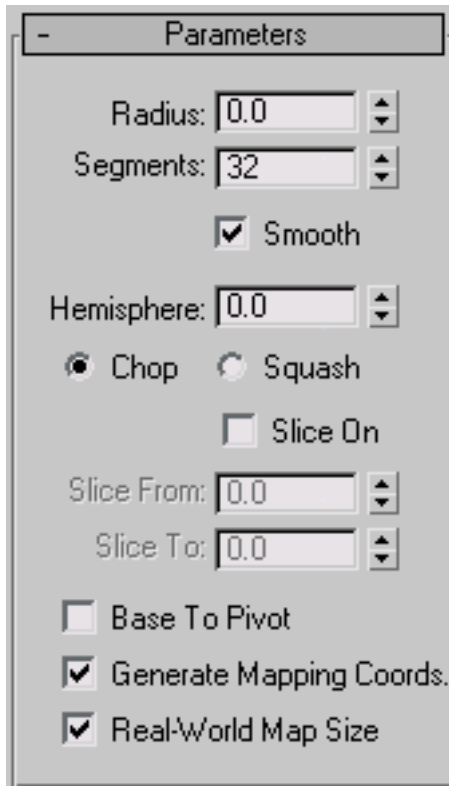

The defaults produce a smooth sphere of 32 segments with the pivot point at its center.

**Radius** Specifies the radius of the sphere.

**Segments** Sets the number of polygonal divisions for the sphere.



**Smooth** Blends the faces of the sphere, creating a smooth appearance in rendered views.

**Hemisphere** Increasing values progressively will "cut off" the sphere, starting at the base, to create a partial sphere. Values range from 0.0 to 1.0. The default is 0.0, producing a full sphere. A setting of 0.5 produces a hemisphere, and 1.0 reduces the sphere to nothing. Default=0.0.

Chop and Squash toggle creation options for Hemisphere.

**Chop** Reduces the number of vertices and faces in the sphere by "chopping" them out as the hemisphere is cut off. Default=on.

**Squash** Maintains the number of vertices and faces in the original sphere, "squashing" the geometry into a smaller and smaller volume toward the top of the sphere.



#### Effects of Chop and Squash during hemisphere creation

**Slice On** Uses the From and To angles to create a partial sphere. The effect is similar to lathing a semicircular shape fewer than 360 degrees.

**Slice From** Sets the start angle.

**Slice To** Sets the stop angle.

For both settings, positive values move the end of the slice counterclockwise; negative values move it clockwise. Either setting can be made first. When the ends meet, the whole sphere reappears.

Smoothing groups are assigned to sliced spheres as follows: The surface of the sphere is always assigned group 1; the bottom, when Smooth is on, gets group 2. Facing the pie-slice surfaces, the cut on the left gets group 3, and the cut on the right gets group 4.

Material IDs are assigned to sliced spheres as follows: The bottom is 1 (when Hemisphere is greater than 0.0), the surface is 2, and the slice surfaces are 3 and 4.

**Base To Pivot** Moves a sphere upward along its local Z axis so the pivot point is at its base. When off, the pivot point is on the construction plane at the center of the sphere. Default=off.

Turning on Base To Pivot lets you place spheres so they rest on the construction plane, like pool balls on a table. It also lets you animate a hemisphere so it appears to grow out of the construction plane or sink into it.

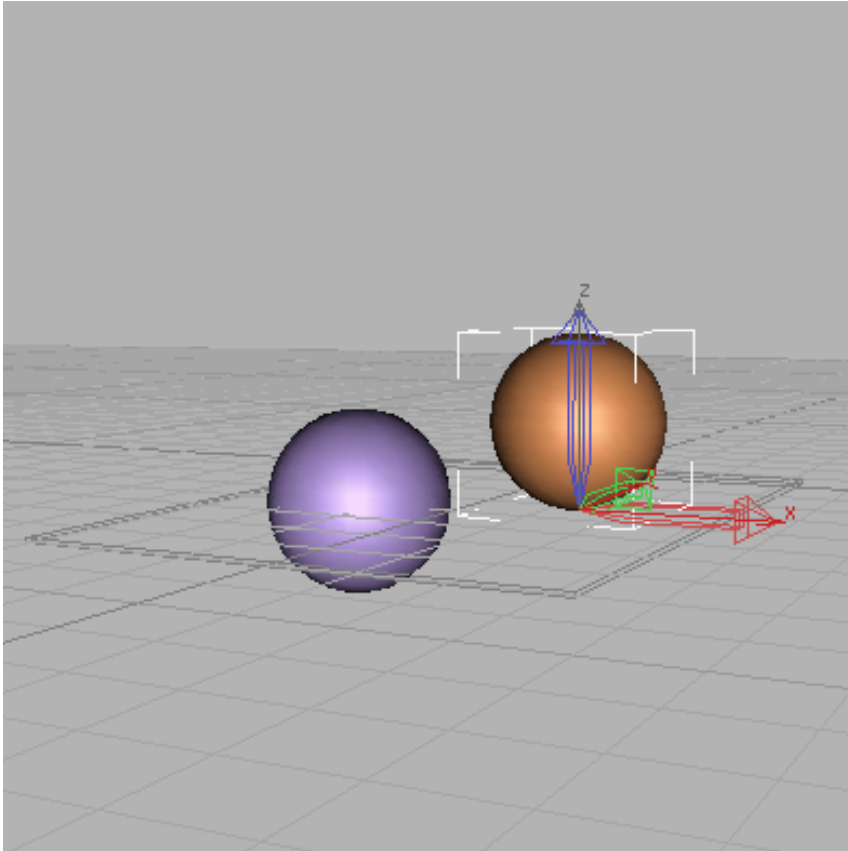

Effect of using Base To Pivot setting

**Generate Mapping Coords** Generates coordinates for applying mapped materials to the sphere. Default=on.

**Real-World Map Size** Controls the scaling method used for texture mapped materials that are applied to the object. The scaling values are controlled by

the Use Real-World Scale settings found in the applied material's [Coordinates rollout](#) on page 5620 . Default=off.

## GeoSphere Primitive

Create panel > Geometry button > Standard Primitives > Object Type rollout > GeoSphere button

Create menu > Standard Primitives > GeoSphere

Use GeoSphere to make spheres and hemispheres based on three classes of regular polyhedrons.

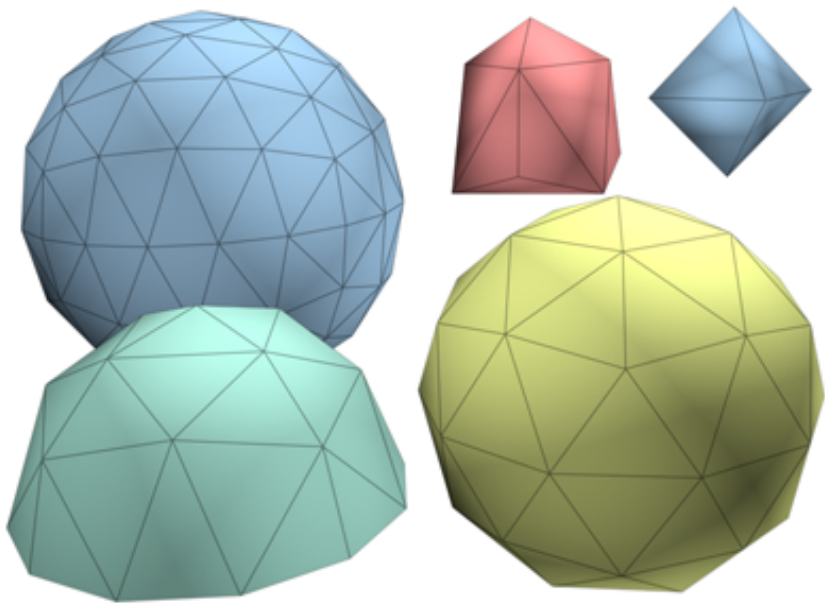

### Examples of geospheres

Geospheres produce a more regular surface than standard spheres. They also render with a slightly smoother profile than a standard sphere given the same number of faces. Unlike a standard sphere, a geosphere has no poles, which can be an advantage when you apply certain modifiers such as [Free-Form Deformation \(FFD\) modifiers](#) on page 1389 .

## Procedures

### To create a geosphere:

- 1 On the Create menu choose Standard Primitives > Geosphere.
- 2 In any viewport, drag to set the center and radius of the geosphere.
- 3 Set parameters such as Geodesic Base Type and Segments.

### To create a geo-hemisphere:

- 1 Create a geosphere.
- 2 In the Parameters rollout, turn on the Hemisphere check box. The geosphere is converted to a hemisphere.

## Interface

### Creation Method rollout

**Diameter** Draws a geosphere from edge to edge. You can change the center location by moving the mouse.

**Center** Draws a geosphere from the center out.

## Parameters rollout

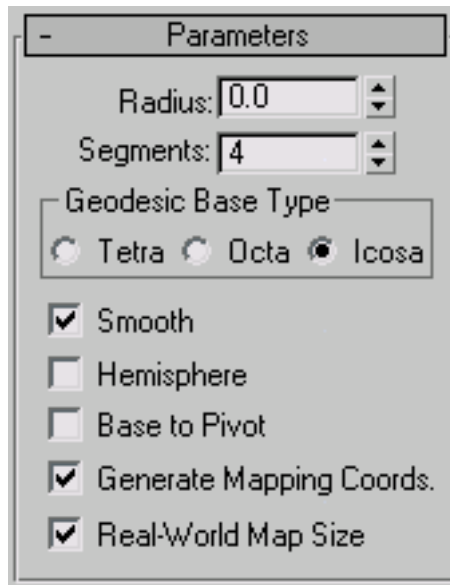

**Radius** Sets the size of the geosphere.

**Segments** Sets the total number of faces in the geosphere. The number of faces in a geosphere is equal to the sides of the base polyhedron times the segments squared.

Lower segment values work best. Using the maximum segment value of 200 can generate up to 800,000 faces, impairing performance.

### Geodesic Base Type group

Lets you choose one of three types of regular polyhedrons for the geosphere's basic geometry.

- **Tetra** Based on a four-sided tetrahedron. The triangular facets can vary in shape and size. The sphere can be divided into four equal segments.
- **Octa** Based on an eight-sided octahedron. The triangular facets can vary in shape and size. The sphere can be divided into eight equal segments.
- **Icosa** Based on a 20-sided icosahedron. The facets are all equally sized equilateral triangles. The sphere can be divided into any number of equal segments, based on multiples and divisions of 20 faces.

**Smooth** Applies smoothing groups to the surface of the sphere.

**Hemisphere** Creates a half-sphere.

**Base To Pivot** Sets the pivot point location. When on, the pivot is at the bottom of the sphere. When off, the pivot is at the center of the sphere. This option has no effect when Hemisphere is on.

**Generate Mapping Coords** Generates coordinates for applying mapped materials to the geosphere. Default=on.

**Real-World Map Size** Controls the scaling method used for texture mapped materials that are applied to the object. The scaling values are controlled by the Use Real-World Scale settings found in the applied material's [Coordinates rollout](#) on page 5620 . Default=off.

## Cylinder Primitive

Create panel > Geometry button > Standard Primitives > Object Type rollout > Cylinder button

Create menu > Standard Primitives > Cylinder

Cylinder produces a cylinder, which you can "slice" around its major axis.

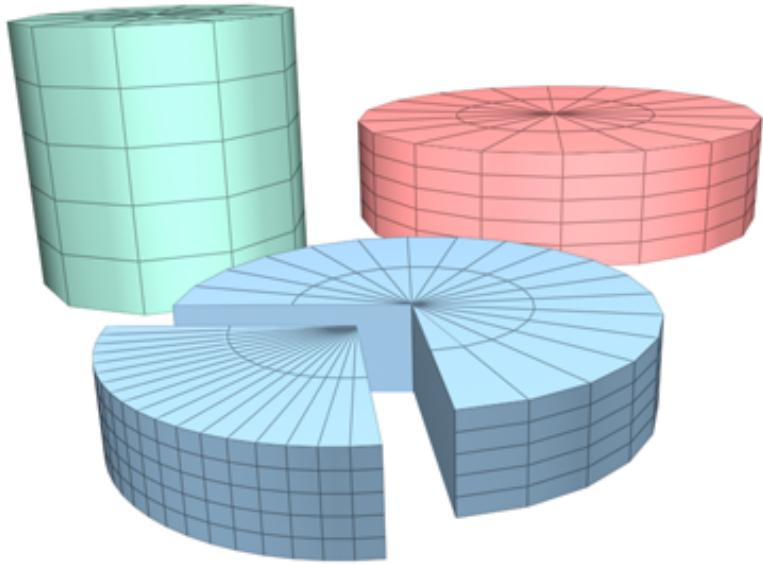

Examples of cylinders

### Procedures

To create a cylinder:

- 1 On the Create panel, choose Standard Primitives > Cylinder.
- 2 In any viewport, drag to define the radius of the base, then release to set the radius.
- 3 Move up or down to define a height, either positive or negative.
- 4 Click to set the height and create the cylinder.

### Interface

#### Creation Method rollout

**Edge** Draws a cylinder from edge to edge. You can change the center location by moving the mouse.

**Center** Draws a cylinder from the center out.

## Parameters rollout

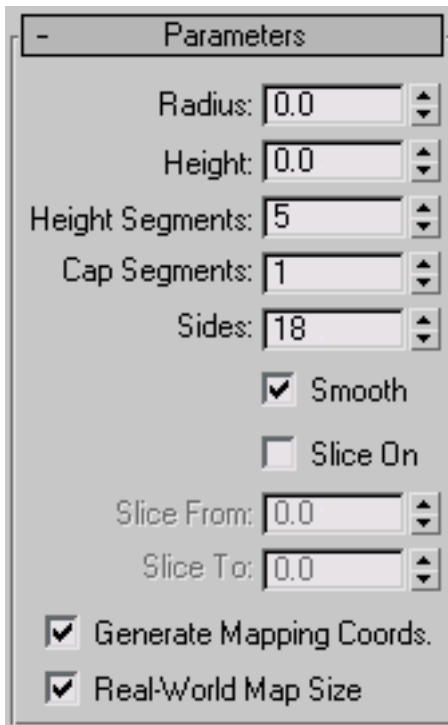

The defaults produce a smooth cylinder of 18 sides with the pivot point at the center of the base. There are five height segments and one cap segment. If you don't plan to modify the cylinder's shape, such as with a Bend modifier, set Height Segments to 1 to reduce scene complexity. If you plan to modify the ends of the cylinder, consider increasing the Cap Segments setting.

**Radius** Sets the radius of the cylinder.

**Height** Sets the dimension along the central axis. Negative values create the cylinder below the construction plane.

**Height Segments** Sets the number of divisions along the cylinder's major axis.

**Cap Segments** Sets the number of concentric divisions around the center of the cylinder's top and bottom.



**Sides** Sets the number of sides around the cylinder. With Smooth on, higher numbers shade and render as true circles. With Smooth off, lower numbers create regular polygonal objects.

**Smooth** The faces of the cylinder are blended together, creating a smooth appearance in rendered views.

**Slice On** Enables the Slice function. Default=off.

When you create a slice and then turn off Slice On, the complete cylinder reappears. You can use this check box to switch between the two topologies.

**Slice From, Slice To** Sets the number of degrees around the local Z axis from a zero point at the local X axis.

For both settings, positive values move the end of the slice counterclockwise; negative values move it clockwise. Either setting can be made first. When the ends meet, the whole cylinder reappears.

**Generate Mapping Coords** Generates coordinates for applying mapped materials to the cylinder. Default=on.

**Real-World Map Size** Controls the scaling method used for texture mapped materials that are applied to the object. The scaling values are controlled by the Use Real-World Scale settings found in the applied material's [Coordinates rollout](#) on page 5620 . Default=off.

## Tube Primitive

Create panel > Geometry button > Standard Primitives > Object Type rollout > Tube button

Create menu > Standard Primitives > Tube

Tube produces both round and prismatic tubes. The tube is similar to the cylinder with a hole in it.

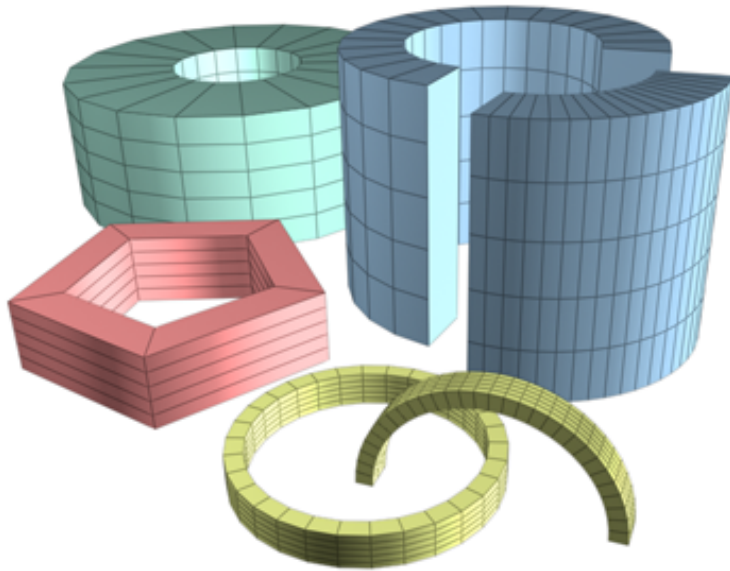

### Examples of tubes

### Procedures

#### To create a tube:

- 1 On the Create menu choose Standard Primitives > Tube.
- 2 In any viewport, drag to define the first radius, which can be either the inner or outer radius of the tube. Release to set the first radius.
- 3 Move to define the second radius, then click to set it.
- 4 Move up or down to define a height, either positive or negative.
- 5 Click to set the height and create the tube.

#### To create a prismatic tube:

- 1 Set the number of sides for the kind of prism you want.
- 2 Turn Smooth off.
- 3 Create a tube.

## Interface

### Creation Method rollout

**Edge** Draws a tube from edge to edge. You can change the center location by moving the mouse.

**Center** Draws a tube from the center out.

### Parameters rollout

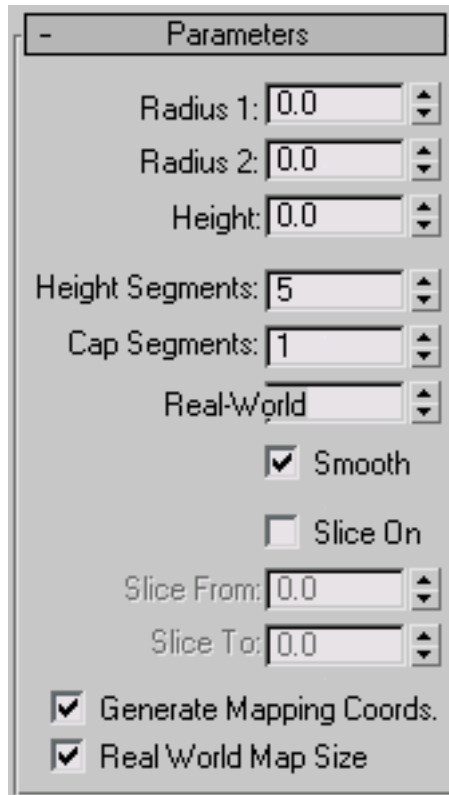

The defaults produce a smooth, round tube of 18 sides with the pivot point at the center of the base. There are five height segments and one cap segment. If you don't plan to modify the cylinder's shape, such as with a Bend modifier, set Height Segments to 1 to reduce scene complexity. If you plan to modify the ends of the cylinder, consider increasing the Cap Segments setting.

**Radius 1, Radius 2** The larger setting specifies the outside radius of the tube, while the smaller specifies the inside radius.

**Height** Sets the dimension along the central axis. Negative values create the tube below the construction plane.

**Height Segments** Sets the number of divisions along the tube's major axis.

**Cap Segments** Sets the number of concentric divisions around the center of the tube's top and bottom.

**Sides** Sets the number of sides around the tube. Higher numbers shade and render as true circles with Smooth on. Lower numbers create regular polygonal objects with Smooth off.

**Smooth** When on (the default), faces of the tube are blended together, creating a smooth appearance in rendered views.

**Slice On** Enables the Slice feature, which removes part of the tube's circumference. Default=off.

When you create a slice and then turn off Slice On, the complete tube reappears. You can therefore use this check box to switch between the two topologies.

**Slice From, Slice To** Sets the number of degrees around the local Z axis from a zero point at the local X axis.

For both settings, positive values move the end of the slice counterclockwise; negative values move it clockwise. Either setting can be made first. When the ends meet, the whole tube reappears.

**Generate Mapping Coords** Generates coordinates for applying mapped materials to the tube. Default=on.

**Real-World Map Size** Controls the scaling method used for texture mapped materials that are applied to the object. The scaling values are controlled by the Use Real-World Scale settings found in the applied material's [Coordinates rollout](#) on page 5620 . Default=off.

## Torus Primitive

Create panel > Geometry button > Standard Primitives > Object Type rollout > Torus button

Create menu > Standard Primitives > Torus

Torus produces a torus, or a ring with a circular cross section, sometimes referred to as a doughnut. You can combine three smoothing options with rotation and twist settings to create complex variations.

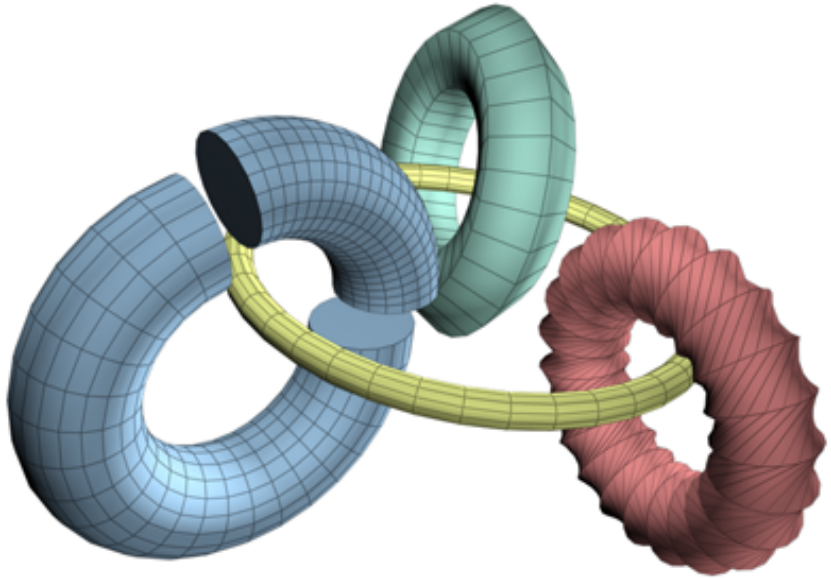

#### Examples of tori

#### Procedures

##### To create a torus:

- 1 From the Create menu, choose Standard Primitives > Torus.
- 2 In any viewport, drag to define a torus.
- 3 As you drag, a torus emerges with its center at the pivot point.
- 4 Release to set the radius of the torus ring.
- 5 Move to define the radius of the cross-sectional circle, then click to create the torus.

## Interface

### Creation Method rollout

**Edge** Draws a torus from edge to edge. You can change the center location by moving the mouse.

**Center** Draws a torus from the center out.

### Parameters rollout

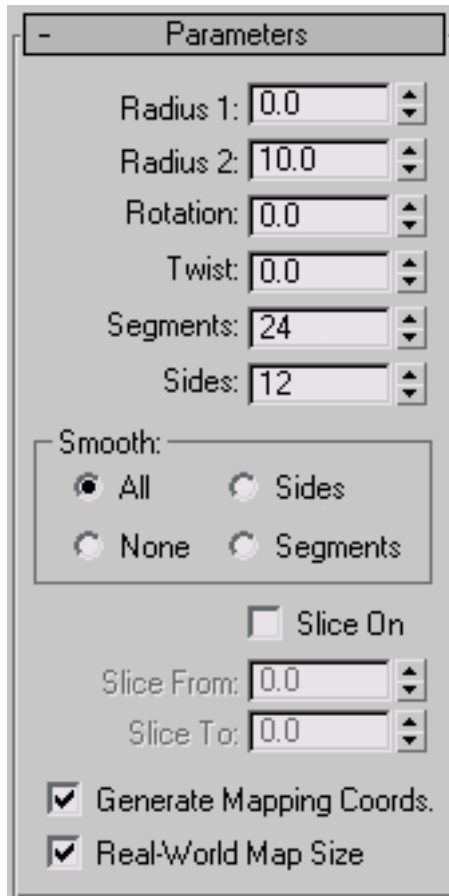

The defaults produce a smooth torus with 12 sides and 24 segments. The pivot point is at the center of the torus on the plane, cutting through the center of

the torus. Higher settings for sides and segments produce a more dense geometry that might be required for some modeling or rendering situations.

**Radius 1** Sets the distance from the center of the torus to the center of the cross-sectional circle. This is the radius of the torus ring.

**Radius 2** Sets the radius of the cross-sectional circle. This value is replaced each time you create a torus. Default = 10.

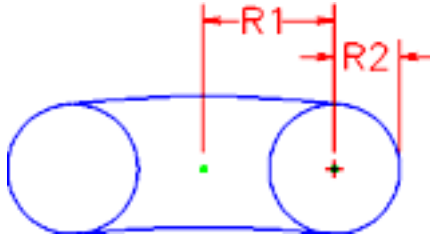

**Radius 1 and Radius 2**

**Rotation** Sets the degree of rotation. Vertices are uniformly rotated about the circle running through the center of the torus ring. Positive and negative values for this setting "roll" the vertices in either direction over the surface of the torus.



**Rotation and Twist**

**Twist** Sets the degree of twist. Cross sections are progressively rotated about the circle running through the center of the torus. Beginning with twist, each successive cross section is rotated until the last one has the number of degrees specified.

Twisting a closed (unsliced) torus creates a constriction in the first segment. You can avoid this by either twisting in increments of 360 degrees, or by turning Slice on and setting both Slice From and Slice To to 0 to maintain a complete torus.

**Segments** Sets the number of radial divisions around the torus. By reducing this number, you can create polygonal rings instead of circular ones.

**Sides** Sets the number of sides on the cross-sectional circle of the torus. By reducing this number, you can create prism-like cross sections instead of circular ones.

### Smooth group

Choose one of four levels of smoothing:

- **All** (default) Produces complete smoothing on all surfaces of the torus.
- **Sides** Smooths the edges between adjacent segments, producing smooth bands running around the torus.
- **None** Turns off smoothing entirely, producing prism-like facets on the torus.
- **Segments** Smooths each segment individually, producing ring-like segments along the torus.

**Slice On** Creates a portion of a sliced torus rather than the entire 360 degrees.

**Slice From** When Slice On is on, specifies the angle where the torus slice begins.

**Slice To** When Slice On is on, specifies the angle where the torus slice ends.

**Generate Mapping Coords** Generates coordinates for applying mapped materials to the torus. Default=on.

**Real-World Map Size** Controls the scaling method used for texture mapped materials that are applied to the object. The scaling values are controlled by the Use Real-World Scale settings found in the applied material's [Coordinates rollout](#) on page 5620 . Default=off.

## Pyramid Primitive

Create panel > Geometry button > Standard Primitives > Object Type rollout > Pyramid button

Create menu > Standard Primitives > Pyramid

The Pyramid primitive has a square or rectangular base and triangular sides.



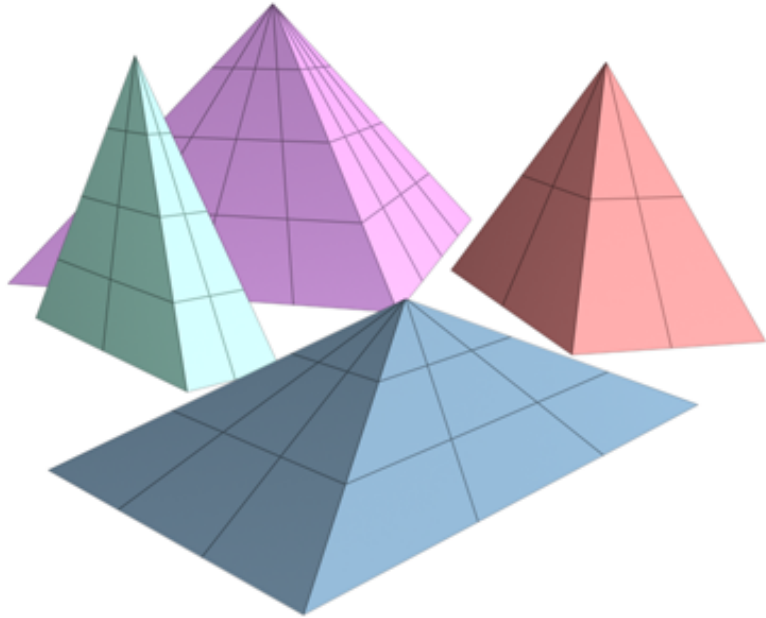

Examples of pyramids

### Procedures

To create a Pyramid:

- 1 On the Create menu choose Standard Primitives > Pyramid.
- 2 Choose a creation method, either Base/Apex or Center.

---

**NOTE** Hold the Ctrl key while using either creation method to constrain the base to a square.

---

- 3 In any viewport, drag to define the base of the pyramid. If you're using Base/Apex, define the opposite corners of the base, moving the mouse horizontally or vertically to define the width and depth of the base. If you're using Center, drag from the center of the base.
- 4 Click, and then move the mouse to define the Height.
- 5 Click to complete the pyramid.

## Interface

### Creation Method rollout

**Base/Apex** Creates the pyramid base from one corner to the diagonally opposite corner.

**Center** Creates the pyramid base from the center out.

### Parameters rollout

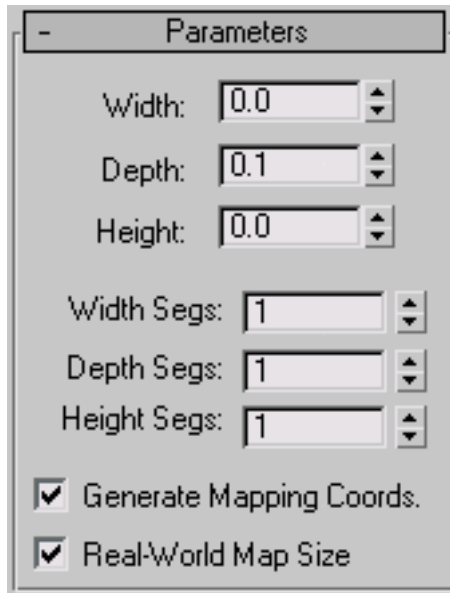

**Width, Depth and Height** Sets the dimension of the corresponding side of the pyramid.

**Width, Depth and Height Segs** Sets the number of segments to the corresponding sides of the pyramid.

**Generate Mapping Coords** Generates coordinates for applying mapped materials to the pyramid. Default=on.

**Real-World Map Size** Controls the scaling method used for texture mapped materials that are applied to the object. The scaling values are controlled by the Use Real-World Scale settings found in the applied material's [Coordinates rollout](#) on page 5620 . Default=off.

## Teapot Primitive

Create panel > Geometry button > Standard Primitives > Object Type rollout > Teapot button

Create menu > Standard Primitives > Teapot

Teapot produces a teapot. You can choose to make the whole teapot at once (the default), or any of its parts. Since the Teapot is a parametric object, you can choose which parts of the teapot to display after creation.

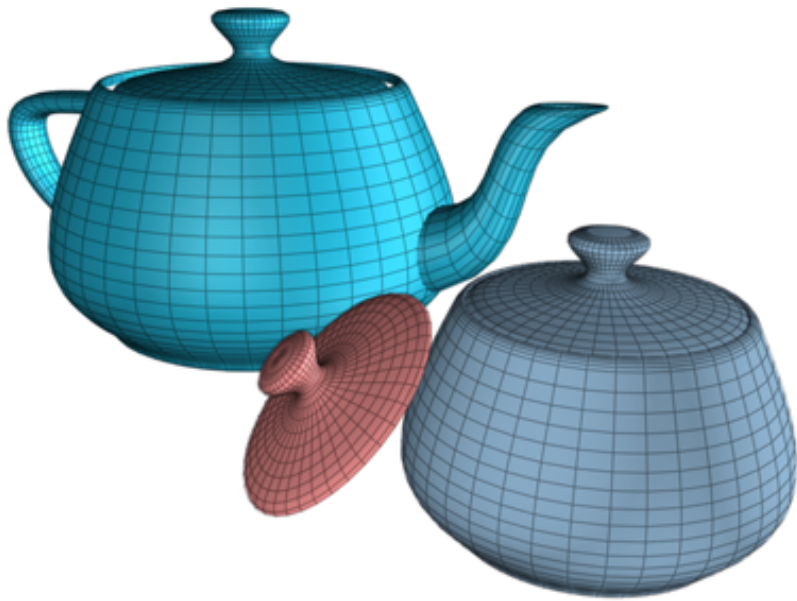

**Examples of teapots**

### History of the Teapot

This teapot derives from the original data developed by Martin Newell in 1975. Beginning with a graph-paper sketch of a teapot that he kept on his desk, Newell calculated cubic [Bezier splines](#) on page 7726 to create a wireframe model. James Blinn, also at the University of Utah during this period, produced early renderings of exceptional quality using this model.

The teapot has since become a classic in computer graphics. Its complexly curved and intersecting surfaces are well suited to testing different kinds of material mappings and rendering settings on a real-world object.

## **Procedures**

### **To create a teapot:**

- 1 On the Create menu, choose Standard Primitives > Teapot.
- 2 In any viewport, drag to define a radius.  
As you drag, a teapot emerges with the pivot point at the center of its base.
- 3 Release the mouse to set the radius and create the teapot.

### **To create a teapot part:**

- 1 In Parameters rollout > Teapot Parts group, turn off all parts except the one you want to create.
- 2 Create a teapot.  
The part you left on appears. The pivot point remains at the center of the teapot's base.
- 3 In Parameters rollout > Teapot Parts group, turn off all parts except the one you want.

The teapot has four separate parts: body, handle, spout, and lid. Controls are located in the Teapot Parts group of the Parameters rollout. You can check any combination of parts to create at the same time. The body alone is a ready-made bowl, or a pot with optional lid.

### **To turn a part into a teapot:**

- 1 Select a teapot part in the viewport.
- 2 On the Modify panel > Parameters rollout, turn on all parts. (This is the default.)  
The whole teapot appears.

You can apply modifiers to any separate part. If you later turn on another part, the modifier affects the additional geometry as well.

## Interface

### Creation Method rollout

**Edge** Draws a teapot from edge to edge. You can change the center location by moving the mouse.

**Center** Draws a teapot from the center out.

### Parameters rollout

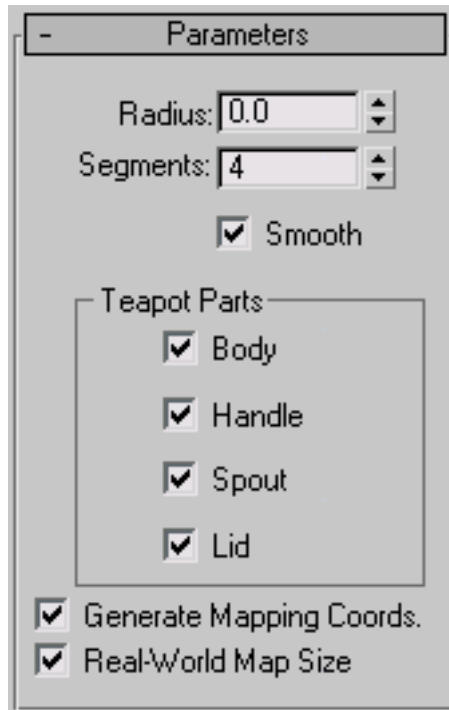

**Radius** Sets the radius of the teapot

**Segments** Sets the number of divisions for the teapot or its individual parts.

**Smooth** Blends faces of the teapot, creating a smooth appearance in rendered views.

## Teapot Parts group

Turn check boxes on or off for teapot parts. By default, all are on, producing a complete teapot.

**Generate Mapping Coords** Generates coordinates for applying mapped materials to the teapot. Default=on.

**Real-World Map Size** Controls the scaling method used for texture mapped materials that are applied to the object. The scaling values are controlled by the Use Real-World Scale settings found in the applied material's [Coordinates rollout](#) on page 5620 . Default=off.

## Plane Primitive

Create panel > Geometry button > Standard Primitives > Object Type rollout > Plane button

Create menu > Standard Primitives > Plane

The Plane object is a special type of flat polygon mesh that can be enlarged by any amount at render time. You can specify factors to magnify the size or number of segments, or both. Use the Plane object for creating a large-scale ground plane that doesn't get in the way when working in a viewport. You can apply any type of modifier to the plane object, such as [Displace](#) on page 1274 to simulate a hilly terrain.

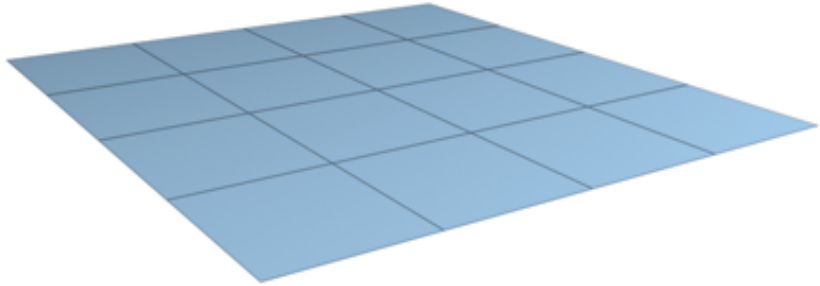

**Example of plane**

### **Procedures**

**To create a plane:**

- 1 On the Create menu choose Standard Primitives > Plane.
- 2 In any viewport, drag to create the Plane.

### **Interface**

#### **Creation Method rollout**

**Rectangle** Creates the plane primitive from one corner to the diagonally opposite corner, interactively setting different values for length and width.

**Square** Creates a square plane where length and width are equal. You can change dimensions in the Parameters rollout subsequent to creation.

## Parameters rollout

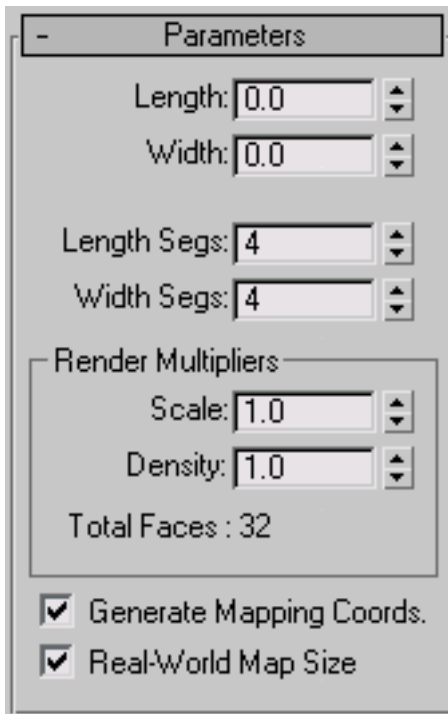

**Length, Width** Sets the length and width of the plane object. These fields act also as readouts while you drag the sides of the box. You can revise these values. Defaults= 0.0, 0.0.

**Length Segs, Width Segs** Sets the number of divisions along each axis of the object. Can be set before or after creation. By default, each side of the plane has four segments. When you reset these values, the new values become the default during a session.

### Render Multipliers group

**Render Scale** Specifies the factor by which both length and width are multiplied at render time. Scaling is performed from the center outward.

**Render Segs** Specifies the factor by which the number of segments in both length and width are multiplied at render time.

**Generate Mapping Coords** Generates coordinates for applying mapped materials to the plane. Default=on.



**Real-World Map Size** Controls the scaling method used for texture mapped materials that are applied to the object. The scaling values are controlled by the Use Real-World Scale settings found in the applied material's [Coordinates rollout](#) on page 5620 . Default=off.

## Extended Primitives

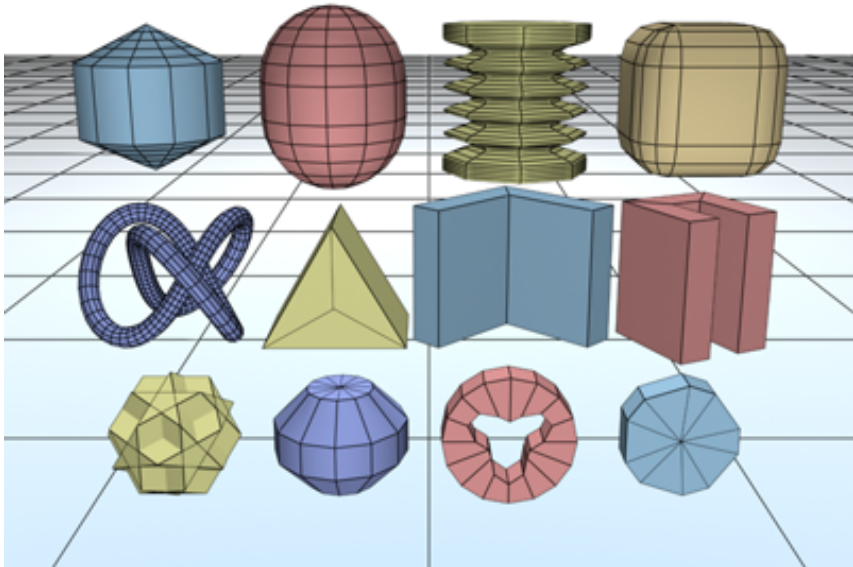

**A collection of extended primitive objects**

Extended Primitives are a collection of complex primitives for 3ds Max. The topics that follow describe each type of extended primitive and its creation parameters.

These primitives are available from the Object Type rollout on the Create panel and from the Create menu > Extended Primitives.

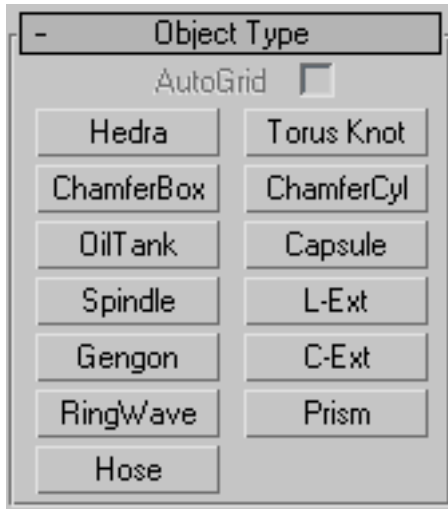

[AutoGrid](#) on page 2513

[Hedra Extended Primitive](#) on page 385

[Torus Knot Extended Primitive](#) on page 389

[ChamferBox Extended Primitive](#) on page 393

[ChamferCyl Extended Primitive](#) on page 396

[OilTank Extended Primitive](#) on page 399

[Capsule Extended Primitive](#) on page 402

[Spindle Extended Primitive](#) on page 405

[L-Ext Extended Primitive](#) on page 409

[Gengon Extended Primitive](#) on page 411

[C-Ext Extended Primitive](#) on page 414

[RingWave Extended Primitive](#) on page 417

[Hose Extended Primitive](#) on page 425

[Prism Extended Primitive](#) on page 423

All primitives have name and color controls, and allow you to enter initial values from the keyboard. See these topics:

[Object Name and Wireframe Color](#) on page 7423

[Creating Primitives from the Keyboard](#) on page 346 (not applicable to Hedra, RingWave, or Hose)

The remaining rollouts are covered in the topic for each primitive.

## Hedra Extended Primitive

Create panel > Geometry button > Extended Primitives > Object Type rollout > Hedra button

Create menu > Extended Primitives > Hedra

Use Hedra to produce objects from several families of polyhedra.

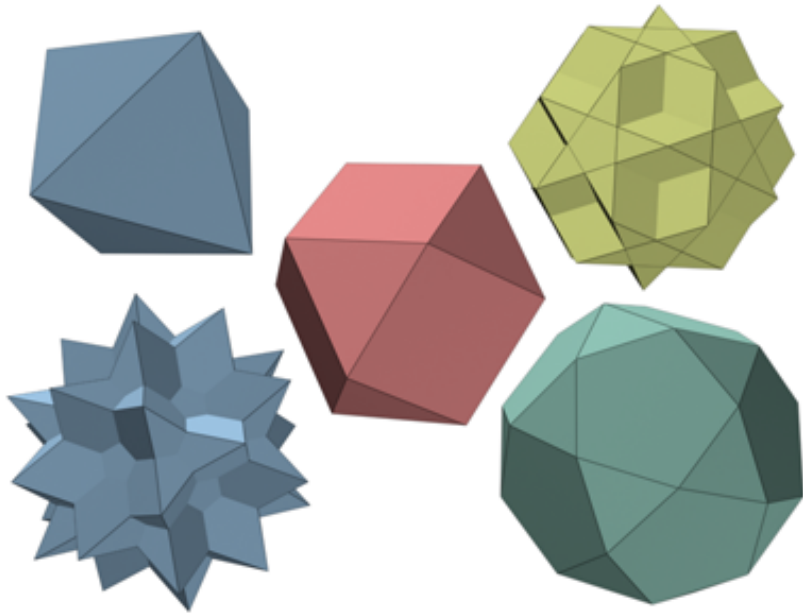

Examples of hedra

### Procedures

To create a polyhedron:

- 1 From the Create menu, choose Extended Primitives > Hedra.

- 2 In any viewport, drag to define a radius, then release to create the polyhedron.  
As you drag, a polyhedron emerges from the pivot point.
- 3 Adjust the Family Parameter and Axis Scaling spinners to vary the Hedra's appearance.

## Interface

## Family group

Use this group to select the type of polyhedron to create.

**Tetra** Creates a tetrahedron.

**Cube/Octa** Creates a cubic or octahedral polyhedron (depending on parameter settings).

**Dodec/Icos** Creates a dodecahedron or icosahedron (depending on parameter settings).

**Star1/Star2** Creates two different star-like polyhedra.

---

**TIP** You can animate between Hedra types. Turn on the Auto Key button, go to any frame, and change the Family check box. There is no interpolation between types; the model simply jumps from a star to a cube or tetrahedron, and so on.

---

## Family parameters group

**P, Q** Interrelated parameters that provide a two-way translation between the vertices and facets of a polyhedron. They share the following:

- Range of possible values is 0.0 through 1.0.
- The combined total of the P and Q values can be equal to or less than 1.0.
- Extremes occur if either P or Q is set to 1.0; the other is automatically set to 0.0.
- Midpoint occurs when both P and Q are 0.

In the simplest terms, P and Q change the geometry back and forth between vertices and facets. At the extreme settings for P and Q, one parameter represents all vertices, the other represents all facets. Intermediate settings are transition points, with the midpoint an even balance between the two parameters.

## Axis Scaling group

Polyhedra can have as many as three kinds of polygonal facets, such as triangle, square, or pentagon. These facets can be regular or irregular. If a polyhedron has only one or two types of facet, only one or two of the axis scaling parameters are active. Inactive parameters have no effect.

**P, Q, R** Controls the axis of reflection for one of the facets of a polyhedron. In practice, these fields have the effect of pushing their corresponding facets in and out. Defaults=100.

**Reset** Returns axes to their default setting.

### **Vertices group**

Parameters in the Vertices group determine the internal geometry of each facet of a polyhedron. Center and Center & Sides increase the number of vertices in the object and therefore the number of faces. These parameters cannot be animated.

**Basic** Facets are not subdivided beyond the minimum.

**Center** Each facet is subdivided by placing an additional vertex at its center, with edges from each center point to the facet corners.

**Center & Sides** Each facet is subdivided by placing an additional vertex at its center, with edges from each center point to the facet corners, as well as to the center of each edge. Compared to Center, Center & Sides doubles the number of faces in the polyhedron.

---

**NOTE** If you scale the axis of the object, the Center option is used automatically, unless Center & Sides is already set.

---

To see the internal edges shown in the figure, turn off Edges Only on the Display command panel.

**Radius** Sets the radius of any polyhedron in current units.

**Generate Mapping Coords** Generates coordinates for applying mapped materials to the polyhedron. Default=on.

## **Torus Knot Extended Primitive**

Create panel > Geometry > Extended Primitives > Object Type rollout > Torus Knot button

Create menu > Extended Primitives > Torus Knot

Use Torus Knot to create a complex or knotted torus by drawing 2D curves in the normal planes around a 3D curve. The 3D curve (called the Base Curve) can be either a circle or a torus knot.

You can convert a torus knot object to a [NURBS surface](#) on page 2218 .

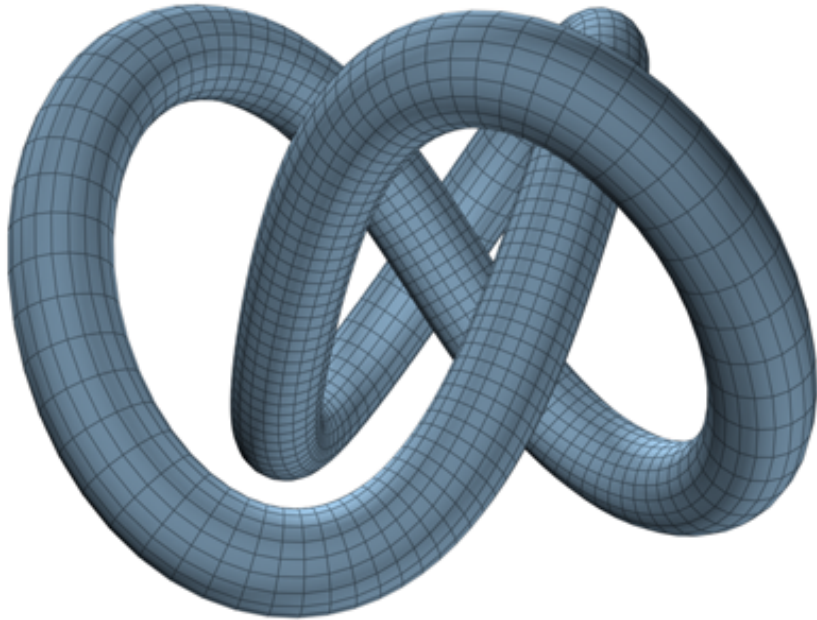

Example of torus knot

### Procedures

To create a Torus Knot:

- 1 On the Create menu, choose Extended Primitives > Torus Knot.
- 2 Drag the mouse to define the size of the torus knot.
- 3 Click, then move the mouse vertically to define the radius.
- 4 Click again to finish the torus.
- 5 Adjust the parameters on the Modify panel.

### Interface

#### Creation Method rollout

**Diameter** Draws the object from edge to edge. You can change the center location by moving the mouse.

**Radius** Draws the object from the center out.



## Parameters rollout > Base Curve group

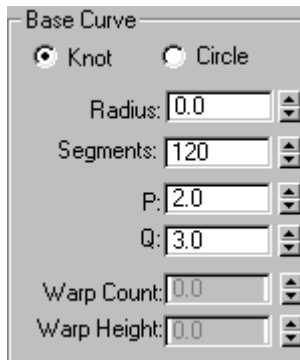

Provides parameters that affect the base curve.

**Knot/Circle** With Knot, the torus interweaves itself, based on various other parameters. With Circle, the base curve is a circle, resulting in a standard torus if parameters such as Warp and Eccentricity are left at their defaults.

**Radius** Sets the radius of the base curve.

**Segments** Sets the number of segments around the perimeter of the torus.

**P and Q** Describes up-and-down (P) and around-the-center (Q) winding numbers. (Active only when Knot is chosen.)

**Warp Count** Sets the number of "points" in a star shape around the curve. (Active only when Circle is chosen.)

**Warp Height** Sets the height of the "points" given as a percentage of the base curve radius.

## Parameters rollout > Cross Section group

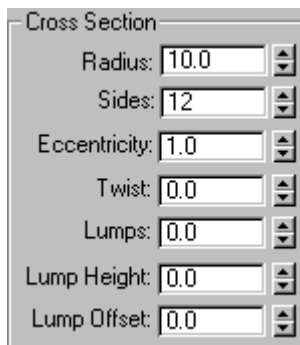

Provides parameters that affect the cross section of the torus knot.

**Radius** Sets the radius of the cross section.

**Sides** Sets the number of sides around the cross section.

**Eccentricity** Sets the ratio of the major to minor axes of the cross section. A value of 1 provides a circular cross section, while other values create elliptical cross sections.

**Twist** Sets the number of times the cross section twists around the base curve.

**Lumps** Sets the number of bulges in the torus knot. Note that the Lump Height spinner value must be greater than 0 to see any effect.

**Lump Height** Sets the height of the lumps, as a percentage of the radius of the cross section. Note that the Lumps spinner must be greater than 0 to see any effect.

**Lump Offset** Sets the offset of the start of the lumps, measured in degrees. The purpose of this value is to animate the lumps around the torus.

### Parameters rollout > Smooth group



Provides options to alter the smoothing displayed or rendered of the torus knot. This smoothing does not displace or tessellate the geometry, it only adds the smoothing group information.

**All** Smooths the entire torus knot.

**Sides** Smooths only the adjacent sides of the torus knot.

**None** The torus knot is faceted.

### Parameters rollout > Mapping Coordinates group

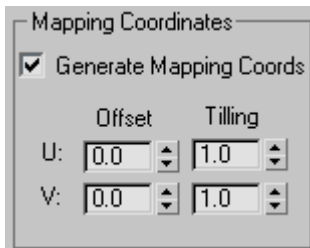

Provides methods of assigning and adjusting mapping coordinates.

**Generate Mapping Coords** Assigns mapping coordinates based on the geometry of the torus knot. Default=on.

**Offset U/V** Offset the mapping coordinates along U and V.

**Tiling U/V** Tile the mapping coordinates along U and V.

## ChamferBox Extended Primitive

Create panel > Geometry button > Extended Primitives > Object Type rollout > ChamferBox button

Create menu > Extended Primitives > Chamfer Box

Use ChamferBox to create a box with beveled or rounded edges.

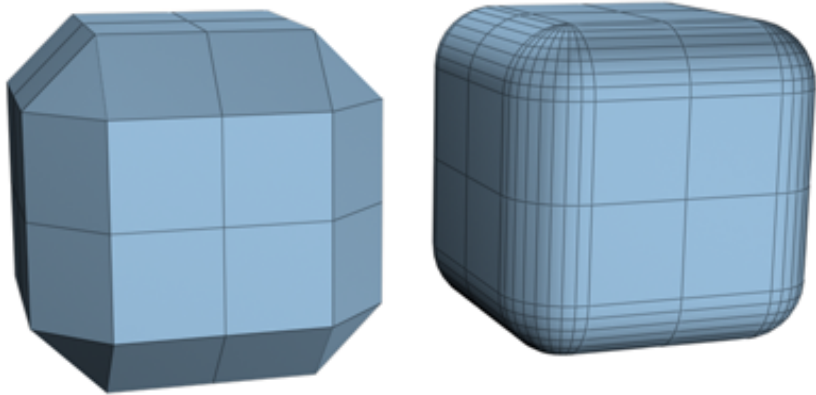

Examples of chamfered boxes

## Procedures

### To create a standard chamfered box:

- 1 From the Create menu, choose Extended Primitives > Chamfer Box.
- 2 Drag the mouse to define the diagonal corners of the base of the chamfered box. (Press Ctrl to constrain the base to a square.)
- 3 Release the mouse button, and then move the mouse vertically to define the height of the box. Click to set the height.
- 4 Move the mouse diagonally to define the width of the fillet, or chamfer (toward the upper left increases the width; toward the lower right decreases it).
- 5 Click again to finish the chamfered box.

### To create a cubic chamfered box:

- 1 On the Creation Method rollout, click Cube.
- 2 Beginning at the center of the cube, drag in a viewport to set all three dimensions simultaneously.
- 3 Release the button, and move the mouse to set the fillet or chamfer.
- 4 Click to create the object.

You can change a cube's individual dimensions in the Parameters rollout.

## Interface

### Creation Method rollout

**Cube** Forces length, width, and height to be equal. You can change a cube's individual dimensions in the Parameters rollout.

**Box** Creates a standard chamfered box primitive from one corner to the diagonally opposite corner, with individual settings for length, width, and height.

## Parameters rollout

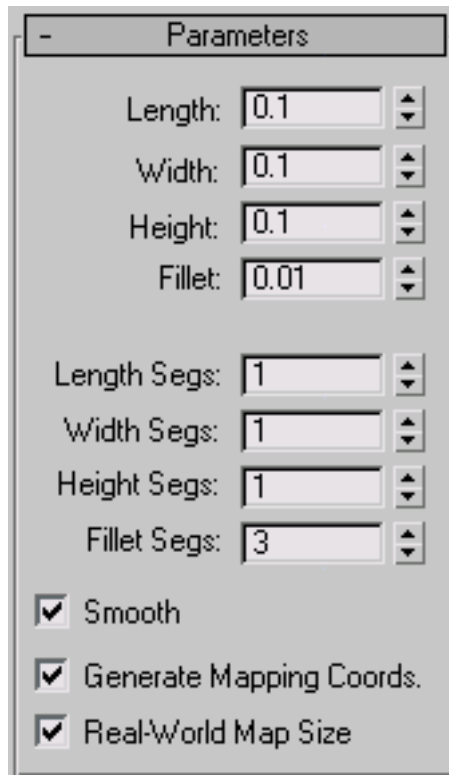

**Length, Width, Height** Sets the corresponding dimensions of the chamfered box.

**Fillet** Slices off the edges of the chamfered box. Higher values result in a more refined fillet on the edges of the chamfered box.

**Length, Width, Height Segs** Sets the number of divisions along the corresponding axis.

**Fillet Segs** Sets the number of segments in the filleted edges of the box. Adding fillet segments increases the edge roundness.

**Smooth** Blends the display of the faces of the chamfered box, creating a smooth appearance in rendered views.

**Generate Mapping Coords** Generates coordinates for applying mapped materials to the chamfered box. Default=on.

**Real-World Map Size** Controls the scaling method used for texture mapped materials that are applied to the object. The scaling values are controlled by the Use Real-World Scale settings found in the applied material's [Coordinates rollout](#) on page 5620 . Default=off.

## ChamferCyl Extended Primitive

Create panel > Geometry button > Extended Primitives > Object Type rollout > ChamferCyl button

Create menu > Extended Primitives > Chamfer Cylinder

Use ChamferCyl to create a cylinder with beveled or rounded cap edges.

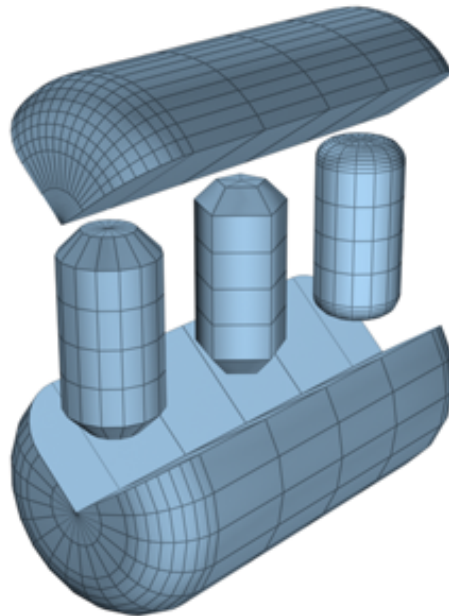

Examples of chamfered cylinders

### Procedures

To create a chamfered cylinder:

- 1 From the Create menu, choose Extended Primitives > Chamfer Cylinder.

- 2 Drag the mouse to define the radius of the base of the chamfered cylinder.
- 3 Release the mouse button, and then move the mouse vertically to define the height of the cylinder. Click to set the height.
- 4 Move the mouse diagonally to define the width of the fillet, or chamfer (toward the upper left increases the width; toward the lower right decreases it).
- 5 Click to finish the cylinder.

## **Interface**

### **Creation Method rollout**

**Edge** Draws the object from edge to edge. You can change the center location by moving the mouse.

**Center** Draws the object from the center out.

## Parameters rollout

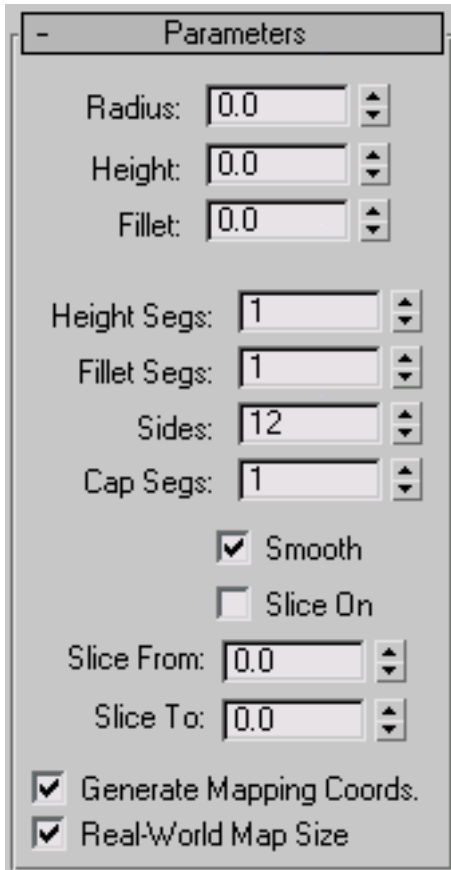

**Radius** Sets the radius of the chamfered cylinder.

**Height** Sets the dimension along the central axis. Negative values create the chamfered cylinder below the construction plane.

**Fillet** Chamfers the top and bottom cap edges of the chamfered cylinder. Higher numbers result in a more refined fillet along the cap edge.

**Height Segs** Sets the number of divisions along the corresponding axis.

**Fillet Segs** Sets the number of segments in the filleted edges of the cylinder. Adding fillet segments curves the edges, producing a filleted cylinder.



**Sides** Sets the number of sides around the chamfered cylinder. Higher numbers shade and render as true circles with Smooth on. Lower numbers create regular polygonal objects with Smooth off.

**Cap Segs** Sets the number of concentric divisions along the center of the chamfered cylinder's top and bottom

**Smooth** Blends the faces of the chamfered cylinder, creating a smooth appearance in rendered views.

**Slice On** Enables the Slice function. Default=off.

When you create a slice and then turn off Slice On, the complete chamfered cylinder reappears. You can use this check box to switch between the two topologies.

**Slice From, Slice To** Sets the number of degrees around the local Z axis from a zero point at the local X axis.

For both settings, positive values move the end of the slice counterclockwise; negative values move it clockwise. Either setting can be made first. When the ends meet, the whole chamfered cylinder reappears.

**Generate Mapping Coords** Generates coordinates for applying mapped materials to the chamfered cylinder. Default=on.

**Real-World Map Size** Controls the scaling method used for texture mapped materials that are applied to the object. The scaling values are controlled by the Use Real-World Scale settings found in the applied material's [Coordinates rollout](#) on page 5620 . Default=off.

## OilTank Extended Primitive

Create panel > Geometry button > Extended Primitives > Object Type rollout > OilTank button

Create menu > Extended Primitives > Oil Tank

Use OilTank to create a cylinder with convex caps.

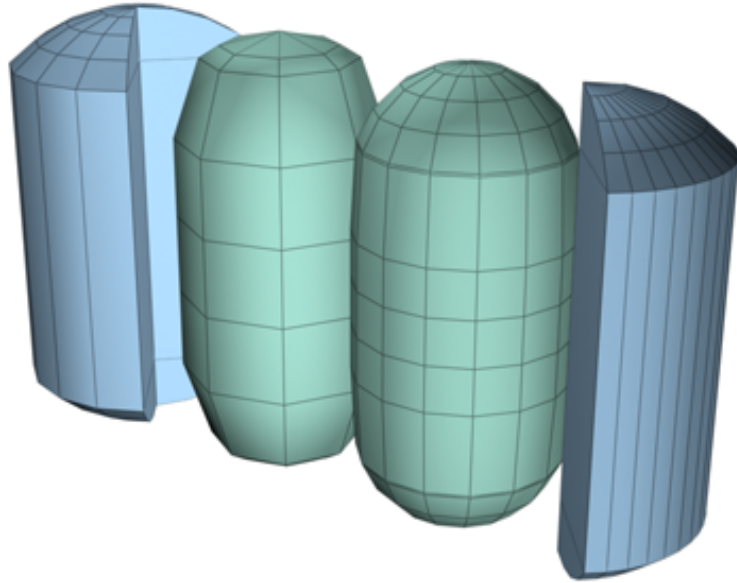

#### Examples of oil tanks

#### Procedures

##### To create an oil tank:

- 1 From the Create menu, choose Extended Primitives > Oil Tank.
- 2 Drag the mouse to define the radius of the base of the oil tank.
- 3 Release the mouse button, and then move the mouse vertically to define the height of the oil tank. Click to set the height.
- 4 Move the mouse diagonally to define the height of the convex caps (toward the upper left to increase the height; toward the lower right to decrease it).
- 5 Click again to finish the oil tank.

## Interface

### Creation Method rollout

**Edge** Draws the object from edge to edge. You can change the center location by moving the mouse.

**Center** Draws the object from the center out.

### Parameters rollout

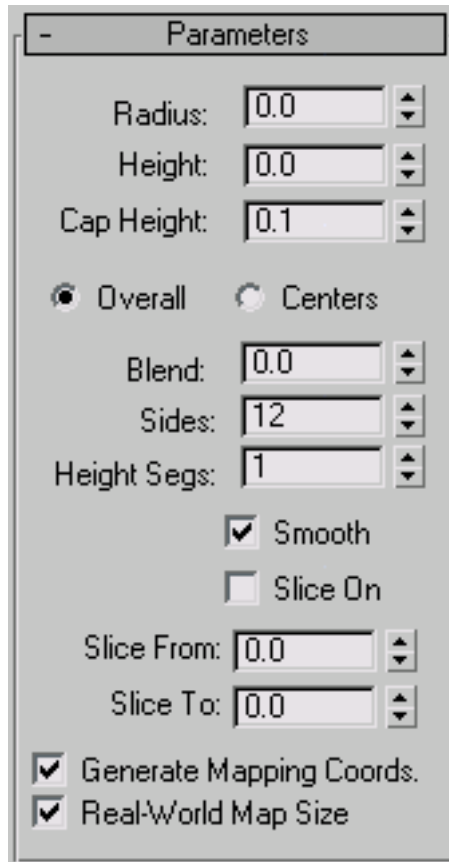

**Radius** Sets the radius of the oil tank.

**Height** Sets the dimension along the central axis. Negative values create the oil tank below the construction plane.

**Cap Height** Sets the height of the convex caps. The minimum value is 2.5% of the Radius setting. The maximum value is the Radius setting, unless the absolute value of the Height setting is less than the double Radius setting, in which case cap height cannot exceed ½ of the absolute value of the Height setting.

**Overall/Centers** Determines what the Height value specifies. Overall is the overall height of the object. Centers is the height of the midsection of the cylinder, not including its convex caps.

**Blend** When greater than 0, creates a bevel at the edge of the caps.

**Sides** Sets the number of sides around the oil tank. To create a smoothly rounded object, use a higher number of sides and turn Smooth on. To create an oil tank with flat sides, use a lower number of sides and turn Smooth off.

**Height Segs** Sets the number of divisions along the oil tank's major axis.

**Smooth** Blends the faces of the oil tank, creating a smooth appearance in rendered views.

**Slice On** Turns on the Slice function. Default=off.

When you create a slice and then turn off Slice On, the complete oil tank reappears. You can therefore use this check box to switch between the two topologies.

**Slice From, Slice To** Sets the number of degrees around the local Z axis from a zero point at the local X axis.

For both settings, positive values move the end of the slice counterclockwise; negative values move it clockwise. Either setting can be made first. When the ends meet, the whole oil tank reappears.

**Generate Mapping Coords** Generates coordinates for applying mapped materials to the oil tank. Default=on.

**Real-World Map Size** Controls the scaling method used for texture mapped materials that are applied to the object. The scaling values are controlled by the Use Real-World Scale settings found in the applied material's [Coordinates rollout](#) on page 5620 . Default=off.

## Capsule Extended Primitive

Create panel > Geometry button > Extended Primitives > Object Type rollout > Capsule button

Create menu > Extended Primitives > Capsule

Use Capsule to create a cylinder with hemispherical caps.

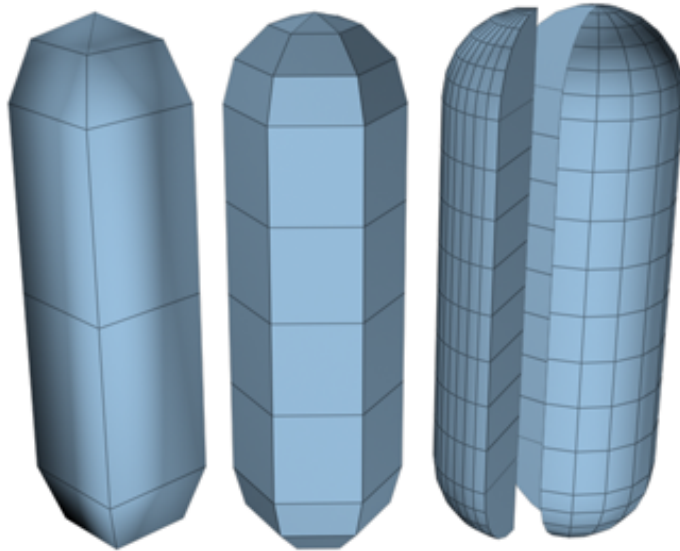

Examples of capsules

### Procedures

To create a capsule:

- 1 From the Create menu, choose Extended Primitives > Capsule.
- 2 Drag the mouse to define the radius of the capsule.
- 3 Release the mouse button, and then move the mouse vertically to define the height of the capsule.
- 4 Click to set the height and finish the capsule.

### Interface

#### Creation Method rollout

**Edge** Draws the object from edge to edge. You can change the center location by moving the mouse.

**Center** Draws the object from the center out.

### Parameters rollout

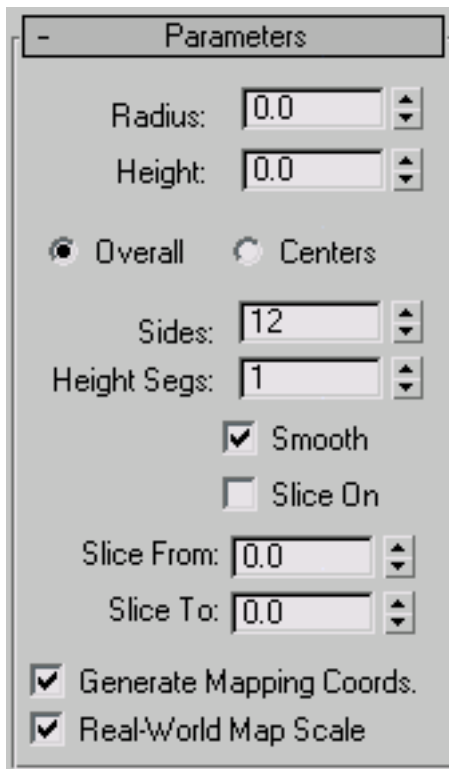

**Radius** Sets the radius of the capsule.

**Height** Sets the height along the central axis. Negative values create the capsule below the construction plane.

**Overall/Centers** Determines what the Height value specifies. Overall specifies the overall height of the object. Centers specifies the height of the midsection of the cylinder, not including its domed caps.

**Sides** Sets the number of sides around the capsule. Higher numbers shade and render as true circles with Smooth on. Lower numbers create regular polygonal objects with Smooth off.

**Height Segs** Sets the number of divisions along the capsule's major axis.

**Smooth** Blends the faces of the capsule, creating a smooth appearance in rendered views.

**Slice On** Turns on the Slice function. Default=off.

When you create a slice and then turn off Slice On, the complete capsule reappears. You can use this check box to switch between the two topologies.

**Slice From, Slice To** Sets the number of degrees around the local Z axis from a zero point at the local X axis.

For both settings, positive values move the end of the slice counterclockwise; negative values move it clockwise. Either setting can be made first. When the ends meet, the whole capsule reappears.

**Generate Mapping Coords** Generates coordinates for applying mapped materials to the capsule. Default=on.

**Real-World Map Size** Controls the scaling method used for texture mapped materials that are applied to the object. The scaling values are controlled by the Use Real-World Scale settings found in the applied material's [Coordinates rollout](#) on page 5620 . Default=off.

## Spindle Extended Primitive

Create panel > Geometry button > Extended Primitives > Object Type rollout > Spindle button

Create menu > Extended Primitives > Spindle

Use the Spindle primitive to create a cylinder with conical caps.

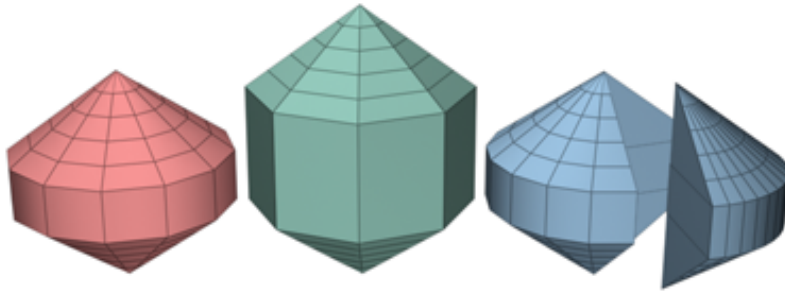

### Examples of spindles

### Procedures

#### To create a spindle:

- 1 From the Create menu, choose Extended Primitives > Spindle.
- 2 Drag the mouse to define the radius of the base of the spindle.
- 3 Release the mouse button, and then move the mouse vertically to define the height of the spindle. Click to set the height.
- 4 Move the mouse diagonally to define the height of the conical caps (toward the upper left to increase the height; toward the lower right to decrease it).
- 5 Click again to finish the spindle.



## Interface

### Creation Method rollout

**Edge** Draws the object from edge to edge. You can change the center location by moving the mouse.

**Center** Draws the object from the center out.

### Parameters rollout

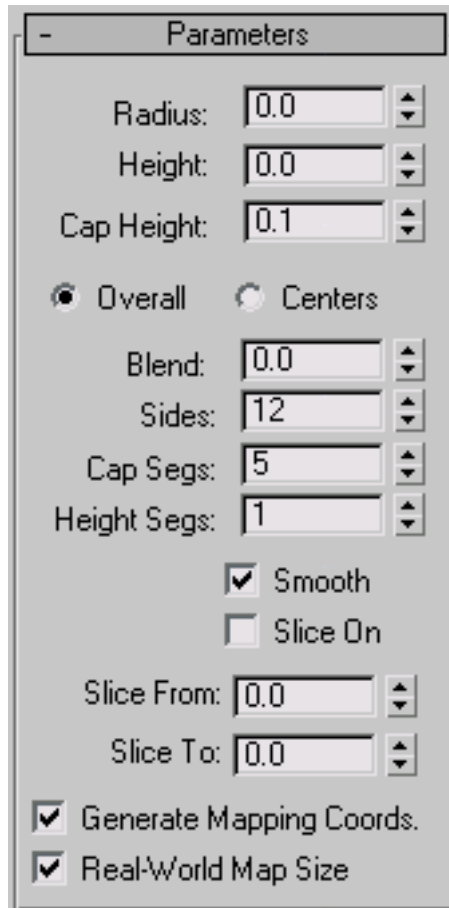

The Parameters rollout dialog box contains the following controls:

- Radius: 0.0
- Height: 0.0
- Cap Height: 0.1
- Radio buttons: Overall (selected), Centers
- Blend: 0.0
- Sides: 12
- Cap Segs: 5
- Height Segs: 1
- Checkboxes: Smooth (checked), Slice On (unchecked)
- Slice From: 0.0
- Slice To: 0.0
- Checkboxes: Generate Mapping Coords. (checked), Real-World Map Size (checked)

**Radius** Sets the radius of the spindle.

**Height** Sets the dimension along the central axis. Negative values create the spindle below the construction plane.

**Cap Height** Sets the height of the conical caps. The minimum value is 0.1; the maximum value is  $\frac{1}{2}$  the absolute value of the Height setting.

**Overall/Centers** Determines what the Height value specifies. Overall specifies the overall height of the object. Centers specifies the height of the midsection of the cylinder, not including its conical caps.

**Blend** When greater than 0, creates a fillet where the caps meet the body of the spindle.

**Sides** Sets the number of sides around the spindle. Higher numbers shade and render as true circles with Smooth on. Lower numbers create regular polygonal objects with Smooth off.

**Cap Segs** Sets the number of concentric divisions along the center of the spindle's top and bottom.

**Height Segs** Sets the number of divisions along the spindle's major axis.

**Smooth** Blends the faces of the spindle, creating a smooth appearance in rendered views.

**Slice On** Turns on the Slice function. Default=off.

When you create a slice and then turn off Slice On, the complete spindle reappears. You can therefore use this check box to switch between the two topologies.

**Slice From, Slice To** Sets the number of degrees around the local Z axis from a zero point at the local X axis.

For both settings, positive values move the end of the slice counterclockwise; negative values move it clockwise. Either setting can be made first. When the ends meet, the whole spindle reappears.

**Generate Mapping Coords** Sets up the required coordinates for applying mapped materials to the spindle. Default=on.

**Real-World Map Size** Controls the scaling method used for texture mapped materials that are applied to the object. The scaling values are controlled by the Use Real-World Scale settings found in the applied material's [Coordinates rollout](#) on page 5620 . Default=off.

## L-Ext Extended Primitive

Create panel > Geometry button > Extended Primitives > Object Type rollout > L-Ext button

Create menu > Extended Primitives > L-Extrusion

Use L-Ext to create an extruded L-shaped object.

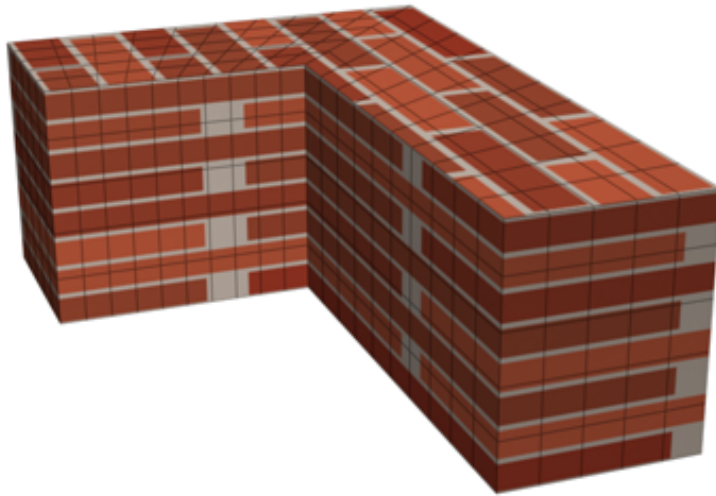

Example of L-Ext

### Procedures

To create an L-Ext object:

- 1 From the Create menu, choose Extended Primitives > L-Ext.
- 2 Drag the mouse to define the base. (Press Ctrl to constrain the base to a square.)
- 3 Release the mouse and move it vertically to define the height of the L-extrusion.

- 4 Click, and then move the mouse vertically to define the thickness or width of the walls of the L-extrusion.
- 5 Click to finish the L-extrusion.

## Interface

### Creation Method rollout

**Corners** Draws the object from corner to corner. You can change the center location by moving the mouse.

**Center** Draws the object from the center out.

### Parameters rollout

The Parameters rollout is a vertical panel with a title bar that says "Parameters". It contains the following controls:

- Side Length: 0.0
- Front Length: 0.0
- Side Width: 0.0
- Front Width: 0.1
- Height: 0.0
- Side Segs: 1
- Front Segs: 1
- Width Segs: 1
- Height Segs: 1
- Generate Mapping Coords.
- Real-World Map Size

**Side/Front Length** Specify the lengths of each "leg" of the L.

**Side/Front Width** Specify the widths of each "leg" of the L.

**Height** Specifies the height of the object.

**Side/Front Segs** Specify the number of segments for a specific "leg" of the object.

**Width/Height Segs** Specify the number of segments for the overall width and height.

---

**NOTE** The object's dimensions (Back, Side, Front) are labeled as though it were created in the Top or Perspective viewports, and seen from the front in world space.

---

**Generate Mapping Coords** Sets up the required coordinates for applying mapped materials to the object. Default=on.

**Real-World Map Size** Controls the scaling method used for texture mapped materials that are applied to the object. The scaling values are controlled by the Use Real-World Scale settings found in the applied material's [Coordinates rollout](#) on page 5620 . Default=off.

## Gengon Extended Primitive

Create panel > Geometry button > Extended Primitives > Object Type rollout > Gengon button

Create menu > Extended Primitives > Gengon

Use Gengon to create an extruded, regular-sided polygon with optionally filleted side edges.

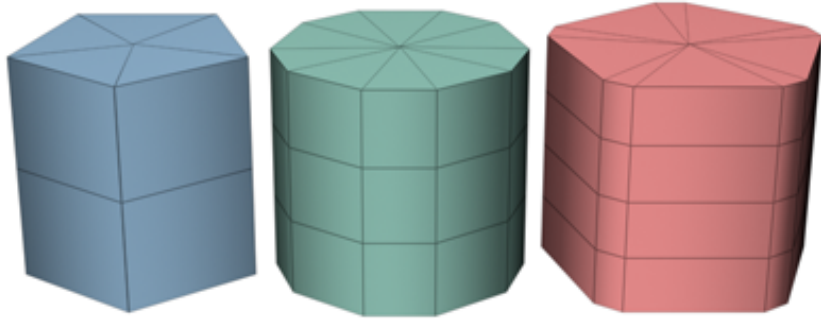

#### Examples of gengons

#### Procedures

##### To create a gengon:

- 1 From the Create menu, choose Extended Primitives > Gengon.
- 2 Set the Sides spinner to specify the number of side wedges in the gengon.
- 3 Drag the mouse to create the radius of the gengon.
- 4 Release the mouse button, then move the mouse vertically to define the height of the gengon. Click to set the height.
- 5 Move the mouse diagonally to specify the size of the chamfer along the side angles (toward the upper left to increase the size; toward the lower right to decrease it).
- 6 Click to finish the gengon.

---

**TIP** In the Parameters rollout, increase the Fillet Segs spinner to round the chamfered corners into fillets.

---

## Interface

### Creation Method rollout

**Edge** Draws the object from edge to edge. You can change the center location by moving the mouse.

**Center** Draws the object from the center out.

### Parameters rollout

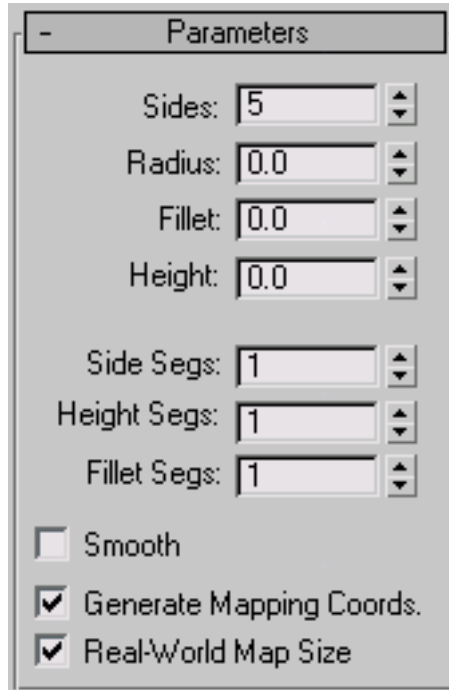

**Sides** Sets the number of sides around the gengon. Higher numbers shade and render as true circles with Smooth on. Lower numbers create regular polygonal objects with Smooth off.

**Radius** Sets the radius of the gengon.

**Fillet** Sets the width of the chamfered corners.

**Height** Sets the dimension along the central axis. Negative values create the gengon below the construction plane.

**Side Segs** Sets the number of divisions around the gengen.

**Height Segs** Sets the number of divisions along the gengen's major axis.

**Fillet Segs** Sets the number of divisions for the edge filleting. Increasing this setting will produce round, filleted corners instead of chamfers.

**Smooth** Blends the faces of the gengen, creating a smooth appearance in rendered views.

**Generate Mapping Coords** Sets up the required coordinates for applying mapped materials to the gengen. Default=on.

**Real-World Map Size** Controls the scaling method used for texture mapped materials that are applied to the object. The scaling values are controlled by the Use Real-World Scale settings found in the applied material's [Coordinates rollout](#) on page 5620 . Default=off.

## C-Ext Extended Primitive

Create panel > Geometry > Extended Primitives > Object Type rollout > C-Ext button

Create menu > Extended Primitives > C-Extrusion

Use C-Ext to create an extruded C-shaped object.



Example of C-Ext



## Procedures

### To create a C-Ext object:

- 1 From the Create menu, choose Extended Primitives > C-Extrusion.
- 2 Drag the mouse to define the base. (Press Ctrl to constrain the base to a square.)
- 3 Release the mouse and move it vertically to define the height of the C-extrusion.
- 4 Click, and then move the mouse vertically to define the thickness or width of the walls of the C-extrusion.
- 5 Click to finish the C-extrusion.

## Interface

### Creation Method rollout

**Corners** Draws the object from corner to corner. You can change the center location by moving the mouse.

**Center** Draws the object from the center out.

## Parameters rollout

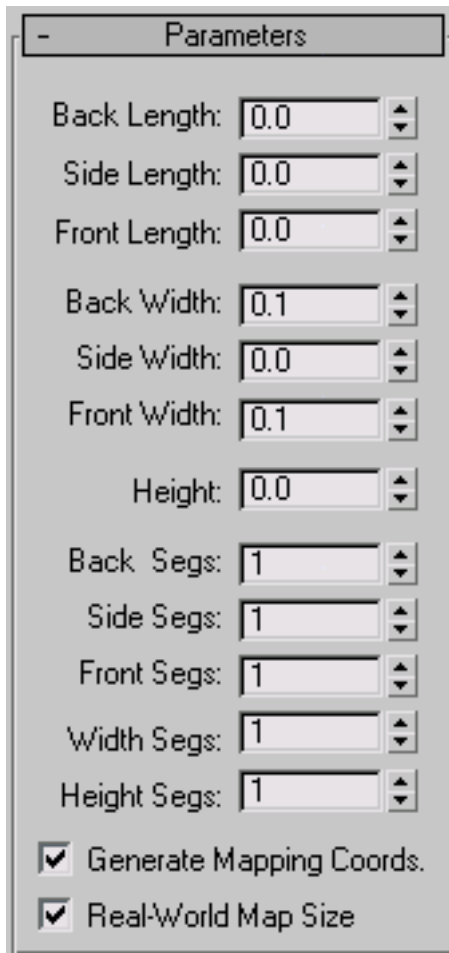

The image shows a 'Parameters' dialog box with a title bar containing a minus sign and the text 'Parameters'. The dialog contains several input fields and checkboxes. The input fields are arranged in two columns. The left column contains: 'Back Length: 0.0', 'Side Length: 0.0', 'Front Length: 0.0', 'Back Width: 0.1', 'Side Width: 0.0', 'Front Width: 0.1', 'Height: 0.0', 'Back Segs: 1', 'Side Segs: 1', 'Front Segs: 1', 'Width Segs: 1', and 'Height Segs: 1'. Each of these fields has a small up/down arrow icon to its right. The right column contains two checked checkboxes: 'Generate Mapping Coords.' and 'Real-World Map Size'.

**Back/Side/Front Length** Specify the length of each of the three sides.

**Back/Side/Front Width** Specify the width of each of the three sides.

**Height** Specifies the overall height of the of the object.

**Back/Side/Front Segs** Specify the number of segments for a specific side of the object.

---

**NOTE** The object's dimensions (Back, Side, Front) are labeled as though it were created in the Top or Perspective viewports, and seen from the front in world space.

---

**Width/Height Segs** Set these to specify the number of segments for the overall width and height of the object.

**Generate Mapping Coords** Sets up the required coordinates for applying mapped materials to the object. Default=on.

**Real-World Map Size** Controls the scaling method used for texture mapped materials that are applied to the object. The scaling values are controlled by the Use Real-World Scale settings found in the applied material's [Coordinates rollout](#) on page 5620 . Default=off.

## RingWave Extended Primitive

Create panel > Geometry button > Extended Primitives > Object Type rollout > RingWave button

Create menu > Extended Primitives > RingWave

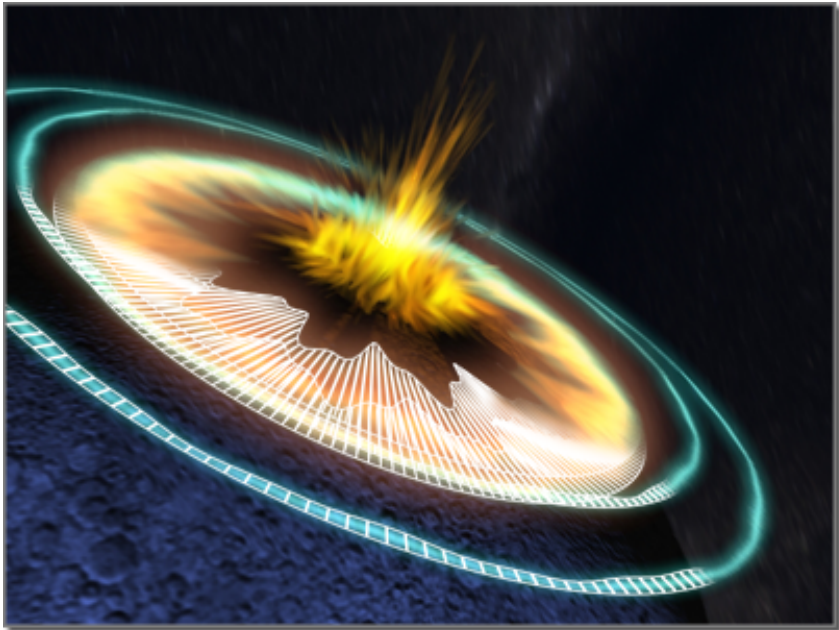

Example of ringwave

Use the RingWave object to create a ring, optionally with irregular inner and outer edges whose shapes can be animated. You can also animate the growth of the ringwave object, and you can use keyframing to animate all numeric settings. Use RingWave for various types of special-effects animation, for example, to depict the shock wave emanating from the explosion of a star or planet.

## **Procedures**

### **To create a basic animated ringwave:**

- 1 On the menu bar choose Create > Extended Primitives > Ringwave.
- 2 Drag in a viewport to set the outer radius of the ringwave.
- 3 Release the mouse button, and then move the mouse back toward the center of the ring to set the inner radius.
- 4 Click to create the ringwave object.
- 5 Drag the time slider to see the basic animation. This is determined by the Inner Edge Breakup group > Crawl Time settings.
- 6 To animate the ring's growth, choose RingWave Timing group > Grow And Stay or Cyclic Growth.

**Interface**

**Parameters rollout**

**Parameters**

**RingWave Size**

Radius: 500.0

Radial Segs: 1

Ring Width: 1.0

Sides: 200

Height: 0.0

Height Segs: 1

**RingWave Timing**

No Growth

Grow and Stay

Cyclic Growth

Start Time: 0

Grow Time: 60

End Time: 100

**Outer Edge Breakup**

On

Major Cycles: 1

Width Flux: 0.0 %

Crawl Time: 100

Minor Cycles: 1

Width Flux: 0.0 %

Crawl Time: -100

**Inner Edge Breakup**

On

Major Cycles: 11

Width Flux: 25.0 %

Crawl Time: 121

Minor Cycles: 29

Width Flux: 10.0 %

Crawl Time: -27

**Surface Parameters**

Texture Coordinates

Smooth

## RingWave Size group

Use these settings to change the ringwave's basic parameters.

**Radius** Sets the outside radius of the ringwave.

**Radial Segs** Sets the segment count between the inner and outer surfaces in the direction of the radius.

**Ring Width** Sets the mean ring width as measured inward from the outer radius.

**Sides** Sets the number of segments in the circumferential direction for both the inner, outer, and end (cap) surfaces.

**Height** Sets the height of the ringwave along its major axis.

---

**TIP** If you leave the Height at 0 for an effect like a shock wave, you will want to apply a two-sided material so that the ring can be seen from both sides.

---

**Height Segs** Sets the number of segments in the direction of the height.

## RingWave Timing group

Use these settings for ringwave animation where the ringwave grows from nothing to its full size.

**No Growth** Sets a static ringwave, which appears at Start Time and disappears after End Time.

**Grow and Stay** Animates a single growth cycle. The ringwave begins growing at the Start Time and reaches its full size at Start Time plus Grow Time.

**Cyclic Growth** The ringwave grows repeatedly from the Start Time to Start Time plus Grow Time.

For example, if you set Start Time to 0 and Grow Time to 25, leaving End Time at the default value of 100, and choose Cyclic Growth, the ringwave grows from nothing to its full size four times over the course of the animation.

**Start Time** The frame number where the ringwave appears, and begins to grow if you choose Grow and Stay or Cyclic Growth.

**Grow Time** The number of frames after Start Time the ringwave takes to reach full size. Grow Time is available only if Grow and Stay or Cyclic Growth is chosen.

**End Time** The frame number after which the ringwave disappears.

## Outer Edge Breakup group

Use these settings to change the shape of the ringwave's outer edge.

---

**TIP** For effects like shock waves, the ringwave typically has little or no breakup on the outer edge but relatively massive breakup on the inner edge.

---

**On** Turns on breakup of the outer edge. The remaining parameters in this group are active only when this is on. Default=off.

**Major Cycles** Sets the number of major waves around the outer edge.

**Width Flux** Sets the size of the major waves, expressed as a percentage of the unmodulated width.

**Crawl Time** Sets the number of frames each major wave takes to move around the outer circumference of the RingWave.

**Minor Cycles** Sets the number of random-sized smaller waves in each major cycle.

**Width Flux** Sets the average size of the smaller waves, expressed as a percentage of the unmodulated width.

**Crawl Time** Sets the number of frames each minor wave takes to move across its respective major wave.

## Inner Edge Breakup group

Use these settings to change the shape of the ringwave's inner edge.

**On** Turns on the breakup of the inner edge. The remaining parameters in this group are active only when this is on. Default=on.

**Major Cycles** Sets the number of major waves around the inner edge.

**Width Flux** Sets the size of the major waves, expressed as a percentage of the unmodulated width.

**Crawl Time** Sets the number of frames each major wave takes to move around the inner circumference of the RingWave.

**Minor Cycles** Sets the number of random-sized smaller waves in each major cycle.

**Width Flux** Sets the average size of the smaller waves, expressed as a percentage of the unmodulated width.

**Crawl Time** Sets the number of frames each minor wave takes to move across its respective major wave.



---

**NOTE** Negative values in the Crawl Time parameters change the direction of the wave. To produce interference patterns, use Crawl Time settings of opposite sign for major and minor waves, but similar Width Flux and Cycles settings.

---

**TIP** To produce the best "random" results, use prime numbers for major and minor cycles that differ by a multiple of two to four. For example, a major wave of 11 or 17 cycles using a width flux of 50 combined with a minor wave of 23 or 31 cycles with a width flux of 10 to 20 makes a nice random-appearing edge.

---

**Texture Coordinates** Sets up the required coordinates for applying mapped materials to the object. Default=on.

**Smooth** Applies smoothing to the object by setting all polygons to smoothing group 1. Default=on.

## Prism Extended Primitive

Create panel > Geometry button > Extended Primitives > Object Type rollout > Prism button

Create menu > Extended Primitives > Prism

Use Prism to create a three-sided prism with independently segmented sides.

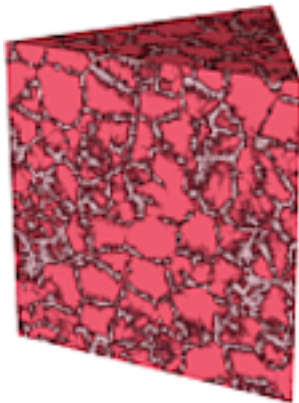

Example of a prism

## Procedures

### To create a prism with an isosceles triangle as its base:

- 1 Choose Isosceles on the Creation Method rollout.
- 2 Drag horizontally in the viewport to define the length of Side 1 (along the X axis). Drag vertically to define the length of Sides 2 and 3 (along the Y axis).  
(To constrain the base to an equilateral triangle, press Ctrl before performing this step.)
- 3 Release the mouse, and move it vertically to define the height of the prism.
- 4 Click to complete the prism.
- 5 On the Parameters rollout, alter the length of the sides as needed.

### To create a prism with a scalene or obtuse triangle at its base:

- 1 Choose Base/Apex in the Creation Method rollout.
- 2 Drag horizontally in the viewport to define the length of Side 1 (along the X axis). Drag vertically to define the length of Sides 2 and 3 (along the Y axis).
- 3 Click, and then move the mouse to specify the placement of the apex of the triangle. This alters the length of sides 2 and 3, and the angles of the corners of the triangle.
- 4 Click, and then move the mouse vertically to define the height of the prism.
- 5 Click to complete the prism.

## Interface

### Creation Method rollout

**Isosceles** Draws a prism with an isosceles triangle at its base.

**Base/Apex** Draws a prism with a scalene or obtuse triangle at its base.

## Parameters rollout

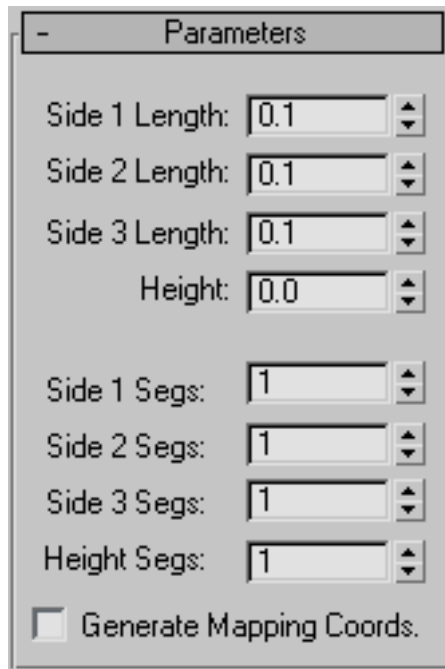

**Side (n) Length** Sets the length of triangle's corresponding side (and thus the triangle's corner angles).

**Height** Sets the dimension of the prism's central axis.

**Side (n) Segs** Specifies the number of segments for each side of the prism.

**Height Segs** Sets the number of divisions along the prism's central axis.

**Generate Mapping Coordinates** Sets up the required coordinates for applying mapped materials to the prism. Default=off.

## Hose Extended Primitive

Create panel > Geometry > Extended Primitives > Object Type rollout > Hose button

Create menu > Extended Primitives > Hose

The Hose object is a flexible object that you can connect between two objects, whereupon it reacts to their movement. It's similar to [Spring](#) on page 820 , but does not have dynamics properties. You can specify the overall diameter and length of the hose, the number of turns, and the diameter and shape of its "wire."

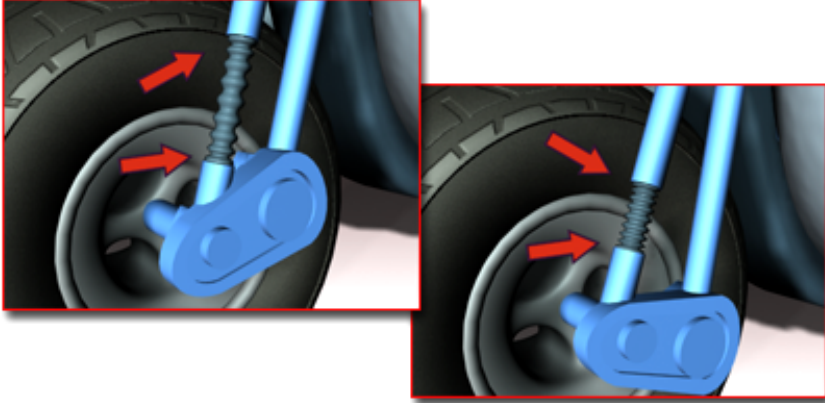

Hose models a workable spring on a motorcycle

## Procedures

### To create a hose:

- 1 From the menu bar, choose Create > Extended Primitives > Hose.
- 2 Drag the mouse to define the radius of the hose.
- 3 Release the mouse, and then move it to define the length of the hose.
- 4 Click to finish the hose.

### To bind a hose to two objects:

- 1 Add a hose and two other objects. Select the hose.
- 2 In the Modify panel > Hose Parameters rollout > End Point Method group, choose Bound To Object Pivots.
- 3 In the Binding Objects group, click Pick Top Object, and then select one of the two objects.
- 4 In the Binding Objects group, click Pick Bottom Object, and then select the second of the two objects.

The two ends of the hose attach themselves to the two objects.

- 5 Move one of the objects.

The hose adjusts itself to remain attached to both objects.

## Interface

### Hose Parameters rollout > End Point Method group

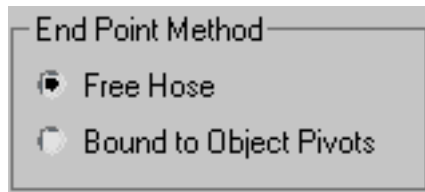

**Free Hose** Choose this when using the hose as a simple object that's not bound to other objects.

**Bound to Object Pivots** Choose this when binding the hose to two objects, using the buttons in the Binding Objects group.

### Hose Parameters rollout > Binding Objects group

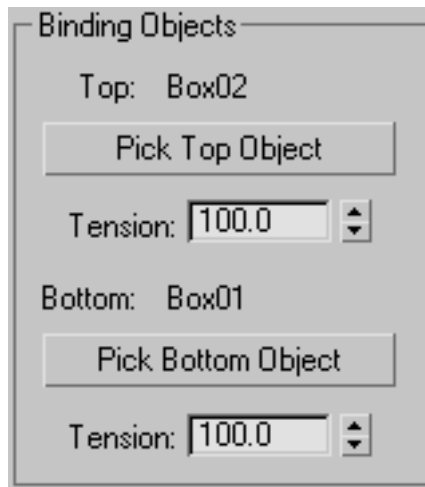

Available only when Bound To Object Pivots is chosen. Use the controls to pick the objects to which the hose is bound and to set the tension between

them. "Top" and "Bottom" are arbitrary descriptors; the two bound objects can have any positional relationship to each other.

Each end point of the hose is defined by the center of the overall diameter. This end point is placed at the pivot point of the object to which it is bound. You can adjust the relative position of the binding object to the hose by transforming the binding object while the Affect Object Only button is turned on in the Hierarchy panel > Adjust Pivot rollout.

**Top (label)** Displays the name of the "top" binding object.

**Pick Top Object** Click this button and then select the "top" object.

**Tension** Determines the tension of the hose curve near the Top object as it reaches for the Bottom object. Lower the tension to have the bend occur closer to the Top object, raise the tension to have the bend occur further away from the Top object. Default=100.

**Bottom (label)** Displays the name of the "bottom" binding object.

**Pick Bottom Object** Click this button and then select the "bottom" object.

**Tension** Determines the tension of the hose curve near the Bottom object as it reaches for the Top object. Lower the tension to have the bend occur closer to the Bottom object, raise the tension to have the bend occur further away from the Bottom object. Default=100.

#### **Hose Parameters rollout > Free Hose Parameters group**

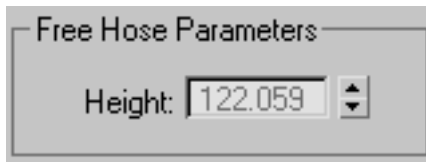

**Height** Use this field to set the straight-line height or length of the hose when it is not bound. This is not necessarily the actual length of the hose. Available only when Free Hose is chosen.

## Hose Parameters rollout > Common Hose Parameters group

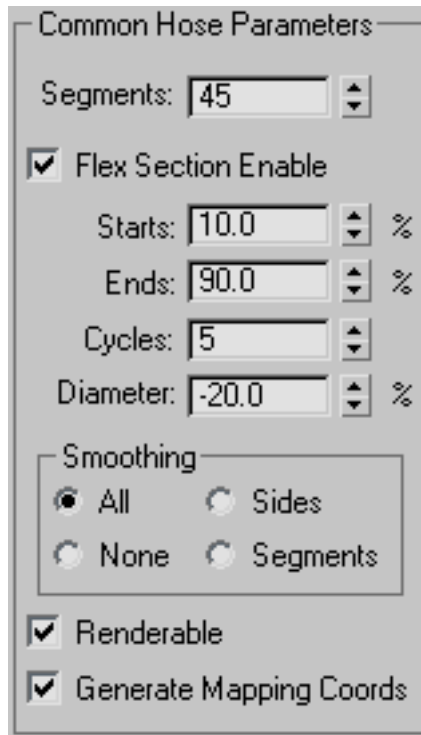

**Segments** The total number of segments in the hose's length. Increase this setting for a smooth profile when the hose is curved. Default=45.

**Flex Section Enable** When on, lets you set the following four parameters for the central, flexible section of the hose. When off, the hose's diameter is uniform throughout its length.

**Starts** The percentage of the hose length from the starting extremity of the hose at which the flex section begins. By default, the starting end of the hose is the end at which the object pivot appears. Default=10%.

**Ends** The percentage of the hose length from the end extremity of the hose at which the flex section ends. By default, the end extremity of the hose is opposite the end at which the object pivot appears. Default=90%.

**Cycles** The number of corrugations in the flex section. The number of visible cycles is limited by the number of segments; if Segments isn't high enough to support the number of cycles, then not all cycles will appear. Default=5.

---

**TIP** To set the appropriate number of segments, first set Cycles, and then increase Segments until the number of visible cycles stops changing.

---

**Diameter** The relative width of the "outside" parts of the cycles. At negative settings, these are smaller than the overall hose diameter. At positive settings, these are larger than the overall hose diameter. Default=-20%. Range=-50% to 500%.

**Smoothing** Defines the geometry that gets smoothed. Default=All:

- **All** The entire hose is smoothed.
- **Sides** Smoothing is applied along the length of the hose but not around its circumference.
- **None** No smoothing is applied.
- **Segments** Smoothing is applied only on the inner section of the hose.

**Renderable** When on, the hose is rendered using the specified settings. When off, the hose is not rendered. Default=on.

**Generate Mapping Coords** Sets up required coordinates for applying mapped materials to the hose. Default=on.



## Hose Parameters rollout > Hose Shape group

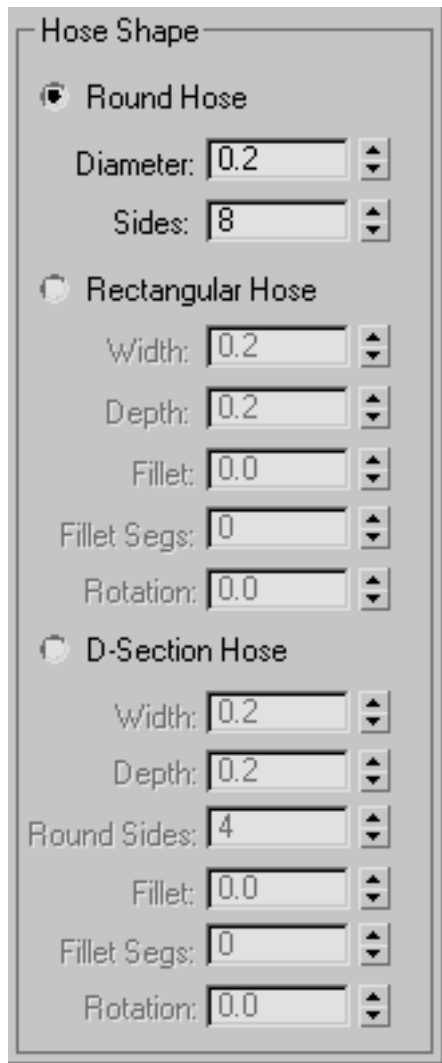

Sets the shape of the hose cross section. Default=Round Hose.

**Round Hose** Sets a circular cross section.

**Diameter** The maximum width of the hose at the ends.

**Sides** The number of sides of the hose. A Sides setting of 3 gives a triangular cross section; 4 gives a square cross section; and 5 gives a pentagonal cross section. Increase Sides for a circular cross section. Default=8.

**Rectangular Hose** Lets you specify different settings for width and depth.

**Width** The width of the hose.

**Depth** The height of the hose.

**Fillet** The amount by which the cross-section corners are rounded. For this to be visible, Fillet Segs must be set to 1 or higher. Default=0.

**Fillet Segs** The number of segments across each filleted corner. A Fillet Segs setting of 1 cuts the corner straight across; use higher settings for rounded corners. Default=0.

**Rotation** The orientation of the hose along its long axis. Default=0.

**D-Section Hose** Similar to Rectangular Hose, but rounds one side for a D-shaped cross-section.

**Width** The width of the hose.

**Depth** The height of the hose.

**Round Sides** The number of segments on the rounded side. Increase for a smoother profile. Default=4.

**Fillet** The amount by which the two cross-section corners opposite the rounded side are rounded. For this to be visible, Fillet Segs must be set to 1 or higher. Default=0.

**Fillet Segs** The number of segments across each filleted corner. A Fillet Segs setting of 1 cuts the corner straight across; use higher settings for rounded corners. Default=0.

**Rotation** The orientation of the hose along its long axis. Default=0.

## Architectural Objects

3ds Max provides an array of architectural objects, useful as building blocks for models of homes, businesses, and similar projects. These include:

[AEC Extended Objects](#) on page 433 : Foliage, Railing, and Wall

[Stairs](#) on page 471

[Doors](#) on page 502

[Windows](#) on page 516

## AEC Extended Objects

Create panel > Geometry > AEC Extended

Create menu > AEC Objects

AEC Extended objects are designed for use in the architectural, engineering, and construction fields. Use Foliage to create plants, Railing to create railings and fences, and Wall to create walls.

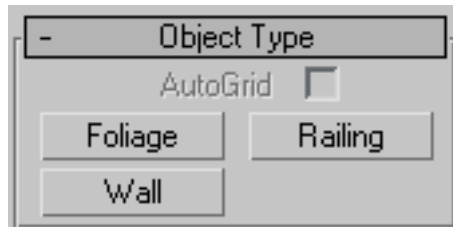

### Interface

[Foliage](#) on page 439

[Railing](#) on page 447

[Wall](#) on page 456

The [Object Name and Wireframe Color rollout](#) on page 7423 in each AEC Extended object's creation panel functions identically. The remaining rollouts are covered in each object's topic.

## Working with AEC Design Elements

3ds Max includes such features as Foliage, Doors, Windows, Stairs, Railing, and Wall to make exploring three-dimensional design ideas much easier.

This section provides general information about these features. For detailed explanations and procedures, see the topics listed below:

[Doors](#) on page 502

[Windows](#) on page 516

[Stairs](#) on page 471

[Railing](#) on page 447

[Wall](#) on page 456

[Foliage](#) on page 439

## **Doors and Windows**

3ds Max supplies a number of parametric window and door objects that you can place into wall openings to add realism to an architectural model. These objects let you control details like trim and panel fill in your model.

---

**TIP** Use [Snaps](#) on page 2587 for added precision when adding doors and windows.

---

When you create a new door or window, you must select four points in the scene that define the size and orientation of the rectangle that will be the door or window. You may find it easier to select these points in a given sequence, depending on your scene and views of the scene.

If you already have a rectangular hole you want to fill, you can still create a door or window to your specifications by using the following procedure.

### **To create a door or window:**

- 1** Set up an angled User view so that you can see the bottom and one vertical edge of the opening and its full height.
- 2** Set the appropriate object snaps, such as Vertex or Endpoint. This helps make the model more precise.
- 3** After clicking Window or Door, choose one of two Creation Methods: Width/Depth/Height or Width/Height/Depth.
- 4** Make parameter adjustments to define details.

The width and orientation of the door/window is always defined by the first mouse click and subsequent mouse drag. Depending on the creation method you use, either the height or depth of the object is defined next.

If you have no object snaps set and are working in a Perspective or User Viewport, using the Width/Depth/Height Creation Method creates an upright Door or Window. The Width/Height/Depth Creation Method creates the object as if it were lying on its side.

## Allowing Non-vertical Jambs

The Allow Non-vertical Jambs toggle is useful for creating doors or windows that do not fit in a vertical plane, such as a skylight window in a sloping roof. By default, this toggle is off, making the third point in the creation sequence either directly above (Width/Height/Depth) or on the same horizontal plane (Width/Depth/Height) with the second point.

When you turn on Allow Non-vertical Jambs, the third point in the creation sequence falls wherever you choose and the fourth point is added by the program. Its offset from the plane is determined by the first three points.

Using the Width/Height/Depth Creation Method in Perspective and User viewports with Allow Non-vertical Jambs off can be an efficient way to create doors and windows with Object Snaps. However, it can also be confusing at first. Keep in mind that the third point you define, the Height, is interpreted as a point on the home grid until you indicate a point higher or lower than the grid. If you are using an Object Snap setting, 3ds Max might not know you mean a point off the grid unless you bring the cursor in proximity to a nonplanar point to which it can snap.

## Additional Parameters

There are additional parameters specific to each door and window type that control overall dimension parameters, as well as detailed parameters for sub-object components such as mullions, trim, and panels within leaves. See [Doors](#) on page 502 and [Windows](#) on page 516 for more information on these parameters.

## Animating Doors and Windows

Certain door and window creation parameters, including the Open parameter, can be animated. See [Doors](#) on page 502 and [Windows](#) on page 516 for more information.

## Creating Stairs and Railings

3ds Max contains four types of stair objects: [spiral stairs](#) on page 480 , [U-type stairs](#) on page 495 with an intermediate landing, [L-type stairs](#) on page 473 with a landing at the bend in the stair, and [straight stairs](#) on page 488 with no intermediate landing. A complementary Railing object can be used to create any number of handrail designs that follow along a spline path.

For more information, see [Stairs](#) on page 471 .

## The Railing Object

Use the Railing button on the Create panel in the to produce railing objects. Railing components include rails, [AEC Extended category](#) on page 433 posts, and fencing. Fencing includes pickets (balusters) or solid-filled material (such as glass or wood strips).

You can create a railing in two ways: specify the orientation and height of the railing, or pick a spline path and apply the railing to that path. The spline path with a railing is called a rail path. Later, if you edit the rail path, the Railing object automatically updates to follow the changes you make. Rail paths can occupy three-dimensional space.

When you create the lower rails, posts, and fencing components of a Railing object, you use a special version of the Spacing Tool to specify the spacing of those components. The program displays the Spacing Tool dialog for each railing component: Lower Rail, Post Spacing, or Picket Spacing. For more information on the Spacing Tool, see [Spacing Tool](#) on page 925 .

For details on Railing parameters and information on creating a Railing object, see [Railing](#) on page 447 .

## Creating Walls

Use the [Wall button](#) on page 456 on the Create panel, in the AEC Extended category, to produce straight-wall objects. A wall object is made up of sub-object segments that you can edit with the Modify panel.

You can:

- Break or insert wall segments to create separate wall objects.
- Delete wall segments.
- Connect two wall objects.

When you create two wall segments that meet at a corner, 3ds Max removes any duplicate geometry. This “cleaning up” of the corners might involve trimming. 3ds Max cleans up only the first two wall segments of a corner, not other wall segments that might share the corner. 3ds Max does not clean up intersections.

You can edit the segments of a wall using sub-object selection mode on the Modify panel. For example, you can define a wall’s height profile. 3ds Max moves the active grid to the plane of the wall you’re editing. This allows you to snap to the profile vertices in the plane of the wall.

If you move, scale, or rotate the wall object, the linked door and window moves, scales, or rotates along with the wall. If you move the linked door or window along the wall, using the door or window's Local coordinate system and activating Restrict to XY Plane in the [Axis Constraints toolbar](#) on page 884 , the opening will follow. Also, if you change a door or window's overall width and height in the Modify panel, the hole will reflect those changes.

## Usage Tips

The following are a few tips for working with wall objects:

- Use the Top viewport when creating wall objects.
- Single walls with many windows and doors can slow down snap calculations and movement of the wall object. To speed up insertion and editing, use multiple walls instead of a single wall.
- You can speed up performance in a scene with many walls, windows, and doors by collapsing them. First save an uncollapsed version for any future parametric changes you might want to make. Then right-click the wall and pick Select Children from the right-click menu. Next use Collapse in the Utility rollout to collapse them all.

For complete information, see [Wall](#) on page 456 .

### To create a wall:

- 1 On the Create panel, in the AEC Extended category, click Wall.
- 2 Use Customize > Units Setup to establish precision, and then set the parameters for the Width, Height, and Justification of the wall.
- 3 In any viewport, click, release the mouse, drag the wall segment to the length you want and click again.  
This creates a wall segment. You can end the wall or you can continue to create another wall segment.
- 4 To complete the wall, right-click, or to add another wall segment, drag the next wall segment to the length you want and click again.  
If you create a room by ending a segment at the end of another segment of the same wall object, the program displays the Weld Point dialog. This dialog lets you convert the two end vertices into a single vertex, or keep the two end vertices separate.

- 5 If you want the wall segments to be welded at a corner (when you move one wall, the other wall stays at the corner), click Yes. Otherwise, click No.
- 6 Right-click to complete the wall, or continue to add another wall segment.

#### **To attach separate walls:**

- 1 Select a wall object.
- 2 On the Modify panel, click Attach, and then pick another wall object.  
The two wall objects become part of the same wall object, but are not physically connected.  
Attach stays active, and you can continue clicking wall segments to attach. To stop attaching, click the Attach button or right-click in the active viewport.  
To attach multiple wall objects simultaneously to the selected wall object, click Attach Multiple on the Modify panel to open the Attach Multiple dialog. This works the same as the [Select From Scene dialog](#) on page 168, except that it shows only wall objects; choose multiple walls to attach, and then click the Attach button.

#### **To connect vertices in a wall:**

This method lets you connect two separate wall sections with a new segment.

---

**TIP** It is easier to work with wall vertices in wireframe view mode.

---

- 1 Select a wall object that has more than one section. Typically you would use Attach to create such an object.
- 2 In the [modifier stack](#) on page 7427, go to the Vertex sub-object level.
- 3 Click Connect and point the mouse over an end vertex until the cursor changes to a cross.
- 4 Click once over the end vertex.
- 5 Move the cursor to another end vertex, and then click to connect the two segments.



### To insert a vertex in a wall:

It is easier to work with wall vertices in wireframe view mode.

- 1 Select a wall segment.
- 2 In the [modifier stack](#) on page 7427 , go to the Vertex sub-object level.
- 3 Click Insert.  
A highlighted line appears along the bottom of the wall, showing where you can insert vertices.
- 4 Click anywhere on the highlighted line to insert a vertex.  
The new vertex is attached to the mouse cursor.
- 5 Move the mouse to position the vertex, and then click to place it.  
Now the mouse is attached to one of the new segments.
- 6 Move the mouse along the segment and click to add vertices.
- 7 Right-click to finish working on this segment. You can now insert vertices in other segments, or right-click again to exit Insert mode.

## Foliage

Create panel > Geometry > AEC Extended > Foliage button

Create menu > AEC Objects > Foliage

Foliage produces various types of plant objects such tree species. 3ds Max generates mesh representations to create fast, efficient, and good-looking plants.



You control height, density, pruning, seed, canopy display, and level of detail. The [seed](#) on page 445 option controls creation of different representations of the same species. You can create millions of variations of the same species, so each object can be unique. With the [viewport canopy mode](#) on page 446 option, you can control the amount of plant detail, reducing the number of vertices and faces 3ds Max uses to display the plant.

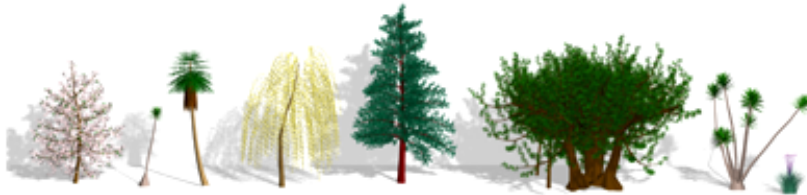

Some of the plants that can be created from the standard library

### Tips

- Use the [Spacing tool](#) on page 925 to place plants along a path.

- Use vertex or face snapping (see [Snaps Settings](#) on page 2578 ) to position plants on a surface.

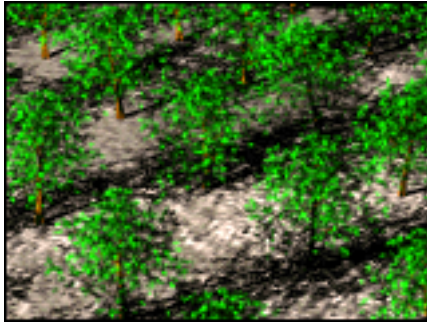

Using the Spacing tool to distribute trees along paths

## Procedures

### To add plants to a scene:

- 1 Click the Favorite Plants rollout > Plant Library button to display the Configure Palette dialog.
- 2 Double-click the row for each plant you want to add or remove from the Palette and click OK.
- 3 On the Favorite Plants rollout, select a plant and drag it to a location in a viewport. Alternatively, select a plant in the rollout and then click in the viewport to place the plant.
- 4 On the Parameters rollout, click the New button to display different seed variations of the plant.
- 5 Adjust the remaining parameters to show elements of the plants, such as leaves, fruit, branches, and if you want, to view the plant in canopy mode.

## Interface

### Object Name and Wireframe Color rollout

This rollout lets you set the foliage object's name, color, and default material. For detailed information, see [Object Name and Wireframe Color](#) on page 7423.

When Favorite Plants rollout > Automatic Materials is on, each plant is assigned its own default material. For more information, see Favorite Plants rollout, following.

### Keyboard Entry rollout

See [Creating Primitives from the Keyboard](#) on page 346 .

### Favorite Plants rollout



The palette displays the plants currently loaded from the [Plant Library](#) on page 443 . There are three ways to add a plant to the scene:

- Use keyboard entry.
- Click the icon in the Favorite Plants list and then click a location in a viewport. Double-click the icon to place the plant at the world origin.
- Drag the plant from the palette and drop it into a viewport.

**Automatic Materials** Assigns default materials for the plant. To modify these material assignments, use the [Material Editor](#) on page 5188 . Select the plant in the viewport, and click Main toolbar > Material Editor. Click the [Get Material button](#) on page 5245 to display the Material/Map Browser. Under Browse From, choose Selected. Then, from the list pane, double-click the material list item for the plant to display the materials in the Basic Parameters rollout of the Material Editor.

If you turn off Automatic Materials, 3ds Max assigns no materials to the object, unless the Name And Color rollout > Default Material check box is on and a default material is assigned. This way you can specify a particular default material for *all* foliage objects. For more information, see [Object Name and Wireframe Color](#) on page 7423 .

When on, Automatic Materials overrides the Default Material settings.

---

**NOTE** Even if Automatic Materials is off, 3ds Max still assigns material IDs to the foliage objects, so that the object is ready for a multi/sub-object material.

---

**Plant Library** Displays the Configure Palette dialog. Using this window, you can view information on the available plants including their names, whether they're in the palette, their scientific names, types, descriptions, and the approximate number of faces per object. You can also add and remove plants from the palette, and clear the palette, which removes all plants from the palette.

---

**TIP** To quickly add or remove a plant from the palette, double-click its row in the Configure Palette dialog. The Fav. (Favorite Plants) column entry switches between "no" and "yes." Click OK to accept the changes and exit the window.

---

## Parameters rollout

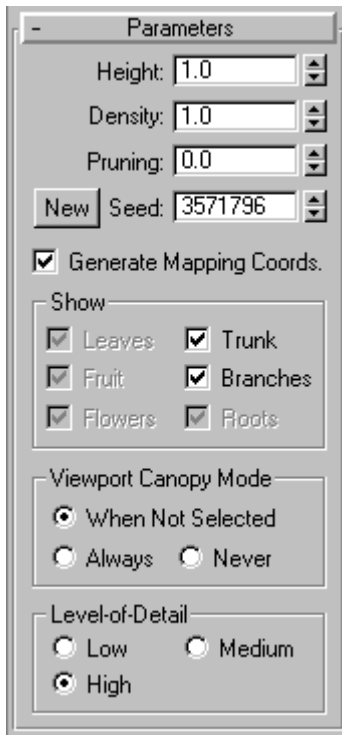

**Height** Controls the approximate height of the plant. 3ds Max applies a random noise factor to the height of all of the plants. Therefore, the actual height of a plant, as measured in the viewports, won't necessarily match the setting given in the Height parameter.

**Density** Controls the amount of leaves and flowers on the plant. A value of 1 displays a plant with all its leaves and flowers, .5 displays a plant with half its leaves and flowers, and 0 displays a plant with no leaves or flowers.

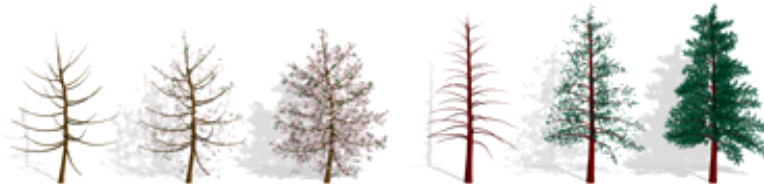

Two trees with varying foliage densities

**Pruning** Applies only to plants with branches. Removes branches that lie below an invisible plane parallel to the construction plane. A value of 0 prunes nothing, a value of .5 prunes the plant at a plane halfway up its height from the construction plane, and a value of 1 prunes everything possible from the plant. What 3ds Max prunes from the plant depends on the type of plant. The trunk is never pruned.

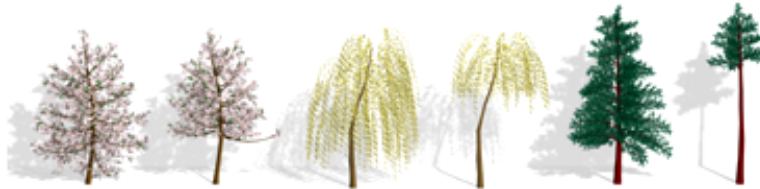

Three pairs of trees, showing different values of pruning

**New** Displays a random variation of the current plant. 3ds Max displays the seed value in the numeric field next to the button.

---

**TIP** Click the New button repeatedly until you find the variation you want. This is often easier than trying to adjust the tree using modifiers.

---

**Seed** A value between 0 and 16,777,215 representing the possible variations of branch and leaf placement and shape and angle of the trunk of the current plant.

**Generate Mapping Coords** Applies default [mapping coordinates](#) on page 7838 to the plant. Default=on.

### Show group

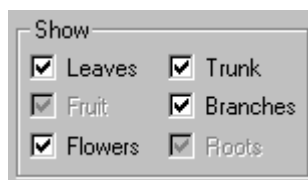

Controls the display of leaves, fruit, flowers, trunk, branches, and roots of plants. Available options depend on the type of plant you select. For example, if a plant doesn't have fruit, 3ds Max disables that option. Turning off options reduces the number of vertices and faces displayed.

## Viewport Canopy Mode group

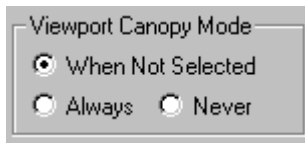

In 3ds Max, the canopy of a plant is a shell covering the outermost parts of the plant, such as the leaves or the tips of the branches and trunk. The term derives from "forest canopy." Use reasonable parameters when you create many plants and want to optimize display performance.

Because this setting applies only to the plant's representation in the viewports, it has no effect on how 3ds Max renders the plant. For information on how 3ds Max renders the plant, see [Level-of-Detail](#) on page 446 .

**When Not Selected** Displays the plant in canopy mode when it's not selected.

**Always** Always displays the plant in canopy mode.

**Never** Never displays the plant in canopy mode. 3ds Max displays all the features of the plant.

## Level-of-Detail group

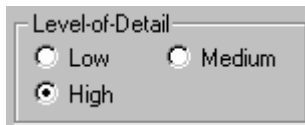

Controls how 3ds Max renders the plant. For information on how 3ds Max displays the plant in the viewports, see [Viewport Canopy Mode](#) on page 446 .

**Low** Renders the plant canopy, providing the lowest level of detail.

**Medium** Renders a reduced-face-count version of the plant. How 3ds Max reduces the face count varies from plant to plant, but it usually involves removing smaller elements of the plant or reducing the number of faces in the branches and trunk.

**High** Renders all the faces of the plant, providing the highest level of detail.

---

**TIP** Set the parameters before creating multiple plants. This can avoid slowing down the display, and might reduce editing you have to do on the plants.

---



# Railing

Create panel > Geometry > AEC Extended > Railing button

Create menu > AEC Objects > Railing

Components of the railing object include rails, posts, and fencing. Fencing includes either pickets (balusters) or solid-filled material, such as glass or wood strip.

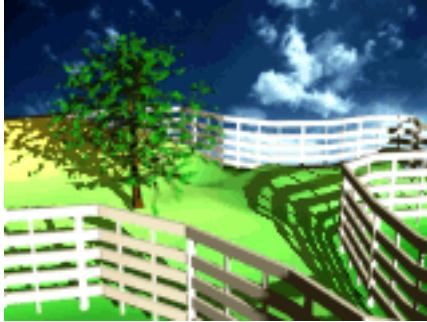

Railings used to create fences in a field.

You can create a railing object either by specifying the orientation and height of the railing, or by picking a spline path and applying the railing to that path. When 3ds Max applies railing to a spline path, the latter is called a *rail path*. Later, if you edit the rail path, the railing object automatically updates to follow the changes you made. You can use three-dimensional splines as rail paths.

When you create the lower rails, posts, and fencing components of a railing, you use the [Spacing tool](#) on page 925 to specify the spacing of those components. 3ds Max names the Spacing tool dialog for each railing component: Lower Rail Spacing, Post Spacing, or Picket Spacing.

---

**TIP** Use Railing to create complete railings for stairs. See [Stairs](#) on page 471 for more information.

---

## Railings and Materials

By default, 3ds Max assigns five different material IDs to railings. The *aec templates.mat* material library includes *Rail-Template*, a [multi/sub-object](#)

[material](#) on page 5558 designed to be used with railings. Each component of the railing/material is listed below along with its corresponding Material ID.

Material ID	Railing/Material Component
1	Lower rails
2	Posts of the railing
3	Solid fill of the railing
4	Top of the railing
5	Pickets of the railing

**NOTE** 3ds Max does not automatically assign a material to the railing object. To use the included material, open the library and then assign the material to your object.

## Procedures

The following procedures describe how to create railings combining each of the components: upper rail, lower rails, posts, picket fencing, and solid filled fencing.

You can create a railing object in any viewport, but for best results, use a Perspective, Camera, or Top viewport.

### To create a railing:

- 1 Click and drag the railing to the desired length.
- 2 Release the mouse button, and then move the mouse vertically to set the height. Click to finish.  
By default, 3ds Max creates the top rail along with two posts, a lower rail at half the railing height, and two evenly spaced pickets.
- 3 If you need to, change any of the parameters to adjust the segments, length, profile, depth, width, and height of the rail.

### To adjust lower rails:

- 1 To modify the lower rail, or add more, choose an option from the Lower Rail(s) group > Profile list.



- 2 Specify the depth and width for the lower rails and then click the Lower Rail(s) > Spacing button.
- 3 Specify the number of lower rails you want using the Count option. Click Close to apply your changes. For more information on spacing options in this dialog, see [Spacing Tool](#) on page 925 .

### To create posts:

- 1 If you want to modify the posts, or add more, choose an option from the Profile list under the Posts rollout.



- 2 Specify the depth and width of the posts and how much they should extend above the top rail. Then click the Posts rollout > Spacing button.
- 3 Specify the number of posts you want using the Count option. Click Close to apply your changes. For more information on spacing options in this dialog, see [Spacing Tool](#) on page 925 .

### To create picket fencing:

- 1 Choose Fencing rollout > Type list > Pickets. The Solid Fill options will be unavailable.



- 2 Choose an option from the Profile list, specify the depth and width of the pickets, and then click the Picket rollout > Spacing button.
- 3 Specify the number of pickets you want using the Count option. Click Close to apply your changes. For more information on spacing options in this dialog, [Spacing Tool](#) on page 925 .

### To create solid-fill fencing:

- 1 Choose Fencing rollout > Type list > Solid Fill. (The options under Picket are unavailable).

- 2 Under Solid Fill, adjust the options for Thickness and offsets.

### To create railings along a spline path:

Before you can create railings along a spline path, you need to create a spline, or use an existing spline from your scene.

- 1 Click Create panel > Geometry > AEC Extended > Railing.
- 2 Click Pick Railing Path, then select a spline in your scene.  
Since the number of segments is 1 by default, the upper rail extends for one segment between the start and end of the spline.
- 3 Change the amount of segments using the Modify panel > Segment setting.  
The higher the segment value, the more closely the railing approximates the spline shape.
- 4 If you want the railing to contain corners where the spline does, turn on Respect Corners.
- 5 Complete the remainder of the railing options as described in the preceding procedures.  
Thereafter, the spline is associated with the railing; any changes you make to the spline shape are reflected in the railing.

## Interface

### Name and Color rollout

This rollout lets you set the selected railing's name and color. For detailed information, see [Object Name and Wireframe Color](#) on page 7423 .

## Railing rollout

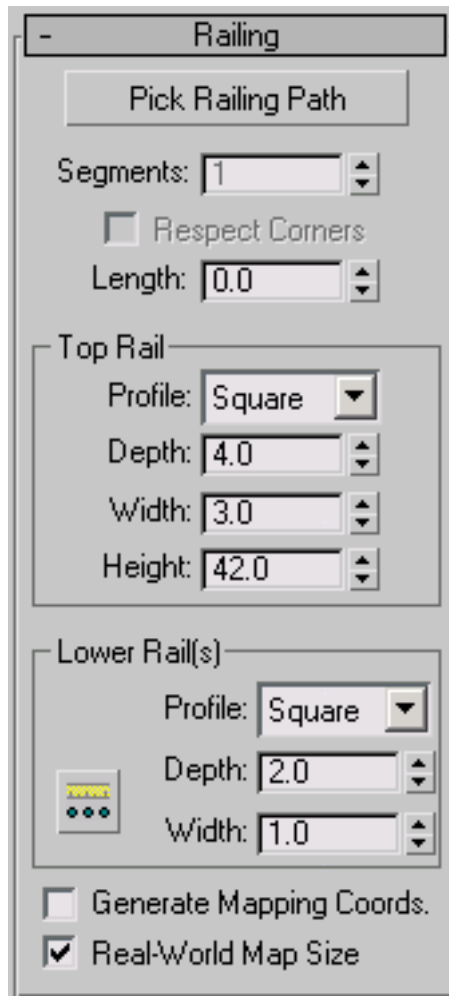

**Pick Railing Path** Click this, and then click a spline in the viewport to use as the railing path. 3ds Max uses the spline as the path along which to apply the railing object.

If you edit the spline you've used as a railing path, the railing adjusts to the changes you make. 3ds Max doesn't immediately recognize 2D Shapes from a linked AutoCAD drawing. To recognize Shapes from a linked AutoCAD drawing, edit the Shape with [Edit Spline](#) on page 1376 in the Modify panel.

---

**TIP** When you create a railing using a closed spline for the rail path, open the [Post Spacing dialog](#) on page 925 , turn off Start Offset and End Offset, and lock End Offset. This will ensure that 3ds Max properly creates the railing with any fill, pickets, and posts you specify.

---

**NOTE** Railing objects that use Pick Path do not stay on the path when substituted using the Substitute modifier. Substituted externally referenced railings do not undo when railings are associated with a path.

---

**Segments** Sets the number of segments of the railing object. Available only when you're using a railing path.

For a close approximation to a railing path, increase the number of segments. Be aware that a high number of segments increases file size and slows down the rendering speed. You might use fewer segments when the spline path has a low curvature (or none) and fewer segments provide an adequate approximation.

**Respect Corners** Puts corners in the railing to match the corners of the railing path.

**Length** Sets the length of the Railing object. When you drag the mouse, the length displays in the edit box.

### Top Rail group

The defaults produce a top rail component, consisting of one segment by the length you specify, a square profile, four units deep, three units wide, and the height you specify.

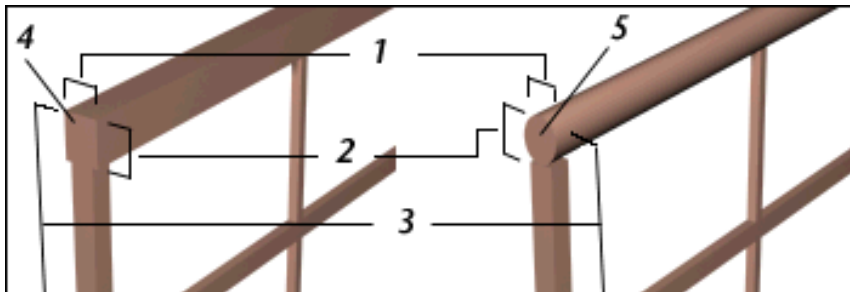

1. Width
2. Depth
3. Height
4. Profile for the square top rail

## 5. Profile for the round top rail

**Profile** Sets the cross-section shape of the top rail.

**Depth** Sets the depth of the top rail.

**Width** Sets the width of the top rail.

**Height** Sets the height of the top rail. During creation, you can drag the top rail to the height you want using the mouse in the viewport. Or you can enter the height amount from the keyboard or use the spinners.

## Lower Rail(s) group

Controls the profile, depth, width, and spacing between the lower rails. You specify how many lower rails you want using the Lower Rail Spacing button.

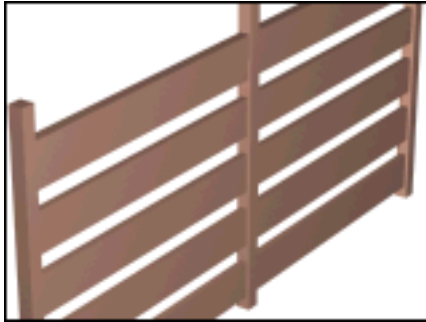

A railing with the rails defined by their profile, depth, and width as planks.

**Profile** Sets the cross-section shape of the lower rails.

**Depth** Sets the depth of the lower rails.

**Width** Sets the width of the lower rails.



**Lower Rail Spacing** Sets the spacing of the lower rails. When you click this button, the Lower Rail Spacing dialog displays. Specify the number of lower rails you want using the Count option. For more information on spacing options in this dialog, see [Spacing Tool](#) on page 925 .

**Generate Mapping Coords** Assigns [mapping coordinates](#) on page 7838 to the railing object.

---

**NOTE** If a visible viewport is set to a non-wireframe or non-bounding-box display, Generate Mapping Coordinates is on for all primitives to which you apply a material containing a map with Show Map In Viewport on. If all viewports are set to wireframe or bounding box, 3ds Max turns on Generate Mapping Coordinates for primitives containing mapped materials at render time.

---

**Real-World Map Size** Controls the scaling method used for texture mapped materials that are applied to the object. The scaling values are controlled by the Use Real-World Scale settings found in the applied material's [Coordinates rollout](#) on page 5620 . Default=off.

### Posts rollout

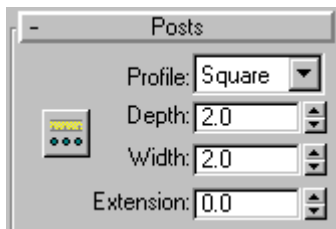

Controls the profile, depth, width, extension, and spacing between the posts. You specify how many posts you want using the Post Spacing button.

**Profile** Sets the cross-section shape of the posts: none, Square, or Round.

**Depth** Sets the depth of the posts.

**Width** Sets the width of the posts.

**Extension** Sets the amount the posts extend above the bottom of the top railing.



**Post Spacing** Sets the spacing of the posts. When you click this button, the Post Spacing dialog displays. Specify the number of posts you want using the Count option. For more information on spacing options in this dialog, see [Spacing Tool](#) on page 925 .

---

**TIP** Setting Profile to (none) makes an "invisible" post. You might want to do this to create a railing with gaps between solid fill fencing. Or you could use it to make a railing with openings between groups of pickets. This is different from setting the post count to 0 in the Post Spacing dialog.

---



## Fencing rollout

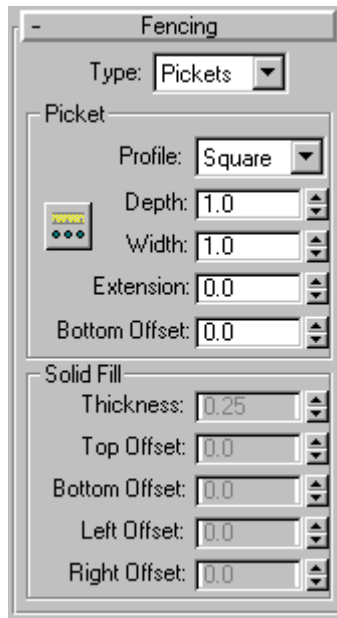

**Type** Sets the type of fencing between the posts: none, Pickets, or Solid Fill.

### Picket group

Controls the profile, depth, width, and spacing between the pickets. Specify how many pickets you want using the Picket Spacing button. Available only when you set Type to Pickets.

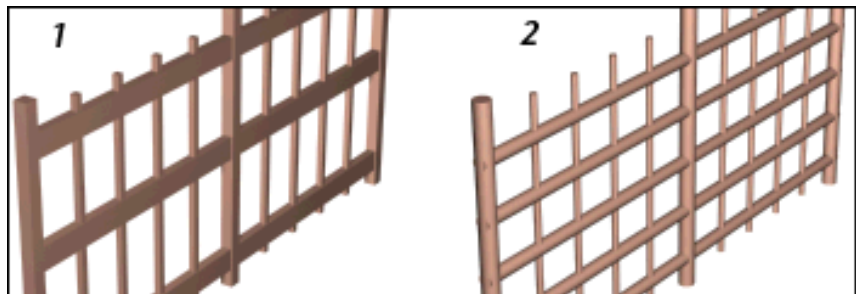

1. A railing with pickets using a square profile

2. A railing with pickets using a round profile

**Profile** Sets the cross-section shape of the pickets.

**Depth** Sets the depth of the pickets.

**Width** Sets the width of the pickets.

**Extension** Sets the amount the pickets extend above the bottom of the top railing.

**Bottom Offset** Sets the amount the pickets are offset from the bottom of the railing object.



**Picket Spacing** Sets the spacing of the pickets. When you click this button, the Picket Spacing dialog displays. Specify the number of pickets you want using the Count option. For more information on spacing options in this dialog, see [Spacing Tool](#) on page 925 .

## Solid Fill group

Controls the thickness and offsets of the solid fill between the posts. Available only when you set Type to Solid.

**Thickness** Sets the thickness of the solid fill.

**Top Offset** Sets the offset of the solid fill from the bottom of the top rail.

**Bottom Offset** Sets the offset of the solid fill from the bottom of the railing object.

**Left Offset** Sets the offset between the solid fill and the adjacent left post.

**Right Offset** Sets the offset between the solid fill and the adjacent right post.

## Wall

Create panel > Geometry > AEC Extended > Object Type rollout > Wall button

Create menu > AEC Objects > Wall

The Wall object is made up of three sub-object types that you can edit in the Modify panel. Similarly to the way you edit splines, you can edit the [wall object](#) on page 466 , its [vertices](#) on page 467 , its [segments](#) on page 468 , and its [profile](#) on page 469 .

When you create two wall segments that meet at a corner, 3ds Max removes any duplicate geometry. This "cleaning up" of the corners might involve trimming. 3ds Max cleans up only the first two wall segments of a corner, not

any other wall segments that might share the corner. 3ds Max does not clean up intersections.

## Inserting Doors and Windows in a Wall

3ds Max can automatically make openings for doors and windows in a wall. At the same time, it links the door or window to the wall as its child. The most effective way of doing both is to create the doors and windows directly on a wall segment by snapping to the faces, vertices, or edges of the wall object.

If you move, scale, or rotate the wall object, the linked door or window moves, scales, or rotates along with the wall. If you move the linked door or window along the wall, using the door or window's local coordinate system and [constraining motion to the XY plane](#) on page 7288, the opening will follow. Also, if you change a door or window's overall width and height on the Modify panel, the hole will reflect those changes.

For further information, see the procedure [To create and place a window or door in a wall](#) on page ? .

## Walls and Materials

By default, 3ds Max assigns five different material IDs to walls. The *aectemplates.mat* material library includes *Wall-Template*, a [multi/sub-object material](#) on page 5558 designed to be used with walls. Each component of the wall/material is listed below along with its corresponding Material ID.

Material ID	Wall/Material Component
1	Vertical ends of the wall
2	Outside of the wall
3	Inside of the wall
4	Top of the wall, including any edges cut out of the wall
5	Bottom of the wall

---

**NOTE** 3ds Max does not automatically assign a material to the wall object. To use the included material, open the library and then assign the material to your object.

---

**NOTE** The definitions of slots 2 and 3 are interchangeable; inside and outside simply depend on your point of view, and how you created the wall.

---

**See also:**

- [Editing Wall Objects](#) on page 466

**Tips**

- To make a passageway through a wall you can perform a [Boolean operation](#) on page 686 with the wall as Operand A, and another object, such as a box or an extruded archway shape, as Operand B. The wall will still be accessible at the Boolean sub-object level. Then, you can add a window or door in the passageway, and [link](#) on page 3267 it as a child of the wall.
- Single walls with many windows and doors can become slow to use because of the amount of boolean calculations used. To speed up movement and editing, you might consider using multiple walls instead of a single wall.
- You can speed up performance in a scene with many walls, windows and doors by collapsing them. First save an uncollapsed version for any future parametric changes you might want to make. Then double-click the wall to select it and its children. Next use Convert To from the right-click menu to convert them to an editable mesh, and so on.

**Procedures**

**To create a wall:**

You can create a wall in any viewport, but for vertical walls, use a Perspective, Camera, or Top viewport.

- 1 Set parameters for the Width, Height, and Justification of the wall.
- 2 In a viewport, click and release, move the mouse to set the desired length for the wall segment, and click again.

This creates a wall segment. You can end the wall by right-clicking or you can continue to create another wall segment.

- 3 To add another wall segment, move the mouse to set the length of the next wall segment and click again.  
If you create a room by ending a segment at the end of another segment of the same wall object, 3ds Max displays the Weld Point dialog. This dialog lets you convert the two end vertices into a single vertex, or to keep the two end vertices distinct.
- 4 If you want the wall segments to be welded at that corner so that when you move one wall, the other wall stays correct at the corner, click Yes. Otherwise, click No.
- 5 Right-click to end the wall, or continue to add other wall segments.

#### To attach separate walls:

- 1 Select a wall object.
- 2 On the Modify panel, click Attach, and then pick another wall object. The two wall objects become part of the same wall object, but are not physically connected.  
Attach stays active, and you can continue clicking wall segments to attach. To stop attaching, click the Attach button or right-click in the active viewport.  
To attach multiple wall objects simultaneously to the selected wall object, click Attach Multiple on the Modify panel to open the Attach Multiple dialog. This works the same as the [Select From Scene dialog](#) on page 168, except that it shows only wall objects; choose multiple walls to attach, and then click the Attach button.

#### To connect vertices in a wall:

This method lets you connect two separate wall sections with a new segment.

---

**TIP** It is easier to work with wall vertices in wireframe view mode.

---

- 1 Select a wall object that has more than one section. Typically you would use Attach to create such an object.
- 2 In the [modifier stack](#) on page 7427, go to the Vertex sub-object level.
- 3 Click Connect and point the mouse over an end vertex until the cursor changes to a cross.
- 4 Click once over the end vertex.

- 5 Move the cursor to another end vertex, and then click to connect the two segments.

#### To insert a vertex in a wall:

It is easier to work with wall vertices in wireframe view mode.

- 1 Select a wall segment.
- 2 In the [modifier stack](#) on page 7427 , go to the Vertex sub-object level.
- 3 Click Insert.  
A highlighted line appears along the bottom of the wall, showing where you can insert vertices.
- 4 Click anywhere on the highlighted line to insert a vertex.  
The new vertex is attached to the mouse cursor.
- 5 Move the mouse to position the vertex, and then click to place it.  
Now the mouse is attached to one of the new segments.
- 6 Move the mouse along the segment and click to add vertices.
- 7 Right-click to finish working on this segment. You can now insert vertices in other segments, or right-click again to exit Insert mode.

#### To detach and reorient a copy of a wall segment:

---

**TIP** It is easier to work with wall vertices in wireframe view mode.

---

- 1 Select a wall.
- 2 In the [modifier stack](#) on page 7427 , go to the Segment sub-object level.
- 3 Select a wall segment.
- 4 Turn on both Reorient and Copy, and then click Detach.
- 5 Enter a name for the new wall object in the Detach dialog or click OK to accept the default name.  
3ds Max copies the original wall's [Local coordinate system](#) on page 7830 when it makes the copy of the detached segment. It places the new object so that its Local coordinate system is coincident with the [World space origin](#) on page 7975 .

## To add a gable point to a wall profile or adjust for uneven terrain:

---

**TIP** It is easier to work with wall vertices in wireframe view mode.

---

- 1 Select a wall.
- 2 In the [modifier stack](#) on page 7427 , go to the Profile sub-object level.
- 3 Select a wall profile by clicking a wall segment.  
A grid appears.
- 4 To add a gable point procedurally, set the height and click Create Gable.  
If you prefer to add the profile point manually, click Insert, click a point on the highlighted top profile, drag the new point into place and then release where you want to place the new gable point. You can move profile points you create with Insert only within the plane of the wall segment, and you cannot move them below the original top edge.  
If you want to adjust the profile for uneven terrain below a wall, click Insert, pick the highlighted bottom profile and add points as necessary.  
If you want to extend multiple segments uniformly downward below floor level, do the following: At the Segment sub-object level, select the segments and, on the Edit Segment rollout, enter a negative Bottom Offset value to move the segments downward. Add the absolute value of the Bottom Offset setting back to the Height value to bring the top of the wall height back up and make it flush with the other wall segments.

## To apply a texture to a wall:

Walls are created with five different [material IDs](#) on page 7842 for their various parts.

The *aectemplates.mat* material library includes *Wall-Template*, a Multi/Sub-Object material designed for use with walls. You can copy or copy and modify this template, or create your own material as follows:

- 1 Create a [Multi/Sub-Object material](#) on page 5558 using five textures for the following Material IDs:
  - Slot #1 is the material for the vertical ends on the wall
  - Slot #2 is the material for the outside of the wall
  - Slot #3 is the material for the inside of the wall
  - Slot #4 is the material for the top of the wall, as well as any inside edges cut out of the wall
  - Slot #5 is the material for the bottom of the wall

---

**NOTE** The definitions of slots 2 and 3 are interchangeable; inside and outside simply depend on your point of view, and how you created the wall.

---

- 2 If the top and bottom surfaces of the wall aren't visible in the rendered scene, you can use a three-sided material instead. The inside and outside of the wall are relative to the direction in which the wall was created. To swap a texture between slots in the Material Editor, drag one of the textures over the other slot in the Basic Parameters rollout of the Multi/Sub-Object material, and then choose Swap.
- 3 For greater control in tiling across the wall surface, apply a [Map Scaler world-space modifier](#) on page 1120 to the wall. Then adjust the scale of the map in the Map Scaler's Parameters rollout.

#### **To create and place a window or door in a wall:**

For best results, perform this procedure in a wireframe viewport.

- 1 Create a [window](#) on page 516 or [door](#) on page 502 (hereafter referred to as "window" for brevity) directly on an existing wall. You can define the window's exact dimensions after insertion. Use [edge snap](#) on page 2578 for the first snaps to place and align the window on the wall and to establish its exact depth. Snap to and then click the rear top edge of the wall to start creation. Drag to another edge snap point on the rear top edge of the wall and release to align the window with the wall segment and to set its width. Snap to the front top edge of the wall to set the proper depth and click. Move the cursor downward and click to define the



window height. This final click doesn't require a snap, as it simply defines a rough height.

- 2 The window should now be cut out of the wall. On the Modify panel for windows or doors, set the correct width and height. Change the depth if it's different from the snap depth you set above.
- 3 Use vertex snap to move the window or door from a reference point to a known point on the wall segment. Then  
Next, use relative offset values from this new position to accurately locate the window or door. As an example, following the next two steps, you could move a window from its top left corner to the top left corner of the wall segment so that you can then move it 3 feet to the right and 2 feet down.
- 4 With the window or door selected, set the coordinate system to Local.
- 5 On the [Coordinate Display](#) on page 7325 , activate Offset mode and then enter the offset distances on the X axis for horizontal and the Y axis for vertical.

---

**NOTE** For best results, do not position an inserted window or door at the bottom of a wall.

---

## Interface

### Keyboard Entry rollout

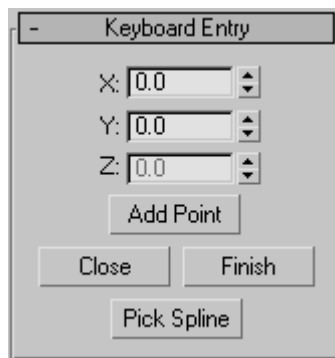

**X** Sets the coordinate position along the X axis for the start point of a wall segment in the active construction plane.

**Y** Sets the coordinate position along the Y axis for the start point of a wall segment in the active construction plane.

**Z** Sets the coordinate position along the Z axis for the start point of a wall segment in the active construction plane.

**Add Point** Adds the point from the X, Y, and Z coordinate values you enter.

**Close** Ends creation of the wall object and creates a segment between the end point of the last segment and the start point of the first segment, to make a closed wall.

**Finish** Ends creation of the wall object, leaving it open ended.

**Pick Spline** Lets you use a spline as the wall path. Click this, and then click a spline in the viewport to use as the wall path. 3ds Max uses the spline as the path along which to apply the wall object. 3ds Max doesn't immediately recognize 2D Shapes from a linked AutoCAD drawing. To recognize Shapes from a linked AutoCAD drawing, edit the Shape with [Edit Spline](#) on page 1376 from the Modify panel.

---

**NOTE** If you designate a curved spline as the path, 3ds Max creates straight wall segments that approximate the spline as closely as possible, with one wall segment per spline segment.

---

## Parameters rollout

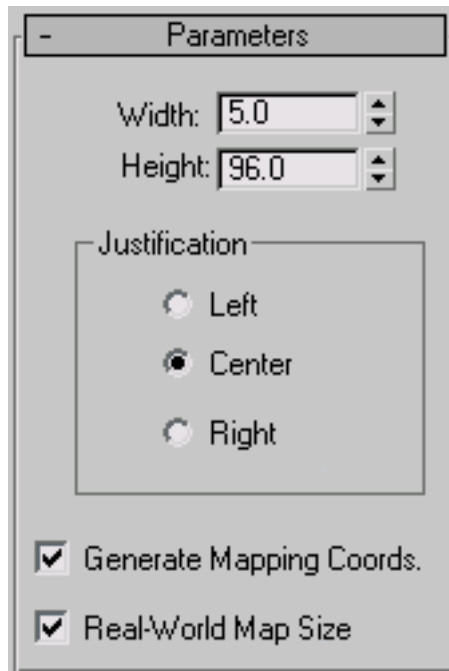

The defaults produce a wall object 5 units wide, 96 units high, and justified at the center of the wall.

**Width** Sets the thickness of the wall. Range=0.01 unit to 100,000 units. Default=5.

**Height** Sets the height of the wall. Range=0.01 unit to 100,000 units. Default=96.

### Justification group

**Left** Justifies the wall at the left edge of its baseline (the line between the wall's front and back sides, which is equal to the wall thickness). If you turn Grid Snap on, the left edge of the wall's baseline snaps to the grid line.

**Center** Justifies the wall at the center of its baseline. If you turn Grid Snap on, the center of the wall's baseline snaps to the grid line. This is the default.

**Right** Justifies the wall at the right edge of its baseline. If you turn Grid Snap on, the right edge of the wall's baseline snaps to the grid line.

**Generate Mapping Coords** Assigns [mapping coordinates](#) on page 7838 to the wall. Default=on.

**Real-World Map Size** Controls the scaling method used for texture mapped materials that are applied to the object. The scaling values are controlled by the Use Real-World Scale settings found in the applied material's [Coordinates rollout](#) on page 5620 . Default=off.

## Editing Wall Objects

Select a wall object. > Modify panel

The following reference describes the Wall options on the Modify panel. It's generally easiest to edit wall objects in wireframe mode.

**See also:**

- [Wall](#) on page 456

### Interface

#### Edit Object rollout

This rollout appears when you select a wall object at the object level; other rollouts, discussed below appear at the different sub-object levels.

**Attach** Attaches another wall in a viewport to the selected wall by a single pick. The object you attach must also be a wall. 3ds Max applies the material of the selected wall to the wall being attached.

**Attach Multiple** Attaches other walls in a viewport to the selected wall. Click this button to open the Attach Multiple dialog, which lists all the other wall objects in the scene. Select the walls you want to attach from the list and click the Attach button. 3ds Max applies the material of the selected wall to the walls being attached.

#### Justification group

See [Justification](#) on page 465 .

**Generate Mapping Coords.** Assigns [mapping coordinates](#) on page 7838 to the wall. Default=on.

**Real-World Map Size** Controls the scaling method used for texture mapped materials that are applied to the object. The scaling values are controlled by

the Use Real-World Scale settings found in the applied material's [Coordinates rollout](#) on page 5620 . Default=off.

### **Edit Vertex rollout**

Appears at the Vertex sub-object level. Each wall segment has two vertices; one in each bottom corner. In wireframe views, wall vertices appear as + symbols. Connected segments in the same wall object each share a vertex. Moving a wall vertex has the effect of scaling attached segments as well as rotating them about their other vertices. You cannot rotate or scale wall vertices.

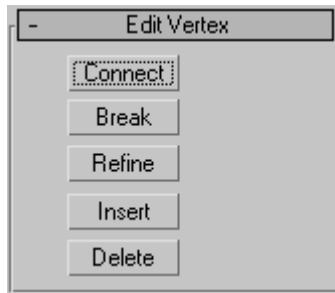

**Connect** Lets you connect any two vertices, creating a new linear segment between the vertices.

Click this button, click a vertex, and then click a second vertex on a different segment. When you move the cursor over a valid second vertex, the mouse icon changes to a Connect icon.

**Break** Lets you disconnect segments at a shared vertex.

---

**TIP** Select a vertex shared between wall segments, and then click the Break button. The segments become disconnected, and each has its own end vertex at the position of the previously shared vertex.

---

**Refine** Adds a vertex to the position along a wall segment that you click. When you move the cursor over a valid Refine point, the mouse icon changes to a Refine icon.

**Insert** Inserts one or more vertices, creating additional segments. When you move the cursor over the a valid Insert point, the mouse icon changes to an Insert icon. Right-click to stop inserting new vertices and segments.

**Delete** Deletes the currently selected vertex or vertices, including any segments in between.

Deleting vertices shared by two or more segments doesn't create a gap, but rather results in a single segment connecting vertices adjacent to those being deleted.

### Edit Segment rollout

This rollout appears when you select a wall object and then access Segment sub-object level.

Each wall segment is defined by, and effectively connects, two wall vertices. Moving a segment is the same as moving its two vertices in tandem. It has the effect of scaling adjacent wall segments as well as rotating them about their other vertices. You can scale a wall segment horizontally only (any Scale function does this). You cannot rotate a segment.

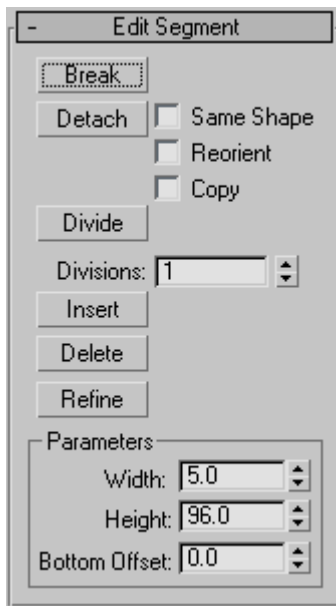

**Break** Specifies a break point in a wall segment.

You needn't select a segment first. When you move the cursor over the object, the mouse icon changes to a Break icon. The position you select on the segment becomes two coincident vertices, and 3ds Max breaks the segment in two.

**Detach** Detaches wall segments you select and creates a new wall object out of them.

**Same Shape** Detaches the wall segment keeping it part of the same wall object. If you also turn on Copy, 3ds Max places a detached copy of the segment in the same location.

**Reorient** Detaches the wall segment, copies the object's [Local coordinate system](#) on page 7830, and places the segment so that its object Local coordinate system is coincident with the [World space origin](#) on page 7975. If you also turn on Copy, 3ds Max detaches a copy of the segment and leaves the original segments in place.

**Copy** Copies the detached wall segment rather than moving it.

**Divide** Subdivides each segment by the number of vertices specified in the Divisions spinner. Select one or more segments, set the Divisions spinner, and then click Divide.

**Divisions** Sets the number by which to divide the segment.

**Insert** Provides the same function as the [Insert button](#) on page 467 in Vertex sub-object selection. Inserts one or more vertices, creating additional segments. When you move the cursor over the a valid Insert point, the mouse icon changes to an Insert icon. Right click to stop inserting new vertices and segments.

**Delete** Deletes any selected wall segments in the current wall object.

**Refine** Provides the same function as the [Refine button](#) on page 467 at the Vertex sub-object level. Adds a vertex to the position along a wall segment you select. When you move the cursor over a valid Refine point, the mouse icon changes to a Refine icon.

### **Parameters group**

**Width** Changes the width of a selected segment or segments.

**Height** Changes the height of a selected segment or segments.

**Bottom Offset** Sets the distance of the bottom of the selected segment or segments from the floor.

### **Edit Profile rollout**

This rollout appears when you select a wall object and then access Profile sub-object level.

The term "profile" refers to the outline of a wall segment's top and bottom edges. When in Profile sub-object mode, the selected wall object's inner horizontal edges appear dark orange. Click any of these edges to select the

corresponding segment, highlight it in red, and place a temporary active grid in the plane of the segment. At that point, you can insert and delete vertices along the horizontal edges, move an inserted vertex along the grid to change the profile, create gables, and change the grid properties.

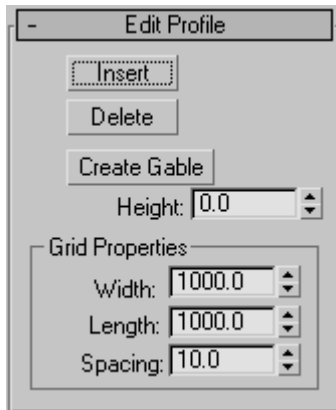

**Insert** Inserts a vertex so that you can adjust the profile of the selected wall segment.

Use this option to adjust the profile of walls under gables or to align walls to a slope. When you move the cursor over the selected segment, the mouse icon changes to an Insert icon. Click to insert a new profile point, then drag and release to position and place it. You can add new profile points to both the top and the bottom of the wall, but you cannot position profile points below the original top edge or above the original bottom edge.

**Delete** Deletes the selected vertices on the profile of the selected wall segment.

**Create Gable** Creates a gable by moving the center point of the top profile of the selected wall segment to a height you specify.

Select the segment, set the height, and then click Create Gable.

**Height** Specifies the height of a gable.

### **Grid Properties group**

The grid constricts profile point insertion and movement to the plane of the wall and allows you to snap to grid points on the plane of the wall.

**Width** Sets the width of the active grid.

**Length** Sets the length of the active grid.



**Spacing** Sets the size of the smallest square in the active grid.

## Stairs

Create panel > Geometry > Stairs

Create menu > AEC Objects

You can create four different types of stairs in 3ds Max:

[Spiral Stair](#) on page 480

[Straight Stair](#) on page 488

[L-Type Stair](#) on page 473

[U-Type Stair](#) on page 495

### Railings and Materials

By default, 3ds Max assigns seven different material IDs to stairs. The *aectemplates.mat* material library includes *Stair-Template*, a [multi/sub-object material](#) on page 5558 designed to be used with stairs. Each component of the stair/material is listed below along with its corresponding Material ID.

Material ID	Railing/Material Component
1	Treads of the stairs
2	Front riser of the stairs
3	Bottom, back, and sides of the risers of the stairs
4	Center pole of the stairs
5	Handrails of the stairs
6	Carriage of the stairs
7	Stringers of the stairs

---

**NOTE** 3ds Max does not automatically assign a material to the stairs object. To use the included material, open the library and then assign the material to your object.

---

## Procedures

### To create railings on stairs:

- 1 Create the stairs. See individual stair-type topics for more information.
- 2 In the Generate Geometry group, turn on Rail Path > Left and Right. 3ds Max places left and right rail paths above the stairs.
- 3 In the Railings rollout, set Height to **0.0**.
- 4 Click Create panel > AEC Extended > [Railing](#) on page 447 to create the first railing.
- 5 Click Railing rollout > Pick Railing Path and select one of the rail paths on the stairs.
- 6 Adjust the railing parameters.  
3ds Max remembers the parameters you set. When you create the next railing, it will have the same parameters as you set for the first railing.
- 7 Right-click to end the creation of the first railing.
- 8 Click Railing again to create the second railing.
- 9 Click Pick Railing Path and select the other rail path on the stairs.

## Interface

### Object Type rollout



**Stair Selection Buttons** Click one of these to specify the type of stairs you want to create.

## Name and Color rollout

This rollout lets you set the stairs object's name and color. For detailed information, see [Object Name and Wireframe Color](#) on page 7423 .

## L-Type Stair

Create panel > Geometry > Stairs > L-Type Stair button

Create menu > AEC Objects > L-Type Stair

The L-Type Stair object lets you create a staircase with two flights at right angles to each other.

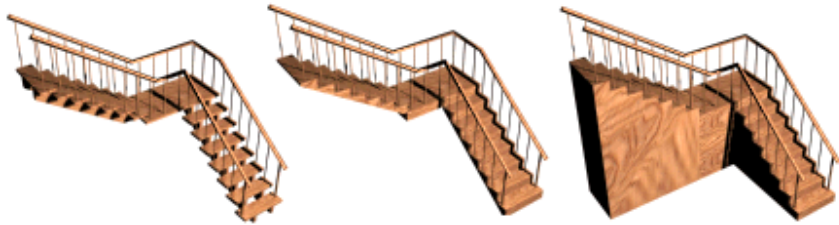

Types of L-type stair: open, closed, and boxed

L-type stairs have two flights at right angles, and a landing.

## Procedures

To create L-Type stairs:

- 1 In any viewport, drag to set the length for the first flight. Release the mouse button, then move the cursor and click to set the length, width, and direction for the second flight.
- 2 Move the cursor up or down to define the rise of the stairs, then click to end.
- 3 Adjust the stairs by using the options in the Parameters rollout.

## Interface

### Parameters rollout > Type group

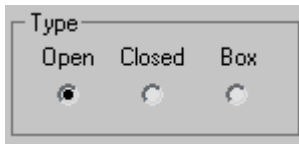

**Open** Creates an open riser stair, as shown on the left in the illustration above.

**Closed** Creates a closed riser stair, as shown in the center in the illustration above.

**Box** Creates a stair with closed risers and closed stringers on both sides, as shown on the right in the illustration above.

### Generate Geometry group

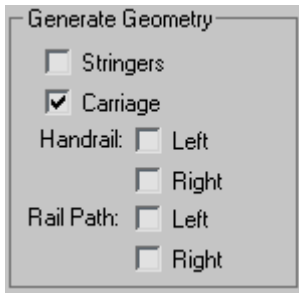

**Stringers** Creates stringers along the ends of the treads of the stairs. To modify the stringers' depth, width, offset and spring from the floor, see [Stringers rollout](#) on page 477 .

**Carriage** Creates an inclined, notched beam under the treads which supports the steps or adds support between the stringers of the stairs. You might also know this as a *carriage piece*, a *horse*, or a *rough string*. See [Carriage rollout](#) on page 478 to modify the parameters.

**Handrail** Creates left and right handrails. See [Railings rollout](#) on page 479 to modify the handrails' height, offset, number of segments, and radius.

**Rail Path** Creates left and right paths you can use to install railings on the stairs. See [Stairs](#) on page 471 for the instructions on how to do this.

## Layout group

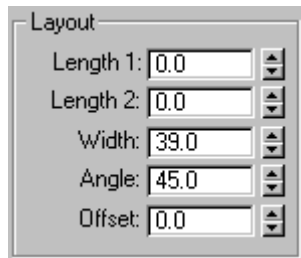

**Length 1** Controls the length of the first flight of stairs.

**Length 2** Controls the length of the second flight of stairs.

**Width** Controls the width of the stairs, including the steps and the landing.

**Angle** Controls the angle of the second flight from the landing. Range=-90 to 90 degrees.

**Offset** Controls the distance of the second flight from the landing. The length of the landing adjusts accordingly.

## Rise group

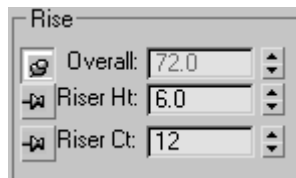

3ds Max keeps one Rise option locked while you adjust the other two. To lock an option, you click a push pin. To unlock an option you click a raised push pin. 3ds Max locks the spinner value of the parameter with the depressed push pin and allows the spinner values of the parameter with the raised push pins to change.

**Overall** Controls the height of the flight of stairs.

**Riser Ht** Controls the height of the risers.

**Riser Ct** Controls the number of risers. There will always be one more riser than steps. This *implied* riser is between the top step of the stair and the upper floor.

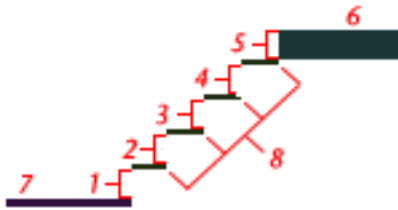

- Linear stair with five risers
- 1 through 4. Risers
  - 5. The implied riser
  - 6. The upper floor you snap to
  - 7. The lower floor you snap to
  - 8. The steps

### Steps group

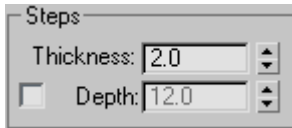

**Thickness** Controls the thickness of the steps.



Step thickness variance between two stairs

**Depth** Controls the depth of the steps.



Step depth variance between two stairs

**Generate Mapping Coords** Applies default [mapping coordinates](#) on page 7838 to the stairs.

---

**NOTE** If a visible viewport is set to a non-wireframe or non-bounding-box display, Generate Mapping Coordinates is on for all primitives to which you apply a material containing a map with Show Map In Viewport on. If all viewports are set to wireframe or bounding box, 3ds Max turns on Generate Mapping Coordinates for primitives containing mapped materials at render time.

---

**Real-World Map Size** Controls the scaling method used for texture mapped materials that are applied to the object. The scaling values are controlled by the Use Real-World Scale settings found in the applied material's [Coordinates rollout](#) on page 5620 . Default=off.

### Stringers rollout

These controls are available only when you turn on Stringers on the Parameters rollout > Generate Geometry group.

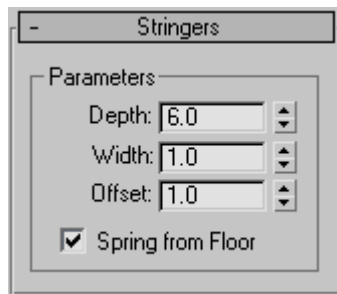

**Depth** Controls how far down the stringers reach toward the floor.

**Width** Controls the width of the stringers.

**Offset** Controls the vertical distance of the stringers from the floor.

**Spring from Floor** Controls whether the stringer starts at the floor, flush with the start of the first riser, or if the stringer extends below the floor. You control the amount the stringer extends below the floor with the Offset option.



Left: The stringer extending below the floor. (Spring From Floor off.)

Right: The stringer springing from the floor. (Spring From Floor on.)

### Carriage rollout

These controls are available only when you turn on Carriage on the Parameters rollout > Generate Geometry group.

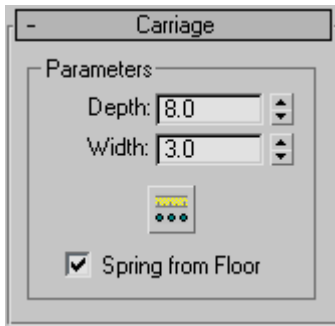

**Depth** Controls how far down the carriage reaches toward the floor.

**Width** Controls the width of the carriage.

**Carriage Spacing** Sets the spacing of the carriage. When you pick this button, the Carriage Spacing dialog displays. Specify the number of carriages you want using the Count option. For more information on spacing options in this dialog, see [Spacing Tool](#) on page 925 .



**Spring from Floor** Controls whether the carriage starts at the floor, flush with the start of the first riser, or if the carriage extends below the floor. You control the amount the carriage extends below the floor with the Offset option.



Left: The carriage springing from the floor. (Spring From Floor on.)



Right: The carriage extending below the floor. (Spring from Floor off.)

### Railings rollout

These controls are available only when you turn on one or more of the Handrail or Rail Path options on the Parameters rollout > Generate Geometry group. Also, Segments and Radius aren't available if neither of the Handrail options is on.

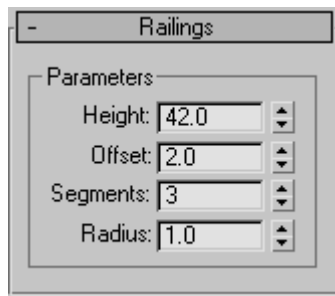

**Height** Controls the height of the railings from the steps.

**Offset** Controls the offset of the railings from the ends of the steps.

**Segments** Controls the number of segments in the railings. Higher values display smoother railings.

**Radius** Controls the thickness of the railings.

## Spiral Stair

Create panel > Geometry > Stairs > Spiral Stair button

Create menu > AEC Objects > Spiral Stair

The Spiral Stair object lets you specify the radius and number of revolutions, add stringers and a center pole, and more.



Types of spiral stair: open, closed, and boxed

Spiral stairs wind around a center

### Procedures

To create spiral stairs:

- 1 In any viewport, click for the start point of the stairs, and drag to the specify the radius you want.
- 2 Release the mouse button, move the cursor up or down to specify the overall rise, and click to end.
- 3 Adjust the stairs with options in the Parameters rollout.

### Interface

Parameters rollout > Type group

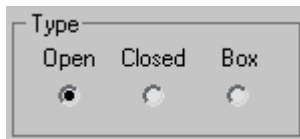

**Open** Creates an open riser stair, as shown on the left of the illustration above.

**Closed** Creates a closed riser stair, as shown in the center of the illustration above.

**Box** Creates a stair with closed risers and closed stringers on both sides, as shown on the right of the illustration above.

### Generate Geometry group

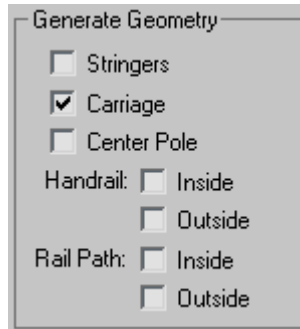

**Stringers** Creates stringers along the ends of the treads of the stairs. To modify the stringers' depth, width, offset and spring from the floor, see [Stringers rollout](#) on page 485 .

**Carriage** Creates an inclined, notched beam under the treads which supports the steps or adds support between the stringers of the stairs. You might also know this as a *carriage piece*, *a horse*, or a *rough string*. See [Carriage rollout](#) on page 485 to modify the parameters.

**Center Pole** Creates a pole at the center of the spiral. See [Center Pole rollout](#) on page 486 to modify the parameters of the pole.

**Handrail** Creates inside and outside handrails. See [Railings rollout](#) on page 487 to modify the handrails' height, offset, number of segments, and radius.

**Rail Path** Creates inside and outside paths which you can use to install railings on the stairs. See [Stairs](#) on page 471 for the instructions on how to do this.

## Layout group

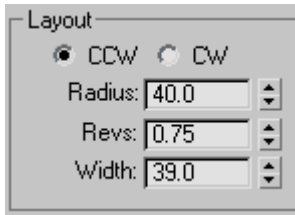

**CCW** Orients the spiral stairs to be a right-hand flight of stairs.

**CW** Orients the spiral stairs to be a left-hand flight of stairs.



**Left:** CCW (counterclockwise) right-hand spiral stairs. The arrow indicates “Up.”

**Right:** CW (clockwise) left-hand spiral stairs. The arrow indicates “Up.”

**Radius** Controls the size of the radius of the spiral.

**Revs** Controls the number of revolutions in the spiral.

**Width** Controls the width of the spiral stairs.

## Rise group

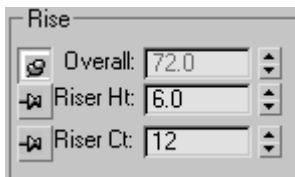

3ds Max keeps one Rise option locked while you adjust the other two. To lock an option, click a pushpin button. To unlock an option, click a raised pushpin. 3ds Max locks the spinner value of the parameter with the depressed pushpin

and allows the spinner values of the parameter with the raised pushpins to change.

**Overall** Controls the height of the flight of stairs.

**Riser Ht** Controls the height of the risers.

**Riser Ct** Controls the number of risers. There will always be one more riser than steps. This *implied* riser is between the top step of the stair and the upper floor.

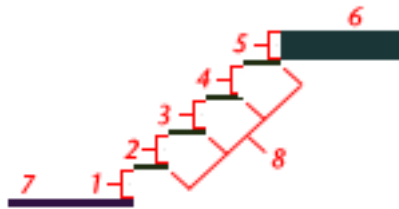

**Linear stair with five risers**

- 1 through 4. Risers
- 5. The implied riser
- 6. The upper floor you snap to
- 7. The lower floor you snap to
- 8. The steps.

### Steps group

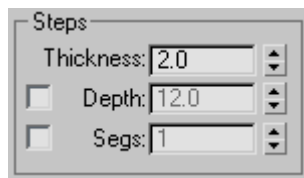

**Thickness** Controls the thickness of the steps.



**Step thickness variance between two stairs**

**Depth** Controls the depth of the steps.



**Step depth variance between two stairs**

**Segs** Controls the number of segments 3ds Max uses to construct the steps.

**Generate Mapping Coords** Applies default [mapping coordinates](#) on page 7838 to the stairs.

---

**NOTE** If a visible viewport is set to a non-wireframe or non-bounding-box display, Generate Mapping Coordinates is on for all primitives to which you apply a material containing a map with Show Map In Viewport on. If all viewports are set to wireframe or bounding box, 3ds Max turns on Generate Mapping Coordinates for primitives containing mapped materials at render time.

---

**Real-World Map Size** Controls the scaling method used for texture mapped materials that are applied to the object. The scaling values are controlled by the Use Real-World Scale settings found in the applied material's [Coordinates rollout](#) on page 5620 . Default=off.

## Stringers rollout

These controls are available only when you turn on Stringers on the Parameters rollout > Generate Geometry group.

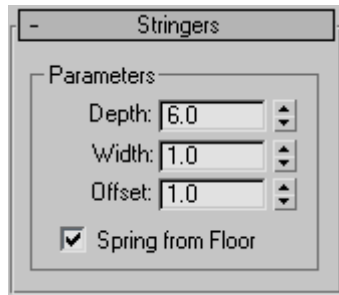

**Depth** Controls how far down the stringers reach toward the floor.

**Width** Controls the width of the stringers.

**Offset** Controls the vertical distance of the stringers from the floor.

**Spring from Floor** Controls whether the stringer starts at the floor, flush with the start of the first riser, or if the stringer extends below the floor. You control the amount the stringer extends below the floor with the Offset option.



Left: The stringer extending below the floor. (Spring From Floor turned off.)

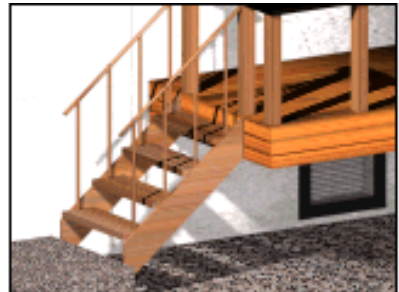

Right: the stringer springing from the floor. (Spring From Floor turned on.)

## Carriage rollout

These controls are available only when you turn on Carriage on the Parameters rollout > Generate Geometry group.

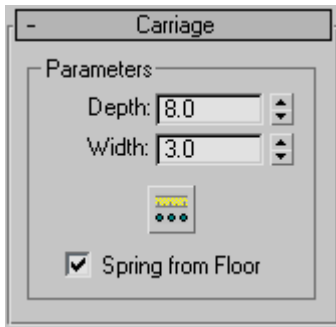

**Depth** Controls how far down the carriage reaches toward the floor.

**Width** Controls the width of the carriage.

**Carriage Spacing** Sets the spacing of the carriage. When you pick this button, the Carriage Spacing dialog displays. Specify the number of carriages you want using the Count option. For more information on spacing options in this dialog, see [Spacing Tool](#) on page 925 .

**Spring from Floor** Controls whether the carriage starts at the floor, flush with the start of the first riser, or if the carriage extends below the floor. You control the amount the carriage extends below the floor with the Offset option.



Left: The carriage springing from the floor. (Spring From Floor turned on.)

Right: The carriage extending below the floor. (Spring From Floor turned off.)

### Center Pole rollout

These controls are available only when you turn on Center Pole on the Parameters rollout > Generate Geometry group.



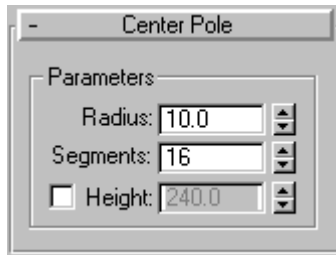

**Radius** Controls the radius size of the center pole.

**Segments** Controls the number of segments in the center pole. Higher values display a smoother pole.

**Height** The spinner controls the height of the center pole. Turning on Height lets you adjust the height of the pole independently of the stairs. Turning off Height makes the spinner unavailable and locks the top of the pole to the top of the implied last riser. Typically, this riser would attach to the fascia of a landing.



Left: The center pole locked to the top of the implied last riser. (Height turned off.)

Right: The center pole adjusted to the height you specify. (Height turned on.)

### **Railings rollout**

These controls are available only when you turn on one or more of the Handrail or Rail Path options on the Parameters rollout > Generate Geometry group. Also, Segments and Radius aren't available if neither of the Handrail options is on.

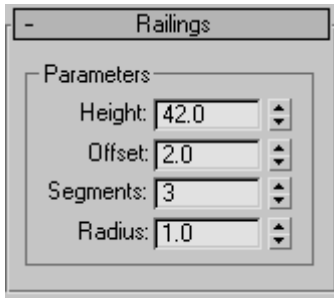

**Height** Controls the height of the railings from the steps.

**Offset** Controls the offset of the railings from the ends of the steps.

**Segments** Controls the number of segments in the railings. Higher values display smoother railings.

**Radius** Controls the thickness of the railings.

## Straight Stair

Create panel > Geometry > Stairs > Straight Stair button

Create menu > AEC Objects > Straight Stair

The Straight Stair object lets you create a simple staircase, with optional stringers, carriage, and handrail.



Types of straight stair: open, closed, and boxed

Straight stairs have a single flight.

## Procedures

### To create straight stairs:

- 1 In any viewport, drag to set the length. Release the mouse button, then move the cursor and click to set the width you want.
- 2 Move the cursor up or down to define the rise of the stairs, and click to end.
- 3 Adjust the stairs with the options in the Parameters rollout.

## Interface

### Parameters rollout > Type group

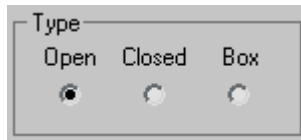

**Open** Creates an open riser stair as shown on the left of the illustration above.

**Closed** Creates a closed riser stair as shown in the center of the illustration above.

**Box** Creates a stair with closed risers and closed stringers on both sides as shown on the right of the illustration above.

### Generate Geometry group

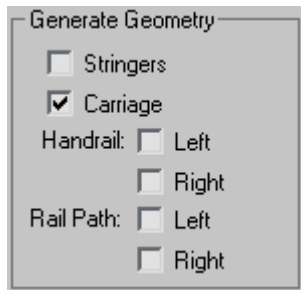

**Stringers** Creates stringers along the ends of the treads of the stairs. To modify the stringers' depth, width, offset and spring from the floor, see [Stringers rollout](#) on page 492 .

**Carriage** Creates an inclined, notched beam under the treads which supports the steps or adds support between the stringers of the stairs. You might also know this as a *carriage piece*, *a horse*, or a *rough string*. See [Carriage rollout](#) on page 493 to modify the parameters.

**Handrail** Creates left and right handrails. See [Railings rollout](#) on page 494 to modify the handrails' height, offset, number of segments, and radius.

**Rail Path** Creates left and right paths you can use to install railings on the stairs. See [Stairs](#) on page 471 for the instructions on how to do this.

### Layout group

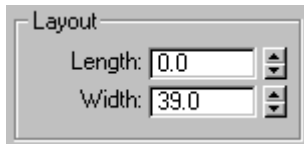

**Length** Controls the length of the stairs.

**Width** Controls the width of the stairs.

### Rise group

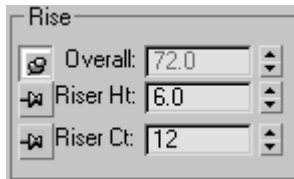

3ds Max keeps one Rise option locked while you adjust the other two. To lock an option, you click a push pin. To unlock an option you click a raised push pin. 3ds Max locks the spinner value of the parameter with the depressed push pin and allows the spinner values of the parameter with the raised push pins to change.

**Overall** Controls the height of the flight of stairs.

**Riser Ht** Controls the height of the risers.

**Riser Ct** Controls the number of risers. There will always be one more riser than steps. This *implied* riser is between the top step of the stair and the upper floor.

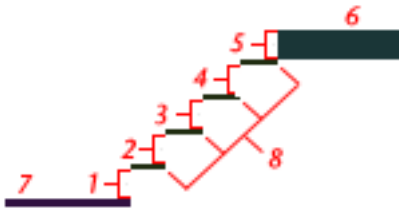

Linear stair with five risers

1 through 4. Risers

5. The implied riser

6. The upper floor you snap to

7. The lower floor you snap to

8. The steps.

### Steps group

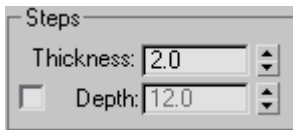

**Thickness** Controls the thickness of the steps.



Step thickness variance between two stairs

**Depth** Controls the depth of the steps.

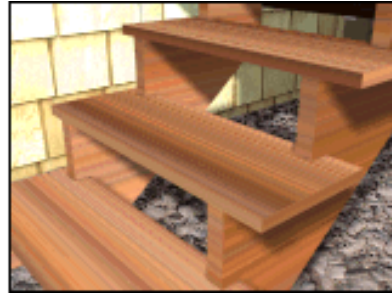
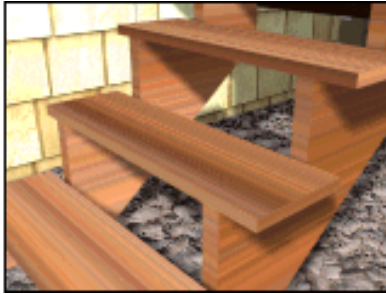

Step depth variance between two stairs

**Generate Mapping Coords** Applies default [mapping coordinates](#) on page 7838 to the stairs.

---

**NOTE** If a visible viewport is set to a non-wireframe or non-bounding-box display, Generate Mapping Coordinates is on for all primitives to which you apply a material containing a map with Show Map In Viewport on. If all viewports are set to wireframe or bounding box, 3ds Max turns on Generate Mapping Coordinates for primitives containing mapped materials at render time.

---

**Real-World Map Size** Controls the scaling method used for texture mapped materials that are applied to the object. The scaling values are controlled by the Use Real-World Scale settings found in the applied material's [Coordinates rollout](#) on page 5620 . Default=off.

### Stringers rollout

These controls are available only when you turn on Stringers on the Parameters rollout > Generate Geometry group.

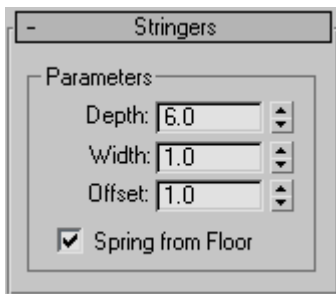

**Depth** Controls how far down the stringers reach toward the floor.

**Width** Controls the width of the stringers.

**Offset** Controls the vertical distance of the stringers from the floor.

**Spring from Floor** Controls whether the stringer starts at the floor, flush with the start of the first riser, or if the stringer extends below the floor. You control the amount the stringer extends below the floor with the Offset option.



Left: The stringer extending below the floor. (Spring From Floor off.)

Right: The stringer springing from the floor. (Spring From Floor on.)

### Carriage rollout

These controls are available only when you turn on Carriage on the Parameters rollout > Generate Geometry group.

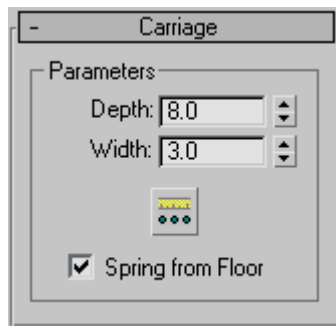

**Depth** Controls how far down the carriage reaches toward the floor.

**Width** Controls the width of the carriage.

**Carriage Spacing** Sets the spacing of the carriage. When you pick this button, the Carriage Spacing dialog displays. Specify the number of carriages you want using the Count option. For more information on spacing options in this dialog, see [Spacing Tool](#) on page 925 .

**Spring from Floor** Controls whether the carriage starts at the floor, flush with the start of the first riser, or if the carriage extends below the floor. You control the amount the carriage extends below the floor with the Offset option.



Left: The carriage springing from the floor. (Spring From Floor on.)



Right: The carriage extending below the floor. (Spring From Floor off.)

### Railings rollout

These controls are available only when you turn on one or more of the Handrail or Rail Path options on the Parameters rollout > Generate Geometry group. Also, Segments and Radius aren't available if neither of the Handrail options is on.

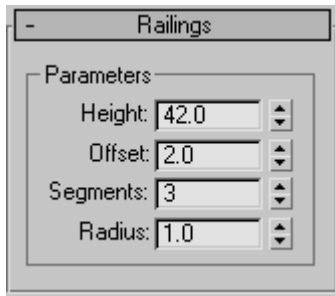

**Height** Controls the height of the railings from the steps.

**Offset** Controls the offset of the railings from the ends of the steps.

**Segments** Controls the number of segments in the railings. Higher values display smoother railings.

**Radius** Controls the thickness of the railings.



## U-Type Stair

Create panel > Geometry > Stairs > U-Type Stair button

Create menu > AEC Objects > U-Type Stair

The U-Type Stair object lets you create a two-flight staircase, with the two flights parallel to each other and a landing between them.



Types of U-type stair: open, closed, and boxed

U-type stairs have two flights in opposite directions, and a landing.

### Procedures

To create U-Type stairs:

- 1 In any viewport, drag to set the length for the first flight. Release the mouse button, then move the cursor and click to set the width of the landing, or the distance separating the two flights.
- 2 Click and move the cursor up or down to define the rise of the stairs, then click to end.
- 3 Adjust the stairs by using the options in the Parameters rollout.

### Interface

Parameters rollout > Type group

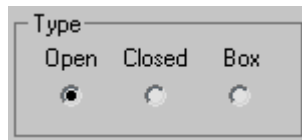

**Open** Creates an open riser stair as shown on the left in the illustration above.

**Closed** Creates a closed riser stair as shown in the center in the illustration above.

**Box** Creates a stair with closed risers and closed stringers on both sides as shown on the right in the illustration above.

### Generate Geometry group

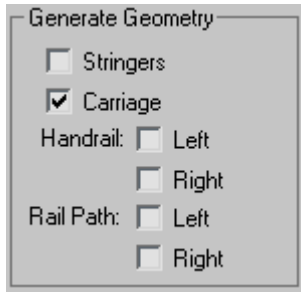

**Stringers** Creates stringers along the ends of the treads of the stairs. To modify the stringers' depth, width, offset and spring from the floor, see [Stringers rollout](#) on page 499 .

**Carriage** Creates an inclined, notched beam under the treads which supports the steps or adds support between the stringers of the stairs. You might also know this as a carriage piece, a horse, or a roughstring. See [Carriage rollout](#) on page 500 to modify the parameters.

**Handrail** Creates left and right handrails. See [Railings rollout](#) on page 501 to modify the handrails' height, offset, number of segments, and radius.

**Rail Path** Creates left and right paths you can use to install railings on the stairs. See [Stairs](#) on page 471 for the instructions on how to do this.

## Layout group

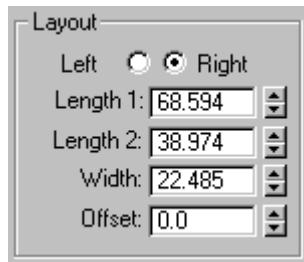

**Left/Right** Controls the position of the two flights (Length 1 and Length 2) relative to each other. If you select left, then the second flight is on the left from the landing. If you select right, then the second flight is the right from the landing.

**Length 1** Controls the length of the first flight of stairs.

**Length 2** Controls the length of the second flight of stairs.

**Width** Controls the width of the stairs, including the steps and the landing.

**Offset** Controls the distance separating the two flights and thus the length of the landing.

## Rise group

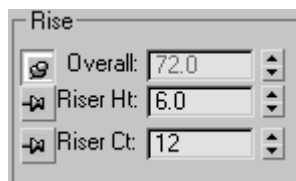

3ds Max keeps one Rise option locked while you adjust the other two. To lock an option, you click a push pin. To unlock an option you click a raised push pin. 3ds Max locks the spinner value of the parameter with the depressed push pin and allows the spinner values of the parameter with the raised push pins to change.

**Overall** Controls the height of the flight of stairs.

**Riser Ht** Controls the height of the risers.

**Riser Ct** Controls the number of risers. There will always be one more riser than steps. This *implied* riser is between the top step of the stair and the upper floor.

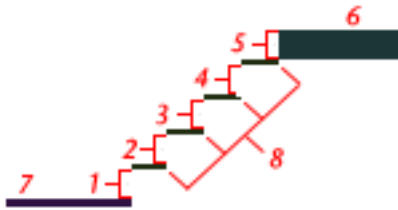

Linear stair with five risers

1 through 4. Risers

5. The implied riser

6. The upper floor you snap to

7. The lower floor you snap to

8. The steps.

### Steps group

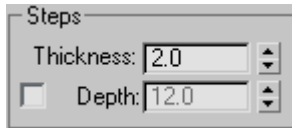

**Thickness** Controls the thickness of the steps.



**Step thickness variance between two stairs**

**Depth** Controls the depth of the steps.

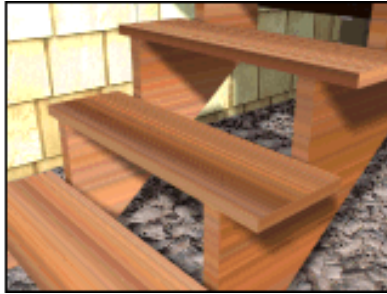

Step depth variance between two stairs

**Generate Mapping Coords** Applies default [mapping coordinates](#) on page 7838 to the stairs.

---

**NOTE** If a visible viewport is set to a non-wireframe or non-bounding-box display, Generate Mapping Coordinates is on for all primitives to which you apply a material containing a map with Show Map In Viewport on. If all viewports are set to wireframe or bounding box, 3ds Max turns on Generate Mapping Coordinates for primitives containing mapped materials at render time.

---

**Real-World Map Size** Controls the scaling method used for texture mapped materials that are applied to the object. The scaling values are controlled by the Use Real-World Scale settings found in the applied material's [Coordinates rollout](#) on page 5620 . Default=off.

### Stringers rollout

These controls are available only when you turn on Stringers on the Parameters rollout > Generate Geometry group.

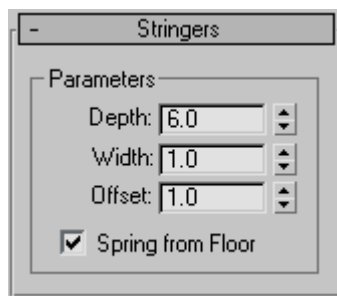

**Depth** Controls how far down the stringers reach toward the floor.

**Width** Controls the width of the stringers.

**Offset** Controls the vertical distance of the stringers from the floor.

**Spring from Floor** Controls whether the stringer starts at the floor, flush with the start of the first riser, or if the stringer extends below the floor. You control the amount the stringer extends below the floor with the Offset option.



Left: The stringer extending below the floor. (Spring From Floor off.)

Right: The stringer springing from the floor. (Spring From Floor on.)

### Carriage rollout

These controls are available only when you turn on Carriage on the Parameters rollout > Generate Geometry group.

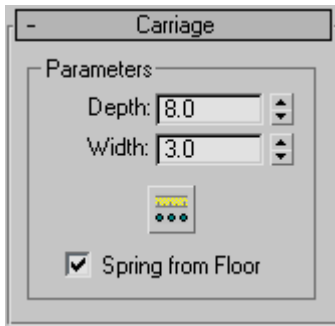

**Depth** Controls how far down the carriage reaches toward the floor.

**Width** Controls the width of the carriage.

**Carriage Spacing** Sets the spacing of the carriage. When you pick this button, the Carriage Spacing dialog displays. Specify the number of carriages you want using the Count option. For more information on spacing options in this dialog, see [Spacing Tool](#) on page 925 .

**Spring from Floor** Controls whether the carriage starts at the floor, flush with the start of the first riser, or if the carriage extends below the floor. You control the amount the carriage extends below the floor with the Offset option.



Left: The carriage springing from the floor. (Spring From Floor on.)



Right: The carriage extending below the floor. (Spring From Floor off.)

### Railings rollout

These controls are available only when you turn on one or more of the Handrail or Rail Path options on the Parameters rollout > Generate Geometry group. Also, Segments and Radius aren't available if neither of the Handrail options is on.

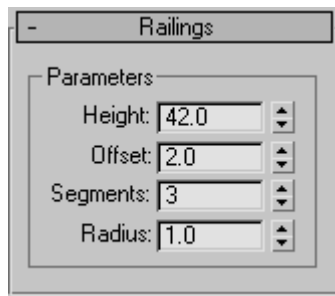

**Height** Controls the height of the railings from the steps.

**Offset** Controls the offset of the railings from the ends of the steps.

**Segments** Controls the number of segments in the railings. Higher values display smoother railings.

**Radius** Controls the thickness of the railings.

# Doors

Create panel > Geometry > Doors

Create menu > AEC Objects

The door models provided let you control details of a door's appearance. You can also set the door to be open, partially open, or closed and you can animate the opening.



Different door types in a model of a house

There are three kinds of doors. The [Pivot door](#) on page 510 is the familiar door that is hinged on one side only. The [Bifold door](#) on page 514 is hinged in the middle as well as the side, like many closet doors. You can also make these kinds of doors a set of double doors. The [Sliding door](#) on page 512 has a fixed half and a sliding half.

The topic for each kind of door describes its unique controls and behavior. Most door parameters are common to all kinds of doors, and are described here.



## Doors and Materials

By default, 3ds Max assigns five different material IDs to doors. The *aectemplates.mat* material library includes *Door-Template*, a multi/sub-object material designed to be used with doors. Each component of the door/material is listed below along with its corresponding Material ID.

---

Material ID	Door/Material Component
1	Front
2	Back
3	Inner Bevel (used for glazing when Panels set to Glass or Beveled).
4	Frame
5	Inner Door

---

**NOTE** 3ds Max does not automatically assign a material to the door object. To use the included material, open the library and then assign the material to your object.

---

### Making an Opening for a Door

To make an opening in a wall, you can perform a [Boolean operation](#) on page 686 with the wall as Operand A, and another object, such as a box, as Operand B. Then, you can create and add a door in the opening, and [link](#) on page 3267 it, if you choose, as a child of the wall.

**NOTE** Using snaps, you can insert a door in a wall object, automatically linking the two and creating a cutout for the door. See the procedure [To create and place a window or door in a wall:](#) on page 462 .

---

### Procedures

#### To create a door:

- 1 On the Object Type rollout, click the button for the type of door you want to create.

- 2 Choose options as needed, such as changing the default creation method. Turn off Create Frame to eliminate the door frame. Turn on Allow Non-vertical Jambs if you want an inclined door.
- 3 Drag the mouse in the viewport to create the first two points, defining the width and angle of the base of the door.
- 4 Release the mouse and move to adjust the depth of the door (default creation method), and then click to set.  
By default, the depth is perpendicular to the line between the first two points and parallel to the active grid.
- 5 Move the mouse to adjust the height, and then click to finish.  
The height is perpendicular to the plane defined by the first three points and perpendicular to the active grid.  
You can adjust the Height, Width, and Depth values on the Parameters rollout.

On the Creation Method rollout, you can change the creation order to width-height-depth instead of width-depth-height.

**To create a door material:**

- 1 Create a door or select an existing door.
- 2 Open the Material Editor, and select a slot for the material.
- 3 Click the Type button below the Material Editor toolbar.  
The Material/Map Browser dialog opens.
- 4 In the Material list, double-click the Multi/Sub-Object item, and then on the Replace Material dialog that appears, choose either option and click OK.
- 5 On the Multi/Sub-Object Basic Parameters rollout, click Set Number and change Number Of Materials to 5. Click OK.
- 6 Optionally, change the sub-material names to those specified in the [above table](#) on page 503 .
- 7 Edit the material as you would any Multi/Sub-Object material.

### To animate a door:

You can animate a door opening and closing by keyframing the Open setting.

- 1 Create a door or select an existing door.  
If using an existing door, also access the Modify panel.
- 2 Set the Parameters rollout > Open parameter to the amount you want the door to be open at the start of the animation. If you want it to be closed, set it to **0**.
- 3 Click the Auto Key button and advance to the first keyframe.
- 4 Change the Open setting.
- 5 Continue moving to any additional keyframes and changing the Open setting as necessary.
- 6 Play the animation.

### Interface

The topic for each kind of door describes its unique controls and behavior. Most door parameters are common to all kinds of doors, and are described here.

### Object Type rollout



There are three kinds of doors in 3ds Max:

**Pivot** The familiar door type that is hinged on one side only. See [Pivot Door](#) on page 510 .

**Sliding** Has a fixed half and a sliding half. See [Sliding Door](#) on page 512 .

**BiFold** Hinged in the middle as well as the side, like many closet doors. You can also use this type of door to make a set of double doors. See [BiFold Door](#) on page 514 .

### Name and Color rollout

See [Object Name and Wireframe Color](#) on page 7423 .

## Creation Method rollout

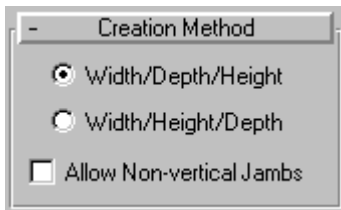

You define each type of door with four points: Drag the first two, followed by two move-click sequences. The Creation Method setting determines the order in which these actions define the door's dimensions.

**Width/Depth/Height** The first two points define the width and angle of the base of the door. You set these points by dragging in a viewport, as the first step in creating a door. The first point, where you click and hold before dragging, defines a point on the jamb at the hinge for single-pivot and bifold doors (both jambs have hinges on double doors, and sliding doors have no hinge). The second point, where you release the button after dragging, specifies the width of the door, as well as the direction from one jamb to the other. This lets you align the door with a wall or opening when you place it. The third point, where you click after moving the mouse, specifies the depth of the door, and the fourth click, where you click after moving the mouse again, specifies the height.

**Width/Height/Depth** Works like the Width/Depth/Height option, except that the last two points create first the height and then the depth.

---

**NOTE** With this method, the depth is perpendicular to the plane set by the first three points. Thus, if you draw the door in the Top or Perspective viewport, the door lies flat on the active grid.

---

**Allow Non-vertical Jamb** Lets you create tilted doors. Set [snaps](#) on page 2568 to define points off the construction plane. Default=off.

## Parameters rollout

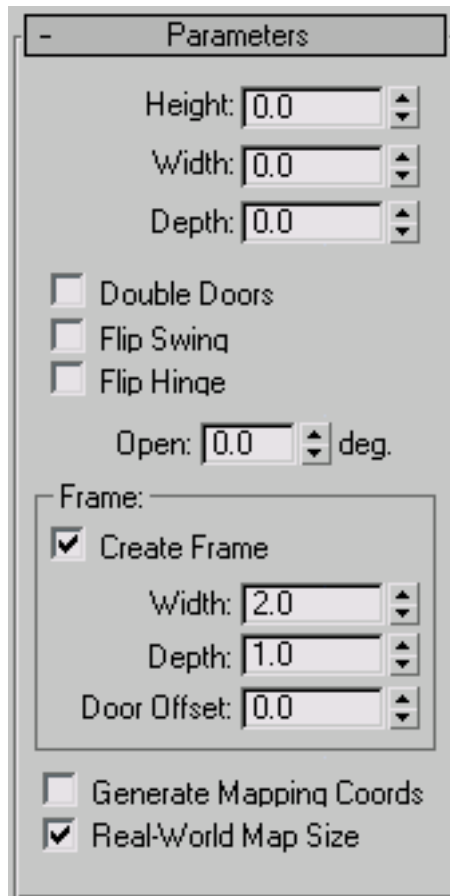

The image shows a software interface titled "Parameters" with a minus sign in the top-left corner. It contains several input fields and checkboxes. The "Height", "Width", and "Depth" fields are set to 0.0. There are three checkboxes: "Double Doors", "Flip Swing", and "Flip Hinge", all of which are unchecked. The "Open" field is set to 0.0 and followed by the unit "deg.". Below this is a "Frame:" section with a "Create Frame" checkbox checked. Inside the "Frame:" section, there are three more input fields: "Width" set to 2.0, "Depth" set to 1.0, and "Door Offset" set to 0.0. At the bottom of the panel, there are two more checkboxes: "Generate Mapping Coords" (unchecked) and "Real-World Map Size" (checked).

**Height** Sets the overall height of the door unit.

**Width** Sets the overall width of the door unit.

**Depth** Sets the depth of the door unit.

**Open** With Pivot doors, specifies in degrees the extent to which the door is open. With Sliding and BiFold doors, Open specifies the percent that the door is open.

## Frame group

This rollout has controls for the door-jamb frame. Though part of the door object, the frame behaves as if it were part of the wall. It doesn't move when you open or close the door.

**Create Frame** This is turned on as a default to display the frame. Turn this off to disable display of the frame.

**Width** Sets the width of the frame parallel to the wall. Available only when Create Frame is on.

**Depth** Sets the depth of the frame as it projects from the wall. Available only when Create Frame is on.

**Door Offset** Sets the location of the door relative to the frame. At 0.0, the door is flush with one edge of the trim. Note that this can be a positive or negative value. Available only when Create Frame is on.

**Generate Mapping Coords** Assigns mapping coordinates to the door.

**Real-World Map Size** Controls the scaling method used for texture mapped materials that are applied to the object. The scaling values are controlled by the Use Real-World Scale settings found in the applied material's [Coordinates rollout](#) on page 5620 . Default=off.

## Leaf Parameters rollout

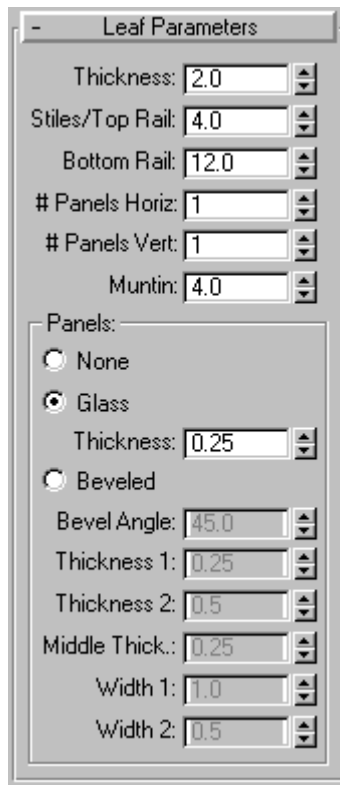

Provides controls that affect the door itself (as opposed to the door unit, which includes the frame). You can adjust the dimensions of the door, add panels, and adjust the dimensions and placement of those panels. The total number of panels for each door element is the number of horizontal divisions times the number of vertical divisions. Pivot doors have a single door element unless they are double doors. BiFold doors have two door elements, or four if they are double doors. Sliding doors have two door elements.

**Thickness** Sets the thickness of the door.

**Stiles/Top Rail** Sets the width of the panel framing on the top and sides. This setting is apparent only if the door is paneled.

**Bottom Rail** Sets the width of the panel framing at the base of the door. This setting is apparent only if the door is paneled.

**# Panels Horiz.** Sets the number of panel divisions along the horizontal axis.

**# Panels Vert.** Sets the number of panel divisions along the vertical axis.

**Muntin** Sets the width of the separations between the panels.

### **Panels group**

Determines how panels are created in the door.

**None** The door has no paneling.

**Glass** Creates glass panels with no beveling.

**Thickness** Sets the thickness of the glass panels.

**Beveled** Choose this to have beveled panels.

The remaining spinners affect the beveling of the panels.

**Bevel Angle** Specifies the angle of the bevel between the outer surface of the door and the surface of the panel.

**Thickness 1** Sets the outer thickness of the panel.

**Thickness 2** Sets the thickness where the bevel begins.

**Middle Thick.** Sets the thickness of the inner part of the panel.

**Width 1** Sets the width where the bevel begins.

**Width 2** Sets the width of the inner part of the panel.

## **Pivot Door**

Create panel > Geometry > Doors > Pivot button

Create menu > AEC Objects > Pivot Door

The Pivot door is hinged on one side only. You can also make the door a double door, with two door elements, each hinged on its outer edge.





### **Single and double pivot doors**

This topic describes only controls and behavior unique to the Pivot door. Most door parameters are common to all kinds of doors; see [Doors](#) on page 502 .

## Interface

### Parameters rollout

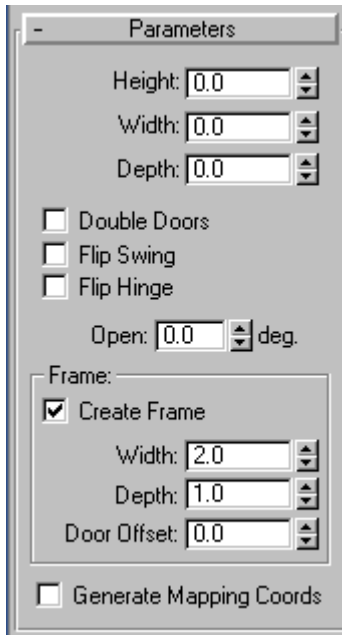

The Parameters rollout contains three check boxes specific to Pivot doors.

**Double Doors** Makes a double door.

**Flip Swing** Changes the direction the door swings.

**Flip Hinge** Places the door hinges on the opposite side of the door. This option is unavailable for double doors.

## Sliding Door

Create panel > Geometry > Doors > Sliding button

Create menu > AEC Objects > Sliding Door

The Sliding door slides as if on a track or railing. It has two door elements: one remains stationary while the other moves.



### **Sliding doors with different numbers of panels**

This topic describes only controls and behavior unique to the Sliding door. Most door parameters are common to all kinds of doors; see [Doors](#) on page 502 .

## Interface

### Parameters rollout

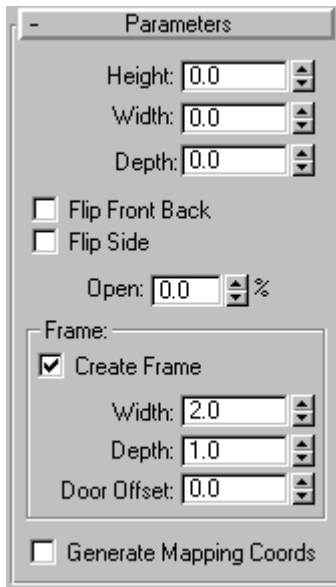

**Flip Front Back** Changes which element is in front, compared to the default.

**Flip Side** Changes the current sliding element to the stationary element, and vice versa.

## BiFold Door

Create panel > Geometry > Doors > BiFold button

Create menu > AEC Objects > BiFold Door

The BiFold door is hinged in the middle as well as on the side. It has two door elements. You can also make the door a double door, with four door elements.



### **Single and double bifold doors**

This topic describes only controls and behavior unique to the BiFold door. Most door parameters are common to all kinds of doors; see [Doors](#) on page 502 .

## Interface

### Parameters rollout

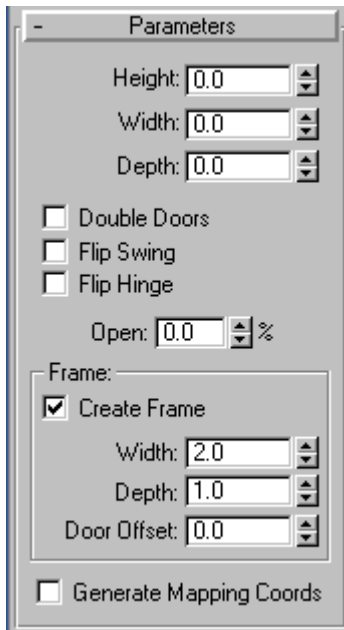

The Parameters rollout contains three check boxes specific to BiFold doors.

**Double Doors** Makes the door a double door, with four door elements, meeting in the center.

**Flip Swing** Makes the door swing in the opposite direction from the default.

**Flip Hinge** Makes the door hinged on the opposite side from the default. Flip Hinge is unavailable when Double Doors is on.

## Windows

Create panel > Geometry > Windows

Create menu > AEC Objects

The window object lets you control details of a window's appearance. You can also set the window to be open, partially open, or closed, and you can animate the opening over time.



**Different types of windows in a model of a house**

3ds Max offers six kinds of windows:

- The [Casement window](#) on page 526 has one or two door-like sashes that swing inward or outward.
- The [Pivoted window](#) on page 530 pivots at the center of its sash, either vertically or horizontally.
- The [Projected window](#) on page 532 has three sashes, two of which open like awnings in opposite directions.
- The [Sliding window](#) on page 534 has two sashes, one of which slides either vertically or horizontally.
- The [Fixed window](#) on page 528 doesn't open.
- The [Awning window](#) on page 523 has a sash that is hinged at the top.

### **Windows and Materials**

By default, 3ds Max assigns five different material IDs to windows. The *aectemplates.mat* material library includes *Window-Template*, a multi/sub-object

material designed to be used with windows. Each component of the window/material is listed below along with its corresponding Material ID.

---

Material ID	Window/Material Component
1	Front Rails
2	Back Rails
3	Panels (glazing), with 50% opacity
4	Front Frame
5	Back Frame

---

**NOTE** 3ds Max does not automatically assign a material to the window object. To use the included material, open the library and then assign the material to your object.

---

### Making an Opening for a Window

To make an opening in a wall, you can perform a [Boolean operation](#) on page 686 with the wall as Operand A, and another object, such as a box, as Operand B. Then, you can create and add a window in the opening, and [link](#) on page 3267 it, if you choose, as a child of the wall.

**NOTE** Using snaps, you can insert a window in a wall object, automatically linking the two and creating a cutout for the window. See the procedure [To create and place a window or door in a wall](#): on page 462 .

---

### Procedures

**To create a window:**

- 1 On the Object Type rollout, click the button for the type of window you want to create.
- 2 Choose options as needed, such as changing the default creation method. Turn on Allow Non-vertical Jambes if you want an inclined window.
- 3 Drag the mouse in the viewport to create the first two points, defining the width and angle of the base of the window.



- 4 Release the mouse and move to adjust the depth of the window (default creation method), and then click to set.  
By default, the depth is perpendicular to the line between the first two points and parallel to the active grid.
- 5 Move the mouse to adjust the height, and then click to finish.  
The height is perpendicular to the plane defined by the first three points and perpendicular to the active grid.  
You can adjust the height, width, and depth values on the Parameters rollout.

In the Creation Method rollout, you can change the creation order to width-height-depth instead of width-depth-height.

**To create a window material:**

- 1 Create a window or select an existing window.
- 2 Open the Material Editor, and select a slot for the material.
- 3 Click the Type button below the Material Editor toolbar.  
The Material/Map Browser dialog opens.
- 4 In the Material list, double-click the Multi/Sub-Object item, and then on the Replace Material dialog that appears, choose either option and click OK.
- 5 On the Multi/Sub-Object Basic Parameters rollout, click Set Number and change Number Of Materials to 5. Click OK.
- 6 Optionally, change the sub-material names to those specified in the [above table](#) on page 518 .
- 7 Edit the material as you would any Multi/Sub-Object material.

**To animate a window:**

You can animate a window opening and closing by keyframing the Open setting.

- 1 Create a window or select an existing window.
- 2 If using an existing window, also access the Modify panel.

- 3 Set the Parameters rollout > Open parameter to the amount you want the window to be open at the start of the animation. If you want it to be closed, set it to **0**.
- 4 Click the [Auto Key button](#) on page 7344 to turn it on, and advance to the first keyframe.
- 5 Change the Open setting.
- 6 Continue moving to any additional keyframes and changing the Open setting as necessary.
- 7 Play the animation.

## Interface

Most window parameters are common to all kinds of windows, and are described here. The topic for each window type describes its unique controls and behavior.

### Object Type rollout



Six types of window are available in 3ds Max:

**Awning** Has a sash that is hinged at the top. See [Awning](#) on page 523 .

**Casement** Has one or two door-like sashes that swing inward or outward. See [Casement](#) on page 526 .

**Fixed** Doesn't open. See [Fixed](#) on page 528 .

**Pivoted** Pivots at the center of its sash, either vertically or horizontally. See [Pivoted](#) on page 530 .

**Projected** Has three sashes, two of which open like awnings in opposite directions. See [Projected](#) on page 532 .

**Sliding** Has two sashes, one of which slides vertically or horizontally. See [Sliding](#) on page 534 .

## Name and Color rollout

See [Object Name and Wireframe Color](#) on page 7423 .

## Creation Method rollout

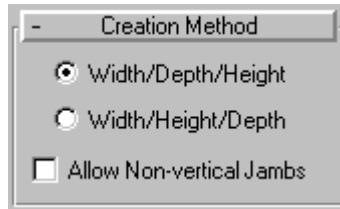

You define each type of window with four points: Drag the first two, followed by two move-click sequences. The Creation Method setting determines the order in which these actions define the window's dimensions.

**Width/Depth/Height** The first two points define the width and angle of the base of the window. You set these points by dragging in a viewport, as the first step in creating a window. This lets you align the window with a wall or opening when you place it. The third point, where you click after moving the mouse, specifies the depth of the window, and the fourth click, where you click after moving the mouse again, specifies the height.

**Width/Height/Depth** Works like the Width/Depth/Height option, except that the last two points create first the height and then the depth.

---

**NOTE** With this method, the depth is perpendicular to the plane set by the first three points. Thus, if you draw the window in the Top or Perspective viewport, the door lies flat on the active grid.

---

**Allow Non-vertical Jamb** Select to create tilted windows. Set [snaps](#) on page 2568 to define points off the construction plane. Default=off.

## Parameters rollout

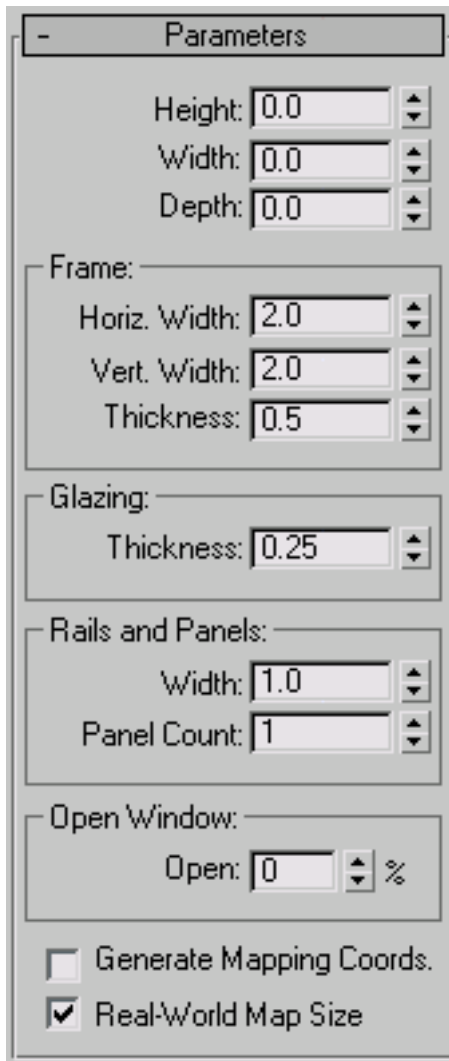

The image shows a 'Parameters' rollout dialog box with the following settings:

- Height: 0.0
- Width: 0.0
- Depth: 0.0
- Frame:
  - Horiz. Width: 2.0
  - Vert. Width: 2.0
  - Thickness: 0.5
- Glazing:
  - Thickness: 0.25
- Rails and Panels:
  - Width: 1.0
  - Panel Count: 1
- Open Window:
  - Open: 0 %
- Generate Mapping Coords.
- Real-World Map Size

**Height/Width/Depth** Specifies the overall dimensions of the window.

## Frame group

**Horiz. Width** Sets the width of the horizontal part of the window frame (at the top and bottom). This setting also affects the glazed portion of the window's width.

**Vert. Width** Sets the width of the vertical part of the window frame (at the sides). This setting also affects the glazed portion of the window's height.

**Thickness** Sets the thickness of the frame. This also controls the thickness of casements or railings on the window's sashes.

## Glazing group

**Thickness** Specifies the thickness of the glass.

**Generate Mapping Coordinates** Creates the object with the appropriate [mapping coordinates](#) on page 7838 already applied.

**Real-World Map Size** Controls the scaling method used for texture mapped materials that are applied to the object. The scaling values are controlled by the Use Real-World Scale settings found in the applied material's [Coordinates rollout](#) on page 5620 . Default=off.

## Awning Window

Create panel > Geometry > Windows > Awning button

Create menu > AEC Objects > Awning Window

The Awning window has one or more sashes that are hinged at the top.



**Awning window**

## Interface

### Parameters rollout

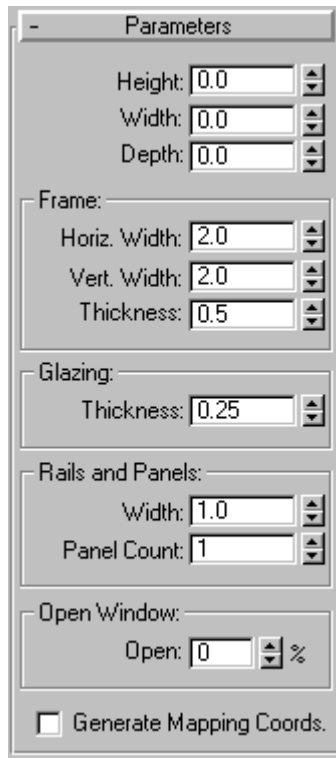

The screenshot shows a 'Parameters' rollout window with the following controls:

- Height: 0.0
- Width: 0.0
- Depth: 0.0
- Frame:
  - Horiz. Width: 2.0
  - Vert. Width: 2.0
  - Thickness: 0.5
- Glazing:
  - Thickness: 0.25
- Rails and Panels:
  - Width: 1.0
  - Panel Count: 1
- Open Window:
  - Open: 0 %
- Generate Mapping Coords.

The topic for each kind of window describes its unique controls and behavior. Some window parameters are common to all kinds of windows; see [Windows](#) on page 516 .

### Rails and Panels group

**Width** Sets the width (depth) of the rails in the sashes.

**Panel Count** Sets the number of sashes in the window. If you use more than one sash, each is hinged at its top edge. Range=1 to 10.

### Open Window group

**Open** Specifies the percent the window is open. This control is animatable.

## Casement Window

Create panel > Geometry > Windows > Casement button

Create menu > AEC Objects > Casement Window

The Casement window has one or two sashes that are hinged on the side, like a door.



Casement window



## Interface

### Parameters rollout

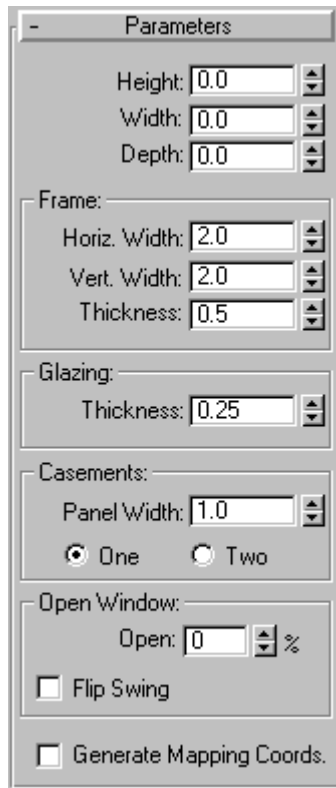

The image shows a 'Parameters' rollout window with the following settings:

- Height: 0.0
- Width: 0.0
- Depth: 0.0
- Frame:
  - Horiz. Width: 2.0
  - Vert. Width: 2.0
  - Thickness: 0.5
- Glazing:
  - Thickness: 0.25
- Casements:
  - Panel Width: 1.0
  - One  Two
- Open Window:
  - Open: 0 %
  - Flip Swing
  - Generate Mapping Coords.

The topic for each kind of window describes its unique controls and behavior. Some window parameters are common to all kinds of windows; see [Windows](#) on page 516 .

### Casements group

**Panel Width** Changes the size of the glazed panel within each sash.

**One/Two** Specifies the number of window panels: one or two. Using two panels creates a window like a double door; each panel is hinged on its outside side edge.

## Open Window group

**Open** Specifies the percent that the window is open. This control is animatable.

**Flip Swing** Turn this on to have the sashes open in the opposite direction.

## Fixed Window

Create panel > Geometry > Windows > Fixed button

Create menu > AEC Objects > Fixed Window

Fixed windows do not open, thus have no Open Window control. In addition to the standard window object parameters, the Fixed window provides the Rails And Panels group of settings for subdividing the window.



Fixed windows

## Interface

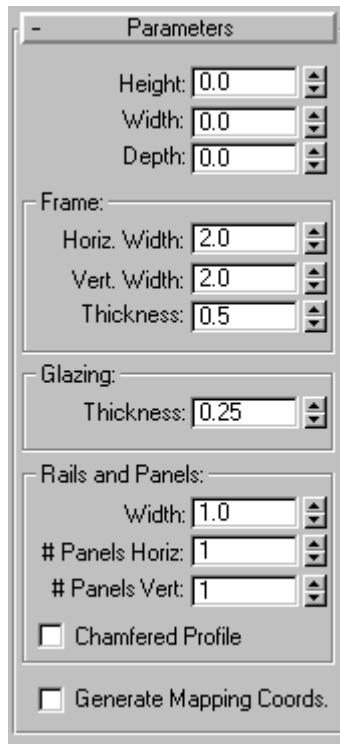

### Parameters rollout

The topic for each kind of window describes its unique controls and behavior. Some window parameters are common to all kinds of windows; see [Windows](#) on page 516 .

### Rails and Panels group

**Width** Sets the width (depth) of the rails in the sashes.

**# Panels Horiz** Sets the number of horizontal divisions in the window.

**# Panels Vert** Sets the number of vertical divisions in the window.

**Chamfered Profile** Chamfers the rails between the glazed panels, as in a conventional wooden window. When Chamfered Profile is off, the rails have a rectangular profile.

## Pivoted Window

Create panel > Geometry > Windows > Pivoted button

Create menu > AEC Objects > Pivoted Window

A pivoted window has one sash only, hinged midway through the side of the sash. It can swing open either vertically or horizontally.

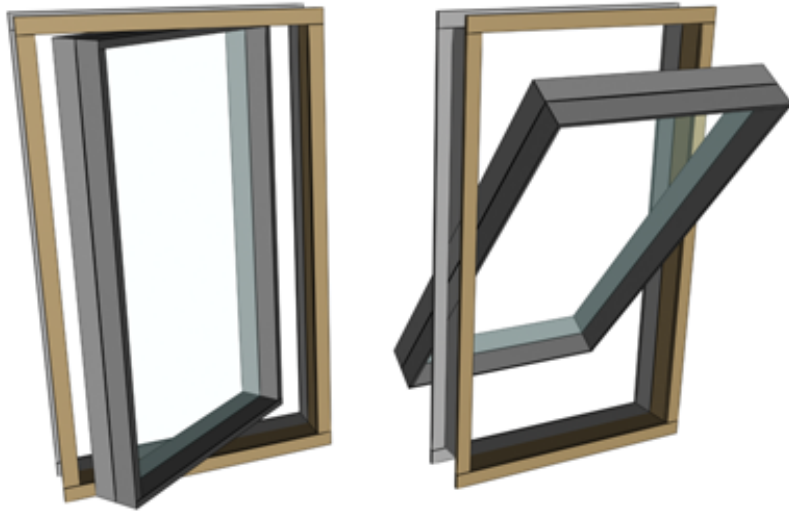

Pivoted windows

## Interface

### Parameters rollout



The image shows a 'Parameters' rollout window with the following controls:

- Height: 0.0
- Width: 0.0
- Depth: 0.0
- Frame:
  - Horiz. Width: 2.0
  - Vert. Width: 2.0
  - Thickness: 0.5
- Glazing:
  - Thickness: 0.25
- Rails:
  - Width: 1.0
- Pivots:
  - Vertical Rotation
- Open window:
  - Open: 0 %
- Generate Mapping Coords.

The topic for each kind of Window describes its unique controls and behavior. Most Window parameters are common to all kinds of Windows; see [Windows](#) on page 516 .

### Rails group

**Width** Sets the width of the rails in the sash.

### Pivots group

**Vertical Rotation** Switches the pivot axis from horizontal to vertical.

## Open Window group

**Open** Specifies the percent that the window is open. This control is animatable.

## Projected Window

Create panel > Geometry > Windows > Projected button

Create menu > AEC Objects > Projected Window

Projected windows have three sashes: The top sash doesn't move, while the bottom two sashes swing open like awning windows, but in opposite directions.



Projected window

## Interface

### Parameters rollout

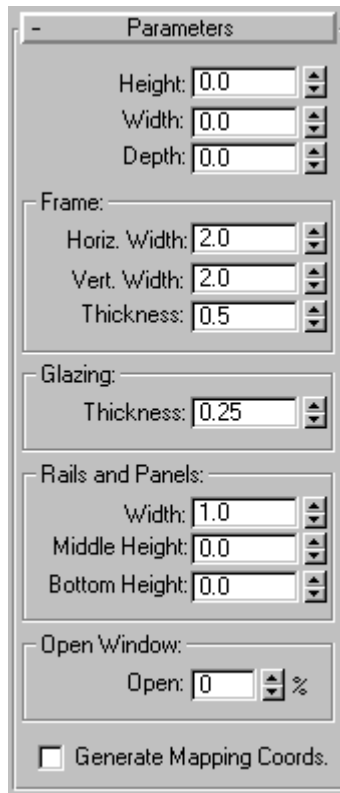

The image shows a 'Parameters' dialog box with several sections of controls:

- Height:** 0.0
- Width:** 0.0
- Depth:** 0.0
- Frame:**
  - Horiz. Width:** 2.0
  - Vert. Width:** 2.0
  - Thickness:** 0.5
- Glazing:**
  - Thickness:** 0.25
- Rails and Panels:**
  - Width:** 1.0
  - Middle Height:** 0.0
  - Bottom Height:** 0.0
- Open Window:**
  - Open:** 0 %
- Generate Mapping Coords.**

The topic for each kind of window describes its unique controls and behavior. Some window parameters are common to all kinds of windows; see [Windows](#) on page 516 .

### Rails and Panels group

**Width** Sets the width (depth) of the rails in the sashes.

**Middle Height** Sets the height of the middle sash, relative to the window's frame.

**Bottom Height** Sets the height of the bottom sash, relative to the window's frame.

## Open Window group

**Open** Specifies the percent that the two movable sashes are open. This control is animatable.

## Sliding Window

Create panel > Geometry > Windows > Sliding button

Create menu > AEC Objects > Sliding Window

Sliding windows have two sashes: one fixed, one movable. The sliding part can move either vertically or horizontally.



Sliding windows



## Interface

### Parameters rollout

Parameters

Height: 0.0

Width: 0.0

Depth: 0.0

Frame:

Horiz. Width: 2.0

Vert. Width: 2.0

Thickness: 0.5

Glazing:

Thickness: 0.25

Rails and Panels:

Rail Width: 1.0

# Panels Horiz: 1

# Panels Vert: 1

Chamfered Profile

Open Window:

Hung

Open: 0 %

Generate Mapping Coords.

The topic for each kind of Window describes its unique controls and behavior. Most Window parameters are common to all kinds of Windows; see [Windows](#) on page 516 .

### Rails and Panels group

**Rail Width** Sets the width of the rails in the sash.

**# Panels Horiz** Sets the number of horizontal divisions in each sash.

**# Panels Vert** Sets the number of vertical divisions in each sash.

**Chamfered Profile** Chamfers the rails between the glazed panels, as in a conventional wooden window. When Chamfered Profile is off, the rails have a rectangular profile.

### **Open Window group**

**Hung** When on, the window slides vertically. When off, the window slides horizontally.

**Open** Specifies the percent that the window is open. This control is animatable.

## **Shapes**

Create panel > Shapes

Create menu > Shapes

A shape is an object made from one or more curved or straight lines.

3ds Max includes the following shape types:

[Splines and Extended Splines](#) on page 542

[NURBS Curves](#) on page 2199

### **Using Shapes**

Shapes are 2D and 3D lines and groups of lines that you typically use as components of other objects. Most of the default shapes are made from splines. You use these spline shapes to do the following:

- Generate planar and thin 3D surfaces
- Define loft components such as paths, shapes, and fit curves
- Generate surfaces of revolution
- Generate extrusions
- Define motion paths

The program supplies 11 basic spline shape objects, plus two types of NURBS curves. You can quickly create these shapes using mouse or keyboard entry

and combine them to form compound shapes. See [Splines](#) on page 542 for information about the methods and parameters used to create these shapes.

## Creating Shapes



To access the shape creation tools, go to the Create panel and click the Shapes button. You'll find the standard shapes under Splines in the category list, and Point Curve and CV Curve under NURBS Curves.

As you add plug-ins, other shape categories might appear in this list.

The Object Type rollout contains the spline creation buttons. You can combine one or more of these spline types into a single shape.

## Create Shape from Edges

You can create shapes from edge selections in mesh objects. In Edit/Editable Mesh objects, at the Edge selection level, in the Edit Geometry rollout, is a button called Create Shape from Edges that creates a spline shape based on selected edges. See [Editable Mesh \(Edge\)](#) on page 2007. Similarly, with Editable Poly objects, you can use the Create Shape button at the Edge selection level. See [Editable Poly \(Edge\)](#) on page 2066

## Editable Splines

You can convert a basic spline to an [editable spline object](#) on page 590. The editable spline has a variety of controls that let you directly manipulate it and its sub-objects. For example, at the Vertex sub-object level you can move vertices or adjust their Bezier handles. Editable splines let you create shapes that are less regular, more free-form than the basic spline options.

When you convert a spline to an editable spline, you lose the ability to adjust or animate its creation parameters.

## Renderable Shapes

When you use a shape to create a 3D object by lofting, extruding, or other means, the shape becomes a renderable 3D object. However, you can make a shape render without making it into a 3D object. There are three basic steps to rendering a shape:

- 1 On the Rendering rollout of the shape's creation parameters, turn on Enable In Renderer.

- 2 Specify the thickness for the spline using the Thickness spinner in the Rendering rollout.

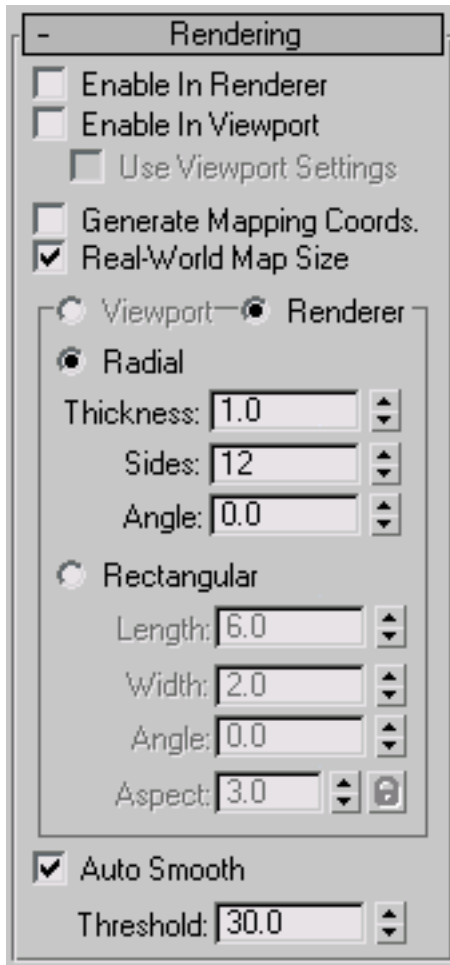

- 3 If you plan to assign a mapped material to the spline, turn on Generate Mapping Coords.

When Enable in Renderer is on, the shape is rendered using a circle as a cross section. Mapping coordinates are generated with U mapped once around the perimeter, and V mapped once along the length.

The software provides more control over renderable shapes; viewports, including wireframe viewports, can display the geometry of renderable shapes. The rendering parameters for shapes appear in their own rollout.

The Steps settings affect the number of cross sections in the renderable shape.

Please observe the following:

- When you apply a modifier that converts a shape into a mesh (such as [Extrude](#) on page 1377 or [Lathe](#) on page 1430 ), the object automatically becomes renderable, regardless of the state of the Enable in Renderer check box. You need to turn on the Enable in Renderer check box only when you want to render an unmodified spline shape in the scene.
- As with all objects, a shape's layer must be on for the shape to render. See [Layer Properties](#) on page 7227 .
- The [Object Properties dialog](#) on page 245 also has a Renderable check box, which is turned on by default. Both this check box and the General rollout > Renderable check box must be turned on in order to render a shape.

### Shapes as Planar Objects

A straightforward usage for shapes is 2D cutouts or planar objects. Examples include ground planes, text for signs, and cutout billboards. You create a planar object by applying an [Edit Mesh modifier](#) on page 1283 to a closed shape, or by converting it to an [editable mesh object](#) on page 1990 .



#### 2D objects

You can also apply an Edit Mesh modifier to a 3D shape (for example, a shape whose vertices have been moved vertically away from the construction plane

by different amounts) to create a curved surface. The resulting 3D surface often requires manual editing of faces and edges to smooth surface ridges.

### Extruded and Lathed Shapes

You can apply modifiers to a shape to create a 3D object. Two of these modifiers are Extrude and Lathe. [Extrude](#) on page 1377 creates a 3D object by adding height to a shape. [Lathe](#) on page 1430 creates a 3D object by rotating a shape about an axis.



Initial text shape with extruded shape below

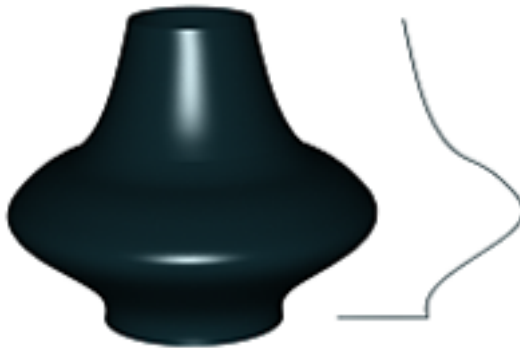

Lathed object with initial shape on right

## Lofting Shapes

You create [Lofts](#) on page 715 by combining two or more splines in special ways. Shapes form the lofting path, loft cross-sections, and loft fit curves.

## Shapes as Animation Paths

You can use shapes to define the position of an animated object. You create a shape and use it to define a path that some other object follows.

Some possible ways for a shape to control animated position are:

- You can use a [Path constraint](#) on page 3222 to use a shape to control object motion.
- You can convert a shape into position keys using the Motion panel > Trajectories > Convert From function (see [Trajectories](#) on page 3045 ).

See also:

- [Edit Modifiers and Editable Objects](#) on page 1027
- [Modifying at the Sub-Object Level](#) on page 1029
- [Modifier Stack Controls](#) on page 7427

# Shape Check Utility

Utilities panel > Utilities rollout > More button Utilities dialog > Shape Check

The Shape Check utility tests spline and NURBS-based shapes and curves for self-intersection and graphically displays any instances of intersecting segments. Self-intersecting shapes used to produce lathed, extruded, lofted, or other 3D objects can result in rendering errors.

The utility is "sticky" in that once you've picked a shape object for it to check, you can pan/zoom viewports and it will continually display the locations of intersecting curves in the shape you pick.

If a shape is animated, moving the time slider will recheck the shape on each frame of the animation, allowing for easy checking of these changing shapes.

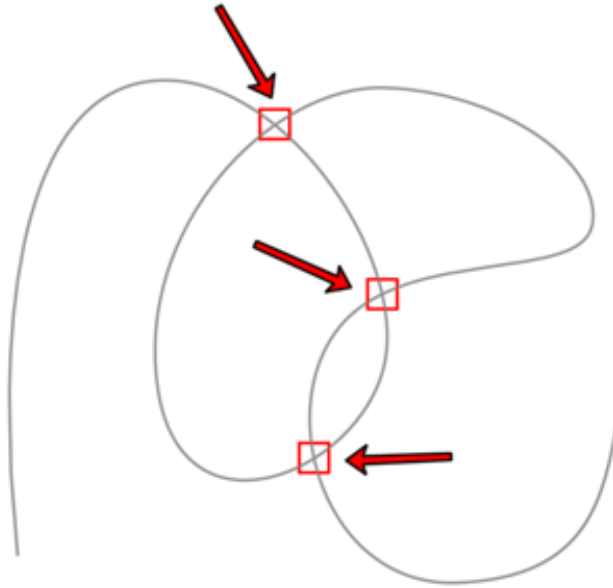

Intersection points highlighted by Shape Check

### Interface

**Pick Object** Click this button, and then click the shape for the utility to check. You can pick only spline- and NURBS-based shapes and curves. Points of intersection discovered by the utility are highlighted with red boxes. The text below the button indicates whether any points of intersection occur.

**Close** Closes the utility.

## Splines and Extended Splines

Create panel > Shapes > Splines

Create menu > Shapes

Create panel > Shapes > Extended Splines

Splines include the following object types:

[Line Spline](#) on page 551



[Rectangle Spline](#) on page 555

[Circle Spline](#) on page 557

[Ellipse Spline](#) on page 559

[Arc Spline](#) on page 560

[Donut Spline](#) on page 564

[NGon Spline](#) on page 565

[Star Spline](#) on page 567

[Text Spline](#) on page 569

[Helix Spline](#) on page 574

[Section Spline](#) on page 576

Extended Splines include the following object types:

[WRectangle Spline](#) on page 580

[Channel Spline](#) on page 583

[Angle Spline](#) on page 585

[Tee Spline](#) on page 587

[Wide Flange Spline](#) on page 588

This topic covers aspects of spline and extended spline creation that are common to all spline object types, including the parameters available in the General rollout. For parameters unique to a particular spline or extended spline type, see its section by clicking the appropriate link above.

## **Procedures**

### **To control starting a new shape manually:**

- 1 On the Create panel, turn off the check box next to the Start New Shape button.
- 2 Click the Start New Shape button.
- 3 Begin creating splines.  
Each spline is added to the compound shape. You can tell you are creating a compound shape because all the splines remain selected.
- 4 Click Start New Shape to complete the current shape and prepare to start another.

Issues to remember about creating shapes:

- You can go back and change the parameters of a shape containing a single spline after the shape is created.
- You can create a compound shape by adding splines to a shape: Select the shape, turn off Start New Shape, and then create more splines.
- You cannot change the parameters of a compound shape. For example, create a compound shape by creating a circle and then adding an arc. Once you create the arc, you cannot change the circle parameters.

**To create a spline using keyboard entry:**

- 1 Click a spline creation button.
- 2 Expand the Keyboard Entry rollout.
- 3 Enter X, Y, and Z values for the first point.
- 4 Enter values in any remaining parameter fields.
- 5 Click Create.

## Interface

### Object Type rollout (Splines and Extended Splines)

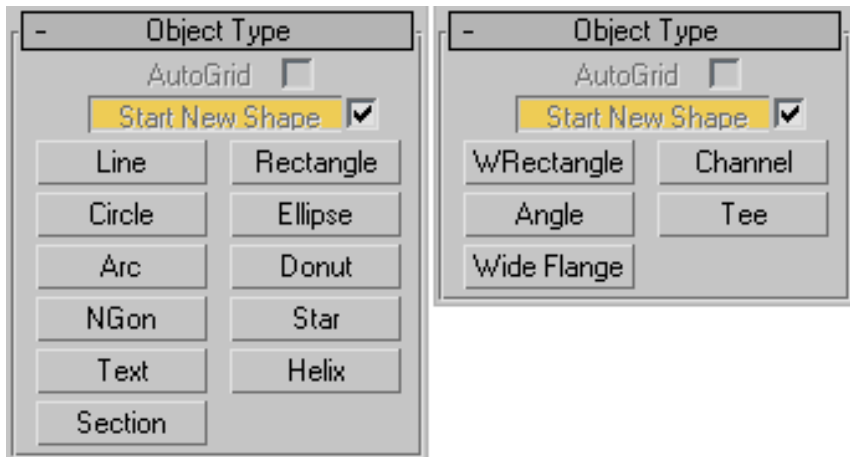

**AutoGrid** Lets you automatically create objects on the surface of other objects by generating and activating a temporary construction plane based on normals of the face that you click.

For more information, see [AutoGrid](#) on page 2513 .

**Start New Shape** A shape can contain a single spline or it can be a compound shape containing multiple splines. You control how many splines are in a shape using the Start New Shape button and check box on the Object Type rollout. The check box next to the Start New Shape button determines when new shapes are created. When the box is on, the program creates a new shape object for every spline you create. When the box is off, splines are added to the current shape until you click the Start New Shape button.

**Shape Selection buttons** Lets you specify the type of shape to create.

### **Name and Color rollout**

Lets you name an object and assign it a viewport color. For details, see [Object Name and Wireframe Color](#) on page 7423 .

## Rendering rollout

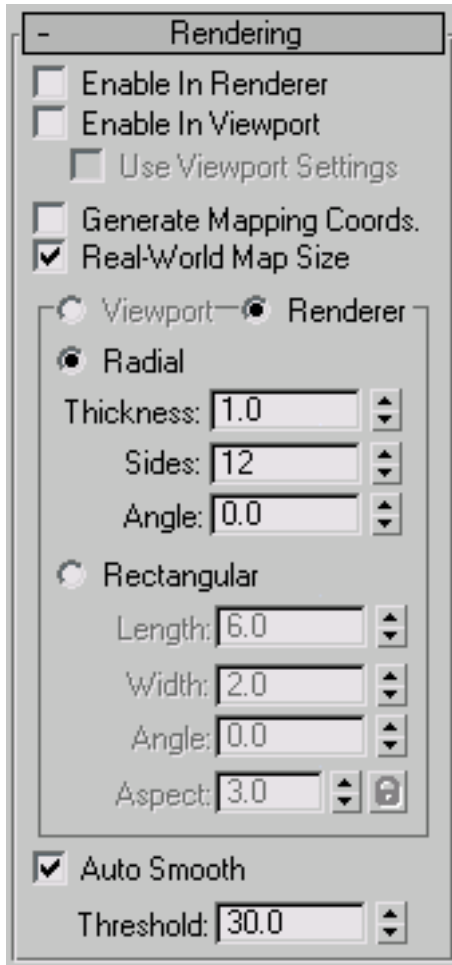

Lets you turn on and off the renderability of a spline or NURBS curve, specify its thickness in the rendered scene, and apply mapping coordinates.

You can animate render parameters, such as the number of sides, but you cannot animate the Viewport settings.

You can convert the displayed mesh into a mesh object by applying an Edit Mesh or Edit Poly modifier or converting to an editable mesh or editable poly object. If Enable In Viewport is off when converting, closed shapes will be “filled in” and open shapes will contain only vertices; no edges or faces. If

Enable In Viewport is on when converting, the system will use the Viewport settings for this mesh conversion. This gives maximum flexibility, and will always give the conversion of the mesh displayed in the viewports.

**Enable In Renderer** When on, the shape is rendered as a 3D mesh using the Radial or Rectangular parameters set for Renderer. In previous versions of the program, the Renderable switch performed the same operation.

**Enable In Viewport** When on, the shape is displayed in the viewport as a 3D mesh using the Radial or Rectangular parameters set for Renderer. In previous versions of the program, the Display Render Mesh performed the same operation.

**Use Viewport settings** Lets you set different rendering parameters, and displays the mesh generated by the Viewport settings. Available only when Enable in Viewport is turned on.

**Generate Mapping Coords** Turn this on to apply mapping coordinates. Default=off.

3ds Max generates the mapping coordinates in the U and V dimensions. The U coordinate wraps once around the spline; the V coordinate is mapped once along its length. Tiling is achieved using the Tiling parameters in the applied material. For more information, see [Mapping Coordinates](#) on page 5183 .

**Real-World Map Size** Controls the scaling method used for texture mapped materials that are applied to the object. The scaling values are controlled by the Use Real-World Scale settings found in the applied material's [Coordinates rollout](#) on page 5620 . Default=off.

**Viewport** Choose this to specify Radial or Rectangular parameters for the shape as it will display in the viewports when Enable In Viewport is on.

**Renderer** Choose this on to specify Radial or Rectangular parameters for the shape as it will display when rendered or viewed in the viewport when Enable in Viewport is turned on.

**Radial** Displays the 3D mesh as a cylindrical object.

**Thickness** Specifies the diameter of the viewport or rendered spline mesh. Default=1.0. Range=0.0 to 100,000,000.0.



**Splines rendered at thickness of 1.0 and 5.0, respectively**

**Sides** Sets the number of sides (or facets) for the spline mesh in the viewport or renderer. For example, a value of 4 results in a square cross section.

**Angle** Adjusts the rotational position of the cross-section in the viewport or renderer. For example, if the spline mesh has a square cross section you can use Angle to position a "flat" side down.

**Rectangular** Displays the spline's mesh shape as a rectangle.

**Length** Specifies the size of the cross-section along the local *Y* axis.

**Width** Specifies the size of the cross-section along the local *X* axis.

**Angle** Adjusts the rotational position of the cross-section in the viewport or renderer. For example, if you have a square cross-section you can use Angle to position a "flat" side down.

**Aspect** Sets the aspect ratio for rectangular cross-sections. The Lock check box lets you lock the aspect ratio. When Lock is turned on, Width is locked to Length that results in a constant ratio of Width to Length.

**Auto Smooth** If Auto Smooth is turned on, the spline is auto-smoothed using the threshold specified by the Threshold setting below it. Auto Smooth sets the smoothing based on the angle between spline segments. Any two adjacent segments are put in the same smoothing group if the angle between them is less than the threshold angle.

---

**NOTE** Turning Auto Smooth on for every situation does not always give you the best smoothing quality. Altering the Threshold angle may be necessary or turning Auto Smooth off may produce the best results.

---

**Threshold** Specifies the threshold angle in degrees. Any two adjacent spline segments are put in the same smoothing group if the angle between them is less than the threshold angle.

### Interpolation rollout

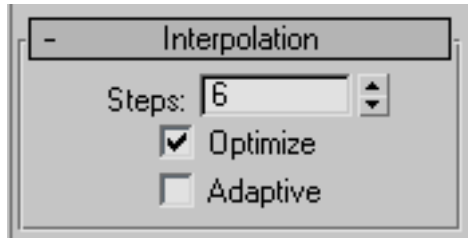

These settings control how a spline is generated. All spline curves are divided into small straight lines that approximate the true curve. The number of divisions between each vertex on the spline are called steps. The more steps used, the smoother the curve appears.

**Steps** Spline steps can be either adaptive (that is, set automatically by turning on Adaptive) or specified manually.

When Adaptive is off, use the Steps field/spinner to set the number of divisions between each vertex. Splines with tight curves require many steps to look smooth while gentle curves require fewer steps. Range=0 to 100.

**Optimize** When on, removes unneeded steps from straight segments in the spline. Optimize is not available when Adaptive is on. Default=on.

**Adaptive** When off, enables manual interpolation control using Optimize and Steps. Default=off.

When on, Adaptive sets the number of steps for each spline to produce a smooth curve. Straight segments always receive 0 steps.

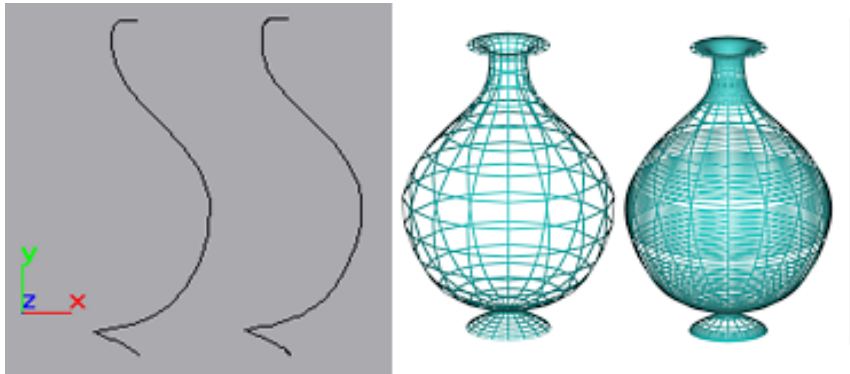

Optimized spline left and adaptive spline right. Resulting wireframe view of each, respectively, on the right.

The main use for manual interpolation of splines is in morphing or other operations where you must have exact control over the number of vertices created.

### Creation Method rollout

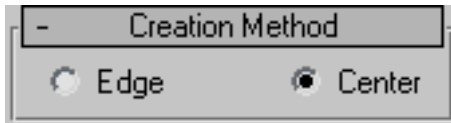

Many spline tools use the Creation Methods rollout. On this rollout you choose to define splines by either their center point or their diagonal.

**Edge** Your first click defines a point on the side or at a corner of the shape and you drag a diameter or the diagonal corner.

**Center** Your first click defines the center of the shape and you drag a radius or corner point.

[Text](#) on page 569 and [Star](#) on page 567 do not have a Creation Methods rollout.

[Line](#) on page 551 and [Arc](#) on page 560 have unique Creation Methods rollouts that are discussed in their respective topics.



## Keyboard Entry rollout

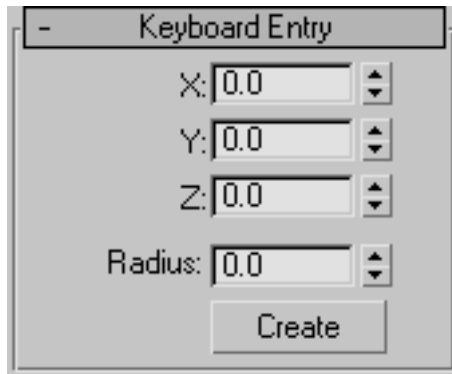

You can create most splines using keyboard entry. The process is generally the same for all splines and the parameters are found under the Keyboard Entry rollout. Keyboard entry varies primarily in the number of optional parameters. The image above shows a sample Keyboard Entry rollout for the Circle shape.

The Keyboard Entry rollout contains three fields for the X, Y, and Z coordinates of the initial creation point, plus a variable number of parameters to complete the spline. Enter values in each field and click the Create button to create the spline.

## Line Spline

Create panel > Shapes > Splines > Object Type rollout > Line

Create menu > Shapes > Line

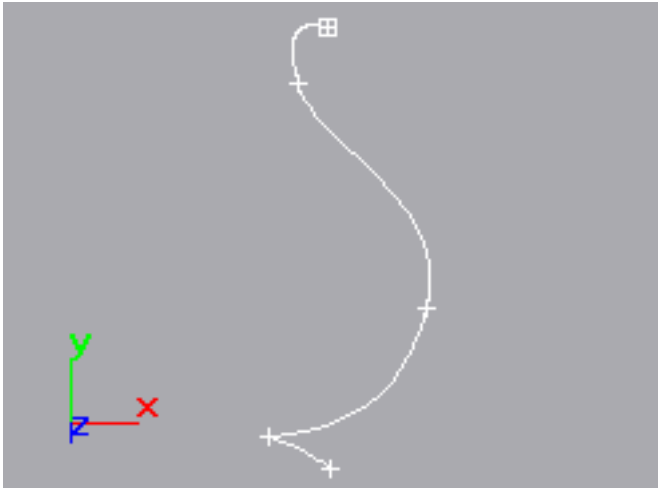

Use Line to create a free-form spline made of multiple segments.



Example of line

## Procedures

To create a line:

- 1   Go to the Create panel and choose Shapes.
- 2 On the Object Type rollout, click the Line button.
- 3 Choose a creation method.
- 4 Click or drag the start point.  
Clicking creates a corner vertex; dragging creates a Bezier vertex.
- 5 Click or drag additional points.  
Clicking creates a corner vertex; dragging creates a Bezier vertex.
- 6 Do one of the following:
  - Right-click to create an open spline.
  - Click the first vertex and click Yes in the "Close spline?" dialog to create a closed spline.

### To create a line using rectilinear and angle-snap options:

These two options aid in creating regular shapes:

- While creating a spline with the mouse, press and hold Shift to constrain new points to 90-degree-angle increments from previous points. Use the default Initial type setting of Corner and click all subsequent points to create fully rectilinear shapes.
- While creating a spline with the mouse, press and hold Ctrl to constrain new points to angle increments determined by the current [Angle Snap setting](#) on page 2523 . To set this angle, go to Customize menu > Grid and Snap Settings, click the [Options tab](#) on page 2587 in the Grid and Snap Settings dialog, and change the value in the Angle (deg) field.

The angle for each new segment relates to the previous segment, so the angle snap works only after you've placed the first two spline vertices (that is, the first segment). Angle Snap need not be enabled for this feature to work.

### To create a line from the keyboard:

- 1 Enter values in the X, Y, and Z fields to specify a vertex coordinate.
- 2 Click Add Point to add a vertex to the current line at the specified coordinate.
- 3 Repeat steps 1 and 2 for each additional vertex.
- 4 Do one of the following:
  - Click Finish to create an open spline.
  - Click Close to connect the current vertex to the first vertex and create a closed spline.

## Interface

### Automatic Conversion to an Editable Spline

Because the Line object has no dimension parameters to be carried over to the Modify panel, it converts to an [editable spline](#) on page 590 when you move from the Create panel to the Modify panel. While you are creating the line, the Create panel displays the original controls, such as Interpolation, Rendering, Creation Method, and Keyboard Entry. After creating the line, when you go to the Modify panel you have immediate access to the Selection and Geometry rollouts to edit the vertices or any part of the shape.

## Rendering and Interpolation rollouts

All spline-based shapes share these parameters. See [Splines](#) on page 542 for an explanation of these parameters.

### Creation Method rollout

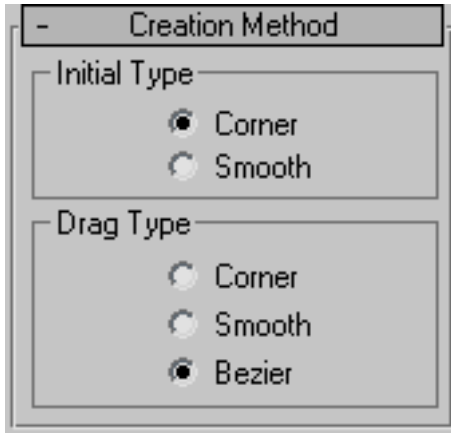

Creation method options for lines are different from other spline tools. You choose options to control the type of vertex created when you click or drag vertices.

You can preset the default types of spline vertices during line creation with these settings:

#### Initial Type group

Sets the type of vertex you create when you click a vertex location.

**Corner** Produces a sharp point. The spline is linear to either side of the vertex.

**Smooth** Produces a smooth, nonadjustable curve through the vertex. The amount of curvature is set by the spacing of the vertices.

#### Drag Type group

Sets the type of vertex you create when you drag a vertex location. The vertex is located at the cursor position where you first press the mouse button. The direction and distance that you drag are used only when creating Bezier vertices.

**Corner** Produces a sharp point. The spline is linear to either side of the vertex.

**Smooth** Produces a smooth, nonadjustable curve through the vertex. The amount of curvature are set by the spacing of the vertices.

**Bezier** Produces a smooth, adjustable curve through the vertex. The amount of curvature and direction of the curve are set by dragging the mouse at each vertex.

### Keyboard Entry rollout

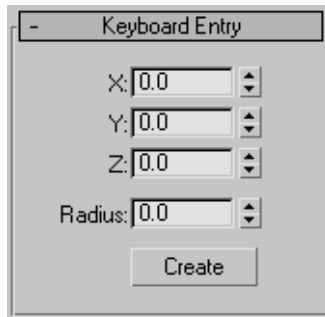

Keyboard entry for lines is different from keyboard entry for other splines. Entering keyboard values continues to add vertices to the existing line until you click Close or Finish.

**Add Point** Adds a new point to the line at the current X/Y/Z coordinates.

**Close** Closes the shape, adding a final spline segment between the most recent vertex and the first.

**Finish** Finishes the spline without closing it.

## Rectangle Spline

Create panel > Shapes > Splines > Object Type rollout > Rectangle

Create menu > Shapes > Rectangle



Use Rectangle to create square and rectangular splines.



Examples of rectangles

## Procedures

To create a rectangle:

- 1   Go to the Create panel and choose Shapes.
- 2 Click Rectangle.
- 3 Choose a creation method.
- 4 Drag in a viewport to create a rectangle.  
Optionally, press Ctrl while dragging to constrain the spline to a square.

## Interface

### Rendering and Interpolation rollouts

All spline-based shapes share these parameters. See [Splines](#) on page 542 for an explanation of these parameters.

### Creation Method rollout

The Rectangle shape uses the standard creation methods of Center or Edge. Most spline-based shapes share the same Creation Method parameters. See [Splines](#) on page 542 for an explanation of these parameters.

## Parameters rollout

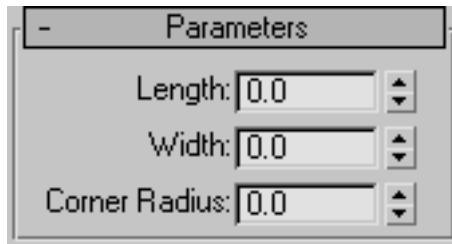

Once you have created a rectangle, you can make changes using the following parameters:

**Length** Specifies the size of the rectangle along the local Y axis.

**Width** Specifies the size of the rectangle along the local X axis.

**Corner Radius** Creates rounded corners. When set to 0, the rectangle contains 90-degree corners.

## Circle Spline

Create panel > Shapes > Splines > Object Type rollout > Circle

Create menu > Shapes > Circle

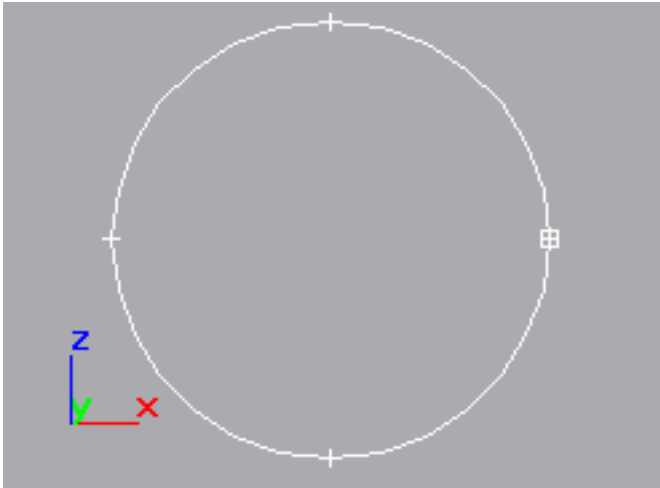

Use Circle to create closed circular splines made of four vertices.



Example of circle

## Procedures

To create a circle:

- 1   Go to the Create panel and choose Shapes.
- 2 Click Circle.
- 3 Choose a creation method.
- 4 Drag in a viewport to draw the circle.

## Interface

### Rendering and Interpolation rollouts

All spline-based shapes share these parameters. See [Splines](#) on page 542 for explanations of these parameters.

### Creation Method rollout

The Circle shape uses the standard creation methods of Center or Edge. Most spline-based shapes share the same Creation Method parameters. See [Splines](#) on page 542 for an explanation of these parameters.



## Parameters rollout

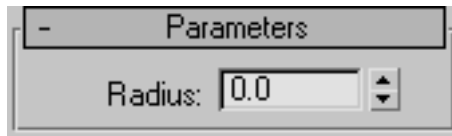

Once you have created a circle, you can make changes using the following parameter:

**Radius** Specifies the radius of the circle.

## Ellipse Spline

Create panel > Shapes > Splines > Object Type rollout > Ellipse

Create menu > Shapes > Ellipse

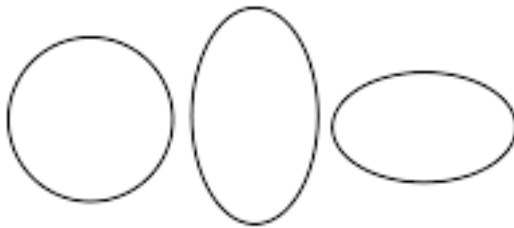

Use Ellipse to create elliptical and circular splines.



Examples of ellipses

## Procedures

To create an ellipse:

- 1   Go to the Create panel and choose Shapes.
- 2 Click Ellipse.
- 3 Choose a creation method.
- 4 Drag in a viewport to draw the ellipse.  
Optionally, press Ctrl while dragging to constrain the spline to a circle.

## Interface

### Rendering and Interpolation rollouts

All spline-based shapes share these parameters. See [Splines](#) on page 542 for explanations of these parameters.

### Creation Method rollout

The Ellipse shape uses the standard creation methods of Center or Edge. Most spline-based shapes share the same Creation Method parameters. See [Splines](#) on page 542 for an explanation of these parameters.

### Parameters rollout

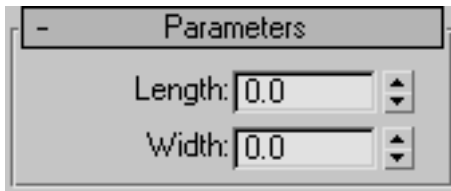

Once you have created an Ellipse, you can make changes using the following parameters:

**Length** Specifies the size of the Ellipse along the local Y axis.

**Width** Specifies the size of the Ellipse local X axis.

## Arc Spline

Create panel > Shapes > Splines > Object Type rollout > Arc

Create menu > Shapes > Arc

Use Arc to create open and closed circular arcs made of four vertices.

### Procedures

To create an arc using the end-end-middle method:

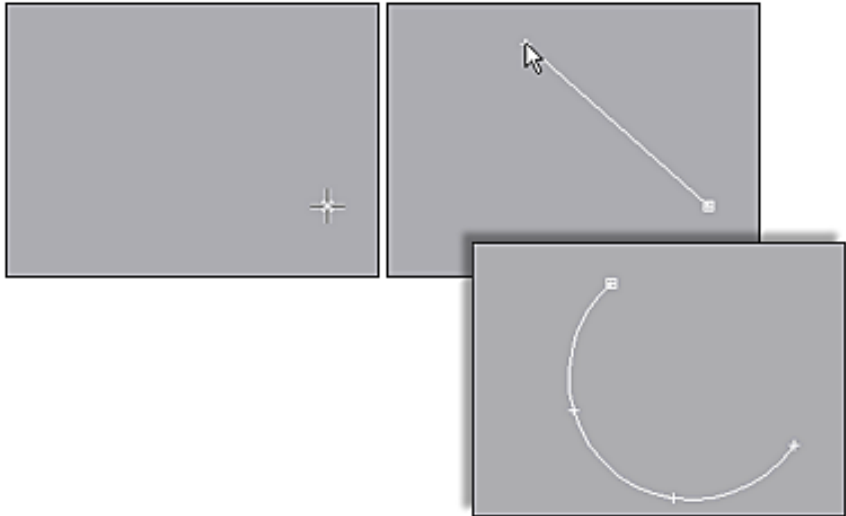

- 1   Go to the Create panel and choose Shapes.

- 2 Click Arc.
- 3 Choose the End-End-Middle creation method.
- 4 Drag in a viewport to set the two ends of the arc.
- 5 Release the mouse button, then move the mouse and click to specify a third point on an arc between the two endpoints.



#### Creating an arc using the End-End-Middle creation method

#### To create an arc using the center-end-end method:

- 1   Go to the Create panel and choose Shapes.
- 2 Click Arc.
- 3 Choose the Center-End-End creation method.
- 4 Press the mouse button to define the center of the arc.
- 5 Drag and release the mouse button to specify the start point of the arc.
- 6 Move the mouse and click to specify the other end of the arc.

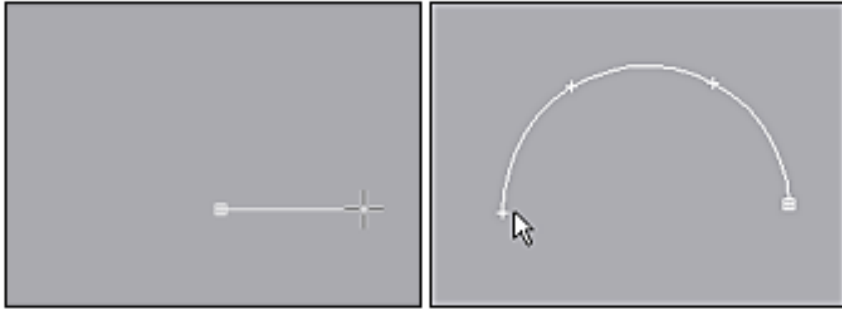

Creating an arc using the Center-End-End creation method

## Interface

### Rendering and Interpolation rollouts

All spline-based shapes share these parameters. See [Splines](#) on page 542 for an explanation of these parameters.

### Creation Method rollout

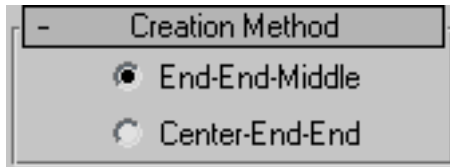

These options determine the sequence of mouse clicks involved in the creation of the arc.

**End-End-Middle** Drag and release to set the two endpoints of the arc, and then click to specify the third point between the two endpoints.

**Center-End-End** Press the mouse button to specify the center point of the arc, drag and release to specify one endpoint of the arc, and click to specify the other endpoint of the arc.

## Parameters rollout

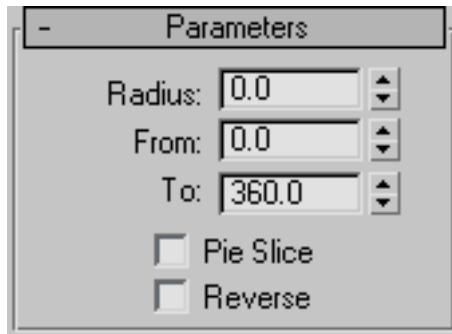

Once you have created an arc, you can make changes using the following parameters:

**Radius** Specifies the arc radius.

**From** Specifies the location of the start point as an angle measured from the local positive X axis.

**To** Specifies the location of the end point as an angle measured from the local positive X axis.

**Pie Slice** When on, creates a closed spline in the form of a pie. The start point and end point are connected to the center with straight segments.

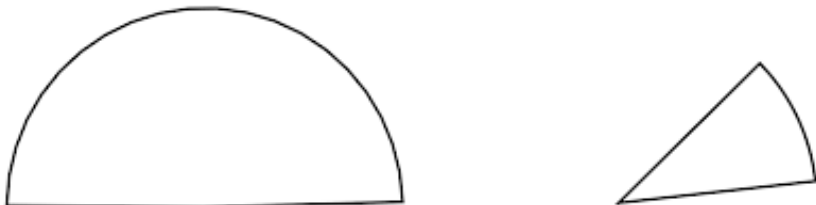

### Closed pie slice arcs

**Reverse** When on, the direction of the arc spline is reversed, and the first vertex is placed at the opposite end of an open arc. As long as the shape remains an original shape (and not an editable spline), you can switch its direction by toggling Reverse. Once the arc is converted to an editable spline, you can use Reverse at the Spline sub-object level to reverse direction.

## Donut Spline

Create panel > Shapes > Splines > Object Type rollout > Donut

Create menu > Shapes > Donut

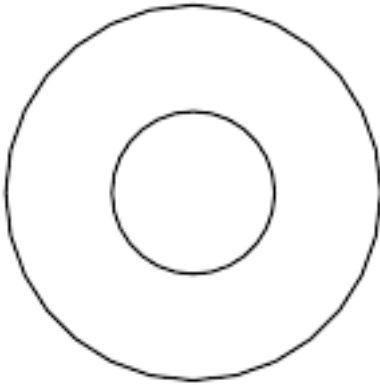

Use Donut to create closed shapes from two concentric circles. Each circle is made of four vertices.



**Example of donut**

### Procedures

To create a donut:

- 1   Go to the Create panel and choose Shapes.
- 2 Click Donut.
- 3 Choose a creation method.
- 4 Drag and release the mouse button to define the first donut circle.
- 5 Move the mouse and then click to define the radius of the second concentric donut circle.  
The second circle can be larger or smaller than the first.

## Interface

### Rendering and Interpolation rollouts

All spline-based shapes share these parameters. See [Splines](#) on page 542 for explanations of these parameters.

### Creation Method rollout

The Donut shape uses the standard creation methods of Center or Edge. Most spline-based shapes share the same Creation Method parameters. See [Splines](#) on page 542 for an explanation of these parameters.

### Parameters rollout

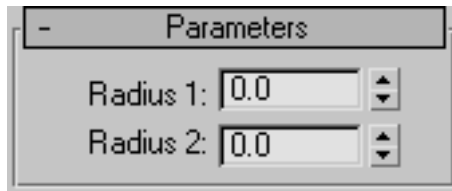

Once you have created a donut, you can make changes using the following parameters:

**Radius 1** Sets the radius of the first circle.

**Radius 2** Sets the radius of the second circle.

## NGon Spline

Create panel > Shapes > Splines > Object Type rollout > NGon

Create menu > Shapes > NGon

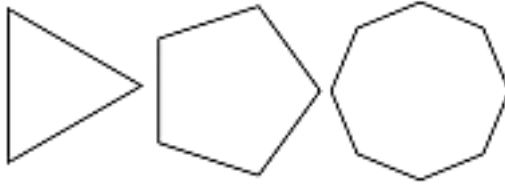

Use NGon to create closed flat-sided or circular splines with any number (N) of sides or vertices.



### Examples of NGons

### Procedures

To create an NGon:

- 1   Go to the Create panel and choose Shapes.
- 2 Click NGon.
- 3 Choose a creation method.
- 4 Drag and release the mouse button in a viewport to draw the NGon.

### Interface

#### Rendering and Interpolation rollouts

All spline-based shapes share these parameters. See [Splines](#) on page 542 for an explanation of these parameters.

#### Creation Method rollout

The NGon shape uses the standard creation methods of Center or Edge. Most spline-based shapes share the same Creation Method parameters. See [Splines](#) on page 542 for an explanation of these parameters.



## Parameters rollout

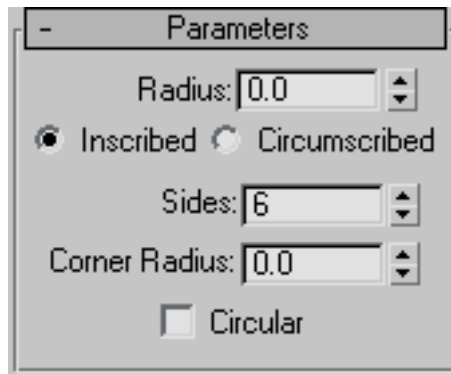

Once you have created an NGon, you can make changes using the following parameters:

**Radius** Specifies the NGon radius. You can use either of two methods to specify the radius:

- **Inscribed** The radius from the center to the corners of the NGon
- **Circumscribed** The radius from the center to the sides of the NGon.

**Sides** Specifies the number of sides and vertices used by the NGon. Range=3 to 100.

**Corner Radius** Specifies the degree of rounding to apply to the corners of the NGon. A setting of 0 specifies a standard unrounded corner.

**Circular** When on, specifies a circular NGon.

## Star Spline

Create panel > Shapes > Splines > Object Type rollout > Star

Create menu > Shapes > Star



Use Star to create closed star-shaped splines with any number of points. Star splines use two radiuses to set the distance between the outer points and inner valleys.



Examples of stars

## Procedures

To create a star:

- 1   Go to the Create panel and choose Shapes.
- 2 Click Star.
- 3 Drag and release the mouse button to define the first star radius.
- 4 Move the mouse and then click to define the second star radius.

## Interface

### Rendering and Interpolation rollouts

All spline-based shapes share these parameters. See [Splines](#) on page 542 for explanations of these parameters.

## Parameters rollout

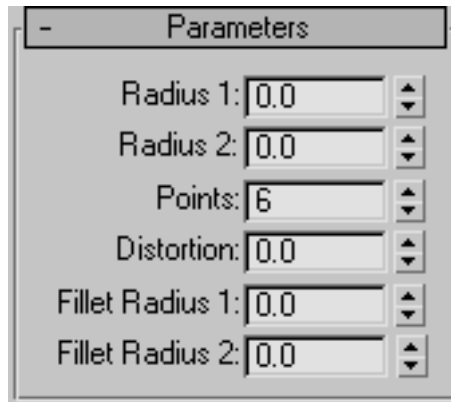

Once you have created a star, you can make changes using the following parameters:

**Radius 1** Specifies the radius of the inner vertices (the valley) of the star.

**Radius 2** Specifies the radius of the outer vertices (the points) of the star.

**Points** Specifies the number of points on the star. Range=3 to 100.

A star has twice as many vertices as the specified number of points. Half the vertices lie on one radius, forming points, and the remaining vertices lie on the other radius, forming valleys.

**Distortion** Rotates the outer vertices (the points) about the center of the star. This produces a sawtooth affect.

**Fillet Radius 1** Rounds the inner vertices (the valleys) of the star.

**Fillet Radius 2** Rounds the outer vertices (the points) of the star.

## Text Spline

Create panel > Shapes > Splines > Object Type rollout > Text

Create menu > Shapes > Text

Use Text to create splines in the shape of text. The text can use any Windows font installed on your system, or a Type 1 PostScript font installed in the directory pointed to by the Fonts path on the [Configure System Paths dialog](#) on page 7523 . Because fonts are loaded only at first use, changing the font path

later in the program has no effect. The program must be restarted before the new path is used, if the font manager has been used by the program.



### Examples of text

You can edit the text in the Create panel, or later in the Modify panel.



### Using Text Shapes

Text shapes maintain the text as an editable parameter. You can change the text at any time. If the font used by your text is deleted from the system, 3ds Max still properly displays the text shape. However, to edit the text string in the edit box you must choose an available font.

The text in your scene is just a shape where each letter and, in some cases, pieces of each letter are individual splines. You can apply modifiers like [Edit Spline](#) on page 1376 , [Bend](#) on page 1139 , and [Extrude](#) on page 1377 to edit Text shapes just like any other shape.

### Procedures

To create text:

- 1   Go to the Create panel and choose Shapes.
- 2 Click Text.
- 3 Enter text in the Text box.

- 4 Do either of the following to define an insertion point:
  - Click in a viewport to place the text in the scene.
  - Drag the text into position and release the mouse button.

**To enter a special Windows character:**

- 1 Hold down the Alt key.
- 2 Enter the character's numeric value on the numeric keypad.  
You *must* use the numeric keypad, not the row of numbers above the alphabetic keys.  
For some characters, you must enter a leading zero. For example, 0233 to enter an e with an acute accent.
- 3 Release the Alt key.

**Interface**

Settings available for text include kerning, leading, justification, multiple lines, and a manual update option.

**Rendering and Interpolation rollouts**

All spline-based shapes share these parameters. See [Splines](#) on page 542 for an explanation of these parameters.

## Parameters rollout

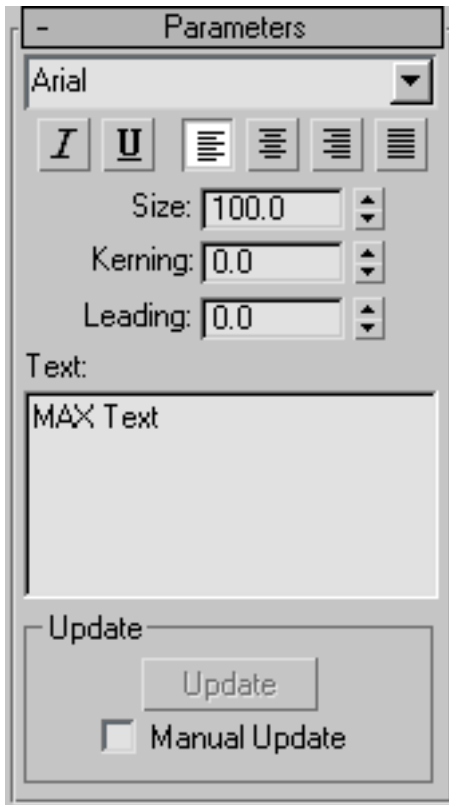

Once you have created text, you can make changes using the following parameters:

**Font list** Choose from a list of all available fonts. Available fonts include:

- Fonts installed in Windows.
- Type 1 PostScript fonts located in the directory pointed to by the Fonts path on the [Configure System Paths dialog](#) on page 7523 .



**Italic style button** Toggles italicized text.



**Underline style button** Toggles underlined text.



**Align Left** Aligns text to the left side of its bounding box.



**Center** Aligns text to the center of its bounding box.



**Align Right** Aligns text to the right side of its bounding box.



**Justify** Spaces all lines of text to fill the extents of the bounding box.

---

**NOTE** The four text-alignment buttons require multiple lines of text for effect because they act on the text in relation to its bounding box. If there's only one line of text, it's the same size as its bounding box.

---

**Size** Sets the text height where the height measuring method is defined by the active font. The first time you enter text, the default size is 100 units.

**Kerning** Adjusts the kerning (the distance between letters).

**Leading** Adjusts the leading (the distance between lines). This has an effect only when multiple lines of text are included in the shape.

**Text edit box** Allows for multiple lines of text. Press Enter after each line of text to start the next line.

- The initial session default is "VIZ Text."
- The initial session default is "MAX Text."
- The edit box does not support word wrap.
- You can cut and paste single- and multi-line text from the Clipboard.

## Update group

These options let you select a manual update option for situations where the complexity of the text shape is too high for automatic updates.

**Update** Updates the text in the viewport to match the current settings in the edit box. This button is available only when Manual Update is on.

**Manual Update** When on, the text that you type into the edit box is not shown in the viewport until you click the Update button.

## Helix Spline

Create panel > Shapes > Splines > Object Type rollout > Helix

Create menu > Shapes > Helix



Use Helix to create open flat or 3D spirals.



Examples of helices

### Procedures

To create a helix:

- 1   Go to the Create panel and choose Shapes.
- 2 Click Helix.
- 3 Choose a creation method.
- 4 Press the mouse button to define the first point of the Helix start circle.
- 5 Drag and release the mouse button to define the second point of the Helix start circle.
- 6 Move the mouse and then click to define the height of the Helix.
- 7 Move the mouse and then click to define the radius of the Helix end.



## Interface

### Rendering rollout

All spline-based shapes share these parameters. See [Splines](#) on page 542 for explanations of these parameters.

### Interpolation

The helix differs from other spline-based shapes in that it always uses *adaptive interpolation*: the number of vertices in a helix is determined by the number of turns.

### Creation Method rollout

The Helix shape uses the standard creation methods of Center or Edge. Most spline-based shapes share the same Creation Method parameters. See [Splines](#) on page 542 for an explanation of these parameters.

### Parameters rollout

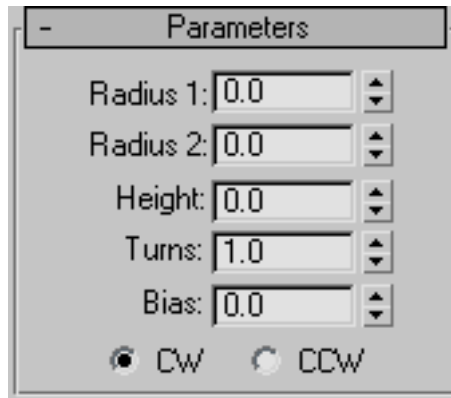

Once you have created a helix, you can make changes using the following parameters:

**Radius 1** Specifies the radius for the Helix start.

**Radius 2** Specifies the radius for the Helix end.

**Height** Specifies the height of the Helix.

**Turns** Specifies the number of turns the Helix makes between its start and end points.

**Bias** Forces the turns to accumulate at one end of the helix. Bias has no visible affect when the height is 0.0.



**Helical spline varied only by bias settings**

- A bias of  $-1.0$  forces the turns toward the start of the helix.
- A bias of  $0.0$  evenly distributes the turns between the ends.
- A bias of  $1.0$  forces the turns toward the end of the helix.

**CW/CCW** The direction buttons set whether the Helix turns clockwise (CW) or counterclockwise (CCW).

## Section Spline

Create panel > Shapes > Splines > Object Type rollout > Section

Create menu > Shapes > Section

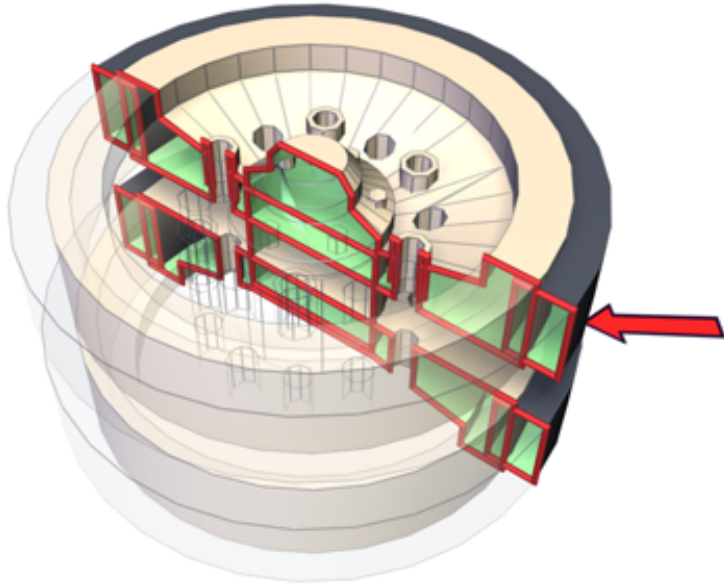

This is a special type of object that generates other shapes based on a cross-sectional slice through mesh objects. The Section object appears as a bisected rectangle. You simply move and rotate it to slice through one or more mesh objects, and then click the Create Shape button to generate a shape based on the 2D intersection.



Red line shows the section shape based on the structure.

### Procedures

To create and use a section shape:

- 1   Go to the Create panel and choose Shapes.
- 2 Click Section.
- 3 Drag a rectangle in the viewport in which you want to orient the plane. (For example, create it in the Top viewport to place the Section object parallel with the XY home grid.)  
The Section object appears as a simple rectangle with crossed lines indicating its center. With the default settings, the rectangle is for display purposes only, because the effect of the Section object extends along its plane to the full extents of the scene.
- 4 Move and rotate the section so that its plane intersects mesh objects in the scene.  
Yellow lines are displayed where the sectional plane intersects objects.

- 5 On the Create panel, click Create Shape, enter a name in the resulting dialog, and click OK.

An [editable spline](#) on page 590 is created, based on the displayed cross sections.

## Interface

### Rendering and Interpolation rollouts

All spline-based shapes share these parameters. See [Splines](#) on page 542 for an explanation of these parameters.

### Section Parameters rollout

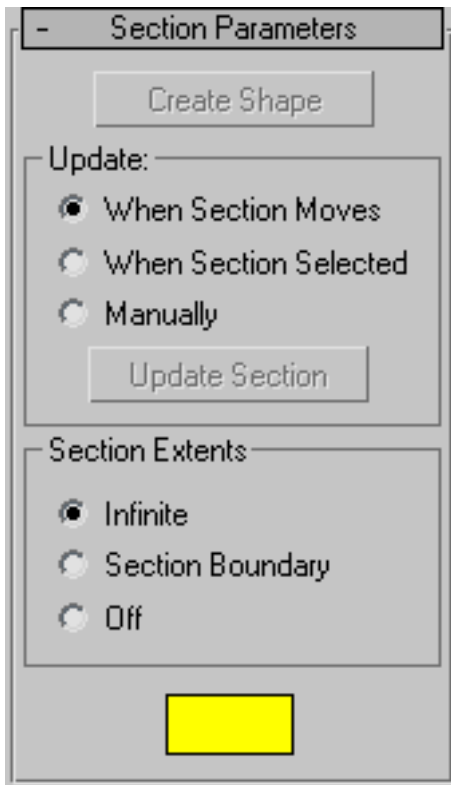

**Create Shape** Creates a shape based on the currently displayed intersection lines. A dialog is displayed in which you can name the new object. The

resulting shape is an editable spline consisting of curve segments and corner vertices, based on all intersected meshes in the scene.

### **Update group**

Provides options for specifying when the intersection line is updated.

**When Section Moves** Updates the intersection line when you move or resize the Section shape.

**When Section Selected** Updates the intersection line when you select the section shape, but not while you move it. Click the Update Section button to update the intersection.

**Manually** Updates the intersection line only when you click the Update Section button.

**Update Section** Updates the intersection to match the current placement of the Section object when using When Section Selected or Manually option.

---

**NOTE** When using When Section Selected or Manually, you can offset the generated cross section from the position of the intersected geometry. As you move the section object, the yellow cross-section lines move with it, leaving the geometry behind. When you click Create Shape, the new shape is generated at the displayed cross-section lines in the offset position.

---

### **Section Extents group**

Choose one of these options to specify the extents of the cross-section generated by the section object.

**Infinite** The section plane is infinite in all directions, resulting in a cross section at any mesh geometry in its plane.

**Section Boundary** The cross-section is generated only in objects that are within or touched by the boundary of the section shape.

**Off** No cross section is displayed or generated. The Create Shape button is disabled.

**Color swatch** Click this to set the display color of the intersection.

### Section Size rollout

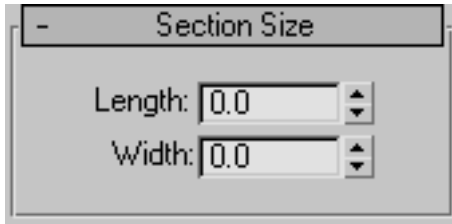

Provides spinners that let you adjust the length and width of the displayed section rectangle.

**Length/Width** Adjust the length and width of the displayed section rectangle.

---

**NOTE** If you convert the section grid to an editable spline, it's converted to a shape based on the current cross section.

---

## Extended Splines

### WRectangle Spline

Create panel > Shapes > Extended Splines > Object Type rollout > WRectangle

Create menu > Shapes > WRectangle

Use WRectangle to create closed shapes from two concentric rectangles. Each rectangle is made of four vertices. The WRectangle is similar to the Donut tool except it uses rectangles instead of circles.



WRectangle stands for “walled rectangle”.



Example of WRectangle

## Procedures

To create a wrectangle:

- 1   Go to the Create panel and choose Shapes.
- 2 Open the Shapes List and choose Extended Splines.
- 3 Click WRectangle.
- 4 Drag and release the mouse button to define the outer rectangle.
- 5 Move the mouse and then click to define the inner rectangle.

## Interface

### Rendering and Interpolation rollouts

All spline-based shapes share these parameters. For explanations, see [Splines and Extended Splines](#) on page 542 .

### Creation Method rollout

The WRectangle shape uses the standard creation methods of Center or Edge. Most spline-based shapes share the same Creation Method parameters. For explanations, see [Splines and Extended Splines](#) on page 542 .

## Parameters rollout

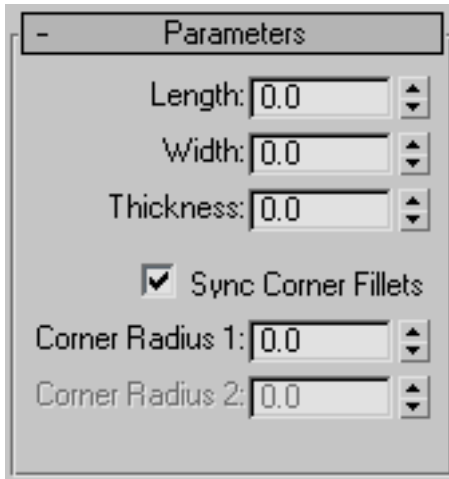

**Length** Controls the height of the wrectangle section.

**Width** Controls the width of the wrectangle section.

**Thickness** Controls the thickness of the walls of the wrectangle.

**Sync Corner Fillets** When turned on, Corner Radius 1 controls the radius of both the interior and exterior corners of the wrectangle. It also maintains the thickness of the section. Default=on.

**Corner Radius 1** Controls the radius of all four interior and exterior corners of the section.

If Sync Corner Fillets is turned off, Corner Radius 1 controls the radius of the four exterior corners of the wrectangle.

**Corner Radius 2** Controls the radius of the four interior corners of the wrectangle.

Corner Radius 2 is only available when Sync Corner Fillets is turned off.

---

**NOTE** Take care when adjusting these settings. There are no constraining relationships between them. Therefore, it's possible to set an inside radius (Corner Radius 2) that is greater than the length and width of the sides.

---



## Channel Spline

Create panel > Shapes > Extended Splines > Object Type rollout > Channel

Create menu > Shapes > Channel



Use Channel to create a closed “C” shaped spline. You have the option to specify the interior and exterior corners between the vertical web and horizontal legs of the section.



Example of Channel

### Procedures

To create a channel:

- 1   Go to the Create panel and choose Shapes.
- 2 Open the Shapes List and select Extended Splines.
- 3 Click Channel.
- 4 Drag and release the mouse button to define the outer perimeter of the channel.
- 5 Move the mouse and then click to define the thickness of the walls of the channel.

### Interface

#### Rendering and Interpolation rollouts

All spline-based shapes share these parameters. For explanations, see [Splines and Extended Splines](#) on page 542 .

## Creation Method rollout

The Channel shape uses the standard creation methods of Center or Edge. Most spline-based shapes share the same Creation Method parameters. For explanations, see [Splines and Extended Splines](#) on page 542 .

## Parameters rollout

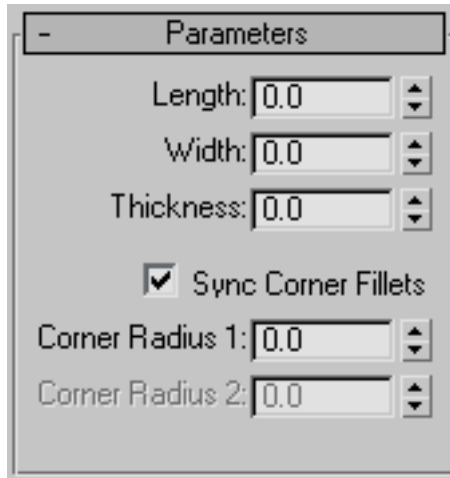

**Length** Controls the height of the vertical web of the channel.

**Width** Controls the width of the top and bottom horizontal legs of the channel.

**Thickness** Controls the thickness of both legs of the angle.

**Sync Corner Fillets** When turned on, Corner Radius 1 controls the radius of both the interior and exterior corners between the vertical web and horizontal legs. It also maintains the thickness of the channel. Default=on.

**Corner Radius 1** Controls the exterior radius between the vertical web and horizontal legs of the channel.

**Corner Radius 2** Controls the interior radius between the vertical web and horizontal legs of the channel.

---

**NOTE** Take care when adjusting these settings. There are no constraining relationships between them. Therefore, it's possible to set an inside radius (Corner Radius 2) that is greater than the length of the web or width of the legs.

---

# Angle Spline

Create panel > Shapes > Extended Splines > Object Type rollout > Angle

Create menu > Shapes > Angle



Use Angle to create a closed “L” shaped spline. You have the option to specify the radii of the corners between the vertical and horizontal legs of the section.



Example of Angle

## Procedures

To create an Angle spline:

- 1   Go to the Create panel and choose Shapes.
- 2 Open the Shapes List and select Extended Splines.
- 3 Click Angle.
- 4 Drag and release the mouse button to define the initial size of the angle.
- 5 Move the mouse and then click to define the thickness of the walls of the angle.

## Interface

### Rendering and Interpolation rollouts

All spline-based shapes share these parameters. For explanations, see [Splines and Extended Splines](#) on page 542 .

## Creation Method rollout

The Angle shape uses the standard creation methods of Center or Edge. Most spline-based shapes share the same Creation Method parameters. For explanations, see [Splines and Extended Splines](#) on page 542 .

## Parameters rollout

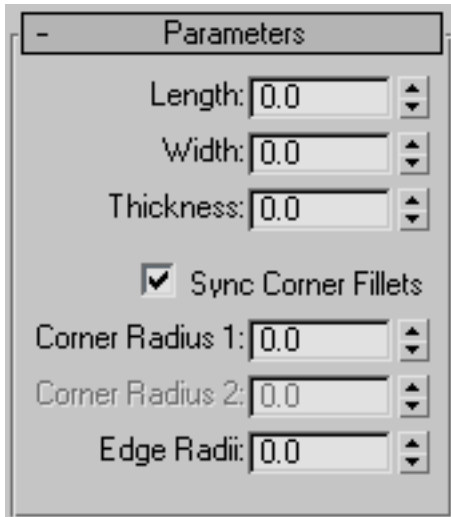

**Length** Controls the height of the vertical leg of the angle.

**Width** Controls the width of the horizontal leg of the angle.

**Thickness** Controls the thickness of both legs of the angle.

**Sync Corner Fillets** When turned on, Corner Radius 1 controls the radius of both the interior and exterior corners between the vertical and horizontal legs. It also maintains the thickness of the section. Default=on.

**Corner Radius 1** Controls the exterior radius between the vertical and horizontal legs of the angle.

**Corner Radius 2** Controls the interior radius between the vertical and horizontal legs of the angle.

**Edge Radii** Controls the interior radius at the outermost edges of the vertical and horizontal legs.

---

**NOTE** Take care when adjusting these settings. There are no constraining relationships between them. Therefore, it's possible to set an inside radius (Corner Radius 2) that is greater than the length or width of the legs of the angle.

---

## Tee Spline

Create panel > Shapes > Extended Splines > Object Type rollout > Tee

Create menu > Shapes > Tee



Use Tee to create a closed T-shaped spline. You can specify the radius of the two interior corners between the vertical web and horizontal flange of the section.



Example of Tee

### Procedures

To create a Tee spline:

- 1   Go to the Create panel and choose Shapes.
- 2 Open the Shapes List and select Extended Splines.
- 3 Click Tee.
- 4 Drag and release the mouse button to define the initial size of the tee.
- 5 Move the mouse and then click to define the thickness of the walls of the tee.

## Interface

### Rendering and Interpolation rollouts

All spline-based shapes share these parameters. For explanations, see [Splines and Extended Splines](#) on page 542 .

### Creation Method rollout

The Tee shape uses the standard creation methods of Center or Edge. Most spline-based shapes share the same Creation Method parameters. For explanations, see [Splines and Extended Splines](#) on page 542 .

### Parameters rollout

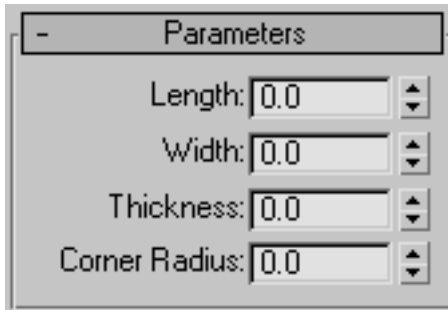

**Length** Controls the height of the vertical web of the tee.

**Width** Controls the width of the flange crossing the tee.

**Thickness** Controls the thickness of the web and flange.

**Corner Radius** Controls the radius of the two interior corners between the vertical web and horizontal flange of the section.

---

**NOTE** Take care when adjusting these settings. There are no constraining relationships between them. Therefore, it's possible to set a radius (Corner Radius) that is greater than the length of the web or width of the flange.

---

## Wide Flange Spline

Create panel > Shapes > Extended Splines > Object Type rollout > Wide Flange

Create menu > Shapes > Wide Flange



Use Wide Flange to create a closed spline shaped like a capital letter I. You can specify the interior corners between the vertical web and horizontal flanges of the section.



**Example of Wide Flange**

## **Procedures**

To create a Wide Flange spline:

- 1   Go to the Create panel and choose Shapes.
- 2 Open the Shapes List and select Extended Splines.
- 3 Click Wide Flange.
- 4 Drag and release the mouse button to define the initial size of the wide flange.
- 5 Move the mouse and then click to define the thickness of the walls of the wide flange.

## **Interface**

### **Rendering and Interpolation rollouts**

All spline-based shapes share these parameters. For explanations, see [Splines and Extended Splines](#) on page 542 .

### **Creation Method rollout**

The Wide Flange shape uses the standard creation methods of Center or Edge. Most spline-based shapes share the same Creation Method parameters. For explanations, see [Splines and Extended Splines](#) on page 542 .

## Parameters rollout

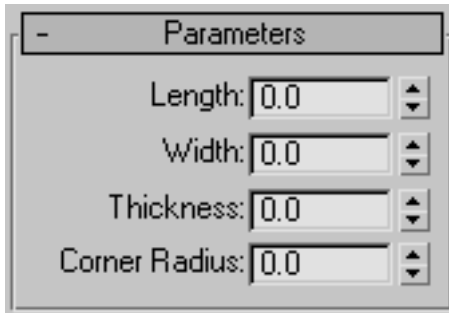

**Length** Controls the height of the vertical web of the wide flange.

**Width** Controls the width of the horizontal flanges crossing the wide flange.

**Thickness** Controls the thickness of the web and flanges.

**Corner Radius** Controls the radius of the four interior corners between the vertical web and horizontal flanges.

---

**NOTE** Take care when adjusting these settings. There are no constraining relationships between them. Therefore, it's possible to set a radius (Corner Radius) that is greater than the length of the web or width of the flanges.

---

## Editable Spline

Create or select a spline > Modify panel > Right-click spline entry in the stack display > Convert To: Editable Spline

Create a line > Modify panel

Create or select a spline > Right-click the spline > Transform (lower-right) quadrant of the quad menu > Convert To: > Convert to Editable Spline

Editable Spline provides controls for manipulating an object as a spline object and at three sub-object levels: vertex, segment, and spline.

The functions in Editable Spline are the same as those in the [Edit Spline modifier](#) on page 1376 . The exception is that when you convert an existing spline shape to an editable spline, the creation parameters are no longer accessible or animatable. However, the spline's interpolation settings (step settings) remain available in the editable spline.



When a spline-editing operation (typically, moving a segment or vertex) causes end vertices to overlap, you can use the [Weld](#) on page 612 command to weld the overlapping vertices together or the [Fuse](#) on page 613 command if you want the two overlapping vertices to occupy the same point in space but remain separate vertices.

---

**NOTE** Welding coincident vertices is controlled by the [End Point Auto-Welding feature](#) on page 605 .

---

## Show End Result



If you have several modifiers higher in the modifier stack, and want to see the results of edits in an Edit Spline modifier or Editable Spline object, then turn on Show End Result on the Modify panel. As you edit the spline network, you'll be able to see the result of modifiers above the Editable Spline object. This is useful for Surface Tools work where you add a Surface modifier above an Editable Spline object in the modifier stack.

### See also:

- [Edit Modifiers and Editable Objects](#) on page 1027
- [Modifying at the Sub-Object Level](#) on page 1029
- [Modifier Stack Controls](#) on page 7427

## Procedures

**To produce an editable spline object, first select the shape, and then do one of the following:**

- 1 Right-click the shape entry in the stack display and choose Convert To: Editable Spline.
- 2 In a viewport, right-click the object and choose Convert To: > Convert to Editable Spline from the Transform (lower-right) quadrant of the quad menu.
- 3 Create a shape with two or more splines by first turning off Start New Shape (on the Create panel). Any shape made up of two or more splines is automatically an editable spline.

- 4 Apply an Edit Spline modifier to a shape, and then collapse the stack. If you use the [Collapse utility](#) on page 1931 to collapse the stack, be sure to choose Output Type > Modifier Stack Result.
- 5 Import a *.shp* file.
- 6 Merge a shape from a 3ds Max file.

**To select shape sub-objects:**

- 1 Expand the object's hierarchy in the stack display and choose a sub-object level, or click one of the sub-object buttons at the top of the Selection rollout.  
You can also right-click the object in the viewports and choose a sub-object level from the quad menu: Tools 1 (upper-left) quadrant > Sub-objects > Choose the sub-object level.
- 2 Click a selection or transform tool, and then select sub-objects using standard click or region-selection techniques.  
Because sub-object selections can be complex, you might consider using one of the following techniques to prevent clearing the sub-object selection by accident:
  - Use [Lock Selection](#) on page 7324 .
  - Name the sub-object selection (see [Named Selection Sets List](#) on page 146 ).

**To clone sub-object selections:**

- Hold down the Shift key while transforming the sub-objects.  
You can clone segment and spline sub-objects, but not vertices.

**To draw a spline cage:**

- 1 Select a segment sub-object on a spline.
- 2 On the Geometry rollout in the Connect Copy group, turn on Connect.
- 3 Hold down the Shift key and transform the selected segment. You can move, rotate or scale using the transform gizmo to control the direction.  
Notice that with Connect Copy on, new splines are drawn between the locations of the segment and its clone.

---

**TIP** Use Area Selection or Fuse before selecting and moving these vertices. They will not move together as they do with the Cross-Section modifier. Or use Fuse to keep the vertices together.

---

## **Interface**

The following controls are available at the object (top) level and at all sub-object levels.

## Rendering and Interpolation rollouts

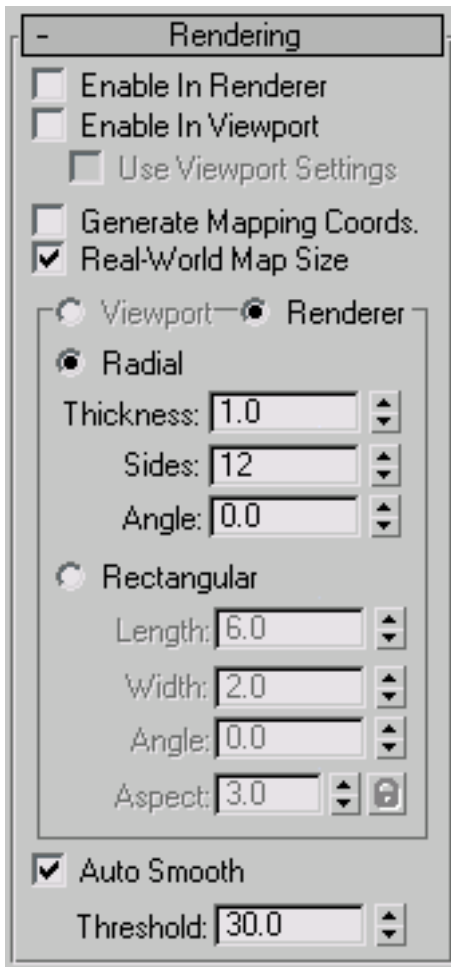

These creation parameters appear in these rollouts for editable splines. For splines to which the Edit Spline modifier has been applied, creation parameters are available by selecting the object type entry (for example, Circle or NGon) at the bottom of the [modifier stack](#) on page 7427 .

### Rendering rollout

Controls here let you turn on and off the renderability of the shape, specify its thickness in the rendered scene, and apply mapping coordinates. The spline

mesh can be viewed in the viewports. You can animate the render parameters, such as the number of sides. Viewport settings cannot be animated.

You can also convert the displayed mesh into a mesh object by applying an Edit Mesh modifier or converting to an Editable Mesh. The system will use the Viewport settings for this mesh conversion if Use Viewport Settings is turned on; otherwise it will use the Renderer settings. This gives maximum flexibility, and will always give the conversion of the mesh displayed in the viewports.

**Enable In Renderer** When on, the shape is rendered as a 3D mesh using the Radial or Rectangular parameters set for Renderer. In previous versions of the program, the Renderable switch performed the same operation.

**Enable In Viewport** When on, the shape is displayed in the viewport as a 3D mesh using the Radial or Rectangular parameters set for Renderer. In previous versions of the program, the Display Render Mesh performed the same operation.

**Use Viewport settings** Lets you set different rendering parameters, and displays the mesh generated by the Viewport settings. Available only when Enable in Viewport is turned on.

**Generate Mapping Coords** Turn this on to apply mapping coordinates. Default=off.

The U coordinate wraps once around the thickness of the spline; the V coordinate is mapped once along the length of the spline. Tiling is achieved using the Tiling parameters in the material itself.

**Real-World Map Size** Controls the scaling method used for texture mapped materials that are applied to the object. The scaling values are controlled by the Use Real-World Scale settings found in the applied material's [Coordinates rollout](#) on page 5620 . Default=off.

**Viewport** Turn this on to specify Radial or Rectangular parameters for the shape as it will display in the viewport when Enable in Viewport is turned on.

**Renderer** Turn this on to specify Radial or Rectangular parameters for the shape as it will display when rendered or viewed in the viewport when Enable in Viewport is turned on.

**Radial** Displays the 3D mesh as a cylindrical object.

■ **Thickness** Specifies the diameter of the viewport or rendered spline mesh. Default=1.0. Range=0.0 to 100,000,000.0.



Splines rendered at thickness of 1.0 and 5.0, respectively

- **Sides** Sets the number of sides (or facets) for the spline mesh in the viewport or renderer. For example, a value of 4 results in a square cross section.
- **Angle** Adjusts the rotational position of the cross-section in the viewport or renderer. For example, if the spline mesh has a square cross section you can use Angle to position a "flat" side down.

**Rectangular** Displays the spline's mesh shape as rectangular.

- **Aspect** Sets the aspect ratio for rectangular cross-sections. The Lock check box lets you lock the aspect ratio. When Lock is turned on, Width is locked to Depth that results in a constant ratio of Width to Depth.
- **Length** Specifies the size of the cross-section along the local *Y* axis.
- **Width** Specifies the size of the cross-section along the local *X* axis.
- **Angle** Adjusts the rotational position of the cross-section in the viewport or renderer. For example, if you have a square cross-section you can use Angle to position a "flat" side down.
- **Aspect** The ratio of length to width. This control is linked to the Length setting; when Aspect is unlocked, changing Length changes Aspect and vice-versa. When Aspect is locked, the control is unavailable, and changing Length or Width automatically changes the Width or Length (respectively) to maintain the current aspect ratio.

**Auto Smooth** When on, the spline is auto-smoothed using the threshold specified by the Threshold setting. Auto Smooth sets the smoothing based on the angle between spline segments. Any two adjacent segments are put in the same smoothing group if the angle between them is less than the threshold angle.

**Threshold** Specifies the threshold angle in degrees. Any two adjacent spline segments are put in the same smoothing group if the angle between them is less than the threshold angle.

### Interpolation rollout

The Interpolation controls set how the program generates a spline. All spline curves are divided into small straight lines that approximate the true curve. The number of divisions between each vertex on the spline is called *steps*. The more steps used, the smoother the curve appears.

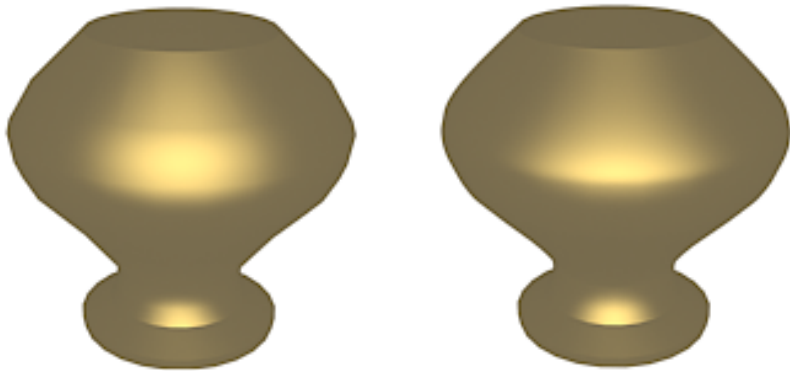

Splines used in above lathed objects contained two steps (left) and 20 steps (right)

**Steps** Use the Steps field to set the number of divisions, or steps, the program uses between each vertex. Splines with tight curves require many steps to look smooth while gentle curves require fewer steps. Range=0 to 100.

Spline steps can be either adaptive or manually specified. The method used is set by the state of the Adaptive check box. The main use for manual interpolation is to create splines for morphing or other operations where you must have exact control over the number of vertices created.

**Optimize** When on, removes unneeded steps from straight segments in the spline. Default=on.

---

**NOTE** Optimize is not available when Adaptive is on.



**Optimize** was used to create spline in this lathed object.

---

**Adaptive** When on, automatically sets the number of steps for each spline to produce a smooth curve. Straight segments always receive 0 steps. When off, enables manual interpolation control using Optimize and Steps. Default=off.



## Selection rollout

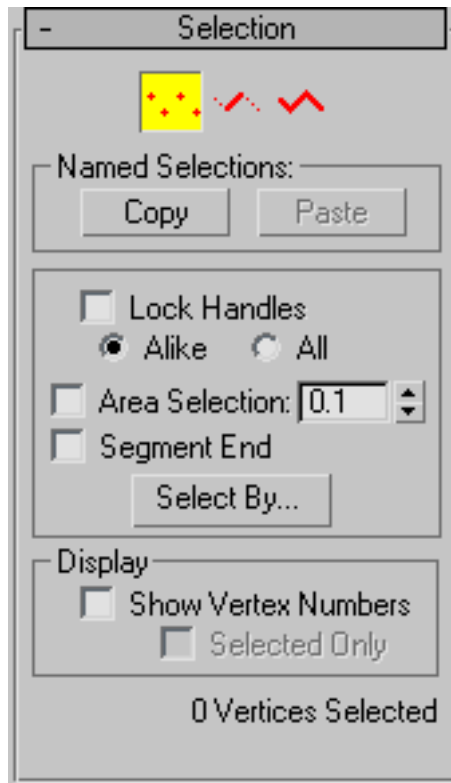

Provides controls for turning different sub-object modes on and off, working with named selections and handles, display settings, and information about selected entities.

When you first access the Modify panel with an editable spline selected, you're at the Object level, with access to several functions available as described in [Editable Spline \(Object\)](#) on page 602 . You can toggle the sub-object modes and access relevant functions by clicking sub-object buttons at the top of the Selection rollout.

You can work with parts of shapes and splines using shape sub-object selection of the Editable Spline object. Clicking a button here is the same as selecting a sub-object type in the Modifier List. Click the button again to turn it off and return to object selection level.



**Vertices** Define points and curve tangents.



**Segments** Connect vertices.



**Splines** Are a combination of one or more connected segments.

### **Named Selections group**

**Copy** Places a named selection into the copy buffer.

**Paste** Pastes a named selection from the copy buffer.

**Lock Handles** Normally you can transform the tangent handles of only one vertex at a time, even when multiple vertices are selected. Use the Lock Handles controls to transform multiple Bezier and Bezier Corner handles simultaneously.

**Alike** As you drag the handle of an incoming vector, all incoming vectors of the selected vertices move simultaneously. Likewise, moving the outgoing tangent handle on one vertex moves the outgoing tangent handle for all selected vertices.

**All** Any handle you move affects all handles in the selection, regardless of whether they're broken. This option is also useful when working with a single Bezier Corner vertex when you want to move both handles.

Shift+click a handle to "break" the tangent and move each handle independently. The Alike option must be chosen to break the tangent.

**Area Selection** Lets you select automatically all vertices within a specific radius of the vertex you click. At the Vertex sub-object level, turn on Area Selection, and then set the radius with the spinner to the right of the Area Selection check box. This is useful when moving vertices that have been created using Connect Copy or Cross Section button.

**Segment End** Select a vertex by clicking a segment. In Vertex sub-object, turn on and select a segment close to the vertex that you want selected. Use this when there are a number of coincident vertices and you want to select a vertex on a specific segment. The cursor changes to a cross when it is over a segment. By holding down the Ctrl key you can add to the selection.

**Select By** Selects vertices on the selected spline or segment. First select a spline or segment in sub-object spline or segment, then turn on vertex sub-object and click Select By and choose Spline or Segment. All the vertices on the selected spline or segment are selected. You can then edit the vertices.

## Display group

**Show Vertex Numbers** When on, the program displays vertex numbers next to the selected spline's vertices at any sub-object level.

**Selected Only** When on, the vertex number or numbers appear only next to selected vertices.

## Soft Selection

For information on the Soft Selection rollout settings, see [Soft Selection Rollout](#) on page 1926 .

## Selection Info

At the bottom of the Selection rollout is a text display giving information about the current selection. If 0 or more than one sub-object is selected, the text gives the number selected.

At the Vertex and Segment sub-object levels, if one sub-object is selected, the text gives the identification numbers of the current spline (with respect to the current object) and of the current selected sub-object. Each spline object contains a spline number 1; if it contains more than one spline, the subsequent splines are numbered consecutively higher.

When a single spline is selected at the Spline sub-object level, the first line displays the identification number of the selected spline and whether it's open or closed, and the second line displays the number of vertices it contains. When more than one spline is selected, the number of splines selected is displayed on the first line, and the total number of vertices they contain is displayed on the second line.

## Geometry rollout

The Geometry rollout provides functions for editing a spline object and sub-objects. The functions available at the spline object level (when no sub-object level is active; see [Editable Spline \(Object\)](#) on page 602 ) are also available at all sub-object levels, and work exactly the same at each level. Other functions are also available, depending on which sub-object level is active. Those that apply to other sub-object levels are unavailable.

For specific information, see these topics:

[Editable Spline \(Object\)](#) on page 602

[Editable Spline \(Vertex\)](#) on page 606

[Editable Spline \(Segment\)](#) on page 618

[Editable Spline \(Spline\)](#) on page 627

## **Editable Spline (Object)**

Select an editable spline > Modify panel > Editable spline (not a sub-object level) selected in the modifier stack

Select an editable spline > Right-click the spline > Tools 1 (upper-left) quadrant of the quad menu > Sub-objects > Top-level

The functions available at the editable spline object level (that is, when no sub-object level is active) are also available at all sub-object levels, and work exactly the same at each level.

### **Interface**

### **Rendering, Interpolation, and Selection rollouts**

See the Editable Spline topic for information on the [Rendering and Interpolation rollouts](#) on page 594 , and [Selection rollout](#) on page 599 settings.

## Geometry rollout



**New Vertex Type group** The radio buttons in this group let you determine the tangency of the new vertices created when you Shift+Clone segments or splines. If you later use Connect Copy, vertices on the splines that connect the original segment or spline to the new one will have the type specified in this group.

This setting has no effect on the tangency of vertices created using tools such as the Create Line button, Refine, and so on.

- **Linear** New vertices will have linear tangency.
- **Smooth** New vertices will have smooth tangency. When this option is chosen, new vertices that overlap are automatically welded.

- **Bezier** New vertices will have bezier tangency.
- **Bezier Corner** New vertices will have bezier corner tangency.

**Create Line** Adds more splines to the selected spline. These lines are separate spline sub-objects; create them in the same way as the [line spline](#) on page 551 . To exit line creation, right-click or click to turn off Create Line.

**Break** Splits a spline at the selected vertex or vertices. Select one or more vertices and then click Break to create the split. There are now two superimposed non-connected vertices for every previous one, allowing the once-joined segment ends to be moved away from each other.

**Attach** Lets you attach another spline in the scene to the selected spline. Click the object you want to attach to the currently selected spline object. The object you're attaching to must also be a spline.

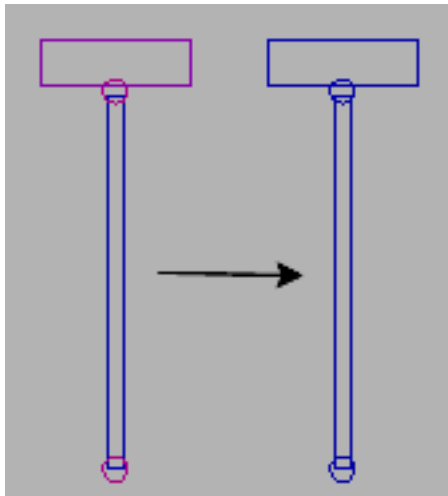

**Unattached splines (left) and attached splines (right)**

When you attach an object, the materials of the two objects are combined in the following way:

- If the object being attached does not have a material assigned, it inherits the material of the object it is being attached to.
- Likewise if the object you're attaching to doesn't have a material, it inherits the material of the object being attached.

- If both objects have materials, the resulting new material is a [multi/sub-object material](#) on page 5558 that encompasses the input materials. A dialog appears offering three methods of combining the objects' materials and material IDs. For more information, see [Attach Options Dialog](#) on page 2031 .

Attached shapes lose their identity as individual shapes, with the following results:

- The attached shape loses all access to its creation parameters. For example, once you attach a circle to a square you cannot go back and change the radius parameter of the circle.
- The modifier stack of the attached shape is collapsed. Any edits, modifiers, and animation applied to the attached shape are frozen at the current frame.

**Reorient** When on, rotates the attached spline so that its creation local coordinate system is aligned with the creation local coordinate system of the selected spline.

**Attach Mult.** Click this button to display the Attach Multiple dialog, which contains a list of all other shapes in the scene. Select the shapes you want to attach to the current editable spline, then click OK.

**Cross Section** Creates a spline cage out of cross-sectional shapes. Click Cross Section, select one shape then a second shape, splines are created joining the first shape with the second. Continue clicking shapes to add them to the cage. This functionality is similar to the Cross Section modifier, but here you can determine the order of the cross sections. Spline cage tangency can be defined by choosing Linear, Bezier, Bezier Corner or Smooth in New Vertex Type group.

#### End Point Auto-Welding group

- **Automatic Welding** When Automatic Welding is turned on, an end point vertex that is placed or moved within the threshold distance of another end point of the same spline is automatically welded. This feature is available at the object and all sub-object levels.
- **Threshold** A proximity setting that controls how close vertices can be to one another before they are automatically welded. Default=6.0.

**Insert** Inserts one or more vertices, creating additional segments. Click anywhere in a segment to insert a vertex and attach the vertex to the mouse. Optionally move the mouse and then click to place the new vertex. Continue

moving the mouse and clicking to add vertices. A single click inserts a corner vertex, while a drag creates a Bezier (smooth) vertex.

Right-click to complete the operation and release the mouse. At this point, you're still in Insert mode, and can begin inserting vertices in a different segment. Otherwise, right-click again or click Insert to exit Insert mode.

## **Editable Spline (Vertex)**

Select an editable spline > Modify panel > Expand the editable spline in the stack display > Vertex sub-object level

Select an editable spline > Modify panel > Selection rollout > Vertex button

Select an editable spline > Right-click the spline > Tools 1 (upper-left) quadrant of the quad menu > Sub-objects > Vertex

While at the Editable Spline (Vertex) level, you can select single and multiple vertices and move them using standard methods. If the vertex is of the Bezier or Bezier Corner type, you can also move and rotate handles, thus affecting the shapes of any segments joined at the vertex. You can copy and paste the handles between vertices using tangent copy/paste. You can reset them or switch between types using the quad menu. The tangent types are always available on the quad menu when a vertex is selected; your cursor doesn't have to be directly over them in the viewport.

### **Procedures**

**To set a vertex type:**

- 1 Right-click any vertex in a selection.



- 2 Choose a type from the shortcut menu. Each vertex in a shape can be one of four types:
- **Smooth:** Nonadjustable vertices that create smooth continuous curves. The curvature at a smooth vertex is determined by the spacing of adjacent vertices.
  - **Corner:** Nonadjustable vertices that create sharp corners.
  - **Bezier:** Adjustable vertex with locked continuous tangent handles that create a smooth curve. The curvature at the vertex is set by the direction and magnitude of the tangent handles.
  - **Bezier Corner:** Adjustable vertex with discontinuous tangent handles that create a sharp corner. The curvature of the segment as it leaves the corner is set by the direction and magnitude of the tangent handles.

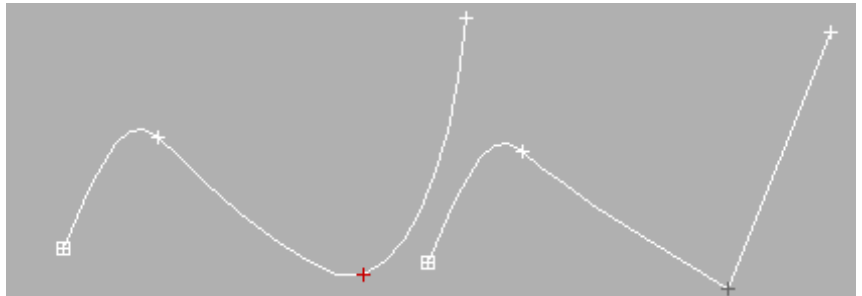

Smooth vertex (left) and Corner vertex (right)

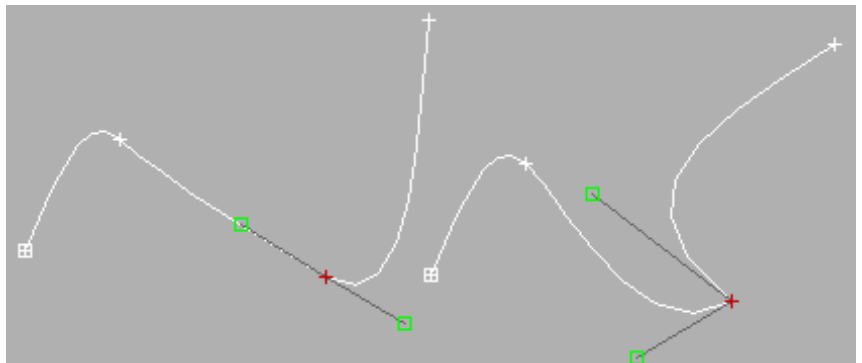

Bezier vertex (left) and Bezier Corner vertex (right)

### To copy and paste vertex tangent handles:



- 1 Turn on Vertex Selection, then Select the vertex you want to copy from.
- 2 On the Geometry rollout scroll down to the Tangent group and click Copy.
- 3 Move your cursor over the vertices in the viewport. The cursor changes to a copy cursor. Click the handle you wish to copy.
- 4 On the Geometry rollout scroll down to the Tangent group and click Paste.
- 5 Move your cursor over the vertices in the viewport. The cursor changes to a paste cursor. Click the handle you wish to paste to.  
The vertex tangency changes in the viewport.

### To reset vertex handle tangency:

It is easy to make the handles very small and coincident with the vertex, which makes them hard to select and edit. Reset the vertex handle tangency to redraw your handles

- 1 Select the vertex that is problematic.
- 2 Right-click and choose Reset Tangents.  
Any vertex handle editing you have done is discarded and the handles are reset.

## Interface

### Soft Selection rollout

For information on the Soft Selection rollout settings, see [Soft Selection Rollout](#) on page 1926 .

## Geometry rollout

### New Vertex Type group

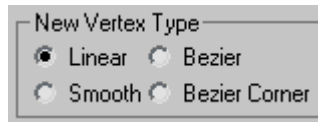

The radio buttons in this group let you determine the tangency of the new vertices created when you Shift+Clone segments or splines. If you later use Connect Copy, vertices on the splines that connect the original segment or spline to the new one will have the type specified in this group.

This setting has no effect on the tangency of vertices created using tools such as the Create Line button, Refine, and so on.

- **Linear** New vertices will have linear tangency.
- **Smooth** New vertices will have smooth tangency.  
When this option is chosen, new vertices that overlap are automatically welded.
- **Bezier** New vertices will have bezier tangency.
- **Bezier Corner** New vertices will have bezier corner tangency.

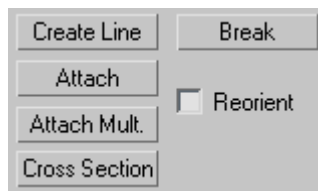

**Create Line** Adds more splines to the selected object. These lines are separate spline sub-objects; create them in the same way as the [line spline](#) on page 551 . To exit line creation, right-click or click to turn off Create Line.

**Break** Splits a spline at the selected vertex or vertices. Select one or more vertices and then click Break to create the split. There are now two superimposed non-connected vertices for every previous one, allowing the once-joined segment ends to be moved away from each other.

**Attach** Attaches another spline in the scene to the selected spline. Click the object you want to attach to the currently selected spline object. The object you're attaching must also be a spline.

For further details, see [Attach](#) on page 604 .

**Attach Mult.** Click this button to display the Attach Multiple dialog, which contains a list of all other shapes in the scene. Select the shapes you want to attach to the current editable spline, then click OK.

■ **Reorient** When on, reorients attached splines so that each spline's creation local coordinate system is aligned with the creation local coordinate system of the selected spline.

**Cross Section** Creates a spline cage out of cross-sectional shapes. Click Cross Section, select one shape then a second shape, splines are created joining the first shape with the second. Continue clicking shapes to add them to the cage. This functionality is similar to the Cross Section modifier, but here you can determine the order of the cross sections. Spline cage tangency can be defined by choosing Linear, Bezier, Bezier Corner or Smooth in New Vertex Type group.

---

**TIP** When you edit the spline cage, use Area Selection before selecting your vertices. This will keep their positions together as you transform them.

---

### Refine group

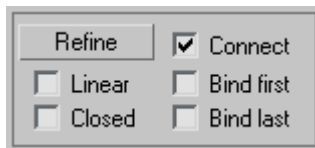

The Refine group includes a number of functions useful for building spline networks for use with the [Surface modifier](#) on page 1695 .

**Refine** Lets you add vertices without altering the curvature values of the spline. Click Refine, and then select any number of spline segments to add a vertex each time you click (the mouse cursor changes to a "connect" symbol when over an eligible segment). To finish adding vertices, click Refine again, or right-click in the viewport.

You can also click existing vertices during a refine operation, in which case 3ds Max displays a dialog asking if you want to **Refine** or **Connect Only** to the vertex. If you choose Connect Only, 3ds Max will not create a vertex: it simply connects to the existing vertex.

The Refine operation creates a different type of vertex depending on the types of vertices on the endpoints of the segment being refined.

- If the bordering vertices are both Smooth types, the Refine operation creates a Smooth type vertex.
- If the bordering vertices are both Corner types, the Refine operation creates a Corner type vertex.
- If either of the bordering vertices is a Corner or Bezier Corner, the Refine operation creates a Bezier Corner type.
- Otherwise, the operation creates a Bezier type vertex.

**Connect** When on, creates a new spline sub-object by connecting the new vertices. When you finish adding vertices with Refine, Connect makes a separate copy of each new vertex and then connects all of the copies with a new spline.

---

**NOTE** For Connect to work, you must turn it on before you click Refine.

---

After turning on Connect and before beginning the refinement process, turn on any combination of these options:

- **Linear** When on, makes all segments in the new spline straight lines by using Corner vertices. When Linear is off, the vertices used to create the new spline are of the Smooth type.
- **Bind First** Causes the first vertex created in a refinement operation to be bound to the center of the selected segment. See [Bound Vertex](#) on page 7735 .
- **Closed** When on, connects the first and last vertices in the new spline to create a closed spline. When Closed is off, Connect always creates an open spline.
- **Bind Last** Causes the last vertex created in a refinement operation to be bound to the center of the selected segment. See [Bound Vertex](#) on page 7735 .

## End Point Auto-Welding group

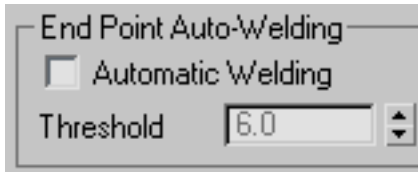

**Automatic Welding** When Automatic Welding is turned on, an end point vertex that is placed or moved within the threshold distance of another end point of the same spline is automatically welded. This feature is available at the object and all sub-object levels.

**Threshold** The threshold distance spinner is a proximity setting that controls how close vertices can be to one another before they are automatically welded. Default=6.0.

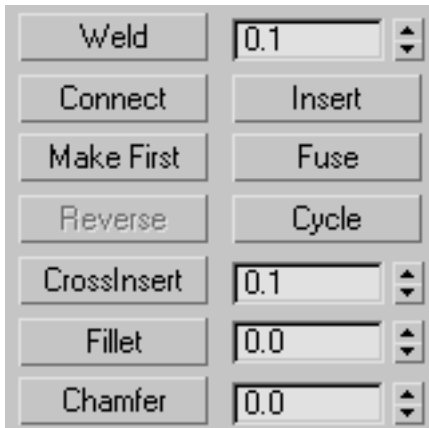

**Weld** Converts two end vertices, or two adjacent vertices within the same spline, into a single vertex. Move either two end vertices or two adjacent vertices near each other, select both vertices, and then click Weld. If the vertices are within the unit distance set by the Weld Threshold spinner (to the right of the button), they're converted into a single vertex. You can weld a selection set of vertices, as long as each pair of vertices is within the threshold.

**Connect** Connects any two end vertices, resulting in a linear segment, regardless of the tangent values of the end vertices. Click the Connect button, point the mouse over an end vertex until the cursor changes to a cross, and then drag from one end vertex to another end vertex.

**Insert** Inserts one or more vertices, creating additional segments. Click anywhere in a segment to insert a vertex and attach the mouse to the spline. Then optionally move the mouse and click to place the new vertex. Continue moving the mouse and clicking to add vertices. A single click inserts a corner vertex, while a drag creates a Bezier (smooth) vertex.

Right-click to complete the operation and release the mouse. At this point, you're still in Insert mode, and can begin inserting vertices in a different segment. Otherwise, right-click again or click Insert to exit Insert mode.

**Make First** Specifies which vertex in the selected shape is the first vertex. The first vertex of a spline is indicated as a vertex with a small box around it. Select one vertex on each spline within the currently edited shape that you want to change and click the Make First button.

On open splines, the first vertex must be the endpoint that is not already the first vertex. On closed splines, it can be any point that isn't already the first vertex. Click the Make First button, and the first vertices will be set.

The first vertex on a spline has special significance. The following table defines how the first vertex is used.

Shape Use	First Vertex Meaning
Loft Path	Start of the path. Level 0.
Loft Shape	Initial skin alignment.
Path Con- straint	Start of the motion path. 0% location on the path.
Trajectory	First position key.

**Fuse** Moves all selected vertices to their averaged center.

Fuse is useful for making vertices coincide when building a spline network for use with the [Surface modifier](#) on page 1695 .

---

**NOTE** Fuse doesn't join the vertices; it simply moves them to the same location.

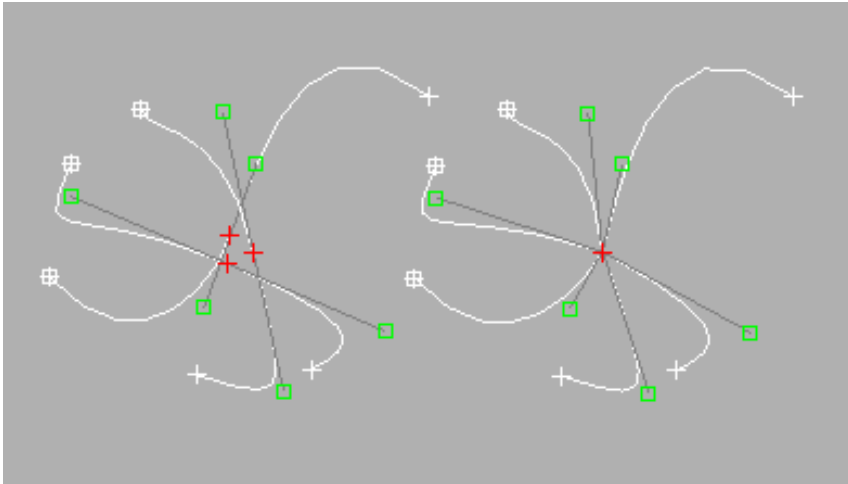

Three selected vertices (left); fused vertices (right)

---

**Cycle** Selects successive coincident vertices. Select one of two or more vertices that share the exact same location in 3D space, and then click Cycle repeatedly until the vertex you want is selected.

Cycle is useful for selecting a specific vertex from a group of coincident vertices at a spline intersection when building a spline network for use with the [Surface modifier](#) on page 1695 .

---

**TIP** Watch the info display at the bottom of the Selection rollout to see which vertex is selected.

---

**CrossInsert** Adds vertices at the intersection of two splines belonging to the same spline object. Click CrossInsert, and then click the point of intersection between the two splines. If the distance between the splines is within the unit distance set by the CrossInsert Threshold spinner (to the right of the button), the vertices are added to both splines.

You can continue using CrossInsert by clicking different spline intersections. To finish, right-click in the active viewport or click the CrossInsert button again.

CrossInsert is useful for creating vertices at spline intersections when building a spline network for use with the [Surface modifier](#) on page 1695 .



---

**NOTE** CrossInsert doesn't join the two splines, but simply adds vertices where they cross.

---

**Fillet** Lets you round corners where segments meet, adding new control vertices. You can apply this effect interactively (by dragging vertices) or numerically (using the Fillet spinner). Click the Fillet button, and then drag vertices in the active object. The Fillet spinner updates to indicate the fillet amount as you drag.

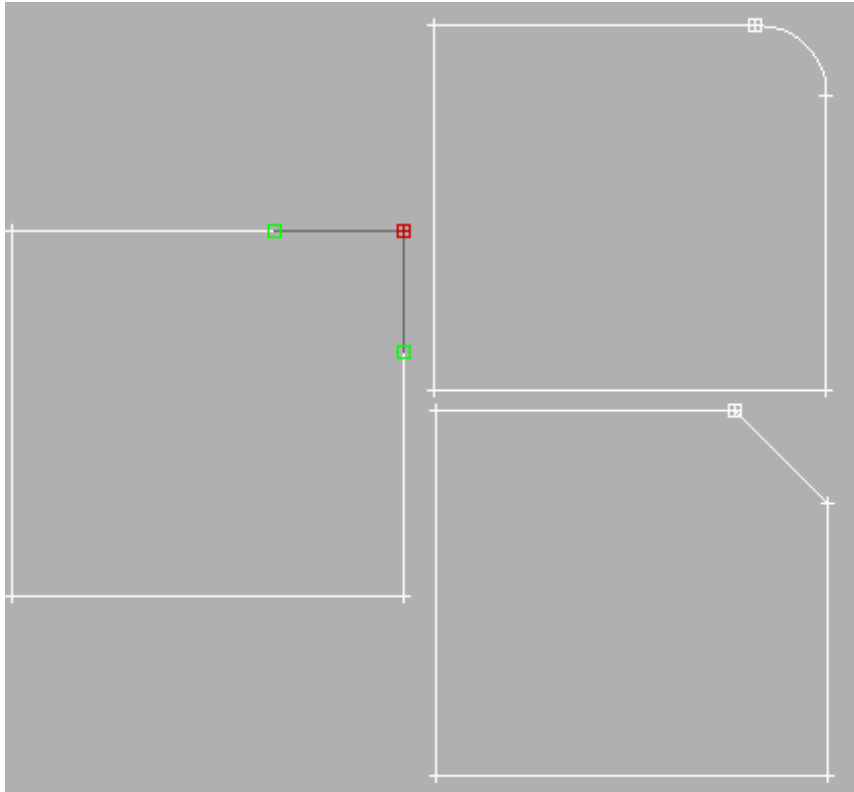

**Original rectangle (left), after applying Fillet (top right), and after applying Chamfer (bottom right)**

If you drag one or more selected vertices, all selected vertices are filleted identically. If you drag an unselected vertex, any selected vertices are first deselected.

You can continue using Fillet by dragging on different vertices. To finish, right-click in an active viewport or click the Fillet button again.

A fillet creates a new segment connecting new points on both segments leading to the original vertex. These new points are exactly <fillet amount> distance from the original vertex along both segments. New fillet segments are created with the material ID of one of the neighboring segments (picked at random).

For example, if you fillet one corner of a rectangle, the single corner vertex is replaced by two vertices moving along the two segments that lead to the corner, and a new rounded segment is created at the corner.

---

**NOTE** Unlike the Fillet/Chamfer modifier, you can apply the Fillet function to *any* type of vertex, not just Corner and Bezier Corner vertices. Similarly, adjoining segments need not be linear.

---

- **Fillet Amount** Adjust this spinner (to the right of the Fillet button) to apply a fillet effect to selected vertices.

**Chamfer** Lets you bevel shape corners using a chamfer function. You can apply this effect interactively (by dragging vertices) or numerically (using the Chamfer spinner). Click the Chamfer button, and then drag vertices in the active object. The Chamfer spinner updates to indicate the chamfer amount as you drag.

If you drag one or more selected vertices, all selected vertices are chamfered identically. If you drag an unselected vertex, any selected vertices are first deselected.

You can continue using Chamfer by dragging on different vertices. To finish, right-click in an active viewport or click the Chamfer button again.

A chamfer "chops off" the selected vertices, creating a new segment connecting new points on both segments leading to the original vertex. These new points are exactly <chamfer amount> distance from the original vertex along both segments. New chamfer segments are created with the material ID of one of the neighboring segments (picked at random).

For example, if you chamfer one corner of a rectangle, the single corner vertex is replaced by two vertices moving along the two segments that lead to the corner, and a new segment is created at the corner.

---

**NOTE** Unlike the Fillet/Chamfer modifier, you can apply the Chamfer function to *any* type of vertex, not just Corner and Bezier Corner vertices. Similarly, adjoining segments need not be linear.

---

- **Chamfer Amount** Adjust this spinner (to the right of the Chamfer button) to apply a chamfer effect to selected vertices.

## Tangent group

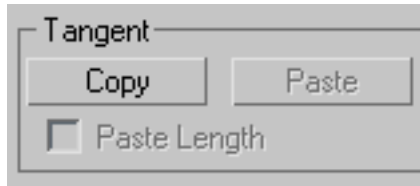

Tools in this group let you copy and paste vertex handles from one vertex to another.

**Copy** Turn this on, then choose a handle. This action copies the selected handle tangent into a buffer.

**Paste** Turn this on, then click a handle. This pastes the handle tangent onto the selected vertex.

**Paste Length** When this is on, the handle length is also copied. When this is off, only the handle angle is considered, the handle length is unchanged.

## Hide and Bind group



**Hide** Hides selected vertices and any connected segments. Select one or more vertices, and then click Hide.

**Unhide All** Displays any hidden sub-objects.

**Bind** Lets you create [bound vertices](#) on page 7735 . Click Bind, and then drag from any end vertex in the current selection to any segment in the current selection except the one connected to the vertex. Before dragging, when the cursor is over an eligible vertex, it changes to a + cursor. While dragging, a dashed line connects the vertex and the current mouse position, and when the mouse cursor is over an eligible segment, it changes to a "connect" symbol. When you release over an eligible segment, the vertex jumps to the center of the segment and is bound to it.

Bind is useful for connecting splines when building a spline network for use with the [Surface modifier](#) on page 1695 .

**Unbind** Lets you disconnect [bound vertices](#) on page 7735 from the segments to which they're attached. Select one or more bound vertices, and then click the Unbind button.

**Delete** Deletes the selected vertex or vertices, along with one attached segment per deleted vertex.

### Display group



**Show selected segs** When on, any selected segments are highlighted in red at the Vertex sub-object level. When off (the default), selected segments are highlighted only at the Segment sub-object level.

This feature is useful for comparing complex curves against each other.

## Editable Spline (Segment)



Select an editable spline > Modify panel > Expand the editable spline in the stack display > Segment sub-object level

Select an editable spline > Modify panel > Selection rollout > Segment button

Select an editable spline > Right-click the spline > Tools 1 (upper-left) quadrant of the quad menu > Sub-objects > Segment

A segment is the portion of a spline curve between two of its vertices. While at the Editable Spline (Segment) level, you can select single and multiple segments and move, rotate, scale or clone them using standard methods.

### Procedures

**To change segment properties:**

- 1 Select an editable spline segment, and then right-click.
- 2 On the Tools 1 (upper-left) quadrant of the quad menu, choose Line or Curve.

The effect of changing segment properties varies according to the type of vertices at the segment end.

- Corner vertices always result in line segments regardless of the segment property.
- Smooth vertices can support both line or curve segment properties.
- Bezier and Bezier Corner vertices apply their tangent handles only to curve segments. Tangent handles are ignored by line segments.
- A tangent handle associated with a line segment displays an X at the end of the handle. You can still transform the handle, but it has no effect until the segment is converted to a curve segment.

---

**TIP** If you have problems transforming the handles, display the axis constraints toolbar and change the transform axis there.

---

## Interface

### Rendering, Interpolation, and Selection rollouts

For information on the [Rendering, Interpolation](#) on page 594 and [Selection rollout](#) on page 599 settings, see [Editable Spline](#) on page 590 .

### Soft Selection rollout

For information on the Soft Selection rollout settings, see [Soft Selection Rollout](#) on page 1926 .

### Geometry rollout

#### New Vertex Type group

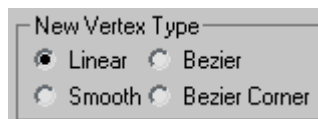

The radio buttons in this group let you determine the tangency of the new vertices created when you Shift+Clone segments or splines. If you later use Connect Copy, vertices on the splines that connect the original segment or spline to the new one will have the type specified in this group.

This setting has no effect on the tangency of vertices created using tools such as the Create Line button, Refine, and so on.

- **Linear** New vertices will have linear tangency.
- **Smooth** New vertices will have smooth tangency.  
When this option is chosen, new vertices that overlap are automatically welded.
- **Bezier** New vertices will have bezier tangency.
- **Bezier Corner** New vertices will have bezier corner tangency.

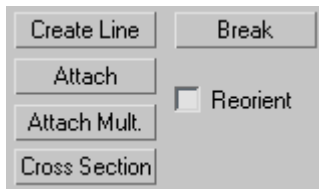

**Create Line** Adds more splines to the selected spline. These lines are separate spline sub-objects; create them in the same way as the [line spline](#) on page 551 . To exit line creation, right-click or click to turn off Create Line.

**Break** Lets you specify a break point at any segment in the shape (you do not have to first select a segment). When on, the mouse icon changes to a Break icon. You can now click any spot on a segment. The clicked spot becomes two coincident vertices, and the segment is split into two parts.

**Attach** Attaches another spline in the scene to the selected spline. Click the object you want to attach to the currently selected spline object. The object you're attaching to must also be a spline.

For further details, see [Attach](#) on page 604 .

**Reorient** Reorients the attached spline so that its creation local coordinate system is aligned with the creation local coordinate system of the selected spline.

**Attach Mult.** Click this button to display the Attach Multiple dialog, which contains a list of all other shapes in the scene. Select the shapes you want to attach to the current editable spline, then click OK.

**Cross Section** Creates a spline cage out of cross-sectional shapes. Click Cross Section, select one segment then another sub-object segment, splines are created joining the first shape with the second. Continue clicking segments to add them to the cage. All segments must be part of the same object to build

cross sections. This functionality is similar to the Cross Section modifier, but here you can determine the order of the cross sections. Spline cage tangency can be defined by choosing Linear, Bezier, Bezier Corner or Smooth in New Vertex Type group.

---

**TIP** When you want to move these vertices, turn on Area Selection before you select them. When you transform them, the vertices will stay together.

---

### Refine group

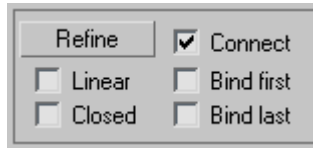

The Refine group includes a number of functions useful for building spline networks for use with the [Surface modifier](#) on page 1695 .

**Refine** Lets you add vertices without altering the curvature values of the spline. Click Refine, and then select any number of spline segments to add a vertex each time you click (the mouse cursor changes to a "connect" symbol when over an eligible segment). To finish adding vertices, click Refine again, or right-click in the viewport.

You can also click existing vertices during a refine operation, in which case 3ds Max displays a dialog asking if you want to **Refine** or **Connect** to the vertex. If you choose Connect, 3ds Max will not create a vertex: it simply connects to the existing vertex.

The Refine operation creates a different type of vertex depending on the types of vertices on the endpoints of the segment being refined.

- If the bordering vertices are both Smooth types, the Refine operation creates a Smooth type vertex.
- If the bordering vertices are both Corner types, the Refine operation creates a Corner type vertex.
- If either of the bordering vertices is a Corner or Bezier Corner, the Refine operation creates a Bezier Corner type.
- Otherwise, the operation creates a Bezier type vertex.

**Connect** When on, creates a new spline sub-object by connecting the new vertices. When you finish adding vertices with Refine, Connect makes a

separate copy of each new vertex and then connects all of the copies with a new spline.

---

**NOTE** For Connect to work, you must turn it on before you click Refine.

---

After turning on Connect and before beginning the refinement process, turn on any combination of these options:

- **Linear** When on, makes all segments in the new spline linear by using Corner vertices. When Linear is off, the vertices used to create the new spline are of the Smooth type.
- **Bind First** Causes the first vertex created in a refinement operation to be bound to the center of the selected segment.  
For more information, see [Bound Vertex](#) on page 7735 .
- **Closed** When on, connects the first and last vertices in the new spline to create a closed spline. When Closed is off, Connect always creates an open spline.
- **Bind Last** Causes the last vertex created in a refinement operation to be bound to the center of the selected segment.  
For more information, see [Bound Vertex](#) on page 7735 .

### Connect Copy group

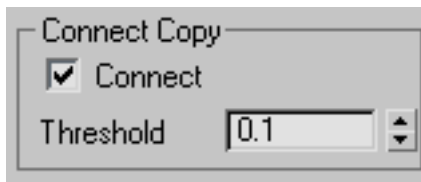

**Connect Copy** When on, Shift+Cloning a segment creates a new spline sub-object with additional splines that connect the new segment's vertices to the vertices of the original segment. It is analogous to Shift+Cloning edges in Editable Mesh and Editable Poly objects.

---

**NOTE** For Connect Copy to work, you must turn it on before you Shift+Clone.

---

**Threshold** Determines the distance soft selection will use when Connect Copy is on. A higher threshold results in more splines being created; a lower threshold results in fewer splines.



## End Point Auto-Welding group

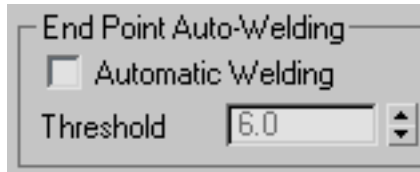

**Automatic Welding** When Automatic Welding is turned on, an end point vertex that is placed or moved within the threshold distance of another end point of the same spline is automatically welded. This feature is available at the object and all sub-object levels.

**Threshold** The threshold distance spinner is a proximity setting that controls how close vertices can be to one another before they are automatically welded. Default=6.0.



**Insert** Inserts one or more vertices, creating additional segments. Click anywhere in a segment to insert a vertex and attach the mouse to the spline. Then optionally move the mouse and click to place the new vertex. Continue moving the mouse and clicking to add vertices. A single click inserts a corner vertex, while a drag creates a Bezier (smooth) vertex.

Right-click to complete the operation and release the mouse. At this point, you're still in Insert mode, and can begin inserting vertices in a different segment. Otherwise, right-click again or click Insert to exit Insert mode.

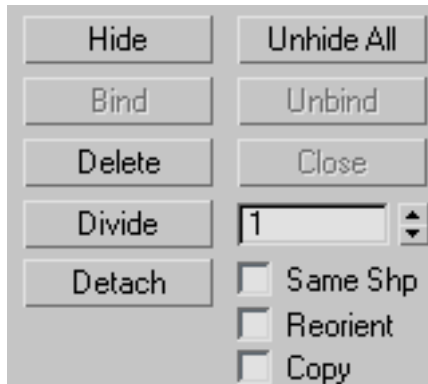

**Hide** Hides selected segments. Select one or more segments, and then click Hide.

**Unhide All** Displays any hidden sub-objects.

**Delete** Deletes any selected segments in the current shape.

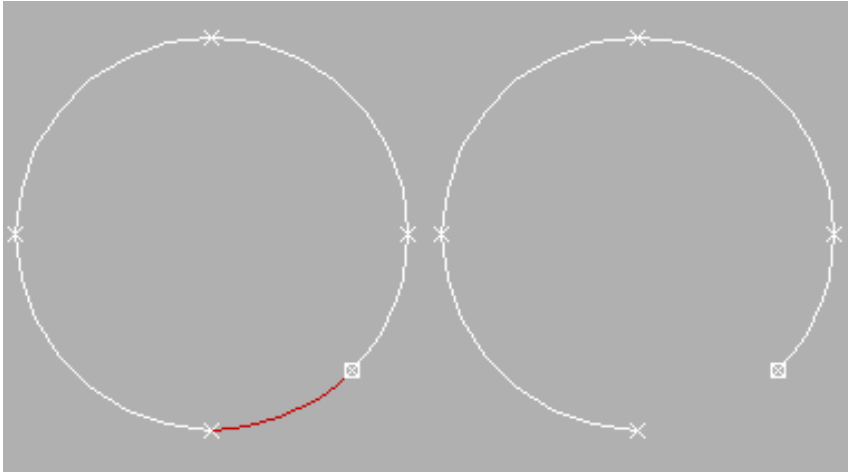

**Selected and deleted segment**

**Divide** Subdivides the selected segment or segments by adding the number of vertices specified by the spinner. Select one or more segments, set the Divisions spinner (to the button's right), and then click Divide. Each selected segment is divided by the number of vertices specified in the Divisions spinner. The distance between the vertices depends on the segment's relative curvature, with areas of greater curvature receiving more vertices.

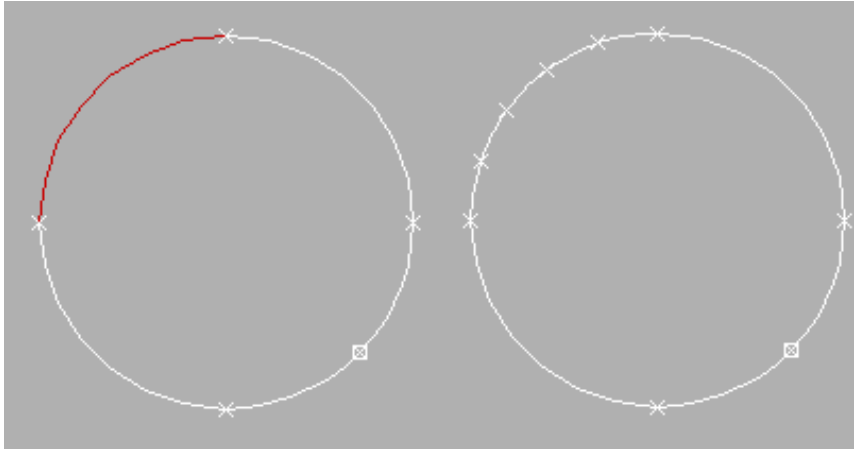

#### Selected and divided segment

**Detach** Lets you select several segments in various splines and then detach them (or copy them) to form a new shape. Three options are available:

- **Same Shp** (Same Shape) When on, Reorient is disabled, and a Detach operation keeps the detached segment as part of the shape (rather than producing a new shape). If Copy is also on, you end up with a detached copy of the segment in the same location.
- **Reorient** The detached segment copies the position and orientation of the source object's creation Local coordinate system. The new detached object is moved and rotated so that its Local coordinate system is positioned and aligned with the origin of the current active grid.
- **Copy** Copies the detached segment rather than moving it.

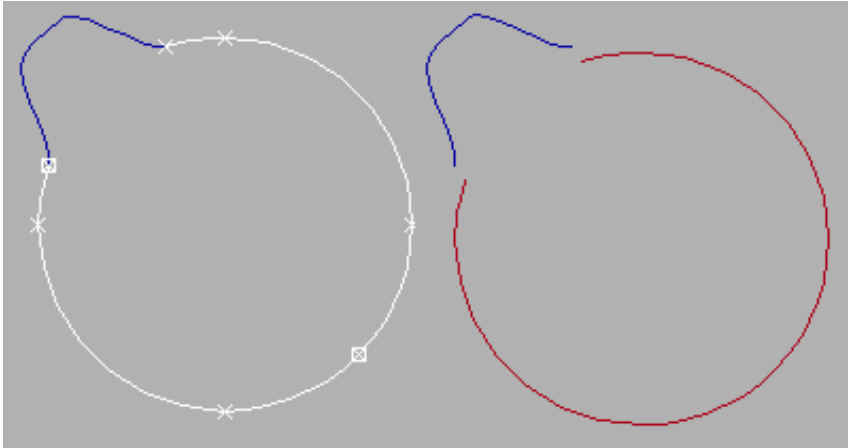

Original and detached splines

### Display group

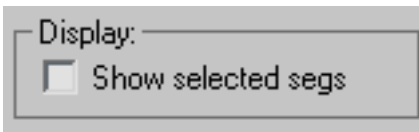

**Show selected segs** When on, any selected segments are highlighted in red at the Vertex sub-object level. When off (the default), selected segments are highlighted only at the Segment sub-object level.

This feature is useful for comparing complex curves against each other.

### Surface Properties rollout

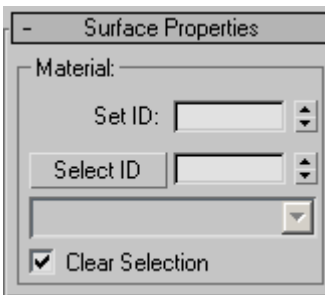

## Material group

You can apply different material IDs to spline segments (see [Material ID](#) on page 7842 ). You can then assign a [multi/sub-object material](#) on page 5558 to such splines, which appears when the spline is renderable, or when used for lathing or extrusion. Be sure to turn on Generate Material IDs and Use Shape IDs when lofting, lathing or extruding.

**Set ID** Lets you assign a particular material ID number to selected segments for use with multi/sub-object materials and other applications. Use the spinner or enter the number from the keyboard. The total number of available IDs is 65,535.

**Select ID** Selects the segments or splines corresponding to the Material ID specified in the adjacent ID field. Type or use the spinner to specify an ID, then click the Select ID button.

**Select By Name** This drop-down list shows the names of sub-materials if an object has a Multi/Sub-object material assigned to it. Click the drop arrow and select a material from the list. The segments or splines that are assigned that material are selected. If a shape does not have a Multi/Sub-Object material assigned to it, the name list will be unavailable. Likewise, if multiple shapes are selected that have an Edit Spline modifier applied to them, the name list is inactive.

**Clear Selection** When turned on, selecting a new ID or material name forces a deselection of any previously selected segments or splines. When turned off, selections are cumulative so new ID or material name selections add to a previous selection set of segments or splines. Default=on.

## Editable Spline (Spline)

Select an editable spline > Modify panel > Expand the editable spline in the stack display > Spline sub-object level

Select an editable spline > Modify panel > Selection rollout > Spline button

Select an editable spline > Right-click the spline > Tools 1 (upper-left) quadrant of the quad menu > Sub-objects > Spline

While at the Editable Spline (Spline) level, you can select single and multiple splines within a single spline object and move, rotate, and scale them using standard methods.

## Procedures

### To change spline properties:

- You change the properties of a spline from Line to Curve by right-clicking and choosing Line or Curve from the Tools 1 (upper-left) quadrant of the quad menu.  
Changing the spline property also changes the property of all vertices in the spline:
  - Choosing Line converts vertices to Corners.
  - Choosing Curve converts vertices to Beziers.

## Interface

### Rendering, Interpolation and Selection rollouts

For information on the [Rendering, Interpolation](#) on page 594 and [Selection rollout](#) on page 599 settings, see [Editable Spline](#) on page 590 .

### Soft Selection rollout

See [Soft Selection Rollout](#) on page 1926 for information on the Soft Selection rollout settings.

## Geometry rollout

**Geometry**

New Vertex Type

Linear  Bezier  
 Smooth  Bezier Corner

Create Line Break

Attach

Attach Mult.  Reorient

Cross Section

Refine  Connect

Linear  Bind first  
 Closed  Bind last

Connect Copy

Connect

Threshold 0'3.937"

End Point Auto-Welding

Automatic Welding

Threshold 19'8.22"

Weld 0'3.937"

Connect Insert

Make First Fuse

Reverse Cycle

CrossInsert 0'3.937"

Fillet 0'0.0"

Chamfer 0'0.0"

Outline 0'0.0"

Center

## New Vertex Type group

The radio buttons in this group let you determine the tangency of the new vertices created when you Shift+Clone segments or splines. If you later use Connect Copy, vertices on the splines that connect the original segment or spline to the new one will have the type specified in this group.

This setting has no effect on the tangency of vertices created using tools such as the Create Line button, Refine, and so on.

- **Linear** New vertices will have linear tangency.
- **Smooth** New vertices will have smooth tangency.  
When this option is chosen, new vertices that overlap are automatically welded.
- **Bezier** New vertices will have bezier tangency.
- **Bezier Corner** New vertices will have bezier corner tangency.

**Create Line** Adds more splines to the selected spline. These lines are separate spline sub-objects; create them in the same way as the [line spline](#) on page 551 . To exit line creation, right-click or click to turn off Create Line.

**Attach** Attaches another spline in the scene to the selected spline. Click the object you want to attach to the currently selected spline object. The object you're attaching to must also be a spline.

For further details, see [Attach](#) on page 604 .

**Reorient** Reorients the attached spline so that its creation local coordinate system is aligned with the creation local coordinate system of the selected spline.

**Attach Mult.** Click this button to display the Attach Multiple dialog, which contains a list of all other shapes in the scene. Select the shapes you want to attach to the current editable spline, then click OK.

**Cross Section** Creates a spline cage out of cross-sectional shapes. Click Cross Section, select one shape then a second shape, splines are created joining the first shape with the second. Continue clicking shapes to add them to the cage. This functionality is similar to the Cross Section modifier, but here you can determine the order of the cross sections. Spline cage tangency can be defined in the New Vertex Type group.

---

**TIP** When you edit the spline cage, use Area Selection before selecting your vertices. This will keep their positions together as you transform them.

---



## Connect Copy group

**Connect Copy** When on, Shift+Cloning a spline creates a new spline sub-object with additional splines that connect the new spline's vertices to the vertices of the original segment. It is analogous to Shift+Cloning edges in Editable Mesh and Editable Poly objects.

---

**NOTE** For Connect Copy to work, you must turn it on before you Shift+Clone.

---

**Threshold** Determines the distance soft selection uses when Connect Copy is on. A higher value results in more splines being created, a lower value results in fewer splines.

## End Point Auto-Welding group

**Automatic Welding** When Automatic Welding is turned on, an endpoint vertex that is placed or moved within the threshold distance of another endpoint of the same spline is automatically welded. This feature is available at the object and all sub-object levels.

**Threshold** A proximity setting that controls how close vertices can be to one another before they are automatically welded. Default=6.0.

**Insert** Inserts one or more vertices, creating additional segments. Click anywhere in a segment to insert a vertex and attach the mouse to the spline. Then optionally move the mouse and click to place the new vertex. Continue moving the mouse and clicking to add vertices. A single click inserts a corner vertex, while a drag creates a Bezier (smooth) vertex.

Right-click to complete the operation and release the mouse. At this point, you're still in Insert mode, and can begin inserting vertices in a different segment. Otherwise, right-click again or click Insert to exit Insert mode.

**Reverse** Reverses the direction of the selected spline. If the spline is open, the first vertex will be switched to the opposite end of the spline. Reversing the direction of a spline is usually done in order to reverse the effect of using the Insert tool at vertex selection level.

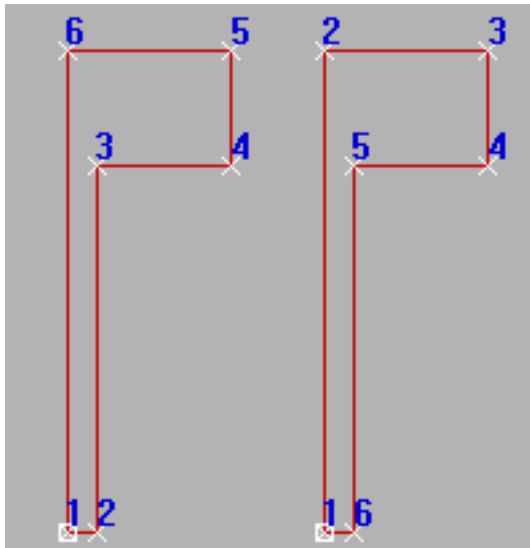

**Original and reversed splines**

**Outline** Makes a copy of the spline, offset on all sides to the distance specified by the Outline Width spinner (to the right of the Outline button). Select one or more splines and then adjust the outline position dynamically with the spinner, or click Outline and then drag a spline. If the spline is open, the resulting spline and its outline will make a single closed spline.

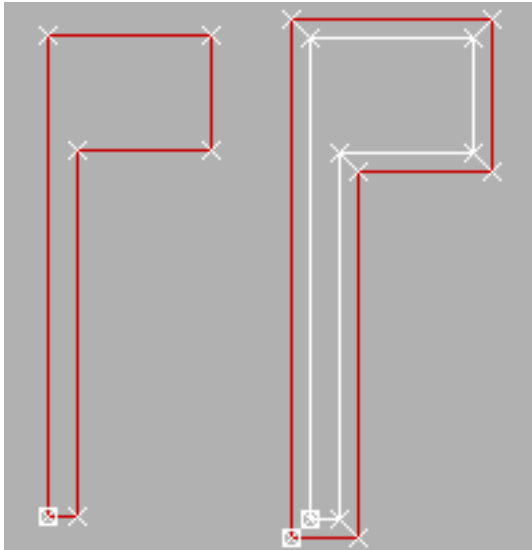

**Original and outlined splines**

---

**NOTE** Normally, if using the spinner, you must first select a spline before using Outline. If, however, the spline object contains only one spline, it is automatically selected for the outlining process.

---

**Center** When off (default), the original spline remains stationary and the outline is offset on one side only to the distance specified by Outline Width.

When Center is on, the original spline and the outline move away from an invisible center line to the distance specified by Outline Width.

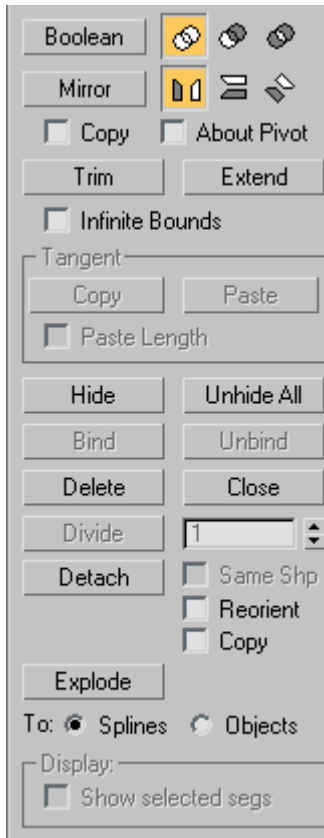

**Boolean** Combines two closed polygons by performing a 2D Boolean operation that alters the first spline you select, and deletes the second one. Select the first spline, then click the Boolean button and the desired operation, and then select the second spline.

---

**NOTE** 2D Booleans only work on 2D splines that are in the same plane.

---

There are three Boolean operations:

- **Union** Combines two overlapping splines into a single spline, in which the overlapping portion is removed, leaving non-overlapping portions of the two splines as a single spline.

- **Subtraction** Subtracts the overlapping portion of the second spline from the first spline, and deletes the remainder of the second spline.
- **Intersection** Leaves only the overlapping portions of the two splines, deleting the non-overlapping portion of both.

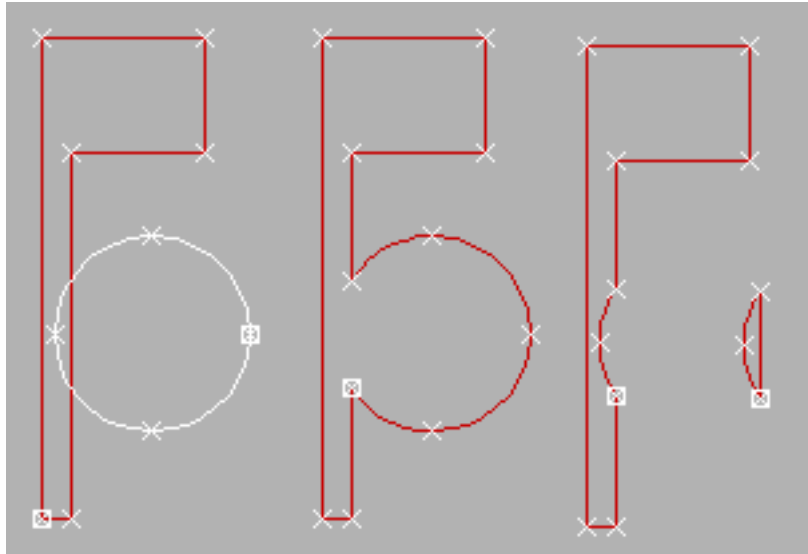

Original splines (left), Boolean Union, Boolean Subtraction, and Boolean Intersection, respectively

**Mirror** Mirrors splines along the length, width, or diagonally. Click the direction you want to mirror first so it is active, then click Mirror.

- **Copy** When selected, copies rather than moves the spline as it is mirrored.
- **About Pivot** When on, mirrors the spline about the spline object's pivot point (see [Pivot](#) on page 3398 ). When off, mirrors the spline about its geometric center.

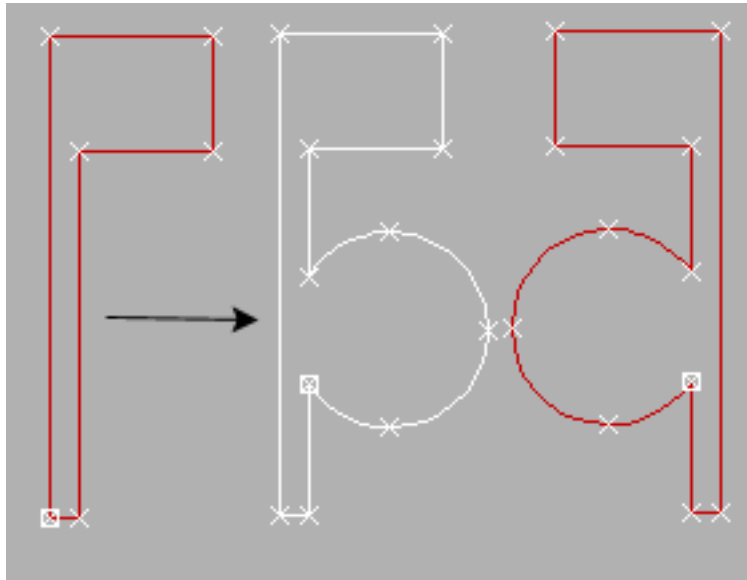

**Mirrored splines**

**Trim** Use Trim to clean up overlapping segments in a shape so that ends meet at a single point.

To trim, you need intersecting splines. Click the portion of the spline you want to remove. The spline is searched in both directions along its length until it hits an intersecting spline, and deleted up to the intersection. If the section intersects at two points, the entire section is deleted up to the two intersections. If the section is open on one end and intersects at the other, the entire section is deleted up to the intersection and the open end. If the section is not intersected, or if the spline is closed and only one intersection is found, nothing happens.

**Extend** Use Extend to clean up open segments in a shape so that ends meet at a single point.

To extend, you need an open spline. The end of the spline nearest the picked point is extended until it reaches an intersecting spline. If there is no intersecting spline, nothing happens. Curved splines extend in a direction tangent to the end of the spline. If the end of a spline lies directly on a boundary (an intersecting spline), then it looks for an intersection further along.

**Infinite Bounds** For the purposes of calculating intersections, turn this on to treat open splines as infinite in length. For example, this lets you trim one linear spline against the extended length of another line that it doesn't actually intersect.

**Hide** Hides selected splines. Select one or more splines, and then click Hide.

**Unhide All** Displays any hidden sub-objects.

**Delete** Deletes the selected spline.

**Close** Closes the selected spline by joining its end vertices with a new segment.

**Detach** Copies selected splines to a new spline object, and deletes them from the currently selected spline if Copy is clear.

- **Reorient** The spline being detached is moved and rotated so that its creation local coordinate system is aligned with the creation local coordinate system of the selected spline.
- **Copy** When selected, copies rather than moves the spline as it is detached.

**Explode** Breaks up any selected splines by converting each segment to a separate spline or object. This is a time-saving equivalent of using Detach on each segment in the spline in succession.

You can choose to explode to splines or objects. If you choose Object, you're prompted for a name; each successive new spline object uses that name appended with an incremented two-digit number.

### Surface Properties rollout

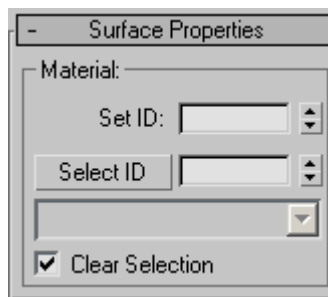

## Material group

You can apply different material IDs (see [material ID](#) on page 7842 ) to splines in shapes containing multiple splines. You can then assign a [multi/sub-object material](#) on page 5558 to such shapes, which appears when the spline is renderable, or when used for lathing or extrusion.

**Set ID** Lets you assign a particular material ID number to selected segments for use with multi/sub-object materials and other applications. Use the spinner or enter the number from the keyboard. The total number of available IDs is 65,535.

**Select ID** Selects the segments or splines corresponding to the Material ID specified in the adjacent ID field. Type or use the spinner to specify an ID, then click the Select ID button.

**Select By Name** This drop-down list shows the names of sub-materials if an object has a Multi/Sub-object material assigned to it. Click the drop arrow and select a material from the list. The segments or splines that are assigned that material are selected. If a shape does not have a Multi/Sub-Object material assigned to it, the name list will be unavailable. Likewise, if multiple shapes are selected that have an Edit Spline modifier applied to them, the name list is inactive.

**Clear Selection** When turned on, selecting a new ID or material name, forces a deselection of any previously selected segments or splines. If turned off, selections are cumulative so new ID or material name selections add to a previous selection set of segments or splines. Default=on.

# Compound Objects

Create panel > Geometry > Compound Objects

Create menu > Compound

Compound objects generally combine two or more existing objects into a single object.



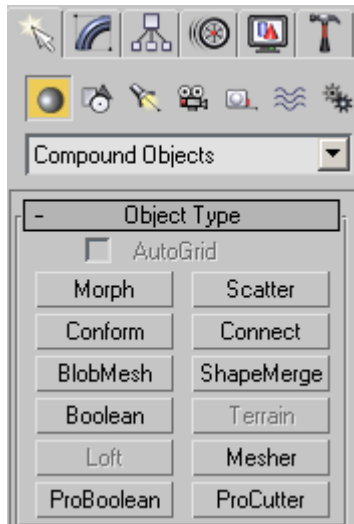

Compound objects include the following object types:

[Morph Compound Object](#) on page 639

[Scatter Compound Object](#) on page 647

[Conform Compound Object](#) on page 660

[Connect Compound Object](#) on page 668

[BlobMesh Compound Object](#) on page 674

[ShapeMerge Compound Object](#) on page 681

[Boolean Compound Object](#) on page 686

[Terrain Compound Object](#) on page 703

[Loft Compound Object](#) on page 715

[Mesher Compound Object](#) on page 767

[ProBoolean Compound Object](#) on page 774

[ProCutter Compound Object](#) on page 792

## Morph Compound Object

Select an object. > Create panel > Geometry > Compound Objects > Object Type rollout > Morph

Select an object. > Create menu > Compound > Morph

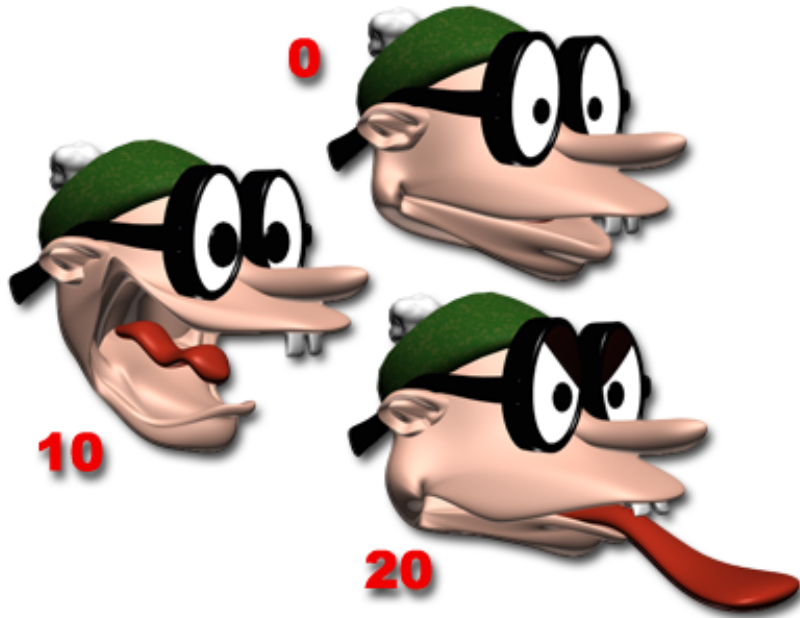

Seed or base object, and the target objects at specific frames



### The resulting animation

Morphing is an animation technique similar to tweening in 2D animation. A Morph object combines two or more objects by interpolating the vertices of the first object to match the vertex positions of another object. When this interpolation occurs over time, a morphing animation results.

The original object is known as the *seed* or *base* object. The object into which the seed object morphs is known as the *target* object.

You can morph one seed into multiple targets; the seed object's form changes successively to match the forms of the target objects as the animation plays.

Before you can create a morph, the seed and target objects must meet these conditions:

- Both objects must be mesh, patch, or poly objects.
- Both objects must have an equal number of vertices.

If these conditions don't apply, the Morph button is unavailable.

You can use any kind of object as a morph target, including an animated object or another morph object, as long as the target is a mesh that has the same number of vertices as the seed object.

Creating a morph involves the following steps:

- Model the base object and target objects.
- Select the base object.
- Click Create panel > Geometry > Compound Objects > Morph.
- Add the target objects.
- Animate.

### Setting Up the Morph Geometry

Make sure that the objects you want to use as the seed and targets have the same number of vertices.

---

**TIP** When you create Loft objects that you want to use as morph seeds and targets, make sure that Morph Capping is on and Adaptive Path Steps and Optimize are turned off. All shapes in the Loft object must have the same number of vertices.

You should also turn off Adaptive and Optimize for other shape-based objects that you want to use with Morph, such as those with Extrude or Lathe modifiers.

---

**WARNING** The selected object is permanently converted to a morph object as soon as you click Morph, whether or not you proceed to select a target object. The only way to restore the original object is to undo the Morph click.

---

### Morph Object and Morpher Modifier

There are two ways to set up morphing animations: the Morph compound object and the Morpher modifier.

The [Morpher modifier](#) on page 1473 is more flexible because you can add it multiple times at any place in an object's modifier stack display. This flexibility lets you animate the base object or the morph targets before reaching the Morpher modifier, for example with a noise modifier. The Morpher modifier works hand in hand with the Morpher material. The Morpher modifier is the ideal way to morph characters.

The Barycentric Morph controller can be simpler to use in Track View. The Track View display for Compound Morph has only one animation track regardless of the number of targets. Each key on the track represents a morph result based on a percentage of all the targets. For basic morphing needs, Compound Morph may be preferable to the Morpher modifier.

Lastly, you can add the Morpher modifier to the stack of a Compound Morph object.

## **Procedures**

### **Example: To create a basic morph:**

- 1 On the Create panel > Geometry > Patch Grids > Object Type rollout, click Quad Patch.
- 2 In the Top viewport, click and drag to create a patch on the left side of the viewport.
- 3 Right-click the modifier stack display in the Modify panel and select Convert To Editable Patch from the pop-up menu.
- 4 Right-click the patch, and then click Move in the Transform quadrant of the quad menu.
- 5 In the Top viewport, hold Shift and drag with the patch to create a copy on the right side of the viewport.
- 6 On the Modify panel > Selection rollout, go to the Vertex sub-object level.
- 7 In the Front viewport, select and move vertices on the selected patch to alter its shape.
- 8 On the Modify panel, in the stack display, click Editable Patch again to return to the top level.
- 9 Select the original patch in the viewports.
- 10 On the Create panel > Geometry > Compound Objects > Objects Type rollout, click Morph.
- 11 On the Pick Targets rollout, click Pick Target.
- 12 In the viewports, click the second patch object.  
Both patch objects are listed in the Morph Targets list.
- 13 Click Modify panel.  
Morph displays above the Editable Patch in the modifier stack.

- 14 Move the time slider to frame 10.
- 15 In the Morph Targets list, click M\_QuadPatch01.
- 16 On the Current Targets rollout, click Create Morph Key.  
On the track bar, a key is displayed at frame 10.
- 17 On the track bar, right-click the key at frame 10 and click QuadPatch01:Morph in the menu.  
A Key Info dialog displays.
- 18 On the Key Info dialog, select M\_QuadPatch01 from the list.
- 19 On the Key Info dialog, drag the percentage spinner.  
The base object changes shape.
- 20 Close the Key Info dialog and drag the time slider back and forth. The patch morphs its shape.

**To select the targets for a morph:**

- 1 Select the seed object.
- 2 On the Create panel > Geometry > Compound Objects, click Morph.  
The name of the seed object is displayed at the top of the Morph Targets list on the Current Targets rollout.
- 3 On the Pick Targets rollout, choose the method for creating targets: Reference, Move, Copy, or Instance.
- 4 Click Pick Target.
- 5 Select one or more target objects in the viewports.  
As you select each target, its name is added to the Morph Targets list. If an object can't be a target (for example, if it has a different number of vertices than the morph seed), you can't select it.  
If you select a target object while you are not at frame 0, creating the target also creates a morph key. You can create additional morph keys from targets you've already selected, as described in the following procedure.

**To create morph keys from existing targets:**

- 1 Drag the time slider to the frame where you want to place the morph key.

---

**NOTE** The Auto Key button does not need to be on to set morph keys.

---

- 2 Highlight the name of a target object on the Morph Targets list.  
The Create Morph Key button is available only when a target object name is selected.
- 3 Click Create Morph Key.  
3ds Max places a morph key at the active frame.
- 4 To preview the effect of the morph, drag the time slider back and forth.  
You can view and edit the morph keys in Track View, which also lets you view the morph's target object parameters.

## Interface

### Pick Targets rollout



When you pick target objects, you designate each target as a Reference, Move (the object itself), Copy, or Instance. Base your selection on how you want to use the scene geometry after you create the morph.

**Pick Target** Use this button to designate the target object or objects.

**Reference/Copy/Move/Instance** Lets you specify how the target is transferred to the compound object. It can be transferred either as a [reference](#) on page 7910 , a copy, an [instance](#) on page 7818 , or it can be moved, in which case the original shape is not left behind.

- Use Copy when you want to reuse the target geometry for other purposes in the scene.
- Use Instance to synchronize morphing with animated changes to the original target object.

- Use Move if you've created the target geometry to be only a morph target, and have no other use for it.

You can use an animated object or another morph as the target of a morph.

### Current Targets rollout

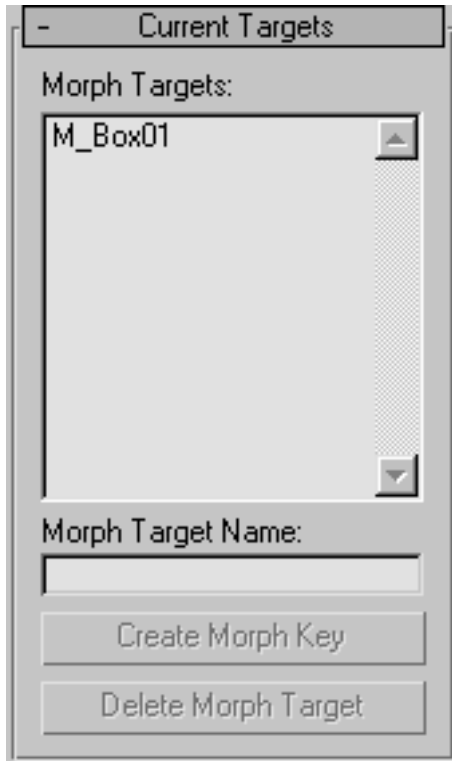

**Morph Targets** Displays a list of the current morph targets.

**Morph Target Name** Use this field to change the name of the selected morph target in the Morph Targets list.

**Create Morph Key** Adds a morph key for the selected target at the current frame.

**Delete Morph Target** Deletes the currently highlighted morph target. If morph keys reference the deleted target, then those keys are deleted as well.



# Scatter Compound Object

Select an object. > Create panel > Geometry > Compound Objects > Object Type rollout > Scatter

Select an object. > Create menu > Compound > Scatter

Scatter is a form of compound object that randomly scatters the selected *source* object either as an array, or over the surface of a *distribution* object.



The plane of the hill is used to scatter the trees and two different sets of rocks.

## Procedures

To create a Scatter object:

- 1 Create an object to be used as a source object.
- 2 Optionally, create an object to be used as a distribution object.
- 3 Select the source object, and then click Scatter in the Compound Objects panel.

---

**NOTE** The source object must be either a mesh object or an object that can be converted to a mesh object. If the currently selected object is invalid, the Scatter button is unavailable.

---

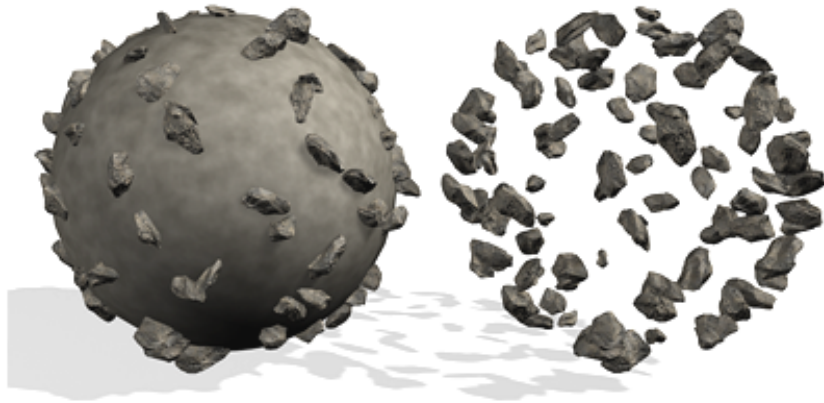

**Results of scattering source object with distribution object visible (above) and hidden (below)**

You now have two choices. You can either scatter the source object as an array without using a distribution object, or use a distribution object to scatter the object. See the following procedures.

**To scatter the source object without a distribution object:**

- 1 Choose Use Transforms Only in the Scatter Objects rollout > Distribution group.
- 2 Set the Duplicates spinner to specify the desired total number of duplicates of the source object.
- 3 Adjust the spinners on the Transforms rollout to set random transformation offsets of the source object.

**To scatter the source object using a distribution object:**

- 1** Make sure the source object is selected.
- 2** Choose the method by which you want to clone the distribution object (Reference, Copy, Move, or Instance.)
- 3** Click Pick Distribution Object, and then select the object you want to use as a distribution object.
- 4** Make sure that Use Distribution Object on the Scatter Object rollout is chosen.
- 5** Use the Duplicates spinner to specify the number of duplicates. (This is not necessary if you're using the All Vertices, All Edge Midpoints or All Face Centers distribution methods.)
- 6** Choose a distribution method in the Scatter Object rollout > Distribute Object Parameters group under Distribute Using.
- 7** Optionally, adjust the Transform spinners to randomly transform the duplicates.
- 8** If the display is too slow, or the meshes too complicated, consider choosing Proxy on the Display rollout or decreasing the percentage of displayed duplicates by reducing the Display percentage.

Most of the spinner values are animatable, so you can animate things like the number of duplicates, their transformations, and so on.



Scatter objects (the grass) with a high number of duplicates

## Interface

### Pick Distribution Object rollout

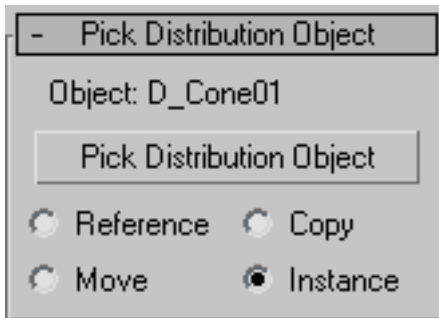

Contains the options for selecting a distribution object.

**Object** Displays the name of the distribution object selected with the Pick button.

**Pick Distribution Object** Click this button, then click an object in the scene to specify it as a distribution object.

**Reference/Copy/Move/Instance** Lets you specify how the distribution object is transferred to the scatter object. It can be transferred either as a [reference](#) on page 7910 , a copy, an [instance](#) on page 7818 , or moved, in which case the original shape is not left behind.

### Scatter Objects rollout

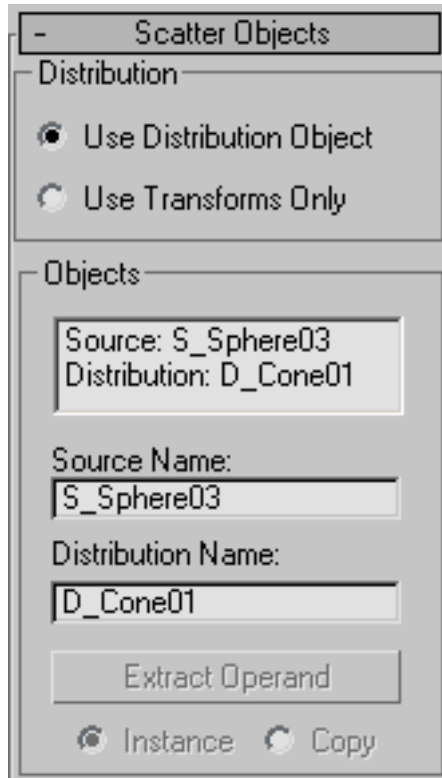

The options on this rollout let you specify how the source object is scattered, and let you access the objects that make up the compound Scatter object.

### Distribution group

These two options let you choose the basic method of scattering the source object.

**Use Distribution Object** Scatters the source object based on the geometry of the distribution object.

**Use Transforms Only** This options doesn't need a distribution object. Instead, duplicates of the source object are positioned using the offset values on the Transforms rollout. If all of the Transform offsets remain at 0, you won't see the array because the duplicates occupy the same space.

### Objects group

Contains a list window showing the objects that make up the Scatter object.

**List Window** Click to select an object in the window so that you can access it in the Stack. For example, if your distribution object is a sphere, you can click Distribution: D\_Sphere01, open the Stack list, and select Sphere to access the sphere's parameters.

**Source Name** Lets you rename the source object within the compound Scatter object.

**Distribution Name** Lets you rename the distribution object.

**Extract Operand** Extract a copy or an instance of the selected operand. Choose an operand in the list window to enable this button.

---

**NOTE** This button is available only on the Modify panel. You can't extract an operand while the Create panel is active.

---

**Instance/Copy** This option lets you specify how the operand is extracted: as either an [instance](#) on page 7818 or a copy.

### Source Object Parameters group

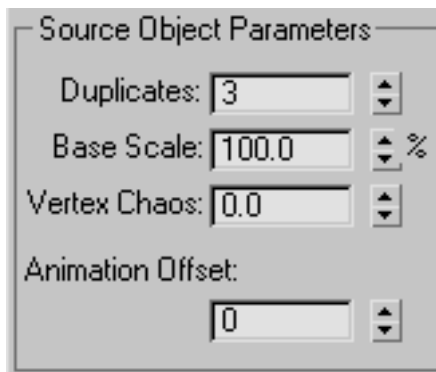

These options affect the source object locally.

**Duplicates** Specifies the number of scattered duplicates of the source object.

This number is set to 1 by default, but you can set it to 0 if you want to animate the number of duplicates, beginning with none. Note that the Duplicates number is ignored if you're distributing the duplicates using either Face Centers or Vertices. In these cases, one duplicate is placed at each vertex or face center, depending on your choice.

**Base Scale** Alters the scale of the source object, affecting each duplicate identically. This scale occurs before any other transforms.

**Vertex Chaos** Applies a random perturbation to the vertices of the source object.

**Animation Offset** Lets you specify the number of frames by which each source object duplicate's animation is offset from the previous duplicate. You can use this feature to produce wave-type animation. At the default setting of 0, all duplicates move identically.

#### **Distribution Object Parameters group**

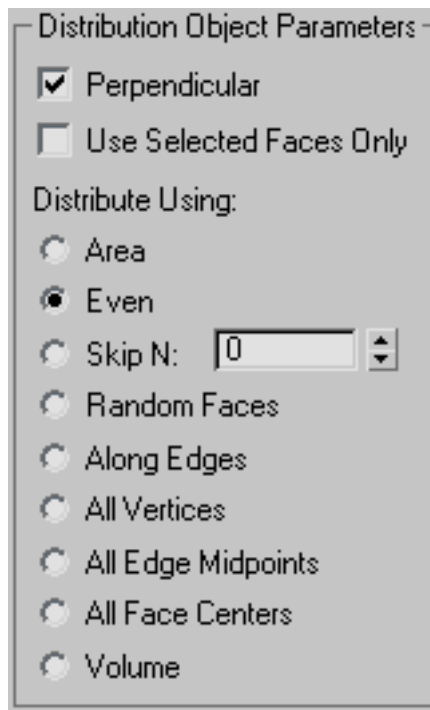

These options affect how the duplicates of the source object are arranged, relative to the distribution object. These options have an effect only when a distribution object is used.

**Perpendicular** When on, orients each duplicate object perpendicular to its associate face, vertex, or edge in the distribution object. When off, the duplicates maintain the same orientation as the original source object.

**Use Selected Faces Only** When on, limits distribution to the selected faces passed up the Stack. Perhaps the easiest way to do this is to use the Instance option when picking the distribution object. You can then apply a Mesh Select modifier to the original object and select only those faces you want to use for the distribution of the duplicates.

### **Distribute Using**

The following options let you specify how the geometry of the distribution object determines the distribution of the source object. These options are ignored if you're not using a distribution object.

**Area** Distributes duplicate objects evenly over the total surface area of the distribution object.

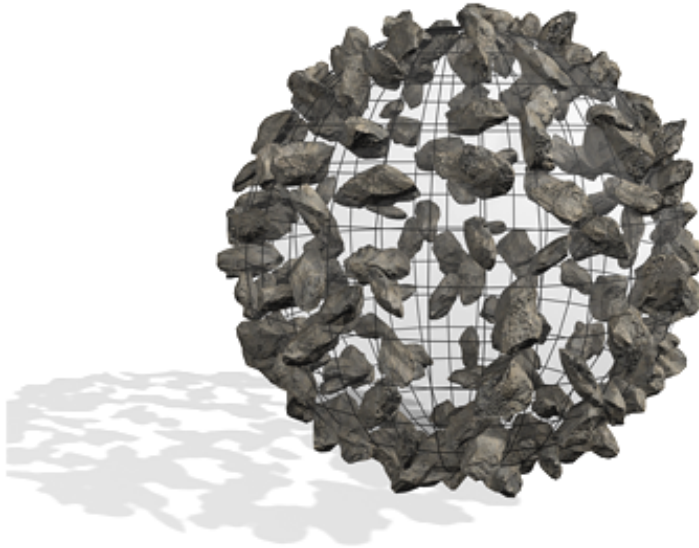

Objects distributed over a spherical surface with Area turned on



**Even** Divides the number of faces in the distribution object by the number of duplicates, and skips the appropriate number of faces in the distribution object when placing duplicates.

**Skip N** Skips N number of faces when placing duplicates. The editable field specifies how many faces to skip before placing the next duplicate. When set to 0, no faces are skipped. When set to 1, every other face is skipped, and so on.

**Random Faces** Applies duplicates randomly over the surface of the distribution object.

**Along Edges** Assigns duplicates randomly to the edges of the distribution object.

**All Vertices** Places a duplicate object at each vertex in the distribution object. The Duplicates value is ignored.

**All Edge Midpoints** Places a duplicate at the midpoint of each segment edge.

**All Face Centers** Places a duplicate object at the center of each triangular face on the distribution object. The Duplicates value is ignored.

**Volume** Scatters objects throughout the distribution object's volume. All other options restrict distribution to the surface. Consider turning on Display rollout > Hide Distribution Object with this option.

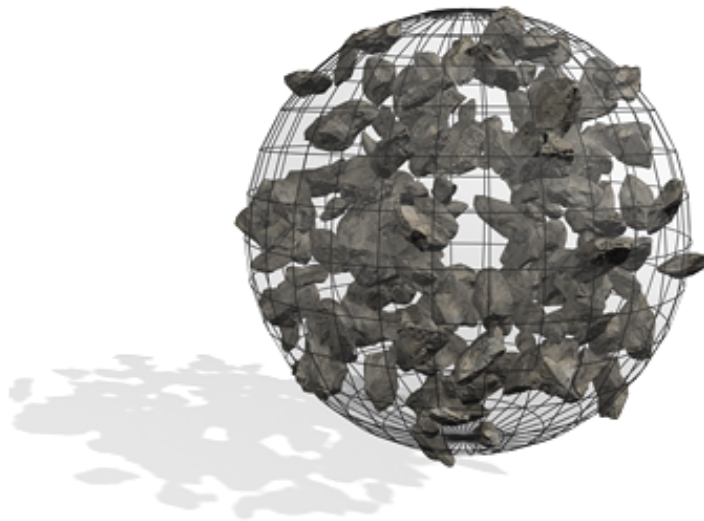

Objects fill a spherical volume with Volume turned on

## Display group

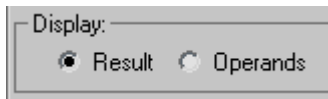

**Result/Operands** Choose whether to display the results of the scatter operation or the operands before the scattering.

## Transforms rollout

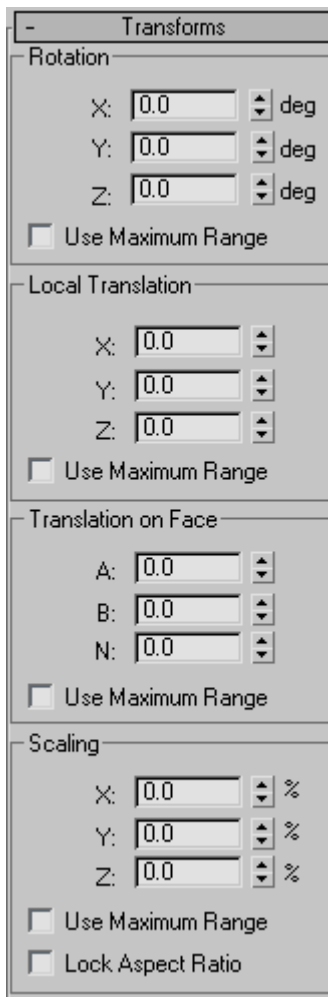

The settings in the Transforms rollout let you apply random transform offsets to each duplicate object. The values in the transform fields specify a maximum offset value that's applied randomly with a positive or negative value to each duplicate. Thus, if you set a rotation angle of 15 degrees, duplicates are rotated randomly from -15 to +15 degrees. For example, one duplicate might be rotated 8 degrees, another -13, another 5, and so on. You can use the Transform settings with or without a distribution object. When there is no distribution object, you must adjust the Transform settings in order to see the duplicates.

### **Rotation group**

Specifies random rotation offsets.

**X, Y, Z deg** Enter the maximum random rotational offset you want about the local X, Y, or Z axis of each duplicate.

**Use Maximum Range** When on, forces all three settings to match the maximum value. The other two settings become disabled, and the setting containing the maximum value remains enabled.

### **Local Translation group**

Specifies translation of the duplicates along their local axes.

**X, Y, Z** Enter the maximum random movement you want along the X, Y, or Z axis of each duplicate.

**Use Maximum Range** When on, forces all three settings to match the maximum value. The other two settings become disabled, and the setting containing the maximum value remains enabled.

### **Translation on Face group**

Lets you specify the translation of duplicates along [barycentric](#) on page 7724 face coordinates of the associate face in the distribution object. These settings have no effect if you're not using a distribution object.

**A, B, N** The first two settings specify the barycentric coordinates on the surface of the face, while the N setting sets the offset along the normal of the face.

**Use Maximum Range** When on, forces all three settings to match the maximum value. The other two settings become disabled, and the setting containing the maximum value remains enabled.

## Scaling group

Lets you specify the scaling of duplicates along their local axes.

**X, Y, Z %** Specifies the percent of random scaling along the X, Y, or Z axis of each duplicate.

**Use Maximum Range** When on, forces all three settings to match the maximum value. The other two settings become disabled, and the one containing the maximum value remains enabled.

**Lock Aspect Ratio** When on, maintains the original aspect ratio of the source object. Typically, this provides uniform scaling of duplicates. When Lock Aspect Ratio is off, and any of the X, Y, and Z settings contain values greater than 0, the result is non-uniform scaling of duplicates because the values represent random scaling offsets in both positive and negative directions.

## Display rollout

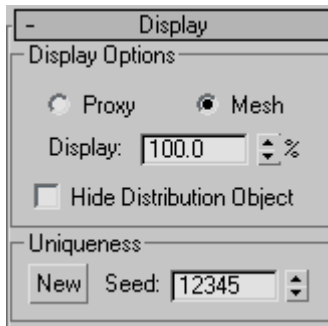

Provides options that affect the display of the Scatter object.

## Display Options group

These options affect the display of the source and destination objects.

**Proxy** Displays the source duplicates as simple wedges and speeds up viewport redraws when manipulating a complex Scatter object. This has no effect on the rendered image, which always displays the mesh duplicates.

**Mesh** Displays the full geometry of the duplicates.

**Display %** Specifies the percentage of the total duplicate objects that appear in the viewports. This has no effect on the rendered scene.

**Hide Distribution Object** Hides the distribution object. The hidden object does not appear in the viewport or in the rendered scene.

## Uniqueness group

Lets you set a seed number upon which the random values are based. Thus, altering this value changes the overall effect of the scattering.

**New** Generates a new, random seed number.

**Seed** Use this spinner to set the seed number.

## Load/Save Presets rollout



Lets you store preset values to use in other Scatter objects. For example, after setting all of your parameters for a specific Scatter object and saving the settings under a specific name, you can then select another Scatter object and load the preset values into the new object.

**Preset Name** Lets you define a name for your settings. Click the Save button to save the current settings under the preset name.

## Saved Presets group

A list window containing saved preset names.

**LOAD** Loads the preset currently highlighted in the Saved Presets list.

**SAVE** Saves the current name in the Preset Name field and places it in the Saved Presets window.

**DELETE** Deletes the selected items in the Save Presets window.

---

**NOTE** Animated parameter values subsequent to frame 0 are not stored.

---

## Conform Compound Object

Select an object. > Create panel > Geometry > Compound Objects > Object Type rollout > Conform

Select an object. > Create menu > Compound > Conform

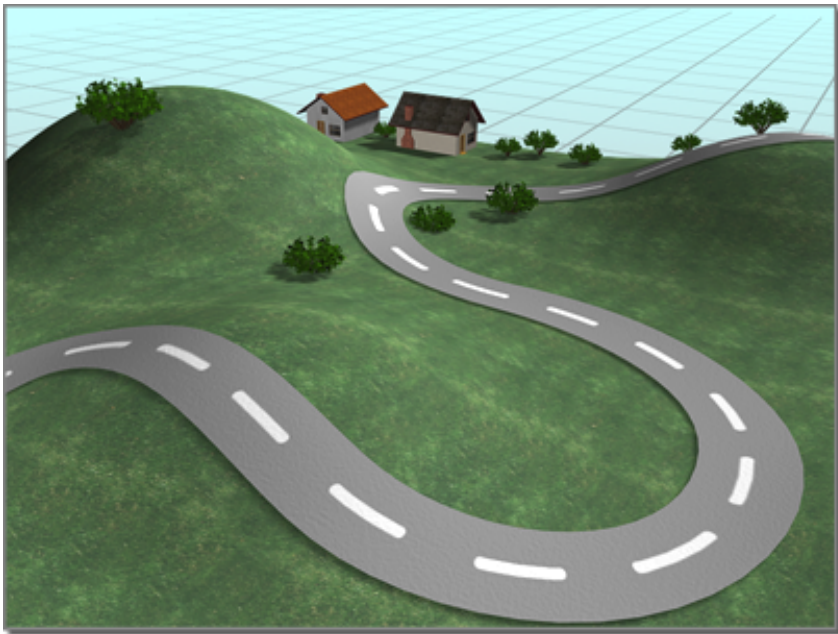

**Conform fits the road to the surface of the hills.**

Conform is a compound object created by projecting the vertices of one object, called the Wrapper, onto the surface of another object, called the Wrap-To. There is also a space-warp version of this function; see [Conform space warp](#) on page 2703 .

Because the space-warp version is somewhat easier to use, it's a good idea to read that topic first, try the example, and then return here. This topic provides additional methods of projecting the wrapper vertices.

---

**NOTE** This tool gives you the ability to morph between any two objects, regardless of the number of vertices in each object. See [Vertex Projection Direction group](#) on page 664 for more information.

---

## Procedures

### Example: To create a Conform object:

- 1 Position two objects, one of which will be the Wrapper, and the other the Wrap-To. (For this example, create a box as the Wrap-To object, and then create a larger sphere that completely surrounds it. The sphere will be the Wrapper.)
- 2 Select the Wrapper object (the sphere), and click Create panel > Geometry > Compound Objects > Object Type rollout > Conform button.

---

**NOTE** Both objects used in Conform must be either mesh objects or objects that can be converted to mesh objects. If the selected Wrapper object is invalid, the Conform button is unavailable.

---

- 3 Specify the method of vertex projection in the Vertex Projection Direction group. (Use Along Vertex Normals for this example.)

---

**NOTE** If you were to choose Use Active Viewport, you would next activate whichever viewport looks in the direction that you want to project the vertices. For example, if the Wrapper hovered over a Wrap-To terrain on the home plane, you'd activate the Top viewport.

---

- 4 Choose Reference, Copy, Move, or Instance to specify the type of cloning to perform on the Wrap-To object. (Choose Instance for this example.)
- 5 Click Pick Wrap-To Object, and then click the object onto which to project the vertices. (You can press the H key and use the [Pick Object dialog](#) on page 168 to select the box.)  
The list windows display the two objects, and the compound object is created with the Wrapper object conforming to the Wrap-To object. (In the example, the sphere is wrapped into the shape of the box.)
- 6 Use the various parameters and settings to alter the vertex projection direction, or adjust the vertices that are being projected.

### To project a road onto terrain:

- 1 Create the road and terrain objects.

---

**TIP** You can quickly make a terrain by creating a [patch grid](#) on page 1982 and applying the [Noise modifier](#) on page 1501 to it. For the road, you can use a [Loft compound object](#) on page 715 by lofting a rectangle along a curved line. Both objects must have a sufficient level of detail to conform smoothly.

---

- 2 Orient both the road and the terrain so you are looking straight down at them in the Top viewport. Position the road so it's completely above the terrain (higher on the world Z axis).

---

**NOTE** For the conform projection to work correctly, the road should not extend beyond the boundaries of the terrain when viewed in the Top viewport.

---

- 3 Select the road object.
- 4 Click Conform.
- 5 In the Pick Wrap-To Object rollout, make sure the Instance option is selected.
- 6 Click Pick Wrap-To Object, and click the terrain.  
An instance of the terrain object is created, with the same object color as the road.
- 7 Activate the Top viewport. In the Parameters rollout > Vertex Projection Direction group, choose Use Active Viewport, and click Recalculate Projection.
- 8 In the Update group, turn on Hide Wrap-To Object.  
This hides the instance of the terrain so you can clearly see the road projected onto it.  
The Parameters rollout > Wrapper Parameters group > Standoff Distance value sets the number of units by which the road sits above the terrain along the world Z axis.
- 9 If necessary, adjust the Standoff Distance to raise or lower the road.



## Interface

### Pick Wrap-To Object rollout

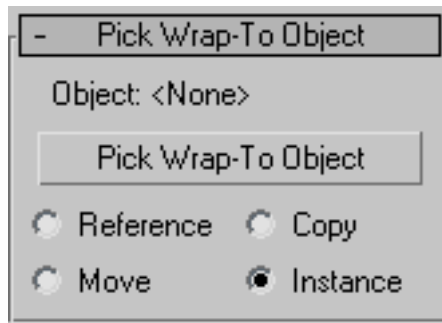

**Object** Displays the name of the selected Wrap-To object.

**Pick Wrap-To Object** Click this button, and then select the object to which you want the current object to wrap.

**Reference/Copy/Move/Instance** This option lets you specify how the Wrap-To object is transferred to the Conform object. It can be transferred either as a [reference](#) on page 7910 , a copy, an [instance](#) on page 7818 , or it can be moved, in which case the original is not left behind.

### Parameters rollout

Contains all parameters for the Conform object.

### Objects group

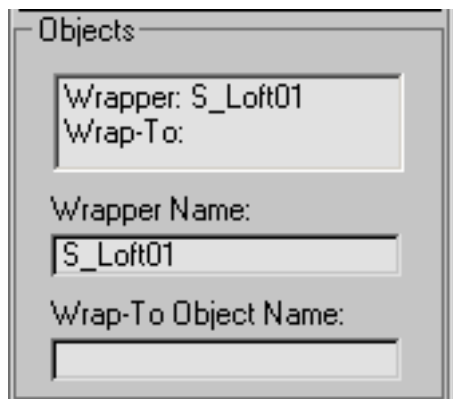

Provides a list window and two edit fields that let you navigate the compound object and rename its components.

**List Window** Lists the Wrapper and the Wrap-To objects. Click to select an object in the window so that you can access it in the Modifier stack.

**Wrapper Name** Lets you rename the wrapper object within the compound Conform object.

**Wrap-To Object Name** Lets you rename the Wrap-To object.

### Vertex Projection Direction group

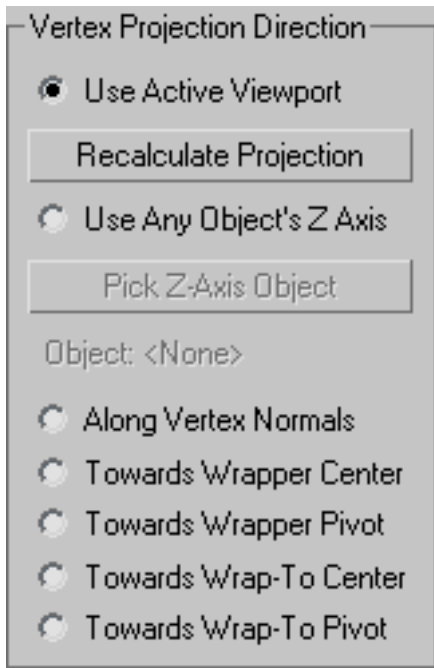

Choose one of these seven options to determine the projection of the vertices.

**Use Active Viewport** The vertices are projected away (inward) from the active viewport.

**Recalculate Projection** Recalculates the projection direction for the currently active viewport. Because the direction is initially assigned when you pick the Wrap-To object, if you want to change viewports after assignment, click this button to recalculate the direction based on the new active viewport.

**Use Any Object's Z Axis** Lets you use the local Z axis of any object in the scene as a direction. Once an object is assigned, you can alter the direction of vertex projection by rotating the direction object.

**Pick Z-Axis Object** Click this button, and then click the object you want to use to indicate the direction of the projection source.

**Object** Displays the name of the direction object.

- **Along Vertex Normals** Projects the vertices of the Wrapper object inward along the reverse direction of its vertex normals. A vertex normal is a vector produced by averaging the normals of all faces attached to that vertex. If the Wrapper object encloses the Wrap-To object, the Wrapper takes on the form of the Wrap-To object.
- **Towards Wrapper Center** Projects the vertices toward the bounding center of the Wrapper object.
- **Towards Wrapper Pivot** Projects the vertices toward the original pivot center of the Wrapper object.
- **Towards Wrap-To Center** Projects the vertices toward the bounding center of the Wrap-To object.
- **Towards the Wrap-To Pivot** Projects the vertices toward the pivot center of the Wrap-To object.

---

**NOTE** Towards Wrapper Pivot and Towards the Wrap-To Pivot operate on the position of the original pivot point of the object before the Conform object is created. Once you create the Conform object, it's a new compound object with a single pivot point.

---

**TIP** You can animate the conforming effect by morphing between the compound object and a previously made copy of the original wrapper object. To do this, however, you must turn on Hide Wrap-To Object in the Update group so that the original object and the compound object have the same number of vertices. Using this technique, you can effectively morph between two objects with a different number of vertices.

---

## Wrapper Parameters group

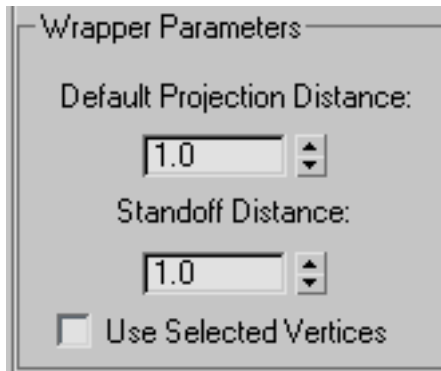

Provides controls that determine how far the vertices are projected.

**Default Projection Distance** The distance a vertex in the Wrapper object will move from its original location if it does not intersect the Wrap-To object.

**Standoff Distance** The distance maintained between the vertex of the Wrapper object and the surface of the Wrap-To object. For example, if you set Standoff Distance to 5, the vertices can be pushed no closer than 5 units from the surface of the Wrap-To object.

**Use Selected Vertices** When turned on, only the selected vertex sub-objects of the Wrapper object are pushed. When turned off, all vertices in the object are pushed, regardless of the Modifier stack selection. To access the Modifier stack of the Wrapper object, select the Wrapper object in the list window, open the Modifier stack, and select the base object name. At this point you can apply a Mesh Select modifier, for example, and select the vertices you want to affect.

## Update group

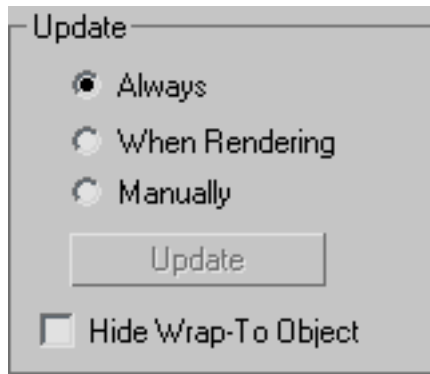

The items in this group determine when the projection for the compound object is recalculated. Because complex compound objects can slow performance, you can use these options to avoid constant calculation.

- **Always** The object is updated constantly.
- **When Rendering** The object is recalculated only when the scene is rendered.
- **Manually** Activates the Update button for manual recalculation.

**Update** Recalculates the projection.

**Hide Wrap-To Object** When on, hides the Wrap-To object.

## Display group

Determines whether the shape operands are displayed.

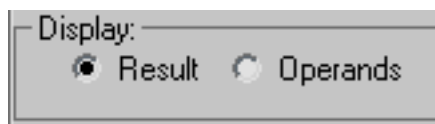

- **Result** Displays the result of the operation.
- **Operands** Displays the operands.

## Connect Compound Object

Select an object. > Create panel > Geometry > Compound Objects > Object Type rollout > Connect

Select an object. > Create menu > Compound > Connect

The Connect compound object lets you connect two or more objects between "holes" in their surfaces. To do this, you delete faces in each object to create one or more holes in their surfaces, position them so that the holes face one another, and then apply Connect.

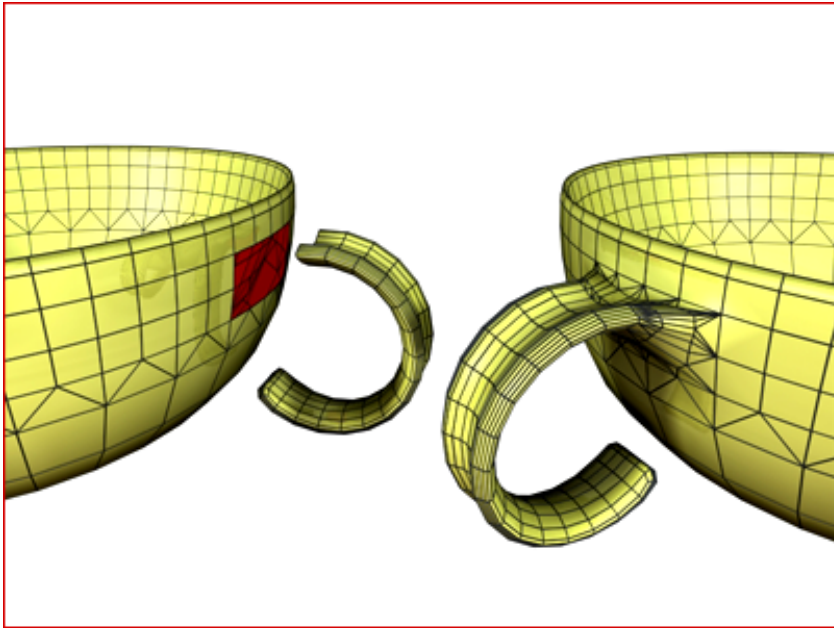

**Left: Before connect**

**Right: After connect**

---

**NOTE** Connect is not suited to NURBS objects, because they convert into many separate meshes instead of one big mesh. The workaround is simple: apply a Weld modifier to the NURBS object (thus converting it to a mesh and zipping up its seams) before using it as part of a connect.

---

Connect generates the best mapping coordinates it can for the bridges between the various holes in the meshes. While some ideal cases, such as a cylinder

above another cylinder, can generate good UVW map interpolations, most cases cannot. You'll need to apply mapping to the bridge faces with a [UVW Map modifier](#) on page 1849 .

Vertex colors, on the other hand, interpolate smoothly.

#### **Notes:**

- You can use Connect on objects that have multiple sets of holes. Connect will do its best to match up the holes between the two objects.
- The mapping coordinates assigned to the original two objects are maintained to the extent possible. You might find irregularities in the bridged area, depending on the complexity and difference between the two original sets of mapping coordinates and the types of geometry.

#### **Procedures**

##### **To create a Connect object:**

- 1 Create two mesh objects.
- 2 Delete faces on each to create holes where you want to bridge the objects. Position the objects so that the normals of the deleted faces of one object point toward the normals of the deleted faces of the other object (assuming that deleted faces could have normals).
- 3 Select one of the objects. On the Create panel > Geometry > Compound Object Type rollout, click Connect.
- 4 Click the Pick Operand button, and then select the other object.
- 5 Faces are generated connecting the holes in the two objects.
- 6 Adjust the connection with the various options.

##### **Example: To connect two cylinders:**

- 1 Create a cylinder with a radius of 15 and a height of 30. Use the default settings for the remaining parameters.
- 2 Create a second cylinder centered on the first with a radius of 30, a height of 30, and 13 sides. (The fewer sides are to demonstrate the mesh interpolation in the connection.)
- 3 Move the first, narrower cylinder straight up along Z so its bottom cap is about 15 units above the top cap of the larger cylinder.

- 4 Convert both cylinders to editable meshes.
- 5 Delete the lower cap of the upper cylinder, and the upper cap of the bottom cylinder. (Hint: Go to Editable Mesh (Polygon) mode, select each end in turn, and then press the Delete key.)
- 6 Exit sub-object mode, select the lower cylinder, and click Connect.
- 7 Click the Pick Operand button, and then click the upper cylinder.  
New faces are created that span the openings in the two cylinders.

**Example continued: To try out some options and create animation:**

- 1 Go to the Modify panel and increase the Segments spinner to **5** or more.  
As the segments increase, the connection becomes curved.
- 2 Set the Tension spinner to **0** to straighten the connecting surface, increase it to 1, and then return it to **0.5**.
- 3 Try different combinations of the Bridge and Ends options.
- 4 Select the upper cylinder, turn on the Auto Key button, and apply various transforms at different frames.
- 5 Play the animation.

**Interface**

**Pick Operand rollout**

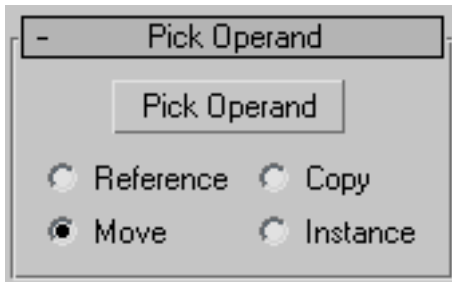

**Pick Operand** Click this button to connect an additional operand to the original object.

For example, you might begin with a single object with two holes, and arrange two additional objects, each with one hole, outside of those holes. Click the Pick Operand button and select one of the objects, which is connected, and



then click Pick Operand again and select the other object, which is connected. Both connected objects are added to the Operands list.

**Reference/Copy/Move/Instance** Lets you specify how the operand is transferred to the compound object. It can be transferred either as a [reference](#) on page 7910 , a copy, an [instance](#) on page 7818 , or moved, in which case the original is not left behind.

---

**NOTE** Connect works only with objects that are capable of being converted into editable surfaces, such as [editable meshes](#) on page 1990 .

---

### Parameters rollout

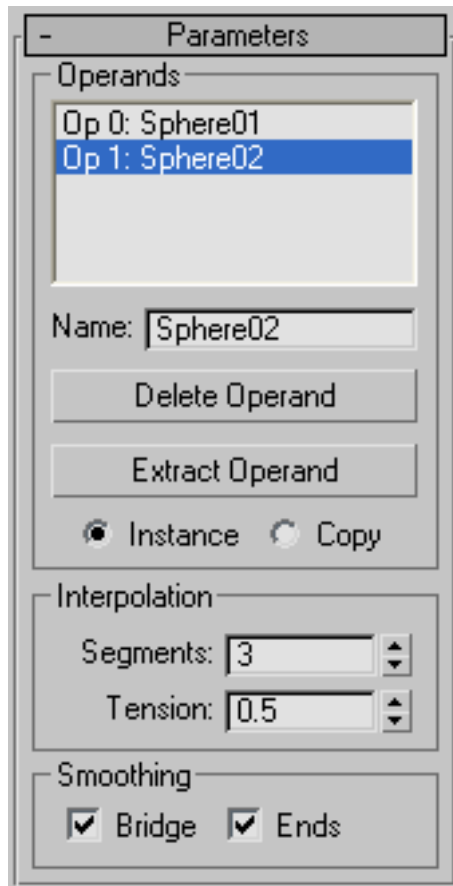

## Operands group

**Operands list** Displays the current operands. Select an operand to rename, delete or extract by clicking it in this list.

**Name** Renames a selected operand. Type in a new name, and then press Tab or Enter.

**Delete Operand** Deletes a selected operand from the list.

**Extract Operand** Extracts a copy or an instance of the selected operand. Choose an operand in the list to enable this button.

---

**NOTE** This button is available only in the Modify panel. You can't extract an operand while in the Create panel.

---

**Instance/Copy** Lets you specify how the operand is extracted: as either an [instance](#) on page 7818 or a copy.

## Interpolation group

**Segments** Sets the number of segments in the connecting bridge.

**Tension** Controls the curvature in the connecting bridge. A value of 0 provides no curvature, while higher values create curves that attempt to more smoothly match the surface normals on either end of the connecting bridge. This spinner has no apparent effect when Segments is set to 0.

## Smoothing group

**Bridge** Applies smoothing between the faces in the connecting bridge.

**Ends** Applies smoothing between the faces that border the old and new surfaces of the connecting bridge and the original objects. When turned off, 3ds Max assigns a new material ID number to the bridge. The new number is one higher than the highest ID number assigned to either of the original objects. When on, the ID number is taken from one of the original objects.

---

**NOTE** If both Bridge and Ends are on, but the original objects contain no smoothing groups, then smoothing is assigned to the bridge and to the faces bordering the bridge.

---

## Display/Update rollout



### Display group

Determines whether the shape operands are displayed.

- **Result** Displays the result of the operation.
- **Operands** Displays the operands.

### Update group

These options determine when the projection for the compound object is recalculated. Because complex compound objects can slow performance, you can use these options to avoid constant calculation.

- **Always** The object is updated constantly.
- **When Rendering** The object is recalculated only when the scene is rendered.
- **Manually** Activates the Update button for manual recalculation.

**Update** Recalculates the projection.

# BlobMesh Compound Object

Create panel > Geometry > Compound Objects > Object Type rollout > BlobMesh

Create menu > Compound > BlobMesh

The BlobMesh compound object creates a set of spheres from geometry or particles, and connects the spheres together as if they were made of a soft, liquid substance. When the spheres move within a certain distance of one another, they connect together. When they move apart, they take on a spherical form again.



In the 3D industry, the general term for spheres that operate in this way is [metaballs](#) on page 7847 . The BlobMesh compound object generates metaballs based on specified objects in the scene, and the metaballs, in turn, form a mesh result called a *blobmesh*. A blobmesh is ideal for simulating thick liquids and soft substances that move and flow when animated.

When you associate an object or particle system with the BlobMesh compound object, the metaballs are placed and sized differently depending on the object used to generate them:

- For geometry and shapes, a metaball is placed at each vertex, and the size of each metaball is determined by the size of the original BlobMesh object. Soft selection can be used to vary the sizes of the metaballs.
- For particles, a metaball is placed at each particle, and the size of each metaball is determined by the size of the particle on which it's based.
- For helpers, a metaball is placed at the pivot point, and the size of the metaball is determined by the original BlobMesh object.

---

**NOTE** You can apply [motion blur](#) on page 7854 to a BlobMesh object to enhance the effects of motion in renderings. For particle systems other than Particle Flow, use Image motion blur. For Particle Flow particle systems and all other types of objects including geometry, shapes, and helpers, use Object motion blur.

---

## **Procedures**

### **To create a blobmesh from geometry or helpers:**

- 1 Create one or more geometry or helper objects. If the scene requires animation, animate the objects as desired.
- 2 Click BlobMesh, and click anywhere on the screen to create the initial metaball.
- 3 Go to the Modify panel.
- 4 In the Blob Objects group, click Add. Select the objects you wish to use to create metaballs. A metaball appears at each vertex of each selected object, or at the centers of helper objects.
- 5 In the Parameters rollout, set the Size parameter as necessary to cause the metaballs to connect.

### **To create a blobmesh with soft selection on geometry:**

- 1 Create a geometry object, and convert it to an Editable Mesh or Editable Poly.
- 2 Apply a Mesh Select modifier to the object, and select some of the vertices on the object.
- 3 In the Soft Selection rollout, turn on Use Soft Selection. Set the Falloff value as desired.
- 4 Apply a Turn to Mesh or Turn to Poly modifier to the object.  
This will retain the soft selection and pass it up the stack regardless of whether you exit the sub-object mode.
- 5 Click Create panel > Compound Objects > BlobMesh, and click anywhere on the screen to create the initial metaball.
- 6 Go to the Modify panel.
- 7 In the Blob Objects group, click Add. Select the Editable Mesh or Editable Poly object.  
A metaball appears at each vertex of the selected object.

- 8 In the Parameters rollout, turn on Use Soft Selection.  
Metaballs are limited to those vertices that are affected by the soft selection.
- 9 Set the Size and Min. Size parameters to set the sizes of the metaballs.

**To create a blobmesh with soft selection on a spline:**

- 1 Create the spline, and convert it to an Editable Spline.
- 2 In the Rendering rollout, turn on both Renderable and Display Render Mesh.
- 3 Apply a Mesh Select modifier, and select the appropriate vertices for soft selection.
- 4 In the Soft Selection rollout, turn on Use Soft Selection. Set the Falloff value as desired.
- 5 Apply a Turn to Mesh or Turn to Poly modifier to the object.  
This will retain the soft selection and pass it up the stack regardless of whether you exit the sub-object mode.
- 6 Click Create panel > Compound Objects > BlobMesh, and click anywhere on the screen to create the initial metaball.
- 7 Go to the Modify panel.
- 8 In the Blob Objects group, click Add. Select the Editable Spline.  
A metaball appears at each vertex of the selected object.
- 9 In the Parameters rollout, turn on Use Soft Selection.  
Metaballs are limited to those vertices that are affected by the soft selection.
- 10 Set the Size and Min. Size parameters to set the sizes of the metaballs.

**To create a blobmesh from a particle system:**

When you use BlobMesh with a particle system, a metaball is created at each particle's location. The size of the metaball is determined by the size of the particle.

- 1 Create a [particle system](#) on page 2713 , and set up its parameters to animate the particles.

- 2 Click Create panel > Compound Objects > BlobMesh, and click anywhere on the screen to create the initial metaball.
- 3 Go to the Modify panel.
- 4 In the Blob Objects group, click Add. Select the particle system. A metaball appears at each particle in the system.
- 5 If you have added a [Particle Flow system](#) on page 2713 to the blobmesh and you want to create metaballs only for particles in specific events, click Add on the Particle Flow Parameters rollout to choose the events from a list.

---

**TIP** If you need to prevent the particles from rendering, do not hide them as this can prevent the blobmesh from generating correctly. Instead, turn off the particle system's Renderable option on the [Object Properties dialog](#) on page 245 .

---

## Interface

### Parameters rollout

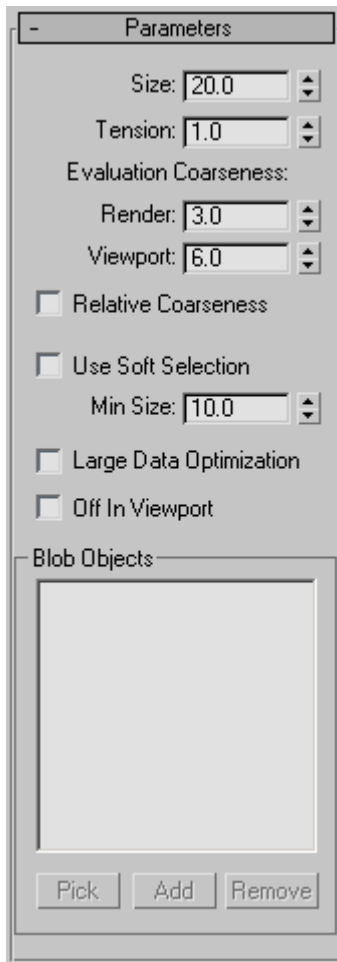

**Size** The radius of each metaball for objects other than particles. For particles, the size of each metaball is determined by the size of the particle, which is set by parameters in the particle system. Default=20.



---

**NOTE** The apparent size of the metaballs is affected by the Tension value. When Tension is set to its lowest possible value, the radius of each metaball accurately reflects the Size setting. Higher Tension values will tighten the surface, and make the metaballs smaller.

---

**Tension** Determines how relaxed or tight the surface will be. A smaller value makes a looser surface. This value can range from 0.01 to 1.0. Default=1.0.

**Evaluation Coarseness** Sets the coarseness, or density, of the resulting blobmesh. When Relative Coarseness (see following) is off, the Render and Viewport values set the absolute height and width of blobmesh faces, and lower values create a smoother, denser mesh. When Relative Coarseness is on, the height and width of blobmesh faces is determined by the ratio of metaball size to this value. In this case, higher values create a denser mesh. Range (both)=0.001 to 1000.0. Render default=3.0, Viewport default =6.0.



The lower end of the range for both Coarseness settings, previously limited to 0.5, is now 0.001, which allows for much higher-resolution metaball geometry when Relative Coarseness is off. Using such low values can also cause lengthy calculation delays; if this happens and you wish to halt calculation, press Esc.

**Relative Coarseness** Determines how the coarseness values will be used. If this option is turned off, the Render Coarseness and View Coarseness values are absolute, where the height and width of each face on the blobmesh is always equal to the coarseness value. This means the faces on the blobmesh will retain a fixed size even if the metaballs change size. If this option is turned on, the size of each blobmesh face is based on the ratio of the metaball size to the coarseness, which will cause the blobmesh face size to change as the metaballs become larger or smaller. Default=Off.

**Large Data Optimization** This option provides an alternate method for calculating and displaying the blobmesh. This method is more efficient than the default method only when a large number of metaballs are present, such as 2,000 or more. Turn on this option only when using a particle system or other object that produces a large number of metaballs. Default=Off.

**Off in Viewport** Turns off the display of the blobmesh in viewports. The blobmesh will still appearing in renderings. Default=Off.

**Use Soft Selection** If soft selection has been used on geometry you add to the blobmesh, turning on this option causes the soft selection to be used for the size and placement of metaballs. Metaballs are placed at selected vertices with the size set by the Size parameter. For vertices that lie within the falloff set on the geometry's Soft Selection rollout, smaller metaballs are placed. For vertices outside the falloff, no metaballs are placed. This option has an effect

only if the Vertex sub-object level for the geometry is still enabled, and Use Soft Selection on the geometry's Soft Selection rollout is turned on. If Use Soft Selection is turned off either for the blobmesh or for the geometry, metaballs are placed at all vertices on the geometry. Default=Off.

**Min Size** Sets the minimum size for metaballs within the falloff when Use Soft Selection is turned on. Default=10.0.

**Pick** Allows you to pick objects or particle systems from the screen to add to the blobmesh.

**Add** Displays a selection dialog where you can select objects or particle systems to add to the blobmesh.

**Remove** Removes objects or particles from the blobmesh.

### Particle Flow Parameters rollout

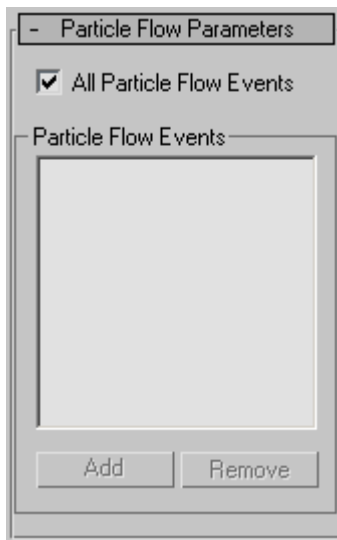

Use this rollout if you have added a Particle Flow system to the blobmesh, and want particles to generate metaballs only during specific events. Before you can specify events on this rollout, you must add the Particle Flow system to the blobmesh on the Parameters rollout.

**All Particle Flow Events** When turned on, all Particle Flow Events will generate metaballs. When turned off, only Particle Flow Events specified in the PFlow Events list will generate metaballs.

**Add** Displays a list of PFlow events in the scene so you can pick events to add to the PFlow Events list.

**Remove** Removes the selected event from the PFlow Events list.

## ShapeMerge Compound Object

Select an object. > Create panel > Geometry > Compound Objects > Object Type rollout > ShapeMerge

Select an object. > Create menu > Compound > ShapeMerge



ShapeMerge combines the lettering, a text shape, with the mesh that models the cake.

ShapeMerge creates a compound object consisting of a mesh object and one or more shapes. The shapes are either embedded in the mesh, altering the edge and face patterns, or subtracted from the mesh.

## Procedures

### To create a ShapeMerge object:

- 1 Create a mesh object and one or more shapes
- 2 Align the shapes in the viewport so they can be projected toward the surface of the mesh object.
- 3 Select the mesh object, and click the ShapeMerge button.
- 4 Click Pick Shape, and then select the shape.

The geometry of the surface of the mesh object is altered to embed a pattern matching that of the selected shape.

## Interface

### Pick Operand rollout

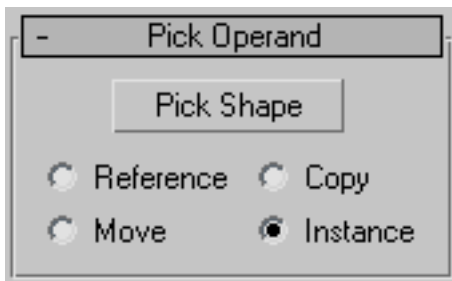

**Pick Shape** Click this button, and then click the shape you want to embed in the mesh object. The shape is projected onto the mesh object in the direction of the shape's local negative Z axis. For example, if you create a box, and then create a shape in the Top viewport, the shape is projected onto the top of the box. You can repeat this process to add shapes, and the shapes can be projected in different directions. Simply click Pick Shape again, and then pick another shape.

**Reference/Copy/Move/Instance** Lets you specify how the shape is transferred to the compound object. It can be transferred either as a [reference](#) on page 7910 , a copy, an [instance](#) on page 7818 , or moved, in which case the original shape is not left behind.

## Parameters rollout

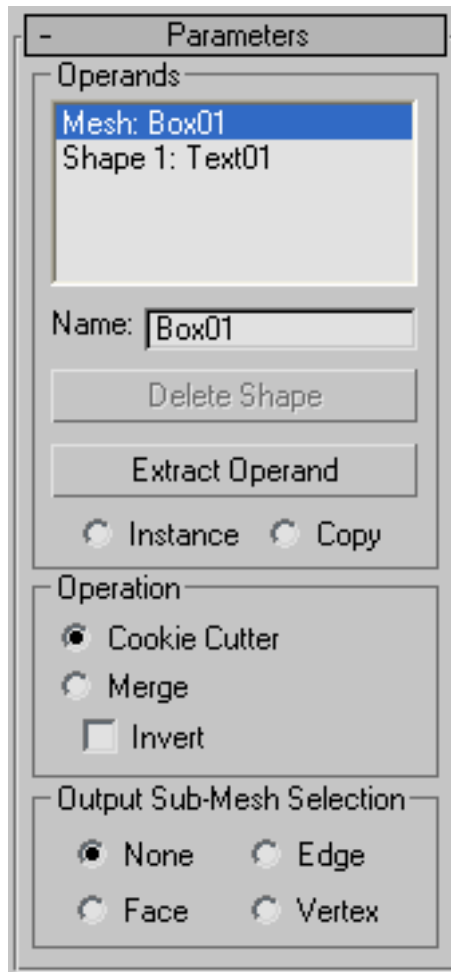

### Operands group

**Operands list** Lists all operands in the compound object. The first operand is the mesh object, and any number of shape-based operands can follow.

**Delete Shape** Remove selected shapes from the compound object.

**Extract Operand** Extracts a copy or an instance of the selected operand. Choose an operand in the list window to enable this button.

**Instance/Copy** Lets you specify how the operand is extracted. It can be extracted either as an [instance](#) on page 7818 or a copy.

### Operation group

These options determine how the shape is applied to the mesh.

**Cookie Cutter** Cuts the shape out of the mesh object's surface.

**Merge** Merges the shape with the surface of the mesh object.

**Invert** Reverses the effect of Cookie Cutter or Merge. With the Cookie Cutter option, the effect is obvious. When Invert is off, the shape is a hole in the mesh object. When Invert is on, the shape is solid and the mesh is missing. When you're using Merge, Invert reverses the sub-object mesh selection. As an example, if you merge a circle shape and apply a Face Extrude, the circular area is extruded when Invert is off, and all but the circular area is extruded when Invert is on.

### Output Sub-Mesh Selection group

Provides options that let you specify what selection level is passed up the Stack. The ShapeMerge object stores all selection levels; that is, it stores the vertices, faces, and edges of the merged shape with the object. (If you apply a Mesh Select modifier and go to the various sub-object levels, you'll see that the merged shape is selected.) Thus, if you follow the ShapeMerge with a modifier that acts on a specific level, such as Face Extrude, that modifier will work properly.

If you apply a modifier that can work on any selection level, such as Volume Select or XForm, the options will specify which selection level is passed to that modifier. Although you can use a [Mesh Select modifier](#) on page 1455 to specify a selection level, the Mesh Select modifier considers the selection only at frame 0. If you've animated the shape operand, that animation will be passed up the Stack for all frames only by using the Output Sub-Mesh Selection options.

- **None** Outputs the full object.
- **Face** Outputs the faces within the merged shape.
- **Edge** Outputs the edge of the merged shape.
- **Vertex** Outputs the vertices defined by the spline of the shape.

## Display/Update rollout



### Display group

Determines whether the shape operands are displayed.

- **Result** Displays the result of the operation.
- **Operands** Displays the operands.

### Update group

These options specify when the display is updated. Typically, you use them when you've animated the merged shape operands and the viewport display is slow.

- **Always** Updates the display at all times.
- **When Rendering** Updates the display only when the scene is rendered.
- **Manually** Updates the display only when you click the Update button.

**Update** Updates the display when any option except Always is chosen.

## Boolean Compound Object

Select an object. > Create panel > Geometry > Compound Objects > Object Type rollout > Boolean

Select an object. > Create menu > Compound > Boolean

A Boolean object combines two other objects by performing a Boolean operation on them.

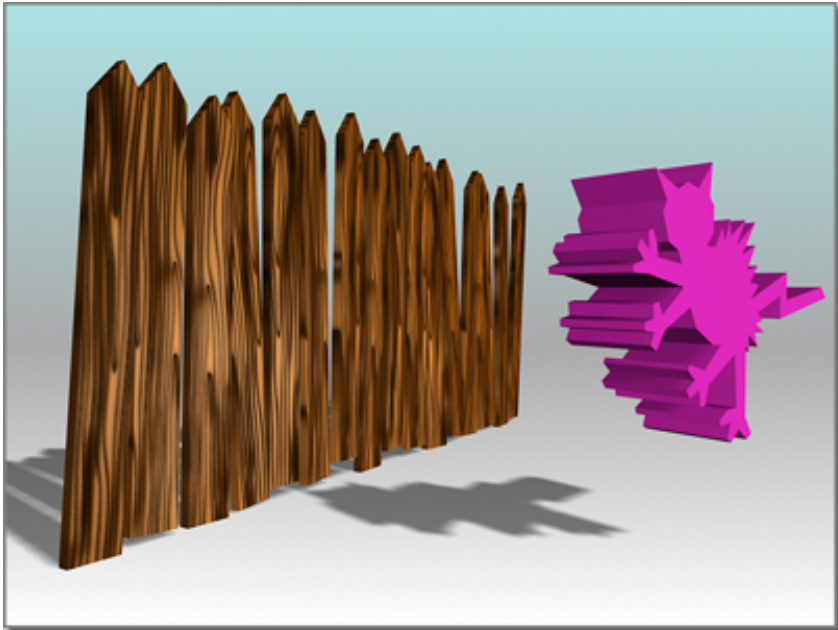

Operand A (left); Operand B (right)

These are the Boolean operations for geometry:

**Union** The Boolean object contains the volume of both original objects. The intersecting or overlapping portion of the geometry is removed.

**Intersection** The Boolean object contains only the volume that was common to both original objects (in other words, where they overlapped).

**Subtraction (or difference)** The Boolean object contains the volume of one original object with the intersection volume subtracted from it.

The two original objects are designated as operand A and B.



Beginning with version 2.5 of 3ds Max, a new algorithm computes the Boolean operation. This algorithm produces more predictable results and less complex geometry than earlier 3D Studio Booleans. If you open a file that contains a Boolean from an earlier version of 3ds Max, the Modify panel displays the interface for the earlier Boolean operation.

You can layer Booleans in the stack display, so that a single object can incorporate many Booleans. By navigating through the stack display, it's possible to revisit the components of each Boolean and make changes to them.

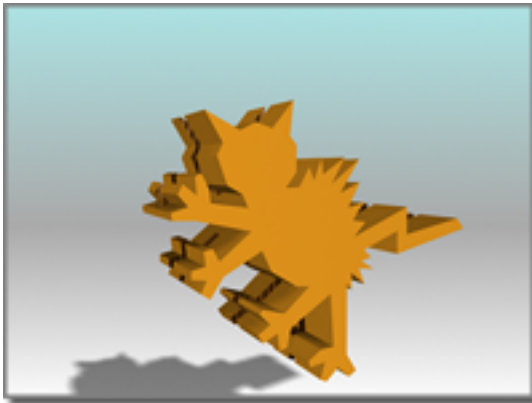
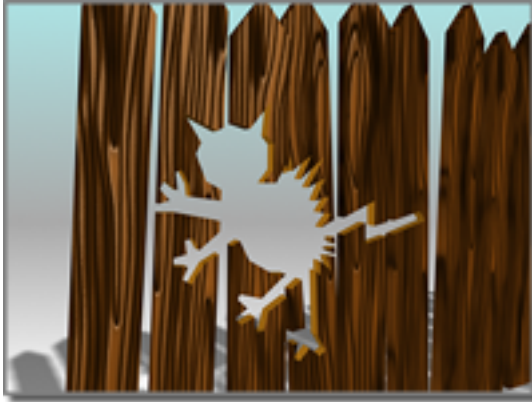

Subtraction: A-B (above); B-A (below)



Union (above); Intersection (below)

### Booleans with Objects That Have Materials Assigned to Them

Most primitives use several [material IDs](#) on page 7842 on their surfaces. For example, a box uses material IDs 1–6 on its sides. If you assign a [Multi/Sub-Object material](#) on page 5558 with six sub-materials, 3ds Max assigns one to each side. If you assign a multi/sub-object material with two sub-materials, 3ds Max assigns the first material to sides 1, 3, and 5, and the second goes to sides 2, 4, and 6.

When you create a Boolean from objects that have materials assigned to them, 3ds Max combines the materials in the following way:

- If operand A doesn't have a material, it inherits operand B's material.

- If operand B doesn't have a material, it inherits operand A's material.
- If both operands have materials, the new material is a multi/sub-object material that combines the materials from both operands.

For more information, see [Material Attach Options Dialog](#) on page 701 .

### **Solutions When Working with Booleans**

The Boolean algorithm caused unpredictable behavior in earlier releases. The solutions are discussed here.

#### **Surface Topology**

Boolean requires that operands' surface topology be intact: This means no missing or overlapping faces and no unwelded vertices. The surface should be one continuous closed surface.

The Boolean corrects operands that fail to meet this requirement. However, the automatic correction may not be exactly what you want, so in some cases it might be safer to correct the surfaces manually.

To check for holes in the geometry, use the [STL-Check modifier](#) on page 1678 or the [Measure utility](#) on page 2597 .

To fill holes, use the [Cap Holes modifier](#) on page 1159 .

#### **Face Normals**

Booleans require that the face normals of the surface be consistent. Flipped normals can produce unexpected results. Surfaces where some faces are facing one way and adjacent faces are flipped are also problematic, and are commonly found in geometry imported from CAD programs. The Boolean fixes these faces as best it can. Again, it might make more sense to correct these manually.

Use shaded viewports to look for normal problems, watching for objects that appear inside-out or look otherwise incorrect. You can also turn on Show in the [Editable Mesh \(Face\)](#) on page 2014 > Surface Properties rollout > Normals group. Fix normals here, or with a [Normal modifier](#) on page 1509 .

#### **Overlapping Elements**

Because Boolean operations depend on a clear understanding of what is inside and what is outside a mesh, meshes that overlap themselves can produce invalid results. For instance, if you use the [Collapse utility](#) on page 1931 with

two overlapping objects without turning on the Boolean feature, the resulting object will not make a good Boolean operand. This is also a problem for the [Teapot primitive](#) on page 377 (with all parts turned on), which overlaps itself.

If you need to use such an object as a Boolean operand, you might reconstruct it as a single non-overlapping mesh by separating the components and combining them with Boolean.

### **Working with Inverted Meshes**

Boolean doesn't always produce the ideal result on "inverted meshes" (meshes that have been turned inside-out by having their normals flipped). The problem is that the area inside the flipped mesh is correctly seen as "outside," but the area outside it may also be seen as "outside." To remedy this, instead of inverting the mesh, make a very large box or other primitive centered on (but not touching) the mesh and subtract the mesh from it using Boolean. Then convert it to an editable mesh, and delete the box faces. This produces a correctly inverted mesh that works correctly with Boolean.

### **Alignment**

If two Boolean operands are perfectly aligned without actually intersecting, the Boolean operation might produce the wrong result. Although this is rare, if it does occur, you can eliminate it by making the operands overlap slightly.

### **Relative Complexity Between Operands**

Boolean works best when the two operands are of similar complexity. If you wish to subtract text (a complex object made of many faces and vertices) from a box without any segments, the result is many long, skinny faces that are prone to rendering errors. Increasing the number of box segments produces better results. Try to maintain a similar complexity between operands.

### **Coplanar Faces/Colinear Edges**

Previously, Boolean required that objects overlap. If two objects did not overlap but merely touched an edge to an edge, or a face to a face, the Boolean would fail.

Boolean allows for non-overlapping objects. Coincident faces/edges and vertices are no longer a problem. You can use objects completely encased within another object, where no edges intersect, to create Booleans.

See also [Collapse Utility](#) on page 1931 to create Booleans with multiple objects.

**See also:**

- [Fixing Boolean Problems](#) on page 7667

**Procedures**

**To create a Boolean object:**

- 1 Select an object. This object becomes operand A.
- 2 Click Boolean. The name of operand A appears in the Operands list on the Parameters rollout.
- 3 On the Pick Boolean rollout, choose the copy method for operand B: Reference, Move, Copy, or Instance. (These methods are described in the Pick Boolean rollout section, later in this topic.)
- 4 On the Parameters rollout, choose the Boolean operation to perform: Union, Intersection, Subtraction (A-B), or Subtraction (B-A). You can also choose one of the Cut operations, described later in the Operation group section.
- 5 On the Pick Boolean rollout, click Pick Operand B.
- 6 Click in a viewport to select operand B. 3ds Max performs the Boolean operation.

The operand objects remain as sub-objects of the Boolean object. By modifying the creation parameters of the Boolean's operand sub-objects, you can later change operand geometry in order to change or animate the Boolean result.

**Example: To create and modify a single object that contains multiple Booleans:**

Suppose you want to create a box with two holes in it. One hole is to be cut by a sphere, and the second by a cylinder. If you want to make changes to the sphere or the cylinder later, you can do so by following these steps:

- 1 Create a Boolean following the steps in the previous sections. The original object (the box) is converted to a Boolean, and is designated operand A. The second object (the sphere) is converted to operand B.
- 2 Deselect the Boolean object. Build the cylinder if it does not already exist.
- 3 Select the Boolean object; and under Compound Objects, click Boolean again.

- 4 Click Pick Operand B and click the cylinder in the viewport. It is converted to operand B.
- 5 On the Modify panel, choose Operand B from the Parameters rollout > Operands list. If you want to see operand B, choose Display/Update rollout > Display group > Operands or Result + Hidden Ops.  
If you want to animate the Cylinder or the Cylinder's parameters you can now access them in the modifier stack display.
- 6 If you want to modify the sphere's parameters, choose the box in the Operands list.
- 7 Now there are two entries labeled Boolean in the stack display. Choose the lower entry. The Sphere is displayed in the Operands list.
- 8 Choose the Sphere from the Operands list. The sphere's parameters are available by clicking the sphere's name in the modifier stack display.
- 9 Use this technique to change parameters or animate any of the operands within the multiple Boolean.

You can also navigate multiple Booleans through Track View. Clicking the operand in Track View gives you direct access to its entry in the modifier stack display. In complex objects with many Booleans, this is an easier method than the one outlined above.

## Interface

### Pick Boolean rollout

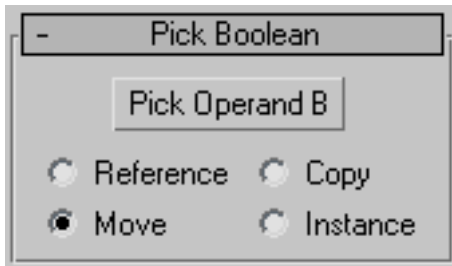

When you select operand B, you designate it as a Reference, Move (the object itself), Copy, or Instance, according to your choice in the Pick Boolean rollout for Boolean objects. Base your selection on how you want to use the scene geometry after you create the Boolean.

Because you usually create Boolean objects from overlapping objects, if the B object isn't removed (if you don't use the default Move option), it often obstructs your view of the completed Boolean. You can move the Boolean or the B object to better see the result.

**Pick Operand B** Use this button to select the second object to use to complete the Boolean operation.

**Reference/Copy/Move/Instance** Lets you specify how operand B is transferred to the Boolean object. It can be transferred either as a [reference](#) on page 7910, a copy, an [instance](#) on page 7818, or moved.

- Use Reference to synchronize modifier-induced changes to the original object with operand B, but not vice-versa.
- Use Copy when you want to reuse the operand B geometry for other purposes in the scene.
- Use Instance to synchronize animation of the Boolean object with animated changes to the original B object, and vice-versa.
- Use Move (the default) if you've created the operand B geometry only to create a Boolean, and have no other use for it. Object B geometry becomes part of the Boolean object regardless of which copy method you use.

## Parameters rollout

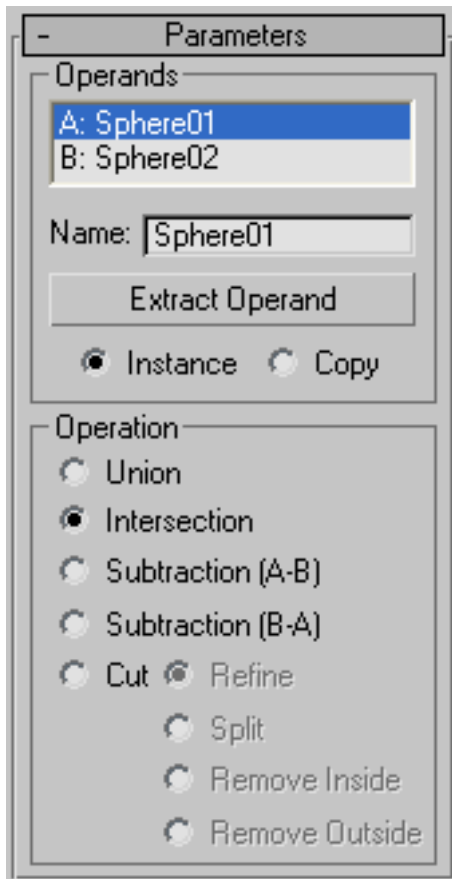

### Operands group

**Operands list field** Displays the current operands.

**Name** Edit this field to change the name of the operands. Choose an operand in the Operands list and it will also appear in the Name box.

**Extract Operand** Extracts a copy or an instance of the selected operand. Choose one of the operands in the list window to enable this button.

---

**NOTE** This button is available only in the Modify panel. You can't extract an operand while the Create panel is active.

---



**Instance/Copy** Lets you specify how the operand is extracted: as either an [instance](#) on page 7818 or a copy.

## Operation group

**Union** The Boolean object contains the volume of both original objects. The intersecting or overlapping portion of the geometry is removed.

**Intersection** The Boolean object contains only the volume that was common to both original objects (in other words, where they overlapped).

**Subtraction (A-B)** Subtracts the intersection volume of operand B from operand A. The Boolean object contains the volume of operand A with the intersection volume subtracted from it.

**Subtraction (B-A)** Subtracts the intersection volume of operand A from operand B. The Boolean object contains the volume of operand B with the intersection volume subtracted from it.

**Cut** Cuts operand A with operand B, but doesn't add anything to the mesh from operand B. This works like the [Slice modifier](#) on page 1658, but instead of using a planar gizmo, Cut uses the shape of operand B as the cutting plane. Cut treats the geometry of the Boolean object as volumes rather than closed solids. Cut does not add geometry from operand B to operand A. Operand B intersections define cut areas for altering geometry in operand A.

There are four types of Cut:

- **Refine** Adds new vertices and edges to operand A where operand B intersects the faces of operand A. 3ds Max refines the resulting geometry of operand A with additional faces inside the intersected area of operand B. Faces cut by the intersection are subdivided into new faces. You might use this option to refine a box with text so that you can assign a separate material ID to the object.
- **Split** Works like Refine but also adds a second or double set of vertices and edges along the boundary where operand B cuts operand A. Split produces two elements belonging to the same mesh. Use Split to break an object into two parts along the bounds of another object.
- **Remove Inside** Deletes all operand A faces inside operand B. This option modifies and deletes faces of operand A inside the area intersected by operand B. It works like the subtraction options, except that 3ds Max adds no faces from operand B. Use Remove Inside to delete specific areas from your geometry.

- **Remove Outside** Deletes all operand A faces outside operand B. This option modifies and deletes faces of operand A outside the area intersected by operand B. It works like the Intersection option, except that 3ds Max adds no faces from operand B. Use Remove to delete specific areas from your geometry.

### Display/Update rollout

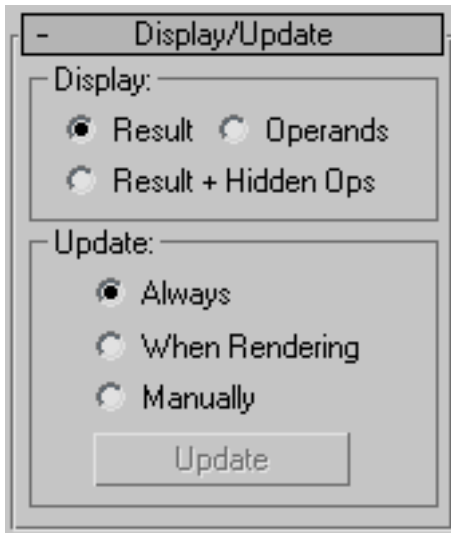

### Display group

Visualizing the result of a Boolean can be tricky, especially if you want to modify or animate it. The Display options on the Boolean Parameters rollout help you visualize how the Boolean is constructed.

The display controls have no effect until you've created the Boolean.

- **Result** Displays the result of the Boolean operation; that is, the Boolean object itself.
- **Operands** Displays the operands instead of the Boolean result.

---

**TIP** When operands are difficult to see in a viewport, you can use the Operand list to select one or the other. Click the name of the A or B operand to select it.

---

- **Results + Hidden Ops** Displays the "hidden" operands as wireframe. Operand geometry remains part of the compound Boolean object, although it isn't visible or renderable. The operand geometry is displayed as wireframes in all viewports.

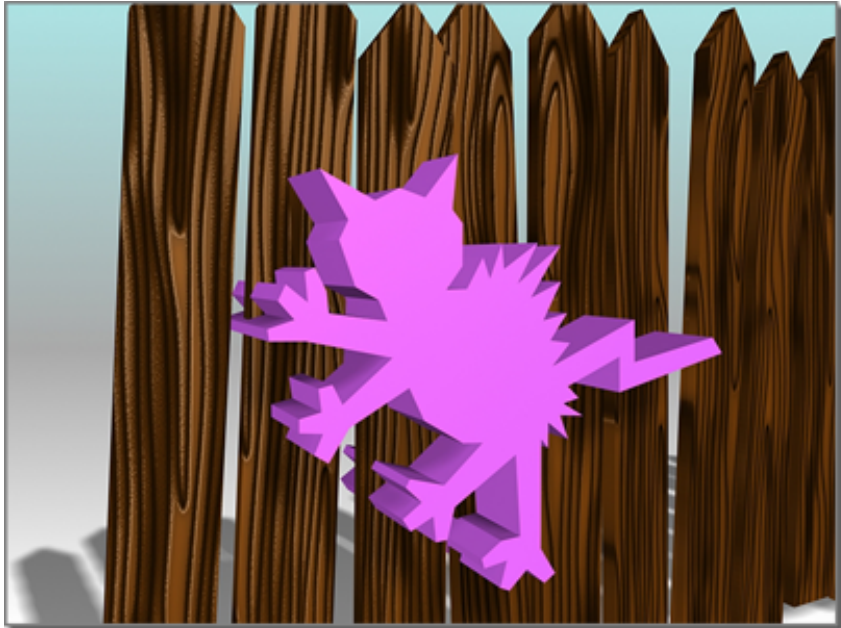

Displaying the operands

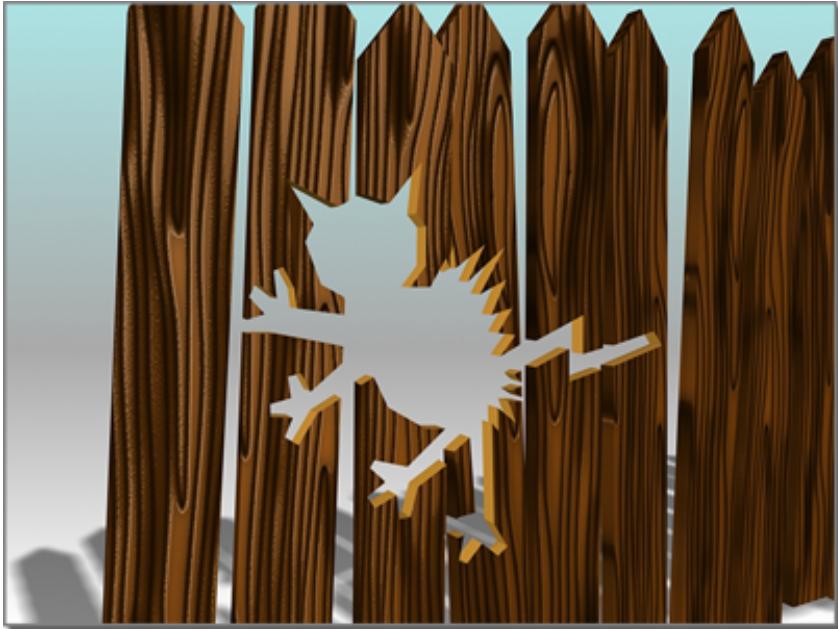

Displaying the result (A-B)

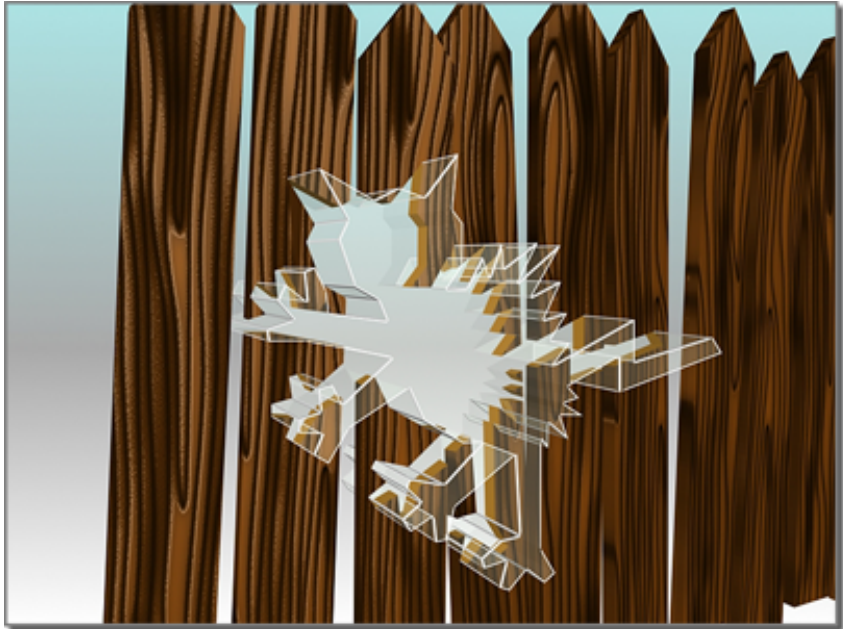

Displaying the hidden operand after A-B

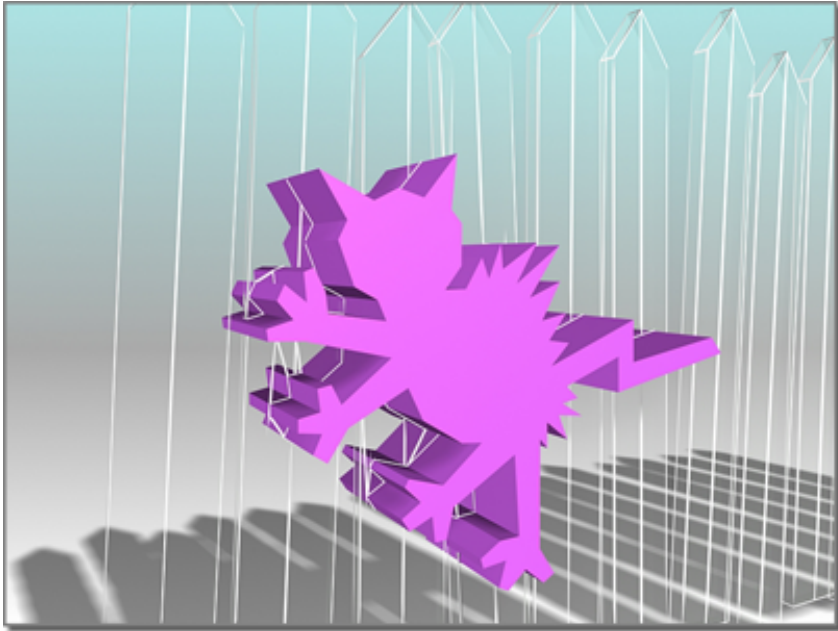

Displaying the hidden operand after B-A

### Update group

By default, Booleans are updated whenever you change the operands. A scene that contains one or more complicated, animated Booleans can impede performance. The update options provide alternate methods to improve performance.

- **Always** Updates Booleans immediately when you change an operand, including the original object of an instanced or referenced B operand. This is the default behavior.
- **When Rendering** Updates Booleans only when you render the scene or click Update. With this option, viewports don't always show current geometry, but you can force an update when necessary.
- **Manually** Updates Booleans only when you click Update. With this option, the viewports and the render output don't always show current geometry, but you can force an update when necessary.

**Update** Updates the Boolean. The Update button is not available when Always is selected.

## Material Attach Options Dialog

Use objects with different materials assigned to them. > Create panel > Geometry > Compound Objects > Object Type rollout > Boolean > Pick Boolean rollout > Pick Operand B button > Select object in the viewport that is operand B.

When you use Boolean operations with objects that have been assigned different materials, 3ds Max displays the Material Attach Options dialog. This dialog offers five methods for handling the materials and the [material IDs](#) on page 7842 in the resultant Boolean object.

---

**NOTE** If operand A has no material, and operand B has a material assigned, the Boolean dialog lets you choose to inherit the material from operand B.

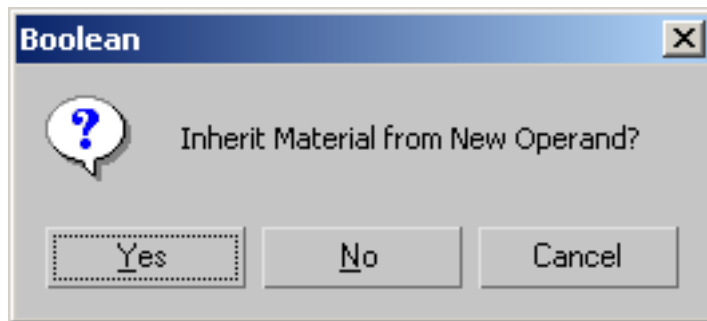

---

If operand A has a material assigned and operand B has no material assigned, the Boolean object automatically inherits materials from operand A.

### Procedures

To create a Boolean from objects that match material IDs to material:

- 1 [Create a Boolean](#) on page ? using at least one object that has a [multi/sub-object material](#) on page 5558 assigned to it.
- 2 On the Pick Boolean rollout, click Pick Operand B.
- 3 Click in a viewport and select the B operand. 3ds Max displays the Match Attach Options dialog.
- 4 Choose Match Material IDs to Material to complete the Boolean operation.

## Interface

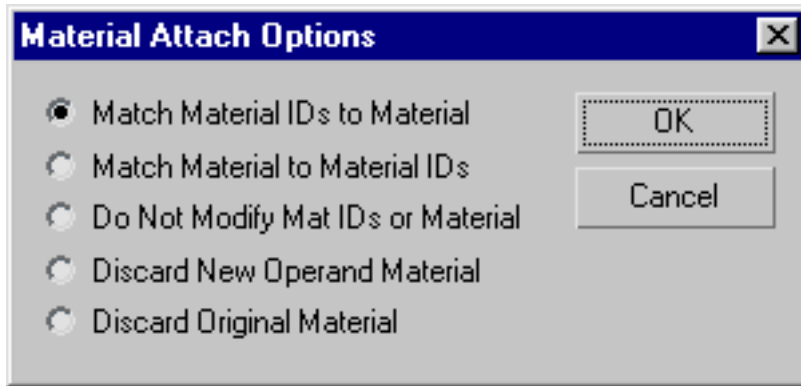

**Match Material IDs to Material** 3ds Max modifies the number of material IDs in the combined object to be no greater than the number of sub-materials assigned to the operands. For example, if you combine two boxes that have standard materials and each box is assigned six material IDs (the default), the resulting combined object has two operands with one material ID each, rather than the 12 that would result from using the Match Material to Material ID option. After you complete the operation, 3ds Max creates a new multi/sub-object material with two slots. 3ds Max assigns the sub-materials to the operands as they appeared before the operation. The number of resulting material IDs matches the number of materials between the original objects. You might use this option to reduce the number of material IDs.

**Match Material to Material IDs** Maintains the original material ID assignment in the operands by adjusting the number of sub-materials in the resultant multi/sub-object material. For example, if you combine two boxes, both assigned single materials, but with their default assignment of six material IDs, the result would be a multi/sub-object material with 12 slots (six containing instances of one box's material, and six containing instances of the other box's material). Use this option when it's important to maintain the original material ID assignments in your geometry. Also use this option when material IDs have been assigned, but materials have not been assigned.

---

**NOTE** To make the instanced sub-materials unique, select them in Track View, and click the Make Unique button on the Track View toolbar. You can also make them unique one at a time with the [Make Unique button](#) on page 5250 in the Material Editor.

---

**Do Not Modify Mat IDs or Material** If the number of material IDs in an object is greater than the number of sub-materials in its multi/sub-object



material, then the resultant face-material assignment might be different after the Boolean operation.

**Discard New Operand Material** Discards the material assignment of operand B. 3ds Max assigns operand A's material to the Boolean object.

**Discard Original Material** Discards the material assignment of operand A. 3ds Max assigns operand B's material to the Boolean object.

---

**NOTE** A [UVW Map modifier](#) on page 1849 must be used with compound objects to apply mapping coordinates.

---

## Terrain Compound Object

Select spline contours. > Create panel > Geometry > Compound Objects > Object Type rollout > Terrain

Select spline contours. > Create menu > Compound > Terrain

The Terrain button lets you produce terrain objects. 3ds Max generates these objects from contour line data. You select editable splines representing elevation contours and create a mesh surface over the contours. You can also create a "terraced" representation of the terrain object so that each level of contour data is a step, resembling traditional study models of land forms.

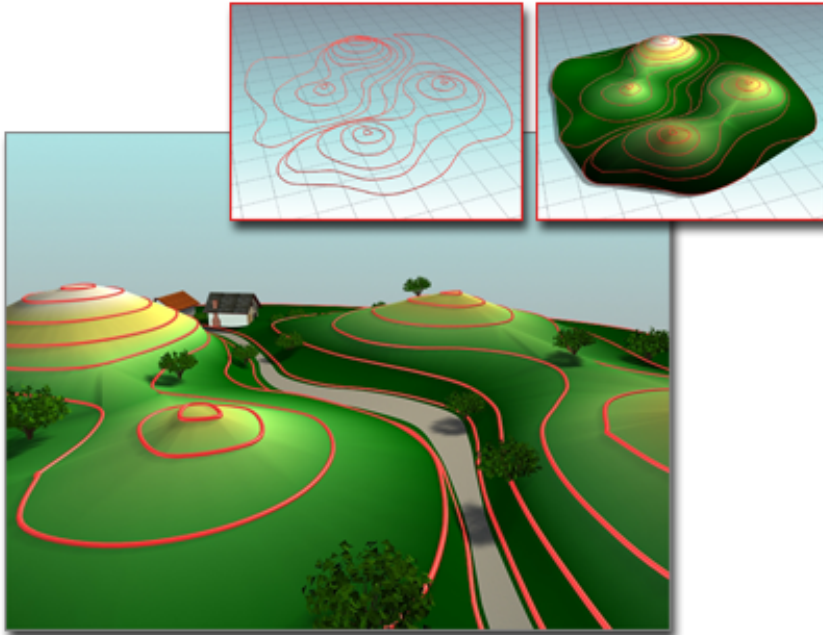

**Using contours to build a terrain**

**Upper left: The contours**

**Upper right: The terrain object**

**Lower left: Terrain object used as the basis of a landscape**

If you import an AutoCAD drawing file to use as contour data, 3ds Max names each object based on the AutoCAD object's layer, color, or object type. A number is appended to each name. For example, an AutoCAD object on the layer *BASE* becomes an object named *BASE.01*. See [Importing DWG Files](#) on page 6979 for more information.

After you import or create the contour data, select the objects, and click the Terrain button, 3ds Max creates a new triangulated mesh object based on the contour data. The name of the first selected spline becomes the name of the terrain object. Other splines in the selection are treated according to the previously set Reference, Move, Copy, or Instance selection in the Pick Operand rollout, described below.

Keep in mind that the Terrain object can use any spline objects as operands, whether they are horizontal splines or not. Though the most common scenario is when sets of elevational contours are used to create terrain forms, it is possible to append or refine Terrain objects by using non-horizontal splines.

---

**NOTE** To ensure that 3ds Max imports polylines as splines, when you import an AutoCAD drawing file, turn off Import AutoCAD DWG File dialog > Geometry Options group > Cap Closed Entities.

---

Following are examples of uses of the Terrain feature:

- Visualizing the effects of grading plans in 3D.
- Maximizing views or sunlight by studying topographical undulation of land forms.
- Analyzing elevation changes by using color on the data.
- Adding buildings, landscaping, and roads to a terrain model to create virtual cities or communities.
- Viewing corridors and completing ridge analyses from particular locations on a site by adding cameras to the scene.

## **Procedures**

**To analyze elevation changes:**

- 1 Import or create contour data.
- 2 Select the contour data, and click the Terrain button.
- 3 On the Color By Elevation rollout, enter elevation zone values between the maximum and minimum elevations in the Base Elev box. Click Add Zone after entering the value.  
3ds Max displays the zones in the list under the Create Defaults button.
- 4 Click the Base Color swatch to change the color of each elevation zone. For example, you could use a deep blue for low elevations, a light blue for intermediate elevations, and perhaps greens for higher elevations.
- 5 Click Solid To Top of Zone to see the elevation changes in a striped effect.
- 6 Click Blend To Color Above to see the elevation changes blended.

## **Interface**

### **Name and Color rollout**

Displays the name of the terrain object. 3ds Max uses the name of one of the selected objects to name the terrain object.

## Pick Operand rollout

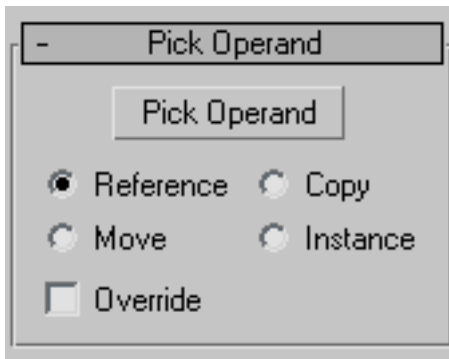

**Pick Operand** Adds splines to the terrain object. You might do this if you didn't select all the objects before generating the terrain object, or if some objects in the imported data weren't included in the terrain object. You can also use this option to add existing splines in the current scene to the terrain object.

**Reference/Copy/Move/Instance** When you click Pick Operand, the copy method you designate determines how the operands are used. When Move is the method, the original contour data is moved from the scene and into the operands of the new terrain object. Copy, Reference, and Instance retain the original contour data in the scene and create copies, references or instances of the contour data as operands in the terrain object. This is similar to the copy method for [Boolean](#) on page 686 .

**Override** Allows you to select closed curves that override any other operand data within their interior. Within the area an Override operand encloses (as seen in plan), other curves and points of the mesh are disregarded and the elevation of the Override operand supersedes them. An Override operand is indicated in the operands list by a # after its name. Override is only effective on closed curves. If multiple override operands overlap, later overrides (higher operand numbers) take preference.

### Parameters rollout

The Parameters rollout dialog box is organized into four sections:

- Operands:** A list box containing four entries: Op 0: Line02, Op 1: Line03, Op 2: Line04, and Op 3: Line01. Below the list is a "Delete Operand" button.
- Form:** A group of five options: "Graded Surface" (selected with a radio button), "Graded Solid" (radio button), "Layered Solid" (radio button), "Stitch Border" (checkbox), and "Retriangulate" (checkbox).
- Display:** A group of three options: "Terrain" (selected with a radio button), "Contours" (radio button), and "Both" (radio button).
- Update:** A group of three options: "Always" (selected with a radio button), "When Rendering" (radio button), and "Manually" (radio button). Below this group is an "Update" button.

## Operands group

**Operand list** Displays the current operands. Each operand is listed as "Op" followed by a number and the name of the object that is being used as the operand. The operand name comprises layer, color, or object type name plus a numeric suffix.

**Delete Operand** Deletes a selected operand from the Operands list.

## Form group

- **Graded Surface** Creates a graded surface of the mesh over the contours.

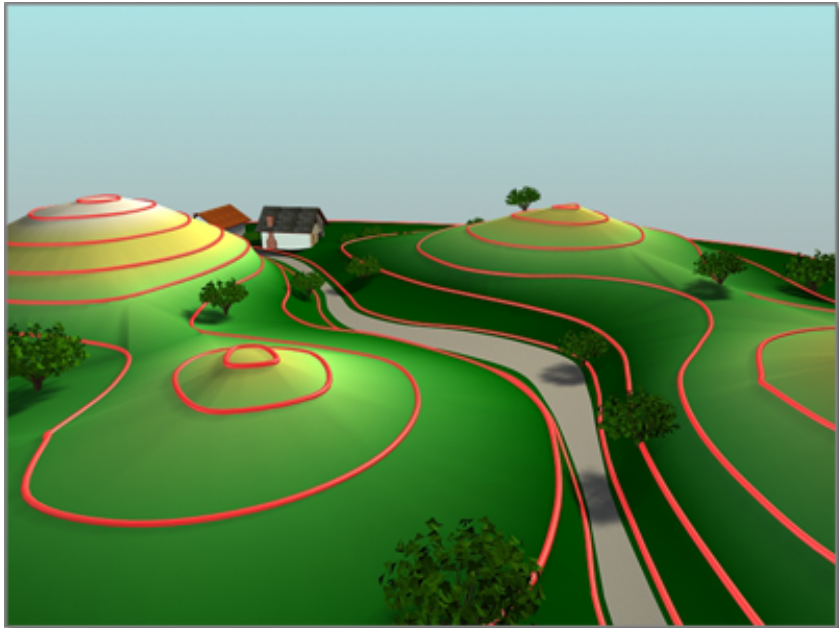

Terrain created as a graded surface

- **Graded Solid** Creates a graded surface with skirts around the sides and a bottom surface. This represents a solid that is visible from every direction.
- **Layered Solid** Creates a "wedding cake" or laminated solid similar to cardboard architectural models.

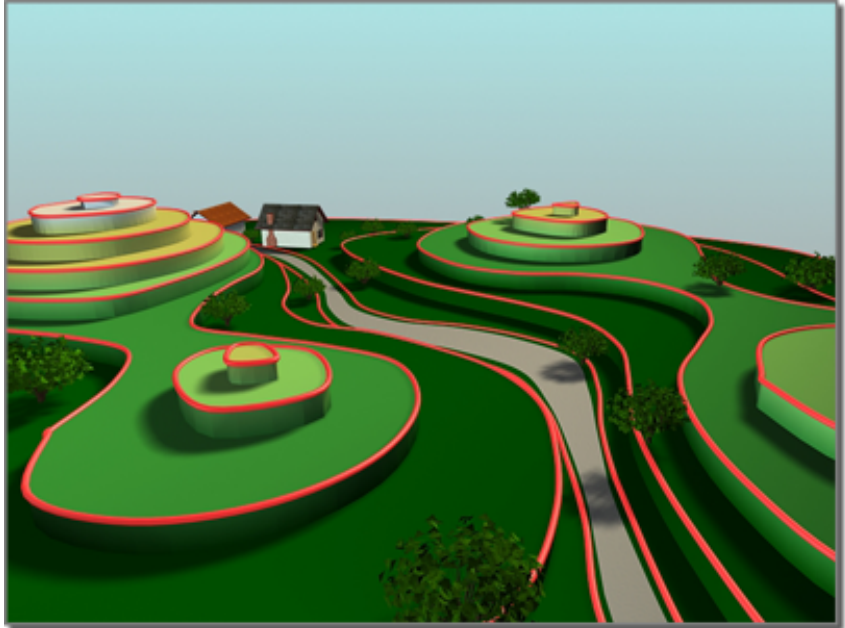

Terrain created as a "layered solid" surface, with levels

**Stitch Border** When on, suppresses the creation of new triangles around the edges of terrain objects when edge conditions are defined by splines that are not closed. Most terrain forms display more reasonably when this is turned off.

**Retriangulate** The basic Terrain algorithm tends to flatten or notch contours when they turn sharply upon themselves. A typical situation in which this may happen is when a narrow creek bed is described with contours; the resulting form may look more like a series of cascades at each elevational contour, rather than a smoothly descending ravine. When Retriangulate is checked, a somewhat slower algorithm is used that follows contour lines more closely. This may be particularly evident in the Layered Solid display mode. For additional precision, try using Retriangulate in conjunction with horizontal interpolation.

### Display group

- **Terrain** Displays only the triangulated mesh over the contour line data.

- **Contours** Displays only the contour line data of the terrain object.
- **Both** Displays both the triangulated mesh and the contour line data of the terrain object. You can select the terrain object by clicking its surface, but not by clicking a contour line. When Both is selected, contour lines may not be apparent in Wireframe display modes or when Edged Faces are displayed.

### **Update group**

The items in this group box determine when 3ds Max recalculates the projection for the terrain object. Because complex terrain objects can slow performance, you can use these options to avoid constant calculation.

- **Always** Updates the terrain object immediately when you change an operand, including the original object of an instanced or referenced operand.
- **When Rendering** Updates the terrain object when you render the scene or when you click Update. With this option, viewports won't show current geometry unless you click Update.
- **Manually** Updates the terrain object when you click Update.

**Update** Updates the terrain object. This button is not enabled only when Always is the active option.



## Simplification rollout

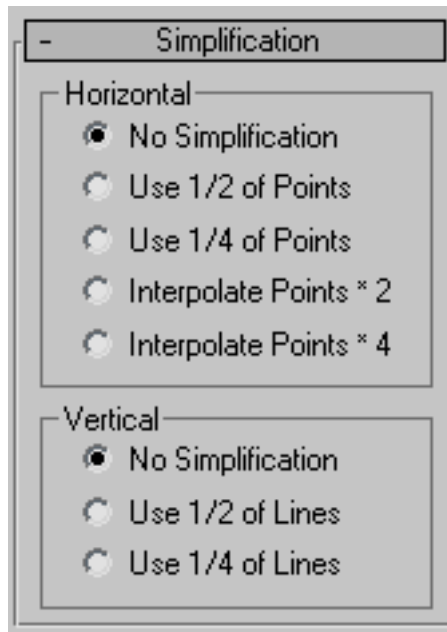

### Horizontal group

- **No Simplification** Uses all the operands' vertices to create a complex mesh. This results in greater detail and a larger file size than the two fractional options.
- **Use 1/2 of Points** Uses half the set of vertices in the operands to create a less complex mesh. This results in less detail and a smaller file size than using No Simplification.
- **Use 1/4 of Points** Uses a quarter of the of vertices in the operands to create a less complex mesh. This results in the least detail and smallest file size of these options.
- **Interpolate Points \* 2** Doubles the set of vertices in the operands to create a more refined but more complex mesh. This is most effective in terrain forms that use constructive curves such as circles and ellipses. This results in more detail and a larger file size than using No Simplification.
- **Interpolate Points \* 4** Quadruples the set of vertices in the operands to create a more refined but more complex mesh. This is most effective in

terrain forms that use constructive curves such as circles and ellipses. This results in more detail and a larger file size than using No Simplification.

### **Vertical group**

- **No Simplification** Uses all the spline operands vertices of the terrain object to create a complex mesh. This results in greater detail and a larger file size than the other two options.
- **Use 1/2 of Lines** Uses half the set of spline operands of the terrain object to create a less complex mesh. This results in less detail and a smaller file size than using No Simplification.
- **Use 1/4 of Lines** Uses a quarter of the of spline operands of the terrain object to create a less complex mesh. This results in the least detail and smallest file size of the three options.

## Color by Elevation rollout

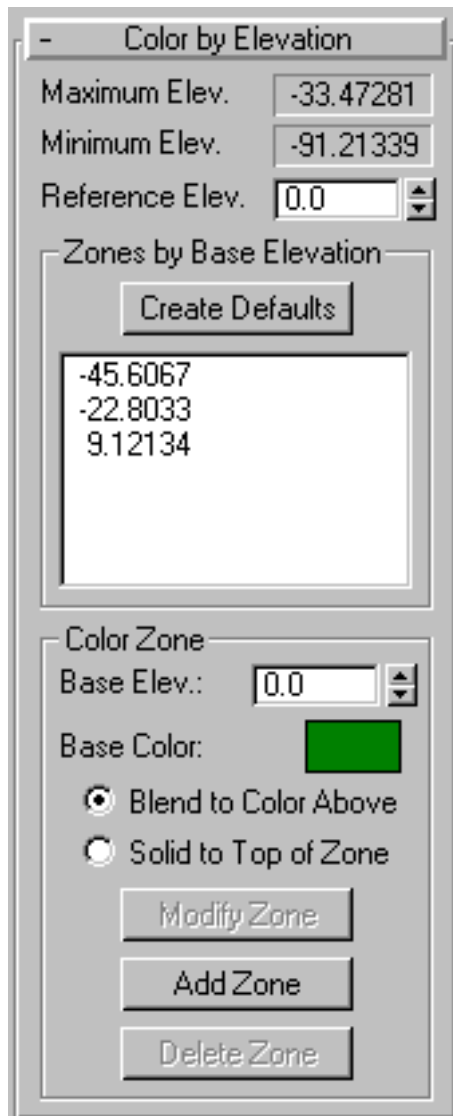

**Maximum Elev.** Displays the maximum elevation in the Z axis of the terrain object. 3ds Max derives this data from the contour data.

**Minimum Elev.** Displays the minimum elevation in the Z axis of the terrain object. 3ds Max derives this data from the contour data.

**Reference Elev.** This is the reference elevation, or datum, that 3ds Max uses as a guide for assigning colors to zones of elevation. After entering a reference elevation, click the Create Defaults button. 3ds Max treats elevations above the reference elevation as solid land and those below the reference elevation as water.

If you enter a value no greater than the minimum elevation in the object, 3ds Max divides the range between the reference and minimum elevations into five color zones: dark green, light green, yellow, purple, and light gray.

If you enter a value between the minimum and maximum elevations, 3ds Max creates six color zones. Two zones (dark blue and light blue) are used for elevations below the reference elevation. These are considered to be under water. One zone (dark yellow) is used for a narrow range around the reference elevation. Three zones (dark green, light green, light yellow) are used for elevations above the reference elevation.

If you enter a value at or above the maximum elevation, 3ds Max divides the range between the minimum and reference elevations into three zones (dark blue, medium blue, light blue).

### **Zones by Base Elevation group**

**Create Defaults** Creates elevation zones. 3ds Max lists the elevation at the bottom of each zone, referenced to the datum (the reference elevation). 3ds Max applies the color of the zone at the base elevation. Whether the colors blend between zones depends on your choice of the Blend to Color Above or Solid to Top of Zone option.

### **Color Zone group**

The items in this group box assign colors to elevation zones. For example, you might want to change levels of blue to indicate the depth for water. Your changes in the Color Zone area don't affect the terrain object until you click the Modify Zone or Add Zone button.

**Base Elev** This is the base elevation of a zone to which you assign color. After entering a value, click Add Zone to display the elevation in the list under Create Defaults.

**Base Color** Click the color swatch to change the color of the zone.

■ **Blend to Color Above** Blends the color of the current zone to the color of the zone above it.

- **Solid to Top of Zone** Makes a solid color at the top of the zone without blending to the color of the zone above it.

**Modify Zone** Modifies selected options of a zone.

**Add Zone** Adds values and selected options for a new zone.

**Delete Zone** Deletes a selected zone.

## Loft Compound Object

Select a path or shape. > Create panel > Geometry > Compound Objects > Object Type rollout > Loft

Select a path or shape. > Create menu > Compound Objects > Loft

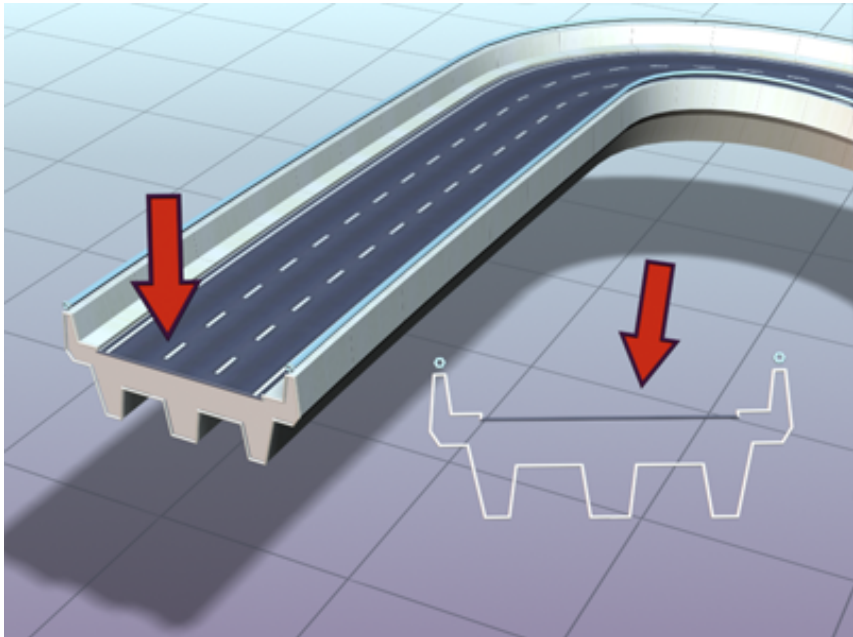

**Roadway created as a lofted shape**

Loft objects are two-dimensional shapes extruded along a third axis. You create loft objects from two or more existing spline objects. One of these splines serves the path. The remaining splines serve as cross-sections, or shapes, of

the loft object. As you arrange shapes along the path, 3ds Max generates a surface between the shapes.

You create shape objects to serve as a path for any number of cross-section shapes. The path becomes the framework that holds the cross sections forming your object. If you designate only one shape on the path, 3ds Max assumes an identical shape is located at each end of the path. The surface is then generated between the shapes.

3ds Max places few restrictions on how you create a loft object. You can create curved, three-dimensional paths and even three-dimensional cross sections.

When using Get Shape, as you move the cursor over an invalid shape, the reason the shape is invalid is displayed in the prompt line.

Unlike other compound objects, which are created from the selected object as soon as you click the compound-object button, a Loft object is not created until you click Get Shape or Get Path, and then select a shape or path.

Loft is enabled when the scene has one or more shapes. To create a loft object, first create one or more shapes and then click Loft. Click either Get Shape or Get Path and select a shape in the viewports.

Once you create a loft object, you can add and replace cross-section shapes or replace the path. You can also change or animate the parameters of the path and shapes.

You can't animate the path location of a shape.

You can convert loft objects to [NURBS surfaces](#) on page 2218 .

## **Procedures**

### **To create a loft object:**

Creating loft objects is detailed and offers many choices, but the basic process is quite simple.

- 1 Create a shape to be the loft path.
- 2 Create one or more shapes to be loft cross sections.
- 3 Do one of the following:
  - Select the path shape and use Get Shape to add the cross sections to the loft.
  - Select a shape and use Get Path to assign a path to the loft. Use Get Shape to add additional shapes.

You can use the loft display settings to view the skin generated by your loft in both wireframe and shaded views.

**To create a loft with Get Path:**

- 1 Select a shape as the first cross-section shape.
- 2 Click Create panel > Geometry > Compound Objects > Loft.
- 3 On the Creation Method rollout, click Get Path.
- 4 Choose Move, Copy, or Instance.
- 5 Click a shape for the path.

The cursor changes to the Get Path cursor as you move it over valid path shapes. If the cursor does not change over a shape, that shape is not a valid path shape and cannot be selected. The first vertex of the selected path is placed at the first shape's pivot and the path tangent is aligned with the shape's local Z axis.

**To create a loft with Get Shape:**

- 1 Select a valid path shape as the path.
- 2 If the selected shape is not a valid path, the Get Shape button is unavailable.
- 3 Click Create panel > Geometry > Compound Objects > Loft.
- 4 On the Creation Method rollout, click Get Shape.
- 5 Choose Move, Copy, or Instance.
- 6 Click a shape.

The cursor changes to the Get Shape cursor as you move it over potential shapes. The selected shape is placed at the first vertex of the path.

---

**TIP** You can flip the shape along the path by holding down Ctrl when using Get Shape. For example, if you select the lowercase letter "b" with a Ctrl+click, the loft will look like the letter "d".

---

**Interface**

You use the following rollouts for setting loft object parameters:

[Creation Method Rollout](#) on page 718

[Surface Parameters Rollout](#) on page 719

[Path Parameters Rollout](#) on page 724

[Skin Parameters Rollout](#) on page 727

Once you've created a loft object, you can also use the Modify panel's Deformations rollout to add complexity. See [Deformations](#) on page 744 for further information.

## Creation Method Rollout

Select a path or shape. > Create panel > Geometry > Compound Objects > Object Type rollout > Loft > Creation Method rollout

Select a path or shape. > Create menu > Compounds > Loft > Creation Method rollout

You can choose between a shape or a path for creating the loft object using the Creation Method rollout, as well as the type of action for the loft object.

### Interface



On the Creation Method rollout, you determine whether to use a shape or path for creating the loft object, and the type of action you want for the resulting loft object.

**Get Path** Assigns a path to the selected shape or changes the current assigned path.

**Get Shape** Assigns a shape to the selected path or changes the current assigned shape.

---

**TIP** Hold down Ctrl while getting the shape to flip the direction of the shape's Z axis.

---

**Move/Copy/Instance** Lets you specify how the path or shape is transferred to the loft object. It can be moved, in which case no copy is left behind, or transferred as a copy or an [instance](#) on page 7818 .



---

**TIP** Use the Instance option if you expect to edit or modify the path after the loft is created.

---

## Surface Parameters Rollout

Select a path or shape. > Create panel > Geometry > Compound Objects > Object Type rollout > Loft > Surface Parameters rollout

Select a path or shape. > Create menu > Compounds > Loft > Surface Parameters rollout

On the Surface Parameters rollout, you control smoothing of the surface of the loft as well as designate if texture mapping is applied along the loft object.

## Interface

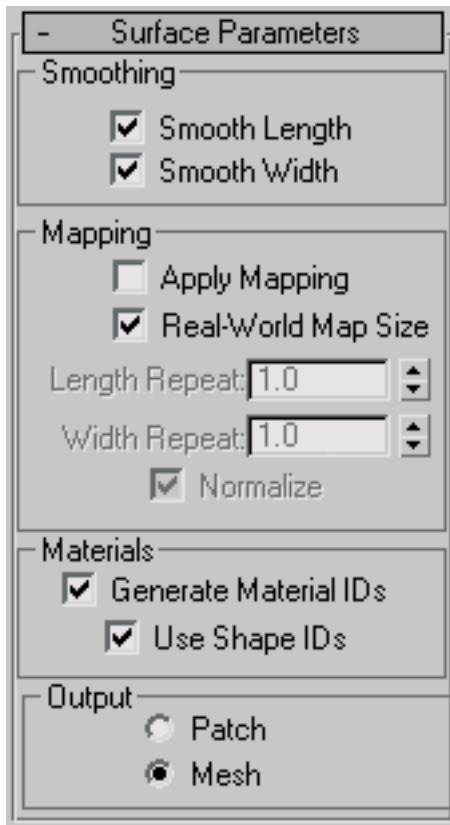

## Smoothing group

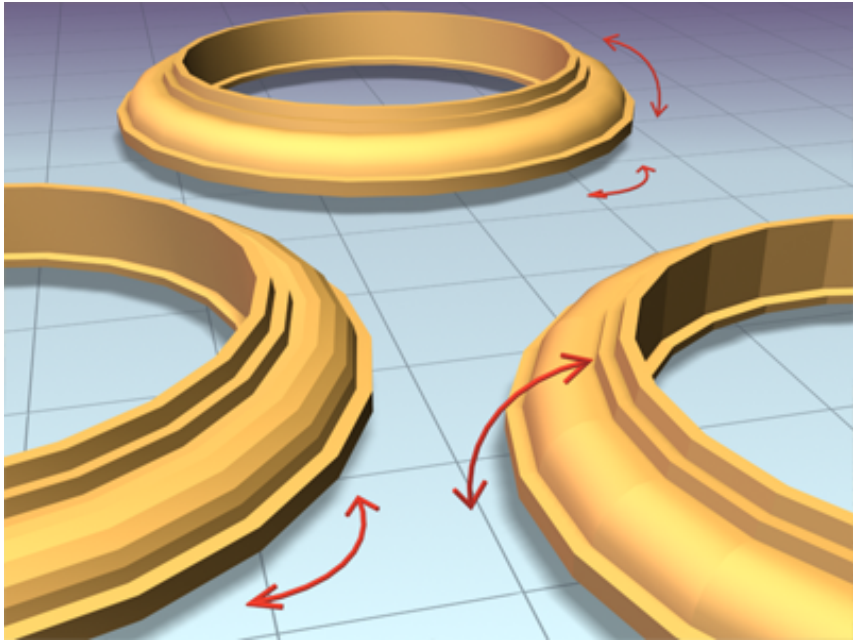

**Left: Smoothing the length**

**Right: Smoothing the width**

**Rear: Smoothing both length and width**

**Smooth Length** Provides a smooth surface along the length of the path. This type of smoothing is useful when your path curves or when shapes on the path change size. Default=on.

**Smooth Width** Provides a smooth surface around the perimeter of the cross-section shapes. This type of smoothing is useful when your shapes change the number of vertices or change form. Default=on.

## Mapping group

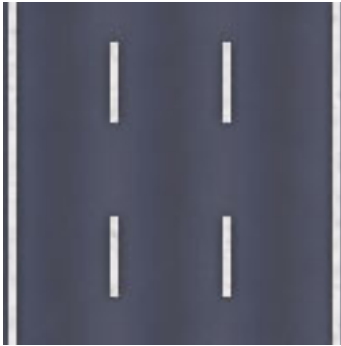

Bitmap used to create the lines on the road

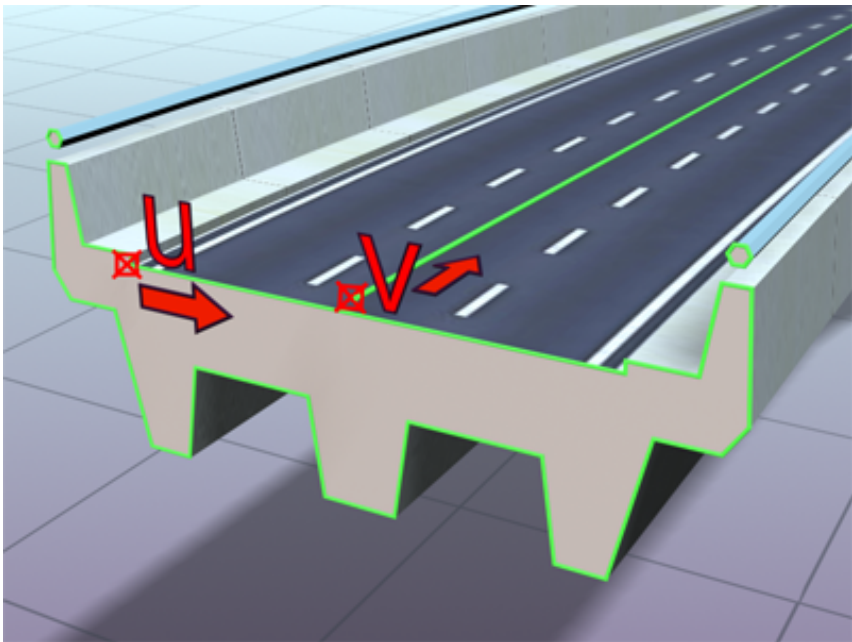

Mapped roadway showing U and V dimensions for the loft

**Apply Mapping** Turns lofted mapping coordinates on and off. Apply Mapping must be on in order to access the remaining items.

**Real-World Map Size** Controls the scaling method used for texture mapped materials that are applied to the object. The scaling values are controlled by

the Use Real-World Scale settings found in the applied material's [Coordinates rollout](#) on page 5620 . Default=off.

**Length Repeat** Sets the number of times a map repeats along the length of the path. The bottom of the map is placed at the first vertex of the path.

**Width Repeat** Sets the number of times a map repeats around the perimeter of cross-section shapes. The left edge of a map is aligned with the first vertex of each shape.

**Normalize** Determines how path vertex spacing affects a map along both the path length and shape width. When on, vertices are ignored. Map coordinates and Repeat values are applied evenly along the length of the path and around the shapes. When off, major path divisions and shape vertex spacing affects map coordinate spacing. Map coordinates and Repeat values are applied proportionally according to the path division spacing or shape vertex spacing.



Before and after applying Normalize to loft

### Materials group

**Generate Material IDs** Creates Material IDs during the loft process.

**Use Shape IDs** Offers the choice of using the spline material IDs to define the material IDs.

---

**NOTE** Prior to version 3 of 3ds Max, splines could not hold material IDs.

---

---

**NOTE** Shape IDs are inherited from shape cross sections, not from the path spline.

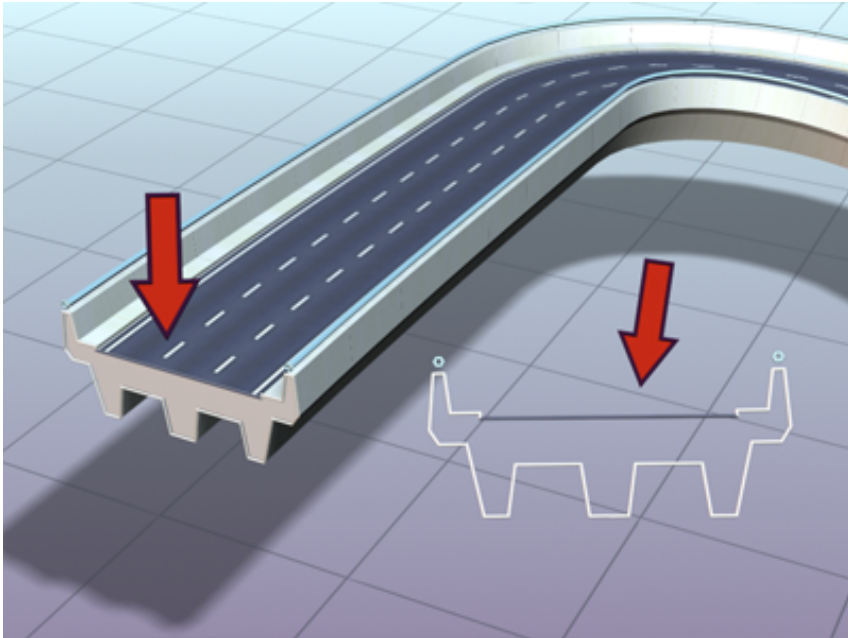

Shape material IDs used to give the roadway two materials: concrete for supports and railings, asphalt with white lines for the traffic lanes

---

### **Output Group**

**Patch** The lofting process produces a patch object.

**Mesh** The lofting process produces a mesh object. This is the default, and was the only output type available with Loft in versions prior to version 3 of 3ds Max.

You can also create NURBS objects from lofting by choosing Convert To: NURBS from the [modifier stack right-click menu](#) on page 7440 .

### **Path Parameters Rollout**

Select a path or shape. > Create panel > Geometry > Compound Objects > Object Type rollout > Loft > Path Parameters rollout

Select a path or shape. > Create menu > Compounds > Loft > Path Parameters rollout

The Path Parameters rollout lets you control the position of shapes at various intervals along the path of the loft object.

### Interface

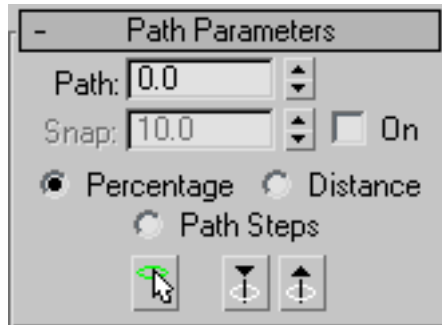

On the Path Parameters rollout, you control the position of multiple shapes at different intervals along the path of the loft object.

**Path** Lets you set a path level by entering a value or dragging the spinner. If Snap is on, the value will jump to the previous snap increment. The Path value depends on the selected measuring method. Changing the measuring method causes the Path value to change.

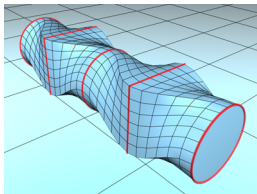

### Inserting different shapes at different positions on the path

**Snap** Lets you set a consistent distance between shapes along the path. The Snap value depends on the selected measuring method. Changing the measuring method also changes the Snap value to keep snap spacing constant.

**On** When On is turned on, Snap is active. Default=off.

**Percentage** Expresses the path level as a percentage of the total path length.

**Distance** Expresses the path level as an absolute distance from the first vertex of the path.

**Path Steps** Places shapes on path steps and vertices, rather than as a percentage or a distance along the path.

When Path Steps is on, the following take place:

- The Path spinner specifies the step along the path. The first step, at 0, is the first vertex.
- The total number of steps, including vertices, appears in parentheses beside the Path spinner.
- The current path level is indicated by the standard yellow X when it's a step, and by a small boxed X when it's a vertex.
- Get Shape places a selected shape on the specified step or a vertex of the path.
- Adaptive Path Steps on the Skin Parameters rollout is unavailable. (If it were available, the path steps and shapes would change positions along the path, depending on the result of the adaptive algorithm.)

Please note the following when using the Path Steps option:

- When you switch to Path Steps with a loft object that already contains one or more shapes, an alert message tells you that this action may relocate shapes. This is because there are a limited number of path steps, and only one shape can be on a single step or vertex. The Percentage and Distance options, on the other hand, provide an almost unlimited number of levels on which to place shapes. Thus, if you change from Percentage or Distance to Path Steps, the shapes must be moved to existing steps. If there are more shapes than can be moved to nearby steps, you could end up with more than one shape on a step. Switching from Path Steps to either Percentage or Distance, however, can always be done without loss of data.
- If you alter the Path Steps spinner while in Path Steps mode, the location of your shapes might change. An alert message warns you of this.
- If you animate the topology of the path while in Path Steps mode (such as animating the number of sides of an NGon), your shapes might jump around trying to find a legitimate position, and you could end up with more than one shape on the same path level.

**Pick Shape** Sets the current level at any shape on the path. When you pick a shape on the path, Snap is turned off and Path is set to the level of the picked shape, where a yellow X appears. Pick Shape is available only from the Modify panel.



**Previous Shape** Jumps the path level from its current location to the previous shape along the path. A yellow X appears at the current level. Clicking this button turns Snap off.

**Next Shape** Jumps the path level from its current location to the next shape along the path. A yellow X appears at the current level. Clicking this button turns Snap off.

## Skin Parameters Rollout

Select a path or shape. > Create panel > Geometry > Compound Objects > Object Type rollout > Loft > Skin Parameters rollout

Select a path or shape. > Create menu > Compounds > Loft > Skin Parameters rollout

On the Skin Parameters rollout, you adjust the complexity of the mesh of the loft object. You can also optimize the mesh by controlling the face count.

### Procedures

**Example: To use a constant cross-section:**

- 1 Enlarge the Front viewport to full screen, and then draw a [Rectangle object](#) on page 555 with Ctrl held down to create a square about 20 x 20 units.
- 2 Create another rectangle beside it about 200 x 100 units.
- 3 Apply a Skew modifier to the large rectangle, but don't alter the Skew parameters.
- 4 Create a loft object in which the larger rectangle is the path and the square is the shape.
- 5 On the Modify panel, open the Skin Parameters rollout, and make sure Skin is on in the Display group.  
You can now see the wireframe structure of the lofted rectangle, with cross-sectional sides parallel to its corners.  
Make sure the color assigned the loft object is easily visible. Change it if necessary.
- 6 Turn off Constant Cross-Section, and observe the corners.  
When Constant Cross-Section is off, the corners become pinched.

- 7 Turn on Constant Cross-Section to restore the corners.  
Acute angles can cause problems when the cross sections formed by the path steps intersect at the corners. You can mitigate this by avoiding acute angles or by reducing the path steps.
- 8 Press H on the keyboard to open the [Select From Scene dialog](#) on page 168 , and select *Rectangle02* (the second larger rectangle).
- 9 On the Modify panel, change the Skew Axis to **Y**, and then set the Amount spinner to **95**.
- 10 Use Zoom Region to zoom in on the upper-right corner of the rectangle so you can see the mesh in detail.  
At a skew of less than 100, the acute angle still works because the path cross-sections haven't intersected.
- 11 Set the Skew Amount to **300**, and examine the same corner.  
At this angle, the path cross sections intersect, causing problems in the mesh.
- 12 Select the loft object, and set Path Steps to **1**.  
The cross sections no longer intersect, and the corner is clean.  
When creating straight-edge molding for architectural modeling, you can avoid mangled corners simply by reducing the path steps to 0.

## Interface

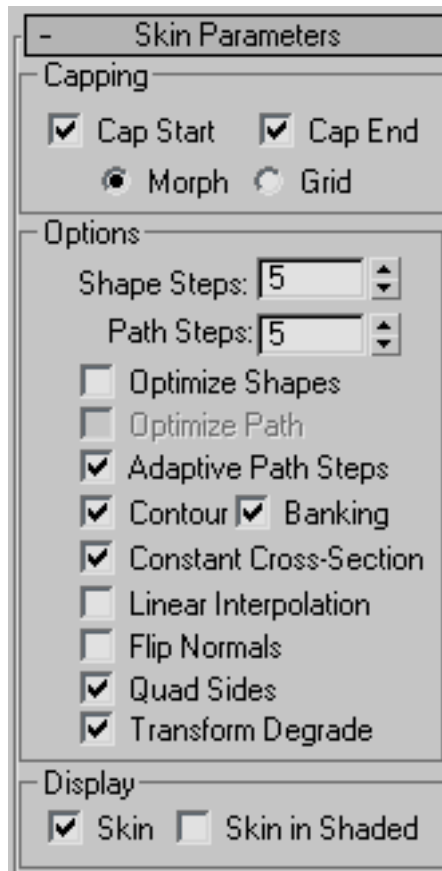

### Capping group

**Cap Start** When on, the end of a loft at the first vertex of the path is covered, or capped. When off, the end is open, or uncapped. Default=on.

**Cap End** When on, the end of a loft at the last vertex of the path is covered, or capped. When off, the end is open, or uncapped. Default=on.

**Morph** Arranges cap faces in a predictable, repeatable pattern necessary for creating morph targets. Morph capping can generate long, thin faces that do not render or deform as well as those created with grid capping.

**Grid** Arranges cap faces in a rectangular grid trimmed at the shape boundaries. This method produces a surface of evenly sized faces that can be deformed easily by other modifiers.

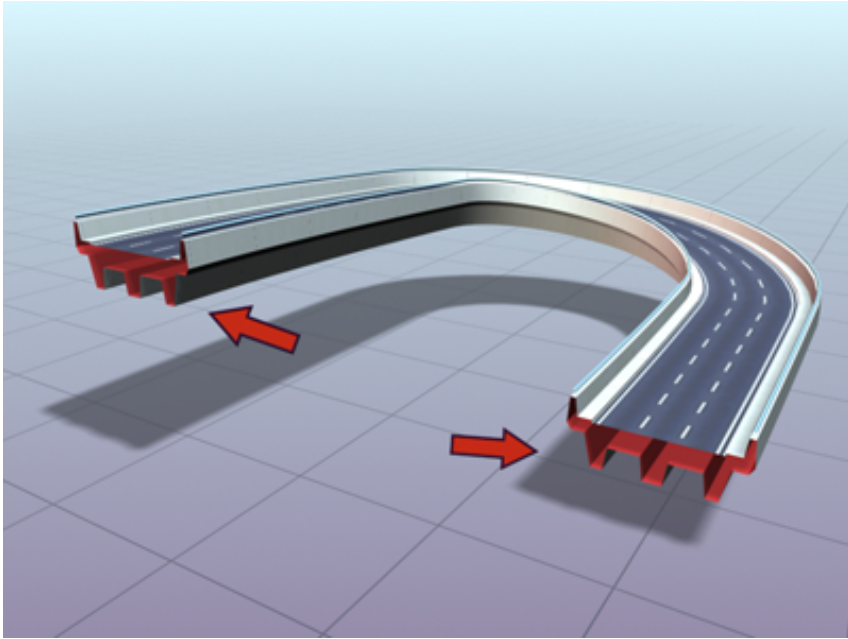

Roadway lofted with capping turned off

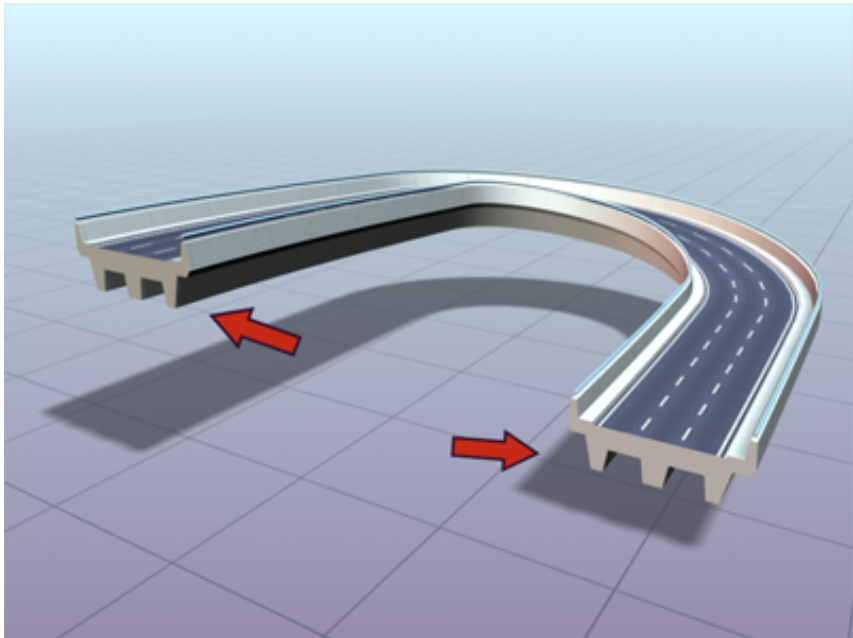

Roadway lofted with capping turned on

### Options group

**Shape Steps** Sets the number of steps between each vertex of the cross-section shapes. This value affects the number of sides around the perimeter of the loft.

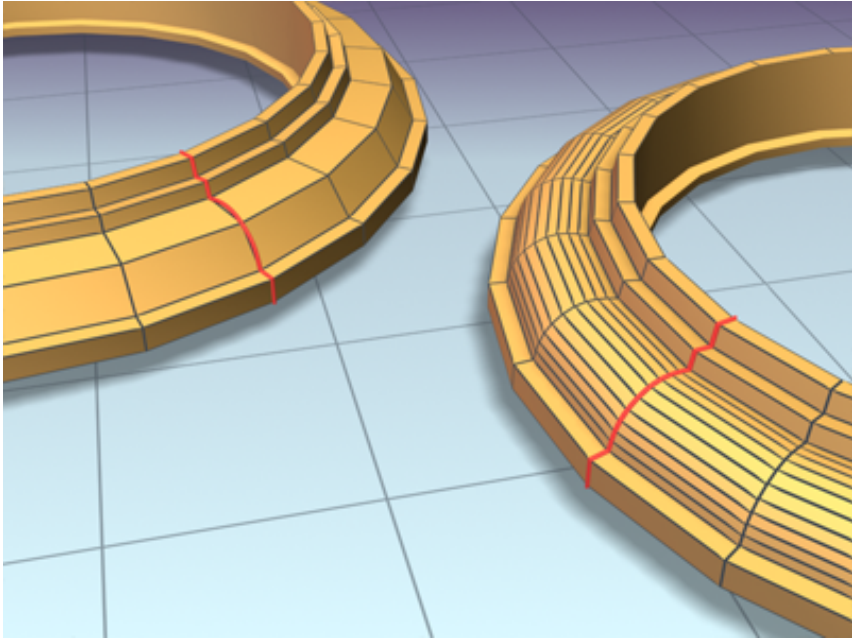

**Left: Shape Steps=0.**

**Right: Shape Steps=4.**

**Path Steps** Sets the number of steps between each main division of the path. This value affects the number of segments along the length of the loft.

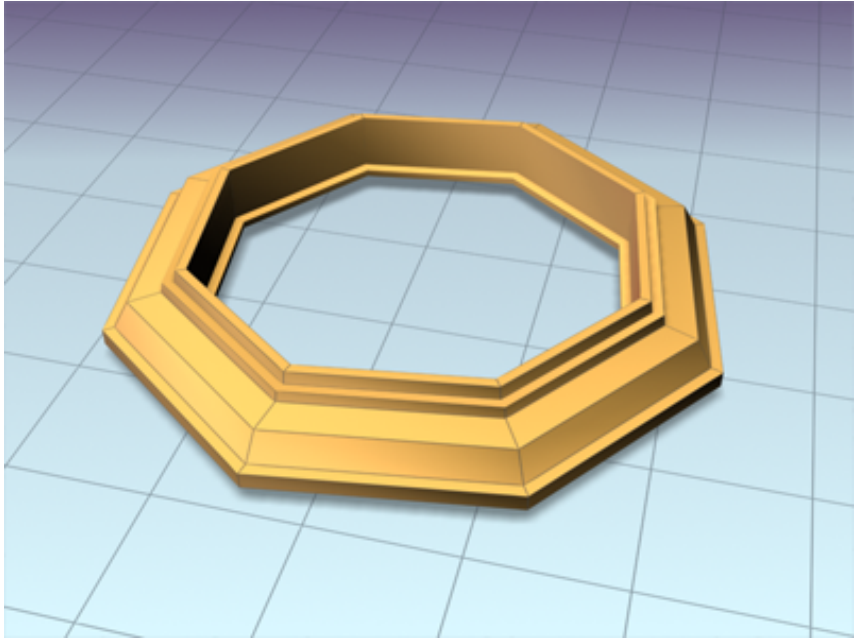

Frame lofted with Path Steps=1

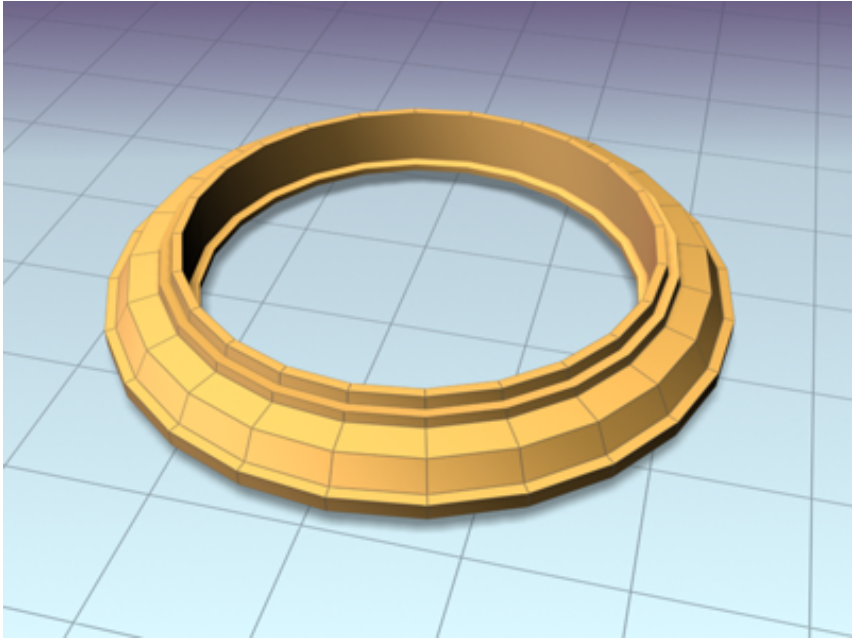

Frame lofted with Path Steps=5

**Optimize Shapes** When on, the Shape Steps setting is ignored for straight segments of cross-section shapes. If multiple shapes are on the path, only straight segments that have a match on all shapes are optimized. Default=off.



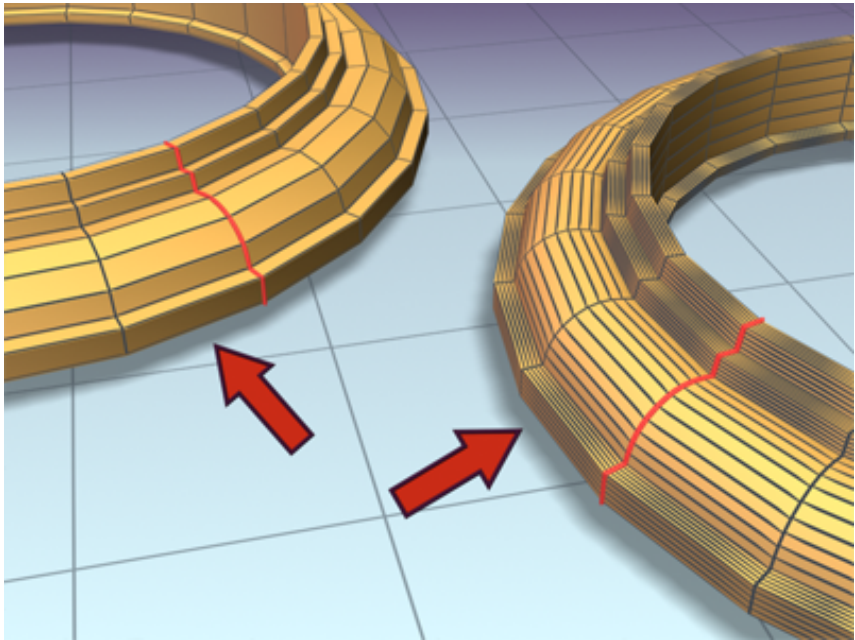

**Left: Optimize Shapes turned on**

**Right: Optimize Shapes turned off**

**Optimize Path** When on, the Path Steps setting is ignored for straight segments of the path. Curved sections respect the Path steps setting. Available only with Path Steps mode. Default=off.

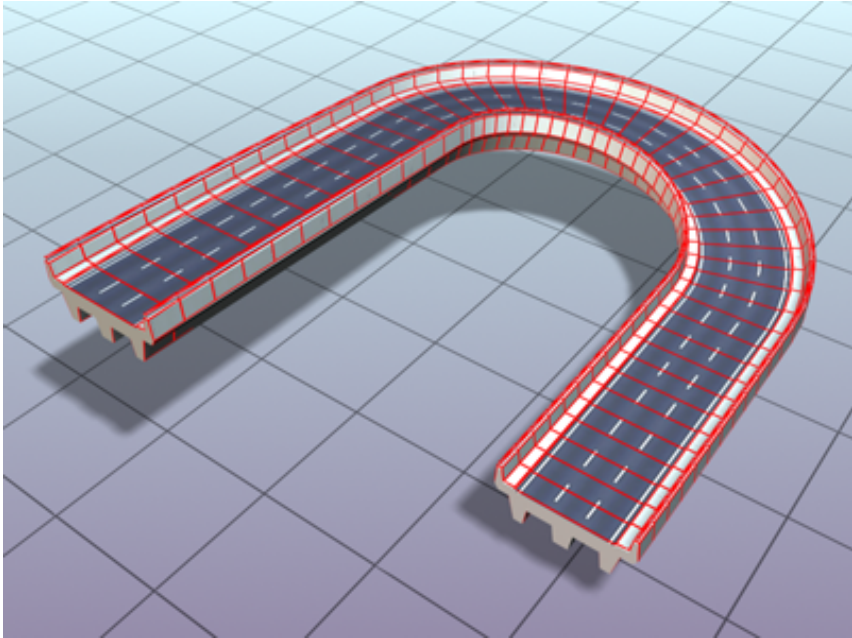

When Optimize Path is off, the lofted roadway uses more steps.

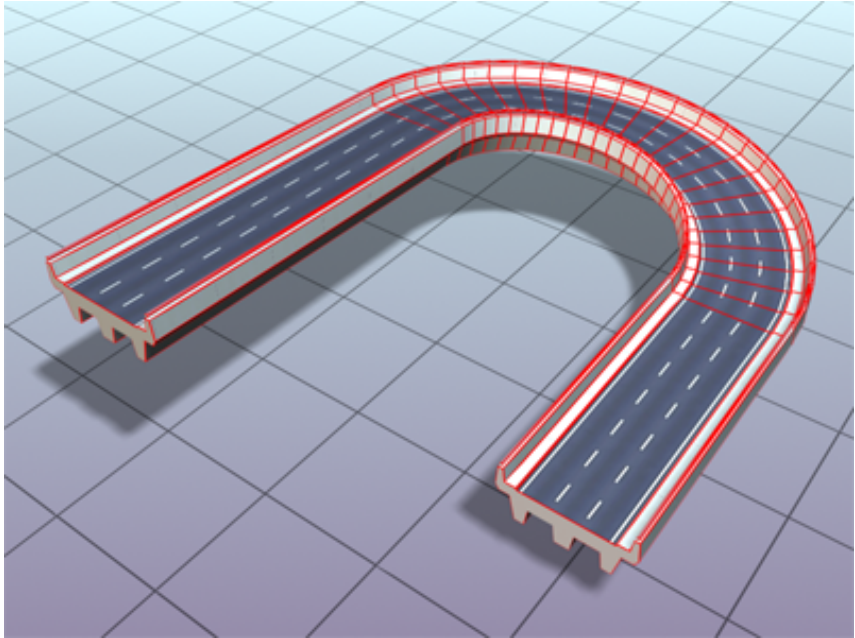

**When Optimize Path is on, straight sections of the lofted roadway don't require additional steps.**

**Adaptive Path Steps** When on, analyzes the loft and adapts the number of path divisions to generate the best skin. Main divisions along the path occur at path vertices, shape locations, and deformation curve vertices. When off, main divisions along the path occur only at path vertices. Default=on.

**Contour** When on, each shape follows the curvature of the path. The positive Z axis of each shape is aligned with the tangent to the path at the shape's level. When off, shapes remain parallel and have the same orientation as a shape placed at level 0. Default=on.

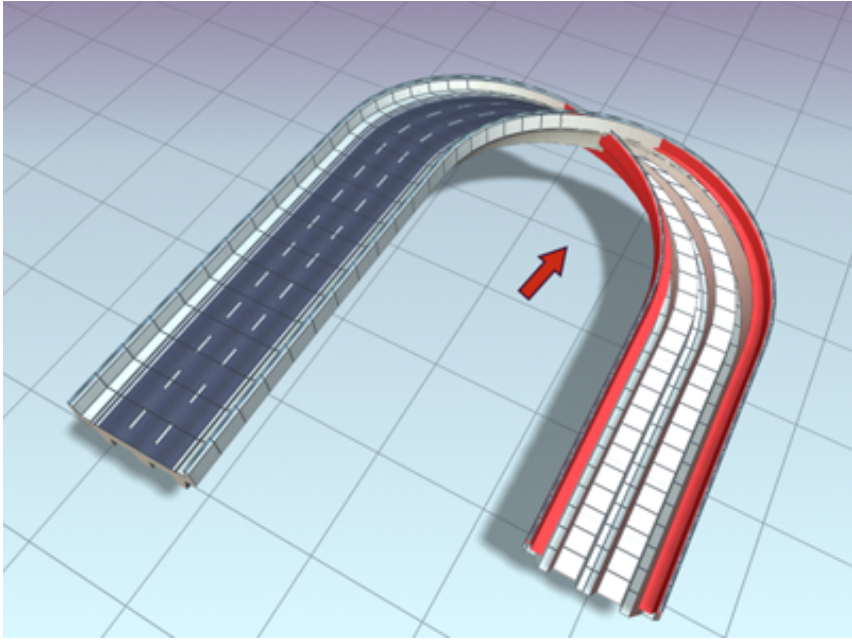

Lofting the roadway with Contour off causes it to twist.

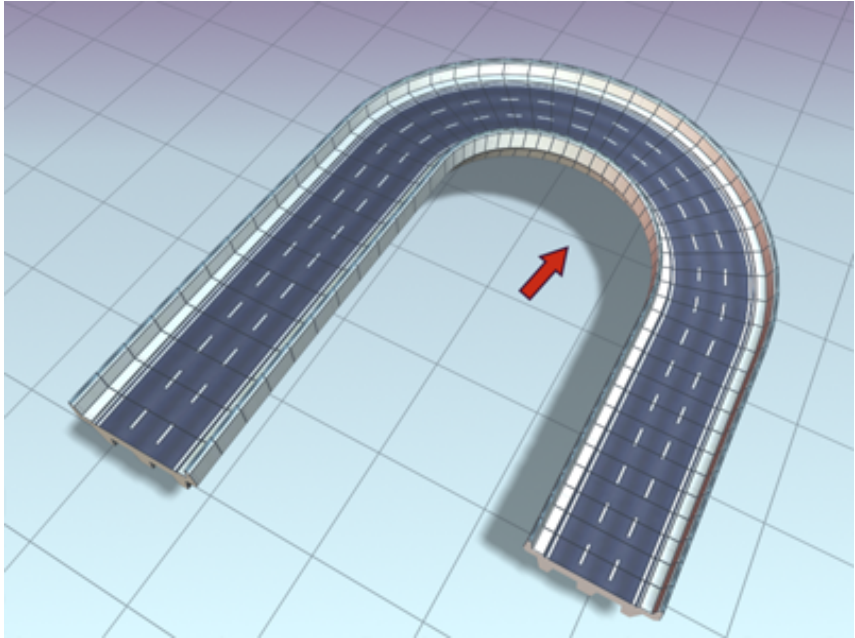

**Roadway lofted with Contour turned on**

**Banking** When on, shapes rotate about the path whenever the path bends and changes height in the path's local Z axis. The bank amount is controlled by 3ds Max. Banking is ignored if the path is 2D. When off, shapes do not rotate about their Z axis as they traverse a 3D path. Default=on.

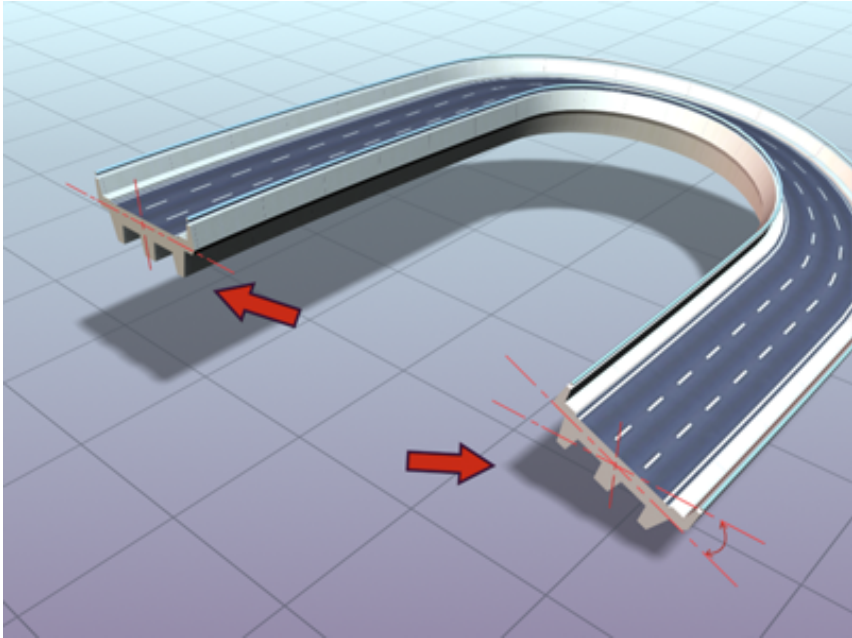

**Roadway lofted with Banking turned on**

**Constant Cross Section** When on, the cross sections are scaled at angles in the path to maintain uniform path width. When off, the cross sections maintain their original local dimensions, causing pinching at path angles.

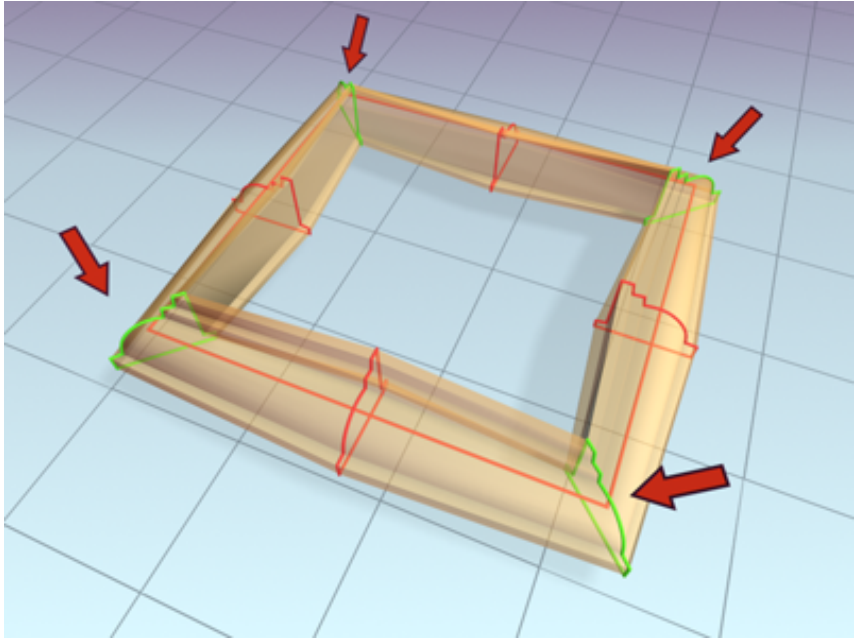

Frame lofted with Constant Cross Section turned off

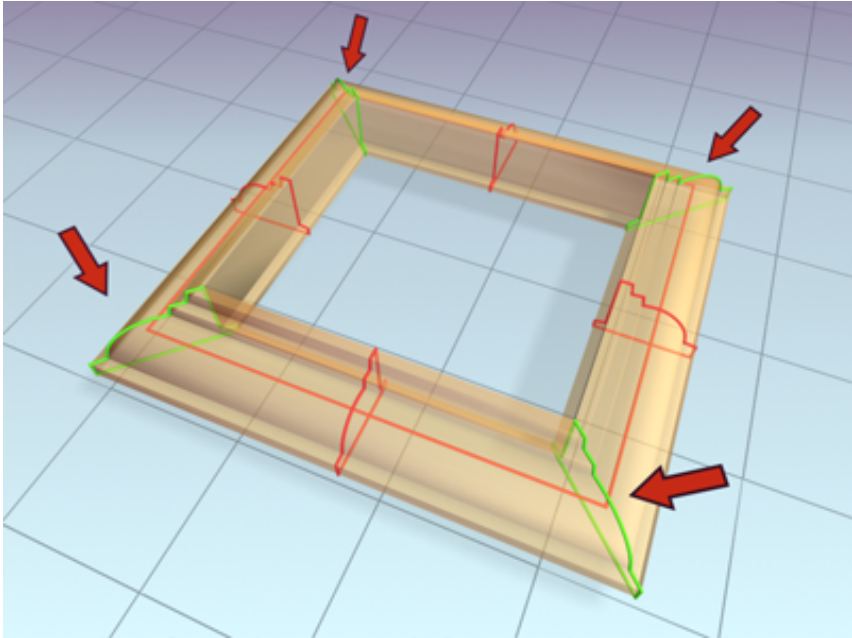

Frame lofted with Constant Cross Section turned on

**Linear Interpolation** When on, generates a loft skin with straight edges between each shape. When off, generates a loft skin with smooth curves between each shape. Default=off.



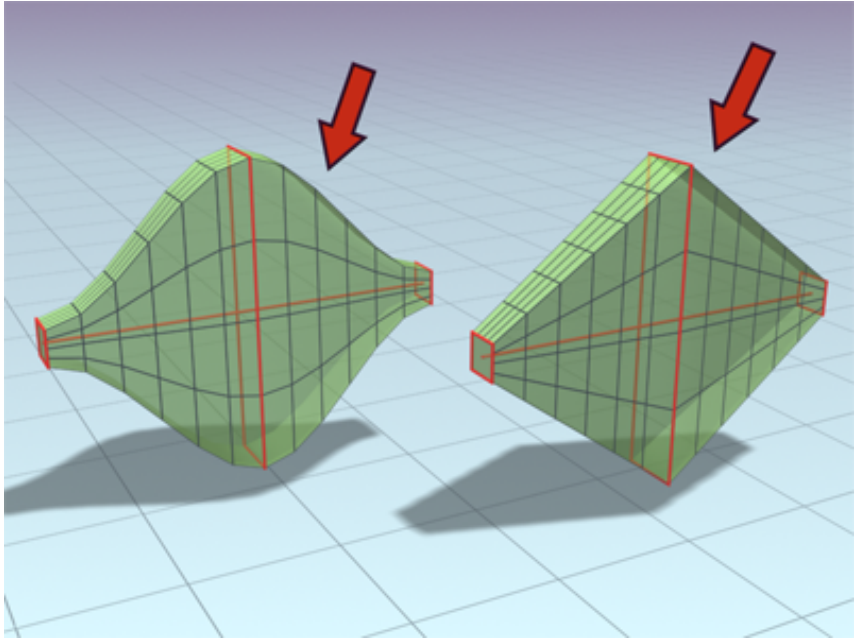

**Left:** Object lofted with Linear Interpolation turned off

**Right:** Object lofted with Linear Interpolation turned on

**Flip Normals** When on, reverses the normals 180 degrees. Use this option to correct objects that are inside-out. Default=off.

**Quad sides** When on, and when two sections of a loft object have the same number of sides, the faces that stitch the sections together are displayed as quads. Sides between sections with different numbers of sides are not affected, and are still connected with triangles. Default=off.

**Transform Degrade** Causes the loft skin to disappear during sub-object shape/path transformations. For example, moving a vertex on the path causes the loft to disappear. When off, you can see the skin during these Sub-Object transformations. Default=off.

### **Display group**

**Skin** When on, displays a loft's skin in all views using any shading level and ignores the Skin In Shaded setting. When off, displays only the loft sub-objects. Default=on.

**Skin in Shaded** When on, displays a loft's skin in shaded views regardless of the Skin setting. When off, skin display is controlled by the Skin setting. Default=on.

The loft object now retains the Skin and Skin In Shaded settings from one loft object to the next one created.

## Deformations

Select a Loft object. > Modify panel > Deformations rollout

Deformation controls let you scale, twist, teeter, bevel or fit shapes along the path. The interface for all deformations is a graph. Lines with control points on the graph represent the deformations along the path. Control points on the graphs can be moved or animated for modeling purposes or for various special effects.

Manually creating and placing shapes along the path to produce these models would be a difficult task. Lofts solve this problem through the use of deformation curves. The deformation curves define changes in scale, twisting, teetering, and beveling along the path.

You gain access to loft deformation curves through the Modify panel's Deformations rollout. Deformations are not available in the Create panel. You must open the Modify panel after you've lofted to access the Deformations rollout, which offers the following features:

- Each deformation button displays its own deformation dialog.
- You can display any or all of the deformation dialogs simultaneously.
- The button to the right of each deformation button is a toggle to enable or disable the deformation's effect.

**See also:**

- [Deformation Dialog](#) on page 756

### Procedures

**To apply deformations to a loft:**

- 1 Select a loft object.

- 2 Go to the Modify panel and choose Loft from the modifier stack display if it's not already displayed.
- 3 Expand the Deformations rollout.
- 4 Click the deformation that you want to use.  
The window for the selected deformation appears.

**To toggle the deformation effect:**

- Click Enable/Disable to the right of the deformation buttons.

### Interface

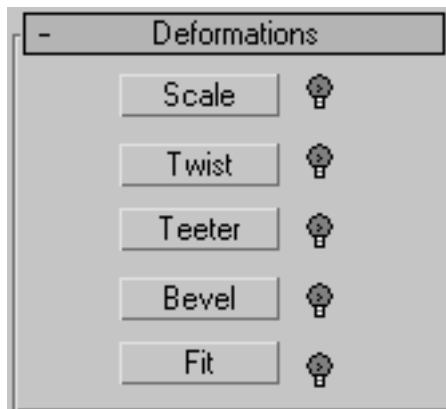

[Deform Scale](#) on page 745

[Deform Twist](#) on page 747

[Deform Teeter](#) on page 749

[Deform Bevel](#) on page 752

[Deform Fit](#) on page 754

## Deform Scale

Select a Loft object. > Modify panel > Deformations rollout > Scale

You can loft objects such as columns and bugles from a single shape that changes only its scale as it travels along a path. Use Scale deformation when you want to make these types of objects.

---

**TIP** By animating scale, a loft object can appear to travel along a path. Using this technique, you can create animations in which letters or lines write themselves onto the screen.

---

These are the properties of Scale deformation curves:

- The two curves are red for X-axis scaling and green for Y-axis scaling.
- Default curve values are at 100%.
- Values greater than 100% make the shape larger.
- Values between 100% and 0% make the shape smaller.
- Negative values scale and mirror the shape.

See [Deformation Dialog](#) on page 756 for specific information on the dialog controls.

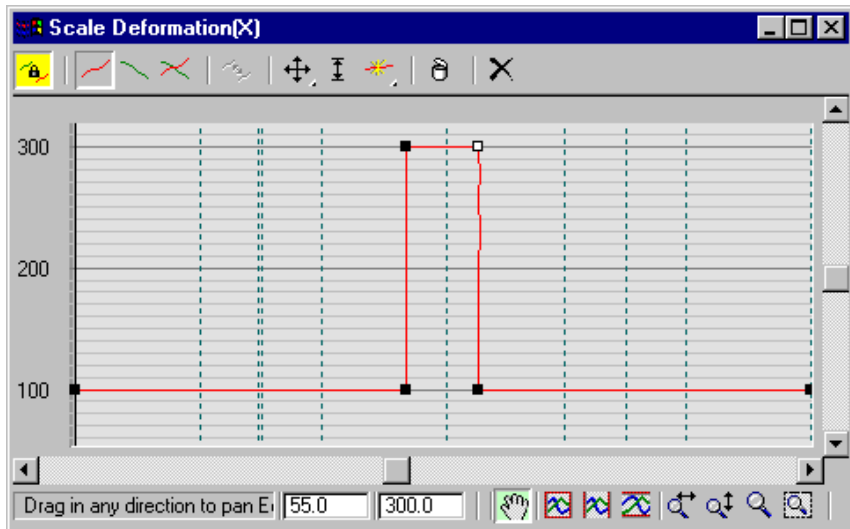

Scale deformation curve dialog

## Procedures

To use Scale deformation:

- 1 Select a loft object.
- 2 Click Loft in the modifier stack display.
- 3 Click Scale on the Deformations rollout.
- 4 Edit the deformation curves for the X axis and Y axis.

## Deform Twist

Select a Loft object. > Modify panel > Deformations rollout > Twist

Twist deformation lets you create objects that spiral or twist along their length. Twist specifies the amount of rotation about the path.

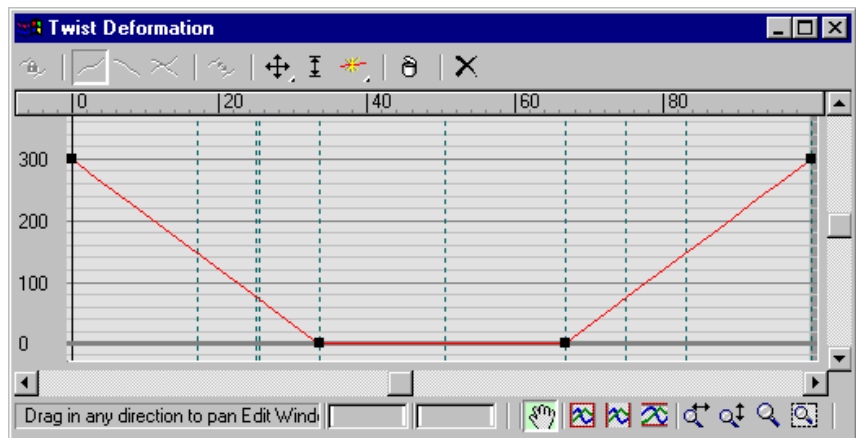

Twist deformation curve dialog

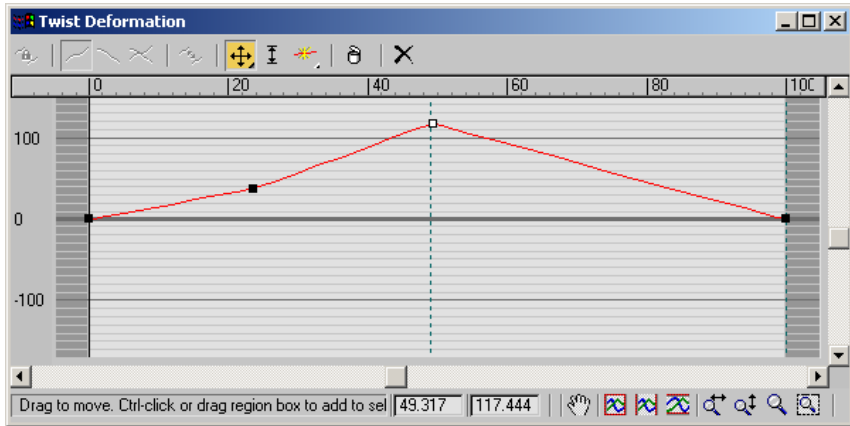

### Using twist to deform the lofted roadway

These are the properties of Twist deformation curves:

- A single red curve determines shape rotation about the path.
- The default curve value is 0 degrees of rotation.
- Positive values produce counterclockwise rotation, when viewed from the start of the path.
- Negative values produce clockwise rotation.
- Both twist deformation and banking produce rotation about the path. Twist rotation is added to a shape after the banking angle is applied. You can use Twist deformation to exaggerate or reduce the amount of banking.

See [Deformation Dialog](#) on page 756 for specific information on the dialog controls.

### Procedures

#### To use Twist deformation:

- 1 Select a loft object.
- 2 Click Loft in the modifier stack display.
- 3 Click Twist on the Deformations rollout.
- 4 Edit the single deformation curve to specify rotation about the path.

## Deform Teeter

Select a Loft object. > Modify panel > Deformations rollout > Teeter

Teeter deformation rotates shapes about their local X axis and Y axis. Teetering is what 3ds Max does automatically when you select Contour on the Skin Parameters rollout. Use Teeter deformation when you want to manually control contour effects.

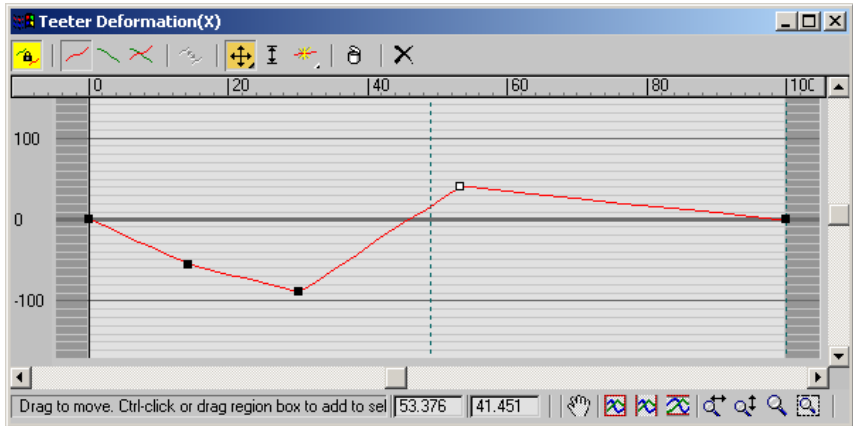

Teeter deformation curve dialog

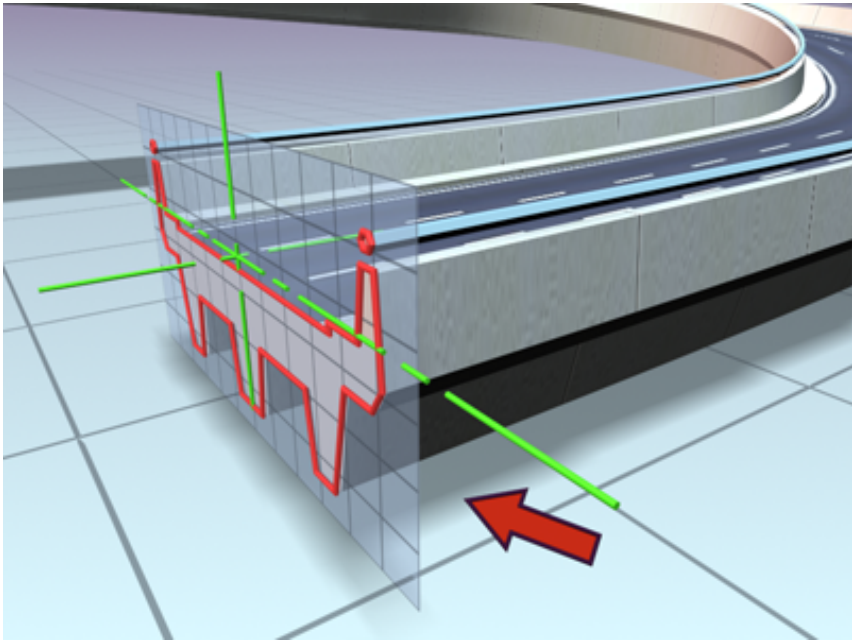

Roadway lofted with no teeter



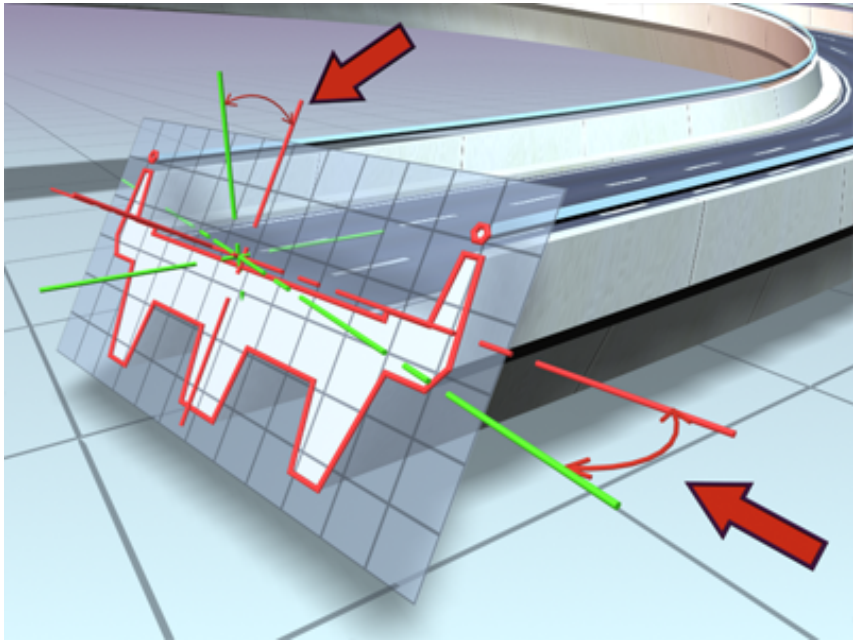

Roadway lofted with teeter turned on. Teeter affects the X and Y axis orientation of the shape in relation to the path.

These are the properties of Teeter deformation curves:

- The two curves are red for X-axis rotation and green for Y-axis rotation.
- Default curve values are at 0 degrees rotation.
- Positive values rotate the shape counterclockwise about the shape's positive axis.
- Negative values rotate the shape clockwise about the shape's positive axis.

See [Deformation Dialog](#) on page 756 for specific information on the dialog controls.

### Procedures

To use Teeter deformation:

- 1 Select a loft object.
- 2 Click Loft in the modifier stack display.

- 3 Click Teeter on the Deformations rollout.
- 4 Edit the deformation curves for X axis and Y axis rotation.

## Deform Bevel

Select a Loft object. > Modify panel > Deformations rollout > Bevel

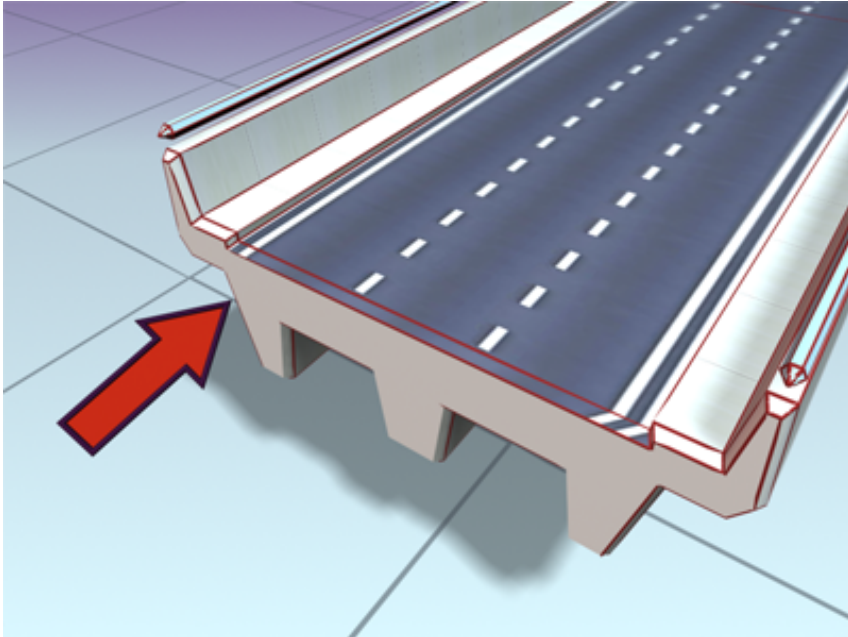

Roadway with beveled edges

Nearly every object that you encounter in the real world is beveled. Because it is difficult and expensive to manufacture a perfectly sharp edge, most objects are created with chamfered, filleted, or eased edges. Use Bevel deformation to simulate these effects.

---

**NOTE** Bevel is not available when loft output is set to Patch.

---

These are the properties of Bevel deformation curves:

- The single red curve is for bevel amount.
- Bevel values are specified in current units.

- The default curve value is 0 units.
- Positive values reduce the shape, bringing it closer to the path.
- Negative values add to the shape, moving it away from the path.

When shapes are nested, the bevel direction is reversed for interior shapes.

See [Deformation Dialog](#) on page 756 for specific information on the dialog controls.

## **Normal and Adaptive Beveling**

The Bevel Deformation dialog provides three types of beveling: Normal, Adaptive Linear, and Adaptive Cubic. These are available from a flyout at the right end of the dialog toolbar.

With normal beveling, the beveled shape remains parallel to the original, regardless of the crotch angle of the shape. Steep crotch angles combined with excessive bevel amounts result in overshooting at the crotch.

Adaptive beveling alters the length of the bevel shape based on the crotch angle. Adaptive Linear alters the length-to-angle in a linear fashion. Adaptive Cubic alters it more on steep angles than on shallow angles, producing a subtly different effect. Both forms of adaptive beveling result in nonparallel beveled edges, and both are less likely to produce invalid bevels due to overshoots at the crotch.

To see the differences in the three types of beveling, loft a star shape along a straight path and apply a bevel. When you switch among the three types of beveling, you'll see the difference in the bevel outline. Alter one radius of the star to examine the beveling with shallow and with sharp crotch angles.

## **Procedures**

### **To use Bevel deformation:**

- 1 Select a loft object.
- 2 Click Loft in the modifier stack display.
- 3 Click Bevel on the Deformations rollout.
- 4 Adjust the deformation curve.

## Deform Fit

Select a Loft object. > Modify panel > Deformations rollout > Fit

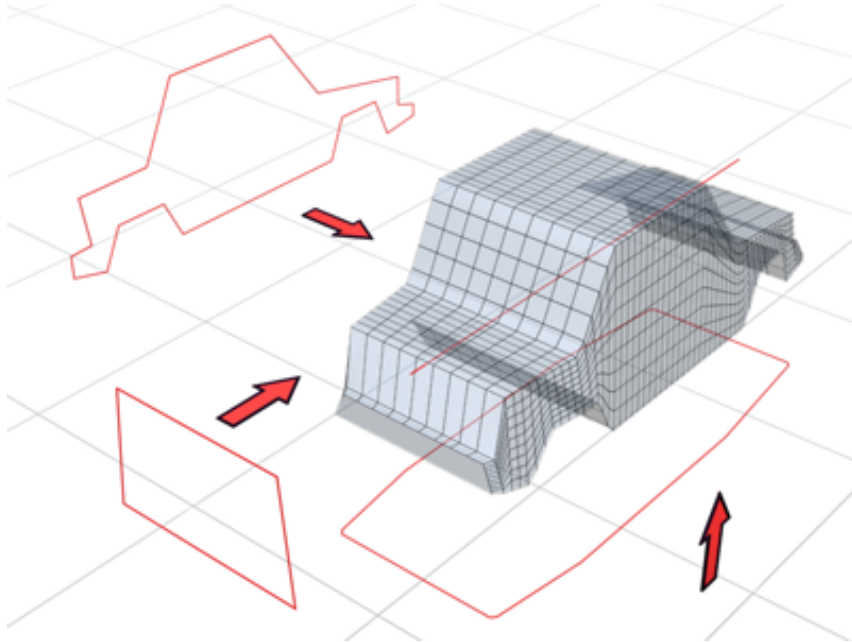

**Fit curves define a lofted shape.**

Fit deformation lets you use two Fit curves to define the top and side profiles of your object. Use Fit deformation when you want to generate loft objects by drawing their profiles.

Fit shapes are really scale boundaries. As your cross-section shape travels along the path, its X axis is scaled to fit the boundaries of the X-axis fit shape and its Y axis is scaled to fit the boundaries of the Y-axis fit shape.

---

**NOTE** Fit is not available when loft output is set to Patch.

---

### Procedures

**To use Fit deformation:**

- 1 Select a loft object.
- 2 Click Loft in the modifier stack display.

- 3 Click Fit on the Deformations rollout.
- 4 Select shapes in the viewport to use as fit curves.

## Interface

### Fit Deformation dialog

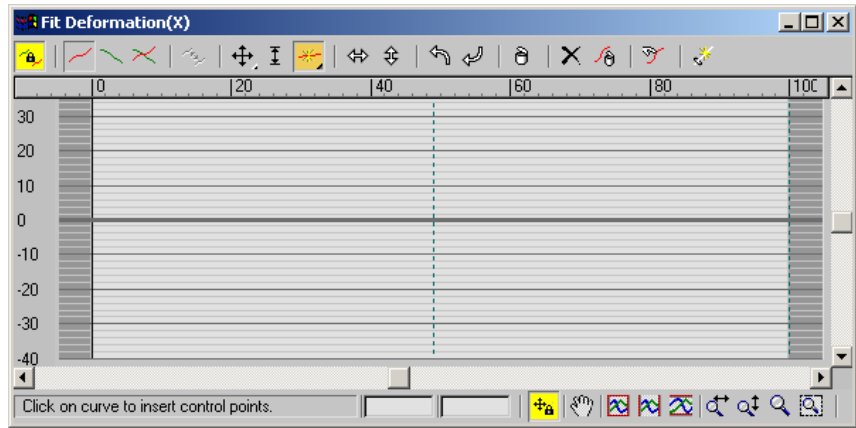

The Fit Deformation dialog contains different buttons than the other deformations. For descriptions of the first eight buttons on the toolbar, see [Deformation Dialog](#) on page 756 . The following descriptions apply to the tools specific to Fit deformation, and are listed from left to right in the order they appear on the toolbar.

### Fit Deformation toolbar

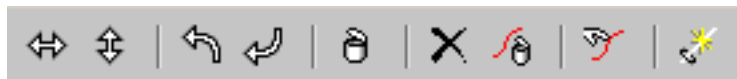

**Mirror Horizontally** Mirrors the shape across the horizontal axis.

**Mirror Vertically** Mirrors the shape across the vertical axis.

**Rotate 90 CCW** Rotates the shape 90 degrees counterclockwise.

**Rotate 90 CW** Rotates the shape 90 degrees clockwise.

**Delete Control Point** Deletes the selected control point.

**Reset Curve** Replaces the displayed Fit curve with a rectangle 100 units wide and centered on the path. If Make Symmetrical is on, both Fit curves are reset even though only one might be displayed.

**Delete Curve** Deletes the displayed Fit curve. If Make Symmetrical is on, both Fit curves are deleted even though only one might be displayed.

**Get Shape** Lets you select the shape to use for Fit deformation. Click Get Shape, and then click the shape to use in a viewport.

**Generate Path** Replaces the original path with a new straight-line path.

## Deformation Dialog

Select a Loft object. > Modify panel > Deformations rollout > Scale, Twist, Teeter, Bevel, or Fit

The Deformation dialogs for Scale, Twist, Teeter, Bevel, and Fit use the same basic layout. The buttons in the window's toolbar and prompt area perform the following functions:

- Change deformation curve display.
- Edit control points (these can be animated).
- Navigate the Deformation dialog.

### Editing Deformation Curves

A deformation curve starts as a straight line using a constant value. To produce more elaborate curves, you insert control points and change their properties.

Use the buttons in the center of the Deformation dialog toolbar to insert and change deformation curve control points (see Interface, later in this topic).

### Control Point Types

Control points on a deformation curve can produce curves or sharp corners, depending on the control point type. To change a control point type, right-click the control point and choose one of these from the shortcut menu:

- **Corner** Non-adjustable linear control point producing a sharp corner.
- **Bezier Corner** Adjustable Bezier control point with discontinuous tangent handles set to produce a sharp corner. This type produces a curve that

looks like the corner type but has control handles like the Bezier Smooth type.

- **Bezier Smooth** Adjustable Bezier control point with locked continuous tangent handles set to produce a smooth curve.

### **Selecting Control Points**

Use the Move Control Point and Scale Control Point buttons with standard selection techniques to select control points.

### **Procedures**

#### **To drag Bezier tangent handles:**

- 1 Select one or more Bezier Smooth or Bezier Corner control points to display their tangent handles.
- 2 Click one of the Move Control Point buttons.
- 3 Drag any tangent handle.
  - Only the tangent handle you drag is affected. Tangent handles on other selected control points do not change.
  - If the tangent handle you drag is part of a Bezier Smooth control point, both handles move to maintain the Bezier Smooth type.
  - If the tangent handle you drag is part of a Bezier Corner control point, only that handle moves.

#### **To move a control point using the Position and Amount fields:**

- 1 Select a single control point.
- 2 Do one of the following:
  - Move the control point horizontally by entering a value in the Position field.
  - Move the control point vertically by entering a value in the Amount field.

### To change the control point type:

You can change control point types at any time by right-clicking a selection of one or more control points.

- 1 Select one or more control points.
- 2 Right-click any selected control point.
- 3 Choose a control point type from the shortcut menu.

The following conditions apply to changing control point types:

- The first and last control points must use the Corner or Bezier Corner type.
- Converting a Bezier Smooth point to a Bezier Corner point unlocks the tangent handles but does not change their position. The curve appears smooth until you drag one of the tangent handles.
- Converting a Bezier Corner point or inserted Bezier point to Bezier Smooth locks the tangent handles and changes their position and magnitude. The handles are rotated to the average between their two angles. The handle magnitudes are averaged and set equal.

### Interface

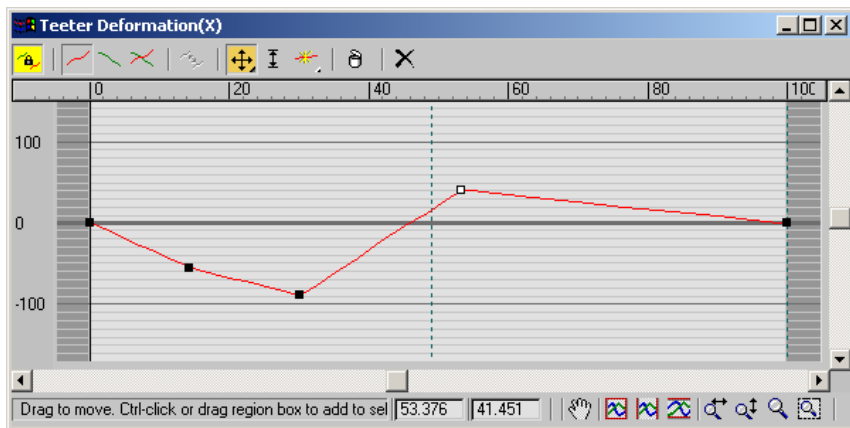

### Toolbar

Buttons for working with a second curve are disabled for the Twist and Bevel deformations, which use only one curve. The disabled buttons are Make



Symmetrical, Display X Axis, Display Y Axis, Display XY Axes, and Swap Deform Curves.

**Make Symmetrical** You can apply the same deformation to both axes of a shape using Make Symmetrical, which is both an action button and a curve editing mode. Turning on Make Symmetrical has the following effect:

- When a single curve is displayed, it copies the displayed deformation curve to the curve for the hidden axis.
- When both axes are displayed, the Apply Symmetry dialog is also displayed. Click the button for the curve you want to apply to both axes.
- Changes you make to the selected curve are duplicated on the other curve.

When Make Symmetrical is not active, curve editing is applied only to the selected curve.

**Display X Axis/Y Axis/XY Axes** You can display one or both deformation curves using the curve display buttons near the upper-left corner of the Deformation dialog.

Turn on the following buttons to display deformation curves:

- **Display X Axis** Displays only the X axis deformation curve in red.
- **Display Y Axis** Displays only the Y axis deformation curve in green.
- **Display XY Axes** Displays X axis and Y axis deformation curves together, each using its own color.

**Swap Deform Curves** Copies curves between the X axis and Y axis. This button has no effect when Make Symmetrical is on.

Click Swap Deform Curves to copy the X axis curve to the Y axis, and the Y axis curve to the X axis. It doesn't matter which curve is currently displayed or selected.

**Move Control Points** This flyout contains three buttons for moving control points and Bezier handles:

- **Move Control Point** Changes the amount of deformation (vertical movement) and the location of the deformation (horizontal movement).
- **Move Vertical** Changes the amount of deformation without changing the location.

- **Move Horizontal** Changes the location of the deformation without changing the amount.

If one control point is selected, you can move it by entering values in the control point Position and Amount fields at the bottom of the Deformation dialog.

You cannot move end points horizontally. Intermediate control points are constrained horizontally to stay between the points on either side. The amount of horizontal constraint is determined by the control point type.

- You can move corner control points very close together, until one is directly above the other.
- You can move Bezier control points no closer than the length of their tangent handles.

**Moving Bezier Tangent Handles** You can use the Move Control Point buttons to drag a tangent handle's angle and magnitude on Bezier Smooth and Bezier Corner vertices.

Dragging a tangent handle has the following constraints:

- You cannot move tangent angles beyond vertical. This prevents deformation curves from doubling back on themselves.
- You cannot move tangent magnitudes beyond the preceding or next control point on the path.

Pressing Shift while moving a Bezier Smooth tangent handle converts the control point to a Bezier Corner type.

**Scale Control Point** Scales the value of one or more selected control points with respect to 0. Use this function when you want to change only the deformation amounts of selected control points while maintaining their relative ratio of values.

- Drag downward to reduce values.
- Drag upward to increase values.

**Insert Control Point** This flyout contains buttons for inserting two control point types.

**Insert Corner Point** Click anywhere on a deformation curve to insert a corner control point at that location.

**Insert Bezier Point** Click anywhere on a deformation curve to insert a modified Bezier control point at that location. The tangent handles of the Bezier control point are set to maintain the shape of the curve before the point was inserted.

If you are not sure which type of control point you need, or if you change your mind, you can convert the point to another type by right-clicking the point and selecting the type from the shortcut menu.

Both Insert Control Point buttons put you in insertion mode. Right-click or choose another button to exit the mode.

**Delete Control Point** Deletes selected control points. You can also delete selected points by pressing the DELETE key.

**Reset Curve** Deletes all but the end control points and sets the curves back to their default values.

**Bevel Type** This flyout, available only in the Bevel Deformation dialog, lets you choose Normal, Adaptive Linear or Adaptive Cubic as the bevel type. For more information, see [Deform Bevel](#) on page 752 .

## Deformation grid

The area in the Deformation dialog that displays the deformation curves is called the deformation grid. This grid charts the value of the deformation along the length of the path.

These are the main grid components:

**Active area** The light-colored area of the grid defines the first and last vertex boundaries of the path. The ends of the deformation curve lie on each boundary and cannot be moved off the boundary.

**Horizontal lines** Mark deformation values on the vertical scale. The following table lists each deformation curve type and the meaning of the deformation values.

Deformation Type	Deformation Value
Scale	Percentage
Twist	Rotation Angle
Teeter	Rotation Angle

Deformation Type	Deformation Value
Bevel	Current Units

The thick horizontal line at 0 represents the deformation value at the loft path.

**Vertical lines** Mark levels of the path. The levels displayed vary with the Adaptive Path Steps setting on the [Skin Parameters rollout](#) on page 727 .

If Adaptive Path Steps is on, levels are displayed at all path vertices and shape locations.

If Adaptive Path Steps is off, levels are displayed only at path vertices.

**Path ruler** Measures the length of the path. The values on the ruler measure percentage along the path. You can drag the path ruler vertically in the Deformation dialog.

**Deformation curves** You can see one or two curves in the Deformation dialog, based on the deformation type and the curve display setting. The curves are color-coded by axis.

A red curve displays deformation along the shape's local X axis. A green curve displays deformation along the shape's local Y axis.

**Control Point fields** At the bottom of the Deformation dialog are two edit fields. When a single control point is selected these fields display the path location and deformation amount of the control point.

**Control Point Position** The left field displays the location of the control point on the loft path as a percentage of the total path length.

**Control Point Amount** The right field displays the deformation value of the control point.

### Deformation Dialog status bar

The Deformation dialogs have their own view navigation buttons in the lower-right corner. These give you controls for zooming and panning the view of the deformation grid as you edit the curve values. The status bar also displays information about the current tool and the selected control point.

**Numeric fields** These two fields are accessible only if a single control point is selected. The first gives the point's horizontal position, and the second gives its vertical position, or value. You can edit these fields with the keyboard.

**Lock Aspect** This button is present only in the Fit Deformation dialog. When active, it restricts zooming to vertical and horizontal at the same time.

**Zoom Extents** Changes the view magnification so the entire deformation curve is visible.

**Zoom Horizontal Extents** Changes the view magnification along the path length so the entire path area is visible in the dialog.

**Zoom Vertical Extents** Changes the view magnification along the deformation values so the entire deformation curve is displayed in the dialog.

**Zoom Horizontally** Changes magnification along the path length.

- Drag to the right to increase magnification.
- Drag to the left to decrease magnification.

**Zoom Vertically** Changes magnification along the deformation value.

- Drag upward to increase magnification.
- Drag downward to decrease magnification.

**Zoom** Changes magnification along both the path length and the deformation value, preserving the curve aspect ratio.

- Drag upward to increase magnification.
- Drag downward to decrease magnification.

**Zoom Region** Drag a region on the deformation grid. The region is then magnified to fill the deformation dialog.

**Pan** Drag in the view to move in any direction.

**Scroll bars** Drag the horizontal and vertical scroll bars to pan the view in a single direction.

## Path Commands

Select a Loft object. > Modify panel > Modifier stack display > Sub-object level > Path > Path Commands

The Path Commands rollout appears only when you are modifying an existing loft object and have selected Path from the Sub-Object list. The Put command allows you to make a copy or instance of the loft path.

## Interface

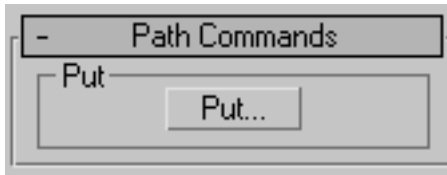

### Put group

**Put** Places the path into the scene as a separate object (as a Copy or Instance).

## Shape Commands

Select a Loft object. > Modify panel > Modifier stack display > Sub-object level > Shape > Shape Commands rollout

These controls let you align and compare shapes along the loft path.

## Interface



**Path Level** Adjusts the shape's position on the path.

**Compare** Displays the [Compare dialog](#) on page 765 in which you can compare any number of cross-section shapes.

**Reset** Undoes rotation and scale of the shape performed with the Select and Rotate or Select and Scale.

**Delete** Deletes the shape from the loft object.

### **Align group**

The six buttons in this group let you align the selected shape in relation to the path. Looking down at a shape from the viewport in which it's created, the orientation is left to right along the X axis, and top to bottom along the Y axis.

You can use a combination of these buttons for placements such as corner alignment. The operations are additive. In other words, you can use both Bottom and Left to place the shape in the lower-left quadrant.

**Center** Centers the shape on the path, based on the bounding box of the shape.

**Default** Returns the shape to its position when first placed on the loft path. When you use Get Shape, the shape is placed so that the path goes through its pivot point. This is not always the same as the center of the shape. Therefore, clicking Center is different than clicking Default.

**Left** Aligns the left edge of the shape to the path.

**Right** Aligns the right edge of the shape to the path.

**Top** Aligns the top edge of the shape to the path.

**Bottom** Aligns the bottom edge of the shape to the path.

### **Put group**

**Put** Puts the shape into the scene as a separate object.

## **Compare Dialog**

Select a Loft object. > Modify panel > Modifier stack display > Sub-object level > Shape > Shape Commands rollout > Compare button

The Compare dialog lets you compare any number of cross-section shapes in a loft object for purposes of making sure their first vertices are properly aligned. If shapes' first vertices aren't aligned, unexpected lofting results can occur.

## Interface

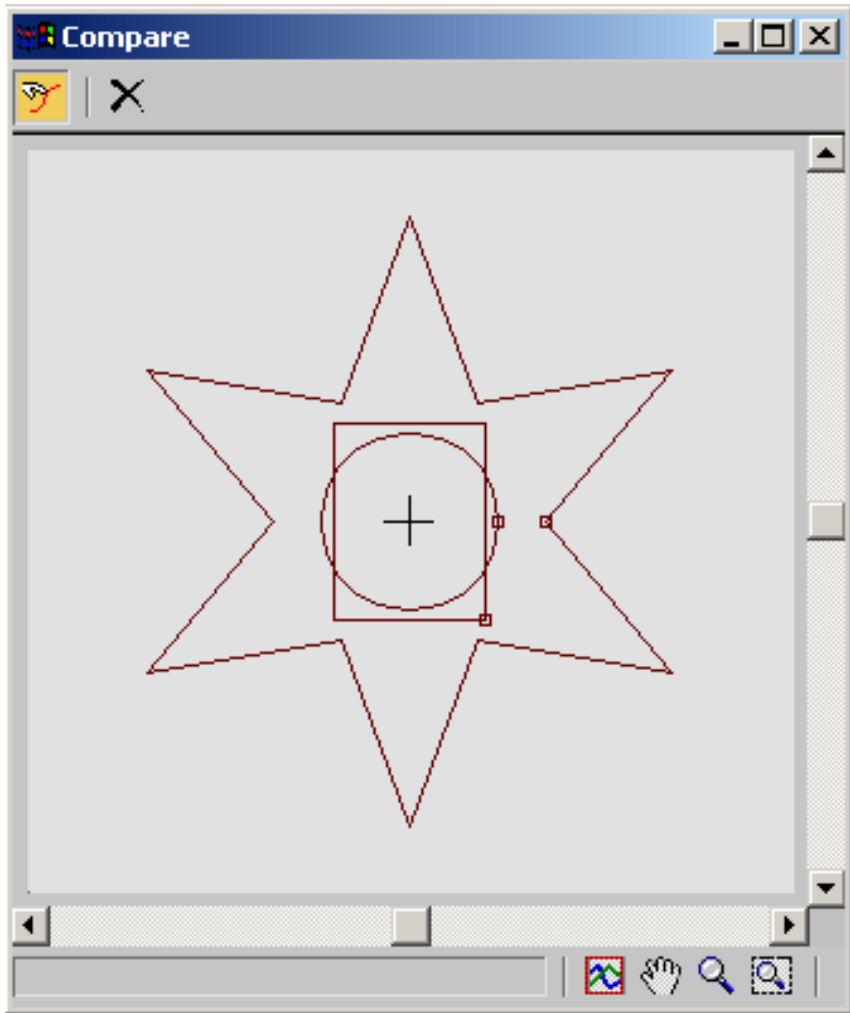

**Pick Shape** Lets you select shapes to display from the selected loft object. Click the Pick Shape button in the upper-left corner of the dialog. Then, in the viewport, select the shapes to display. Select a shape a second time to remove it from the display.

When you position the mouse cursor over a shape in the loft object, the cursor image changes to show whether the shape appears in the dialog window: a + sign appears if the shape isn't selected (indicating that if you select the shape,



it will be added to the dialog window), and a - sign appears if the shape is already selected.

With each shape, the Compare dialog displays the first vertex as a small square. For correct lofting, the first vertices of all shapes on the path need to be in the same position.

**Reset** Removes all shapes from the display.

### **Dialog controls**

You can scroll the Compare dialog with the scroll bars at the bottom and right sides. You can also use the buttons in the lower-right corner to perform View Extents, Pan, Zoom, and Zoom Region functions.

### **Align group**

While the Compare dialog is open, you can affect the shapes' positions in the dialog window with the Shape Commands rollout > Align group buttons. Turn off Pick Shape, select a shape in the viewport, and then click the Align group buttons. See [Shape Commands](#) on page 764 for further information.

## **Mesher Compound Object**

Create panel > Geometry > Compound Objects > Object Type rollout > Mesher  
Create menu > Compound > Mesher

The Mesher compound object converts procedural objects to mesh objects on a per-frame basis so that you can apply modifiers such as Bend or UVW Map. It can be used with any type of object, but is designed primarily to work with [particle systems](#) on page 2923. Mesher is also useful for low-overhead instancing of objects with complex modifier stacks.

### **Procedures**

**To use a Mesher object:**

- 1 Add and set up a particle system.
- 2 Click the Create panel > Geometry > Compound Objects > Object Type rollout > Mesher button.
- 3 Drag in a viewport to add the Mesher object. The size doesn't matter, but the orientation should be the same as that of the particle system.

- 4 Go to the Modify panel, click the Pick Object button, and then select the particle system.  
The Mesher object becomes a clone of the particle system, and shows the particles as mesh objects in the viewports no matter what the particle system's Viewport Display setting is.
- 5 Apply a modifier to the Mesher object, and set its parameters. For example, you might apply a Bend modifier and set its Angle parameter to 180.
- 6 Play the animation.  
Depending on the original particle system and its settings, as well as any modifiers applied to the Mesher object, you might be getting unexpected results. This typically occurs because the bounding box for the modifier, as applied to the particle system, is recalculated at each frame. For example, with a bent Super Spray particle system set to spread out over time, as the particles stream away and separate, the bounding box becomes longer and thicker, potentially causing unexpected results. To resolve this, you can use another object to specify a static bounding box.
- 7 To use another object's bounding box to limit the modified Mesher object, first add and set up the object. Its position, orientation, and size are all used in calculating the bounding box.
- 8 Select the Mesher object, and go to the Mesher stack level.
- 9 In the Parameters rollout, turn on Custom Bounding Box, click the Pick Bounding box button, and then select the bounding box object.  
The particle stream uses the new, static bounding box.

---

**TIP** You can use any object as a bounding box, so it is often fastest to use the particle system itself. Move to the frame where the particle system is the size you want and pick it.

---

In the following illustration, you can see a Super Spray particle system (left) and a Mesher object derived from the Super Spray (right). A Bend modifier is applied to the Mesher. In the center is a box object being used as a custom bounding box. The bounding box applied to the Bend modifier is visible as an orange wireframe when the modifier is highlighted in the stack.

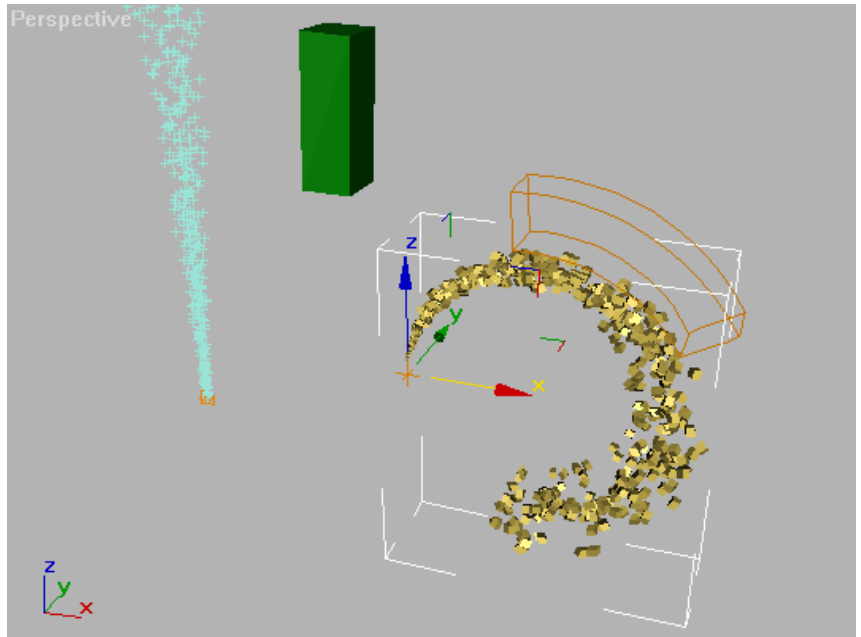

#### Using a custom bounding box with a bent particle system

To modify the particles aspect of the Mesher, edit the original particle system.

To modify the custom bounding box, move, rotate, or scale the bounding box object, and then reapply it using the Mesher object.

At this point, both particle systems will render. The original particle system must exist in order to be able to be used by the Mesher object, so if you want only the Mesher replica to render, hide the original system before rendering.

## Interface

### Parameters rollout

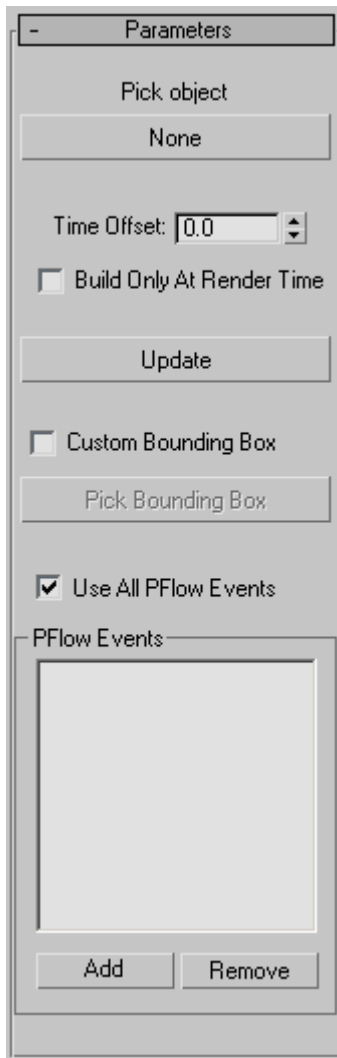

**Pick Object** Click this button and then select the object to be instantiated by the Mesher object. After doing so, the name of the instanced object appears on the button.

**Time Offset** The number of frames ahead of or behind the original particle system that the Mesher's particle system will run. Default=0.

**Build Only At Render Time** When on, the Mesher results do not appear in the viewports, but only when you render the scene. Default=off.

Use this option to reduce the amount of computation required for the viewport display.

**Update** After editing the original particle system settings or changing the Mesher Time Offset setting, click this button to see the changes in the Mesher system.

**Custom Bounding Box** When on, Mesher replaces the dynamic bounding box derived from the particle system and modifier with a static bounding box of the user's choice.

**Pick Bounding Box** To specify a custom bounding box object, click this button and then select the object.

The custom bounding box appears as an orange wireframe when the modifier is highlighted in the stack.

---

**TIP** You can use any object as a bounding box, so it is often fastest to use the particle system itself. Move to the frame where the particle system is the size you want and pick it.

---

**(coordinate values)** Displays the coordinates of the opposite corners of the custom bounding box.

**Use All PFlow Events** When on, and you've applied Mesher to a [Particle Flow](#) on page 2713 system, Mesher automatically creates mesh objects for every [event](#) on page 7770 in the system.

To use only certain events, turn this off and specify the events to use with the PFlow Events group controls (see following).

### **PFlow Events group**

When the Mesher object is applied to a Particle Flow system, use these controls to create meshes for specific events in the system. Mesher does not create meshes for the remaining events.

**[list box]** Displays all Particle Flow events currently affected by Mesher.

**Add** Lets you specify Particle Flow events to be affected by Mesher.

If the Mesher object is applied to a Particle Flow system, when you click Add, an Add PF Events dialog opens listing all events in the system. Highlight the events to add, and then click OK. The events now appear in the list.

**Remove** Deletes highlighted events from the list.

## ProBoolean/ProCutter Compound Objects



The ProBoolean and ProCutter compound objects provide you with modeling tools for combining 2D and 3D shapes in ways that would be difficult or impossible otherwise. The [ProBoolean compound object](#) on page 774 takes a 3ds Max mesh and adds extra intelligence to it prior to performing Boolean operations. First it combines the topologies, then it determines coplanar triangles and removes incident edges. The Booleans are then performed not on triangles but N-sided polygons. Once the Boolean operations are completed, the result is retriangulated and sent back into 3ds Max with coplanar edges hidden. The result of this extra work is twofold: The reliability of the Boolean object is extremely high, and the resulting output is much cleaner in terms of having fewer small edges and triangles.



Advantages of ProBoolean over the legacy 3ds Max Boolean compound object include:

- **Better quality mesh** - fewer small edges, fewer narrow triangles.
- **Smaller mesh** - fewer vertices and faces.
- **Easier and faster to use** - unlimited objects per Boolean operation.
- **Cleaner-looking mesh** - coplanar edges remain hidden.
- **Integrated decimation and quad meshing**

In addition, [ProCutter](#) on page 792 is an excellent tool for exploding, breaking apart, assembling, sectioning, or fitting together objects such as a 3D puzzle. See the following illustration for an example of a goblet shattering.



See also:

- [ProBoolean Compound Object](#) on page 774
- [ProCutter Compound Object](#) on page 792
- [Quad Meshing and Smoothing](#) on page 799

## ProBoolean Compound Object

Select an object. > Create panel > Geometry > Compound Objects > Object Type rollout > ProBoolean

A Boolean object combines two or more other objects by performing a Boolean operation or operations on them. ProBoolean adds a range of functionality to the traditional 3ds Max Boolean object, such as the ability to combine multiple objects at once, each using a different Boolean operation. ProBoolean can also automatically subdivide the Boolean result into quadrilateral faces, which lends itself well to smoothing edges with [MeshSmooth](#) on page 1460 and [TurboSmooth](#) on page 1750 .

### Materials, Textures, Vertex Colors

ProBoolean and ProCutter transfer texture coordinates, vertex colors, optionally materials, and maps from the operands to the final results. You can choose to apply the operand material to the resulting faces, or you can retain the original material. If one of the original operands had material maps or vertex colors, the resulting faces derived from that operand maintain those graphical



attributes. However, when texture coordinates or vertex colors are present, it is impossible to remove coplanar faces, so the resulting mesh quality will be lower. We suggest that you apply textures after the ProBoolean operations.

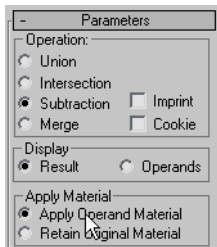

ProBoolean provides two options for applying materials. You can see these two options in the Apply Material group on the Parameters panel (see above illustration). The default choice is Apply Operand Material. This option applies the operand material to the resulting faces. Choosing Retain Original Material causes the resulting faces to use the material of the first selected object in the Boolean operation.

You can see the difference in the following illustration. The Boolean operation starts with a red box and a blue sphere. The box is used as the base object and the sphere is the subtracted operand. Using the default Apply Operand Material option gives the result shown in the center of the illustration. Choosing Retain Original Material yields the result shown on the right side of the illustration.

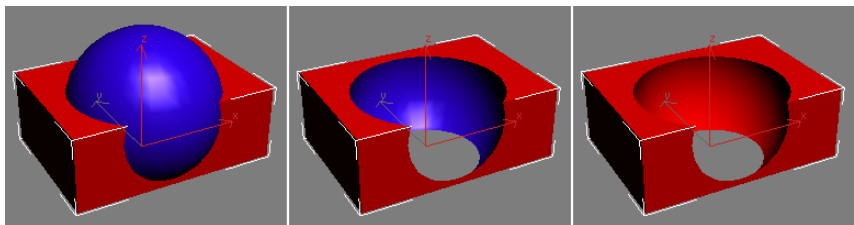

### Supported Boolean Operations

ProBoolean supports Union, Intersection, Subtraction, and Merge. The first three operations work similarly to their counterparts in the standard Boolean compound object. The Merge operation intersects and combines two meshes without removing any of the original polygons. This can be useful for cases in which you need to selectively remove parts of the mesh.

Also supported are two variants of the Boolean operations: Cookie Cutter and Imprint. Cookie Cutter performs the specified Boolean operation but does not add the faces from the operands into the original mesh. It can be used to cut

a hole in a mesh or to get the portion of a mesh inside of another object. The Imprint option inserts (imprints) the intersection edges between the operands and the original mesh without removing or adding faces. Imprint only splits faces and adds new edges to the mesh of the base object (original selected object).

### **Editing the Boolean Object**

When you access a ProBoolean or ProCutter object from the Modify panel, you can add operands to the existing set. You can also remove and transform (move, rotate, etc.) operands.

### **Polygon Reduction**

ProBoolean and ProCutter have a built-in decimation function. Typically, decimation is of better quality if it is integrated with the Boolean operations. The reason for this is that the Boolean object contains meta-information about which edges are intersection edges. The decimation function takes this information into account and uses it to properly maintain intersection edges.

### **Text, Lofts and NURBS**

When performing Boolean operations with [text objects](#) on page 569 , make sure characters don't intersect each other and that each letter is closed. Also, it's easy to inadvertently create [loft objects](#) on page 715 and [NURBS objects](#) on page 2152 in such a way as to have self-intersections. With loft objects, check the ends and points where the loft curve bends.

**See also:**

- [ProCutter Compound Object](#) on page 792

### **Procedures**

**To create a ProBoolean compound object:**

- 1 Set up objects for the Boolean operation. For example, to subtract spherical shapes from a box, create the box and spheres and arrange the spheres so that their volumes intersect the box where the subtractions should take place.
- 2 Select the base object. In the example in step 1, you would select the box.

- 3 On the Create panel > Geometry section, choose Compound Objects from the drop-down list, and then click ProBoolean.
- 4 On the Parameters rollout, choose the type of Boolean operation you want to use: Union, Intersection, Subtraction, etc. Also choose how the software will transfer the next operand you pick into the Boolean object: Reference, Copy, Move, or Instance. You can also choose to retain the original material, or keep the default Apply Material choice: Apply Operand Material.
- 5 Click the Start Picking button.
- 6 Pick one or more objects to participate in the Boolean operation.
- 7 As you pick objects, you can also change, for each newly picked object, the Boolean operation (Merge, etc.) and options (Cookie or Imprint), as well as how the next operand is transferred to the Boolean (Reference, Copy, etc.) and the Apply Material choice. You can continue picking operands as long as the Start Picking button stays pressed in. Each of the objects you pick is added to the Boolean operation.  
  
When the Modify panel is active, you can add objects to a selected ProBoolean object by clicking the Start Picking button and then picking the objects to add.

**Example: To change an existing Boolean with sub-object operations:**

ProBoolean offers a great deal of flexibility in combining various Boolean operations simultaneously, plus the ability to change the way operands combine both as you build the Boolean object and after the fact.

- 1 Start by adding a box, a sphere, a smaller box, and a cylinder, as shown in the following illustration.

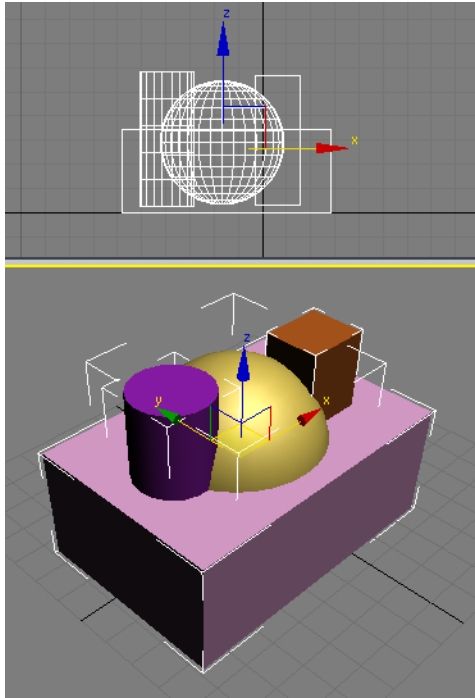

**Top: Front viewport**

**Bottom: Perspective viewport**

- 2 Select the box.
- 3 On the Create panel > Geometry section, choose Compound Objects from the drop-down list, and then click ProBoolean.
- 4 On the Parameters rollout, in the Operation group, choose Intersection.

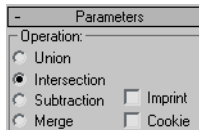

- 5 On the Pick Boolean rollout, click Start Picking, and then click the sphere. The result is the intersection of the sphere and the box; that is, a single object that represents the *common* volume both objects occupy. In this case, it's the overlap of the sphere and the box. Although neither has a

material at this point, the result uses the default color originally assigned by the software, at random, to the box when it was created.

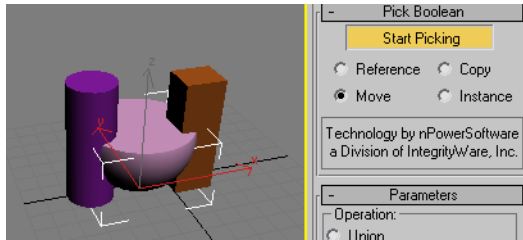

Note that Start Picking stays active (yellow). This means you can continue picking objects to incorporate into the Boolean object, optionally changing the operation as you go.

- 6 Set Operation to Union, and then click the small box.

The result is the union (adding) of the small box with the intersection of the sphere and larger box. Again, the original object's color is assigned to the result.

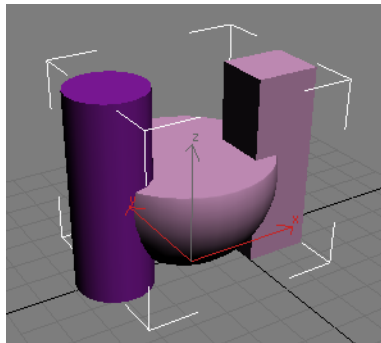

- 7 Set Operation to Subtraction, and then click the cylinder.

The cylinder's intersecting volume is subtracted from the previous Boolean result.

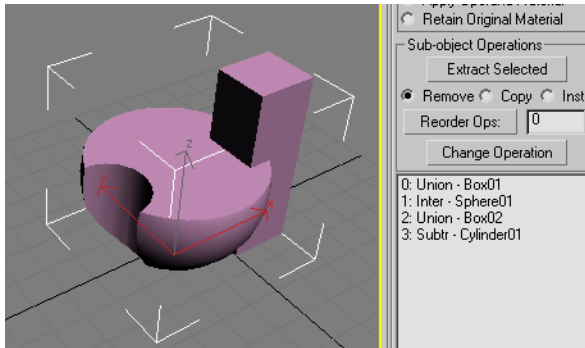

Note that the entire history of operands and operations used to build the Boolean object is listed in the hierarchy view list at the bottom of the Parameters rollout. Box01 starts the Boolean with Union, Sphere01 is then incorporated with Intersection, Box02 is incorporated with Union, and finally Cylinder01 is incorporated with Subtraction.

---

**NOTE** The operation for the first object in the list has no effect on the Boolean object, but if you move it to another position in the list it does. You'll see an example of this at the end of this exercise.

---

You can use the list and the other controls in the Sub-object Operations group to change the results.

- 8 In the list, highlight the Subtr - Cylinder01 entry, and then set Operation to Union.
- 9 In the Sub-object Operations group, click the Change Operation button. As a result of the change of operation, the cylinder appears in the Boolean object as an additive volume instead of a subtractive one. Also, its entry in the list changes to "Union - Cylinder01", showing that the Boolean operation for the cylinder is now Union.

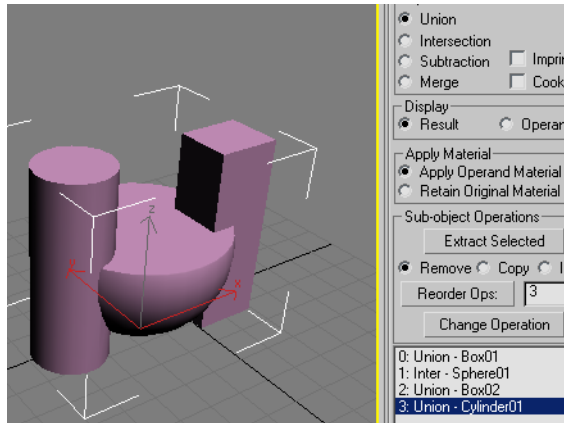

You can also change the order of the operations, which can affect the results.

- 10 In the list, click the Union - Cylinder01 entry to remove the highlighting, and then highlight the entry 1: Inter - Sphere01.

Note that its position in the list, 1, appears in the editable field next to the Reorder Ops button.

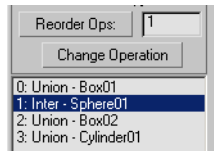

- 11 Change the value in the field from 1 to 3, and then click the Reorder Ops button.

The Inter - Sphere01 item jumps to the end of the list.

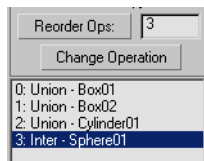

The Boolean object changes significantly. The new order in the list tells you how this shape was achieved: The two boxes and the cylinder were all combined with Union, adding their volumes together, and then the sphere was incorporated into that result with Intersection, leaving only the volume shared by all four objects.

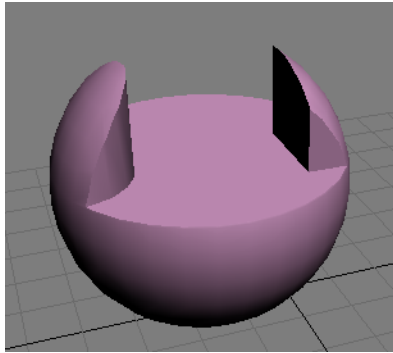

## Interface

### Modifier stack

With an unmodified ProBoolean object selected, the modifier stack shows a single, expandable entry: ProBoolean.

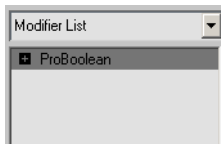

Expanding this entry (by clicking the + icon) reveals a single subsidiary branch: Operands.

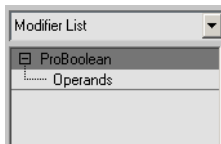

To transform operands in the ProBoolean object independent of the entire object, click the Operands branch to highlight it.

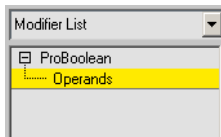



You can then select one or more operands, either by using standard selection methods in the viewport, or by highlighting their names in the [hierarchy view](#) on page 789 list at the bottom of the Parameters rollout.

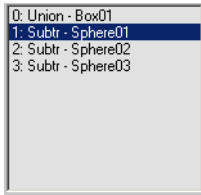

When one, and only one, operand is selected, the object type (not its name) appears as a separate stack entry below the ProBoolean entry. Clicking this entry provides direct access to the operand's parameters on the Modify panel.

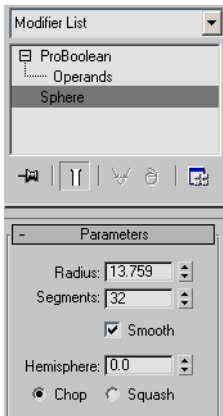

If Parameters rollout > Display is set to Result, selecting an operand displays the operand's axis tripod or transform gizmo in the viewport, although the operand itself is not visible by default.

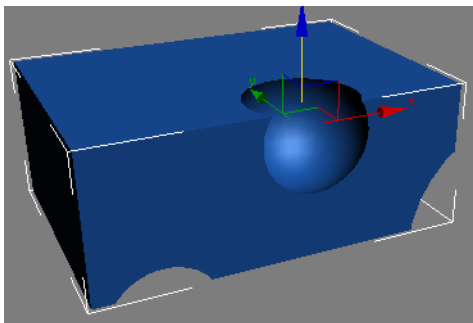

To view the operand, set Parameters rollout > Display to Operands.

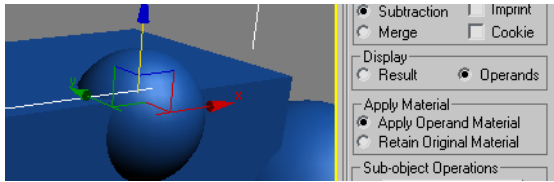

Whether or not the operands are visible, you can transform and animate them at the Operands sub-object level, as with any other object in 3ds Max.

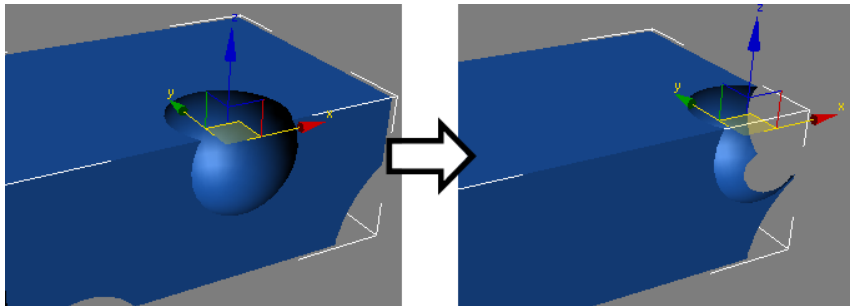

You can also transform and animate the base object; that is, the first object in the hierarchy view list.

### Pick Boolean rollout

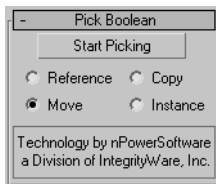

**Start Picking** Click this and then click each operand to transfer to the Boolean object in turn. Before picking each operand, you can change the Reference/Copy/Move/Instance choice, the Operation options, and the Apply Material choice.

---

**TIP** When you're adding many operands to a Boolean object using the default settings, calculating the result each time you pick an object can slow down the process. To maintain optimum feedback, set Parameters rollout > Display to Operands. Then, when you're finished, set it back to Result. Alternatively, on the Advanced Options rollout set Update to Manually, and then click the Update button to view the results after performing the Boolean operations.

---

Choose a radio button to specify how the next operand you pick is transferred to the Boolean object:

- **Reference** The Boolean operation uses a [reference](#) on page 7910 to the picked operand, so the object remains after being incorporated into the Boolean object. Future modifications to the originally picked object will also modify the Boolean operation. Use Reference to synchronize modifier-induced changes to the original operand with the new operand, but not vice-versa.
- **Copy** The Boolean operation uses a copy of the picked operand. The selected object is unaffected by the Boolean operation, but a copy of it participates in the Boolean operation.
- **Move** The picked operand becomes part of the Boolean operation and is no longer available as a separate object in the scene. This is the default choice.
- **Instance** The Boolean operation makes an [instance](#) on page 7818 of the selected object. Future modifications of the selected object will also modify the instanced object participating in the Boolean operation and vice-versa.

## Parameters rollout



## Operation group

These settings determine how the Boolean operands interact physically.

**Union** Combines two or more separate entities into a single Boolean object.

**Intersection** Creates a "new" object from the physical intersection between the original objects; the non-intersecting volumes are removed.

**Subtraction** Removes the volume of a selected object from the original object.

**Merge** Combines objects into a single object without removing any geometry. New edges are created where the objects intersect.

---

**NOTE** In the following illustration, the display property Backface Cull was turned off so that all edges are visible.

---

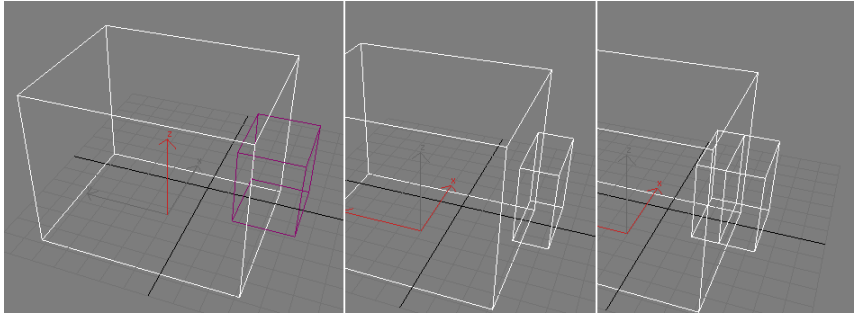

**Left:** Original object (box) and operand (small box)

**Center:** Union operation; part of the smaller box is removed.

**Right:** Merge operation, showing new edges at intersection

**Cookie** Cuts the faces of the original mesh shape, affecting only those faces. The faces of the selected operand are not added to the Boolean result.

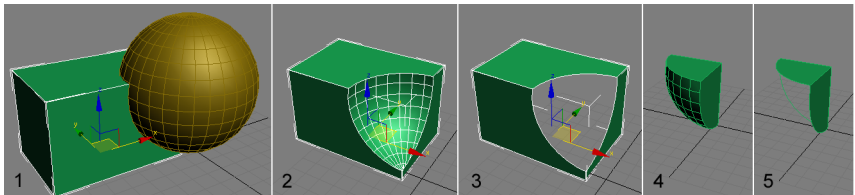

**1.** Original object (box) and operand (sphere)

**2.** Standard Subtraction operation

**3.** Subtraction with Cookie on

**4.** Standard Intersection operation

**5.** Intersection with Cookie on

**Imprint** Prints the outline of the shape (or intersection edges) onto the original mesh object.

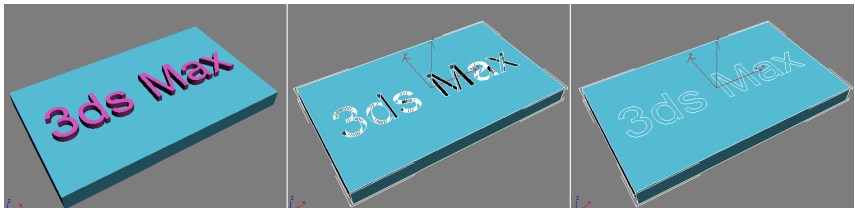

**Left:** Original object (box) and operand (text)

**Center:** Standard Subtraction operation

## Right: Subtraction with Imprint

---

**NOTE** The result of the Imprint operation is always the same; the main Operation choice has no effect on it.

---

**Display** Choose one of the following display modes:

- **Result** Displays only the result of the Boolean operations, not the individual operands.  
Choosing Result also activates the ProBoolean level in the [modifier stack](#) on page 782 .
- **Operands** Displays the operands that define the Boolean result. Use this mode to edit the operands and modify the result.  
Choosing Operands also activates the Operands level in the [modifier stack](#) on page 782 .  
Also, when picking many operands, use this mode to avoid having to recalculate the result each time, and then set Display back to Result at the end.

**Apply Material** Choose one of the following material application modes:

- **Apply Operand Material** New faces created by the Boolean operation acquire the material of the operand.
- **Retain Original Material** New faces created by the Boolean operation retain the material of the original object.

## Sub-object Operations group

These functions operate on operands highlighted in the hierarchy view list (see following).

---

**NOTE** For these operations, you need not be at the Operands sub-object level in the modifier stack.

---

**Extract Selected** Based on the chosen radio button (Remove, Copy, or Inst; see following), Extract Selected applies the operation to the highlighted operand in the hierarchy view list. Three modes of extraction are available:

- **Remove** Removes the operand or operands highlighted in the hierarchy view list from the Boolean result. It essentially undoes the addition of the highlighted operand(s) to the Boolean object. Each extracted operand becomes a top-level object again.

- **Copy** Extracts a copy of the operand or operands highlighted in the hierarchy view list. The original operand remains part of the Boolean result.
- **Inst** Extracts an instance of the operand or operands highlighted in the hierarchy view list. Subsequent modifications to this extracted operand also modify the original operand, thus affecting the Boolean object.

**Reorder Ops** Changes the ordering of the highlighted operand in the hierarchy view list. The reordered operand is moved to the position listed in the text field next to the Reorder Ops button.

**Change Operation** Changes the type of operation (see [Operation group](#) on page 786 ) for the highlighted operand. To change the operation type, highlight the operand in the hierarchy view, then choose the operation type radio option, and then click Change Operation.

### Hierarchy View

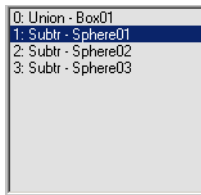

The hierarchy view, found at the bottom of the Parameters rollout, displays a list of all of the Boolean operations that define the selected mesh. Each time you perform a new Boolean operation, the software adds an entry to the list.

You can highlight operands for modification by clicking them in the hierarchy view list. To highlight multiple contiguous items in the list, click the first, and then Shift+click the last. To highlight multiple non-contiguous entries, use Ctrl+click. To remove highlighting from a list entry, Alt+click the highlighted item.

At the ProBoolean level in the modifier stack, you can perform only [sub-object operations](#) on page 788 on highlighted items. At the Operands sub-object level, you can transform highlighted operands as well as perform sub-object operations; see [Modifier stack](#) on page 782 for details.

## Advanced Options rollout

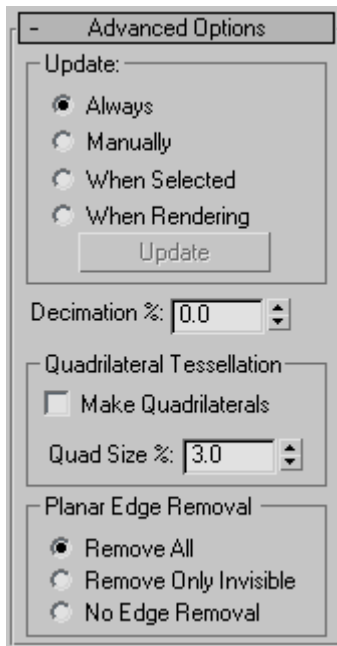

### Update group

These options determine when updates are performed on the Boolean object after you make changes. Choose one of the following:

- **Always** Updates occur as soon as you make changes to the Boolean object.
- **Manually** Updates occur only when you click the Update button.
- **When Selected** Updates occur whenever the Boolean object is selected.
- **When Rendering** Updates are applied to the Boolean object only at render time, or when you click Update.

**Update** Applies changes to the Boolean object. Available with all options except Always.



---

**NOTE** When you first create a ProBoolean object with Manually or When Rendering active, no operands, including the base object, are visible until you update at least once. Thereafter, the base object is visible, but no subsequently picked operands are until you update again.

---

**Decimation %** The percentage of edges to remove from the polygons in the Boolean object, thus reducing the number of polygons. For example, a Decimation % setting of 20.0 removes 20 percent of the polygon edges.

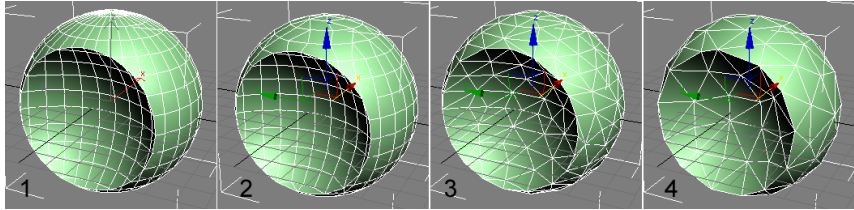

1. Decimation %=0.0

2. Decimation %=30.0

3. Decimation %=60.0

4. Decimation %=80.0

### Quadrilateral Tessellation group

These options enable quadrilateral tessellation of the Boolean object. This makes the object suitable for editing [subdivision surfaces](#) on page 1926 and for smoothing meshes. It also makes the object suitable for conversion to Editable Poly format.

For further discussion of this option, see the topic [Quad Meshing and Smoothing](#) on page 799 .

**Make Quadrilaterals** When on, changes the tessellation of the Boolean object from triangles to quadrilaterals.

---

**NOTE** When Make Quadrilaterals is on, the Decimation setting has no effect.

---

**Quad Size %** Determines the size of the quadrilaterals as a percentage of the overall Boolean object length.

## Planar Edge Removal group

This option determines how the polygons on planar faces are handled. Choose one of the following:

- **Remove All** Removes all extra coplanar edges on a face such that the face itself will define the polygon.
- **Remove Only Invisible** Removes invisible edges on each face.
- **No Edge Removal** No edges are removed.

## ProCutter Compound Object

Select an object. > Create panel > Geometry > Compound Objects > Object Type rollout > ProCutter

The ProCutter Compound object lets you perform specialized Boolean operations, primarily for the purpose of breaking apart or subdividing volumes. The results of ProCutter operations are particularly suitable for use in dynamics simulations where an object explodes or is shattered by impact with a force or another object.

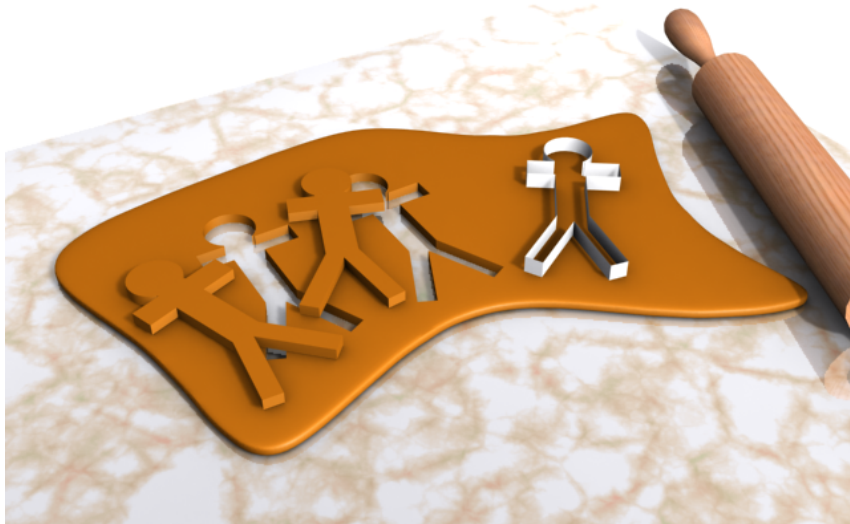

Following is a list of ProCutter features:

- Break apart a stock object into elements of an editable mesh or into separate objects using cutters that are either solids or surfaces.
- Use one or more cutters on one or more stock objects at the same time.
- Perform a volume decomposition of a set of cutter objects.
- Use a single cutter many times without maintaining the history.

**See also:**

- [ProBoolean Compound Object](#) on page 774

## **Procedures**

**To use ProCutter:**

- 1 Select an object to use as a cutter.
- 2 Activate the ProCutter compound object.
- 3 On the Cutter Picking Parameters rollout, click Pick Cutter Objects, and then select additional cutters.
- 4 On the Cutter Picking Parameters rollout, click Pick Stock Objects, and then select objects to be cut by the cutter objects.
- 5 In the Cutter Parameters rollout > Cutter Options group, choose the parts of the originals you wish to keep: Stock Outside Cutters, Stock Inside Cutters, Cutters Outside Stock.
- 6 To get separate objects to manipulate or animate, collapse the result to an [Editable Mesh](#) on page 1990 object and use the Explode tool set to 180.0. Alternatively, use Auto Extract Mesh and Explode By Elements, described below.

## Interface

### Cutter Picking Parameters rollout

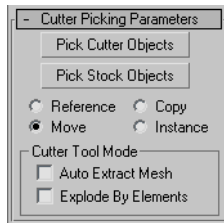

**Pick Cutter Objects** When on, objects you select are designated as cutters, used to subdivide stock objects.

**Pick Stock Objects** When on, objects you select are designated as stock objects; that is, objects that are subdivided by cutters.

Choose a radio button to specify how the next object you pick is transferred to the ProCutter object:

- **Reference** The Boolean operation uses a [reference](#) on page 7910 to the picked operand, so the object remains after being incorporated into the Boolean object. Future modifications to the originally picked object will also modify the Boolean operation. Use Reference to synchronize modifier-induced changes to the original operand with the new operand, but not vice-versa.
- **Copy** The Boolean operation uses a copy of the picked operand. The selected object is unaffected by the Boolean operation, but a copy of it participates in the Boolean operation.
- **Move** The picked operand becomes part of the Boolean operation and is no longer available as a separate object in the scene. This is the default choice.
- **Instance** The Boolean operation makes an [instance](#) on page 7818 of the selected object. Future modifications of the selected object will also modify the instanced object participating in the Boolean operation and vice-versa.

### Cutter Tool Mode group

These options let you use the cutter as a sculpting tool, cutting the same object repeatedly in different places. You can also get separate objects without having to go through Editable Mesh conversion.

**Auto Extract Mode** Automatically extracts the result when you select a stock object. It does not maintain the stock as a sub-object, but edits it and replaces the object with the result of the cut. This lets you quickly cut, move the cutter, and cut again.

**Explode By Elements** When Auto Extract is on, detaches each element into a separate object automatically. Has no effect when Auto Extract is off.

This convenient option makes it unnecessary to convert the ProCutter object to Editable Mesh format and then use Explode, as mentioned in [this procedure](#) on page ? . This is useful when cutting up an object. For example, you could use it to slice a loaf of bread. You use the cutter to cut a piece off, move the cutter, and then cut again.

### Parameters rollout

You can choose any combination of the three cutting options to get the desired result. If you have non-closed meshes, the orientation of the mesh might determine which part of the stock is considered to be inside or outside the cutter.

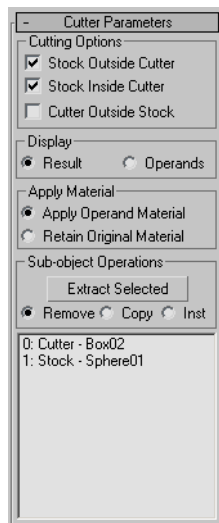

**Stock Outside Cutter** The result contains the parts of the stock outside of all of the cutters. This option gives you a similar result to a Boolean subtraction of the cutters from the stock objects. The gold part of the object in the following illustration results from this option.

**Stock Inside Cutter** The result contains the parts of the stock inside one or more cutters. This option gives you similar results to a Boolean intersection of the cutters and the stock objects. There is some difference because each cutter is treated individually. The green, blue and red parts of the object on the left side of the following illustration are the results of this option.

**Cutters Outside Stock** The result contains the parts of the cutters that are not inside the stock objects. Note that the cutters will cut each other if they intersect also. You can see in the following illustration. The parts on the right side of the following illustration that are not present on the left side are results of this option.

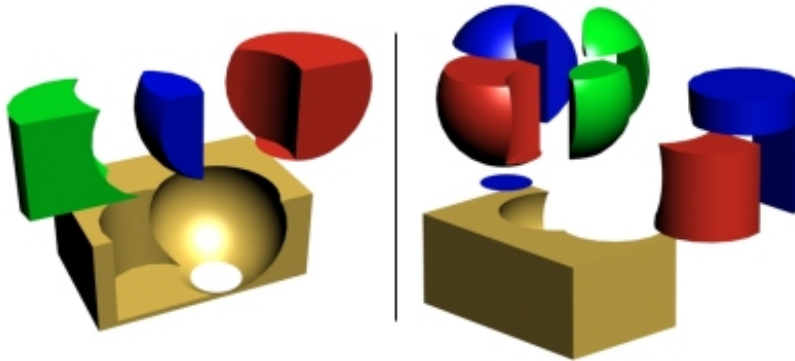

Cylinder and sphere as cutters and box as stock

Left: Keeping stock inside and outside cutters

Right: Keeping stock inside/outside cutters and cutters outside stock

**Display** Choose one of the following display modes:

- **Show Result** Displays the result of the Boolean operations.
- **Show Ops** Displays the operands that define the Boolean result. Use this mode to edit the operands and modify the result.

**Apply Material** Choose one of the following material application modes:

- **Apply Operand Material** New faces created by the Boolean operation acquire the material of the operand.
- **Retain Original Material** New faces created by the Boolean operation retain the material of the original object.

## Sub-object Operations group

These functions operate on operands highlighted in the hierarchy view list (see following).

**Extract Selected** Based on the chosen radio button (Remove, Copy, or Inst; see following), Extract Selected applies the operation to the highlighted operand in the hierarchy view list. Three modes of extraction are available:

- **Remove** Removes the operand or operands highlighted in the hierarchy view list from the Boolean result. It essentially undoes the addition of the highlighted operand(s) to the Boolean object. Each extracted operand becomes a top-level object again.
- **Copy** Extracts a copy of the operand highlighted in the hierarchy view list. The original operand remains part of the Boolean.
- **Inst** Extracts an instance of the operand highlighted in the hierarchy view list. Subsequent modifications to this extracted operand also modify the original operand, thus the Boolean object.

## Hierarchy View

The hierarchy view displays a list of all operands: cutters and stock objects. You can select and edit objects using the hierarchy view, as with ProBoolean.

## Advanced Options rollout

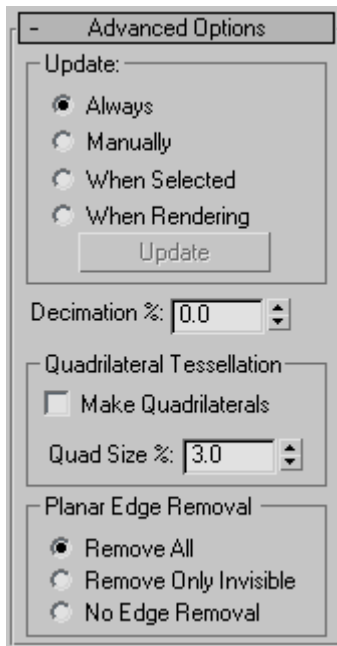

### Update group

These options determine when updates are performed on the Boolean object after you make changes. Choose one of the following:

- **Always** Updates occur as soon as you make changes to the Boolean object.
- **Manually** Updates occur only when you click the Update button.
- **When Selected** Updates occur whenever the Boolean object is selected.
- **When Rendering** Updates are applied to the Boolean object only at render time, or when you click Update.

**Update** Applies changes to the Boolean object. Available with all options except Always.



---

**NOTE** When you first create a ProCutter object with Manually or When Rendering active, no operands, including the base object, are visible until you update at least once. Thereafter, the base object is visible, but no subsequently picked operands are until you update again.

---

**Decimation %** The percentage of edges to remove from the polygons in the Boolean object, thus reducing the number of polygons. For example, a Decimation % setting of 20.0 removes 20 percent of the polygon edges.

### **Quadrilateral Tessellation group**

**Make Quadrilaterals** When on, changes the tessellation of the Boolean object from triangles to quadrilaterals. This makes the object suitable for editing [subdivision surfaces](#) on page 1926 and for smoothing meshes. It also makes the object suitable for conversion to Editable Poly format.

**Quad Size %** Determines the size of the quadrilaterals as a percentage of the overall Boolean object length.

### **Planar Edge Removal group**

This option determines how the polygons on planar faces are handled. Choose one of the following:

- **Remove All** Removes all extra coplanar edges on a face such that the face itself will define the polygon.
- **Remove Only Invisible** Removes invisible edges on each face.
- **No Edge Removal** No edges are removed.

## **Quad Meshing and Smoothing**

ProBoolean and ProCutter can re-mesh planar surfaces using a quadrilateral meshing algorithm. This capability, in combination with the subdivision surface tools in MeshSmooth, TurboSmooth, and Editable Poly, can produce dramatic results.

It does require some level of expertise to understand what is possible and how to achieve the best results using the quadrilateral tessellation. This topic shows the basics of how to use quad meshing and also contains tips and tricks about what works and how it works.

---

**TIP** You can apply quadrilateral tessellation to a mesh object without necessarily performing an actual Boolean operation on it. First create an additional object that's not touching the object you want to tessellate. Select the object to tessellate, apply ProBoolean, turn on Make Quadrilaterals, and then subtract the other object. You can then collapse the tessellated object to Editable Mesh/Poly if you like.

---

### Quad Meshing Basics

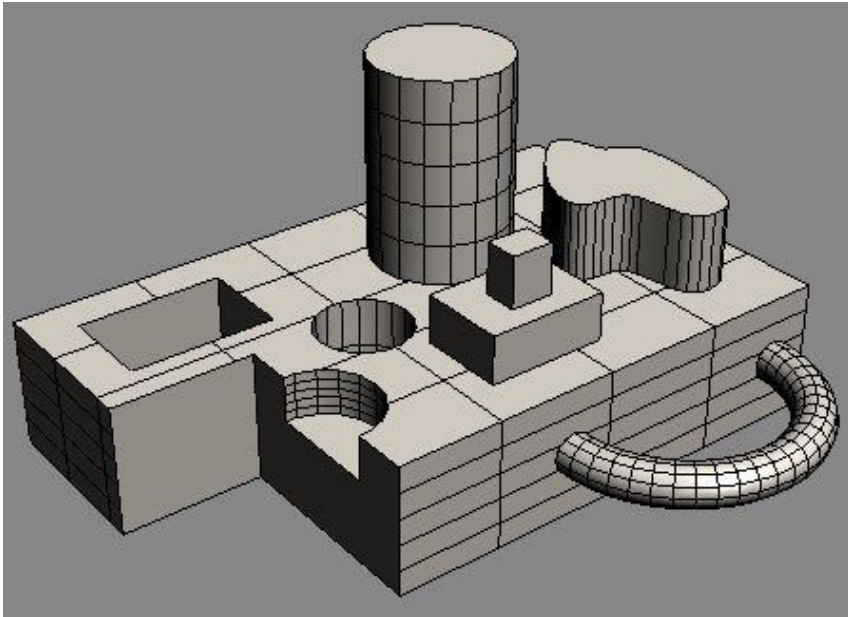

**ProBoolean of an object containing several primitives**

To make a quadrilateral mesh, select a ProBoolean or ProCutter object, go to the Modify panel, and expand the Advanced Options panel as shown following.

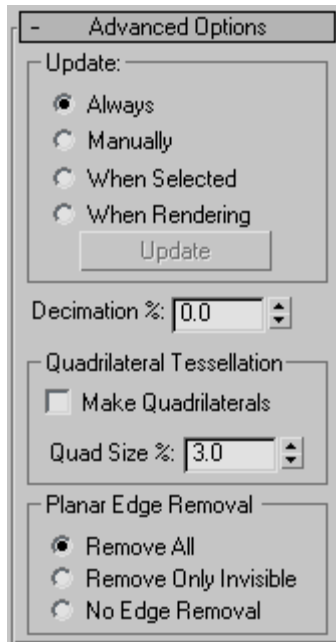

To get a result similar to the following illustration, turn on Make Quadrilaterals check box:

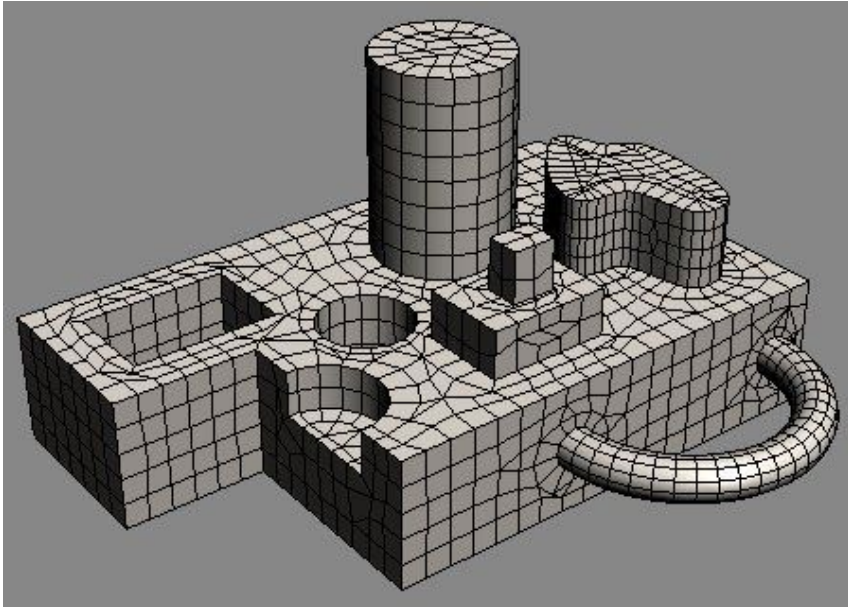

**Result of a quad mesh with Quad Size %=3.0**

To change the size of the individual quadrilaterals, adjust the Quad Size % parameter. Typically a value between 1 and 4 percent achieves the desired results. The smaller the quad size, the smaller the resulting fillets or blends between the surfaces when the mesh is smoothed. The default Quad Size value is 3.0 percent. A Quad Size value of 2.0 percent produces the following result:

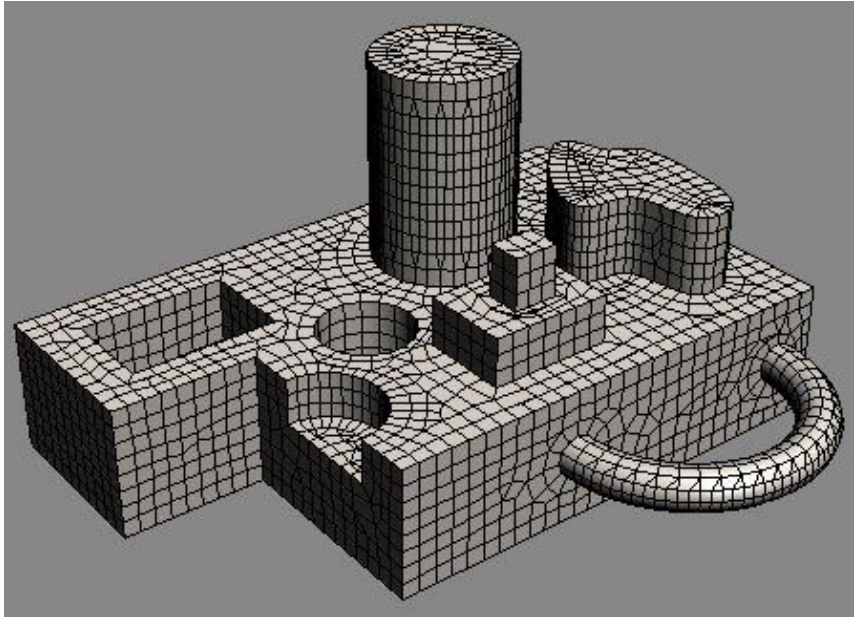

**Quad meshing with Quad Size %=2.0**

If you know that you have the desired result and don't plan to go back and change the quad size or the original primitives, you can convert the object to Editable Poly format and apply smoothing with the Subdivision Surface settings. If this is not the case, however, and you plan to make further adjustments, use the [MeshSmooth](#) on page 1460 or [TurboSmooth](#) on page 1750 modifier to retain the history of the ProBoolean object. The following illustration shows the result of a MeshSmooth modifier with Subdivision Amount > Iterations=1 applied to a ProBoolean object with Quad Size % set to 3.0.

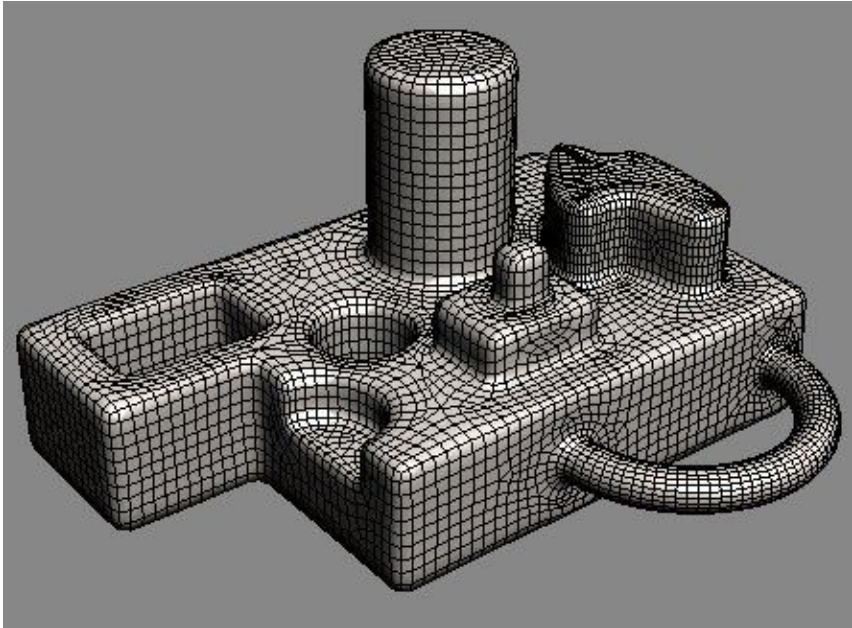

MeshSmooth modifier with NURMS and Iterations=1

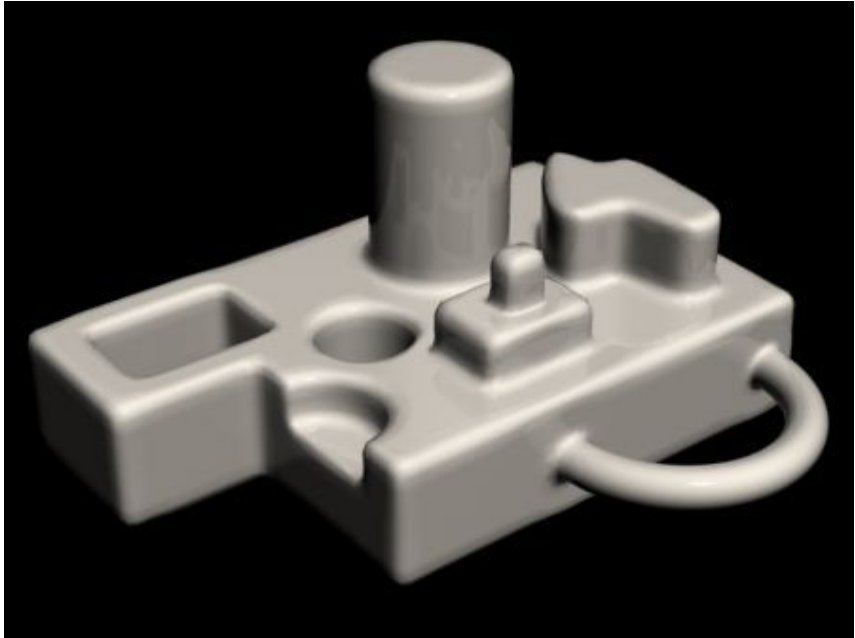

Rendered image after MeshSmooth modifier applied

### **Quad Meshing Tips and Tricks**

Sometimes the results of quad meshing can produce undesirable results in the smoothed model.

**Problem #1:** Stripes along cylinders or bumpiness on other surface

**Solution:** Increase the number of subdivisions around cylinders or along other surfaces.

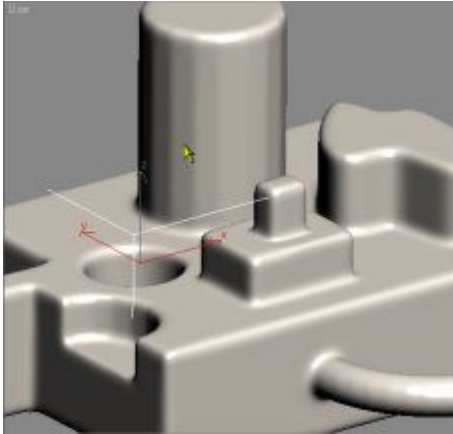

**Stripes and bumps with Quad Size %=2.0**

To fix the problem depicted above, the number of sides on the two cylinders was changed from 18 to 30 and the number of segments on the torus was changed from 24 to 36. The following illustration shows the improved result:

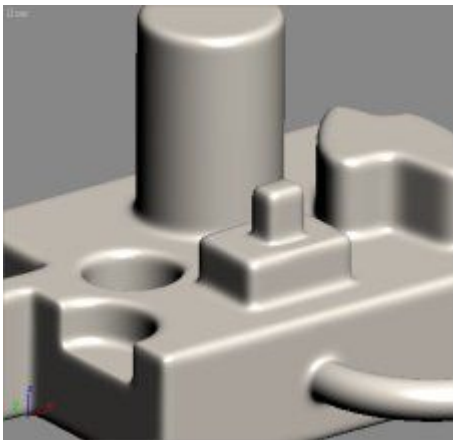

**Increasing the primitives' resolution fixes the problem.**

**Problem #2:** Triangles along boundaries caused by conflicts with visible edges from original mesh

**Solution:** Make sure Advanced Options rollout > Planar Edge Removal is set to Remove All or create the original primitives without subdivisions on coplanar faces.



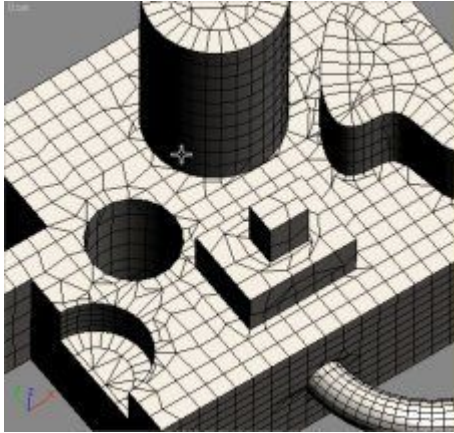

Coplanar edges not removed from original box

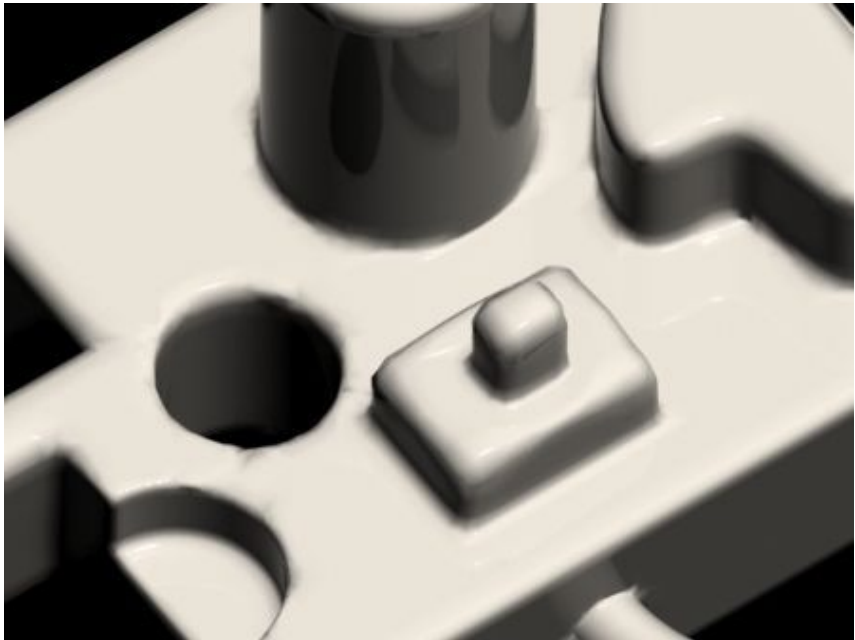

When rendered, misshapen geometry results from the presence of coplanar edges.

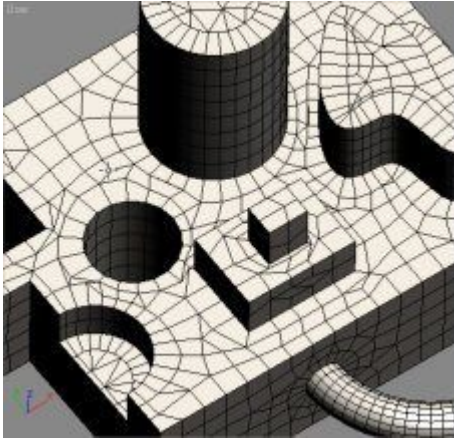

**Quad mesh with all coplanar edges removed**

**Problem #3:** Poor alignment of original primitive meshes causes undesirable results.

**Solution:** Rotate or move original primitives into position to maximize mesh quality.

The following illustration shows the result of subtracting three spheres of the same size from a box. The left-hand sphere is aligned properly so that there are good quads along both boundaries. This should produce a good result when smoothed. The middle sphere was lifted so that there is a strip of very thin quads near the boundary. This produces very little smoothing along that edge, as you can see in the rendered image. The right-hand sphere was rotated, producing poor alignment and many triangles on the sphere as well as small quads on the plane of the box. You can see the undesirable results in the rendered image.

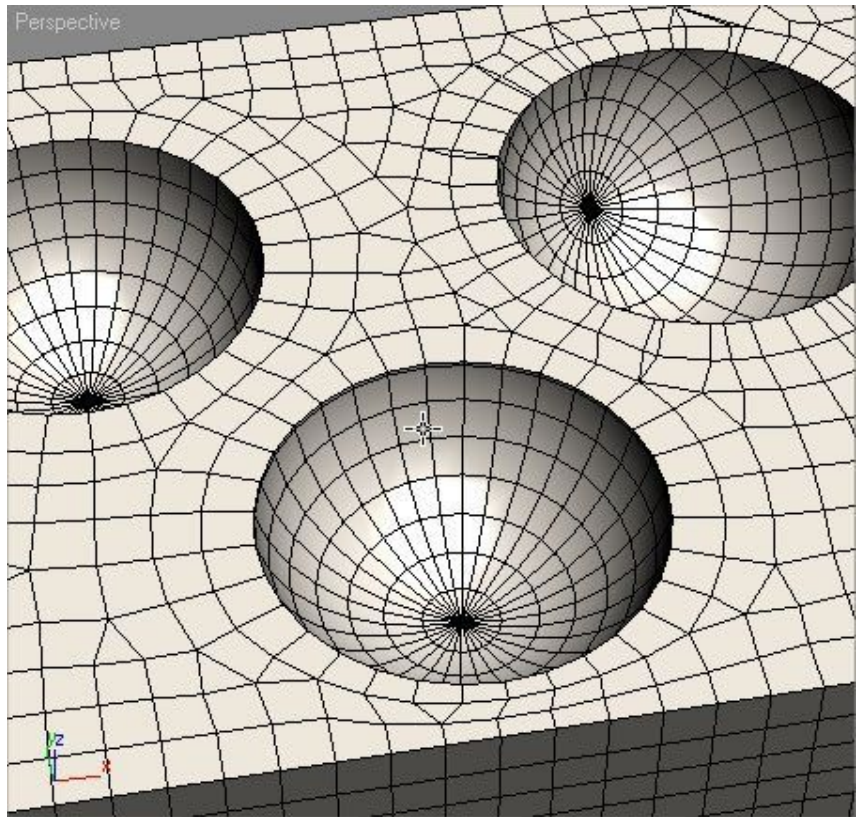

Quads produced by three spheres with different rotations and translations

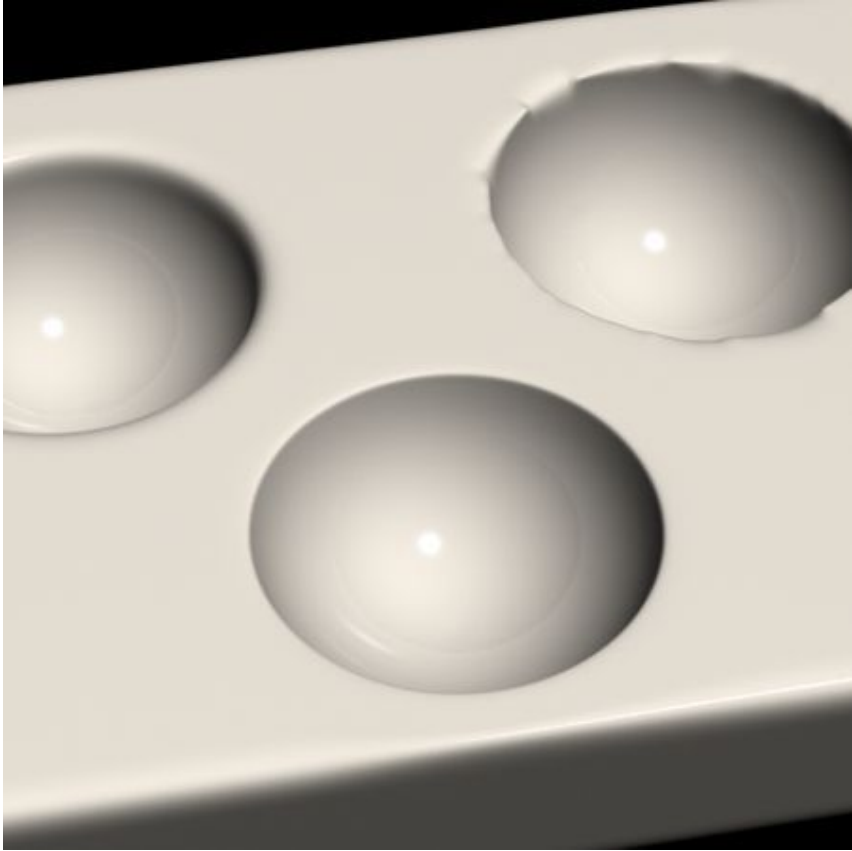

Rendered image of smoothed three-sphere example

## Dynamics Objects

Create panel > Geometry > Dynamics Objects

Create menu > Dynamics

Dynamics objects are similar to other mesh objects, except that they can be made to react to the motion of objects to which they are bound, or they can provide dynamic forces when included in a [dynamics simulation](#) on page 3775

.

The following topics describe the types of dynamics objects and how to create and use them:

[Spring Dynamics Object](#) on page 820

[Damper Dynamics Object](#) on page 811

## Damper Dynamics Object

Create panel > Geometry > Dynamics Objects > Object Type rollout > Damper button

Create menu > Dynamics > Damper

The Damper object provides a dynamic object that can behave as either a shock-absorber or an actuator. It consists of a base, a main housing, and a piston, with an optional boot. The piston slides within the main housing, providing different heights. The overall height can be affected by binding objects, in the same way as the Spring dynamic object.

---

**NOTE** Damper is similar to Spring in many respects. See [Spring object](#) on page 820 for more detailed descriptions of similar parameters and procedures.

---

### Procedures

#### To create a damper:

- 1 Drag and release to specify the diameter.
- 2 Move the mouse and click to specify the overall height of the damper.

#### To use a damper in a dynamics simulation:

The following must be in place to use the damper forces in a dynamics simulation:

- 1 Bind two objects to the ends of the damper, and choose Bound to Object Pivots in the End Point Method group box at the top of the command panel.
- 2 In the dynamics simulation, add the damper to the Object List. (The damper itself is not adjusted in the dynamics simulation, so all of the dynamics parameters will be disabled for the damper object.)
- 3 Include at least one of the bound objects *or a parent* of one of the bound objects in the simulation. For example, you can bind two dummy objects to the ends of a damper, and one of the dummies can be the child of an

object that's included in the simulation. In this case, the dummy itself does not need to be in the simulation.

---

**NOTE** Damper is an "ideal" object with no mass. While it can be used in dynamics simulations, it cannot participate directly in collisions or effects. As a result, when you assign a damper object to a dynamics simulation, and then view it in the Edit Object dialog, all of the parameter settings are disabled.

---

## Interface

The image shows a software interface for configuring a damper. It is titled "Damper Parameters" and is divided into several sections:

- End Point Method:** Contains two radio buttons. "Free Damper/Actuator" is selected, and "Bound to Object Pivots" is unselected.
- Binding Objects:** Contains two labels: "Piston: <None>" and "Base: <None>". Below each label is a button: "Pick Piston Object" and "Pick Base Object".
- Free Damper Parameters:** Contains a label "Pin-to-Pin Height:" followed by a numeric input field containing "2.0" and a vertical spinner control.
- Common Damper Parameters:** Contains two checked checkboxes: "Renderable" and "Generate Mapping Coords".

### End Point Method group

**Free Damper/Actuator** Choose this when using the damper as a simple object that's not bound to others or used in a dynamics simulation.

**Bound to Object Pivots** Choose this option when binding the damper to two objects, using the buttons described next.

## Binding Objects group

Use these controls to pick the objects to which the damper is bound. To complete the binding, you must select two binding objects, and then click Bound to Object Pivots.

**Piston (label)** Displays the name of the object bound to the piston of the damper.

**Pick Piston Object** Click this button and then select the object to be bound to the piston of the damper.

**Base (label)** Displays the name of the object bound to the base of the damper.

**Pick Base Object** Click this button and then select the object to be bound to the base of the damper.

## Free Damper Parameters group

**Pin-to-Pin Height** Use this field/spinner to specify the distance between the bottom center of the base and the top center of the piston when the damper is not bound.

## Common Damper Parameters group

**Renderable** When on, the object appears in the rendering; when off, the object does not appear.

Material IDs are assigned to the damper object as follows:

1: Base

2: Main housing

3: Piston

4: Boot Stop (appears only if you enable Boot Parameters)

5: Boot (appears only if you enable Boot Parameters)

**Generate Mapping Coords** Sets up the required coordinates for applying mapped materials to the object. Default=on.



## Cylinder Parameters group

Cylinder Parameters

Base Dia: 0.5

Height: 0.2

Main Dia: 1.0

Height: 1.0

Sides: 8

Fillet 1: 0.0

Fillet Segs: 1

Fillet 2: 0.0

Fillet Segs: 1

Inside Dia: 0.0

Smooth Cylinder

Provides parameters for the base and main cylinder of the damper.

**Base Dia** The diameter of the base, or "mount" of the damper.

**Height** The height of the base.

**Main Dia** The diameter of the main housing of the damper.

**Height** The height of the main housing.

**Sides** The number of sides of both the base and the main housing.

**Fillet 1** The size of the fillet on the lower edge of the main housing.

**Fillet Segs** The number of segments for Fillet 1. The higher this setting, the rounder the fillet profile appears.

**Fillet 2** The size of the fillet on the upper edge of the main housing.

**Fillet Segs** The number of segments for Fillet 2. The higher this setting, the rounder the fillet profile appears.

**Inside Dia** Specifies the inside diameter of the main housing, which is actually a tube rather than a cylinder.

**Smooth Cylinder** When on, smoothing is applied to both the base and the main housing.

### **Piston Parameters group**

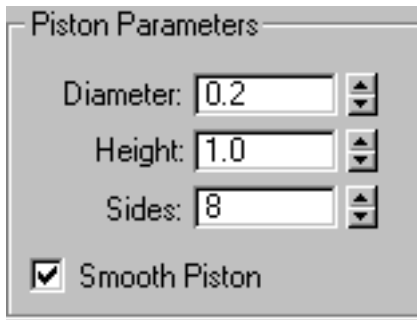

Provides parameters for the piston of the damper.

**Diameter** The diameter of the piston.

**Height** The height of the piston.

**Sides** The number of sides in the piston.

**Smooth Piston** When on, smoothing is applied to the piston.

## Boot Parameters group

Boot Parameters

Enable

Min Dia: 0.25

Max Dia: 1.0

Sides: 8

Folds: 4

Resolution: 4

Stop Dia: 0.4

Stop Thick: 0.2

Setback: 0.2

Stop Fillet: 0.0

Fillet Segs: 0

Smooth Boot

The boot is an optional component of the damper that's similar to the rubber "accordion" boot found on various types of dampers, such as shock absorbers. The boot acts like a bound dynamic object, in that one of its ends is bound to the main housing, while the other is bound to the piston. Thus, as the piston moves within the housing, the boot expands and contracts to follow.

**Enable** Turn this on to add the boot to the damper.

**Min Dia** The minimum diameter of the boot. This and the next parameter affect the depth of the accordion folds in the boot.

**Max Dia** The maximum diameter of the boot.

**Sides** The number of sides making up the boot.

**Folds** The number of accordion folds (bulges) along the height of the boot.

**Resolution** The number of segments in each fold.

**Stop Dia** The diameter of the stop, which is the ring at the top of the boot.

**Stop Thick** The thickness (height) of the stop ring.

**Setback** The distance of the stop ring from the top of the piston.

**Stop Fillet** The size of the fillet on the upper edge of the stop ring.

**Fillet Segs** The number of segments the stop fillet. The higher this setting, the round the fillet profile appears.

**Smooth Boot** When on, smoothing is applied to the boot.

## Dynamics Parameters group

The image shows a software interface for configuring a damper object. It is divided into two main sections: "Damper Parameters" and "Actuator Parameters".

**Damper Parameters:**

- Object is Damper
- Drag:  (with up/down arrow buttons)
- Drag is measured in:
  - Pounds per in/sec
  - Newtons per m/sec
- Damper works in:
  - Compression Only
  - Extension Only
  - Both

**Actuator Parameters:**

- Object is Actuator
- Force:  (with up/down arrow buttons)
- Force is measured in:
  - Pounds
  - Newtons

Unlike the Spring object, the damper can also be used as an actuator. Basically, a damper absorbs force (like a shock absorber) while an actuator applies force.

The parameters in this group box, available only when End Point Method is set to Bound to Object Pivots, specify how forces are applied by the damper object in a dynamics simulation.

**Damper Parameters** Provides parameters for a damper type of object. Specifically, this simulates a viscous linear damper, which provides linear resistance to motion (between the two binding objects) proportional to the rate at which the damper experiences displacement. The faster it gets hit, the harder it fights back. Push it slowly, and there's almost no resistance.

- **Object is Damper** Select this option to use the damper object as a damper rather than an actuator.

**Drag** Specifies the force per unit linear speed, measured in one of the methods specified below.

- **Drag is measured in** Lets you specify the measurement of drag to use: Pounds per in(ch)/sec or Newtons per m(eter)/sec.
- **Damper works in** Provides directional options for the damper.

**Compression Only** The damper reacts only to compression forces.

**Extension Only** The damper reacts only to expansion forces.

**Both** The damper reacts to both compression and expansion forces.

**Actuator Parameters** Provides parameters for an actuator. When used as an actuator, the damper object exerts force between the two binding objects. A real-world example might be the thrusting piston in a log splitter. When used in a simulation, the force is applied by adjusting the value in the Force spinner. You can see the result only after solving the dynamics simulation.

- **Object is Actuator** Choose this when using the damper object as an Actuator.

**Force** Specifies the amount of force exerted between the two bound objects. Positive values push the objects apart, while negative values pull them together.

- **Force is measured in** Lets you specify the measurement of force to use: Pounds per inch or Newtons per meter.

## Spring Dynamics Object

Create panel > Geometry > Dynamics Objects > Object Type rollout > Spring button

Create menu > Dynamics > Spring

The Spring object is a dynamics object in the shape of a coiled spring that lets you simulate a flexible spring in dynamics simulations. You can specify the overall diameter and length of the spring, the number of turns, and the diameter and shape of its “wire.” When used in a dynamics simulation, the compression and extension pressure of the spring are calculated as well.

## **Procedures**

### **To create a spring:**

- 1 Drag and release to specify the outside diameter.
- 2 Move the mouse and click to specify the overall length of the spring.

### **To use a spring in a dynamics simulation:**

The following must be in place to use the spring forces in a dynamics simulation:

- 1 Bind two objects to the ends of the spring, and choose Bound to Object Pivots in the End Point Method group box at the top of the command panel.
- 2 In the dynamics simulation, add the spring to the Object List. (The spring itself is not adjustable in the dynamics Edit Object dialog, so all of the dynamics parameters will be disabled for the spring object.)
- 3 Include at least one of the bound objects *or a parent* of one of the bound objects in the simulation. For example, you can bind the ends of a spring to two dummy objects, and one of the dummies can be the child of an object that’s included in the simulation. The dummy without a parent will be stationary and the spring will pass its force through the other dummy to its parent.

---

**NOTE** Spring is an “ideal” object with no mass. While it can be used in dynamics simulations, it cannot participate directly in collisions or effects. A spring can only exert force on other objects in simulations. As a result, when you assign a spring object to a dynamics simulation, and then view it in the Edit Object dialog, all of the parameter settings are disabled.

---

## Interface

### Spring Parameters rollout

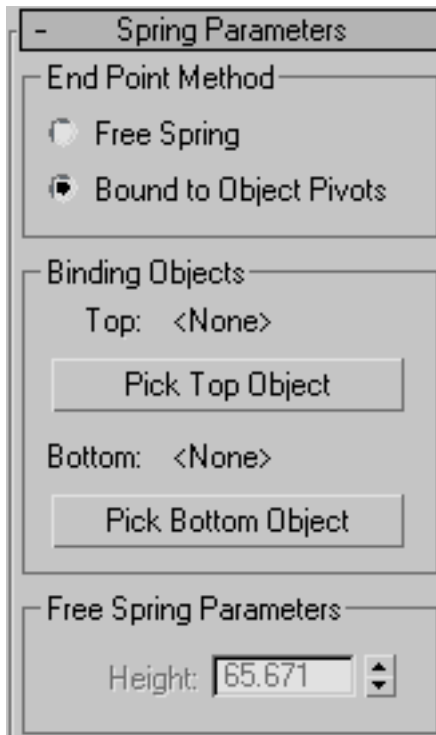

#### End Point Method group

**Free Spring** Choose this when using the spring as a simple object that's not bound to other objects or used in a dynamics simulation.

**Bound to Object Pivots** Choose this when binding the spring to two objects, using the buttons described next.

#### Binding Objects group

Use these controls to pick the objects to which the spring is bound. "Top" and "Bottom" are arbitrary descriptors; the two bound objects can have any positional relationship to each other. To complete the binding, select two binding objects, and then click Bound to Object Pivots.



Each end point of the spring is defined by the center of the overall diameter and the center of the wire. This end point is placed at the pivot point of the object to which it is bound. You can adjust the relative position of the binding object to the spring by transforming the binding object while the Affect Object Only button is turned on in the Hierarchy > Pivot panel.

**Top (label)** Displays the name of the "top" binding object.

**Pick Top Object** Click this button and then select the "top" object.

**Bottom (label)** Displays the name of the "bottom" binding object.

**Pick Bottom Object** Click this button and then select the "bottom" object.

### **Free Spring Parameters group**

**Height** Use this field/spinner to set the straight-line height or length of the spring when it is not bound. This is not the actual length of the spring's wire.

## Common Spring Parameters group

Common Spring Parameters

Diameter: 1.0

Turns: 1.0

CCW  CW

Automatic Segments

Segs/Turn: 16

Manual Segments

Segments: 16

Smoothing

All  Sides

None  Segments

Renderable

Generate Mapping Coords

**Diameter** The overall diameter of the spring, as measured at the center of the wire. (The diameter of the wire itself has no effect on this setting.)

**Turns** The number of full 360-degree turns in the spring.

**CCW/CW** Specifies whether the coils of the spring are counterclockwise (CCW) or clockwise (CW).

**Automatic Segments** Choose this option to force each turn of the spring to contain the same number of segments, as specified in the Segs/Turn spinner. Thus, if you increase the number of turns, the number of segments also increases.

**Segs/Turn** This spinner lets you specify the number of segments in each 360-degree turn of the spring.

**Manual Segments** When this option is chosen, the length of the spring contains a fixed number of segments, no matter how many turns in the spring. Thus, as you increase the number of turns, you must manually increase the number of segments to maintain a smooth curve.

**Segments** This spinner lets you specify the total number of manual segments in the spring.

**Smoothing** Provides various methods of smoothing the object. The options here work the same as those in the [Torus primitive](#) on page 370 .

- **All** All surfaces are smoothed.
- **Sides** Smoothing runs along the length of the wire, but not around its perimeter.
- **Segments** Smoothing runs around the perimeter of the wire, but not along its length.
- **None** No smoothing is applied.

**Renderable** When on, the object appears in the rendering; when off, the object does not appear.

**Generate Mapping Coords** Assigns mapping coordinates to the object. Default=on.

## Wire Shape group

Wire Shape

Round Wire

Diameter: 8.66

Sides: 6

Rectangular Wire

Width: 8.66

Depth: 8.66

Fillet: 0.0

Fillet Segs: 0

Rotation: 0.0

D-Section Wire

Width: 8.66

Depth: 8.66

Round Sides: 4

Fillet: 0.0

Fillet Segs: 0

Rotation: 0.0

Provides three different types of wire cross-sections for the spring: round, rectangular, or D-shaped. Each type has its own set of parameters.

**Round Wire** Specifies a round wire for the spring.

- **Diameter** The diameter of the wire.
- **Sides** The number of sides that make up the cross section.

**Rectangular Wire** Specifies a rectangular wire.

- **Width** Determines the width of the cross section.
- **Depth** Determines the depth of the cross section.
- **Fillet** When combined with Fillet Segs (below), this lets you fillet (round) the corners of the cross section.
- **Fillet Segs** Specifies the number of segments in the fillet.
- **Rotation** Rotates the angle of the cross section along the entire length of the spring.

**D-Section Wire** Specifies a D-shaped wire.

- **Width** Determines the width of the cross section.
- **Depth** Determines the depth of the cross section.
- **Round Sides** Specifies the number of segments that make up the rounded side of the D-shape.
- **Fillet** When combined with Fillet Segs (below), this lets you fillet (round) the corners of the cross section.
- **Fillet Segs** Specifies the number of segments in the fillet.
- **Rotation** Rotates the angle of the cross section along the entire length of the spring.

## Dynamics Parameters group

Dynamics Parameters

Relaxed Hgt: 258.1

Constant k: 226.0

Spring constant is in:

Pounds per inch

Newtons per meter

Spring works in:

Compression Only

Extension Only

Both

Enable Nonlinearity

These parameters specify the forces that the spring contributes to a dynamic simulation.

**Relaxed Hgt** Specifies the height (or length) at which the spring is "relaxed" and therefore contributes no force--either compression or extension. For example, if the placement of the binding objects stretches the spring to a length of 50 units but the Relaxed Len is set to 30, then an extension force is in effect because the spring is stretched further than its relaxed length.

**Constant k** The amount of force exerted per unit change in length with respect to the Relaxed Hgt value. This could also be described as the measure of force-per-units-change in length as compared to the Relaxed Length. For example, if your spring is set to a Spring Constant of  $k=10$  lb per in, and you stretch it to be ten inches longer than the Relaxed Hgt value, it will try to close with a force of 100 pounds. If you compress it two inches shorter than the Relaxed Hgt value, it will push back with 20 pounds of force.

**Spring constant is in** Lets you specify the measurement of force to use: Pounds per inch or Newtons per meter.

**Spring works in** Lets you specify the type of force you want the spring to exert. While most springs actually provide both compression and extension force, if your simulation requires only one, you can save calculation time by using one instead of both.

- **Compression Only** This type of spring provides only expansive force when its length is shorter than the specified Free Length.
- **Extension Only** Provides contractive force when its length is greater than the specified Free Length.
- **Both** Provides both expansive and contractive force, depending on the variation from Relaxed Hgt.

**Enable Nonlinearity** When on, the compression and extension of the spring are non-linear, based on the assumption that a spring has physical limits to the amount it can stretch or contract. Thus, the further the spring gets from the Relaxed Hgt setting, the less linear the feedback. The non-linear compression is calculated using the relationship between the coil dimensions, wire diameter, and length. Extension compares the relationship between the wire diameter and overall spring diameter.

## Systems

Create panel > Systems

A system combines objects, linkages, and controllers to produce an object set that has behavior as well as geometry. Systems help you create animations that would be much more difficult or time-consuming to produce using features independently. Systems can range from simple object generators to full-scale subsystem programs.

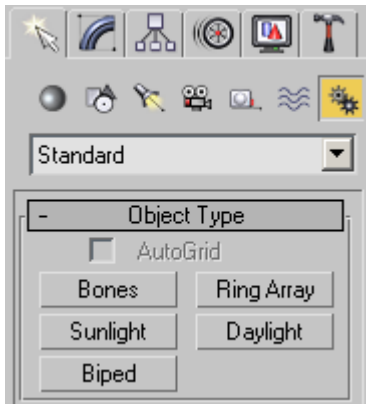

- [Bones](#) on page 831 creates a hierarchically linked set of bones and joints. You can transform and animate bones using both forward and inverse kinematics. See [Animating with Forward Kinematics](#) on page 3279 and [Inverse Kinematics \(IK\)](#) on page 3299 .
- [Ring Array](#) on page 853 creates a ring of boxes.
- [Sunlight](#) on page 5024 creates and animates a directional light that follows the geographically correct angle and movement of the sun over the earth at a given location.
- [Daylight](#) on page 5024 creates an assembly with a sky and a sun. Using the Get location function you can create and animate a light that follows the geographically correct angle and movement of the sun over the earth at a given location.
- [Biped](#) on page 4069 creates a two-legged character skeleton designed for animation.

Systems are primarily intended for [plug-in](#) on page 7896 component software. Additional systems might be available if your configuration includes plug-in systems.

You can externally reference system objects in your scene. For more information, see [XRef Objects](#) on page 6732 .

## Procedures

### To create a system:

- 1 On the Create panel, click Systems.



The Systems panel is displayed.

- 2 On the Object Type rollout, choose a system to create.
- 3 Drag in a viewport to create the system.

## Bones System

Create panel > Systems > Bones button

Animation menu > Bone Tools > Create Bones

A Bones system is a jointed, hierarchical linkage of bone objects that can be used to animate other objects or hierarchies. Bones are especially useful for animating character models that have a continuous skin mesh. You can animate bones with forward or inverse kinematics. For inverse kinematics, bones can use any of the available [IK solvers](#) on page 3307 , or through [Interactive](#) on page 3383 or [applied IK](#) on page 3386 .

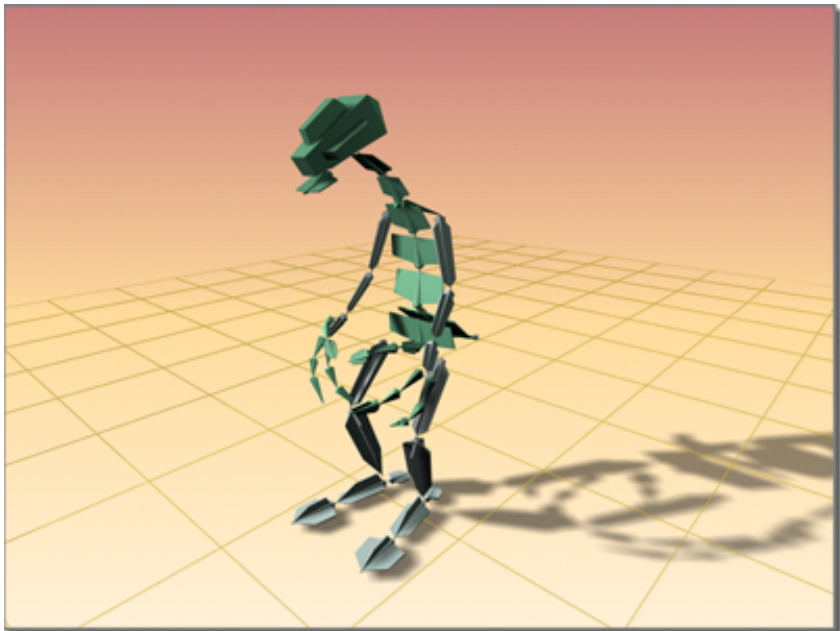

Dinosaur character modeled using bones

Bones are renderable objects. They have several parameters, such as taper and fins, that can be used to define the shape the bone represents. The fins make it easier to see how the bone is rotating.

For animation, it is very important that you understand the structure of a bone object. The bone's geometry is distinct from its link. Each link has a pivot point at its base. The bone can rotate about this pivot point. When you move a child bone, you are really rotating its parent bone.

It might be useful to think of bones as joints, because it is their pivot placements that matter, more than the actual bone geometry. Think of the geometry as a visual aid that is drawn lengthwise from the pivot point to the bone's child object. The child object is usually another bone.

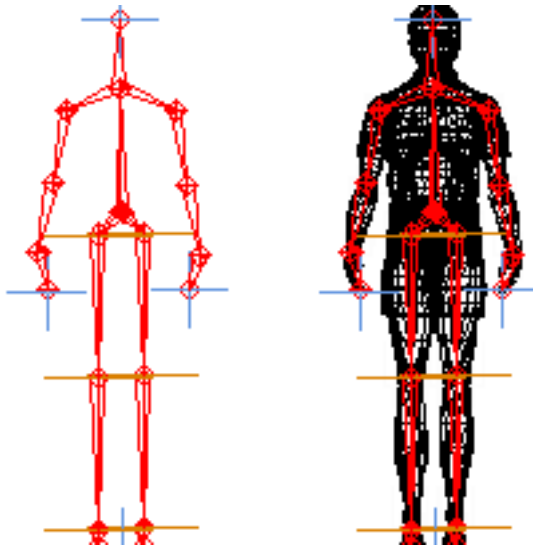

Bones system seen alone and inside a wireframe model

Any hierarchy can display itself as a bone structure (see [Using Objects as Bones](#) on page 843 ), by simply turning on Bone On in the [Bone Editing Tools rollout](#) on page 845 .

**See also:**

- [Bone Tools](#) on page 845

## Creating Bones

You start creating bones by clicking the Create Bones button on the [Bone Editing Tools rollout](#) on page 845 , or by clicking the Bones button in the Systems category on the Create panel.

To create bones, do the following.

- 1 Your first click in a viewport defines the start joint of the first bone.
- 2 The second click in a viewport defines the start joint of the next bone. Visually only one bone is drawn at this point because bones are visual aids drawn between two pivot points. It is the actual pivot point's placement that is important.
- 3 Each subsequent click defines a new bone as a child of the previous bone. The result of multiple clicks is a single chain of bones.
- 4 Right-click to exit bone creation.

This creates a small “nub” bone at the end of the hierarchy, which is used when assigning an IK chain. If you are not going to assign an IK chain to the hierarchy, you can delete the small nub bone.

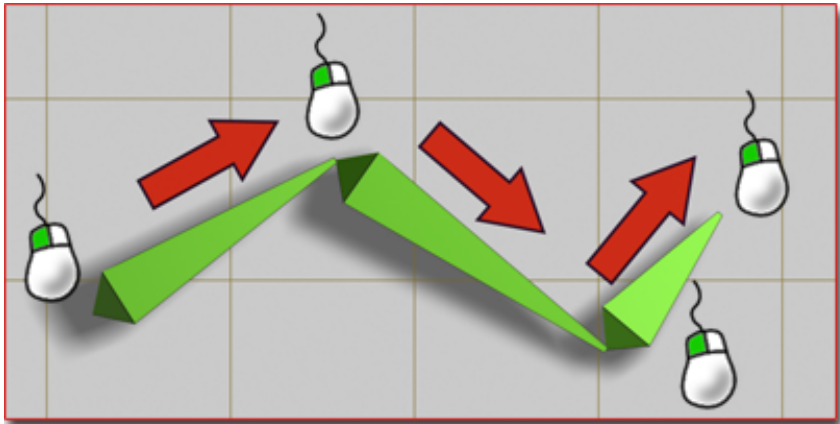

### Creating a simple chain of three bones

3ds Max lets you create a branching hierarchy of bones. To create a branching hierarchy, such as legs branching from a pelvis, do the following:

- 1 Create a chain of bones, and then right-click to exit bone creation.

- 2 Click Bones (or Create Bones) again, and then click the bone where you want to begin branching. The new chain of bones branches from the bone you click.

---

**WARNING** The behavior of a branching bone hierarchy is not always intuitive.

---

---

**NOTE** You can also use [Select And Link](#) on page 3268 to connect one bone hierarchy to its branches. However, except for this one special case, using Select And Link with bones is *not recommended*. To edit an existing bone structure, whether branching or not, use the [Bone Tools](#) on page 845 instead.

---

### Assigning IK Controllers to Bones

By default, bones are not assigned inverse kinematics (IK). Assigning an IK solver can be done in one of two ways. Typically, you create a bone hierarchy, then manually assign an IK solver. This allows for very precise control over where IK chains are defined.

The other way to assign an IK solver is more automatic. When you create bones, choose IK solver from the list in the IK Chain Assignment rollout, and then turn on Assign To Children. When you exit bone creation, the chosen IK solver is automatically applied to the hierarchy. The solver extends from the first bone in the hierarchy to the last.

For more information about IK, see [Introduction to Inverse Kinematics](#) on page 3299.

### Setting the Initial Position of Bones

When you first create a bones system, the position of the bones is the *initial state*. Before you assign an IK solver or method, you can change the initial state of the bones by moving, rotating, or stretching the bones individually.

### Bone Color

By default, bones are assigned the color specified for Bones in the [Colors panel](#) on page 7505 of the [Customize User Interface dialog](#) on page 7489. Choose Object as the Element and then choose Bones in the list. You can change the color of individual bones by selecting the bone, clicking the active color swatch next to the bone's name in the Create panel or Modify panel, and then selecting a color in the [Object Color dialog](#) on page 327.

You can also use the [Bone Tools](#) on page 845 to assign bone colors, or to assign a color gradient to a bone hierarchy.

## Bone Fins

Fins are visual aids that help you clearly see a bone's orientation. Fins can also be used to approximate a character's shape. Bones have three sets of fins: side, front, and back. By default, fins are turned off.

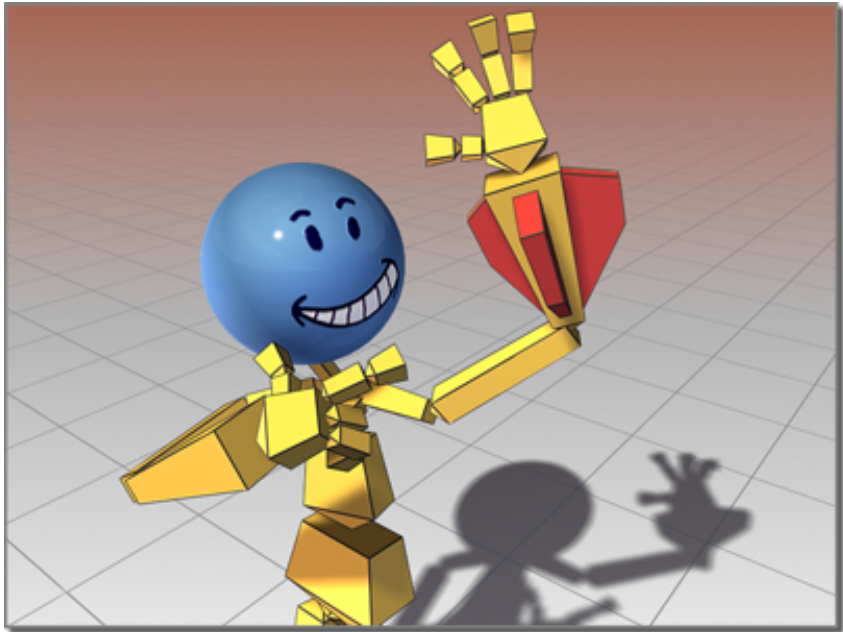

Bones can have fins.

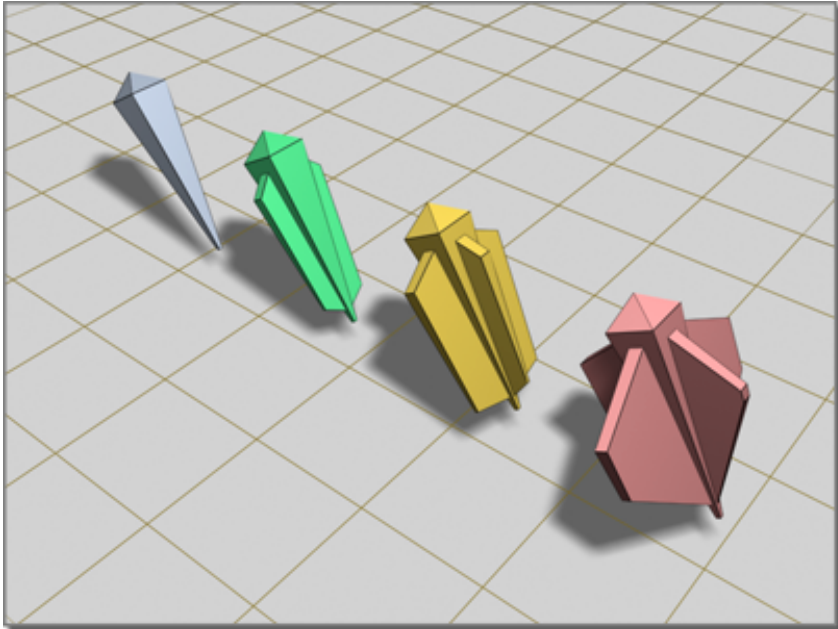

Bones with various fin configurations

### Renderable Bones

Bones can be renderable, though by default, they are not. To make a bone renderable, turn on the Renderable check box in the bone's [Object Properties dialog](#) on page 245 .

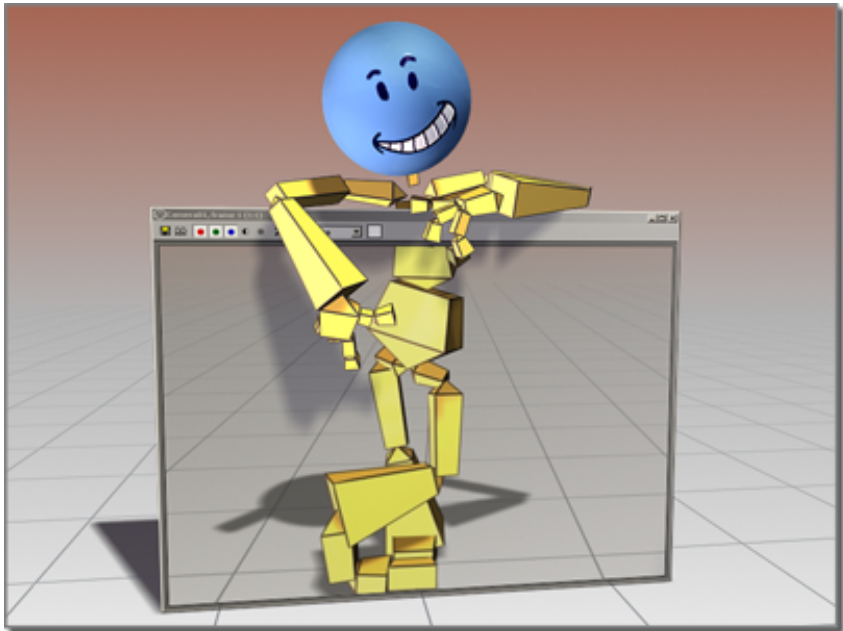

Bones can be renderable.

### **Object Properties for Bones**

In addition to visual properties, bones have behavioral properties. The controls for these are located on the [Bone Tools floater](#) on page 845 .

You can use these controls to turn other kinds of objects into bones.

### **Using Constraints with Bones**

You can apply [constraints](#) on page 3212 to bones as long as an IK solver or method is not controlling the bones. If the bones have an assigned IK controller, you can constrain only the root of the hierarchy or chain. However, applying position controllers or constraints to a linked bone can cause undesirable effects, such as breaking of the bone chain.

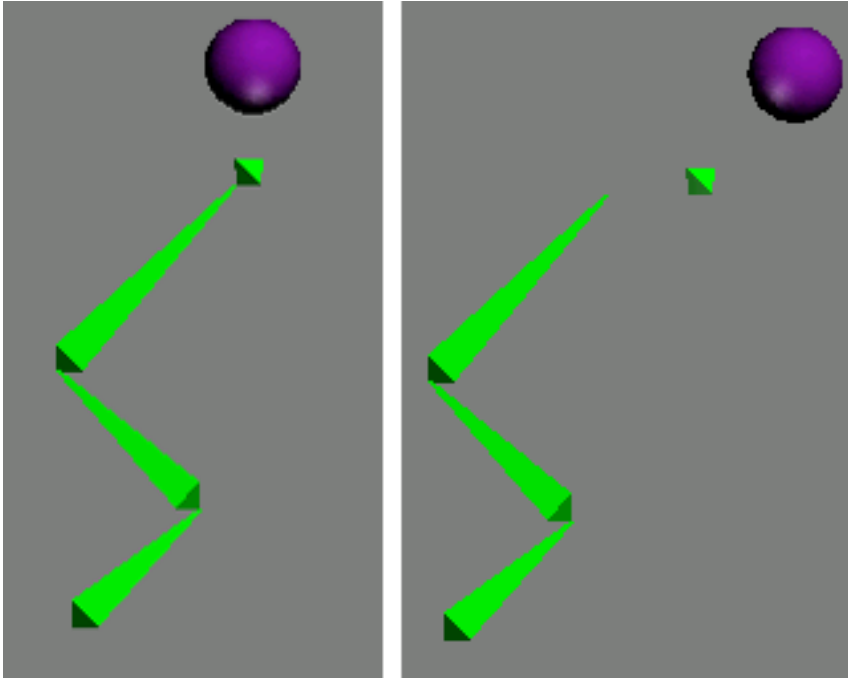

The “nub” bone at the end of the chain has a Spring controller applied to it. The Spring controller is connected to an animated sphere.

**Right:** The sphere's movement breaks the bone chain.

To avoid this problem, don't apply position controllers directly to child bones. Instead, create an IK chain and apply the controller to the IK chain's end effector.



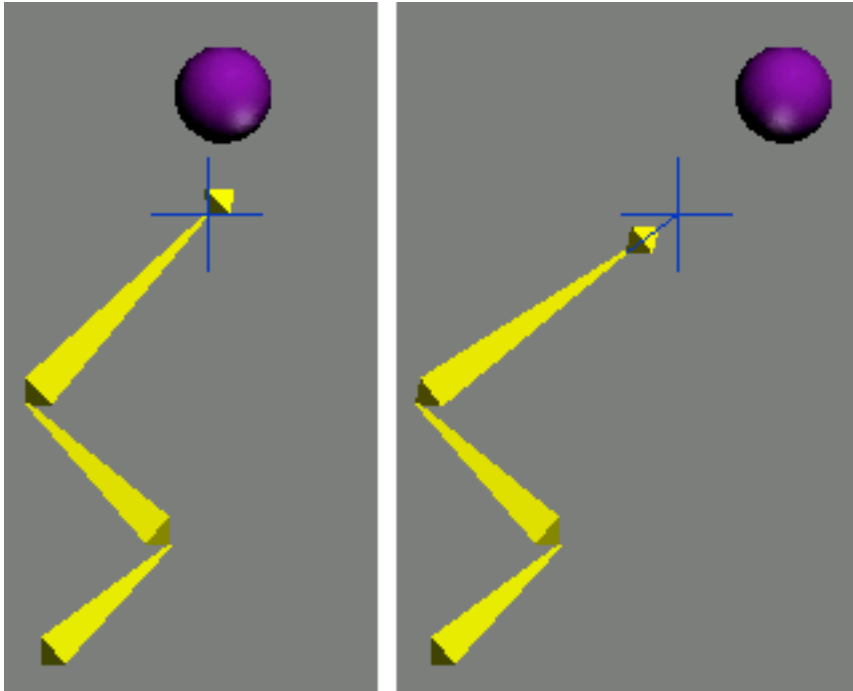



A IK chain has been applied, connecting the end nub to its parent bone. The IK chain's end effector is connected to the ball by a Spring controller.

**Right:** Now when the sphere moves, the IK chain prevents the bones from breaking.

Constraints and controllers that affect orientation only, such as Orientation or Look At, do not present this problem when applied to child bones.

## Procedures

To create a bones system:



- 1   On the Create panel, click Systems, and then click Bones.  
You can also access Create Bones through the Bone Tools rollout.
- 2 Click in a viewport.  
This creates a joint that is the base of the bone's hierarchy.
- 3 Drag to define the length of the second bone.

- 4 Click to set the length of the second bone, and then drag to create the third bone. Drag and click to continue creating new bones.
- 5 Right-click to end creation.

3ds Max creates a small “nub” bone at the end of the hierarchy. This bone is used when assigning an IK chain.

The first bone you create is at the top of the hierarchy. The last bone you create is at the bottom. For more about linked objects, see the [Hierarchy Panel](#) on page 7453 .

#### To create a bones hierarchy with an IK solver automatically applied:

- 1   In the Create panel, click Systems, and then click Bones.
- 2 In the IK Chain Assignment rollout, select an IK solver from the list.
- 3 Turn on Assign To Children.
- 4 In a viewport, click and drag to create the bones. Right-click to end bone creation.

After the bones are created, the chosen IK solver is applied to them.

#### To edit the appearance of a bone:

- 1 Select a bone.
- 2  Click the Modify tab on the command panel.
- 3 Change settings in the Bone Parameters rollout.

#### To change the length of bones after they’ve been created:

---

**IMPORTANT** Repositioning a bone affects its length visually. More importantly, it affects the bone’s pivot position. The length of the bone is only a visual aid drawn between each bone’s pivot point. A bone has only one pivot. The bone you see visually is connecting its pivot point to the next bone’s pivot point.

---

- 1 Choose Animation menu > Bone Tools.
- 2 On the Bone Tools dialog, click Bone Edit Mode.
- 3 Move the child of the bone you want to change. The length of its immediate parent changes to reach the child bone.

- 4 Turn off Bone Edit Mode when you are finished editing the bones.

**To add fins to bones:**

- 1 Select the bone.
- 2 Choose Animation menu > Bone Tools.
- 3 Select the bones to which you want to add fins.
- 4 In the Fin Adjustment Tools rollout, turn on Side Fins, Front Fin or Back Fin.
- 5 Adjust the size and appearance of the fins with the appropriate spinners.

---

**NOTE** You can also add fins to an individual bone on the Modify panel.

---

## Interface

### IK Chain Assignment rollout (creation time only)

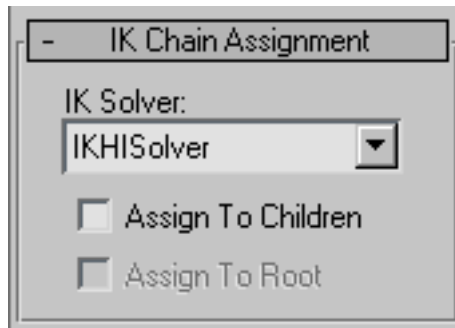

Provides the tools to quickly create a bone chain with an IK solver automatically applied. Also allows for bone creation with no IK solver.

**IK Solver drop-down list** Specifies the type of IK solver to be automatically applied if Assign To Children is turned on.

**Assign To Children** When on, assigns the IK solver named in the IK solver list to all the newly created bones except the first (root) bone. When off, assigns a standard [PRS Transform controller](#) on page 3145 to the bones. Default=off.

---

**NOTE** Choosing the SplineIKSolver and turning on Assign To Children causes the [Spline IK Solver dialog](#) on page 3376 to appear after bones have been created.

---

**Assign To Root** When on, assigns an IK solver to all the newly created bones including the first (root) bone.

Turning on Assign To Children also automatically turns on Assign To Root.

### **Bone Parameters rollout (creation and modification time)**

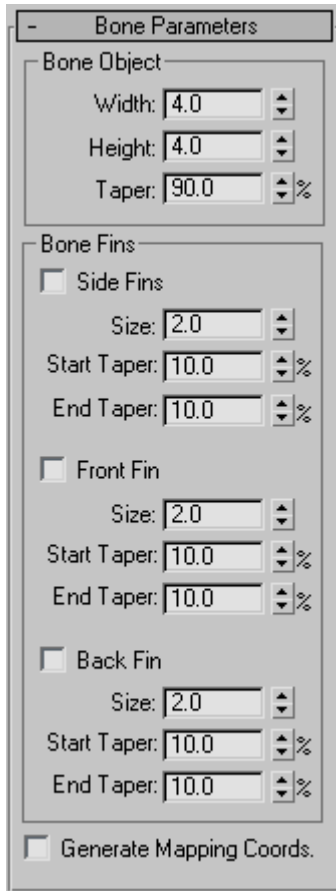

These controls change the appearance of the bones.

## **Bone Object group**

**Width** Sets the width of the bone to be made.

**Height** Sets the height of the bone to be made.

**Taper** Adjusts the taper of the bone shape. A Taper of 0 produces a box-shaped bone.

## **Bone Fins group**

**Side Fins** Lets you add a set of fins to the sides of the bones you create.

- **Size** Controls the size of the fin.
- **Start Taper** Controls the start taper of the fin.
- **End Taper** Controls the end taper of the fin.

**Front Fin** Lets you add a fin to the front of the bone you create.

- **Size** Controls the size of the fin.
- **Start Taper** Controls the start taper of the fin.
- **End Taper** Controls the end taper of the fin.

**Back Fin** Lets you add a fin to the back of the bone you create.

- **Size** Controls the size of the fin.
- **Start Taper** Controls the start taper of the fin.
- **End Taper** Controls the end taper of the fin.

**Generate Mapping Coords** Creates mapping coordinates on the bones. Since the bones are renderable, they can also have materials applied, which can use these mapping coordinates.

## **Using Objects as Bones**

Select a linked object or multiple objects linked to each other. > Animation menu > Bone Tools > Object Properties rollout > Bone On toggle

You can use arbitrary objects such as cylinders or boxes as bones, controlling their animation as if they were bones in a [bones system](#) on page 831 . You can apply an [IK solver](#) on page 3307 to the boned objects.

To use objects as bones, select them and then turn on the Bone On toggle on the Object Properties rollout of the [Bone Tools dialog](#) on page 845 .

---

**WARNING** Turning on Freeze Length has no visible effect unless you transform the *child* of the object to which Freeze Length is applied.

---

Once you've set objects to function as bones, applying an IK solution behaves as it does for standard bone objects. The geometry of the boned objects can stretch or squash during animation.

## Procedures

### To use objects as bones:

1  Link the objects you want to display as bones.

2  Select all of these objects.

---

**NOTE** You can set a single object to work as a bone, but this doesn't have much use.

---

3 Choose Animation menu > Bone Tools.  
The floating Bone Tools dialog is displayed.

4 On the Object Properties rollout, turn on Bone On.  
3ds Max now treats the selected objects as bones.

5  Select the object to use as the start of the IK chain.

6 Choose Animation > IK Solvers > HI Solver.  
You can choose a different IK solver, but the HI Solver is the preferred choice.

7 Click to select the end of the IK chain.  
Now when you transform the boned objects, their movement is governed by the IK solver.

## Bone Tools

Animation menu > Bone Tools

This command opens the Bone Tools floater, which provides functions for working with bones. The floater contains three rollouts, described in these topics:

[Bone Editing Tools Rollout](#) on page 845

[Fin Adjustment Tools Rollout](#) on page 849

[Object Properties Rollout \(Bone Tools\)](#) on page 851

## Bone Tools Rollouts

### Bone Editing Tools Rollout

Animation menu > Bone Tools > Bone Tools floater > Bone Editing Tools rollout

Controls on the Bone Editing Tools rollout let you create and modify bone geometry and structure, and set bone color for one or more bones.

**See also:**

■ [Bones System](#) on page 831

## Interface

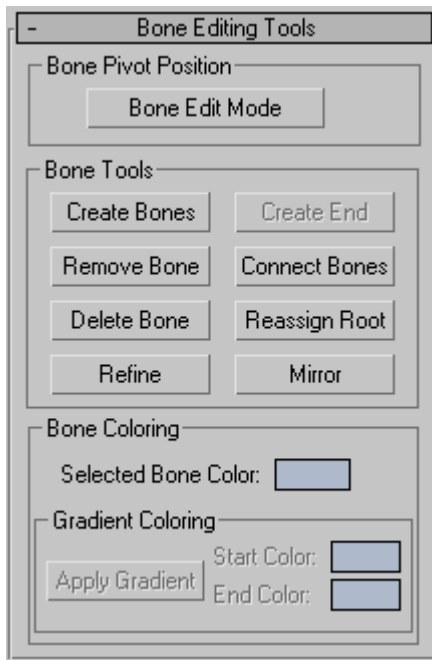

### Bone Pivot Position group

**Bone Edit Mode** Lets you change the lengths of bones and their positions relative to one another.

When this button is on, you can change the length of a bone by moving its child bone. In effect, you can scale or stretch a bone by moving its child bone while in this mode. You can use this tool both before and after assigning an IK chain to the bone structure.

When Bone Edit Mode is on, you cannot animate, and when Auto Key or Set Key is on, Bone Edit Mode is unavailable. Turn off Auto/Set Key to edit bones.

---

**NOTE** Moving a bone in Bone Edit mode affects the length of *both the child and its parent*. If the bones aren't spatially aligned in the usual way (for example, if you are using other objects as bones), this might have unexpected results.

---



## **Bone Tools group**

**Create Bones** Begins the bone-creation process. Clicking this button is the same as clicking Create panel > Systems > [Bones](#) on page 831 .

**Create End** Creates a nub bone at the end of the currently selected bone. If the selected bone is not at the end of a chain, the nub is linked in sequence between the currently selected bone and the next bone in the chain.

**Remove Bone** Removes the currently selected bone. The bone's parent bone is stretched to reach the removed bone's pivot point, and any children of the removed bone are linked to its parent. Any IK chains that included the removed bone will remain intact.

**Connect Bones** Creates a connecting bone between the currently selected bone and another bone. When you click this button, a dotted line appears in the active viewport from the first selected bone. Move the cursor to another bone to create a new connecting bone. The first selected bone will become a parent to the connecting bone, which is in turn a parent to the second selected bone.

**Delete Bone** Deletes the currently selected bone, removing all its parent/child associations. A nub is placed at the end of the deleted bone's parent. Any IK chains that included this bone become invalid.

**Reassign Root** Makes the currently selected bone the root (parent) of the bone structure.

If the current bone is the root, clicking this has no effect. If the current bone is the end of the chain, the chain is completely reversed. If the current bone is in the middle of the chain, the chain becomes a branching hierarchy.

**Refine** Splits a bone in two. Click Refine, and then click a bone where you want it to split.

**Mirror** Opens the Bone Mirror dialog (see following), which lets you create mirror copies of selected bones without changing the sign of the bones' scale. Instead, Mirror flips one of the bone axes: Y or Z. You can specify the mirroring axis and the flip axis with the dialog controls.

## Bone Mirror Dialog

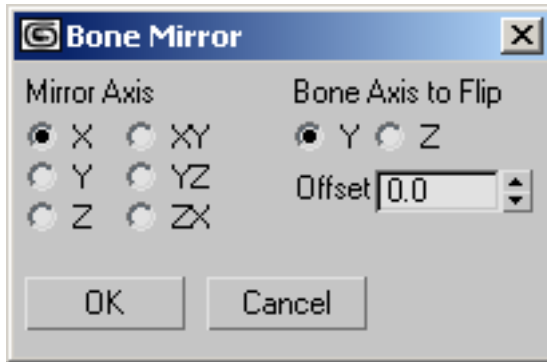

Opens when you click the Mirror button. Use it to specify the mirroring axis, the flip axis, and an offset value.

While the dialog is open, you can see a preview of the mirrored bone(s) in the viewports. Click OK to create the bones, or Cancel to prevent creation.

**Mirror Axis** Choose an axis or plane about which the bones will be mirrored: X/Y/Z or XY/YZ/ZX.

**Bone Axis to Flip** To avoid creating a negative scale, choose the bone axis to flip: Y or Z.

**Offset** The distance between the original bones and the mirrored bones. Use this to move the mirrored bones to the other side of the character.

## Bone Coloring group

**Selected Bone Color** Sets the color for selected bones.

**Apply Gradient** Applies a gradient color across several bones based on the Start Color and End Color values. This option is available only when two or more bones are selected. The Start Color is applied to the highest parent bone in the selected chain, while the End Color is applied to the last child object in the selected chain. Intermediate colors in the gradient are applied to bones in between.

**Start Color** Sets the starting color for the gradient.

**End Color** Sets the ending color for the gradient.

## Fin Adjustment Tools Rollout

Animation menu > Bone Tools > Bone Tools floater > Fin Adjustment Tools rollout

Controls on the Fin Adjustment Tools rollout are for adjusting some aspects of bone geometry, including fins.

### Interface

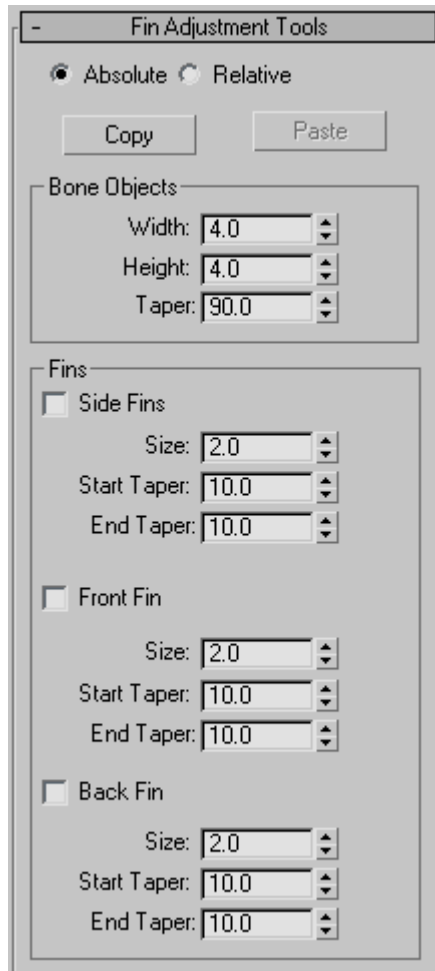

**Absolute** Sets the fin parameters as absolute values. Use this option to set the same fin values for all selected bones.

**Relative** Sets the fin parameters relative to their current values. Use this option to retain size relationships between bones with different-sized fins.

**Copy** Copies the bone and fin settings for the currently selected bone, in preparation for pasting to another bone.

**Paste** Pastes the copied bone and fin settings to the currently selected bone.

### **Bone Objects group**

**Width** Sets the width of the bone.

**Height** Sets the height of the bone.

**Taper** Adjusts the taper of the bone shape. A Taper with a 0 value produces a box-shaped bone. Higher values pinch the bone where it joins its child bone, while lower values expand that end of the bone.

### **Fins group**

**Side Fins** Adds side fins to selected bones.

- **Size** Controls the size of the fin.
- **Start Taper** Controls the start taper of the fin.
- **End Taper** Controls the end taper of the fin.

**Front Fin** Adds front fins to selected bones.

- **Size** Controls the size of the fin.
- **Start Taper** Controls the start taper of the fin.
- **End Taper** Controls the end taper of the fin.

**Back Fin** Adds fins to the backs of selected bones.

- **Size** Controls the size of the fin.
- **Start Taper** Controls the start taper of the fin.
- **End Taper** Controls the end taper of the fin.

## Object Properties Rollout (Bone Tools)

Animation menu > Bone Tools > Bone Tools floater > Object Properties rollout

Controls on the Object Properties rollout for bones let you turn other objects into bones. They also control bone rigidity and alignment.

---

**NOTE** You can reset the scale of bones with the Reset Scale option.

---

### Interface

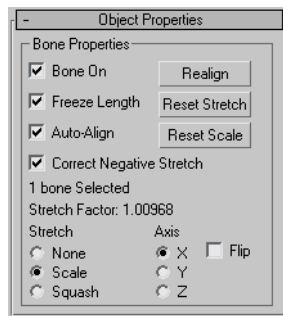

**Bone On/Off** When turned on, the selected bone or object behaves as a bone. Turning this option off causes the object to stop behaving like a bone: there is no auto alignment or stretching. Default=on for bone objects, off for other kinds of objects.

---

**NOTE** Turning this option on doesn't immediately cause objects to align or stretch. However, future transforms of children can cause rotation and stretching.

---

**Freeze Length** When turned on, the bone maintains its length. When turned off, the bone's length is based on the translation of its child bone. This option is available only if Bone On is on. Default=on.

---

**WARNING** When you turn on Freeze Length, this has no visible effect unless you transform the *child* of the object to which Freeze Length is applied.

---

**Auto-Align** When turned off, the bone's pivot point doesn't align to its child object. The translation of a child bone will not be converted into rotation of the parent. Instead, the child is allowed to move away from the parent's X axis. This option is available only if Bone On is on. Default=on.

---

**NOTE** Changing the Auto-Align state does not have an immediate visual effect on the skeleton. It affects future behavior when bones are moved.

---

**Correct Negative Stretch** When turned on, any stretching of the bone that results in a negative scale factor will be corrected to a positive number. This option is available only if Bone On is on. Default=on.

**Realign** Causes the bone's X axis to realign and point at the child bone (or the average pivot of multiple children). Normally this alignment is maintained, and there is no need to use this option. However, it is possible for the bones to come out of alignment by turning off Auto-Align and moving a child bone. Use Realign to align the bone back to its child. This option is available only if Bone On is on.

**Reset Stretch** Stretches the bone to reach its child object if the child has been moved away from the bone. This option is available only if Bone On is on.

**Reset Scale** Resets a stretched bone's internally calculated scale to 100% on each axis. Using this option avoids unexpected behavior due to objects which are both linked and scaled. This option has no visual effect on the bone. This option is available only if Bone On is on.

### Stretch Factor Information

Under the Correct Negative Stretch options is a text display giving information about the number of bones selected and the respective stretch factor for all three axes. If more than one bone is selected, the Stretch Factor text displays *undefined*.

---

**NOTE** The Stretch Factor text only updates when you are in [Bone Edit Mode](#) on page 845 .

---

### Stretch and Axis Options

**Stretch** Determines what kind of stretch takes place when the child bone is transformed and Freeze Length is off. Default=Scale.

- **None** No stretch takes place.
- **Scale** Lets the bone scale. The stretch happens along one axis.
- **Squash** Lets the bone squash. The bone gets fatter as it gets shorter, and thinner as it gets longer.

**Axis** Determines the axis used for the stretch.

- **X/Y/Z** Choose the axis for scaling or squashing.
- **Flip** Flips the stretch along the selected axis.

## Ring Array System

Create panel > Systems > Ring Array button

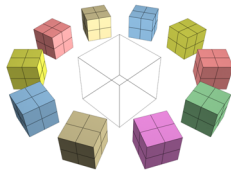

The Ring Array object consists of a [dummy object](#) on page 2531 surrounded by a ring of boxes. You can arrange the boxes in the ring along a sine curve, vary their number, and animate the ring array's parameters. You can also replace the boxes with other objects using Track View, as described in the Procedures section, below.



Example of ring array

### Procedures

To create the ring array system:

- 1   On the Create panel, click Systems, and then click Ring Array.
- 2 Drag in a viewport to set the center and radius of the array.  
A dummy object appears at the center. By default, four boxes are evenly spaced in a circle around it.

To animate the ring array:

- 1  Turn on Auto Key.
- 2 Move to a nonzero frame.

- 3 Adjust the ring array parameters.  
You can't animate the number of boxes in the ring.
- 4 Repeat steps 2 and 3 for additional keyframes.

---

**NOTE** To animate the ring array after creation, use the Motion panel, not the Modify panel.

---

**To put other kinds of objects in the ring:**

You can use either version of Track View: Curve Editor or Dope Sheet.

- 1 In the Track View Controller window, click the name of object container of the object to put in the ring.  
The name highlights.



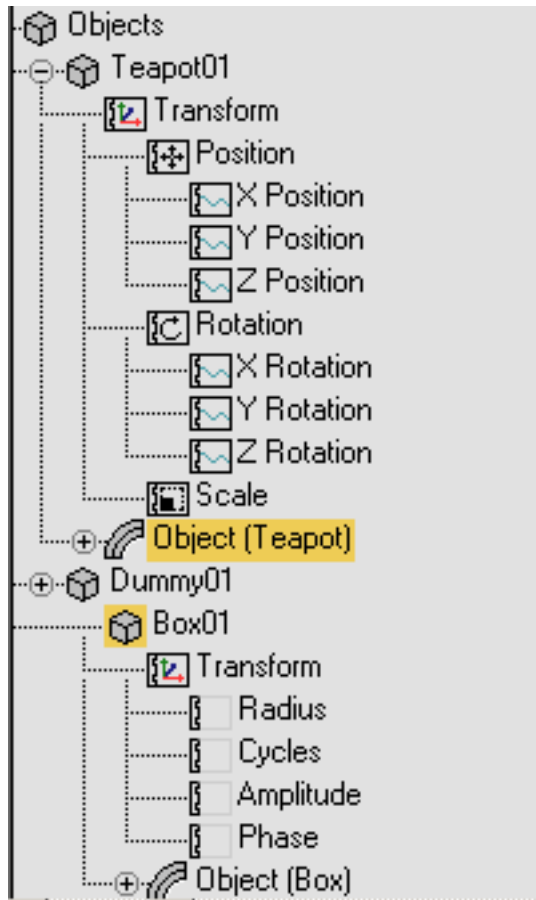

- 2 Still in the Controller window, right-click and choose Copy from the menu.
- 3 Highlight the object container of one of the ring array boxes.

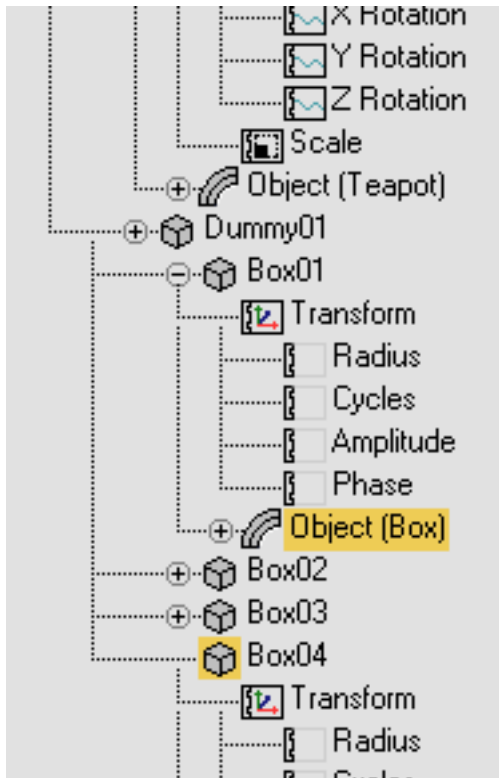

- 4 Right-click and choose Paste.
- 5 In the Paste dialog, choose Copy or Instance. Optionally, to replace all the boxes with the copied object, turn on Replace All Instances. Click OK.

The box or boxes are replaced with the copied object.

---

**TIP** To see the replacement objects, you might need to refresh the viewports.

---

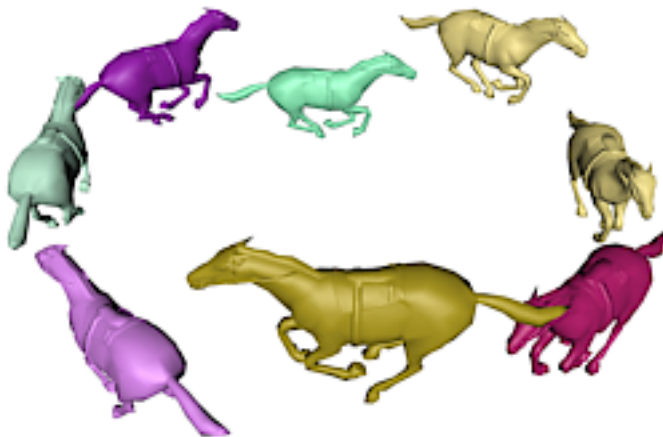
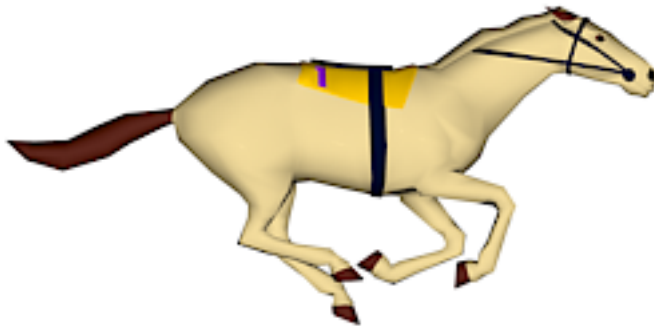

Top: Object substituted for boxes in array

Bottom: The result

## Interface

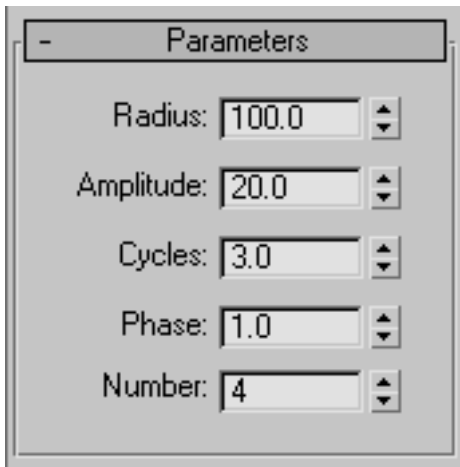

These parameters control ring arrays. To adjust and animate the ring array after creation, select one of the array objects (not the dummy), and then go to the Motion panel, not the Modify panel.

**Radius** Sets the radius of the ring. You set the initial Radius value when you drag to create the ring array.

**Amplitude** Sets the amplitude of the ring's sine curve, in active units. Amplitude is a height offset from the local origin of the center dummy object.

**Cycles** Sets the number of cycles in the ring's sine curve. When Cycles is 0.0, the ring is flat. When Cycles is 1.0, the ring is tilted. Greater values increase the number of peaks in the curve.

**Phase** Offsets the phase of the wave. That is, it has the effect of moving the wave along the circumference of the ring. Whole values have no effect; only fractional values do.

**Number** Sets the number of boxes in the ring.

# Moving, Rotating, and Scaling Objects

# 7

To change an object's position, orientation, or scale, click one of the three transform buttons on the main toolbar or choose a transform from a shortcut menu. Apply the transform to a selected object using the mouse, the status bar Coordinate Display fields, a type-in dialog, or any combination of the above.

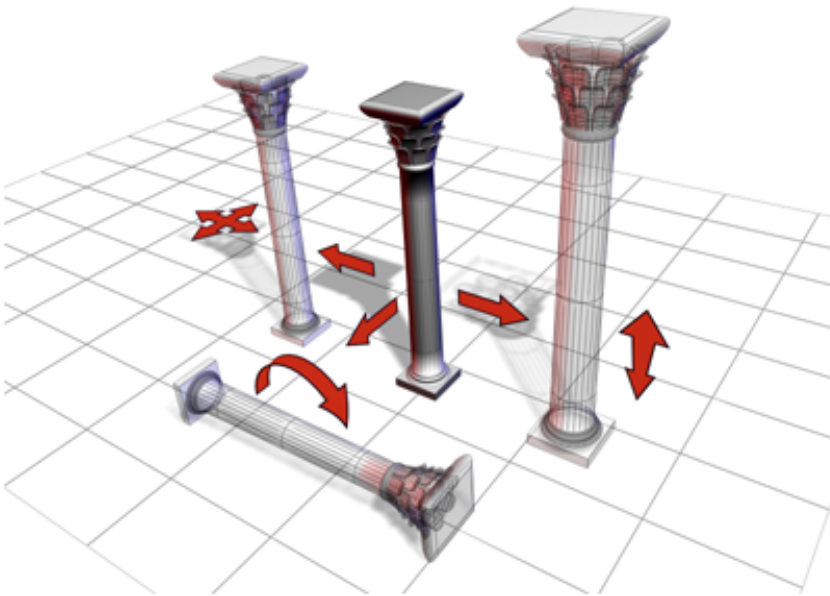

The column can be moved, rotated, and scaled.

These topics describe how to use and animate transforms, with procedures:

[Using Transforms](#) on page 862

[Using Transform Gizmos](#) on page 865

[Transform Type-In](#) on page 874

[Animating Transforms](#) on page 877

[Transform Managers](#) on page 879

[Specifying a Reference Coordinate System](#) on page 881

[Choosing a Transform Center](#) on page 882

[Using the Axis Constraints](#) on page 884

[Transform Commands](#) on page 887

[Transform Coordinates and Coordinate Center](#) on page 896

[Transform Tools](#) on page 909

## Scaling and Dimensions

If you scale an object and later check its base parameters in the Modify panel, you see the dimensions of the object before it was scaled. The base object exists independently of the scaled object that is visible in your scene.

You can use the [Measure utility](#) on page 2597 to measure the current dimensions of an object that has been scaled or changed by a modifier.

**See also:**

- [Creating Copies and Arrays](#) on page 953
- [Using +Clone](#) on page 968

# Axis Tripod and World Axis

Two visual aids in 3ds Max give you information about your current orientation in the workspace.

## Axis Tripod

If no transform tool is active, an axis tripod appears in the viewports whenever you select one or more objects, to assist you visually in your transforms. When a transform tool *is* active, the [transform gizmo](#) on page 865 appears instead, unless you've turned it off.

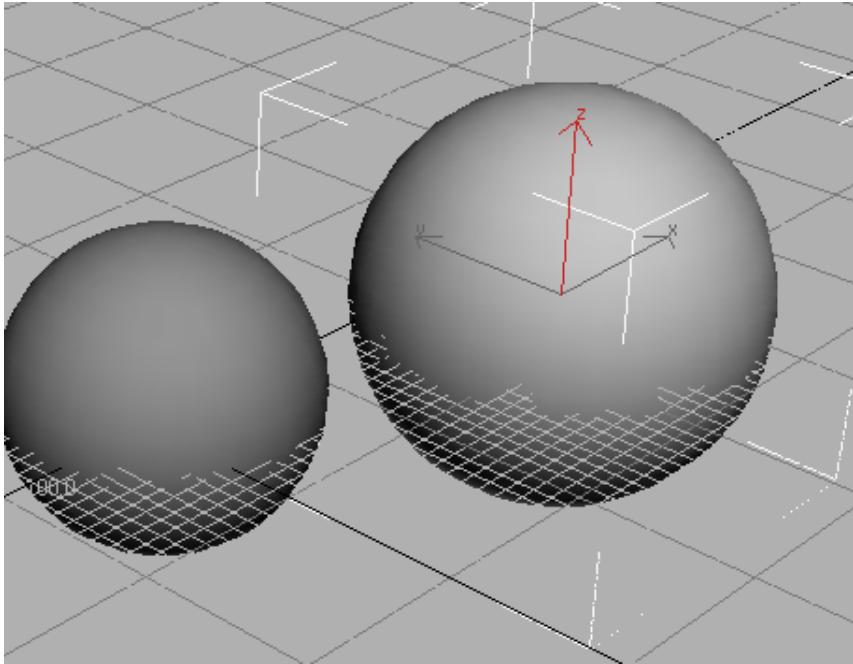

**The axis tripod appears when the transform gizmo is inactive.**

The axis tripod consists of three lines, labeled X, Y, and Z, and shows you three things:

- The orientation of the tripod reveals the orientation of the current reference coordinate system.
- The location of the junction of the three axis lines shows you where your transform center is.
- The highlighted red axis lines show you the axis or axes to which the transform is constrained. For example, if only the X axis line is red, you can move objects only along the X axis.

### **World Axis**

In the lower-left corner of each viewport you can find the world axis, which shows the current orientation of the viewport with respect to world coordinate system. The world axis colors are red for X, green for Y, and blue for Z. You can toggle the display of the world axis in all viewports by turning off Display

World Axis, on the [Viewports panel](#) on page 7545 of the Preference Settings dialog.

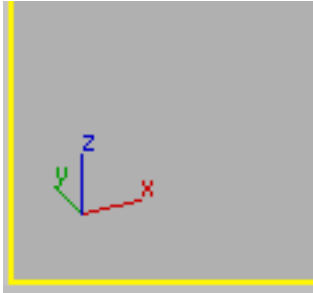

The world axis shows the current viewport orientation.

See also:

- [Using Transform Gizmos](#) on page 865
- [Transform Managers](#) on page 879

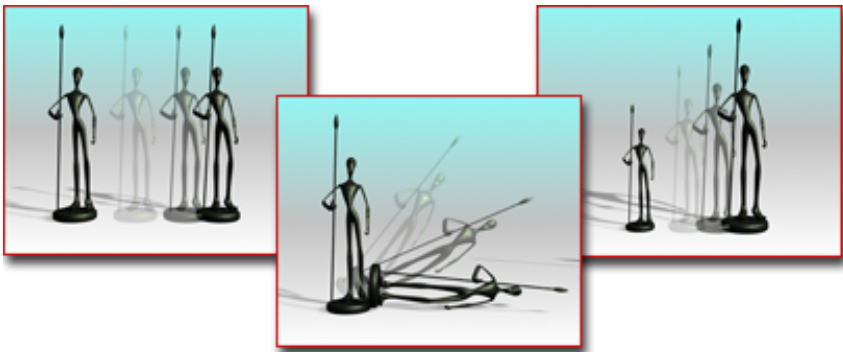

## Using Transforms



Changing a model by changing its position, rotation, or scale



A transform is an adjustment of an object's position, orientation, or scale, relative to the 3D world (or world space) in which you're working. You can apply three types of transform to an object:

-  [Position](#) on page 888
-  [Rotation](#) on page 889
-  [Scale](#) on page 891

This section presents these brief topics designed to help you quickly start learning how to transform objects, and how to animate your transforms:

[Using Transform Gizmos](#) on page 865

[Animating Transforms](#) on page 877

[Transform Managers](#) on page 879

[Specifying a Reference Coordinate System](#) on page 881

[Choosing a Transform Center](#) on page 882

[Using the Axis Constraints](#) on page 884

### **Failure to Move or Rotate**

In some cases, an object might fail to move or rotate, even when the proper button is on and the object is selected. This could be due to one of the following reasons:

- The object is frozen. See [Selecting Objects](#) on page 131 .
- A transform controller has been assigned to the object. See [Animation Controllers](#) on page 3058 .
- Inverse Kinematics mode is on and the preference called Always Transform Children of the World is off. See [Introduction to Inverse Kinematics \(IK\)](#) on page 3299 .

## Procedures

To transform an object using the Main toolbar :



- 1 On the Main toolbar , click one of the three transform buttons: [Select And Move](#) on page 888 , [Select And Rotate](#) on page 889 , or [Select And Scale](#) on page 891 . These buttons are usually referred to as Move, Rotate, and Scale.
- 2 Position the mouse over the object you want to transform.
  - If the object is already selected, the cursor changes to indicate the transform.
  - If the object is not selected, the cursor changes to a small plus sign to show that the object can be selected.
- 3 Drag the mouse to apply the transform.

If you drag the mouse over an unselected object, it becomes selected and is also transformed.

You can use the Transform gizmo to easily restrict transforms to one or two axes. See [Using Transform Gizmos](#) on page 865 .

To cancel a transform:

- Right-click while you're dragging the mouse.

To transform an object from the quad menu:

- 1 Right-click a selected object. The [quad menu](#) on page 7300 lists the three transforms.
- 2 Choose one of the transforms. The equivalent transform button is selected on the main toolbar.
- 3 Drag the object to apply the transform.

To use transform type-in:

- 1 Choose Tools menu > Transform Type-In to display the dialog.
- 2 Apply a transform to a selected object.

- 3 You can do any of the following, switching from one to the other as required.
  - Type a value in an axis field and press Enter to apply the transform change to the selection.
  - Drag a spinner in an axis field to update the selection.
  - Drag the object to apply the transform and read the resulting change in the dialog.

For example, if Move is active, the dialog fields read out both the absolute and offset positions of the selected object in world space. If no object is selected, the fields turn gray.

#### To use transform type-in on the status bar:

- 1 Select an object or a group of objects.
- 2 On the Main toolbar, choose a transform (Move, Rotate, or Scale) to perform on the objects.
- 3 On the status bar, you can do any of the following, switching from one to another as required:



- Type a value in an axis field and press Enter to apply the transform change to the selection. The Absolute/Offset toggle, to the right of the X, Y, and Z fields, lets you switch between entering values that are absolute (in world space) or offset (relative to the selection's present position, orientation, and dimensions).
- Drag a spinner in an axis field to update the selection.
- Drag the object to apply the transform and read the resulting change in the X, Y, and Z fields.

---

**TIP** To see the Z field, drag the transform type-in portion of the toolbar while a pan hand is visible.

---

## Using Transform Gizmos

Select an object. > main toolbar > Click any transform button to display the object's Transform Gizmo icon.

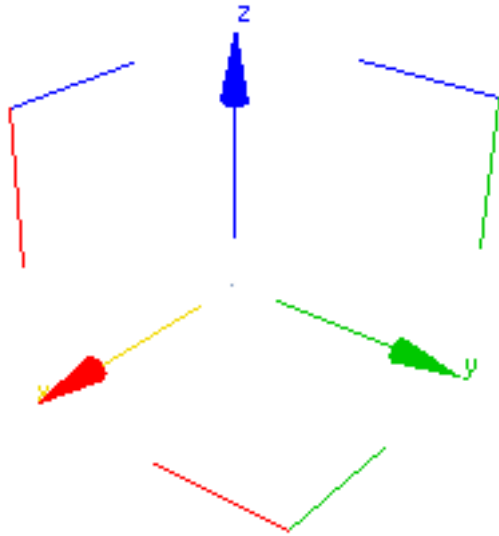

Move gizmo

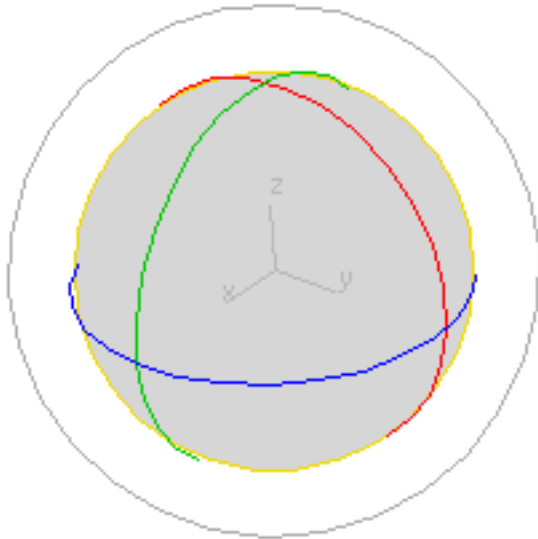

Rotate gizmo

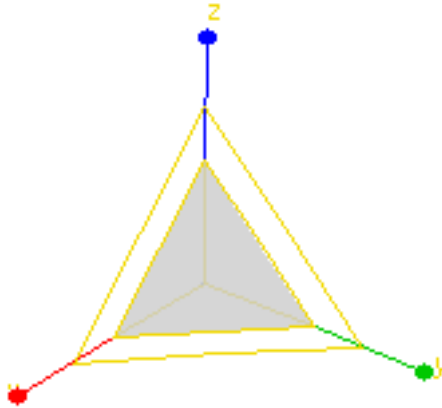

### Scale gizmo

The Transform gizmos are viewport icons that let you quickly choose one or two axes when transforming a selection with the mouse. You choose an axis by placing the mouse over any axis of the icon, and then drag the mouse to transform the selection along that axis. In addition, when moving or scaling an object, you can use other areas of the gizmo to perform transforms along any two axes simultaneously. Using a gizmo avoids the need to first specify a transform axis or axes on the [Axis Constraints toolbar](#) on page 7288 , and also lets you switch quickly and easily between different transform axes and planes.

A Transform gizmo appears when one or more objects are selected and one of the transform buttons ( [Select And Move](#) on page 888 , [Select And Rotate](#) on page 889 , or [Select And Scale](#) on page 891 ) is active on the main toolbar. Each transform type uses a different gizmo. By default, each axis is assigned one of three colors: X is red, Y is green, and Z is blue. The corners of the Move gizmo are assigned the two colors of the related axes; for example, the corner for the XZ plane is red and blue.

When you position the mouse over any axis, it turns yellow to indicate that it's active. Similarly, position the mouse over one of the plane handles, and both associated axes turn yellow. You can now drag the selection along the indicated axis or axes. Doing so changes the [Axis Constraints toolbar "Restrict to ..." setting](#) on page 884 .

### Move Gizmo

The Move gizmo includes plane handles, and the option to use a center box handle.

You can select any of the axis handles to constrain movement to that axis. In addition, the plane handles allow you to constrain movement to the XY, YZ, or XZ planes. The selection hotspot is within the square formed by the plane handles. You can change the size and offset of the handles and other settings on the [Gizmos panel](#) on page 7570 of the [Preferences dialog](#) on page 7534 .

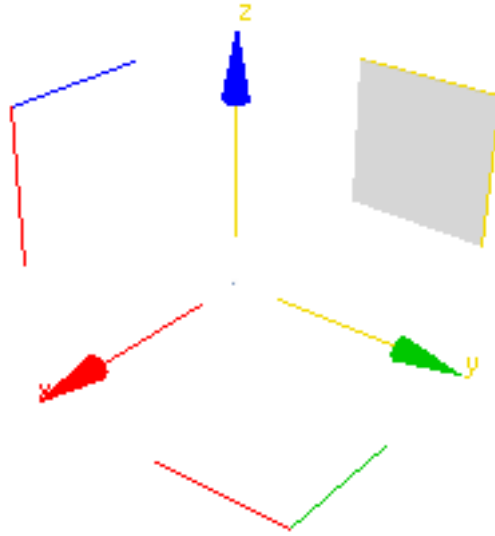

The Move gizmo with the YZ axes selected.

You can constrain translation to the viewport plane by dragging the center box. To use this optional control, turn on [Move In Screen Space](#) on page 7572 .

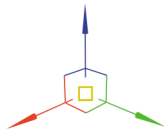

### Rotate Gizmo

The Rotate gizmo is built around the concept of a virtual trackball. You can rotate an object freely, about the X, Y, or Z axis, or about an axis perpendicular to the viewport.

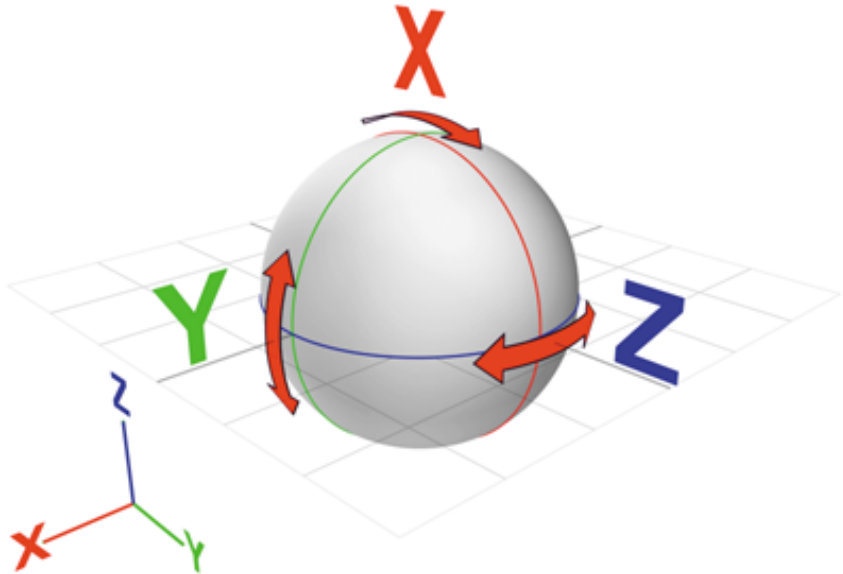

The axis handles are circles around the trackball. Drag anywhere on one of them to rotate the object about that axis. As you rotate about the X, Y, or Z axis a transparent slice provides a visual representation of the direction and amount of rotation. If you rotate more than  $360^\circ$ , the slice overlaps and the shading becomes increasingly opaque. The software also displays numerical data to indicate a precise rotational measurement.

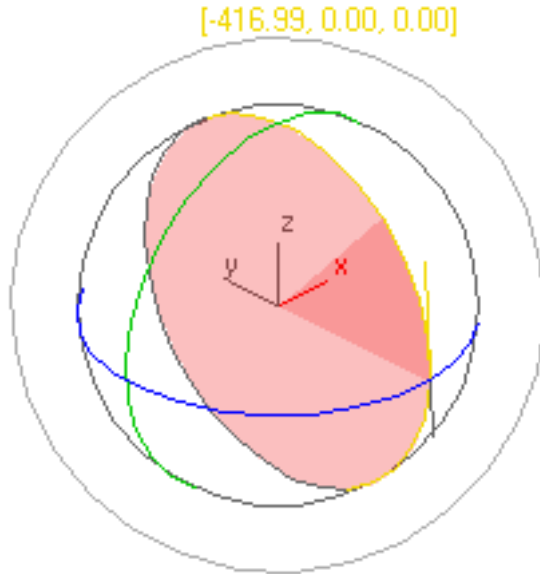

In addition to XYZ rotation, you can also use free rotation or the viewport handle to rotate objects.

Drag inside the Rotate gizmo (or the outer edge of the gizmo) to perform free rotation. Rotation should behave as if you were actually spinning the trackball.

The outermost circle around the Rotate gizmo is the Screen handle, which lets you rotate the object on a plane parallel to the viewport.

You can adjust settings for the Rotate gizmo on the [Gizmos panel](#) on page 7570 of the [Preferences dialog](#) on page 7534

### **Scale Gizmo**

The Scale gizmo includes plane handles and scaling feedback through the stretching of the gizmo itself.

The plane handles let you perform uniform and non-uniform scaling without changing your selection on the main toolbar:

- To perform Uniform scaling, drag in the center of the gizmo.



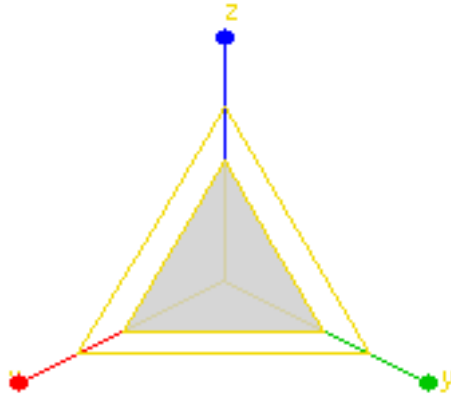

The Transform gizmo with Uniform scaling selected.

- To perform non-uniform scaling, drag on a single axis or a plane handle.

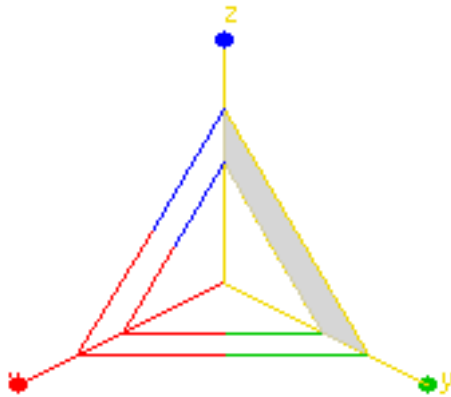

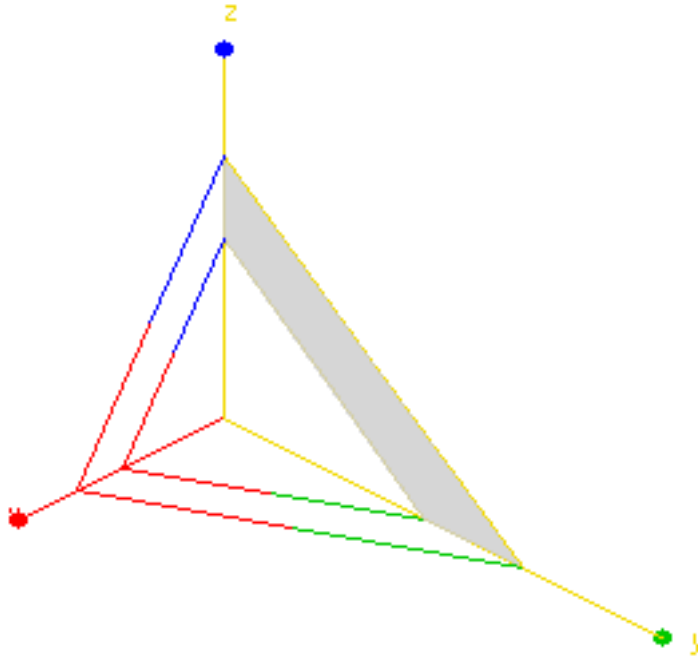

**Top: The Scale gizmo with the YZ plane handle selected**

**Bottom: Non-uniform scaling on the YZ plane**

---

**NOTE** To perform a Squash operation, you must choose [Select and Squash](#) on page 894 on the main toolbar.

---

The Scale gizmo provides feedback by changing its size and shape; in the case of a uniform scale operation, it will grow or shrink as the mouse moves, and during non-uniform scaling, the gizmo will stretch and deform while dragging. However, once the mouse button is released, the gizmo returns to its original size and shape.

You can adjust settings for the Scale gizmo on the [Gizmos panel](#) on page 7570 of the [Preferences dialog](#) on page 7534

### **Notes**

Using a Transform gizmo sets the default axis constraint to the last axis or plane you used.



If Lock Selection Set is on, you can drag anywhere in the viewport to transform the object. Dragging an axis, however, still applies the constraint along that axis.

**See also:**

- [Gizmos Preferences](#) on page 7570

## Procedures

**Example: To explore use of the transform gizmo:**

-  1 Reset the program, then create a sphere, and then click the Select and Move button.  
The Transform gizmo appears at the center of the sphere. Because the default axis constraint on the Axis Constraints toolbar is XY Plane, the X and Y shafts of the Transform gizmo are yellow (active), while the Z shaft is blue.
-  2 Use [Arc Rotate](#) on page 7395 to adjust the Perspective view for a better view of the Transform gizmo. When you're done, right-click to return to Select and Move .
- 3 Point to any part of the sphere away from the Transform gizmo, and drag to confirm that the sphere is locked to the XY plane.
- 4 Point to the Z-axis shaft, and drag.  
The Z shaft turns yellow, the X and Y shafts turn red and green, respectively, and the sphere moves along the Z axis.
- 5 Point to the Y shaft, and drag.  
The Y shaft turns yellow, and the sphere moves along only the Y axis.
- 6 Point to the red-and-green corner mark opposite the ends of the X and Y axes, and drag.  
The sphere moves along the XY plane.
- 7 Press the Spacebar to turn on [Selection Lock](#) on page 7324 .
- 8 Drag the mouse anywhere in a viewport away from the selection.  
The sphere moves along the XY plane.

9 Point to the X shaft, and drag.

The sphere moves along only the X axis.

Experiment with other transformations, such as rotation and scale. Try different reference coordinate systems. Experiment with sub-object transformations.

## Interface

**Change default colors** Customize menu > Customize User Interface dialog > [Colors panel](#) on page 7505 > Gizmos Element > Active Transform Gizmo and Transform Gizmo X/Y/Z.

**Enable/disable Transform Gizmo** Customize menu > Preferences > [Gizmos panel](#) on page 7570 > On check box.

---

**NOTE** When you turn off the Transform gizmo in Preferences, the standard axis tripod appears instead. To toggle display of either the gizmo or the tripod, press the X key or use Views menu > Show Transform Gizmo.

---

There are additional controls for each Gizmo in the [Gizmos panel](#) on page 7570 of the Preferences dialog.

## Transform Type-In

Status bar > Transform Type-In

Edit menu > Transform Type-In

F12

Main toolbar > Right-click Select And Move, Select And Rotate, or one of the Select And Scale buttons.

Transform Type-In is a dialog that lets you enter precise values for move, rotate, and scale [transforms](#) on page 7958 . You can use Transform Type-In with anything that can display an axis tripod or Transform gizmo.

You can also use the Transform Type-In boxes on the [status bar](#) on page 7308 . To use the Transform Type-In boxes on the status bar, simply enter the appropriate values in the boxes and press Enter to apply the transformation. You can alternate between entering absolute transform values or offset values by clicking the Relative/Absolute Transform Type-In button to the left of the transform boxes.

If you choose Transform Type-In from the Edit menu, press F12, or right-click one of the transform toolbar buttons, Transform Type-In pops up as a dialog. The title of the dialog reflects the active transform. If Rotate is active, the dialog's title is Rotate Transform Type-In and its controls affect rotation. If Scale is active, its title is Scale Transform Type-In, and so on. You can enter either absolute transform values or offset values.

In most cases, both absolute and offset transforms use the active [reference coordinate system](#) on page 896. The exceptions are View, which uses the World coordinate system, and Screen, which uses World for absolute moves and rotations. Also, absolute scaling always uses the Local coordinate system. The dialog labels change to show the reference coordinate system being used.

When you use the Transform Type-In at a sub-object level, you transform the transform gizmo of the sub-object selection. So, for example, the absolute position values represent the absolute world position of the transform gizmo. If you've selected a single vertex, it's the absolute world position of the vertex.

If multiple vertices are selected, the Transform gizmo is placed at the center of the selection, so the position you specify in the Transform Type-In sets the absolute position of the center of the selected vertices.

When multiple vertices are selected in Local transform mode, you end up with multiple transform gizmos. In this case, only the Offset control is available.

Because the axis tripods are not scaled, the Absolute Scale control is not available at the sub-object level. Only Offset is available.

When you use the Transform Type-In for Absolute rotation, the state of the Center flyout is respected. You can perform absolute rotations about the pivot point of the object, the selection center, or transform coordinate center. See [Choosing a Transform Center](#) on page 882.

### **Using Type-In with Sub-Object Selection**

You can use Transform Type-In with any sub-object selection or gizmo. The transform affects the axis tripod for the selection.

Absolute and offset world coordinates are those of the object's or selection's coordinate system, whose origin is indicated by the axis tripod. If multiple vertices are selected, the tripod is at the center of the selection and its location is given in world coordinates.

Because axis tripods cannot be scaled, Absolute Scale fields are unavailable when you are at a sub-object level.

See [Basics of Creating and Modifying Objects](#) on page 317 for information on sub-object selection and gizmos.

## Procedures

### To use transform type-in:

- 1 Select an object or a group of objects.
- 2 Choose a transform to perform on the objects (Move, Rotate, or Scale).
- 3 You can do any of the following, switching from one to another as required:
  - Type a value in an axis field and press Enter to apply the transform change to the object in the viewport.
  - Drag a spinner in an axis field to update the object in the viewport.
  - Drag the object to apply the transform and read the resulting change in the axis fields.  
For example, if Move is active, the fields read out both the absolute positions of the selected object in world space. If no object is selected, the fields turn gray.

## Interface

### Status bar

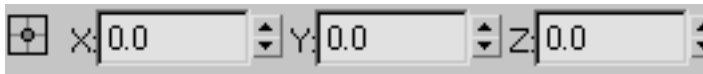

**Absolute/Offset Mode Transform Type-In** When this is off, the software treats values you enter into the X, Y, and Z fields as absolutes. When this is on, the software applies transform values you enter as relative to current values; that is, as an offset. Default=off.

**X, Y, and Z** Display and accept entry for values of position, rotation, and scale along each axis.

### Absolute group (Dialog)

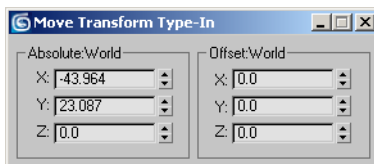

**X, Y, and Z** Display and accept entry for absolute values of position, rotation, and scale along each axis. Position and rotation are always displayed, as world scale is always local.

### **Offset group (Dialog)**

**X, Y, and Z** Display and accept entry for offsets of the position, rotation, and scale values along each axis.

Displayed offset values revert to 0.0 after each operation. For example, if you enter 45 degrees in a Rotate Offset field, when you press Enter, the software rotates the object 45 degrees from its previous position, increases the Absolute field value by 45 degrees, and resets the Offset field to 0.0.



Offset labels reflect the active reference coordinate system. The Offset can be Offset: Local, Offset: Parent, and so on. If you use Pick to select the reference coordinate system of a particular object, the Offset will be named with that object.

## **Animating Transforms**

You can animate changes in position, rotation, and scale (transforms) by turning on the Auto Key button and then performing the transform at any frame other than frame 0. This creates a key for that transform at the current frame.

**Example: To animate an object moving among three points:**

-  Turn on the [Auto Key button](#) on page 3007 .  
The Auto Key button and the highlight border around the active viewport both turn red.
- Drag the time slider to frame 25.
- Move the object from its current position (point A) to another location (point B).  
The software creates Move keys at frames 0 and 25. These appear on the [track bar](#) on page 7315 . The establishing key at frame 0 describes the object's original position, at point A. The key at frame 25 describes the object's position at point B.
- Drag the time slider to frame 50.

- 5 Move the object from point B to a third location (point C).  
The software creates a Move key at frame 50 that describes the object's position at point C.
- 6 Click the Auto Key button to stop recording.
- 7  Click the [Play button](#) on page 7355 .  
The object moves from point A to point B over frames 0 to 25, and then proceeds to point C over frames 26 to 50.
- 8  The Play button has turned into a Stop button; click Stop to stop playback.

You can combine different transforms in a single animation sequence, so that an object appears to move as it rotates and changes in size.

See [Animation Concepts and Methods](#) on page 3002 for more information on animation techniques.

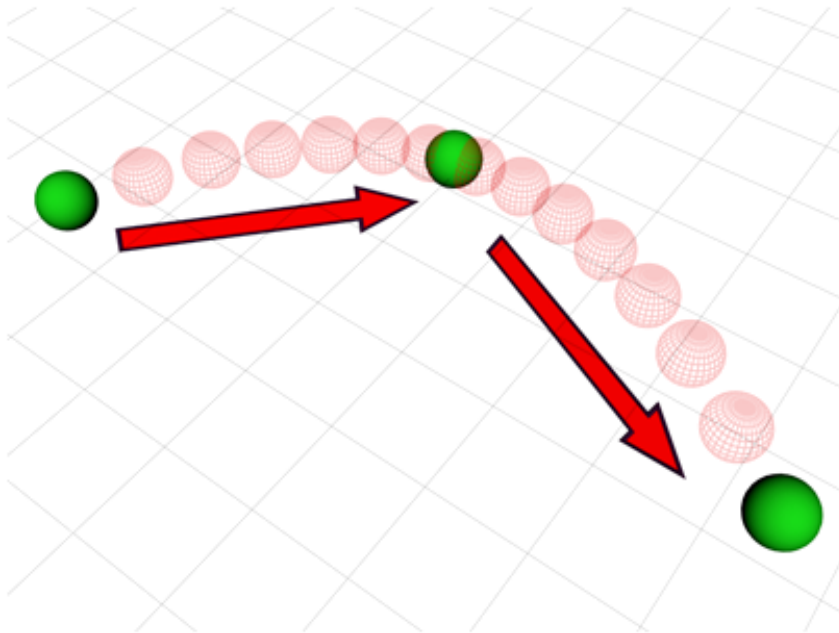

An object animated among three points



# Transform Managers

3ds Max provides three controls, collectively referred to as the transform managers, for modifying the action of the transform tools.

The transform manager controls are as follows:

- The [Reference Coordinate System drop-down list](#) on page 896 , which controls the orientation of the transform axes, is found to the right of the Move, Rotate, and Scale transform buttons on the main toolbar.
- The [Transform Center flyout](#) on page 904 , which controls the center about which the software applies the transform, is found to the right of the Reference Coordinate System drop-down list.
- The [Axis Constraint setting](#) on page 884 lets you restrict the transform to a single axis or two axes (that is, a plane). The axis constraint tools appear on the Axis Constraints toolbar, which is off by default. You can open the toolbar by right-clicking an empty spot on the main toolbar and choosing Axis Constraints from the menu.

---

**TIP** You can also restrict transforms with the [transform gizmos](#) on page 865 .

---

## Definitions

Certain terms are used in the description of transforms and the transform managers.

- An *axis* is a straight line along which an object is moved or scaled, or about which an object is rotated. When you work in 3D, you use three axes, labeled X, Y, and Z, which are oriented 90 degrees from each other.
- A *coordinate system* specifies the orientation of the X, Y, and Z axes used by a transform.  
For example, in the World coordinate system, as seen from the Front view, the X axis runs horizontally from left to right, the Y axis runs from back to front, and the Z axis runs vertically, from bottom to top.  
On the other hand, each object carries its own Local coordinate system. If the object has been rotated, its Local coordinate system might be different from the world coordinate system.
- The *transform center*, or pivot point, is the spot about which a rotation takes place, or to and from which scaling occurs.

Using the transform managers, you can specify any combination of axes, transform coordinate systems, and transform centers.

### Axis Tripod Icon

- An axis tripod appears in the viewports when you select one or more objects, to assist you visually in your transforms. This tripod consists of three lines, labeled X, Y, and Z, and shows you three things:
- The orientation of the tripod reveals the orientation of your coordinate system.
- The location of the junction of the three axis lines shows you where your transform center is.
- The highlighted red axis lines show you the axis or axes to which the transform is constrained. For example, if only the X axis line is red, you can move objects only along the X axis.

---

**NOTE** The Transform gizmo supplants the axis tripod for selections when a transform mode is active. Besides providing all of the above functions, it lets you specify the transform axis or axes without explicitly setting constraints; see [Using the Axis Constraints](#) on page 884 . For more on the Transform gizmo, see [Using Transform Gizmos](#) on page 865 .

---

You can toggle the display of the axis tripod in all viewports by choosing Views menu > Show Transform Gizmo, or by pressing the X key.

### Transform Manager Settings

The state of the three transform managers (coordinate system, center, and axis constraints) is stored with each type of transform. When you switch from Move to Rotate to Scale, the transform managers change to whatever combination they were in when you last used that transform.

For example, if you click Rotate and set the transform managers to Local, Selection Center, and Y constraint, when you click Move, the controls might shift to View, Pivot Point, and XY constraint (whichever combination was set the last time you used Move). When you go back to Rotate, the controls revert to Local, Selection Center, and Y constraint.

---

**TIP** To avoid surprises, always click the transform button first, and then set the transform managers. If, instead, you first set the transform managers, their settings are likely to change as soon as you choose a new transform button. One way to remember this is always to set the transform and managers by working from left to right on the toolbar. Alternatively, you can turn on Custom menu > Preferences > General tab > Reference Coordinate System group > Constant, which keeps the transform manager settings the same for all transforms.

---

## Specifying a Reference Coordinate System

The reference coordinate system determines the orientation of the X, Y, and Z axes used by the transform. The type of transform system you use affects all transform operations.

You specify the transform coordinate system using the [Reference Coordinate System list](#) on page 896 .

### Creating a Local Axis

While modeling, it's often helpful to have a temporary, movable local axis so you can rotate or scale about an arbitrary center.

---

**NOTE** This technique does not work for animation. See [Choosing a Transform Center](#) on page 882 for animation tips.

---

**TIP** As an alternative to this method, you can use the [Working Pivot](#) on page 3402 .

---

### To create an adjustable local axis:

- 1 Create a [Point helper object](#) on page 2544 .
- 2 From the Transform Coordinate System list, choose Pick, and then click the point object.  
The name of the point object appears in the list as the active coordinate system.

Now you can use the point object's coordinate system as an adjustable axis.

### To use the adjustable axis:

- 1 Place the point object where you want the rotate or scale transform to be centered.
- 2 Select the object you want to transform.
- 3 Choose the point object's name in the Transform Coordinate System drop-down list.
- 4 From the [Use Center flyout](#) on page 904 choose Use Transform Coordinate Center. For more information, see [Choosing a Transform Center](#) on page 882 .
- 5 Proceed with the transform.

## Choosing a Transform Center

The transform center affects scale and rotation transforms, but has no effect on position transforms.

The software lets you choose from three types of transform center using the [Use Center flyout](#) on page 904 on the main toolbar . When you change the transform center, the junction of the axis tripod icon moves to the location you specify.

By default, 3ds Max sets the transform center to Use Pivot Point center for single objects. When you select multiple objects, the default transform center changes to Use Selection Center, because selection sets have no pivot point. You can change the transform center in either case, and the program remembers and restores the transform center setting separately for selections of single and multiple objects (during the current session).

For example, you might select a single object and choose Use Transform Coordinate Center, and then select multiple objects and choose Use Pivot Point Center. When you next select a single object, the program switches back to Use Transform Coordinate Center. Then, when you select multiple objects, the center switches back to Pivot Point.

1. User selects single object.
2. User clicks Use Transform Coordinate Center from Use Center flyout on Main toolbar.
3. User adds second object to selection.
4. Transform center changes to Use Selection Center when selection set contains more than one object.
5. User clicks Use Pivot Point Center while multiple objects still selected.
6. User selects single object.
7. Transform center returns to Use Transform Coordinate Center (see step 2).
8. User selects multiple objects.
9. Transform center returns to Use Pivot Point Center (see step 5).

### **Transforming About Snapped Points**

While the transform center choices are often useful at the object level, they are not usually convenient when transforming sub-object selections. You can override the active transform center and perform the current transform about a temporary point by using snaps. When Snaps is active, and your selection is locked, the point you snap to will set the point about which the transform is performed. Using this technique, you can:

- Move relative to two snap points.
- Rotate about a snapped point.
- Scale about a snapped point.

For more details, see [Snap Settings](#) on page 2578 .

### **Animation and the Transform Center**

Because of the nature of keyframing, you can animate rotation and scale transforms properly only by using an object's local pivot point. For example, while modeling, you can rotate an object that's offset from the world origin around the world center coordinate system. The object sweeps around the origin in a large arc. However, if you attempt to animate this, the object rotates about its local axis and moves in a straight line from one end of the arc to the other.

To avoid this discrepancy, if the Auto Key button is on and either the Rotate or Scale button is active, the Use Center flyout is unavailable and set to Use Pivot Point. When the Auto Key button is off, all transforms use the center settings previously described.

You can override this behavior by turning off [Local Center During Animate](#) on page 7567 in the Animation Preferences settings.

Keep in mind that this affects only the center of the transform. The orientation of the selected transform coordinate system is still in effect.

### **Animating "Off-Center"**

You can animate a rotation or scale about an off-center point by linking your object as the child of a dummy helper object, and then rotating or scaling the dummy.

Another technique is to offset the pivot point of your object using the Hierarchy panel.

For information about linking, dummy objects, and the Hierarchy panel, see [Hierarchies](#) on page 3256 .

## **Using the Axis Constraints**

Axis Constraints toolbar > Restrict to X, Y, Z, or a plane

Keyboard >

F5 restricts to X

F6 restricts to Y

F7 restricts to Z

F8 cycles through the three plane restrictions

The Restrict to ... buttons, also called the Axis Constraint buttons, are located on the [Axis Constraints toolbar](#) on page 7288 , which is off by default. You can turn it on by right-clicking an empty spot on the main toolbar and choosing Axis Constraints from the pop-up menu. These buttons let you specify one or two axes about or along which the transform takes place. They help you avoid transforming an object in a direction you didn't intend.

---

**NOTE** It's generally easier to use the Transform gizmos than these buttons; see [Using Transform Gizmos](#) on page 865 . However, it is helpful to understand the concepts explained below.

---

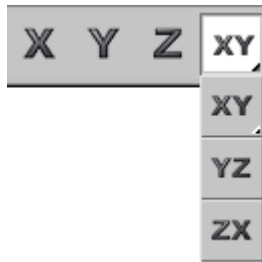

#### Axis Constraint buttons

Only one axis constraint can be active at a time. When a button is turned on, transforms are constrained to the specified axis (or plane). For example, if you turn on the Restrict To X button, you can rotate an object only about the X axis of the current transform coordinate system.

The axis or axes to which you're constrained are highlighted in red on the axis tripod icon in viewports, or in yellow on the Transform gizmo.

---

**NOTE** By default, axis constraints don't apply when using Snap. You can override this by turning on Snaps Use Axis Constraint Toggle on the [Axis Constraints toolbar](#) on page 7288 , or by turning on Use Axis Constraints in [Snap Options](#) on page 2587 .

---

**NOTE** Constraints are set on a transform-by-transform basis, so select the transform before you select the axis constraint. If you do not want the constraints to change, turn on Customize menu > Preferences > General tab > Reference Coordinate System group > Constant.

---

The axis constraints are stored separately at object and sub-object levels. If you set these three controls one way while in sub-object mode and another way while in object selection level, when you return to sub-object mode, they're restored to the way they were previously set. For example, if you're using XY constraints at object level, then switch to sub-object level and use Z constraint, when you return to object level, XY will be restored.

## Restrict to Plane Flyout



The Restrict To Plane flyout, available from the Axis Constraints toolbar, lets you limit all transformations (move, rotate, scale) to the XY, YZ, or ZX planes (by default, parallel with the Top view).

You can also select planar constraint by using the [Move Transform Gizmo](#) on page 865 . Instead of dragging one of the axis indicators, drag one of the plane indicators near the center of the gizmo.

When you move an object along a plane that is head-on to your view, the object moves along the single available axis shown in the view.

## Reset Transform Utility

Utilities panel > Utilities rollout > Reset XForm button

Use the Reset Transform utility to push object rotation and scaling values onto the modifier stack and align object pivot points and bounding boxes with the World coordinate system. Reset Transform removes all Rotation and Scale values from selected objects and places those transforms in an XForm modifier.

To reset the transform of a group, use the Transform button in the Reset group box of the Hierarchy > Pivot command panel.

### Procedures

**To reset an object's transform:**

- 1 Select an object.
- 2 On the Utilities panel, click Reset XForm.
- 3 On the Utilities panel > Utilities rollout, click the More button and choose Reset XForm.



- 4 On the Reset Transform rollout, click Reset Selected.

Object rotation and scaling are now carried by an XForm modifier placed at the top of the modifier stack.

When you apply the Reset Transform utility, an [XForm modifier](#) on page 1922 that carries the rotation and scale values is placed at the top of the Modifier Stack display. You can apply other modifiers above and below the XForm modifier. You can select the XForm modifier and add other Move, Rotate, and Scale transforms. You can delete the XForm modifier to completely remove the transforms from the object. You can collapse the object to absorb the rotation and scale values into the object mesh.

### Interface



**Reset selected** Removes all Rotation and Scale values from selected objects and places those transforms in an XForm modifier.

## Transform Commands

The basic transform commands are the most straightforward way to change an object's position, rotation, or scale. These commands appear on the [default main toolbar](#) on page 7284 . They are also available from the default [quad menu](#) on page 7300 .



[Select and Move](#) on page 888



[Select and Rotate](#) on page 889



[Select and Uniform Scale](#) on page 892



[Select and Non-Uniform Scale](#) on page 893



[Select and Squash](#) on page 894

**See also:**

- [Moving, Rotating, and Scaling Objects](#) on page 859
- [Using +Clone](#) on page 968
- [Transform Type-In](#) on page 874

## Select and Move



Main toolbar > Select and Move

Right-click an object. > quad menu > Transform quadrant > Move

Edit menu > Select and Move

Use the Select And Move button or the Move command on the Edit or quad menu to select and move objects.

To move a single object, you do not need to select it first. When this button is active, clicking an object selects it and dragging the mouse moves it.

The direction of the movement is determined both by your mouse and by the current reference coordinate system. To restrict object movement to the X, Y, or Z axis, or to any two axes, click the appropriate button on the [Axis Constraints toolbar](#) on page 7288 , use the [Transform gizmo](#) on page 865 , or right-click the object, and select the constraint from the Transform submenu.



Moving an object

See also:

- [Move Gizmo](#) on page 867

## Select and Rotate



Main toolbar > Select and Rotate

Right-click an object. > quad menu > Transform quadrant > Rotate

Edit menu > Select and Rotate

Use the Select and Rotate button or the Rotate command on the Edit or quad menu to select and rotate objects.

To rotate a single object, you don't need to select it first. When this button is active, clicking an object selects it and dragging the mouse rotates it.

When you are rotating an object about a single axis (as is usually the case), don't rotate the mouse, expecting the object to follow the mouse movement. Just move the mouse straight up and straight down. Up rotates the object one way, down rotates it the opposite way.

The center of rotation is determined by the [Transform Center setting](#) on page 896 .

To restrict rotation about the X, Y, or Z axis, or to any two axes, click the appropriate button on the [Axis Constraints toolbar](#) on page 7288 , use the [Transform gizmo](#) on page 865 , or right-click the object, and select the constraint from the Transform submenu.

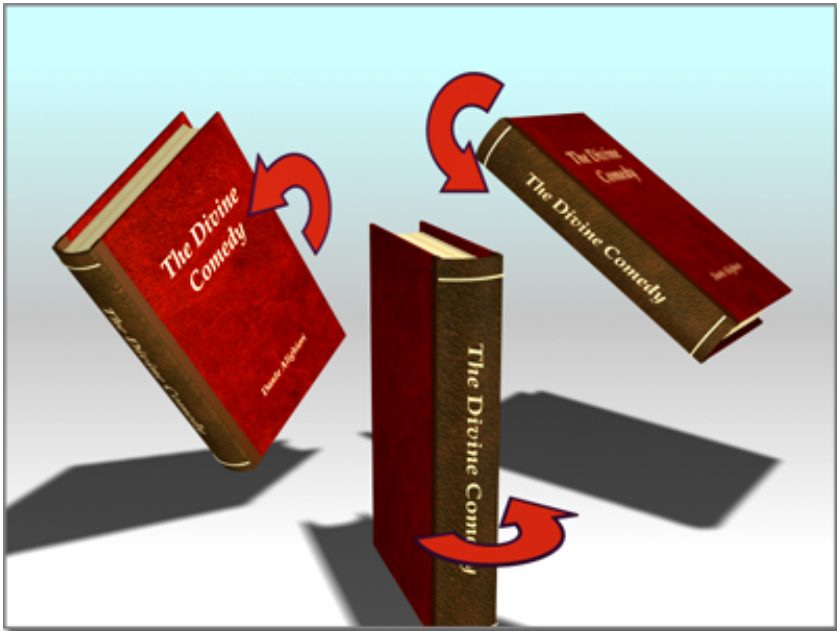

Rotating an object



See also:

- [Rotate Gizmo](#) on page 868

### Procedures

This procedure illustrates the intuitive usage of the default [Euler XYZ rotation controller](#) on page 3076 .

### To animate object rotation interactively:

- 1 Add an object.
- 2  Move the [time slider](#) on page 7312 to a frame other than 0 and turn on [Auto Key](#) on page 7344 .
- 3  Choose Select And Rotate.
- 4 Rotate the object on any axis by any amount.
- 5 Move the time slider to a later frame.
- 6 Rotate the object on the same axis by an amount greater than 180 degrees.
- 7 Play back the animation.  
The rotation plays back exactly as you recorded it.

## Select and Scale

Main toolbar > Select and Scale flyout

Right-click an object. > quad menu > Transform quadrant > Scale

Edit menu > Select and Scale



The Select And Scale flyout on the main toolbar provides access to three tools you can use to change object size. These are, from top to bottom:

[Select and Uniform Scale](#) on page 892

[Select and Non-Uniform Scale](#) on page 893

[Select and Squash](#) on page 894

In addition, the Scale command is available on the Edit menu and the Transform quadrant of the quad (right-click) menu; this activates whichever scale tool is currently chosen in the flyout.

---

**NOTE** The Smart Scale command activates the Select And Scale function and, with repeated invocations, cycles through the available scaling methods. By default, Smart Scale is assigned to the R key; you can use [Customize User Interface](#) on page 7489 to assign it to a different keyboard shortcut, a menu, etc.

---

## Select and Uniform Scale

Main toolbar > Select and Uniform Scale (on Select And Scale flyout)

Right-click an object. > Scale (selects current toolbar Scale mode)

The Select And Uniform Scale button, available from the [Select And Scale flyout](#) on page 891, lets you scale objects by the same amount along all three axes, maintaining the object's original proportions.

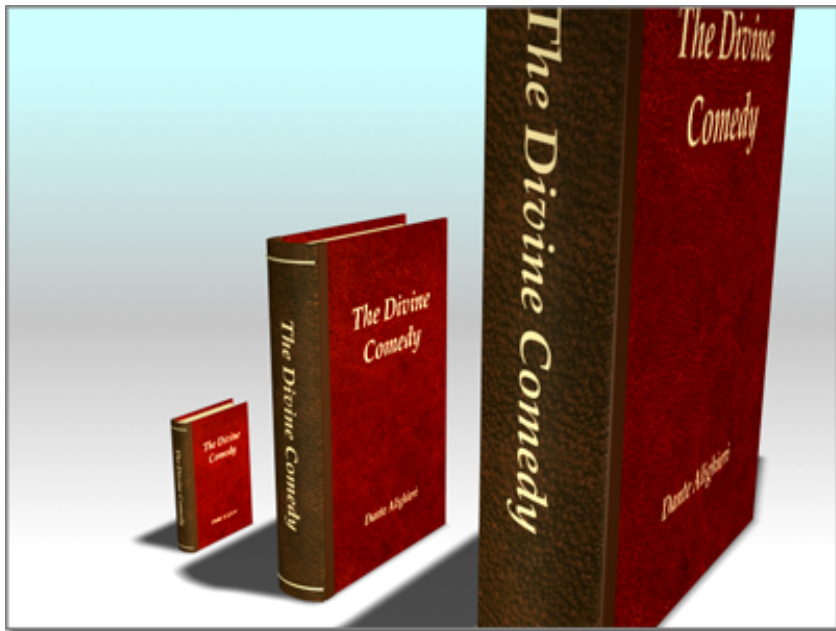

Uniform scale does not change an object's proportions.

To scale a single object, you don't need to select it first. When this tool is active, clicking an object selects it and dragging the mouse scales it.

See also:

- [Scale Gizmo](#) on page 870

## Select and Non-Uniform Scale

Main toolbar > Select and Non-Uniform Scale (on Select And Scale flyout)

Right-click an object. > Scale (selects current toolbar Scale mode)

The Select And Non-Uniform Scale button, available from the [Select And Scale flyout](#) on page 891, lets you scale objects in a non-uniform manner according to the active axis constraint.

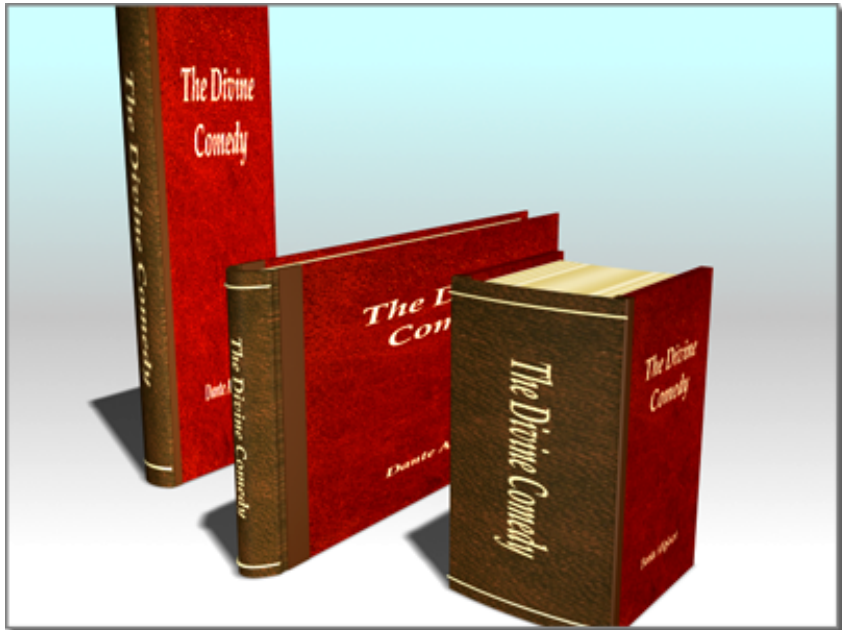

Non-uniform scale can change proportions with different values for different axes.

You can restrict the objects' scaling about the X, Y, or Z axis, or to any two axes, by first clicking the appropriate button on the [Axis Constraints toolbar](#) on page 7288 , or with the [Transform gizmo](#) on page 865 .

To scale a single object, you don't need to select it first. When this tool is active, clicking an object selects it and dragging the mouse scales it.

---

**IMPORTANT** Avoid applying non-uniform scale at the object level. Non-uniform scaling is applied as a transform and changes the axes of the object, so it affects other object properties. It also alters the properties passed hierarchically from parent to child. When you perform other operations on the object, such as rotation, inverse kinematic calculations, and other positioning operations, you might not get the results you expect. To recover from these problems, use the Hierarchy panel's Reset Scale button or the Utilities panel's Reset XForm utility. Either of these options will reset the axes to use the non-uniform scale as the fundamental scale for the object.

As an alternative to non-uniform scaling, consider using the [XForm modifier](#) on page 1922 .

---

**See also:**

- [Scale Gizmo](#) on page 870

## Select and Squash



Main toolbar > Select And Squash (on Select And Scale flyout)

Right-click an object. > Scale (selects current toolbar Scale mode)

The Select And Squash tool is useful for creating different phases of the “squash and stretch”-style animation often found in cartoons. The Select And Squash tool, available from the [Select And Scale flyout](#) on page 891 , lets you scale objects according to the active axis constraint. Squashing an object always involves scaling down on one axis while simultaneously scaling up uniformly on the other two (or vice-versa).



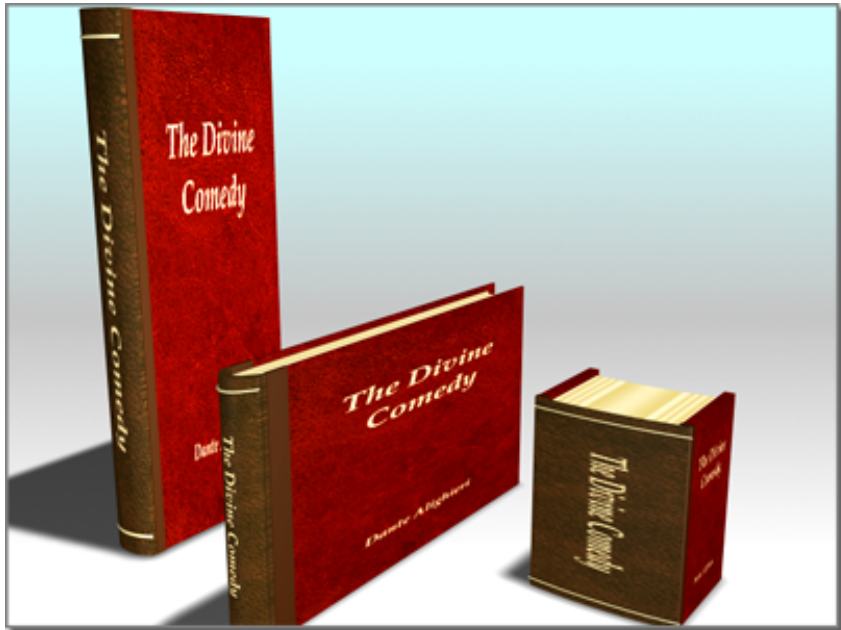

Squash scales two axes in opposite directions, maintaining the object's original volume.

You can restrict object scaling to the X, Y, or Z axis, or to any two axes, by first clicking the appropriate button on the [Axis Constraints toolbar](#) on page 7288 .

When the Select And Squash tool is active, clicking an object selects it and dragging the mouse scales it.

---

**IMPORTANT** Avoid using Select And Squash at the object level. The non-uniform scaling that it effects is applied as a transform and changes the axes of the object, so it affects other object properties. It also alters the properties passed hierarchically from parent to child. When you perform other operations on the object, such as rotation, inverse kinematics calculations, and other positioning operations, you may not get the results you expect. To recover from these problems, use the Hierarchy panel's Reset Scale button or the Utilities panel's Reset XForm utility. Either of these options will reset the axes to use the non-uniform scale as the fundamental scale for the object.

As an alternative to non-uniform scaling with Select And Squash, consider using the [XForm modifier](#) on page 1922 .

---

See also:

- [Scale Gizmo](#) on page 870

## Transform Coordinates and Coordinate Center

Controls for setting the coordinate system and the active center for transforms to use are on the default [main toolbar](#) on page 7284 .

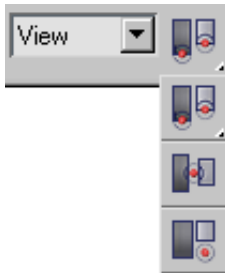

[Reference Coordinate System](#) on page 896



[Use Pivot Point Center](#) on page 905



[Use Selection Center](#) on page 907



[Use Transform Coordinate Center](#) on page 908

See also:

- [Moving, Rotating, and Scaling Objects](#) on page 859

## Reference Coordinate System

Main toolbar > Reference Coordinate System list

The Reference Coordinate System list lets you specify the coordinate system used for a transformation (Move, Rotate, and Scale). Options include View, Screen, [World](#) on page 7975 , Parent, [Local](#) on page 7830 , Gimbal, Grid, [Working](#) on page 3402 , and Pick.

In the Screen coordinate system, all views (including perspective views) use the viewport screen coordinates.

View is a hybrid of World and Screen coordinate systems. Using View, all orthographic views use the Screen coordinate system, while perspective views use the World coordinate system.

---

**TIP** The coordinate system is set on a transform-by-transform basis, so choose the transform before you specify the coordinate system. If you do not want the coordinate system to change, turn on Customize menu > Preferences > General panel > Ref. Coord. System group > Constant.

---

## Interface

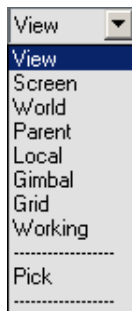

**View** In the default View coordinate system, X, Y, and Z axes are the same in all orthogonal viewports. When you move an object using this coordinate system, you are moving it relative to the space of the viewport.

- X always points right.
- Y always points up.
- Z always points straight out of the screen toward you.

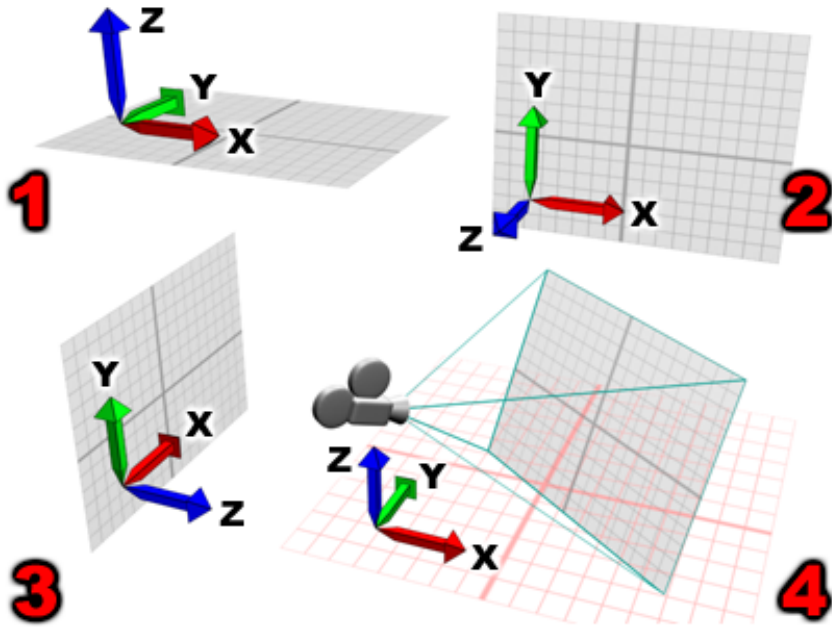

Different orientations of the View coordinate system:

1. Top viewport.
2. Front viewport.
3. Left viewport.
4. Perspective viewport.

**Screen** Uses the active viewport screen as the coordinate system.

- X is horizontal, running in a positive direction toward the right.
- Y is vertical, running in a positive direction upward.
- Z is depth, running in a positive direction toward you.

Since the Screen mode depends on the active viewport for its orientation, the X, Y, and Z labels on an [axis tripod](#) on page 860 in an inactive viewport show the orientation of the currently active viewport. The labels on that tripod change when you activate the viewport it is in.

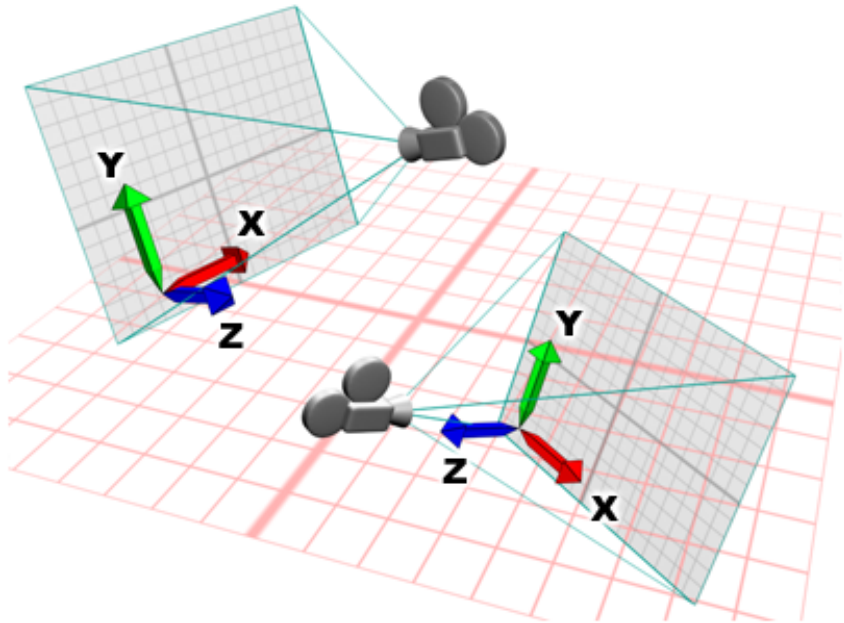

The coordinate system in Screen mode is always relative to the point of view.

**World** Uses the world coordinate system. Seen from the front:

- X runs in a positive direction to the right.
- Z runs in a positive direction upward.
- Y runs in a positive direction away from you.

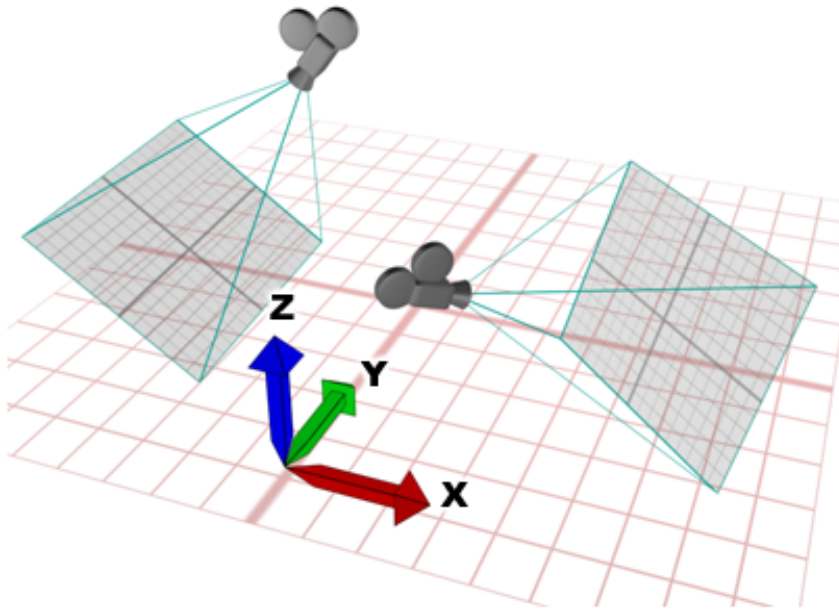

The World coordinate system is always fixed.

**Parent** Uses the coordinate system of the parent of the selected object. If the object is not linked to a specific object, it's a child of the world, and the parent coordinate system is the same as the world coordinate system.

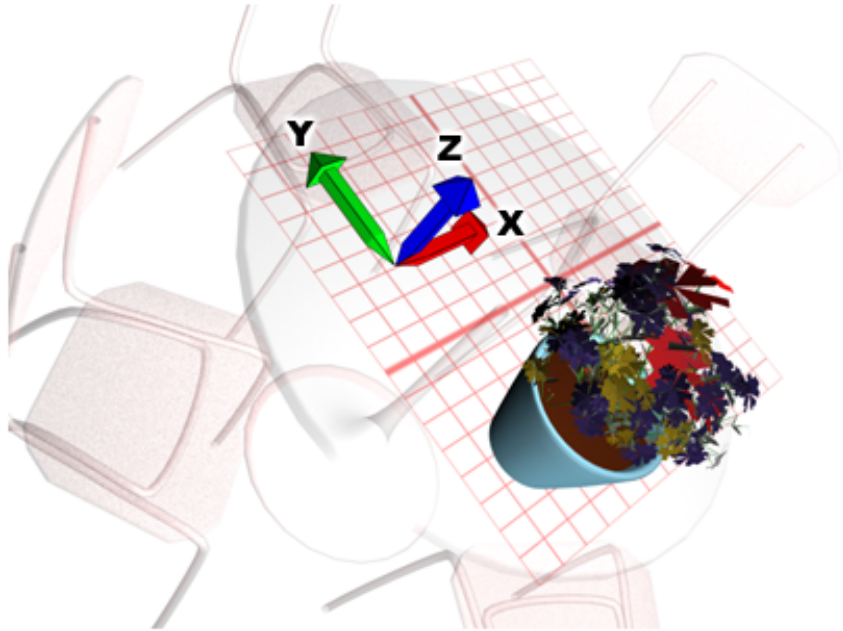

**Example of a Parent object coordinate system**

**Local** Uses the coordinate system of the selected object. An object's local coordinate system is carried by its [pivot point](#) on page 7895 . You can adjust the position and orientation of the local coordinate system, relative to its object, using the options on the Hierarchy command panel.

When Local is active, the Use Transform Center button is inactive and all transforms use the local axis as the center of transformation. In a selection set of several objects, each uses its own center for the transform.

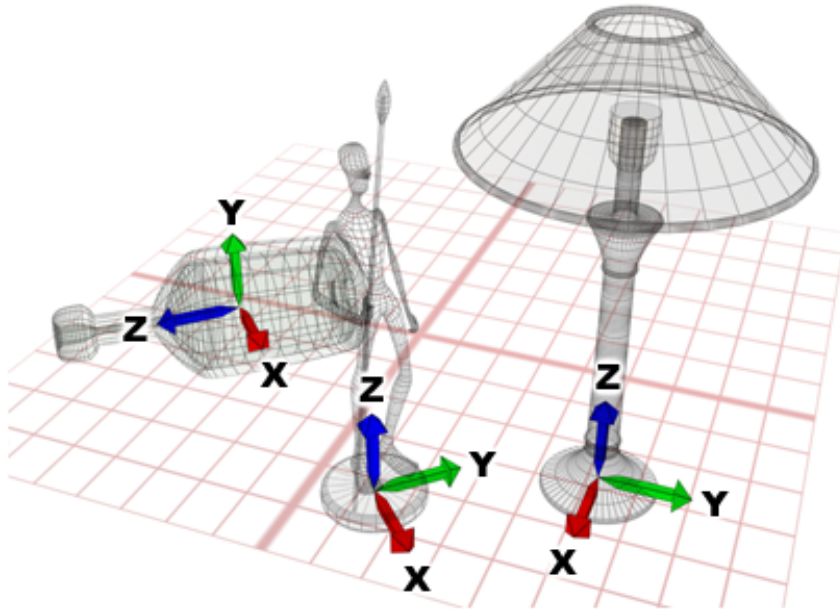

**Local** uses an individual coordinate system specific to each object.

**Gimbal** The Gimbal coordinate system is meant to be used with the [Euler XYZ Rotation controller](#) on page 3076 . It is similar to Local, but its three rotation axes are not necessarily orthogonal to each other.

When you rotate about a single axis with the Local and Parent coordinate systems, this can change two or three of the Euler XYZ tracks. The Gimbal coordinate system avoids this problem: Euler XYZ rotation about one axis changes only that axis's track. This makes function curve editing easier. Also, absolute transform type-in with Gimbal coordinates uses the same Euler angle values as the animation tracks (as opposed to Euler angles relative to the World or Parent coordinate system, as those coordinate systems require).

For move and scale transforms, Gimbal coordinates are the same as Parent coordinates. When the object does not have an Euler XYZ Rotation controller assigned, Gimbal rotation is the same as Parent rotation.

The Euler XYZ controller can be the active controller in a List controller, too.

**Grid** Uses the coordinate system of the active grid.



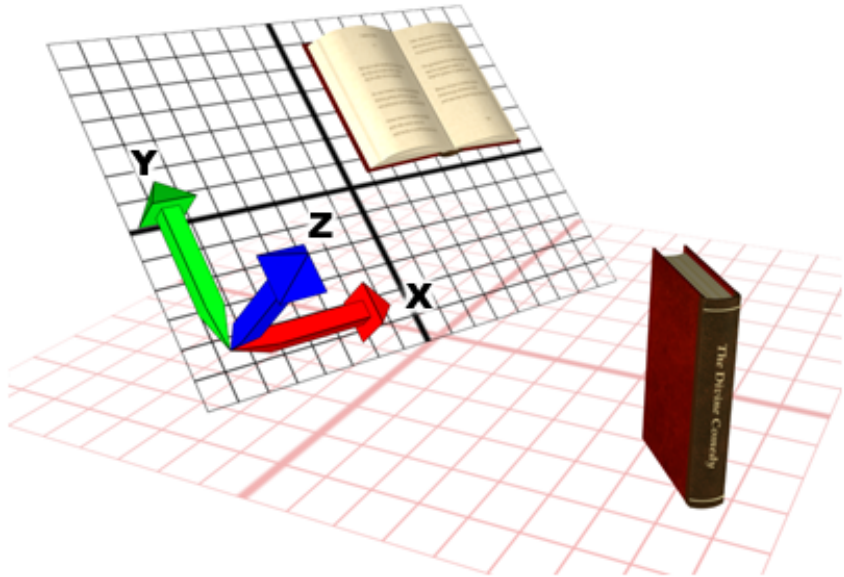

Using an active grid coordinate system.



**Working** Uses the coordinate system of the [working pivot](#) on page 3402 . You can use this coordinate system at any time, whether or not the working pivot is active. When [Use Working Pivot](#) on page 3405 is on, this is the default coordinate system.

**Pick** Uses the coordinate system of another object in the scene.

After you choose Pick, click to select the single object whose coordinate system the transforms will use. The object's name appears in the Transform Coordinate System list.

Because the software saves an object's name in the list, you can pick an object's coordinate system, change the active coordinate system, and then use the object's coordinate system again at a later time. The list saves the four most recently picked object names.

When using Pick to specify an object as a reference coordinate system, you can press H to open the Pick Object dialog, which works like [Select From Scene](#) on page 168 , and pick the object from there.

---

**NOTE** You can pick objects within an XRef scene as coordinate reference system.

---

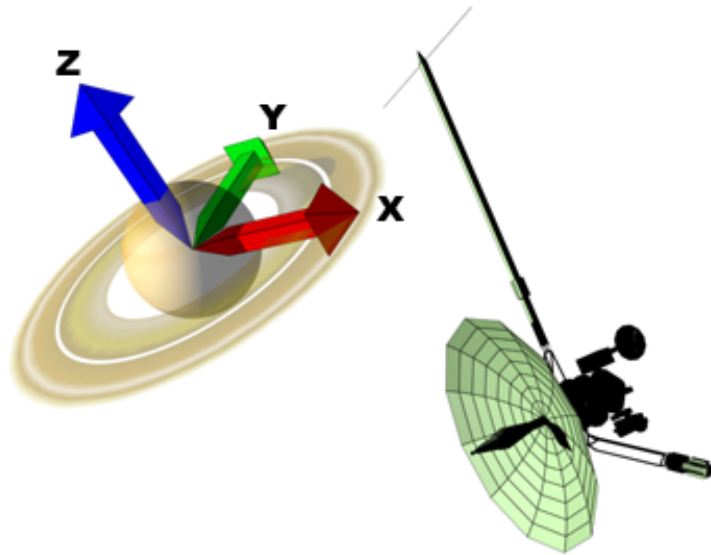

Using another object as the coordinate system

## Use Center Flyout

Main toolbar > Use Center flyout



The Use Center flyout provides access to three methods you can use to determine the geometric center for scale and rotate operations. They are, from top to bottom:

[Use Pivot Point Center](#) on page 905

[Use Selection Center](#) on page 907

[Use Transform Coordinate Center](#) on page 908

See also:

- [Choosing a Transform Center](#) on page 882

## Use Pivot Point Center



Main toolbar > Use Pivot Point Center (on Use Center flyout)

The Use Pivot Point Center option, available from the [Use Center flyout](#) on page 904 , lets you enable rotation or scaling of one or more objects around their respective [pivot points](#) on page 7895 . When [Auto Key](#) on page 7344 is active, Use Pivot Point Center is automatically chosen and no other option is available.

The [axis tripods](#) on page 860 show the centers that are currently being used.

---

**NOTE** The transformation center mode is set on a transform-by-transform basis, so select the transform before you select the center mode. If you do not want the center setting to change, turn on Customize menu > Preferences > General tab > Reference Coordinate System group > Constant.

---

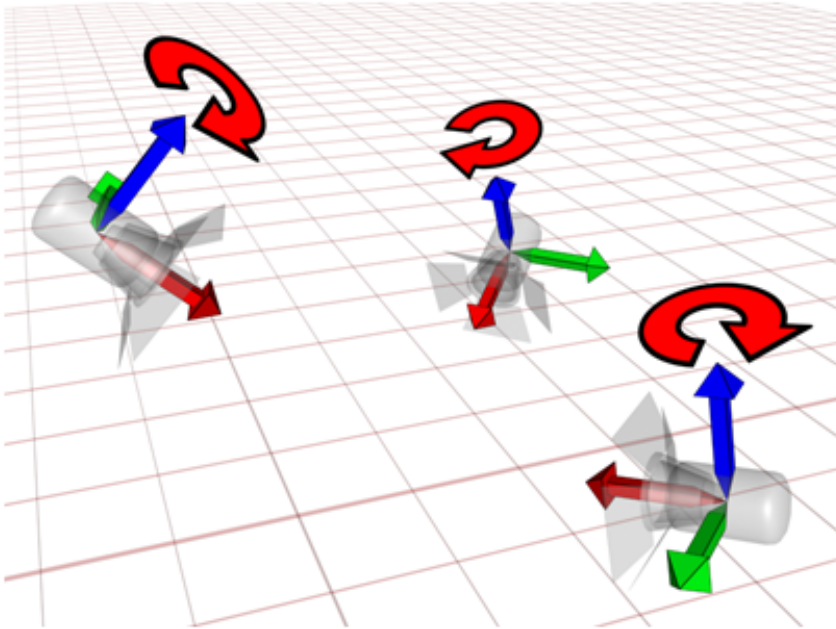

Applying a rotation with the Pivot Point rotates each object around its own local axis.

### Rotating Multiple Linked Objects

When rotating a chain of [linked](#) on page 3267 objects (that is, a hierarchy) with Use Pivot Point Center active, the rotation is applied equally to each

object in the chain. This results in a accumulated rotations, which makes it easy to animate such effects as fingers curling.

---

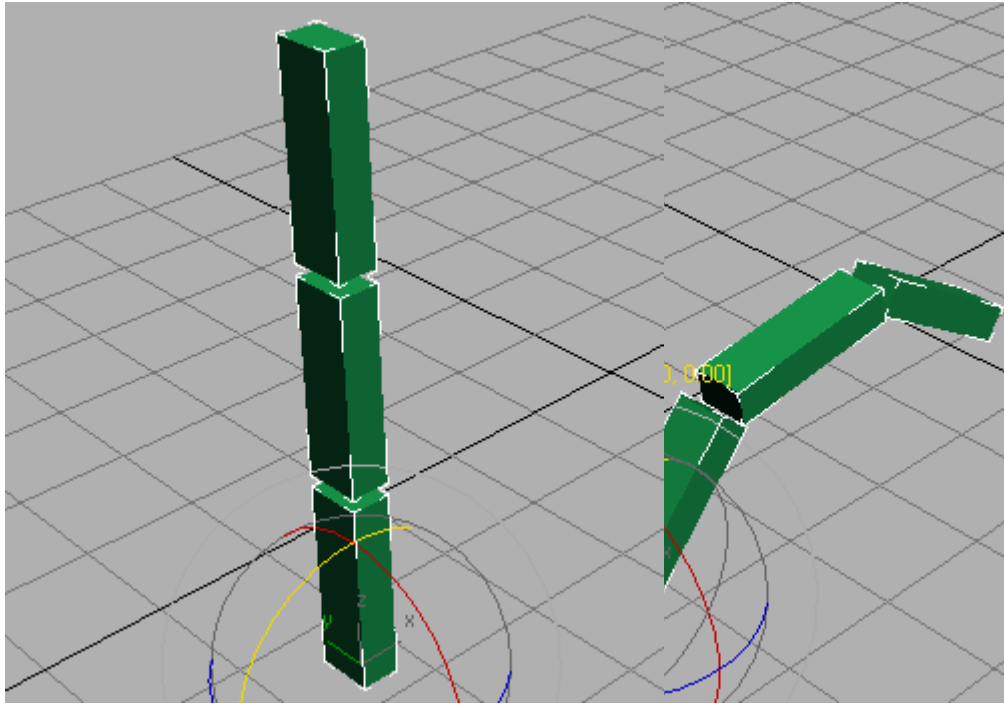

---

## Use Selection Center



Main toolbar > Use Selection Center (on Use Center flyout)

The Use Selection Center button, available from the [Use Center flyout](#) on page 904 , lets you enable rotation or scaling of one or more objects around their collective geometric center. If you transform multiple objects, the software calculates the average geometric center of all the objects and uses that for the transform center.

The [axis tripod](#) on page 860 shows the center that is currently being used.

---

**NOTE** The transformation center mode is set on a transform-by-transform basis, so select the transform before you select the center mode. If you do not want the center setting to change, turn on Customize menu > Preferences > General tab > Reference Coordinate System group > Constant.

---

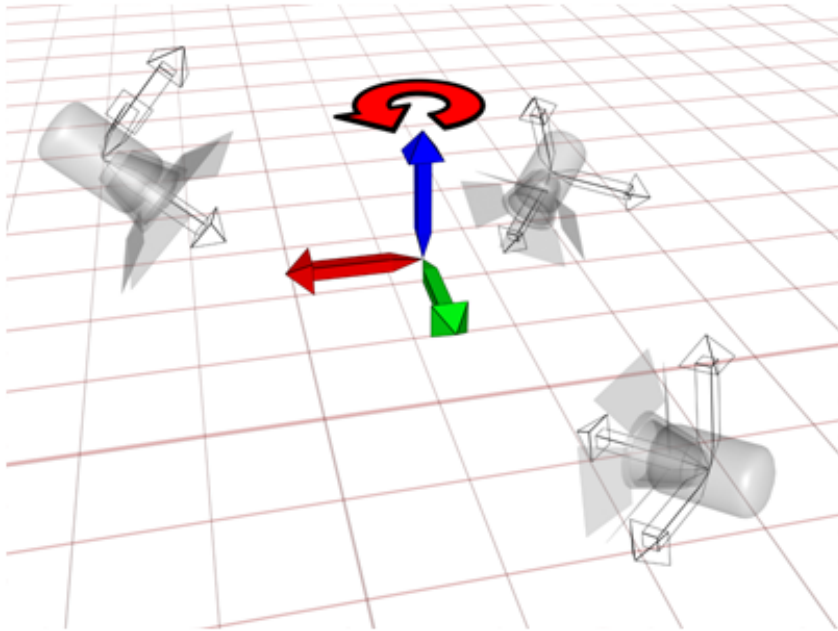

With the Selection Center option, an averaged coordinate system is used to rotate the objects.

## Use Transform Coordinate Center

Main toolbar > Use Transform Coordinate Center (on Use Center flyout)

The Use Transform Coordinate Center button, available from the [Use Center flyout](#) on page 904 , lets you enable rotation or scaling of an object or objects around the center of the current coordinate system. When you designate another object as the coordinate system with the Pick function (see [Specifying a Reference Coordinate System](#) on page 881 ), the coordinate center is the location of that object's pivot.

The [axis tripod](#) on page 860 shows the center that is currently being used.

---

**NOTE** The transformation center mode is set on a transform-by-transform basis, so select the transform before you select the center mode. If you do not want the center setting to change, turn on Customize menu > Preferences > General tab > Reference Coordinate System group > Constant.

---

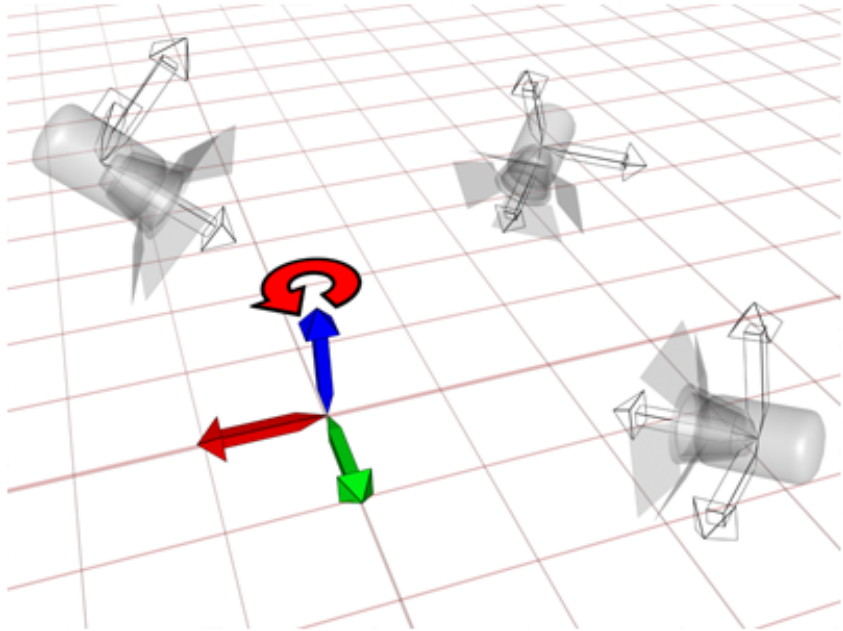

An example of the World coordinate center

## Transform Tools

The transform tools can transform objects according to certain conditions. Some of them, such as Array, can also create copies of objects.

These tools (except for Array, Snapshot, Spacing Tool, and Clone And Align) are available on the default [main toolbar](#) on page 7284 ; the remainder are on the [Extras toolbar](#) on page 7290 . Also, they all appear on the default [Tools menu](#) on page 7260 .



[Mirror Selected Objects](#) on page 911



[Array](#) on page 915



[Snapshot](#) on page 921



[Spacing Tool](#) on page 925



[Clone and Align Tool](#) on page 933



[Align](#) on page 938



[Quick Align](#) on page 944



[Normal Align](#) on page 945



[Place Highlight](#) on page 948



[Align Camera](#) on page 950



[Align to View](#) on page 951

**See also:**

- [Moving, Rotating, and Scaling Objects](#) on page 859
- [Using +Clone](#) on page 968
- [Creating Copies and Arrays](#) on page 953



# Array Flyout

Extras toolbar > Array flyout

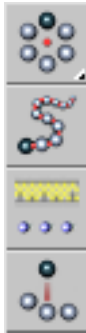

The Array flyout, available from the [Extras toolbar](#) on page 7290 , provides access to various tools for creating arrays of objects. These are, from top to bottom:

[Array](#) on page 915

[Snapshot](#) on page 921

[Spacing Tool](#) on page 925

[Clone and Align Tool](#) on page 933

## Mirror Selected Objects



Main toolbar > Mirror Selected Objects

Tools menu > Mirror

Clicking Mirror displays the Mirror dialog, which enables you to move one or more objects while mirroring their orientation. The Mirror dialog also allows you to mirror the current selection about the center of the current coordinate system. You can create a clone with the mirror dialog at the same time. If you mirror a hierarchical linkage, you have the option to mirror the IK limits.

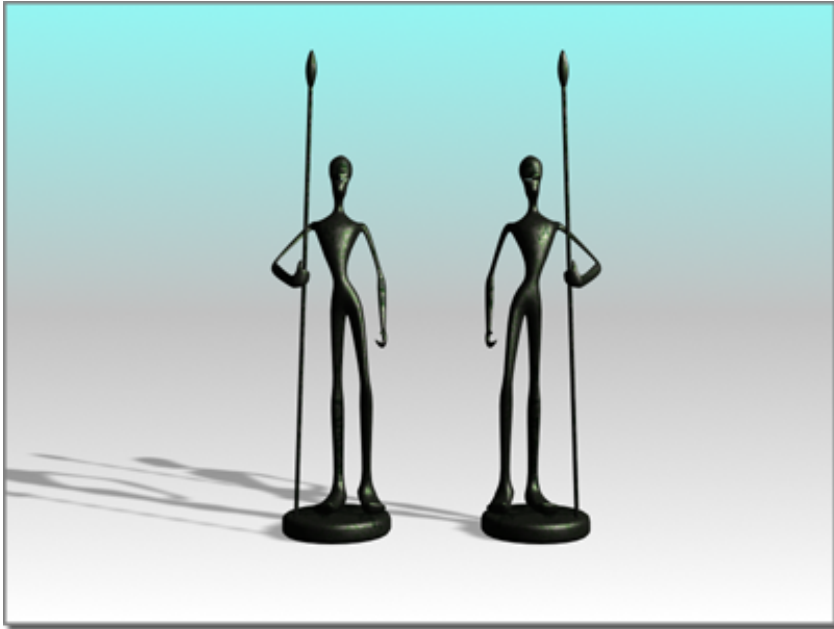

### Mirroring an object

The Mirror dialog uses the current [reference coordinate system](#) on page 896 , as reflected in its name. For example, if Reference Coordinate System is set to Local, the dialog is named Mirror: Local Coordinates. There is one exception: If Reference Coordinate System is set to View, Mirror uses Screen coordinates.

As you adjust the various settings in the Mirror dialog, you see the results in the viewports.

For more information on using Mirror, see [Mirroring Objects](#) on page 996 .

### Procedures

#### To mirror an object:

- 1 Make any object selection.



- 2 Click Mirror on the Main toolbar, or choose Tools menu > Mirror. The Mirror dialog opens.
- 3 Set the mirror parameters in the dialog and click OK.

The active viewport changes to show the effect of each parameter as you set it. When you click OK, the software creates the choice of mirror that you see previewed.

**To make a clone using mirror:**

- 1 Make any object selection



- 2 Click Mirror on the Main toolbar, or choose Tools menu > Mirror.  
The Mirror dialog opens.
- 3 In the Clone Selection group, choose Copy, Instance, or Reference.
- 4 Make any additional settings as desired and then click OK.

## Interface

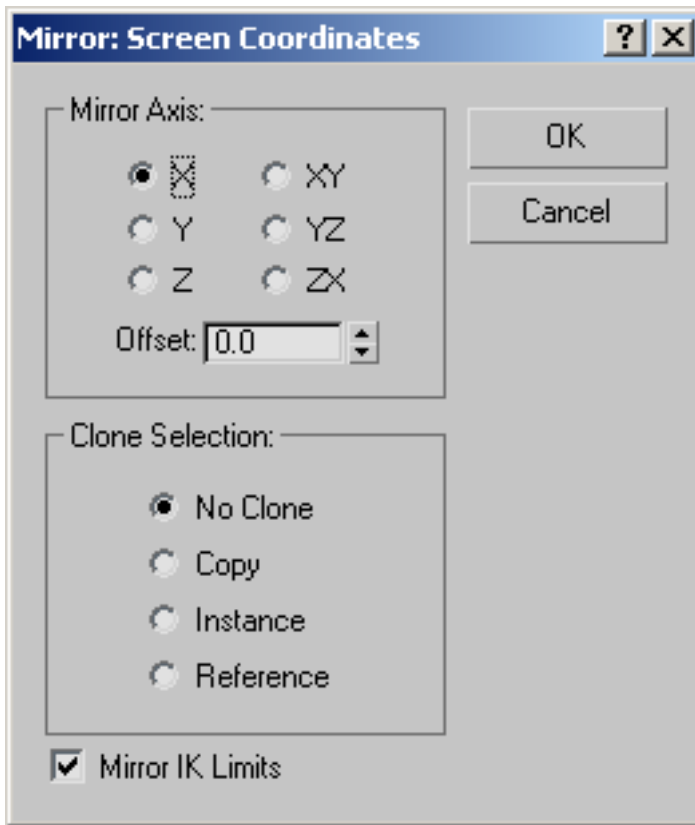

### Mirror Axis group

The mirror axis choices are X, Y, Z, XY, XZ, and YZ. Choose one to specify the direction of mirroring. These are equivalent to the option buttons on the [Axis Constraints toolbar](#) on page 7288 .

**Offset** Specifies the distance of the mirrored object's [pivot point](#) on page 7895 from the original object's pivot point.

### Clone Selection group

Determines the type of copy made by the Mirror function. Default is No Clone.

**No Clone** Mirrors the selected object without making a copy.

**Copy** Mirrors a copy of the selected object to the specified position.

**Instance** Mirrors an [instance](#) on page 7818 of the selected object to the specified position.

**Reference** Mirrors a [reference](#) on page 7910 of the selected object to the specified position.

If you [animate](#) on page 3002 the mirror operation, mirroring generates a Scale key. If you set Offset to a value other than 0.0, mirroring also generates Position keys.

**Mirror IK Limits** Causes the IK constraints to be mirrored (along with the geometry) when you mirror the geometry about a single axis. Turn this off if you don't want the IK constraints to be affected by the mirror command.

The end effectors used by the IK are not affected by the Mirror command. To successfully mirror an IK hierarchy, first delete the end effectors: Go to the Motion panel > IK Controller Parameters rollout > End Effectors group and, under Position, click the Delete button. After the mirror operation, create the new end effector using the tools on the same panel.

## Array



Extras toolbar > Array

Tools menu > Array

The Array command displays the Array dialog, which enables you to create an array of objects based on the current selection.

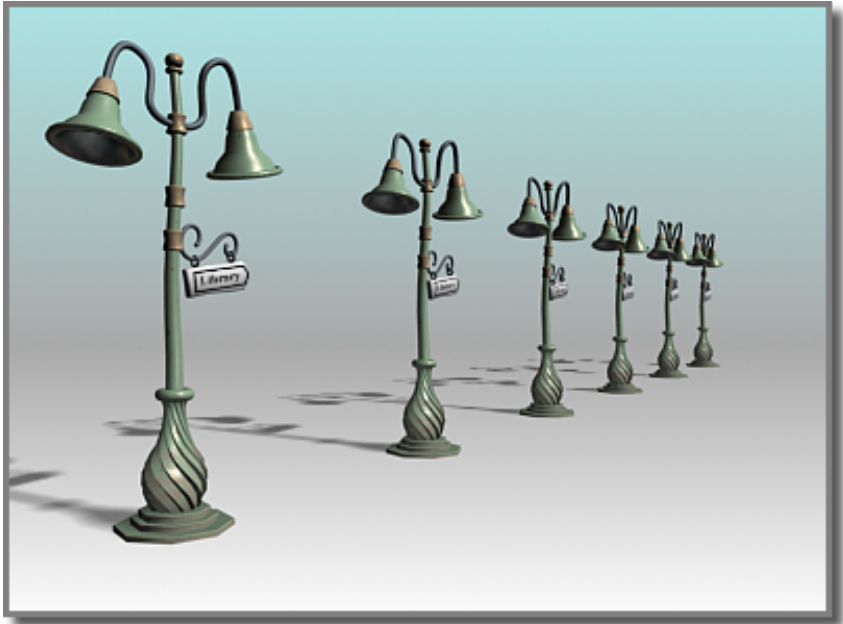

### A one-dimensional array

The items in the Array Dimensions group let you create one-, two-, and three-dimensional arrays. For example, a row of five objects is a single-dimension array, even though it takes up three-dimensional space in the scene. An array of objects that's five rows by three columns is a two-dimensional array, and an array of objects that's five rows by three columns by two levels is a three-dimensional array.

---

**TIP** You can preview the array by turning on the Preview button. With Preview on, changing the array settings updates the viewports in real time.

---

For more information on using Array, see [Arraying Objects](#) on page 981 .

### Procedures

**To create an array:**

- 1 Select the objects to array.

- 2  Click the Array button, or choose Tools > Array.

- 3 Choose Tools > Array.
- 4 On the Array dialog, select the type of object to output: Copy, [Instance](#), on page 7818 or [Reference](#) on page 7910 ).
- 5 In the Preview group, click the Preview button to turn it on.  
This lets you see the results of the array operation in the viewports, with changes appearing in real time.
- 6 In the Array Transformation group, click the arrows to set Incremental or Totals array parameters for Move, Rotate, and Scale.
- 7 Enter coordinates for the Array Transformation parameters.
- 8 Indicate whether you want a 1D, 2D, or 3D array.
- 9 Set Count to the number of copies on each axis.
- 10 Enter the appropriate values in the numeric fields for Incremental Row Offsets.
- 11 Click OK.  
The current selection is duplicated the specified number of times, with each object transformed as indicated.

**To replace an array:**

- 1 Undo the array to replace, using Edit > Undo Create Array, or press Ctrl+Z.
- 2 Change the coordinate system and transform center, if needed.
- 3  Click the Array button, or choose Tools > Array, and adjust any parameters on the Array dialog that is displayed.
- 4 Choose Tools > Array, and adjust any parameters on the Array dialog that is displayed.
- 5 Click OK to create a new array, which replaces the previous version.  
Repeat these steps to fine-tune the array.

**Example: To create an array of objects that numbers 5 x 4 x 3:**

- 1 Create a teapot with a radius of 10 units.
- 2 Choose Tools > Array to display the Array dialog.

- 3 In the Incremental set of parameters, set Move X (the upper-left field) to **50**. This causes each object in the array to be positioned 50 units apart on the X axis.
- 4 In the Array Dimensions group, choose the 3D button to enable all the spinners in that group.
- 5 Set the 1D Count spinner to **5**, the 2D Count spinner to **4**, and the 3D Count spinner to **3**.

This creates a row of 5 objects that are 50 units apart, and then 4 rows of those five objects, and then 3 rows of the 5 x 4 matrix of objects, resulting in a box array.
- 6 In the 2D row, set the Y spinner to **80**.
- 7 In the 3D row, set the Z spinner to **100**.
- 8 Click OK.

A box array of teapots appears. The first dimensional array is five teapots created along the X world axis, 50 units apart (as specified in the Array Transform group). The second dimensional array is four layers created along the Y world axis, 80 units apart (as specified in the Array Dimensions group). The third dimensional array is three layers created along the Z world axis, 100 units apart. The total number of objects in the array is 60.

**Example: To create a 360-degree array:**

- 1 Reset 3ds Max.
- 2 Near the top of the Front viewport (away from its center), create a long, thin box at the twelve-o'clock position (as if the viewport were a clock face).
- 3 Choose Use Transform Coordinate Center on the Main toolbar.
- 4 Choose Tools > Array.
- 5 Click the arrow button to the right of the Rotate label to enable the three Rotate fields in the Totals section.
- 6 Set the Z parameter to **360.0**.
- 7 In the Array Dimensions group, choose 1D and set Count to **12**.
- 8 Click OK.

The software creates an array of 12 boxes in a full circle.



## Interface

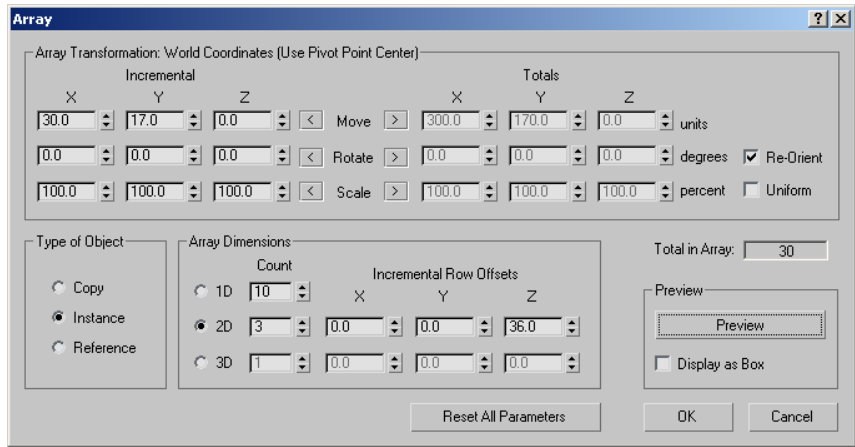

### Array Transformation group

Specifies which combination of the three transforms to use to create the array. You also specify the extent, along the three axes, for each transform. You can specify the extent of the transform in increments between each object, or in totals for all objects. In either case, the distances are measured between the pivot points of the objects. The arrays occur using the current transform settings, so the group title changes depending on the transform settings.

Click the left or right arrow button for Move, Rotate, or Scale to indicate whether you want to set Incremental or Total array parameters.

### Incremental

**Move** Specifies the distance between each arrayed object along the X, Y, and Z axes, in units.

**Rotate** Specifies the degree of rotation about any of the three axes for each object in the array, in degrees.

**Scale** Specifies the percentage of scale along any of the three axes for each object in the array, in percentages.

### Totals

**Move** Specifies the overall distance, along each of the three axes, between the pivot points of the two outer objects in the resulting array. For example,

if you're arraying 6 objects and set Move X total to 100, the six objects will be arrayed in a row that's 100 units between the pivot points of the two outer objects in the row.

**Rotate** Specifies the total degrees of rotation applied to the objects along each of the three axes. You can use this, for example, to create an array that totals 360 degrees.

**Re-Orient** Rotates the generated objects about their local axes while rotating them about the world coordinates. When clear, the objects maintain their original orientation.

**Scale** Specifies the total scale of the objects along each of the three axes.

**Uniform** Disables the Y and Z spinners and applies the X value to all axes, resulting in a uniform scale.

### **Type of Object group**

Determine the type of copies made by the Array function. The default is Copy.

**Copy** Arrays copies of the selected object to the specified position.

**Instance** Arrays instances of the selected object to the specified position.

**Reference** Arrays references of the selected object to the specified position.

### **Array Dimensions group**

Lets you add to the Array Transformation dimension. The additional dimensions are positional only. Rotation and scale are not used.

**1D** Creates a one-dimensional array, based on the settings in the Array Transformation group.

**Count** Specifies the total number of objects along this dimension of the array. For 1D arrays, this is the total number of objects in the array.

**2D** Creates a two-dimensional array.

**Count** Specifies the total number of objects along this second dimension of the array.

**X/Y/Z** Specifies the incremental offset distance along each axis of the second dimension of the array.

**3D** Creates a three-dimensional array.

**Count** Specifies the total number of objects along this third dimension of the array.

**X/Y/Z** Specifies the incremental offset distance along each axis of the third dimension of the array.

**Total in Array** Displays the total number of entities that the array operation will create, including the current selection. If you're arraying a selection set, the total number of objects will be the result of multiplying this value times the number of objects in the selection set.

**Preview** Toggles a viewport preview of the current array settings. Changing a setting updates the viewports immediately. If the update slows down feedback with large arrays of complex objects, turn on Display As Box.

**Display as Box** Displays the array-preview objects as bounding boxes instead of geometry.

**Reset All Parameters** Resets all the parameters to their default settings.

## Snapshot

Extras toolbar > Snapshot (on Array flyout)

Tools menu > Snapshot

Choosing Tools > Snapshot displays the Snapshot dialog. This enables you to clone an animated object over time.

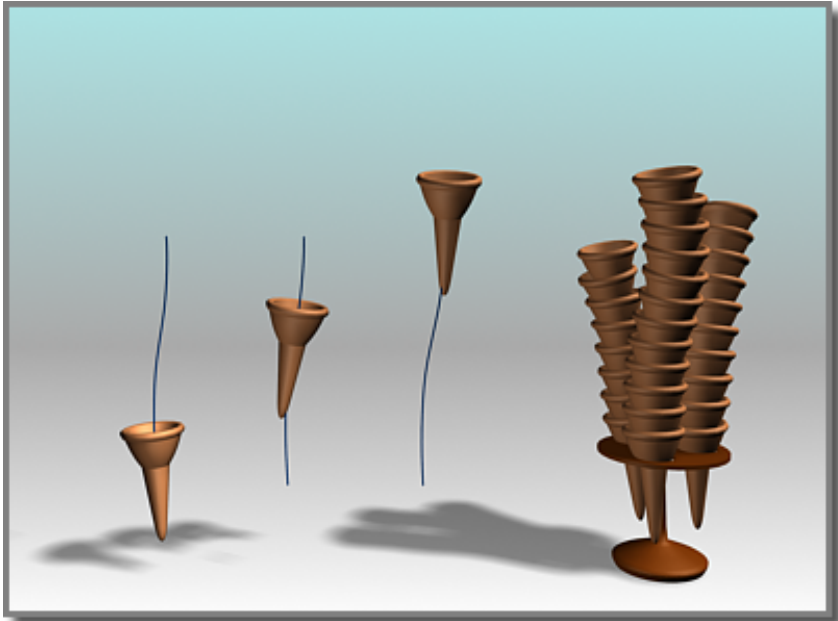

Using an ice-cream cone animated along a path, Snapshot creates a stack of cones.

Snapshot spaces the clones equally in time. Adjustments in Track View let you space the clones equally along the path instead (see the second procedure, below).

Like other clone techniques, Snapshot creates copies, instances, or references. You can also choose a mesh option for use with particle systems.

### **Particle Snapshots**

You can clone particle systems as static mesh objects. You can also produce clones of the particles themselves as meshes, when using the Snapshot dialog > Clone Method > Mesh option. This works with all configurations of particle systems, including those using MetaParticles. Usage is the same as with other types of objects.

### **Procedures**

**To clone an object over time:**

- 1 Select an object with an animation path.

Snapshot also shows the effect of any other transform animations, such as rotate or scale as well as parametric modifier animation.



- 2 Click the Snapshot button on the Extras toolbar > Array flyout, or choose Tools menu > Snapshot.
- 3 Set parameters in the dialog, and click OK.

**To space clones evenly by distance:**

- 1 Select an object with an animated position.
- 2 Open Track View and find the Position track for the original object.
- 3 Click Assign Controller and check that the track is using a Bezier Position controller. Do one of the following:
  - If the track is already using a Bezier Position controller, proceed to step 4.
  - If the track is not using a Bezier Position controller, [change the controller](#) on page 3515 , then proceed to step 4.
- 4 Select all the transform keys and right-click one of the selected keys to display the [Key Info dialog](#) on page 3052 .
- 5 Click Advanced to expand the dialog.
- 6 Click Normalize Time.
- 7 Set Constant Velocity on.
- 8 Choose Tools menu > Snapshot.  
The Snapshot dialog appears.
- 9 Set parameters in the dialog, and click OK.

## Interface

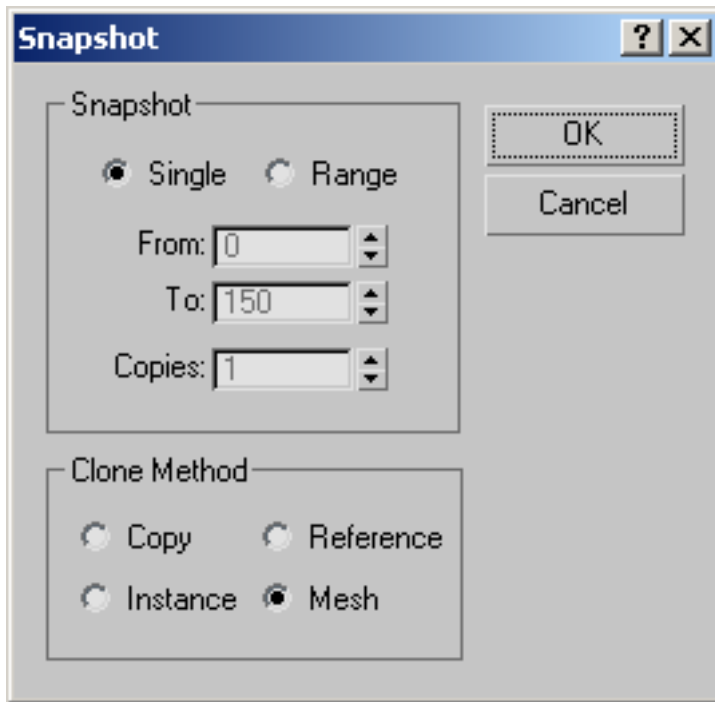

### Snapshot group

**Single** Makes a clone of the geometry of the object at the current frame.

**Range** Makes clones of the geometry of the object along the trajectory over a range of frames. Specify the range with the From/To settings and the number of clones with the Copies setting.

**From/To** Specifies the range of frames to place the cloned object along the trajectory.

**Copies** Specifies the number of clones to place along the trajectory. They are evenly distributed over the time period, but not necessarily over the spatial distance along the path.

## Clone Method group

With the Copy, Instance, and Reference methods, the clone retains any animation within the object, so all the clones will be animated in the same way.

**Copy** Clones copies of the selected object.

**Instance** Clones [instances](#) on page 7818 of the selected object. Not available with particle systems.

**Reference** Clones [references](#) on page 7910 of the selected object. Not available with particle systems.

**Mesh** Use this to create mesh geometry out of particle system. Works with all kinds of particles.

## Spacing Tool

Extras toolbar > Spacing Tool (on Array flyout)

Tools menu > Spacing Tool

The Spacing tool lets you distribute objects based on the current selection along a path defined by a spline or a pair of points.

The distributed objects can be copies, [instances](#) on page 7818, or [references](#) on page 7910 of the current selected object. You define a path by picking a spline or two points and by setting a number of parameters. You can also specify how the spacing between objects is determined and whether the pivot points of the objects align to the tangent of the spline.

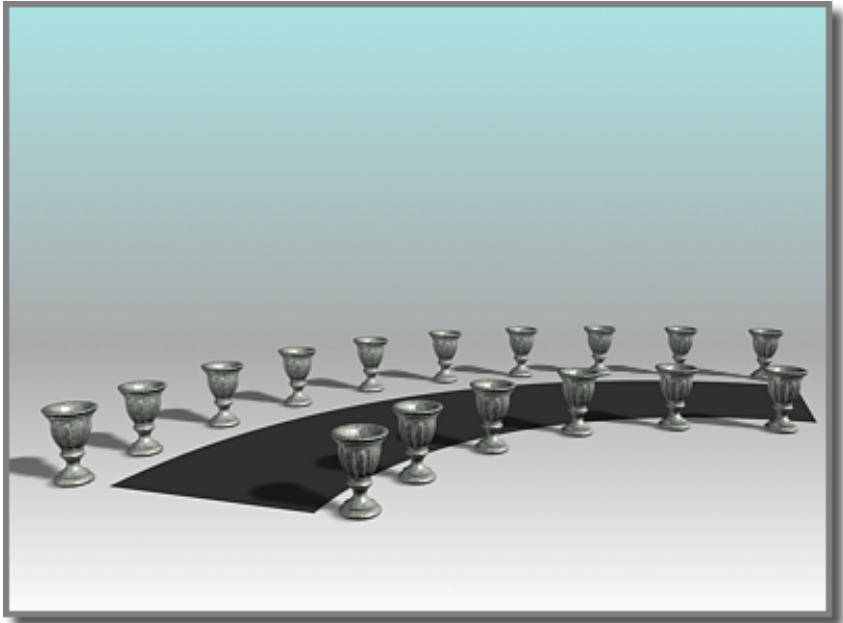

The Spacing tool distributes the vases along the sides of the curved street. The vases are all the same distance from each other; fewer appear on the shorter side.

---

**TIP** You can use compound shapes containing multiple splines as the spline path for distributing objects. Before creating shapes, turn off Start New Shape on the Create panel. Then create your shapes. The software adds each spline to the current shape until you click the Start New Shape button so that it's turned on. When you select the compound shape so that the Spacing tool can use it as a path, objects are distributed along all of the splines of the compound shape. For example, you might find this technique useful in spacing light standards along a path defined by separated splines.

You can pick splines within an XRef scene as path reference.

---

For more information, see [Using the Spacing Tool](#) on page 998 .

## Procedures

**To distribute objects along a path:**

- 1 Select the objects to distribute.





- 2 Click Spacing Tool, or choose Tools menu > Spacing Tool.

---

**NOTE** The Spacing tool is also available on rollouts for various components of the [Railing object](#) on page 447 .

---

- 3 On the Spacing Tool dialog, click Pick Path or Pick Points to specify a path.  
If you click Pick Path, select a spline from your scene to use as the path.  
If you click Pick Points, pick a start and an end to define a spline as the path. When you're finished with the Spacing tool, the software deletes this spline.
- 4 Choose a spacing option from the Parameters list.  
The parameters available for Count, Spacing, Start Offset, and End Offset are dependent on the spacing option you choose.
- 5 Specify the number of objects to distribute by setting the value of Count.
- 6 Depending on the spacing option you choose, adjust the spacing and offsets.
- 7 Under Context, choose Edge to specify that spacing be determined from the facing edges of each object's bounding box, or choose Centers to specify that spacing be determined from the center of each object's bounding box.
- 8 Turn on Follow if you want to align the pivot points of the distributed objects to the tangent of the spline.
- 9 Under Type of Object, select the type of object to output (copy, [instance](#) on page 7818 , or [reference](#) on page 7910 ).
- 10 Click Apply.

## Interface

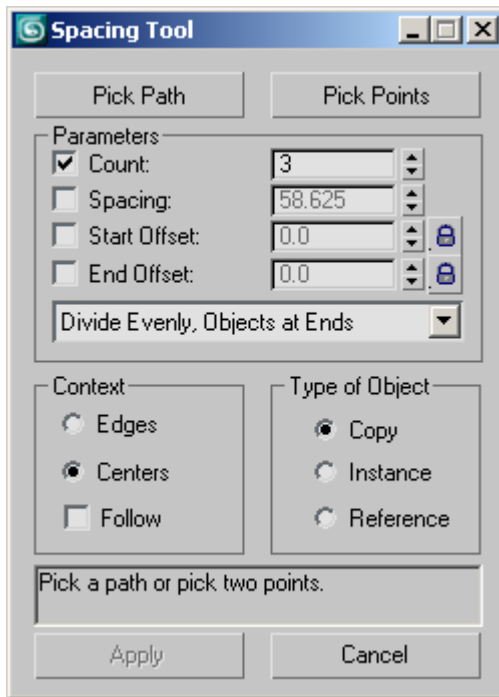

The Spacing tool gives you a choice of two basic methods for setting spacing: using a path, or specifying endpoints explicitly.

**Pick Path** Click this, and then click a spline in the viewport to use as the path. The software uses the spline as the path along which to distribute objects.

**Pick Points** Click this, and then click a start and an end to define a path on the construction grid. You can also use object snap to specify points in space. The software uses these points to create a spline as the path along which to distribute objects. When you're finished with the Spacing tool, the software deletes the spline.

### Parameters group

**Count** The number of objects to distribute.

**Spacing** Specifies the space in units between the objects. The software determines this spacing based on whether you chose [Edges](#) on page 932 or [Centers](#) on page 932 .

**Start Offset** The number of units specifying an offset from the start of the path. Clicking the lock icon locks the start offset value to the spacing value and maintains the count.

**End Offset** The number of units specifying an offset from the end of the path. Clicking the lock icon locks the end offset value to the spacing value and maintains the count.

**Distribution drop-down list** This list contains a number of options for how to distribute the objects along the path, as follows:

- **Free Center** Distributes equally spaced objects along a straight line toward the end point of the path, beginning at the start of the path. A spline or a pair of points defines the path. You specify the number of objects and the spacing.
- **Divide Evenly, Objects at Ends** Distributes objects along a spline. The group of objects is centered at the middle of the spline. The Spacing tool evenly fills the spline with the number of objects you specify and determines the amount of space between objects. When you specify more than one object, there are always objects at the ends of the spline.
- **Centered, Specify Spacing** Distributes objects along a path. The group of objects is centered at the middle of the path. The Spacing tool attempts to evenly fill the path with as many objects as it can fit along the length of the path using the amount of space you specify. Whether there are objects at the ends of the path depends on the length of the path and the spacing you provide.
- **End Offset** Distributes the number of objects you specify along a straight line. The objects begin at an offset distance that you specify. This distance is from the end of the spline to its start point, or from the second pair of points to the first point. You also specify the spacing between objects.
- **End Offset, Divide Evenly** Distributes the number of objects you specify between the start of a spline or a pair of points and an end offset that you specify. The software always places an object at the end or its offset. When you specify more than one object, there is always an object placed at the start. The Spacing tool attempts to evenly fill the space with the objects between the end offset and the start.
- **End Offset, Specify Spacing** Distributes objects toward the start of a spline or a pair of points, starting at the end or its offset. The software always places an object at the end or its offset. You specify the spacing between objects and the offset from the end. The Spacing tool attempts to evenly

fill the space with as many objects as it can fit between the end or its offset and the start. There might not always be an object placed at the start.

- **Start Offset** Distributes the number of objects you specify along a straight line. The objects start at an offset distance that you specify. This distance is from the start of the spline to its end point, or from the first of a pair of points to the second. You also specify the spacing between objects.
- **Start Offset, Divide Evenly** Distributes the number of objects you specify between the end of a spline or a pair of points, starting at an offset that you specify from the start. The software always places an object at the start or its offset. When you specify more than one object, there is always an object placed at the end. The Spacing tool attempts to evenly fill the space with the objects between the start or its offset and the end.
- **Start Offset, Specify Spacing** Distributes objects toward the end of a spline or a pair of points, starting at the start. The software always places an object at the start or its offset. You specify the spacing between objects and the offset from the start. The Spacing tool attempts to evenly fill the space with as many objects as it can fit between the start or its offset and the end. There might not always be an object placed at the end.
- **Specify Offsets and Spacing** Distributes as many equally spaced objects as possible along a spline or between a pair of points. You specify the spacing between objects. When you specify offsets from the start and end, the software distributes equally spaced objects between the offsets. There might not always be an object placed at the start and ends.
- **Specify Offsets, Divide Evenly** Distributes the number of objects you specify along a spline or between a pair of points. If you specify one object the software places it at the center of the path. If you specify more than one object the software always places an object at the start offset and the end offset. If you specify more than two objects the software evenly distributes the objects between the offsets.
- **Space from End, Unbounded** Distributes the number of objects you specify along a straight line from the end toward the start of a spline or a pair of points. You specify the spacing between objects. The software locks the end offset so that it's the same as the spacing.
- **Space from End, Specify Number** Distributes the number of objects you specify toward the start of a spline or a pair of points, starting at the end. The Spacing tool determines the amount of space between objects based on the number of objects and the length of the spline or the distance between the pair of points. The software locks the end offset so that it's the same as the spacing.

- **Space from End, Specify Spacing** Distributes as many equally spaced objects as possible toward the start of a spline or a pair of points, starting at the end. You specify the spacing between objects. The software locks the end offset so that it's the same as the spacing.
- **Space from Start, Unbounded** Distributes the number of objects you specify along a straight line toward the end of a spline or a pair of points, starting at the start. You specify the spacing between objects. The software locks the start offset so that it's the same as the spacing.
- **Space from Start, Specify Number** Distributes the number of objects you specify toward the end of a spline or a pair of points, starting at the start. The Spacing tool determines the amount of space between objects based on the number of objects and the length of the spline or the distance between the pair of points. The software locks the start offset so that it's the same as the spacing.
- **Space from Start, Specify Spacing** Distributes as many evenly spaced objects as possible toward the end of a spline or a pair of points, starting at the start. You specify the spacing between objects. The software locks the start offset so that it's the same as the spacing.
- **Specify Spacing, Matching Offsets** Distributes as many evenly spaced objects as possible along a spline or between a pair of points (and their offsets). You specify the spacing. The software locks the start and end offsets so that they're the same as the spacing.
- **Divide Evenly, No Objects at Ends** Distributes the number of objects you specify along a spline or between a pair of points (and their offsets). The Spacing tool determines the amount of space between objects. The software locks the start and end offsets so that they're the same as the spacing.

## Context group

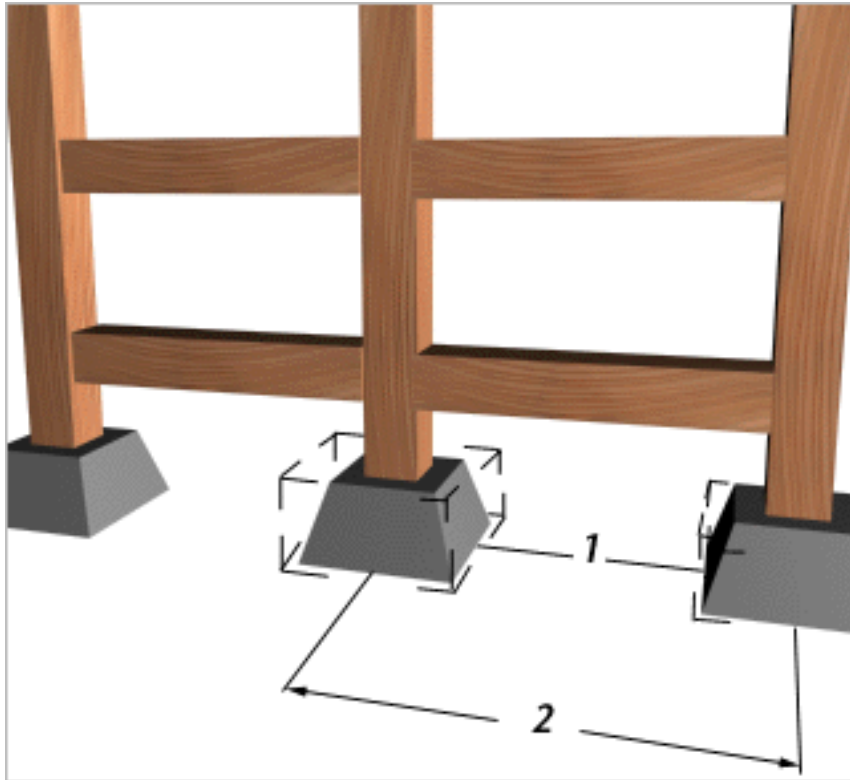

1. Edge-to-edge spacing

2. Center-to-center spacing

**Edges** Use this to specify that spacing is determined from the facing edges of each object's bounding box.

**Centers** Use this to specify that spacing be determined from the center of each object's bounding box.

**Follow** Use this to align the pivot points of the distributed objects to the tangent of the spline.

### Type of Object group

Determines the type of copies made by the Spacing tool. The default is Copy. You can copy, [instance](#) on page 7818 , or [reference](#) on page 7910 objects.

**Copy** Distributes copies of the selected object to the specified position.

**Instance** Distributes instances of the selected object to the specified position.

**Reference** Distributes references of the selected object to the specified position.

---

**TIP** You can use compound shapes containing multiple splines as the spline path for distributing objects. Before creating shapes, turn off Start New Shape under Shapes on the Create panel. Then create your shapes. 3ds Max adds each spline to the current shape until you click the Start New Shape button so that it's checked. When you select the compound shape so that the Spacing tool can use it as a path, objects are distributed along all of the splines of the compound shape. For example, you might find this technique useful in spacing light standards along a path defined by separated splines.

---

## Clone and Align Tool



Extras toolbar > Clone and Align Tool (on Array flyout)

Tools menu > Clone and Align

The Clone And Align tool lets you distribute source objects based on the current selection to a second selection of destination objects. For example, you can populate several rooms simultaneously with the same furniture arrangement. Similarly, if you import a CAD file that contains 2D symbols that represent chairs in a conference room, you can use Clone And Align to replace the symbols with 3D chair objects *en masse*.

The distributed objects can be copies, [instances](#) on page 7818 , or [references](#) on page 7910 of the current selected object. You determine the number of clones or clone sets by specifying any number of destination objects. You can also specify position and orientation alignment of the clones on one, two, or three axes, with optional offsets.

You can use any number of source objects and destination objects.

You can pick objects within an XRef scene as destination objects.

With multiple source objects, Clone And Align maintains the positional relationships among the members of each cloned group, aligning the selection center with the destination's pivot.

## Procedures

### To use the Clone And Align tool:

- 1 Create or load an object or objects to be cloned, as well as one or more destination objects.
- 2 Select the object or objects to be cloned.
- 3 Open the Clone And Align dialog.

---

**NOTE** The order of steps 2 and 3 can be reversed.

---

- 4 Do either of the following:
  - Click Pick once and then click each destination object in turn. Next, click Pick again to turn it off.
  - Click Pick List and then use the Pick Destination Objects dialog to pick all destination objects simultaneously.
- 5 On the Clone Parameters rollout, choose the type of clone, and, if appropriate, how to copy the controller. For details, see [Clone Options Dialog](#) on page 965 .
- 6 Use the Clone Parameters rollout settings to specify position, orientation, and scale options.
- 7 At any time, when Pick is off, you can change the source selection in a viewport. This causes the dialog to lose focus; click it again to regain focus and refresh the viewport preview of the clone operation.
- 8 To make the clones permanent, click Apply, and then click Cancel or the close button (X, in upper-right corner) to close the dialog.



## Interface

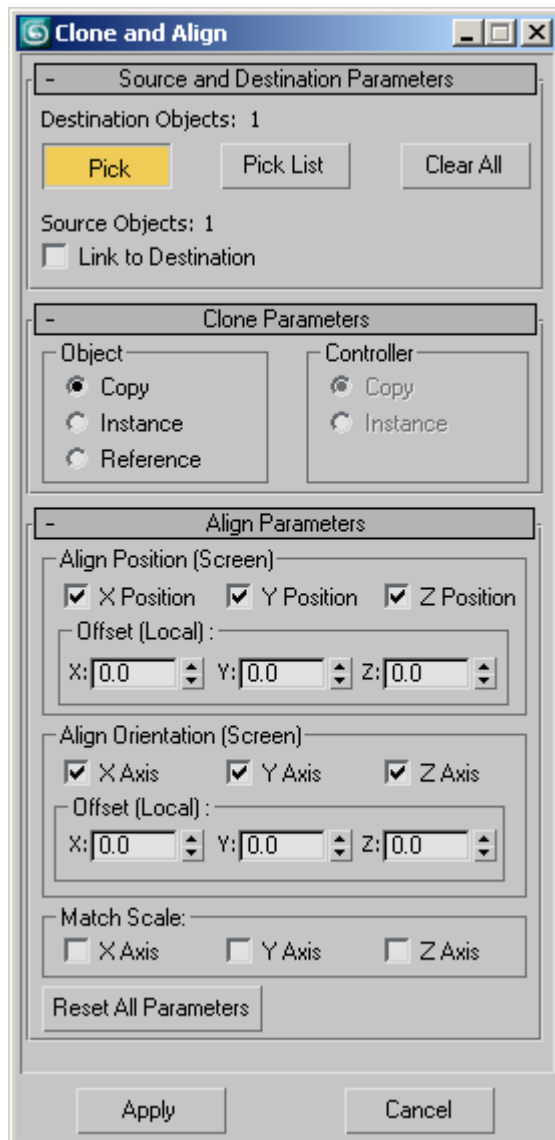

The Clone and Align tool takes the form of a non-modal dialog; it remains open while you work in the viewports. While the dialog is active, the results of the current settings appear as a preview in the viewports. Because of the

dialog's non-modal nature, you can change the selection of source and destination objects on the fly and see the results immediately in the viewports.

When the dialog focus is lost by activating another dialog or clicking in a viewport (that is, its title bar is gray rather than blue), the preview no longer appears in the viewports. To make the cloned objects permanent, click Apply when the dialog is active.

### **Source and Destination Parameters rollout**

Designate source objects by selecting them in a viewport. If you do this with the Clone And Align dialog open, the dialog loses focus; click the dialog to regain focus and update the settings.

**Destination Objects [label]** This read-only field shows the number of destination objects. To change this value, use Pick, Pick List, and Clear.

**Pick** When on, each object you click in the viewports is added to the list of destination objects. Click again to turn off after picking all destination objects.

To qualify as a valid destination object, an object must:

- not have been designated as a source or destination object.
- be selectable (frozen objects can't be selected).
- not be a temporary cloned object.

**Pick List** Opens the Pick Destination Objects dialog, which lets you pick all destination objects simultaneously, by name. In the dialog, highlight the destination objects, and then click Pick.

**Clear All** Removes all destination objects from the list. Available only when at least one destination object is designated.

**Source Objects [label]** This read-only field shows the number of source objects. To change this value, keep the dialog open, make sure Pick is off, and then select source objects in the viewports. When you click the dialog, the field updates.

**Link to Destination** Links each clone as a child of its destination object.

### **Clone Parameters rollout**

These settings let you determine the type of clone to create, and, if appropriate, how to copy the controller. For details, see [Clone Options Dialog](#) on page 965.

## Align Parameters rollout

The Align Position and Align Orientation group names are followed by the current [reference coordinate system](#) on page 896 , in parentheses, which they use as the coordinate system for positioning and aligning the clones. When the View coordinate system is active, alignment uses the World coordinate system.

The Offset parameters always use each destination object's Local coordinate system.

### Align Position group

**X/Y/Z Position** Specifies the axis or axes on which to align the clones' position. Turning on all three options positions each set of clones at the respective destination object's location.

**X/Y/Z Offset** The distance between the destination object's pivot and the source object's pivot (or source objects' coordinate center). For an Offset value to take effect, the respective Position check box must be on.

### Align Orientation group

**X/Y/Z Orientation** Specifies the axis or axes about which to align orientation. Turning on all three options aligns each set of clones' orientation fully with that of the respective destination object.

**X/Y/Z Offset** The angle by which the source objects are rotated away from the destination object's orientation about each axis. For an Offset value to take effect, the respective Orientation check box must be on.

**Match Scale** Use the X Axis, Y Axis, and Z Axis options to match the scale axis values between the source and destination.

This matches only the scale values you'd see in the [coordinate display](#) on page 7325 . It does not necessarily cause two objects to be the same size. Matching scale causes no change in size if none of the objects has previously been scaled.

**Reset All Parameters** Returns all settings in the Align Parameters rollout to their default values.

**Apply** Generates the clones as permanent objects. After clicking Apply, you can use Clone And Align to generate additional clones, using the results of previous clonings as source or destination objects if you like.

**Cancel** Aborts the current cloning operation and closes the dialog.

# Align Flyout

Main toolbar > Align flyout

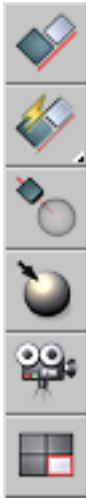

The Align flyout, available from the [Main toolbar](#) on page 7284 , provides access to six different tools for aligning objects. These are, from top to bottom:

[Align](#) on page 938

[Quick Align](#) on page 944

[Normal Align](#) on page 945

[Place Highlight](#) on page 948

[Align Camera](#) on page 950

[Align to View](#) on page 951

## Align

Main toolbar > Align (on Align flyout)

Keyboard > Alt+A

[Interface](#) on page 943

Clicking **Align** , available from the [Align flyout](#) on page 938 , then selecting an object, displays the Align dialog, which lets you align the current selection to a target selection. The name of the target object appears in the title bar of the Align dialog. When performing sub-object alignment, the title bar of the Align dialog reads "Align Sub-Object Selection."



**Aligning objects along an axis**

**Left: X position, center**

**Upper right: Y position, minimum**

**Lower right: Y position, maximum**

You can align the position and orientation of the [bounding box](#) on page 7736 of the source object to the bounding box of a target object.

You can use the Align tool with any selection that can be transformed. If an axis tripod is displayed, you can align the tripod (and the geometry it represents) to any other object in the scene. You can use this to align an object's pivot point.

You can use objects within an XRef scene as references with all alignment tools on the Align flyout, except Align to View.

When performing sub-object alignment, the Current Object options and the Match Scale boxes are disabled. If you plan to align orientation for sub-objects, first switch to Local transform mode on the main toolbar so that the axis tripod is properly aligned with your sub-object selection.

Other alignment tools on the Align flyout are [Quick Align](#) on page 944 , [Normal Align](#) on page 945 , [Place Highlight](#) on page 948 , [Align to Camera](#) on page 950 , and [Align to View](#) on page 951 .

## Procedures

### To align an object with a point object:

- 1 Create a point helper object and position it at a target location in your scene. Rotate it as necessary to adjust final orientation.
- 2 Select a source object.



- 3 On the Main toolbar, click Align, or choose Tools > Align.  
The Align cursor appears attached to a pair of cross hairs.
- 4 Move the cursor over the point object and click.  
The Align Selection dialog appears. If necessary, move the dialog out of the way so you can see the active viewport.
- 5 In the Align Position group, turn on X Position.  
The selected source object shifts to align with the X axis of the point object.
- 6 Turn on Y Position and Z Position.  
The source object moves so its center is at the point object.
- 7 Turn on X Axis, Y Axis, and Z Axis in the Align Orientation group to reorient the object to match the coordinates of the point.

### To align objects by position and orientation:

- 1 Select a source object (the object to move into alignment with the target object).

- 2  On the Main toolbar, click Align, or choose Tools > Align.  
The Align cursor appears. When over an eligible target object, the cursor also shows crosshairs.
- 3 Position the cursor over the target object and click.  
The Align Selection dialog appears. By default, all options in the dialog are turned off.
- 4 In the Current Object and Target Object groups, choose Minimum, Center, Pivot Point, or Maximum.  
These settings establish the points on each object that become the alignment centers.
- 5 Begin alignment by turning on any combination of X Position, Y Position, and Z Position.  
The source object moves in relation to the target object, along the axes of the reference coordinate system. Setting all three moves the objects as close as possible, given the Current Object and Target Object settings.
- 6 In the Align Orientation group, turn on any combination of X Axis, Y Axis, or Z Axis.  
The source object realigns accordingly. If the objects already share an orientation, turning on that axis has no effect. Once two axes are aligned in orientation, the third is automatic.

**To align a gizmo to another object:**

- 1 Display the gizmo level of the Sub-Object selection.
- 2  On the Main toolbar, click Align, or choose Tools > Align.
- 3 Choose Tools > Align.
- 4 Click to select a target object in the viewport. (You can select the same object containing the gizmo to align the gizmo to a part of its own object.)
- 5 Use the available settings in the Align dialog to adjust the transformation of the gizmo.

**To align a sub-object selection of geometry to another object:**

- 1 Do one of the following:
  - Convert the object to an editable mesh, and then make the sub-object selection at any level.
  - Apply a Mesh Select or Poly Select modifier, make a sub-object selection, apply an XForm modifier (The Mesh/Poly Select modifier by itself doesn't allow transforms.), and then activate the Gizmo sub-object level of the XForm modifier.



- 2 On the Main toolbar, click Align, or choose Tools > Align, and then select a target object.
- 3 Use the Align dialog controls to perform the alignment.



## Interface

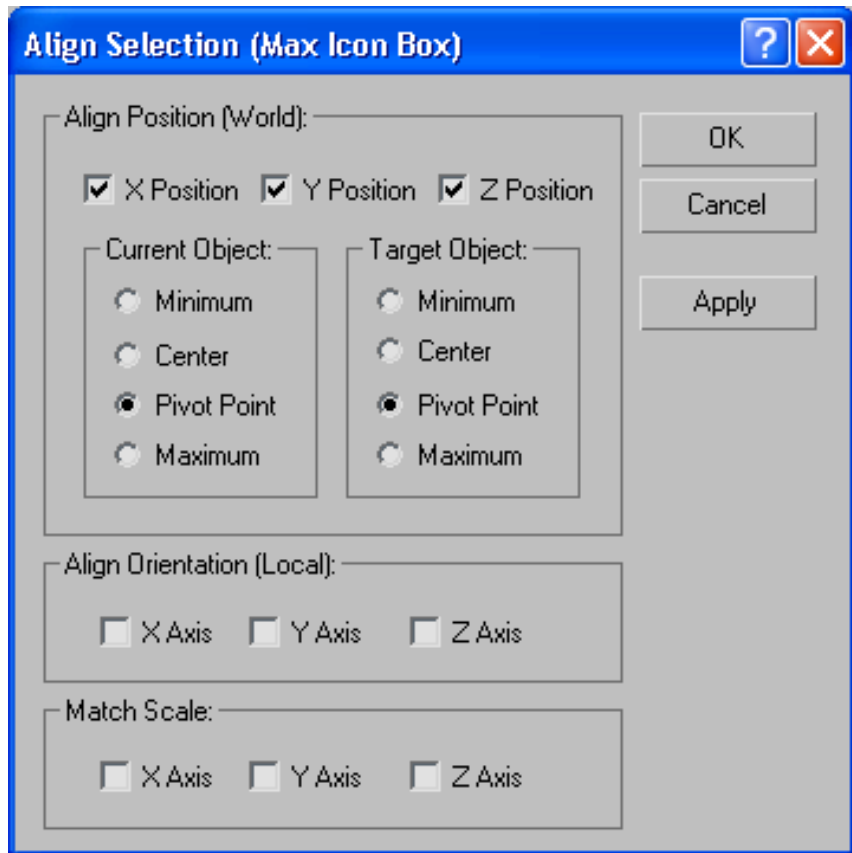

### Align Position group

**X/Y/Z Position** Specifies the axis or axes on which to perform the alignment. Turning on all three options moves the selection to the target object's location.

### Current Object/Target Object groups

Specify the points on the objects' bounding boxes to use for the alignment. You can choose different points for the current object and the target object. For example, you can align the current object's [pivot point](#) on page 7895 with the center of the target object.

**Minimum** Aligns the point on the object's bounding box with the lowest X, Y, and Z values with the chosen point on the other object.

**Center** Aligns the center of the object's bounding box with the chosen point on the other object.

**Pivot Point** Aligns the object's pivot point with the chosen point on the other object.

**Maximum** Aligns the point on the object's bounding box with the highest X, Y, and Z values with the chosen point on the other object.

### **Align Orientation (Local) group**

These settings let you match the orientation of the local coordinate systems between the two objects on any combination of axes.

This option is independent of the position alignment settings. You can leave the Position settings alone and use the Orientation check boxes to rotate the current object to match the orientation of the target object.

Position alignment uses [world coordinates](#) on page 7975 , while orientation alignment uses [local coordinates](#). on page 7830

### **Match Scale group**

Use the X Axis, Y Axis, and Z Axis options to match the scale axis values between the two selected objects. This matches only the scale values you'd see in the [Transform Type-In](#) on page 874 . It does not necessarily cause two objects to be the same size. There will be no change in size if neither of the objects has previously been scaled.

## **Quick Align**

Main toolbar > Quick Align (on Align flyout)

Tools menu > Quick Align

Keyboard > Shift+A

Quick Align lets you instantly align the position of the current selection to that of a target object. If the current selection is a single object, Quick Align uses the two objects' [pivots](#) on page 7895 . If the current selection comprises

multiple objects or sub-objects, Quick Align aligns the source's [selection center](#) on page 907 with the pivot of the target object.

## Procedures

### To use Quick Align:

- 1 Select one or more objects or sub-objects to align.
- 2 Press Shift+A or choose Quick Align from the Tools menu or Main toolbar > Align flyout.  
The mouse cursor turns into a “lightning-bolt” symbol. When positioned over an acceptable alignment target, a crosshairs symbol also appears.
- 3 Click an object to which to align the selection from step 1.  
The alignment is performed.

## Normal Align



Main toolbar > Normal Align (on Align flyout)

Tools menu > Normal Align

Keyboard > Alt+N

Normal Align uses the Normal Align dialog to align two objects based on the direction of the [normal](#) on page 7863 of a face or selection on each object. To open the Normal Align dialog, select the object to be aligned, click a face on the object, and then click a face on a second object. Upon releasing the mouse, the Normal Align dialog appears.

If you use Normal Align while a sub-object selection is active, only that selection is aligned. This is useful when aligning sub-object selections of faces, since otherwise there's no valid face normal for the source object.

Normal Align respects smoothing groups and uses the interpolated normal, based on face smoothing. As a result, you can orient the source object face to any part of the target surface, rather than having it snap to face normals.

For an object with no faces (such as helper objects, space warps, particle systems, and atmospheric gizmos), Normal Align uses the Z axis and origin of the object as a normal. Thus, you can use a [Point object](#) on page 2544 with Normal Align.

Other alignment tools on the Align flyout are [Align](#) on page 938 , [Quick Align](#) on page 944 , [Place Highlight](#) on page 948 , [Align to Camera](#) on page 950 , and [Align to View](#) on page 951 .

## Procedures

### To align normals:

- 1 Select a source object. This is the object that moves during alignment.



- 2 Click Normal Align on the Main toolbar, or choose Tools > Normal Align.

- 3 Drag across the surface of the source object.

The Normal Align cursor appears, attached to a pair of cross hairs. A blue arrow at the cursor indicates the current normal.

- 4 Move the cursor and blue arrow until you locate the normal you want to use, then release.

The blue arrow remains as reference to the source normal.

- 5 Drag across the surface of the target object.

A green arrow at the cursor indicates the current normal.

- 6 Move the cross hairs and green arrow until you locate the normal you want to use as a target, then release.

The source object moves into alignment with the target normal, and the Normal Align dialog appears.

- 7 Do one of the following:

- Click OK to accept the alignment.
- Using the dialog, make modifications to the alignment before clicking OK.
- Click Cancel Align to cancel the alignment procedure.

## Interface

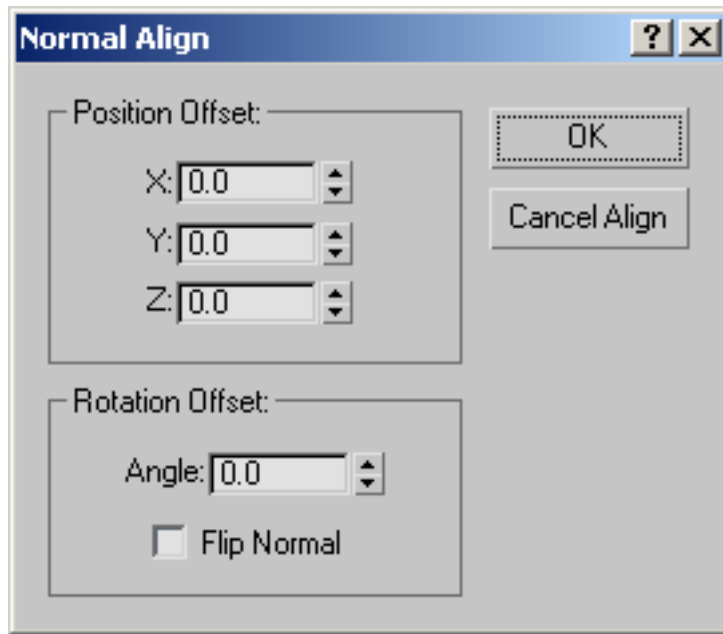

The Normal Align dialog lets you adjust or cancel the current alignment, and contains the following controls:

### Position Offset group

Lets you translate the source object perpendicular to the normal on the X, Y or Z axes.

**X/Y/Z** These three fields let you affect how much of an offset will be given to the selected faces.

### Rotation Offset group

Lets you rotate the source object about the normal's axis. You see the rotation in real time.

**Angle** This field lets you define the angle for the rotational offset.

**Flip Normal** Determines whether the source normal matches the target normal's direction. This defaults to off, since you usually want the two normals to have opposing directions. When you turn this on or off, the source object flips 180 degrees.

**OK/Cancel Align** The Cancel button is labeled Cancel Align to make it clear that you're not only canceling the settings in the dialog, but canceling the original [transform](#) on page 7958 of the source object.

## Place Highlight

Main toolbar > Place Highlight (on Align flyout)

Tools menu > Place Highlight

Keyboard > Ctrl+H

Place Highlight, available from the [Align flyout](#) on page 938, enables you to align a light or object to another object so that its highlight or reflection can be precisely positioned.

In Place Highlight mode, you can click and drag the mouse around in any viewport. Place Highlight is a viewport-dependent function, so use the viewport that you're going to be rendering. As you drag the mouse in the scene, a ray is shot from the mouse cursor into the scene. If it hits a surface, you see the surface [normal](#) on page 7863 at that point on the surface.

When you designate a surface, any selected objects are positioned along a line that represents the ray reflected off the surface about the surface normal. The objects are positioned along this line based on their original distance from the surface point. For example, if the object is 100 units from the surface point before being moved, it will be positioned 100 units from the surface point along the reflected ray.

If the object is a light, the position of the highlight on the surface of the object will be the surface point that you've chosen.

---

**TIP** Place Highlight works with any kind of selected object. It can be used to move objects based on a combination of face normals and initial distance from the face. You can also use Place Highlight with a selection set that contains more than one object. All objects maintain their initial distance from the face. In this case it has nothing to do with highlights, but is simply being used to position objects.

---

---

**NOTE** Highlight rendering depends on the material's specular properties and the type of rendering you use.

---

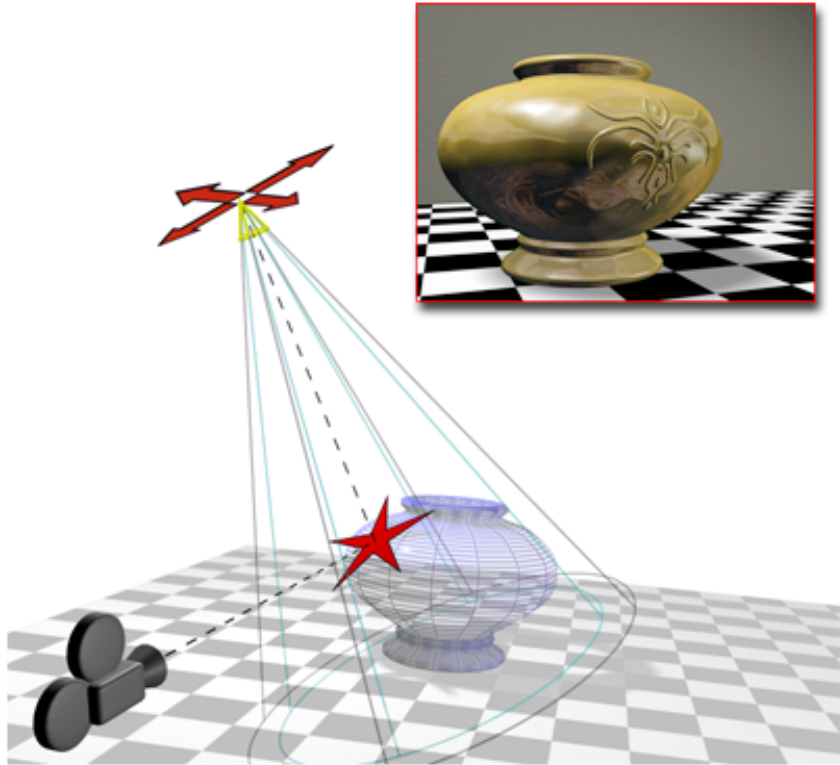

**Place Highlight aligns a camera and a spotlight to the same face.**

Other alignment tools on the Align flyout are [Align](#) on page 938 , [Quick Align](#) on page 944 , [Normal Align](#) on page 945 , [Align to Camera](#) on page 950 , and [Align to View](#) on page 951 .

### **Procedures**

**To position a light to highlight a face:**

- 1 Make sure the viewport you plan to render is active, and that the object you want to highlight is visible in it.  
The result of Place Highlight depends on what is visible in the viewport.
- 2 Select a light object.

- 3  Click Place Highlight, or choose Tools > Place Highlight.  
Choose Tools > Place Highlight.  
If the button is not visible on the toolbar, choose it from the Align flyout.
- 4 Drag over the object to place the highlight.  
When you place an omni, free spot, or directional light, the software displays a face normal for the face the mouse indicates.  
When you place a target spotlight, the software displays the light's target and the base of its cone.
- 5 Release the mouse when the normal or target display indicates the face you want to highlight.  
The light now has a new position and orientation. You can see the highlight illumination in shaded viewports that show the face you chose, and when you render those views.

## Align Camera

Main toolbar > Align Camera button (on Align flyout)

Tools menu > Align Camera

Align Camera, available from the [Align flyout](#) on page 938 , lets you align a camera to a selected face normal.

Align Camera works similarly to [Place Highlight](#) on page 948 , except that it operates on face normals instead of the angle of incidence, and occurs when you release the mouse button instead of dynamically acting during the mouse drag. Its purpose is to let you align a Camera viewport to a specified face normal.

Other alignment tools on the Align flyout are [Align](#) on page 938 , [Quick Align](#) on page 944 , [Normal Align](#) on page 945 , [Place Highlight](#) on page 948 , and [Align to View](#) on page 951 .

### Procedures

#### To use Align Camera:

- 1 Select the camera used for the viewport you want to align.



-  Click **Align Camera** or choose **Tools menu > Align Camera**.
- In any viewport, drag the mouse over an object surface to choose a face. The chosen face normal appears as a blue arrow beneath the cursor.
- Release the mouse to perform the alignment. The software moves the camera so it faces and centers the selected normal in the camera viewport.

## Align to View

Main toolbar > **Align to View** (on **Align** flyout)

Tools menu > **Align to View**

**Align to View**, available from the [Align flyout](#) on page 938, displays the **Align To View** dialog, which lets you align the local axis of an object or sub-object selection with the current viewport.

You can use **Align to View** with any selection that can be transformed.

Other alignment tools on the **Align** flyout are [Align](#) on page 938, [Quick Align](#) on page 944, [Normal Align](#) on page 945, [Place Highlight](#) on page 948, and [Align to Camera](#) on page 950.

### Procedures

#### To align the local axis of a selection with the current viewport:

- Select the objects or sub-objects to align.



- Click **Align to View**.
- Specify the local axis of the selected object to align with the current viewport's Z axis.
- Select the **Flip** check box when you switch the direction of the alignment. The alignment takes place while the dialog is displayed.
- Click **OK** to complete the process.

## Interface

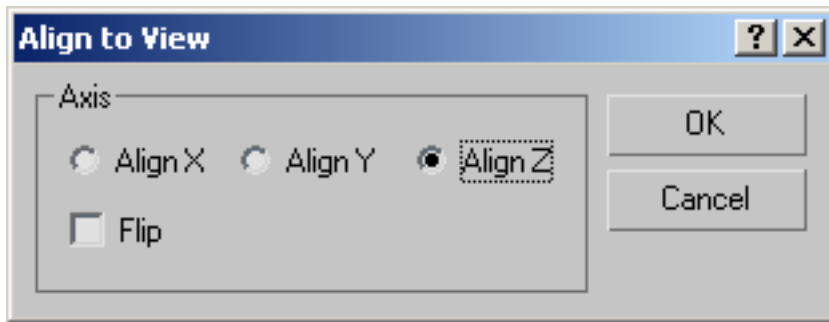

The Align to View dialog contains the following options:

**Align X, Align Y, Align Z** Specifies which local axis of the selected object will be aligned with the current viewport's Z axis.

**Flip** Switches the direction of the alignment.

# Creating Copies and Arrays

# 8

With 3ds Max, you can quickly create multiple versions of one or more selected objects during a transform operation. You do this by holding down the Shift key as you move, rotate, or scale the selection.



Portico created from arrays of columns

The general term for duplicating objects is *cloning*. This section presents all the methods and choices available for cloning objects. In addition to the transform method, the tools include the following:

- *Array* lets you set all three transforms, in all three dimensions, at the same time. The results are precise linear and circular arrays in 2D or 3D space.
- *Mirror* produces a "reflected" clone about one or more axes. If you mirror an object without cloning, the result is a "flip" of the geometry, optionally to a new location.
- *Snapshot* lets you create clones equally spaced over time or distance, based on an animation path.
- *Spacing Tool* distributes objects based on the current selection along a path defined by a spline or pair of points.

You can animate any of the cloning techniques. These topics supply overview information, as well as specifics of animation for each of them:

[Techniques for Cloning Objects](#) on page 958

[Overview of Copies, Instances, and References](#) on page 955

[Using +Clone](#) on page 968

■ [Cloning with Shift+Move](#) on page 970

■ [Cloning with Shift+Rotate](#) on page 972

■ [Cloning with Shift+Scale](#) on page 975

[Animating +Rotate and +Scale](#) on page 977

[Cloning Objects Over Time with Snapshot](#) on page 979

[Arraying Objects](#) on page 981

■ [Using the Array Dialog](#) on page 983

■ [Creating Linear Arrays](#) on page 989

■ [Creating Circular and Spiral Arrays](#) on page 993

[Mirroring Objects](#) on page 996

[Using the Spacing Tool](#) on page 998

# Overview of Copies, Instances, and References

To duplicate an object, you use one of three methods. For all three methods, the original and clone (or clones) are identical at the geometry level. Where the methods vary is in the way they handle modifiers (for example, Bend or Twist).

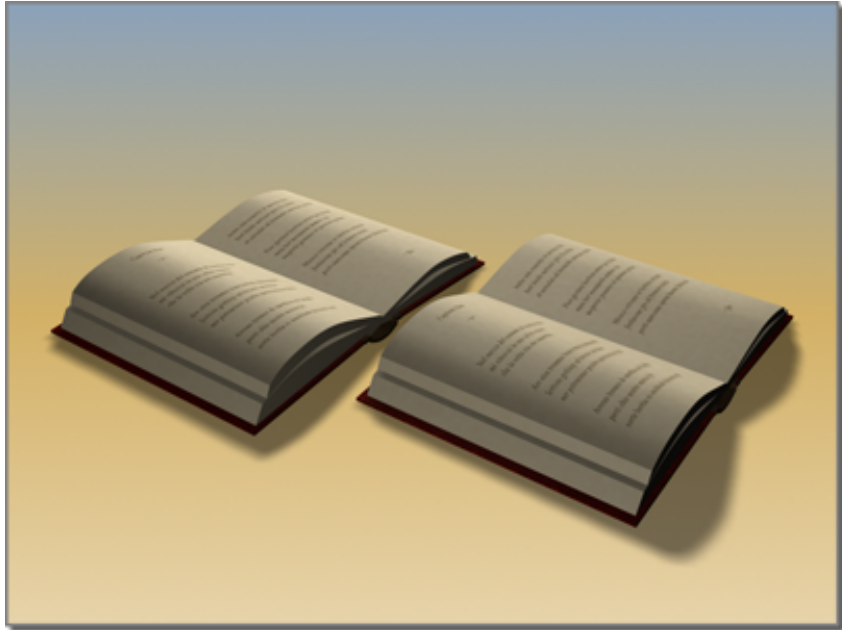

**An object can be a copy of another.**

**Copy method:** Creates a completely separate clone from the original. Modifying one has no effect on the other.

**Instance method:** Creates a completely interchangeable clone of the original. Modifying an instanced object is the same as modifying the original.

**Reference method:** Creates a clone dependent on the original up to the point when the object is cloned. Changing parameters for modifiers that were applied to the object *before* the object was referenced, will change both objects. However, a new modifier can be applied to one of the reference objects, and it will affect only the object to which it is applied.

Depending on the method used to create them, cloned objects are called *copies*, *instances*, or *references*.

The following discussion focuses on how you might use these methods.

## **Copies**

*Copies* are the most familiar kind of clone object. When you copy an object, you create a new, independent master object and data flow resulting in a new, named object. The copy duplicates all of the data of the original object at the time it is copied. The copy has no connection to the original object.

## **Example of Using Copied Objects**

If you modeled a basic head shape and wanted to create a group of individual characters, you would probably make a copy of the basic head shape each time you started a new character. You could then model an individual nose, mouth, and other features.

## **Copying Actively Linked Objects**

When you copy objects that are actively linked through the [File Link Manager](#) on page 6783, the software automatically converts the copies to editable mesh objects. If your selection contains several objects that instance another object, the resulting copies also instance the same object.

## **Instances**

*Instances* are alike not only in geometry, but also in every other way as well. Instancing an object results in multiple named objects based on a single master object. Each named object instance has its own set of transforms, space warp bindings, and object properties, but it shares the object modifiers and master object with the other instances. The data flow for an instance branches just after evaluating object modifiers.

When you change one instance by applying or adjusting a modifier, for example, all the other instances change with it.

Within 3ds Max, instances derive from the same master object. What you're doing "behind the scenes" is applying a single modifier to a single master object. In the viewport, what you see as multiple objects are multiple instances of the same definition.

## **Example of Using Instanced Objects**

If you wanted to create a school of swimming fish, you might begin by making many instanced copies of a single fish. You could then animate the swimming

motion by applying a Ripple modifier to any fish in the school. The whole school would swim with exactly the same motions.

### **Instances of Actively Linked Objects**

Creating instances of actively linked objects is not recommended. Reliability issues can arise if the instanced object is deleted in the linked file.

### **References**

*References* are based on the original object, as are instances, but can also have their own unique modifiers. Like instances, references share, at minimum, the same master object and possibly some object modifiers.

The data flow for a reference branches just after the object modifiers but then evaluates a second set of object modifiers unique to each reference. When you create references, 3ds Max displays a gray line, called the *derived-object line*, at the top of the modifier stack for all clones. Any modification made below the line is passed on to other references, and to the original object. New modifiers added above the line are not passed on to other references. Changes to the original object, such as in its creation parameters, are passed on to its references.

This effect is useful for maintaining an original that will affect all its references, while the references themselves can take on individual characteristics.

All shared modifiers reside below the derived-object line and are displayed in bold. All modifiers unique to the selected reference reside above the derived-object line and are not bold. The original object does not have a derived object line: its creation parameters and modifiers are all shared, and all changes to this object affect all references.

The results of changing or applying a modifier to a named object reference depends on where in the modifier stack it is applied:

- Applying a modifier to the top of the modifier stack affects only the selected named object.
- Applying a modifier below the gray line affects all references branching above that line.
- Applying a modifier at the bottom of the modifier stack affects all references derived from the master object.

## References of Actively Linked Objects

Creating references of actively linked objects is not recommended. Reliability issues can arise if the referenced object is deleted in the linked file.

## Example of Using Referenced Objects

In the example of modeling heads, you might want to keep a family resemblance in your characters. You could model basic features on the original, then model specifics on each reference.

At some point, if you wanted to see what your characters would look like as "cone-heads," you could apply a Taper modifier to the original head, and have all the other characters take on the same feature. You could give the original character a very pointed head, then apply a separate Taper to some referenced characters to reduce the point toward normal.

For swimming fish, you might choose to make all members of the school as referenced objects based on a single, original fish. You could still control the swimming motion from the original fish, and also add modifiers to individual fish in the school to vary their behavior.

# Techniques for Cloning Objects

3ds Max provides several techniques for copying or duplicating objects; *cloning* is the general term for this process. These techniques can be used to clone any selection set.

- Clone
- Shift+Clone
- Snapshot
- Array
- Mirror
- Spacing Tool
- Clone and Align Tool



## Shared Features

While each technique has distinct uses and advantages in cloning objects, in most cases the cloning techniques share some similarities in how they work:

- You can apply a transform when you clone. New objects are moved, rotated, or scaled as they are created.
- The transform is relative to the current coordinate system, axis constraint, and transform center.
- When cloning creates new objects, you have the choice of making them copies, instances, or references.

Each of the following items is discussed later in this chapter.

## Clone

Using the Clone command on the Edit menu is the easiest method for copying an object in place; no transformation is involved. See [Clone](#) on page 965 .

## Shift+Clone

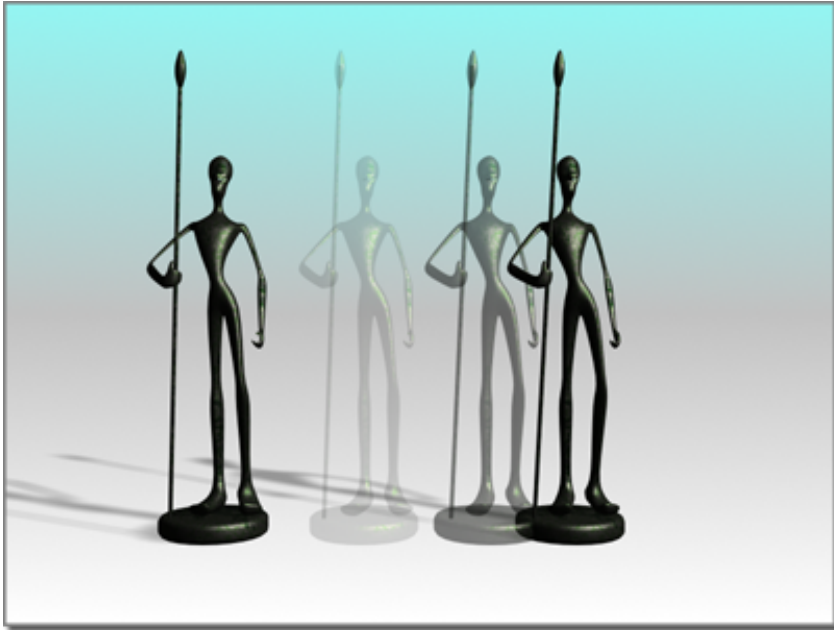

**Shift+Clone clones an object when you transform it.**

You can clone an object as you transform it interactively in the viewport. The process is referred to as [SHIFT+Clone](#) on page 968 : the technique of holding down the Shift key while transforming a selected object with the mouse.

Quick and versatile, this technique is probably the one you'll use most often to duplicate objects. Snap settings give you precise results.

How you set the center and axes for the transforms determines the arrangement of the cloned objects. Depending on the settings, you can create both linear and radial arrays.

You need a working knowledge of transform features to take full advantage of Shift+Clone. See [Using Transforms](#) on page 862 .

## Snapshot

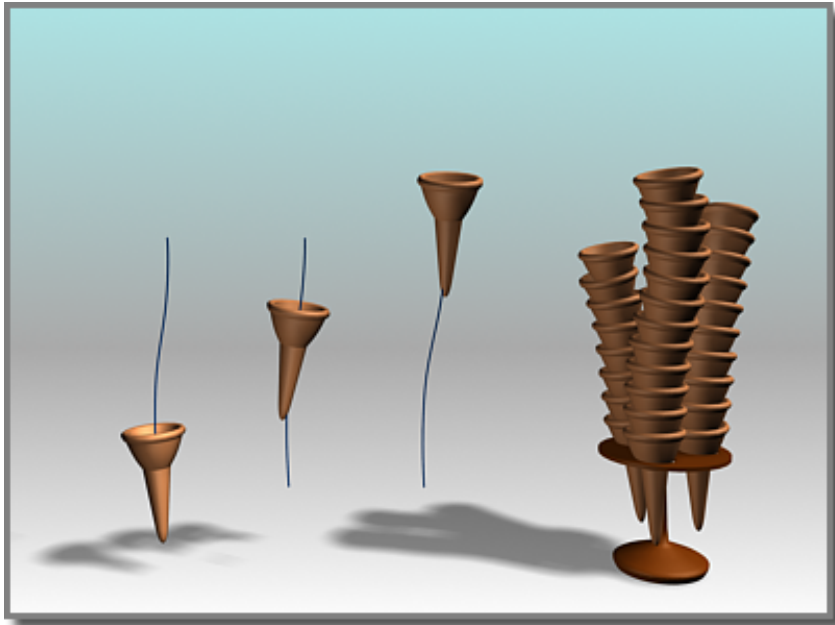

Using an ice-cream cone animated along a path, Snapshot creates a stack of cones.

[Snapshot](#) on page 921 clones an animated object over time. You can create a single clone on any frame, or space multiple clones along the animation path. The spacing is a uniform time interval; it can also be a uniform distance.

## Array



### A one-dimensional array

Array creates repeating design elements: for example, the gondolas of a Ferris wheel, the treads of a spiral stair, or the battlements along a castle wall.

Array gives you precise control over all three transforms and in all three dimensions, including the ability to scale along one or more axes. It is the combination of transforms and dimensions, coupled with different centers, that gives you so many options with a single tool. A spiral stair, for example, would be a combination of Move and Rotate around a common center. Another array using Move and Rotate might produce the interlocked links of a chain.

See [Arraying Objects](#) on page 981 .

## Mirror

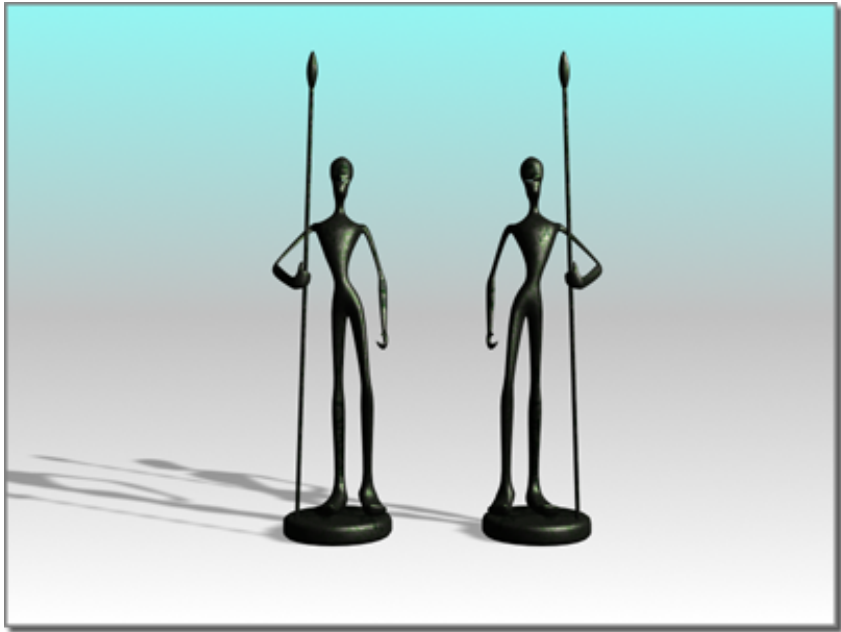

### Mirroring an object

Mirror produces a symmetrical copy around any combination of axes. There is also a "No Clone" option that performs the mirror operation without copying. The effect is a flip or move of the object to a new orientation.

Mirror has an interactive dialog. As you change settings, you see the effect in the active viewport; in other words, a preview of what the mirror will look like.

There is also a Mirror modifier that gives you parametric control of the mirror effect.

See [Mirroring Objects](#) on page 996 .

## Spacing Tool

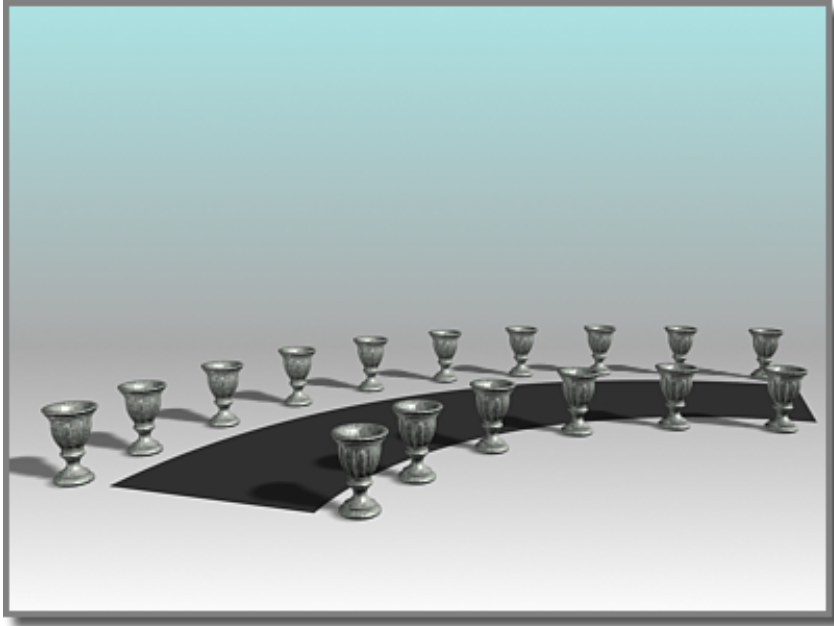

The Spacing Tool distributes the vases along the sides of the curved street.

The Spacing Tool distributes along a path defined by a spline or pair of points. You define a path by picking a spline or two points and by setting a number of parameters. You can also specify how the spacing between objects is determined and whether the insertion points of the objects align to the tangent of the spline.

See [Spacing Tool](#) on page 925 .

## Clone and Align Tool

The Clone And Align tool lets you distribute source objects based on the current selection to a second selection of destination objects. For example, you can use Clone And Align to populate several rooms simultaneously with the same furniture arrangement. Similarly, if you import a CAD file that contains 2D symbols that represent chairs in a conference room, you can use Clone And Align to replace the symbols with 3D chair objects *en masse*.

See [Clone and Align Tool](#) on page 933 .

# Clone

Make a selection. > Edit menu > Clone

Make a selection. > Hold down Shift key. > Move, rotate, or scale the selection with the mouse.

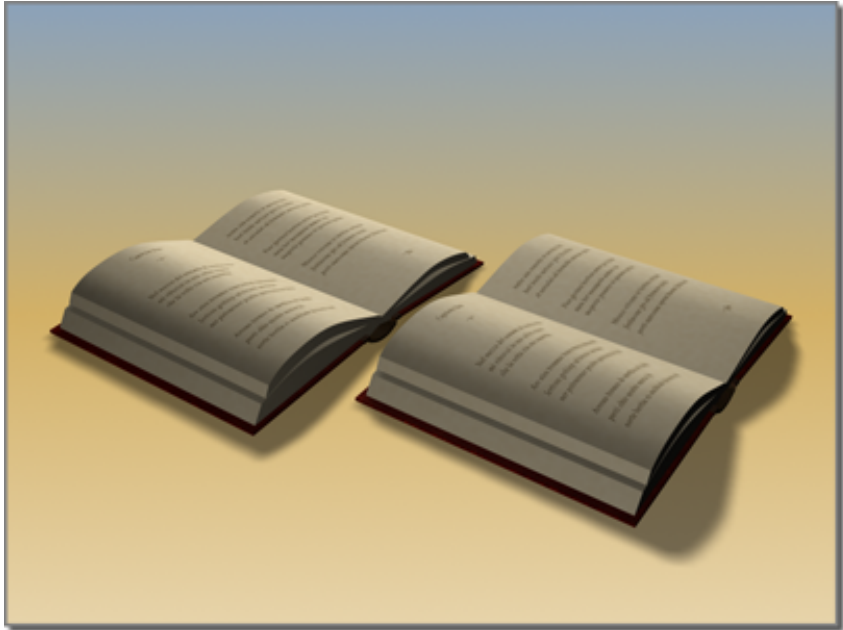

**Clone creates a copy, instance, or reference of an object.**

With the Clone command you can create copies, instances, or references of a selected object or a set of objects.

The Clone command on the Edit menu creates a single copy of your selection. Alternatively, you can clone multiple copies by holding down the Shift key as you [move](#) on page 888, [rotate](#) on page 889, or [scale](#) on page 891 your selection. Either method displays the [Clone Options dialog](#) on page 965 .

## Clone Options Dialog

Make a selection. > Edit menu > Clone

Make a selection. > Hold down Shift key. > Move, rotate, or scale the selection with the mouse.

Clone creates a copy, [instance](#) on page 7818 , or [reference](#) on page 7910 of a selected object or set of objects. The Clone command on the Edit menu creates a single copy. You can clone multiple copies by holding down the Shift key as you transform the selection.

## Procedures

### To clone an object without transforming it:

- 1 Select an object, or set of objects.
- 2 From the Edit menu, choose the Clone command.
- 3 The Clone Options dialog opens.

---

**NOTE** All options are present except Number Of Copies.

---

- 4 Change the settings or accept the defaults, and then click OK.  
Each new, cloned object occupies the same space as the original. Select a clone by name to move or modify it.

### To clone and transform an object:



- 1 On the main toolbar, click the Move, Rotate, or Scale button.
- 2 Select an object, multiple objects, group, or sub-object.
- 3 Hold down the Shift key and drag the selection.  
As you drag your selection, the clone is created, selected, and transformed. The original object is deselected and unaffected by the transform.  
When you release the mouse button, the Clone Options dialog displays.
- 4 Change the settings or accept the defaults, and then click OK.



## Interface

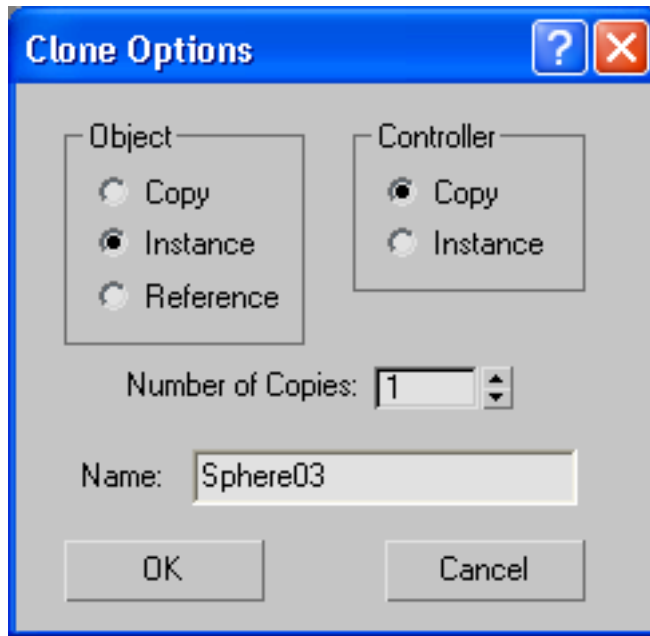

### Object group

**Copy** Places a copy of the selected object at the specified position.

**Instance** Places an instance of the selected object at the specified position.

**Reference** Places a reference of the selected object at the specified position.

### Controller group

Lets you choose to copy or instance the [transform controllers](#) on page 7712 of the original object's child objects. This option is available only when the selection you are cloning includes two or more [hierarchically linked objects](#) on page 7806 .

When cloning non-linked objects, transform controllers are simply copied. Also, when cloning linked objects, the highest-level cloned object's transform controller is simply copied. This option applies only to the transform controllers of objects at levels below the top of the cloned hierarchy.

**Copy** Copies the cloned objects' transform controllers.

**Instance** Instances the cloned objects' transform controllers *below* the top level of the cloned hierarchy. With instanced transform controllers, you can change the transform animation of one set of linked children, and automatically have the change affect any cloned sets.

This allows you to animate all clones identically with a single animation setup. For example, consider a scene containing three objects named Torso, Thigh, and Calf. The objects are linked hierarchically so that Torso is the parent of Thigh and Thigh is the parent of Calf. Say you select all three objects and then clone them, and choose Clone Options > Controller > Instance. Thereafter, if you transform either Thigh or Calf object, the corresponding object in the other hierarchy is transformed identically, along with any child objects. However, if you transform either Torso object, the other hierarchy is not affected.

**Number of Copies** Specifies the number of copies of the object you want to create. Available only when you Shift+Clone an object.

Using Shift+Clone to generate multiple copies applies the transform successively to each additional copy. If you Shift+Move an object and specify two copies, the second copy is offset from the first copy by the same distance that the first copy is offset from the original. For Rotate, two copies of the rotated object are created, with the second copy rotated twice as far as the first. For Scale, two copies of the scaled object are created, with the second copy scaled from the first copy by the same percentage that the first copy was scaled from the original.

**Name** Displays the name of the cloned object.

You can use this field to change the name; additional copies use the same name followed by a two-digit number, starting at 01 and incrementing by one for each copy. So, for instance, if you Shift+Move an object and then specify the name **building** and two copies, the first copy will be named *building* and the second will be named *building01*.

## Using Shift+Clone

Shift+Clone is the primary way to duplicate objects in 3ds Max. You hold down the Shift key and drag during any of the standard transform operations: Move, Rotate, or Scale.

## To **Shift+Clone** an object:



- 1 On the main toolbar, click the Move, Rotate, or Scale button.
  - 2 Select a transform coordinate system and constraints. Each transform carries its own settings. To avoid surprises, always click the transform button first, and then set your transform coordinate system and constraints.
- 
- NOTE** You can also use the Transform Gizmo to set axis constraints.
- 
- 3 Select the object or set of objects you want to clone. The selection can be a single object, multiple objects, a group, or a sub-object selection.
  - 4 Hold down the Shift key and drag the selection to apply the transform. As you drag, a clone is created and selected; it is now the object being transformed. The original object is no longer selected and is unaffected by the transform.

When you release the mouse button, the Clone Options dialog appears. Change settings in this dialog or accept the defaults, and then click OK.

Shift+Clone uses the [Clone Options dialog](#) on page 965 for any transform you choose.

### See also:

- [Cloning with +Move](#) on page 970
- [Cloning with +Rotate](#) on page 972
- [Cloning with +Scale](#) on page 975

## Animating **Shift+Clone**

You can animate any Shift+Clone operation. See [Animating with Shift+Rotate and Shift+Scale](#) on page 977 .

## Cloning Without Transforming

Cloning objects with Shift+Clone requires transforming them at the same time, by moving, rotating, or scaling them. In some cases, you might want to

clone an object without transforming it in any way. The Edit menu Clone command gives you this option, which lets you create only one clone at a time.

**To clone objects without transforming:**

- 1 Select the object or objects to clone.
- 2 Choose Edit menu > Clone. The Clone Options dialog appears. This is the same dialog used with Shift+Clone except that there's no Number Of Copies setting. The Clone command lets you create only one copy.
- 3 Change settings in this dialog or accept the defaults, and click OK.

---

**NOTE** The cloned object occupies the exact same space as the original, and is selected when cloning is complete. Use [Select By Name](#) on page 168 to select the original or reselect the clone.

---

## Cloning with **Shift+Move**

Cloning objects while moving them is quick and easy. It produces a linear array of two or more objects.

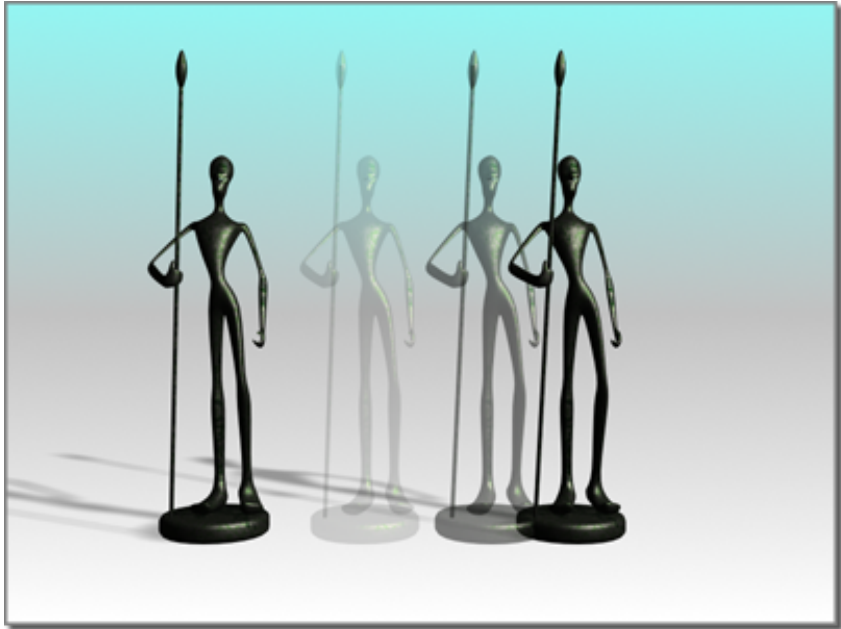

**Shift+Move** creates a clone in a different location.

To clone with **Shift+Move**:

- 1  Click the Move button on the main toolbar.
- 2 Choose a coordinate system and axis constraint.
- 3 Make the selection you want to clone.
- 4 Hold down Shift and drag to move a clone of the selection away from the original.
- 5 Choose the number of copies you want to make on the Clone Options dialog, and whether you want them to be copies, instances, or references.

## About Arrays Created with Shift+Move

Multiple clones produced by Shift+Move form an equally spaced linear array with these characteristics:

- The line of the array runs from the center of the original through the centers of the clones.
- The distance between each neighboring pair of copies is the same the distance between the original and the first clone.

By using snaps as you move the selection, you can make precise arrays.

An example of the Shift+Move array is a picket fence. From a single picket, you can generate long runs of fencing. You can array the fence along a major axis of the home grid, then group the pickets, rotate them to a particular angle, and move them into position.

You can also make three-dimensional arrays with Shift+Move. The main choice is the combination of axes to allow movement off the construction plane. For example, to build a stairway, you can create a box that forms the top step, then use Shift+Move to copy it diagonally downward, using an array to create a downward flight.

## Cloning with Shift+Rotate

Cloning objects while rotating them produces a variety of effects, depending on how you set up the transformation.

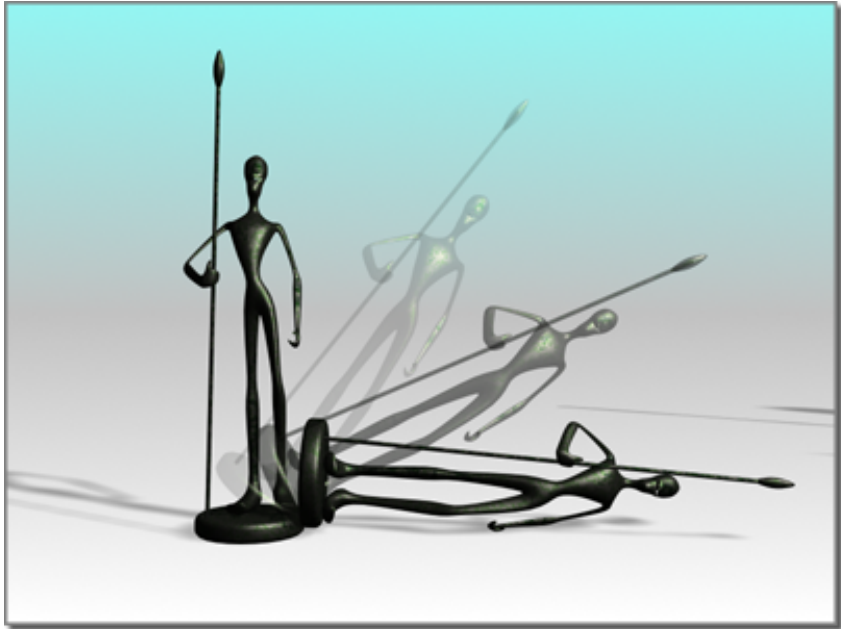

**Shift+Rotate** creates a clone with a different orientation.

To clone with **Shift+Rotate**:

- 1  Click the Rotate button on the main toolbar.
- 2 Choose a coordinate system, transformation center, and axis constraint.
- 3 Make the selection you want to clone.
- 4 Hold down the Shift key and drag to rotate the selection.
- 5 Choose the number of copies you want to make on the Clone Options dialog, and whether you want them to be copies, instances, or references.

### **Effects of Transform Settings**

Where you locate the transform center determines how 3ds Max positions clones when using Shift+Rotate.

- For all settings, the direction of rotation is constrained by the active axis or axes of the viewport's coordinate system.

- Each clone is rotated from the previous one by the same amount as the first clone from the original.

### **Local Pivot at Center**

An object's default pivot point is often located at its center or its base. When you use Shift+Rotate around an object's default pivot point, the clones overlap evenly as each one is rotated the same amount. This is true for multiple objects with a local-pivot setting, since each object uses its own local center.

Clones of a circular object, like a sphere or cylinder, can be overlaid exactly on the original. You might need to move them away from the original to see them.

With [angle snap](#) on page 2523 set to divide a circle evenly, you can produce complex symmetrical objects from simple ones. For example, you can clone a tetrahedron around one axis, then clone the new set about another axis to produce a faceted star.

### **Local Pivot at a Distance**

When you separate the local pivot from the original, clones create a wheel-like arrangement. Long shapes like petals or blades, cloned with the center near one end, can create flowers or propellers. See [Adjust Pivot Rollout](#) on page 3399 .

You can move the local pivot any distance from the object, creating large circular arrays. Since direct animation is limited to the local pivot, this is a key technique in animating circular arrays. See [Animating +Rotate and +Scale](#) on page 977 .

### **Selection Center**

For either single or multiple objects, the selection center is the geometric center of the [bounding box](#) on page 7736 enclosing the entire selection. Clones are arrayed around this center, forming wheel-like arrays.

For a single object, this center is usually different from its local center, but the effects are similar to those based on a local pivot.

### **Coordinate Center**

Using the coordinate center, Shift+Rotate can produce circular arrays of any size.



The rotation takes place around the center of the home grid, the screen, or whichever coordinate system you choose. While clones can be created this way, the process cannot be directly animated. For details on overcoming this limitation, see [Animating +Rotate and +Scale](#) on page 977 .

## Cloning with **Shift+Scale**

Cloning objects while scaling them can produce a variety of nested objects and arrays, depending on the center you choose.

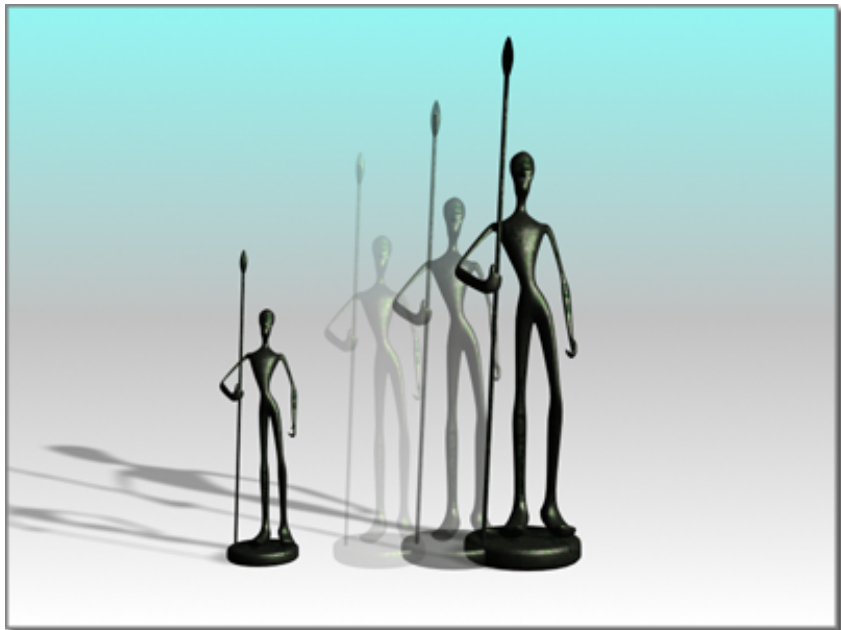

**Shift+Scale** creates a clone of a different size.

To clone with **Shift+Scale**:

- 1  Click a Scale button on the main toolbar.
- 2 Choose a coordinate system, axis constraint, and transform center.
- 3 Make the selection you want to clone.
- 4 Hold down Shift and drag to scale the selection.

- 5 Use the Clone Options dialog to choose the number of clones you want to make and whether you want them to be copies, instances, or references.

### **Effects of Transform Settings**

Transform settings determine how 3ds Max distributes clones of a selection during Shift+Scale. In all scaling operations, the transform center acts as the center of scaling:

- When clone objects decrease in size, they shrink toward the transform center.
- When clone objects increase in size, they expand away from the transform center.

The distance between cloned objects is scaled like the clones themselves, based on the initial distance from the original to the first clone. The spacing increases or decreases proportionately with respect to the transform center.

### **Nested Copies**

When the selection center is used as the transform center for a single object, scaling occurs symmetrically around that center, producing nested copies.

- As you scale in toward the center, smaller and smaller copies are created.
- In the other direction, the original object is enclosed by increasingly larger copies.

Variations are possible, depending on the type of scale and axis limitations. For example, you can scale a flat box into a progressively stepped pyramid by using [Squash](#) on page 894 and cloning inward on the Z axis.

### **Offset Centers**

For Shift+Scale, any center other than the local pivot has the effect of creating an array of progressively scaled objects. Again, objects scale down in size toward the center, while increasing in size further away. However, this effect is limited by the particular scale option and the axis constraints, as discussed next.

## Axis Constraints

Uniform Scale is unaffected by axis constraints, which you can set with the Transform Gizmo. Copies are always arrayed in or out from the center of the current coordinate system.

For Non-Uniform Scale and Squash, scaling occurs only along the axis or axes set with the restricted axes.

---

**NOTE** The Restrict To ... buttons (also called the Axis Constraints buttons) are available on the [Axis Constraints toolbar](#) on page 7288 , which is off by default. You can toggle display of this toolbar by right-clicking an empty area of a toolbar and choosing Axis Constraints from the [Customize Display right-click menu](#) on page 7479 .

---

## Animating Shift+Rotate and Shift+Scale

When the [Auto Key button](#) on page 7344 is on, the transform center defaults to local pivot, and the [Use Center flyout](#) on page 904 on the toolbar is unavailable. If you choose one of the other centers and activate Auto Key, the center returns to the local pivot. This means you can't directly animate about a non-local pivot center with Shift+Rotate and Shift+Scale. For example, you can't use this method to create clones in an arc or circular array around a common center.

### Using Non-Local Centers

To use a center separate from the object you're cloning, you can do any of the following:

- Use a dummy object.
- Offset the local pivot.
- Change the default animation center.

### Using a Dummy Object as Center

In this procedure, you use the axis tripod of the dummy object as the center for rotation or scale.

### To use a dummy object as center:

- 1 Create a [dummy object](#) on page 2531 at the center of rotation or scaling.



- 2 Link the object or objects you want to clone to the dummy object, which becomes the parent.
- 3 Select both the dummy and the objects, then transform them with Shift+Rotate or Shift+Scale.
  - For Shift+Rotate, the dummy's center becomes the pivot.
  - For Shift+Scale, the dummy and selected objects scale together toward the center of the dummy.

For details of dummy object use in hierarchies, see [Using Dummy Objects](#) on page 3288 .

### Offsetting the Local Pivot

In this procedure, you move the object's pivot to the center of rotation or scale. This works much like using a dummy object.

#### To offset the local pivot:

- 1 Select the object whose pivot you wish to move.



- 2 On the Hierarchy command panel, choose Pivot and then turn on Affect Pivot Only.
- 3 Move the local pivot of the original object to another location in your scene.
- 4 On the Hierarchy panel, click Affect Pivot Only again to turn it off. Shift+Rotate or Shift+Scale now animates around the offset center. This works with the default setting for local center.

---

**NOTE** Moving the local pivot can adversely affect linking and inverse kinematics. If this is a possibility, consider changing the default axis instead of moving the local pivot.

---

### To change the default axis while animating:

In this procedure, you set 3ds Max to allow animation of transforms about any center on the Use Center flyout.

- 1 Choose Customize menu > Preferences and click the Animation tab of the Preference dialog.
- 2 In the Animate group, turn off Local Center During Animate.  
This changes the default and makes all the transform center options available when animating. You can now animate around either the selection or transform coordinate center, as well as local pivot.

---

**NOTE** Changing the default setting animates the rotation you see in viewports as a rotation plus translation, which might not be the effect you wanted.

---

## Cloning Objects Over Time with Snapshot

The [Snapshot tool](#) on page 921 lets you clone an object along its animation path. You can make a single clone at any frame, or multiple clones spaced over a selected number of frames.

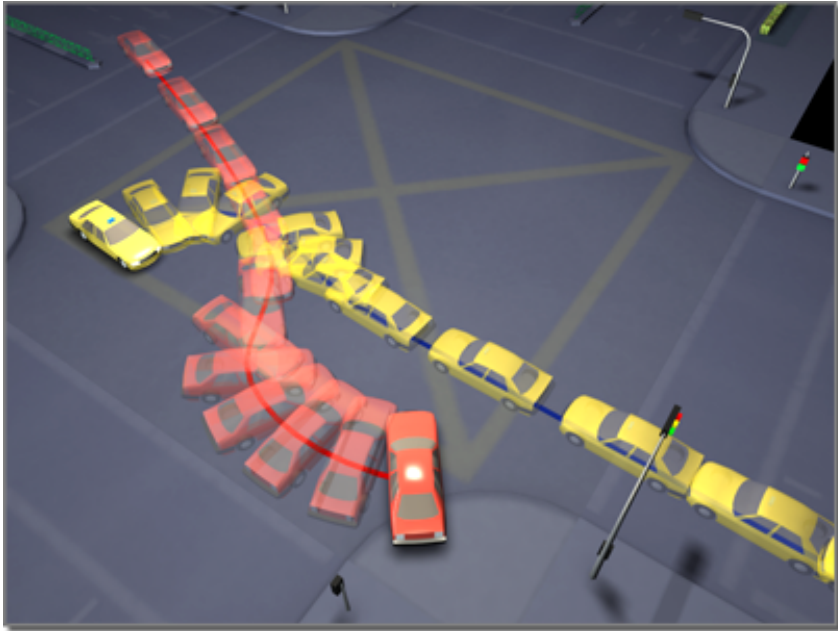

Using car models animated along paths, Snapshot creates an image of a collision.

Snapshot can also clone a particle system's particles.

Snapshot spaces the clones equally in time. Adjustments in Track View let you space the clones equally along the path instead.

Like other clone techniques, Snapshot creates copies, instances, or references. You can also choose a mesh option.

To clone an object with Snapshot, the object must already be animated. You can use Snapshot from any frame on the path. The Auto Key button has no effect on Snapshot, since Snapshot creates static clones, not animation. This is the general procedure:

**To clone an object with Snapshot:**

- 1 Select an object with an animation path, or a particle system. The animation can result from applying transforms, controllers, or any combination of effects.



- 2 On the [Array flyout](#) on page 911 click Snapshot, or choose Tools menu > Snapshot to display the Snapshot dialog.

---

**NOTE** The Array flyout is on the Extras toolbar, which is off by default. You can toggle display of this toolbar by right-clicking an empty spot on the main toolbar and choosing Axis Constraints from the [Customize Display right-click menu](#) on page 7479 .

---

- 3 Set parameters in the dialog, and click OK.

## Arraying Objects

Array is a dedicated tool for cloning and precisely transforming and positioning groups of objects in one or more spatial dimensions. For each of the three transforms (move, rotate, and scale), you can specify parameters for individual objects in the array, or for the array as a whole. Many results you can get with Array would be laborious or impossible using Shift+Clone techniques.

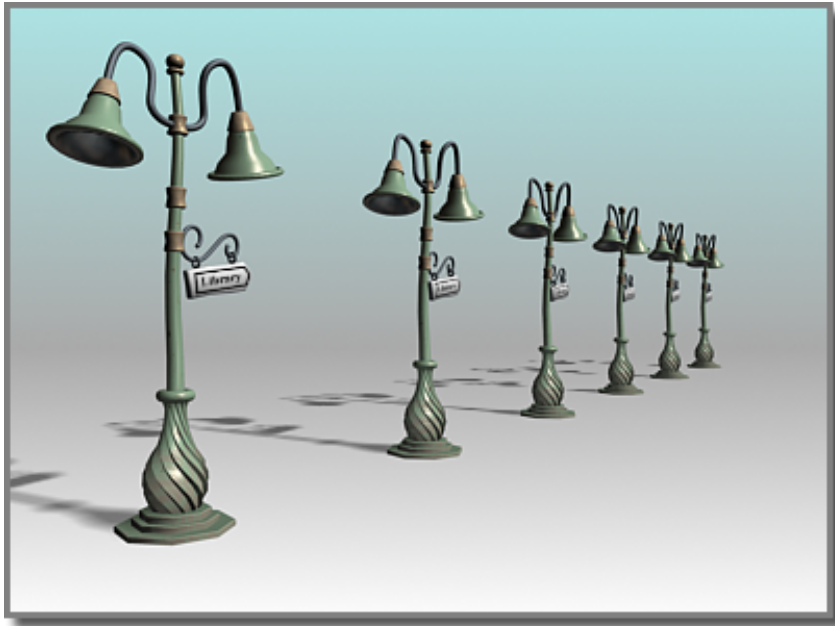

A one-dimensional array

### Creating an Array

This is the general procedure. For more details, see these topics:

[Using the Array Dialog](#) on page 983

[Creating Linear Arrays](#) on page 989

[Creating Circular and Spiral Arrays](#) on page 993

**To create an array:**

- 1 Select one or more objects to be in the array.
- 2 Choose a coordinate system and transform center.



- 3 Click Array on the Array flyout, or choose [Array](#) on page 915 from Tools menu.

The Array dialog appears.

---

**NOTE** The Array flyout is on the Extras toolbar, which is off by default. You can toggle display of this toolbar by right-clicking an empty spot on the main toolbar and choosing Axis Constraints from the [Customize Display right-click menu](#) on page 7479 .

---

- 4 Set array parameters on this dialog, then click OK.

### **Reuse of Array Settings**

Generally you should approach Array creation as an iterative process. The dialog settings are not interactive, so you get feedback only after creating the array. By revising the current settings and repeating the array, you develop a solution that meets your needs.

After creating an array and checking its result, you can undo the array using Edit menu > Undo Create Array or Ctrl+Z. This leaves the original selection set in place.

### **Repeating an Array**

When you create an array, object selection moves to the last copy or set of copies in the array. By simply repeating current settings, you create a seamless continuation of the original array.

During a session, 3ds Max maintains all the dialog settings for your current array.

Array settings are saved only during the current session, not with the file. Be sure you've finished an array before you quit 3ds Max.



## General Considerations

When you create an array, keep these points in mind:

- Array is relative to the current viewport settings for coordinate system and transform center.
- Axis constraints do not apply, because Array allows you to specify transforms along all axes.
- You can animate array creation. By changing the default Animate preferences setting, you can activate all the transform center buttons, allowing direct animation around either the selection or coordinate center, as well as local pivot. For information about changing the default setting, see the procedure, [To change the default axis while animating](#) on page ? .
- To make an array of a hierarchically linked object, select all the objects in the hierarchy before you click Array.

## Using the Array Dialog

The Array dialog provides two main control areas where you set the important parameters: Array Transformation and Array Dimensions.

You can set parameters in any order, but in practice it's useful to start with Array Transformation. This creates the basic building block for the larger array, as defined by Array Dimensions.

These topics discuss specific strategies for using these controls:

[Creating Linear Arrays](#) on page 989

[Creating Circular and Spiral Arrays](#) on page 993

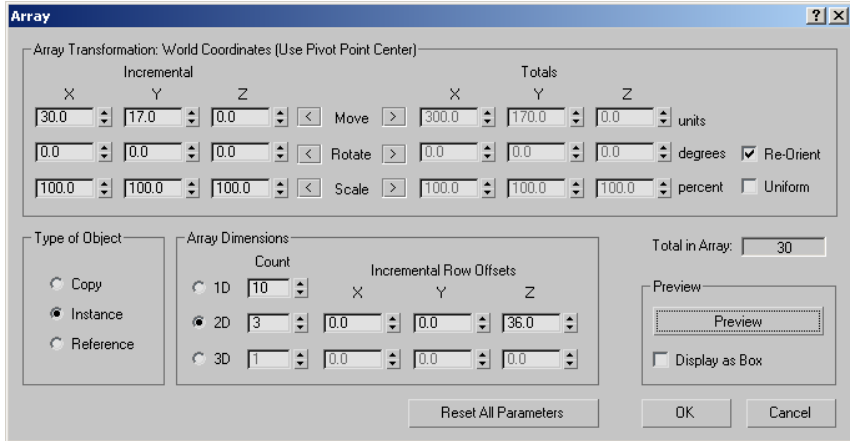

See also:

- [Array](#) on page 915

## Array Transformation

This area lists the active coordinate system and transform center. It's where you set the transforms that define the first row of the array. You decide here on the distance, rotation, or scale of individual elements, and along what axes. You then repeat this row in other dimensions to produce the finished array.

### Move, Rotate, and Scale Transforms

You set Move, Rotate, and Scale parameters along any of the three axes of the current coordinate system.

- Move is set in current units. Use a negative value to create the array in the negative direction of the axis.
- Rotate is set in degrees. Use a negative value to create the array in a clockwise direction around the axis.
- Scale is set as a percentage. 100 percent is full size. Settings below 100 decrease the size, and above 100 increase it.

## Incremental and Totals

For each transform, you have the choice of whether to apply the transforms successively to each newly created element in the array or to the overall array. For example, if you set Incremental > X > Move to 120.0 and Array Dimensions > 1D > Count to 3, the result is an array of three objects, each of whose transform centers is 120.0 units apart. However, if you set Totals > X > Move to 120.0 instead, the three elements are spaced 40.0 units apart for a total array length of 120.0 units.

- Click arrows on either side of the transform labels to choose between Incremental or Totals.

Incremental and Totals settings are toggles for each transform. When you set a value on one side, the other side is unavailable. However, the unavailable value updates to show the equivalent setting.

**Incremental:** Parameters set on this side apply to individual objects in the array. Here are examples:

- An Incremental Move X setting of 25 specifies a spacing of 25 units on the X axis between centers of arrayed objects.
- An Incremental Rotate Z setting of 30 specifies a progressive rotation of 30 degrees on the Z axis for each object in the array. In the finished array, each object is rotated 30 degrees farther than the one before it.

**Totals:** Parameters set on this side apply to the overall distance, number or degrees, or percentage scale in the array. Here are examples:

- A Totals Move X setting of 25 specifies a total distance of 25 units on the X axis between the centers of the first and last arrayed objects.
- A Totals Rotate Z setting of 30 specifies a combined rotation of 30 degrees on the Z axis divided equally among every object in the array.

## Type of Object

**Copy** Creates new array members as copies of the originals.

**Instance** Creates new array members as instances of the originals.

**Reference** Creates new array members as references of the originals.

For further information, see [Overview of Copies, Instances, and References](#) on page 955 .

## Array Dimensions

The Array Dimensions controls determine the number of dimensions used in the array and the spacing between the dimensions.

**Count:** The number of objects, rows, or layers in each dimension.

**1D:** One-dimensional arrays form a single line of objects in 3D space, like a line of columns. 1D Count is the number of objects in a row. Spacing for these objects is defined in the Array Transformation area.

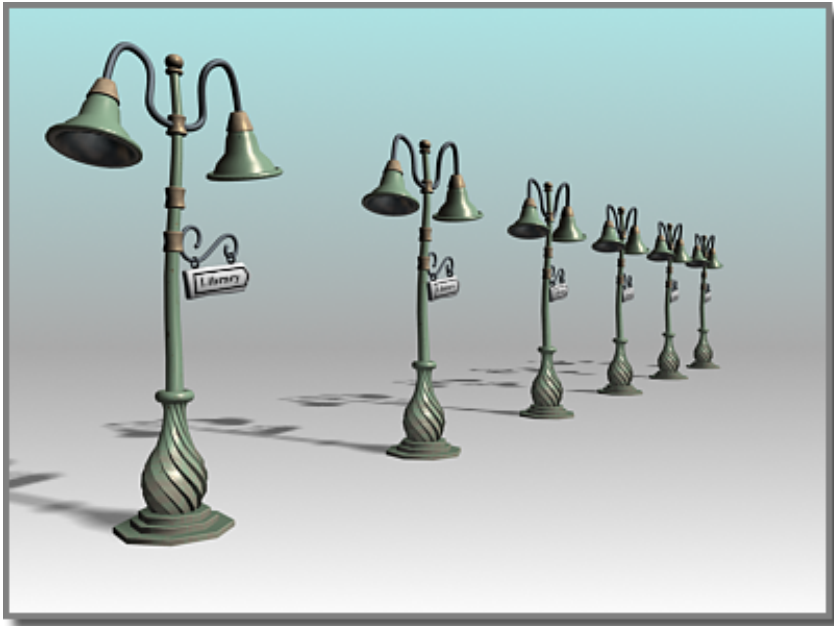

A one-dimensional array, with 1D Count=6

**2D:** Two-dimensional arrays form a layer of objects along two dimensions, like the rows of squares on a chess board. 2D Count is the number of rows in the array.



A two-dimensional array, with 1D Count=7 and 2D Count=4

**3D:** Three-dimensional arrays form multiple layers of objects in 3D space, like neatly stacked boxes. 3D Count is the number of layers in the array.



A three-dimensional array, with 1D Count=10, 2D Count=6, 3D Count=3

### Incremental Row Offsets

These parameters become available when you choose a 2D or 3D array. These are distances along any of the three axes of the current coordinate system.

- If you set a Count value for 2D or 3D, but no row offsets, the array is created with overlapping objects. You need to specify at least one offset distance to prevent this.
- If some objects appear to be missing from the array, it is possible that some objects have been created exactly on top of other objects in the array. To determine whether this has occurred, use [Select By Name](#) on page 168 to see the full listing of objects in your scene. If objects are on top of one another and you don't want this effect, click Ctrl+Z to undo the array, and try again.

# Creating Linear Arrays

A linear array is a series of clones along one or more axes. A linear array can be anything from a line of trees or cars to a stairway, a picket fence, or a length of chain. Any scene requiring repeated objects or shapes is a candidate for a linear array.

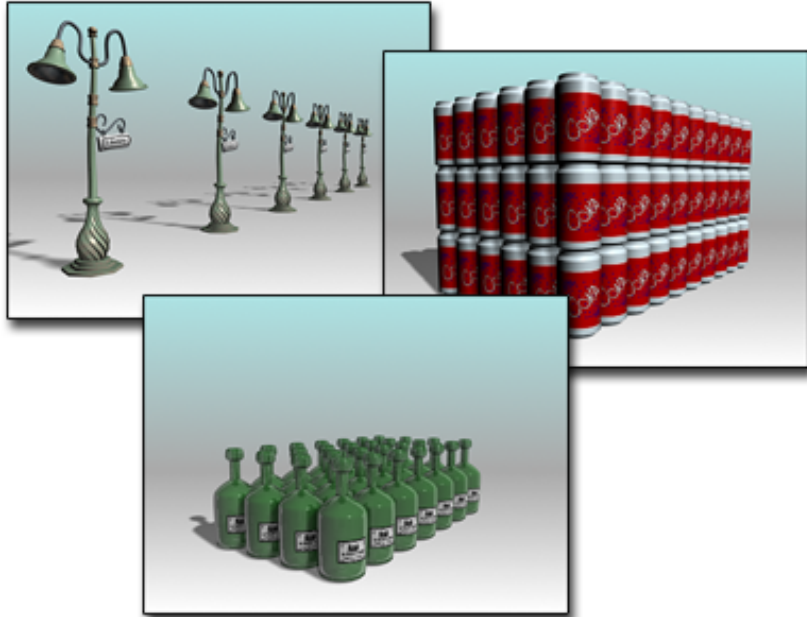

## Examples of linear arrays

For an explanation of interface terms used here, see [Using the Array Dialog](#) on page 983 . For the basic steps in making an array, see [Arraying Objects](#) on page 981 .

## Creating Simple Linear Arrays

The simplest 2D linear array is based on moving a single object along a single axis. These are the basic choices to make on the Array dialog.

Make these choices in the Array Transformation group:

- Use *Incremental Move* settings where you know the spacing you want between objects.

- Use *Totals Move* settings when you know the overall space or volume you want the array to occupy.
- For either of these two types of arrays, enter a value for one axis. Leave the other transforms at their default values.

Make these choices in the Array Dimensions group:

- Choose 1D.
- Enter a Count value for the number of objects in the array. The Total In Array field updates to show you the current total of objects in the array you are designing.
- Click OK to create a linear array along the chosen axis, with the number of objects specified by Count.

### **2D and 3D Linear Arrays**

Arrays in 2D and 3D have the same Array Transformation group setup as 1D, with the addition of Incremental Row Offsets settings for moving the additional dimensions apart.

- Set 2D or 3D and enter a Count value.  
If you set 3D, the 2D values also become available. Both Count values are 1 by default, which has the same effect as 1D. Set the 2D and 3D Count values greater than 1 to produce a more complex array.
- Set a nonzero value for at least one Incremental Row Offsets setting for 2D and 3D. Otherwise, there will be no separation between the 1D row and the new clones.

A wide variety of linear arrays are possible. Experiment with moving along all three axes and varying the row offsets in 2D and 3D.



## Using Rotation in Linear Arrays



Linear array with elements rotated about their Y axis

You can rotate elements in a linear array by applying a Rotate value for a specified axis. When you add rotation to a linear array, the choice of transform center becomes important.

## Using Scale in Linear Arrays



Linear array with progressive scaling

When you apply a Scale factor, 3ds Max scales each copy from the previous copy. Objects in the array become progressively smaller or larger, as in the illustration.

## Scale and Movement in Nested Arrays

Using only Scale settings and the local pivot of an object produces nested arrays, like Russian dolls, just as it does when you Shift+Scale from the local pivot. However, with the Array tool, you can add movement as well. This means you can create increasingly larger or smaller copies and array them at the same time.

### Using Uniform Scaling

By default, all axes are available for scaling.

If you turn on Uniform, only the Scale X field is active; the Y and Z fields are unavailable. The X value is applied as uniform scaling on all axes of the arrayed objects.

## Creating Circular and Spiral Arrays

Creating circular and spiral arrays typically involves some combination of moving, scaling, and rotating copies along one or two axes and around a common center. The effects can vary from the uniform radial arrangement of bolts on a wheel hub to the complex geometry of a spiral staircase. You can model many circular patterns with these techniques.

See [Using the Array Dialog](#) on page 983 for an explanation of interface terms used here. See [Arraying Objects](#) on page 981 for the basic steps in making an array.

### Using a Common Center

Both circular and spiral arrays require a common center for the arrayed objects. This can be the world center, the center of a custom grid object, or the center of the object group itself. You can also move the pivot point of an individual object and use that as the common center.

## Circular Arrays

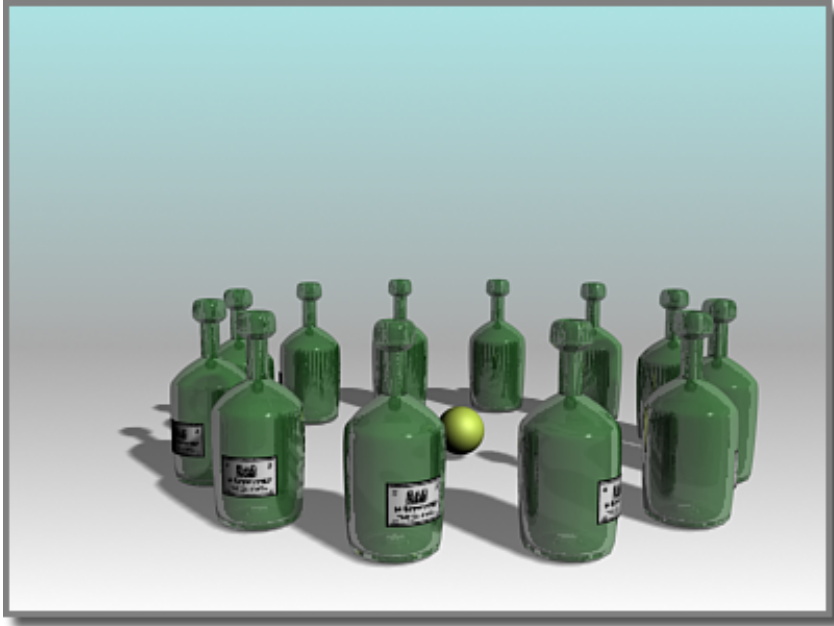

### A circular array

Circular arrays are similar to linear arrays, but based on rotation around a common center rather than movement along an axis. The following procedure makes a circle of objects on the XY plane of the home grid with the Z axis as the center.

#### To create a circular array:

- 1 On the main toolbar, choose a transform center to become the center of the array. In this case, choose Use Transform Coordinate Center so the center of the grid becomes the array center.
- 2 Select an object and position it at some distance from the center of the grid.  
This distance is the radius of the finished circle.

- 3  Choose Array from the Array flyout or the Tools menu to display the Array dialog.

---

**NOTE** The Array flyout is on the Extras toolbar, which is off by default. You can toggle display of this toolbar by right-clicking the main toolbar and choosing Axis Constraints from the [Customize Display right-click menu](#) on page 7479 .

---

- 4 On the Array dialog, enter **360** in the Totals Rotate Z field.  
This is the total rotation for the array, a complete circle. To create a partial circle, enter a smaller value.
- 5 Choose 1D and enter a Count value (this can be any number) and click OK.  
3ds Max arrays that number of clones within the total rotational angle you specify.

### Spiral Arrays

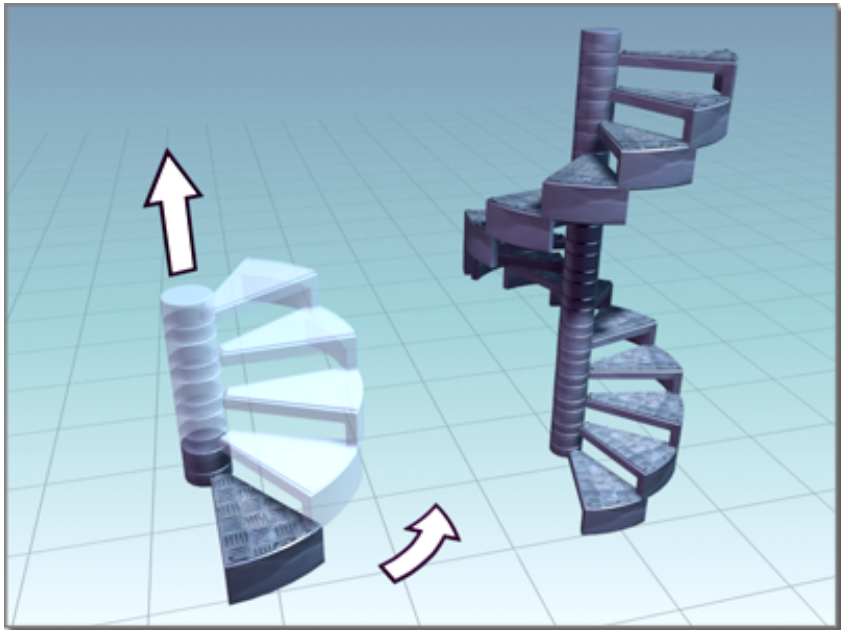

A spiral array

The simplest spiral arrays are rotated circular arrays with a movement along the central axis. The same circle is formed, but now the circle rises upward.

If Z is the central axis, enter a value for Incremental Move Z. Each clone is then moved upward this amount as the circle is formed.

### **Rotation in Spiral Arrays**

In spiral arrays, the direction of rotation determines the direction of the spiral: which way it winds up or down.

Enter a positive rotation for a counterclockwise spiral.

Enter a negative rotation for a clockwise spiral.

### **Reorienting an Array**

By default, each object, when copied into the array, rotates around its own center to follow the main rotation around the common center. This is controlled by the Re-Orient option.

To cause objects to maintain their original orientation while being rotated, turn off Re-Orient. In effect, objects remain "facing the same direction" as the original object.

## **Mirroring Objects**

The Mirror tool uses a dialog that either creates a mirrored clone of a selected object, or mirrors the orientation of the object without creating a clone. You can preview the effects of settings before committing to the operation.

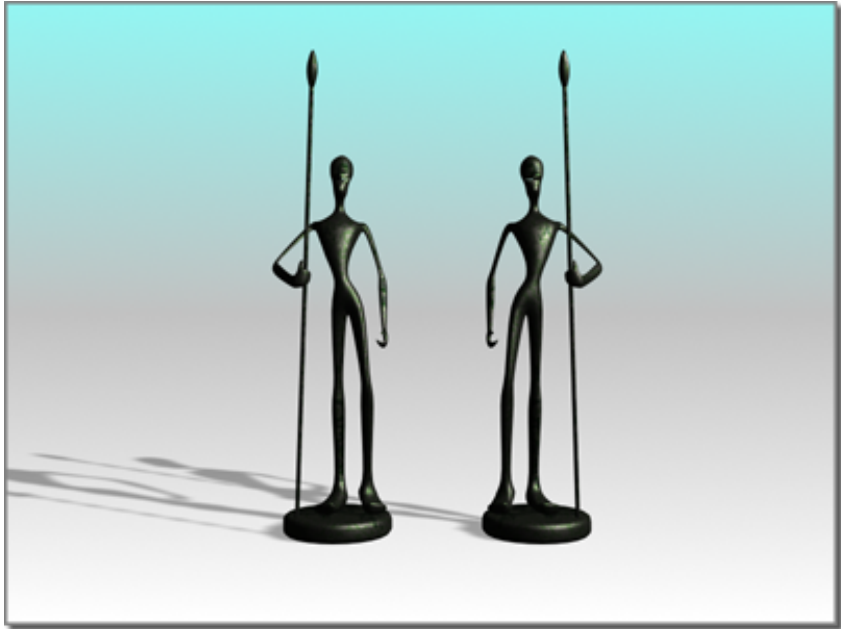

### **Mirroring an object**

This is the general procedure for mirroring an object. Begin by selecting the object.

-  Click the Mirror button on the main toolbar, or choose Tools menu > Mirror. This displays the Mirror dialog. The title bar indicates the coordinate system currently in use.

For information on the Mirror dialog options, see [Mirror Selected Objects](#) on page 911 .

### **Mirrored Arrays**

You can combine the Mirror and Array tools by using them in succession. An entire array can be mirrored, or you can set up mirrored objects before creating an array.

## Animating Mirror

When you use Mirror with Auto Key turned on, you see the transition occur as the mirrored object moves into place. For example, a cylinder mirrored to the other side of an axis appears to flatten and reshape itself. The object is, in fact, scaled from 100% to 0% to -100%. This effect is not visible unless the mirror operation is animated.

## Mirror Modifier

The [Mirror modifier](#) on page 1471 provides a parametric method of mirroring an object or sub-object selection within the modifier stack. You can apply the Mirror modifier to any type of geometry. You can animate the mirror effect by animating the modifier's gizmo.

# Using the Spacing Tool

The Spacing Tool distributes objects based on the current selection along a path defined by a spline or pair of points. The distributed objects can be copies, instances, or references of the current selected object. You define a path by picking a spline or two points and by setting a number of parameters. You can also specify how the spacing between objects is determined and whether the insertion points of the objects align to the tangent of the spline.



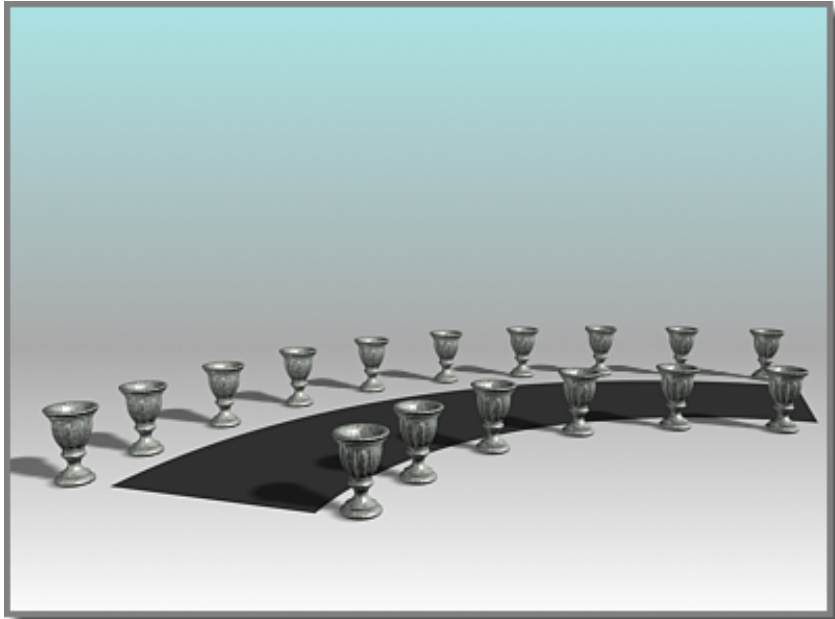

The **Spacing Tool** distributes the vases along the sides of the curved street. The vases are all at the same distance from each other; fewer of them appear on the shorter side.

For details on the Spacing Tool parameters, see [Spacing Tool](#) on page 925 .

#### To distribute objects along a path:

- 1 Select one or more objects to distribute.



- 2 Choose Spacing tool from the Array flyout or the Tools menu.

---

**NOTE** The Array flyout is on the Extras toolbar, which is off by default. You can toggle display of this toolbar by right-clicking an empty area on the main toolbar and choosing Axis Constraints from the [Customize Display right-click menu](#) on page 7479 .

---

- 3 On the Spacing Tool dialog, click Pick Path or Pick Points to specify a path.  
If you click Pick Path, select a spline from your scene to use as the path.

If you click Pick Points, click a start point and an end point to define a spline as the path. When you're finished with the Spacing Tool, 3ds Max deletes this spline.

- 4 From the drop-down list at the bottom of the Parameters group, choose a spacing option.  
The parameters available for Count, Spacing, Start Offset, and End Offset depend on the spacing option you choose.
- 5 Specify the number of objects to distribute by entering a Count value, or by using the spinner.
- 6 Depending on the spacing option you choose, adjust the spacing and offsets.
- 7 In the Context group, choose one of the following:
  - **Edges** specifies that spacing be determined from the facing edges of each object's bounding box.
  - **Centers** specifies that spacing be determined from the center of each object's bounding box.
- 8 To align the insertion points of the distributed objects to the tangent of the spline, turn on Follow.
- 9 In the Type Of Object group, choose the type of object to output (copy, instance, or reference) and click Apply.

# Modifiers

# 9

Modifiers provide a way for you to sculpt and edit objects. They can change the geometry of an object, and its properties.

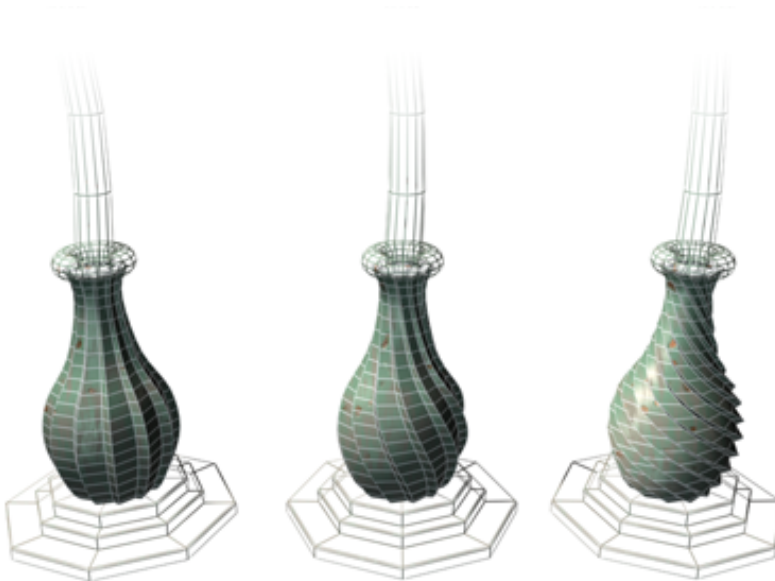

## Example: effects of the Twist modifier on an object

The modifiers you apply to an object are stored in a [stack](#) on page 7850 . By navigating up and down the stack, you can change the effect of the modifier, or remove it from the object. Or you can choose to “collapse” the stack and make your changes permanent.

There are other general things to know about using modifiers:

- You can apply an unlimited number of modifiers to an object or part of an object.

- When you delete a modifier, all its changes to the object disappear.
- You can move and copy modifiers to other objects using controls in the [modifier stack display](#) on page 7427 .
- The order or sequence in which you add modifiers is important. Each modifier affects those that come after it. For instance, adding a [Bend modifier](#) on page 1139 before a [Taper](#) on page 1739 can give you distinctly different results than if you first added the Taper followed by the Bend.

**See also:**

- [List of Available Modifiers](#) on page 1011
- [Using the Modifier Stack](#) on page 1020
- [Modifier Stack Controls](#) on page 7427

## **How Modifiers Differ from Transforms**

Modifiers and transforms differ in how they affect an object and the order in which they are applied to an object.

### **Transforms**

The transform is the most basic of 3D manipulations. Unlike most modifiers, transforms are independent of an object's internal structure, and they always act in [world space](#) on page 7976 . An object can carry any number of modifiers, but it always has only a single set of transforms.

The transforms of an object are expressed as a matrix of values that contain the following information:

- Position of the object center in world space
- Rotation of the object in world space
- Scale of the object along its local axes

The matrix is called the *transformation matrix*, and its information relates directly to the transforms Move, Rotate, and Scale. Applying one of these transforms alters the values in the transformation matrix.

Transforms have the following properties. They are:

- Applied to the entire object.

- Independent of their order of application. No matter how many times you transform an object, the results are stored as one set of values in the matrix.
- Applied after all object-space modifiers have been evaluated, but before the world-space modifiers. See [Using the Modifier Stack](#) on page 1020 .

Most transforms produce equal displacement along one or more axes of an object, or part of an object. For [Move](#) on page 888 , [Rotate](#) on page 889 , and [Uniform Scale](#) on page 892 transforms, the displacement is equal along all three axes. When you rotate a box, all sides remain parallel. In general, all vertices keep the same relative position to one another. The exceptions are [Squash](#) on page 894 and [Non-Uniform Scale](#) on page 893 , which displace axes by different amounts.

---

**TIP** Use the [XForm modifier](#) on page 1922 if you want to transform an object at a specific location in the stack (that is, after some object-space modifiers but before others), or if you want to transform a sub-object selection. See [Modifying at the Sub-Object Level](#) on page 1029 .

---

## Modifiers

Most modifiers allow you to perform operations on the internal structure of an object in [object space](#) on page 7868 . For example, when you apply a modifier such as [Twist](#) on page 1765 to a mesh object, the position of each vertex of the object is changed in object space to produce the twisting effect.

Modifiers can operate at the sub-object level, and are dependent on the internal structure of the object when the modifier is applied.

Modifiers have the following properties. They are:

- Applied to all of an object or part of an object (using a sub-object selection).
- Dependent on the order of application. Applying a Bend followed by a Twist produces a result different from applying a Twist followed by a Bend.
- Displayed as individual entries in the modifier stack, where you can turn them on or off, and change the order in which they're applied.

Some modifiers operate in world space. These use world-space coordinates, and are applied to the object after all object-space modifiers and transforms have been applied. Otherwise, they have the same overall properties as object-space modifiers.

# Transforms, Modifiers, and Object Data Flow

Once you have defined an object, 3ds Max evaluates changes affecting the base object and displays the result in the scene. What these changes are, and the order in which they are evaluated, is called the *object data flow*.

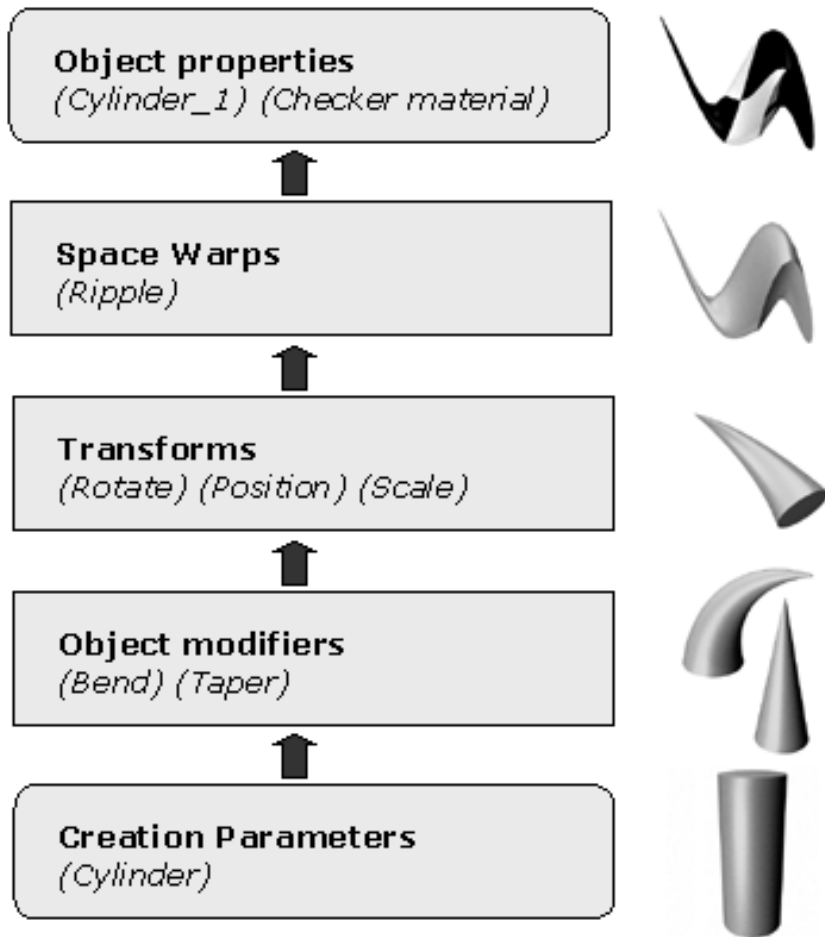
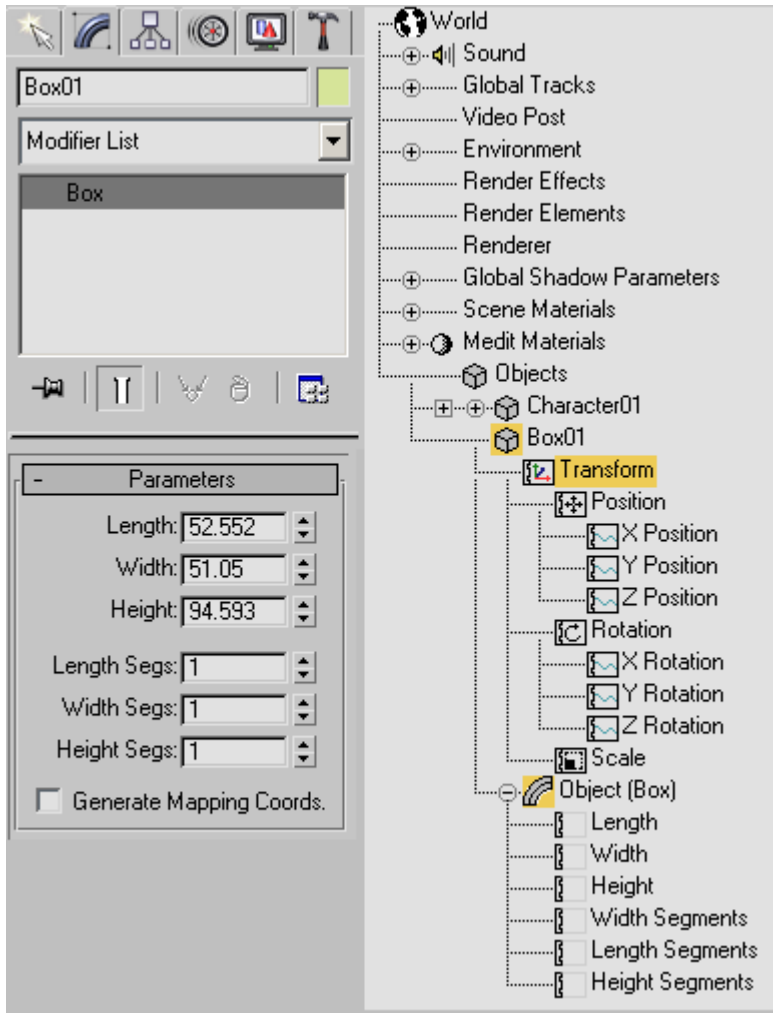

Diagram of data flow

## Master Object

*Master object* refers to an object defined by a set of creation parameters and the original position and orientation of its pivot point. You never see the master object. What you see in the viewport is always the result of at least the following data flow:

```
Master Object  
  -> Object Transforms  
      -> Object Properties
```



Object creation parameters in the Modify panel and Track View



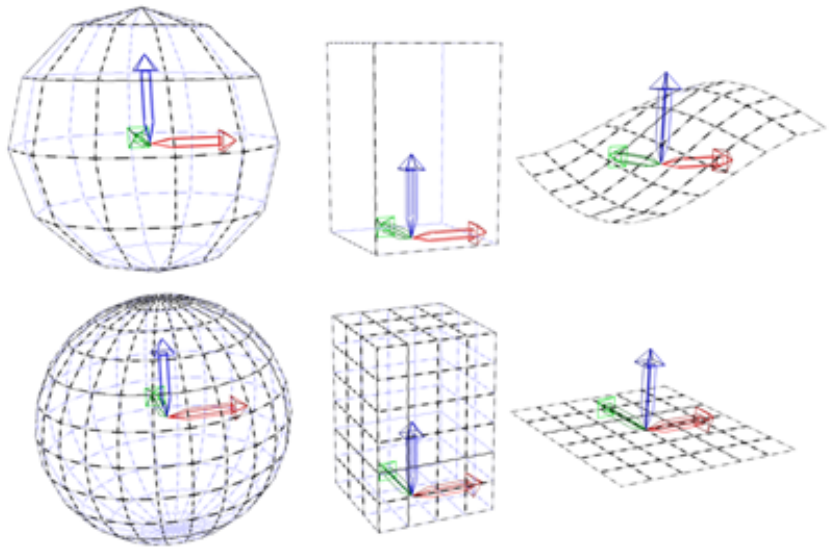

An example of master objects with different creation parameters.

### Object-Space Modifiers

The [object-space modifiers](#) on page 1132 are the next group evaluated in the data flow. Each modifier is evaluated in the order it was placed on the modifier stack. The modifications all occur in the object's object space and the result is called the modified object.

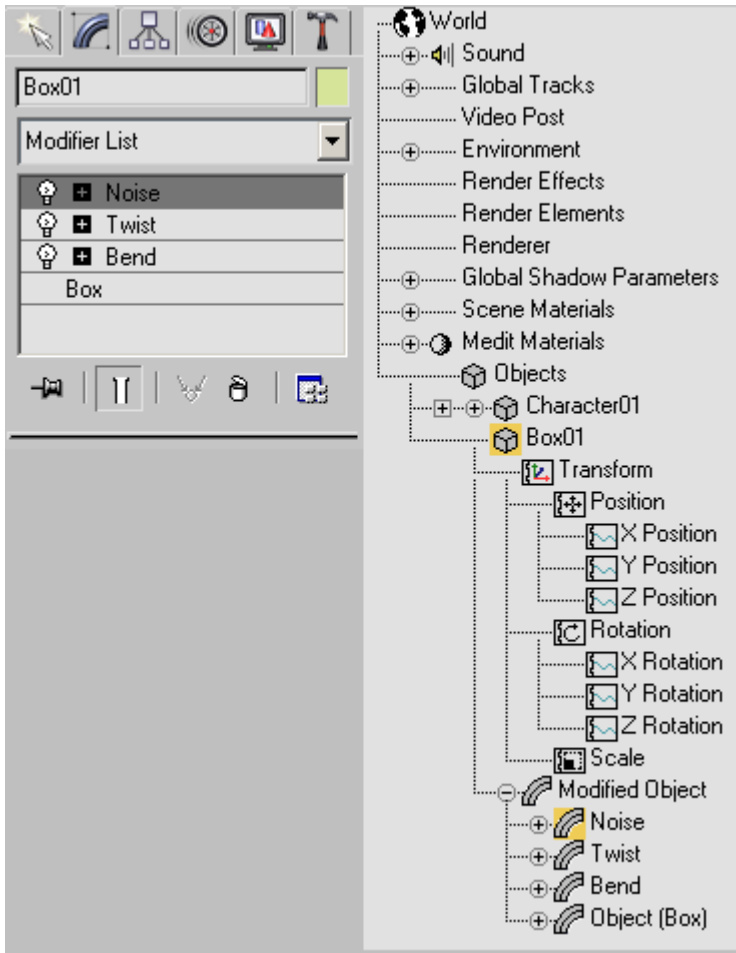

Object modifiers in the Modify panel and Track View

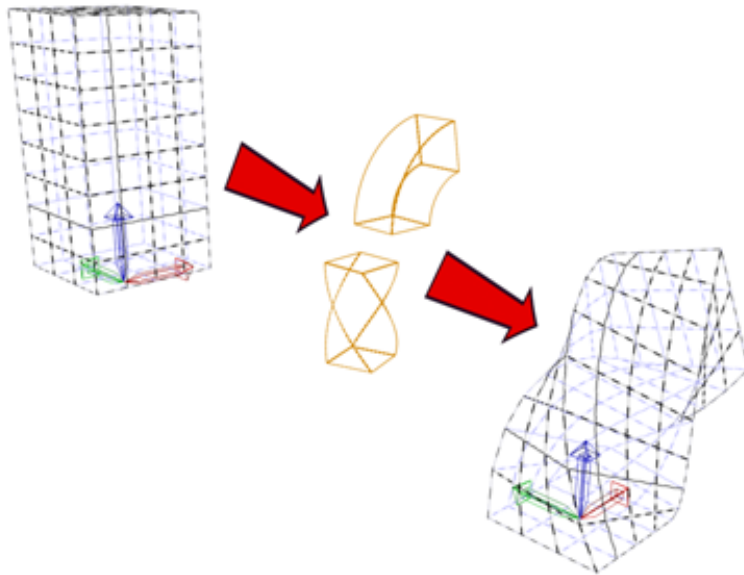

**The effect of modifiers on a master object.**

### **Object Transforms**

Once the modified object has been evaluated, it is transformed within the world coordinate system. Transforms cover the position, rotation, and scale changes applied from the transform buttons on the toolbar .

The method of evaluating all modifiers first and then evaluating the combined transforms has ramifications for the way you work with 3ds Max. The effect of transforms is independent of the order in which they are applied. The order in which you apply modifiers, on the other hand, does affect the resulting geometry. If you want to apply a transform that is evaluated in a specific order in the modifier stack, use the [XForm modifier](#) on page 1922 .

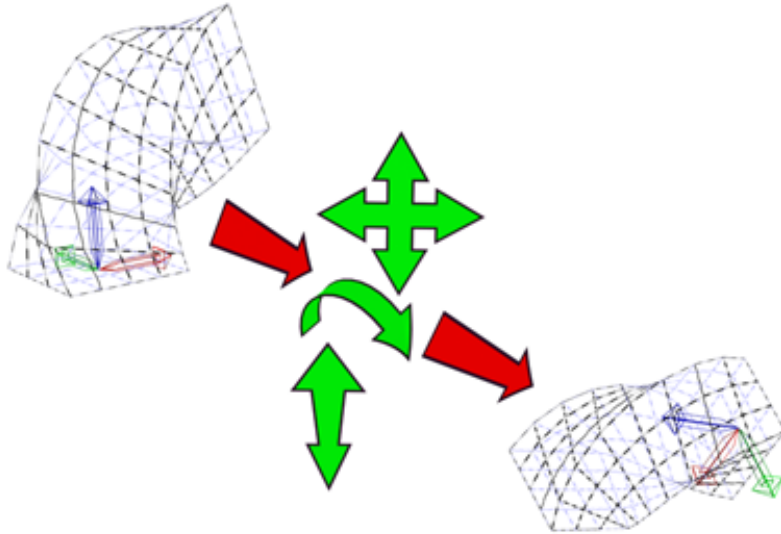

**Transforming a modified object**

## **Space Warps**

[Space warps](#) on page 2603 are evaluated after transforms. They distort objects bound to the space warp based on the position of the object in world space. For example, a [Wave space warp](#) on page 2695 causes the surface of an object to undulate in the form of a wave. As the object or the space warp moves through world space, the waves move across the object's surface.

Like space warps, [world-space modifiers](#) on page 1043 are evaluated after transforms. A world-space modifier is like a space warp bound to a single object.

## **Object Properties**

Object properties are the last to be evaluated before the object is displayed. These are values specific to an object such as its name or settings you specify on the [Object Properties dialog](#) on page 245, such as shadow-casting properties; and materials you have applied to the object.

This is the end of the data flow, and the result is the named object you see in your scene.

Right-click an object and choose Properties to display its Object Properties dialog.

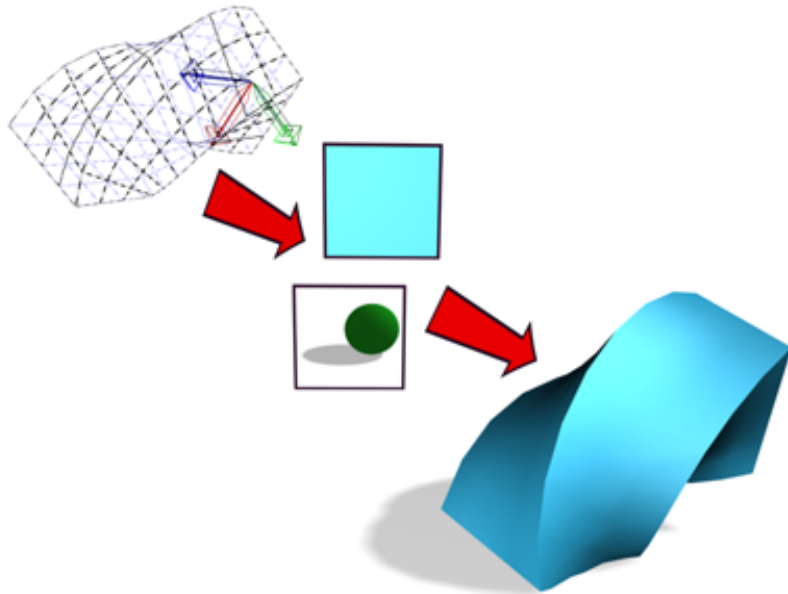

Object Properties affect the look of an object's rendered output.

## List of Available Modifiers

Following is a list of the modifiers, listed in alphabetical order.

---

**NOTE** The availability of certain modifiers depends on the current selection. For example, Bevel and Bevel Profile appear in the Modifier List drop-down menu only when a shape or spline object is selected. For the conditions under which a specific modifier is available, see the path annotation at the top of the modifier's topic in this reference.

---

[Affect Region Modifier](#) on page 1133

[Attribute Holder Modifier](#) on page 1136

[Bend Modifier](#) on page 1139

[Bevel Modifier](#) on page 1142

[Bevel Profile Modifier](#) on page 1150

[Camera Map Modifier \(Object Space\)](#) on page 1154

[Camera Map Modifier \(World Space\)](#) on page 1043

[Cap Holes Modifier](#) on page 1159

[Cloth Modifier](#) on page 1178

[CrossSection Modifier](#) on page 1259

[Delete Mesh Modifier](#) on page 1266

[Delete Patch Modifier](#) on page 1267

[Delete Spline Modifier](#) on page 1269

[Disp Approx Modifier](#) on page 1270

[Displace Modifier](#) on page 1274

[Displace Mesh Modifier \(World Space\)](#) on page 1045

[Displace NURBS Modifier \(World Space\)](#) on page 1047

[Edit Mesh Modifier](#) on page 1283

[Edit Normals Modifier](#) on page 1284

[Edit Patch Modifier](#) on page 1290

[Edit Poly Modifier](#) on page 1293

[Edit Spline Modifier](#) on page 1376

[Extrude Modifier](#) on page 1377

[Face Extrude Modifier](#) on page 1381

[FFD \(Free-Form Deformation\) Modifiers](#) on page 1383

[FFD \(Free-Form Deformation\) \(Box/Cyl\) Modifier](#) on page 1389

[FFD \(Free-Form Deformation\) Select Modifier](#) on page 1395

[Fillet/Chamfer Modifier](#) on page 1396

[Flex Modifier](#) on page 1400

[Garment Maker Modifier](#) on page 1228

[Hair And Fur Modifier](#) on page 1049

[HSDS Modifier](#) on page 1420

[Lathe Modifier](#) on page 1430

[Lattice Modifier](#) on page 1435  
[Linked XForm Modifier](#) on page 1440  
[LS Colors Modifier \(World Space\)](#) on page 1118  
[LS Mesh Modifier](#) on page 1442  
[MapScaler Modifier \(Object Space\)](#) on page 1443  
[MapScaler Modifier \(World Space\)](#) on page 1120  
[Material Modifier](#) on page 1445  
[MaterialByElement Modifier](#) on page 1448  
[Melt Modifier](#) on page 1451  
[Mesh Select Modifier](#) on page 1455  
[MeshSmooth Modifier](#) on page 1460  
[Mirror Modifier](#) on page 1471  
[Morpher Modifier](#) on page 1473  
[MultiRes Modifier](#) on page 1493  
[Noise Modifier](#) on page 1501  
[Normal Modifier](#) on page 1509  
[NSurf Sel Modifier](#) on page 1513  
[Normalize Spline Modifier](#) on page 1511  
[Optimize Modifier](#) on page 1515  
[PatchDeform Modifier \(World Space\)](#) on page 1123  
[PathDeform Modifier \(World Space\)](#) on page 1123  
[PatchDeform Modifier](#) on page 1525  
[Patch Select Modifier](#) on page 1520  
[PathDeform Modifier](#) on page 1528  
[Physique Modifier](#) on page 4589  
[Point Cache Modifier](#) on page 1533  
[Point Cache Modifier \(World Space\)](#) on page 1129  
[Poly Select Modifier](#) on page 1541  
[Preserve Modifier](#) on page 1550

[Projection Modifier](#) on page 1556  
[Projection Holder Modifier](#) on page 1574  
[Push Modifier](#) on page 1574  
[Relax Modifier](#) on page 1575  
[Renderable Spline Modifier](#) on page 1580  
[Ripple Modifier](#) on page 1583  
[Select By Channel Modifier](#) on page 1587  
[Shell Modifier](#) on page 1588  
[Skew Modifier](#) on page 1596  
[Skin Modifier](#) on page 1600  
[Skin Morph Modifier](#) on page 1636  
[Skin Wrap Modifier](#) on page 1648  
[Skin Wrap Patch Modifier](#) on page 1657  
[Slice Modifier](#) on page 1658  
[Smooth Modifier](#) on page 1665  
[Spherify Modifier](#) on page 1668  
[Spline IK Control Modifier](#) on page 1670  
[Spline Select Modifier](#) on page 1673  
[Squeeze Modifier](#) on page 1676  
[STL Check Modifier](#) on page 1678  
[Stretch Modifier](#) on page 1681  
[Subdivide Modifier](#) on page 1688  
[Substitute Modifier](#) on page 1691  
[Surface Mapper Modifier \(World Space\)](#) on page 1129  
[Surface Modifier](#) on page 1695  
[SurfDeform Modifier](#) on page 1707  
[SurfDeform Modifier \(World Space\)](#) on page 1132  
[Sweep Modifier](#) on page 1709  
[Symmetry Modifier](#) on page 1735



[Taper Modifier](#) on page 1739  
[Tessellate Modifier](#) on page 1743  
[Trim/Extend Modifier](#) on page 1746  
[TurboSmooth Modifier](#) on page 1750  
[Turn To Mesh Modifier](#) on page 1756  
[Turn To Patch Modifier](#) on page 1758  
[Turn To Poly Modifier](#) on page 1761  
[Twist Modifier](#) on page 1765  
[Unwrap UVW Modifier](#) on page 1769  
[UVW Map Modifier](#) on page 1849  
[UVW Mapping Add Modifier](#) on page 1871  
[UVW Mapping Clear Modifier](#) on page 1871  
[UVW XForm Modifier](#) on page 1872  
[VertexPaint Modifier](#) on page 1876  
[Vertex Weld Modifier](#) on page 1874  
[Volume Select Modifier](#) on page 1910  
[Wave Modifier](#) on page 1918  
[XForm Modifier](#) on page 1922

## Using Modifiers

This section contains a number of topics intended to help you learn how to use modifiers and the Modify panel. These include:

[Using the Modify Panel](#) on page 1016  
[Using the Modifier Stack](#) on page 1020  
[Editing the Stack](#) on page 1023  
[Edit Modifiers and Editable Objects](#) on page 1027  
[Modifying at the Sub-Object Level](#) on page 1029  
[Using the Stack at the Sub-Object Level](#) on page 1032

[Modifying Multiple Objects](#) on page 1034

[How Instanced Modifiers Work](#) on page 1040

## Using the Modify Panel

After adding objects to your scene from the Create panel, you often move to the Modify panel to change an object's original creation parameters and to apply modifiers. Modifiers are the basic tools for reshaping and adjusting primitive geometry.

---

**NOTE** You can [float](#) on page 7761 or dismiss the command panel using the [Customize Display right-click menu](#) on page 7479 . The default setting is to display the command panel docked at the right of your screen. If it is not displayed or you want to change its location and docking or floating status, right-click in a blank area on any toolbar, and choose from the shortcut menu.

---

The Modify panel stays in view until you click another command panel tab. The panel updates to show the options and controls that are available for the currently selected object or modifier.

### Using Modifiers

Once you've applied modifiers to an object, you can use the [Modifier Stack](#) on page 7427 to find a particular modifier, change its parameters, edit its sequence in the modifier stack, copy its settings to another object, or delete it entirely.

You can find a complete, alphabetical list of modifiers in [List of Available Modifiers](#) on page 1011 .

### General Guidelines

You can generally do the following with the Modify panel:

- Modify anything you can select. This includes any object or set of objects, or any part of an object down to the sub-object level. For example, you can use the Mesh Select modifier to select a single face, then apply a Taper modifier to it.
- Apply an unlimited number of modifiers to an object or part of an object. The order or sequence in which you make modifications is important. Each modification affects those that come after it. See [Using the Modifier Stack](#) on page 1020 .

---

**NOTE** Some modifiers can be applied only to certain types of objects.

---

## Modifier Sub-Object Levels

In addition to its own set of parameters, a modifier typically has one or more sub-object levels that you access through the [modifier stack](#) on page 1020 . The most common of these are a gizmo and a center.

**Gizmo** Displays in viewports as a wireframe that initially surrounds the selected object. A gizmo acts like a mechanical apparatus that transfers its modification to the object it's attached to. To alter the effect of the modifier on the object, you can move, scale, and rotate the gizmo as you would any object.

**Center** The center is the modifier's [pivot point](#) on page 7895 . You can move a modifier's center, which alters the effect of the modifier on the object.

## Parametric Deformations and Other Modifier Types

One set of object-space modifiers is known as *parametric deformations* (“parametric deforms” on the Modifiers menu). [Twist](#) on page 1765 and [Bend](#) on page 1139 are examples. Parametric deformations alter the selection passed to them without explicitly depending on topology.

Many other types of modifiers, however, perform operations on the explicit topology of sub-object selections. The Edit modifiers and Select modifiers are examples. When a topology-dependent modifier is present on the stack, you can adversely affect its results if you visit previous stack operations and change the number or order of sub-objects (such as faces or vertices) in the selection. If you try to do this, a warning alerts you to the situation.

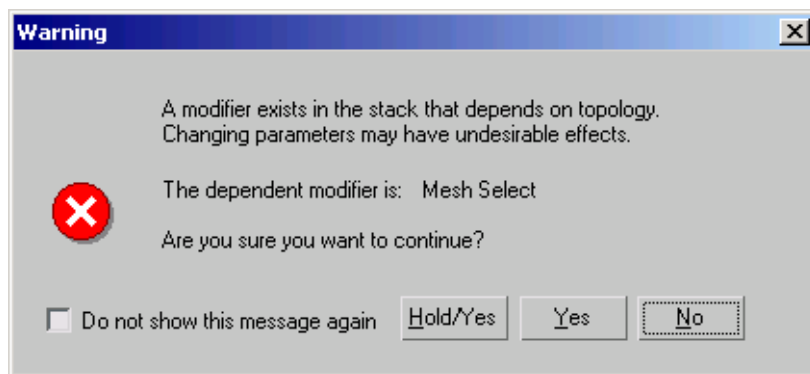

You can safely edit the stack beneath the topology-dependent modifier, as long as you do not add or remove sub-objects from the selection on which it operates.

## Procedures

### To use the Modify panel:

- 1 Select an object in your scene.



- 2 Click the Modify tab to display the Modify panel.

The name of the selected object appears at the top of the Modify panel, and fields change to match this object.

The object's creation parameters appear in rollouts on the Modify panel, below the modifier stack display. You can use these rollouts to change the creation parameters for an object. As you change them, the object updates in the viewports.

- 3 Apply a modifier to an object (described in the next procedure).

After you apply a modifier, it becomes active, and rollouts below the modifier stack display settings specific to the active modifier.

### To apply a modifier to an object:

- 1 Select the object.
- 2 Do one of the following:
  - Choose a modifier from the Modifier List. This is a drop-down list at the top of the Modify panel.

---

**TIP** You can use the mouse or keyboard to choose a modifier from the Modifier List. To use the keyboard, first open the list with the mouse, and then type the first letter in the modifier's name. From there you can use the arrow keys or the method described in the following paragraph to highlight the desired modifier, and then press Enter to assign the modifier. In many cases, several modifier names start with the same letter. You can go directly to a particular modifier if you type the first few letters (enough for a unique combination) in the desired modifier's name quickly. For example, say you want to assign the Mirror modifier to an object. Typing **M** goes to Mesh Select, which isn't anywhere near Mirror in the Modifier list, but typing **MI** goes directly to Mirror.

---

- Choose a modifier from the Modifiers menu. This menu is organized into sets by functionality. Not all modifiers appear on the Modifiers menu.
- If the modifier buttons are visible on the Modify panel and the modifier you want is one of them, click the button.



If the buttons are not visible but you want to use them, click the [Configure Modifier Sets button](#) on page 7450 (below the modifier stack display) and choose Show Buttons. A set of buttons with the names of modifiers appears between the modifier list and the stack display. Click Configure Modifier Sets again, choose the set of modifiers you want to use (for example, Free-Form Deformations), and then click the button for the modifier you want to apply.

Rollouts are now displayed below the modifier stack display, showing settings for the modifier. As you change these settings, the object updates in viewports.

#### To drag a modifier to an object:

- 1 Select an object that already has a modifier you would like to use on another object.
- 2 To copy the modifier without instancing it, drag the modifier's name from the stack display to the object in a viewport that you want to use the same modifier. To move the modifier, use Shift+drag; this removes it from the original object and applying it to the new one. To instance the modifier, use Ctrl+drag; this creates an instanced modifier applied to both the original object and the new one.

---

**NOTE** Instancing a modifier causes its name to be displayed in italics in the modifier stack. This indicates that the modifier is instanced, meaning that a change to the modifier parameters of one object will affect the other.

---

## Using the Modifier Stack

The modifier stack and its editing dialog are the keys to managing all aspects of modification. You use these tools to:

- Find a particular modifier and adjust its parameters.
- View and manipulate the sequence of modifiers.
- Copy, cut, and paste modifiers between objects, or sets of objects.
- Deactivate the effect of a modifier in the stack, the viewport display, or both.
- Select a modifier's components, such as gizmo or center.
- Delete modifiers.

**See also:**

- [Editing the Stack](#) on page 1023
- [Modifier Stack Controls](#) on page 7427
- [Modifier Stack Right-Click Menu](#) on page 7440

### Examining the Modifier Stack

The modifier stack (or "stack" for short) is a list on the Modify panel. It contains the accumulated history of a selected object and any modifiers you have applied to it.

Internally, the software "evaluates" an object beginning at the bottom of the stack and applies changes to the object by moving sequentially to the top of the stack. You should therefore "read" the stack from bottom up to follow the sequence used by the software in displaying or rendering the final object.

Here is an example of stack entries for a capsule object (an extended primitive):

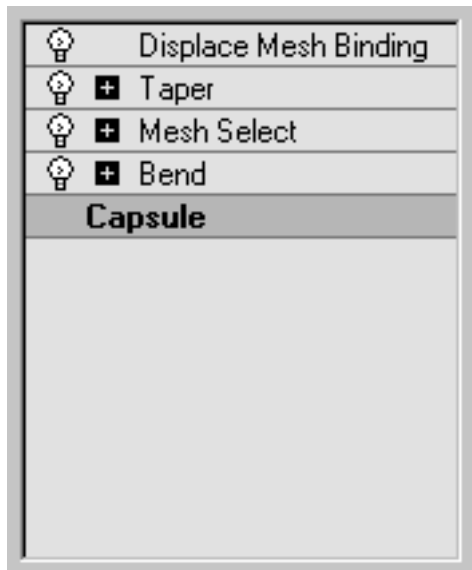

- At the bottom of the stack, the first entry always lists the object type (in this case, Capsule). You click this entry to display the original object creation parameters so you can adjust them. If you haven't applied any modifiers yet, this is the only entry in the stack.
- Object-space modifiers appear above the object type. You click a modifier entry to display the modifier's parameters so you can adjust them, or to delete the modifier.
  -  Modifiers are preceded by a plus or minus icon if they have sub-object (or sub-modifier) levels. See [Using the Stack at Sub-Object Level](#) on page 1032 .
- At the top of the stack are world-space modifiers and space warps bound to the object. (In the illustration, Displace Mesh is a world-space modifier.) These always appear at the top, and are described as "bindings."

### Basics of Using the Stack

With the stack feature, no modification has to be permanent. By clicking an entry in the stack, you can go back to the point where you made that modification. You can then rework your decisions, temporarily turn off the modifier, or discard the modifier entirely by deleting it. You can also insert a new modifier in the stack at that point. The changes you make ripple upward through the stack, changing the current state of the object.

## Adding Multiple Modifiers

You can apply any number of modifiers to an object, including repeated applications of the same modifier. As you start applying object modifiers to an object, the modifiers "stack up" in the order they're applied. The first modifier appears just above the object type at the bottom of the stack.

- The program inserts a new modifier in the stack just above the current selection, but always in the proper location. If you try to insert a world-space modifier between two object-space modifiers, the program automatically places it at the top of the stack.
- If you select the object type on the stack and apply a new object-space modifier, it appears just above the object type and becomes the first modifier evaluated.

## Effect of Stack Sequence

The software applies modifiers in their stack order (beginning at the bottom and carrying the cumulative change upward), so a modifier's location in the stack can be critical.

The following figure shows the difference between the objects based entirely on a reversal in the stack order of two modifiers. On the left-hand tube, a Taper modifier is applied before a Bend modifier, and on the right-hand tube, the Bend is applied first.

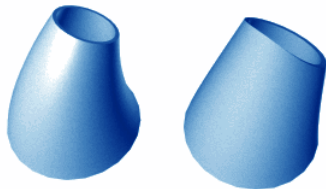

Results of reversing stack order of two modifiers

## Using the Buttons

The Modifier Stack rollout has the following buttons to help you manage the stack:





**Pin Stack** Locks the stack and all Modify panel controls to the selected object's stack. You can continue to edit the object even if you select a different object in the viewports.



**Show End Result** When on, shows the effect of the entire stack on the selected object. When off, shows the effect of the stack only up to the currently highlighted modifier.



**Make Unique** Makes an instanced object unique, or an instanced modifier unique to a selected object. See details in [Editing the Stack](#) on page 1023 . This option is also available from the [Modifier Stack right-click menu](#) on page 7440 .



**Remove Modifier** Deletes the current modifier from the stack, eliminating all changes caused by that modifier.



**Configure Modifier Sets** Click to display a pop-up menu that lets you configure how to display and choose modifiers on the Modify panel.

## Editing the Stack

You can copy, cut, and paste modifiers within an object's stack, or into the stacks of other objects. Among other features, you can give modifiers explicit names to help you remember the intended effect.

### To edit the stack:

- 1 Choose an item in the stack.
- 2 Right-click.

This displays the [Modifier Stack right-click menu](#) on page 7440 , which is briefly introduced in this topic.

## Rearranging and Sharing Modifiers

### To rearrange modifiers:

The easiest way to move a modifier to a different location in the stack is simply to drag it there. Alternatively, you can use the following cut/copy and paste procedure.

- 1 Choose one or more modifiers, right-click, and choose Copy or Cut.
- 2 Choose a new location in the list, right-click, and choose Paste. The paste occurs immediately above the new location.

### To share modifiers with other objects:

- 1 Choose one or more modifiers, right-click, and choose Copy.
- 2 Select a different object or group of objects.
- 3 Choose a location in the new stack, right-click, and choose Paste.  
You can also drag from the modifier stack display to an object in a viewport.

---

**TIP** Select world-space and object-space modifiers separately. Cut, Copy, and Paste are disabled if both types are selected. If you try to paste a world-space modifier into the section for object-space types, the paste occurs at the top of the world-space section. The reverse is also true.

---

## Unique and Instanced Modifiers

By default, pasted modifiers are *unique*: they lose all connection with the modifier from which they were copied. Compare with an *instanced* modifier, which is shared between two or more objects. Changing a parameter on an instanced modifier automatically changes the same parameter on the other instanced objects.

### To create an instance of a modifier:

- After copying or cutting the modifier, right-click and choose Paste Instanced.  
In the stack, the name of an instanced modifier appears in italics.

Any instance of a modifier controls all other instances. Use this feature when you want a number of objects to take on the same feature.

For example, copying an instanced [Bend modifier](#) on page 1139 to a number of trees would make them all bend identically. Changing Bend parameters on any one tree would change the bend on all the others.

**To remove the instancing from a modifier:**

-  Select the instanced modifier and click Make Unique. This converts the modifier from instanced to unique.

### **Using Make Unique with Multiple Items**

Assume you have a group of trees all sharing the same instanced Bend modifier. If you select two of them and click [Make Unique](#) on page 7446, a message asks, "Do you want to make the selected objects unique with respect to each other?"

- If you click Yes, the two trees become independent of one another. Each has a unique copy of the modifier and can be bent separately.
- If you click No, the two trees continue to share the same instanced modifier, but separately from the instance in the original group. The two trees can be bent together.

See [How Instanced Modifiers Work](#) on page 1040.

### **Collapsing the Stack**

You can use Collapse All or Collapse To to collapse all or part, respectively, of an object's stack to an editable object that preserves the cumulative effect of the collapsed modifiers on the base object. You might choose to do this in these cases:

- You've finished modifying an object and want to keep it as is.
- You want to discard an object's animation tracks. Alternatively, you can Alt+right-click a selected object and choose Delete Selected Animation.
- You want to simplify a scene and save some memory.

---

**NOTE** In most cases, collapsing all or part of the stack will save memory. However, collapsing some modifiers, such as Bevel, increases file size and memory use.

---

After you collapse an object's stack, you can no longer parametrically adjust either its creation parameters or the individual modifiers affected by the

collapse. Animation tracks that were assigned to such parameters also disappear.

Collapsing the stack does not affect the object's transforms; it affects world-space bindings only if you use Collapse To. Collapsing the stack does not save memory if the stack contains no modifiers.

---

**TIP** Before you use either Collapse option, use File menu > Save Selected to preserve a copy of the original parametric object.

---

### To collapse the stack:

- 1 Right-click the modifier stack display.
- 2 If modifiers have been applied to the object, choose Collapse To or Collapse All.

**Collapse To** Collapses the stack, up to and including the chosen modifier, into an editable object. Modifiers on the stack above the chosen modifier are not affected, and you can still adjust them individually.

The resultant object type depends on the uppermost modifier that outputs a specific geometry type, if any. If the stack contains no such modifier, the result is an [editable mesh](#) on page 1990 . If the collapsed portion of the stack contains a modifier that outputs a specific geometry type, and no other such modifier is above it, the result is that type of object. For example, if the topmost such collapsed modifier is Edit Poly, the resultant object is Editable Poly.

**Collapse All** Collapses the entire stack into an editable object, other than world-space bindings. Any world-space bindings on the stack are left intact.

The resulting stack list shows a single entry: Editable Mesh, unless any modifiers on the stack output a different type of geometry. For example, if the topmost such modifier is Edit Poly, the resultant object is Editable Poly.

If no modifiers are applied to the object, choose one of the Convert To options:

- Editable Mesh
- Editable Spline
- Editable Patch
- Editable Poly
- NURBS

---

**NOTE** Depending on the object type, not all Convert To options might be available.

---

## Edit Modifiers and Editable Objects

To achieve highly detailed modeling effects, you can directly transform, modify, and align the geometry of objects at a [sub-object level](#) on page 7940 , using the [Modify panel](#) on page 7425 . The following table shows the different object types and their respective sub-objects.

Object Type	Sub-Object Geometry
Mesh	Vertex, Edge, Face, Polygon, Element
Poly	Vertex, Edge, Border, Polygon, Element
Spline	Vertex, Segment, Spline
Patch Surface	Vertex, Edge, Patch, Element, Handle
NURBS Curve	Curve CV or Point, Curve
NURBS Surface	Surface CV or Point, Surface

With the exception of NURBS, to gain access to an object's sub-objects, in most cases you must first either convert the object into an editable object, or apply any of various modifiers to the object, such as Edit Mesh/Spline/Patch or Mesh/Spline Select. The Select modifiers simply let you specify sub-objects for modification by subsequently applied modifiers. The distinctions between

transforming an object into an editable object and applying an Edit modifier to it are as follows:

<b>Method</b>	<b>Advantage</b>	<b>Disadvantage</b>
Editable object	More efficient Can animate sub-objects	Lose creation parameters
Edit/Select modifier	Keep creation parameters	Less efficient Cannot animate sub-objects

To convert a parametric object to an editable object, see any of the following topics:

[Editable Mesh Surface](#) on page 1990

[Editable Poly Surface](#) on page 2038

[Editable Spline](#) on page 590

[Editable Patch Surface](#) on page 1934

To apply an Edit modifier, see any of the following topics:

[Edit Mesh Modifier](#) on page 1283

[Edit Spline Modifier](#) on page 1376

[Edit Patch Modifier](#) on page 1290

To apply a Select modifier, see the following topics:

[Mesh Select Modifier](#) on page 1455

[Poly Select Modifier](#) on page 1541

[Spline Select Modifier](#) on page 1673

[Volume Select Modifier](#) on page 1910

[Patch Select Modifier](#) on page 1520

## Modifying at the Sub-Object Level

To achieve highly detailed modeling effects, you can directly transform, modify, and align the geometry of objects at the [sub-object level](#) on page 7940 .

Sub-objects are the pieces that make up objects, such as vertices and faces. You can also access and transform the sub-object components of modifiers.

The particular geometry available at sub-object level depends on the object type. See [Edit Modifiers and Editable Objects](#) on page 1027 for details on each object type.

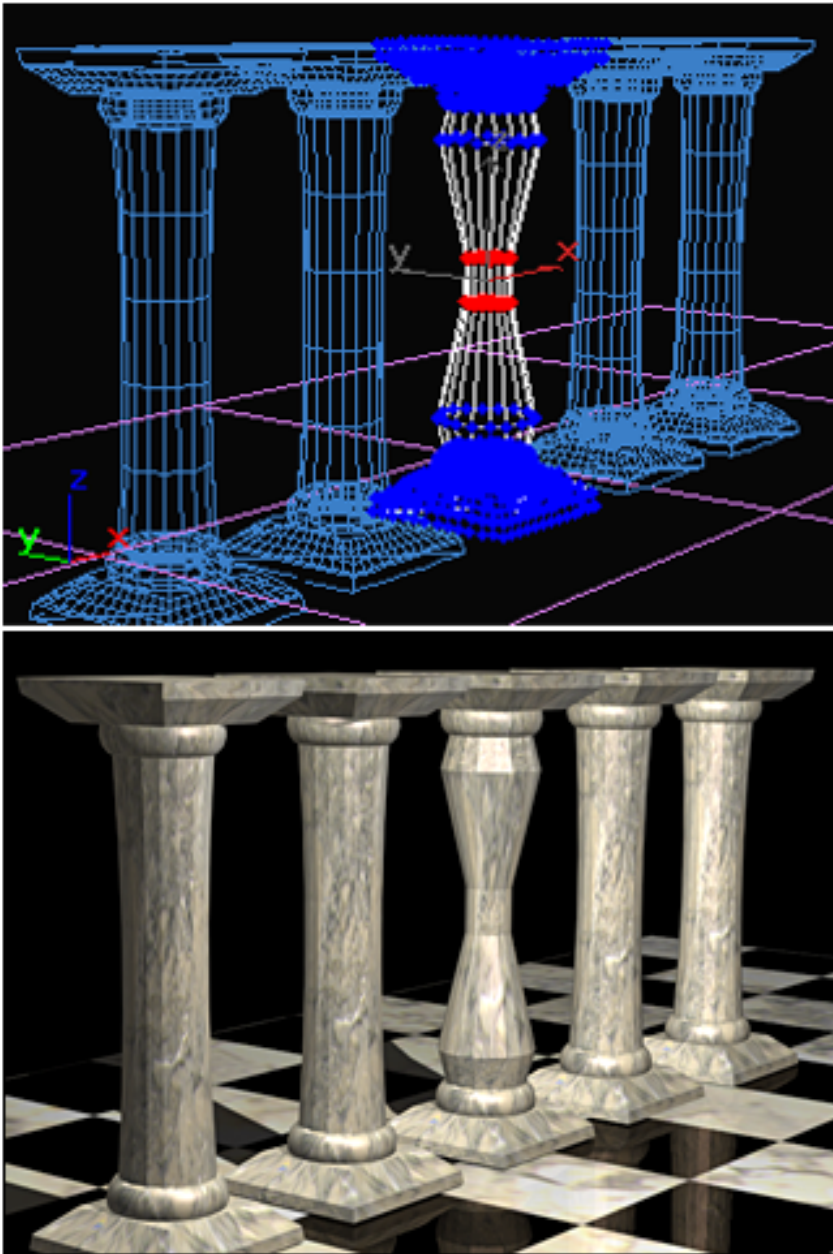

In a row of column sub-objects, a single column has been modified at the sub-object level.



## Making a Sub-Object Selection

These are the general steps in setting up an object for sub-object selection. See [Edit Modifiers and Editable Objects](#) on page 1027 for more information.

- 1 Convert the object into an editable object such as an editable mesh, editable spline, editable poly, and so on. (Some modifiers you can apply to the object, such as Edit Mesh, Mesh Select or Spline Select, also have sub-object levels.)

---

**TIP** Work in a wireframe viewport so you can see the geometry.

---

- 2  On the modifier stack display, click the plus icon to the left of the name of the modifier or editable object. This expands the object's hierarchy, showing the names of the sub-object levels at which you can work.
- 3 On the stack display, choose the kind of sub-object geometry you want to work with: for example, Vertex, Face, or Edge. Each sub-object selection level has rollouts with their own sets of options.  
The sub-object level highlight is yellow by default.
- 4 Use standard selection techniques to select sub-object geometry, from a single sub-object to the entire object. By default, the sub-object selection highlights in red.

Once you make a sub-object selection of geometry, you can do any of the following:

- Apply any options supplied for the kind of object and the selection level.
- Apply standard transforms: Move, Rotate, Scale. For more information, see [Transforming a Sub-Object Selection](#), following.
- Apply object-space modifiers (Bend, Taper, and Twist, for example) to perform useful modeling operations.
- Apply object-space modifiers (UVW Map or Smooth, for example) to perform useful surfacing operations.
- Bind a [space warp](#) on page 2603 to the selection. The rest of the object is unaffected by the warping.
- Use the toolbar commands [Align](#) on page 938, [Normal Align](#) on page 945, and [Align To View](#) on page 951 with face selections.

## Transforming a Sub-Object Selection

Using an editable mesh, poly, patch, or spline, you can directly transform any sub-object selection. However, "Select" modifiers like [Mesh Select](#) on page 1455 and [Spline Select](#) on page 1673 enable only selection.

**To transform a sub-object selection made with a Select modifier:**

- 1 Add an [XForm modifier](#) on page 1922 to the stack, following (or somewhere above) the Select modifier.
- 2 In the stack, open the Select modifier and make a sub-object selection.
- 3 Choose XForm in the stack. You then transform the XForm gizmo, which applies the transform to the selection.

## Selecting and Transforming Modifier Components

Most modifiers have sub-object components, such as a gizmo and center. Like sub-object geometry, these components can be accessed and transformed at sub-object level, directly modifying the object's shape.

Other modifiers, like those for free-form deformation, have control points and lattices at a sub-object level. Moving these components creates the modeling effects of the modifier.

# Using the Stack at the Sub-Object Level

With editable objects such as meshes and splines, or modifiers with sub-object levels such as Mesh Select and Spline Select, you can continue to model a single sub-object selection by applying any number of other modifiers. When you go back and change the original selection, the new selection is "passed up the stack" to the modifiers that follow.

Editable meshes and splines have "built-in" sub-object selection at their base level. But the selections you make with Mesh Select and Spline Select work exactly the same way on the stack.

This topic uses meshes for its examples. You can apply the same concepts to editable splines, patches, and poly objects.

## Working at Two Levels

When you select an object and apply modifiers (for example, Bend and Taper), you're working with the object as a single unit, or "whole object", at the object level.

When you make a sub-object selection, the stack display changes to show you are no longer working with the whole object. Consider the effect of a Mesh Select applied between Bend and Taper modifiers (Bend is below Taper). To the right of the Mesh Select and Taper modifiers, a sub-object icon (similar to the sub-object button in the Selection rollout) appears to show that sub-object selection is now in effect.

The vertex sub-object selection made at the Mesh Select level is passed up the stack to the Taper modifier. This means the Taper modifier is applied only to the vertices selected at the Mesh Select level.

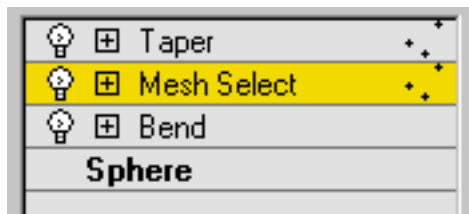

**Sub-object icon (in this case, for Vertex) to the right of modifier names in the stack display**

Sub-object selection carries upward through the stack. If you add more modifiers, each shows the sub-object icon to indicate this state.

By learning to "read the stack," you can move back and forth between the object and sub-object levels while you work on an object.

## Returning to Whole-Object Level

When you finish modeling a certain sub-object selection, you can return to work on the whole object.

**To return the stack to object level:**

- 1 At any point in the stack, apply another Mesh Select modifier.
- 2 Leave this Mesh Select modifier at the top level (the object level, which highlights in gray). Any modifiers already on the stack above this modifier no longer show the sub-object icon. Any modifiers you add above the second Mesh Select now apply to the whole object.

- 3 To continue sending the sub-object selection up the stack, delete the second Mesh Select.

### **Naming Sub-Object Selections**

Sub-object selections are often quite complex, involving a great many small elements that would be difficult to select a second time. For this reason, it's a good idea to name important selection sets using the [Named Selection Sets list](#) on page 146 on the Main toolbar.

Named sub-object selections only appear at the type of level where they were first named. For example, if you select a set of vertices, you can name the selection at that vertex sub-object level. Then, when you later go to retrieve the named selection, you can access it only from the same modifier's vertex sub-object level.

### **Copying Sub-Object Selections**

Once you name a sub-object selection set, you can copy it between modifiers in the same stack, or to the stack of another object of the same type. Editable meshes and Mesh Select (and their spline, patch, and poly counterparts) have buttons for Copy and Paste at each level of geometry, in the Modify panel > Selection rollout.

**To copy/paste named sub-object selections:**

- 1 Make a sub-object selection.
- 2 In the Selection rollout, click Copy. From the dialog, choose any available named selection set for that level of geometry.
- 3 Go to another Select modifier or to an editable mesh or poly, at the same level of geometry. Click Paste to complete the copy.

## **Modifying Multiple Objects**

You can apply modifiers to multiple objects. In general, the process is parallel to modifying a single object. You make a selection set and apply an available modifier. The modifier then appears on a special stack that refers only to the *commonality* of that selection set.

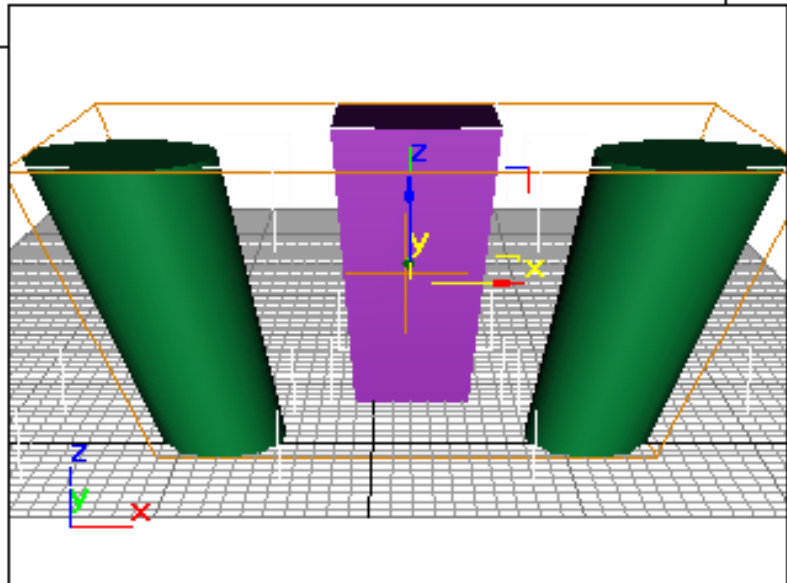
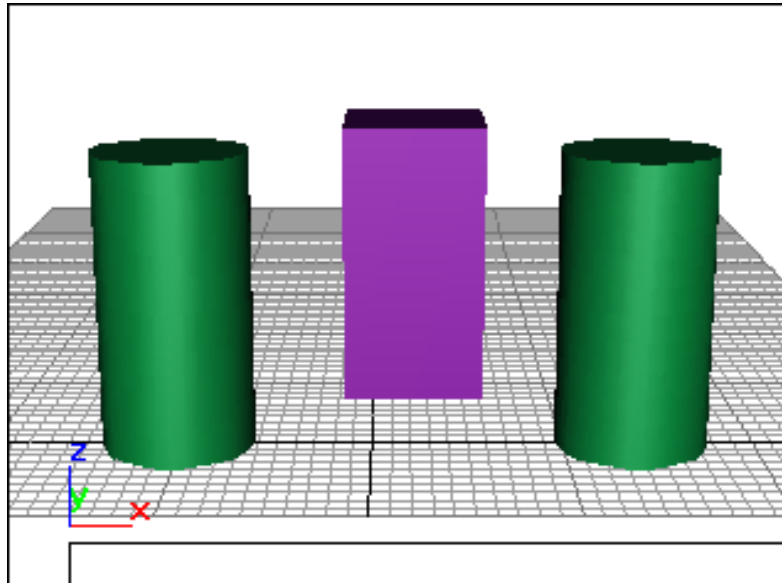

Top: Original objects

Bottom: Single modifier applied to objects

## The Principle of Commonality

When you select multiple objects, 3ds Max determines what the particular selected set of geometry has in common, if anything. Given any "commonality" among objects, 3ds Max presents the options as available modifiers. Unavailable modifiers represent areas where commonality does not hold.

You can apply modifiers to different categories of objects, depending on the modifier. For example, you might apply Bend to both a 3D object and a 2D shape. You can apply Mesh Select to a spline primitive and convert it to a mesh, but the reverse is not true: Spline Select is restricted to objects of the spline category.

### To modify multiple objects:

- 1 Select two or more objects.  
For selection sets, the name at the top of the Modify panel changes to read "Multiple Selected." If the objects are grouped, the group name appears.
- 2 Choose the kind of pivot point you want to use. See Using Pivot Points, (below).
- 3 Apply a modifier and adjust its parameters.  
If you apply a Mesh Select modifier, you can select geometry on one or more of the objects to use as a sub-object selection set.

## Using Pivot Points

The first item in the Modifier List is a toggle called Use Pivot Points. This toggle is available only when multiple objects are selected.

- When on, the program uses the pivot point of each object as the center of a modifier's operation. For example, if you bend a line of trees around the Z axis, each bends along its own trunk.
- When off, the program calculates a central pivot point for the entire selection set, and modifies the selection as a whole. For a Z-axis bend, trees at the end of a line would deform more than those at the center where the pivot is located.

---

**IMPORTANT** Choose the pivot setting before you apply the modifier. You can't change the pivot point afterward, although you can delete the modifier and start over without deselecting the selection set.

---

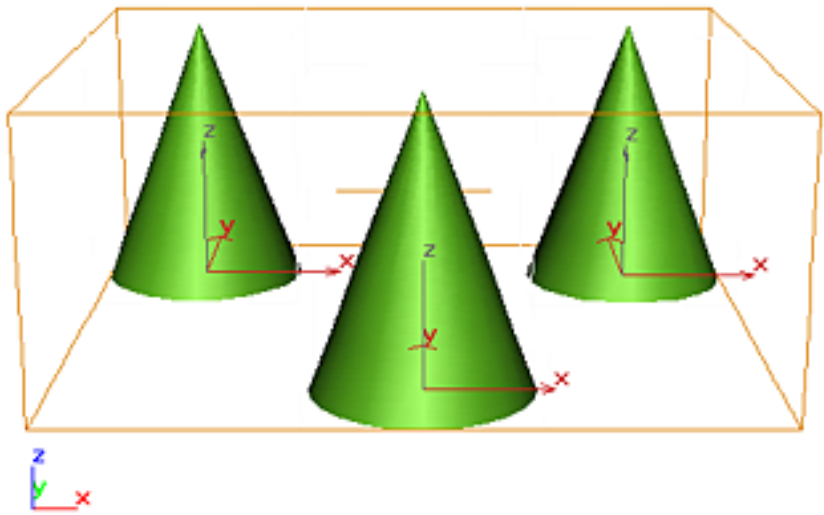

Original objects

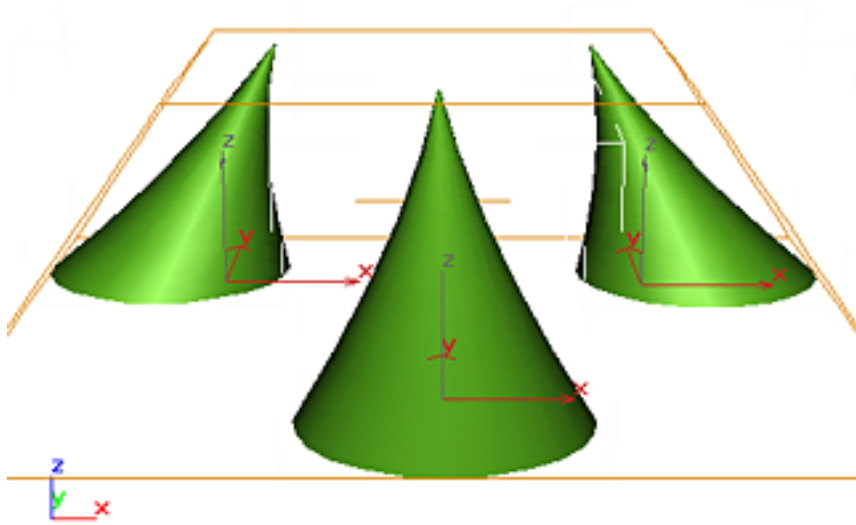

Single modifier applied to all objects



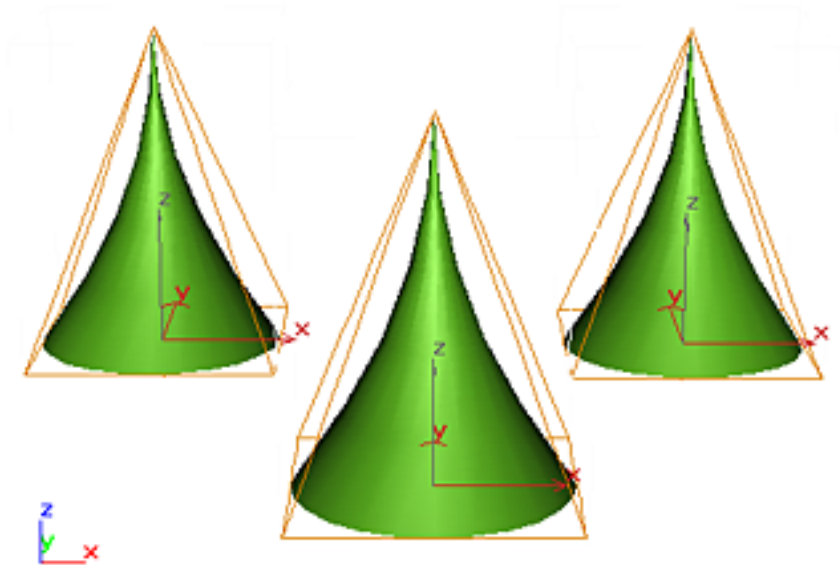

Single modifier applied with Use Pivot Points activated

### Instanced Modifiers

When you apply a modifier to multiple objects, each object receives an identical version of the modifier. These are called *instanced* modifiers. They are interchangeable. A change to any one of the instances affects all the other instances. [How Instanced Modifiers Work](#) on page 1040 covers instanced modifiers in detail.

---

**TIP** Sometimes you might apply modifiers to a selection set, perform some other operations, and select the set again, only to find its modifier stack is empty. This happens if you applied another modifier to an individual object in the original selection set. When you select the set again, the modifier stack is empty because all members of the set no longer have all modifiers in common. You can still access the instanced modifiers by selecting a single object in the set. The individual object's stacks still contain the modifiers you applied to the set as a whole.

---

# How Instanced Modifiers Work

When you apply a modifier to a selection set, the same modifier is carried on the stack for each individual object. These are *instanced* modifiers: they are all exactly the same, and a change to the instance for any one object will change all the others.

In the stack, the name of an instanced modifier appears in *italic*.

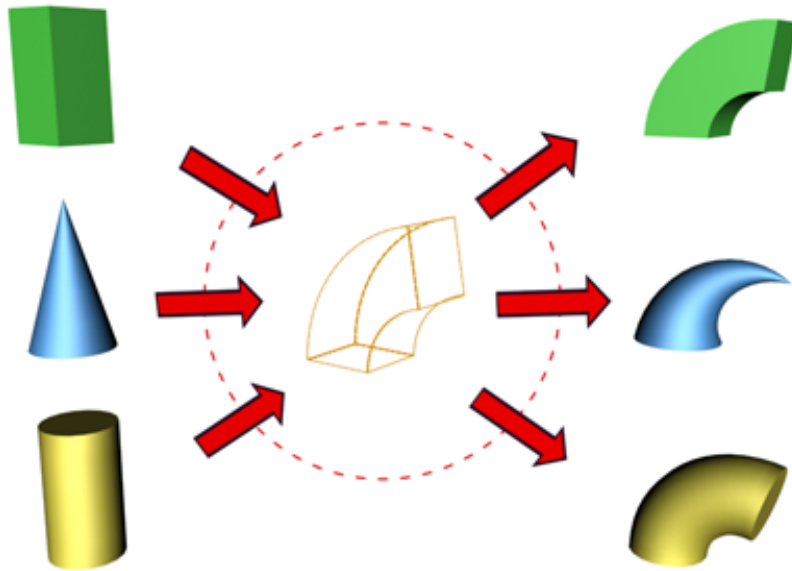

Objects sharing a single instanced modifier

## Identifying Instanced Modifiers

You can quickly lose track of which objects share the same modifier. An option on the Views menu highlights those objects.

### To identify objects sharing instanced modifiers:

- 1 Select an object with an instanced modifier. Choose the instanced modifier in its stack.
- 2 Choose Views menu > Show Dependencies. Other objects with instances of the same modifier appear in a distinctive color (purple by default).

## Adjusting Instanced Modifiers

You can make changes to an entire set of objects from a single instance. This is a major advantage of instanced modifiers.

To adjust instanced modifiers:

- 1 Select any object in a set of objects with instances of the same modifier.
- 2 Choose the instanced modifier in its stack.

The single object highlights and the appropriate gizmos appear for the entire selection set. Adjustments to this modifier now affect the entire set.

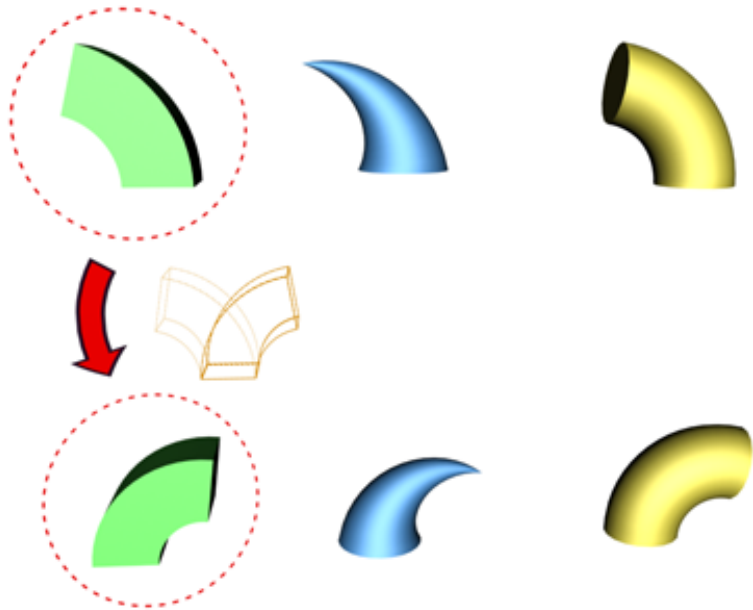

Changing the parameter of an instanced modifier for one object affects all the objects sharing the modifier.

## Making Instanced Modifiers Unique

At some point in your work, you might want to turn a modifier instance into a local copy that affects only a single object. To do so, click [Make Unique](#) on page 7446 on the Modify panel. This button appears beneath the modifier stack

display. (Make Unique is also available as a pop-up menu choice when you right-click the instanced modifier's name in the stack display.)

**To make an instanced modifier unique:**

- 1 Select an object with an instanced modifier.
- 2 Choose the instanced modifier in its stack.



- 3 Click Make Unique beneath the modifier stack display. The modifier is no longer listed in italic text and if Show Dependencies is set, the highlight disappears from the other objects.

The modifier is now separate from the set of instanced modifiers. Adjustments you make to this modifier no longer affect other objects. Its parameters and gizmo remain unchanged from their original, instanced settings until you adjust them.

**To make multiple modifier instances unique:**

- 1 Select two or more objects with the same instanced modifier. The stack now shows what the objects have in common.
- 2 Choose the instanced modifier in the stack.

There can be more than one instanced modifier in this stack. Click the one you want to make unique for each of the selected objects.



- 3 Click Make Unique.
- 4 Right-click and choose Make Unique from the menu. The modifier is no longer listed in italic text and if Show Dependencies is set, the highlight disappears from the other objects.
- 5 Click Yes to make the two objects become independent of one another. Click No for the two objects to continue to share the same instanced modifier, but separate from the instance in the original group.

The parameters for this modifier disappear, because the objects no longer share the modifier. For each object, the modifier is now separate from the set of instanced modifiers.

As with a single object, the parameters and gizmo are unchanged in the now unique modifiers.

- To access the unique modifiers, select the objects individually.

---

**NOTE** If both the object and the modifier are instances, you can choose either in the stack before you click Make Unique.

---

## World-Space Modifiers (WSMs)

World-space modifiers act as object-specific space warps. They are carried with the object, but like space warps use [world space](#) on page 7976 rather than object space for their effects. World-space modifiers eliminate the need for binding to a separate space-warp gizmo, making them convenient for modifying a single object or selection set.

You apply world-space modifier like you apply standard object-space modifier. You can access world-space modifiers from the Modifiers menu, the Modifier List in the Modify panel, and applicable [modifier sets](#) on page 7449 . A world-space modifier is indicated by either an asterisk or the letters “WSM” next to its name. (The asterisk or “WSM” distinguishes the world-space version from the object-space version of the same modifier, if one exists.)

When you assign a world-space modifier to an object, it appears at the top of the modifier stack, listed as a binding, in the same area as the space warp bindings.

For a list of world-space modifiers, see [List of Available Modifiers](#) on page 1011 .

### World-Space Modifiers and Earlier Space Warps

3ds Max 1 provided PathDeform and MapScaler space warps. In subsequent versions, these were replaced by comparable world-space modifiers. When you open a v1 MAX file in a later version of 3ds Max, objects bound to the v1 space warps are automatically assigned the corresponding world-space modifiers.

## Camera Map Modifier (World Space)

Modify panel > Select an object. > Modifier List > World-Space Modifiers > \* Camera Map

Select an object. > Modifiers menu > UV Coordinates > \* Camera Map

The Camera Map world-space modifier is similar to the [Camera Map modifier](#) on page 1154 , in that it applies UVW mapping coordinates to the object based on a specified camera. As a result, if you assign the same map as a Screen environment to the background as you apply to the object, the object is invisible in the rendered scene.

The main difference between the world-space version of Camera Map and the object-space version is that, when you move the camera or the object using the object-space version, the object becomes visible, because the UVW coordinates are fixed to the object's local coordinates. When you move the camera or object using the world-space version, the object remains invisible because world coordinates are used instead.

### Interface



#### Current Camera Object group

**Label** Names the current camera used for mapping. If there is no current camera, reads "None."

**Pick Camera** Click this button, and then select the camera you want used for mapping.

#### Channel group

**Map Channel** Specifies use of a [map channel](#) on page 7836 . Map channels are specified in the [Material Editor](#) on page 5188 .

**Vertex Color Channel** Specifies use of the Vertex Color Channel (see [UVW Map Modifier](#) on page 1849 ).

## Displace Mesh Modifier (World Space)

Select an object. > Modify panel > Modifier List > World-Space Modifiers > \* Displace Mesh

The Displace Mesh world-space modifier (World Space) lets you see the effect of [displacement mapping](#) on page 5391 on [editable mesh objects](#) on page 1990 and objects with a [Disp Approx modifier](#) on page 1270 applied to them. If a displacement map is applied to the object, the mesh shows the effect of the displacement map. Displace Mesh replaces the mesh with its displaced version.

There are two main reasons for using Displace Mesh:

- As a visualization aid to see the effect of a displacement map in viewports, and to compare the placement of displaced objects with other objects in the scene.

For example, if you use an animated displacement map to create waves on a water surface, you might temporarily apply Displace Mesh to see where the ripples meet the waterline of a boat.

When you use Displace Mesh in this way, usually you delete it once you've obtained the effect you want.

- To obtain an editable mesh created from a displacement map  
To use the Displace Mesh this way, you apply it to the object that has a displacement map, then apply the [Snapshot command](#) on page 921 from the Tools menu, and choose Mesh as the clone method.

Snapshot creates a permanently displaced mesh. As it does for other kinds of objects, Snapshot also leaves the original, displacement-mapped object in the scene. After applying Snapshot, you can delete the original object, or you can keep it in your scene to use for other purposes.

---

**TIP** Use Disp Approx to displace editable meshes. Use Displace Mesh for previewing, as in the first item, but avoid using Snapshot. The mesh created by using Displace Mesh and Snapshot can have a high polygon count. This makes it slow to use interactively, and can cause smoothing problems, where the underlying mesh edges are visible.

---

## Interface

The rollout for Displace Mesh lets you choose which surface approximation settings are used to produce the mesh.

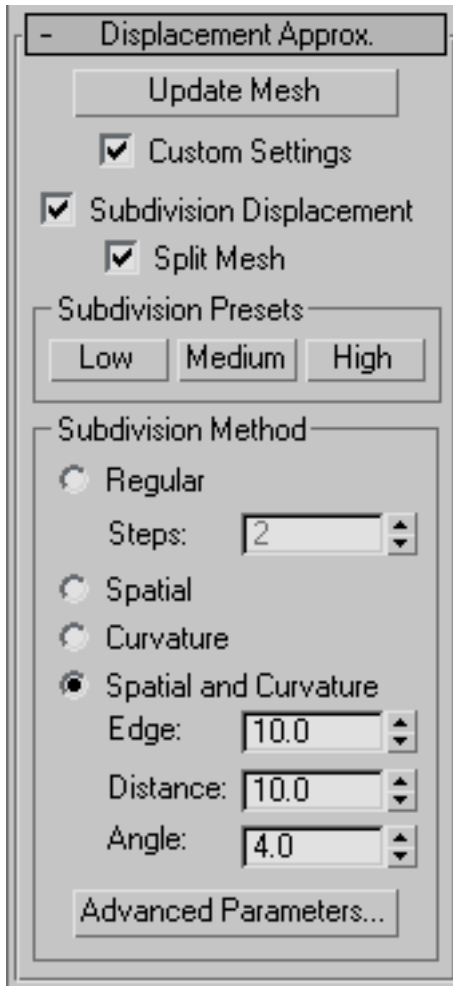

**Update Mesh** Updates the mesh if you have changed the displacement mapping and want to see the results of the change. The mesh isn't updated automatically because that can become extremely time consuming.



**Custom Settings** When turned off, Displace Mesh uses default settings to subdivide the mesh for the purposes of displacement mapping. When turned on, the subdivision controls in this rollout are enabled. Default=off.

**Subdivision Displacement** Subdivides mesh faces to accurately displace the map, using the method and settings you specify in the Subdivision Presets and Subdivision Method group boxes. When turned off, the modifier applies the map by moving vertices in the mesh, the way the [Displace modifier](#) on page 1274 does. Default=on.

**Split Mesh** Affects the seams of displaced mesh objects; also affects texture mapping. When on, the software splits the mesh into individual faces before displacing them; this helps preserve texture mapping. When off, the software uses an internal method to assign texture mapping. Default=on.

---

**TIP** This parameter is required because of an architectural limitation in the way displacement mapping works. Turning Split Mesh on is usually the better technique, but it can cause problems for objects with clearly distinct faces, such as boxes, or even spheres. A box's sides might separate as they displace outward, leaving gaps. And a sphere might split along its longitudinal edge (found in the rear for spheres created in the Top view) unless you turn off Split Mesh. However, texture mapping works unpredictably when Split Mesh is off, so you might need to add a Displace Mesh modifier and make a [snapshot](#) on page 921 of the mesh. You would then apply a [UVW Map modifier](#) on page 1849 and then reassign mapping coordinates to the displaced snapshot mesh.

---

### **Subdivision Presets group and Subdivision Method group**

The controls in these two group boxes specify how the modifier applies the displacement map when Custom Settings and Subdivision Displacement are both turned on. They are identical to the [surface approximation controls](#) on page 2469 for NURBS surfaces.

## **Displace NURBS Modifier (World Space)**

Select a NURBS object. > Modify panel > Modifier List > World-Space Modifiers > \* Displace NURBS

The Displace NURBS world-space modifier (World Space) converts a [NURBS](#) on page 2152 object into a mesh. If a displacement map is applied to the object,

the mesh shows the effect of the displacement map in viewports. There are two main reasons for using Displace NURBS:

- As a visualization aid to see the effect of a displacement map in viewports  
When you use Displace NURBS this way, you usually delete the modifier once you've obtained the effect you want.
- To obtain an editable mesh created from a displacement map on a NURBS object  
To use Displace NURBS this way, you apply it to the object that has a displacement map, then use the [Snapshot command](#) on page 921 from the Tools menu, and choose Mesh as the Clone Method.  
Snapshot creates a permanently displaced mesh. As it does for other kinds of objects, Snapshot also leaves the original, displacement-mapped object in the scene. After applying Snapshot, you can delete the original object, or you can keep it in your scene to use for other purposes.

### **Interface**

The rollout for Displace NURBS lets you choose which surface approximation settings are used to produce the mesh.

**Animated Displacement Map** If you use an animated displacement map on the mesh, turn on this toggle to have the NURBS Modifier correctly update the mesh as the displacement map animates.

You can apply a [displacement map](#) on page 5391 using the [Material Editor](#) on page 5188 .

**Update Mesh** Click to update the mesh if you have changed the displacement mapping and want to see the results of the change. The mesh isn't updated automatically because that could become extremely time consuming.

**Viewport** Uses the tessellation that the NURBS object currently uses in viewports.

**Renderer** Uses the tessellation that the NURBS object currently uses for the renderer.

**Custom** Set the tessellation directly in the Tessellation Method group box.

**Base Surface, Surface Edge, Displaced Surface, and Lock** These controls are the same as in the [surface approximation controls](#) on page 2469 for NURBS objects.

### **Tessellation Method group**

The controls in this group are the same as the surface approximation controls for NURBS objects.

**Ignore Surface Settings** When turned off, Displace NURBS uses the surface approximation settings for surface sub-objects. When turned on, Displace NURBS uses the settings in the Tessellation Method group and overrides settings for surface sub-objects. Default=off.

**Auto Weld** All vertices closer than the *Threshold* value are automatically welded together. This can simplify the mesh geometry. It is useful to turn this on when you have increased the Merge value in order to eliminate gaps between surface edges in the approximation of the NURBS object.

## **Hair And Fur Modifier**

Modify panel > Make a selection. > Modifier List > World-Space Modifiers > Hair And Fur

The Hair And Fur modifier is the heart of the Hair And Fur feature. You apply it to any object that you want to grow hair from: either a mesh object or a spline object. If object is a mesh, the hair grows from the entire surface unless

you make a sub-object selection. If the object is a spline, hair grows between the splines.

When you select an object modified by Hair And Fur, hair is displayed in viewports. The hair itself as displayed in the viewports is not selectable, though hair *guides* are selectable when you work at the Guides sub-object level or style hair (see below).

---

**NOTE** Hair And Fur renders only in Perspective and Camera views. If you attempt to render an orthographic view, 3ds Max displays a warning that says the hair will not appear.

---

## Components of the Hair And Fur Feature

Hair And Fur in 3ds Max has a few different components in the interface:

- The Hair And Fur modifier is the main component. This is where you style the hair guides, and set parameters for size and coloration, kinkiness, frizziness, and so on.
- The [Hair And Fur render effect](#) on page 6386 more directly controls how hair is rendered. Typically you don't need to change the render effect parameters, unless you have special rendering requirements. A Hair And Fur render effect is automatically added to your scene when you apply the Hair And Fur modifier.
- A [Hair Light Attributes rollout](#) on page 5076 appears for all supported lights when a Hair And Fur render effect is active using the scanline renderer, and the render effect's Use All Lights At Render Time toggle is turned on. Controls on this rollout let you fine-tune how hair shadows appear under specific lights.  
The following light types are *not supported* when rendering hair with the “buffer” method (see “Lighting Considerations,” below): Skylight, mr Area Omni, mr Area Spot, IES Sun, IES Sky, mr Sky and mr Sun. However, mr Area Omni, mr Area Spot, mr Sky, and mr Sun *are supported* for hair when you use the “mr prim” method and the mental ray renderer.

---

**NOTE** For the purposes of rendering shadows in hair, Direct lights are treated as point (omni) lights.

---

- There is also a [Hair And Fur render element](#) on page 6163 , which you can use when you are doing your own compositing.

## Growth Objects

You can grow Hair either from a surface or from splines.

To grow hair from a surface, select the object and then apply the Hair And Fur modifier. You can use either geometric primitives or an editable surface type such as Polymesh.

To grow hair from splines, you can draw several splines and combine them into a single object (or turn off Start New Shape during creation), and then apply the Hair And Fur modifier. You will see some preview interpolated hairs appear in viewports. The order of the spline sub-objects is important because Hair uses this order to interpolate hair in between the splines. If the interpolation seems incoherent, you might need to physically rearrange the splines.

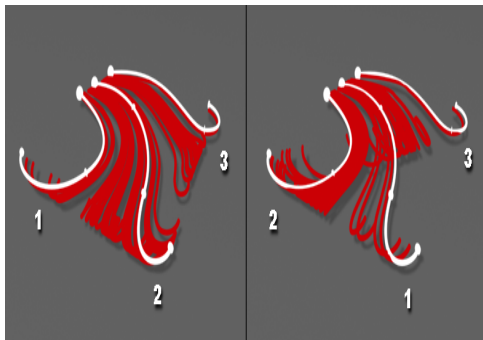

Using a spline emitter, Hair interpolates hair growth between pairs of splines in logical, numerical order.

**Left:** Splines in sequential order result in predictable hair growth.

**Right:** Splines in nonsequential order can produce undesirable results.

---

**TIP** To check the numerical order of splines, go to the Editable Spline level of the modifier stack and access the Spline sub-object level. Then click each spline in turn and check its ID number at the bottom of the Selection rollout. It also can help to make sure that each spline's first vertex is where the hair roots should be.

---

## Guide Hairs

Storing and manipulating millions of dynamic, simulated hairs is demanding on today's technology. Therefore, just as standard 3D graphics technology uses boundaries such as surfaces to describe solid objects, Hair uses hair "guides" to describe basic hair shape and behavior.

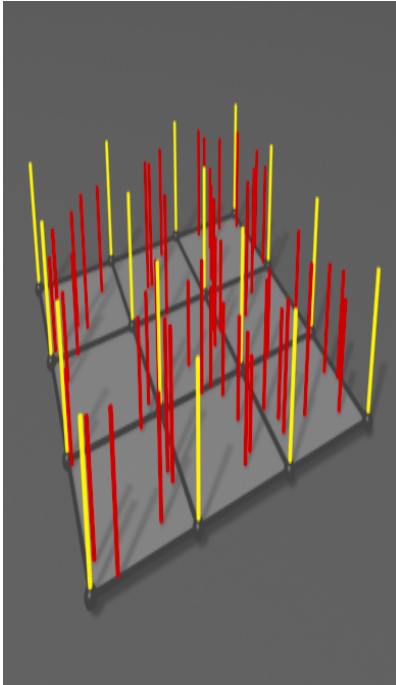

**Guides (yellow) occur at each polygon corner.**

**Hairs (red) are interpolated between guides.**

When the growth object is a surface, Hair And Fur generates guide hairs at the corners of polygons. When the growth object is a spline, the spline sub-objects are themselves the guides.

For surface-grown hair, you can manipulate the guides with [styling tools](#) on page 1070 to form a “control volume” that gets populated by interpolated hairs. The hairs can then be further manipulated with distorting controls such as [Kink](#) on page 1104 and [Frizz](#) on page 1099 , which can be driven by maps or solid textures.

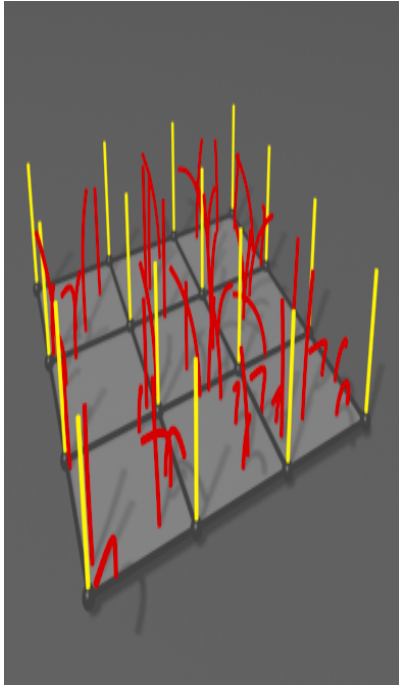

**Frizz settings affect the hairs but not the guides.**

 By default, a percentage of hairs are displayed in the viewports, but surface-grown guides do not appear except when you are working at the Guides sub-object level. You can adjust the viewport display of guides and hairs with settings on the [Display rollout](#) on page 1116 .

Guides are also used to calculate dynamics. After this calculation, hair interpolation takes place when you render. This is when parameters such as Frizz, as well as displacement and coloration, are calculated. You don't have control of every single hair, but this two-phase process makes the creation of realistic hair computationally feasible on a typical computer.

### **Styling Hair**

The Hair And Fur modifier's growth settings have a great effect on the hair's appearance and behavior, but you can also manipulate the guides directly (or in other words, style the hair).

For surface-grown hair, use the tools on the [Styling rollout](#) on page 1070 . First, select the surface whose hair you want to edit, and then on the Modify panel,

either click the Style Hair button on the Styling rollout or choose the Guides sub-object level from the [Selection rollout](#) on page 1059 or the modifier stack display.

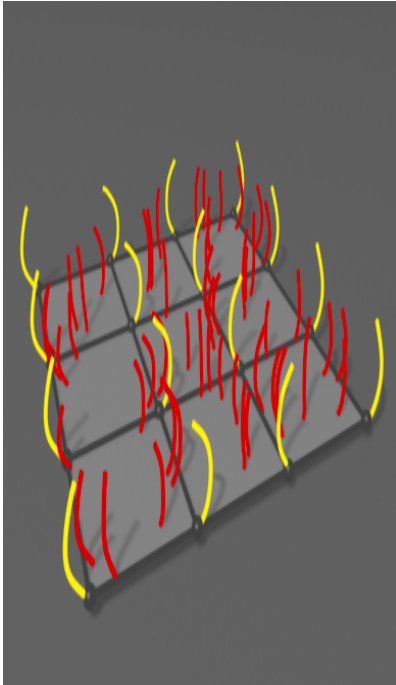

After guides have been styled, hair is interpolated between neighboring guide pairs.



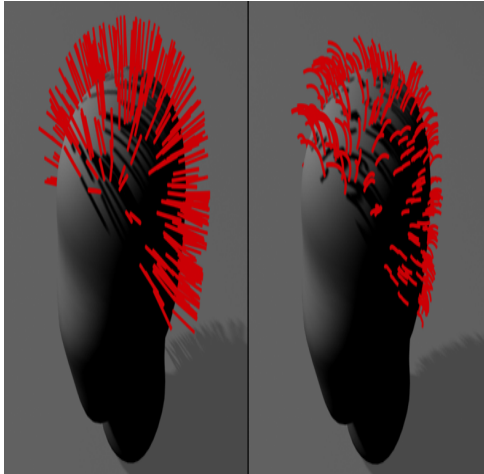

**Mesh-based hair guides before and after styling.**

With spline growth, you style the hair by editing the growth splines in the viewports.

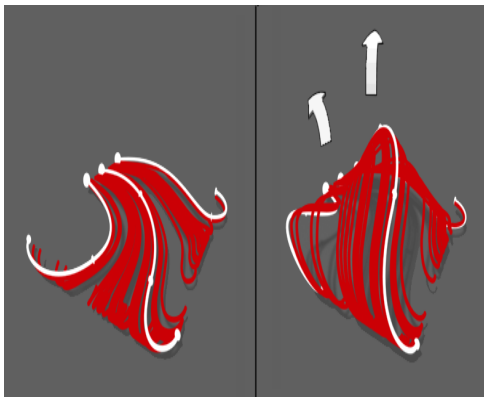

**Style spline-based hair by manipulating the splines.**

### **Copying and Pasting Hair**

You can copy and paste a Hair And Fur modifier from one stack to another, but you need to line up the objects as closely as possible, because Hair uses proximity to determine how to position copied guides. If the objects have significantly different geometry, the transfer of guides can be inaccurate.

Copying and pasting the Hair And Fur modifier automatically adjusts the hair scaling. Copying from a large object to a small object, for instance, results in a smaller default size in the copied modifier.

If you copy an object that has Hair And Fur in its modifier stack, Hair will also copy the modifier's data to a new modifier that will track the new object.

## **Textures, Vertex Maps, and Shaders**

You can control many Hair And Fur modifier parameters with maps. If you apply a map to a parameter that is not a color, such as Density, Hair uses the texture as a grayscale map that is multiplied by the parameter value (0.0 to 100.0) .

You apply a map by clicking the square button to the right of the parameter. After applying a map, the letter "M" appears on the button. To place this map in the first slot in the Material Editor, Shift+click the button. To disable the map temporarily, Ctrl+click the button. A disabled map is indicated by a lower-case "m".

## **Lighting Considerations**

When you render using the default "buffer" method, Hair And Fur provides its own default lighting (a single omni light), unless you have one or more supported lights in the scene.

Supported lights for the scanline renderer and "buffer" method include spotlights, omni lights, direct lights (which are treated as omni lights for hair purposes), and photometric lights except for IES Sun and IES Sky. Supported lights for the mental ray renderer and "mr prim" method include the lights supported by the scanline renderer, *and* these mental ray light types: mr Area Omni Light, mr Area Spotlight, mr Sky, and mr Sun.

If supported lights exist in the scene, by default they are used to light the hair, and the internal default omni light is not used. This is because in the [Hair And Fur render effect](#) on page 6386 , the Use All Lights At Render Time option is on by default. Also, any supported lights set to cast shadow-mapped shadows will cast shadows from rendered hair.

For Hair's "buffer" render to consider only certain lights, select the lights you'd like Hair to use, go to the Hair And Fur render effect, turn off Use All Lights At Render Time, and then click Add Hair Properties. This causes only the designated lights to illuminate the hair. It also adds a [Hair Light Attr rollout](#) on page 5076 to each of the designated lights. This lets you fine-tune the light's shadow settings for Hair.

With the “buffer” method, you can also raytrace your scene.

---

**NOTE** The other rendering methods provided are “geometry” and “mr prim.” The “geometry” method creates actual geometry for the rendered hair at render time. The “mr prim” method uses a mental ray shader to generate hair, and is for use only with the mental ray renderer. Use the Hair And Fur render effect to choose the rendering method.

---

### **Loading and Saving**

Hair And Fur data in your scene is automatically saved when you save your MAX scene file. The state data for the hair can consume quite a bit of space, so your scene file will probably be significantly larger than it was before you applied hair.

### **Animating Hair**

You cannot keyframe hair styling. You *can* keyframe Modify panel parameters to create special effects such as hair growing. But to animate hair motion, you can use the Frizz Animation parameters or use dynamics.

To animate frizz, use the [Frizz Anim.](#) on page 1104 , Anim. Speed, and Frizz Anim. Dir. parameters. It's not necessary to keyframe these to create animation; just set them to values other than the defaults.

To animate with dynamics, use the [Dynamics rollout](#) on page 1109 . See [To generate a precomputed dynamics simulation with Hair](#) on page ? . A gravity force is built in to Hair And Fur. You can add space warps to act as external forces (for example, Wind).

#### **See also:**

- [Hair and Fur Render Effect](#) on page 6386
- [Hair and Fur Render Element](#) on page 6163
- [Hair Light Attr\(ributes\) Rollout](#) on page 5076

## Procedures

### To use the Hair And Fur modifier:

This procedure lists the essential steps for growing hair on an object. For more information, see other Hair And Fur topics in this help, and the tutorials in the *Autodesk 3ds Max Tutorials*, available from Help menu > Tutorials.

- 1 Apply the Hair And Fur modifier to a mesh or spline object.  
The hairs appear in the viewports as brown lines.
- 2 Set the modifier parameters according to the desired results (see [Interface](#) on page 1058 ). Available settings include the number of hairs, length, thickness, and coloring.
- 3 Activate a Perspective or Camera viewport, and then render the scene.  
Hair cannot render in an orthogonal viewport.

### To apply hair to a limited area of a high-resolution object:

An efficient working method for applying hair to part of a high-poly-count object is to use a low-poly proxy object.

- 1 Create the object to which you wish to apply hair.
- 2 Make a copy of the object in the same location as the original, remove any geometry where hair shouldn't grow, and reduce the polygon count. For example, you could use the [MultiRes modifier](#) on page 1493 .
- 3 If the original object is to move, make the low-resolution proxy object a child of the original object.
- 4 Apply the Hair And Fur modifier to the low-resolution proxy object and adjust as necessary.
- 5 Make the low-resolution proxy object non-renderable (see [General Panel \(Object Properties Dialog\)](#) on page 245 ). The hair will still render.

## Interface

You control the Hair And Fur modifier from a series of rollouts on the Modify panel. See these topics:

[Selection Rollout \(Hair and Fur\)](#) on page 1059

[Tools Rollout \(Hair and Fur\)](#) on page 1061

[Styling Rollout \(Hair and Fur\)](#) on page 1070

[General Parameters Rollout \(Hair and Fur\)](#) on page 1084

[Material Parameters Rollout \(Hair and Fur\)](#) on page 1091

[mr Parameters Rollout \(Hair and Fur\)](#) on page 1098

[Frizz Parameters Rollout \(Hair and Fur\)](#) on page 1099

[Kink Parameters Rollout \(Hair and Fur\)](#) on page 1104

[Multi Strand Parameters Rollout \(Hair and Fur\)](#) on page 1107

[Dynamics Rollout \(Hair and Fur\)](#) on page 1109

[Display Rollout \(Hair and Fur\)](#) on page 1116

## Selection Rollout (Hair and Fur)

Select an object with the Hair And Fur modifier applied. > Modify panel > Selection rollout

The Selection rollout provides tools for accessing different sub-object levels and display settings and for creating and modifying selections, and displays information about selected entities.

When you first apply the Hair And Fur modifier to an object, the entire object is affected by the modifier. You can specify that the only part of an object should grow hair by accessing a sub-object level and making a selection.

Clicking a button here is the same as choosing a sub-object level in the modifier stack display. Click the button again to turn it off and return to the Object selection level.

### Interface

---

**NOTE** Controls on this rollout are available only when the growth object is a mesh. If the growth object is a spline, the Selection controls have no effect, and sub-object levels for the Hair And Fur modifier are not visible in the modifier stack.

---

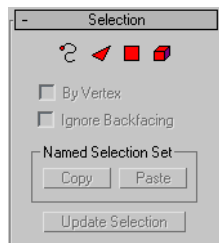



**Guides** Accesses the Guides sub-object level, which lets you edit the styling guides using tools on the [Styling rollout](#) on page 1070 . When you click Guides, the Style Hair button on the Styling rollout is automatically turned on, and vice versa.



**Face** Accesses the Face sub-object level, which lets you select a triangular face beneath the cursor; region selection selects multiple triangular faces within the region.



**Polygon** Accesses the Polygon sub-object level, which lets you select polygons beneath the cursor. Region selection selects multiple polygons within the region.



**Element** Accesses the Element sub-object level, which lets you select all contiguous polygons in an object by clicking once. Region selection lets you select multiple elements.

**By Vertex** When on, you can select a sub-object only by selecting a vertex that it uses. When you click a vertex, all sub-objects that use the selected vertex are selected.

**Ignore Backfacing** When on, using the mouse to select sub-objects affects only those facing you. When off (the default), you can select any sub-objects under the mouse cursor, regardless of their visibility or facing. If there are more than one sub-object under the cursor, repeated clicking cycles through them. Likewise, with Ignore Backfacing off, region selection includes all sub-objects, regardless of the direction they face.

---

**NOTE** The state of the Backface Cull setting on the Display panel does not affect sub-object selection. Thus, if Ignore Backfacing is off, you can still select sub-objects, even if you can't see them.

---

### **Named Selection Set group**

**Copy** Places a named selection into the copy buffer.

**Paste** Pastes a named selection from the copy buffer.

---

**TIP** You can use this to grow hair from an existing selection lower on the stack. However, because the Hair And Fur modifier outputs an editable mesh, the copied sub-object selection should be from a mesh-based modifier. For example, if your base object is an editable poly, you can use tools such as Ring, Loop, and Grow to make a procedural edge selection, and then Ctrl+click the Polygon button on the Selection rollout to convert the selection to polygons. Next, apply a Mesh Select modifier ( *not* Poly Select), and go to the Polygon sub-object level; the Mesh Select modifier inherits the Editable Poly selection. Use the Named Selection Sets field on the main toolbar to name the selection, and then use the Mesh Select modifier's Copy function on the named selection. Finally, apply the Hair And Fur modifier, go to the Poly sub-object level, and paste the selection.

---

**Update Selection** Recalculates the area from which hair is grown, based on the current sub-object selection, and refreshes the display.

When you access a sub-object level within the Hair modifier and make a selection, the area of hair growth doesn't automatically update. Click Update Selection to view the results of a change in sub-object selection.

## Tools Rollout (Hair and Fur)

Select an object with the Hair And Fur modifier applied. > Modify panel > Tools rollout

This rollout provides tools for accomplishing a variety of tasks with Hair, including creating a hairstyle from an existing spline object, resetting the hair, and loading and saving general presets for the modifier as well as specific hairdos. Here you can also specify an object from the current scene to be used as hair, such as a flower or group of flowers for creating a garden.

### Using Instanced Hair

Besides the built-in hair strands, which are created at render time, you can assign any source object as hair strands, using the Instance Node controls on the Tools rollout. For example, in the following illustration, the original orientation of the source object affects its orientation when it is used as hair strands.

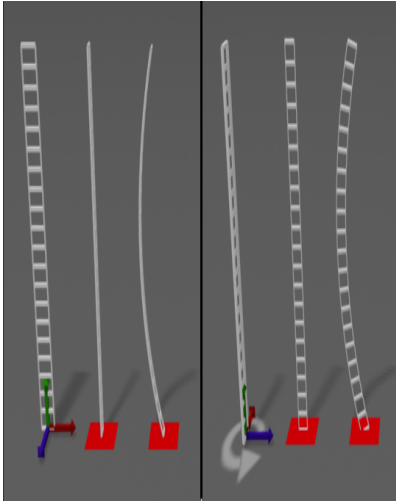

**Rotating the source object affects the hair orientation.**

The next illustration shows how increasing the Frizz Root value creates greater amounts of distortion in the resulting instanced hairs. This image also shows how a raised pivot in the source object causes the root of the hair to go below the surface of the growth object (the red square). Compare this with the previous illustration, in which the pivot rests at the base of the source object.

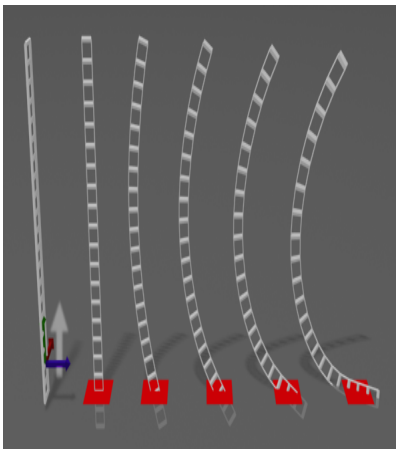

**Frizz causes the instanced hairs to change shape.**

The next illustration shows the effect of the Merge Material check box. On the left side, Merge Material was left on, with the result that the flower model



retained its original material and coloring when used as hair. On the right, Merge material was turned off, so the flower-hairs took on the material of the flower pot growth object.



**Left: Merge Material on**

**Right: Merge Material off**

In the next illustration, the Root Thick setting, from left to right, is 2.0, 10.0, 20.0, and 30.0. With instanced geometry, the Root Thick value affects the thickness of the resulting object uniformly along its height, while the Tip Thick value has no effect. (The Root Thick and Tip Thick settings are on the [General Parameters rollout](#) on page 1084 .)



**Increasing Root Thick affects the overall thickness of the hair geometry.  
From left to right: Root Thick = 2.0, 10.0, 20.0, and 30.0**

The final illustration, below, shows how the instanced hair aligns itself faithfully to the guides, no matter how they're styled. The styled hair was brushed from the center, and the instances align perfectly in all directions, face up, without twisting or other distortion. This makes it easy to style instances as scales, for example.

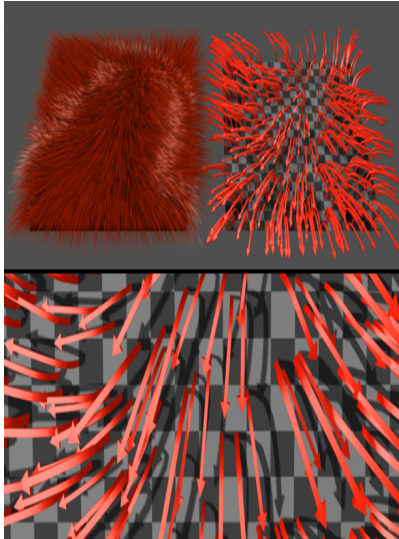

Top left: The original styled hair

Top right: The instanced hair (arrows) conforms to the styling.

Bottom: Close-up view of instanced hair

## Interface

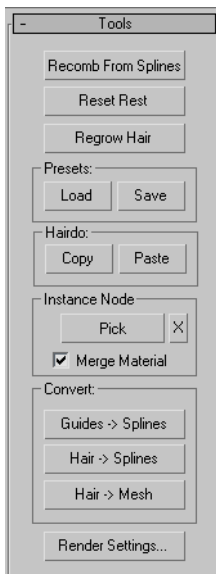

**Recomb From Splines** Lets you use a spline object to style the hair. Click this button and then select an object that is made up of spline curves. Hair will turn the curves into guides and populate each guide of the selected growth mesh with a replica of the closest curve.

This tool is particularly useful for creating a specific style and length, such as short hair with a part on the side, without having to manually groom the hair in the Style dialog. For optimal control, position the splines fairly closely together and use as many as possible.

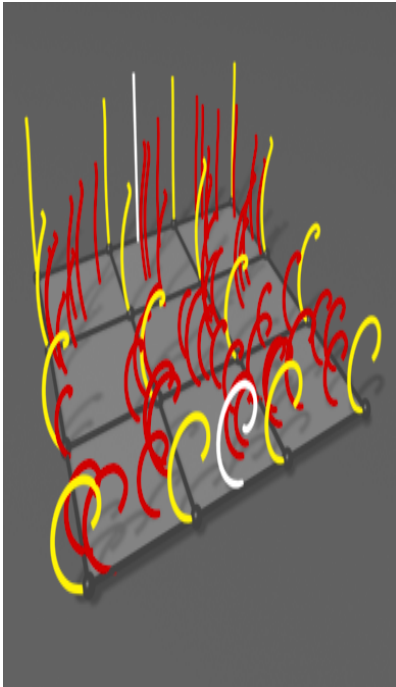

**Hair and guides are recombined by the spline object (white).**

**Reset Rest** Performs an averaging of hair guides using the growth mesh's connectivity.

This function is particularly useful after using Recomb From Splines. It's also advantageous when you change the size ratios of polygons in the growth object. For example, if you stretch part of the mesh by moving some vertices, by default the larger polygons will contain fewer hairs per unit area. Use Reset Rest to redistribute the number of hairs on the surface for more even coverage.

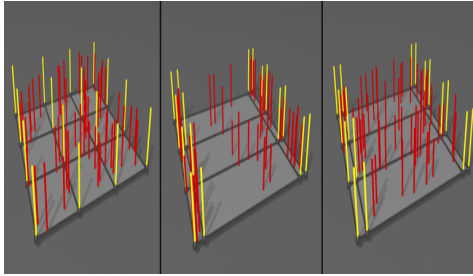

**Left:** Even hair distribution before resizing polygons

**Center:** Uneven hair distribution after moving edges, altering polygon size ratios

**Right:** After using Reset Rest, distribution is again evened out.

**Regrow Hair** Discards any styling information, resetting the hair to its default state, retaining all current Modify panel settings.

### **Presets group**

Lets you load and save hair presets. Each preset contains all current Modify panel settings (except Display settings), but *not* any styling information.

**Load** Opens the Hair Presets dialog, which contains a list of presets in the form of named swatches. To load a preset, double-click its swatch. Several sample presets are included with 3ds Max.

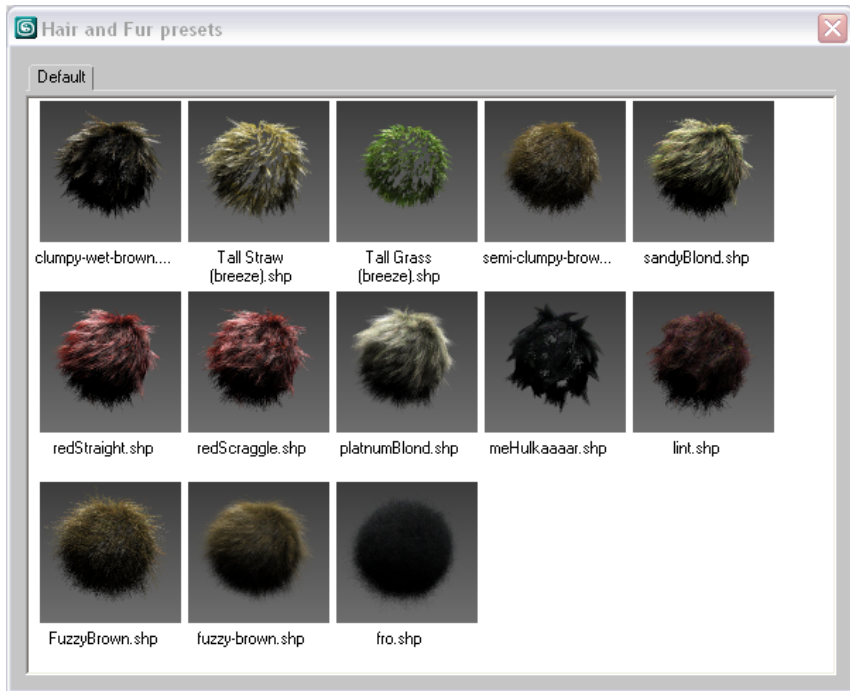

**Hair And Fur Presets dialog**

**Save** Creates a new preset. You're prompted for a preset name; after entering one, Hair renders the swatch, as shown by a message on the status bar. You can abort the creation of the preset by clicking the Cancel button on the status bar during rendering. If you enter an existing preset name, Hair asks you to confirm overwriting the preset.

### **Hairdo group**

Lets you copy and paste hairdos. Each hairdo contains all the current Modify panel settings (except Display settings) and styling information. This lets you apply all hair settings from one object to another.

**Copy** Copies all hair settings and styling information into a paste buffer.

**Paste** Pastes all hair settings and styling information to the current Hair-modified object.

## Instance Node group

Lets you specify an object to use as custom hair geometry. The hair geometry is not instanced from the original object, but all hairs created from it are instances of each other, to save memory.

---

**NOTE** Hair does not use animation from instance objects. If an object is animated, Hair uses its state at the first animation frame.

---

**Pick** To specify a hair object, click the Pick button and then pick an object to use. Thereafter, the button shows the name of the object you picked. To use a different instance object, or to use a modified version of the original object, click this button and then pick the new object.

---

**TIP** In order for the instances to be properly scaled and fit to the hair, place the model's pivot at the "root" of the object. Hair will then scale your model appropriately so that the height of each instance matches the length of the hair it has been applied to. Any part of your model that extends below the pivot will intersect the surface. This can be useful; if the hair grows at an oblique angle to the growth surface, you can raise the pivot in the original model to make sure the instanced hairs will extend all the way to the growth surface.

---

Also, bear in mind that the instancing engine will be deforming your model as it fits it to the hairs. Make sure that your model has enough divisions along the Z (vertical) axis for the deformation to look as smooth as it needs to; the number of subdivisions should be approximately equal to the Hair Segments value. Hair doesn't perform automatic subdivision on the geometry.

**X** To stop using the instance node, click the Clear Instance button (labeled "X").

**Merge Material** When on, combines the material applied to the growth object and the material applied to the hair object into a single Multi/Sub-Object material and applies it to the growth object. When off, the growth object's material is applied to the instanced hair. Default=on.

---

**NOTE** The merged material is instanced from the instance node, so that changing the original material affects the resulting material applied to the hair.

---

## Convert group

Use these controls to convert guides or hair generated by the Hair And Fur modifier to 3ds Max objects that you can operate on directly.

**Guides -> Splines** Copies all guides to a new, single spline object. The original guides are left intact.

**Hair -> Splines** Copies all hairs to a new, single spline object. The original hairs are left intact.

**Hair -> Mesh** Copies all hair to a new, single mesh object. The original hairs are left intact.

**Render Settings** Opens the [Effects panel and rollout](#) on page 6383 and adds a [Hair And Fur render effect](#) on page 6386 to the scene, if one doesn't already exist.

---

**NOTE** The Hair And Fur render effect settings are global, so even if you click Render Settings to open the effect settings from different Hair And Fur modifiers, you'll get the same render-effect settings.

---

## Styling Rollout (Hair and Fur)

Select an object with the Hair And Fur modifier applied. > Modify panel > Styling rollout

The Guides sub-object level of the [Hair And Fur modifier](#) on page 1049 lets you style hair interactively in viewports. Interactive styling controls are on the Styling rollout, which has a Style Hair button that you can also click to begin styling.

### Styling with Hair Guides

Styling tools aren't available until you click Style Hair to turn it on, or choose the Guides sub-object level in either the Selection rollout or the modifier stack.

Each guide hair has 15 segments and 14 vertices (there's an additional, non-selectable vertex at the root); for a tool to affect a guide, at least one of its vertices must be selected. To select vertices, click Select (in the Styling group) to turn it on, then use standard 3ds Max selection tools to select a portion of the guides. For example, you might drag a selection rectangle to select vertices on adjacent hair guides. By default, selected guides are displayed as orange, and unselected guides are displayed as yellow.

Selections you make this way are constrained by the buttons at the top of the Selection group: Select Hair By Ends, Select Whole Guide (the default), Select Guide Vertices, or Select Guide By Root. As these names imply, the constraints affect how the Hair Brush modifies hair guides. The best way to get a feel for



the difference between selection constraints is to practice using the various selection constraints with tools such as Translate. The Hair Brush uses a combination of these constraints and IK to alter guide geometry.

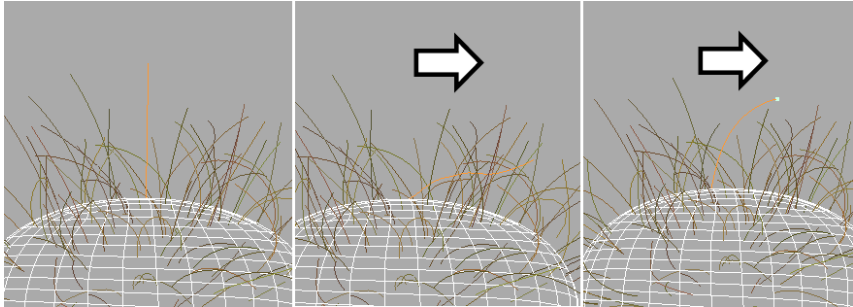

**Left: Hair guide before styling**

**Center: Translating while Select Whole Guide is active**

**Right: Translating while Select Hair By Ends is active**

Once you've made a selection, typically you will click Hair Brush (also in the Styling group, to the left of Select), and then use the brush in conjunction with one of the tools at the bottom of the Styling group: Translate, Stand, Puff Roots, Clump, Rotate, or Scale.

While you style, only selected guides are affected, and in addition, only guides that fall within the brush area are affected at any given time. You can change the brush size using the slider in the Styling group, or by holding down Ctrl+Shift and dragging the mouse.

The Hair Cut tool on the Styling rollout (between Hair Brush and Select) cuts hair guides by scaling them based on the brush location.

## **Interface**

---

**NOTE** Controls on this rollout are available only when the growth object is a mesh. If the growth object is a spline, the Styling controls have no effect. Instead, you can style the hair by editing the underlying spline object.

---

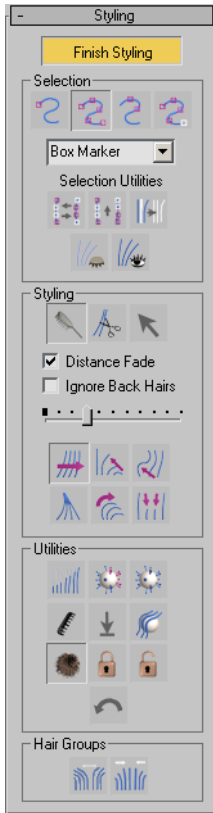

**Style Hair / Finish Styling** Click Style Hair to begin styling. Click Finish Styling to turn off styling mode. When you turn this button on, a brush is immediately available and by default the active tool is Translate. Turning on Style Hair turns on the Guides sub-object level in the [Selection rollout](#) on page 1059 , and vice versa.

### Selection group



**Select Hair by Ends** You can select only the vertex at the end of each guide hair.



**Select Whole Guide** (The default.) Selecting any vertex on a guide hair selects all vertices on the guide hair. When you first turn on Style Hair, Hair activates this mode and selects all vertices of all guide hairs.



**Select Guide Vertices** You can select any vertices on a guide hair.



**Select Guide by Root** You can select only the vertex at the root of each guide hair, and doing so selects all vertices on the guide hair.

**Vertex display drop-down list** Chooses how selected vertices are displayed in viewports.

- **Box Marker** (The default.) Selected vertices display as small squares.
- **Plus Marker** Selected vertices display as small plus signs.
- **X Marker** Selected vertices display as small Xes.
- **Dot Marker** Selected vertices display as dots.

**Selection Utilities** The buttons labeled “Selection Utilities” are for handling selections.



**Invert Selection** Inverts the vertex selection.

Keyboard shortcut: Ctrl+I



**Rotate Selection** Rotates the selection in space.



**Expand Selection** Expands the selection by growing its area incrementally.



**Hide Selected** Hides selected guide hairs.

---

**TIP** If interactive styling in viewports seems to be slow, try hiding those guides you aren't working on.

---



**Show Hidden** Unhides any hidden guide hairs.

## Styling group



**Hair Brush** (The default.) In this styling mode, dragging the mouse affects only selected vertices within the brush area.

While Hair Brush is on, a brush gizmo is displayed in viewports. In the active viewport, the brush appears as a circle, but as you can see in the other viewports, the brush is actually a three-dimensional cylindrical region.

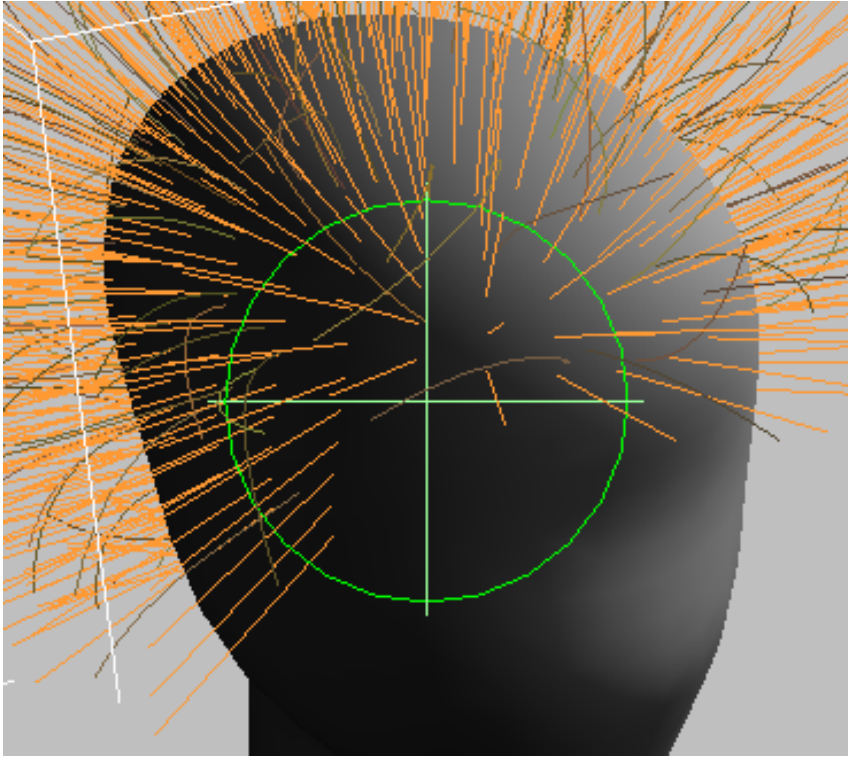

In the active viewport, the brush appears to be a circle.

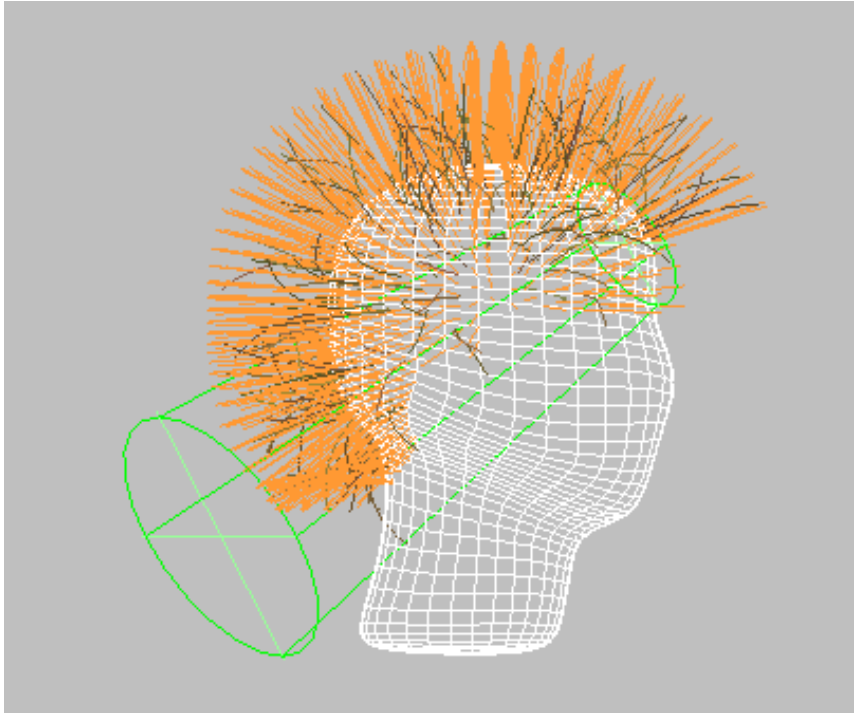

Inactive viewports show the brush to be a cylindrical region.



**Hair Cut** Lets you trim the guide hairs. To cut hair, follow this suggested procedure:

- 1 In Selection mode, choose any selection method.
- 2 Drag the mouse to select guide hairs to trim.
- 3  Turn on Hair Cut.
- 4 Resize the brush using the slider.
- 5 Position the brush circle over hairs to cut, and then click to cut the hairs. Hairs with vertices inside the brush circle are shortened so that their endpoints touch the brush circle.

---

**NOTE** Cutting hair doesn't actually remove vertices; it only scales the guide hairs. You can restore guide hairs to their original length with Scale or one of the [Pop commands](#) on page 1079 .

---

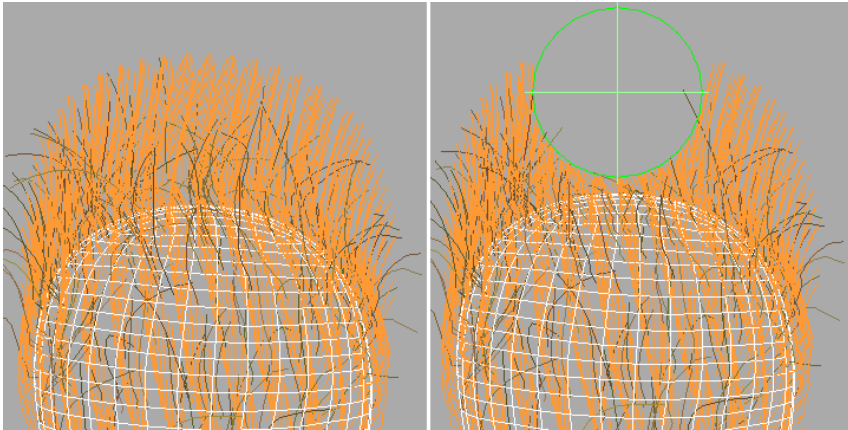

**Left:** Hair guides before cutting

**Right:** Hair guides after cutting



**Select** Goes into selection mode, where you can use 3ds Max selection tools to select guide vertices according to the constraints chosen in the Selection group (Whole Guide, Ends, and so on).

**Distance Fade** Available only for Hair Brush. When on, the effect of brushing fades toward the edges of the brush, giving a gentler effect. When off, brushing affects all selected vertices equally, giving a hard-edged effect. Default=on.

**Ignore Back Hairs** Available only for Hair Brush and Hair Cut. When on, hairs on back faces are not affected by the brush. Default=off.

**Brush size slider** Drag this slider to change the size of the brush.

Keyboard shortcut: Ctrl+Shift+drag

The styling buttons below the Brush Size Slider are available only while Hair Brush is on.



**Translate** Moves selected vertices in the direction that you drag the mouse.



**Stand** Pushes selected guides toward a perpendicular orientation to the surface.

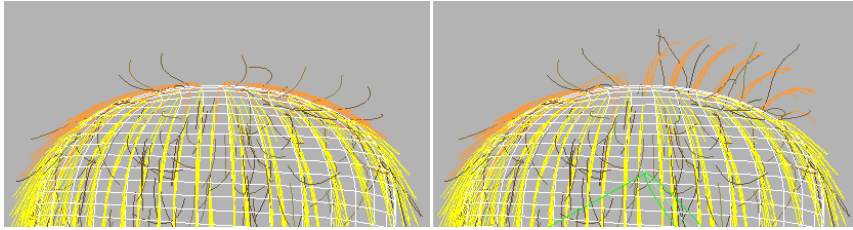

**Left: Guide hairs before styling with Stand**

**Right: Guide hairs after styling with Stand (on the right)**



**Puff Roots** Pushes selected guide hairs toward a perpendicular orientation to the surface. The bias for this tool is closer to the root of the hair than to the endpoint.

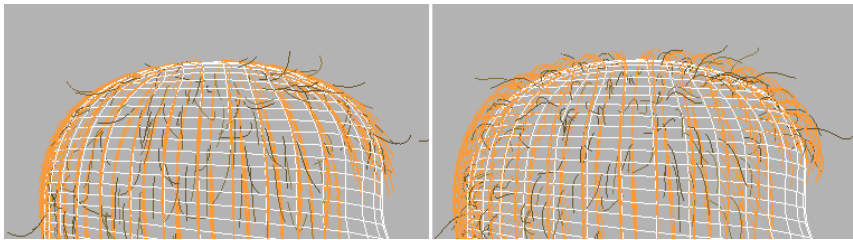

**Left: Hair guides before puffing roots**

**Right: Hair guides after puffing roots**



**Clump** Forces selected guides to move towards each other (drag mouse leftward) or farther apart (drag mouse rightward).

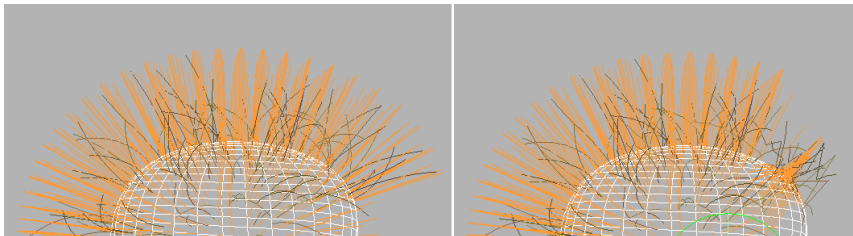

**Left: Hair guides before clumping**

**Right: Hair guides after clumping (at the right)**



**Rotate** Rotate or swirls guide hair vertices around the cursor location (at the center of the brush).

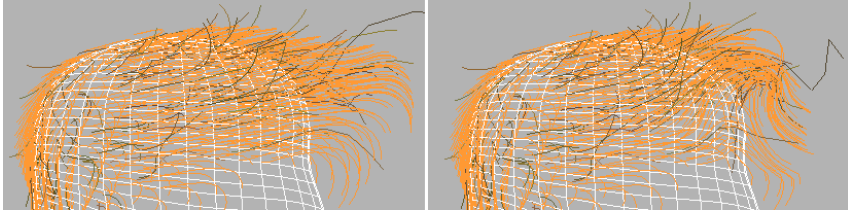

**Left:** Hair guides before rotating

**Right:** Hair guides after rotating (at the forelock)



**Scale** Scales selected guides larger (drag mouse rightward) or smaller (drag mouse leftward).

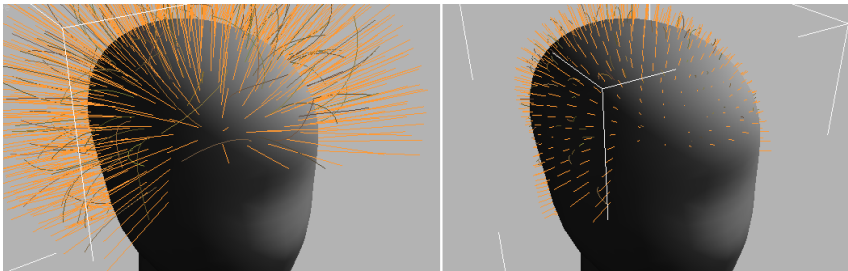

**Left:** Hair guides at original lengths

**Right:** Hair guides after scaling shorter

## Utilities group



**Attenuate Length** Scales selected guides according to the surface area of underlying polygons. This is useful, for example, in applying fur to an animal model, which typically has smaller polygons in areas with shorter hair. For example, the polygons on an animals paws are usually smaller than the ones on the chest, and the chest fur tends to be longer.





**Pop Selected** Pops selected hairs out along the surface normal.

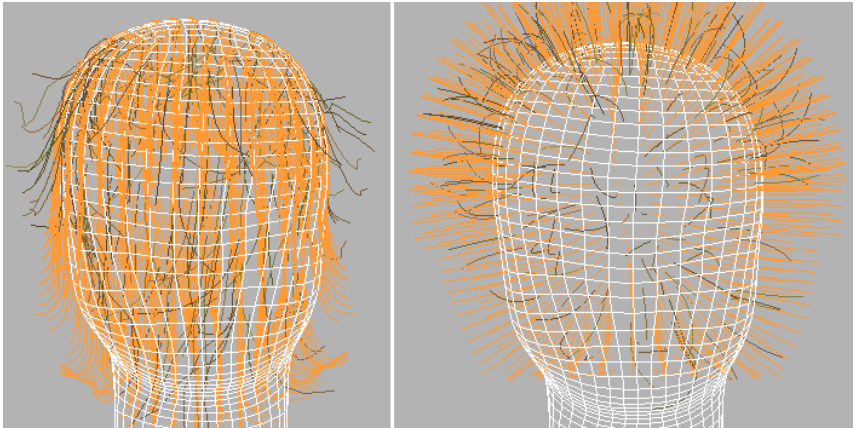

**Left:** Hair guides before using Pop Selected

**Right:** Hair guides after using Pop Selected



**Pop Zero-Sized** Works like Pop Selected, but only operates on zero-length hairs.

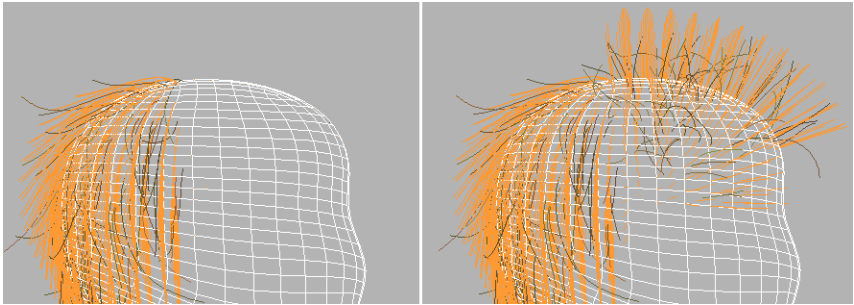

**Left:** Hair guides on top of head were scaled to zero length.

**Right:** Using Pop Zero affects only the zero-length hair guides.



**Recomb** Makes a guide parallel to the surface, using the guide's current direction as a hint.

Here's a suggested procedure: Turn on Hair Brush, select guides using Select Whole Guide, and then move the guides around not worrying about skin penetration or hair shape. You're just trying to indicate the direction of the hair flow. Click Recomb frequently, and you will soon start to see hair flowing smoothly wherever you want it to. Once you have this flow, you can do your other styling. With the Recomb tool, you probably won't need to use Comb Away. Once you have the flow as you like it, you can go in and start styling in scale, cut guides, and move some of the tips around, "shaping" or "styling" the hair.

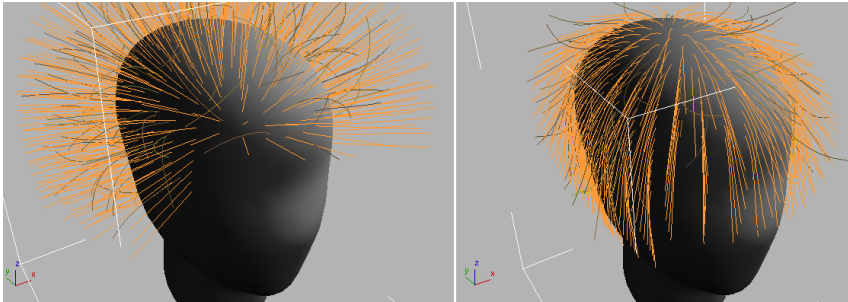

**Left: Hair guides in their default position**

**Right: Hair guides after clicking Recomb**



**Reset Rest** Performs an averaging of hair guides using the growth mesh's connectivity.

This function is particularly useful after using Recomb.



**Toggle Collisions** When on, styling takes hair collisions into account. When off, styling ignores collisions. Default=off.

For collisions to be used while styling, you need to have already added at least one collision object using the [Dynamics rollout](#) on page 1109 . If no collisions are specified, this button has no effect.

---

**TIP** If you collisions are enabled and styling interaction seems slow, try turning off Toggle Collisions.

---



**Toggle Hair** Toggles viewport display of generated (interpolated) hair. This doesn't affect display of the hair guides. Default=on (hair is displayed).



**Lock** Locks selected vertices with respect to the orientation to and distance from the nearest surface. Locked vertices can be selected, but they can't be moved.

This is useful for creating different types of hair shapes. For example, to make a braid, you would comb hair down some straight tubes, and then lock the vertices to the tubes. Then, in 3ds Max, when you twist the tubes, the hairs will follow. Locked vertices are no longer dynamic, although they will follow whatever the surface does, but if other vertices on the same guides aren't locked, they can still move freely, as usual.



**Unlock** Unlocks all locked guide hairs.



**Undo** Reverses the most recent action.

Keyboard shortcut: Ctrl+Z

## Hair Groups group



**Split Selected Hair Groups** Splits the selected guides into a group. This can be useful for creating a part or a cowlick, for example.



**Merge Selected Hair Groups** Recombines selected guides.

If you don't use Split Selected Hair Groups, then when you render hair, the generated hairs are interpolated across a styled part. When Split Selected Hair Groups is on, there is no interpolation between the split group and other hairs. To remove this effect and make the part less “clean,” click Merge Selected Hair Groups.

## Quad Menu for Hair Styling

While you are styling hair at the Guides sub-object level, right-clicking a viewport displays a quad menu that contains shortcuts to many styling controls that are also found on the [Styling rollout](#) on page 1070 .

### Interface

Merge Hairgroups Split Hairgroups	
Unlock Lock	Ignore Back ✓Soft Falloff
Toggle Hairs Toggle Collisions	Scale Rotate
Reset Rest Recomb Pop Zerosized Pop Selected Attenuate	Clump Puff Stand Translate
	Cut
utilities	styling
selection utils	selection
Invert Selection Rotate Selection Expand Selection	Tip ✓Guide Verts
Hide Selected Show Hidden	Root

### Utilities quadrant

The first two choices are shortcuts to the buttons in the Hair Groups group:

- [Merge Hairgroups](#) on page 1081
- [Split Hairgroups](#) on page 1081

The other choices in this quadrant are shortcuts to the buttons in the Utilities group:

- [Unlock](#) on page 1081
- [Lock](#) on page 1081
- [Toggle Hairs](#) on page 1081
- [Toggle Collisions](#) on page 1080
- [Reset Rest](#) on page 1080
- [Recomb](#) on page 1079
- [Pop Zerosized](#) on page 1079
- [Pop Selected](#) on page 1079
- [Attenuate](#) on page 1078

### **Styling quadrant**

The choices in this quadrant are shortcuts to most of the controls in the Styling group:

- [Ignore Back](#) on page 1076
- [Soft Falloff](#) on page 1076
- [Scale](#) on page 1078
- [Rotate](#) on page 1078
- [Clump](#) on page 1077
- [Puff](#) on page 1077
- [Stand](#) on page 1076
- [Translate](#) on page 1076
- [Cut](#) on page 1075

To exit Cut mode and return to the hair brush, choose one of the other styling modes in this quadrant.

---

**TIP** While the brush is active, you can resize it in viewports by holding down Ctrl+Shift and dragging the mouse.

---

## Selection Utils quadrant

These choices are shortcuts to the buttons under “Selection Utilities” in the Selection group:

- [Invert Selection](#) on page 1073
- [Rotate Selection](#) on page 1073
- [Expand Selection](#) on page 1073
- [Hide Selected](#) on page 1073
- [Show Hidden](#) on page 1073

## Selection quadrant

These choices are shortcuts to the buttons at the top of the Selection group that constrain how you can select hair guides:

- [Tip](#) on page 1072
- [Guide](#) on page 1072
- [Verts](#) on page 1073
- [Root](#) on page 1073

## General Parameters Rollout (Hair and Fur)

Select an object with the Hair And Fur modifier applied. > Modify panel > General Parameters rollout

This rollout lets you set the hair count and density, the length, thickness at the root and tip, and various other comprehensive parameters.

## Interface

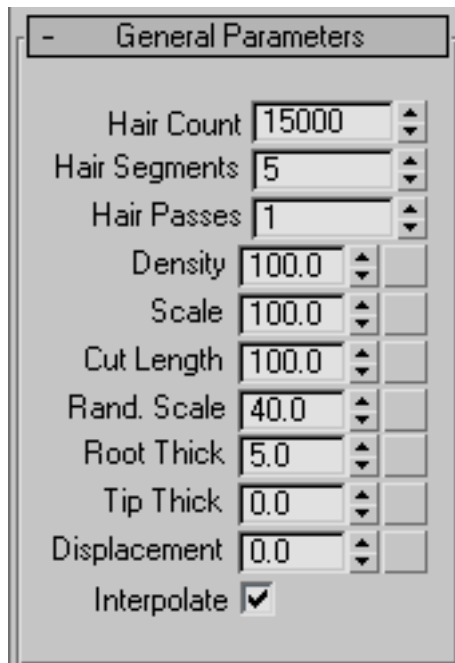

**Hair Count** The total number of hairs generated by Hair. In some cases this is an approximate count, but the actual count is usually very close to the specified quantity. Default=15000. Range=0 to 10000000 (ten million).



**Top: Hair Count=1000**

**Bottom: Hair Count=9000**

By default, Hair normalizes density to surface area; that is, larger polygons receive more hairs than smaller ones. If you edit the growth object in a way that changes the polygon-size ratios, use [Reset Rest](#) on page 1066 to adjust the hair distribution automatically.

**Hair Segments** The number of segments per hair. Default=5. Range=1 to 150.

This is equivalent to spline segments; with more segments, curly hair looks more natural, but the generated mesh object is larger. For perfectly straight hair, set Hair Segments to 1.



**Left: Hair Segments=5**

**Right: Hair Segments=60**



**Hair Passes** Sets the number of transparency passes. Default=1. Range=1 to 20.

Hair's [buffer render](#) on page 6388 has a fairly novel way of handling hair transparency. Instead of resolving actual hair transparency, the hair is rendered multiple times (as opaque hair) with different random seeds. These buffers are then blended together. As you increase the Hair Passes value, the transparency (or wispiness) of the hair increases. In addition, increasing the value increases the actual number of rendered hairs as well, although the apparent density, or fill, seems about the same because of the additional transparency. Render time also increases linearly.



**Top: Hair Passes=1**

**Bottom: Hair Passes=4**

---

**NOTE** For best results when using the “mr prim” hair rendering method (see [Hair and Fur Render Effect](#) on page 6386 ) with the mental ray renderer, be sure to set the Trace Depth > Max. Depth value (see [Rendering Algorithms Rollout \(mental ray Renderer\)](#) on page 6118 ) higher than the Hair Passes value.

---

**Density** The numeric value sets the overall hair density; that is, it acts as a percentage multiplier of the Hair Count value. Default=100.0. Range=0.0 to 100.0.

This attribute is also mappable via the map button to the right of the spinner. Mapping lets you add a texture map to control the amount of hair. An area of the map whose gray value is 50% will reduce the amount of hair grown in

that area by 50%. To change the overall hair count, use the Hair Count value (see above).

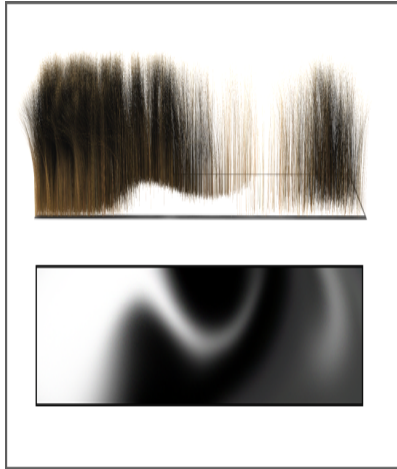

**Top:** Density=100.0 + map

**Bottom:** The bitmap used to control density

---

**TIP** For optimal efficiency, use the Hair Count value to set the actual number of hairs, leave Density at 100.0, and use mapping to create uneven hair distribution. Simply lowering the Density value without specifying a map causes hairs to be created and then discarded, which unnecessarily increases rendering time.

---

**Scale** Sets the overall scaling for the hairs. Default=100.0. Range=0.0 to 100.0.

At the default value of 100.0, the hairs are full size. Reduce this value to make the hairs smaller. To make the hairs larger, use the [styling tools](#) on page 1070. Default=100.0. Range=0.0 to 100.0.

This attribute is also mappable via the map button to the right of the spinner. Mapping allows you to add a texture map to control the length of the hair. An area of the map whose gray value is 50% will cut the hair grown in that area to 50% of its original length, with no shape change.



Scale value ramped from 0.0 (left) to 100.0 (right) using a linear gradient map

---

**NOTE** The default size of the hairs depends on the size of the object to which the modifier is applied. The larger the object, the greater the initial size.

---

**Cut Length** The numeric value sets the overall hair length as a percentage multiplier of the Scale value. Default=100.0. Range=0.0 to 100.0.

This attribute is also mappable via the map button to the right of the spinner. Mapping allows you to add a texture map to control the length of the hair. An area of the map whose gray value is 50% will cut the hair grown in that area to 50% of its original length, with no shape change.

This parameter is more computationally expensive than a density map, since each curve is re-parameterized on the fly, and should not be confused with a density map. It's really more useful as an animated effect for growing hair (for example, creating a wolfman character).

**Rand. Scale** Introduces random scaling into the rendered hairs. Default=40.0. Range=0.0 to 100.0.



Random Scale value ramped from 0.0 (left) to 100.0 (right) using a linear gradient map

At the default value of 40.0, 40 percent of the hairs are scaled down randomly by varying amounts. At 0.0, no random scaling is introduced.

**Root Thick** Controls the thickness of the hair at its root. With instanced hair, this controls the overall thickness as a multiplier of the original object's dimensions on the X and Y axes in object space.

This setting affects both native hair and instanced hair. With instanced hair, Root thick controls the overall thickness of the hair, not just at the root.

**Tip Thick** Controls the thickness of the hair at its tip.

This setting affects native hair only, not instanced hair. To create tapering in instanced hair, apply the tapering when modeling the object to be instanced within Hair.

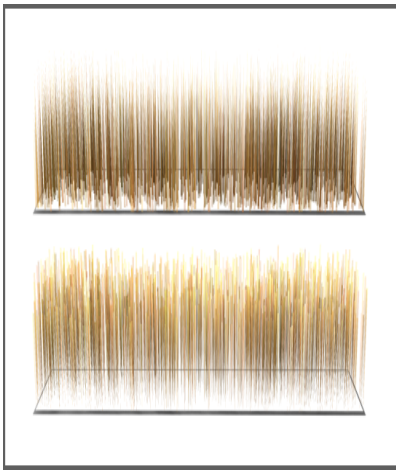

**Top: Root Thick=10.0, Tip Thick=0.0**

**Bottom: Tip Thick=10.0, Root Thick=0.0**

Hair is translucent if its width is less than one pixel. Thin hair that rendered as opaque in previous versions of the software might give unexpected results when rendered in this version. On the other hand, setting Root Thick and Tip Thick to small values (close to or less than 1.0) can be a good way to obtain translucent hair.

**Displacement** Displaces the hair roots from the surface of the growth object. Default=0.0. Range=-999999.0 to 999999.0.

When you render an object with a high polygon count, but use a low-polygon proxy object to grow the hair, adjusting Displacement can help make the hair seem to grow from the high-polygon object, rather than floating above it.

Another use for this setting can be animating the hair falling onto or moving away from the growth object.

**Interpolate** When on, hair growth is interpolated among the guide hairs, and the surface is fully populated with hair according to the General Parameters settings. When off, Hair generates only one hair per triangular face on the growth object, up to the limit imposed by the Hair Count setting. Default=on.

## Material Parameters Rollout (Hair and Fur)

Select an object with the Hair And Fur modifier applied. > Modify panel > Material Parameters rollout

The parameters on this rollout apply to [buffer-rendered hair](#) on page 6388 generated by Hair. In the case of [geometry-rendered hair](#) on page 6388, the hair coloring is derived from the growth object. In the case of hair rendered by "mr prim", all parameters apply except Self Shadow and Geom. Shadow. With instanced hair, Hair uses the material from the instanced object.

You can apply a map to any value by clicking the blank button to the right of the parameter. Values in the map act as multipliers to the base value.

---

**TIP** If you apply a colored texture map to a color attribute such as Tip Color, start by setting the base color to white. Because the map acts as a multiplier, not doing so can lead to unexpected results. For example, if Tip Color is set to yellow and you apply a blue texture map, the hair will be black: this is because if you multiply those RGB values, they zero each other out.

---

## Interface

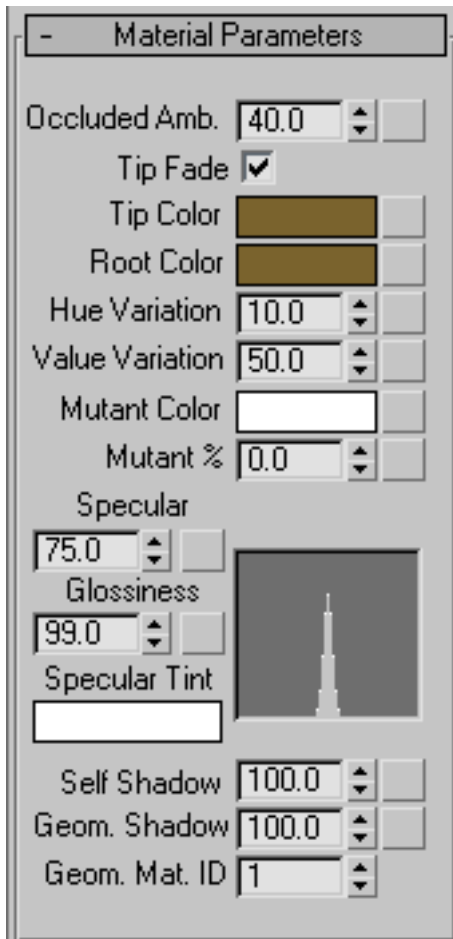

**Occluded Amb.** Controls the bias of the ambient/diffuse contributions of the illumination model. A setting of 100.0 renders the hair with flat lighting. A value of 0.0 is lit only by scene light sources, typically resulting in a higher-contrast solution. Default=40.0. Range=0.0 to 100.0.



**Left: Occluded Amb=0.0**

**Right: Occluded Amb=100.0**

**Both: Color=white, Self Shadow=50.0**

**Tip Fade** Applies only to [mr prim](#) on page 6388 rendering (with the mental ray renderer). When on, the hair fades to transparent toward its tip. When off, the hair is equally opaque for its entire length.

**Tip Color** Hair color at the tips, farthest from the growth object surface. To change the color, click the color swatch and use the Color Selector.

**Root Color** Hair color at the roots, closest to the growth object surface. To change the color, click the color swatch and use the Color Selector.

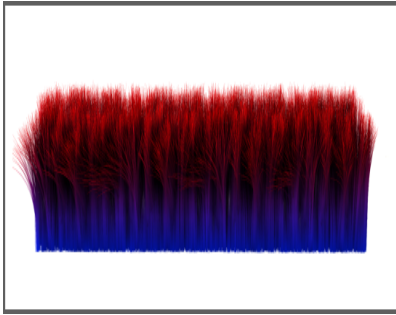

**Tip Color=red**

**Root Color=blue**

**Hue Variation=0.0**

The Tip Color and Root Color attributes are also mappable via the map buttons to the right of the spinners. These let you add texture maps to control the hair coloring, separately at the tip and base. The UVW mapping used for the texture is the same as that of the growth object.

For results closest to the map colors, set Tip Color and Root Color to white. Alternatively, set a different color to tint the map coloring.

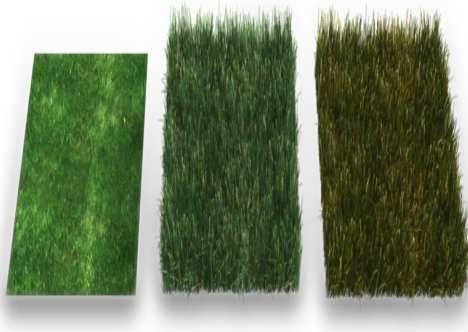

**Left:** The texture map used for the hair (center and right)

**Center:** The map applied to Tip Color and Root Color causes the hair to use the same coloring.

**Right:** Setting Tip Color and Root Color to orange adds an orange tint to the hair.

**Hue Variation** The amount by which Hair varies the color of the hairs. The default value results in natural-looking hair. Default=10.0. Range=0.0 to 100.0.



**Value Variation** The amount by which Hair varies the brightness of the hairs. The default value results in natural-looking hair. Default=50.0. Range=0.0 to 100.0.



**Top: Hue/Value Variation=0.0**

**Middle: Value Variation=100.0**

**Bottom: Hue Variation=100.0**

**Mutant Color** The color for mutant hairs. Mutant hairs are randomly selected, based on the Mutant % value (see following), and receive this color.

One example of mutant hairs are the gray hairs that appear as we age.

**Mutant %** The percentage of hairs that receive the mutant color (see above).

You can animate the Mutant % value to produce, for example, a rapidly aging character. Default=0.0. Range=0.0 to 100.0.

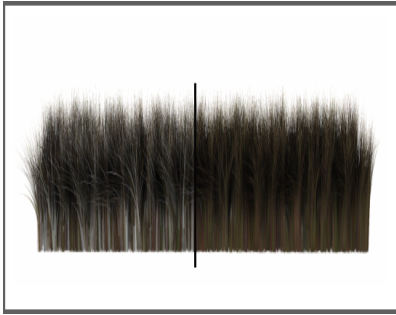

**Left: Mutant %=30.0**

**Right: Mutant %=0.0**

**Both: Color=brown, Mutant Color=white**

**Specular** The brightness of highlights on the hairs.

**Glossiness** The relative size of highlights on the hairs. Smaller highlights result in glossier-looking hair.

The combined results of the Specular and Glossiness settings appear in a graph to the right of the two parameters.



**Left: Specular=0.0, Glossiness=0.0**

**Center: Specular=100.0, Glossiness=75.0**

**Right: Specular=100.0, Glossiness=0.1**

**Specular Tint** This color tints specular highlights. Click the color swatch to use the Color Selector. Default=white.

**Self Shadow** Controls the amount of self-shadowing; that is, hairs casting shadows on other hairs within the same Hair And Fur modifier. A value of 0.0 disables self shadowing, while a value of 100.0 results in maximum self-shadowing. Default=100.0. Range=0.0 to 100.0.



**Top: Self Shadow=0.0**

**Center: Self Shadow=50.0**

**Bottom: Self Shadow=100.0**

---

**NOTE** You can adjust the shadow characteristics by changing the [Hair Light Attr rollout](#) on page 5076 settings for lights that illuminate the hair.

---

**Geom. Shadow** The amount of shadow contribution hair receives from geometry in the scene. Default=100.0. Range=0.0 to 100.0.

**Geom. Mat. ID** The material ID assigned to [geometry-rendered hair](#) on page 6388 . Default=1.

## mr Parameters Rollout (Hair and Fur)

Select an object with the Hair And Fur modifier applied. > Modify panel > mr Parameters rollout

Lets you assign a [mental ray shader](#) on page 5801 to generate hair. 3ds Max passes the object's UV coordinate data, including map channels, to the mental ray shader; strictly speaking, the shader generates hair from this UV and mapping data, not from the object geometry itself. (Multiple map channels are supported.)

When you use a mental ray shader for hair, you must render your scene using the [mental ray renderer](#) on page 6039 and set the [Hair And Fur render effect](#) on page 6386 method to “mr prim”.

---

**IMPORTANT** When you assign a mental ray shader, only the shader's own controls apply to the generated hair. All other Hair And Fur settings are disregarded.

---

Aside from the “mr prim” option that you can choose as a render effect (see [Hair and Fur Render Effect](#) on page 6386 ), no mental ray hair shaders are provided with 3ds Max. This feature is meant to support third-party hair shader products or custom-coded hair shaders.

### Interface

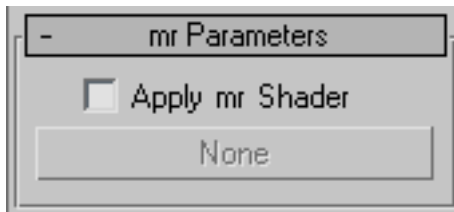

**Apply mr Shader** When on, lets you apply a mental ray shader to generate hair.

**[shader button]** Enabled only when “Apply mr Shader” is on. Click to display a [Material/Map Browser](#) on page 5194 and assign the shader.

When no shader is assigned, this button is labeled “None”. When a shader is assigned, the button's label shows the shader's name.

## Frizz Parameters Rollout (Hair and Fur)

Select an object with the Hair And Fur modifier applied. > Modify panel > Frizz Parameters rollout

Frizz displacement is accomplished by doing a Perlin noise lookup at the hair's rest position root, and then displacing the hair much the way bump mapping displaces a surface normal. The frequency of the noise function is set by the Frizz X/Y/Z Frequency parameters. The magnitude of the displacement is controlled with Frizz Root and Frizz Tip. If you set [dynamics mode](#) on page 1113 to Live, the viewports show the effects of changing these settings in real time.



1. Frizz Root/Tip=0.0
2. Frizz Root=50.0, Frizz X/Y/Z Freq=14.0
3. Frizz Root=150.0, Frizz X/Y/Z Freq=60.0
4. Frizz Tip=30.0, Frizz X/Y/Z Freq=14.0
5. Frizz Root=50.0, Frizz Root=100.0, Frizz X/Y/Z Freq=60.0

Frizz actually calculates two noise fields, both of which use the same frequency settings and tip/root amplitudes. One of the noise fields is static relative to the hair. The Anim parameters let you animate the second noise field through the hair over time. This is useful for things like grassy fields, where it would

be overkill to compute real dynamics. These parameters give you a similar result, at a small fraction of the computational overhead.



All Frizz/Kink settings=0.0; this reference image provided for comparison with the Frizz and Kink illustrations (below).

## Interface

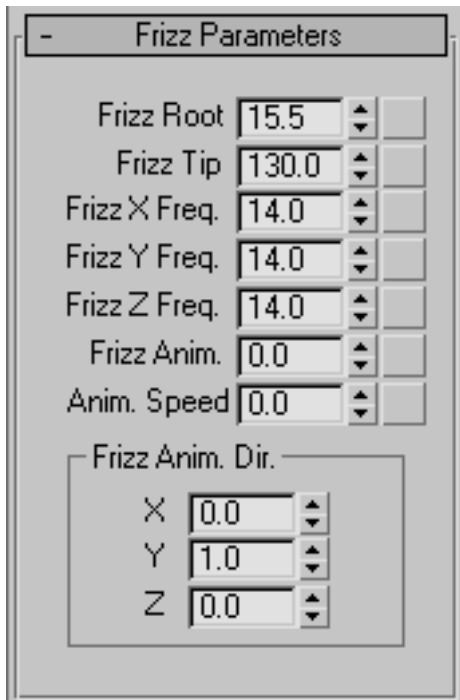

**Frizz Root** Controls the displacement of the hair at its root. Default=15.5.  
Range=0.0 to 360.0.

**Frizz Tip** Controls the displacement of the hair at its tip. Default=130.0.  
Range=0.0 to 360.0.





Frizz Root=30.0, Frizz Tip=100.0, Frizz X/Y/Z Freq=14.0

Top: Styled

Bottom: Unstyled

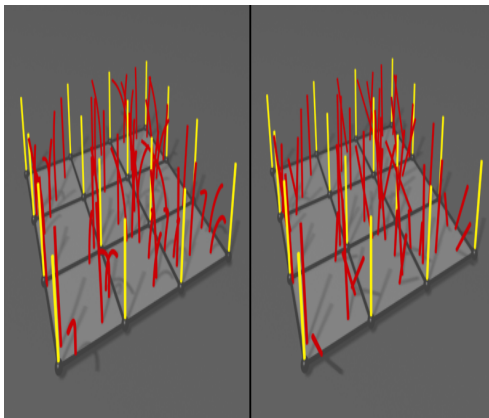

Left: Differing values for Frizz Root and Frizz Tip result in curved hairs.

Right: When Frizz Root=Frizz Tip, the hairs are straight.

**Frizz X/Y/Z Freq(ueency)** Controls the frequency of the frizz effect on each of the three axes. Default=14.0. Range=0.0 to 100.0.

Like frizz, Frizz Anim displaces the hair with a noise field. The difference is that you can move the noise field to create animated displacement, resulting in wavy movement without having to resort to dynamics.

**Frizz Anim.** Sets the amplitude of the wavy motion. Default=0.0. Range=-9999.0 to 9999.0.

**Anim. Speed** This multiplier controls the speed at which the animating noise field moves through space. This value is multiplied by the X, Y, and Z components of the Frizz Anim Dir attribute to determine the per-frame offset of the animating noise field. Default=0.0. Range=-9999.0 to 9999.0.

**Frizz X/Y/Z Anim. Dir(ection)** Sets the direction vector of the frizz animation. Default=0.0. Range=-1.0 to 1.0.

This vector is not normalized before use. This means that you can apply small tweaks to the values to achieve fine control over the speed of the animation on a given axis. To reduce confusion it's a good idea to keep these directions either -1, 0, or 1. Once you've got the animation close to what you want, you can diverge from these and adjust the values to achieve the exact result you need.

## Kink Parameters Rollout (Hair and Fur)

Select an object with the Hair And Fur modifier applied. > Modify panel > Kink Parameters rollout

Kink displacement works similarly to Frizz, but evaluates noise lookups along the whole length of the guide. The result is a noise pattern that works on a larger scale than the Frizz noise. The effect is similar to crimped hair.



1. All settings=0.0 (no kink)
2. Kink Root=0.5 (rest=0.0)
3. Kink Tip=10.0, Kink Root=0.0, Kink X/Y/Z Freq=4.0,
4. Kink Tip=10.0, Kink Root=0.0, Kink X/Y/Z Freq=50.0,

## Interface

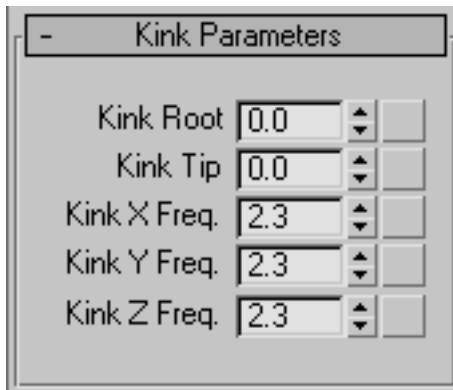

**Kink Root** Controls the amount of kink displacement of the hair at its root.  
Default=0.0. Range=0.0 to 100.0



**Kink Root=0.5, Kink Tip=0.0, Kink X/Y/Z Freq=4.0**

**Top: Styled**

**Bottom: Unstyled**

**Kink Tip** Controls the amount of kink displacement of the hair at its tip.  
Default=0.0. Range=0.0 to 100.0



Top: Styled, Kink Tip=10.0, Kink Root=0.5, Kink X/Y/Z Freq=50.0

Bottom: Unstyled, Kink Tip=10.0, Kink Root=0.0, Kink X/Y/Z Freq=50.0

**Kink X/Y/Z Freq(ueency)** Controls the frequency of the kink effect on each of the three axes. Default=0.0. Range=0.0 to 100.0.

## Multi Strand Parameters Rollout (Hair and Fur)

Select an object with the Hair And Fur modifier applied. > Modify panel > Multi Strand Parameters rollout

Some degree of clumping gets naturally created when you use Frizz at low frequencies, but you can go a bit further here with the Multi Strand parameters. For each hair that is normally rendered, Multi Strand renders a clump of additional hairs scattered around the original hair. The Splay settings control the degree of scattering at the roots and tips, and Multi Strand Count controls the number of hairs to create for the clump. You can use Splay to shape the clump by spreading or compressing the roots and tips.

---

**TIP** For each original hair, Multi Strand creates a cluster of hairs around that hair, offset at the bottom by the Root Splay factor. The hair is offset in the plane tangent to the root of the hair, which is not necessarily the surface of the object. To make sure Multi Strand hairs actually make contact with the surface, make the growth surface a bit smaller than the rendered surface.

---



1. Multi Strand Count=0, Hair Count=500
2. Multi Strand Count=10, Root Splay=0.1, Tip Splay=0.1, Hair Count=500
3. Multi Strand Count=10, Root Splay=0.4, Tip Splay=0.1, Hair Count=500
4. Multi Strand Count=10, Root Splay=0.0, Tip Splay=1.0, Hair Count=500

## Interface

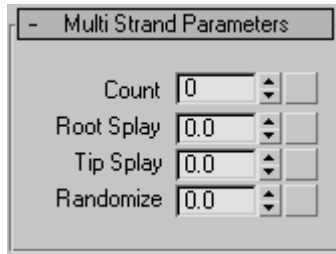

**Count** The number of hairs per clump.

**Root Splay** Provides a random offset for each hair in a clump, at the root.

**Tip Splay** Provides a random offset for each hair in a clump, at the tip.

**Randomize** Randomizes the size of each hair in a clump.

## Dynamics Rollout (Hair and Fur)

Select an object with the Hair And Fur modifier applied. > Modify panel > Dynamics rollout

For hair to seem natural in an animation, it must respond to the motion of the body it's attached to and to external influences such as wind and gravity. Hair's Dynamics functions let the hair behave like real-world hair, in interactive (Live) or Precomputed mode.

### Designating Collision Surfaces

Hair dynamics uses guide hairs to calculate collision. To reduce computation, you have to explicitly designate the objects with which hair will collide. The object from which the hair grows is a special case: to have hair collide with this object (for example, a human head), simply turn on Use Growth Object.

If there is a collision object that you want more than one Hair modifier to interact with, you have to add that object as a collision object for each different Hair And Fur modifier.

There are two different methods for calculating collision: Sphere and Polygon. Spherical collision uses a bounding sphere for collision objects; polygonal collision uses the collision object's actual geometry. The Polygon option is more accurate, but the Sphere option is quicker to calculate.

## Procedures

### Example: To view hair dynamics in real time:

- 1 Apply the Hair And Fur modifier to an object.
- 2 On the Dynamics rollout (scroll the command panel down to view it), set Mode to Live.
- 3 Move the object around.  
The hair moves realistically.
- 4 On the Tools rollout, click Regrow Hair.  
The hair resumes its default position, growing straight out of the object.
- 5  Click the Play Animation button.
- 6 The hair settles and droops, as if affected by gravity. Note that, as the animation repeats, the effects of gravity are cumulative; the hair animation doesn't restart at the first frame.
- 7 On the Tools rollout, click Regrow Hair again.
- 8 Add a Wind space warp to the scene.
- 9 On the Dynamics rollout, set Dynamics Params > Gravity to **0.0**.
- 10 In the External Forces group (at the bottom of the Dynamics rollout), click Add and then select the Wind space warp.
- 11 Play the animation again.  
This time, the hair isn't affected by gravity, but simply blown by the wind. Again, the effect is cumulative and the animation doesn't repeat.  
All of this animation takes place only in real time; no keyframes are set, so it can't be rendered. To learn how to set up a renderable dynamics simulation with Hair, see the following procedure.

### To generate a precomputed dynamics simulation with Hair:

- 1 Apply the Hair And Fur modifier to an object.
- 2 Set up the animation. It could simply be motion of the growth object, or you could use the Dynamics rollout > External Forces group to add space warps, such as Wind, that should affect the hair. Actually, because the hair is affected by its own gravity by default, you don't need to set up any explicit animation at all to see hair dynamics.



- 3 On the Modify panel > Dynamics rollout, use the Collisions group to set objects the hair should collide with. Also set other simulation parameters in the Dynamics Params group.
- 4 In the Stat Files group, click the ellipsis (...) button. Use the Save As dialog to specify the location and name of the stat files to be generated.

---

**NOTE** When you run the simulation, Hair will generate a separate stat file for each animation frame.

---

---

**IMPORTANT** If you plan to render the animation with a networked render farm, make sure the path you specify can be seen in exactly the same way from each node on the render farm. If stat files aren't found, hair will be stiff and just oriented to the skin as it moves. If the wrong stat files are found, hair can float right off an object.

---

---

**TIP** If using Windows XP, click the My Network Places button to set a path using the Universal Naming Convention (UNC), even if it's on a local drive. Such a path can be accessed readily by other computers on the network.

---

The path and stat file name appear in the text field next to the ellipsis button.

- 5 In the Simulation group, set the frame range for the simulation and then click Run.  
Hair runs the dynamics simulation and generates a stat file for each frame in the animation. It also automatically sets the mode to Precomputed, so when you play or render the animation, it reads the stat files and uses the information for the hair positioning in each frame.
- 6 Play the animation.  
The dynamics simulation stored in the stat files appears in the viewports.
- 7 In the Mode group, choose None, and then play the animation again.  
The dynamics animation no longer appears. However, it's still stored in the stat files, and will reappear if you choose Precomputed.
- 8 Make sure Precomputed is on, and then render the animation.

## Interface

Dynamics

Mode

None

Live

Precomputed

Stat Files

...

Delete all files

Simulation

Start

End

Run

Dynamics Params

Gravity

Stiffness

Root Hold

Dampen

Collisions

None

Sphere

Polygon

Use Growth Object

Add Replace Delete

External Forces

Add Replace Delete

## Mode group

Chooses the method Hair uses to generate dynamics. Live mode is suitable for experimentation, but for best results when rendering animation with Hair, use Precomputed mode.

- **None** Hair doesn't simulate dynamics.
- **Live** Hair simulates dynamics interactively in the viewports, but doesn't generate animation keyframes or stat files for the dynamics. For best results with Live mode, turn off Display rollout > Display Hairs group > As Geometry.

For some methods of using live dynamics, see this procedure: [Example: To view hair dynamics in real time](#): on page 1110 .

If you press ESC while using live dynamics, 3ds Max displays a dialog that asks whether you want to stop live dynamics. Both Freeze and Stop reset the mode to None, but Freeze freezes the hair in its current position. You can use this as a starting point for precomputed dynamics, or as a point from which you style the hair.

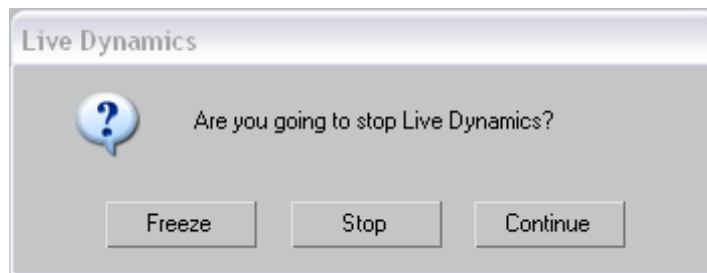

- **Precomputed** Lets you generate stat files for rendering dynamics-animated hair. Available only after setting a name and location for stat files (see following and [To generate a precomputed dynamics simulation with Hair](#): on page 1110 ).

## Stat Files group

Stat files let you record and play back a Hair-generated dynamics simulation. For a workflow example, see this procedure: [To generate a precomputed dynamics simulation with Hair](#): on page 1110 .

**Text field** Displays the path and file name for the stat files.

**... (ellipsis) button** Click to choose a name prefix and location for stat files using the Save As dialog.

Hair adds a four-digit frame number (with leading zeroes) and the file name extension “.stat” to the name you provide (for example, *hair\_test0001.stat*).

**Delete all files** Deletes stat files from the target directory. The files must have the name prefix you assigned using the ... button.

---

**TIP** You can still use stat files even if you move them to another location. Follow this procedure:

- 1 Open the MAX file used to generate the stat files.
- 2 On the Modify panel > Dynamics rollout, click the ... [ellipsis] button.
- 3 Use the Save As dialog to navigate to the directory with the stat files, and then click any stat file. Its name appears in the File Name field.
- 4 Edit the File Name field to delete the four-digit extension after the stat file name. For example, if the stat file name is *test0033.stat*, delete the “0033” so that it reads *test.stat*.
- 5 Click the Save button. The new stat file path appears in the Stat Files field.

---

Now, when you play or render the animation, Hair uses the stat files as originally generated.

### **Simulation group**

Determines the extent of the simulation, and lets you run it. These controls become available only after you choose Precomputed mode and specify stat files in the Stat Files group. Set Start and End to the frames at which to begin and end the simulation, and then click the Run button. The software then computes the dynamics and saves the stat files.

**Start** The first frame to consider in calculating the simulation.

**End** The final frame to consider in calculating the simulation.

**Run** Click to run the simulation and generate the stat files within the frame range indicated by Start and End.

To abort a simulation while it's running, click Cancel on the status bar.

### **Dynamics Params group**

These controls specify the basic parameters for the dynamics simulation. The Stiffness, Root Hold, and Dampen values can be mapped: click the map button

to the right of the spinner to assign a map. Grayscale values in the map multiply the parameter's value at that hair location.

**Gravity** Lets you specify a force that moves hair vertically in world space. Negative values pull hair up while positive values pull it down. To cause hair not to be affected by gravity, set the value to 0.0. Default=1.0. Range=-999.0 to 999.0.

**Stiffness** Controls the magnitude of the effect of dynamics. If you set Stiffness to 1.0, the dynamics will have no effect. Default=0.4. Range=0.0 to 1.0.

**Root Hold** Comparable to stiffness, but affects the hair only at the roots. Default=1.0. Range=0.0 to 1.0.

**Dampen** Dynamic hair carries velocity forward to the next frame. Increasing dampening increases the amount by which these velocities are diminished. Thus, a higher Dampen value means that hair dynamics will be less active (the hair can also start to get “floaty”). Default=0.0. Range=0.0 to 1.0.

### **Collisions group**

Use these settings to determine which objects hair collides with during a dynamic simulation and the method by which collision is calculated.

- **None** Collisions are not considered during the dynamic simulation. This can cause the hair to penetrate its growth object as well as other objects it comes into contact with.
- **Sphere** Hair uses a spherical bounding box to calculate collisions. This method is faster because it requires less computation, but can cause inaccurate results. It's most effective when the hair is seen from a distance.
- **Polygon** Hair considers each polygon in the collision objects. This is the slowest method, but the most accurate.

**Use Growth Object** When on, hair collides with the growth (mesh) object.

**Objects list** Lists the names of scene objects with which hair should collide.

**Add** To add an object to the list, click Add and then click the object in a viewport.

**Replace** To replace an object, highlight its name in the list, click Replace, then click a different object in a viewport.

**Delete** To remove an object, highlight its name in the list, then click Delete.

## External Forces group

This group lets you specify [space warps](#) on page 2603 that will affect the hair during the dynamics simulation. For example, you can add a [Wind space warp](#) on page 2642 to cause the hair to be blown by a breeze.

---

**NOTE** Hair dynamics already has a built-in gravity force, so it's not necessary to add one.

---

**Objects list** Lists the names of forces that dynamically affect the hair.

**Add** To add a space warp to the list, click Add and then click the warp's icon in a viewport.

**Replace** To replace a space warp, highlight its name in the list, click Replace, then click a different warp's icon in a viewport.

**Delete** To remove a space warp, highlight its name in the list, then click Delete.

## Display Rollout (Hair and Fur)

Select an object with the Hair And Fur modifier applied. > Modify panel > Display rollout

These settings let you control how hairs and guides display in the viewports. By default, Hair displays a small percentage of the hairs as lines. Alternatively, you can display the hairs as geometry, and you can also choose to display the guides.

## Interface

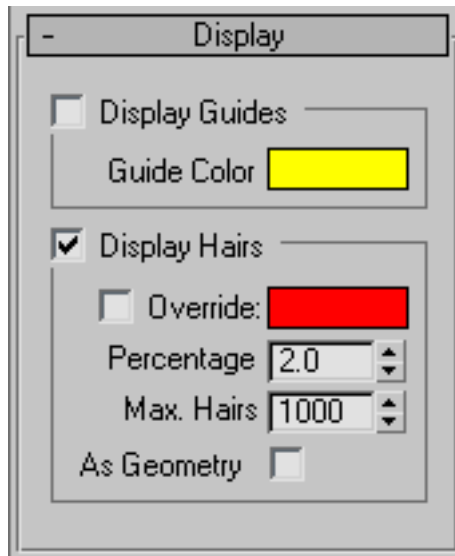

### Display Guides group

**Display Guides toggle** When on, Hair displays guides in the viewports, using the color shown in the color swatch. Default=off.

---

**NOTE** At the Guides sub-object level, guides always appear in the viewports.

---

**Guide Color** Click to display the Color Selector and change the color used to display guides.

Guides do not reflect some settings made to the hair, such as Frizz. Use the Guides display mainly to see where hair will appear on the growth object. Hair places one guide at each vertex on the growth surface.

### Display Hairs group

**Display Hairs toggle** When on, Hair displays hairs in the viewports. Default=on.

**Override** When off, 3ds Max displays hairs using an approximation of their rendered color. When on, displays hairs using the color shown in the color swatch. Default=off.

**Color swatch** Click to display the Color Selector and change the color used to display hairs when Override is on.

---

**NOTE** When hair is displayed as geometry (see below), the color setting is ignored.

---

**Percentage** The percentage of total hairs displayed in the viewports. Lower this value to improve real-time performance in the viewports.

**Max. Hairs** The maximum number of hairs displayed in the viewports, regardless of the Percentage value.

**As Geometry** When on, displays the hairs in the viewports as the actual geometry to be rendered, rather than the default lines. Default=off.

## LS Colors Modifier (World Space)

Select a Lightscape mesh object. > Modify panel > Modifier List > World-Space Modifiers > \* LS Colors

The LS Colors modifier converts Lightscape radiosity values to 3ds Max vertex colors.

When a Lightscape model is imported into 3ds Max, the radiosity values are kept as irradiances; that is, they describe the intensity of light falling on a mesh in physical units. This modifier converts the physical units to RGB colors. In conjunction with the Lightscape mesh modifier, this modifier can be used to produce meshes suitable for game engines.



## Interface

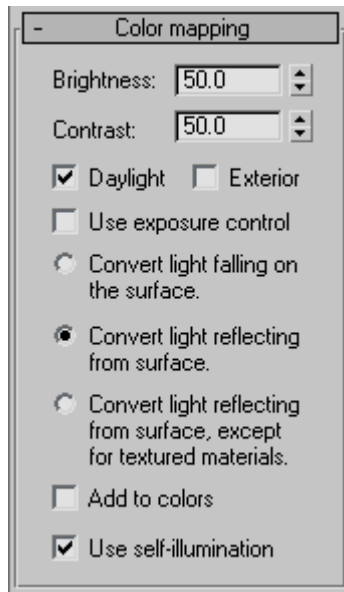

**Brightness** Controls the brightness of the displayed image on your monitor. The setting of this control does not affect the actual lighting levels in the model. Default=50.0.

**Contrast box** Controls the contrast between light and dark regions in the model. Default=50.0.

**Daylight** Determines whether you want natural daylight to be used in the calculation. Default=on.

**Exterior Scene** Turn on for exterior daylight simulations. Default=off.

---

**TIP** Use the [logarithmic exposure control](#) on page 6540 to control the brightness and contrast of the colors when you render.

---

**Use exposure control** When on, disregards the settings of Brightness, Contrast, Daylight, and Exterior, and instead uses the settings of the active exposure control. If no exposure control is active in the scene, this toggle is disabled. Default=off.

The three radio buttons that follow choose how to handle irradiance values.

- **Convert light falling on the surface** When chosen, converts the irradiance values directly to RGB values. In order to properly render the mesh, the

vertex colors need to be interpolated and multiplied by the color of the material on the mesh.

- **Convert light reflecting from the surface** When chosen, takes the irradiance values and multiplies them by the material's ambient color, then converts the result to RGB. To properly render the mesh, you need to interpolate the vertex colors over the faces. If textures are displayed by multiplying them by the vertex colors, they will not be correctly displayed unless the material color is white.  
By default, this is the active option.
- **Convert light reflecting from the surface, except for textured materials** When chosen, takes the irradiance values and multiplies them by the material's ambient color, and then converts the result to RGB, unless a texture is applied to the material's ambient component. If the ambient component has a map, this method converts the irradiance value directly to the vertex color. To properly render the mesh, you need to interpolate the vertex colors over the faces, unless the material is textured. If textures are displayed by multiplying them by the vertex colors, they will be correctly displayed.

**Add to colors** When on, the result of the color conversion is added to existing vertex color values, if there are any. Default=off.

**Use self-illumination** When on, the material's self illumination is included in the final vertex colors. Default=on.

## MapScaler Modifier (World Space)

Select an object. > Modify panel > Modifier List > World-Space Modifiers > MapScaler (WSM)

Select an object. > Modifiers menu > UV Coordinates > Map Scaler (WSM)

MapScaler maintains the scale of a map applied to an object. This lets you resize the object without altering the scale of the map. Typically, you might use this to maintain the size of a map regardless of how the geometry is scaled.

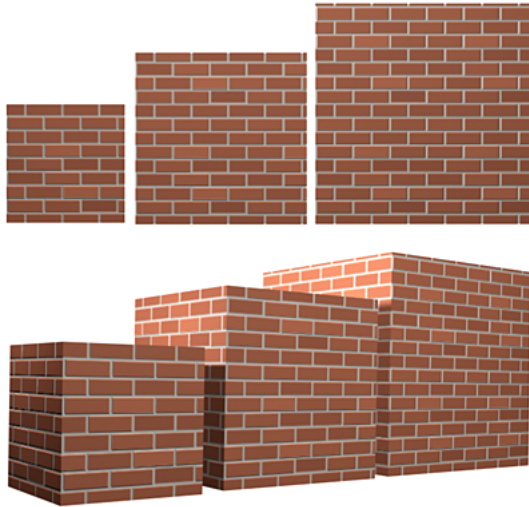

**MapScaler sets the scale of a map on an object.**

This differs from the [MapScaler \(OSM\) modifier](#) on page 1443 , which maintains the scale of the map with respect to the object size when scaled with a Select And Scale tool. See the latter's definition for other differences between the two versions.

---

**NOTE** This world-space modifier is for use primarily with vertically oriented objects, such as walls in an architectural model, or objects with large, flat surfaces. While you can apply the MapScaler to any object, the results are less realistic on curved surfaces, especially complex ones, which can show cracks in the finished texture.

---

## Interface



**Scale** Represents the size of one repetition of the texture pattern. Size is measured in current system units. Repetitions occur across the object in the U and V directions. Default=1.0.

---

**NOTE** When the Use Real-World Texture Coordinates switch is active in the [General Preferences dialog](#) on page 7536 , the scale setting defaults to 1.0. If Use Real-World Texture Coordinates is turned off, scale defaults to 100.0.

---

**U/V Offset** Specify horizontal and vertical offsets respectively. Available only when Wrap Texture is off.

**Wrap Texture** When on, Map Scaler attempts to wrap the texture evenly around the object. This option requires more computing, but usually produces the most satisfactory results. Default=on.

**Wrap Using Smoothing Groups** When turned on, textures are wrapped around corners when they share the same smoothing groups. Curved walls will map smoothly while sharp corners get a new texture origin. This switch is only available when the Wrap Textures switch is turned on. Default=off.

**Channel** Specifies the [map channel](#) on page 7836 . Default=1.

### **Up Direction group**

**World Z Axis** Aligns the map with the Z axis of the world.

If you choose this option and then rotate the object, the mapping is *not* fixed to the object.

**Local Z Axis** Aligns the map with the local Z axis of the object.

With this option, the mapping remains fixed to the object.

## **PatchDeform Modifier (World Space)**

Select an object. > Modify panel > Modifier List > World-Space Modifiers > \* PatchDeform

The PatchDeform world-space modifier lets you deform an object based on the contours of a patch object. It works the same as the [PathDeform \(World Space\)](#) on page 1123 , but uses a patch instead of a curve. With the exception of the Move to Patch button, its parameters are the same as those in the object-space [PatchDeform modifier](#) on page 1525 .

## **PathDeform Modifier (World Space)**

Select an object. > Modify panel > Modifier List > Animation Modifiers > \* PathDeform

The PathDeform world-space modifier deforms an object based on a shape, spline or NURBS curve path. With the exceptions noted in the Interface section, this world-space modifier works the same as the object-space [PathDeform modifier](#) on page 1528 .

### **Procedures**

The first two examples, below, demonstrate the basic differences in orientation and the relationship between the object and its path when using the PathDeform modifier and the PathDeform (WSM) modifier.



**Example: To use the PathDeform modifier to curve text:**

- 1 In the Top viewport, create a circle that's **100** units in radius.
- 2 In the Front viewport, create a text shape with six or seven letters, and a size of **25**.
- 3 Apply an Extrude modifier to the text shape, and set the Amount to **-5.0**.
- 4 On the Main toolbar, set the Reference Coordinate System to Local.  
Looking at the axis tripod for the extruded text object, you can see that its Z axis runs from back to front relative to world space.
- 5 Apply a [PathDeform](#) on page 1528 object-space modifier to the text object. Click the Pick Path button, and then select the circle.  
A circular gizmo appears. The circle runs through the local Z axis of the text object. Because of its orientation, its effect is minimal, but you can see a slight wedge-shaped deformation from the top view.
- 6 In the Path Deform Axis group, choose the Y option, and then the X option.  
The circle gizmo rotates to run through the specified axes, deforming the text object differently with each change.
- 7 Adjust the Percent spinner to view its effect, and then set it to zero. Try the same with Stretch, Rotation, and Twist, and then restore them to their original values.

---

**TIP** Use the Ctrl key with Twist to amplify the effect.

---

- 8 Turn on Flip to switch the direction of the path, and then turn it off.

- 9 Go to the Gizmo sub-object level, and move the gizmo path around.  
The text object is further deformed by its relative position to the gizmo.
- 10 Select the original circle shape, and change its radius.  
The deformation of the text object alters because its gizmo is an instance of the shape object.

**Example: To use the PathDeform world space modifier:**

This procedure continues from the previous one.

- 1 Select the text object, and then remove the Path Deform modifier from the stack.
- 2 Apply a Path Deform (WSM) modifier.
- 3 Click Pick Path, and select the circle.  
The text object flips around and moves in world space. Note that its orientation and deformation are difficult to analyze because there's an offset distance between the path and the object.
- 4 Click Move to Path.  
The text object is transformed so that its local Z axis is aligned with the path and its position is at the first vertex of the path.  
In the following steps, you'll use various controls to re-orient the text object so that it's at the front of the circle and readable from the Front viewport.
- 5 Choose the X option in the Path Deform Axis group to place the length of the text object along the path.
- 6 Adjust the Percent spinner to **-25** to move the text to the front of the circle.
- 7 Adjust the Rotation spinner to **-90** to rotate the text so it faces the Front viewport.
- 8  Turn on Auto Key, go to frame 100, and set Percent to **-125**.
- 9 Play the animation to watch the text run around the circle.

**Example: To create a growing vine:**

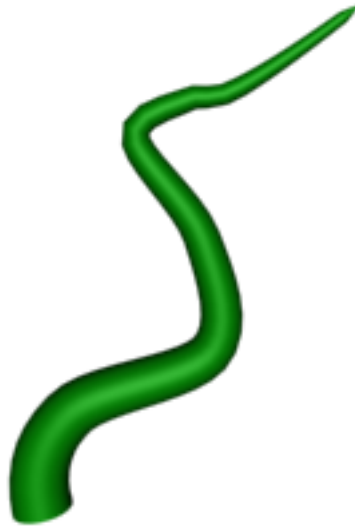

- 1 Use the Line tool and, optionally, Editable Spline to create a path along which the vine will grow.
- 2 Create a Cone, and apply the \* Path Deform modifier.



- 3 Pick the path, and then click Move to Path. (The local Z axis of the cone should be along the path.)

- 4  Go to frame 100, and turn on Auto Key.

- 5 Increase the Stretch value to stretch the cone along the path until it reaches the end. There won't be enough height segments in the cone, but you can fix that in step 7.

- 6  Turn off Auto Key.

- 7 In the stack, click Cone, and then in the Parameters rollout increase the Height Segments setting until the stretched cone is smooth on the path.

- 8 Play the animation.  
The cone grows along the path, like a vine.

## Interface

Since this is a world-space rather than an object-space modifier, the object is affected in world space coordinates, and also affected by the relative position of the path to the object. Thus, if you transform the object relative to the path, or vice-versa, it has an affect on the deformation.

Generally speaking, the Path Deform world-space modifier leaves the path in place while moving the object to the path, while the Path Deform object-space modifier leaves the object in place while moving the path to the object.

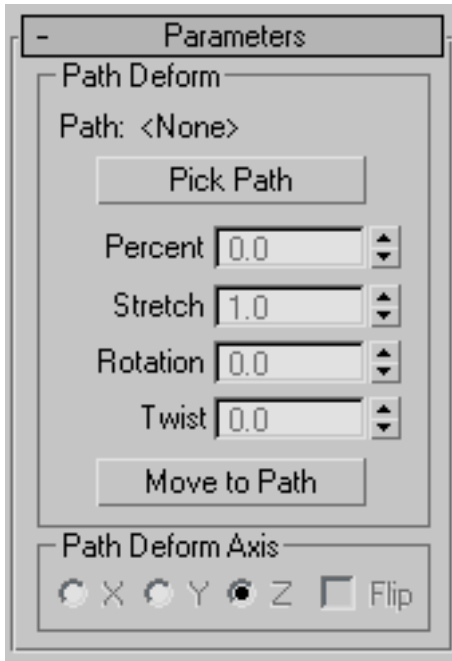

For all parameters except the following, refer to the [PathDeform modifier](#) on page 1528 .

### Path Deform group

**Move to Path** Moves the object from its original position to the start of the path.

When you first pick a path, the object is deformed by the path based on the offset distance between the first vertex in the path and the object's location. Thus, as you adjust the Percent spinner, for example, the result will be distorted depending on the offset distance.

---

**IMPORTANT** Using the Move To Path button applies a transform to the object that's not removed if you later remove the Path Deform binding from the object. However, you can [undo](#) on page 202 the transform immediately after it's been performed.)

---

**NOTE** If the Auto Key button is on when you perform Move To Path, transform keys are created.

---

## Point Cache Modifier (World Space)

Select an object. > Modify panel > Modifiers List > World-Space Modifiers > \* Point Cache

The world-space version of the Point Cache modifier works exactly the same as the [Point Cache modifier](#) on page 1533 , except that it uses world-space coordinates instead of local-space coordinates. Use this version when animating with world-space modifiers such as [PatchDeform \(WSM\) modifier](#) on page 1123 or [PathDeform \(WSM\) modifier](#) on page 1123 .

## Subdivide Modifier (World Space)

Make a selection. > Modify panel > Modifier List > World-Space Modifiers > Subdivide

Make a selection. > Modifiers menu > Radiosity Modifiers > \* Subdivide

The Subdivide (WSM) modifier is similar to the object-space [Subdivide modifier](#) on page 1688 , and has the same parameters. In the world-space version of Subdivide, the size limit is on the mesh after it is transformed into world space coordinates.

## Surface Mapper Modifier (World Space)

Make a selection. > Modify panel > Modifier List > World-Space Modifiers > \* Surface Mapper

The Surface Mapper (WSM) modifier takes a map assigned to a [NURBS](#) on page 2152 surface and projects it onto the modified object or objects. Surface Mapper is especially useful for seamlessly applying a single map to a group of surface sub-objects within the same NURBS model. You can also use it for other kinds of geometry.

The NURBS surface's map is projected onto the other geometry in the direction of the NURBS surface's normals, or opposite the normals if the modified object is on the other side of the NURBS surface.

## Procedures

### To use the surface mapper world-space modifier:

- 1 Create the NURBS surface to use for projection, and transform it so it wraps the objects you want to map.



- 2 Use the [Material Editor](#) on page 5188 to assign a mapped material to the NURBS surface.

- 3 Select the objects you want to map.



- 4 Use the Material Editor to assign the same material to the objects you want to map.

- 5 Apply the Surface Mapper world-space modifier.

- 6 In the Parameters rollout, turn on Pick NURBS Surface, and then click the NURBS projection surface in a viewport.

The software now uses the NURBS surface's normals to project the texture onto the modified objects.

---

**TIP** To fine-tune the map placement on the mesh, you can use the NURBS surface's [Edit Texture Surface dialog](#) on page 2453 .

---

## Interface

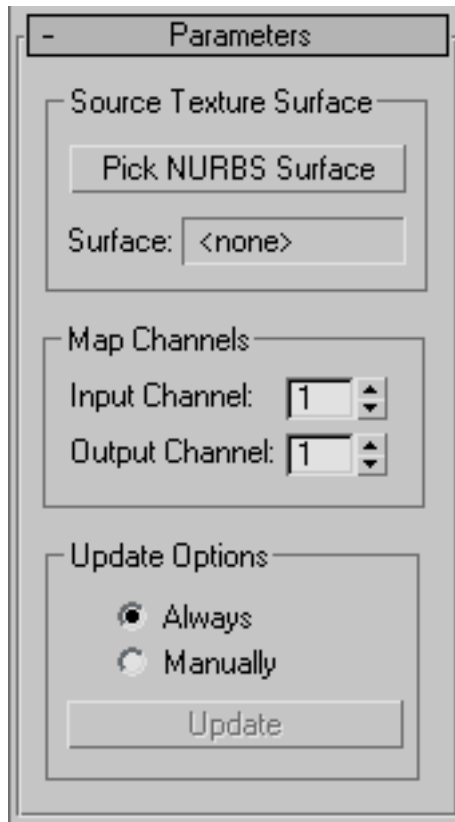

### Source Texture Surface group

These controls let you choose the NURBS surface to project.

**Pick NURBS Surface** Picks the NURBS surface to use for projection. Click to turn on this button, then click the NURBS surface in an active viewport.

**Surface** Shows "<none>" before you pick a NURBS surface; shows the name of the surface after you pick one.

### Map Channels group

These controls let you choose which [map channels](#) on page 7836 to use.

**Input Channel** Selects the NURBS surface map channel to use before projection.

**Output Channel** Selects the modified object's map channel to use after projection.

### Update Options group

These controls let you choose how to update the mapping displayed in viewports. They have no effect if [Show Map In Viewport](#) on page 5254 is turned off.

**Always** Updates viewports whenever the mapping changes.

**Manually** Updates viewports only when you click Update.

**Update** Updates viewports. This is unavailable unless you've chosen Manually.

## SurfDeform Modifier (World Space)

Select an object. > Modify panel > Modifier List > World-Space Modifiers > \* Surf Deform

Select an object. > Modifiers menu > Animation Modifiers > \* Surf Deform

The SurfDeform (WSM) modifier works the same as the [PathDeform \(WSM\) modifier](#) on page 1123 , except that it uses a NURBS Point or CV surface instead of a curve.

## Object-Space Modifiers

Object-space modifiers directly affect an object's geometry in local [object space](#) on page 7868 .

When you apply an object-space modifier, it appears directly above the object with other object-space modifiers in the [modifier stack](#) on page 7427 . The order in which the modifiers appear in the stack can affect the resulting geometry.

For a list of object-space modifiers, see [List of Available Modifiers](#) on page 1011 .

# Affect Region Modifier

Modify panel > Make a vertex sub-object selection. > Modifier List > Object-Space Modifiers > Affect Region

Make a vertex sub-object selection. > Modifiers menu > Parametric Deformers > Affect Region

The Affect Region modifier is a surface modeling tool, primarily used with vertex sub-object selections while surface modeling. With Affect Region, transforming a selection of vertices can also transform vertices in the region that surrounds the selection. This can help you form a bubble or indentation in the surface of an object. The easiest way to see this modifier's effect is with a shallow, flat box object with plenty of subdivisions. The Affect Region modifier has a two-part, arrow-shaped gizmo plus numeric controls.

When you apply the Affect Region modifier, it assigns an arrow-like gizmo consisting of two points connected by a line. The base of the arrow is the start point. The length and direction of the arrow defines the amount of movement of the vertices. Any vertices within Falloff distance of the base of the arrow are translated in the direction of the arrow.

Because no points on the mesh are directly selected, this modifier doesn't depend on the topology of the input object. You can apply it to any renderable object. However, you can limit the effect by using a selection modifier like [Mesh Select](#) on page 1455 or [Volume Select](#) on page 1910 to pass a sub-object selection up the stack.

---

**NOTE** The Affect Region modifier is ideal for simple animated effects, especially when you need to use interactive parameters. However, for fine-tuned modeling, you'll probably prefer the expanded capabilities of [Soft Selection](#) on page 1926 in [Editable Mesh](#) on page 1990, [Editable Poly](#) on page 2038, [Edit Mesh](#) on page 1283, [Mesh Select](#) on page 1455, [Volume Select](#) on page 1910, the [HSDS modifier](#) on page 1420, and [NURBS](#) on page 2172.

---

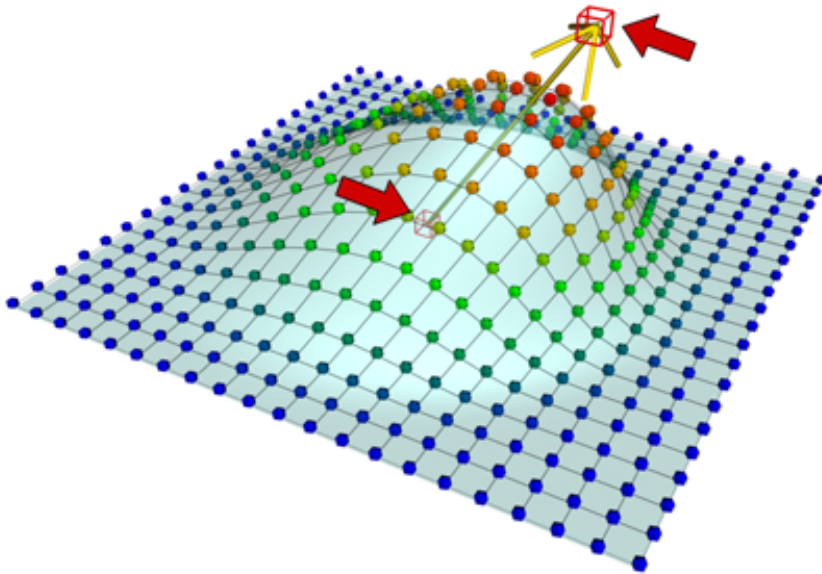

Affect Region modifier applied

## Procedures

**Example: To form a bubble over the surface of a plane:**

- 1 Create a plane with **15** width and length segments.
- 2 Set the length and width of the plane to **50** units.
- 3 Apply the Affect Region modifier.
- 4 In the Parameters group, set Falloff to **50**.
- 5 Adjust the parameters to achieve different effects.

## Interface

---

**NOTE** The parameters of this modifier are similar to those of the [Soft Selection function](#) on page 1926 of an Editable Mesh.

---



## Modifier Stack

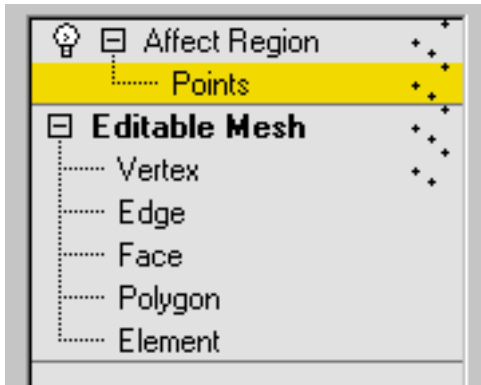

**Point sub-object level** At this sub-object level, the base and tip of the gizmo arrow are points that can be selected. You can select, translate, and animate these two points together or individually.

For more information on the stack display, see [Modifier Stack](#) on page 7427 .

## Parameters rollout

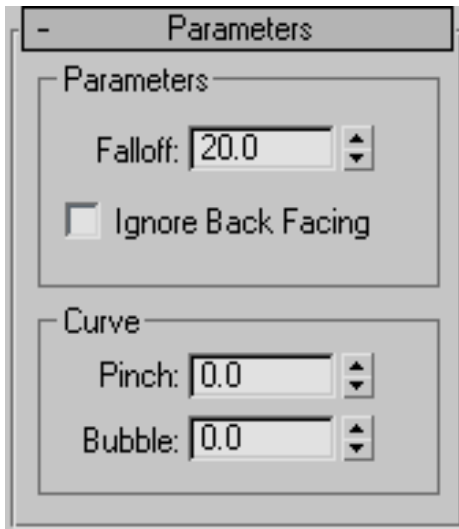

## Parameters group

**Falloff** Sets the radius of affected vertices, in units, from the base of the gizmo arrow. (Spinner value range: float, 0.0 to 999,999.0)

**Ignore Back Facing** Affects only those vertices whose face normals are in the same general direction as the gizmo arrow. When turned off, all vertices in the Falloff group are affected.

## Curve group

**Pinch** Affects the tangency of the curve where it meets the arrow tip. Positive values produce a pointed tip while negative values produce a dimple. (Spinner value range: float, -999,999.0 to 999,999.0)

**Bubble** Changes the curvature of the affected vertices. A value of 1.0 produces a half-dome. As you reduce this value, the sides of the dome slope more steeply. Negative values lower the base of the curve below the base of the arrow gizmo. (Spinner value range: float, -999,999.0 to 999,999.0)

# Attribute Holder Modifier

Create or select an object. > Modify panel > Modifier List > Object-Space Modifiers > Attribute Holder

Create or select an object > Modifiers menu > Animation > Attribute Holder

The Attribute Holder modifier is an empty modifier that provides a readily accessible user interface on the Modify panel to which you can add [custom attributes](#) on page 267 . It has no user interface of its own; the interface consists solely of those attributes you assign to it. In essence, Attribute Holder is a stripped-down version of [Parameter Collector](#) on page 285 that can collect only custom attributes and appears on the Modify panel instead of a floating dialog.

## Procedures

**Example: To collect different custom attributes in an Attribute Holder modifier:**

Before undertaking this procedure, you should be familiar with basic usage of the [Parameter Wiring dialog](#) on page 3249 .

- 1 Add a small box to an empty scene. Make it about **20.0** units on a side.
- 2 Apply a Taper modifier and an Attribute Holder modifier, in that order.

In the modifier stack, the Attribute Holder modifier should be highlighted.

- 3 From the Animation menu, choose Parameter Editor.
- 4 In Parameter Editor, on the Attribute Rollout, make or ensure the following settings:
  - Add to Type=Selected Object's Current Modifier
  - Parameter Type=Float
  - UI Type=Slider
  - Name=**Box Height**
- 5 On the Float UI Options rollout, keep all the default settings.
- 6 On the Attribute Rollout, click Add.  
The Custom Attributes rollout appears on the Modify panel, containing the new Box Height slider.
- 7 Add another attribute:
  - Add to Type=Selected Object's Current Modifier
  - Parameter Type=Integer
  - UI Type=Spinner
  - Name=**Box Height Segs**
  - Integer UI Options > Range=From **1** to **50**.
- 8 Add two more Float/Spinner attributes named **Taper Amount** and **Taper Curve**.  
The Attribute Holder modifier now has four custom attributes, but they don't do anything because they're not connected. You'll use Parameter Wiring to hook them up.
- 9 Close the Parameter Editor dialog.
- 10 In the active viewport, right-click the box and choose Wire Parameters. From the pop-up menu that appears, choose Modified Object > Box (Object) > Height.  
A rubber-band dashed line appears connecting the mouse cursor to the box.

- 11** You can't connect this “wire” directly to the custom attribute, so just left-click in an empty part of the viewport to open the Parameter Wiring dialog.

The hierarchy list on the left side, Box01, is expanded to the box's Height parameter, which is highlighted.
- 12** On the right side, expand this path: Object > Box01 > Modified Object > Attribute Holder > Custom Attributes, and then click Box Height to highlight it.
- 13** Click the Two-way Connection button (double-headed arrow), and then click Connect.
- 14** Similarly, connect Height Segments on the left side to Box Height Segments on the right.
- 15** Close the Parameter Wiring dialog.
- 16** Right-click the box again, choose Parameter Wiring, choose Modified Object > Taper > Amount, and then left-click to open the Parameter Wiring dialog.

The Amount parameter is highlighted on the left side of the dialog.
- 17** On the right side, click the Attribute Holder's Taper Amount parameter, and then connect them.
- 18** Connect Curvature on the left side to Taper Curve on the right side, and then close the dialog.

All the parameters are now hooked up.
- 19** Experiment with changing the values on the Custom Attributes rollout. The Attribute Holder modifier lets you change the box's creation parameters as well as the Taper modifier's settings without switching back and forth in the modifier stack. In this way you can access, in one convenient location, as many different parameters from different levels in an object's modifier stack, or even from different objects, as you like.

You might notice that you can't set the taper to curve inward. You can resolve this by reopening Parameter Editor, clicking Edit/Delete, and then modifying the Taper Curve attribute to allow negative values. The change takes effect immediately, with no rewiring required.

# Bend Modifier

Modify panel > Make a selection. > Modifier List > Object-Space Modifiers > Bend

Make a selection. > Modifiers menu > Parametric Deformers > Bend

The Bend modifier lets you bend the current selection up to 360 degrees about a single axis, producing a uniform bend in an object's geometry. You can control the angle and direction of the bend on any of three axes. You can also limit the bend to a section of the geometry.



**Bend applied to a streetlight model**

## Procedures

**To bend an object:**

- 1 Select an object and apply the Bend modifier.
- 2 On the Parameters rollout, set the axis of the bend to X, Y, or Z. This is the axis of the Bend gizmo, not the axis of the selected object.

You can switch between axes at any time, but the modifier carries only one axis setting.

- 3 Set the angle of the bend along the chosen axis.  
The object bends to this angle.
- 4 Set the direction of the bend.  
The object swivels around the axis.

You can reverse angle and direction by changing a positive value to a negative value.

#### To limit the bend:

- 1 Turn on Limit Effect in the Limits group.
- 2 Set values for the upper and lower limits. These are distances in current units above and below the modifier's center, which is at zero on the gizmo's Z axis by default. You can make the upper limit zero or positive, and the lower limit zero or negative. If the limits are equal, the result is the same as turning off Limit Effect.

The bend is applied between these limits. The surrounding geometry, while unaffected by the bend itself, rotates to keep the object intact. This is analogous to bending a pipe, where the unbent sections rotate but remain straight.

- 3 At the sub-object level, you can select and move the modifier's center.

The Limit settings remain on either side of the center as you move it. This lets you relocate the bend area to another part of the object.

### Interface

#### Modifier Stack

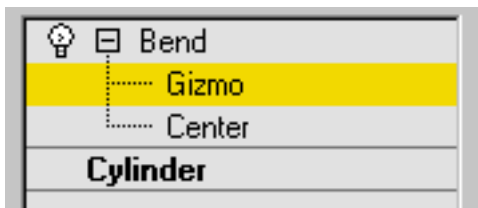

**Gizmo sub-object** You can transform and animate the gizmo like any other object at this sub-object level, altering the effect of the Bend modifier. Translating the gizmo translates its center an equal distance. Rotating and scaling the gizmo takes place with respect to its center.

**Center sub-object** You can translate and animate the center at this sub-object level, altering the Bend gizmo's shape, and thus the shape of the bent object.

For more information on the stack display, see [Modifier Stack](#) on page 7427 .

### Parameters rollout

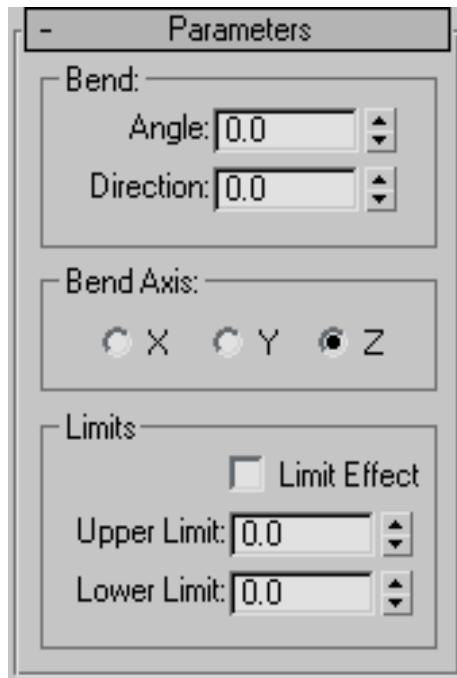

### Bend group

**Angle** Sets the angle to bend from the vertical plane. Range=-999,999.0 to 999,999.0.

**Direction** Sets the direction of the bend relative to the horizontal plane. Range=-999,999.0 to 999,999.0.

### **Bend Axis group**

**X/Y/Z** Specifies the axis to be bent. Note that this axis is local to the Bend gizmo and not related to the selected entity. Default=Z.

### **Limits group**

**Limit Effect** Applies limit constraints to the bend effect. Default=off.

**Upper Limit** Sets the upper boundary in world units from the bend center point beyond which the bend no longer affects geometry. Default=0. Range=0 to 999,999.0.

**Lower Limit** Sets the lower boundary in world units from the bend center point beyond which the bend no longer affects geometry. Default=0. Range=-999,999.0 to 0.

## **Bevel Modifier**

Select a shape. > Modify panel > Modifier List > Bevel

The Bevel modifier extrudes shapes into 3D objects and applies a flat or round bevel to the edges. A common use for this modifier is to create 3D text and logos, but you can apply it to any shape.

Bevel takes a shape as the base of a 3D object. You then extrude the shape up to four levels and assign an outline amount for each level.



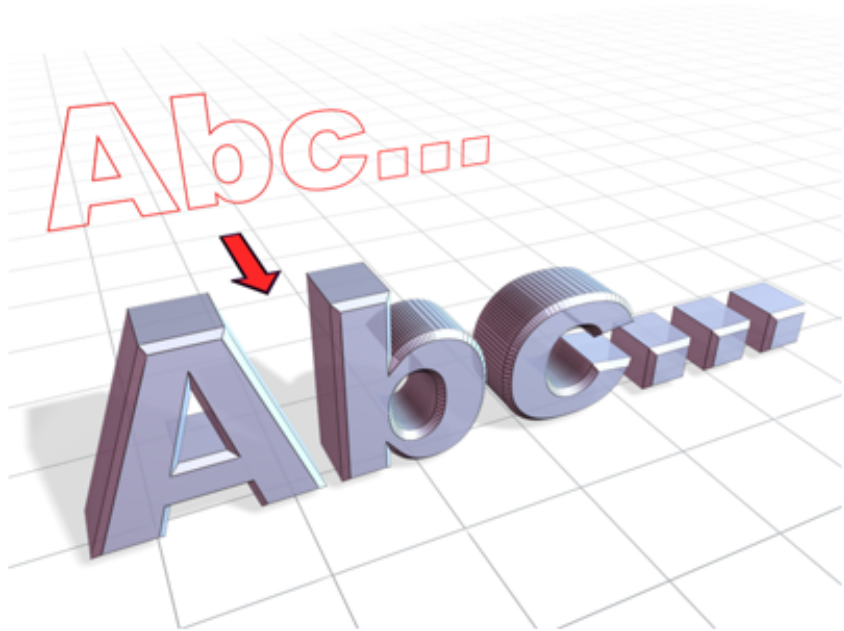

### Beveled text

### Procedures

#### Example: To create beveled text:

This example produces typical 3D beveled text, with equal bevels in front and back.

- 1 Create [text](#) on page 569 using default settings.  
Font=Arial, Size=100.0.
- 2 Apply the Bevel modifier.
- 3 Type **-1.0** in the Start Outline field.
- 4 For Level 1, do the following:
  - Type **5.0** for Height.
  - Type **2.0** for Outline.
- 5 Turn on Level 2, and do the following:
  - Type **5.0** for Height.

- Type **0.0** for Outline.
- 6 Turn on Level 3 and do the following:
    - Type **5.0** for Height.
    - Type **-2.0** for Outline.
  - 7 If needed, turn on Keep Lines From Crossing.

## Interface

### Parameters rollout

The image shows a software interface with two rollouts: "Parameters" and "Bevel Values".

**Parameters Rollout:**

- Capping:**  Start,  End
- Cap Type:**  Morph,  Grid
- Surface:**  Linear Sides,  Curved Sides
  - Segments:
  - Smooth Across Levels
  - Generate Mapping Coords.
  - Real-World Map Size
- Intersections:**  Keep Lines From Crossing
  - Separation:

**Bevel Values Rollout:**

- Start Outline:
- Level 1:
  - Height:
  - Outline:
- Level 2:
  - Height:
  - Outline:
- Level 3:
  - Height:
  - Outline:

## Capping group

You can determine whether or not the beveled object is capped at either end with the check boxes in the Capping group.

**Start** Caps the end with the lowest local Z value (bottom) of the object. When turned off, the bottom is open.

**End** Caps the end with the highest local Z value (top) of the object. When turned off, the end is left open.

## Cap Type group

Two radio buttons set the type of cap used.

**Morph** Creates cap faces suitable for morphing.

**Grid** Creates cap faces in a grid pattern. This cap type deforms and renders better than morph capping.

## Surface group

Controls the side curvature, smoothing, and mapping of the surface.

The first two radio buttons set the interpolation method used between levels; a numeric field sets the number of segments to interpolate.

**Linear Sides** When active, segment interpolation between levels follows a straight line.

**Curved Sides** When active, segment interpolation between levels follows a Bezier curve. For visible curvature, use multiple segments with Curved Sides.

**Segments** Sets the number of intermediate segments between each level.



Four-level bevels with 1 and 2 segments



**Bevels with linear and curved sides**

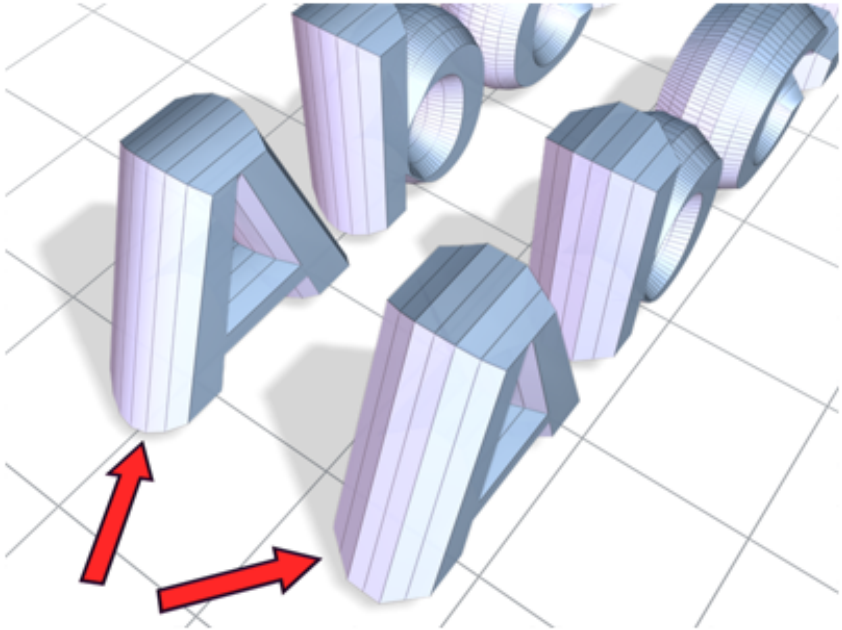

**Rounding and smoothing the bevel object sides**

**Smooth Across Levels** Controls whether smoothing groups are applied to the sides of a beveled object. Caps always use a different smoothing group than the sides.

- When turned on, smoothing groups are applied to the sides. The sides appear rounded.
- When turned off, smoothing groups are not applied. The sides appear as flat bevels.

**Generate Mapping Coordinates** When turned on, mapping coordinates are applied to the beveled object.

**Real-World Map Size** Controls the scaling method used for texture mapped materials that are applied to the object. The scaling values are controlled by the Use Real-World Scale settings found in the applied material's [Coordinates rollout](#) on page 5620 . Default=on.

### Intersections group

Prevents sharp corners from overlapping neighboring edges.

Bevel works best with rounded shapes or shapes with corners greater than 90 degrees. Acute angles (less than 90 degrees) produce extreme bevels and often overlap nearby edges.

**Keep Lines From Crossing** Prevents outlines from crossing over themselves. This is accomplished by inserting extra vertices in the outline and replacing sharp corners with a flat line segment.

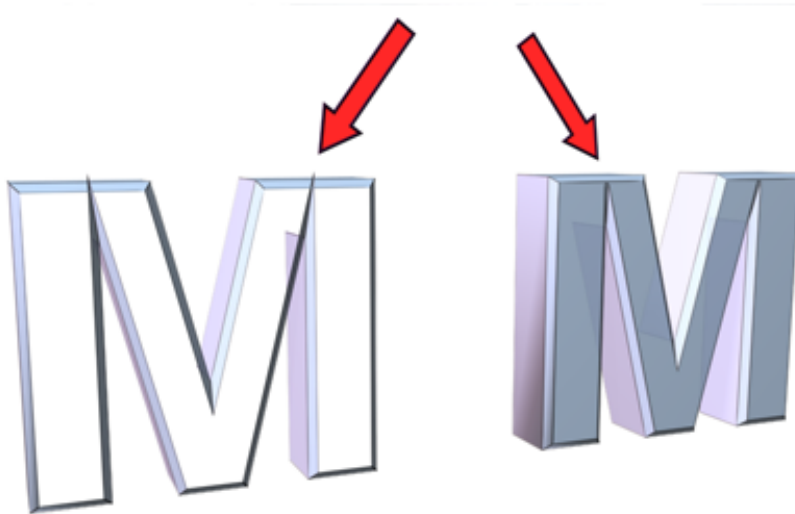

Using **Keep Lines From Crossing**:

Left: Off

Right: On

**Separation** Sets the distance to be maintained between edges. The minimum value is 0.01.

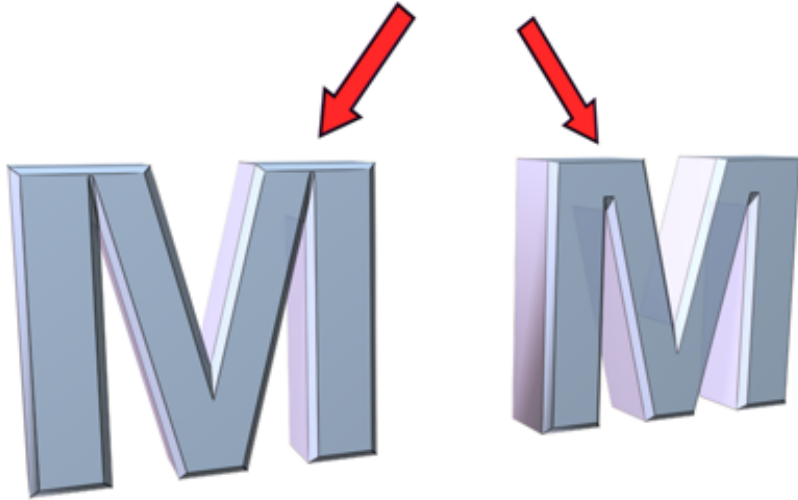

### Changing the Separation value

### Bevel Values rollout

Contains the parameters that set the height and bevel amount of up to four levels.

A beveled object requires a minimum of two levels: a start and an end. You add more levels to vary the amount and direction of bevel from start to end.

You can think of bevel levels as layers on a cake. The Start Outline is the bottom of the cake and the Level 1 parameters define the height and size of the first layer.

Turning on Level 2 or Level 3 adds another layer to the beveled object with the height and outline specifying the amount of change from the previous level.

The last level on is always the top of the object.

You must always set the Level 1 parameters.

**Start Outline** Sets the distance the outline is offset from the original shape. A non-zero setting changes the original shape's size.

- Positive values make the outline larger.
- Negative values make the outline smaller.

**Level 1** Includes two parameters that indicate the change from the Start level.

**Height** Sets the distance of Level 1 above the Start level.

**Outline** Sets the distance to offset the Level 1 outline from the Start Outline.

Levels 2 and Level 3 are optional and allow you to change the bevel amount and direction.

**Level 2** Adds a level after Level 1.

**Height** Sets the distance above Level 1.

**Outline** Sets the offset distance of the Level 2 outline from Level 1.

**Level 3** Adds a level after the previous level. If Level 2 is not on, Level 3 is added after Level 1.

**Height** Sets the distance above the previous level.

**Outline** Sets the offset distance of Level 3 from the previous level.

Traditional beveled text uses all levels with these typical conditions:

- Start Outline can be any value, usually 0.0.
- Level 1 Outline is a positive value.
- Level 2 Outline is 0.0. No change from Level 1.
- Level 3 Outline is the negative of Level 1. Returns Level 3 to the same size as the Start Outline.

## Bevel Profile Modifier

Select a shape. > Modify panel > Modifier List > Bevel Profile

The Bevel Profile modifier extrudes a shape using another shape path as the "beveling profile." It's a variation on the [Bevel modifier](#) on page 1142 .



---

**IMPORTANT** Bevel Profile fails if you delete the original beveling profile. Unlike a loft object, which incorporates the shape, Bevel Profile is simply a modifier.

---

**NOTE** Although this modifier might seem similar to a loft object with varying scale settings, it's actually different because it uses different outline values as distances between line segments rather than as scale values. This more complex method of resizing a shape results in some levels having either more or less vertices than others, and generally works better with text, for example.

---

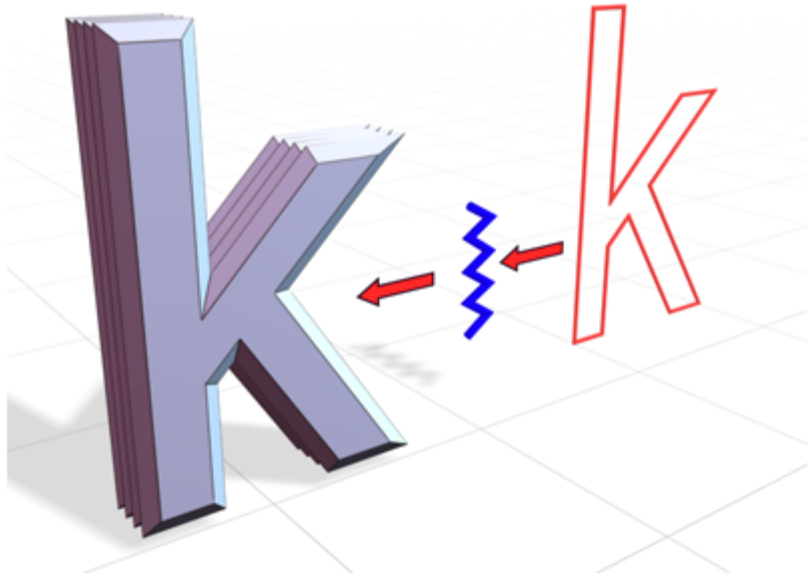

Bevel Profile creates an object using an open spline.

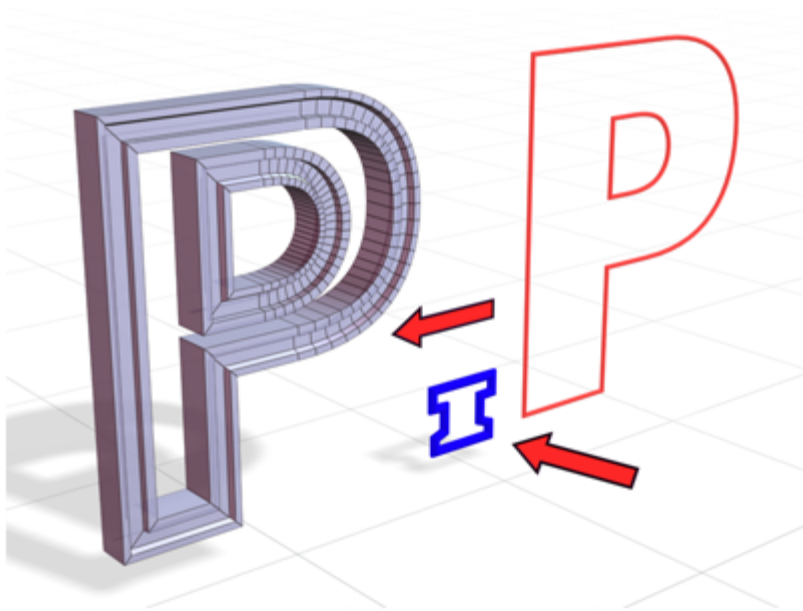

**Bevel Profile creates an object using a closed spline, yielding a different result.**

### **Procedures**

**To use the Bevel Profile modifier:**

- 1 Create the shape you want to bevel (preferably in the Top viewport).
- 2 In the Front (XZ) viewport, create a shape to use as the beveling profile.
- 3 Select the first shape and apply the Bevel Profile modifier.
- 4 Click the Pick Profile button in the Bevel Profile modifier, and then click the profile shape.

## Interface

### Modifier Stack

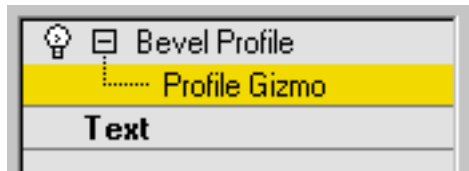

For more information on the stack display, see [Modifier Stack](#) on page 7427 .

### Parameters rollout



### Bevel Profile group

**Pick Profile** Selects a shape or NURBS curve to be used for the profile path.

**Generate Mapping Coords** Assigns UV coordinates.

**Real-World Map Size** Controls the scaling method used for texture mapped materials that are applied to the object. The scaling values are controlled by the Use Real-World Scale settings found in the applied material's [Coordinates rollout](#) on page 5620 . Default=on.

### **Capping group**

**Start** Caps the bottom of the extruded shape.

**End** Caps the top of the extruded shape.

### **Cap Type group**

**Morph** Selects a deterministic method of capping that provides the same number of vertices for morphing between objects.

**Grid** Creates gridded caps that are better for cap deformations.

### **Intersections group**

**Keep Lines From Crossing** Prevents beveled surfaces from self intersecting. This requires more processor calculation and can be time-consuming in complex geometry.

**Separation** Sets the distance that sides should be kept apart to prevent intersections.

## **Camera Map Modifier (Object Space)**

Select one object. > Modify panel > Modifier List > Object-Space Modifiers > Camera Map

Select one object. > Modifiers menu > UV Coordinates > Camera Map

The Camera Map modifier (object-space version) assigns planar mapping coordinates based on the current frame and the camera specified in the Camera Map modifier. This differs from the [Camera Map \(WSM\) modifier](#) on page 1043 that updates the object's mapping coordinates on every frame.

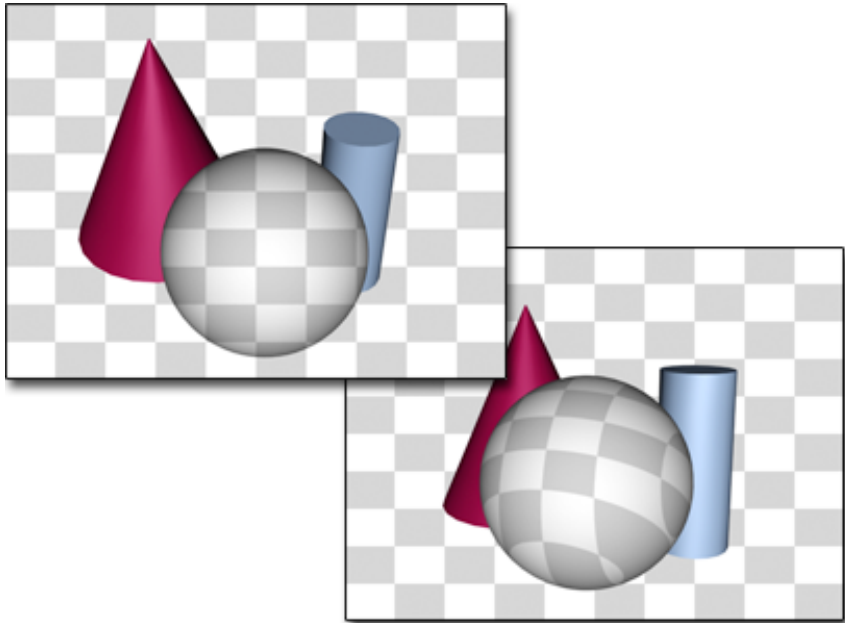

**Left:** The texture of an object with a camera map modifier matches the background when seen by the camera the modifier uses.

**Right:** When seen by a camera not used by camera map, the object's texture is based on object geometry.

### **Blending an Object into the Background**

In the Procedures section (below), you'll be blending an object into the background using the Camera Map modifier. If the background uses the same image as the object's texture map, then the object blends with the background at the frame where the modifier is applied and a camera is specified. The object becomes visible if either the camera or object moves. In order to make the illusion work, you must assign the same map to the background that you assign to the object.

### **Mapping Coordinates**

Because the accuracy of mapped objects depends partly on the complexity of the mesh, the "blend to background" effect works best when applied to an object with a relatively high density of triangular faces. The necessary density also depends on the distance of the object from the camera.

A simple box might look fine when it occupies only a small portion of the background, but up close the mapping will look distorted without adequate tessellation. Some experimentation is required to get an ideal mapping and still minimize the complexity of the geometry. (In general, for a box object that's filling a quarter of the screen, a tessellation of 4x4x4 works well.)

---

**NOTE** When using the Camera Map modifier, apply the modifier to a single object at a time. If it's applied to a selection set, only the first item in the selection will be mapped properly.

---

Use [Camera Map \(WSM\)](#) on page 1043 if you want to move the camera and maintain the match to the background.

### **Using the Plate Match/MAX R2.5 Rendering Filter**

Prior to 3ds Max 3, the antialiasing affected only geometric edges, with the filtering of bitmaps being controlled in the Bitmap Map parameters (pyramidal, summed area, or no filtering). Antialiasing filters affect every aspect of the object, filtering textures along with geometric edges. While antialiasing provides superior results, it produces inconsistencies when rendering objects that are supposed to match the environment background. This is because the antialiasing filters do not affect the background by default. You can turn on background antialiasing in Customize > Preferences > Rendering > Background Antialiasing > Filter Background. To correctly match an object's map to an unfiltered background image, you need to use the Plate Match/MAX R2.5 filter so the texture is not affected by the antialiasing.

There are three ways you can render objects in 3ds Max to blend seamlessly into a background environment:

- By assigning a Matte/Shadow Material
- By assigning a 100% self-illuminated diffuse texture to an object using Camera Mapping
- By assigning a 100% self-illuminated diffuse texture using Environment/Screen projection

The Plate Match/MAX R2.5 antialiasing should be used whenever trying to match foreground objects with an unfiltered background or when trying to match the antialiasing qualities of the 3ds Max 2.5 renderer.

## Procedures

The following steps show how to apply the Camera Map modifier, and how to set up your scene.

### To apply the Camera Map modifier:

- 1 Create a scene with a camera and one or more objects. Make sure the object you want to map is visible in the Camera viewport.
- 2 Select the object, and apply the Camera Map modifier.  
Be sure to use the Object-Space version of the Camera Map modifier.
- 3 If you have animation in the scene, move to the frame where you want the object map to match the background. For example, if the camera is animated, the mapping will match only at this frame.
- 4 On the Camera Mapping rollout, click Pick Camera, and then select the camera used for the rendered view.

### To assign a background image to the Camera viewport:

---

**NOTE** This procedure is not necessary for successful rendering, but if you want to see the effect in a viewport, follow these steps.

---

- 1 Activate the Camera viewport and turn off the grid.
- 2 Choose Views menu > Viewport Background.
- 3 On the Viewport Background dialog that displays, click the Files button, and choose the same bitmap that you plan to apply as a background for the rendered scene, and as a diffuse map on the object.
- 4 In the Aspect Ratio group, choose Match Rendering Output.
- 5 Turn on Display Background, and click OK.  
The dialog is dismissed and the map is displayed in the viewport.

### To assign a mapped material to the object:

- 1 In the Material Editor, create a standard material to whose Diffuse component you've assigned the same bitmap as you assigned to the background.
- 2 At the Diffuse Map level of the material, turn on the Show Map In Viewport button.

- 3 Select the object, and click Assign Material To Selection.  
The map on the object in the viewport matches the viewport background, but the shading makes the object visible. To make the object truly invisible, go to the next step.
- 4 At the top level of the object's material, set Specular Level and Glossiness to 0. Turn off Self Illumination Color, and set Self Illumination to 100.  
The object is now camouflaged against the background.

**To assign the background to the rendered background:**

- 1 Choose Rendering menu > Environment.
- 2 In the Environment dialog that displays, click the button below "Environment Map" to open the Material/Map Browser.
- 3 Under the Browse From group box, choose Material Editor.
- 4 Turn off Root Only, find the map in the list window, highlight it, and choose OK.
- 5 Choose Copy in the dialog, and click OK.
- 6 In the Exposure Control rollout on the Environment dialog, make sure the exposure is set to *<no exposure control>* or the turn off the Active switch.  
If this is not done, you will be able to see the object in the rendering.
- 7 Render the Camera viewport.  
The mapped object is camouflaged against the background in the rendered scene.



## Interface



**Pick Camera** To apply the UVW coordinates, click this button, and then select the camera through which you're going to view the scene.

**Map Channel** Turn on and choose a map channel to use. Map channels are specified in the Material Editor.

**Vertex Color Channel** Uses the Vertex Color channel.

## Cap Holes Modifier

Select a mesh object. > Modify panel > Modifier List > Cap Holes

Select a mesh object. > Modifiers menu > Mesh Editing > Cap Holes

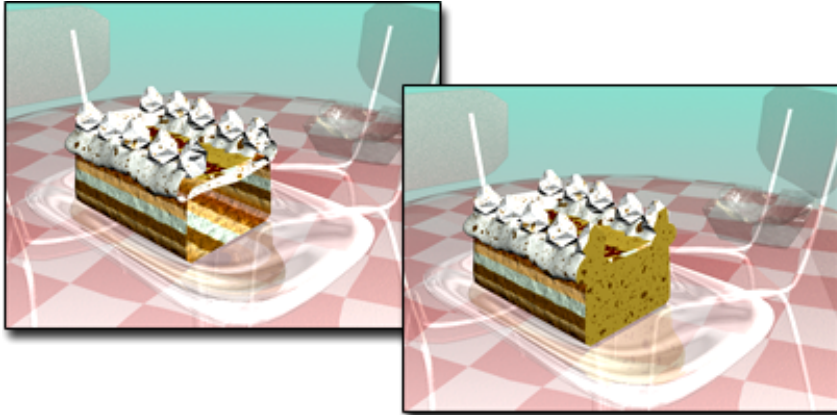

### Cap Holes used to make the cake appear solid

The Cap Holes modifier builds faces in the holes in a mesh object. A hole is defined as a loop of edges, each of which has only one face. For example, one or more missing faces from a sphere would produce one or more holes. The modifier works best on reconstructing planar holes, but can do a reasonable job on non-planar holes as well.

---

**NOTE** This modifier can cap holes in a sub-object selection passed up the stack. It caps any part of the hole that's adjacent to, or within the selected geometry, whether vertex, edge, or face.

---

### Tips

- If the Cap Holes modifier doesn't appear to work, remove it, apply a [Mesh Select modifier](#) on page 1455 to select the faces surrounding the hole, then apply Cap Holes to the sub-object selection.
- The Cap Holes modifier creates faces with invisible edges unless you turn on All New Edges Visible before you apply it.

### Procedures

**Example: To cap a hole in a sphere:**

- 1 Create a sphere.
- 2 Apply an Edit Mesh modifier to the sphere.

- 3 In the stack display, choose the Face selection level.
- 4 Select and delete a contiguous group of faces.
- 5 Turn off the Face selection level.
- 6 Apply a Cap Holes modifier.  
The hole you created should be filled.

---

**TIP** Turning on Smooth With Old Faces makes the cap less visible.

---

### Interface



**Smooth New Faces** Assigns the same smoothing group number to all new faces. If possible, this will be a smoothing group number not used elsewhere in the object.

**Smooth With Old Faces** Smooths new triangular faces using the smoothing groups from bordering old faces. This smooths only one level in from the perimeter of the border of the hole, so you might need to use both this and the Smooth New Faces option to properly smooth a large hole.

---

**NOTE** When Smooth With Old Faces is turned on, the faces in the capped holes inherit a material face ID from one of the surrounding faces. When this item is turned off, the faces in the capped holes are assigned a new ID.

---

**Triangulate Cap** Makes all of the edges visible in the new faces.

## Cloth and Garment Maker Modifiers



Laura by Georges Walser

Cloth provides you with advanced tools for creating realistic fabrics and tailor-made clothing for characters and creatures. The Cloth system comprises two modifiers:

- The [Cloth modifier](#) on page 1178 is responsible for simulating the motion of cloth as it interacts with the environment, which may include collision objects (a character or a table, for example) and external forces, such as gravity and wind.
- The [Garment Maker modifier](#) on page 1228 is a specialized tool for creating 3D garments from 2D splines, similarly to the way real clothes are made, by stitching together flat pieces of cloth.

You can model clothing in two ways: by creating the cloth objects with standard 3ds Max modeling methods and applying the Cloth modifier to them, or by designing virtual clothing patterns with splines and stitching together these various virtual panels to form a full garment using the Garment Maker modifier. With Garment Maker, you can even import spline patterns from external applications and use these as your pattern panels.

**See also:**

- [Cloth Overview](#) on page 1163

## **Cloth Overview**

Cloth is an advanced cloth-simulation engine that lets you create realistic garments for your characters and other creations. Cloth is designed to work in concert with the modeling tools in 3ds Max and can turn just about any 3D object into clothing; it also allows you to build garments from scratch.

Before you begin working with Cloth, we recommend that you read this overview. It provides background information on cloth-simulation technology, so you can begin to grasp exactly the way Cloth works. It will give you a better overall understanding of how to set up Cloth scenes, the way the cloth behaves, and the array of advanced controls you will have at your disposal.

As an artist and creator, you can use this knowledge to tailor (no pun intended) how Cloth will affect and interact with your scenes, and how you can best take advantage of this software.

### **Cloth-Simulation Technology**

Cloth simulation is the process of replicating the movement and deformation of a piece of fabric or clothing to mimic how cloth would react in the real world. To make cloth simulation work, first you need a cloth object, such as a tablecloth or a pair of pants. Next, you need something for the fabric to interact with. This can be a collision object such as a table top or character's leg, or a force such as wind or gravity.

### **Limitations**

While Cloth is designed to help you create clothing for your models, you should be aware that, by its very nature, cloth simulation is only an approximation of how real fabric would react under certain circumstances; this system does have some limitations.

One of the most important aspects of working with Cloth is the amount of time it can take to create a simulation. If you're looking to create a fully physically correct simulation, you might run into problems. Even with a fast computer, cloth dynamics at that level of accuracy (and geometric detail) could take virtually forever. So you must learn to scale your simulations back

to a reasonable level. This doesn't mean you can't get believable clothing; it simply means that there are tradeoffs you should be willing to make.

### **Tradeoffs**

In order to create a believable simulation, you need to balance time against quality and accuracy. The more time you have, the more accuracy and quality your simulation can have. There's no reason to make a model with 10,000 polygons if you can define the form equally well with 3,000. The same rule applies to cloth simulations.

### **Internal and External Forces**

When simulating cloth, different forces come into play. Some internal forces like bend, stretch, and shear allow the fabric to deform in a realistic manner. External forces such as gravity, wind, and collisions make the cloth interact with its environment. To obtain a good-looking simulation, most or all of these things need to come into play. Without these forces, a piece of cloth will remain a flat, lifeless plane.

### **Collision Detection**

When putting a shirt or pair of pants on a character, you don't want any part of the body to protrude through the fabric. The desired result is to have the garment deform around the mesh (rather than through it) so there are no intersections. This is done with *collision detection*; with Cloth, you tell the simulation system which objects will act as cloth, and which ones will act as collision objects.

Basically, virtual feelers are sent out from the vertices of the cloth objects to see if there are any other objects that they might collide with. When one of the feelers hits something, the simulation knows that it must deform the fabric. It is important to remember that a cloth mesh with more vertices has more feelers and can do a better job of collision detection. This is critical, because if you are working with a high-poly character (collision object), you will need to increase the density of your cloth, or the high-poly mesh will protrude through the lower-poly cloth object. The reason is that there aren't enough feelers to detect all of the detail in the collision object.

The alternative to this is to add one or more low-polygon proxy meshes for the character so there doesn't need to be such high density cloth objects that will slow down simulation. We'll cover the mesh density a bit more in the next section.

Lastly, if you are simulating with fast-moving cloth objects, you might need to increase the Density value to give you the benefit of more feelers. You also might adjust the Step size to check more often for collision objects in the way.

### **Clothing and Pattern Design Overview**

Traditionally, sewing patterns are cut from flat pieces of cloth and stitched together. The place where one piece of cloth is sewn to another is called a seam. Patterns are generally symmetrical, where the left side of the garment matches the right.

#### **Skirt**

The simplest is a skirt pattern with two pieces, with a similar shape for the front and back. The back shape is a little larger than the front to account for the hips and buttocks.

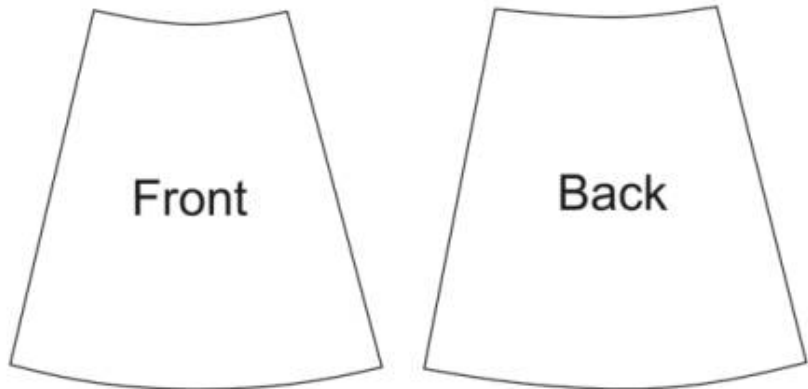

The shapes are sewn together at the sides to form a simple skirt.



The bottom edge of a garment is called a hem. In the skirt pattern, the waistline and hem are slightly curved. When a person puts on the skirt, the curve sits flat on the waist, while the skirt falls in folds to the hem. Because both the waistline and hem are curved, the skirt falls to the same length all the way around.

### **Shirt**

A shirt pattern is slightly more complicated. A simple T-shirt pattern is made of two pieces, one for the front and another for the back. The collar on the back piece is higher than the collar on the front. You sew seams up the sides and at the shoulders, leaving the arm hole open.



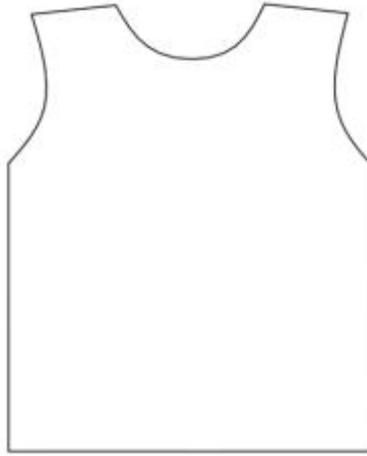

You can also add sleeves to the shirt. A sleeve pattern is bell-shaped.

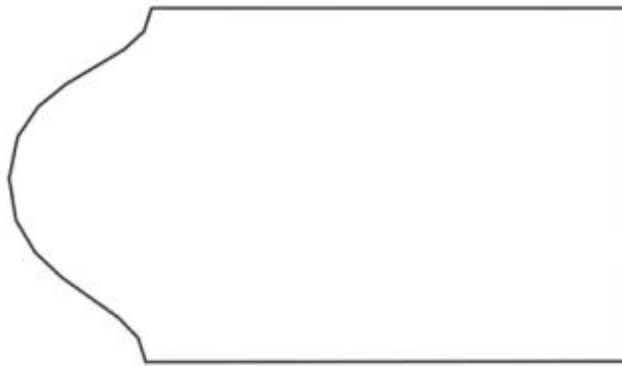

It might not be immediately obvious how this pattern turns into a sleeve. The large hump of the bell fits over the shoulder, to give room for it to move.



### **Pants**

A pants pattern has a curved shape at the top to accommodate the hips. The longer straight edge is the outside seam, while the shorter edge is the inseam. The curve near the top fits around the belly or buttocks, and under the crotch area.

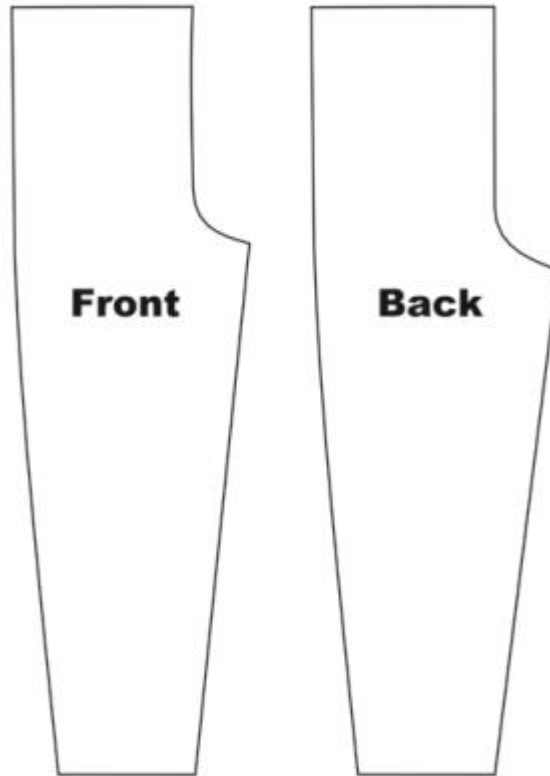

Each piece is cut twice. The two front pieces are sewn together along the crotch, and the two back pieces are sewn together in the same way. Then the front is attached to the back at the outside seams and inseams.



### **Darts**

Darts are diamond-shaped holes inside a panel or V-shaped cutouts at an edge of a garment panel (see figure below), which when closed up cause the garment to assume a curved shape.

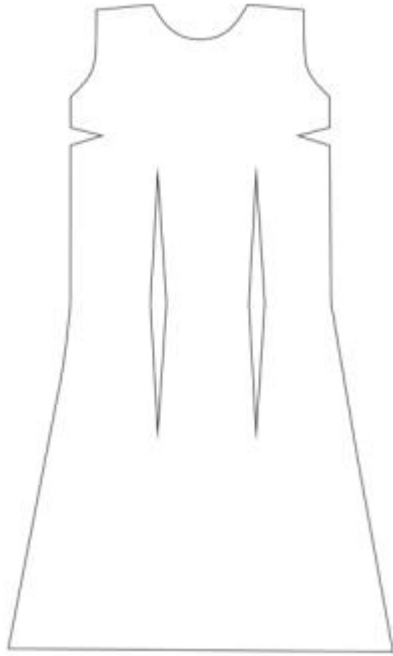



Darts used to be a common part of women's everyday clothing, especially in blouses and dresses. However, darts are not needed with loose garments or stretchy clothing. Today, they are used mostly in formal wear and tailored garments.

### **Clothing Design and Techniques**

One way to create clothing is to lay out a pattern and put it together with Garment Maker. Garment Maker is a modifier that is used to make seams, lay out cloth panels and define fabric densities. You can use Garment Maker to create seams for the pattern either in a traditional, flat layout or in a visual, easy-to-use 3D layout.

In the real world, clothes are made by cutting out shapes from pieces of cloth and sewing them together along seams with thread. Garment Maker emulates this approach. First you must create a pattern that will define the shapes of the panels. Clothing patterns typically use shapes that we don't encounter in everyday life. Those of us who aren't an experienced clothing designers might have a hard time creating these shapes from scratch. It's often best to start out with a pattern made by somebody else. Cloth includes a variety of patterns for shirts, pants, jackets and so forth. You can also buy software that will generate these patterns in DXF format.

One program that does this is PatternMaker, available from <http://www.patternmaker.com>. When you want to move beyond editing the patterns included with Cloth, it's often helpful to use such applications to help create patterns and familiarize yourself with the process .



Shirt pattern and shirt sewn together with Garment Maker

### Modeling Clothing

Garment Maker is a useful tool for putting together patterns and adjusting seams, but you can also achieve good results by modeling with the standard 3ds Max tools and using Cloth on top of these meshes. You can create clothing with polygons, patches, or NURBS.

---

**IMPORTANT** Keep in mind that modeled clothing must not have any overlapping vertices or interpenetrating faces. This type of geometry can cause the simulation to fail. Using Garment Maker; you will not run into this problem. If you are careful in creating your mesh, then this is an easy rule to follow.

---

### Pros and Cons

When designing clothing, Garment Maker is usually the best way to go. It lets you define seams, seam strength, pleats, and other clothing parameters that cannot be defined with clothing modeled via other methods. Either methods lets you define separate portions of your clothing with different fabrics, but Garment Maker gives you greater control over this. The advantage to using modeled clothing is that it can sometimes be a faster setup with familiar methods and it's a great way to repurpose older clothing models you have made in the past. Using polygon-modeled clothing can result in overly regular creases and folds. Garment Maker uses a Delaunay mesh, which tends to avoid this problem. However, the irregular triangulation can result in rendering artifacts for low-resolution clothes, so it is advisable to apply the *HSDS modifier* after Cloth on garments created with Garment Maker and subdivide all the triangles once.

---

**NOTE** MeshSmooth does not give good results with Garment Maker meshes.

---

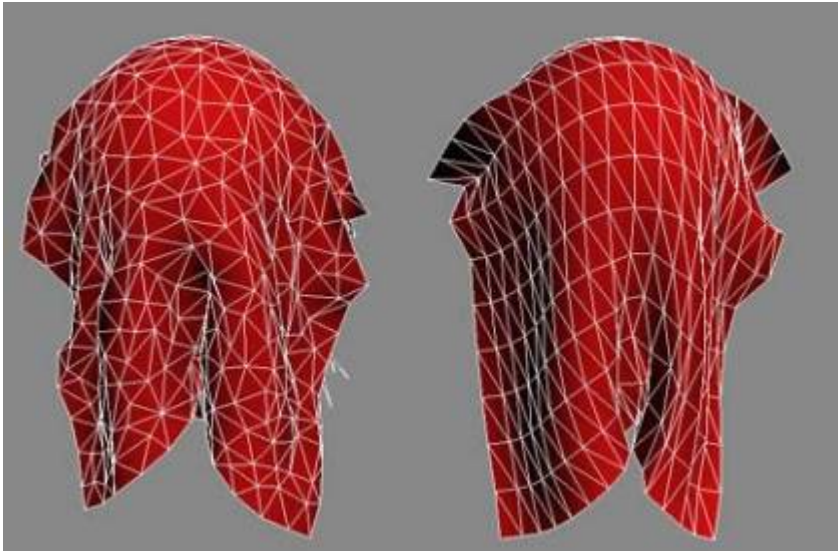

Left: Garment Maker Delaunay mesh

Right: Modeled quad mesh

### How Cloth Works

Cloth exists within 3ds Max as a pair of modifiers: Garment Maker and Cloth. Between these two, you can turn just about any 3D object into a cloth object, or you can create clothing in a more traditional method from 2D patterns, and then sew the panels together. However, before getting into the specifics



of the two modifiers, it's useful to discuss how to preplan for using Cloth. This includes how geometry affects Cloth behavior as well as the density of the meshes you use as fabric.

### **Effect of Geometry on Cloth**

Ideally, the way you model your cloth should not affect how it behaves. However, in practice, the nature of the cloth geometry impacts the simulation. First of all, the density of the mesh defines how fine the folds are that can develop. If you create a plane with only nine vertices, when you drape it over a sphere, you are obviously not going to get much detailed folding.

In addition to this aspect, there is the nature of the edges in the mesh. Folding can occur only at edges between triangles, so the regularity or irregularity of the mesh also dictates the resulting deformation. For example, a plane all of whose triangle hypotenuse edges are aligned will result in a cloth with folds aligned along those edges. Garment Maker creates meshes with an irregular layout (but with fairly equal-sized and close-to-equilateral triangles) that avoids this folding bias. However, this can also result in rendering artifacts with low-resolution cloths, so it is advisable to apply the HSDS modifier after Cloth on garments created with Garment Maker and subdivide all the triangles once.

---

**NOTE** MeshSmooth does not give good results with Garment Maker meshes.

---

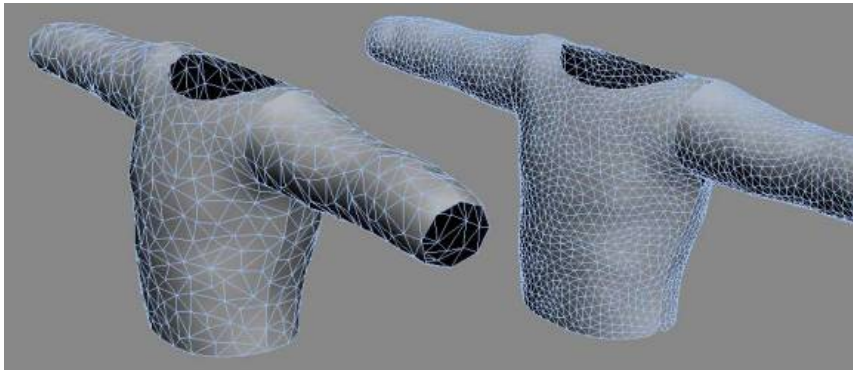

**Left:** A low-density shirt.

**Right:** The same shirt with HSDS applied, above Cloth in the modifier stack

---

**NOTE** There should never be any modifiers that can alter topology between Garment Maker and Cloth. For example, you can use Unwrap UVW, but not modifiers such as Edit Mesh, MeshSmooth, or HSDS.

---

The type of geometry you work with can have a great impact on how the cloth will react. You're probably accustomed to using triangular and quadrilateral polygons for modeling. Garment Maker uses a Delaunay mesh subdivision that promotes non-uniform deformation. When using quad polygons for cloth simulation be careful of getting uniform or symmetrical results.

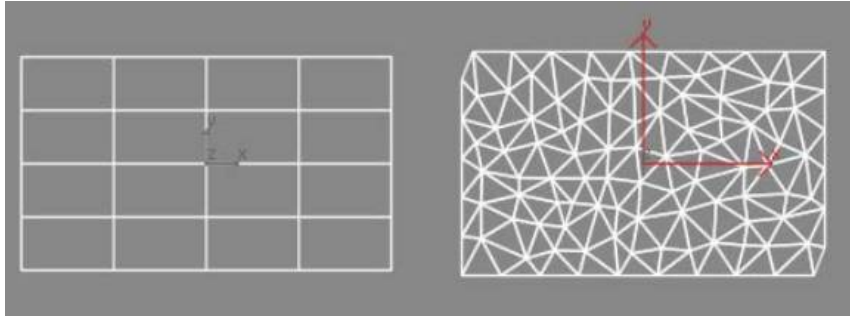

**Left: A quad mesh**

**Right: A Delaunay mesh**

### **Cloth Mesh Density**

It is important to think about how dense your mesh has to be to achieve the result you want. Making the mesh too dense will slow down the system, while having your mesh at too low resolution might not give you the folds or detail you want to see.

For example, if you applied a Bend modifier to a cylinder with only a few height segments, the result would be angular and unsmooth. On the other hand, if you created the cylinder with 1,000 height segments, you'd be wasting resources. The same is true for Cloth. You must find a balance between level of detail and performance that is appropriate for your scene.

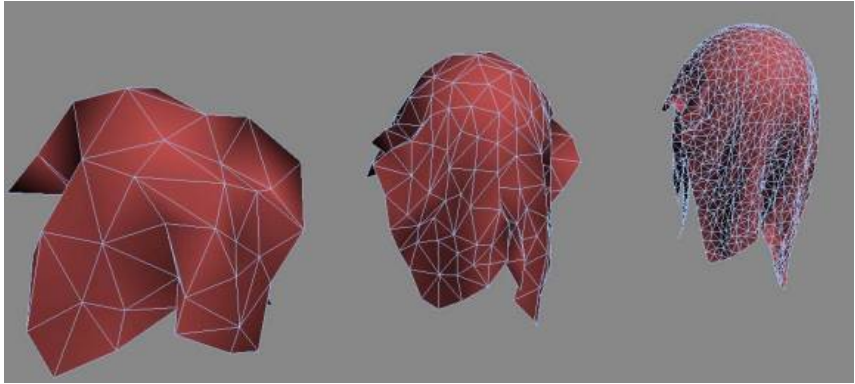

Low, medium, and high-density meshes and the way they deform

### Notes on the HSDS Modifier

Using the HSDS modifier to add detail to your model can be an effective solution that lets you simulate with a lower resolution mesh, and still get high-quality results. However, if you choose to use the HSDS modifier on top of your Cloth garments, you may want to apply an Edit Mesh modifier below it to weld the vertices together along the seams. This prevents the mesh from coming apart at the seams as it is subdivided.

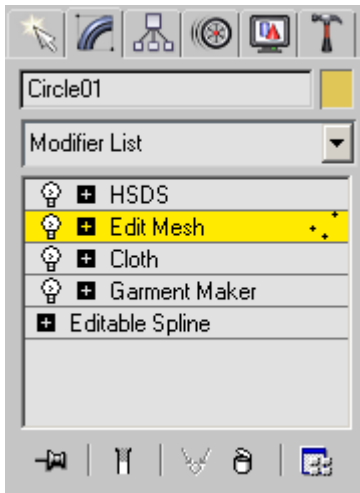

Shown above is how the modifier stack should look when using HSDS. The intermediate Edit Mesh modifier is used to weld the panel edge vertices together. If you want to preserve the seam creases, you should apply further

Mesh Select and Smooth modifiers to reselect the panels and apply different smoothing groups across the garment.

### **Pattern-Making Software**

Below is a list of traditional pattern-making software that you can use to create patterns for import into 3ds Max and use with Cloth. After ensuring that your Internet connection is active, click the software names to display the makers' Web sites.

- <http://www.fashioncad.net/index.html>*Fashion CAD*
- <http://www.patternmaker.com>*PatternMaker*
- <http://www.wildginger.com/products/cameo.htm>*Wild Ginger Software*
- <http://www.autometrix.com>*Autometrix*
- *AccuMark Pattern Design*
- <http://www.tukatech.com>*TUKATECH*

**See also:**

- [Cloth Modifier](#) on page 1178
- [Garment Maker Modifier](#) on page 1228

## **Cloth Modifier**

Select an object. > Modify panel > Modifier List > Object-Space Modifiers > Cloth

The Cloth modifier is the heart of the Cloth system, and is applied to all objects in your scene that need to be part of the Cloth simulation. This is where you define cloth and collision objects, assign properties, and execute the simulation. Other controls include creating constraints, interactively dragging the cloth, and erasing parts of the simulation.

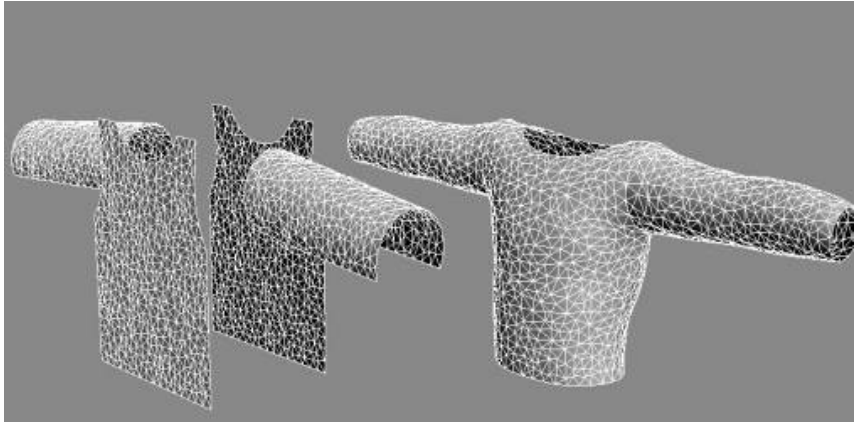

**Left: Cloth modifier not yet applied**

**Right: Cloth modifier applied and simulated**

**See also:**

- [Object Properties Dialog \(Cloth\)](#) on page 1219
- [Cloth and Garment Maker Modifiers](#) on page 1162
- [Cloth Overview](#) on page 1163
- [Garment Maker Modifier](#) on page 1228

### **Basic Concepts**

In a Cloth simulation, you will let Cloth know which objects will be part of the simulation, and which objects will not. Once you have done this, you define what the objects are made of. You can specify what is made of cloth, and what is a solid, collision object.

Because Cloth is a modifier, an instance of it is assigned to each object to be included in the Cloth simulation. This includes all cloth and collision objects. Be aware that two cloth objects with two separate applications of the Cloth modifier will not interact with one another. There are a couple of ways to include objects in the simulation:

- Select all of the objects at once and apply the Cloth modifier to them.

- Apply Cloth to one or more objects and then add objects with the Add Objects button, available on both the Object rollout and the [Object Properties dialog](#) on page 1219 .

## Units of Measure

---

**IMPORTANT** The following information is necessary only if you change the system unit after applying the Cloth modifier. If you change the system unit before applying Cloth, the modifier automatically adjusts the cm/unit setting.

---

It is important to think about size in doing clothing simulations. A very large flag behaves differently from a handkerchief. If the scale is off, then the simulation will be off. Because Cloth deals with real-world physics, it works in real-world units. This means that Cloth needs to know the relationship between units in 3ds Max and units in its own world.

For example, suppose you create a plane that is 10 x 10 3ds Max units. If you want this plane to behave like a 10-inch x 10-inch handkerchief, you would tell Cloth that 1 3ds Max unit=1 inch. If you want it to behave like a 10-foot x 10-foot bed sheet, you would tell Cloth that 1 3ds Max unit=1 foot.

Except as noted at the start of this section, Cloth ignores the 3ds Max System Units Setup (under Customize menu > Units Setup > System Units Setup). Cloth has its own units setup, which is determined by the [cm/unit parameter](#) on page 1195 on the Simulation Parameters rollout. This tells Cloth how many centimeters (cm) correspond to each 3ds Max unit. One inch equals 2.54 cm, so the default setting of 2.54 means that one 3ds Max unit corresponds to 1 inch.

Following is the procedure to follow to determine what setting to use here.

- 1 Use the measure utility or tape helper to measure some dimension of your cloth (or character) in 3ds Max units (call this number x).
- 2 Decide how big you want this object to be in the real world Convert this number to centimeters. If you have the dimension in inches, simply multiply by 2.54 (call this number y).
- 3  $\text{cm/unit}=y/x$

Here is a quick example: You import a file, *man.obj*, into 3ds Max, and want to put a shirt on him.

- 1 Using the Measure utility, you find that the man is 170 3ds Max units tall. So  $y=170$ .

- 2 You determine that this man is about 6 feet tall.
  - $6 \text{ feet} = 72 \text{ inches}$ .
  - And  $72 \text{ inches} = 72 \times 2.54 = 182.88 \text{ cm}$ . So  $x = 182.88$
- 3 So now you have the values to make sure the shirt behaves correctly.  
 $\text{Cm/unit} = y/x = 170/182.88 = 0.929$ . Or you can round the spinner's value up to 1.0, since pinpoint accuracy is not needed here.

## **Fabric Behavior**

Cloth provides many different ways to set up fabric behaviors. You can make your cloth behave like leather, silk, burlap, and anything in between.

## **The Simulation**

Once all of your parameters are set and you're ready to go, it's time to simulate. In many cases, you will first perform a local simulation to fit your fabric to your character. Once your fabric is in place, you can simulate over time.

Running a simulation in Cloth is very freeform. You are able to make many changes and edits to a simulation, making it more of a work in progress than a click and a "hope for the best" scenario.

## **Constraints**

You can constrain fabric in various ways to create different fabric effects during simulations. Cloth can constrain cloth to have extra drag as it flies through the air, or can cause it to be affected by a space warp in the scene. Linking a portion of the fabric to an animated object or attaching to a surface are other common constraints. If you wanted to create a pair of pants you would constrain the top portion of the pants to the waist of the character or a curtain can be constrained to a rod. Constraints are a very important and robust part of Cloth. Cloth has the ability to make multiple groups of constrained vertices for great flexibility. You can constrain many different parts of a piece of clothing to different nodes' surfaces or other cloth objects.

You build constraints in Cloth at the modifier's [Group sub-object level](#) on page 1198 . At this level, you can see vertices of all selected objects, both cloth and collision. You can then select these and place them in groups. Once a group is defined, you can then attach or "constrain" the selection set to another object, or have it affected by some external force.

## Procedures

### Example: To use the Keep Shape option:

If your cloth object starts out with 3D shape that you'd like to retain during the simulation, you can use the Keep Shape option and setting to preserve this shape, or even reverse it. This simple procedure provides an example of how to use Keep Shape.

- 1 In the Top or Perspective viewport, add a Plane primitive object of about 90 x 90 units, with 20 x 20 segments.
- 2 Apply a Bend modifier, set Angle to **250.0**, and set Bend Axis to X.  
This produces the initial tubular shape.
- 3 Copy the bent plane twice so you have three planes in a row. Rename the planes as follows:
  - don't keep shape
  - keep shape
  - reverse shape

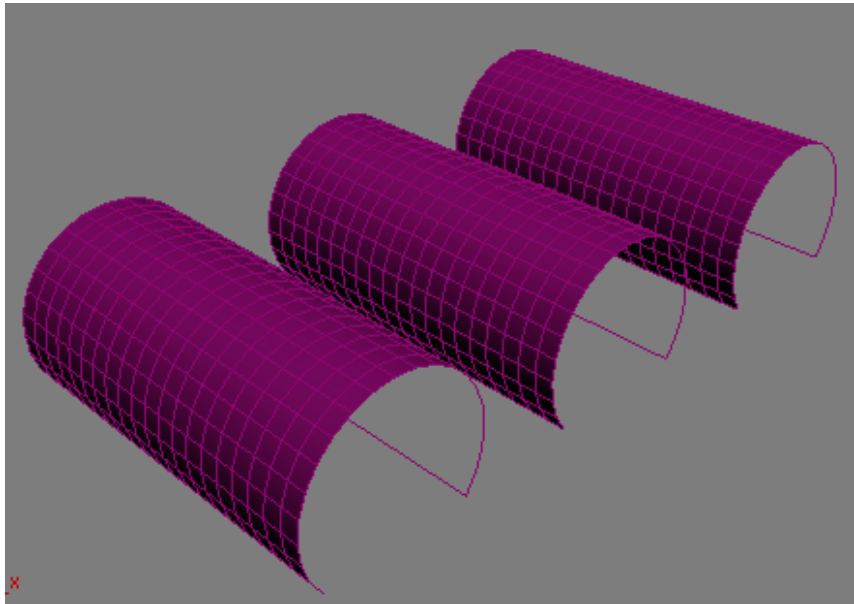

- 4 Select all three planes and apply the Cloth modifier.



- 5 On the Simulation Parameters rollout, turn off Gravity and set cm/unit to **0.5**.

Turning off Gravity keeps the cloth objects from falling during the simulation, so they stay in view, and lowering the cm/unit setting compensates for the planes' relatively large size.

- 6 On the Object rollout, click Object Properties.

This opens the Object Properties dialog.

- 7 In the Objects In Simulation list, highlight all three planes (by dragging), and then, above the Cloth Properties group, choose Cloth. Also set U Bend to **500.0**.

This sets V Bend also to 500.0 automatically.

Using high Bend values allows the simulation to proceed more quickly.

Next, you'll set different Keep Shape properties separately for each object.

- 8 Highlight the *reverse shape* object in the list and set the Bend % value to **-100.0**.

---

**NOTE** The default value was 100.0.

---

- 9 Click OK to exit the dialog.
- 10 Select the *don't keep shape* object and note that Object rollout > Selected Objects Manip group > Use Target State is off.
- 11 Select both the *reverse shape* and the *keep shape* objects, but not *don't keep shape*, and then turn on Use Target State.
- 12 On the Object rollout, click Simulate Local.

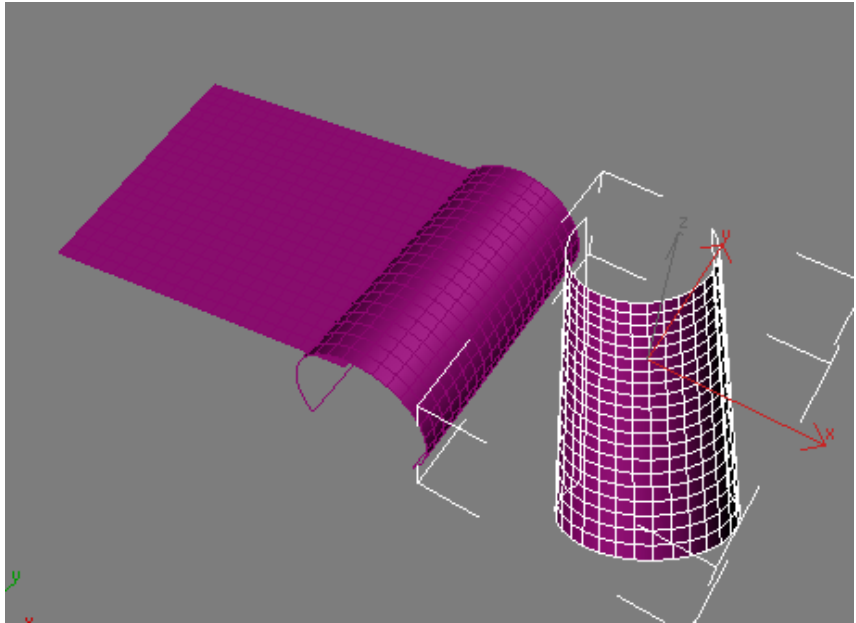

After a few seconds, the *don't keep shape* object starts to flatten out, the *keep shape* object doesn't change, and the *reverse shape* object has, in fact, reversed its shape, effectively creating a negative bend angle.

---

**TIP** You can also use Use Target State with Grab State to maintain or reverse a shape created with a previous cloth simulation or shape-changing modifier.

---

#### **To run a cloth simulation with a networked render farm:**

A complex cloth simulation can require extensive computation and take a long time. Cloth includes commands that make it easy to run a simulation on a networked machine (part of a render farm), freeing up your machine for working on other parts of the scene.

- 1 Set up the simulation.
- 2 For each cloth object in the simulation, select the object, and then on the Selected Object rollout click Set and specify a path and file name for the cache.

For best results, specify a mapped drive and turn on Force UNC Path. This specifies the path using the Universal Naming Convention so that

it can be found by all computers in the network. Also, it's probably a good idea to keep all the cache files in the same directory.

- 3 On the Simulation Parameters rollout, turn on Sim On Render.
- 4 Save the scene file.
- 5 On the Render Scene dialog, turn on Net Render, and then click Render. Submit the job to a single Server.

Unlike rendering, network Cloth simulation cannot be split up among multiple Server machines.

---

**NOTE** You needn't render the entire animation to trigger the cache creation; a single frame suffices.

---

As soon as the Server machine starts the render, it begins computing the simulation and saving it to disk. At any point you can load the simulation in its current state from the cache file to check its progress by clicking the Load button.

## Interface

The Cloth interface varies depending on the current modifier stack level: [Object](#) on page 1185 or one of the four sub-object levels:

- [Group](#) on page 1198
- [Panel](#) on page 1211
- [Seams](#) on page 1217
- [Faces](#) on page 1218

## Object rollout

The Object rollout is the first rollout you see on the Command panel once you apply the Cloth modifier. It comprises mostly controls to create a Cloth simulation and adjust fabric properties.

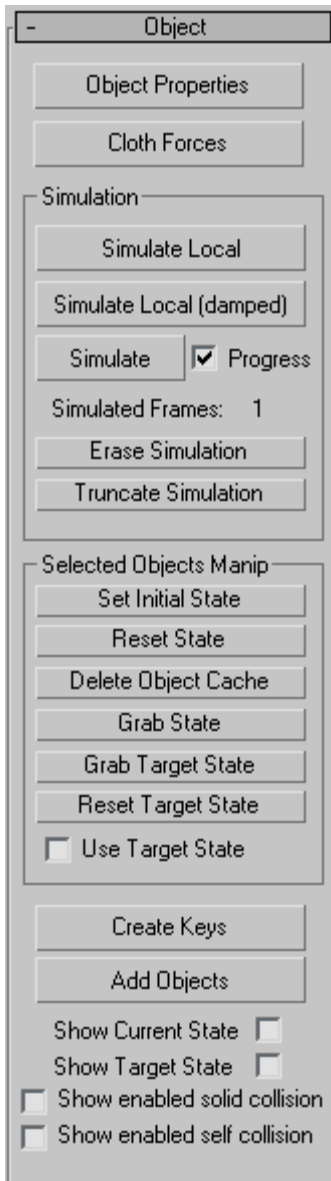

**Object Properties** Opens the [Object Properties dialog](#) on page 1219 , where you can define which objects to include in the simulation, whether they are cloth or collision objects, and the parameters associated with them.

**Cloth Forces** Add forces (that is, space warps in the scene) such as wind to the simulation. Click Cloth Forces to open the Forces dialog. To add forces to the simulation, in the Forces In Scene list on the left side, highlight the forces to add, and then click the > button to move them to the Forces In Simulation list, thus adding them to the simulation. Thereafter, the forces affect all cloth objects in the simulation.

To remove forces from the simulation, in the Forces In Simulation list on the right side, highlight the forces to remove, and then click the < button to move them to the Forces In Scene list.

## Simulation group

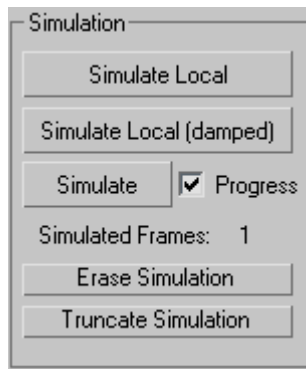

To run a cloth simulation, click any of the three Simulate buttons in this group. To halt a simulation, press Esc or if the Cloth Simulation dialog is open (i.e., [Progress](#) on page 1188 is on), click the Cancel button.

**Simulate Local** Starts the simulation process without creating animation. Use this to drape the clothes on a character or sew the panels of a garment together.

**Simulate Local (damped)** Same as Simulate Local, but with a large amount of damping added to the cloth. When sewing a garment together, sometimes the panels come together at high speed, causing problems. Using a damped simulation alleviates this problem.

**Simulate** Creates a simulation over the active time segment. Unlike Simulate Local, this creates animation data in the form of a simulation cache at every frame.

The simulator advances by a time step called dT. The initial value is the [Step setting](#) on page 1196 on the Simulation Parameters rollout. When the simulator encounters certain situations, it decreases dT in order to overcome the

obstacles. Sometime later, the simulator increases dT again up to the maximum Step value you set. The current value of dT appears on the Cloth Simulation dialog that shows the progress of the simulation as it takes place (see following).

When the simulator decreases dT, it shows "dT decreased" on the Cloth Simulation dialog along with one of the following messages (explanation follows each message):

- could not solve equations – The solver could not solve the equations of motion.
- cloth has become over-stretched – In attempting to solve one step, some edges of the cloth became too elongated, indicating a failure of the solver.
- cloth-solid collision velocity was too large – The speed of the cloth relative to that of the collision object is too high.
- cloth-cloth collision velocity was too large – The speed of colliding cloth parts is too high.

**Progress** When on, opens the Cloth Simulation dialog during the simulation. The dialog shows the progress of the simulation, including information about time, and messages about errors or time step size adjustments.

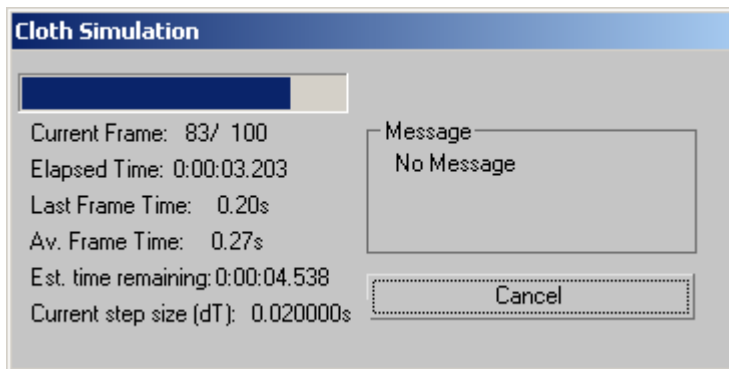

The Cloth Simulation dialog shows information about the simulation while it's running.

**Simulated Frames** Shows the number of frames simulated so far.

**Erase Simulation** Deletes the current simulation. This deletes the cache of all cloth objects and sets the Simulated Frames count back to 1.

**Truncate Simulation** Deletes animation created by the simulation after the current frame.

For example, if you've simulated an animation to frame 50 but want to keep only animation keys from frames 0 to 30, set the time slider to frame 30, then click this button. The simulation is then deleted from frame 31 on.

### Selected Object Manip group

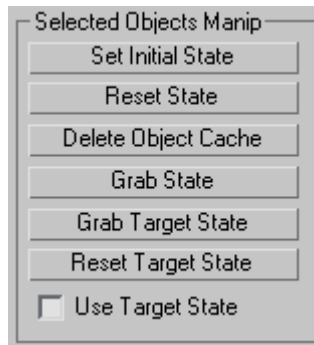

**Set Initial State** Updates the first frame of the selected cloth object's cache to the current position.

**Reset State** Resets the selected cloth object's state to the state before Cloth in the modifier stack. When you click this, the simulation is erased; that is, Simulated Frames returns to 1.

**Delete Object Cache** Deletes the cache for selected non-cloth objects. If an object is simulated as cloth, and is then turned into a collision object (or inactive) via the Object Properties dialog, it will retain the cloth motion in its cache.

This is useful for simulating clothes in layers. For example, you may simulate a character's pants, then turn the pants into a collision object for simulating a coat. By simulating in layers, you avoid the problems of cloth-to-cloth collision detection. If you want to remove the cached motion from the selected object(s), click this button.

**Grab State** Grabs the current state from the top of the modifier stack and updates the cache for the current frame.

Following is an example of how this might be used:

- 1 Simulate to frame 100. When you play back the simulation, you see a collision object poking through the cloth at frame 24.
- 2 Add an Edit Mesh modifier after Cloth and pull the cloth vertices so the object doesn't poke through.

- 3 Go down the stack to Cloth and click Grab State. The vertices are now moved twice as far as you intended because the vertex displacement was applied once by Cloth, and again with Edit Mesh.
- 4 Remove the Edit Mesh modifier. The vertices should now be where you want them.

**Grab Target State** Lets you specify the target shape for [Keep Shape](#) on page 1226 . Grabs the current deformation from the top of the modifier stack and uses that mesh to define the target bend angles between triangles. Also turns on [Use Target State](#) on page 1190 .

---

**NOTE** Only the bend angles from the Target State mesh are used, not the edge lengths.

---

**TIP** To add some natural creasing to your cloth, drop the cloth on the floor, click Grab Target State, and then run the simulation. After clicking Grab Target State and before running the simulation, click Reset State (unless you want the cloth to stay on the floor!).

---

**Reset Target State** Resets the default bend angles to the mesh below Cloth in the stack.

---

**NOTE** For [Garment Maker](#) on page 1228 objects, the target bend angles will depend on the output method set in the Garment Maker modifier. To see what is actually being used, use [Show Target State](#) on page 1191 .

---

**Use Target State** When on, preserves the shape of the mesh as stored by [Grab Target State](#) on page 1190 . It uses the Bend % and Stretch % settings in the [Keep Shape](#) on page 1226 group on the Object Properties dialog for Cloth.

If multiple cloth objects with different Use Target State settings are selected, this check box appears unavailable, but you can click it to make the setting for all selected objects.



---

**NOTE** In previous versions, this check box was labeled Keep Shape and was found on the Object Properties dialog for Cloth.

---



**Create Keys** Creates keys for a selected cloth object. The object is collapsed to an editable mesh, and any deformation is stored as vertex animation.

**Add Objects** Lets you add objects to the simulation without opening the Object Properties dialog. Click Add Objects, and then click an object to add. To add multiple objects at once, press H and use the Pick Objects dialog.

**Show Current State** Shows the current state of the cloth at the end of the last simulation time step.

If the simulation is cancelled, the last time step could lie between two frames. If the simulation is allowed to successfully finish, the last time step corresponds to the last frame.

**Show Target State** Shows the current target state of the cloth; that is, the desired bend angles used by the Keep Shape option.

**Show enabled solid collision** When on, highlights all groups of vertices for which [Solid Coll](#) on page 1203 is on. This is handy for seeing exactly which vertices will be involved in solid-object collisions.

**Show enabled self collision** When on, highlights all groups of vertices for which [Self Coll](#) on page 1203 is on. This is handy for seeing exactly which vertices will be involved in cloth-to-cloth collisions.

### **Selected Object rollout**

The Selected Object rollout lets you control the simulation caches, control and optionally animate the cloth properties with a texture map or interpolation, and specify a bend map. This rollout appears only when a single object in the simulation is selected.



### Cache group

Use these settings for network simulation. When you render with [Sim On Render](#) on page 1197 on, Cloth can run the simulation on a networked machine,

leaving your local machine free for other work. For a procedure, see [To run a cloth simulation with a networked render farm](#): on page 1184 .

**[text field]** Shows the current path and file name for the cache file. You can edit this field, but the path must exist; the file will be created if necessary.

For any cloth object for which you have not specified a file name, Cloth creates one based on the object name.

**Force UNC Path** If the text field path is to a mapped drive, converts the path to [UNC format](#) on page 7961 . This makes the path readily accessible to any computer on the network. To convert cache paths for all cloth objects in the current simulation to UNC format, click the All button.

**Overwrite Existing** When on, Cloth can overwrite existing cache files. To enable overwriting for all cloth objects in the current simulation, click the All button.

**Set** Lets you specify the path and filename of the cache file for the selected object. Click Set, navigate to the directory, enter the file name, and then click Save.

**Load** Loads the specified file into the selected object's cache.

**Import** Opens a file dialog to load a cache file other than the specified one.

**Load All** Loads the specified cache file for every cloth object in the simulation.

**Save** Saves the current cache, if any, using the specified file name and path. If no file is specified, Cloth creates one based on the object name.

**Export** Opens a file dialog to save the cache to a file other than the specified one. You can save in the default CFX format or in PointCache2 format.

**Extra Cache** To create a second cache in PointCache2 format, turn on Extra Cache and click Set to specify a path and file name. This file is also created when you render with Sim On Render on.

## **Property Assignment group**

**Interpolate** Interpolates between the two different property settings in the [Object Properties dialog](#) on page 1219 (as determined by the Property 1 and Property 2 radio buttons at the top right corner). You can use this slider to animate between these two properties to adjust the type of fabric settings the garment is using.

**Texture Map** Set a texture map and apply the Property 1 and Property 2 settings to the cloth object. You can add a grayscale texture map in this slot to blend between the two properties set in the Object Properties dialog. Black

will represent property 1 and white property 2. Any grayscale value will blend between these two properties. You can drag a texture map onto this button.



**Cloth object with a burlap material in Property 1 and silk in Property 2 being controlled by a Checker procedural map**

**Mapping Channel** Lets you specify the mapping channel the Texture map will work from, or choose Vertex Color to use that instead. Vertex color can be particularly useful in conjunction with the new painting tools in 3ds Max. You can paint vertex colors directly onto your object and use the painted areas for material assignment.

### **Bend Map group**

The Bend Map option lets you use a texture map, map channel, or vertex colors to modulate the target bend angles. The value of this is that you can paint deformations onto your cloth, or use some kind of noise map to add irregularity to the cloth.

**Bend Map** Toggles the use of the Bend Map option.

Set the strength of the modulation with the numeric value. In most cases, the value should be less than 1.0. Range=0.0 to 100.0. Default=0.5.

**[map type]** Choose the map type for the Bend map:

- **Vertex Color** Uses the Vertex Color channel for modulation.
- **Map Channel** Uses a map channel other than Vertex Color for modulation. Set the channel with the spinner.
- **Texture Map** Uses a texture map for modulation. To specify a texture map, click the button (labeled None by default) and then use the Material/Map Browser to choose the map. Thereafter the map name appears on the button.

## Simulation Parameters rollout

The Simulation Parameters rollout settings let you specify general properties of the simulation such as gravity, start and end frames, and sewing-spring options. These settings apply to the simulation on a global scale, that is, to all objects in the simulation.

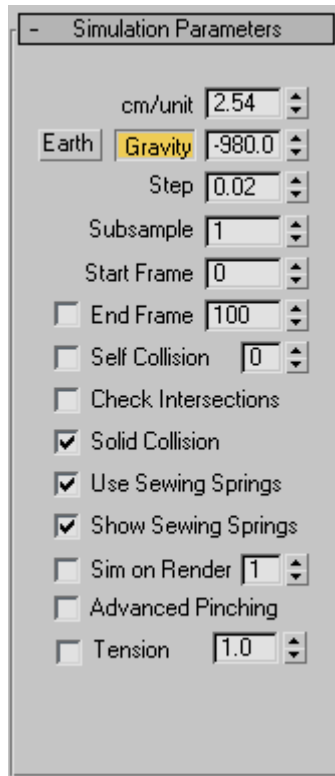

**cm/unit** Determines how many centimeters there are per 3ds Max system unit.

Cloth automatically sets cm/unit to the equivalent of 2.54 centimeters per inch (the default system unit in 3ds Max). For example, if you set the system unit to one foot, Cloth automatically sets cm/unit to 30.48 (12x2.54).

Size and scale are important when doing cloth simulation because a 10-foot curtain behaves much differently from a one-foot square handkerchief, even if they are made from the same fabric.

**Earth** Click this button to set the Gravity value to that of planet Earth.

**Gravity** When on, the Gravity value (see following) affects cloth objects in the simulation.

**[Gravity value]** The force of gravity in cm/sec<sup>2</sup>. A negative value applies gravitational force downward. A positive value (i.e., no sign) means gravity will act to move cloth objects upward. The default value is set to be the same as Earth's gravity: -980.0 cm/sec<sup>2</sup>.

**Step** The maximum size of the time step the simulator takes.

This value is measured in seconds. The value must be less than the length of one frame (less than 0.033333 for 30 fps animation). A value of 0.02 is generally the largest value you want to use. Reducing this value causes the simulator to take longer to calculate, but will in general give better results. The simulator will automatically reduce its time steps as needed, but this is the maximum value that it will try. This value works in conjunction with the Subsample parameter: The actual maximum value=Step value divided by Subsample value.

**Subsample** The number of times per frame that the software samples the position of solid objects. Default=1.

At the default value, Cloth samples the solid objects in the simulation once every frame. Increasing this value should help when objects are moving or rotating quickly, but be aware that the higher you set the value, the slower the simulation will be.

**Start Frame** The frame at which the simulation starts. If you change this value after the simulation has been performed, the cache will be moved to this frame. Default=0.

**End Frame** When on, determines the frame at which the simulation will stop. Default=100.

**Self Collision** When on, detects cloth-to-cloth collisions. Leaving this off will speed up the simulator, but will allow cloth objects to interpenetrate.

The numeric setting specifies the extent to which Cloth tends to avoid self-colliding cloth objects, at the cost of simulation time. Range=0 to 10. Default=0.

This is a maximum limit. If Cloth needs fewer calculations to resolve all collisions, it will use fewer. In most cases, a value greater than 1 isn't necessary.

**Check Intersections** (Discontinued feature. This check box has no effect.)

**Solid Collision** When on, the simulator takes into account cloth-to-solid object collisions. This is almost always left on.

**Use Sewing Springs** When on, uses the sewing springs created with Garment Maker to pull the fabric together.

This works only with objects that have been made with [Garment Maker](#) on page 1228 . Turn this option off once the garment has been pulled together. When off, Cloth will identify vertices that are sewn together and will always keep them coincident. When on, there is always a chance for the vertices to come apart if the sewing springs are not strong enough (actually, there will always be some slight gap between the vertices in this case).

**Show Sewing Springs** Toggles the visual representation of the sewing springs in the viewports. These do not render.

**Sim on Render** When on, triggers the simulation at render time. Use this for generating a simulation with a network computer, which lets you continue to work on other aspects of your scene with your own computer. See a procedure [here](#) on page ? .

After the render is completed, Cloth writes a cache for each cloth object. You can specify this cache file on the [Selected Object rollout](#) on page 1191 (which is available only when a single object is selected). If you do not specify a name, the software creates one.

The numeric value indicates the priority of the simulation; the simulations are run in ascending order. For modifiers with the same priority, the order is undefined.

---

**NOTE** Each object has its own cache file, which is temporarily created when the MAX file is opened. On saving the file, the cache is incorporated into the MAX file. When Sim On Render is on, the cache file specified is created and written to, but is not read from as you change the time slider. The cache file must be [loaded into the internal cache file](#) on page 1193 before you can see it.

---

**Advanced Pinching** When on, Cloth tests for cloth pinched between two parts of the same collision object.

This option helps with cloth colliding with small features of the collision objects, such as fingers. There is a significant performance hit for high-resolution collision objects.

**Tension** Lets you visualize the compression/tension in the fabric by means of vertex coloring. Stretched cloth is indicated by red, compressed by blue, neutral by green. The numeric setting lets you change the range of tension/compression illustrated by a complete traversal from red to blue. The higher this value, the more gradual the shading. This works only for Garment Maker objects.

## Group rollout

The Group sub-object rollout is for selecting groups of vertices and constraining them to surfaces, collision objects, or other cloth objects. At the Group sub-object level, all selected objects that are part of the Cloth simulation are shown with their vertices visible so that you can select them in an efficient fashion.

When you create or select a group at this sub-object level, the Group Parameters rollout becomes available.

---

**IMPORTANT** The concept of a group for Cloth can be applied to both the cloth objects and to the collision objects in the simulation. And when created, groups can then be given unique properties. For example, a group on a collision object can have a different collision offset from the rest of the object. This is a powerful feature when working with groups.

---

**NOTE** You can select groups of vertices explicitly, with the mouse in the viewports, and you can also specify a soft selection or use a texture map to select vertices using controls on the Group Parameters rollout. See [Soft Selection group](#) on page 1210 . In addition, [named selection set](#) on page 179 tools are available at this level.

---



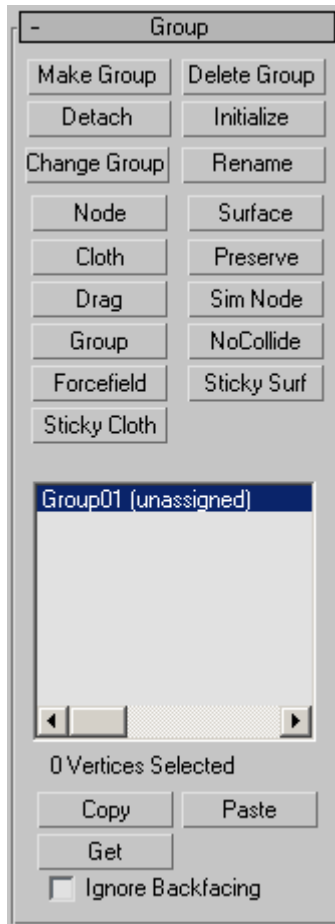

**Make Group** Makes a group out of selected vertices. Select the vertices to include in the group, and then click this button. Name the group, and it will then show up in the list below for you assign to an object.

**Delete Group** Deletes the group highlighted in the list.

**Detach** Removes any constraint assigned to the group and sets it back to being unassigned (i.e., without any constraint). Any unique properties assigned to this group will remain in effect.

**Initialize** Constraints that involve attaching the vertices to another object (Node, SimNode, Surface and Cloth constraints) contain information regarding the relative positions of the group vertices to the other object. This information

is created upon the creation of the constraint. To regenerate this information, click this button.

**Change Group** Lets you modify the vertex selection in the group. To use, follow this procedure:

- 1 Choose the group in the list.
- 2 Change the selection of vertices.
- 3 Click Change Group.

**Rename** Renames the highlighted group.

**Node** Constrains the highlighted group to the transforms of an object or node in the scene. To use, click Node, and then select the node for constraining. The node cannot be an object in the simulation; for that purpose, use the [SimNode constraint](#) on page 1201 .

---

**NOTE** Node and SimNode simply constrain the group to an object's *transforms* , not to the object itself. They need not be near each other. When the cloth and the constraining object should be in close proximity, such as with clothing on a character mesh, use the Surface constraint instead (see following).

---

**Surface** Attaches the selected group to the surface of a collision object in the scene. To use, click Surface, and then select the node for attaching.

---

**TIP** This constraint is best suited for when the cloth and the constraining object should be in close proximity, such as with clothing on a character mesh.

---

**Cloth** Attaches the selected group of cloth vertices to another cloth object.

**Preserve** This group type preserves the motion from below the Cloth modifier in the modifier stack. For example, you might have a dress that you've skinned to a skeleton. You want the upper portion of the dress to be unaffected by the Cloth simulation (that is, to retain its deformation defined by the skinning), and the lower part to be simulated. In this case, you'd make a Preserve constraint from the upper vertices.

**Drag** This group type locks the vertices in place or adds a damping force to selected group. When Group Parameters rollout > [Soft](#) on page 1202 is off, you can use this constraint for “nailing” vertices in place so that they do not move at all. When Soft is on, the vertices will have a drag force applied where the amount of drag is controlled by the Strength and Damping values, also on the Group Properties rollout.

**SimNode** This option works the same as the [Node option](#) on page 1200 , except the node must be part of the Cloth simulation.

**Group** Attaches one group to another. This is recommended only for single-vertex groups. (that is, groups that contain only one vertex). With this, you can make one cloth vertex stick to another cloth vertex. Select one group, click this button to open the Pick Group dialog , and then choose another group.

**NoCollide** Causes collisions between the currently selected group and another group to be ignored. When you click this button, you're prompted to choose another group. You could use this option to prevent the simulator from processing collisions between cloth and the body under an arm or between the legs.

**Forcefield** Allows you to link a group to a space warp and have the space warp affect the vertices.

**Sticky Surf** The group sticks to a surface only after it has collided with that surface. [Solid Coll](#) on page 1203 must be enabled for this constraint to work.

**Sticky Cloth** The group sticks to a surface only after it has collided with that surface. [Self Coll](#) on page 1203 must be enabled for this constraint to work.

**[group list]** Shows all current groups. The number of vertices associated with the highlighted group is shown below the list. To assign, copy, paste, delete or alter a created group, first highlight the group name in the list.

**Copy** Copies a named selection set to the copy buffer.

**Paste** Pastes the named selection set from copy buffer.

### **Group Parameters rollout**

The Group Parameters rollout appears after you use Make Group on a vertex selection to create at least one group. Thereafter, highlight the group in the Group rollout list to display and edit the group's settings with the Group Parameters rollout.

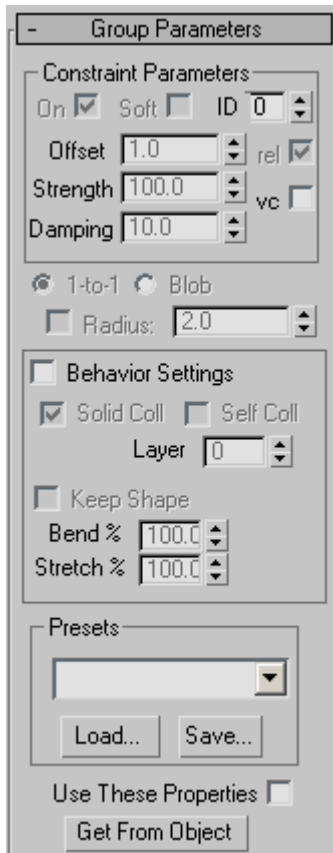

### Constraint Parameters group

**On** When on, enables the constraint specified for the current group in the group list on the Group rollout, using remaining settings in this group box.

**Soft** Sets the constraint type to soft. A soft constraint uses springs between vertices. When off, the constraint is hard or rigid. The constraint types Node, Surface, Preserve, Drag, and SimNode can be hard or soft. Cloth, Group, and Forcefield constraints are always soft.

**ID** Uses a Material ID to attach the group to an object. This option applies only to Surface and Cloth constraints. If, when the constraint is created or initialized, the cloth vertices are not over a triangle, then the constraint will be created to the center of the nearest triangle that has the requisite Material ID. This could mean that several vertices might be constrained to the center of the same triangle. In this case, you should only use soft constraints. A hard

constraint would pull all those cloth vertices to the same exact point on the triangle, which would look strange.

**Offset** The variance in the distance between a constrained group and its constraining, or target, object. The default value is 1.0 with **Rel.** on page 1203 on. This sets the constrained group to maintain its original distance from the target object. When set to 0.0, the constraint seeks to set the distance to the target object to zero.

**Strength** The stiffness of the springs used if the constraint is soft.

**Damping** The damping of the springs if the constraint is soft.

**Rel.** Specifies the offset as a ratio of the original value. Available only with the Surface and Cloth constraint types. For example, if you want to move a constrained vertex by half its original distance, turn on the Rel. check box and set Offset to 0.5.

**Vc** Sets vertex colors to determine the strength of the constraint.

**1-to-1** When the mesh density is changed in Garment Maker, the group selection is reassigned. The 1-to-1 option selects the vertex closest to the original vertex.

**Blob** When the mesh density is changed in Garment Maker, the group selection is reassigned. The Blob option selects the original vertex and the ones created within a certain radius of it. The radius can be left at default or auto, or it can be set manually.

**Radius** When on, lets you set the radial distance used by the Blob option (see preceding). When off, Blob uses an automatic radial value.

## **Behavior Settings group**

**Behavior Settings** Toggles the availability of the other settings in this group. When off, the other settings have no effect.

**Solid Coll** When on, the group vertices are used in solid-collision detection.

**Self Coll** When on, the group vertices are used in self-collision detection.

**Layer** Indicates the correct "order" of cloth pieces that might come in contact with each other. Range=-100 to 100. Default=1.

If your garments and/or panels are all correctly orientated to begin with, then cloth-to-cloth collision detection should keep items from interpenetrating. However, the initial state of a garment/panel might have some interpenetration that cannot be resolved. For example, suppose you make a jacket with Garment Maker where the front right panel is supposed to sit on top of the front left

panel. When you sew together the garment (generally with self-collision off), the front panels will interpenetrate, so to make sure that the right panel sits outside the left panel, you might have to use constraints or Live Drag. Using the Layers option on the panels can help here.

Here is the logic of layers: When two pieces of cloth (A and B) are in collision-detection range, their layers (layerA and layerB) are compared and the following rules are applied:

- If either layerA or LayerB is 0, then Cloth uses the regular cloth-to-cloth collision method.
- If layerA=layerB, then Cloth uses the regular cloth-to-cloth collision method.
- If  $\text{abs}(\text{layerA}) > \text{abs}(\text{layerB})$  then piece A is pushed to the appropriate side of piece B. Which side? If layerB > 0, then to the side indicated by the face normals. If layerB < 0 then to the opposite side.

The sign of the Layer value indicates what the "outside" of that piece of cloth is. A positive sign means "The side that the normals face is the outside".

**Keep Shape** When on, preserves the shape of the mesh based on the Bend % and Stretch % settings (see following). In normal operation, when Cloth creates a simulation, it tries to "flatten out" the cloth.

**Bend %** Modulates the target bend angles to a value between 0.0 and the angles defined by the [target state](#) on page 1190 . A negative value inverts the angles. Range=-100.0 to 100.0. Default=100.0.

**Stretch %** Modulates the target stretch angles to a value between 0.0 and the angles defined by the [target state](#) on page 1190 . A negative value inverts the angles. Range=-100.0 to 100.0. Default=100.0.

### **Presets group**

Sets the Cloth Properties parameters to the preset selected in the drop-down list. Any presets that are built into the system or that have been loaded will show up here.

**Load** Loads presets from the hard drive. Click this button and then navigate to the directory with your presets to load them into your Cloth Properties.

**Save** Saves your Cloth Properties parameters to a file that you can then load at a later time.

**Use These Properties** Determines the cloth properties from the settings on the rollout below.

**Get From Object** Sets the cloth properties of the group to be the same as the object they are selected on.

U Bend	5.0
V Bend	5.0
U B-Curve	0.0
V B-Curve	0.0
U Stretch	50.0
V Stretch	50.0
U Compress	50.0
V Compress	50.0
Shear	50.0
Density	0.005
Thickness	0.0
Repulsion	1.0
Damping	0.01
Air Res.	0.02
Dyn. Fric.	0.1
Static Fric.	0.5
Self Fric.	0.0
U Scale	1.0
V Scale	1.0
Seam Force	5000.0
Depth	1.0
Offset	1.0
Plasticity	0.0
Cling	0.0
Based on: default	
Anisotropic	<input type="checkbox"/>
Use Edge Springs	<input type="checkbox"/>
Use Cloth Depth/Offset	<input type="checkbox"/>

**U Bend/V Bend** Resistance to bending. The higher this value is set, the less the fabric will be able to bend. A cotton fabric might bend more easily than leather, so a value of 15.0 for both U and V Bend might be good for cotton, while 50.0 would work well for leather.

By default, the U Bend and V Bend parameters are locked together so that changing one sets the other to the same value. You can set different values for the two only when [Anisotropic](#) on page 1210 is off. It is recommended to do this only for [Garment Maker](#) on page 1228 objects.

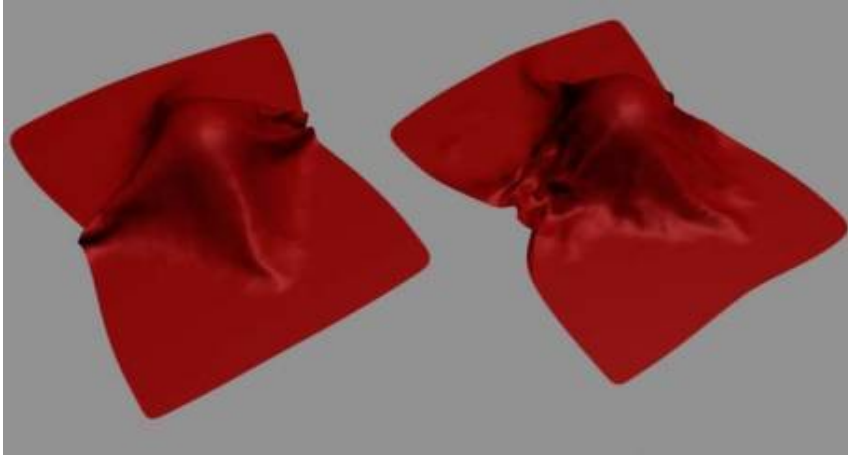

**Left:** U and V Bend=50, simulating a burlap material

**Right:** U and V Bend=2.5, simulating silk or other light fabric

**U B-Curve/V B-Curve** Resistance to bending as the fabric folds. The default value of 0 sets the bend resistance to be constant. A setting of 1 makes the fabric very resistant to bending as the angle between triangles approaches 180 degrees. You never want two adjacent triangles to pass through each other, so you can increase this value to prevent this from happening.

By default, the U B-Curve and V B-Curve parameters are locked together so that changing one sets the other to the same value. You can set different values for the two only when [Anisotropic](#) on page 1210 is off. It is recommended to do this only for [Garment Maker](#) on page 1228 objects.

**U Stretch/V Stretch** Resistance to stretching. The default value of 50.0 is a reasonable value for most types of cloth. A larger value will be stiffer, while a smaller one will be stretchy like rubber.

By default, the U Stretch and V Stretch parameters are locked together so that changing one sets the other to the same value. You can set different values



for the two only when [Anisotropic](#) on page 1210 is off. It is recommended to do this only for [Garment Maker](#) on page 1228 objects.



**U Compress / V Compress** Resistance to compression. Although these values default to 50.0, like their counterpart Stretch values, assigning values lower than the Stretch values can give good results, because when cloth is compressed along the length of its fibers, it tends to buckle rather than shrink.

By default, the U Compress and V Compress parameters are locked together so that changing one sets the other to the same value. You can set different values for the two only when [Anisotropic](#) on page 1210 is off. It is recommended to do this only for [Garment Maker](#) on page 1228 objects.

**Shear** Resistance to shearing. Higher values result in stiffer cloth fabrics. Shear defines how much the individual triangles can deform. If you were to lay the edges of the triangle out in a straight line this value would represent how long this line can stretch out to. With a high value this length will only be the sum of the length of all of the sides at rest. A low value will allow this length to be greater than that of all of its sides at rest. This length of stretched sides is not on a one to one basis. One side of the polygon may stretch more than another as long as the total shear value is not exceeded.

**Density** The weight of the cloth per unit area (in gm/cm<sup>2</sup>). Higher values mean heavier cloth like denim. Use smaller values for lighter cloth like silk.

**Thickness** Defines the virtual thickness of a fabric for the purpose of detecting cloth-to-cloth collisions. This value is irrelevant if cloth-to-cloth collisions are disabled. Larger values keep the cloth separated by greater distances. Be careful not to use too large or small values in this field. Very large values will interfere with the natural behavior of the cloth. Very small values will cause the simulator to take too long to calculate. This distance is measured in cm (centimeters) and should be smaller than the size of the triangles that make up the cloth object. A setting of 0.0 will let Cloth automatically assign a reasonable value for thickness.

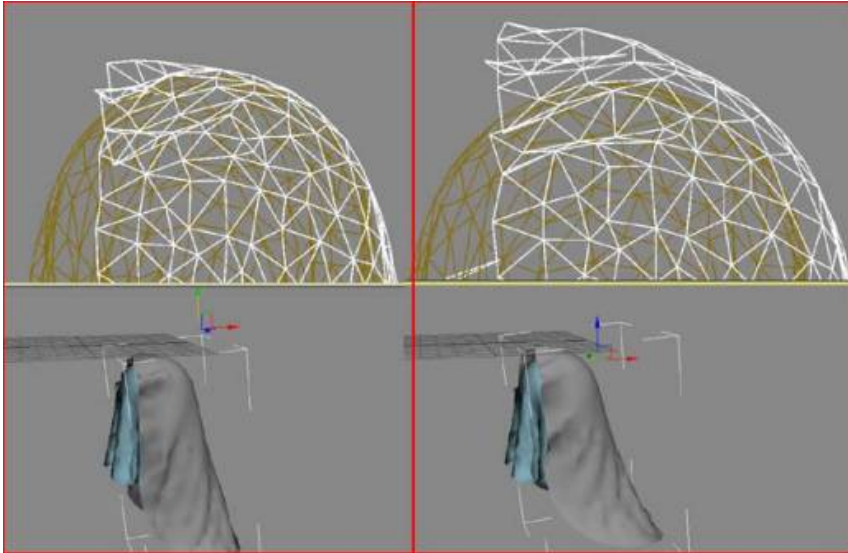

**Left:** The top piece of cloth with a Thickness of 0

**Right:** Thickness of 9

**Repulsion** The amount of force used to repel other cloth objects. This value is irrelevant if cloth-to-cloth collisions are disabled. The simulator will apply a repulsion force scaled by this value to keep the cloth from coming in contact with other cloth objects. Increase this value if there are a lot of collisions between different parts of cloth, or if the cloth is tending to interpenetrate.

**Damping** The larger this value, is the more sluggishly the fabric will react. With a lower value, the fabric will behave with more spring. Cloth with more damping will come to rest sooner than cloth with less damping. High damping results in cloth that behaves as though it is moving through oil. Excessive damping may also cause simulation instabilities. A good value is the default, 0.01.

**Air Res.** Resistance to Air. This value will determine how much the air will effect the cloth. A higher amount of air resistance would be useful for a tightly woven fabric, while a lower amount would be suitable for a loose-knit garment.

**Dyn. Fric.** Dynamic friction between the cloth and solid objects. A larger value will add more friction and cause the fabric to slide less across an object. A lower value will allow the fabric to slip off an object very easily, similarly to how silk would react.

**Static Fric.** Static friction between the cloth and solid objects. When the cloth is in stationary position, this value will control its ability stay where it is, or slip away.

**Self Fric.** Friction between the cloth and itself. This is similar to dynamic and static friction, but applies to cloth-to-cloth or self-collisions. A larger value will cause more friction between the cloth and itself.

**U Scale** Controls how much to shrink or expand the cloth along the U direction (as defined by Garment Maker. For non-Garment Maker meshes, this applies a uniform scaling to the cloth along both axes, and the V Scale parameter is ignored). A value of less than 1 will shrink the fabric at simulation time, while a value of more than 1 will stretch it.

**V Scale** Controls how much to shrink or expand the cloth along the V direction (as defined by Garment Maker). A value of less than 1 will shrink the fabric at simulation time, while a value of more than 1 will stretch it.

**Seam Force** Not presently used and only kept for backward compatibility with older versions of the former product called Stitch. This was a global seam strength, but seam strength is now defined on a seam-by-seam basis in the Seams sub-object Mode.

**Depth** Collision depth. If a portion of cloth reaches this depth inside a collision object, then the simulation will no longer try to push the cloth out of the mesh. This value is measured in 3ds Max units.

**Offset** The amount of distance kept between the cloth and the collision object. A very low value can cause the collision mesh to protrude out from under the cloth. A very high value will cause the fabric to look as if it is floating on top of the collision object.

**Plasticity** The tendency of the cloth to keep its current deformation (that is, the bend angles).

This is different from [Keep Shape](#) on page 1226 , which determines the extent to which the cloth tends to keep its original deformation (or the one defined by the Target State). If you set Plasticity to 100.0, the cloth will not attempt to change the angles between triangles. If you want stiffer cloth, but you don't want the cloth to "balloon" up, increase the Plasticity value.

**Cling** The extent to which the cloth object adheres to a collision object. Range=0.0 to 99999.0. Default=0.0.

You can use this parameter to simulate effects such as wet cloth. A setting of 1.0 should be just enough to hold the default material onto a surface against its own weight.

**Based on** Displays the preset that the group properties are based on. When you modify parameters and save a preset, Cloth uses the name of the last preset you loaded as the “Based on” name.

**Anisotropic** When on, you can set different U and V values for the Bend, B-Curve, and Stretch parameters. The U and V directions are defined by [Garment Maker](#) on page 1228 and do not apply to non-Garment Maker meshes, for which setting different U/V values might result in unexpected behavior.

**Use Edge Springs** This is an alternative method for calculating stretch. When this option is on, stretch force is based on springs along triangle edges. (Whereas normally the stretch and shear forces are calculated in a more sophisticated manner to more accurately reflect the underlying physics).

**Use Cloth Depth/Offset** Uses the [Depth and Offset](#) on page 1209 values set for the group. When on, the cloth object ignores the collision object Depth and Offset values.

### Soft Selection group

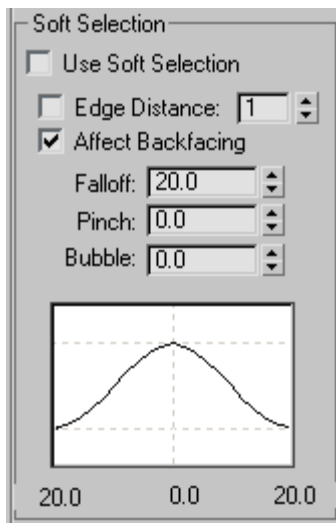

The Soft Selection controls apply on a per-group basis to permit soft selection of vertices neighboring the explicitly selected group members. This works the same as soft selection of vertices in other parts of 3ds Max. For details, see [Soft Selection Rollout](#) on page 1926 . Alternatively, you can select vertices for a group based on a texture map.

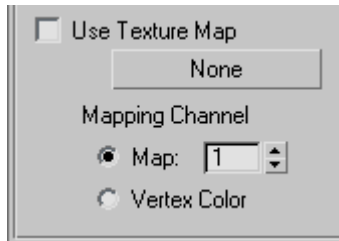

**Use Texture Map** When on, Cloth uses a texture map to specify a soft selection of vertices that belong to the current group. Click the button (by default, labeled “None”) to choose a texture map. Use the Mapping Channel controls to choose a map channel or vertex color channel.

You can add a grayscale texture map in this slot to blend between unselected and fully selected pixels in the group. Black represents unselected and white represents fully selected. Any grayscale value blends between the two. You can drag a texture map onto this button.

---

**NOTE** For a texture map to apply to a group, at least one vertex must be explicitly selected. However, when Use Texture Map is on, the group's explicit vertex selection has no effect.

---

### Panel rollout

At the Panel sub-object level, you can select one panel (cloth section) at a time and change its cloth properties. A panel, which must be created by the [Garment Maker modifier](#) on page 1228 , is a closed spline that is not enclosed by another spline. If a closed spline is enclosed by another spline, it forms a hole in the outer spline.

---

**NOTE** To be able to select a panel at this sub-object level, you must first use [Object Properties](#) on page 1219 to specify that the object is cloth. Also, to be able to change settings on this rollout, first turn on Object Properties > [Use Panel Properties](#) on page 1221 .

---

## Presets group

**Presets** Sets the selected panel's properties parameters to the preset selected in the drop-down list. Any presets that are built into the system or that have been previously saved and loaded will show up here. Presets have the filename extension *.sti*.

**Load** Load presets from a specified location on your hard drive. Click this button and navigate to the directory with your presets to load them into your Cloth Properties.

**Save** Save your Cloth Properties parameters to a file to be loaded at a later time. By default, Cloth preset files are saved to the `\cloth` folder inside the program install directory.

## Properties group

**U Bend/V Bend** Resistance to bending. The higher this value is set, the less the fabric will be able to bend. A cotton fabric might bend more easily than leather, so a value of 15.0 for both U and V Bend might be good for cotton, while 50.0 would work well for leather.

By default, the U Bend and V Bend parameters are locked together so that changing one sets the other to the same value. You can set different values for the two only when [Anisotropic](#) on page 1216 is off. It is recommended to do this only for [Garment Maker](#) on page 1228 objects.

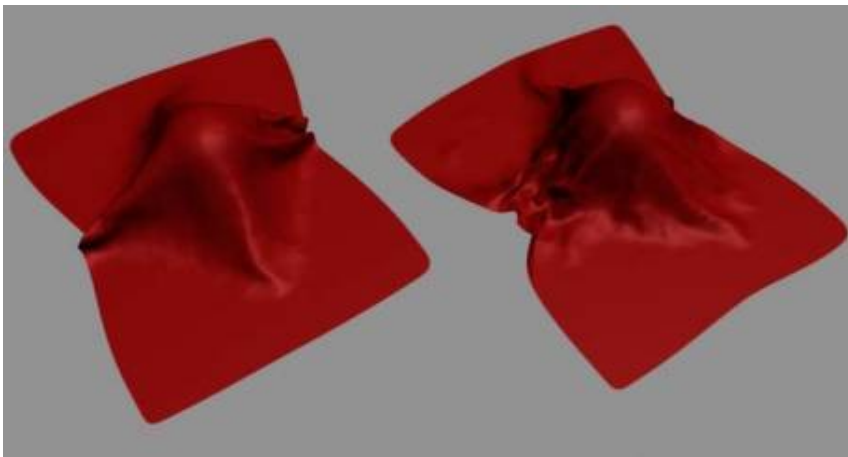

Left: U and V Bend=50, simulating a burlap material

Right: U and V Bend=2.5, simulating silk or other light fabric

**U B-Curve/V B-Curve** Resistance to bending as the fabric folds. The default value of 0 sets the bend resistance to be constant. A setting of 1 makes the fabric very resistant to bending as the angle between triangles approaches 180 degrees. You never want two adjacent triangles to pass through each other, so you can increase this value to prevent this from happening.

By default, the U B-Curve and V B-Curve parameters are locked together so that changing one sets the other to the same value. You can set different values for the two only when [Anisotropic](#) on page 1216 is off. It is recommended to do this only for [Garment Maker](#) on page 1228 objects.

**U Stretch/V Stretch** Resistance to stretching. The default value of 50.0 is a reasonable value for most types of cloth. A Larger value will be stiffer, while a smaller one will be stretchy like rubber.

By default, the U Stretch and V Stretch parameters are locked together so that changing one sets the other to the same value. You can set different values for the two only when [Anisotropic](#) on page 1216 is off. It is recommended to do this only for [Garment Maker](#) on page 1228 objects.



**U Compress / V Compress** Resistance to compression. Although these values default to 50.0, like their counterpart Stretch values, assigning values lower than the Stretch values can give good results, because when cloth is compressed along the length of its fibers, it tends to buckle rather than shrink.

By default, the U Compress and V Compress parameters are locked together so that changing one sets the other to the same value. You can set different values for the two only when [Anisotropic](#) on page 1210 is off. It is recommended to do this only for [Garment Maker](#) on page 1228 objects.

**Shear** Resistance to shearing. Higher values result in stiffer cloth fabrics. Shear defines how much the individual triangles can deform. If you were to lay the edges of the triangle out in a strait line this value would represent how long this line can stretch out to. With a high value this length will only be the sum of the length of all of the sides at rest. A low value will allow this length to be greater then that off all of its sides at rest. This length of stretched sides is not on a one to one basis. One side of the polygon may stretch more then another as long as the total shear value is not exceeded.

**Density** The weight of the cloth per unit area (in gm/cm<sup>2</sup>). Higher values mean heavier cloth like denim. Use smaller values for lighter cloth like silk.

**Thickness** Defines the virtual thickness of a fabric for the purpose of detecting cloth-to-cloth collisions. This value is irrelevant if cloth-to-cloth collisions are disabled. Larger values keep the cloth separated by greater distances. Be careful

not to use too large or small values in this field. Very large values will interfere with the natural behavior of the cloth. Very small values will cause the simulator to take too long to calculate. This distance is measured in cm (centimeters) and should be smaller than the size of the triangles that make up the cloth object. A setting of 0.0 will let Cloth automatically assign a reasonable value for thickness.

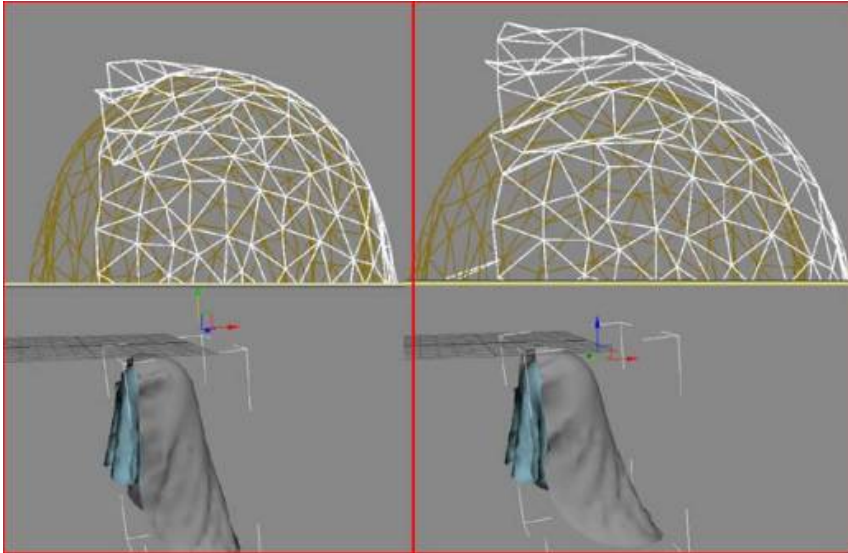

**Left:** The top piece of cloth with a Thickness of 0

**Right:** Thickness of 9

**Repulsion** The amount of force used to repel other cloth objects. This value is irrelevant if cloth-to-cloth collisions are disabled. The simulator will apply a repulsion force scaled by this value to keep the cloth from coming in contact with other cloth objects. Increase this value if there are a lot of collisions between different parts of cloth, or if the cloth is tending to interpenetrate.

**Damping** The larger this value, is the more sluggishly the fabric will react. With a lower value, the fabric will behave with more spring. Cloth with more damping will come to rest sooner than cloth with less damping. High damping results in cloth that behaves as though it is moving through oil. Excessive damping may also cause simulation instabilities. A good value is 0.01 (note: the default is 0.1, but in practice, it seems that this value is too high).

**Air Res.** Resistance to Air. This value will determine how much the air will effect the cloth. A higher amount of air resistance would be useful for a tightly woven fabric, while a lower amount would be suitable for a loose-knit garment.



**Dyn. Fric.** Dynamic friction between the cloth and solid objects. A larger value will add more friction and cause the fabric to slide less across an object. A lower value will allow the fabric to slip off an object very easily, similarly to how silk would react.

**Static Fric.** Static friction between the cloth and solid objects. When the cloth is in stationary position, this value will control its ability stay where it is, or slip away.

**Self Fric.** Friction between the cloth and itself. This is similar to dynamic and static friction, but applies to cloth-to-cloth or self-collisions. A larger value will cause more friction between the cloth and itself.

**U Scale** Controls how much to shrink or expand the cloth along the U direction (as defined by Garment Maker. For non-Garment Maker meshes, this applies a uniform scaling to the cloth along both axes, and the V Scale parameter is ignored). A value of less than 1 will shrink the fabric at simulation time, while a value of more than 1 will stretch it.

**V Scale** Controls how much to shrink or expand the cloth along the V direction (as defined by Garment Maker). A value of less than 1 will shrink the fabric at simulation time, while a value of more than 1 will stretch it.

**Seam Force** Not presently used and only kept for backward compatibility with older versions of the former product called Stitch. This was a global seam strength, but seam strength is now defined on a seam-by-seam basis at the Seams sub-object level.

**Plasticity** The tendency of the cloth to keep its current deformation (that is, the bend angles).

This is different from [Keep Shape](#) on page 1226 , which determines the extent to which the cloth tends to keep its original deformation (or the one defined by the Target State). If you set Plasticity to 100.0, the cloth will not attempt to change the angles between triangles. If you want stiffer cloth, but you don't want the cloth to "balloon" up, increase the Plasticity value.

**Depth** Collision depth. If a portion of cloth reaches this depth inside a collision object, then the simulation will no longer try to push the cloth out of the mesh. This value is measured in 3ds Max units.

**Offset** The amount of distance kept between the cloth and the collision object. A very low value can cause the collision mesh to protrude out from under the cloth. A very high value will cause the fabric to look as if it is floating on top of the collision object.

**Use Cloth Depth/Offset** Uses the Depth and Offset values set for the panel (see preceding). When on, the cloth object ignores the collision object Depth and Offset values.

**Cling** The extent to which the cloth object adheres to a collision object. Range=0.0 to 99999.0. Default=0.0.

You can use this parameter to simulate effects such as wet cloth. A setting of 1.0 should be just enough to hold the default material onto a surface against its own weight.

**Based on** Lists the preset that the panel properties are based on. When you modify parameters and save a preset, Cloth uses the name of the last preset you loaded as the “Based on” name.

**Anisotropic** When on, you can set different U and V values for the Bend, B-Curve, and Stretch parameters. The U and V directions are defined by [Garment Maker](#) on page 1228 and do not apply to non-Garment Maker meshes, for which setting different U/V values might result in unexpected behavior.

**Use Edge Springs** This is an alternative method for calculating stretch. When this option is on, stretch force is based on springs along triangle edges. (Whereas normally the stretch and shear forces are calculated in a more sophisticated manner to more accurately reflect the underlying physics).

**Use Solid Friction** Uses the friction of the collision object to determine friction. Values for collision can be assigned either to the cloth or the collision objects. This enables you to set different friction values for each collision object

### **Keep Shape group**

**Keep Shape** When on, preserves the shape of the mesh based on the Bend % and Stretch % settings (see following). In Lanormal operation, when Cloth creates a simulation, it tries to "flatten out" the cloth.

**Bend %** Modulates the target bend angles to a value between 0.0 and the angles defined by the [target state](#) on page 1190 . A negative value inverts the angles. Range=-100.0 to 100.0. Default=100.0.

**Stretch %** Modulates the target stretch angles to a value between 0.0 and the angles defined by the [target state](#) on page 1190 . A negative value inverts the angles. Range=-100.0 to 100.0. Default=100.0.

### **Layer group**

**Layer** Sets the layer for the selected panel. See “Behavior Settings,” above.

## Seams rollout

The Seams sub-object rollout is used to define seam properties.

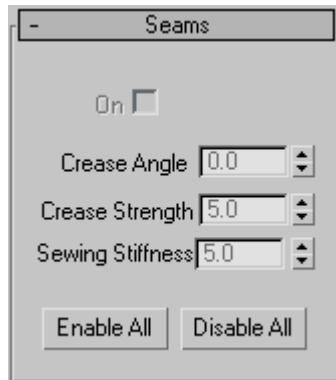

**On** Turn the seam on or off to make it active or inactive.

**Crease angle** Creates a crease at your seam. The angle value will determine the angle of the crease that will be between the two panels. (Can be positive or negative depending on which way you want to crease)



**Left: High crease angle**

**Right: Low crease angle**

**Crease Strength** Increase or decrease the strength of your seam. This value will effect how much the seam will resist bending in relation to the rest of the cloth object. A value of 2.0 means that the cloth will have twice the resistance to bending that it would otherwise have (as defined by the object/panel/vertex group properties).

**Sewing Stiffness** The amount of force with which the panels will be pulled together at simulation time. A larger value will pull the panels together harder and faster.

**Enable All** Sets all seams on selected garment to be active.

**Disable All** Sets all seams on selected garment to be off. This button deactivates the On check box for all seams.

### Faces rollout

The Faces sub-object rollout enables interactive dragging of cloth objects while they are simulated locally. This sub-object level is useful for positioning cloth within your scenes in a more interactive way.

---

**NOTE** If you position your cloth incorrectly, you can restore the original position by returning to the Object level and clicking the Reset State button.

---



**Simulate Local** Starts local simulation of the cloth. In order for the real-time interactive feedback with the cloth to occur, this button must be on.

**Live Drag!** When active you can drag selected faces as the local simulation is taking place.

**Live Rotate!** When active, you can rotate selected faces as the local simulation is taking place.

**Sim on mouse down** Runs the local simulation only when the left mouse button is clicked. This mode is usually preferred since you can start and stop the local simulation simply by releasing the mouse button. As a result, it makes it far easier to position and rotate the faces of your cloth within your scene.

**Ignore Backfacing** When on, you can select only faces facing you. When off (the default), you can select any faces under the mouse cursor, regardless of visibility or facing.

## **Object Properties Dialog (Cloth)**

Select an object. > Modify panel > Modifier List > Object-Space Modifiers > Cloth > Object rollout > Object Properties button

Use the Object Properties dialog to specify which objects are included in a [Cloth](#) on page 1178 simulation, whether they are cloth or collision objects, and define parameters associated with them.

## Interface

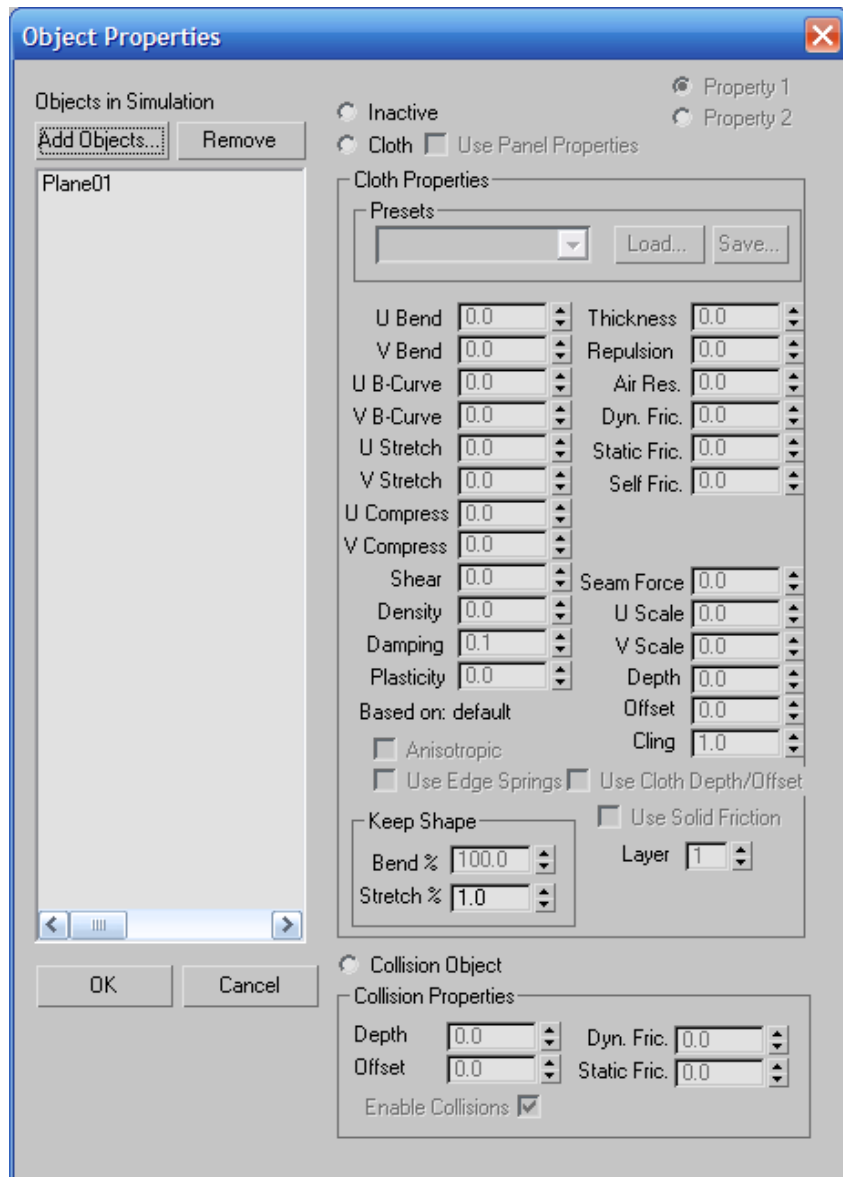

**Objects in Simulation** Lists objects currently included in the simulation. To change an object's properties, first highlight its name in the list. You can

highlight multiple object names using standard methods: Ctrl+click, Shift+click, and dragging.

**Add Objects** Opens a dialog that lets you select objects from your scene to be added to the Cloth simulation. After adding an object with this button, it appears in the Objects In Simulation list, and an instance of the Cloth modifier is applied to the object.

**Remove** Removes objects highlighted in the Objects In Simulation list from the simulation. You cannot remove objects currently selected in 3ds Max.

**Inactive** Makes an object inactive in the simulation. The object can still be in the simulation, but it will not react to anything. This is good for testing how different objects react and isolating dynamic effects.

**Property 1/Property 2** These two radio buttons let you assign two different sets of cloth properties to objects highlighted in the Objects In Simulation list. You can then use the [Property Assignment group](#) on page 1193 settings to interpolate or animate between the sets. The Use Cloth Depth/Offset, Use Edge Springs, Use Solid Friction, and Keep Shape options can be set only for Property 1 because Property 2 uses the same settings.

**Cloth** Sets the object or objects highlighted in the Objects In Simulation list to cloth objects and allows you to define parameters for them in the Cloth Properties section of the dialog.

**Use Panel Properties** When on, tells Cloth to use the Cloth Properties from the Panel sub-object level of the Cloth modifier. This allows you to define different cloth properties on a panel-by-panel basis.

### **Cloth Properties group**

**Presets** Sets the Cloth Properties parameters to the preset chosen from the drop-down list. Any presets that are built into the system or that have been previously saved and loaded will show up here.

**Load** Loads presets from your hard drive. Click this button and then navigate to the directory with your presets to load them into Cloth Properties.

**Save** Saves Cloth Properties parameters to a file to be loaded at a later time. By default, all Cloth preset files are saved to your `\scenes\cloth` folder.

**U Bend/V Bend** Resistance to bending. The higher this value is set, the less the fabric will be able to bend. A cotton fabric might bend more easily than leather, so a value of 15.0 for both U and V Bend might be good for cotton, while 50.0 would work well for leather.

By default, the U Bend and V Bend parameters are locked together so that changing one sets the other to the same value. You can set different values for the two only when [Anisotropic](#) on page 1226 is off. It is recommended to do this only for [Garment Maker](#) on page 1228 objects.

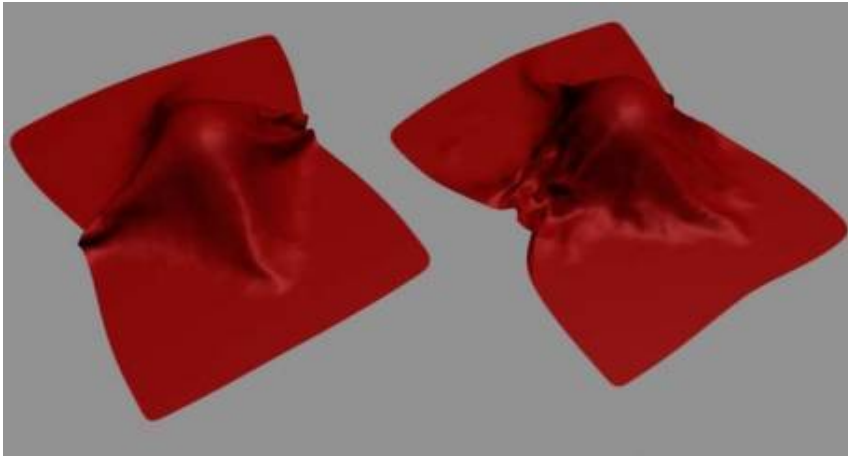

**Left:** U and V Bend=50, simulating a burlap material

**Right:** U and V Bend=2.5, simulating silk or other light fabric

**Thickness** Defines the virtual thickness of a fabric for the purpose of detecting cloth-to-cloth collisions. This value is irrelevant if cloth-to-cloth collisions are disabled. Larger values keep the cloth separated by greater distances. Be careful not to use too large or small values in this field. Very large values will interfere with the natural behavior of the cloth. Very small values will cause the simulator to take too long to calculate. This distance is measured in cm (centimeters) and should be smaller than the size of the triangles that make up the cloth object. A setting of 0.0 will let Cloth automatically assign a reasonable value for thickness.



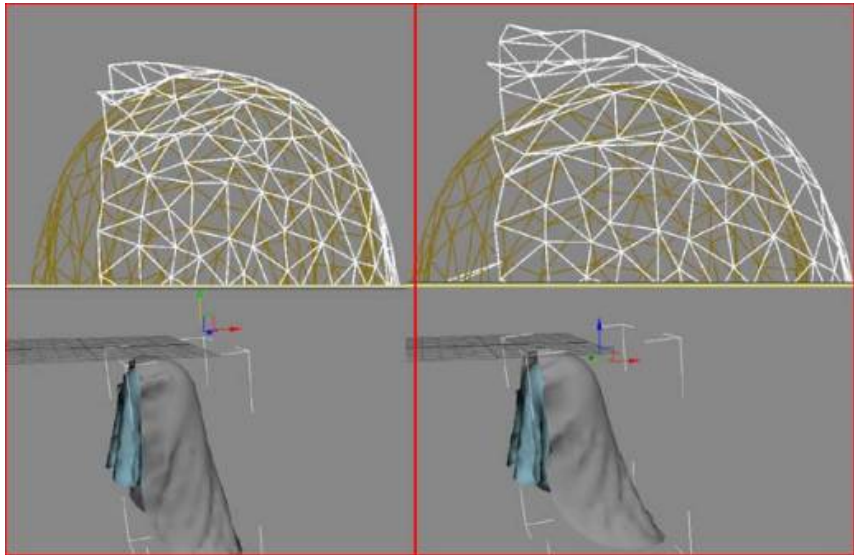

**Left: The top piece of cloth with a Thickness of 0**

**Right: Thickness of 9**

**Repulsion** The amount of force used to repel other cloth objects. This value is irrelevant if cloth-to-cloth collisions are disabled. The simulator will apply a repulsion force scaled by this value to keep the cloth from coming in contact with other cloth objects. Increase this value if there are a lot of collisions between different parts of cloth, or if the cloth is tending to interpenetrate.

**U B-Curve/V B-Curve** Resistance to bending as the fabric folds. The default value of 0 sets the bend resistance to be constant. A setting of 1 makes the fabric very resistant to bending as the angle between triangles approaches 180 degrees. You never want two adjacent triangles to pass through each other, so you can increase this value to prevent this from happening.

By default, the U B-Curve and V B-Curve parameters are locked together so that changing one sets the other to the same value. You can set different values for the two only when [Anisotropic](#) on page 1226 is off. It is recommended to do this only for [Garment Maker](#) on page 1228 objects.

**Air Res.** Resistance to air. This value will determine how much the air will effect the cloth. A higher amount of air resistance would be useful for a tightly woven fabric, while a lower amount would be suitable for a loose-knit garment.

**Dyn. Fric.** Dynamic friction between the cloth and solid objects. A larger value will add more friction and cause the fabric to slide less across an object.

A lower value will allow the fabric to slip off an object easily, similarly to how silk would react.

**U Stretch/V Stretch** Resistance to stretching. The default value of 50.0 is a reasonable value for most types of cloth. A Larger value will be stiffer, while a smaller one will be stretchy like rubber.

By default, the U Stretch and V Stretch parameters are locked together so that changing one sets the other to the same value. You can set different values for the two only when [Anisotropic](#) on page 1226 is off. It is recommended to do this only for [Garment Maker](#) on page 1228 objects.



**U Compress / V Compress** Resistance to compression. Although these values default to 50.0, like their counterpart Stretch values, assigning values lower than the Stretch values can give good results, because when cloth is compressed along the length of its fibers, it tends to buckle rather than shrink.

By default, the U Compress and V Compress parameters are locked together so that changing one sets the other to the same value. You can set different values for the two only when [Anisotropic](#) on page 1210 is off. It is recommended to do this only for [Garment Maker](#) on page 1228 objects.

**Static Fric.** Static friction between the cloth and solid objects. When the cloth is in stationary position, this value will control its ability stay where it is, or slip away.

**Self Fric.** Friction between the cloth and itself. This is similar to dynamic and static friction, but applies to cloth-to-cloth or self-collisions. A larger value will cause more friction between the cloth and itself.

**Shear** Resistance to shearing. Higher values result in stiffer cloth fabrics. Shear defines how much the individual triangles can deform. If you were to lay the edges of the triangle out in a strait line this value would represent how long this line can stretch out to. With a high value this length will only be the sum of the length of all of the sides at rest. A low value will allow this length to be greater then that off all of its sides at rest. This length of stretched sides is not on a one to one basis. One side of the polygon may stretch more then another as long as the **Seam Force** Not presently used and only kept for backward compatibility with older versions of the former product, called Stitch. This was a global seam strength, but seam strength is now defined on a seam-by-seam basis at the Seams sub-object level.total shear value is not exceeded.

**Density** The weight of the cloth per unit area (in gm/cm<sup>2</sup>). Higher values mean heavier cloth like denim. Use smaller values for lighter cloth like silk.

**Damping** The larger this value, is the more sluggishly the fabric will react. With a lower value, the fabric will behave with more spring. Cloth with more damping will come to rest sooner than cloth with less damping. High damping results in cloth that behaves as though it is moving through oil. Excessive damping may also cause simulation instabilities. A good value is 0.01 (note: the default is 0.1, but in practice, it seems that this value is too high).

**U Scale** Controls how much to shrink or expand the cloth along the U direction (as defined by Garment Maker). For non-Garment Maker meshes, this applies a uniform scaling to the cloth along both axes, and the V Scale parameter is ignored). A value of less than 1 will shrink the fabric at simulation time, while a value of more than 1 will stretch it.

**V Scale** Controls how much to shrink or expand the cloth along the V direction (as defined by Garment Maker). A value of less than 1.0 will shrink the fabric at simulation time, while a value of more than 1.0 will stretch it.

**Plasticity** The tendency of the cloth to keep its current deformation (that is, the bend angles).

This is different from [Keep Shape](#) on page 1226 , which determines the extent to which the cloth tends to keep its original deformation (or the one defined by the Target State). If you set Plasticity to 100.0, the cloth will not attempt to change the angles between triangles. If you want stiffer cloth, but you don't want the cloth to "balloon" up, increase the Plasticity value.

**Depth** Collision depth for the cloth object. If a portion of cloth reaches this depth inside a collision object, then the simulation will no longer try to push the cloth out of the mesh. This value is measured in 3ds Max units.

To specify a Depth value specific to the cloth object, use this setting and be sure to turn on [Use Cloth Depth/Offset](#) on page 1226 .

**Offset** The distance maintained between the cloth object and the collision object. A very low value can cause the collision mesh to protrude from under the cloth. A very high value causes the fabric to appear to be floating above the collision object. This value is measured in 3ds Max units.

To specify an Offset value specific to the cloth object, use this setting and be sure to turn on [Use Cloth Depth/Offset](#) on page 1226 .

**Cling** The extent to which the cloth object adheres to a collision object. Range=0.0 to 99999.0. Default=0.0.

You can use this parameter to simulate effects such as wet cloth. A setting of 1.0 should be just enough to hold the default material onto a surface against its own weight.

**Use Cloth Depth/Offset** Uses the [Depth](#) on page 1225 and [Offset](#) on page 1225 values set in Cloth Properties. When on, the cloth object ignores the collision object Depth and Offset values.

**Based on** Displays the preset that the Cloth Properties are based on. When you modify some parameters and save a preset, it will use the name of the last preset you loaded as the *Based on* name.

**Anisotropic** When on, you can set different U and V values for the Bend, B-Curve, and Stretch parameters. The U and V directions are defined by [Garment Maker](#) on page 1228 and do not apply to non-Garment Maker meshes, for which setting different U/V values might result in unexpected behavior.

**Use Edge Springs** Enables an alternative method for calculating stretch. When on, stretch force is based on springs along triangle edges. When off, the stretch and shear forces are calculated in a more sophisticated manner to more accurately reflect the underlying physics.

**Use Solid Friction** Uses the friction of the collision object to determine friction. Values for collision can be assigned either to the cloth or the collision objects. This enables you to set different friction values for each collision object.

**Keep Shape** These settings preserves the shape of the mesh based on the values of Bend % and Stretch % (see following). In normal operation, when Cloth creates a simulation, it tries to "flatten out" the cloth. To enable these settings, turn on [Use Target State](#) on page 1190 .

**Bend %** Modulates the target bend angles to a value between 0.0 and the angles defined by the [target state](#) on page 1190 . A negative value inverts the angles. Range=-100.0 to 100.0. Default=100.0.

**Stretch %** Modulates the target stretch angles to a value between 0.0 and the angles defined by the [target state](#) on page 1190 . Range=0.0 to 100.0. Default=100.0.

**Layer** Indicates the correct "order" of cloth pieces that might come in contact with each other. Range=-100 to 100. Default=0.

If your garments and/or panels are all correctly orientated to begin with, then cloth-to-cloth collision detection should keep items from interpenetrating. However, the initial state of a garment/panel might have some interpenetration that cannot be resolved. For example, suppose you make a jacket with Garment Maker where the front right panel is supposed to sit on top of the front left

panel. When you sew together the garment (generally with self-collision off), the front panels will interpenetrate, so to make sure that the right panel sits outside the left panel, you might have to use constraints or Live Drag. Using the Layers option on the panels can help here.

Here is the logic of layers: When two pieces of cloth (A and B) are in collision-detection range, their layers (layerA and layerB) are compared and the following rules are applied:

- If either layerA or LayerB is 0, then Cloth uses the regular cloth-to-cloth collision method.
- If layerA=layerB, then Cloth uses the regular cloth-to-cloth collision method.
- If  $\text{abs}(\text{layerA}) > \text{abs}(\text{layerB})$  then piece A is pushed to the appropriate side of piece B. Which side? If  $\text{layerB} > 0$ , then to the side indicated by the face normals. If  $\text{layerB} < 0$  then to the opposite side.

The sign of the Layer value indicates what the "outside" of that piece of cloth is. A positive sign means "The side that the normals face is the outside".

### Collision Properties group

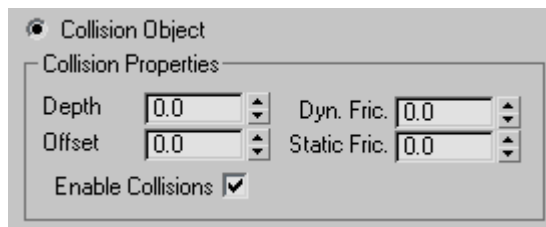

**Collision Object** Sets the object or objects highlighted in the left-hand column to be collision objects. Cloth objects bounce off or wrap around collision objects.

**Depth** Collision depth for the collision object. If a portion of cloth reaches this depth inside a collision object, then the simulation will no longer try to push the cloth out of the mesh. This value is measured in 3ds Max units.

**Offset** The distance maintained between the cloth object and the collision object. A very low value can cause the collision mesh to protrude out from under the cloth. A very high value will look like the fabric is floating on top of the collision object. This value is measured in 3ds Max units.

**Dyn. Fric.** Dynamic friction between the cloth and this particular solid object. A larger value will add more friction and cause the fabric to slide across an object less. A lower value will allow the fabric to slip off an object very easily, similarly to how silk would react. This value is only used for interaction with cloth objects that have Use Solid Friction enabled, otherwise the friction value is taken from the cloth's own properties.

**Static Fric.** Static friction between the cloth and solid objects. When the cloth is in stationary position, this value will control its ability stay where it is, or slip away. This value is only used for interaction with cloth objects that have Use Solid Friction enabled otherwise the friction value is taken from the cloth's own properties.

**Enable Collisions** Enables or disables collisions for this object while still allowing it to be in the simulation. This means the object can still be used for making surface constraints.

## Garment Maker Modifier

Select a shape object (spline or NURBS curve). > Modify panel > Modifier List > Object-Space Modifiers > Garment Maker

Garment Maker is a modifier that is designed to put together 2D patterns that you can then use with [Cloth](#) on page 1178. With Garment Maker you can take a simple, flat, spline-based pattern and convert it to a mesh, arrange its panels, and create seams to sew the panels together. You can also specify [internal seam lines](#) on page 1236 for creases and cuts.

**See also:**

- [Troubleshooting and Error Codes in Garment Maker](#) on page 1258
- [Cloth and Garment Maker Modifiers](#) on page 1162
- [Cloth Overview](#) on page 1163
- [Cloth Modifier](#) on page 1178

### Basic Concepts

#### Splines

When you start working with Garment Maker, you begin either by importing or drawing traditional 2D splines in the 3ds Max Top viewport. To use a spline

with Garment Maker and eventually Cloth, it must be a closed shape. This does not mean that you cannot have splines inside of splines, but if you have multiple spline shapes inside of one another, the inner splines are treated as "holes" in the fabric, as shown below.

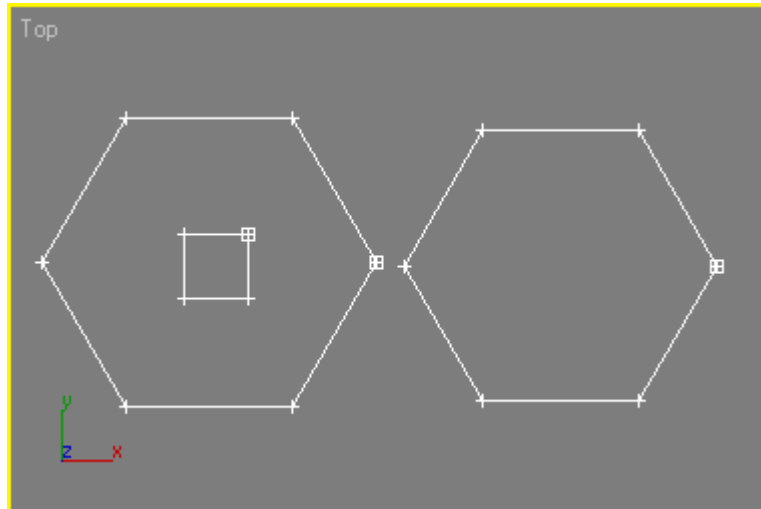

Two closed splines - one with a nested spline inside

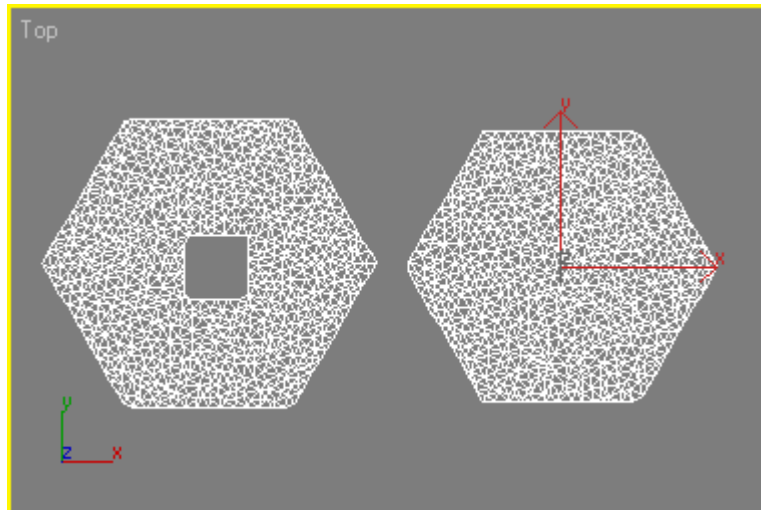

Resulting geometry after applying Garment Maker

---

**TIP** For best results, when applying Garment Maker to multiple splines, first combine the splines into a single object.

---

Also, to keep your patterns precise, no rounding of boundary edges and corners, you must break the splines at the corner vertices. This is also important because it directly impacts the segments of the splines that are to be used to create seams between the individual panels. To understand this better, take a look at the following example.

In the image below are two rectangular splines to which a user might want to apply Garment Maker. After applying Garment Maker, the idea is to then create a seam between the two panels along the inner edge. First, it should be noted that both splines are closed shapes and have been attached so they are part of the same editable spline object.

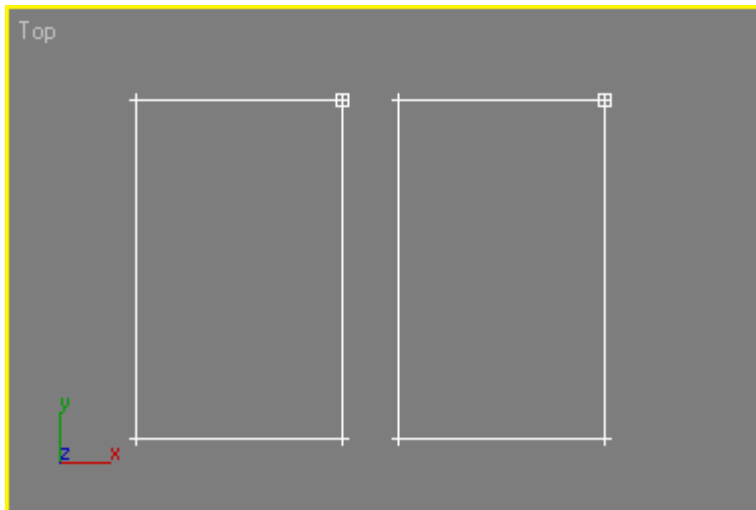

When Garment Maker is assigned, look what happens:



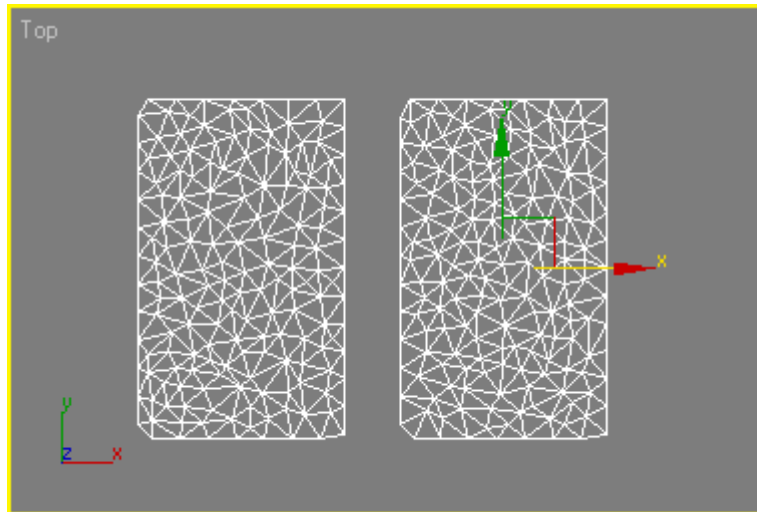

Garment Maker seems to have "chopped" corners of the rectangular splines off, altering the pattern. Beyond that, if the user tried to select the edges of the panels that make up the seam, they will not be able to. This is because Garment Maker currently has only a single spline to work with for each panel.

To keep the pattern clean, do the following:

- 1 Access the Vertex sub-object level of the editable spline.
- 2 Select the vertices where seams are to be created.
- 3 Click Break to create unique segments that Garment Maker can use to create a seam.

Shown below are the results when all of the vertices are selected and then broken.

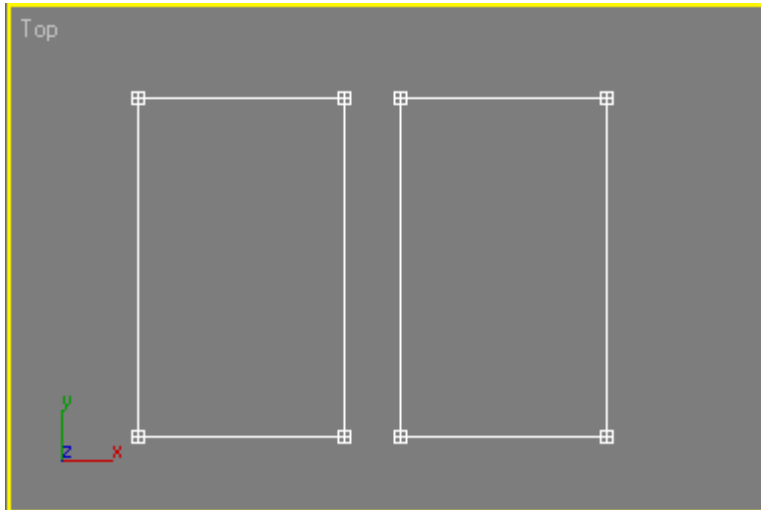

All vertices in both panels selected and then "broken"

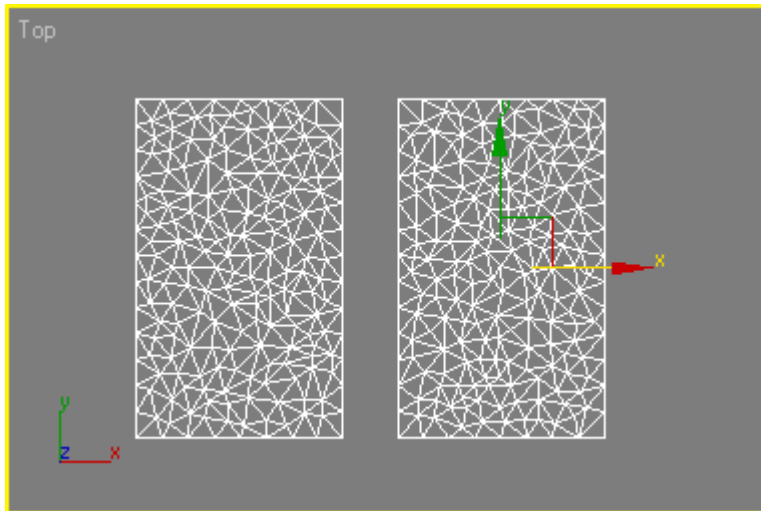

Garment Maker applied to "broken" splines

The corners are now preserved. When the user goes to select the edges between the panels to act as seams, they will be selected independently of the other panel edges and highlight in red. This is what you want in order to create seams.

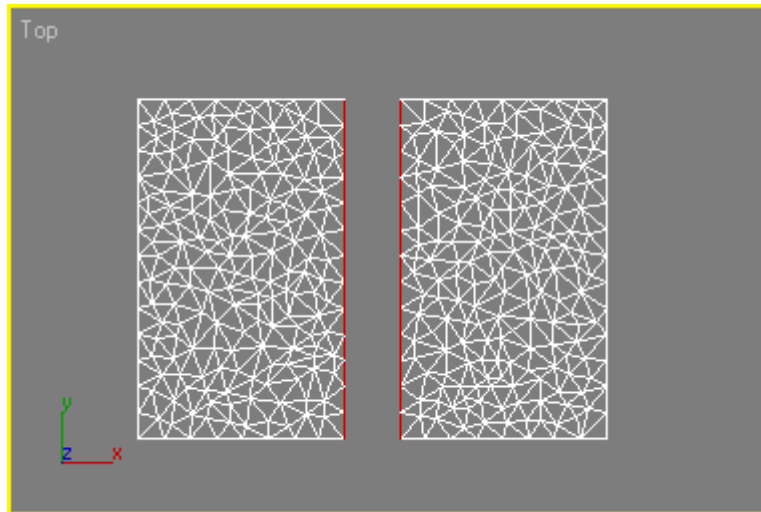

Seam edges selected at the Seam sub-object level in red

### **Garment Panels**

Garment Maker's Panels sub-object level lets you arrange the panels of the pattern around the character. You can then create seams where the panels should connect and be "sewn" together. This lets you create the seams you need while seeing how the clothing will look around your character. Creating seams like this is in many cases far superior to making them in a flat layout because it allows you to visualize what is being done.

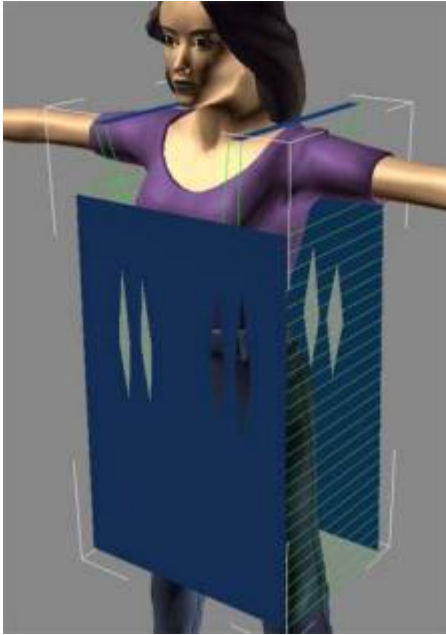

Arranged panels with seams defined

### **Pattern Creation**

To make patterns you can use the basic 2D spline tools in 3ds Max. Cloth comes with several patterns, but after you learn to use them, you will most likely want to start making your own. Patterns can take advantage of many features that real sewing patterns have, such as darts and multi-segment seams. To learn about other pattern making software, see [Pattern-Making Software](#) on page 1178 .

### **Tricky Assemblies**

As you begin to move beyond the basic patterns for your garments, there are a number of rules that you should follow in order to work effectively with Cloth:

- Always create your pattern splines in the Top viewport. Garment Maker assumes that the pattern is laid out this way.
- When seaming garments with MultiSegment edges, you must take care of the order in which the seams are made.

---

**NOTE** A MultiSegment comprises two or more individual segments acting as a single segment; you create it with Garment Maker.

---

When creating a seam you *cannot* use:

- A MultiSegment that has multiple gaps in it, unless all but one of those gaps are bridged by another seam.
- A segment or MultiSegment that forms a closed loop (that is, a path directly, or via seams, completely encloses the MultiSegment).

Both these issues arise in the common sleeve assembly shown below. The sleeve needs to be sewn to the armhole. When assembled, both the sleeve and the armhole form closed loops. The sleeve forms a loop via the seam along its underside. The armhole is closed by two seams: one across the shoulder and one down the side.

Now, since you cannot seam closed loops together, it therefore follows that both the armhole and sleeve must be left open when creating the seam connecting them. So the order is as follows:

- 1 Because the sleeve is one segment and the armhole is two segments, you must make a MultiSegment out of those two segments first.
- 2 When dealing with MultiSegment seams, the order of creation is important. If you attempt to create seams in the wrong order, you might get a “Seamline topology is wrong” error, and the seams will not be created. When dealing with MultiSegment seams, create the minimum number of seams necessary to make the MultiSegment seam match the topology of the other piece to that you are going to connect.  

In this case, you have an arm seam that is open at the bottom, and a MultiSegment that is open at both the top and the bottom. If you closed the side of the garment, you'd end up with the situation illustrated in the center image below, where the seam is twisted (it cannot be “untwisted” by reversing the seam). By closing the top of the armhole MultiSegment with a seam at the shoulder, you'll create proper topology to make the MultiSegment seam.
- 3 Next, you can seam up the sleeve to the armhole. See the leftmost image below.
- 4 Finally, you can add the seam down the side of the garment and across the underside of the sleeve (the order is irrelevant here).

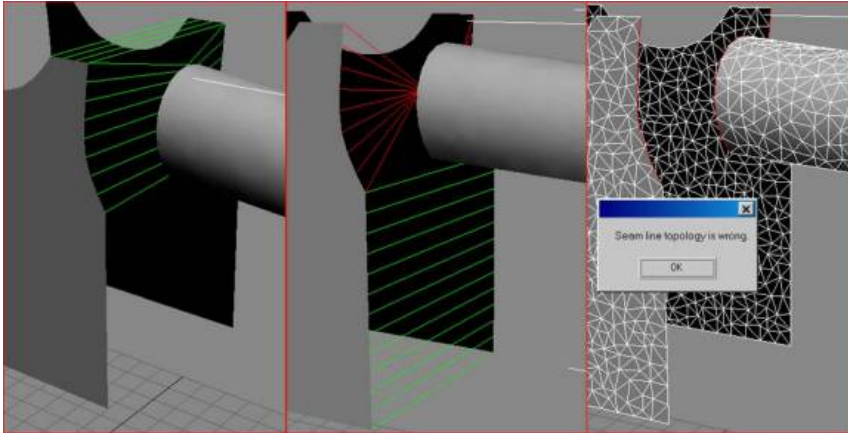

**Left:** Seam created for shoulder first and then for the MultiSegment, producing the desired result.

**Middle:** Seam created at the bottom of the body MultiSegment first, resulting in an irreversible MultiSegment seam from the arm to the body.

**Right:** No seams made on the body to connect its MultiSegment, resulting in a seam topology error.

### Internal Seam Lines

When drawing panels, you can use extra open splines to define seam lines within the panels, also known as internal seam lines. Triangulation always occurs along these internal seam lines, so you can use them to help define the structure of the cloth panel, and as [crease lines](#) on page 1257 . Also, you can specify that an internal seam line should be [cut](#) on page 1252 , so that the cloth separates along the line during the simulation.

To create an internal seam line, simply specify a Material ID of 2 for the internal spline, which should not be closed. Also, for best results, keep its endpoints away from other splines in the shape. And, as with outside seam lines, an internal spline should not cross over itself or other splines.

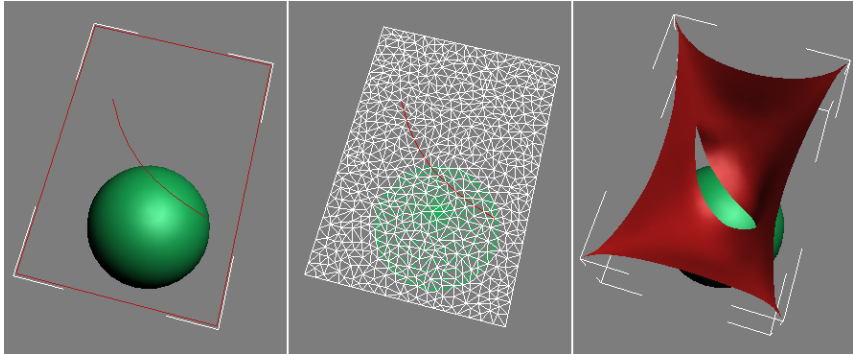

**Left:** Open spline, set to Material ID 2, specifies internal seam line.

**Center:** At Garment Maker > Curves or Seams sub-object level, seam line is selected and Cut is turned on.

**Right:** Cloth separates along cut line during simulation.

## Procedures

### To place garment panels automatically:

The Garment Maker modifier provides tools for positioning garment panels on a humanoid character model. This automatic placement is approximate; further adjustment is typically necessary.

- 1 Load or create your character model.
- 2 Create your panels as splines or NURBS curves parallel to the world XY plane (that is, create them in the Top viewport).

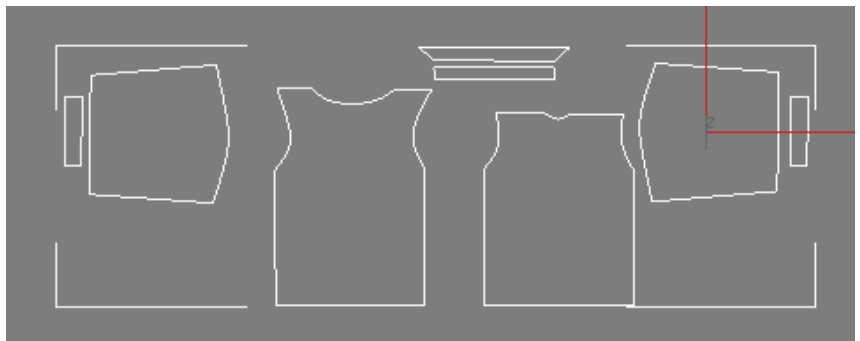

Shirt panels, as seen in the Top viewport

---

**TIP** When applying Garment Maker to multiple splines, for best results, first combine the splines into a single object. You can still manipulate the separate pieces within the Garment Maker modifier at the Panels sub-object level.

---

- 3 Apply the Garment Maker modifier. Set parameters as necessary.

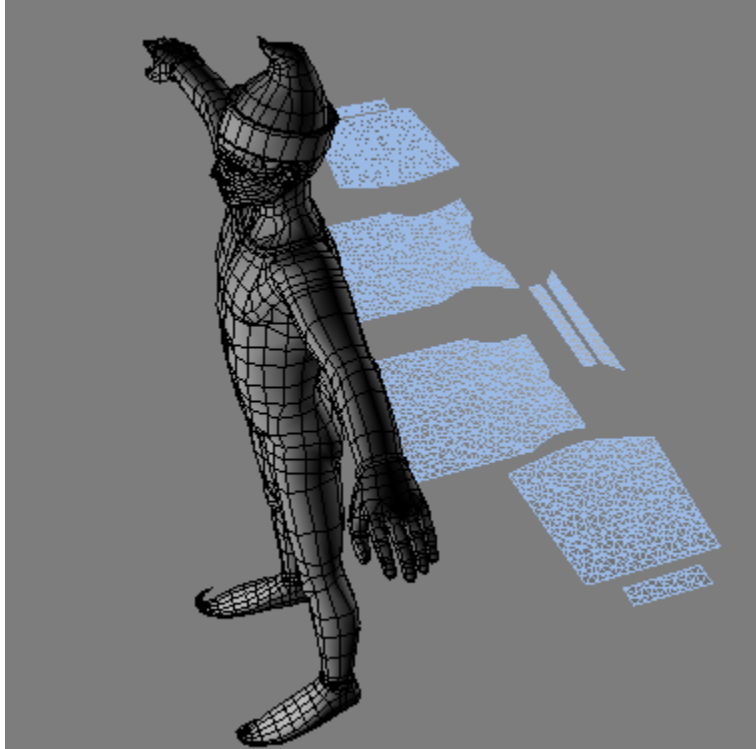

- 4 On the Main Parameters rollout, click the None button, and then click the character model.  
The object's name appears on the button.
- 5 Below this button, click the Mark Points On Figure button.  
A character outline appears in the corner of each viewport. Superimposed on the outline are seven asterisk-shaped points; the one at the center-top of the chest is highlighted in red.



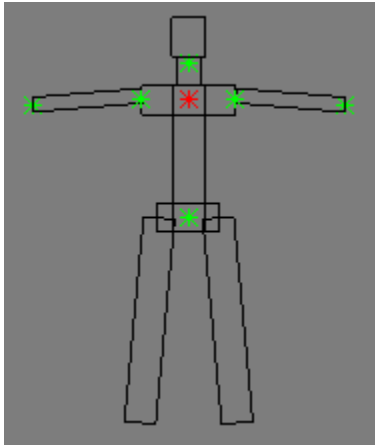

The character outline lets you mark points for positioning panels.

- 6 Click the corresponding point on the front of your model.

As you move the mouse cursor over the surface of the model, a red circle shows where the marker will be placed. When you click, an axis tripod appears on the surface at that location, and the next point on the character outline, at the center of the pelvic region, is highlighted in red.

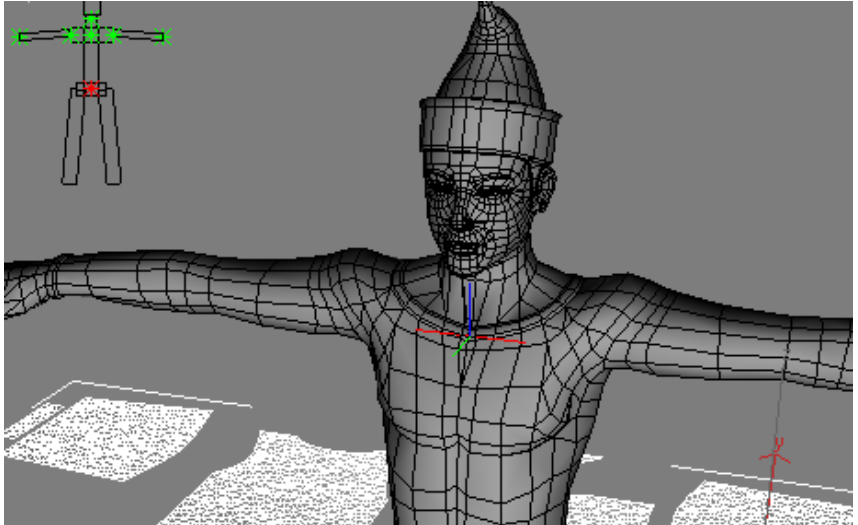

The axis tripod appears on the object surface where you click.

- 7 Continue to click at each location on your model that corresponds to the highlighted marker on the character outline until you've designated all seven points.

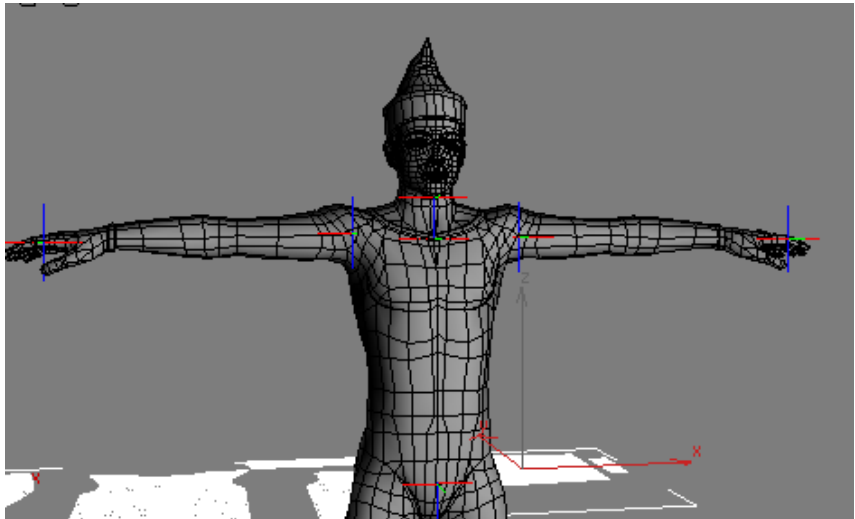

All seven points are marked on the character model.

To finish, right-click in the viewport.

- 8 Go to the Panels sub-object level and select a panel.

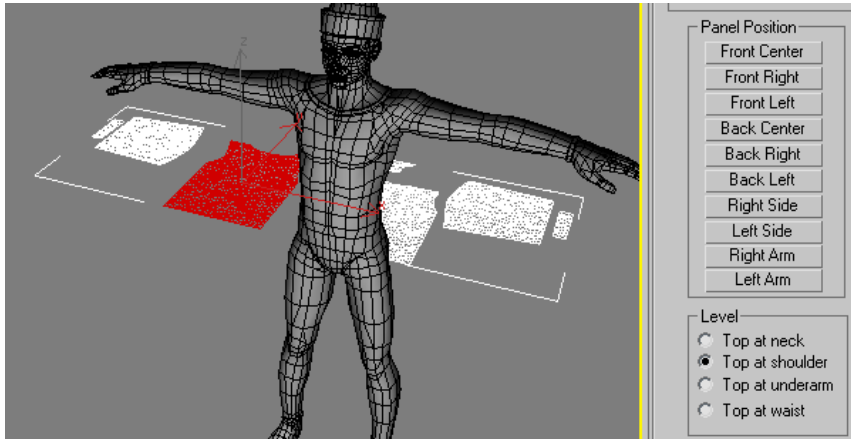

The front shirt panel is selected.

- 9 At the bottom of the Panels rollout, choose a Level, and then in the Panel Position group, click the button corresponding to the desired position for the panel.

The panel moves to the designated position.

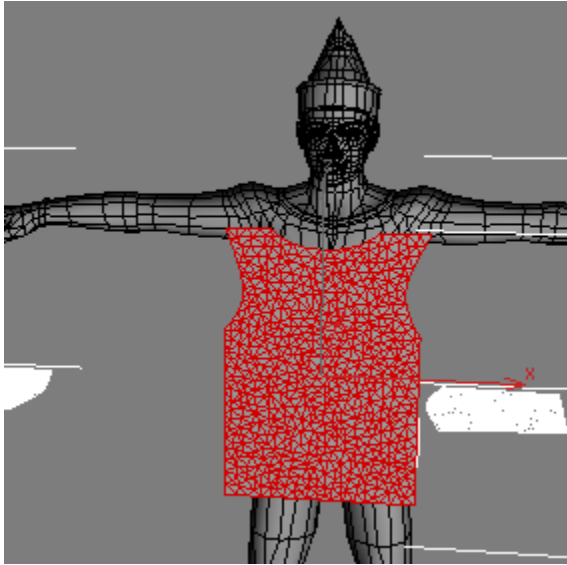

**Panel Position=Front Center; Level=Top at shoulder**

- 10 Adjust as necessary. For example, in the above illustration, Level should probably be set to Top At Neck. To correct this, you would choose Top At Neck, and then click Panel Position > Front Center again.

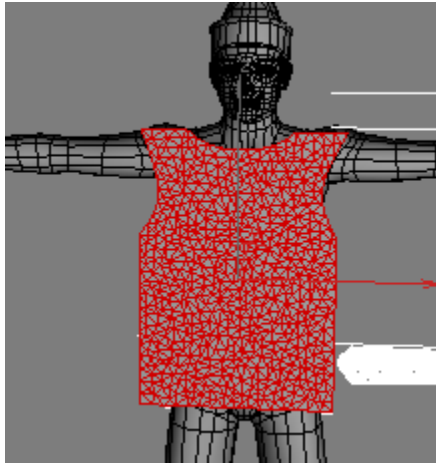

**Panel Position=Front Center; Level=Top at neck**

Of course, you can also move the panel manually; in fact, in most cases it will probably be necessary to do so. Panel Position serves primarily as a starting point for placing panels.

- 11** Continue selecting panels and placing them, adjusting as necessary.

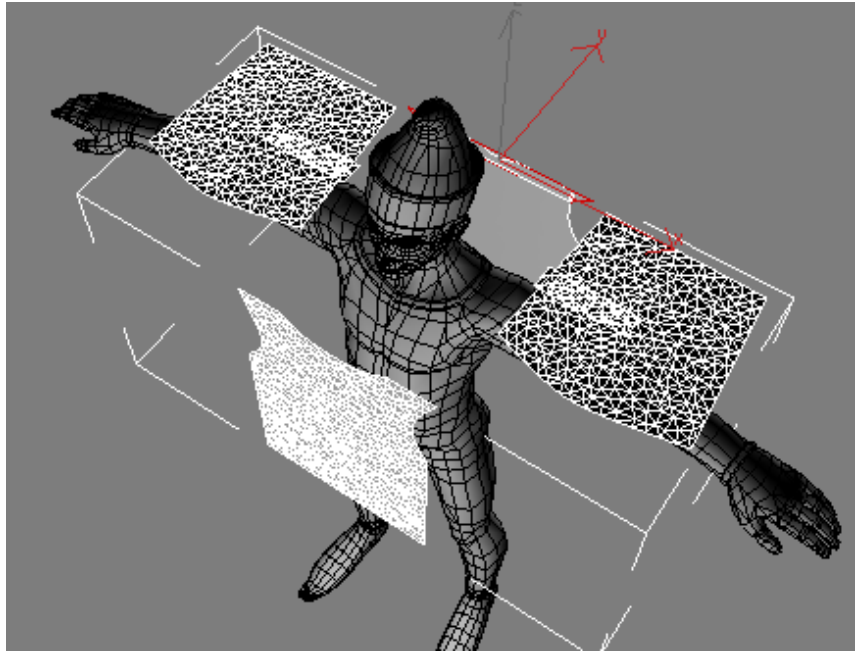

All panels placed with Panel Position. Note that sleeve panels need to be rotated 90 degrees, and cuff panels need to be rotated and moved to the wrists.

## Interface

The Garment Maker interface varies depending on the current modifier stack level: [object \(Main Parameters\)](#) on page 1243 or one of the four sub-object levels:

- [Curves](#) on page 1249
- [Panels](#) on page 1252
- [Seams](#) on page 1255

## Main Parameters rollout

The Main Parameters rollout is the first rollout you see on the Modify panel once you apply the Garment Maker modifier. This rollout comprises mostly controls to create and adjust the mesh.

The remaining rollouts are available at the sub-object levels.

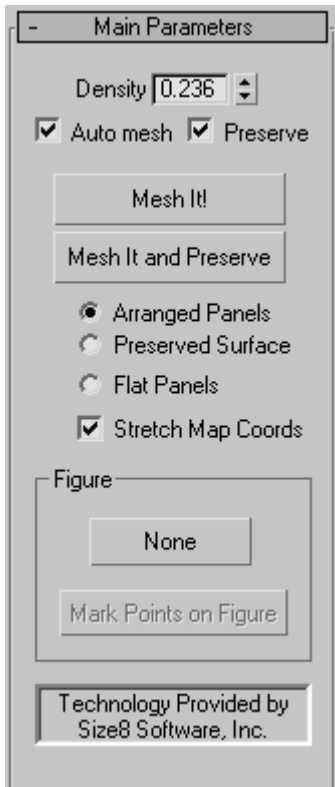

**Density** Adjusts the relative density of the mesh (in other words, the number of triangles per unit area). Possible values range between 0.01 and 10.0. A value of 10.0 creates a very dense mesh, while 0.01 creates a comparatively low-resolution mesh.

For best results, use the lowest possible density to achieve the desired result. This speeds up simulation time and overall performance.

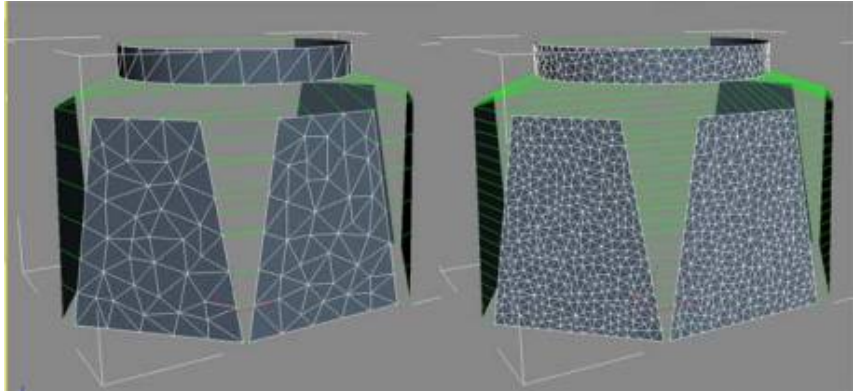

**Left: Density=0.5**

**Right: Density=1.5**

**Auto mesh** When on, Garment Maker updates the mesh automatically if you change the density or add/remove seams.

This setting is active at all sub-object levels, so it's recommended you leave it on to see changes as you make them. The only time you might want to turn off Auto Mesh is while creating the seams at the Curves sub-object level. Re-meshing can take some time, so you might want to define a number of seams before re-meshing.

**Preserve** When on along with Auto mesh, Garment Maker preserves the 3D shape of the object. When off, if you change the Density value, the panels are flat.

**Mesh It!** Applies a change in the Density value. If Auto mesh is off when you change the Density value, you must click the Mesh It! button to apply the change.

---

**TIP** Sometimes in an error condition Mesh It! will no longer respond. If this happens, go to the spline level in the modifier stack, and then return to the Garment Maker level.

---

**Mesh It and Preserve** Applies a Density change and also preserves the 3D shape of the object. This lets you change the density of the cloth or the

underlying spline shape after simulating without having to run the simulation again.

The following setting, comprising three radio buttons, determines how the cloth panels are passed up the modifier stack to the Cloth modifier:

- **Arranged Panels** With this option, the mesh passed up the stack will be have the panels arranged/bent around the figure as they were placed by the user in panels sub-object mode.
- **Preserved Surface** When both Auto mesh and Preserve are on, or when you click Mesh It And Preserve, Garment Maker takes a snapshot of the mesh at the top of the stack (where Cloth is applied). This snapshot is passed up the stack when you choose Preserved Surface. This way, if you change the Density value, the mesh will retain its deformation. Once a snapshot has been taken, at the Panel sub-object level, the panels will have the Use Preserved check box on. This means you can move the panels around while maintaining their deformation. Also note that once a snapshot has been taken, Garment Maker automatically chooses the Preserved Surface option.
- **Flat Panels** Displays all the panels as flat surfaces. This mode defines the texture coordinates of the garment vertices. With this output mode active, you can adjust texture coordinates at the Panel sub-object level by moving and rotating the panels.

**Stretch Map Coords** When on, Garment Maker uses the bounding box of the original spline shape in defining the texture mapping coordinates. The lower-left corner of the box is always assigned UV coordinates of (0,0). If Stretch Map Coords is on, the upper-right corner has coordinates of (1,1). This conforms to the 3ds Max convention for bitmap textures. If the box is off, the upper-right corner has coords (1,a) (a>1) or (a,1) (a>1), which are chosen to preserve the proportions of the box. This is appropriate for procedural textures.





**Left: Stretch Map Coords on**  
**Right: Stretch Map Coords off**

### **Figure group**

Use these controls to specify locations for each panel on the figure to be clothed

**[button]** Click this button, labeled “None” by default, and then click the object, or figure, to which the clothing is to be applied. Typically this is a character model. Thereafter, the name of the object appears on the button.

**Mark Points on Figure** After specifying a figure using the “None” button (see preceding), use this control to specify locations on the figure for automatically positioning panels in the garment.

When you click Mark Points On Figure, this character outline appears in the corner of each viewport:

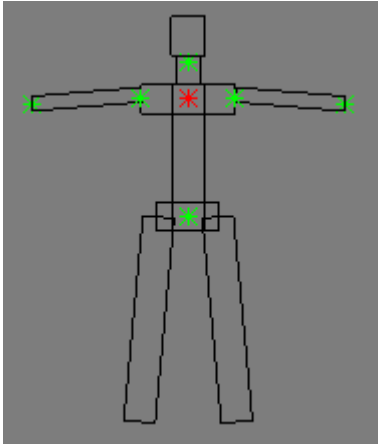

**The character outline lets you mark points for positioning panels.**

As each point highlights in red, click the corresponding location on your figure. When you do so, an axis tripod appears on the object surface and the next point on the outline highlights. During this process you can manipulate the viewport as usual, zooming, panning, and rotating freely. You can continue clicking points as long as you like; to stop, right-click in the viewport, or turn the button off.

---

**NOTE** If you return to marking points later, the software starts again where you left off earlier.

---

The points highlight in this order:

- 1 Upper Chest
- 2 Pelvis
- 3 Neck
- 4 Right shoulder
- 5 Left shoulder
- 6 Right hand
- 7 Left hand

After setting the points, you can use the [Panel Position](#) on page 1254 and [Level](#) on page 1254 controls at the Panels sub-object level to place the panels automatically.

## Curves rollout

Use the Curves sub-object level to stitch your pattern panels together. You can also connect seams in the Seams sub-object mode with a more three-dimensional representation of the panels. The Curves sub-object level provides a flat layout to work in that can be useful for more complex patterns. You can create and delete seams and adjust the way your pattern fits together.

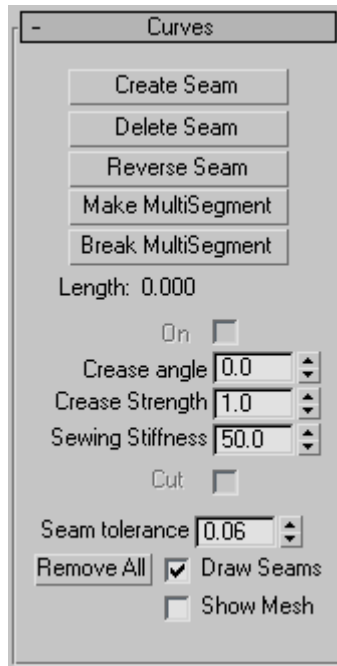

**Create Seam** Creates a seam between two segments. Select two segments of the panels you would like to sew together, and click Create Seam. This will make a seam between these two panels that will be sewn together at simulation time. Seams get a randomly-generated color to distinguish them from the panels.

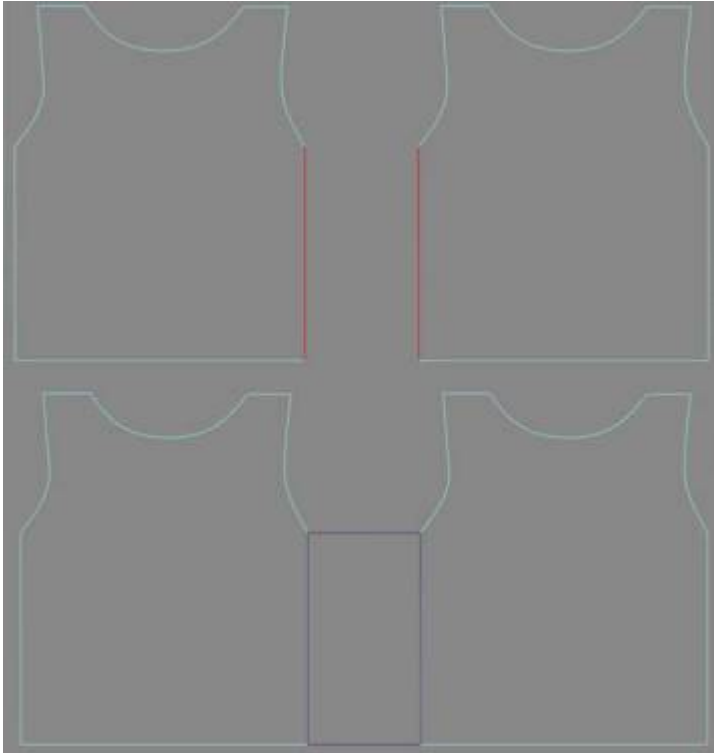

**Top: Segments selected**

**Bottom: Seam made between two panels**

**Delete Seam** Deletes selected seam. (Selected seam is colored red).

**Reverse Seam** Reverses or flips a twisted seam.

When creating seams, the first vertex on each segment is used to line up the resulting seam panel. Sometimes you can end up with a twisted seam and will need to use Reverse Seam to untwist it.

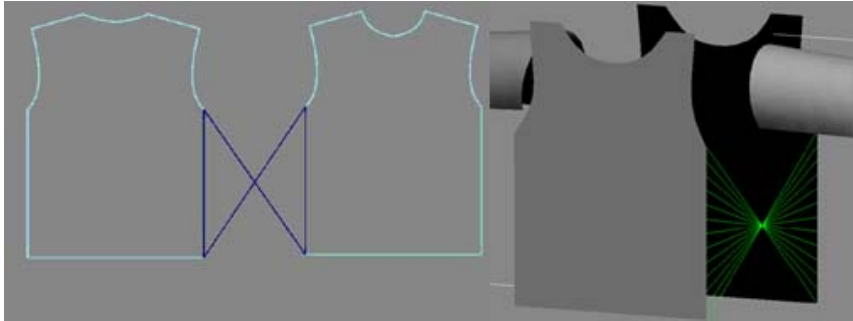

**A twisted seam that needs to be reversed**

**Make MultiSegment** A MultiSegment is a combination of two or more segments that will be treated as one segment for the purpose of creating seams. Select the segments you want to combine then click this button. Note that if the segments are not contiguous, the gaps must be bridged by seams before this MultiSegment can be used in a seam.

**Break MultiSegment** Break apart selected MultiSegments.

**On** Turns the selected seam on or off, making it active or inactive.

**Crease angle** Creates a crease at the selected seam. The angle value determines the target angle of the crease between the two panels or along an [internal seam line](#) on page 1236



**Left: High crease angle**

**Right: Low crease angle**

**Crease Strength** Increase or decrease the strength of the selected seam. This value affects how much the seam will resist bending in relation to the rest of the cloth object. A value of 2.0 means that the cloth will have twice the

resistance to bending that it would otherwise have (as defined by the object/panel/vertex group properties).

**Sewing Stiffness** The amount of force with which the panels are pulled together at simulation time. A larger value pulls the panels together harder and faster.

**Cut** Applies only to an [internal seam line](#) on page 1236 . Makes a cut in the fabric at this seam line.

**Seam Tolerance** The amount of difference in length between two edges that is permitted in the formation of a seam. The two segments that comprise a seam should be about the same length. If they have different lengths, the difference must be within this tolerance range. If you seam together two segments that are significantly different in length, the cloth will tend to bunch up (which could be a desired effect). In order to allow the creation of such a seam, the Seam Tolerance will need to be increased. The default value is 0.06, which means that the two segment lengths must be within 6 percent of each other's lengths.

**Draw Seams** Shows the seams in the viewport; hides them when off.

**Show Mesh** Shows the mesh in the viewport, or hides it to work on your pattern. When this option is off, the mesh is represented with a bounding box.

### **Panels rollout**

The Panels sub-object level of the Garment Maker modifier lets you position and bend the panels of your pattern to fit your object or figure. You can also use these controls to adjust the texture mapping of your garment.

**Density** Controls the mesh density of a selected panel. This value is applied as a multiplier of the [Main Parameters rollout > Density setting](#) on page 1244 . You can increase the density of a particular panel by raising this value.

If Main Parameters rollout > Auto Mesh is off when you change this value, go back to the Main Parameters rollout (Cloth level in modifier stack) and click [Mesh It!](#) on page 1245 to update the mesh. For this reason, it is recommended that you leave Auto Mesh on. The only time you might want to turn off Auto Mesh is while creating the seams at the Curves sub-object level. Re-meshing can take some time, so you might want to define a number of seams before re-meshing.



**Different Density settings applied to separate panels**

**Mat ID** Set the material ID for the selected panel. Using this option enables you to assign different materials to select portions of the clothing.

### **Position group**

**Reset** Resets the position of the selected panels to their original locations (that is, the locations immediately after Garment Maker was applied).

**Reset All** Resets the position of all panels to their original locations.

### **Deformation group**

Most controls in this group are available only when one or more panels are selected.

**Reset** Removes the deformation of the selected panels (restoring the flat state).

**Reset All** Removes the deformation from all panels.

**Use Preserved** Turn this on to override the None or Curved deformation options. When on, the panel gets its shape from the preserved mesh instead of the deformation options.

**None** Makes this panel flat.

**Curved** Use the value in the Curvature field to bend the panel.

**Curvature** Sets the amount of curve or bend of a panel. The higher this value is, the more the panel will curve.

**X-axis** Sets the axis for the curvature to the panel's local X axis.

**Y-axis** Sets the axis for the curvature to the panel's local Y axis.

**Panel Position** Moves the selected panel to the position specified by the button you click. These locations are determined by the software based on the positions you set with the [Mark Points On Figure](#) on page 1247 controls at the Garment Maker object level. The positions are:

- Front Center
- Front Right
- Front Left
- Back Center
- Back Right
- Back Left
- Right Side
- Left Side
- Right Arm
- Left Arm

---

**NOTE** The terms Front, Back, Right, and Left refer to the character's orientation.

---

**Level** Sets where the top of the panel should go. Garment Maker derives these locations from the locations you specify with the [Mark Points On Figure](#) on page 1247 controls. The choices are:

- Top at neck
- Top at shoulder



- Top at underarm
- Top at waist

If you change the setting here, it affects the subsequent Panel Position results.

### **Adjusting Texture Coordinates**

When Garment Maker is in Flat Panels mode (that is, the Main Parameters rollout > [Flat Panels option](#) on page 1246 is chosen), the texture coordinates are defined by the positions of the panels. Imagine the panels are being cut out of a large piece of fabric. The location and orientation of a panel in that large piece of fabric determine how the texture is aligned on it. By moving and rotating a panel, you can change its texture coordinates. Remember, you must be in Flat Panels mode to do this.

### **Seams rollout**

At the Seams sub-object level, you can define and edit seams and their properties. Seams have the same functionality as curves, but at this level the mesh is displayed three-dimensionally instead of in a flat layout. Also, at this level the mesh is always updated when you add or remove a seam.

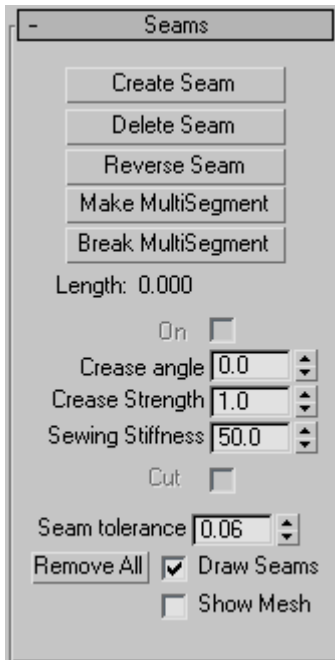

**Create Seam** Creates a seam between two segments. Select two segments of the panels you would like to sew together and then click Create Seam. This creates a seam between the two panels that will be sewn together at simulation time.

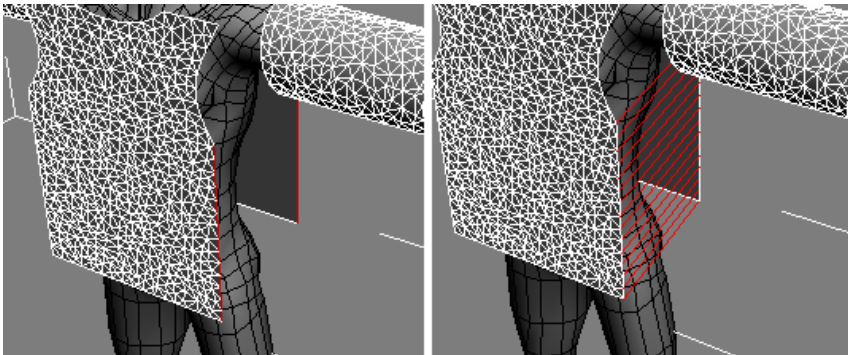

**Left:** Segments selected

**Right:** Seam created between the two segments

**Delete Seam** Deletes selected seam. (Selected seam is colored red).

**Reverse Seam** Reverses or flips a seam that has been made with a twist in it. When creating seams, the first vertex on each segment is used to line up the resulting seam panel. Sometimes you can end up with a twisted seam and will need to use Reverse Seam to untwist it.

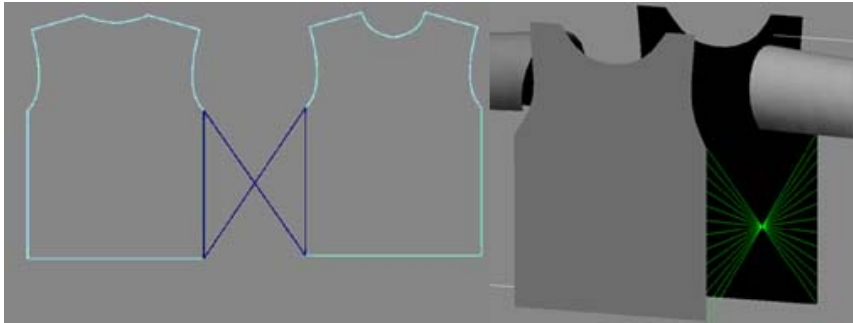

A twisted seam that needs to be reversed

**Make MultiSegment** A MultiSegment is a combination of two or more segments that will be treated as one segment for the purpose of creating seams. Select the segments you want to combine then click this button. Note that if the segments are not contiguous, the gaps must be bridged by seams before this MultiSegment can be used in a seam.

**Break MultiSegment** Break apart selected MultiSegments.

**On** Turns the selected seam on or off, making it active or inactive.

**Crease angle** Creates a crease at the selected seam. The angle value determines the target angle of the crease between the two panels or along an [internal seam line](#) on page 1236 .



Left: High crease angle

Right: Low crease angle

**Crease Strength** Specifies the strength of the selected seam. This value affects the extent to which the seam resists bending in relation to the rest of the cloth object. A value of 2.0 means that the cloth will have twice the resistance to bending that it would otherwise have (as defined by the object/panel/vertex group properties).

**Sewing Stiffness** The amount of force with which the panels are pulled together at simulation time. A larger value will pull the panels together harder and faster.

**Cut** This applies only to an [internal seam line](#) on page 1236 . Makes a cut in the fabric at this seam line.

**Seam Tolerance** The amount of difference in length between two edges that is permitted in the formation of a seam. The two segments that comprise a seam should be about the same length. If they have different lengths, the difference must be within this tolerance range. If you seam together two segments that are significantly different in length, the cloth will tend to bunch up (which may be a desired effect). In order to allow the creation of such a seam, the Seam Tolerance will need to be increased. The default is 0.06, which means that the two segment lengths must be within 6%.

**Remove All** Deletes all seams.

**Draw Seams** Shows the seams in the viewport; hides them when turned off.

**Show Mesh** Show the mesh in the viewport, or hide it to work on your pattern. When this option is off, the mesh is represented with a bounding box.

## Troubleshooting and Error Codes in Garment Maker

When you are working with Garment Maker, you may encounter errors if your splines are set up incorrectly. Here is a list of the common error messages you may see, and how to correct them.

**Cannot remesh: the number of panels has changed:** This error occurs when the user has modified the original pattern, and added new closed splines to it. The only way to correct this is to delete the original Garment Maker modifier and reapply a new one.

**Number of boundary curves has changed:** Users will get this error if they add or remove splines from the pattern after the initial application of Garment

Maker. To correct it, delete the original Garment Maker modifier and reapply a new one.

**Boundary splines do not form a closed loop:** In this case, the splines that the user has tried to apply Garment Maker to don't form closed loops. Often, this is caused by an extra vertex and segment attached to one of the splines, and usually this segment is so small you cannot see it. It can be difficult to find the offending part. To remedy this situation, select all the vertices, weld them, then re-break them at the corners.

**Splines form overlapping loops:** When a user gets this error, it means that some panel loops overlap others (in the XY plane of the local view). If you create the shape in the Top view this should not happen (provided you don't create overlapping loops). Most commonly, this occurs when the user create the splines in a viewport other than Top and on a plane other than the XY plane.

**Unable to create seam:** This error happens in when trying to create a seam in two cases:

- One (or more) of the segments/MultiSegments in the attempted seam forms a closed loop (for example, if you make a MultiSegment from the armhole segments, that MultiSegment forms a closed loop if you create seams at the shoulder and below the armhole). You will have to delete one of the seams so that the MultiSegment is no longer closed. For an armhole, you generally keep the seam below the armhole open when you join it with the sleeve. You can then close the seam. For the same reason, the sleeve cannot be seamed at the underside before joining to the armhole.
- A MultiSegment in the attempted seam contains segments that are not contiguous and that are not linked by any seam.

## CrossSection Modifier

Select a spline object with spline cross sections. > Modify panel > Modifier List > CrossSection

Make a selection. > Modifiers menu > Patch/Spline Editing > CrossSection

The CrossSection modifier creates a "skin" across multiple splines. It works by connecting the vertices of 3D splines to form a skin. The resulting object is another spline object that can be used with the [Surface modifier](#) on page 1695 to create a patch surface. These two modifiers, when used together, are sometimes referred to collectively as "Surface Tools."

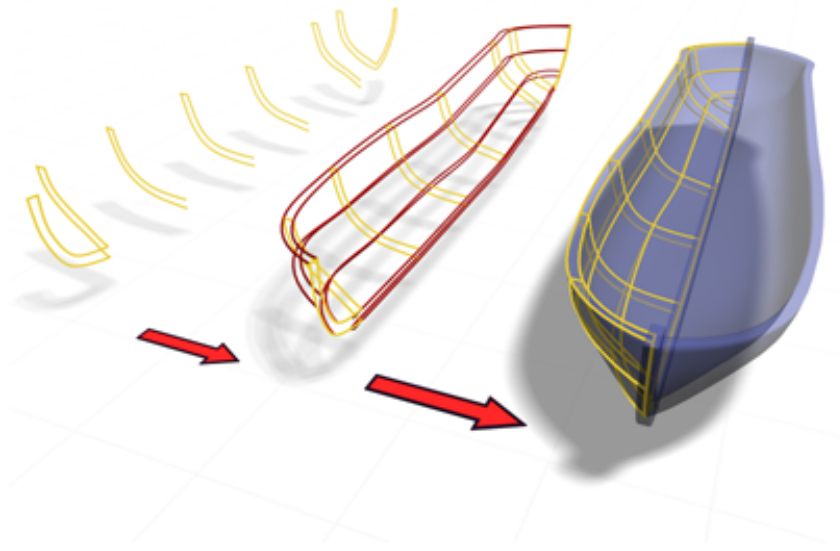

**CrossSection uses splines to create a model of a boat.**

CrossSection can build a skin across various-shaped splines with different vertex counts and open/closed status. The more different the splines in vertex count and complexity, the more likely the skin will have discontinuity.



---

**NOTE** Similar functionality is provided by the [Editable Spline object](#) on page 590 . At the Editable Spline > Segment and Spline sub-object levels, you can create a spline cage using Connect Copy and Cross Section. Using this method, you need to region-select the created vertices to transform them. Also, this method lets you define the ordering of the spline more easily than does the CrossSection modifier.

---

## Procedures

**Example:** To explore the CrossSection modifier:

- 1   On the Create panel, click Shapes, then click Circle.
- 2 Drag in the Top viewport to create a circle about **100** units in radius.

- 3  On the Modify panel, choose Edit Spline from the Modifier List.
- 4 In the modifier stack display, turn on Spline sub-object, then select the circle.
- 5 In the Front viewport, Shift+Move the spline up to copy it.
- 6 Shift+Move the copy up to create a third circle.

---

**NOTE** The order that you attach or clone splines is important: this is the order that CrossSection uses to create the skin.

---

- 7  On the Modify panel, choose CrossSection from the Modifier List. CrossSection joins the vertices of the three circles. A basic spline cylinder is displayed.

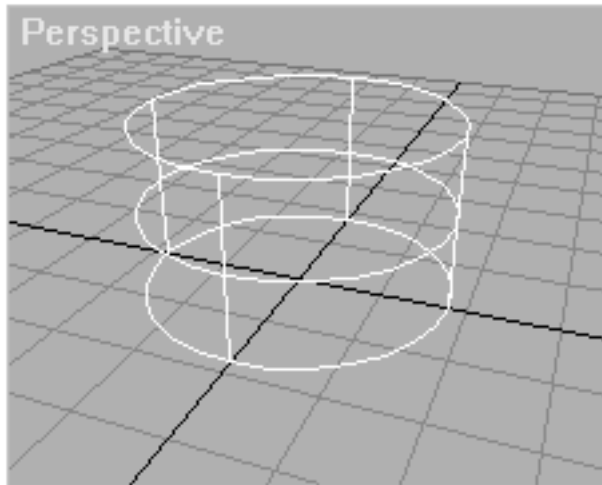

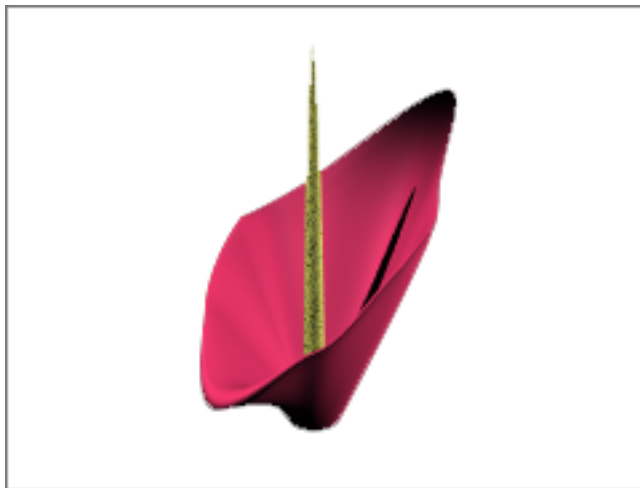
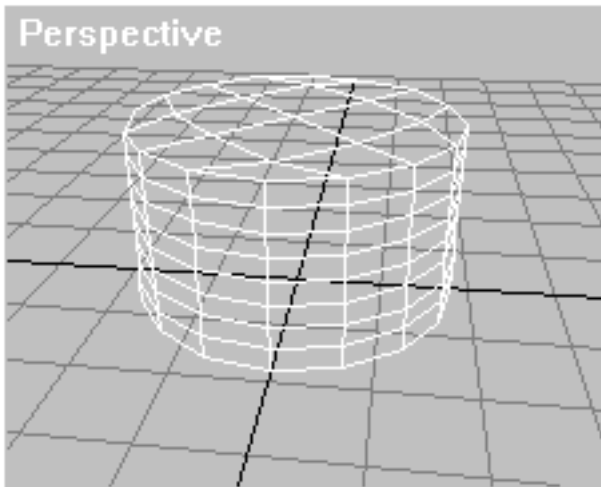

- 8 On the Modify panel, on the Modifiers List, choose Surface to add the Surface modifier.  
The spline cylinder is transformed into a patch surface by the Surface modifier.
- 9 To edit the model's surface, change the splines using controls in the Edit Spline modifier. Or, since the output of the Surface modifier is a patch surface, add an Edit Patch modifier and use patch edit controls to change the surface.





An Edit Patch modifier above the Surface modifier was used to create the image.

**Example: Using the CrossSection modifier to skin several splines with different shapes:**

- 1   On the Create panel, click Shapes.
- 2 On the Object Type rollout, turn on Start New Shape, then click NGon.



3 In the Top viewport, create two five-sided circular NGons.

4   On the Create panel, with Shapes still active, click Line. Create two lines, each with four vertices. Create the vertices left-to-right.



5  On the main toolbar, click Select And Move, then move the objects in the viewport to order them along the Z axis with the NGons at the bottom and the lines above the NGons.

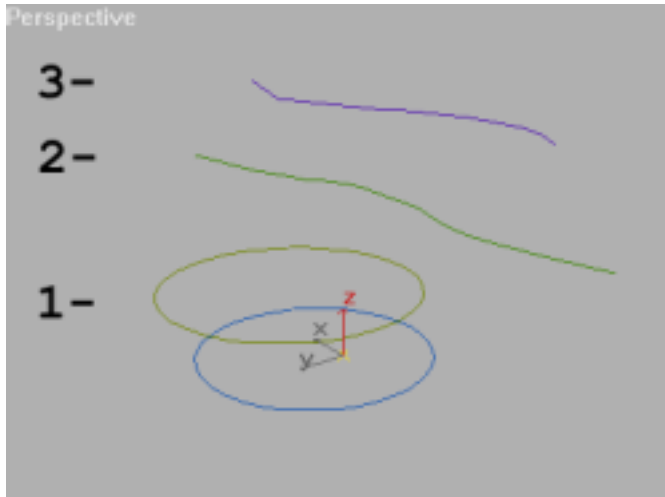

6 Select the bottom NGon.



7 On the Modify panel, choose Edit Spline from the Modifier List.

8 In the Geometry rollout, click Attach.

9 Select the remaining NGon and lines in an ascending order, as numbered in the image.

---

**NOTE** The order of selection is important. The CrossSection modifier uses the selection order to define the skin.

---

#### Example continued: Lining up the vertices:



1 On the Modify panel, choose the Vertex sub-object level in the stack display.

Lining up the first vertex of each spline is important to prevent the surface from twisting.

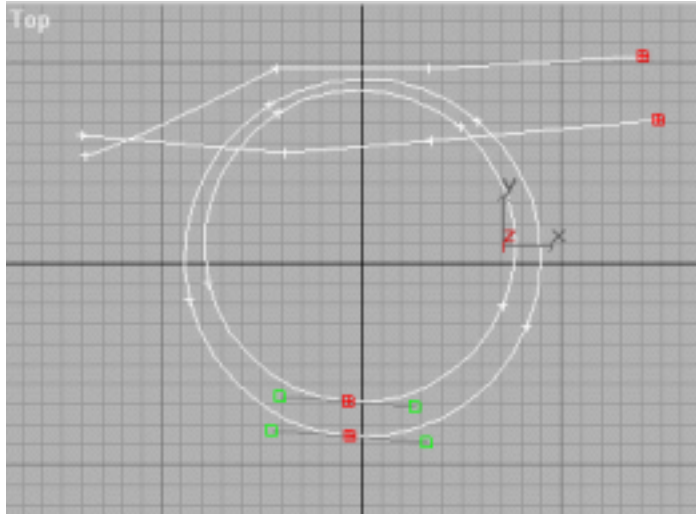

2 Use Ctrl+click to select the rightmost vertex of each line and the bottommost vertex of each NGon.

3 On the Geometry rollout, click Make First.



Aligning the first vertex is important. This is where the seam forks, going from a closed to an open spline.

**Example continued: Using CrossSection and Surface to "skin" the shapes:**

- 1  On the Modify panel, choose CrossSection from the Modifier List. The CrossSection modifier connects the splines at the vertices.
- 2 On the Modifiers List, choose Surface. The Surface modifier generates a patch surface based on the splines.
- 3 In the modifier stack display, choose the CrossSection modifier.
- 4 On the CrossSection Parameters rollout, toggle between Linear and Smooth. Notice how the splines change.
- 5  On the Modify panel, toggle the Show End Result On/Off Toggle button to display the final patch surface. The toggle won't remain on if the CrossSection modifier is current. Drop down to the Editable Patch in the stack and turn on the Show End Result toggle if you like.

---

**TIP** When you use CrossSection, draw splines in a consistent direction. A twisted surface results when lines are created from vertices that are not lined up.

---

## Interface

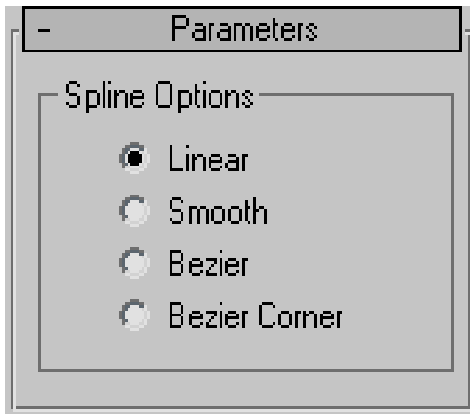

**Linear/Smooth/Bezier/Bezier Corner** Determines what type of curve will be used through the spline vertices.

## Delete Mesh Modifier

Modify panel > Make a sub-object selection. > Modifier List > Delete Mesh

Modify panel > Make a sub-object selection. > Modifiers menu > Mesh Editing > Delete Mesh

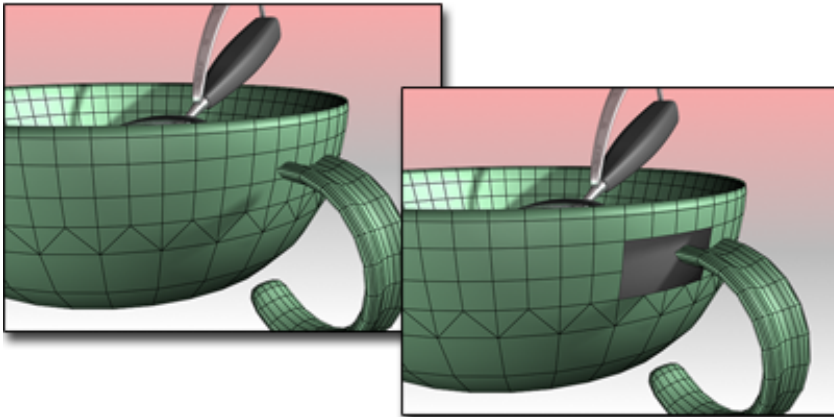

Delete Mesh used to remove the faces where the handle joins the cup.

Delete Mesh provides parametric deletion based on the current sub-object selection level in the stack. The possible choices are faces, vertices, edges, and objects. Apply the Delete Mesh modifier to delete the geometry specified at that sub-object level.

For example, you can apply a [Mesh Select modifier](#) on page 1455 , select a row of faces in a cylinder, and then apply a Delete Mesh modifier to delete those faces. To undo the deletion, you can simply remove the Delete Mesh modifier.

---

**TIP** Try applying a Delete Mesh modifier following an animated [Vol. Select modifier](#) on page 1910 .

---

## Procedures

**Example: To delete a row of faces in a cylinder:**

- 1 Create a [cylinder](#) on page 364 .
- 2 Apply a Mesh Select modifier and select a row of faces in the cylinder.
- 3 Apply the Delete Mesh modifier to delete those faces.



To undo the deletion, remove the Delete Mesh modifier.

## Interface

This modifier has no parameters.

# Delete Patch Modifier

Modify panel > Make a patch selection. > Modifier List > Delete Patch

Make a selection. > Modifiers menu > Patch/Spline Editing > Delete

Delete Patch provides parametric deletion based on the current sub-object level in the stack. The possible choices are vertices, edges, patches, and elements. Apply the Delete Patch modifier to delete the geometry specified at that sub-object level.

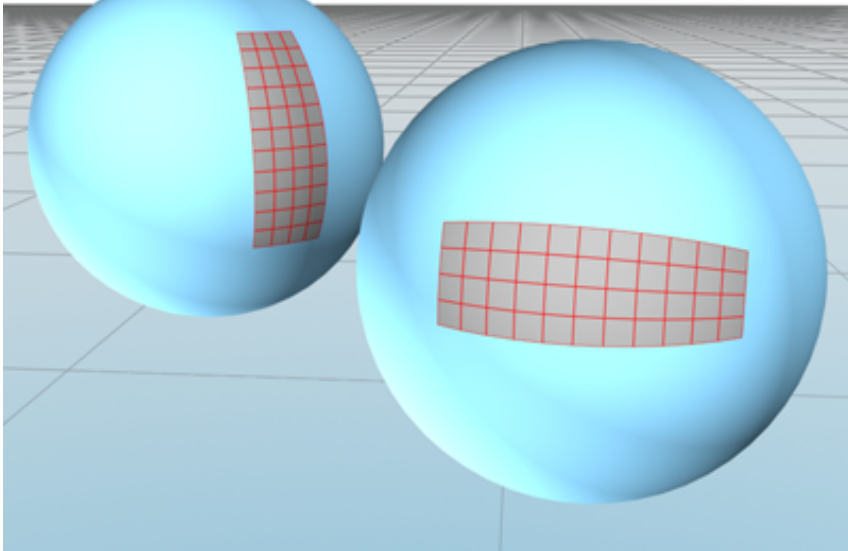

For example, you can apply a Patch Select modifier, select a row of patches in a patch sphere, and then apply a Delete Patch modifier to delete those patches. To undo the deletion, remove the Delete Patch modifier.



Delete Patch used to remove sections of a patch sphere.

## Procedures

**Example: To delete a patch in a sphere:**

- 1 Create a sphere.
- 2 Right-click the sphere, and choose Convert To > Convert To Editable Patch on the quad menu.
- 3  On the Modify panel, in Editable Patch, choose the Patch sub-object level, and select a patch.
- 4 In the Modifier List, choose the Delete Patch modifier.  
This deletes the selected patch.  
 To undo the deletion, remove the Delete Patch modifier.

## Interface

There are no parameters for this modifier.

## Delete Spline Modifier

Modify panel > Select a spline sub-object. > Modifier List > Delete Spline

Modify panel > Select a spline sub-object. > Modifiers menu > Patch/Spline Editing > Delete Spline

The Delete Spline modifier provides parametric deletion of spline geometry based on the current sub-object selection level in the stack. The possible selection levels include vertices, segments, and splines. Apply the Delete Spline modifier to delete the geometry specified at that sub-object level.

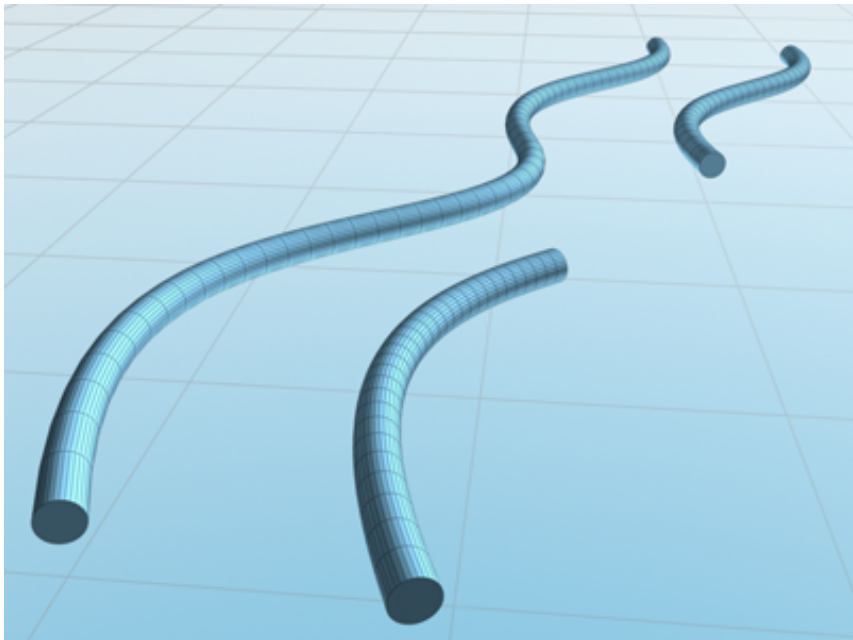

Delete Spline used to remove a segment in the middle of a spline.

## Procedures

To use the delete spline modifier:

- 1 Create a shape that contains multiple splines.
- 2 Apply a [Spline Select modifier](#) on page 1673 and select a section of the spline for deletion.
- 3 Apply a Delete Spline modifier to delete the section.



To undo the deletion, remove the Delete Spline modifier.

## Interface

This modifier has no parameters.

# Disp Approx Modifier

Modify panel > Make a selection. > Modifier List > Object-Space Modifiers > Disp Approx

Make a selection. > Modifiers menu > Surface Deformers > Disp Approx

Make a selection. > Modifiers menu > NURBS Editing > Disp Approx

The Disp Approx modifier (short for Displacement Approximation) lets you make the displacement mapping settings on an object in the [modifier stack](#) on page 7427 . It converts its input object to an [editable mesh](#) on page 1990 , so you can use this modifier to add displacement mapping to [geometry primitives](#) on page 348 and any other kind of object that can convert to an editable mesh.



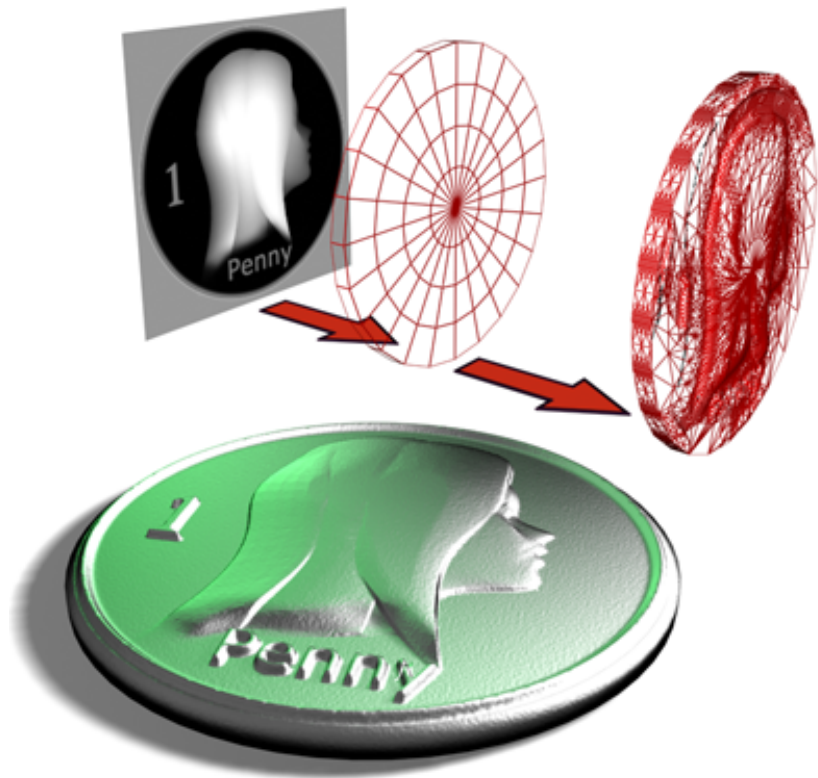

Using an image to displace the surface of a cylinder

[Displacement mapping](#) on page 5391 uses a map to change surface geometry. You apply the map using the [Material Editor](#) on page 5188 .

You don't need to apply this modifier to [NURBS](#) on page 2152 surfaces, [patches](#) on page 1982 , [editable meshes](#) on page 1990 , or [editable polymeshes](#) on page 2038 , because you can apply displacement mapping directly to these kinds of objects.

### Procedures

To apply displacement mapping:

- 1 Select an object other than a NURBS surface, patch, editable mesh, or editable poly.

- 2 Apply the Disp Approx modifier.

Now you can apply displacement mapping to the object. The Displacement Approx. rollout has parameter that you can adjust, but displacement mapping will work using the default settings.



- 3 Go to the Material Editor. Apply a Standard material to the object.
- 4 In the material's Maps rollout, click the Displacement button, then use the Material/Map Browser to apply a displacement map.

## Interface

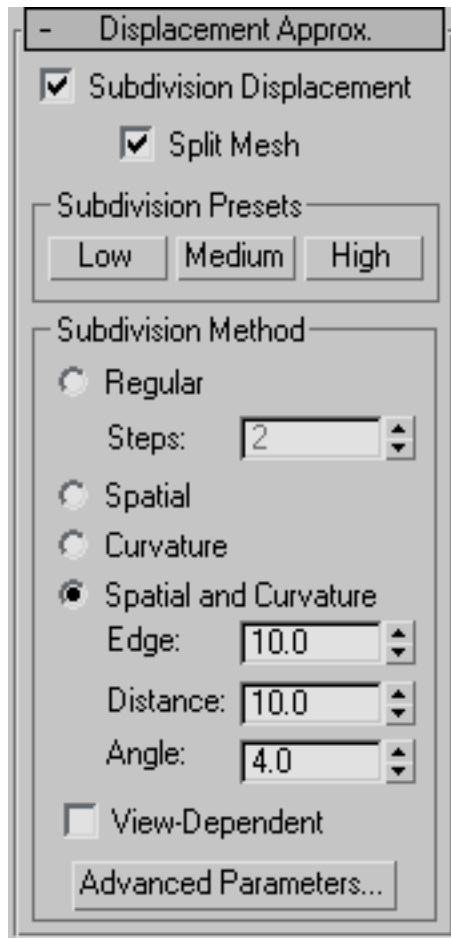

**Subdivision Displacement** Subdivides mesh faces to accurately displace the map, using the method and settings you specify in the Subdivision Presets and Subdivision Method group boxes. When turned off, the modifier applies the map by moving vertices in the mesh, the way the [Displace modifier](#) on page 1274 does. Default=on.

**Split Mesh** Affects the seams of displaced mesh objects; also affects texture mapping. When on, the mesh is split into individual faces before displacing them; this helps preserve texture mapping. When off, texture mapping is assigned using an internal method. Default=on.

---

**TIP** This parameter is required because of an architectural limitation in the way displacement mapping works. Turning Split Mesh on is usually the better technique, but it can cause problems for objects with clearly distinct faces, such as boxes, or even spheres. A box's sides might separate as they displace outward, leaving gaps. And a sphere might split along its longitudinal edge (found in the rear for spheres created in the Top view) unless you turn off Split Mesh. However, texture mapping works unpredictably when Split Mesh is off, so you might need to add a [Displace Mesh modifier](#) on page 1045 and make a [snapshot](#) on page 921 of the mesh. You would then apply a [UVW Map modifier](#) on page 1849 and then reassign mapping coordinates to the displaced snapshot mesh.

---

### **Subdivision Presets and Subdivision Method group boxes**

The controls in these two group boxes specify how the modifier applies the displacement map when Custom Settings and Subdivision Displacement are both turned on. They are identical to the [Surface Approximation controls](#) on page 2469 used for NURBS surfaces.

## **Displace Modifier**

Modify panel > Make a selection. > Modifier List > Object-Space Modifiers > Displace

Make a selection. > Modifiers menu > Parametric Deformers > Displace

The Displace modifier acts as a force field to push and reshape an object's geometry. You can apply its variable force directly from the modifier gizmo, or from a bitmapped image.

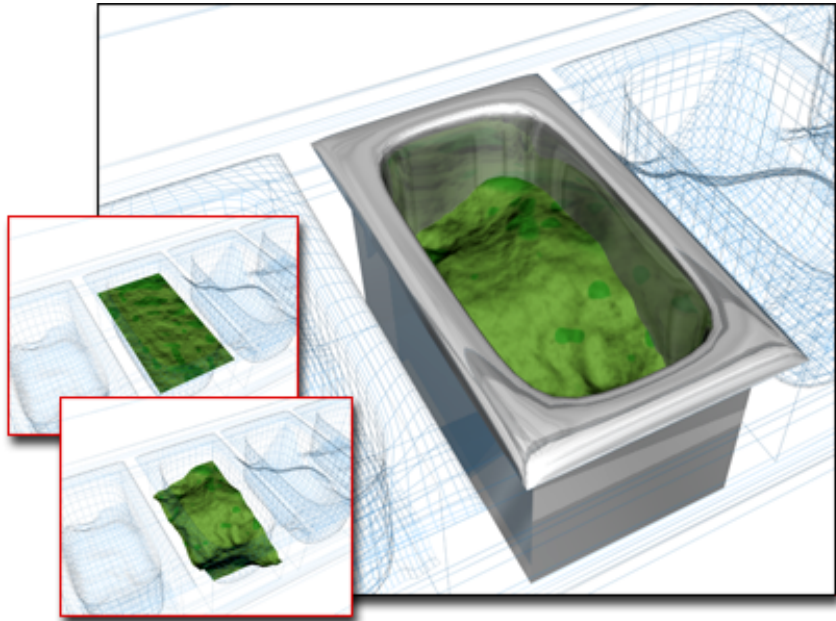

#### **Displace used to change the surface in the container**

There are two basic ways to use the Displace modifier:

- Apply displacement effects directly by setting Strength and Decay values.
- Apply the grayscale component of a bitmapped image to generate the displacement. Lighter colors in the 2D image push outward more strongly than darker colors, resulting in a 3D displacement of the geometry.

The [Displace space warp](#) on page 2645 has similar features. It's useful for applying effects to a large number of objects or a particle system.

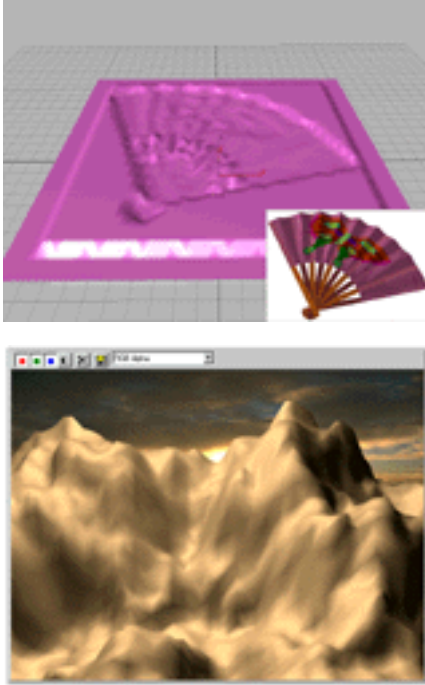

Top: Bitmap displacement on a patch and the bitmap used.

Bottom: Terrain effects using Displace

### Force Distribution

Displace distributes its force through four different gizmos: Planar, Cylindrical, Spherical, and Shrink Wrap. Gizmos are also used as mapping coordinates for applying bitmaps. Sphere and Shrink Wrap have the same effect when modeling, but differ in the way they map.

The Spherical and Shrink Wrap gizmos begin with a uniform field around them. The Cylinder and Planar gizmos are both directional. Cylinder pushes at right angles to its axis, and Planar pushes at right angles to its surface.

By default, gizmos are centered on the object. However, you can transform any of these shapes and use it directly as a tool to deform the geometry of an object.

## Modeling Options

Displace is a versatile modifier with many possible applications. Here are some options:

- Produce interior modeling effects by scaling down the gizmo and moving it inside the object. The outward force shapes the geometry from within.
- Animate the modeling process. One result is a roving, magnetic-like field that pushes and pulls on a surface.
- Add additional Displace modifiers to an object, using each one to create a different modeling effect.
- Collapse a finished model into a plain mesh. This reduces the object's complexity and removes all modifiers, but keeps the modeled surface intact.

## Procedures

### To displace an object:

- 1 Select an object and apply the Displace modifier.
- 2 In the Parameters rollout > Map group, select one of the four gizmo types.
- 3 In the Displacement group, set values for Strength and Decay. Vary these settings to see the effect of the displacement on the object.

Depending on the object and the complexity of the bitmap, you might need to use dense geometry to see the effect clearly. Try a test run and, if necessary, add tessellation in the areas of greatest detail.

### To apply a bitmap as a displacement map:

- 1 In the Parameters rollout > Image group, click the Bitmap button (which is labeled "None" until a map has been chosen). Use the file dialog to choose a bitmap.
- 2 Adjust the Strength value. Vary the strength of the field to see the effect of the bitmap displacing the object's geometry.

After you get the image you want from bitmapped displacement, you can apply an [Optimize modifier](#) on page 1515 to reduce the complexity of the geometry while retaining the detail.

### To model with the displace modifier:

- 1 Apply Displace to the object you want to model. Choose a gizmo from the Map group.
- 2 Increase the Strength setting until you begin to see a change in the object.
- 3 Scale, rotate, and move the gizmo to concentrate the effect. As you do this, adjust the Strength and Decay settings to fine-tune the effect.

### Interface

#### Displacement group

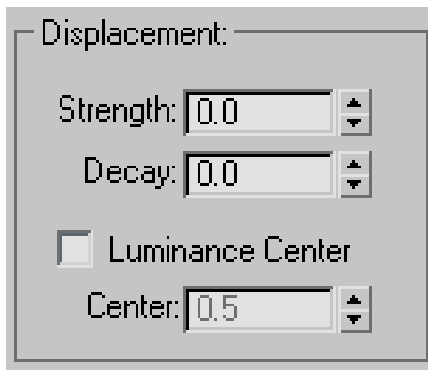

**Strength** When set to 0.0, Displace has no effect. Values greater than 0.0 displace object geometry or particles away from the position of the gizmo. Values less than 0.0 displace geometry toward the gizmo. Default=0.0.

**Decay** Varies the displacement strength with distance.

By default, Displace has the same strength throughout world space. Increasing Decay causes the displacement strength to diminish as distance increases from the position of the Displace gizmo. This has the effect of concentrating the force field near the gizmo, similar to the field around a magnet repelling its opposite charge. Default=0.0.

**Luminance Center** Determines which level of gray Displace uses as the zero displacement value.

By default, Displace centers the luminance by using medium (50 percent) gray as the zero displacement value. Gray values greater than 128 displace in the outward direction (away from the Displace gizmo) and gray values less than 128 displace in the inward direction (toward the Displace gizmo). Use the



Center spinner to adjust the default. With a Planar projection, the displaced geometry is repositioned above or below the Planar gizmo. Default=0.5. Range=0 to 1.0.

### Image group

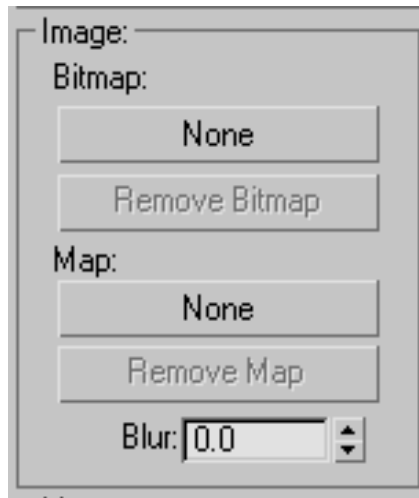

Lets you choose a [bitmap](#) on page 7730 and [map](#) on page 7840 to use for displacement. Both are assigned and removed in the same way.

**Bitmap button** Assigns a bitmap or map from a selection dialog. After you make a valid choice, these buttons display the name of the bitmap or map.

This button is labeled "None" until you choose a map.

**Remove Bitmap/Map** Removes the bitmap or map assignment.

**Blur** Increase this value to blur or soften the effect of the bitmapped displacement.

## Map group

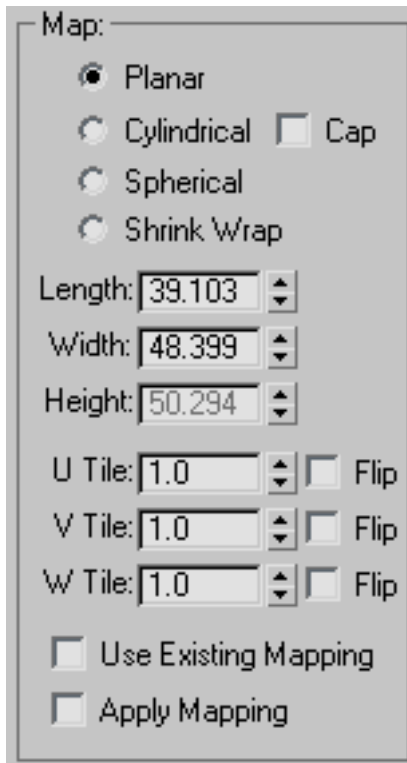

The image shows a 'Map' group control panel with the following settings:

- Map:  Planar,  Cylindrical  Cap,  Spherical,  Shrink Wrap
- Length: 39.103
- Width: 48.399
- Height: 50.294
- U Tile: 1.0  Flip
- V Tile: 1.0  Flip
- W Tile: 1.0  Flip
- Use Existing Mapping
- Apply Mapping

Contains mapping parameters for bitmapped displacement. See [UVW Map modifier](#) on page 1849 .

The four mapping modes control how Displace projects its displacement. The type of Displace gizmo and its location in the scene determine the final effect.

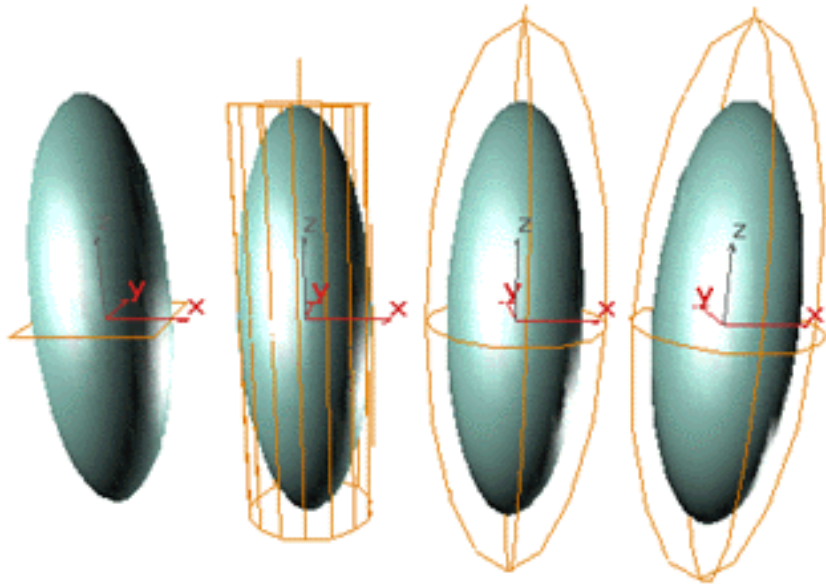

**Displace gizmos: Planar, Cylindrical, Spherical, and Shrink Wrap**

**Planar** Projects the map from a single plane.

**Cylindrical** Projects the map as if it were wrapped around the cylinder. Turn on Cap to project a copy of the map from the ends of the cylinder.

**Spherical** Projects the map from a sphere, with singularities at the top and bottom of the sphere where the bitmap edges meet at the sphere's poles.

**Shrink Wrap** Projects the map from a sphere, as Spherical does, but truncates the corners of the map and joins them all at a single pole, creating only one singularity at the bottom.

**Length, Width, Height** Specifies the dimensions of the Displace gizmo's bounding box. Height has no effect on Planar mapping.

**U/V/W Tile** Sets the number of times the bitmap repeats along the specified dimension. The default value of 1.0 maps the bitmap exactly once; a value of 2.0 maps the bitmap twice, and so on. Fractional values map a fractional portion of the bitmap in addition to copies of the whole map. For example, a value of 2.5 maps the bitmap two and a half times.

**Flip** Reverses the orientation of the map along the corresponding U, V, or W axis.

**Use Existing Mapping** Has Displace use mapping set earlier in the stack. This has no effect if the object is not mapped.

**Apply Mapping** Applies the Displace UV mapping to the bound object. This lets you apply material maps to the object using the same mapping coordinates as the modifier.

### Channel group

Specifies whether to apply the displacement projection to a mapping channel or a vertex color channel, and which channel to use. For more information on these channels, see [UVW Map modifier](#) on page 1849 .

**Map Channel** Choose this to specify a UVW channel to use for the mapping, and use the spinner to its right to set the channel number.

**Vertex Color Channel** Choose this to use the vertex color channel for the mapping.

### Alignment group



Contains controls for adjusting the mapping gizmo's size, position, and orientation.

**X, Y, Z** Flips the alignment of the mapping gizmo along its three axes.

**Fit** Scales the gizmo to fit the object's bounding box.

**Center** Centers the gizmo relative to the object's center.

**Bitmap Fit** Displays a Select Bitmap dialog. The gizmo is scaled to fit the aspect ratio of the bitmap you select.

**Normal Align** Turns on Pick mode to let you select a surface. The gizmo is aligned to the normal of that surface.

**View Align** Orients the gizmo in the same direction as the view.

**Region Fit** Turns on Pick mode to let you drag two points. The gizmo is scaled to fit the specified area.

**Reset** Returns the gizmo to its defaults.

**Acquire** Turns on Pick mode to let you choose another object and acquire its Displace gizmo settings.

## Edit Mesh Modifier

Create or select an object > Modify panel > Modifier List > Object-Space Modifiers > Edit Mesh

Create or select an object > Modifiers menu > Mesh Editing > Edit Mesh

The Edit Mesh modifier provides explicit editing tools for different sub-object levels of the selected object: vertex, edge, and face/polygon/element. The Edit Mesh modifier matches all the capabilities of the base Editable Mesh object, except that you cannot animate sub-objects in Edit Mesh. See [Editable Mesh](#) on page 1990 for a complete parameter reference.

When possible, it's far more efficient and reliable to perform explicit modeling at the Editable Mesh level rather than store those edits within the Edit Mesh modifier. The Edit Mesh modifier must copy the geometry passed to it, and this storage can lead to large file sizes. The Edit Mesh modifier also establishes a topological dependency that can be adversely affected if earlier operations change the topology being sent to it.

There are, however, situations where using the Edit Mesh modifier is the preferred method.

- You want to edit a parametric object as a mesh, but want to retain the ability to modify its creation parameters after the edit.
- You want to store your edits temporarily within Edit Mesh until you are satisfied with the results, before collapsing them permanently to an editable mesh object.
- You need to make edits across several objects at once, but do not want to convert them to a single editable mesh object.

- You have a modifier in the stack that must remain parametric, and the mesh must be edited after the modifier is applied.

---

**NOTE** Collapsing an object that has an Edit Mesh modifier applied to it results in an Editable Mesh object.

---

## Edit Normals Modifier

Select a mesh, patch, spline or NURBS object. > Modify panel > Modifier List > Edit Normals

Select a mesh, patch, spline, or NURBS object. > Modifiers menu > Mesh Editing > Edit Normals

The Edit Normals modifier gives you explicit and procedural, interactive control over each of an object's vertex [normals](#) on page 7863 . It is meant to be used primarily with mesh objects destined for output to game engines and other 3D rendering engines that support specified normals. The results are visible in the viewports and in rendered images.

The orientation of a vertex normal affects how neighboring surfaces reflect light. By default, normals are set so that reflection of light in 3ds Max follows the rules of real-world physics: The angle of reflection equals the angle of incidence. But by reorienting vertex normals, you can set the angle of reflection to be anything you want. The Edit Normals modifier lets you specify vertex normals' directions, combine and separate them, change the type, and copy and paste values among normals.

---

**WARNING** Don't apply an Edit Normals modifier to the low-res object used in [normal bump projection](#) on page 6182 . Normal bump projection relies on the low-res object having standard normals, and altering them causes normal bump maps to have unpredictable results.

---

### Types of Normals

Three types of normals are available with the Edit Normals modifier:

- **Unspecified:** These are the normals that the modifier derives from smoothing groups and initially assigns to the modified mesh vertices. The software calculates the direction of an unspecified normal based on the average facing of all polygons to which it belongs that are in its smoothing group.

By default, each vertex has as many normals as the number of unique smoothing groups used by surrounding polygons. For example, each side of a box uses a different smoothing group by default, so each vertex at which three sides meet (typically a corner) has three different normals: one perpendicular to each of the three sides. On the other hand, a sphere uses a single smoothing group, so each of its vertices has one normal, perpendicular to the average facing of the polygons that share it. By default, unspecified normals are displayed as blue.

- **Specified:** These are normals that are intended for use by particular corners of particular faces, without regard to smoothing groups. For instance, you might create a box, apply Edit Normals, select a group of normals at a particular vertex, and click Unify. Now those three faces are told specifically to use that one unified normal, and they ignore their smoothing groups at that vertex. But specified normals are not set to *explicit* values; they ignore smoothing groups, but they're still based on the face normals of the faces that use them. Specified normals are displayed as cyan.
- **Explicit:** These are normals that are set to particular values. For instance, if you use the Move or Rotate command to change a normal from its default value, it has to be made explicit, so it won't be recomputed based on the face normals. Explicit normals are green by default.

---

**NOTE** Explicit normals are also considered to be specified.

---

---

**NOTE** A selected normal is always red. When not selected, its color indicates as type, as noted above. You can find the [customizable color entries](#) on page 7505 for these normal types in the Elements > Geometry list. The three entry names are:

- Normals - Explicit
- Normals - Specified
- Normals - Unspecified

---

## Usage Examples

Following are two instances in which a 3D artist creating content for output to a game engine might find practical use for the Edit Normals modifier:

- An artist is working on a knight with a chrome shield. The chrome shield has a DirectX cube map [shader](#) on page 7925 on it so that the artist can see

the reflections in the viewport. The artist would like to make the reflections in the shield look "dented" by fights in battle. The artist applies the Edit Normals modifier to the shield object. He then adjusts several of the normals slightly, viewing the results in real time, thanks to the pixel shader. He then exports the character with a custom export tool designed to handle normal information.

- A game artist is working on an object that will explode in the game. To do this, the game engine requires the object to be split into multiple objects: the broken pieces that will result from the explosion. When the object is broken apart in 3ds Max (using Slice), the normals are pointing in different directions; this makes it easy to see the seams between the broken pieces. To fix this, the artist selects all the pieces of the breaking object and applies the Edit Normal modifier to all of them at once. She then selects the normals across the seam and unifies them so they are pointing in the same direction. The artist then exports to the game engine.

### Usage Notes

Please observe the following notes and precautions when using the Edit Normals modifier:

- Edit Normals supports both poly objects (polygon-based) and mesh objects (triangle-based). If you apply Edit Normals to a poly object, the result is a poly object. If you apply Edit normals to any other object type, the result is a mesh object.
- Edit Normals also supports embedding of edited-normal data when collapsing the stack, and when converting from poly object to mesh object, but not when converting from a mesh object to any other object type. If you apply Edit Normals to a primitive object, adjust the normals, and then collapse the stack (or convert to Editable Mesh), the software embeds any changes to the normals in the mesh object, including selection status. Primitive objects are mesh-based, so if you convert the same object to Editable Poly, the edited normals are lost. On the other hand, if you convert a primitive object to Editable Poly, apply Edit Normals, adjust the normals, and then collapse the stack, resulting in a poly object, the normals are retained. You can subsequently regain access to embedded, edited normals in a collapsed object by applying another Edit Normals modifier.
- Any modifiers that change topology will remove changes applied to the normals with the Edit Normals modifier. These include MeshSmooth, Tessellate, Slice, Mirror, Symmetry, Face Extrude, and Vertex Weld. Oddly enough, it also means that the Normal modifier (used to flip face



orientations) will not support the edited normals. Since Turn To Poly can be used to modify face topology, it also strips off the edited normals.

- All compound objects strip off the edited normals from their operands.
- The good news: All deformation and map modifiers preserve the normals. For instance, if you apply a Bend, the normals should be bent along with the geometry. Map modifiers, such as Unwrap UVW, won't affect the normals at all.
- However, a few geometric modifiers do not fully support the new normals. They won't strip them away, but neither will they correctly deform any explicit normals. Modifiers in this category include Push and Relax.
- The Smooth modifier correctly modifies any non-specified normals, while leaving the specified and explicit normals alone.
- Like Mesh Select and Poly Select, Edit Normals “inherits” attributes from below it in the stack. For example, if you create a box, apply an Edit Normals modifier, change some normals, and then apply a second Edit Normals modifier, the top Edit Normals “inherits” the user-specified normals from the pipeline, just as Mesh Select adopts the current selection when you apply it. But the top Edit Normals modifier ignores any subsequent changes to the original Edit Normals modifier, just as Mesh Select ignores any changes made to the selection below it in the stack after it is applied.

## Interface

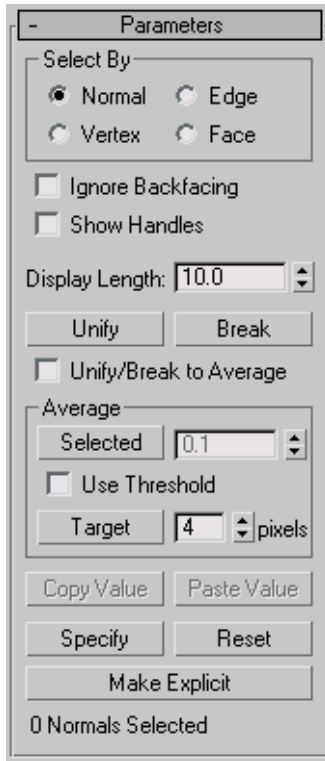

The Edit Normals modifier is useful mainly at the sub-object level, Normal, so this level is active by default as soon as you apply the modifier to an object. At this point, you can see the normals as lines emanating from the mesh vertices, select and transform them, copy and paste them, and change their settings on the Modify panel.

You can transform normals only by moving and rotating them, not by scaling them. However, moving a normal effectively rotates it, so in most cases you'll have better control by using the Rotate tool.

The following command reference includes keyboard shortcuts, which are available when the [Keyboard Shortcut Override Toggle](#) on page 7646 (on the toolbar) is on. In addition, you can use Ctrl+0 (zero) to access the object level of the modifier.

**Select By group** Lets you specify how to select normals in the viewport:

- **Normal** (Ctrl+1): Click a normal to select it.

- **Vertex (Ctrl+2):** Click a mesh vertex to select all of its normals.
- **Edge (Ctrl+3):** Click a mesh edge to select the normals associated with the neighboring polygons.
- **Face (Ctrl+4):** Click a mesh face (or polygon) to select the associated normals.

Of course, with all of these methods, you can also use region selection to select multiple normals at once.

**Ignore Backfacing** When on, selection of sub-objects affects only those facing you. When off (the default), you can select any sub-object(s) under the mouse cursor, regardless of their visibility or facing. If there are more than one sub-object under the cursor, repeated clicking cycles through them. Likewise, with Ignore Backfacing off, region selection includes all sub-objects, regardless of the direction they face.

**Show Handles** Enables the display of handles, which are small squares at the end of each normal. Turn this on to make it easier to select normals.

**Display Length** Specifies the length of each normal. This is for display purposes only; the length has no effect on the normal's functionality.

**Unify (U)** Combines all selected normals at each vertex into a single [specified normal](#) on page 1284 . By default, with Unify/Break To Average off, Unify sets the direction for each unified normal to be perpendicular to the averaged surface at that point. With Unify/Break To Average on, Unify sets the direction be the average of the combined normals at each location.

**Break (B)** Separates all selected, unified normals into their original components. With Unify/Break To Average off, Break orients each separated normal perpendicular to its respective face, thus splaying out the normals at each vertex if the connected faces are at different angles (as with a sphere). With Unify/Break To Average on, each separated normal uses the orientation of the original normal.

Break converts any selected normals to specified normals.

**Unify/Break to Average** Determines normal orientation as the result of a Unify or Break operation. See the descriptions above for details. Default=off.

### **Average group**

These controls give you different methods of averaging vertex normals; that is, setting them all to the same absolute angle, which is the average of their combined angles.

**Selected** Sets selected normals to the same absolute angle: the average angle of all of them. If Use Threshold is on, averages only normals whose distance from each other is less than that specified in the Average Threshold spinner (to the button's right).

**Use Threshold** Activates the Average Threshold setting, and causes the Selected to average only normals whose distance from each other is less than the specified value.

**Target** Enters an interactive mode in which you specify pairs of normals to average. Click Target, and then select a normal. When the mouse cursor is over a normal, it changes to a + cursor. After clicking the first normal, a rubber-band dashed line connects the normal to the mouse cursor. Click a second normal to average the angles of the two normals.

The pixels spinner to the right of the Target button sets the maximum distance in screen pixels between the mouse cursor and the target normal.

**Copy Value (Ctrl+C)** Copies the selected normal's orientation to the copy buffer. Available only when a single normal is selected.

Use Copy Value and Paste Value to apply a normal's orientation to one or more others within the same Edit Normals modifier. You cannot copy normals between modifiers.

**Paste Value (Ctrl+V)** Applies the paste buffer contents to the current selection. Available only after Copy Value has been used to place a normal's orientation in the copy, and one or more target normals are selected.

**Specify (S)** Converts selected normals to [specified normals](#) on page 1285 .

**Reset (R)** Causes all selected normals to revert to [unspecified](#) on page 1284 status, and returns them to their initial, calculated positions. Also breaks apart unified normals.

**Make Explicit (E)** Converts selected normals to [explicit normals](#) on page 1285 .

**[Selection Display]** When one normal is selected, shows its ID number. When 0 or more than one normal is selected, shows the number of normals selected.

## Edit Patch Modifier

Create or select an object > Modify panel > Modifier List > Object-Space Modifiers > Edit Patch

Create or select an object > Modifiers menu > Patch/Spline Editing > Edit Patch

The Edit Patch modifier provides editing tools for different sub-object levels of the selected object: vertex, handle, edge, patch, and element. The Edit Patch modifier matches all the capabilities of the base Editable Patch object, except that you cannot animate sub-objects in Edit Patch. See [Editable Patch](#) on page 1934 for a parameter reference.

Other than the inability to animate sub-objects with Edit Patch, the main difference between Edit Patch and Editable Patch is that the modifier incorporates the ability of the Surface modifier to generate a patch object from a spline cage. For details, see [Spline Surface](#) on page ? .

When possible, it's far more efficient and reliable to perform explicit editing on an Editable Patch object rather than store those edits within the Edit Patch modifier. The Edit Patch modifier must copy the geometry passed to it, and this storage can lead to large file sizes. The Edit Patch modifier also establishes a topological dependency that can be adversely effected if earlier operations change the topology being sent to it.

There are, however, situations where using the Edit Patch modifier is the preferred method.

- You want to edit a parametric object as a patch, but want to retain the ability to modify its creation parameters after the edit.
- You want to store your edits temporarily within Edit Patch until you are satisfied with the results, before committing them permanently to an editable patch.
- You want to streamline your workflow with the Spline Surface tools, which are unique to Edit Patch.
- You need to make edits across several patch objects at once, but do not want to convert them to a single editable patch object.
- You have a modifier in the stack that must stay parametric, and the resulting patch must be edited after the modifier is applied.

## Procedures

### To create a patch object using the Cross Section and Spline Surface tools:

This procedure describes how to simplify the workflow of building objects using a spline cage to which a patch surface is applied, a method described in the [Surface modifier](#) on page 1695 topic as "Surface Tools."

- 1 Create a spline object.

Make sure that the spline vertices form valid three-sided or four-sided polygons. Vertices on splines that cross one another should be coincident.

To make spline vertices coincident, drag vertices over each other with 3D Snap turned on. 3D Snap must have the Vertex or End Point option turned on. With 3D Snap turned on, you can snap to vertices on existing splines as you create new splines. You can also select vertices and use the Fuse option in an Editable Spline to make vertices coincident.

- 2 Convert the spline object to an Editable Spline, if necessary, or apply an Edit Spline modifier.
- 3 Use the [Cross Section command](#) on page 605 in Edit/Editable Spline to add splines connecting different splines in the spline object, thus creating a spline cage.

This replaces the previous workflow of using the CrossSection modifier.

- 4 Apply the Edit Patch modifier to the spline object.

By default, in Edit Patch the Geometry rollout > Spline Surface group > Generate Surface option is on, causing the modifier to create patches over all valid three- and four-sided polygons in the spline cage.

This replaces the previous workflow of using the Surface modifier.

- 5 Adjust the Spline Surface settings and edit the object as necessary. If you modify the spline object, for best results, edit at the Vertex sub-object level, and be sure to select all vertices at an intersection before moving them.

## Interface

### Spline Surface group

The Geometry rollout > Spline Surface group is found only in the Edit Patch modifier; it's not available in the Editable Patch object. The group becomes available when the object to which the Edit Patch modifier is applied consists of splines. Its controls replicate the functionality of the [Surface modifier](#) on page 1695 .

For best results, apply the Spline Surface controls after creating a spline cage with the [CrossSection modifier](#) on page 1259 or the [Editable Spline Cross Section command](#) on page 605 . The latter approach approximates the Surface Tools workflow (described in the Surface Modifier topic), but with a simpler modifier stack; instead of additional CrossSection and Surface modifiers, the

stack need contain only an Editable Spline object and an Edit Patch modifier. Alternatively, you can use the Edit Spline modifier's Cross Section command.

**Generate Surface** Creates a patch surface using existing splines to define the patch edges. Default=on.

**Threshold** Determines the overall distance that is used to weld the vertices of the spline object. All vertices/vectors within the threshold distance of each other are treated as one. Threshold uses units set in the [Units Setup dialog](#) on page 7601 . Default=1.0.

---

**NOTE** Spline control handles are also treated as vertices, so setting high Threshold levels can produce unexpected results.

---

**Flip Normals** Reverses the facing direction of the patch surface. Default=off.

**Remove Interior Patches** Removes interior faces of an object that you would not normally see. These are the faces created within the caps or other interior patches of the same type of a closed polygon. Default=on.

**Use Only Selected Segs** Only segments selected in the Edit Spline modifier or the editable spline object will be used by the Surface modifier to create patches. Default=off.

---

**NOTE** Segment Sub-Object does not have to be left on in the Edit Spline modifier or editable spline object.

---

## Edit Poly Modifier

Create or select an object. > Modify panel > Modifier List > Object-Space Modifiers > Edit Poly

Create or select an object. > Modifiers menu > Mesh Editing > Edit Poly

The Edit Poly modifier provides explicit editing tools for different sub-object levels of the selected object: vertex, edge, border, polygon, and element. The Edit Poly modifier includes most capabilities of the base Editable Poly object, except for Vertex Color information, Subdivision Surface rollout, Weight and Crease settings, and Subdivision Displacement rollout. Edit Poly lets you animate sub-object transforms and parameter changes. In addition, because it's a modifier, you can retain the object creation parameters and change them later. For detailed information about animating with Edit Poly, see [these procedures](#) on page 1301 .

Edit Poly gives you these options:

- Transform or Shift+Clone the selection, as with any object.
- Use the options on the Edit rollouts to modify the selection or object. Later topics discuss these options for each of the polymesh components.
- Pass a sub-object selection to a modifier higher in the stack. You can apply one or more standard modifiers to the selection.

---

**TIP** You can exit most Edit Poly command modes, such as Extrude, by right-clicking in the active viewport.

---



### **Overriding Actions with Press/Release Keyboard Shortcuts**

While working with Edit Poly objects, you can use a “press/release keyboard shortcut” to temporarily override the current operation and perform a different one. As soon as you release the keyboard shortcut, you return to the previous operation.

For example, you might be working at the Polygon sub-object level, moving polygons, and need to rotate the object to access a different part of it. Instead of having to exit the Polygon sub-object level, rotate the object and then re-enter the sub-object level, you could simply press and hold **6**, rotate the object, release the key, and immediately return to moving polygons.

To see a list of press/release keyboard shortcuts for Edit Poly, go to Customize > Customize User Interface > Keyboard panel, open the Group drop-down list, and choose Editable Poly. The actions in boldface are the ones that you can assign as press/release shortcuts. Not all are assigned; for information about assigning keyboard shortcuts, see [Keyboard Panel](#) on page 7489 .



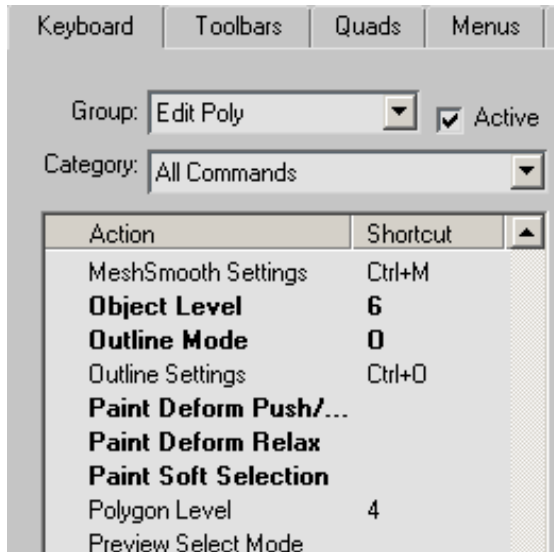

The boldface actions can be assigned as press/release shortcuts.

### Differences Between Edit Poly and Editable Poly

Functionality in Edit Poly is mostly the same as that of Editable Poly. Please note the following differences:

- Edit Poly is a modifier, with all properties that modifier status entails. These include the ability to place Edit Poly above a base object and other modifiers on the stack, to move the modifier to different locations in the stack, and to apply multiple Edit Poly modifiers to the same object, each containing different modeling or animation operations.
- Edit Poly has two distinct modes of operation: Model and Animate. See [Edit Poly Mode rollout](#) on page 1304 .
- Delete Isolated Vertices is now an option on the Edit Geometry rollout. Previously, it appeared as a dialog every time you deleted contiguous polygons. Now you can set it and forget it.
- Edit Poly eliminates the Full Interactivity switch; this feature is on all the time.
- Edit Poly provides two new ways of obtaining an existing selection from lower in the stack: [Use Stack Selection](#) on page 1312 and [Get Stack Selection](#) on page 1317 .

- In addition to the Settings dialogs from Editable Poly, Edit Poly gives you a new Settings dialog for Align operations, available on the [Edit Poly Mode rollout](#) on page 1304 .
- Edit Poly lacks Editable Poly's Subdivision Surface and Subdivision Displacement rollouts. There are no Weight or Crease settings for vertices, edges, or borders. If you need to use Weight and Crease settings, apply a [Meshsmooth modifier](#) on page 1460 , set Iterations to **0** , and then make the settings as desired. Also, there is no provision for setting vertex properties such as color.
- In Animate mode, you begin a slice operation by clicking Slice, not Slice Plane. You still need to click Slice Plane to move the plane around. You can animate the slice plane.
- In some cases, several [Undo commands](#) on page 202 might be required to revert from changes made with certain Edit Poly operations, such as Extrude.  
For example, if you extrude a polygon using the [Extrude Polygons dialog](#) on page 2141 , there will be three Undo actions. The first undoes the Commit, which happens automatically when you click the dialog OK button at the end; the second undoes the change in height (from 0 to the height you set); and the third undoes the entry into the Extrude operation.

Following is a table showing the Edit Poly functions that are and are not animatable. Functions that are not animatable are unavailable in Animate mode. Functions marked “Yes” can be animated explicitly in Animate mode.

Functions marked “Proc” cannot be animated explicitly, but can be animated procedurally. This means they can be applied to different parts of the Edit Poly object at different points in the animation by means of an animated sub-object selection passed up the stack. For further information, see [this procedure](#) on page 1302 .

Function	Animatable?
Transform sub-objects	Yes
Shift+Transform sub-objects	Yes
Constraints	No
Preserve UVs	No

<b>Function</b>	<b>Animatable?</b>
By Vertex	No
Ignore Backfacing	No
Ring	No
Loop	No
Shrink	No
Grow	No
Selection conversion	No
Named Selection copy/paste	No
Soft Selection (most settings)	Yes (but not painting soft selection)
Shaded Face toggle	No
Delete	Proc
Create Vertex	No
Create Face	No
Create Edge	No
Collapse	Proc
Attach / Attach List	No
Detach	No
Slice	Yes

<b>Function</b>	<b>Animatable?</b>
Quickslice	No
Cut	No
MSmooth	Proc
Tessellate	Proc
Make Planar	Proc
View Align	Yes
Grid Align	Yes
Relax	Yes
Hide Selected	No
Hide Unselected	No
Unhide All	No
Remove	Proc
Break	Proc
Extrude	Yes
Chamfer	Yes
Bridge	Yes
Weld (selected)	Proc (can animate Weld Threshold)
Target Weld	No

<b>Function</b>	<b>Animatable?</b>
Connect	Yes
Remove Isolated Vertices	Proc
Remove Unused Map Verts	Proc
Remove	Yes
Split	Yes
Insert Vertex	No
Weld (selected)	Yes (Threshold)
Target Weld	No
Connect (Vertex)	Proc
Connect (Edge)	Yes
Create Shape	No
Edit Triangulation	No
Cap	Proc
Insert Vertex	No
Extrude	Yes
Bevel	Yes
Outline	Yes
Inset	Yes

<b>Function</b>	<b>Animatable?</b>
Retriangulate	Proc
Flip	Proc
Hinge from Edge	Yes
Extrude Along Spline	Yes
Set Material ID	Yes
Select by Material ID	No
Set Smoothing Group	Yes
Select by Smoothing Group	No
Auto Smooth	Proc

### **Edit Poly Workflow**

Edit Poly differs from other Edit modifiers in 3ds Max in that it provides two different modes, available on the Edit Poly Mode rollout: one for modeling, and the other for animating. By default, Edit Poly operates in Model mode, whose functionality is mostly the same as that of Editable Poly. Alternatively, you can work in Animate mode, where only functions you can animate are available.

Each Edit Poly modifier can preserve any number of keyframes animating a single operation type, such as transforming faces, on the same sub-object selection. To animate other parts of the object, or to animate a different operation on the same sub-object selection, just use another Edit Poly modifier.

Sub-object-specific functions in the Edit Poly user interface can be found in their own rollouts, leaving the Edit Geometry rollout with functions that can be used at most sub-object levels, as well as at the object level.



Also, many commands are accompanied by a Settings button, which gives you two ways of using the command:

- In Direct Manipulation mode, activated by clicking the command button, you apply the command by manipulating sub-objects directly in the viewport. An example of this is Extrude.

---

**NOTE** Some buttons, such as Tessellate, operate on the mesh immediately, with no viewport manipulation required.

---



- Interactive Manipulation mode is well suited to experimentation. You activate this mode by clicking the command's Settings button. This opens a non-modal settings dialog and places you in preview mode, where you can set parameters and see results immediately in the viewport. You can then accept the results by clicking OK, or reject them by clicking Cancel. You can also use this mode to apply the same or different settings to several different sub-object selections in a row. Make the selection, optionally change the settings, click Apply, and then repeat with a different selection.

---

**IMPORTANT** When you click Apply, the settings are “baked into” the selection, and then applied again to the selection as a preview. If you then click OK to exit, you will have applied the settings twice. If your intention is to apply them only once, simply click OK the first time, or click Apply, and then Cancel.

---

#### See also:

- [Poly Select Modifier](#) on page 1541
- [Turn To Poly Modifier](#) on page 1761
- [Editable Poly Surface](#) on page 2038

#### Procedures

##### To animate an Edit Poly operation on a sub-object selection:

- 1 Select an object.
- 2 Apply the Edit Poly modifier.

- 3 **Auto Key** Go to the first frame at which to set a key and turn on Auto Key.
- 4 On the Modify panel > Edit Poly Mode rollout, choose Animate.
- 5 Make a sub-object selection.
- 6 Perform an operation on the selection, such as a transform or extrusion.
- 7 Proceed to the next keyframe and continue to change settings for the current operation and sub-object selection.

If you change the selection, the existing animation is applied to the new selection, and lost from the previous one. If you change the operation, any changes from the previous animation are frozen (that is, “baked” into the model) at the current frame, and only new keyframes are recorded in the current Edit Poly modifier.

To animate different sub-object selections using different operations, use multiple applications of the Edit Poly modifier.

#### **To apply an Edit Poly operation to an animated sub-object selection:**

This procedure demonstrates procedural animation with Edit Poly: the ability to change the location of application on an object during an animation using an existing, animated sub-object selection.

- 1 Select an object.
- 2 Create an animated sub-object selection. One way to do this is to apply a [Volume Select modifier](#) on page 1910 and animate the gizmo's transform, or animate the modifier effect by using an animated texture map.
- 3 Apply the Edit Poly modifier.
- 4 Go to the same sub-object level in Edit Poly, and then, on the Selection rollout, turn on Use Stack Selection.
- 5 Scrub the time slider.  
The animated selection appears on the Edit Poly object.
- 6 On the Modify panel > Edit Poly Mode rollout, choose Animate.
- 7 Perform an operation on the sub-object selection, such as a chamfer or extrusion. You needn't turn on Auto Key or use Set Key.

---

**NOTE** With Use Stack Selection on, you can't change the selection.

---



Now, when you play the animation, the Edit Poly effect moves along with the animation of the sub-object selection.

If you decide to animate a different function procedurally, first click Edit Poly Mode rollout > Cancel.

**Example: To apply an Edit Poly operation procedurally to an animated model:**

Edit Poly lets you layer an animated sub-object operation on top of an existing animation. Try this brief example:

- 1 Create an animated model, such as a box with an animated Bend modifier.
- 2 Apply an Edit Poly modifier, and on the Edit Poly Mode rollout, choose Animate. Also turn on Auto Key.
- 3 Go to the Polygon sub-object level.
- 4 Go to frame 20 and extrude a polygon.
- 5 Play the animation.

The extrusion animation plays “on top” of the existing animation. This isn't possible with the Edit Mesh modifier.

## Interface

### Stack Display

For more information on the stack display, see [Modifier Stack](#) on page 7427 .

**Show End Result** Because Edit Poly is a modifier, if you apply further modifiers and then return to the Edit Poly stack entry, Show End Result is on by default, and you can still see the results of any modifiers above Edit Poly on the stack. This is different from the Editable Poly object, where if you apply a modifier such as [Symmetry](#) on page 1735 and then return to the Editable Poly stack entry, you cannot see the effect of the modifier on the object's geometry. While at a sub-object level, if you turn on Show Cage on the Edit Poly Mode rollout, you can see the final object as a white mesh, the original sub-object selection as a yellow mesh, and the original Edit Poly object as an orange mesh.

## Edit Poly Mode rollout

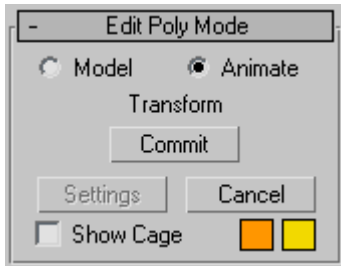

This rollout provides access to Edit Poly's two modes of operation: Model, for modeling, and Animate, for animation of modeling effects. For example, you can animate the Taper and Twist settings for polygons extruded along a spline.

During and between sessions, the software remembers the current mode for each object separately. The same mode remains active at all sub-object levels.

Edit Poly Mode also gives you access to the current operation's Settings dialog, if any, and lets you commit to or cancel out of modeling and animation changes.

**Model** Lets you model using the Edit Poly functions. Operations in Model mode cannot be animated.

**Animate** Lets you animate using the Edit Poly functions.

In addition to choosing Animate, you must turn on [Auto Key](#) on page 7344 or use [Set Key](#) on page 7347 for animating sub-object transforms and parameter changes. Alternatively, in Animate mode you can apply a single command, such as Extrude or Chamfer, to an animated sub-object selection passed up the stack.

---

**TIP** If you use Set Key to animate with Edit Poly, be sure to turn on Key Filters > Modifiers.

---

**NOTE** The Edit Poly modifier can store any number of keyframes animating a single operation, such as transforming polygons, on the same sub-object selection. Use additional Edit Poly modifiers to:

- animate other parts of the object;
  - animate repeated applications of the same operation on the same sub-object selection;
  - animate repeated applications of a different operation on the same sub-object selection.
-

For example, say you want to animate a polygon extruding from an object from frame 1 to 10, and then moving back to the original position over the next 10 frames. You can accomplish this with a single Edit Poly modifier using the Extrude function, setting one keyframe at 10 and another at 20. However, say you want to animate a polygon extruding outward, and then animate movement of one of the resultant side polygons. In that case, you'd need two Edit Poly modifiers: one for the extrusion, and another for the poly transform.

---

**TIP** While modeling in Animate mode, you can use [Commit](#) on page 1305 to freeze the animation at the current frame.

---

**[label]** Shows the current command, if any. Otherwise, it shows <No Current Operation>.

When you're working in Model mode using direct manipulation (that is, working in the viewports), the label shows the current operation during drag operations, and then returns to the unavailable state.

When you're working in Model mode using a Settings dialog, or in Animate mode using direct manipulation or a Settings dialog, the label continually shows the current operation.

**Commit** In Model mode, using a Settings dialog, accepts any changes and closes the dialog (same as the OK button on the dialog). In Animate mode, freezes the animated selection in its state at the current frame and closes the dialog. Any existing keyframes are lost.

---

**TIP** Commit lets you use animation as a modeling aid. For example, you could animate a vertex selection between two positions, scrub between the two to find a suitable in-between position, and then use Commit to freeze the model at that point.

---

**Settings** Toggles the Settings dialog for the current command.

**Cancel** Cancels the most recently used command.

**Show Cage** Toggles the display of a two-color wireframe that shows the editable poly object before modification or subdivision. The cage colors are shown as swatches to the right of the check box. The first color represents unselected sub-objects, and the second color represents selected sub-objects. Change a color by clicking its swatch. The Show Cage toggle is available only at sub-object levels.

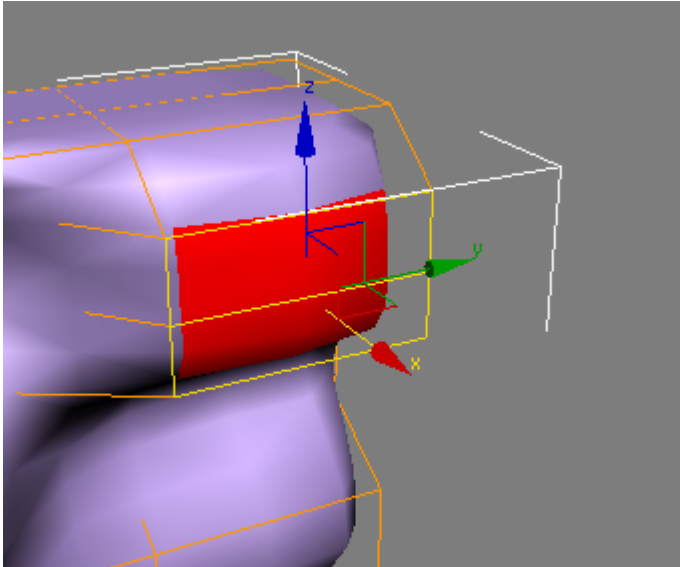

The cage displays the original structure of the edited object.

Typically this feature is used in conjunction with the [MeshSmooth modifier](#) on page 1460 because it lets you easily toggle visibility of the unsmoothed base object while simultaneously viewing the smoothed result, but it works with any modifier.

---

**TIP** Show Cage is also particularly helpful when used with the [Symmetry modifier](#) on page 1735 .

---

### **Selection rollout**

The Selection rollout provides tools for accessing different sub-object levels and display settings and for creating and modifying selections. See [Selection Rollout \(Edit Poly Modifier\)](#) on page 1307 .

### **Soft Selection rollout**

Soft Selection controls apply a smooth falloff between selected sub-objects and unselected ones. When Use Soft Selection is on, unselected sub-objects near your selection are given partial selection values. These values are shown in the viewports by means of a color gradient on the vertices, and optionally on the faces. They affect most types of sub-object deformations, such as the Move, Rotate, and Scale functions and any deformation modifiers (such as

Bend) applied to the object. This provides a magnet-like effect with a sphere of influence around the selection.

For more information, see [Soft Selection Rollout](#) on page 1926 .

### **Edit (sub-object) rollout**

The Edit (sub-object) rollout provides sub-object-specific functions for editing an Edit Poly object and its sub-objects. For specific information, click any of the following links:

[Edit Vertices rollout](#) on page 1323

[Edit Edges rollout](#) on page 1333

[Edit Borders rollout](#) on page 1345

[Edit Polygons/Elements rollout](#) on page 1351

### **Edit Geometry rollout**

The [Edit Geometry rollout](#) on page 1363 provides global functions for editing an Edit Poly object and its sub-objects. For information specific to a sub-object level, click one of the following links:

[Edit Poly \(Object\)](#) on page 1319

[Edit Poly \(Vertex\)](#) on page 1321

[Edit Poly \(Edge\)](#) on page 1330

[Edit Poly \(Border\)](#) on page 1343

[Edit Poly \(Polygon/Element\)](#) on page 1350

### **Paint Deformation rollout**

Paint Deformation lets you stroke elevated and indented areas directly onto object surfaces. For more information, see [Paint Deformation Rollout](#) on page 2125 .

## **Selection Rollout (Edit Poly Modifier)**

Select an Edit Poly object. > Modify panel > Selection rollout

The Selection rollout provides tools for accessing different sub-object levels and display settings and for creating and modifying selections. It also displays information about selected entities.

When you first access the Modify panel with an Edit Poly object selected, you're at the Object level, with several functions available as described in [Edit Poly \(Object\)](#) on page 1319 . You can toggle the various sub-object levels and access relevant functions by clicking the buttons at the top of the Selection rollout.

Clicking a button here is the same as choosing a sub-object type in the modifier stack display. Click the button again to turn it off and return to the Object selection level.

---

**NOTE** You can convert sub-object selections in three different ways with the use of the Ctrl and Shift keys:

- Clicking a sub-object button in the Selection rollout with Ctrl held down converts the current selection to the new level, selecting all sub-objects in the new level that touch the previous selection. For example, if you select a vertex, and then Ctrl-click the Polygon button, all polygons using that vertex are selected.
- To convert the selection to only sub-objects all of whose source components are originally selected, hold down both Ctrl and Shift as you change the level. For example, if you convert a vertex selection to a polygon selection with Ctrl+Shift+click, the resultant selection includes only those polygons all of whose vertices were originally selected.
- To convert the selection to only sub-objects that border the selection, hold down Shift as you change the level. The selection conversion is inclusive, meaning:
  - When you convert faces, the resulting selection of edges or vertices all belong to selected faces that bordered unselected faces. Only the edges or vertices that bordered unselected faces are selected.

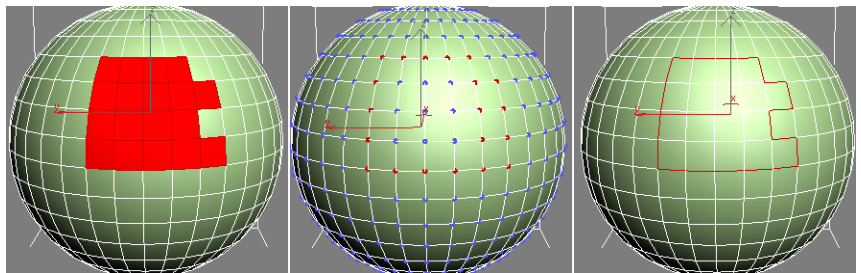

Face selection (left) converted to vertex border (center) and edge border (right)

- When you convert vertices to faces, the resulting selection of faces had all of their vertices selected and bordered unselected faces. When you convert vertices to edges, the resulting selection contains only edges all of whose vertices were previously selected and only edges of faces that did not have all vertices selected; that is, of faces around the border of the vertex selection.

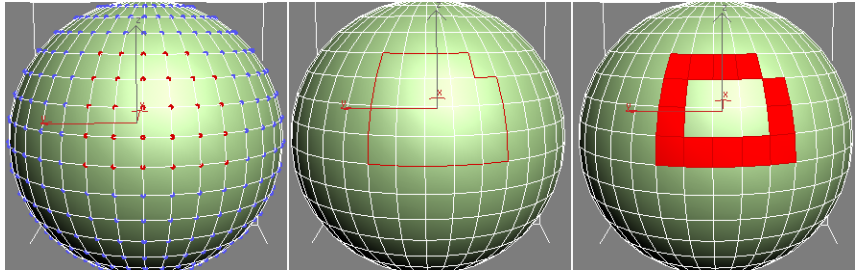

Vertex selection (left) converted to edge border (center) and face border (right)

- When you convert edges to faces, the resulting selection of faces had some but not all of their edges selected, and were next to faces with no edges selected. When you convert edges to vertices, the resulting vertices are on previously selected edges, but only at intersections where not all edges were selected.

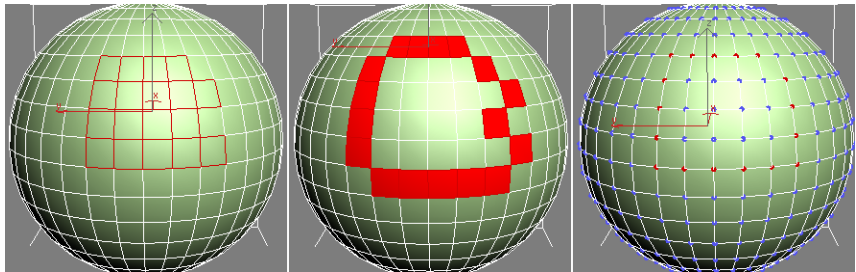

Edge selection (left) converted to face border (center) and vertex border (right)

Conversion commands are also available from the quad menu.

---



## Interface

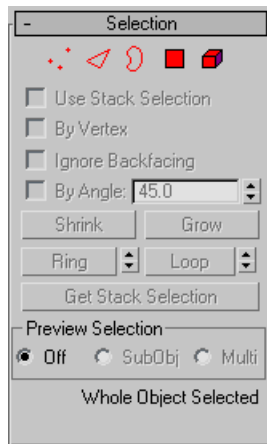

**Vertex** Accesses the Vertex sub-object level, which lets you select a vertex beneath the cursor; region selection selects vertices within the region.



**Edge** Accesses the Edge sub-object level, which lets you select a polygon edge beneath the cursor; region selection selects multiple edges within the region.



**Border** Accesses the Border sub-object level, which lets you select a sequence of edges that borders a hole in the mesh. A border is always composed of edges with faces on only one side of them, and is always a complete loop. For example, a box doesn't normally have a border, but the Teapot object has several of them: on the lid, on the body, on the spout, and two on the handle. If you create a cylinder and then delete one end, the row of edges around that end forms a circular border.

When Border sub-object level is active, you can't select edges that aren't on borders. Clicking a single edge on a border selects the whole border.

You can cap a border, either in Edit Poly or by applying the [Cap Holes modifier](#) on page 1159 . You can also connect borders between objects with the [Connect compound object](#) on page 668 .

The Edge and Border sub-object levels are compatible, so if you go from one to the other, any existing selection is retained.



**Polygon** Accesses the Polygon sub-object level, which lets you select polygons beneath the cursor. Region selection selects multiple polygons within the region.



**Element** Turns on Element sub-object level, which lets you select all contiguous polygons in an object. Region selection lets you select multiple elements.

The Polygon and Element sub-object levels are compatible, so if you go from one to the other, any existing selection is retained.

**Use Stack Selection** When on, Edit Poly automatically uses any existing sub-object selection passed up the stack, and prevents you from manually changing the selection.

**By Vertex** When on, you can select a sub-object only by selecting a vertex that it uses. When you click a vertex, all sub-objects that use the selected vertex are selected.

**Ignore Backfacing** When on, selection of sub-objects affects only those facing you. When off (the default), you can select any sub-object(s) under the mouse cursor, regardless of visibility or facing. If multiple sub-objects lie under the cursor, repeated clicking cycles through them. Likewise, with Ignore Backfacing off, region selection includes all sub-objects, regardless of the direction they face.

---

**NOTE** The state of the Backface Cull setting in the Display panel does not affect sub-object selection. Thus, if Ignore Backfacing is off, you can still select sub-objects, even if you can't see them.

---

**By Angle** When on, if you select a polygon, the software also selects neighboring polygons based on the angle setting to the right of the check box. This value determines the maximum angle between neighboring polygons that will be selected. Available only at the Polygon sub-object level.

For example, if you click a side of a box and the angle value is less than 90.0, only that side is selected, because all sides are at 90-degree angles to each other. But if the angle value is 90.0 or greater, all sides of the box are selected. This function speeds up selection of contiguous areas made up of polygons at similar angles to one another. You can select coplanar polygons with a single click at any angle value.

**Shrink** Reduces the sub-object selection area by unselecting the outermost sub-objects. If the selection size can no longer be reduced, the remaining sub-objects are unselected.

**Grow** Expands the selection area outward in all available directions.

For this function, a border is considered to be an edge selection.

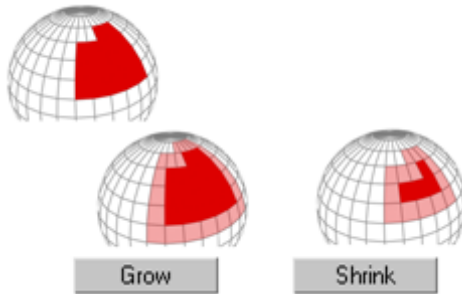

**With Shrink and Grow, you can add or remove neighboring elements from the edges of your current selection. This works at any sub-object level.**

**Ring** Expands an edge selection by selecting all edges parallel to the selected edges. Ring applies only to edge and border selections.

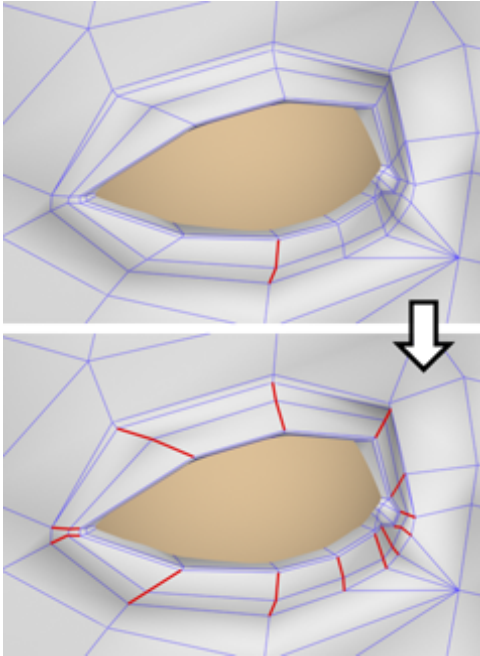

**Ring selection adds to the selection all the edges parallel to the ones selected originally.**

---

**TIP** After making a ring selection, you can use [Connect](#) on page 2080 to subdivide the associated polygons into new edge loops.

---

 **[Ring Shift]** The spinner next to the Ring button lets you move the selection in either direction to other edges in the same ring; that is, to neighboring, parallel edges. If you have a loop selected, you can use this function to select a neighboring loop. Applies only to Edge and Border sub-object levels.

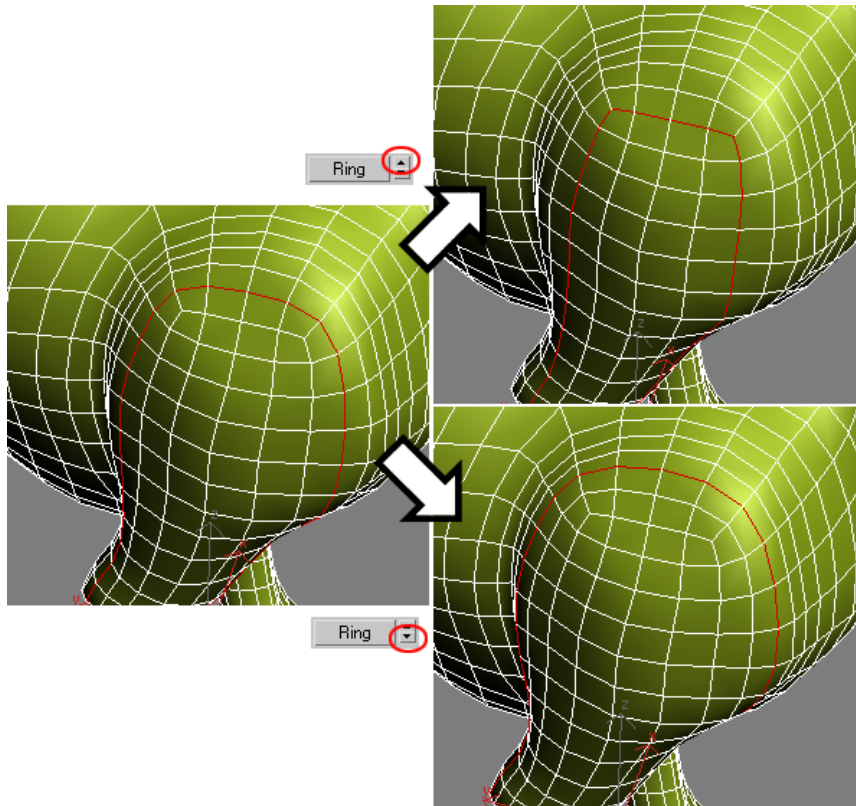

**Left: Original loop selection**

**Upper right: Ring Shift up moves selection outward (from center of model).**

**Lower right: Ring Shift down moves selection inward (toward center of model).**

To expand the selection in the chosen direction, Ctrl+click the up or down spinner button. To shrink the selection in the chosen direction, Alt+click the up or down spinner button.

**Loop** Expands the selection as far as possible, in alignment with selected edges.

Loop applies only to edge and border selections, and propagates only through four-way junctions.

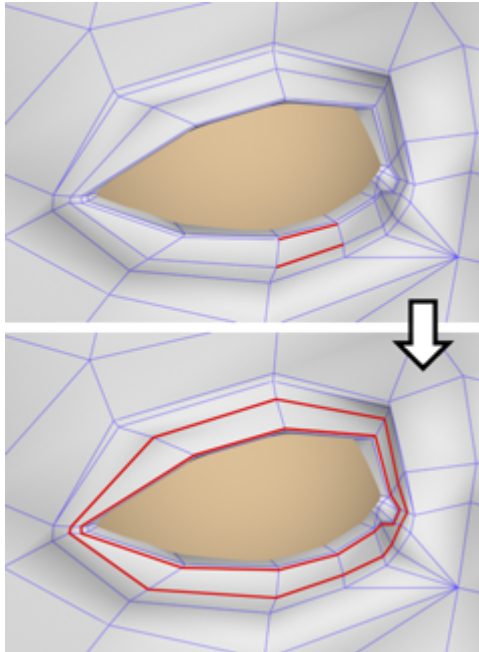

**Loop selection extends your current edge selection by adding all edges aligned to the ones selected originally.**



**[Loop Shift]** The spinner next to the Loop button lets you move the selection in either direction to other edges in the same loop; that is, to neighboring, aligned edges. If you have a ring selected, you can use this function to select a neighboring ring. Applies only to Edge and Border sub-object levels.

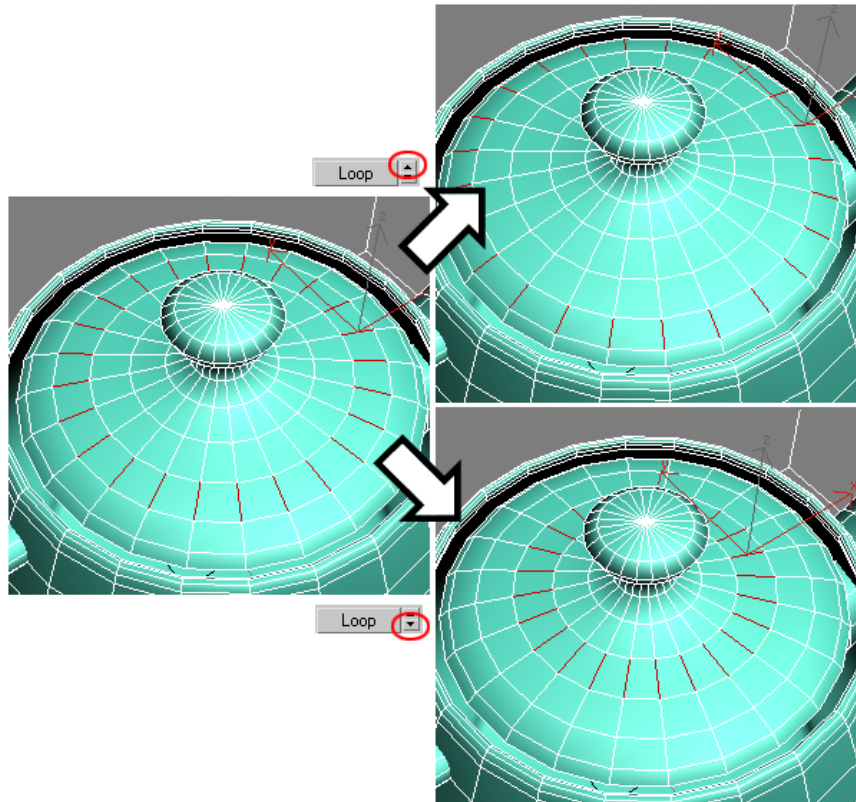

**Left: Original ring selection**

**Upper right: Loop Shift up moves selection outward.**

**Lower right: Loop Shift down moves selection inward.**

To expand the selection in the chosen direction, Ctrl+click the up or down spinner button. To shrink the selection in the chosen direction, Alt+click the up or down spinner button.

**Get Stack Selection** Replaces the current selection with the sub-object selection passed up the stack. You can then modify this selection using standard methods.

If no selection exists in the stack, all sub-objects are unselected.



## Preview Selection

This option lets you preview a sub-object selection before committing to it. You can preview at the current sub-object level, or switch sub-object levels automatically based on the mouse position. The choices are:

- **Off** No preview is available.
- **SubObj** Enables previewing at the current sub-object level only. As you move the mouse over the object, the sub-object under the cursor highlights in yellow. To select the highlighted object, click the mouse. To select multiple sub-objects at the current level, press and hold Ctrl, move the mouse to highlight more sub-objects, and then click to select all highlighted sub-objects.

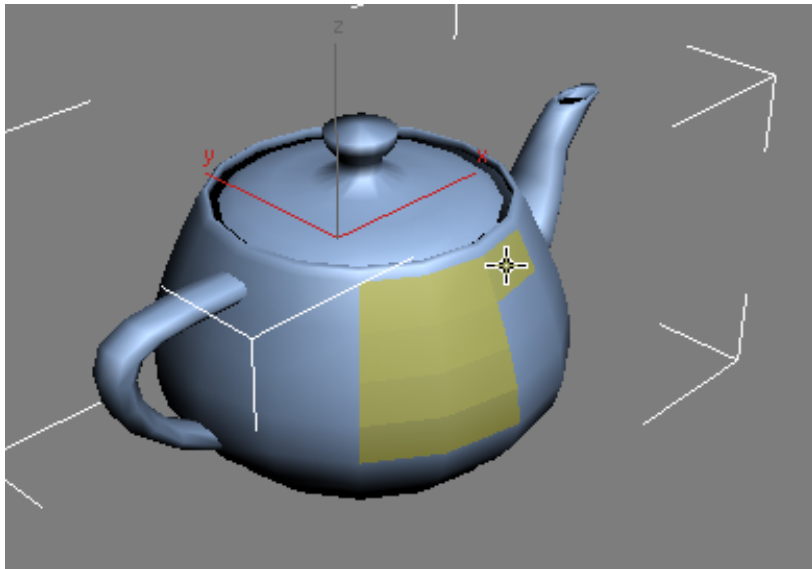

Polygon sub-object selection preview with **Ctrl** held down

To deselect multiple sub-objects at the current level, press and hold Ctrl+Alt, move the mouse to highlight more sub-objects, and then click a selected sub-object. This deselects all highlighted sub-objects.

- **Multi** Works like SubObj, but also switches among the Vertex, Edge, and Polygon sub-object levels on the fly, based on the mouse position. For example, if you position the mouse over an edge, the edge highlights, and then clicking activates the Edge sub-object level and selects the edge.



To select multiple sub-objects of the same type, press and hold Ctrl after highlighting a sub-object, move the mouse to highlight more sub-objects, and then click to activate that sub-object level and select all highlighted sub-objects.

To deselect multiple sub-objects *at the current sub-object level*, press and hold Ctrl+Alt, move the mouse to highlight more sub-objects, and then click a selected sub-object. This deselects all highlighted sub-objects. Note that this method does not switch sub-object levels.

---

**NOTE** When Ignore Backfacing is off, you'll see backfacing vertices and edges highlight while previewing a sub-object selection.

---

### **Selection Information**

At the bottom of the Selection rollout is a text display giving information about the current selection. If 0 or more than one sub-object is selected, the text gives the number and type selected; for example, "4 Polygons Selected." If one sub-object is selected, the text gives the identification number and type of the selected item; for example, "Polygon 73 Selected."



When using [Preview Selection](#) on page 1318, a second line gives additional information about the identity or number of highlighted sub-objects.

## **Edit Poly (Object)**

Select an Edit Poly object. > Modify panel

Edit Poly (Object) functions are available when no sub-object levels are active. These functions are also available at all sub-object levels, and work the same in each mode, except as noted below.

## Interface

### Edit Geometry rollout

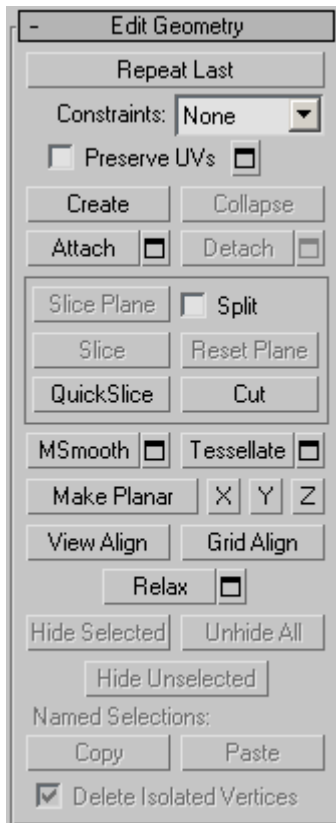

See [Edit Geometry Rollout \(Edit Poly Modifier\)](#) on page 1363 for detailed descriptions of these controls.

### Paint Deformation rollout

Paint Deformation lets you stroke elevated and indented areas directly onto object surfaces. For more information, see [Paint Deformation Rollout](#) on page 2125 .

## Edit Poly (Vertex)

Select an Edit Poly object. > Modify panel > Selection rollout > Vertex

Select an Edit Poly object. > Modify panel > Modify Stack display > Expand Edit Poly. > Vertex

Select an Edit Poly object. > Quad menu > Tools 1 quadrant > Vertex

Vertices are points in space: They define the structure of other sub-objects that make up the poly object. When vertices are moved or edited, the geometry they form is affected as well. Vertices can also exist independently; such isolated vertices can be used to construct other geometry but are otherwise invisible when rendering.

At the Edit Poly (Vertex) sub-object level, you can select single and multiple vertices and move them using standard methods. This topic covers the Edit Vertices and Edit Geometry rollouts; for other controls, see [Edit Poly Modifier](#) on page 1293 .

### Procedures

#### To weld polygon vertices:

You can use either of two methods to combine several vertices into one, also known as welding. If the vertices are very close together, use the Weld function. You can also use Weld to combine a number of vertices to the average position of all of them.

Alternatively, to combine two vertices that are far apart, resulting in a single vertex that's in the same position as one of them, use Target Weld.

#### 1 To use Weld:

- On the Selection rollout, turn on Ignore Backfacing, if necessary. This ensures that you're welding only vertices you can see.
- Select the vertices to weld.
- If the vertices are very close together, simply click Weld. If that doesn't work, proceed to the next step.
-  Click the Settings button to the right of the Weld button.

This opens the [Weld Vertices dialog](#) on page 2150 .

- Increase the Weld Threshold value gradually using the spinner (click and hold on the up-down arrow buttons to the right of the numeric field and then drag upward). If you need the value to change more quickly, hold down the Ctrl key as you drag.  
When the threshold equals or exceeds the distance between two or more of the vertices, the weld occurs automatically, and the resulting vertex moves to their average location.
- If not all the vertices are welded, continue increasing the Weld Threshold value until they are.
- Click OK to exit.

**2** To use Target Weld:

- 1** On the Selection rollout, turn on Ignore Backfacing, if necessary.  
This ensures that you're welding only vertices you can see.
- 2** Find two vertices you want to weld, and determine the ultimate location of the resulting vertex. The two vertices must be contiguous; that is, they must be connected by a single edge.  
For this example, we'll call the vertices A and B, and the resulting vertex will be at vertex B's location.
- 3** Click the Target Weld button.  
The button stays highlighted, to indicate that you're now in Target Weld mode.
- 4** Click vertex A and then move the mouse.  
A rubber-band line connects the vertex and the mouse cursor.
- 5** Position the cursor over vertex B, whereupon the cursor image changes from an arrow to a crosshairs. Reminder: Only vertices connected to the first vertex by a single edge qualify for target welding.
- 6** Click to weld the two.  
The resulting vertex remains at vertex B's position, and you exit Target Weld mode.

## Interface

### Edit Poly Mode rollout

See [Edit Poly Mode rollout](#) on page 1304 for information on the Edit Poly Mode rollout settings.

### Selection rollout

See [Selection rollout](#) on page 1306 for information on the Selection rollout settings.

### Soft Selection rollout

Soft Selection controls apply a smooth falloff between selected sub-objects and unselected ones. When Use Soft Selection is on, unselected sub-objects near your selection are given partial selection values. These values are shown in the viewports by means of a color gradient on the vertices, and optionally on the faces. They affect most types of sub-object deformations, such as the Move, Rotate, and Scale functions, as well as any deformation modifiers (such as Bend) applied to the object. This provides a magnet-like effect with a sphere of influence around the selection.

For more information, see [Soft Selection Rollout](#) on page 1926 .

### Edit Vertices rollout

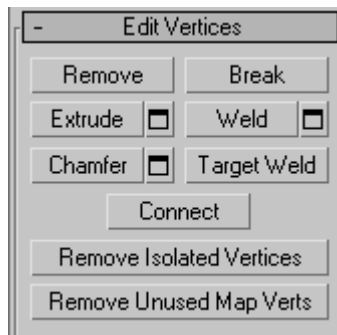

This rollout includes commands specific to vertex editing.

---

**NOTE** To delete vertices, select them and press the Delete key. This can create one or more holes in the mesh. To delete vertices without creating holes, use Remove (see following entry).

---

**Remove** Deletes selected vertices and combines the polygons that use them. The keyboard shortcut is Backspace.

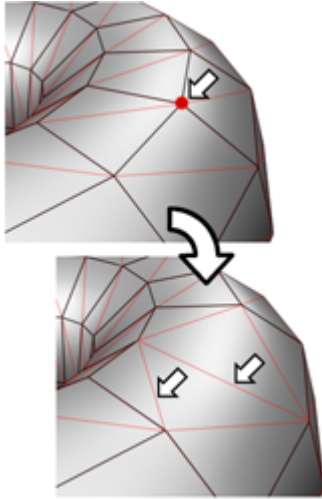

Removing one or more vertices deletes them and retriangulates the mesh to keep the surface intact. If you use the **Delete** key instead, the polygons depending on those vertices are deleted as well, creating a hole in the mesh.

---

**WARNING** Use of Remove can result in mesh shape changes and non-planar polygons.

---

**Break** Creates a new vertex for each polygon attached to selected vertices. This allows the polygon corners to move away from each other where they were once joined at each original vertex. If a vertex is isolated or used by only one polygon, it is unaffected.

**Extrude** Lets you extrude vertices manually via direct manipulation in the viewport. Click this button, and then drag vertically on any vertex to extrude it.

Extruding a vertex moves it along a normal and creates new polygons that form the sides of the extrusion, connecting the vertex to the object. The extrusion has the same number of sides as the number of polygons that originally used the extruded vertex.

Important aspects of vertex extrusion are:

- The mouse cursor changes to an Extrude cursor when over a selected vertex.

- Drag vertically to specify the extent of the extrusion, and horizontally to set the size of the base.
- With multiple vertices selected, dragging on any one extrudes all selected vertices equally.
- You can drag other vertices in turn to extrude them while the Extrude button is active. Click Extrude again or right-click in the active viewport to end the operation.

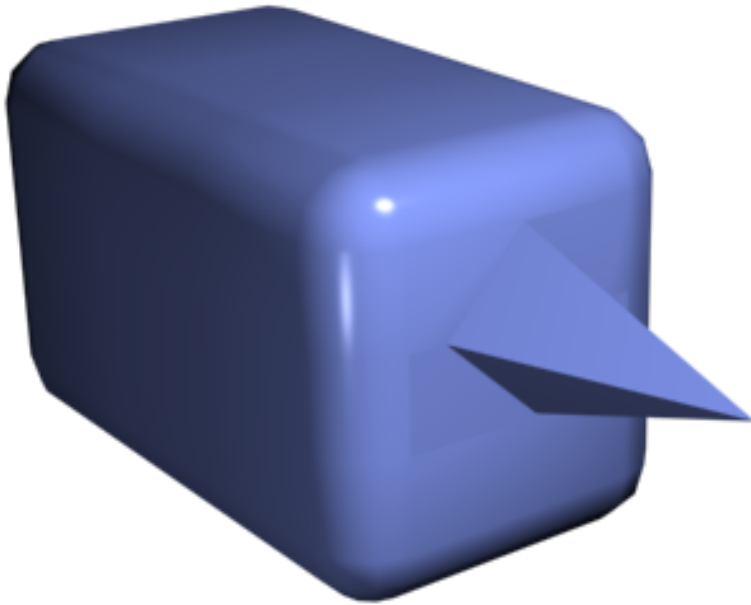

**Chamfer box showing extruded vertex**



**Extrude Settings** Opens the [Extrude Vertices dialog](#) on page 2142 , which lets you perform extrusion via interactive manipulation.

If you click this button after performing a manual extrusion, the same extrusion is performed on the current selection as a preview and the dialog opens with Extrusion Height set to the amount of the last manual extrusion.

**Weld** Combines contiguous, selected vertices that fall within the tolerance specified in the [Weld dialog](#) on page 2150 . All edges become connected to the resulting single vertex.

Weld is best suited to automatically simplify geometry that has areas with several vertices in close proximity.



**Weld Settings** Opens the [Weld dialog](#) on page 2150 , which lets you specify the weld threshold.

**Chamfer** Click this button and then drag vertices in the active object. To chamfer vertices numerically, click the Chamfer Settings button and adjust the Chamfer Amount value.

If you chamfer multiple selected vertices, all of them are chamfered identically. If you drag an unselected vertex, any selected vertices are first unselected.

Each chamfered vertex is effectively replaced by a new face that connects new points on all edges leading to the original vertex. These new points are exactly <chamfer amount> distance from the original vertex along each of these edges. New chamfer faces are created with the material ID of one of the neighboring faces (picked at random) and a smoothing group that is an intersection of all neighboring smoothing groups.

For example, if you chamfer one corner of a box, the single corner vertex is replaced by a triangular face whose vertices move along the three edges that led to the corner. Outside faces are rearranged and split to use these three new vertices, and a triangle is created at the corner.



Alternatively, you can create open space around the chamfered vertices; for details, see [Chamfer Vertices dialog](#) on page 2136 .



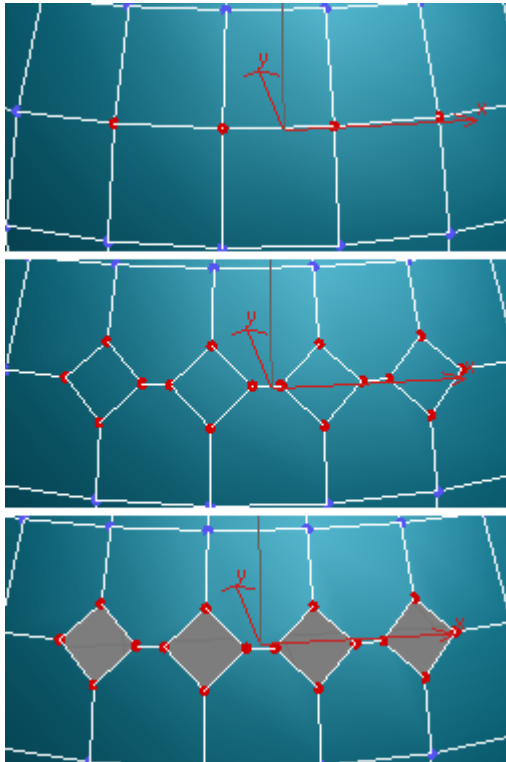

**Top:** The original vertex selection

**Center:** Vertices chamfered

**Bottom:** Vertices chamfered with Open on



**Chamfer Settings** Opens the [Chamfer Vertices dialog](#) on page 2136, which lets you chamfer vertices via interactive manipulation and toggle the Open option.

If you click this button after performing a manual chamfer, the same chamfer is performed on the current selection as a preview and the dialog opens with Chamfer Amount set to the amount of the last manual chamfer.

**Target Weld** Lets you select a vertex and weld it to a target vertex. When positioned over a vertex, the cursor changes to a + cursor. Click and move the mouse and a dashed line appears from the vertex with an arrow cursor at the other end of the line. Position the cursor over a neighboring vertex and when the + cursor appears again, click the mouse. The first vertex moves to the position of the second, and the two are welded.

**Connect** Creates new edges between pairs of selected vertices.

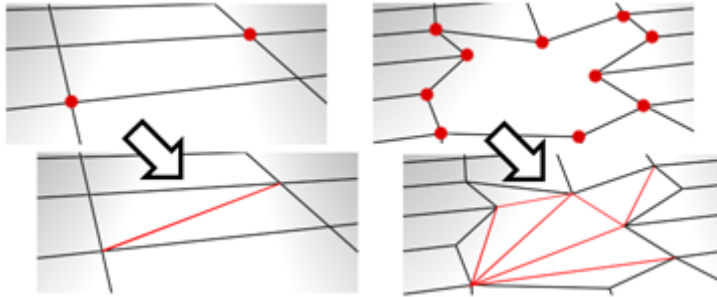

Connect will not let the new edges cross. For example, if you select all four vertices of a four-sided polygon and then click Connect, only two of the vertices will connect. In this case, to connect all four vertices with new edges, use [Cut](#) on page 2113 .

**Remove Isolated Vertices** Deletes all vertices that don't belong to any polygons.

**Remove Unused Map Verts** Certain modeling operations can leave unused (isolated) map vertices that show up in the [Unwrap UVW editor](#) on page 1788 , but cannot be used for mapping. You can use this button to delete these map vertices automatically.

## Edit Geometry rollout

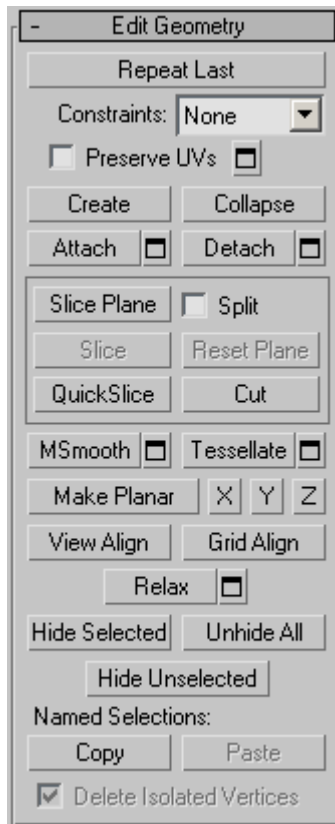

See [Edit Geometry Rollout \(Edit Poly Modifier\)](#) on page 1363 for detailed descriptions of these controls.

## Paint Deformation rollout

Paint Deformation lets you stroke elevated and indented areas directly onto object surfaces. For more information, see [Paint Deformation Rollout](#) on page 2125 .

## Edit Poly (Edge)

Select an Edit Poly object. > Modify panel > Selection rollout > Edge

Select an Edit Poly object. > Modify panel > Modifier Stack display > Expand Edit Poly. > Edge

Select an Edit Poly object. > Quad menu > Tools 1 quadrant > Edge

An edge is a line connecting two vertices that forms the side of a polygon. An edge can't be shared by more than two polygons. Also, the normals of the two polygons should be adjacent. If they aren't, you wind up with two edges that share vertices.

At the Edit Poly Edge sub-object level, you can select single and multiple edges and transform them using standard methods. This topic covers the Edit Geometry and Edit Edges rollouts; for other controls, see [Edit Poly Modifier](#) on page 1293 .

### Procedures

**To create a shape from one or more edges:**

- 1 Select the edges you want to make into shapes.
- 2 On the Edit Edges rollout, click the Create Shape button. This creates the shape immediately, using default settings. Alternatively, click the Settings button next to Create Shape.
- 3 Make changes, as needed, on the Create Shape dialog that appears.
  - Enter a curve name or keep the default.
  - Choose Smooth or Linear as the shape type.
- 4 Click OK.

The resulting shape consists of one or more splines whose vertices are coincident with the vertices in the selected edges. The Smooth option results in rounded-corner Bezier vertices, while the Linear option results in straight-line splines with Corner vertices.

If the selected edges are not continuous, or if they branch, the resulting shape will consist of more than one spline. When the Create Shape function runs into a branching 'Y' in the edges, it makes an arbitrary decision about which edge produces which spline. If you need to control this, select only edges that will result in a single spline, and perform a

Create Shape operation repeatedly to make the correct number of shapes. Finally, use [Attach](#) on page 627 in the Editable Spline to combine the shapes into one.

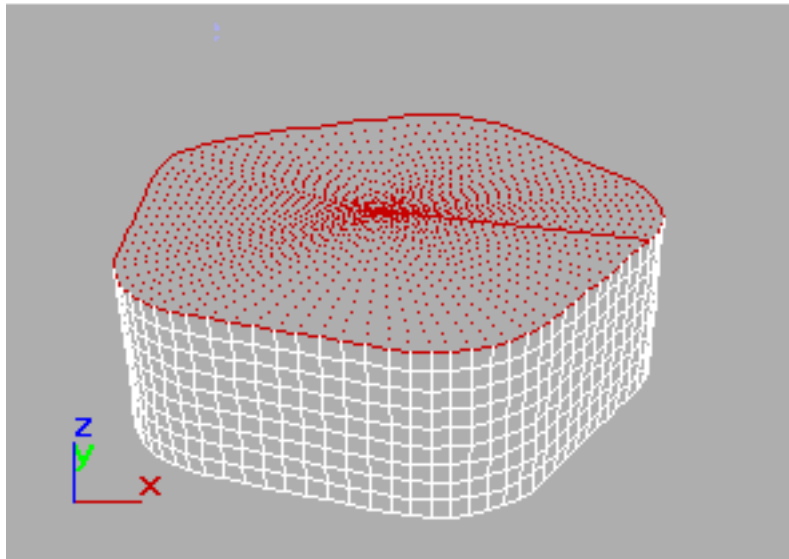
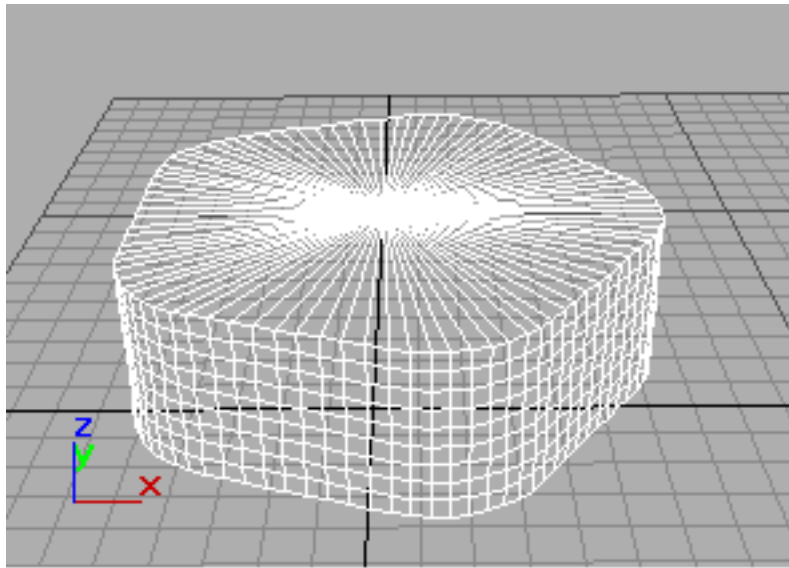

Above: Original object

Below: Object with edges selected

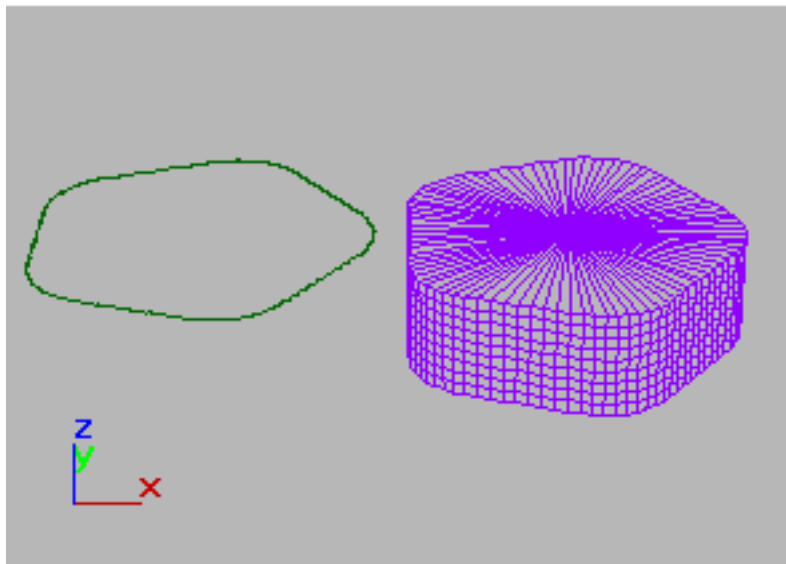
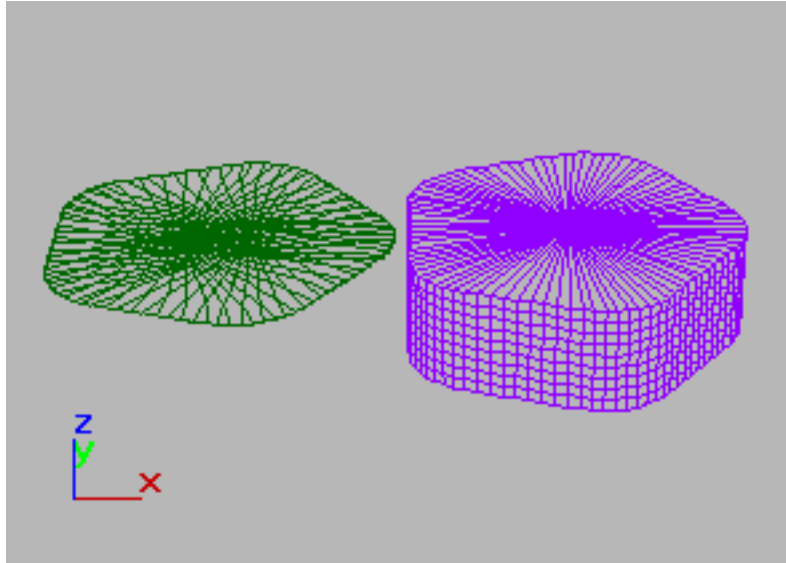

Above: Selected edges removed from original object

Below: Unwanted edges removed

## Interface

### Edit Poly Mode rollout

See [Edit Poly Mode rollout](#) on page 1304 for information on the Edit Poly Mode rollout settings.

### Selection rollout

See [Selection rollout](#) on page 1306 for information on the Selection rollout settings.

### Soft Selection rollout

Soft Selection controls apply a smooth falloff between selected sub-objects and unselected ones. When Use Soft Selection is on, unselected sub-objects near your selection are given partial selection values. These values are shown in the viewports by means of a color gradient on the vertices, and optionally on the faces. They affect most types of sub-object deformations, such as the Move, Rotate, and Scale functions, as well as any deformation modifiers (such as Bend) applied to the object. This provides a magnet-like effect with a sphere of influence around the selection.

For more information, see [Soft Selection Rollout](#) on page 1926 .

### Edit Edges rollout

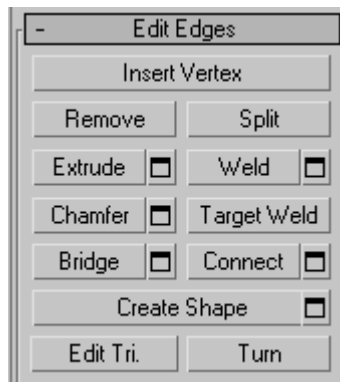

This rollout includes commands specific to edge editing.

---

**NOTE** To delete edges, select them and press the Delete key. This deletes all selected edges and attached polygons, which can create one or more holes in the mesh. To delete edges without creating holes, use Remove (see following entry).

---

**Insert Vertex** Lets you subdivide visible edges manually.

After turning on Insert Vertex, click an edge to add a vertex at that location. You can continue subdividing polygons as long as the command is active.

To stop inserting edges, right-click in the viewport, or click Insert Vertex again to turn it off.

**Remove** Deletes selected edges and combines the polygons that use them. The keyboard shortcut is Backspace.

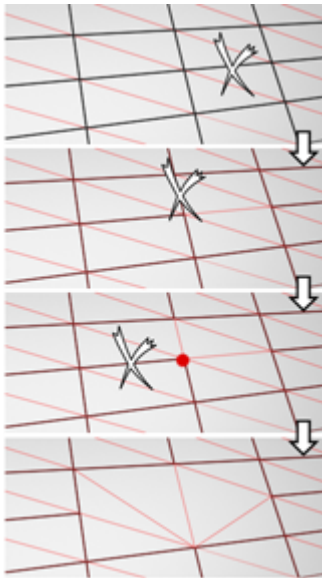

Removing one edge is like making it invisible. The mesh is affected only when you remove all but one of the edges depending on one vertex. At that point, the vertex itself is deleted and the surface is retriangulated.

To delete the associated vertices as well, press and hold Ctrl while executing a Remove operation, either by mouse or with the Backspace key. This option, called Clean Remove, ensures that the remaining polygons are planar.



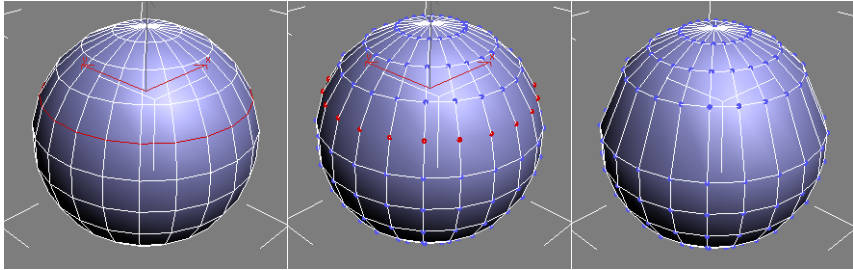

**Left:** The original edge selection

**Center:** Standard Remove operation leaves extra vertices.

**Right:** Clean Remove with **Ctrl+Remove** deletes the extra vertices.

Edges with the same polygon on both sides usually can't be removed.

---

**WARNING** Use of Remove can result in mesh shape changes and non-planar polygons.

---

**Split** Divides the mesh along the selected edges.

Split does nothing when applied to a single edge in the middle of a mesh. The vertices at the end of affected edges must be separable for this option to work. For example, it would work on a single edge that intersects an existing border, since the border vertex can be split in two. Additionally, two adjacent edges could be split in the middle of a grid or sphere, since the shared vertex can be split.

**Extrude** Lets you extrude edges manually via direct manipulation in the viewport. Click this button, and then drag vertically on any edge to extrude it.

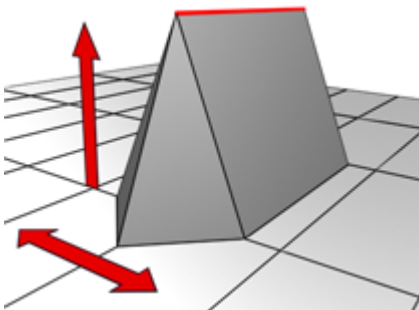

When extruding a vertex or edge interactively in the viewport, you set the extrusion height by moving the mouse vertically and the base width by moving the mouse horizontally.

Extruding an edge moves it along a normal and creates new polygons that form the sides of the extrusion, connecting the edge to the object. The extrusion has either three or four sides; three if the edge was on a border, or four if it was shared by two polygons. As you increase the length of the extrusion, the base increases in size, to the extent of the vertices adjacent to the extruded edge's endpoints.

Important aspects of edge extrusion are:

- The mouse cursor changes to an Extrude cursor when over a selected edge.
- Drag vertically to specify the extent of the extrusion, and horizontally to set the size of the base.
- With multiple edges selected, dragging on any one extrudes all selected edges equally.
- You can drag other edges in turn to extrude them while the Extrude button is active. Click Extrude again or right-click in the active viewport to end the operation.

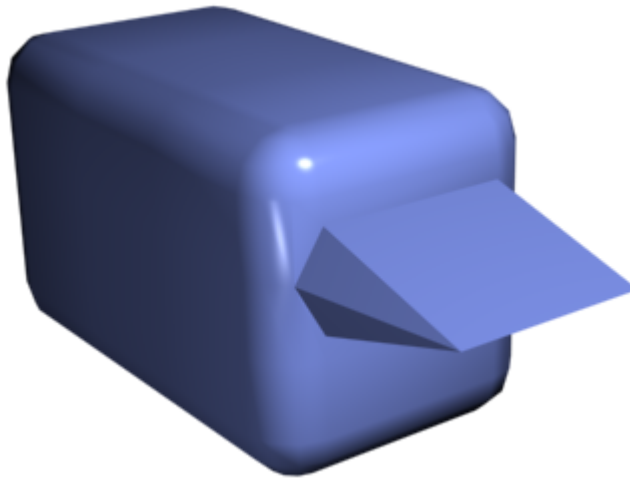

Chamfer box showing extruded edge



**Extrude Settings** Opens the [Extrude Edges dialog](#) on page 2142 , which lets you perform extrusion via interactive manipulation.

If you click this button after performing a manual extrusion, the same extrusion is performed on the current selection as a preview and the dialog opens with Extrusion Height set to the amount of the last manual extrusion.

**Weld** Combines selected edges that fall within the threshold specified in the [Weld dialog](#) on page 2150 .

You can weld only edges that have one polygon attached; that is, edges on a border. Also, you cannot perform a weld operation that results in illegal geometry, such as an edge shared by more than two polygons. For example, you cannot weld opposite edges on the border of a box that has a side removed.

**Weld Settings** Opens the [Weld dialog](#) on page 2150 , which lets you specify the weld threshold.

**Chamfer** Click this button and then drag edges in the active object. To chamfer vertices numerically, click the Chamfer Settings button and change the Chamfer Amount value.

If you chamfer multiple selected edges, all of them are chamfered identically. If you drag an unselected edge, the software first deselects any selected edges.

An edge chamfer "chops off" the selected edges, creating a new polygon connecting new points on all visible edges leading to the original vertex. The new edges are exactly <chamfer amount> distance from the original edge along each of these edges. New chamfer faces are created with the material ID of a neighboring face (picked at random) and a smoothing group that is an intersection of all neighboring smoothing groups.

For example, if you chamfer one edge of a box, each corner vertex is replaced by two vertices moving along the visible edges that lead to the corner. Outside faces are rearranged and split to use these new vertices, and a new polygon is created at the corner.

Alternatively, you can create open space around the chamfered edges; for details, see [Chamfer Edges dialog](#) on page 2136 .



**Chamfer Settings** Opens the [Chamfer Edges dialog](#) on page 2136 , which lets you chamfer edges via interactive manipulation and toggle the Open option.

If you click this button after performing a manual chamfer, the same chamfer is performed on the current selection as a preview and the dialog opens with Chamfer Amount set to the amount of the last manual chamfer.

**Target Weld** Allows you to select an edge and weld it to a target edge. When positioned over an edge, the cursor changes to a + cursor. Click and move the mouse and a dashed line appears from the vertex with an arrow cursor at the

other end of the line. Position the cursor over another edge and when the + cursor appears again, click the mouse. The first edge is moved to the position of the second, and the two are welded.

You can weld only edges that have one polygon attached; that is, edges on a border. Also, you cannot perform a weld operation that results in illegal geometry, such as an edge shared by more than two polygons. For example, you cannot weld opposite edges on the border of a box that has a side removed.

**Bridge** Connects border edges on an object with a polygon “bridge.” Bridge connects only border edges; that is, edges that have a polygon on only one side. This tool is particularly useful when creating edge loops or profiles.

There are two ways to use Bridge in Direct Manipulation mode (that is, without opening the Bridge Edges settings dialog):

- Select two or more border edges on the object, and then click Bridge. This immediately creates the bridge between the pair of selected borders using the current Bridge settings, and then deactivates the Bridge button.
- If no qualifying selection exists (that is, two or more selected border edges), clicking Bridge activates the button and places you in Bridge mode. First click a border edge and then move the mouse; a rubber-band line connects the mouse cursor to the clicked edge. Click a second edge on a different border to bridge the two. This creates the bridge immediately using the current Bridge settings; the Bridge button remains active for connecting more edges. To exit Bridge mode, right-click the active viewport or click the Bridge button.

---

**NOTE** Bridge always creates a straight-line connection between edges. To make the bridge connection follow a contour, apply modeling tools as appropriate *after* creating the bridge. For example, bridge two edges, and then use [Bend](#) on page 1139 .

---



**Bridge Settings** Opens the [Bridge Edges dialog](#) on page 2133 , which lets you add polygons between pairs of edges via interactive manipulation.

**Connect** Creates new edges between pairs of selected edges using the current Connect Edges dialog settings. Connect is particularly useful for creating or refining edge loops.

---

**NOTE** You can connect only edges on the same polygon. Also, Connect will not let the new edges cross. For example, if you select all four edges of a four-sided polygon and then click Connect, only neighboring edges are connected, resulting in a diamond pattern.

---

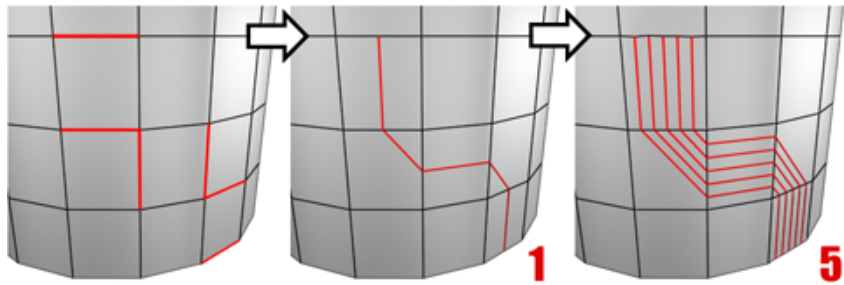

Connecting two or more edges creates equally spaced edges. The number of edges is set in the dialog.



**Connect Settings** Opens the [Connect Edges dialog](#) on page 2137 , which lets you preview the Connect results, specify the number of edge segments created by the operation, and set spacing and placement for the new edges.

**Create Shape** After selecting one or more edges, click this button to create a spline shape or shapes from the selected edges, using the current settings from the Create Shape Settings dialog (see following).

The new shape's pivot is placed at the same location as that of the Edit Poly object.



**Create Shape Settings** Lets you preview the Create Shape function, name the shape, and set it to Smooth or Linear.

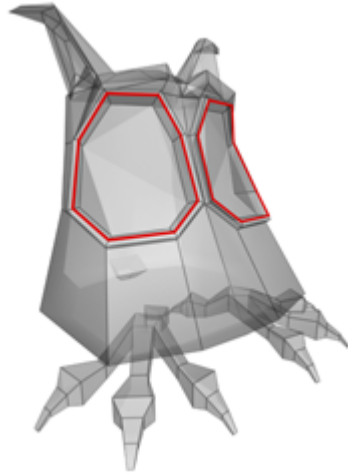



An edge selection (top); a smooth shape (center); a linear shape (bottom)

**Edit Tri[angulation]** Lets you modify how polygons are subdivided into triangles by drawing diagonals.

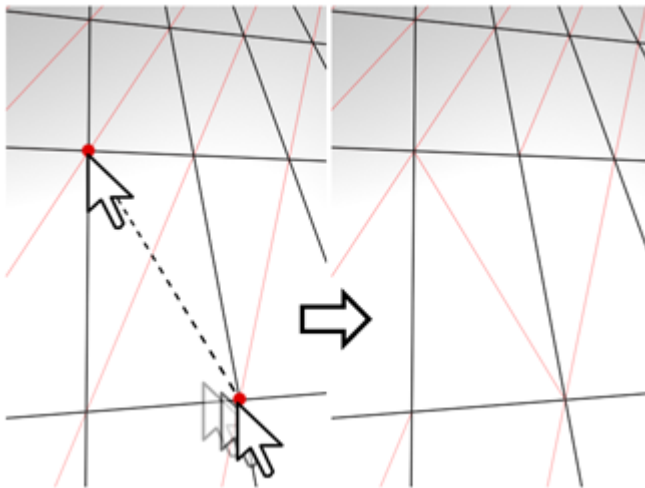

In Edit Triangulation mode, you can see the current triangulation in the viewport, and change it by clicking two vertices on the same polygon.

To edit triangulation manually, turn on this button. The diagonals appear. Click a polygon vertex. A rubber-band line appears, attached to the cursor. Click a non-adjacent vertex to create a new triangulation for the polygon.

---

**TIP** For easier editing of triangulation, use the Turn command instead (see following).

---

**Turn** Lets you modify how polygons are subdivided into triangles by clicking diagonals. When you activate Turn, the [diagonals](#) on page 7757 become visible as dashed lines in wireframe and edged-faces views. In Turn mode, click a diagonal to change its position. To exit Turn mode, right-click in the viewport or click the Turn button again.

Each diagonal has only two available positions at any given time, so clicking a diagonal twice in succession simply returns it to its original position. But changing the position of a nearby diagonal can make a different alternate position available to a diagonal.

For more information on how to use Turn with the enhanced Cut tool, see [this procedure](#) on page ? .



## Edit Geometry rollout

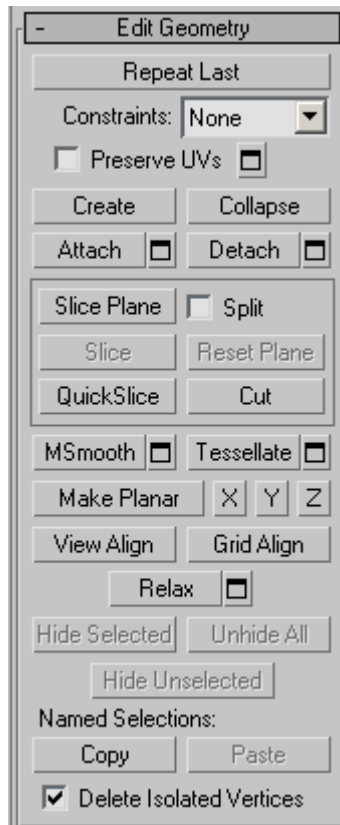

See [Edit Geometry Rollout \(Edit Poly Modifier\)](#) on page 1363 for detailed descriptions of these controls.

## Paint Deformation rollout

Paint Deformation lets you stroke elevated and indented areas directly onto object surfaces. For more information, see [Paint Deformation Rollout](#) on page 2125 .

## Edit Poly (Border)

Select an Edit Poly object. > Modify panel > Selection rollout > Border

Select an Edit Poly object. > Modify panel > Modifier Stack display > Expand Edit Poly. > Border

Select an Edit Poly object. > Quad menu > Tools 1 quadrant > Border

A border is a linear section of a mesh that can generally be described as the edge of a hole. This is usually a sequence of edges with polygons on only one side. For example, a box doesn't have a border, but the teapot object has several: on the lid, on the body, on the spout, and two on the handle. If you create a cylinder, and then delete an end polygon, the adjacent row of edges forms a border.

At the Edit Poly Border sub-object level, you can select single and multiple borders and transform them using standard methods. This topic covers the Edit Geometry and Edit Borders rollouts; for other controls, see [Edit Poly Modifier](#) on page 1293 .

## Procedures

**To create a polygon that closes the surface at the selected border:**

- 1 At the Border sub-object level, select any open edge.  
This selects the entire closed loop of continuous open edges that make up the border selection.
- 2 Click Edit Borders rollout > Cap.

## Interface

### Edit Poly Mode rollout

See [Edit Poly Mode rollout](#) on page 1304 for information on the Edit Poly Mode rollout settings.

### Selection rollout

See [Selection rollout](#) on page 1306 for information on the Selection rollout settings.

### Soft Selection rollout

Soft Selection controls apply a smooth falloff between selected sub-objects and unselected ones. When Use Soft Selection is on, unselected sub-objects near your selection are given partial selection values. These values are shown in the viewports by means of a color gradient on the vertices, and optionally

on the faces. They affect most types of sub-object deformations, such as the Move, Rotate, and Scale functions, as well as any deformation modifiers (such as Bend) applied to the object. This provides a magnet-like effect with a sphere of influence around the selection.

For more information, see [Soft Selection Rollout](#) on page 1926 .

### Edit Borders rollout



This rollout includes commands specific to editing borders.

---

**NOTE** To delete a border, select it and press the Delete key. This deletes the border and all attached polygons.

---

**Extrude** Lets you extrude a border manually via direct manipulation in the viewport. Click this button, and then drag vertically on any border to extrude it.

Extruding a border moves it along a normal and creates new polygons that form the sides of the extrusion, connecting the border to the object. The extrusion can form a varying number of additional sides, depending on the geometry near the border. As you increase the length of the extrusion, the base increases in size, to the extent of the vertices adjacent to the extruded border's endpoints.

Important aspects of border extrusion are:

- The mouse cursor changes to an Extrude cursor when over a selected border.
- Drag vertically to specify the extent of the extrusion, and horizontally to set the size of the base.
- With multiple borders selected, dragging on any one extrudes all selected borders equally.

- You can drag other borders in turn to extrude them while the Extrude button is active. Click Extrude again or right-click in the active viewport to end the operation.



**Extrude Settings** Opens the [Extrude Edges dialog](#) on page 2142 , which lets you perform extrusion via interactive manipulation.

If you click this button after performing a manual extrusion, the same extrusion is performed on the current selection as a preview and the dialog opens with Extrusion Height set to the amount of the last manual extrusion.

**Insert Vertex** Lets you subdivide border edges manually.

After turning on Insert Vertex, click a border edge to add a vertex at that location. You can continue subdividing border edges as long as the command is active.

To stop inserting vertices, right-click in the viewport, or click Insert Vertex again to turn it off.

---

**NOTE** In previous versions of the software, this command was called Divide.

---

**Chamfer** Click this button and then drag a border in the active object. The border need not be selected first.

If you chamfer multiple selected borders, all of them are chamfered identically. If you drag an unselected border, any selected borders are first unselected.

A border chamfer essentially “frames” the border edges, creating a new set of edges paralleling the border edges, plus new diagonal edges at any corners. These new edges are exactly <Chamfer Amount> distance from the original edges. New chamfer faces are created with the material ID of a neighboring face (picked at random) and a smoothing group which is an intersection of all neighboring smoothing groups.



Alternatively, you can create open space around the chamfered borders, essentially cutting away at the open edges; for details, see [Chamfer Edges dialog](#) on page 2136 .



**Chamfer Settings** Opens the [Chamfer Edges dialog](#) on page 2136 , which lets you chamfer borders via interactive manipulation and toggle the Open option.

If you click this button after performing a manual chamfer, the same chamfer is performed on the current selection as a preview and the dialog opens with Chamfer Amount set to the amount of the last manual chamfer.

**Cap** Caps an entire border loop with a single polygon.

Select the border, and then click Cap.

**Bridge** Connects two borders on an object with a polygon “bridge.” There are two ways to use Bridge in Direct Manipulation mode (that is, without opening the Bridge Settings dialog):

- Select an even number of borders on the object, and then click Bridge. This immediately creates the bridge between each pair of selected borders using the current Bridge settings, and then deactivates the Bridge button.
- If no qualifying selection exists (that is, two or more selected borders), clicking Bridge activates the button and places you in Bridge mode. First click a border edge and then move the mouse; a rubber-band line connects the mouse cursor to the clicked edge. Click a second edge on a different border to bridge the two. This creates the bridge immediately using the current Bridge settings; the Bridge button remains active for connecting more pairs of borders. To exit Bridge mode, right-click the active viewport or click the Bridge button.

---

**NOTE** Bridge always creates a straight-line connection between border pairs. To make the bridge connection follow a contour, apply modeling tools as appropriate *after* creating the bridge. For example, bridge two borders, and then use [Bend](#) on page 1139 .

---



**Bridge Settings** Opens the [Bridge dialog](#) on page 2131 , which lets you connect pairs of borders via interactive manipulation.

**Connect** Creates new edges between pairs of selected border edges. The edges are connected from their midpoints.

You can connect only edges on the same polygon.

Connect will not let the new edges cross. Thus, for example, if you select all four edges of a four-sided polygon and then click Connect, only neighboring edges are connected, resulting in a diamond pattern.



**Connect Settings** Lets you preview the Connect and specify the number of edge segments created by the operation. To increase the mesh resolution around the new edge, increase the Connect Edge Segments setting.

**Create Shape** After selecting one or more borders, click this button to create a spline shape or shapes from the selected edges, using the current settings from the Create Shape Settings dialog (see following).

The new shape's pivot is placed at the same location as that of the Edit Poly object.



**Create Shape Settings** Lets you preview the Create Shape function, name the shape, and set it to Smooth or Linear.

**Edit Tri[angulation]** Lets you modify how selected polygons are subdivided into triangles by drawing internal edges.

To manually edit triangulation, turn on this button. The hidden edges appear. Click a polygon vertex. A rubber-band line appears, attached to the cursor. Click a non-adjacent vertex to create a new triangulation for the polygon.

---

**TIP** For easier editing of triangulation, use the Turn command instead (see following).

---

**Turn** Lets you modify how polygons are subdivided into triangles by clicking diagonals. When you activate Turn, the [diagonals](#) on page 7757 become visible as dashed lines in wireframe and edged-faces views. In Turn mode, click a diagonal to change its position. To exit Turn mode, right-click in the viewport or click the Turn button again.

Each diagonal has only two available positions at any given time, so clicking a diagonal twice in succession simply returns it to its original position. But changing the position of a nearby diagonal can make a different alternate position available to a diagonal.

For more information on how to use Turn with the enhanced Cut tool, see [this procedure](#) on page ? .

## Edit Geometry rollout



See [Edit Geometry Rollout \(Edit Poly Modifier\)](#) on page 1363 for detailed descriptions of these controls.

## Paint Deformation rollout

Paint Deformation lets you stroke elevated and indented areas directly onto object surfaces. For more information, see [Paint Deformation Rollout](#) on page 2125 .

## Edit Poly (Polygon/Element)



Select an Edit Poly object. > Modify panel > Selection rollout > Polygon/Element

Select an Edit Poly object. > Modify panel > modifier stack display > Expand Edit Poly. > Polygon/Element

Select an Edit Poly object. > Quad menu > Tools 1 quadrant > Polygon/Element

A *polygon* is a closed sequence of three or more edges connected by a surface. Polygons provide the renderable surface of Edit Poly objects.

At the Edit Poly (Polygon) sub-object level, you can select single and multiple polygons and transform them using standard methods. This is similar for the Element sub-object level; for the distinctions between polygon and element, see [Edit Poly > Selection rollout](#) on page 1306 . This topic covers the Edit Polygons/Elements rollout and Edit Geometry rollout functions for these sub-object types. For other controls, see [Edit Poly Modifier](#) on page 1293 .

---

**NOTE** Workflow enhancements in the Edit Poly user interface give you a choice of editing methods. See [Edit Poly Workflow](#) on page 1300 for more information.

---

### Interface

#### Edit Poly Mode rollout

See [Edit Poly Mode rollout](#) on page 1304 for information on the Edit Poly Mode rollout settings.

#### Selection rollout

See [Selection rollout](#) on page 1306 for information on the Selection rollout settings.

#### Soft Selection rollout

Soft Selection controls apply a smooth falloff between selected sub-objects and unselected ones. When Use Soft Selection is on, unselected sub-objects near your selection are given partial selection values. These values are shown in the viewports by means of a color gradient on the vertices, and optionally on the faces. They affect most types of sub-object deformations, such as the Move, Rotate, and Scale functions, as well as any deformation modifiers (such



as Bend) applied to the object. This provides a magnet-like effect with a sphere of influence around the selection.

For more information, see [Soft Selection Rollout](#) on page 1926 .

## Edit Polygons/Elements rollout

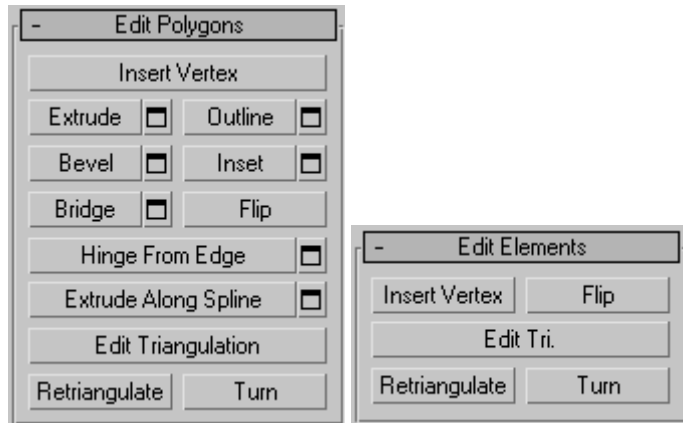

At the Element sub-object level, this rollout includes commands common to both polygons and elements, plus, at the Polygon level, some that are unique to polygons. The commands available at both levels are Insert Vertex, Flip, Edit Triangulation, Retriangulate, and Turn.

---

**NOTE** To delete polygons or elements, select them and press the Delete key. If [Delete Isolated Vertices](#) on page 2117 is off, this can result in isolated vertices; that is, vertices with no associated face geometry.

---

**Insert Vertex** Lets you subdivide polygons manually. Applies to polygons, even if at the element sub-object level.

After turning on Insert Vertex, click a polygon to add a vertex at that location. You can continue subdividing polygons as long as the command is active.

To stop inserting vertices, right-click in the viewport, or click Insert Vertex again to turn it off.

---

**NOTE** In previous versions of the software, this command was called Divide.

---

**Extrude** Lets you perform manual extrusion via direct manipulation in the viewport. Click this button, and then drag vertically on any polygon to extrude it.

Extruding polygons moves them along a normal and creates new polygons that form the sides of the extrusion, connecting the selection to the object.

Important aspects of polygon extrusion are:

- The mouse cursor changes to an Extrude cursor when over a selected polygon.
- Drag vertically to specify the extent of the extrusion, and horizontally to set the size of the base.
- With multiple polygons selected, dragging on any one extrudes all selected polygons equally.
- You can drag other polygons in turn to extrude them while the Extrude button is active. Click Extrude again or right-click in the active viewport to end the operation.

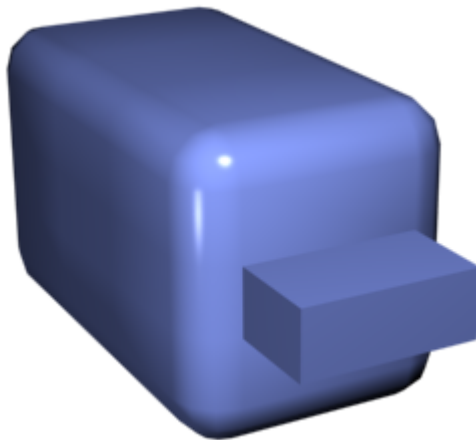

**Chamfer box showing extruded polygon**



**Extrude Settings** Opens the [Extrude Faces dialog](#) on page 2141 , which lets you perform extrusion via interactive manipulation.

If you click this button after performing an extrusion, the same extrusion is performed on the current selection as a preview and the dialog opens with Extrusion Height set to the amount of the last manual extrusion.

**Outline** Lets you increase or decrease the outside edge of each contiguous group of selected polygons.

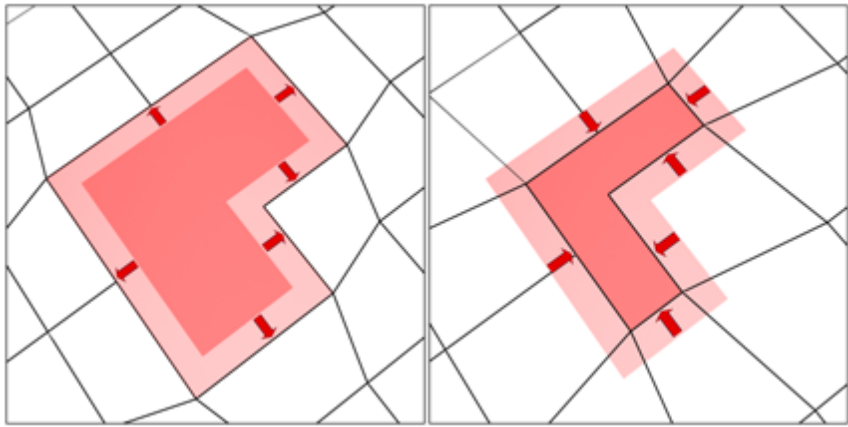

Outline is often used after an extrusion or bevel to adjust the size of the extruded faces. It doesn't scale the polygons; only changes the size of the outer edge. For example, in the following illustration, note that the sizes of the inner polygons remain constant.



Click the Outline Settings button to open the Outline Selected Faces dialog, which lets you perform outlining with a numeric setting.

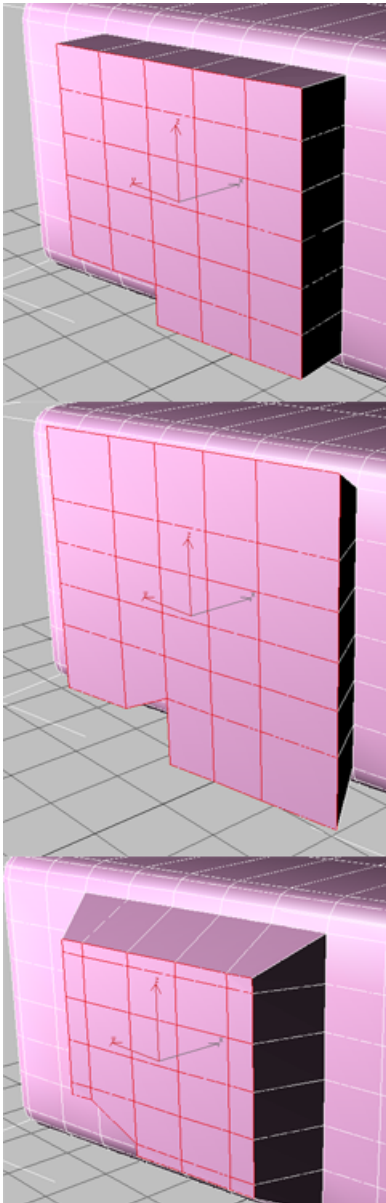

Extruded polygons (top), outline expanded (middle), outline reduced (bottom)  
Note that the size of inner polygons doesn't change.

**Bevel** Lets you perform manual beveling via direct manipulation in the viewport. Click this button, and then drag vertically on any polygon to extrude it. Release the mouse button and then move the mouse vertically to outline the extrusion. Click to finish.

- The mouse cursor changes to a Bevel cursor when over a selected polygon.
- With multiple polygons selected, dragging on any one bevels all selected polygons equally.
- You can drag other polygons in turn to bevel them while the Bevel button is active. Click Bevel again or right-click to end the operation.

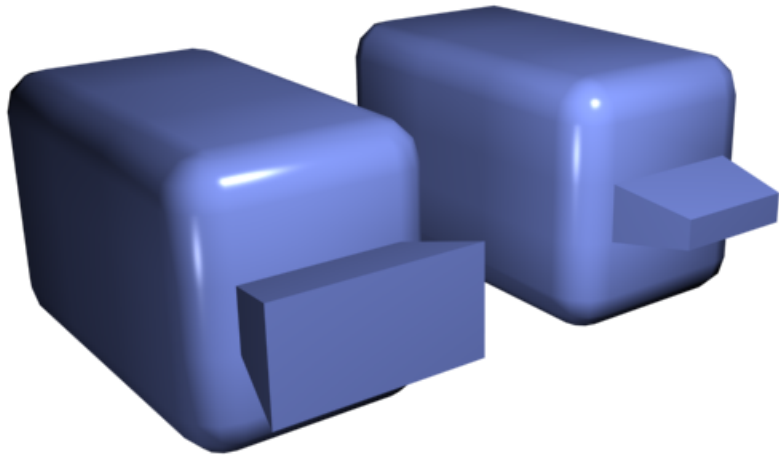

Polygon beveled outward (left) and inward (right)



**Bevel Settings** Opens the [Bevel Polygons dialog](#) on page 2129 , which lets you perform beveling via interactive manipulation.

If you click this button after performing a bevel, the same bevel is performed on the current selection as a preview and the dialog opens with the same settings used for the previous bevel.

**Inset** Performs a bevel with no height; that is, within the plane of the polygon selection. Click this button, and then drag vertically on any polygon to inset it.

- The mouse cursor changes to an Inset cursor when over a selected polygon.

- With multiple polygons selected, dragging on any one insets all selected polygons equally.
- You can drag other polygons in turn to inset them while the Inset button is active. Click Inset again or right-click to end the operation.

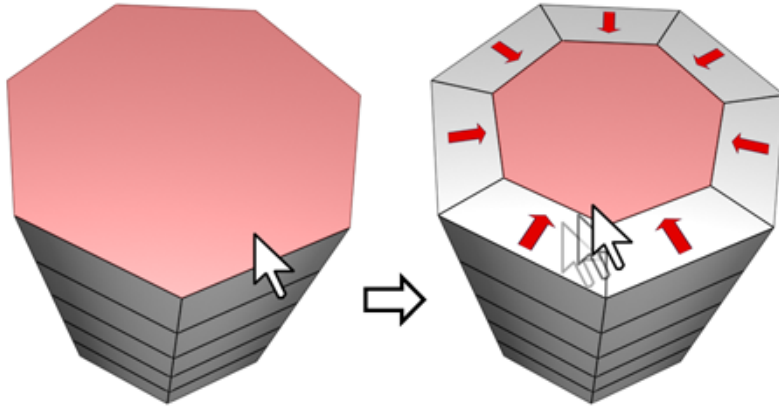

**Inset** works on a selection of one or more polygons. As with **Outline**, only the outer edges are affected.

 **Inset Settings** Opens the [Inset Selected Faces dialog](#) on page 2144 , which lets you inset polygons via interactive manipulation.

If you click this button after performing a manual inset, the same inset is performed on the current selection as a preview and the dialog opens with Inset Amount set to the amount of the last manual inset.

**Bridge** Connects two polygons or polygon groups on an object with a polygon “bridge.” There are two ways to use Bridge in Direct Manipulation mode (that is, without opening the Bridge Settings dialog):

- Make two separate polygon selections on the object, and then click Bridge. This creates the bridge immediately using the current Bridge settings, and then deactivates the Bridge button.
- If no qualifying selection exists (that is, two or more discrete polygon selections), clicking Bridge activates the button and places you in Bridge mode. First click a polygon and move the mouse; a rubber-band line connects the mouse cursor to the clicked polygon. Click a second polygon to bridge the two. This creates the bridge immediately using the current

Bridge settings; the Bridge button remains active for connecting more pairs of polygons. To exit Bridge mode, right-click the active viewport or click the Bridge button.

---

**NOTE** Bridge always creates a straight-line connection between polygon pairs. To make the bridge connection follow a contour, apply modeling tools as appropriate *after* creating the bridge. For example, bridge two polygons, and then use [Bend](#) on page 1139 .

---



**Bridge Settings** Opens the [Bridge dialog](#) on page 2131 , which lets you connect pairs of polygon selections via interactive manipulation.

**Flip** Reverses the directions of the normals of selected polygons, hence their facing.

**Hinge From Edge** Lets you perform a manual hinge operation via direct manipulation in the viewport. Make a polygon selection, click this button, and then drag vertically on any edge to hinge the selection. The mouse cursor changes to a cross when over an edge.

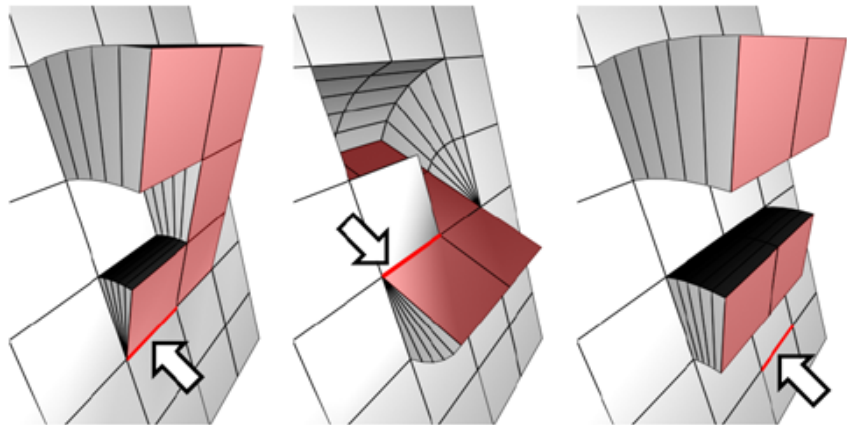

The hinge edge needn't be part of the selection. It can be any edge of the mesh. Also, the selection needn't be contiguous.

Hinging polygons rotates them around an edge and creates new polygons that form the sides of the hinge, connecting the selection to the object. It's essentially an extrusion with rotation, with one exception: If the hinge edge belongs to a selected polygon, that side is not extruded. The manual version of Hinge From Edge works only with an existing polygon selection.

---

**TIP** Turn on Ignore Backfacing to avoid inadvertently hinging around a backfacing edge.

---

 **Hinge Settings** Opens the [Hinge From Edge dialog](#) on page 2143 , which lets you hinge polygons via interactive manipulation.

If you click this button after performing a manual hinge, the dialog opens with Angle set to the extent of the last manual hinge.

**Extrude Along Spline** Extrudes the current selection along a spline.

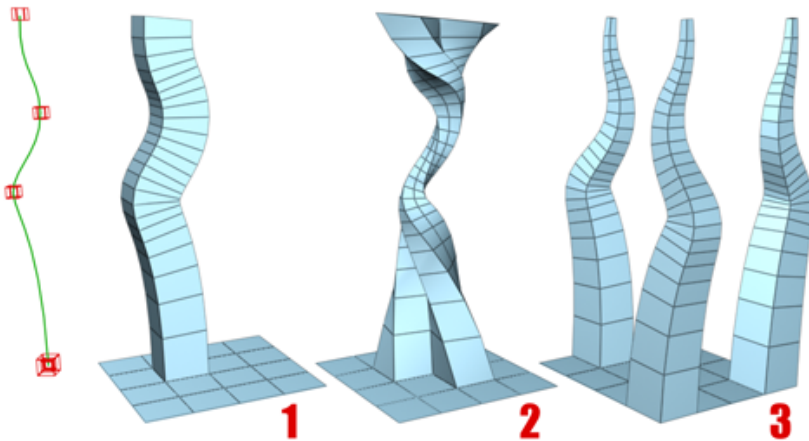

You can extrude a single face (1) or a selection of contiguous (2) or non-contiguous faces (3). Extrusion 2 uses Taper Curve and Twist. Extrusion 3 uses Taper Amount; each extrusion has a different curve rotation.

Make a selection, click Extrude Along Spline, and then select a spline in the scene. The selection is extruded along the spline, using the spline's current orientation, but as though the spline's start point was moved to the center of each polygon or group.

 **Extrude Along Spline Settings** Opens the [Extrude Polygons Along Spline dialog](#) on page 2139 , which lets you extrude along splines via interactive manipulation.

**Edit Triangulation** Lets you modify how polygons are subdivided into triangles by drawing internal edges.



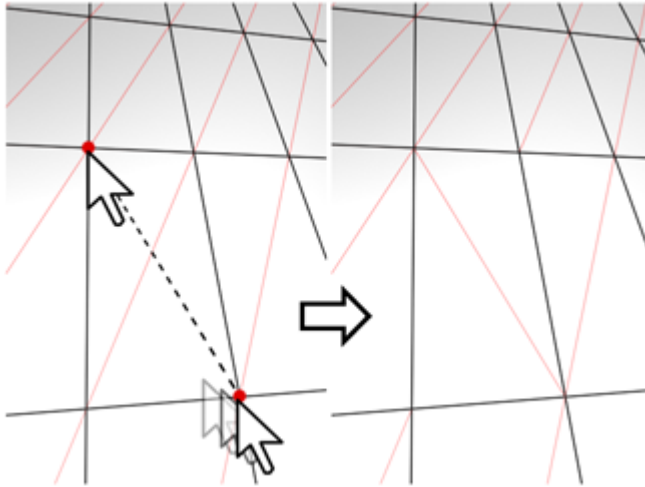

In **Edit Triangulation** mode, you can see the current triangulation in the viewport, and change it by clicking two vertices on the same polygon.

To edit triangulation manually, turn on **Edit Triangulation**. The hidden edges appear. Click a polygon vertex. A rubber-band line appears, attached to the cursor. Click a non-adjacent vertex to create a new triangulation for the polygon. You can continue clicking vertices to retriangulate, or right-click in the viewport to exit this mode.

**Retriangulate** Lets the software automatically perform optimal triangulation on the polygon or polygons currently selected.

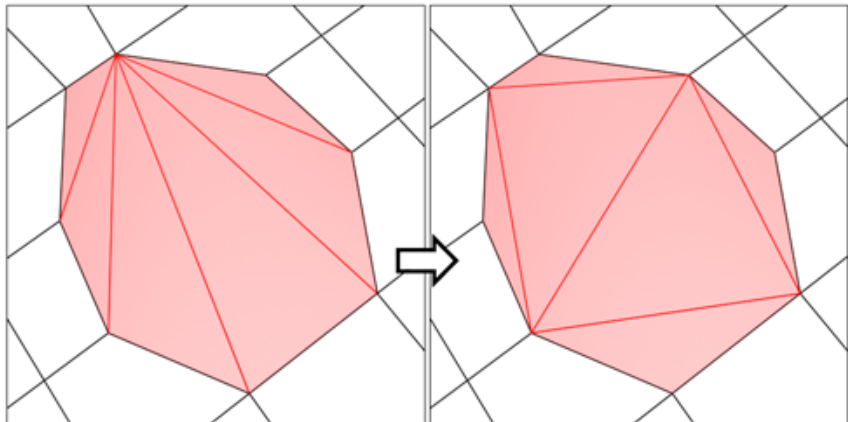

**Retriangulate** attempts to optimize the subdivision of selected polygons into triangles.

---

**TIP** For easier editing of triangulation, use the Turn command instead (see following).

---

**Turn** Lets you modify how polygons are subdivided into triangles by clicking diagonals. When you activate Turn, the [diagonals](#) on page 7757 become visible as dashed lines in wireframe and edged-faces views. In Turn mode, click a diagonal to change its position. To exit Turn mode, right-click in the viewport or click the Turn button again.

Each diagonal has only two available positions at any given time, so clicking a diagonal twice in succession simply returns it to its original position. But changing the position of a nearby diagonal can make a different alternate position available to a diagonal.

### Edit Geometry rollout

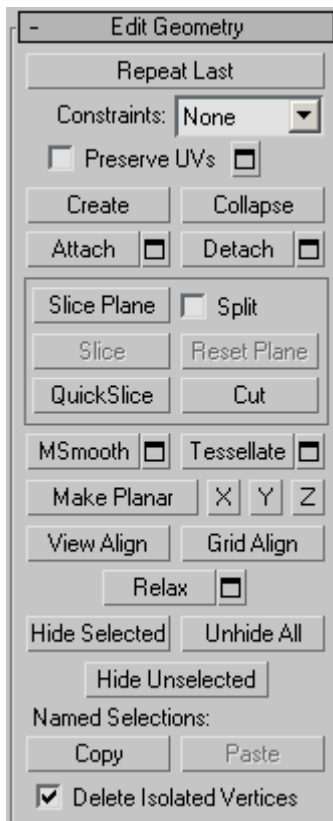

See [Edit Geometry Rollout \(Edit Poly Modifier\)](#) on page 1363 for detailed descriptions of these controls.

## Polygon Properties rollout

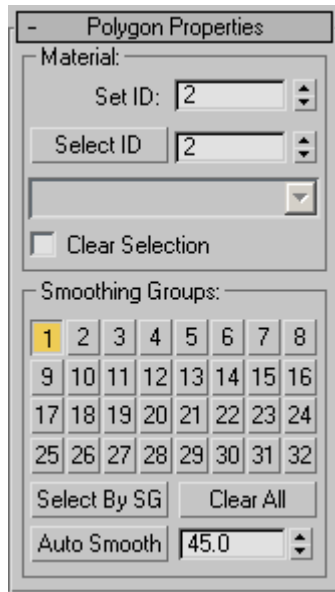

These controls let you work with material IDs and smoothing groups.

### Material group

**Set ID** Lets you assign a particular [material ID](#) on page 7842 number to selected sub-objects for use with [multi/sub-object materials](#) on page 5558 and other applications. Use the spinner or enter the number from the keyboard. The total number of available IDs is 65,535.

**Select ID** Selects sub-objects corresponding to the Material ID specified in the adjacent ID field. Type or use the spinner to specify an ID, then click the Select ID button.

**[Select By Name]** This drop-down list shows the names of sub-materials if an object has a multi/sub-object material assigned to it. Click the drop arrow and choose a sub-material from the list. This selects any sub-objects assigned that material. If an object does not have a multi/sub-object material assigned, the name list is unavailable. Likewise, if multiple selected objects have an Edit Patch, Edit Spline, or Edit Mesh modifier applied, the name list is inactive.

---

**NOTE** Sub-material names are those specified in the Name column on the material's multi/sub-object Basic Parameters rollout. By default, 3ds Max assigns the material name "No Name" followed by a sequence number in parentheses. These names don't appear in the Material Editor, but they do show up in the drop-down list.

---

**Clear Selection** When on, choosing a new ID or material name unselects any previously selected sub-objects. When off, selections are cumulative, so new ID or sub-material name selections add to the existing selection set of patches or elements. Default=off.

### **Smoothing Groups group**

Use these controls to assign selected polygons to different [smoothing groups](#) on page 7932 , and to select polygons by smoothing group.

To assign polygons to one or more smoothing groups, select the polygons, and then click the number(s) of the smoothing group(s) to assign them to.

**Select By SG (Smoothing Group)** Displays a dialog that shows the current smoothing groups. Select a group by clicking the corresponding numbered button and clicking OK. If Clear Selection is on, any previously selected polygons are first unselected. If Clear Selection is off, the new selection is added to any previous selection set.

**Clear All** Removes any smoothing group assignments from selected polygons.

**Auto Smooth** Sets smoothing groups based on the angle between polygons. Any two adjacent polygons are put in the same smoothing group if the angle between their normals is less than the threshold angle, set by the spinner to the right of this button.

**[threshold]** This numeric setting (to the right of Auto Smooth) lets you specify the maximum angle between the normals of adjacent polygons that determines whether those polygons will be put in the same smoothing group.

### **Paint Deformation rollout**

Paint Deformation lets you stroke elevated and indented areas directly onto object surfaces. For more information, see [Paint Deformation Rollout](#) on page 2125 .

## Edit Geometry Rollout (Edit Poly Modifier)

Select an Edit Poly object. > Modify panel > Edit Geometry rollout

The Edit Geometry rollout provides global controls for changing the geometry of the Edit Poly object, at either the top (Object) level or the sub-object levels. The control are the same at all levels, except as noted in the descriptions below.

### Interface

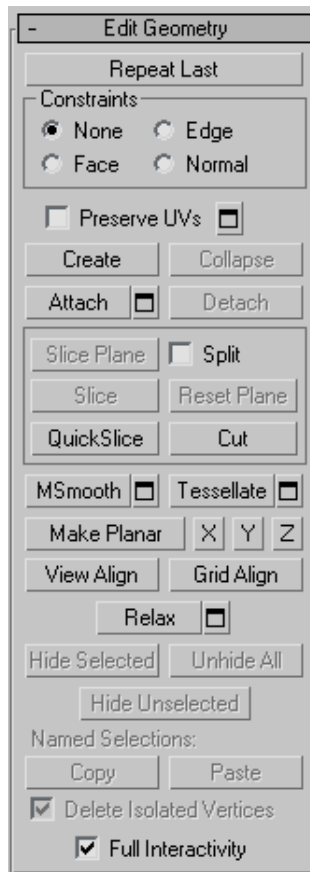

**Repeat Last** Repeats the most recently used command.

For example, if you extrude a polygon, and want to apply the same extrusion to several others, select the others, and then click Repeat Last.

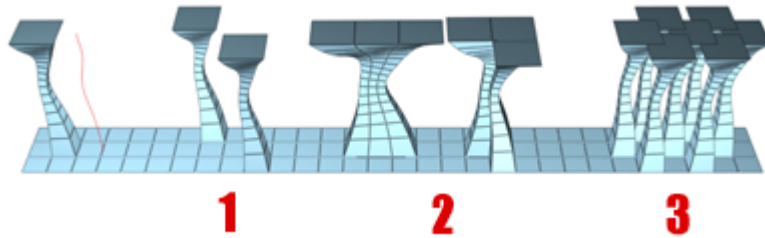

You can apply a spline extrusion of a single polygon (left) repeatedly to other single polygons (1) or to multiple polygon selections, contiguous (2) or not (3).

---

**NOTE** Repeat Last does not repeat all operations. For example, it does not repeat transforms. To determine which command will be repeated when you click the button, check the button's tooltip, which gives the name of the last operation that can be repeated. If no tooltip appears, nothing will happen when you click the button.

---

**Constraints** Lets you use existing geometry to constrain sub-object transformation. Choose the constraint type:

- **None:** No constraints. This is the default option.
- **Edge:** Constrains sub-object transformations to edge boundaries.
- **Face:** Constrains sub-object transformations to individual face surfaces.
-  **Normal:** Constrains each sub-object's transformations to its normal, or the average of its normals. In most cases, this causes sub-objects to move perpendicular to the surface.

---

**NOTE** This constraint works like the [Push modifier](#) on page 1574, including the fact that it operates on unmodified base normals. Edited normals are unsupported.

---

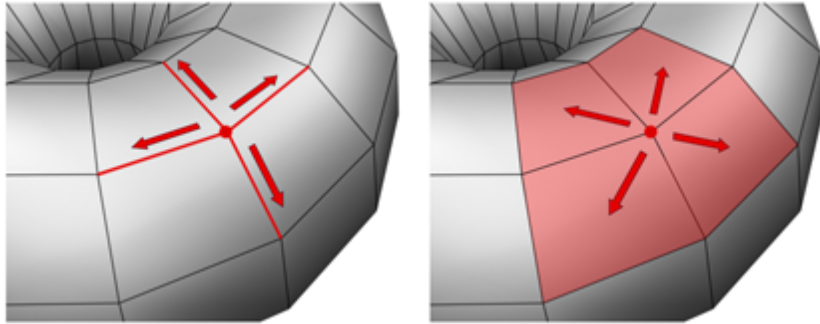

When set to **Edge**, moving a vertex will slide it along one of the existing edges, depending on the direction of the transformation. If set to **Face**, the vertex moves only on the polygon's surface.

---

**NOTE** You can set constraints at the Object level, but their use pertains primarily to sub-object levels. The Constraints setting persists at all sub-object levels.

---

**Preserve UVs** When on, you can edit sub-objects without affecting the object's UV mapping. You can choose any of an object's mapping channels to preserve or not; see [Preserve UVs Settings](#), following. Default=off.

Without **Preserve UVs**, there is always a direct correspondence between an object's geometry and its UV mapping. For example, if you map an object and then move vertices, the texture moves along with the sub-objects, whether you want it to or not. If you turn on **Preserve UVs**, you can perform minor editing tasks without changing the mapping.

---

**TIP** For best results with **Preserve UVs** at the vertex level, use it for limited vertex editing. For example, you'll usually have no trouble moving a vertex within edge or face constraints. Also, it's better to perform one big move than several smaller moves, as multiple small moves can begin to distort the mapping. If, however, you need to perform extensive geometry editing while preserving mapping, use the [Channel Info utility](#) on page 5858 instead.

---



**Preserve UVs Settings** Opens the [Preserve Map Channels dialog](#) on page 2146, which lets you specify which vertex color channels and/or texture channels (map channels) to preserve. By default, all vertex color channels are off (not preserved), and all texture channels are on (preserved).

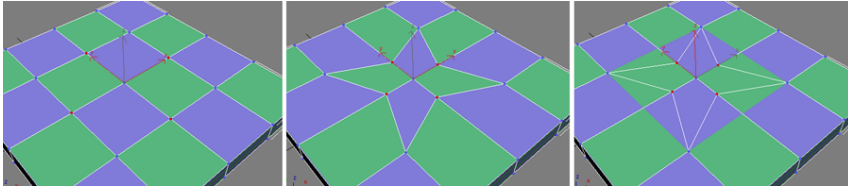

**Original object (left); Scaled vertices with Preserve UVs off (center); Scaled vertices with Preserve UVs on (right)**

**Create** Lets you create new geometry. How this button behaves depends on which level is active:

- Object, Polygon, and Element levels** Lets you add polygons in the active viewport. After you turn on Create, click three or more times in succession anywhere, including on existing vertices, to define the shape of the new polygon. To finish, right-click.

While creating a polygon at the Polygon or Element level, you can delete the most recently added vertex by pressing Backspace. You can do this repeatedly to remove added vertices in reverse order of placement.

You can start creating polygons in any viewport, but all subsequent clicks must take place in the same viewport.

---

**TIP** For best results, click vertices in counterclockwise (preferred) or clockwise order. If you use clockwise order, the new polygon will face away from you.

---

- Vertex level** Lets you add vertices to a single selected poly object. After selecting the object and clicking Create, click anywhere in space to add free-floating (isolated) vertices to the object. The new vertices are placed on the active construction plane unless object snapping is on. For example, with face snapping on, you can create vertices on object faces.
- Edge and Border levels** Creates an edge from vertex to vertex. Click Create, click a vertex, and then move the mouse. A rubber-band line extends from the vertex to the mouse cursor. Click a second, non-adjacent vertex on the same polygon to connect them with an edge. Repeat, or, to exit, right-click in the viewport or click Create again. Edges you create separate the polygons. For example, by creating an edge inside a quadrilateral polygon, you turn it into two triangles.

**Collapse (Vertex, Edge, Border, and Polygon levels only)** Collapses groups of contiguous selected sub-objects by welding their vertices to a vertex at the selection center.



**Attach** Lets you attach another object in the scene to the selected editable poly. You can attach any type of object, including splines, patch objects, and NURBS surfaces. Attaching a non-mesh object converts it to editable-poly format. Click the object you want to attach to the currently selected poly object.

When you attach an object, the materials of the two objects are combined in the following way:

- If the object being attached does not have a material assigned, it inherits the material of the object it is being attached to.
- Likewise, if the object you're attaching to doesn't have a material, it inherits the material of the object being attached.
- If both objects have materials, the resulting new material is a [multi/sub-object material](#) on page 5558 that includes the input materials. A dialog appears offering three methods of combining the objects' materials and material IDs. For more information, see [Attach Options Dialog](#) on page 2031 .  
Attach remains active in all sub-object levels, but always applies to objects.



**Attach List** Lets you attach other objects in the scene to the selected mesh. Click to open the Attach List dialog, which works like the [Select From Scene dialog](#) on page 168 to let you choose multiple objects to attach.



Shaded view of model (upper left); wireframe view of model (upper right); model with objects attached (lower left); and subsequent multi/sub-object material (lower right)

**Detach (sub-object levels only)** Detaches the selected sub-objects and the polygons attached to them as a separate object or element. The Detach As Clone option copies the sub-objects rather than moving them.

You're prompted to enter a name for the new object. Detached faces leave a hole in the original object when you move them to a new position, unless you use the Detach As Clone option.

### **Cut and Slice group**

These knife-like tools let you subdivide the poly mesh along a plane (Slice) or in a specific area (Cut). Also see [Full Interactivity](#) on page 2117 .

**Slice Plane (sub-object levels only)** Creates a gizmo for a slice plane that you can position and rotate to specify where to slice. Also enables the Slice and Reset Plane buttons.

If snapping is turned off, you see a preview of the slice as you transform the slice plane. To perform the slice, click the Slice button.

**Split** When on, the QuickSlice and Cut operations create double sets of vertices at the points where the edges are divided. This lets you easily delete the new polygons to create holes, or animate the new polygons as separate elements.

**Slice (sub-object levels only)** Performs the slice operation at the location of the slice plane. Available only when Slice Plane is on. This tool slices the poly just like the “Operate On: Polygons” mode of the [Slice modifier](#) on page 1658.

**Reset Plane (sub-object levels only)** Returns the Slice plane to its default position and orientation. Available only when Slice Plane is on.

**QuickSlice** Lets you quickly slice the object without having to manipulate a gizmo. Make a selection, click QuickSlice, and then click once at the slice start point and again at its endpoint. You can continue slicing the selection while the command is active.

To stop slicing, right-click in the viewport, or click QuickSlice again to turn it off.

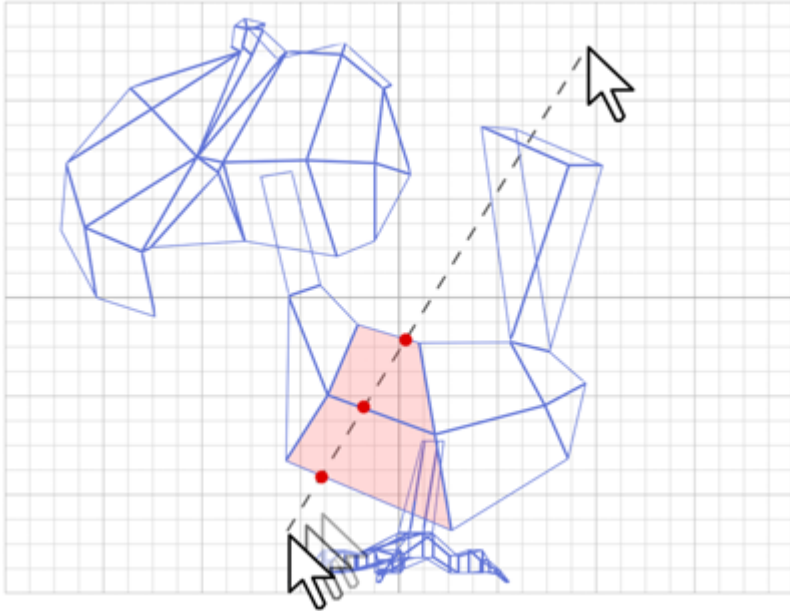

With Quickslice on, you can draw a line across your mesh in any viewport, including Perspective and Camera views. The mesh is sliced interactively as you move the line endpoint.

---

**NOTE** At the Object level, QuickSlice affects the entire object. To slice only specific polygons, use QuickSlice on a polygon selection at the Poly sub-object level.

---

**NOTE** At the Polygon or Element sub-object level, QuickSlice affects only selected polygons. To slice the entire object, use QuickSlice at any other sub-object level, or at the object level.

---

**Cut** Lets you create edges from one polygon to another or within polygons. Click at the start point, move the mouse and click again, and continue moving and clicking to create new connected edges. Right-click once to exit the current cut, whereupon you can start a new one, or right-click again to exit Cut mode.

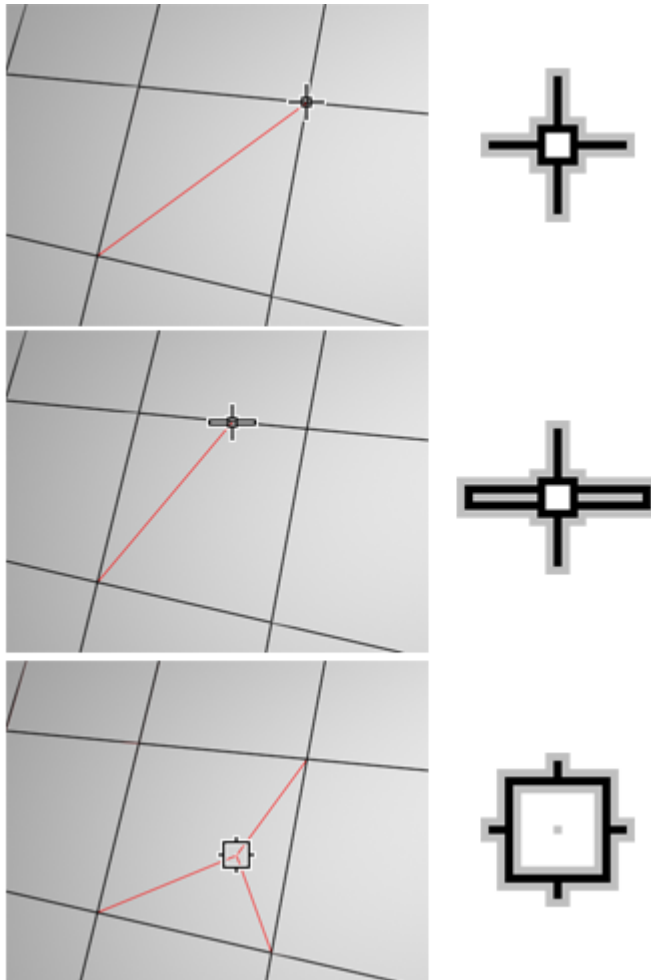

Cutting to a vertex (top); cutting an edge (center); cutting a polygon (bottom). Cut is available at the object level and all sub-object levels.

---

**NOTE** You can use Cut with Turn for enhanced productivity. For more information, see [this procedure](#) on page ? .

---

**MSmooth** Smooths the object using the current settings. This command uses subdivision functionality similar to that of the [MeshSmooth modifier](#) on page 1460 with NURMS Subdivision, but unlike NURMS Subdivision, it applies the smoothing instantly to the selected area of the control mesh.



**MSmooth Settings** Opens the [MeshSmooth Selection dialog](#) on page 2145 , which lets you specify how smoothing is applied.

**Tessellate** Subdivides all polygons in the object based on the [Tessellation settings](#) on page 2149 .

Tessellation is useful for increasing local mesh density while modeling. You can subdivide any selection of polygons. Two tessellation methods are available: Edge and Face.



**Tessellate Settings** Opens the [Tessellate Selection dialog](#) on page 2149 , which lets you specify how smoothing is applied.

**Make Planar** Forces all selected sub-objects to be coplanar. The plane's normal is the average surface normal of the selection.

At the Object level, forces *all* vertices in the object to become coplanar.

---

**TIP** One application for Make Planar is making a flat side on an object. Normally, you would use a contiguous selection set. If the selection includes vertices on various parts of the object, the vertices are still made planar, but with distorting effects on the rest of the geometry.

---

**X/Y/Z** Makes all selected sub-objects planar and aligns the plane with the corresponding plane in the object's local coordinate system. The plane used is the one to which the button axis is perpendicular; so, for example, clicking the X button aligns the object with the local YZ axis.

At the Object level, makes *all* vertices in the object planar.

**View Align** Aligns all vertices in the object to the plane of the active viewport. If a sub-object mode is active, this function affects only selected vertices or those belonging to selected sub-objects. In the case of orthographic viewports, using View Align has the same effect as aligning to the construction grid when the home grid is active. When aligning to a perspective viewport (including camera and light views), the vertices are reoriented to be aligned to a plane that is parallel to the camera's viewing plane. This plane is perpendicular to the view direction that is closest to the vertices' average position.

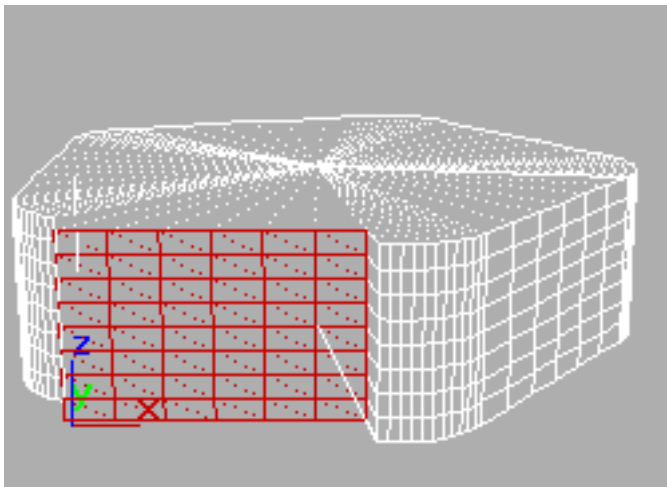
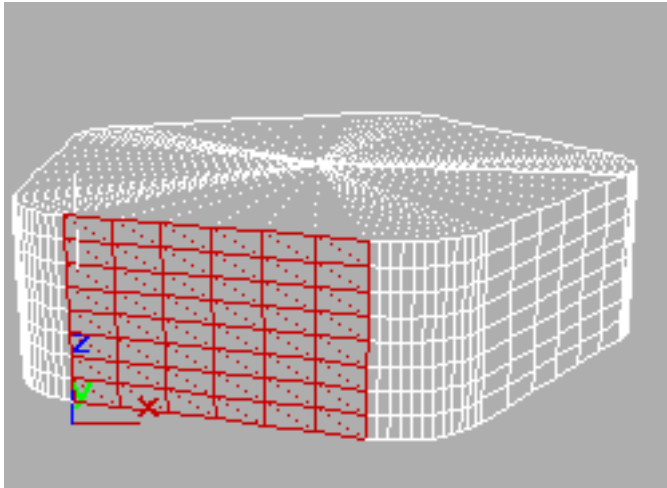

**Above: Selected polygons in Perspective view**

**Below: Same polygons aligned to Front view**

**Grid Align** Aligns all vertices in the selected object to the plane of the current view. If a sub-object mode is active, function aligns only selected sub-objects. This function aligns the selected vertices to the current construction plane. The current plane is specified by the active viewport in the case of the home grid. When using a grid object, the current plane is the active grid object.

**Relax** Applies the Relax function to the current selection, using the Relax dialog settings (see following). Relax normalizes mesh spacing by moving each

vertex toward the average location of its neighbors. It works the same way as the [Relax modifier](#) on page 1575 .

---

**NOTE** At the object level, Relax applies to the entire object. At any sub-object level, Relax applies only to the current selection.

---



**Relax Settings** Opens the [Relax dialog](#) on page 2148 , which lets you specify how the Relax function is applied.

**Hide Selected (Vertex, Polygon, and Element levels only)** Hides any selected sub-objects.

**Unhide All (Vertex, Polygon, and Element levels only)** Restores any hidden sub-objects to visibility.

**Hide Unselected (Vertex, Polygon, and Element levels only)** Hides any unselected sub-objects.

### **Named Selections (sub-object levels only)**

Lets you copy and paste named selection sets of sub-objects between objects. Start by creating one or more named selection sets, copy one, select a different object, go to the same sub-object level, and then paste the set.

---

**NOTE** This function uses sub-object IDs, so if the target object's geometry differs from that of the source object, the pasted selection will probably comprise a different set of sub-objects.

---

For more information, see [Named Selection Sets](#) on page 146 .

**Copy** Opens a dialog that lets you specify a named selection set to place into the copy buffer.

**Paste** Pastes the named selection from the copy buffer.

**Delete Isolated Vertices (Edge, Border, Polygon, and Element levels only)** When on, deletes isolated vertices when you delete a selection of contiguous sub-objects. When off, deleting sub-objects leaves all vertices intact. Default=on.



## Align Geometry Dialog

Select an Edit Poly object. > Modify panel > object level or any sub-object level > Animate mode > Edit Geometry rollout > Click View Align or Grid Align > Edit Poly Mode rollout > Settings button

This Edit Poly-specific dialog lets you change the alignment method after using the View Align or Grid Align function. Available only in Animate mode after using the View Align or Grid Align command.

### Interface

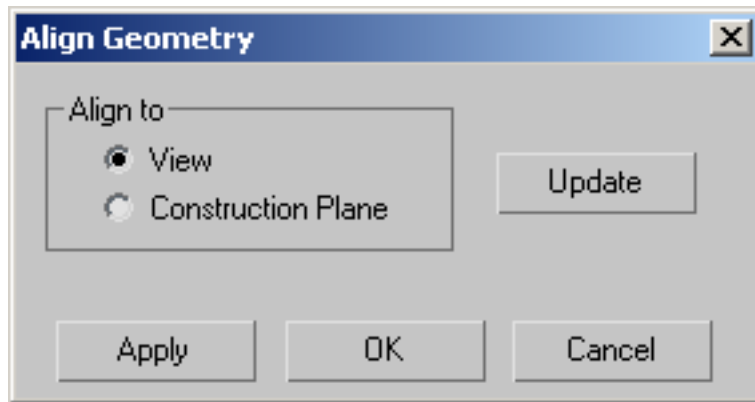

**Align to** Lets you choose what to align the selection with:

- **View** Aligns the selection with the view plane.
- **Construction Plane** Aligns the selection with the active grid.

**Update** Click this button to realign the selection with the designated entity after changing it. Typically you'd use this with the View option after rotating the view.

## Detach Dialog

Select an Edit Poly object. > Modify panel > any sub-object level > Edit Geometry rollout > Detach Settings button

This dialog lets you specify how a sub-object selection is detached from an Edit Poly object.

By default, both Detach To Element and Detach As Clone are off. Thus, when you detach a sub-object selection, it's removed from the original object and becomes a new object. The dialog options let you keep the detached item as an element of the original object and/or detach it as a copy of the original selection.

---

**NOTE** When you detach a vertex or an edge, any adjacent polygons are detached as well. Also, a detached item remains in its original location.

---

**NOTE** Any Detach dialog settings you change are saved as program defaults automatically.

---

### Interface

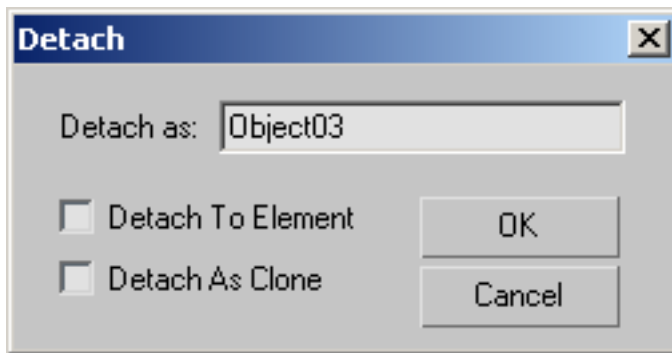

**Detach as** Lets you assign a name to the new object. By default, the name is "Object" followed by a sequence number.

This option is unavailable when Detach To Element is on.

**Detach To Element** The detached sub-object selection remains as part of the original object, but becomes a new element. It can then be manipulated independently at the Element sub-object level. Default=off.

**Detach As Clone** Detaches the selection as a copy of the original selection; the latter remains intact. Default=off.

## Edit Spline Modifier

Create or select a spline > Modify panel > Object-Space Modifiers > Edit Spline

Create or select a spline > Modifiers menu > Patch/Spline Editing > Edit Spline

The Edit Spline modifier provides explicit editing tools for different levels of the selected shape: vertex, segment, or spline. The Edit Spline modifier matches all the capabilities of the base Editable Spline object, with the exceptions noted below. For a complete parameter reference, see [Editable Spline](#) on page 590 .

The Rendering and Interpolation rollouts found in Editable Spline, which allow manipulation of the spline's creation parameters, are not available in the Edit Spline modifier. (The creation parameters are available in the [modifier stack](#) on page 7427 for a spline to which Edit Spline is applied.) In addition, the direct vertex animation capabilities of Editable Spline are not possible in Edit Spline.

When possible, it's far more efficient and reliable to perform explicit editing at the Editable Spline level rather than store those edits within the Edit Spline modifier. The Edit Spline modifier must copy the geometry passed to it, and this storage can lead to large file sizes. The Edit Spline modifier also establishes a topological dependency that can be adversely effected if earlier operations change the topology being sent to it.

There are, however, situations where using Edit Spline is the preferred method.

- You want to edit a parametric shape as a spline, but want to retain the ability to modify its creation parameters after the edit.
- You want to store your edits temporarily within Edit Spline until you are satisfied with the results, before committing them permanently to an editable spline object.
- You need to make edits across several shapes at once, but do not want to convert them to a single editable spline object.
- You have a modifier in the stack that must stay parametric, and the resulting spline must be edited after the modifier is applied.

## Extrude Modifier

Select a shape. > Modify panel > Modifier List > Object-Space Modifiers > Extrude

Select a shape. > Modifiers menu > Mesh Editing > Extrude

The Extrude modifier adds depth to a shape and makes it a parametric object.

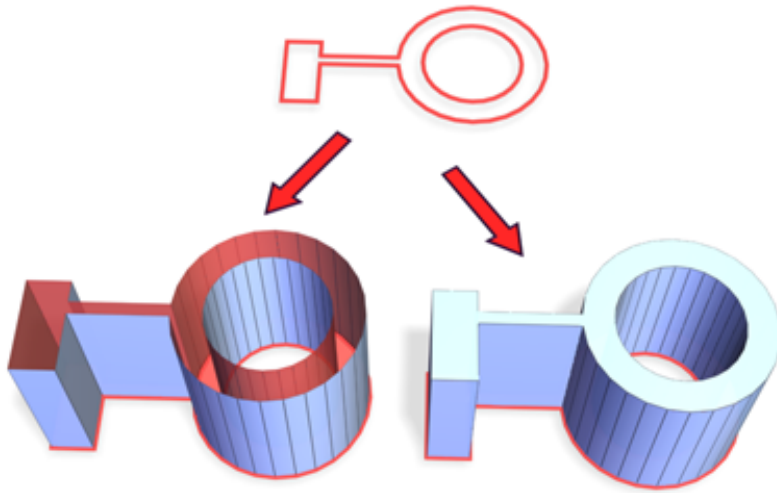

Above: Spline before extrusion

Below left: Extruded spline with Cap End off

Below right: Extruded spline with Cap End on

## Interface

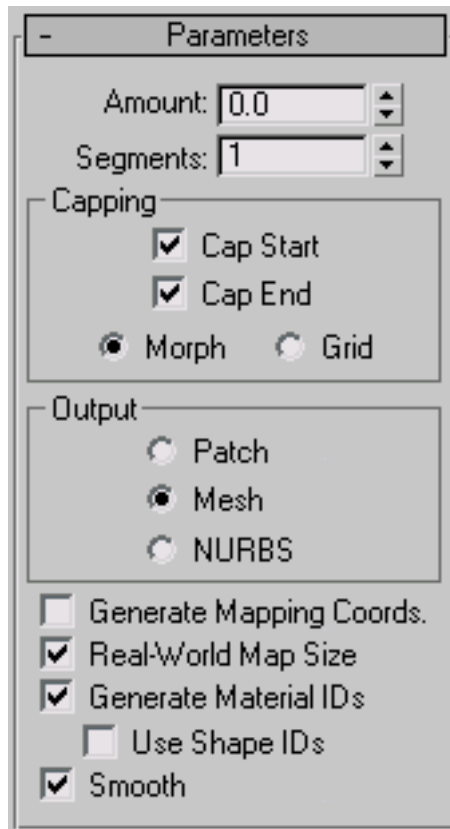

**Amount** Sets the depth of the extrusion.

**Segments** Specifies the number of segments that will be created in the extruded object.

### Capping group

**Cap Start** Generates a flat surface over the start of the extruded object.

**Cap End** Generates a flat surface over the end of the extruded object.

**Morph** Arranges cap faces in a predictable, repeatable pattern, which is necessary for creating [Morph targets](#) on page 639 . Morph capping can generate long, thin faces that don't render or deform as well as grid capping. Use morph capping primarily if you're extruding multiple morph targets.

**Grid** Arranges cap faces in a square grid trimmed at the shape boundaries. This method produces a surface of evenly sized faces that can be deformed easily by other modifiers. When you choose the Grid capping option, the grid lines are hidden edges rather than visible edges. This primarily affects any objects assigned a material with the Wire option turned on, or any objects that use the [Lattice modifier](#) on page 1435 .

### Output group

**Patch** Produces an object that you can collapse to a patch object; see [Editing the Stack](#) on page 1023 .

**Mesh** Produces an object that you can collapse to a mesh object; see [Editing the Stack](#) on page 1023 .

**NURBS** Produces an object that you can collapse to a NURBS surface; see [Editing the Stack](#) on page 1023 .

**Generate Mapping Coords** Applies mapping coordinates to the extruded object. Default=off.

When on, Generate Mapping Coordinates applies separate mapping coordinates to the end caps, placing a single 1 x 1 tile on each cap.

**Real-World Map Size** Controls the scaling method used for texture mapped materials that are applied to the object. The scaling values are controlled by the Use Real-World Scale settings found in the applied material's [Coordinates rollout](#) on page 5620 . Default=on.

**Generate Material IDs** Assigns different material IDs to the sides and the caps of the extruded object. Specifically, the sides receive ID 3, and the caps receive IDs 1 and 2.

This check box is turned on as a default when you create an extruded object, but if you load an extruded object from a *MAX* file, the check box is turned off, maintaining the same material ID assignment for that object as it had in R1.x.

**Use Shape IDs** Uses the material ID values assigned to segments in the [spline](#) on page 542 you extruded, or curve sub-objects in the [NURBS](#) on page 2152 curve you extruded.

**Smooth** Applies smoothing to the extruded shape.

# Face Extrude Modifier

Modify panel > Select one or more faces of a mesh object. > Modifier List > Face Extrude

Modify panel > Select one or more faces of a mesh object. > Modifiers menu > Mesh Editing > Face Extrude

The Face Extrude modifier extrudes faces along their normals, creating new faces along the sides of the extrusion that connect the extruded faces to their object. As with most modifiers, this affects the current face selection passed up the stack. There are various differences between the Face Extrude modifier and the Face Extrude function in an [editable mesh](#) on page 1990 , especially the fact that all parameters in the Face Extrude modifier are animatable.

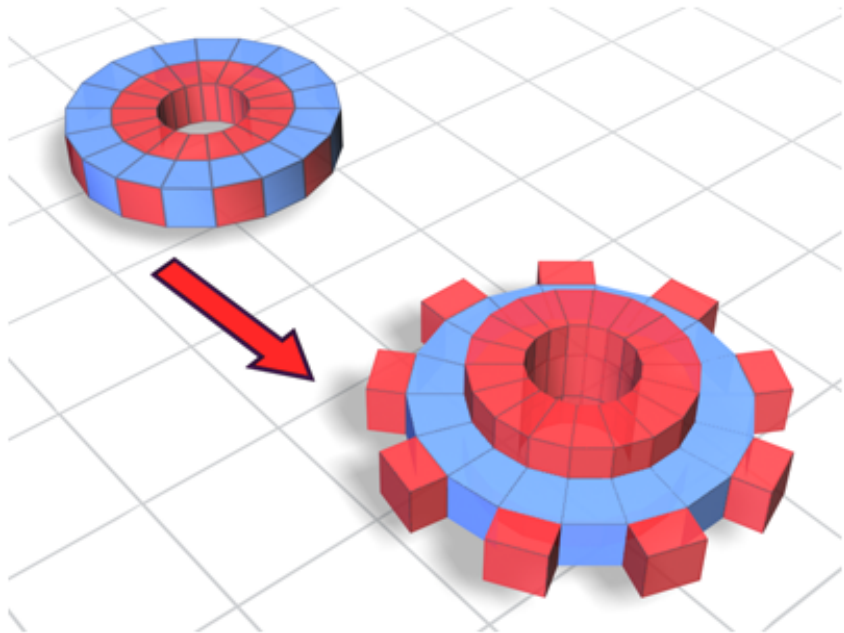

Faces extruded on the top and along the edge of the object

## Interface

### Modifier Stack

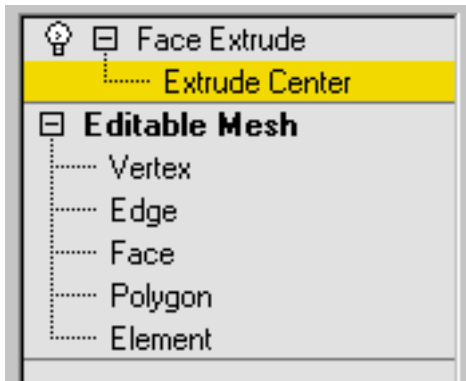

**Extrude Center** At this sub-object level, you can select and move (or animate) the center point. This affects the geometry only if you turn on Extrude From Center.

For more information on the stack display, see [Modifier Stack](#) on page 7427 .

### Parameters rollout

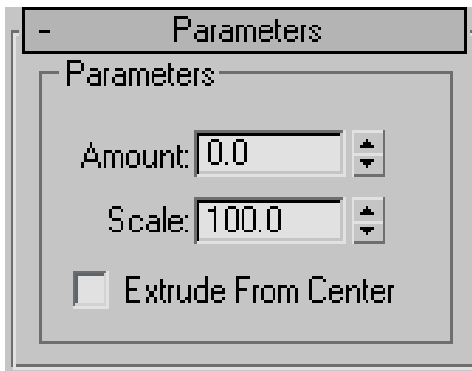

**Amount** Determines the extent of the extrusion. You can adjust and readjust the Amount spinner as often as you choose. To extrude a second level, apply another Face Extrude modifier.

**Scale** Scales each cluster of selected faces independently about its center.



---

**NOTE** By using multiple extrude modifiers with Scale, you can achieve a bevel effect.

---

**Extrude From Center** Extrudes each vertex radially from the center point.

The direction in which the faces are extruded is slightly different than Face Extrude in the editable mesh. Each vertex is displaced in the direction of the average surface normal of selected faces that share that vertex. So each vertex may move in a slightly different direction. Put another way, each vertex is extruded in the direction of the surface normal at the point on the surface where that vertex lies.

## FFD (Free-Form Deformation) Modifiers

Modify panel > Make a selection. > Modifier List > Object-Space Modifiers > FFD 2x2x2, FFD 3x3x3, or FFD 4x4x4

Make a selection. > Modifiers menu > Free Form Deformers > FFD 2x2x2, FFD 3x3x3, or FFD 4x4x4

FFD stands for Free-Form Deformation. Its effect is used in computer animation for things like dancing cars and gas tanks. You can use it as well for modeling rounded shapes such as chairs and sculptures.

The FFD modifier surrounds the selected geometry with a lattice. By adjusting the control points of the lattice, you deform the enclosed geometry.

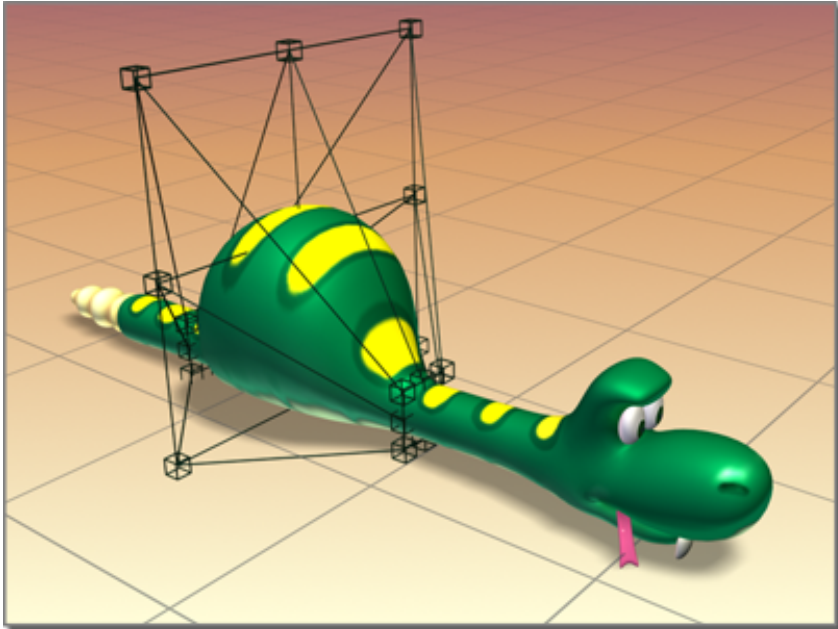

**FFD deformation creates a bulge in the snake.**

There are three FFD modifiers, each providing a different lattice resolution: 2x2, 3x3, and 4x4. The 3x3 modifier, for example, provides a lattice with three control points across each of its dimensions or nine on each side of the lattice.

There are also two FFD-related modifiers that provide supersets of the original modifiers; see [FFD \(Box/Cyl\) modifier](#) on page 1389 . With the FFD (Box/Cyl) modifiers, you can set any number of points in the lattice, which makes them more powerful than the basic FFD modifier.

### **Animating FFD Control Points and the Master Point Controller**

Turn on the Auto Key button and move the lattice points to animate an FFD and any underlying geometry. When you animate FFD control points, a Master Point Controller is created automatically. In Track View the master controller allows you to move multiple animated control points in time by simply moving one master key (master keys display green in Track View).

## Procedures

### To use an FFD modifier:

- 1 Select the geometry. This can be the whole object, or you can use a Mesh Select modifier to select a portion of the object's vertices.
- 2 Apply the FFD 2X2, FFD 3X3, or FFD 4X4 modifier, depending on the resolution of the lattice you want.  
An orange lattice gizmo surrounds the geometry.
- 3 In the modifier stack display, choose the Control Points sub-object level, and then move the control points of the lattice to deform the underlying geometry. To animate the deformation, turn on Auto Key.

The lattice volume defaults to the bounding box of the selected geometry. However, you can position, rotate, and/or scale the lattice box so that it modifies only a subset of vertices. Choose the Lattice sub-object level, and then use any of the transform tools to adjust the lattice volume relative to the geometry.

## Interface

### Modifier Stack

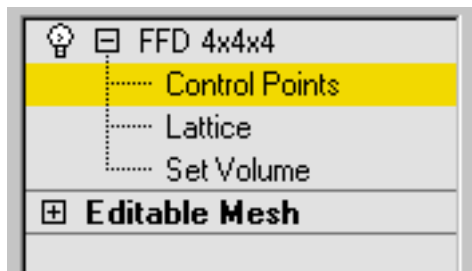

**Control Points** At this sub-object level, you can select and manipulate control points of the lattice, one at a time or as a group (select multiple points using standard techniques). Manipulating control points affects the shape of the underlying object. You can use standard transformation methods with the control points. If the Auto Key button is turned on when modifying the control points, the points become animated.

**Lattice** At this sub-object level, you can position, rotate, or scale the lattice box separately from the geometry. If the Auto Key button is turned on, the lattice becomes animated. When you first apply an FFD, its lattice defaults to

a bounding box surrounding the geometry. Moving or scaling the lattice so that only a subset of vertices lies inside the volume makes it possible to apply a localized deformation.

**Set Volume** At this sub-object level, the deformation lattice control points turn green, and you can select and manipulate control points without affecting the modified object. This lets you fit the lattice more precisely to irregular-shaped objects, giving you finer control when deforming.

Set Volume essentially lets you set the initial state of the lattice. If you use it after you have animated a control point or when the Auto Key button is turned on, then it works the same as at the Control Points sub-object level, deforming the object as you manipulate points.

For more information on the stack display, see [Modifier Stack](#) on page 7427 .

## FFD Parameters rollout

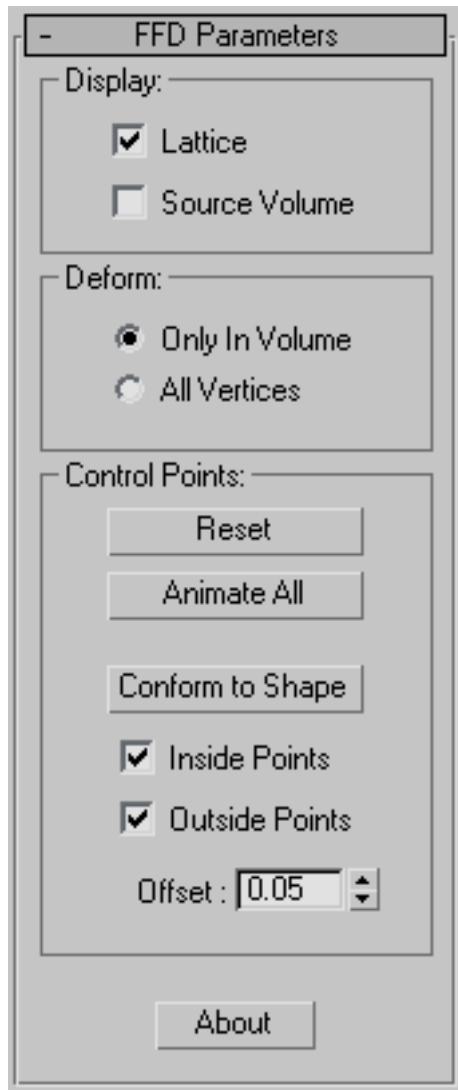

### Display group

Affects the display of the FFD in the viewports.

**Lattice** Draws lines connecting the control points to make a grid.

Although the viewports can sometimes become cluttered when these lines are drawn, it helps to visualize the lattice.

**Source Volume** Displays the control points and lattice in their unmodified state.

When you're in the Lattice selection level, this helps to position the source volume.

---

**TIP** To see which points lie in the source volume (and therefore will be deformed), temporarily deactivate the modifier by clicking to turn off the light bulb icon in the modifier stack display.

---

### **Deform group**

**Only in Volume** Deforms vertices that lie inside the source volume. Default=on.

**All Vertices** Deforms all vertices, regardless of whether they lie inside or outside the source volume.

The deformation outside the volume is a continuous extrapolation of the deformation inside the volume. The deformation can be extreme for points far away from the source lattice.

### **Control Points group**

**Reset** Returns all control points to their original positions.

**Animate All** Assigns Point3 controllers to all control points so that they're immediately visible in Track View.

By default the control points of an FFD lattice don't appear in Track View because they don't have controllers assigned to them. But when a control point is animated, a controller is assigned to it and becomes visible in Track View. With Animate All, you can add and delete keys and perform other key operations.

**Conform to Shape** Moves each FFD control point to the intersection of the modified object with a straight line extending between the object's center to the control point's original location, plus an offset distance specified by the Offset spinner.

---

**NOTE** Conform to Shape works best with regular shapes, such as primitives. It's less effective if the object has degenerate (long, narrow) faces or sharp corners. All the controls are unavailable with shapes, because there are no faces to intersect with.

---

**Inside Points** Only control points inside the object are affected by Conform to Shape.

**Outside Points** Only control points outside the object are affected by Conform to Shape.

**Offset** The distance by which control points affected by Conform to Shape are offset from the object surface.

**About** Displays a dialog with copyright and licensing information.

## FFD (Box/Cylinder) Modifiers

Modify panel > Make a selection. > Modifier List > Object-Space Modifiers > FFD(box) or FFD(cyl)

Make a selection. > Modifiers menu > Free Form Deformers > FFD Box or FFD Cylinder

FFD stands for Free-Form Deformation. Its effect is used in computer animation for things like dancing cars and gas tanks. You can use it as well for modeling rounded shapes such as chairs and sculptures.

The FFD modifier surrounds the selected geometry with a lattice box. By adjusting the control points of the lattice, you deform the enclosed geometry. With the Auto Key button turned on, you can animate the lattice points, and thus the deformation of the geometry.

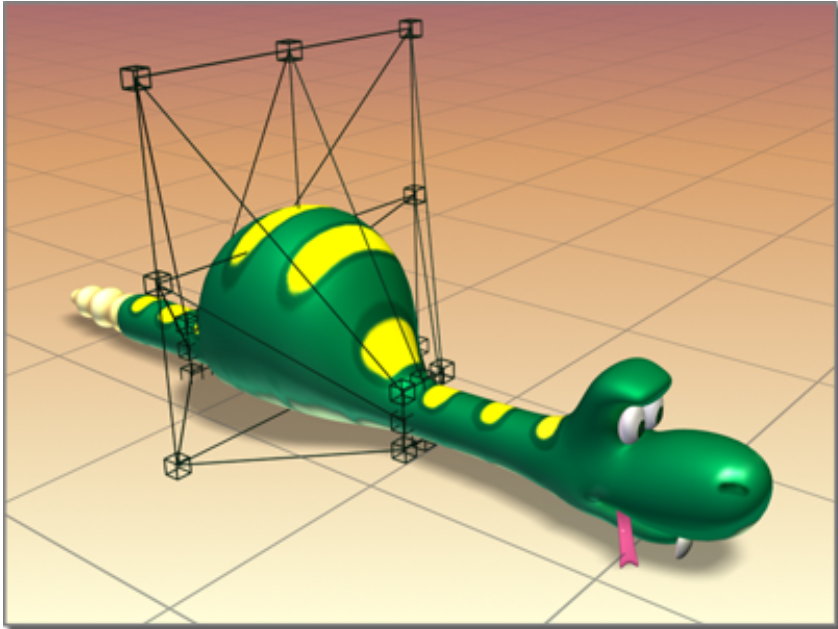

**FFD deformation creates a bulge in the snake.**

With the FFD(box) and FFD(cyl) modifiers you can create box-shaped and cylinder-shaped lattice free-form deformation objects. Both are available as object modifiers and as space warps.

The source lattice of an FFD modifier is fitted to the geometry it's assigned in the stack. This can be a whole object, or a sub-object selection of faces or vertices.

## **Interface**

### **Modifier Stack**

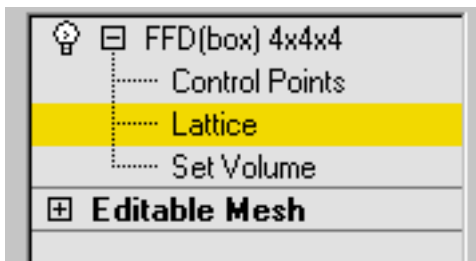



**Control Points** At this sub-object level, you can select and manipulate control points of the lattice, one at a time or as a group (select multiple points using standard techniques). Manipulating control points affects the shape of the underlying object. You can use standard transformation methods with the control points. If the Auto Key button is turned on when modifying the control points, the points become animated.

**Lattice** At this sub-object level, you can position, rotate, or scale the lattice box separately from the geometry. If the Auto Key button is turned on, the lattice becomes animated. When you first apply an FFD, its lattice defaults to a bounding box surrounding the geometry. Moving or scaling the lattice so that only a subset of vertices lie inside the volume makes it possible to apply a localized deformation.

**Set Volume** At this sub-object level, the deformation lattice control points turn green, and you can select and manipulate control points without affecting the modified object. This lets you fit the lattice more precisely to irregular-shaped objects, giving you finer control when deforming.

Set Volume essentially lets you set the initial state of the lattice. If a control point is already animated or the Animate button is turned on, then Set Volume works the same as at the Control Points sub-object level, deforming the object as you manipulate points.

For more information on the stack display, see [Modifier Stack](#) on page 7427 .

## FFD Parameters rollout

- FFD Parameters

Dimensions:  
4x4x4  
Set Number of Points

Display:  
 Lattice  
 Source Volume

Deform:  
 Only In Volume  
 All Vertices  
Falloff: 0.0

Tension: 25.0  
Continuity: 25.0

Selection:  
All X All Y All Z

Control Points:  
Reset

Conform to Shape  
 Inside Points  
 Outside Points  
Offset: 0.05

About

## Dimensions group

Adjusts the unit dimensions of the source volume and specifies the number of control points in the lattice. Note that the point dimensions also show up beside the modifier name in the stack list.

**Lattice dimensions** The text displays the current number of control points in the lattice (for example 3x4x4).

**Set Number of Points** Displays a dialog containing three spinners labeled Length, Width, and Height, plus OK/Cancel buttons. Specify the number of control points you want in the lattice, and then click OK to make the change.

---

**WARNING** Make changes to the lattice dimensions before you adjust the positions of the lattice control points. When you change the number of control points with this dialog, you lose any adjustments you've already made to the control points. (You can undo this dialog.)

---

## Display group

Affects the display of the FFD in the viewports.

**Lattice** Draws lines connecting the control points to make a grid. Although the viewports can sometimes become cluttered when these extra lines appear, they help to visualize the lattice.

**Source Volume** Displays the control points and lattice in their unmodified state. This is an important display when you're adjusting the source volume to affect specific vertices that lie inside or outside it.

---

**TIP** To see which points lie in the source volume (and therefore will be deformed), temporarily deactivate the modifier by clicking to turn off the light bulb icon in the modifier stack display.

---

## Deform group

Provides controls that specify which vertices are affected by the FFD.

**Only In Volume** Deforms vertices that lie inside the source volume. Vertices outside the source volume are not affected.

**All Vertices** Deforms all vertices regardless of whether they lie inside or outside the source volume depending on the value in the Falloff spinner. The deformation outside the volume is a continuous extrapolation of the deformation inside the volume. Note that the deformation can be extreme for points far away from the source lattice.

**Falloff** Determines the distance from the lattice that the FFD effect will decrease to zero. Available only when you choose All Vertices. When set to 0, it's effectively turned off, and there is no falloff. All vertices are affected regardless of how far they are from the lattice. The units of the Falloff parameter are actually specified relative to the size of the lattice. A falloff of 1 means that the effect will go to 0 for points that are a lattice width/length/height away from the lattice (depending on which side they are).

**Tension/Continuity** Adjusts the tension and continuity of the deformation splines. Although you can't actually see the splines in an FFD, the lattice and control points represent the structure that controls the splines. As you adjust the control points, you alter the splines (which move through each of the points). The splines, in turn, deform the geometry of the object. By altering the tension and continuity of the splines, you alter their effect on the object.

### **Selection group**

Provides additional methods of selecting the control points. You can toggle the state of any combination of the three buttons to select in one, two, or three dimensions at once.

**All X, All Y, All Z** Selects all control points along the specified local dimension when you select a control point. By turning on two buttons, you can select all control points in two dimensions.

### **Control Points group**

**Reset** Returns all control points to their original positions.

**Animate All** By default, the control points of an FFD lattice don't appear in Track View because they don't have controllers assigned to them. But when you animate a control point, a controller is assigned and it becomes visible in Track View. You can also add and delete keys and perform other key operations. Animate All assigns Point3 controllers to all control points so that they're immediately visible in Track View.

**Conform to Shape** Moves each FFD control point to the intersection of the modified object with a straight line extending between the object's center to the control point's original location, plus an offset distance specified by the Offset spinner.

---

**NOTE** Conform to Shape works best with regular shapes, such as primitives. It's less effective if the object has degenerate (long, narrow) faces or sharp corners. All the controls are unavailable with shapes, because there are no faces for the lattice to intersect with.

---

**Inside Points** Only control points inside the object are affected by Conform to Shape.

**Outside Points** Only control points outside the object are affected by Conform to Shape.

**Offset** The distance by which control points affected by Conform to Shape are offset from the object surface.

**About** Displays a dialog with copyright and licensing information.

## FFD (Free-Form Deformation) Select Modifier

Select an FFD space warp. > Modify panel > Modifier List > FFD Select

Select an FFD space warp. > Modifiers menu > Selection Modifiers > FFD Select

The FFD Select modifier works on an [FFD \(Box\) Space Warp](#) on page 2678 or [FFD \(Cyl\) Space Warp](#) on page 2685 to change the selection of its control points, and pass the selection up the stack.

The space-warp versions of the FFD modifiers provide sub-object geometry that you can manipulate in the stack. For example, you can apply a [Bend modifier](#) on page 1139 to an FFD space warp, bend its control points, and thus bend the object to which the space warp is bound. Using the FFD Select modifier, you can select a sub-object pattern of control points, and then use the subsequent modifier(s) to deform the selected points.

The FFD Select modifier is especially useful for assigning [Linked XForm modifiers](#) on page 1440 to portions of an FFD space warp.

### Procedures

**Example: To use the Linked XForm modifier with an FFD space warp:**

- 1 Create an object, an FFD space warp (such as [FFD \(Box\)](#) on page 2678 ), and a couple of [dummies](#) on page 2531 .
- 2 Bind the FFD space warp to the object you want to deform.
- 3 Select the FFD space warp and apply an FFD Select modifier.

- 4 In the Control Points sub-object mode, select the control points you want to use to affect the object.
- 5 Apply a Linked XForm modifier, and then pick one of the dummies as a control object.
- 6 Apply another FFD Select modifier, and select a different collection of control points.
- 7 Apply another Linked XForm modifier and assign the other dummy as a control object.
- 8 You can now move either of the dummy objects to both translate the linked control points in the FFD space warp, and to deform the target object.

### Interface



**All X/All Y/ All Z** Select the control points corresponding to the specified axis plane.

First click a selection button, and then select FFD control points in the viewports.

## Fillet/Chamfer Modifier

Select a shape. > Modify panel > Modifier List > Object-Space Modifiers > Fillet/Chamfer

Select a shape. > Modifiers menu > Patch/Spline editing > Fillet/Chamfer

The Fillet/Chamfer modifier lets you fillet or chamfer the corners between linear segments of [Shape objects](#) on page 7929 . Fillet rounds corners where segments meet, adding new control vertices. Chamfer bevels corners, adding another vertex and line segment. Note that this modifier works on the splines at the sub-object level of the shape. It does not work between two or more independent shape objects.

When you apply Fillet/Chamfer, you're placed in a Vertex sub-object selection level. You can select (and move) any vertex, but only Corner vertices and Bezier Corner vertices are valid for fillet and chamfer functions. In addition, both segments connected by a Bezier Corner vertex must be linear rather than curved.

There are two methods for applying either fillets or chamfers:

- Select one or more valid corner vertices, and then adjust either the Radius spinner to fillet the selected corners, or the Distance spinner to chamfer the corners.
- You can preset the Radius or Distance values, and then select one or more valid corner vertices, and click one of the Apply buttons to apply the specified value to the selected vertices.

**NOTE** As of version 3 of 3ds Max, [Edit/Editable Spline](#) on page 606 includes interactive fillet/chamfer functions. The only reason to use this modifier is to apply it at a specific location on the stack.

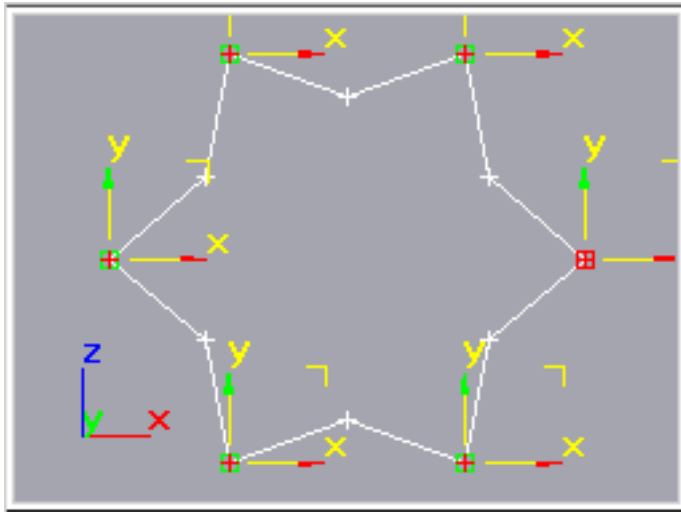

Star with selected vertices

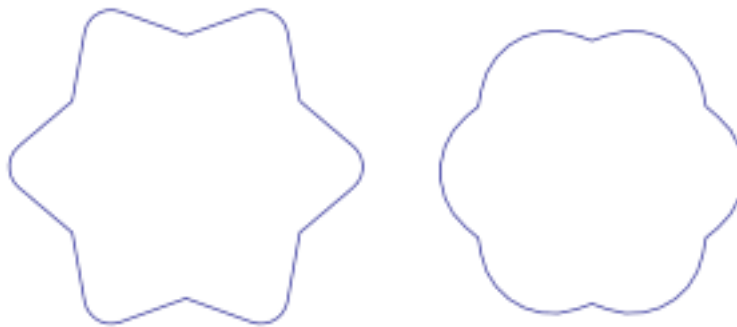

Fillet applied to above star with radius of 20 (left) and 40 (right)



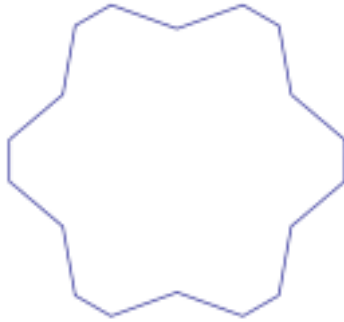

Chamfer applied to above star with distance of 20

---

### Procedures

**Example: To fillet/chamfer a star:**

- 1 Create a [Star shape](#) on page 567 .
- 2 Apply a Fillet/Chamfer modifier.
- 3 Select one or more of the star's vertices.
- 4 Adjust the parameters to achieve different effects.

## Interface

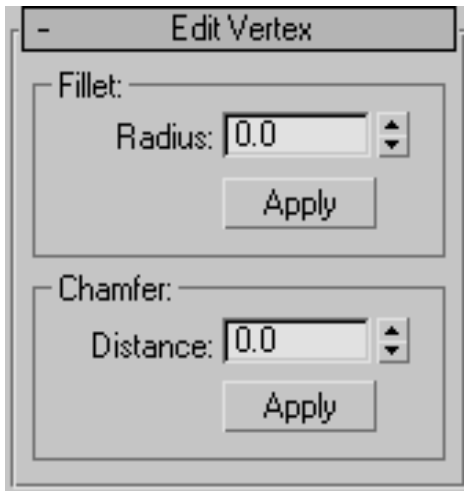

### Fillet group

**Radius** Specifies the radius of the filleted corner.

**Apply** Applies the value specified in the Radius spinner to selected vertices. For example, before selecting any vertices, set the Radius to the desired value, then select your vertices and click Apply to fillet the selection with the specified radius.

### Chamfer group

**Distance** Specifies the distance of the new vertices from the original corner vertex.

**Apply** Applies the value specified in the Distance spinner to selected vertices. For example, before selecting any vertices, set Distance to the desired value, then select your vertices and click Apply to chamfer the corners.

## Flex Modifier

Select a Mesh , Patch, or NURBS object. > Modify panel > Modifier List > Object-Space Modifiers > Flex

Select a Mesh, Patch, or NURBS object. > Modifiers menu > Animation Modifiers > Flex Modifier

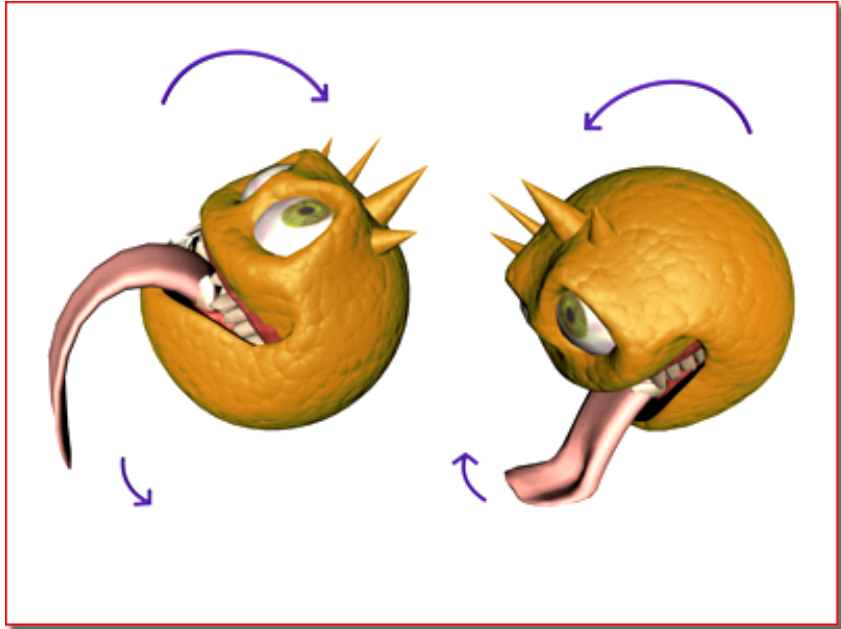

**Flex causes the tongue to wag as the head rotates.**

The Flex modifier simulates soft-body dynamics using virtual springs between an object's vertices. You can set the springs' stiffness, or how actively they keep vertices from coming close to each other, as well as stretch, or how far apart they can move. At a more advanced level, you can also control the sway, or how much the spring angle can change. At its simplest, this system causes vertices to lag behind an object as it moves.

Flex works with NURBS, patches, meshes, shapes, FFD space warps, and any plug-in-based object types that can be deformed. You can combine Flex with space warps such as Gravity, Wind, Motor, Push, and PBomb to add realistic physically based animation to an object. In addition, you can apply deflectors to soft-body objects to simulate collision.

---

**NOTE** The Flex modifier is aware of vertex/control-point motion in any animated modifier that deforms points below Flex in the modifier stack, such as the [Morpher modifier](#) on page 1473 . Use this to simulate soft body motion on a morphed or otherwise deform-animated object.

---

---

**TIP** After applying the Flex modifier to an object or sub-object selection, choose the Flex modifier's Center sub-object and use Move to change where the flex effect is centered.

---

**TIP** Using Flex's advanced capabilities can significantly impede real-time playback. In such cases, use the [Point Cache modifier](#) on page 1533 to record the vertex animation to disk, and then play it back using the cache.

---

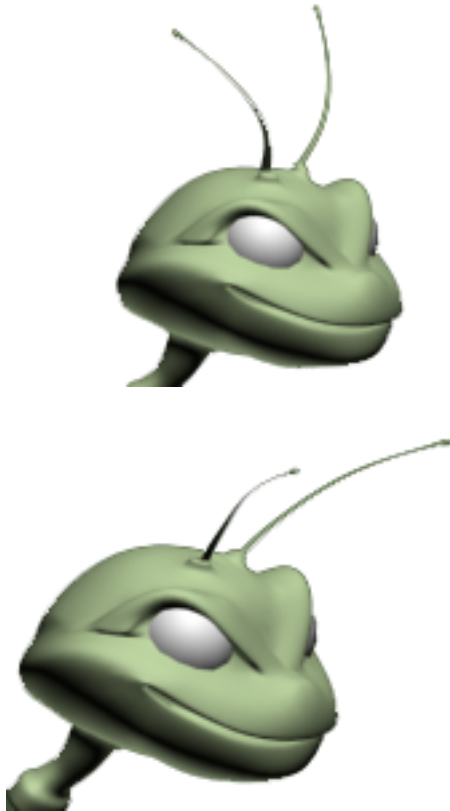

The antennae, with the Flex modifier applied, move around like springs reacting to the motion of the character's head.

### **Surfaces Influenced by the Flex Modifier**

- On a mesh surface, the Flex modifier influences every vertex.

- On a patch surface, the Flex modifier influences both control points and tangent handles. Tangent handles are unlocked and moved independently by the Flex modifier.
- On a NURBS surface, the Flex modifier influences control vertices (CVs) or points.
- On a Spline (shape), the Flex modifier influences both control points and tangent handles.
- On an FFD Space Warp, the Flex modifier influences control points.

## Effects



You can apply space warps to the Flex modifier. For example, you can add Wind to animate plants and trees, or a waving flag. In such cases, you don't need to create keyframes to see the effects; the space warp alone can animate the surface.

## Character Animation

Use Flex above the [Skin modifier](#) on page 1600 to add secondary motion to a character animated with Bones. If you are using the 3ds Max product, use Flex above the Physique modifier to add secondary motion to a character.

## Procedures

### Example: To paint on weights:

- 1 Create a sphere on the left side of the Top viewport.
- 2  Turn on the Auto Key button and move the time slider to frame 50.
- 3 In the Top viewport, move the sphere to the right side of the viewport.
- 4 Turn off Auto Key.
- 5  On the Modify panel, click Modifier List, and then choose Flex. The Flex modifier is applied to the sphere.
- 6  Click Play.

The sphere flexes around the Transform gizmo evenly.

- 7 Open the Flex modifier hierarchy in the stack display, and click Weights & Springs.

This enables modification of the Weights & Springs sub-object settings.

- 8 In the Paint Weights group, turn on Paint.

- 9 In the Left viewport, paint on the lower part of the sphere.

The vertex color changes as the vertex weight changes. Yellow vertices are more rigid, blue vertices are less rigid.

---

**NOTE** You can change Flex vertex colors through Customize menu > Customize User Interface > Colors > Geometry > Subselection Hard/Medium/Soft.

---

- 10  Click Play.



The sphere wobbles on one side more than the other.

If the Strength setting in the Paint Vertex group is a positive value, you paint rigidity. If the values are negative, you paint flexibility.

Paint with negative numbers for Strength to reverse the effect.

**Example: To use wind as a force:**

- 1 In the Top viewport, create a sphere.

- 2   On the Create panel, click Space Warps, and then, if necessary, choose Forces from the drop-down list.

- 3 Click Wind, and then click and drag in the Front viewport to create a wind gizmo.

- 4 On the Wind Parameters rollout, set Strength and Turbulence to **4**.

- 5 Select the Sphere.

- 6  Apply the Flex modifier.

- 7 On the Modify panel > Parameters rollout, set Samples to **1**.

- 8 On Forces and Deflectors rollout > Forces group, click the Add button, and then select the Wind gizmo in the viewports.

- 9  Click Play.

The sphere undulates in the wind. The Advanced Parameters rollout > Reference Frame setting determines the frame where the force(s) in the list take effect.

You can also use this example to see how the Chase Springs option works.

- 10  Turn off Chase Springs and click Play again.

The sphere keeps moving in the direction the wind is blowing without "bouncing" back. That's because the chase springs, which attempt to return the object to its original shape, are no longer in effect.

### To add custom springs:

- 1 Apply Flex to an object and go to the Weights & Springs sub-object level. The Flex vertices appear at object vertices in the viewports.
- 2 In the Advanced Springs rollout, turn on Show Springs.
- 3 Click the Options button and in the [Spring Option dialog](#) on page 1418 , choose how you want to add springs. Exit the Spring Option dialog.
- 4 Select vertices according to the options.  
For instance, if you want to add one Hold Shape spring between two vertices, select both vertices.
- 5 Click Add Spring.  
The new spring or springs appear. Edge springs are blue and Hold Shape springs are red.

### Example: To create a swinging rope:

- 1 Use Create menu > Space Warps to add a Drag and a Gravity space warp in the Top viewport.
- 2 Use Create menu > Shapes > Line to create a line with ten vertices spaced evenly in the top viewport.
- 3 In the Modify panel, turn on Vertex sub-object and select all the vertices except the first vertex.
- 4 Add the Flex modifier.
- 5 In the modifier stack view, open Weights and Springs sub-objects.

- 6 Turn off Use Chase Springs.
- 7 Turn off Use Weights.
- 8 Set the solver to Runge-Kutta4.
- 9 Set Samples to 5.
- 10 In a viewport, select all the points on the spline.
- 11 In the Advance Springs rollout, click the Option button.
- 12 In the dialog, turn on Hold Edge Length Springs and click OK.
- 13 Click Add Springs.
- 14 On the Forces and Deflectors rollout, add Gravity and Drag in the Forces group.
- 15 Click Play.  
The spline resembles a swinging rope.

**Example: To create cloth draping on a sphere:**

- 1 Use Create menu > Space Warps to add a Drag and a Gravity space warp in the Top viewport.
- 2 Use Create menu > Space Warps > Deflectors > SDeflector to create a spherical deflector. Set Bounce to 0 and Friction to 100. Place the deflector below Z=0.
- 3 Use Create menu > Geometry > Standard Primitives > Plane to create a 20 x 20 plane in the Top viewport. It should be above the spherical deflector.
- 4 Apply a Mesh Select modifier to the plane.
- 5 In the Top viewport, select all the vertices except for the leftmost column.
- 6 Apply the Flex modifier to the plane.
- 7 Turn off Use Chase Springs and Use Weights.
- 8 Set Samples to 3.
- 9 Click Create Simple Soft Body.
- 10 In the Forces and Deflectors rollout, add the Gravity and Drag forces.
- 11 In the Forces and Deflectors rollout, add the spherical deflector.



12 Click Play.

The plane drapes over the spherical deflector like cloth.

## Interface

### Modifier Stack

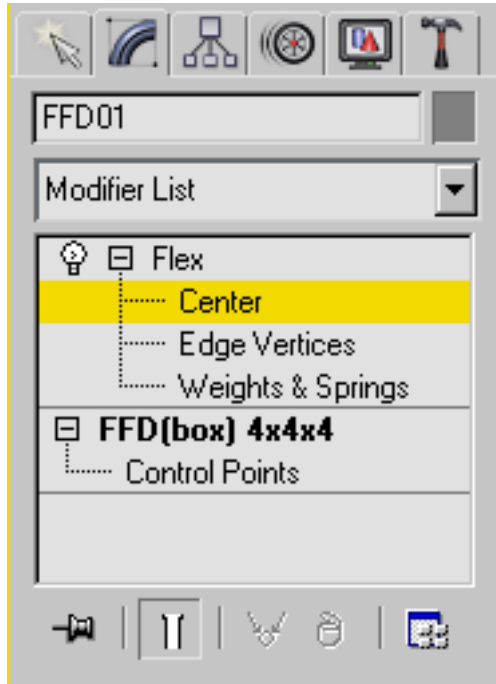

These modifier sub-object levels are available in the stack display by opening the modifier hierarchy (click the + icon to the left of the modifier name).

**Center** Move the Transform gizmo in the viewports to set the center of the effect.

The flex effect increases as the distance between the center and a vertex increases.

**Edge Vertices** Select vertices in the viewports to control the falloff and direction of the flex effect.

Selected vertices flex less than unselected vertices.

**Weights & Springs** Use the Weights And Painting rollout controls to select and deselect vertices for subsequent operations in the Weights And Painting rollout and the Advanced Springs rollout.

You can paint weights at any sub-object level, and add and remove springs at any sub-object level (or even at the Flex modifier object level), but while a Weights & Springs selection is active, only the selected vertices are affected.

### Parameters rollout

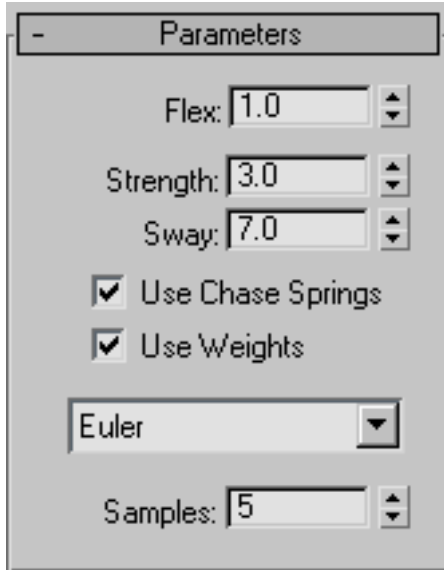

**Flex** Sets the amount of flex and bend. Range=0 to 1000; Default=1.

This value represents the amount of the flexed animation that is used; the flexed animation is determined by other factors such as motion and vertex weighting. The default setting of 1 causes the flexed animation to occur unmodified; higher settings cause unnaturally high amounts of stretching, and lower settings cause diminished stretching.

**Strength** Sets the overall spring strength of the chase springs.

A value of 100 is rigid. Range=0 to 100; Default=3.

**Sway** Sets the time for the object to come to rest for chase springs.

Lower values increase the time for the object to come to rest. Range=0 to 100; Default=7.

**Use Chase Springs** When on, enables chase springs, which force the object to return to its original shape. When off, no chase springs are used, and the amount by which vertices move depends only on their weights. Default=on.

Typically, for soft-body simulations when you want objects to be influenced by forces and deflectors, you would turn off Use Chase Springs.

**Use Weights** When on, Flex recognizes the different weights assigned to an object's vertices, applying different amounts of flexing accordingly. When off, the flex effect applies itself to the object as a monolithic whole. Default=on.

Typically, for soft-body simulations when you want objects to be influenced by forces and deflectors, you would turn off Use Weights.

**Solver Type** Choose a solver for the simulation from the drop-down list. The three choices are Euler, Midpoint, and Runge-Kutta4. Midpoint and Runge-Kutta4 require successively more computation than Euler, but are more stable and accurate. Default=Euler.

---

**TIP** In most cases, you can use Euler successfully, but if unexpected object deformations occur during a simulation, try using one of the more accurate solver types. Specifically, you might need to use Midpoint or Runge-Kutta4 with higher Stretch and Stiffness settings.

---

**Samples** The number of times per frame the Flex simulation is run at equal time intervals. The more samples you take, the more accurate and stable the simulation. When using the Midpoint or Runge-Kutta4 solver, you might not need as many samples as with Euler. Default=5.

---

**TIP** If your simulation produces unexpected results, such as object vertices moving to seemingly random locations, try increasing the Samples setting.

---

## Simple Soft Bodies rollout

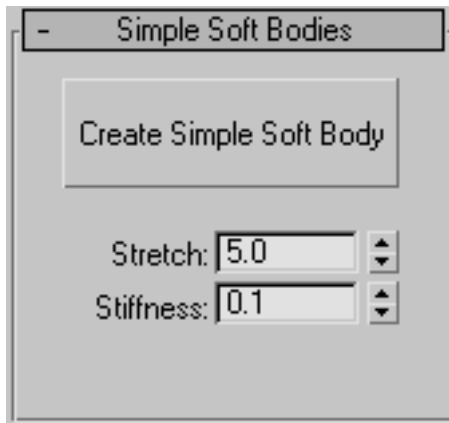

Lets the software determine spring settings for the entire object automatically. Alternatively, you can use the [Advanced Springs](#) on page 1416 rollout settings to specify spring settings between each pair of vertices.

**Create Simple Soft Body** Generates spring settings for the object based on the Stretch and Stiffness settings.

---

**NOTE** After you use Create Simple Soft Body, you can change the Stretch and Stiffness settings without having to click the button again; the changes take effect immediately.

---

**Stretch** Determines how much object edges can elongate. When Advanced Springs rollout > Enable Advanced Springs is off, the Stretch setting is linked to the Advanced Springs rollout > Stretch Str. and Stretch Sway settings.

**Stiffness** Determines how rigid the object is. When Advanced Springs rollout > Enable Advanced Springs is off, the Stretch setting is linked to the Advanced Springs rollout > Shape Str. and Shape Sway settings.

The differences between Stretch and Stiffness are subtle, and understanding them is further complicated by the fact the two affect each other. In addition, how they work depends on object topology. For example, say you create a box, add a Flex modifier, apply Create Simple Soft Body, and then set a high Stretch value and a low Stiffness value. If you use the box in a Flex-based dynamics simulation, such as dropping it onto a surface (deflector) with gravity, you might expect the box to fall over and flatten out. But instead, because of the box's topology, which causes Create Simple Soft Body to apply a relatively small number of shape springs, you'd actually get better results with a low Stretch value and a high Stiffness value. However, if you use a

sphere of eight segments instead, you'll get the collapsing behavior with the default Stretch and Stiffness settings, and as expected, increasing rigidity with higher Stiffness settings.

In soft-body simulations, such as the above-cited example of dropping an object onto a surface, particularly with dense meshes, you might get better results by applying the mesh to an FFD space warp that's bound to the object. If the object's shape isn't suitable for use with the space warp, you might have to instead use the [Advanced Springs](#) on page 1416 rollout settings to apply springs manually. In such cases, you should create shape springs between opposite vertices rather than adjacent ones.

Cloth-like animation usually works best with a high Stretch setting and a low Stiffness setting. For soft bodies, you would usually use high settings for both Stretch and Stiffness, depending on how "squishy" you want the object to be.

### Weights and Painting rollout



When you first apply Flex to an object, the modifier automatically sets vertex weights based on distance from the modifier's center. The higher a vertex weight, the less prone it is to being affected by Flex effects. The modifier applies the highest weights to vertices closest to its center, and the lowest weights to vertices farthest from the center. So, for example, with a cylinder whose pivot point is at the base, you'll get the greatest amount of flexing at the top. But

with a sphere, all of whose vertices are equidistant from the pivot point (center), all vertices have, by default, equal weight values.

The Paint Weights controls let you use a spherical brush with adjustable radius and falloff to change vertex weights in the viewports, thus controlling the amount of lag. The Vertex Weights controls let you apply absolute or relative weighting to single vertices or groups of vertices.

### **Paint Weights group**

**Paint** At any sub-object level, click Paint, and then drag the cursor over the mesh in the viewports to "paint" vertex weights using the current Strength and Feather settings. Vertex colors changes to reflect the new vertex weight.

Painting changes vertex weights *relative* to their current values; it does not apply an absolute weight. Longer strokes over an area of the mesh will increase or decrease vertex weights more than short strokes, and repeated strokes over the same area will cause incremental changes in weight values unless they're already at their extremes.

The vertex coloring shown at any Flex sub-object level provides an approximate indication of weighting. The colors are determined by the settings in Customize menu > Customize User Interface > Colors tab > Elements: Geometry. In this list are three color entries: Subselection Hard, used to display vertices with the highest Weight values; Subselection Medium, used to display vertices with medium Weight values; and Subselection Soft, used to display vertices with low Weight values.

**Strength** Sets the amount by which painting changes weight values. Higher values change weighting more quickly. At Strength=0, painting does not change weight values. Range=-1 to 1; Default=0.1.

Negative values allow you to remove weight.

---

**TIP** When painting, you can use the Alt key to invert the strength.

---

**Radius** Sets the size of the brush in world units. Range=.001 to 99999; Default=36.

---

**NOTE** If you position the mouse cursor over the object before painting, you can see a wireframe representation of the spherical "brush" that depicts the Radius setting.

---

**Feather** Sets the falloff in strength from the center of the brush to its edge. Default=.7. Range=.001 to 1.

Vertices at the center of the brush are always changed by the full amount of the Strength setting, but the higher the Feather setting, the less vertices closer to the edge change. At the lowest setting, all vertices inside the radius are changed equally.

### **Vertex Weights group**

Sets vertex weighting manually. At the Weights & Springs sub-object level, select vertices in the viewports, and then change the value of the Vertex Weight parameter. Alternatively, turn on Absolute Weight, set the desired Vertex Weight, and then select vertices to set; changes are immediate.

**Absolute Weight** Turn on to assign absolute weights to the selected vertices. Turn off to add or remove weight based on the Vertex Weight setting.

**Vertex Weight** Assigns weight to selected vertices.

Depending on the state of the Absolute Weight parameter, weight assignment is either absolute or relative.

---

**NOTE** The Vertex Weight range is -100 to 100. With Absolute Weight on, the negative Vertex Weight settings have no effect; the effective range is 0 to 100. With Absolute Weight off, changing the Vertex Weight setting adds the amount to the current weights of selected vertices, and then the setting is reset to 0.

---

## Forces and Deflectors rollout

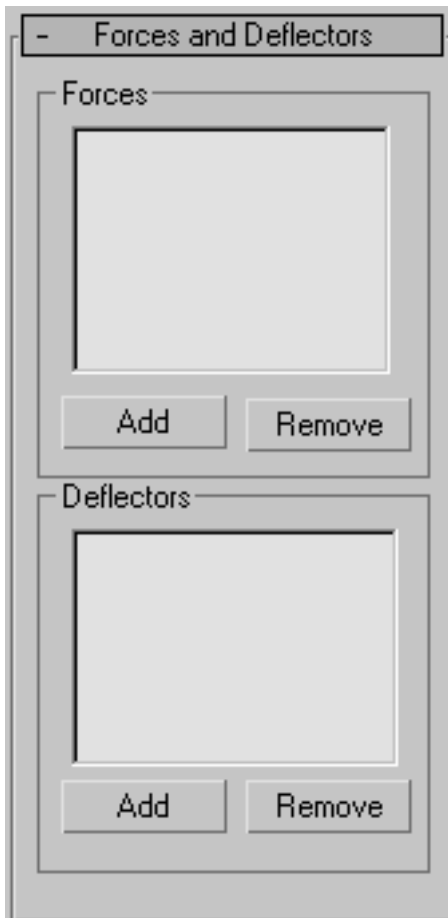

### Forces group

Use these controls to add space warps in the Forces category to the Flex modifier. Supported space warps are:

- [Displace](#) on page 2645
- [Drag](#) on page 2624
- [Gravity](#) on page 2639
- [Motor](#) on page 2614



- [PBomb](#) on page 2629
- [Push](#) on page 2609
- [Vortex](#) on page 2619
- [Wind](#) on page 2642

**List Window** Displays particle space warps applied to the Flex modifier.

**Add** Click this, and then select a particle space warp in the viewports to add the effect to Flex. The added space warp displays in the list window.

**Remove** Select a space warp in the list and click Remove to remove the effect from Flex.

### **Deflectors group**

Using deflectors with Flex lets object movement be impeded by surfaces. This lets you simulate collisions with soft-body objects. For best results with collisions, in the deflector settings use a low value for Bounce and a high value for Friction.

Supported deflectors are:

- [POmniFlect](#) on page 2650
- [SOmniFlect](#) on page 2661
- [UOmniFlect](#) on page 2664
- [UDeflector](#) on page 2672
- [SDeflector](#) on page 2669
- [Deflector](#) on page 2675

**List Window** Displays deflectors applied to the Flex modifier.

**Add** Click this, and then select a deflector in the viewports to add the effect to Flex. The added deflector displays in the list window.

**Remove** Select a deflector in the list and click Remove to remove the effect from Flex.

## Advanced Parameters rollout

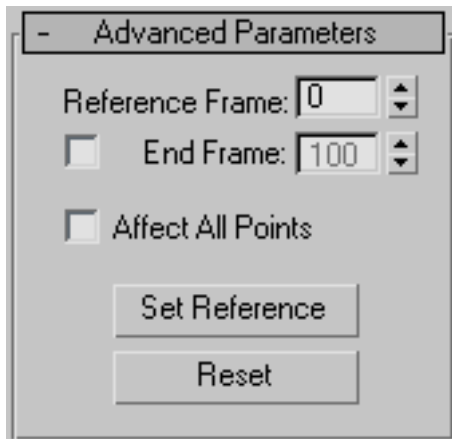

**Reference Frame** Sets the first frame at which Flex begins its simulation.

**End Frame** When on, sets the last frame at which Flex is to take effect. After this frame, the object snaps back to its shape as currently defined by the stack. For instance, if you animate a Bend modifier in the stack under Flex, then when Flex stops, the object's shape is altered only by the Bend modifier settings as of that frame.

**Affect All Points** Forces Flex to ignore any sub-object selection in the stack and apply itself to the entire object.

**Set Reference** Updates the viewports.

After moving the effect center, click Set Reference to update the viewports.

**Reset** Resets vertex weighting to the defaults.

## Advanced Springs rollout

Use these settings when you need a more precise springs setup than is provided by the Simple Soft Body feature. Flex uses two types of spring: *edge springs*, which create springs only along existing edges, and *shape springs*, which can exist between any two vertices in the object that are not connected by an edge. In general, add edge springs along existing edges and shape springs between vertices that don't share an edge.

---

**NOTE** Before using these controls, go to the Weights & Springs sub-object level.

---

---

**NOTE** Additional spring types are available using MAXScript. See the MAXScript reference for details.

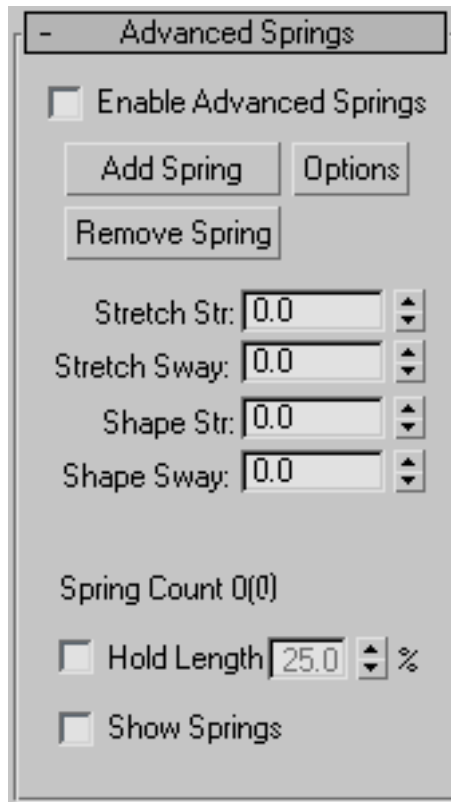

---

**Enable Advanced Springs** Makes the numeric controls available for editing, and disconnects the Strength and Sway settings from the Simple Soft Bodies controls. Default=off.

The four numeric Stretch and Sway settings in this rollout are available only when Enable Advanced Springs is on.

**Add Spring** Adds one or more springs to the object based on the vertex selection at the Weights & Springs sub-object level and the [Spring Option dialog](#) on page 1418 settings.

---

**NOTE** You cannot undo this action. To delete existing springs, select the endpoints and click Remove Spring.

---

**Options** Opens the [Spring Option dialog](#) on page 1418 for determining how springs are added with the Add Spring function.

**Remove Spring** Deletes any springs that have both vertices selected at the Weights & Springs sub-object level.

**Stretch Str.** Determines the strength of the edge springs; the higher the strength, the less the distance between them can vary.

**Stretch Sway** Determines the sway of the edge springs; the higher the strength, the less the angle between them can vary.

**Shape Str.** Determines the strength of the shape springs; the higher the strength, the less the distance between them can vary.

**Shape Sway** Determines the sway of the shape springs; the higher the strength, the less the angle between them can vary.

**Spring Count** Displays the number of edge springs, followed by the number of shape springs in parentheses.

**Hold Length** Maintains the length of edge springs within the specified percentage.

---

**NOTE** This setting, which is applied after the Flex simulation, can affect the object shape, and thus cause collision detection to fail.

---

**Show Springs** Displays edge springs as blue lines and shape springs as red lines. Springs are visible only when a Flex sub-object mode is active.

You can change the spring colors using MAXScript.

## Spring Option Dialog

Select a Mesh, Patch, or NURBS object. > Modify panel > Modifier List > Animation Modifiers > Flex > Advanced Springs rollout > Options button

Use the Spring Option dialog to determine how springs are added in the Flex modifier when you click the Advanced Springs rollout > Add Spring button.

## Interface

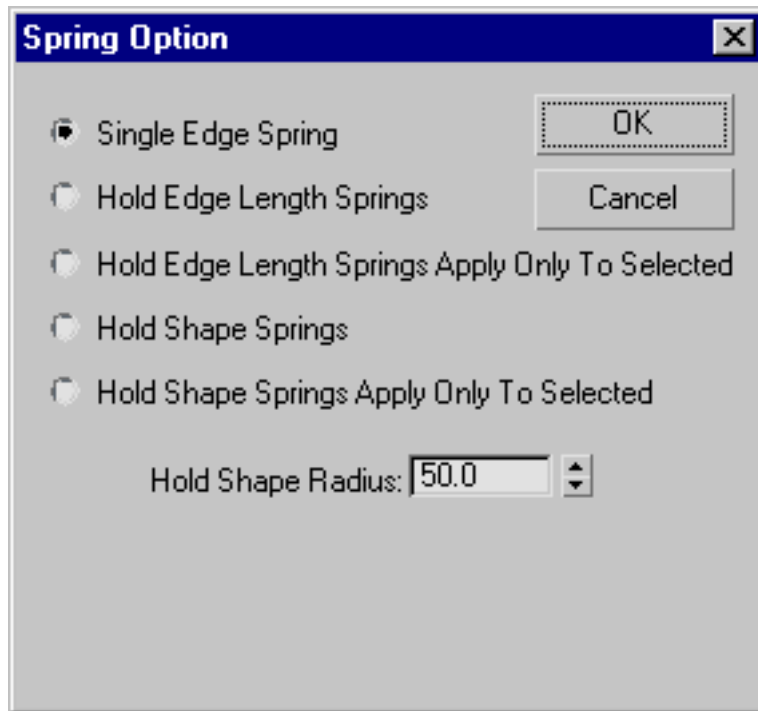

**Single Edge Spring** Creates one edge spring between two selected vertices. If any number of vertices is selected other than two, no springs are created.

**Hold Edge Length Springs** Creates edge springs along the edges of the objects between any vertex selection and neighboring vertices.

**Hold Edge Length Springs Apply Only To Selected** Creates edge springs along the edges of the objects between all selected vertices.

**Hold Shape Springs** Creates shape springs from the selected vertex or vertices to all other vertices within the Hold Shape Radius.

**Hold Shape Springs Apply Only To Selected** Creates shape springs between all selected vertices within the Hold Shape Radius.

**Hold Shape Radius** The radius within which shape springs are created. No shape springs are created between vertices farther apart than this distance.

At the bottom of the dialog is an informational display showing the object's average edge length, maximum edge length, and minimum edge length. This information can help in determining an appropriate Hold Shape Radius setting.

## HSDS Modifier

Select an object. > Modify panel > Modifier List > Object-Space Modifiers > HSDS Modifier

Select an object. > Modifiers menu > Subdivision Surfaces > HSDS Modifier

The HSDS modifier implements Hierarchical SubDivision Surfaces. It is intended primarily as a *finishing* tool rather than as a modeling tool. For best results, perform most of your modeling using low-polygon methods, and then use HSDS to add detail and adaptively refine the model.

---

**NOTE** Better speed optimization has been implemented in the HSDS modifier. Subdivision calculations are now handled more efficiently making the HSDS modifier faster.

---

The modifier's primary features are:

- Local refinement
- Hierarchical modeling
- Adaptive tessellation

With local refinement, you subdivide part of a polygon mesh and edit the mesh in the subdivided area. This is done indirectly by manipulating sub-objects in a *control grid*. Use this feature when you need to increase mesh resolution in specific areas of a model rather than uniformly over the entire object, as with the [Tessellate modifier](#) on page 1743. An example of usage would be a human hand. Once you've modeled the basic shape, you might use the HSDS modifier to add bumps for the knuckles.

The HSDS modifier supports multiple levels of detail, hence its hierarchical nature. The Subdivision Stack lets you visually navigate the levels of detail at any time while using the modifier. Thus, you can edit the same part of a mesh at different mesh resolutions. If you work at a level of detail lower than the highest available, the higher-detail areas are still in effect, but you control them indirectly by means of the more widespread sub-objects at the lower level.

Sub-object animation is supported only at the lowest level of detail: Base Level. This is accomplished by animating the mesh below the HSDS modifier. To apply deformation animation after HSDS modeling, first convert the object to an editable mesh by right-clicking the modifier stack and choosing Collapse All.

The adaptive tessellation automatically subdivides polygons as needed to maintain a smoothly curved surface when transforming mesh sub-objects. You can use a preset or provide custom settings.

---

**IMPORTANT** HSDS models are not passed up the modifier stack. The HSDS modifier takes a polygon mesh as input, and outputs a triangle-based mesh.

---

Also, The HSDS modifier does not handle changes to the modified object's topology, such as altering a sphere's Segments setting. Topology changes to the input mesh results in the loss of all edits made in the HSDS modifier.

## Procedures

### To use the HSDS modifier:

- 1 Apply the HSDS modifier to an object.

By default, the HSDS modifier doesn't convert non-quadrilateral polygons to quads. Because the modifier works best with four-sided polygons, it's recommended you perform the conversion if necessary.

- 2 If the object contains any non-quadrilateral polygons, in the HSDS Parameters dialog, turn on Force Quads. Click Yes in the Force Quads? dialog that appears.

---

**NOTE** Upon conversion to quads, the modifier automatically performs one level of subdivision with smoothing (like [MeshSmooth](#) on page 1460 with one iteration) on the object to which it's applied. Thus, for best results, use it with relatively low-polygon objects. For example, if you usually work with the Sphere object at the default 32 segments, use a 16-segment sphere with HSDS.

If the object is made up of quads only, Force Quads isn't available because no conversion is necessary.

---

- 3 Choose a sub-object mode at which to subdivide.

The object is covered with a gold control grid (or, in Vertex sub-object mode, a white grid with blue vertices), indicating that the entire mesh is available for subdivision and/or sub-object transformation at base level.

- 4 Select one or more sub-objects.
- 5 Click the Subdivide button.

The modifier again subdivides and smoothes the selected sub-objects as well as all surrounding polygons. The resultant sub-objects reside at a higher level of detail, as indicated by the addition of a level in the Subdivision Stack. Now the control grid shows only polygons at the new level. With sub-objects other than Element, this typically covers only part of the object's surface.

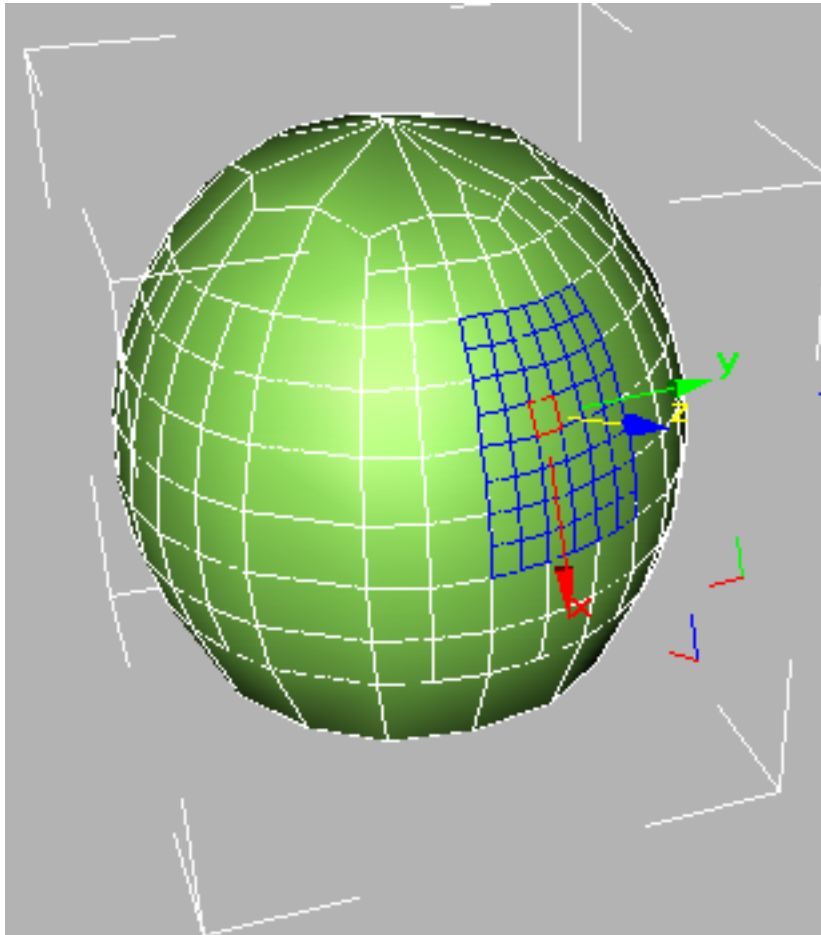

A control grid on a sphere at level 2. Subdivisions at lower levels are visible as gold lines.



In wireframe views, you can still see polygons at lower levels of detail, but you can select only sub-objects resulting from the subdivision, as indicated by the control grid. You can subdivide sub-objects further, transform them, hide and delete them, and change material IDs.

---

**NOTE** When you transform an HSDS sub-object, the control grid tends to expand by adding segments at its edges, in order to maintain surface smoothness.

---

- 6 To subdivide a different part of the object, choose a lower level in the Subdivision Stack, and then repeat steps 2–4.

Each time you subdivide a sub-object that has been subdivided, a higher level in the Subdivision Stack is highlighted, indicating a finer mesh resolution. You can then work at that level, or any lower level by selecting the level.

---

**NOTE** If you transform a sub-object at a level lower than the highest level in which the subject exists, the mesh uses the resolution imparted by the detail in the higher levels.

---

## Interface

### HSDS Parameters rollout

The sub-objects available in the HSDS modifier belong to the control grid rather than the mesh object itself. Transforming the grid sub-objects also transforms the underlying mesh, but the mesh doesn't always move to the full extent of the control grid. This is particularly true in cases where you transform a sub-object at a level lower than the highest level in which the sub-object resides.

For example, if you subdivide a vertex at the Base Level, it then resides in the Base Level and Level 1. If you then move the vertex in the base level, the mesh doesn't, by default, move as far as the vertex. This is roughly analogous to the way free-form deformation works, but with HSDS, the control grid conforms much more closely to the shape of the mesh object.

With vertices, you can control the degree to which the mesh follows the control-grid vertex with the settings on the [Vertex Interpolation](#) on page 1425 group.

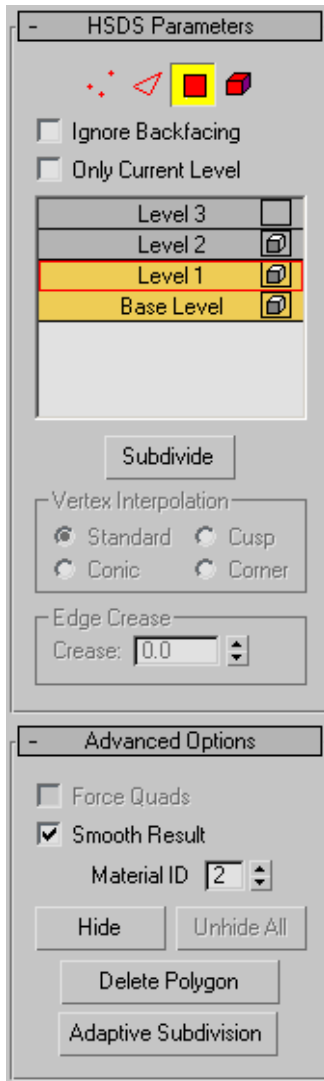

**Vertex** Turns on Vertex sub-object mode, which lets you select a vertex beneath the cursor; region selection selects vertices within the region.



**Edge** Turns on Edge sub-object mode, which lets you select a face or polygon edge beneath the cursor; region selection selects multiple edges within the region.



**Polygon** Turns on Polygon sub-object mode, which lets you select a single face or polygon. A polygon is the area you see within the visible wire edges. Region selection selects multiple polygons within the region.



**Element** Turns on Element sub-object mode, which lets you select all contiguous polygons beneath the cursor in the current level of detail.

**Ignore Backfacing** When on, you can select only those sub-objects whose normals are visible in the viewport. When off (the default), selection includes all sub-objects, regardless of the direction of their normals. Default=off.

**Only Current Level** Displays only polygons at the current level of detail, with highlights, but without smoothing. Use this option to speed up the display when working with complex objects. Default=off.

**Subdivision Stack** Shows the current level of the subdivision hierarchy. Automatically increments when you subdivide a sub-object selection. To edit at a different level of detail, select the level in the stack. The current level is outlined in red.

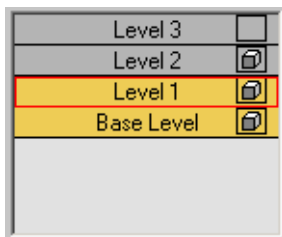

- Visibility is controlled by the box icon to the right of the level label. Turning on the visibility at one level activates the visibility from that level down to the base level. Visibility above that level will be turned off.

**Subdivide** Performs subdivision and smoothing on the current selection, and adds a level to the Subdivision Stack. When the subdivision results in a control grid and other subdivisions have been performed at the same level of detail, the control grids may become interconnected.

**Vertex Interpolation group**

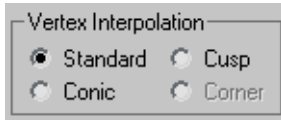

Determines how selected vertices are treated during subdivision. Available only in Vertex sub-object mode.

For best results, use when moving control grid vertices at a level of detail lower than the highest in which the vertex resides.

**Standard/Conic/Cusp/Corner** Determines how closely mesh vertices follow the movement of control grid vertices. Standard provides the least amount of relative movement, while Cusp and Corner provide the most. Corner also keeps edges adjacent to subdivided vertices from being rounded off during subdivision. Default=Standard.

---

**NOTE** Corner is available only when the selected vertex or vertices aren't surrounded by polygons, such as the vertices on the edge of a plane object.

---

### Edge Crease group

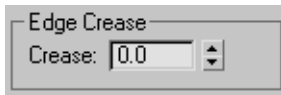

Determines the extent to which selected edges are treated as creases during subdivision. Available only in Edge sub-object mode.

For best results, use with control grid edges at a level of detail lower than the highest in which the edge resides. Also, for creasing to be visible, the edge should be offset from the surrounding surface by a significant amount.

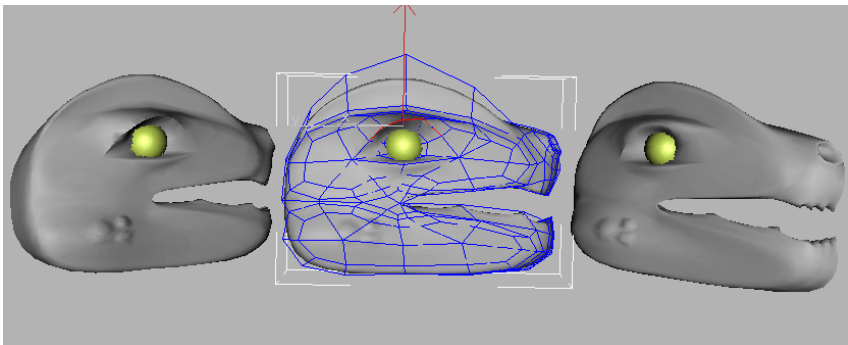

Left: Crease=1.0

Center: The eyebrow edges selected at LOD 0

**Right: Crease=0.0**

**Crease** Specifies how much creasing is performed on the selected edge or edges. At low settings, the edge is relatively smooth. At higher settings, the crease becomes increasingly visible. At 1.0, the highest setting, the edge is not smoothed at all. Default=0.0. Range=0.0 to 1.0.

### **Advanced Options rollout**

**Force Quads** When on, the modifier converts all non-quadrilateral faces or polygons to four-sided polygons. When off, converts all polygons to triangles. Available only when the object contains any non-quadrilateral faces or polygons. Default=off.

When you change the status of Force Quads, any edits made in the HSDS modifier are lost. A message appears warning you of this, and asking you to confirm the change.

Because the modifier works best with four-sided polygons, it's recommended you confirm the conversion if an object contains non-quadrilateral faces or polygons. The sphere primitive is an example of such an object; the uppermost and lowermost faces are three-sided.

**Smooth Result** When turned on, all faces on the object will be in smoothing group 1, but if Smooth Result is turned off, each face will inherit smoothing groups from the input MNMesh.

**Material ID** Displays the material ID assigned to the current selection. Available only in Polygon and Element sub-object modes. If multiple sub-objects are selected and they don't share an ID, this field is blank.

You can change the material ID assigned to selected sub-objects at the current and higher levels of detail by changing this setting.

Material IDs are used primarily with [Multi/Sub-Object material](#) on page 5558 .

**Hide** Hides the current polygon selection. Available only at the Polygon and Element sub-object levels. Use Unhide All to reveal hidden polygons.

---

**TIP** Use Hide to isolate part of an object you want to work on. The Select Invert command on the Edit menu is useful in this case. Select the faces you want to focus on, choose Edit > Select Invert, then click the Hide button.

---

**Unhide All** Reveals hidden polygons.

**Delete Polygon** Deletes the current polygon selection, creating a hole or holes in the surface. Available only in Polygon sub-object mode.

---

**NOTE** When the current level of detail does not encompass the entire object surface, you cannot delete polygons at the border of the control grid; that is, polygons that do not share all edges with other polygons in the grid.

---

**Adaptive Subdivision** Opens the [Adaptive Subdivision dialog](#) on page 1428 . This option is best used for smoothing subdivided and edited portions of the mesh when you're finished using the HSDS functionality.

### **Soft Selection rollout**

These controls let you set a gradual falloff of influence between selected and unselected vertices. See [Soft Selection Rollout \(Edit/Editable Mesh\)](#) on page 1926 .

## **Adaptive Subdivision Dialog**

Select an object. > Modify panel > Modifier List > Object-Space Modifiers > HSDS Modifier > HSDS Parameters rollout > Adaptive Subdivision button

Select an object. > Modifiers menu > Subdivision Surfaces > HSDS Modifier > HSDS Parameters rollout > Adaptive Subdivision button

Use adaptive subdivision for smoothing subdivided and edited portions of the mesh when you're finished using the [HSDS modifier](#) on page 1420 . Alternatively, you can use adaptive subdivision to remove a level of detail from the object.

### **Procedures**

#### **To use adaptive subdivision:**

- 1 Edit an object with the HSDS modifier.
- 2 Choose Add Detail or Remove Detail, depending which operation you want to perform.
- 3 Set the desired amount of detail with one of the presets or by specifying custom Length and Angle settings.
- 4 Click OK to perform the specified operation.

The detail addition or removal is performed, and you're returned to the HSDS modifier. Depending on whether you removed or added detail, the highest level of detail is decremented or incremented by 1.

## Interface

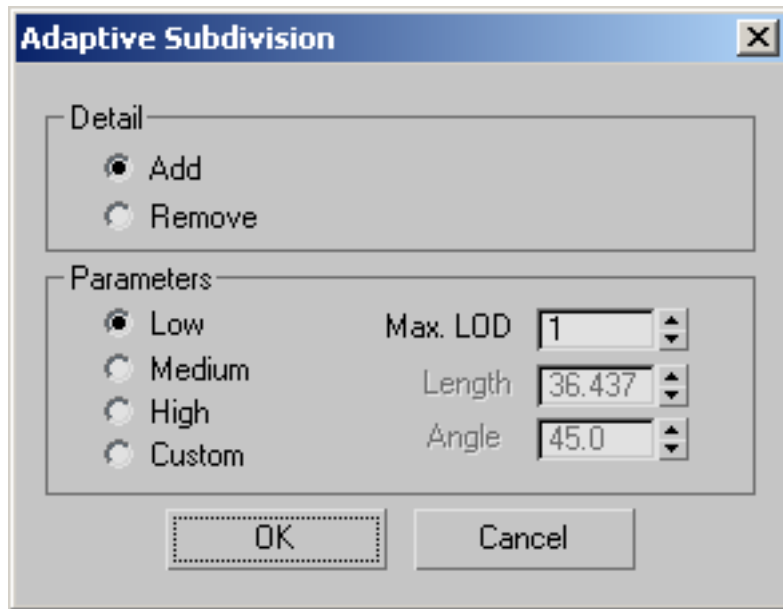

### Detail group

**Add/Remove** Determines whether clicking the OK button increases or decreases detail.

### Parameters group

These settings determine the extent to which detail is added or removed. The Length and Angle settings are available for editing only when the Custom option is chosen. However, they show the default settings for the Low, Medium, and High options.

**Low/Medium/High/Custom** Choose one of the presets, or choose Custom to set your own Length and Angle values.

**Max. LOD** Specifies the highest number of levels of detail that the software can add when increasing detail. Not available when removing detail.

**Length** The maximum permissible length of any edge after adding or removing detail. The smaller the length, the higher the amount of tessellation that is allowed.

**Angle** The maximum permissible angle between two opposite edges emanating from a vertex. The smaller the angle, the higher the amount of tessellation that is allowed.

**OK** Performs the subdivision or removal of detail and closes the dialog.

**Cancel** Closes the dialog without changing the mesh.

## Lathe Modifier

Select a shape. > Modify panel > Modifier List > Lathe

Select a shape. > Modifiers menu > Patch/Spline Editing > Lathe

Lathe creates a 3D object by rotating a shape or NURBS curve about an axis.

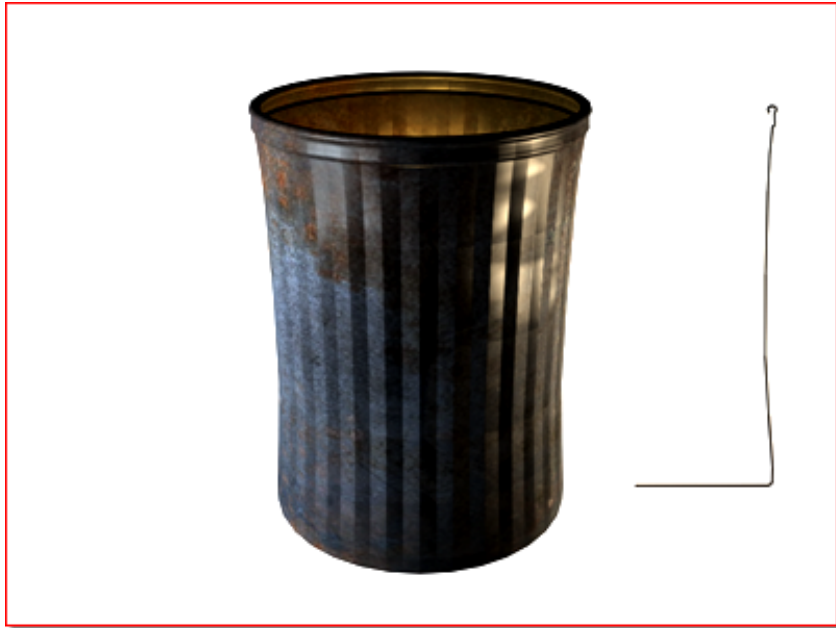

Object resulting from 360-degree lathe



## Interface

### Modifier Stack

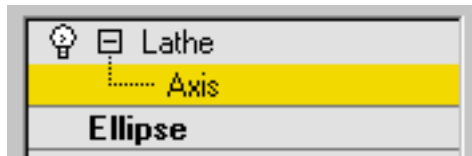

**Axis** At this sub-object level, you can transform and animate the axis of revolution.

For more information on the stack display, see [Modifier Stack](#) on page 7427 .

## Parameters rollout



**Degrees** Determines the number of degrees that the object is spun around the axis of revolution (0 to 360, default=360). You can set keyframes for Degrees

to animate the circular growth of a lathed object. The Lathe axis auto-sizes itself to the height of the shape being lathed.

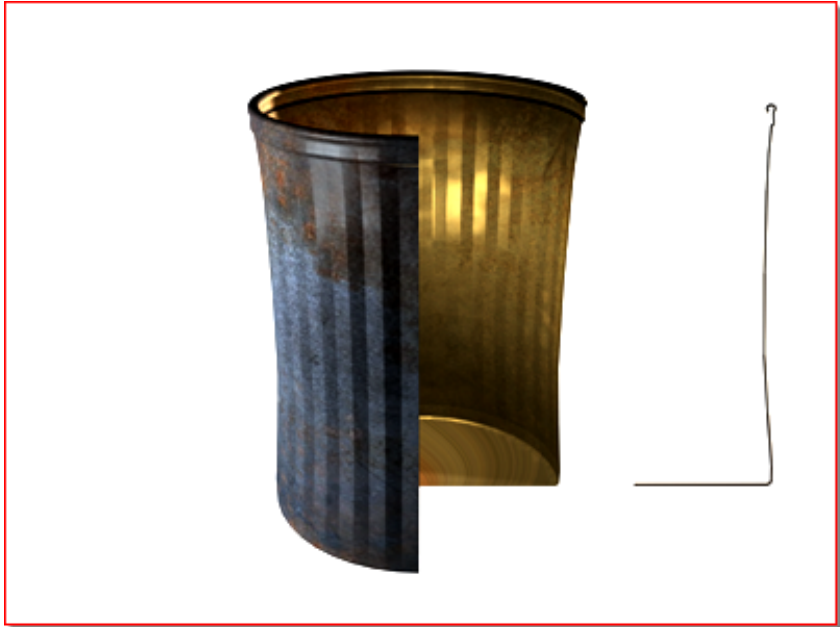

**Object resulting from 270-degree lathe**

**Weld Core** Simplifies the mesh by welding together vertices that lie on the axis of revolution. Keep it turned off if you intend to create morph targets.

**Flip Normals** Depending on the direction of the vertices on your shape, and the direction of rotation, the lathed object might be inside out. Toggle the Flip Normals check box to fix this.

**Segments** Determines how many interpolated segments are created in the surface between the start and endpoint. This parameter is also animatable. Default=16

---

**NOTE** You can create up to 10,000 segments using the segments spinner. Try not to create geometry that is more complex than you need. Often you can get satisfactory results by using smoothing groups or smoothing modifiers, rather than increasing segmentation.

---

## Capping group

Controls whether or not caps are created for the interior of the lathed object if Degrees is set to less than 360.

**Cap Start** Caps the start of the lathed object with Degrees set to less than 360 and a closed shape.

**Cap End** Caps the end of the lathed object with Degrees set to less than 360 and a closed shape.

**Morph** Arranges cap faces in a predictable, repeatable pattern necessary for creating morph targets. Morph capping can generate long, thin faces that don't render or deform as well as grid capping. Use morph capping primarily if you are lathing multiple morph targets.

**Grid** Arranges cap faces in a square grid trimmed at the shape boundaries. This method produces a surface of evenly sized faces that can easily be deformed by other modifiers.

## Direction group

Sets up the direction of the axis of revolution, relative to the pivot point of the object.

**X/Y/Z** Set the direction of the axis of revolution relative to the pivot point of the object.

## Align group

**Min/Center/Max** Align the axis of revolution to the minimum, center, or maximum extents of the shape.

## Output group

**Patch** Produces an object that you can collapse to a patch object (see [Editing the Stack](#) on page 1023 ).

**Mesh** Produces an object that you can collapse to a mesh object (see [Editing the Stack](#) on page 1023 ).

**NURBS** Produces an object that can be collapsed to a NURBS surface (see [Editing the Stack](#) on page 1023 ).

**Generate Mapping Coordinates** Applies mapping coordinates to the lathed object. When Degrees is less than 360, and Generate Mapping Coordinates is

turned on, additional mapping coordinates are applied to the end caps, placing a 1 x 1 tile on each cap.

**Real-World Map Size** Controls the scaling method used for texture mapped materials that are applied to the object. The scaling values are controlled by the Use Real-World Scale settings found in the applied material's [Coordinates rollout](#) on page 5620 . Default=on.

**Generate Material IDs** Assigns different material IDs to the sides and the caps of the lathed object. Specifically, the sides receive ID 3, and the caps (when Degrees is less than 360 and the lathed shape is closed) receive IDs 1 and 2. Default=on.

**Use Shape IDs** Uses the material ID values assigned to segments in the [spline](#) on page 542 you lathed, or curve sub-objects in the [NURBS](#) on page 2152 curve you lathed. Use Shape IDs is available only when Generate Material IDs is turned on.

**Smooth** Applies smoothing to the lathed shape.

## Lattice Modifier

Select an object or a shape. > Modify panel > Modifier List > Object-Space Modifiers > Lattice

Select an object or a shape. > Modifiers menu > Parametric Deformers > Lattice

The Lattice modifier converts the segments or edges of a shape or object into cylindrical struts with optional joint polyhedra at the vertices. Use this either to create renderable structural geometry based on the mesh topology, or as an alternate method to achieve a rendered wireframe effect.

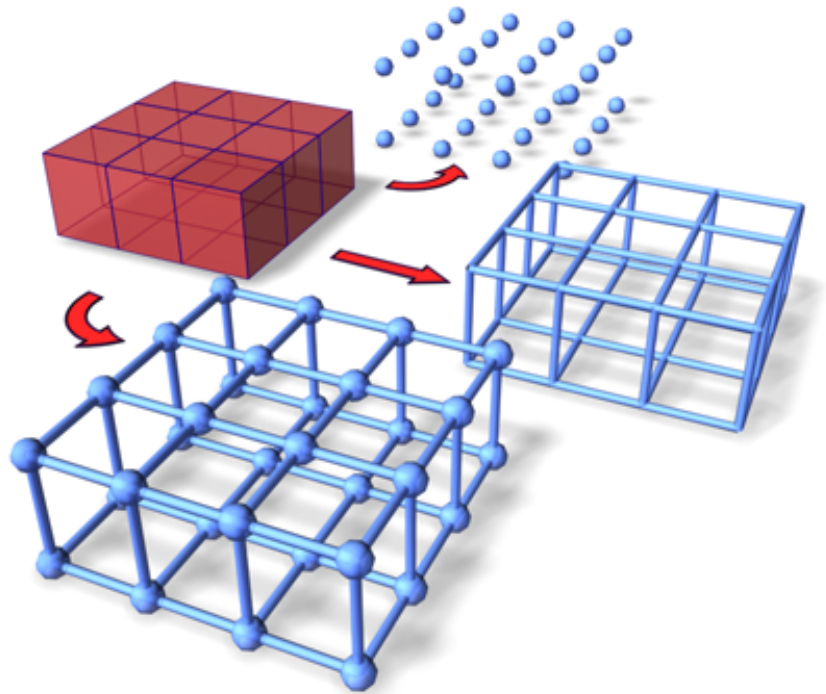

**Top: Joints only**

**Middle: Struts only**

**Bottom: Both (joints and struts)**

---

**NOTE** This modifier can act on the whole object or on sub-object selections in the stack.

---

---

**TIP** You can combine the [Scatter compound object](#) on page 647 with the Lattice modifier to place any object you want as a joint, rather than the provided polyhedra. To do this, create your mesh distribution object and your source object (for example, a box). Use Scatter to scatter the box at the vertices of the distribution object. (Be sure to use the Copy option rather than Instance.) In the Scatter Display parameters, hide the distribution object. Select the original object that was used as a distribution object, apply Lattice to it, and turn off the joints. You'll have two coincident objects: one providing the lattice struts, and the other positioning the boxes.

---

## Interface

- Parameters

Geometry

- Apply to Entire Object
- Joints Only from Vertices
- Struts Only from Edges
- Both

Struts

Radius: 2.0

Segments: 1

Sides: 4

Material ID: 1

- Ignore Hidden Edges
- End Caps
- Smooth

Joints

Geodesic Base Type

- Tetra
- Octa
- Icosa

Radius: 5.0

Segments: 1

Material ID: 2

- Smooth

Mapping Coordinates

- None
- Reuse Existing
- New

### Geometry group

Specifies whether to use the whole object or selected sub-objects, and which of the two components (struts and joints) is displayed.



**Apply To Entire Object** Applies Lattice to all edges or segments in the object. When turned off, applies Lattice only to selected sub-objects passed up the stack. Default=on.

---

**NOTE** When Apply To Entire Object is turned off, unselected sub-objects render normally. For example, if you convert a box to an editable mesh, select one polygon, and then apply Lattice with Apply To Entire Object turned off, the face does not render, while the edges and vertices that form that face are converted to struts and joints, and the remaining faces render normally. However, if you select the four edges surrounding the polygon and turn off Ignore Hidden Edges, the struts and joints are added to the object while all faces render as normal. If you turn on Struts group > Ignore Hidden Edges, one of the polygon's faces renders, while the other doesn't.

---

**Joints Only From Vertices** Displays only the joints (polyhedra) generated by the vertices of the original mesh.

**Struts Only From Edges** Displays only the struts (cylinders) generated by the segments of the original mesh.

**Both** Displays both struts and joints.

### **Struts group**

Provides controls that affect the geometry of the struts.

**Radius** Specifies the radius of the struts.

**Segments** Specifies the number of segments along the struts. Increase this value when you need to deform or distort the struts with subsequent modifiers.

**Sides** Specifies the number of sides around the perimeter of the struts.

**Material ID** Specifies the material ID to be used for the struts. The struts and the joints can have different material IDs, making it easy to assign them different materials. The struts default to ID #1.

**Ignore Hidden Edges** Generates struts only for visible edges. When turned off, generates struts for all edges, including the invisible edges. Default=on.

**End Caps** Applies end caps to the struts.

**Smooth** Applies smoothing to the struts.

### **Joints group**

Provides controls that affect the geometry of the joints.

**Geodesic Base Type** Specifies the type of polyhedron used for the joints.

**Tetra** Uses a tetrahedron.

**Octa** Uses an octahedron.

**Icosa** Uses an icosahedron.

**Radius** Specifies the radius of the joints.

**Segments** Specifies the number of segments in the joints. The more segments, the more spherical the joints' shape.

**Material ID** Specifies the material ID to be used for the joints. Defaults to ID #2.

**Smooth** Applies smoothing to the joints.

### **Mapping Coordinates group**

Determines the type of mapping assigned to the object.

**None** Assigns no mapping.

**Reuse Existing** Uses the mapping currently assigned to the object. This might be the mapping assigned by Generate Mapping Coords., in the creation parameters, or by a previously assigned mapping modifier. When using this option, each joint inherits the mapping of the vertex it surrounds.

**New** Uses mapping designed for the Lattice modifier. Applies cylindrical mapping to each strut, and spherical mapping to each joint.

## **Linked XForm Modifier**

Modify panel > Select objects or sub-objects. > Modifier List > Object-Space Modifiers > Linked XForm

Select an object or sub-objects. > Modifiers menu > Animation Modifiers > Linked XForm

The Linked XForm modifier links the transforms for any object or sub-object selection to another object, called the control object. The control object's motion, rotation, and/or scale transforms are passed onto the object or sub-object selection.

## Using Linked XForm

Linked XForm connects any geometry it receives from the stack to another object, which is called the control object. Its single control simply picks the control object. To use this modifier, you must have at least two objects in your scene.

**See also:**

- [XForm Modifier](#) on page 1922

## Procedures

**To apply a Linked XForm modifier:**

- 1 Choose a location in an object's stack and apply a Linked XForm from the Modifier List.
- 2 On the Parameter's rollout, click Pick Control Object. When animating, do this at frame 0.
- 3 Select the object you want to be the control object.  
This completes the link. The name of the control object appears on the Parameters rollout.

**To apply a Linked XForm modifier at a Sub-Object level:**

- 1 Choose an Editable Mesh or an object to which a Mesh Select modifier has been applied.
- 2 Turn on the Vertex sub-object level and select some vertices on the object.
- 3 Apply a Linked XForm modifier.
- 4 On the Parameter's rollout, click Pick Control Object. When animating, do this at frame 0.
- 5 Select another object that you want to control the sub-object selection.  
This completes the link. The name of the control object appears on the Parameters rollout.
- 6 Move the control object and see how the vertices are affected.

## Interface

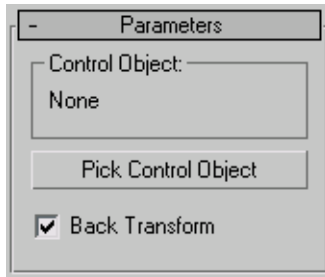

**Control Object** Object that the vertices are linked to. When transformed, the vertices follow.

**Pick Control Object** Click this button, and then select the object that you want to be the control object.

**Back Transform** Allows an object with a Linked XForm modifier to be linked to a Control Object. Normally, moving the Control Object causes the linked object to move twice as much as it should, once with the Control Object and once with the link. When the switch is turned on, any transforms to the Control Object are only applied to the linked object once. This switch is similar to the 'Back Transform Vertices' switch of the [Skin](#) on page 1600 modifier.

## LS Mesh Modifier

Select a Lightscape mesh object. > Modify panel > Modifier List > LS Mesh

The LS Mesh modifier refines a Lightscape mesh object.

When a Lightscape scene is imported into 3ds Max, the mesh produced by Lightscape doesn't contain the refinements that Lightscape introduced to improve the lighting. This information is kept and used by the [Lightscape material](#) on page 5579 while rendering. This modifier will add these refinements to the Lightscape mesh. In conjunction with the [LS Colors modifier](#) on page 1118, this modifier can be used to produce meshes suitable for game engines.

The refinement stored in a Lightscape mesh is hierarchical. When a polygon is refined, it is broken into four smaller polygons. These polygons can then be refined further. A polygon in the refinement has a depth from the original polygon, which is the number of refinements needed to get from the original polygon to the polygon in question.

The modifier allows you to reduce the number of polygons in the result by limiting the depth to which the modifier will descend, or by limiting the size of polygons that will be refined.

You can apply the LS Mesh modifier to a Face sub-object selection of a Lightscape mesh object. In this case, only the selected faces will be refined.

### Interface

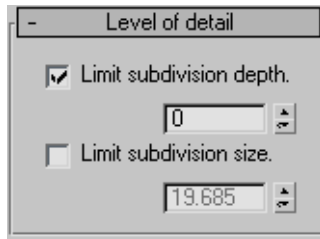

**Limit subdivision depth** When the toggle is on, the value sets the maximum depth of refinement. When the toggle is off, then the mesh modifier will descend to the bottom of the refinement. Default=on, 0.

**Limit subdivision size** When the toggle is on, the value limits the size of polygons that are refined. When the toggle is off, then the mesh modifier will refine polygons to any size. The size is a length in the current view units. Polygons smaller than that size squared will not be refined by the modifier. Default=off, 19.685 units or 0.5 meters.

## MapScaler Modifier (Object Space)

Select an object. > Modify panel > Modifier List > Object-Space Modifiers > MapScaler

The MapScaler (OSM) modifier works in object space to maintain the scale of a map applied to an object. This lets you resize the object via its creation parameters without altering the scale of the map. Typically, you might use this to maintain the size of a map regardless of how the geometry is scaled, if you change the object size by adjusting its creation parameters. However, if you use a Select And Scale tool to change the object size, the map scales along with the object.

To maintain the scale of the map regardless of how the object is resized, use the [MapScaler \(WSM\) modifier](#) on page 1120 .

For example, if you scale a brick wall with the MapScaler (WSM) modifier applied, the bricks will all remain the same size as you increase the size of the wall. However, if you scale the same wall with the MapScaler (OSM) modifier applied, the size of the bricks will grow in proportion with the scale of the wall.

The MapScaler (OSM) modifier has two primary benefits compared to the WSM version:

- As an object-space modifier, it can reside anywhere in the stack and be collapsed with the stack, rather than being restricted to the top of the stack, as with world-space modifiers. This lets other object-space modifiers take effect after the map-scaling operation.
- When instanced among multiple objects, the object-space version appears in the modifier stack display when any number of objects is selected. This differs from the world-space version, which, when instanced among multiple objects, appears in the stack display only when a single object is selected.

---

**TIP** MapScaler also works at the sub-object level. If the object you're working on requires different scaling of the texture map on each surface, you can do so by creating a modifier stack with multiple occurrences of the MapScaler modifier.

---

### Interface

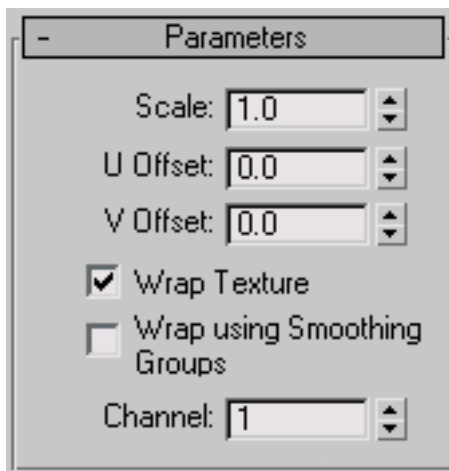

**Scale** Represents the size of one repetition of the texture pattern. Size is measured in current scene units. Repetitions occur across the object in the U and V directions. Default=1.0.

---

**NOTE** When the Use Real-World Texture Coordinates switch is active in the [General Preferences dialog](#) on page 7536 , the scale setting defaults to 1.0. If Use Real-World Texture Coordinates is turned off, scale defaults to 100.0.

---

**U/V Offset** Specify horizontal and vertical offsets respectively. Available only when Wrap Texture is off.

**Wrap Texture** When on, Map Scaler attempts to wrap the texture evenly around the object. This option requires more computing, but usually produces the most satisfactory results. Default=on.

**Wrap Using Smoothing Groups** When turned on, textures are wrapped around corners when they share the same smoothing groups. Curved walls will map smoothly while sharp corners get a new texture origin. This switch is only available when the Wrap Textures switch is turned on. Default=off.

**Channel** Specifies the [map channel](#) on page 7836 . Default=1.

## Material Modifier

Select an object. > Modify panel > Modifier List > Object-Space Modifiers > Material

Select an object. > Modifiers menu > Surface > Material

Select an object. > Modifiers tab > Material Modifier

The Material modifier allows you to animate, or simply change, the assignment of [material IDs](#) on page 7842 on an object. If the material ID is animated, the change to a new material ID is abrupt, from one frame to the next.

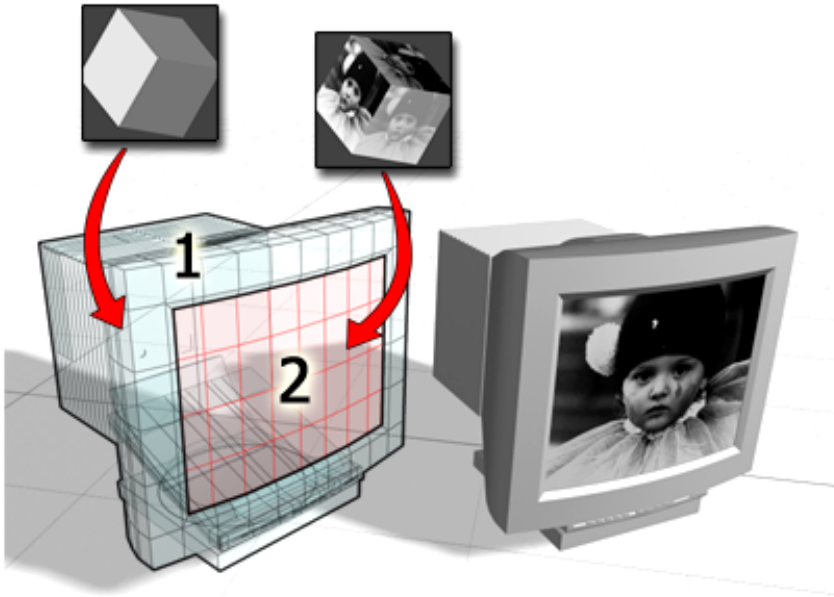

**Object mapped using a multi/sub-object material:**

**Material ID 1 for the housing of the monitor**

**Material ID 2 for the image on the screen**

---

**TIP** If you want a gradual blend from one material to another, try animating the Mix parameter on a [Blend](#) on page 5546 material.

---

Use this modifier in conjunction with the [multi/sub-object](#) on page 5558 material type, to assign different materials to objects or faces at different frames of an animation, or to quickly change the material ID of an object.

**See also:**

- [Editable Mesh Surface](#) on page 1990

### **Patches**

As of 3ds Max 4, patch objects coming up the modifier stack are not converted to a mesh by this modifier. A patch object input to the Material modifier retains its patch definition. Files that contain patch objects with the Material



modifier from previous versions of the software will be converted to meshes to maintain backward compatibility.

## Procedures

### Example: To change the material ID of a sub-object selection:

- 1 In the Top viewport, create a sphere.



- 2 In the Material Editor, create a multi/sub-object material. Make the colors of material ID 1 and 2 different.



- 3 Assign the multi/sub-object material to the sphere.



- 4 On the Modify panel, choose Mesh Select from the Modifier List.



- 5 On the Mesh Select Parameters rollout, click Polygon.
- 6 In the Front viewport, region-select the lower half of the sphere. The selected polygons turn red.
- 7 While Polygon is still the active sub-object level (in the stack display, a square polygon icon appears to the right of Mesh Select), choose Material from the Modifier List.
- 8 On the Material modifier Parameters rollout, set the value of the Material ID to **1** and **2** to toggle the color on and off. In the shaded viewport, the lower half of the sphere changes to the color of the selected material ID.

## Interface

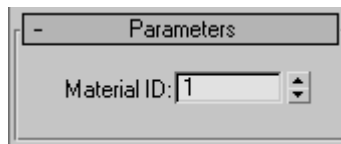

**Material ID** Sets the material ID to be assigned; this can be animated. If the input object is in face sub-selection, then the ID is only applied to selected

faces; otherwise, it is applied to the entire object. The ID number refers to one of the materials in a multi/sub-object material.

## MaterialByElement Modifier

Modify panel > Make a selection. > Modifier List > Object-Space Modifiers > MaterialByElement

Make a selection. > Modifiers menu > Surface > Material By Element

The MaterialByElement modifier lets you apply different material IDs to objects containing multiple elements, at random or according to a formula. When animated, this effect is useful for such applications as an office building at night with window illumination turning on and off at random.

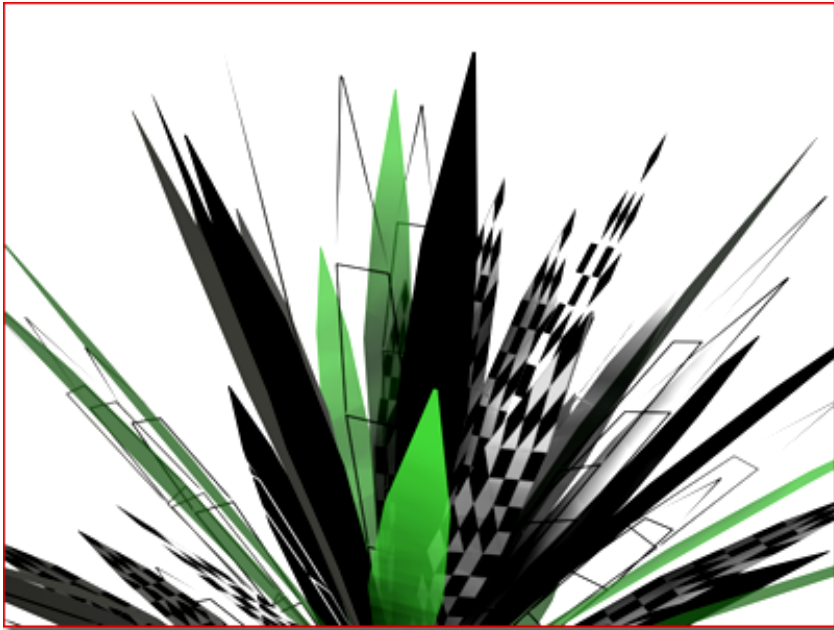

Various materials randomly applied to the leaves of the plant

### Procedures

**Example:** To assign colors randomly in a group of spheres:

- 1 Create six spheres.

---

**TIP** One method is to add a [sphere](#) on page 356 primitive, then use Shift+[Move](#) on page 888 with the Copy option, and enter **5** in the Number Of Copies field.

---

- 2 Combine the spheres into a single editable mesh object.  
Right-click a selected sphere and from the Transform (lower-right) quadrant of the quad menu, choose Convert To: > Convert to Editable Mesh. Then click Modify panel > Edit Geometry rollout > Attach List. In the Attach List dialog, click All, and then Attach.
- 3 Create a [multi/sub-object material](#) on page 5558 with six materials, and specify a different color for each material. Assign the material to the object with multiple spheres.  
Because sphere primitives are assigned material ID 2 by default, all the spheres now have the color assigned to material number 2 in the multi/sub-object material.
- 4 Assign the MaterialByElement modifier to the object.
- 5 From the Parameters rollout, turn on Random Distribution.  
Because the default ID Count setting is 2, some of the spheres are assigned sub-material #1, and the rest are assigned #2.
- 6 Use the spinner to increase the ID Count setting to 3. Also change the Uniqueness group > Seed value.  
Now the first three materials are assigned to the spheres at random, although with some Seed settings, you may see only two different colors.
- 7 Keep increasing the ID Count setting until you see all six colors in the multi/sub-object material. As the assignments are random, it may take awhile.

## Interface

The image shows a software interface window titled "Parameters". It is divided into two main sections: "Material ID By Element" and "Uniqueness".

**Material ID By Element**

- There are two radio buttons: "Random Distribution" (unselected) and "List Frequency" (selected).
- Below "Random Distribution" is a text input field labeled "ID Count" with the value "2".
- Below "List Frequency" are eight text input fields labeled "Mat'l ID #1" through "Mat'l ID #8". The values are: 50.0, 50.0, 0.0, 0.0, 0.0, 0.0, 0.0, and 0.0.

**Uniqueness**

- There is a text input field labeled "Seed" with the value "12345".

### Material ID By Element group

The two choices in this group let you either create a truly random distribution of material IDs or divide the assignments among up to eight materials according to percentages you set.

**Random Distribution** Assigns the materials at random to different elements in the object.

**ID Count** Determines the minimum number of material IDs to assign. Because material ID assignment is random, setting it to the number of materials in the multi/sub-object material or higher doesn't guarantee that all materials get used.

**List Frequency** Determines an approximate relative weight (percentage) for each of up to eight material IDs, as set by the Mat'l ID #1-8 spinners. The modifier assigns material IDs until the weights total 100.

For example, if you set Mat'l ID #1 to 40, #2 to 35, and #3 to 60, approximately 40 percent of the elements will be assigned material ID 1, 30 percent will be assigned material ID 2, and 25 percent ( $100 - [40 + 35]$ ) will be assigned material ID 3. Any remaining percentages (as set in Mat'l IDs 4-8) are ignored.

---

**NOTE** These percentages are approximate. The more elements the object contains, the closer the assigned percentage comes to the set percentage.

---

### **Uniqueness group**

**Seed** Sets the seed value for the (pseudo-)randomization of material ID assignments. Not animatable.

## **Melt Modifier**

Modify panel > Make a selection. > Modifier List > Melt

Make a selection. > Modifiers menu > Animation Modifiers > Melt

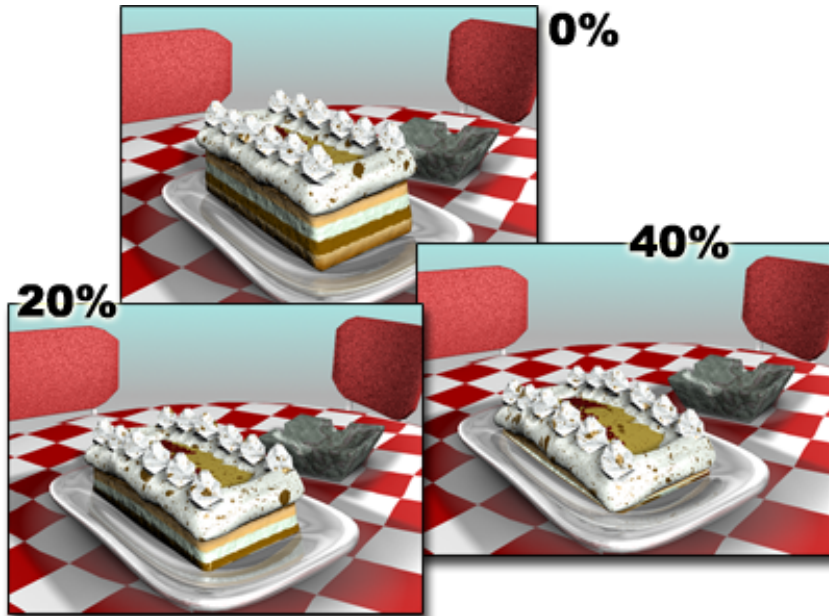

Increasing the Melt amount progressively melts the cake

The Melt modifier lets you apply a realistic melting effect to all types of objects, including editable patches and NURBS objects, as well as to sub-object selections passed up the stack. Options include sagging of edges, spreading while melting, and a customizable set of substances ranging from a firm plastic surface to a jelly type that collapses in on itself.

### Procedures

**Example: To animate a jelly-like melting sphere:**

- 1 In the Top viewport, create a Sphere primitive with a radius of about **50** units.
- 2 Apply the Melt modifier.
- 3 Turn on the Auto Key button and go to frame 100.
- 4 In the Melt group box, set Amount to **70**.
- 5 In the Solidity group box, choose Jelly.
- 6 Turn off the Auto Key button.

7 Drag the time slider to see the sphere melt.

## Interface

### Modifier Stack



**Gizmo** At this sub-object level, you can transform and animate the gizmo like any other object, altering the effect of the Melt modifier. Translating the gizmo translates its center an equal distance. Rotating and scaling the gizmo takes place with respect to its center.

**Center** At this sub-object level, you can translate and animate the center, altering the Melt gizmo's shape, and thus the shape of the melted object.

For more information on the stack display, see [Modifier Stack](#) on page 7427 .

## Parameters rollout

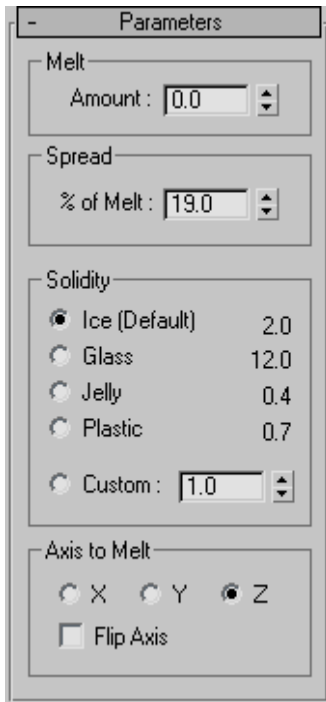

### Melt group

**Amount** Specifies the extent of the "decay," or melting effect applied to the gizmo, thus affecting the object. Range=0.0 to 1000.0.

### Spread group

**% of Melt** Specifies how much the object and melt will spread as the Amount value increases. It's basically a "bulge" along a flat plane.

### Solidity group

Determines the relative height of the center of the melted object. Less-solid substances like jelly tend to settle more in the center as they melt. This group provides several presets for different types of substances, as well as a Custom spinner for setting your own solidity.

**Ice** The default Solidity setting.



**Glass** Uses a high Solidity setting to simulate glass.

**Jelly** Causes a significant drooping effect in the center.

**Plastic** Relatively solid, but droops slightly in the center as it melts.

**Custom** Sets any solidity between 0.2 and 30.0.

### **Axis to Melt group**

**X/Y/Z** Choose the axis (local to the object) on which the melt will occur. Note that this axis is local to the Melt gizmo and not related to the selected entity. By default, the Melt gizmo's axes are lined up with the object's local coordinates, but you can change this by rotating the gizmo.

**Flip Axis** Normally, the melt occurs from the positive direction toward the negative along a given axis. Turn on Flip Axis to reverse this direction.

## **Mesh Select Modifier**

Create or select an object > Modify panel > Modifier List > Mesh Select

Make a selection. > Modifiers menu > Selection Modifiers > Mesh Select

The Mesh Select modifier lets you pass a sub-object selection up the stack to subsequent modifiers. It provides a superset of the selection functions available in the [Edit Mesh modifier](#) on page 1283 . You can select vertices, edges, faces, polygons or elements, and you can change the selection from sub-object level to object level.

Note the following:

- When you apply the Mesh Select modifier and then go to any sub-object level, the select-and-transform buttons in the toolbar are unavailable, and the Select Object button is automatically activated.
- The Mesh Select modifier automatically turns off the Show End Result button, which becomes "spring loaded" while you're in the modifier.

For more information on the stack display, see [Modifier Stack](#) on page 7427 .

### **Using XForm Modifiers to Animate a Mesh Selection**

When you apply a Mesh Select modifier, there are no animation controllers assigned to the sub-object selection. This means that the selection has no way to "carry" the transform information needed for animation.

To animate a sub-object selection using Mesh Select, apply either an XForm or Linked XForm modifier to the selection. These modifiers provide the necessary controllers for animating the effects of transforms. In a sense, they give "whole-object status" to the sub-object selection.

- [XForm](#) on page 1922  
Animates transforms directly on a sub-object selection. Creates a gizmo and center for the sub-object selection. You can animate both, with the center acting as a pivot point for the selection.
- [Linked XForm](#) on page 1440  
Lets you choose another object to control the animation. The sub-object selection is linked to the "control object." When you transform the control object, the sub-object selection follows accordingly.

## Procedures

### To use the Mesh Select modifier:

- 1 Create a mesh object.
- 2 Select a mesh object.
- 3 Apply a Mesh Select modifier.
- 4 Select vertices, edges, faces, polygons or elements.
- 5 Add another modifier to affect only the selection from step 3.

## Interface

### Modifier Stack controls



**Show End Result** Normally, if you apply a modifier such as Twist to an editable-mesh object and then return to the Editable Mesh stack entry, you cannot see the effect of the modifier on the object's geometry. But if you turn on Show End Result, you can see the final object as a white mesh, and the original editable mesh as an orange mesh.

---

**NOTE** With modifiers such as MeshSmooth, which apply by default to an entire object, no special treatment is necessary. However, if you intend to use this functionality with other modifiers that work on a sub-object selection passed up the stack, such as Bend, and you want to apply the modifier to the entire object, you should place a [Volume Select modifier](#) on page 1910 between the editable mesh object and the modifier in the stack. You should leave the Volume Select modifier's level at the top (the default: no sub-object level chosen).

---

### Mesh Select Parameters rollout

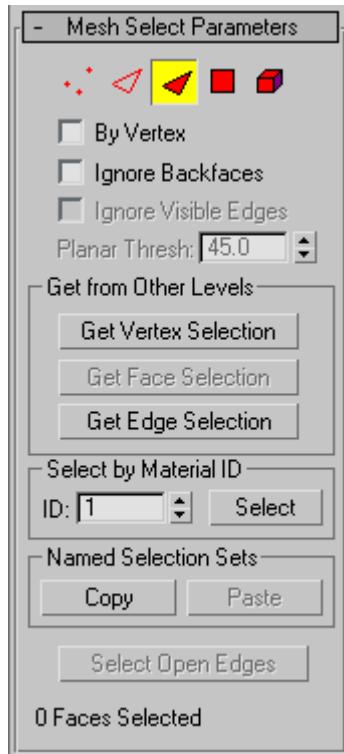

Provides buttons for turning different sub-object modes on and off, working with named selections and handles, display settings, and information about selected entities.

The icons at the top of the Selection rollout let you specify the method of sub-object selection.

Clicking a button here is the same as selecting a sub-object level in the modifier stack. Click the button again to turn it off and return to the object selection level.



**Vertex** Selects a vertex beneath the cursor; region selection selects vertices within the region.



**Edge** Selects a face or polygon edge beneath the cursor; region selection selects multiple edges within the region.



**Face** Selects a triangular face beneath the cursor; region selection selects multiple triangular faces within the region.



**Polygon** Selects all coplanar faces (defined by the value in the Planar Threshold spinner) beneath the cursor. Usually, a polygon is the area you see within the visible wire edges. Region selection selects multiple polygons within the region.



**Element** Selects all contiguous faces in an object. Region selection selects the same.

**By Vertex** Selects any sub-objects at the current level that use a vertex you click. Applies to all sub-object levels except Vertex. Also works with Region Select.

**Ignore Backfaces** Selects only those sub-objects whose normals make them visible in the viewport. When turned off (the default), selection includes all sub-objects, regardless of the direction of their normals.

---

**NOTE** The state of the Backface Cull setting in the Display panel doesn't affect sub-object selection. Thus, if Ignore Backfacing is turned off, you can select sub-objects even if you can't see them.

---

---

**NOTE** The state of the Ignore Backfaces check box also affects edge selection at the Edge sub-object selection level.

---

**Ignore Visible Edges** When turned off (the default), and you click a face, the selection won't go beyond the visible edges no matter what the setting of the Planar Thresh spinner. When turned on, face selection ignores the visible

edges, using the Planar Thresh setting as a guide. Enabled when the Polygon face selection method is chosen.

Generally, if you want to select a "facet" (a coplanar collection of faces), you set the Planar Threshold to 1.0. On the other hand, if you're trying to select a curved surface, increase the value depending on the amount of curvature.

**Planar Thresh (Planar Threshold)** Specifies the threshold value that determines which faces are coplanar for Polygon face selection.

### **Get from Other Levels group**

Applies selections from one sub-object level to another.

**Get Vertex Selection** Selects faces based on the last vertex selection. Selects all faces shared by any selected vertex. The selection is added to the current selection. Available only when Vertex is not the current sub-object level.

**Get Face Selection** Selects vertices based on the last face/polygon/element selection. This selection is added to the current selection. Available only when Face/Polygon/Element is not the current sub-object level.

**Get Edge Selection** Selects faces based on the last edge selection. Selects those faces that contain the edge. Available only when Edge is not the current sub-object level.

### **Select by Material ID group**

Selects faces based on their material ID.

**ID** Set the spinner to the ID number you want to select, and then click the Select button. Press Ctrl while clicking to add to the current selection, or press Alt to remove from the current selection.

### **Named Selection Sets group**

These functions are primarily for copying [named selection sets](#) on page 146 of sub-objects between similar objects, and between comparable modifiers and editable objects. For example, you can apply a mesh select modifier to a sphere, create a named selection set of edges, and then copy the selection to a different sphere that's been converted to an editable mesh object. You can even copy the selection set to a different type of object, because the selection is identified by the entities' ID numbers.

The standard procedure is to create a selection set, name it, and then use Copy to duplicate it into the copy buffer. Next, select a different object and/or

modifier, go to the same sub-object level as you were in when you copied the set, and click Paste.

---

**NOTE** Because sub-object ID numbers vary from object to object, the results of copying named selection sets between different objects can be unexpected. For example, if the buffered set contains only entities numbered higher than any that exist in the target object, no entities will be selected when the set is pasted.

---

**Copy** Places a named selection into the copy buffer.

**Paste** Pastes a named selection from the copy buffer.

**Select Open Edges** Selects all edges with only one face. In most objects, this will show you where missing faces exist. Available only at the Edge sub-object level.

### **Selection Information**

At the bottom of the Mesh Select Parameters rollout is a text display giving you information about the current selection. If 0 or more than one sub-object is selected, the text gives the number and type selected. If one sub-object is selected, the text gives the ID number and type of the selected item.

---

**NOTE** When the current sub-object type is Polygon or Element, selection information is given in faces.

---

### **Soft Selection rollout**

These controls let you set a gradual falloff of influence between selected and unselected vertices. See [Soft Selection Rollout \(Edit/Editable Mesh\)](#) on page 1926 .

## **MeshSmooth Modifier**

Modify panel > Make a selection. > Modifier List > Object-Space Modifiers > MeshSmooth

Make a selection. > Modifiers menu > Subdivision Surfaces > MeshSmooth

The MeshSmooth modifier smoothes geometry in your scene by means of several different methods. It lets you subdivide the geometry while interpolating the angles of new faces at corners and edges, and apply a single smoothing group to all faces in the object. The effect of MeshSmooth is to round over corners and edges as if they had been filed or planed smooth. Use

MeshSmooth parameters to control the size and number of new faces, and how they affect the surface of the object.

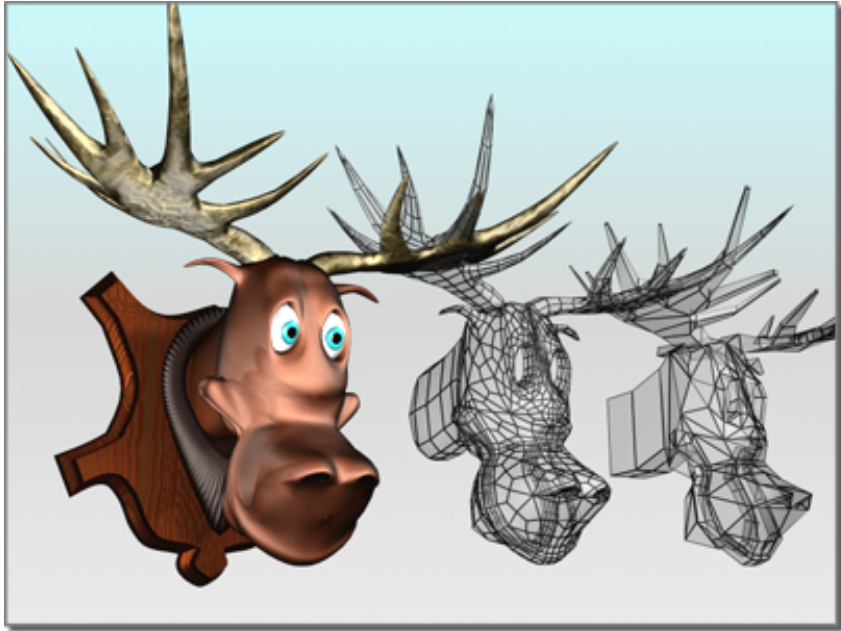

**Angular model (shown on the right) changed to a smooth model with MeshSmooth**

You can use MeshSmooth to produce a Non-Uniform Rational MeshSmooth object (NURMS for short). A NURMS object is similar to a NURBS object in that you can set different weights for each control vertex. You can further control the object's shape by changing edge weights.

MeshSmooth's effect is most dramatic on sharp corners and least visible on rounded surfaces. Use MeshSmooth on boxes and geometry with crisp angles. Avoid using it on spheres and similar objects.

---

**TIP** To better understand MeshSmooth, create a sphere and a cube and apply MeshSmooth to both. The cube's sharp corners become rounded, while the sphere's geometry becomes more complex without changing shape significantly.

---

**NOTE** Having an animated deformer placed before a meshsmoothed object that has had control level editing can result in the meshsmoothed object becoming distorted. It's recommended that deforming modifiers be placed after the MeshSmooth modifier in the stack if you're using the deformers for animation.

---

## Procedures

### To apply MeshSmooth to an object:

- 1 Select an angular object.
- 2 Apply the MeshSmooth modifier.
- 3 Set MeshSmooth parameters.

### To apply MeshSmooth to sub-objects:

- 1 Select an object.
- 2 Apply a Mesh Select modifier.
- 3 Select a group of vertices or faces.
- 4 Apply MeshSmooth.
- 5 In the Subdivision Method rollout, turn off Apply To Whole Mesh.  
This lets MeshSmooth work only on the sub-object selection.
- 6 Set MeshSmooth parameters.

## Interface

### Modifier Stack

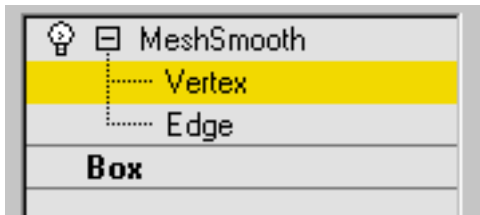

**Vertex** At this sub-object level you can transform or edit vertices in the smoothed mesh.

**Edge** At this sub-object level you can transform or edit face edges in the smoothed mesh.

See [Local Control rollout](#) on page 1466 .

For more information on the stack display, see [Modifier Stack](#) on page 7427 .



## Subdivision Method rollout

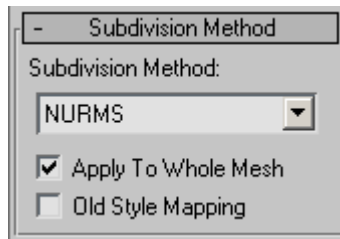

**Subdivision Method list** Choose one of the following to determine the output of the MeshSmooth operation:

- **NURMS** Produces Non-Uniform Rational MeshSmooth object (NURMS for short). The Strength and Relax smoothing parameters are unavailable with the NURMS type.  
A NURMS object is similar to a NURBS object in that you can set different weights for each control vertex. You can further control the object's shape by changing edge weights. See Display/Weighting group, following, for further information on changing weights.
- **Classic** Produces three- and four-sided facets. (This is the same as applying MeshSmooth in version 2.x without turning on Quad Output.)
- **Quad Output** Produces only four-sided facets (assuming you don't look at the hidden edges, since the object is still made up of triangular faces). If you apply this with default parameters to a whole object, like a box, it's topologically exactly the same as [Tessellate](#) on page 1743, edge-style. However, rather than using tension to project face and edge vertices out of the mesh, use the MeshSmooth Strength to relax the original vertices and the new edge vertices into the mesh.

**Apply To Whole Mesh** When turned on, any sub-object selection passed up the stack is ignored and MeshSmooth is applied to the entire object. Note that the sub-object selection is still passed up the stack to any subsequent modifiers.

**Old Style Mapping** Uses the 3ds Max version 3 algorithm to apply MeshSmooth to the mapping coordinates. This technique tends to distort the underlying mapping coordinates as it creates new faces and as texture coordinates shift.

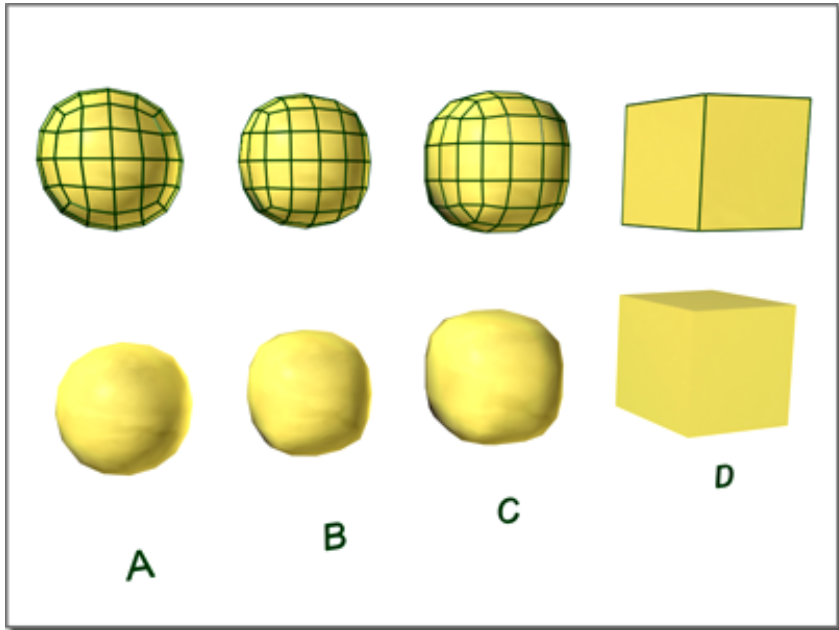

Effect of MeshSmooth with two iterations on a cube and different iteration method:

- A. NURMS
- B. Quad
- C. Classic
- D. Original object with no MeshSmooth

### Subdivision Amount rollout

Sets how many times to apply MeshSmooth.

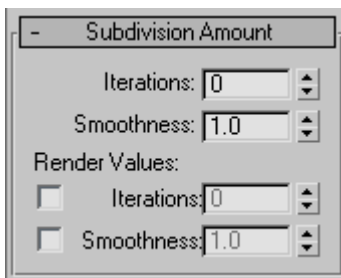

**Iterations** Sets the number of times the mesh is subdivided. When you increase this value, each new iteration subdivides the mesh by creating

smoothly interpolated vertices for every vertex, edge, and face from the iteration before. The modifier then subdivides the faces to use these new vertices. Default=0. Range=0 to 10.

The default value of 0 iterations allows you to modify any setting or parameter, such as the type of MeshSmooth or the update options, before the program starts subdividing the mesh.

---

**NOTE** Be cautious when increasing the number of iterations. The number of vertices and faces in an object (and thus the calculation time) can increase as much as four times for each iteration. Applying four iterations to even a moderately complex object can take a long time to calculate. You can press Esc to stop calculation; this also automatically sets Update Options to Manually. Reduce the Iterations value before setting Update Options back to Always.

---

**Smoothness** Determines how sharp a corner must be before faces are added to smooth it. Smoothness is calculated as the average angle of all edges connected to a vertex. A value of 0.0 prevents the creation of any faces. A value of 1.0 adds faces to all vertices even if they lie on a plane.

---

**TIP** To subdivide only sharp edges and corners, use a Smoothness value of less than 1.0. To see the subdivisions in Wireframe/Edged Faces viewports, turn off [Isoline Display](#) on page 1467 .

---

**Render Values** These let you apply a different number of smoothing iterations and a different Smoothness value to the object at render time. Typically you would use a low number of iterations and a lower Smoothness value for modeling, and higher values for rendering. This lets you work quickly with a low-resolution object in the viewports, while producing a smoother object for rendering.

**Iterations** Lets you choose a different number of [smoothing iterations](#) on page 1464 to be applied to the object at render time. Turn on Iterations, and then use the spinner to its right to set the number of iterations.

**Smoothness** Lets you choose a different Smoothness value to be applied to the object at render time. Turn on Smoothness, then use the spinner to its right to set the smoothness value.

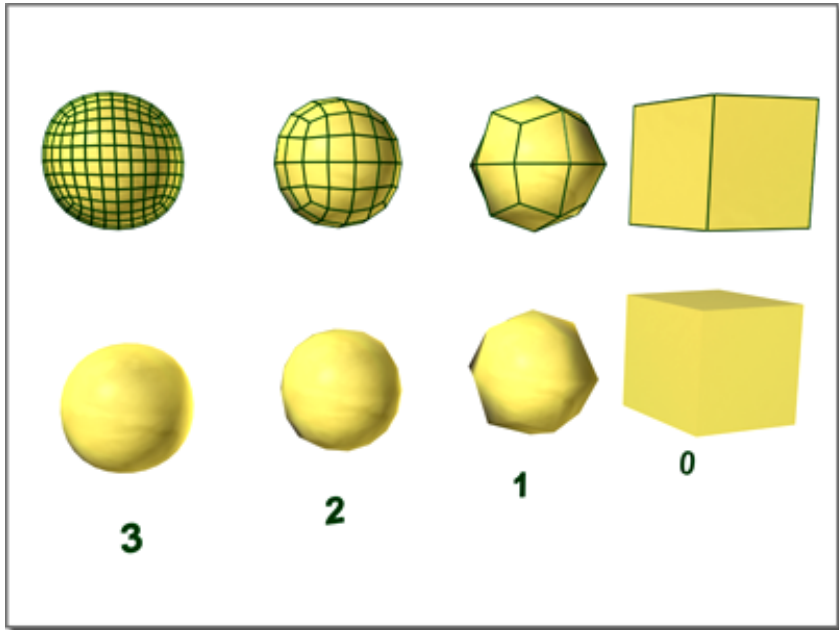

From right to left, effect of increasing the number of iterations

### Local Control rollout

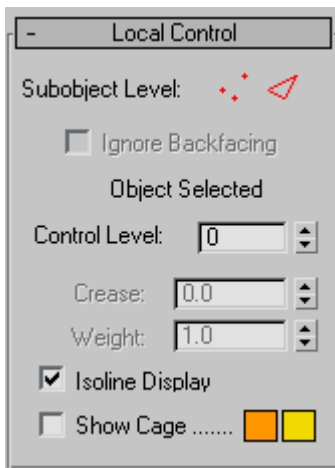

**Sub-object Level** Turns Edge or Vertex level on or off. When both levels are off, you're working at the object level. Information about the selected edges

or vertices is displayed in the message area under the Ignore Backfacing check box.

**Ignore Backfacing** When on, selection of sub-objects selects only those sub-objects whose normals make them visible in the viewport. When off (the default), selection includes all sub-objects, regardless of the direction of their normals.

**Control Level** Allows you to see the control mesh after one or more iterations and to edit sub-object points and edges at that level. Transform controls and the Weight setting are available for all sub-objects at all levels. The Crease setting is available only at the Edge sub-object level.

**Crease** Creates a discontinuity on a surface so you get a hard edge, such as a wrinkle or lip. You select one or more edge sub-objects and adjust the Crease setting; the crease appears in the surfaces associated with the selected edges. Available only at the Edge sub-object level.

**Weight** Sets the weight of selected vertices or edges. Increasing a vertex weight "pulls" the smoothed result toward that vertex. Edge weights are more complex and behave in an opposite manner in some respects. They aren't really "weights" as such, but "knot intervals," in NURBS terminology. Consequently, increasing an edge weight tends to push the smoothed result away. Kinks will form in the result if weights of 0 are used.

**Isoline Display** When on, the software displays only isolines: the object's original edges, before smoothing. The benefit of using this option is a less cluttered display. When off, the software displays all faces added by MeshSmooth; thus, higher Iterations settings (see [Subdivision Amount Rollout](#) on page 1464 ) result in a greater number of lines. Default=on.

**Show Cage** Toggles the display of a two-color wireframe that shows the modified object before subdivision. The cage colors are shown as swatches to the right of the check box. The first color represents unselected edges at the Vertex sub-object level, and the second color represents unselected edges at the Edge sub-object level. Change a color by clicking its swatch.

### **Soft Selection rollout**

Soft Selection controls affect the action of sub-object Move, Rotate, and Scale functions. When these are on, 3ds Max applies a spline curve deformation to unselected vertices surrounding the transformed selected sub-object. This provides a magnet-like effect with a sphere of influence around the transformation.

For more information, see [Soft Selection Rollout](#) on page 1926 .

## Parameters rollout

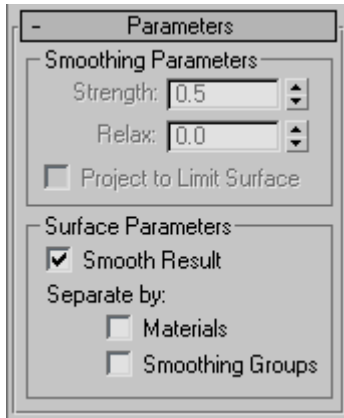

### Parameters rollout > Smoothing Parameters group

These settings are available only when MeshSmooth Type is set to Classic or Quad Output. Also, Project To Limit Surface is available only in Classic mode.

**Strength** Sets the size of the added faces using a range from 0.0 to 1.0.

- Values near 0.0 create small faces that are very thin and close to the original vertices and edges.
- Values near 0.5 size faces evenly between edges.
- Values near 1.0 create large new faces and make the original faces very small.

**Relax** Applies a positive relax effect to smooth all vertices.

**Project to Limit Surface** Places all points on the "limit surface" of the MeshSmooth result, which is the surface that would be produced after an infinite number of iterations. The topology is still controlled by the number of iterations.

### Parameters rollout > Surface Parameters group

Applies smoothing groups to the object and restrict the MeshSmooth effect by surface properties.

**Smooth Result** Applies the same smoothing group to all faces.

**Separate by Materials** Prevents the creation of new faces for edges between faces that do not share Material IDs.

**Separate by Smoothing Groups** Prevents the creation of new faces at edges between faces that don't share at least one smoothing group.

### Settings rollout

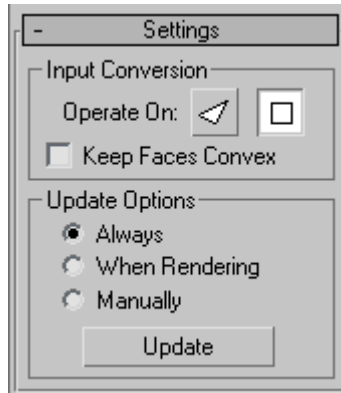

### Settings rollout > Input Conversion group

**Operate On Faces/Polygons** Operate On Faces treats every triangle as a face and smoothes across all edges, even invisible edges. Operate On Polygons ignores invisible edges, treating polygons (like the quads making up a box or the cap on a cylinder) as a single face.

**Keep Faces Convex** (Available only with Operate On Polygons mode.) Keeps all input polygons convex. Selecting this option causes non-convex polygons to be handled as a minimum number of separate faces, each of which is convex. (Turn on Display/Weighting group > Display Control Mesh to see what's happening here.)

"Convex" means that you can connect any two points in the polygon with a line that doesn't go outside the polygon. Most letters aren't convex. In the capital letter "T," for example, you can't connect the upper-left corner to the bottom with a straight line without going outside the shape. Circles, rectangles, and regular polygons are all convex.

Problems that can occur with non-convex faces include the fact that changes in the geometry of the input object can result in a different topology for the MeshSmooth result. For instance, in a box, if you drag one of the top corners across the middle of the top face, the box becomes non-convex. MeshSmooth

would then see this as two triangles instead of one quad, and the number of points in the result would change.

If you need to make sure your output topology is stable, turn this off. If you have a lot of letters or other non-convex faces in your mesh, however, you'll probably want it on.

### **Settings rollout > Update Options group**

Sets manual or render-time update options, for situations where the complexity of the smoothed object is too high for automatic updates. Note that you can also set a greater degree of smoothing to be applied only at render time, on the Subdivision Amount rollout.

**Always** Updates the object automatically whenever you change any MeshSmooth settings.

**When Rendering** Updates the viewport display of the object only at render time.

**Manually** Turns on manual updating. When manual updating is selected, any settings you change don't take effect until you click the Update button.

**Update** Updates the object in the viewport to match the current MeshSmooth settings. Works only when you choose When Rendering or Manually.

### **Resets rollout**

This rollout allows you to go back to default or initial settings on any changes you made such as sub-object transforms (geometric edits), and changes to edge creases, vertex weights, and edge weights.

You can reset changes for all control levels or to the current control level. Turn on the reset option for the sub-object level you want, and then click the appropriate button.



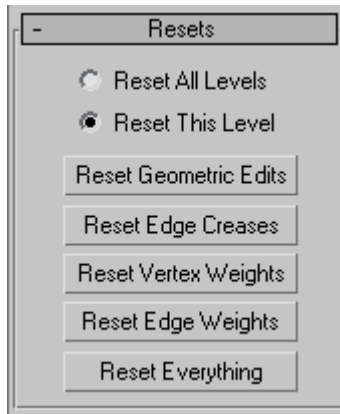

**Reset All Levels** Returns to the default or initial settings for geometric edits, creases, and weights for all sub-object levels.

**Reset This Level** Returns to the default or initial settings for geometric edits, creases, and weights for the current sub-object level.

**Reset Geometric Edits** Returns to the default or initial settings for any transforms made to vertices or edges.

**Reset Edge Creases** Returns to the default or initial setting for edge creases.

**Reset Vertex Weights** Returns to the default or initial setting for vertex weights.

**Reset Edge Weights** Returns to the default or initial setting for edge weights.

**Reset Everything** Returns to the default or initial setting for everything.

## Mirror Modifier

Modify panel > Make a selection. > Modifier List > Object-Space Modifiers > Mirror

Make a selection. > Modifiers menu > Parametric Deformers > Mirror

The Mirror modifier provides a parametric method of mirroring an object or a sub-object selection. You can apply the Mirror modifier to any type of geometry, and you can animate the mirror effect by animating the modifier's gizmo.

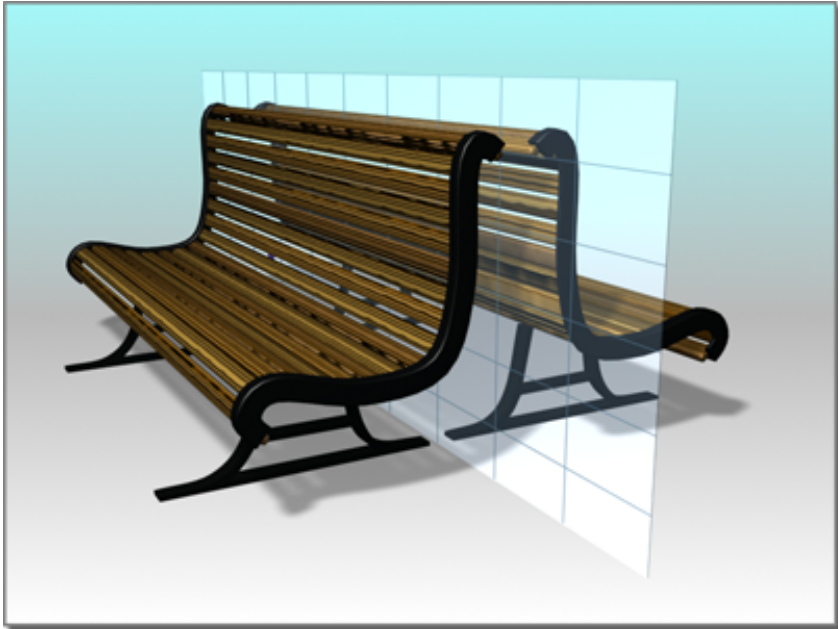

### Mirroring a bench

### Procedures

To apply the Mirror modifier:

- 1 Apply the Mirror modifier to a selection.
- 2 Set the axis or axis pair on which to mirror the object.
- 3 To create a mirrored pair, specify an Offset amount and turn on Copy.

### Interface

### Modifier Stack

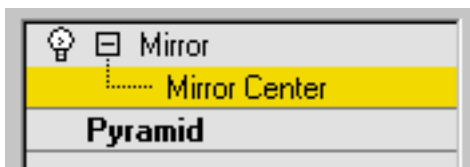

**Mirror Center** Represents the axis of the mirror effect. You can move, rotate or scale the gizmo to affect the mirroring. You can animate the gizmo transforms, which you can't do with the toolbar [Mirror](#) on page 911 tool.

For more information on the stack display, see [Modifier Stack](#) on page 7427 .

### Parameters rollout

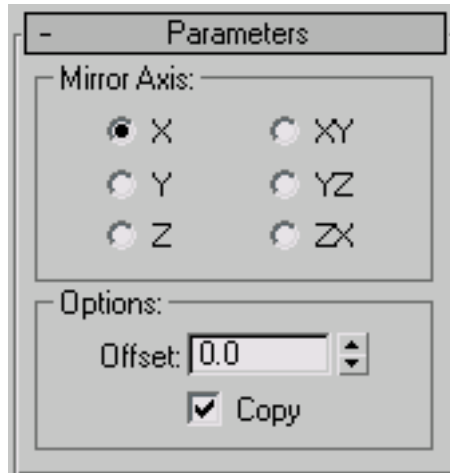

#### Mirror Axis group

**X, Y, Z, XY, YZ, ZX** Specify the axis or axes about which the mirroring takes place. You can usually see the effect in the viewport as you select the option.

#### Options group

**Offset** Specifies the offset, in units, from the mirror axis. This is an animatable parameter.

**Copy** Copies the geometry rather than simply mirroring it.

---

**NOTE** The Copy option affects only geometry with triangular meshes.

---

## Morpher Modifier

Select a mesh, patch, or NURBS object. > Modify panel > Modifier List > Morpher

Select a mesh, patch, or NURBS object. > Modifiers menu > Animation Modifiers > Morpher



**On this patch model, morph targets are created by moving control vertices and tangent handles in an Editable Patch.**

Use the Morpher modifier to change the shape of a mesh, patch, or NURBS model. You can also morph shapes (splines), and World Space FFDs. As well as morphing from one shape to another, the Morpher modifier also supports material morphing.

Morphing is commonly used for lip sync and facial expression on a 3D character, but can be used to change the shape of any 3D model. There are 100 channels available for morph targets and materials. Channel percentages can be mixed, and the result of the mix can be used to create a new target.

On a mesh object, vertex count on the base object and targets must be the same. On a patch or NURBS object, the Morpher modifier works on control

points only. This means that the resolution of patches or NURBS surfaces can be increased on the base object to increase detail at render time.

A Flex modifier above the Morpher modifier is aware of vertex/control point motion in the Morpher modifier. If, for example, a jaw is morphed to slam shut, then the Flex modifier placed above the Morpher modifier in the modifier stack can be used to make the lips quiver to simulate soft tissue.

**See also:**

- [Morpher Material](#) on page 5554

## **Lip Sync and Facial Animation**

For lip sync and facial animation, create a character's head in an "at rest" pose. The head can be a mesh, patch, or NURBS model. Copy and modify the original head to create the lip-sync and facial-expression targets. Select the original or "at rest" head and apply the Morpher modifier. Assign each lip-sync and facial-expression target to a channel in the Morpher modifier. Load an audio file in the Track View sound track, turn on the Auto Key button, scrub the time slider, and view the audio waveform in Track View to locate frames for lip sync. Then set the channel spinners on the Morpher modifier to create key frames for lip position and facial expression.

Teeth can either be a part of the model or animated separately. If the teeth and head are two different objects, model the teeth in an open position, and then apply the Morpher modifier, and create one target with the teeth closed. Eyes and head motion can be animated after the morph keys are created.

## **Morph Targets for Speech**

Nine mouth shape targets are commonly used for speech. If your character speaks an alien dialect, don't hesitate to create extra morph targets to cover these mouth shapes.

Include cheek, nostril, and chin-jaw movement when creating mouth position targets. Examine your own face in a mirror or put a finger on your face while mouthing the phonemes, if necessary, to establish the direction and extent of cheek motion.

Set lip-sync keys by viewing the audio waveform as well as listening to the sound as you scrub the time slider. Many mouth-position keys benefit from being set a frame early. Often the mouth must assume a shape before the appropriate sound is uttered. For the word "kilo", the "K" mouth shape precedes the actual sound, for example.



A, I



E



F, V



C, D, G, J, K, N, S, T, Y, Z



L, T



O



U



W,Q



M,B,P (This target can be the same shape as the "at rest" base object)

### **Morph Targets for Expression**

Create as many expression targets as necessary for the character. Joy, sadness, surprise, evil can all have their own targets. Depending on the personality of the character, certain targets, like a terror target, may not be necessary. Targets like nostril flare, jaw-muscle bunching, temple twitching can be effective to



give a character an edge. Each morph channel can contain a material as well: as you morph the brows up, a bump map can crease the forehead, for example.

Save time and create targets as the need arises; if the audio file or scene you are working on requires a look of surprise, create the "surprise" target while the mood of the scene is with you.

If the character has teeth, copy the teeth and the base head to create a new target. The teeth act as a guide to shape and position the lips.



**Blink**









**Brows up**





A blend of the Pain, Blink, and Brows targets

## Procedures

**Example:** To add the morpher modifier to an object and assign a morph target to a channel:

-   On the Create panel, click Geometry.
- On the drop-down list, choose Patch Grids.
- On the Object Type rollout, click Quad Patch.
- In the Top viewport, click and drag to create a patch grid.
-  On the Modify panel, on the modifier stack display, right-click Quad Patch and choose Convert To: Editable Patch from the right-click menu.  
The base object is now an Editable Patch.
-  In the Top viewport, use Shift+Move to create a copy of the patch object.
-   On the Modify panel, on the Selection rollout, click Vertex.
-  In the Front viewport, move patch vertices to deform the patch surface.

- 9  In the stack display, choose Editable Patch to go to the object (top) level. (The highlight should change from yellow to gray, and the Vertex sub-object icon is no longer displayed at the right of the stack.)
- 10  Select the first patch object.
- 11  On the Modify panel, choose Morpher from the Modifier List. The Morpher modifier is added to the modifier stack.
- 12 On the Morpher modifier, on the Channel List rollout, right-click the first channel (over the word "empty"). A right-click menu displays.
- 13 Choose Pick from Scene on the right-click menu, and click the deformed patch grid in the viewports. QuadPatch02 is listed in the channel as a morph target.
- 14 Drag the Channel spinner, to the right of QuadPatch02, up and down. The flat patch grid "morphs" to the shape of the target.

**To use progressive morphing:**

- 1 Create starting and ending morph targets, and one or more intermediate targets.
- 2 Apply the Morpher modifier to the starting morph target, and click Load Multiple Targets to load the starting and ending morph targets.
- 3 In the Channel List rollout, select the channel you want to be influenced by an intermediate target.
- 4 In the Channel Parameters rollout, click Pick Object from Scene, and select the intermediate target.
- 5 In the Progressive Morph group Target List, set the Target % to determine the degree to which each target affects the channel.
- 6 Use the down arrow button to move the original channel target to the bottom of the Target List.

## Interface

Whatever is assigned as the default float controller in the software will be assigned as the float controller on the morph channels as well. Float controllers handle the interpolation between keys; Bezier is the default float controller. You can assign the TCB float controller to the morph channels in Track View, if you prefer.

For morphing, the Bezier controller allows you to use function curves with vector handles on the keys for smoothing and easing control of interpolation in Track View. Default parameters of the TCB controller, however, handles morph interpolation with less overshoot. Try using both controllers, to decide which one you prefer.

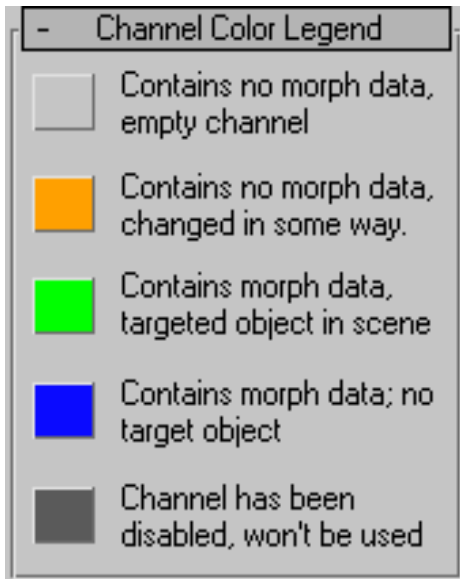

**Gray** The channel is empty, and has not been edited.

**Orange** The channel has been changed in some way but contains no morph data.

An artist may wish to name a channel and set up its parameters before actually assigning a morph target.

**Green** The channel is live. The channel contains morph data and the target object still exists in scene (the target is available for refresh).

**Blue** The channel contains morph data but the target has been deleted from the scene.

**Dark Gray** The channel is disabled.

- There is a problem with the morph, the topology of the base object, or targets, have changed and are no longer valid; for example, the vertex count might have changed. The channel cannot be used.
- The channel is not active. This is controlled by the Channel is Active toggle in the Channel Parameters rollout.
- Disabled channels are not included in the morph result.

### Global Parameters rollout

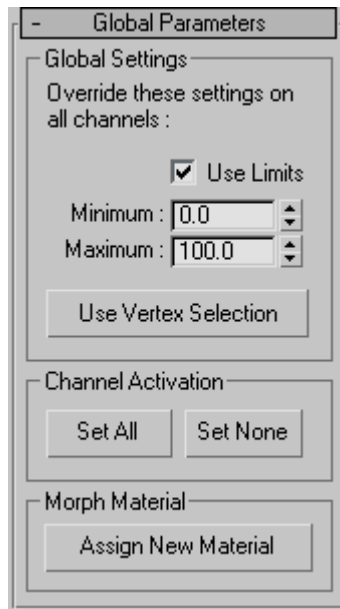

### Global Settings group

**Use Limits** Use the minimum and maximum limits for all channels.

You can turn off limits to double purpose a target. The target for a smile can be used to turn the corners of the mouth down using negative values for example.

**Minimum** Sets the minimum limit.

**Maximum** Sets the maximum limit.

**Use Vertex Selection** Turn on to limit morphing to vertices selected in a modifier below the Morpher modifier in the modifier stack.

If you are using Character Studio Physique, limit morph animation on the base object to just the head and exclude the neck, for example. Place the Physique modifier above the Morpher modifier and assign the head vertices as rigid (green) in the Physique modifier.

### **Channel Activation group**

**Set All** Click to activate all channels.

**Set None** Click to deactivate all channels.

### **Morph Material group**

**Assign New Material** Click to assign the Morpher material to the base object (the object to which the Morpher modifier is applied).

Open the Material Editor to view and edit the Morpher material. There is a direct correlation between the Channel Material Maps and the Channel list in the Morpher modifier (100 channels and 100 maps). For example, if channel 1 contains a brows up target and the Morpher material has a material assigned to map 1, then, as the brows are morphed so is the material.

In the Morpher material, if a material is assigned to a map or channel that has no morph target in the Morpher modifier, then the channel spinner in the Morpher modifier can be used to simply morph the material on a static object. See [Morpher Material](#) on page 5554 .

## Channel List rollout

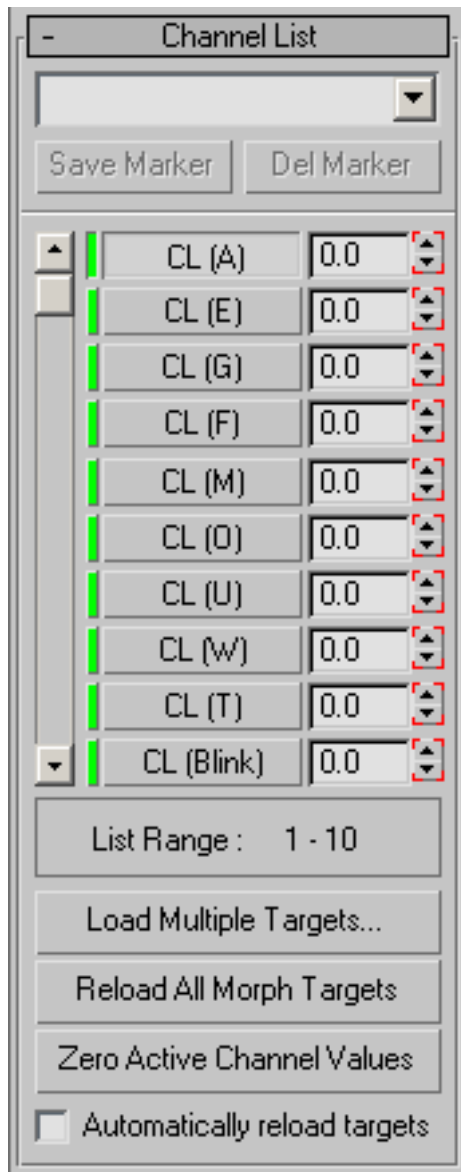

The upper section of the Channel List rollout contains controls for managing markers, which designate different locations in the list of morph targets. For

example, channels 15 through 24 might contain all the emotion targets. Rather than scrolling to display these tracks, you can choose a marker from the list to display those channels.

**[marker drop-down list]** Choose a previously saved marker in the list, or enter a new name in the text field and click Save Marker to create a new marker.

For example, channel 15 through 24 might contain all the emotion targets. Rather than scrolling to display these tracks, you can choose a marker from the list to display these channels in the list.

**Save Marker** Move the scroll bar to frame a particular set of 10 channels, enter a name in the text field, and then click Save Marker to store the channel selection.

**Delete Marker** Choose a marker name to delete from the drop-down list, and then click Delete Marker to delete it.

**Channel List** The Morpher modifier provides up to 100 morph channels. Scroll through the channels using the slider. Once you've assigned a morph target to a channel, the target's name appears in the channel list. Each channel has a percentage value field and a spinner to change the value.

You can change channel names and order in the [Channel Parameters](#) on page 1487 rollout.

Right-click a morph channel to display a right-click menu:

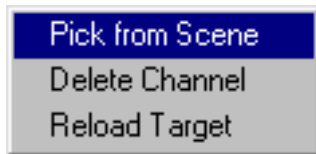

**Pick from Scene** Choose this command and select an object in the viewports to assign a morph target to the channel.

**Delete Channel** Deletes the morph data, name and parameters from the channel. Displays only if the channel has data.

**Reload Target** Retrieves morph data from the target. Use this after editing a target.





**List Range** Displays the range of visible channels in the channel list.

**Load Multiple Targets** Load multiple morph targets into empty channels by selecting object names in the selection dialog and clicking Load.

If there are more targets than empty channels, a warning displays and the channels are not assigned.

**Reload All Morph Targets** Reloads all the morph targets.

If the targets have been edited, the channels are updated to reflect the changes. If a morph target has been deleted from the scene, then the morpher updates using the stored data in the channel, functions using the last stored morph data.

**Zero Active Channel Values** Click to create keys with a value of 0 for all active morph channels, if the Auto Key is on.

This is handy to prevent key interpolation from distorting the model. First click Zero Active Channel Values, and then set a particular channel to the value you want; only the altered channel affect the model.

**Automatically reload targets** Turn this on to allow animated targets to be updated dynamically by the Morph modifier. There is a performance penalty when using this option.

### **Channel Parameters rollout**

The channel number button and channel name field at the top of this rollout reflect the current active channel in the channel list.

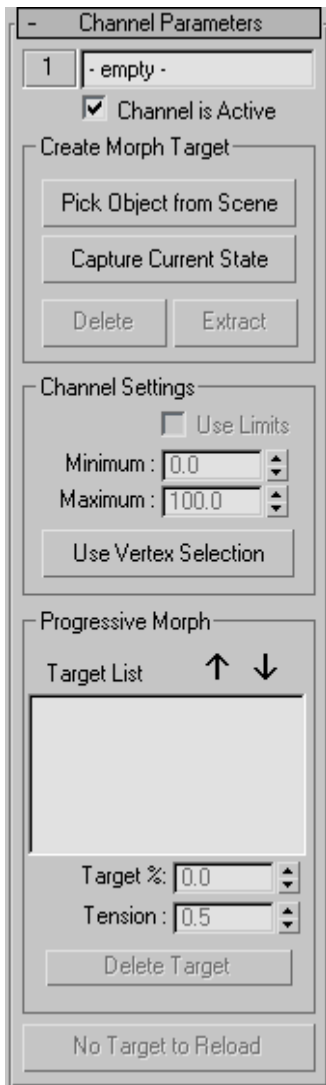

**[channel number]** Click the number next to the channel name to display a menu. Use commands on the menu to group and organize channels, or to locate a channel.

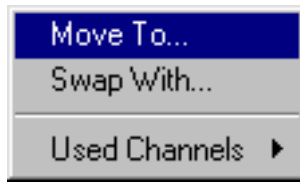

**Move To** Displays the Channel Operations dialog. To move the current channel to the selected channel, choose a channel from the list, and click Move To.

**Swap With** Displays the Channel Operations dialog. To swap the current channel with the selected channel, choose a channel from the list, and click Swap With.

**Used Channels** Displays a list of active channels. Choose a channel to place it at the top of the channel list display in the Channel List rollout.

**Channel Name** Displays the name of the current target. Change the name of the target in the text field if necessary. Parameter changes in the Channel Parameters rollout affect the current target.

**Channel is Active** Toggles a channel on and off. Inactive channels do not affect the morph result. Use this control to turn off certain channels to focus on animating other channels.

### **Create Morph Target group**

**Pick Object from Scene** Turn on and click an object in the viewports to assign a morph target to the current channel. Picking an object adds it to the Progressive Morph list.

**Capture Current State** Choose an empty channel to activate this function. Click to create a target using the current channel values.

The captured channel is always blue because there is morph data but no specific geometry. Use Extract to create a mesh copy of the captured state.

**Delete** Deletes the target assignment for the current channel.

**Extract** Choose a blue channel and click this option to create an object from the morph data.

If you have used Capture Current State to take a snapshot of a group of channel values, but then want to edit it, use Extract to make a new object, pick it as the channel's target, and then start editing.

## Channel Settings group

**Use Limits** Turn on to use limits on the current channel if Use Limits is turned off in the Global Parameters rollout.

**Minimum** Sets the lower limit.

**Maximum** Sets the upper limit.

**Use Vertex Selection** Morphs only selected vertices on the current channel.

## Progressive Morph group

Progressive morphing performs a tension-based interpolation, similar to the TCB animation controller, that creates smooth interpolation through each intermediary targets. This provides the artist with an unprecedented amount of control over the morph transformation.

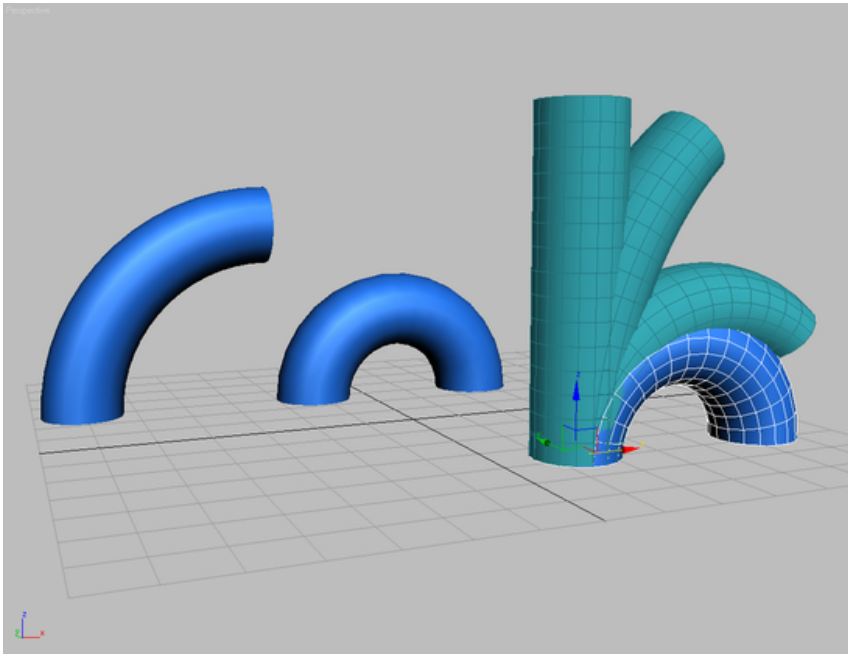

Morphed object using multiple, intermediary targets

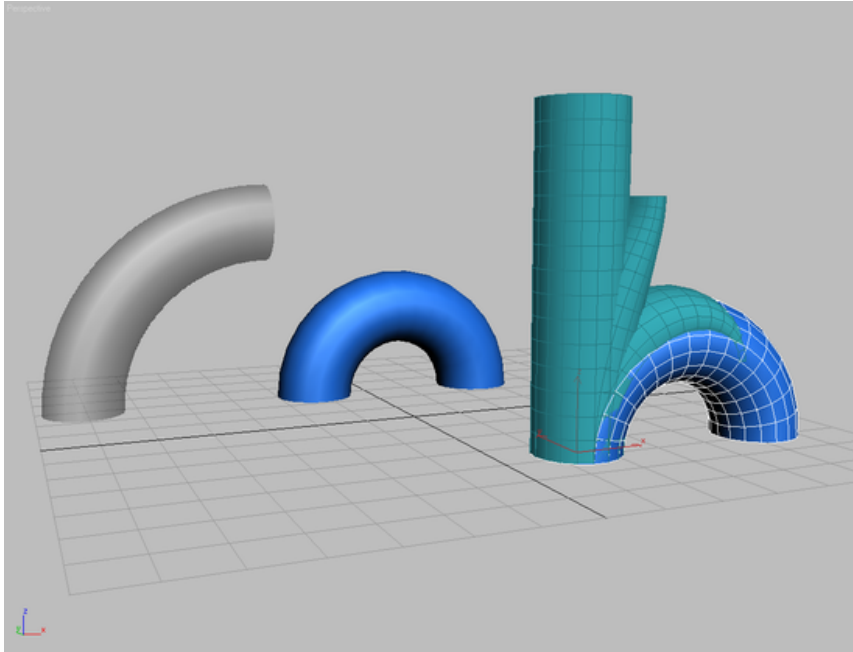

#### **Morphed object using a single target**

When morphing from one target to another, the object can sometimes pass through intermediary stages that are not desirable. For example, morphing a straight cylinder directly to a bent cylinder causes the cylinder to squash at intermediate stages.

You could get a better result by creating several intermediate morph targets for the object, and using them as channels. However, an easier solution is to create fewer intermediate targets, and use progressive morphing. With progressive morphing, you do not use the intermediate targets as channels; you use them to influence the end targets.

**Target List** Lists all intermediary morph targets associated with the current channel. To add morph targets to the list, click Pick Object from Scene.

**Move Up** Moves the selected intermediary morph target up in the list.

**Move Down** Moves the selected intermediary morph target down in the list.

---

**TIP** For best results, move the original morph target (the one in the channel) to the bottom of the list.

---

**Target %** Specifies how much the selected intermediate morph target contributes to the overall morph solution.

**Tension** Specifies the overall linearity of the vertex transformation between intermediary morph targets. A value of *1.0* creates a “loose” transition, causing the interpolation to overshoot each target slightly. A value of *0.0* creates a direct, linear transformation between each intermediary target.

**Delete Target** Deletes the selected intermediary morph target from the target list.

**Reload Morph Target** Reloads data from the current target into the channel. Reload a target if it has been adjusted or edited.

If the active morph target entry in the channel list is empty, this button is unavailable, and displays the text “No Target to Reload.”

### Advanced Parameters rollout

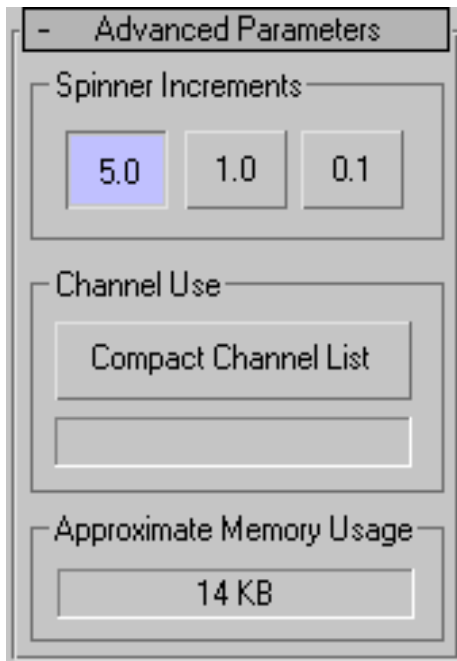

**Spinner Increments** Specify fine or coarse spinner increments. 5.0 is coarse and 0.1 is fine. Default=1.0

**Compact Channel List** Compact the channel list by filling in any empty channels in between assigned channels. The status window displays how many channels were moved.

**Approximate Memory Usage** Displays an approximation of the current memory usage.

## MultiRes Modifier

Select an object. > Modify panel > Modifiers List > Object-Space Modifiers > MultiRes

Make a selection. > Modifiers menu > Mesh Editing > MultiRes

The MultiRes modifier reduces the memory overhead needed to render models by decreasing the number of vertices and polygons. This is useful not only within 3ds Max but for game and Web content creators who export models for use outside of the program. MultiRes offers several advantages over the Optimize modifier, including faster operation and the ability to specify reduction as an exact percentage or vertex count.

---

### NOTE

The MultiRes modifier supports the preservation of map channels when face count is increased or reduced.

---

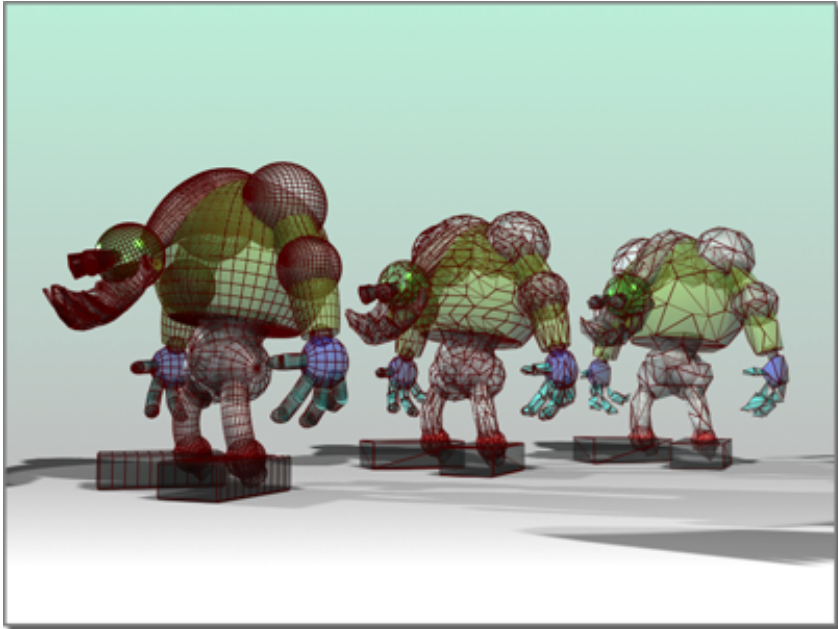

Left: Original model

Center and right: Model progressively simplified by the MultiRes modifier

### Modeling Tips for MultiRes

The MultiRes multi-resolution mesh algorithms are designed to be general-purpose, and yield high-quality meshes on a wide variety of model types. However, careful modeling can improve the results of the algorithm. The following are suggestions to yield high-quality multi-resolution meshes:

- Avoid using complex model hierarchies with MultiRes. For such models you should generate an individual multi-resolution mesh for each model component, or collapse the entire model into a single mesh. In general, single-skin meshes work best with animation engines like Physique in **character studio**. MultiRes works especially well with single-skin meshes.
- Avoid duplicating vertices. The presence of extra vertices is an often-overlooked artifact of some modeling techniques. The Weld function in the [Edit Mesh modifier](#) on page 1283 and [Editable Poly](#) on page 2038 is useful for cleaning these up.
- Be conservative with texture and normal discontinuities. For example, an artist might associate multiple texture coordinates with a single vertex.



MultiRes will seek to preserve this discontinuity and the border between the two texture mappings, but it might do so at the expense of model shape.

- Create high-resolution models. High-resolution models provide MultiRes with more faces and vertices that describe the shape of the model. The more initial information MultiRes has about the shape of the model, the better the decisions it makes in generating a final multi-resolution mesh.

## Procedures

### To use the MultiRes modifier:

- 1 Select a model and apply the MultiRes modifier.
- 2 In the Generation Parameters group in the MultiRes Parameters rollout, click the Generate button to initialize the modifier.
- 3 In the Resolution group, use the keyboard or spinner controls to decrease the Vert Percent or Vert Count value.  
As the vertex and polygon counts decrease, the mesh updates in real time in the viewports.

### To maintain part of a mesh at full resolution while reducing the rest:

- 1 Select a model and apply the MultiRes modifier.
- 2 In the modifier stack display, click the + icon next to the MultiRes modifier to open the sub-object hierarchy.
- 3 Click the Vertex label to access the Vertex sub-object level.
- 4 Select the vertices in areas whose resolution you want to maintain.
- 5 In the Generation Parameters group, turn on Maintain Base Vertices.
- 6 Click the Generate button to initialize or re-initialize the mesh.  
Notice that the selected vertices look like asterisks instead of standard ticks.
- 7 Reduce the resolution as in the first procedure.  
The selected vertices are the last to be removed during vertex reduction.

---

**NOTE** You can change the base vertices at any time by selecting a different group of vertices and regenerating the mesh.

---

### To merge vertices:

If there are gaps between vertices that you want to close as vertex resolution decreases, use the Vertex Merging feature of the MultiRes modifier. With vertex merging, vertices within a given threshold distance eventually collapse during vertex reduction.

You can estimate the gap length by activating the [Select Object tool](#) on page 132, moving the mouse cursor over the extents of the gap in the active viewport (it might help to access the Vertex sub-object level), and comparing the values displayed in the X/Y/Z readouts in the status bar, or use the [Tape helper](#) on page 2546 object to get an exact measurement. Enter the estimated gap length value in the Threshold field.

- 1 Select a model and apply the MultiRes modifier.
- 2 Turn on Vertex Merging. This makes the Merge Threshold and Within Mesh controls available.
- 3 Set the appropriate parameters:
  - To define the maximum distance over which vertices are merged, enter a value in Merge Threshold.
  - To merge boundaries of adjacent elements and vertices within elements, turn on Within Mesh.
- 4 Click the Generate button.

The effect of the change is displayed in the object.

After the Generate button is clicked, a busy cursor will display. If the merge threshold is too large relative to the dimensions of the model, the busy cursor may display for a long time. To cancel the generation process at any time, press the Esc key.

## Interface

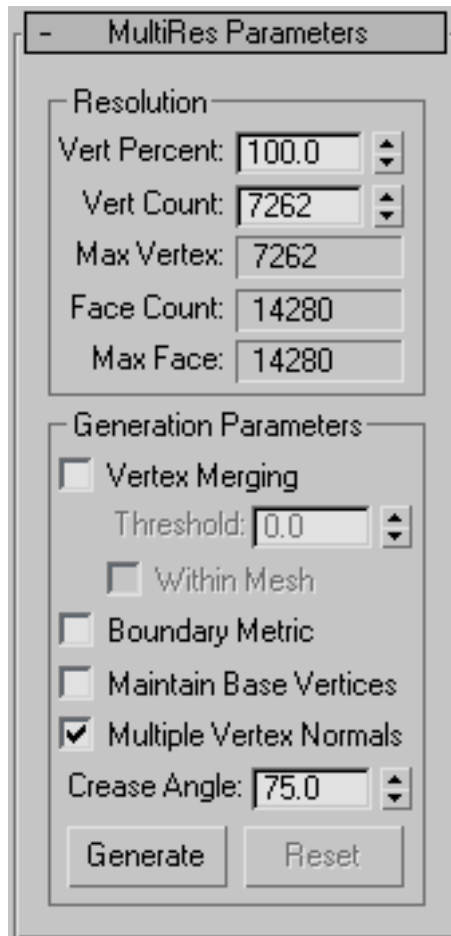

### Resolution group

Use these controls to change the vertex count and overall topology of the modified object.

**Vert Percent** The modified object's vertex count as a percentage of the overall number of vertices in the original mesh. Adjusting this setting alters the Vert Count value as well.

---

**NOTE** After you enter a specific percentage, such as 30, you might find that the software changes the value to a slightly lower one, such as 29.971. This is due to the relationship between the overall number of vertices in the model and the percentage calculation. It is not a bug, but simply the closest solution to your request.

---

**Vert Count** The total number of vertices in the modified object. Use this control to set the maximum number of vertices in the output mesh. Adjusting this setting alters the Vert Percent value as well.

**Max Vertex** Displays the vertex count from the original mesh that you applied MultiRes to. You cannot enter values larger than this in the Vert Count field.

**Face Count** Displays the current face count. As you adjust the *Vert Percent/Vert Count* settings, the value for the face count will update on the fly.

**Max Face** Displays the maximum face count.

### **Generation Parameters group**

**Vertex Merging** When on, lets MultiRes merge vertices between discrete [elements](#) on page 7766 in a model.

For example, if you apply MultiRes to a teapot, which comprises four separate elements, and turn on Vertex Merging, as you adjust the vertex resolution, the separate components will meld together into one contiguous lower-resolution object.

To control Vertex Merging, you can set a Merge Threshold. This value determines the unit distance within which vertices will merge at a higher rate.

**Threshold** Sets the maximum distance in 3ds Max units between vertices in order for those vertices to be considered for merging. Within this distance, the vertices between elements are welded together at a higher rate as the mesh is reduced in complexity. Available only when Vertex Merging is on.

---

**NOTE** To eliminate only coincident vertices, set Threshold to 0.0. This is similar to the Weld Vertex function.

---

**Within Mesh** When on, MultiRes merges the boundaries of adjacent elements and vertices within elements. Many objects can contain multiple groups of vertices that don't share connectivity. A simple example of this is the [Teapot object](#) on page 377. It comprises four different elements: the body, the handle, the spout, and the lid. Normally, MultiRes optimizes each discrete element in a mesh on its own.

The default behavior of the Vertex Merging option is to merge vertices between elements. Turning on Within Mesh causes vertices within elements to be merged as well.

**Boundary Metric** When on, MultiRes preserves materials assigned to the selected model. The material boundaries defined by Material IDs are retained as long as possible, and are the last to be eliminated at low vertex counts. Default=off.

**Maintain Base Vertices** When on, overrides the MultiRes optimization algorithms and preserves any vertices selected at the MultiRes Vertex sub-object level as "critical" ones. Use this feature to retain critical features of an object or character such as its fingers or claws, or other geometry that might become unrecognizable if reduced too severely.

To select vertices for use with this option, use the MultiRes Vertex sub-object level. To access this level, first go to the modifier stack display and click the plus-sign icon next to the MultiRes modifier. This opens its hierarchy, which consists of the single Vertex sub-object level. Next, click the Vertex entry. The MultiRes vertices appear on the mesh as blue dots. You can select these using any standard interactive method, but you cannot transform them.

---

**IMPORTANT** After selecting MultiRes sub-object vertices with Maintain Base Vertices turned on, regenerate the mesh before changing the vertex resolution.

---

In the following illustration, the clown started out as a high-resolution mesh. All of the MultiRes vertices in the right half were selected, Maintain Base Vertices was turned on, and then the vertices were reduced.



**Clown model with left half reduced, right half at original resolution**

**Multiple Vertex Normals** When on, lets MultiRes assign multiple normals for each vertex. By default, MultiRes generates a single normal per vertex.

If multiple normals are generated, they are applied as the vertex resolution is decreased and increased.

When the Multiple Vertex Normals option is on, the MultiRes modifier generates normal updates when the geometry surrounding a vertex changes.

You must specify a *crease angle* in degrees (0.0 - 180.0). The crease angle is the angle between the face normals. It is used to decide when a normal should be shared across an edge between two faces.

For example, in a plane defined as a mesh grid of 10 x 10 faces, any two adjacent faces have a crease angle of zero. In a cube, adjacent faces have a crease angle of 90 degrees. In general, crease angles approaching 0 yield smoother shading. Crease angles approaching 180 yield more visible corners.

**Crease Angle** The value of the crease necessary in order to generate multiple normals. Available only when Multiple Normals Per Vertex is on.

The optimal crease angle depends on the model; set it interactively and check the viewport and rendered images for shading effects. While use of Multiple Vertex Normals enables more accurate shading, it can require more internal data.

**Generate** Applies the current MultiRes settings to the modified object. When you first apply MultiRes to an object, you must use Generate to initialize the mesh-optimizing algorithm before you can change the vertex count.

**Reset** Sets all Generation Parameters rollout settings to their values as of the last time you used Generate. Available only when one or more of these settings has changed.

Use Reset to review the generation parameters as of the last time you generated the mesh.

## Noise Modifier

Modify panel > Make a selection. > Modifier List > Object-Space Modifiers > Noise

Make a selection. > Modifiers menu > Parametric Deformers > Noise

The Noise modifier modulates the position of an object's vertices along any combination of three axes. This important animation tool simulates random variations in an object's shape.

Using a fractal setting, you can achieve random, rippling patterns, like a flag in the wind. With fractal settings, you can also create mountainous terrain from flat geometry.

You can apply the Noise modifier to any kind of object. The Noise gizmo changes shape to help you visualize the effects of changing parameter settings. The results of the Noise modifier are most noticeable on objects that have greater numbers of faces.

Most of the Noise parameters have an animation controller. The only keys set by default are for Phase.

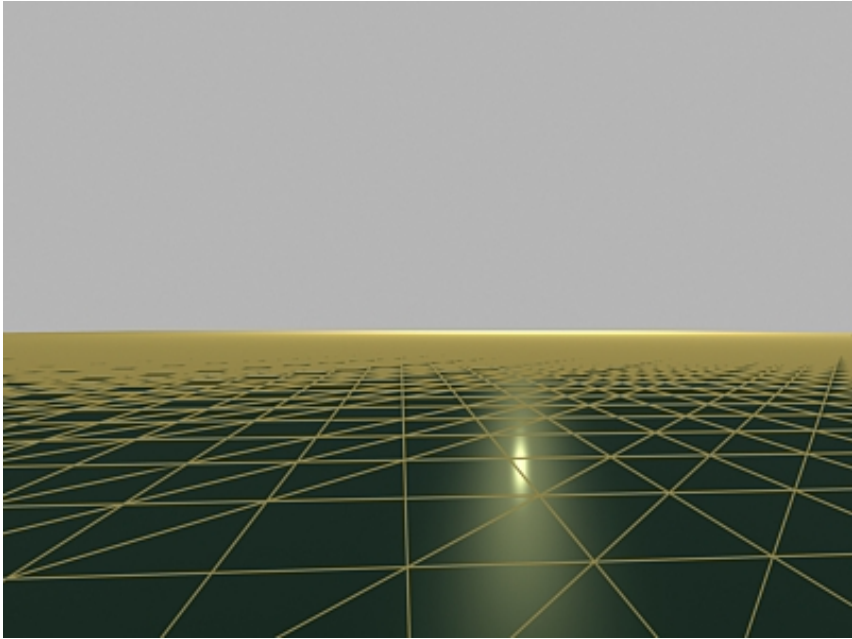

Plane with no noise applied



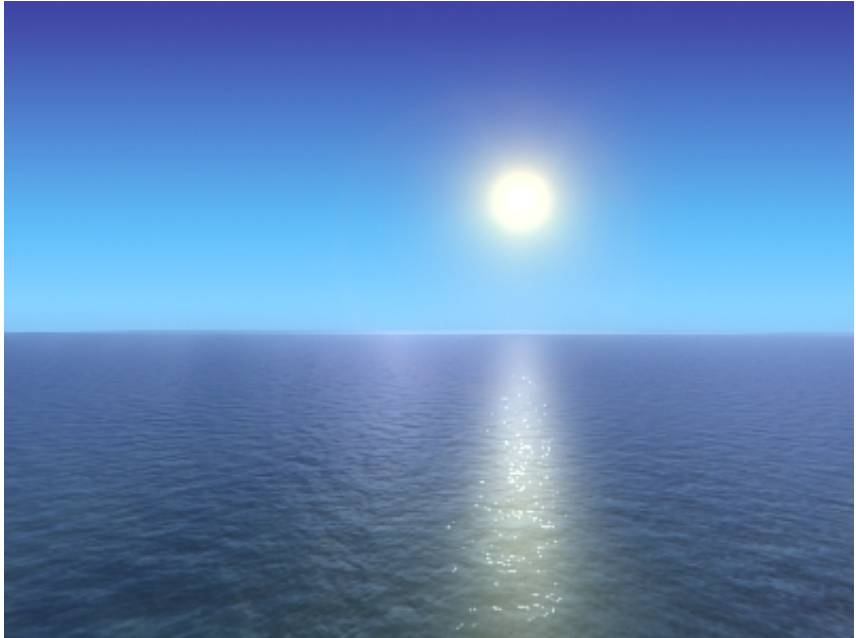

**Adding texture to the plane creates a calm sea.**

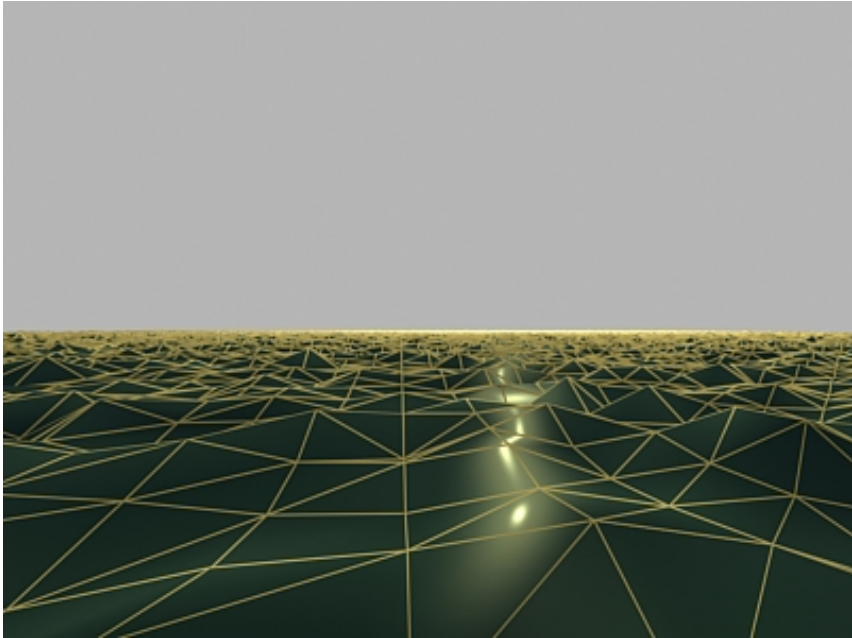

Plane with fractal noise applied

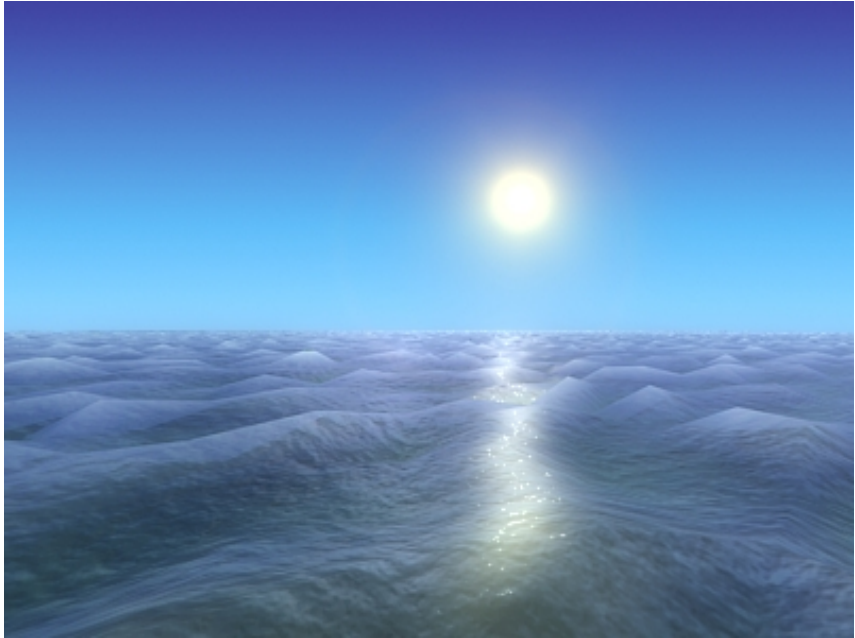

Textured plane with noise creates a stormy sea.

## Procedures

### To apply noise to an object:

- 1 Select an object and apply the Noise modifier. To animate, move to a nonzero frame and turn on the Auto Key button.
- 2 In the Parameters rollout > Strength group, increase Strength values along one or more of the three axes.  
You begin to see noise effects as the strength goes up.
- 3 In the Noise group, adjust Scale. Lower values increase the dynamics of the Strength settings, making the effect more obvious. See Noise group, below, for other options.

If you've animated this procedure, you can change parameters as the animation runs to see the effects.

For another source of noise effects, go to the sub-object level of the Noise modifier and transform the gizmo and center of the modifier.

### To create terrain effects:

When set for Fractal, the Noise modifier produces a random fractal noise that creates a variety of topological and terrain effects. You can animate these effects or use them to model static landscapes and other complex forms.

The following steps assume you begin with a broad object like a multi-segment box lying on the XY plane.

- 1 Apply the Noise modifier to the object.
- 2 In the Parameters rollout > Noise group, turn on Fractal. Roughness and Iterations settings are now available.
- 3 Increase Strength on the Z axis and adjust other parameters.  
Once you have a base terrain, you can select sub-objects with Edit Mesh and apply Noise to grow mountains in a smaller region. You can also apply a second Noise modifier to amplify the first one.

### Interface

#### Modifier Stack

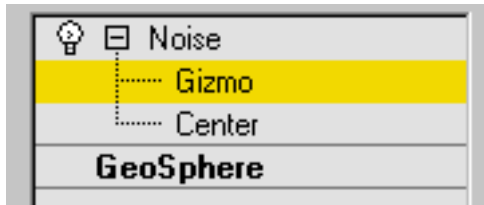

**Gizmo/Center** You can move, rotate, or scale the gizmo and center sub-objects to affect the noise. You can also animate the sub-object transforms.

For more information on the stack display, see [Modifier Stack](#) on page 7427 .

## Parameters rollout

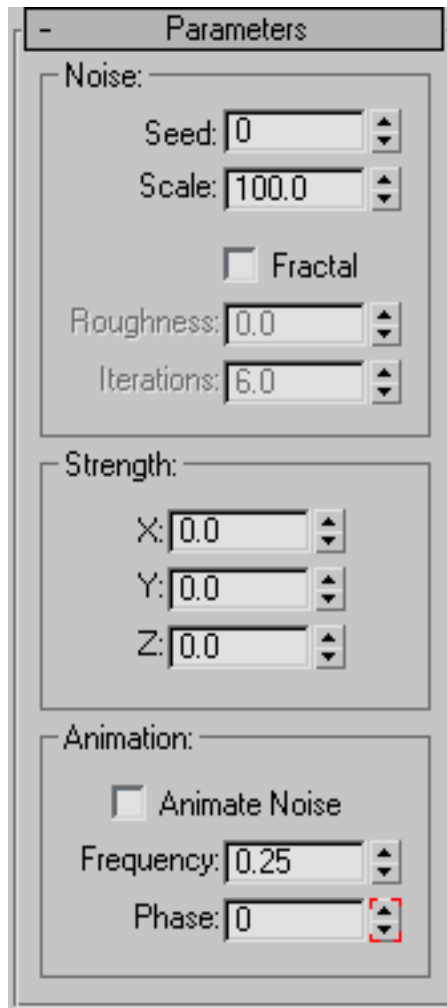

## Noise group

Controls the appearance of the noise, and thus its effect on the physical deformations of the object. By default, the controls are inactive until you change the settings.

**Seed** Generates a random start point from the number you set. Especially useful in creating terrain, because each setting can produce a different configuration.

**Scale** Sets the size of the noise effect (not strength). Larger values produce smoother noise, lower values more jagged noise. Default=100.

**Fractal** Produces a fractal effect based on current settings. Default=off.

If you turn on Fractal, the following options are available:

**Roughness** Determines the extent of fractal variation. Lower values are less rough than higher values. Range=0 to 1.0. Default=0.

**Iterations** Controls the number of iterations (or octaves) used by the fractal function. Fewer iterations use less fractal energy and generate a smoother effect. An iteration of 1.0 is the same as turning Fractal off. Range=1.0 to 10.0. Default=6.0.

### **Strength group**

Controls the magnitude of the noise effect. No noise effect occurs until some strength is applied.

**X, Y, Z** Set the strength of the noise effect along each of three axes. Enter a value for at least one of these axes to produce a noise effect. Default=0.0,0.0,0.0.

### **Animation group**

Controls the shape of the noise effect by overlaying a sine wave for the noise pattern to follow. This keeps the noise within bounds, dampening random extremes. When Animate Noise is turned on, these parameters influence the overall noise effect. However, you can animate Noise and Strength parameters independently; these do not require Animate Noise to be on during animation or playback.

**Animate Noise** Regulates the combined effect of Noise and Strength parameters. The following parameters adjust the underlying wave.

**Frequency** Sets the periodicity of the sine wave. Regulates the speed of the noise effect. Higher frequencies make the noise quiver faster. Lower frequencies produce a smoother and more gentle noise.

**Phase** Shifts the start and end points of the underlying wave. By default, animation keys are set at either end of the active frame range. You can see the effect of Phase more clearly by editing these positions in Track View. Select Animate Noise to enable animation playback.

# Normal Modifier

Select an object. > Modify panel > Modifier List > Normal

Select an object. > Modifiers menu > Mesh Editing > Normal Modifier

The Normal modifier allows you to unify or flip the normals of an object without applying an Edit Mesh modifier.

For example, if you wanted to fly inside of a procedural object, such as a sphere or a cylinder, and wanted to retain control over the radius and number of segments, you couldn't collapse the object to an Editable Mesh and maintain the procedural nature of the primitive.

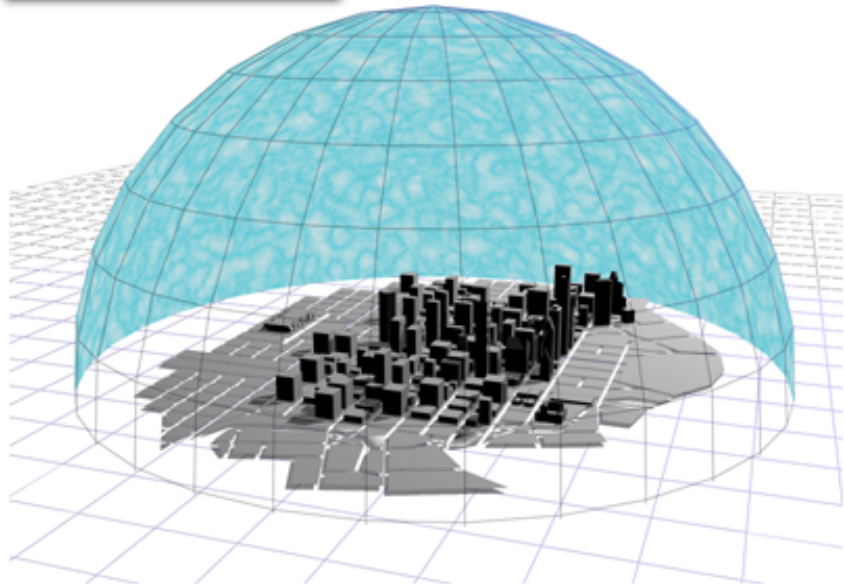
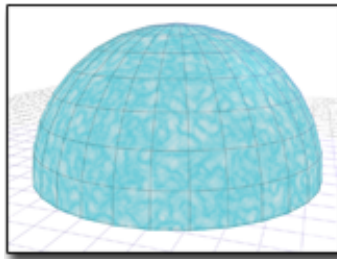

Flipping the normals of a sphere creates a sky dome over a city.

---

**TIP** If you are animating the creation of a complex object such as a nested Boolean or a loft, and you think the operation might result in inconsistent faces, apply Normal to the result and turn on Unify.

---

**TIP** The Lathe modifier sometimes creates an object with normals pointing inward. Use the Normal modifier with both Unify and Flip turned on to fix "inside-out" lathe objects. The Normal modifier allows whole-object manipulations of normals to be performed quickly without using an Edit Mesh modifier.

---

## Patches

Patch objects coming up the modifier stack are not converted to a mesh by this modifier. A patch object input to the Material modifier retains its patch definition. Files that contain patch objects with the Material modifier from previous versions of the software will be converted to meshes to maintain backward compatibility.

## Procedures

**To use the normal modifier:**



- 1 Select an object, then on the Modify panel, choose Mesh Editing > Normal from the Modifier List.  
The object appears to turn inside-out, since Flip Normals is on by default.
- 2 If the object has some faces pointing inward and others outward, turn on Unify Normals to make all the faces point similarly.

---

**TIP** To flip or unify normals on portions of objects, convert to Editable Mesh and select Faces or Polygons. On the Surface Properties rollout in the Normals group, use the Flip and Unify buttons.

---



## Interface

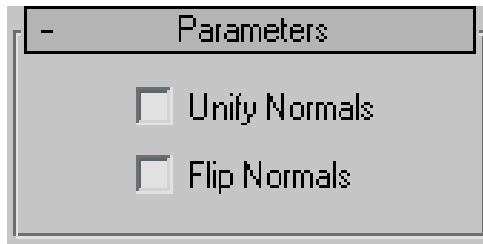

**Unify Normals** Unifies the normals of an object by flipping the normals so that they all point in the same direction, usually outward. This is useful for restoring an object's faces to their original orientations. Sometimes normals of scenes that have come into 3ds Max as part of a DWG or DXF file are irregular, depending on the methods used to create the scene. Use this option of the modifier to correct them.

---

**NOTE** Unify Normals does not work on [editable poly](#) on page 2038 objects; before applying the Normal modifier, convert the model to editable mesh format or apply a [Mesh Select](#) on page 1455 or [Turn To Mesh](#) on page 1756 modifier.

---

**Flip Normals** Reverses the direction of all the surface normals of the faces of the selected object or objects. Default=on.

## Normalize Spline Modifier

Select a spline object. > Modify panel > Modifier List > Normalize Spl.

Select a spline object. > Modifiers menu > Patch/Spline Editing > Normalize Spline

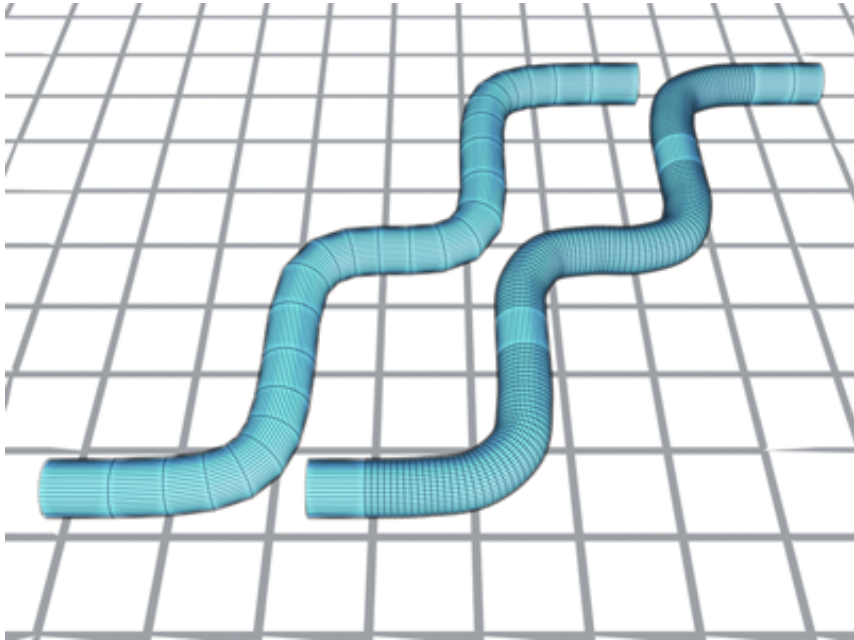

The spline on the left has been normalized.

The Normalize Spline modifier adds new control points in the spline at regular intervals. Use Normalize Spline to produce splines for motion paths that require constant velocity.

---

**NOTE** This feature is not animatable.

---

### Interface

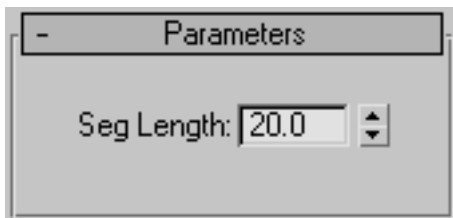

**Seg Length** Sets the length of the spline's segments, in 3ds Max units. The positions of the original vertices are discarded, and vertices are set to regular intervals. Segment length determines how many control points are added:

shorter segments result in more control points, longer segments result in fewer.  
Default=20.0 units.

## NSurf Sel Modifier

Select a NURBS curve or surface object. > Modify panel > Modifier List > NSurf Sel

Select a NURBS curve or surface object. > Modifiers menu > Selection Modifiers > NURBS Surface Select

Select a NURBS curve or surface object. > Modifiers menu > NURBS Editing > Surface Select

The NSurf Sel (NURBS Surface Selection) modifier lets you place a [NURBS](#) on page 2152 sub-object selection on the modifier stack. This lets you modify only the selected sub-objects. Also, selected curve sub-objects are shape objects that you can use as paths and motion trajectories.

If a NURBS surface object is [nonrelational](#) on page 2219, NSurf Sel can't select the sub-object levels Curve, Curve CV, or Point. NURBS surfaces are nonrelational by default. You can make the surface relational by turning on Relational Stack on the object's General rollout.

NSurf Sel can select any kind of NURBS sub-objects except imports. Each sub-object selection is of one particular sub-object level only.

---

**NOTE** The NSurf Sel modifier doesn't support copying and pasting selections as [Mesh Select](#) on page 1455 does. Copying and pasting mesh selections is based on vertex indexes. NURBS selections are based on object IDs, which are unique to each model.

---

### Procedures

To use the NSurf Sel (NURBS Surface Selection) modifier:

-  1 With a NURBS object selected in the Modify command panel, apply NSurf Sel.

This modifier has no controls at the top level.

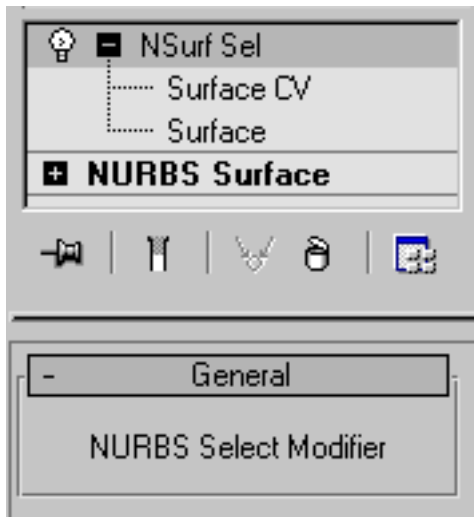

- 2 In the stack display, choose a sub-object level from the list.

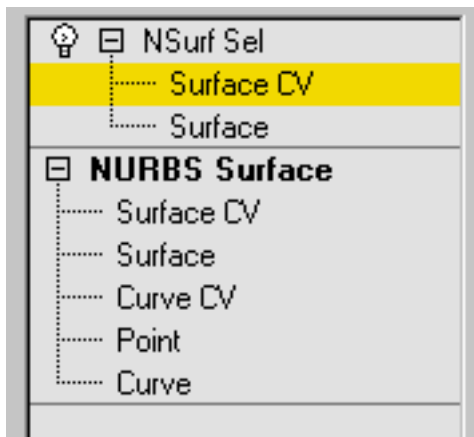

NSurf Sel has the same selection controls you see for NURBS surfaces, except that selecting connected curves or surfaces is not available.

For more information on the stack display, see [Modifier Stack](#) on page 7427 .

While applying the modifier, you can also select NURBS sub-objects by name. Turn on the [Keyboard Shortcut Override toggle](#) on page 7646 and then press the H key. This displays a version of the [Selection Floater](#) on

page 171 that lists only sub-objects at the current level. Choose one or more objects in the list, and then click Select.

- 3 Use the selection controls to create a selection set of the chosen sub-object type.  
With NSurf Sel, the selection can be of surface CV or surface sub-objects. If you turn on Relational Stack for the NURBS object, you can also select point, curve, and curve CV sub-objects.
- 4 At the Surface CV sub-object level, adjust Soft Selection controls as you wish. These controls are the same as those in the [Soft Selection rollout](#) on page 2275 for NURBS curves and surfaces, except that the Same Type Only toggle is absent.

Once you've used the modifier to create the selection, you can apply other modifiers to it.

## Optimize Modifier

Select an object. > Modify panel > Modifier List > Optimize

Select an object. > Modifiers menu > Mesh Editing > Optimize

The Optimize modifier lets you reduce the number of faces and vertices in an object. This simplifies the geometry and speeds up rendering while maintaining an acceptable image. A Before/After readout gives you exact feedback on the reduction as you make each change.



**Optimize** simplifies a smooth model with a high number of faces without greatly changing the model's appearance.

---

**TIP** Because Optimize makes decisions based on angles between faces, it's sometimes best to apply it to selected face sub-objects rather than to an entire object. Avoid applying Optimize to areas where you want to preserve geometric detail.

---

### **Applying Optimize**

When you first apply Optimize, you might not see any change in the viewports. Adjust the Face Threshold setting to obtain the best optimization. In the Last Optimize Status group, you can see how the object or faces were optimized. Watch these values while you adjust the Optimize parameters, until you have the best possible result.

### **Setting Level of Detail**

Optimize lets you maintain two levels of optimization detail. You might set a lower optimization level, with fewer faces, to speed up your viewport work, and a higher level for final output in the renderer. However, you can render

at either level. You can also switch to the higher level in a viewport to get an idea of what the rendered image will look like.

## **Procedures**

### **To optimize manually:**

- 1 Set up two viewports: one wireframe, one smooth shaded.
- 2 Select an object and apply the Optimize modifier.  
The Parameters rollout for this modifier appears.
- 3 Turn off Manual Update and then adjust the Face Thresh value. Observe the result in the viewports.  
You can also choose to view the results of the Optimize operation manually by leaving the Manual Update check box turned on and clicking the Update button every time you wish to view a result.
- 4 In the Parameters rollout > Last Optimize Status group, notice the Before/After count for vertices and faces.
- 5 In the Optimize group, vary parameters to continue reducing geometry.  
Compare the result in the two viewports against the Before/After count.

### **To set the level of detail:**

- 1 In the Parameters rollout > Level of Detail group, choose Viewports L1.
- 2 Adjust parameters in the Optimize and Preserve groups.  
This sets the L1 level of optimization for both the viewport and the renderer.
- 3 Repeat steps 1 and 2 for Viewports L2, adjusting parameters for a different optimization.

### **To use level of detail:**

- Switch between L1 and L2 for either Viewports or Renderer.  
You see the effect immediately in a smooth shaded viewport. Do a test rendering to see the effect on the renderer.

The following parameters are stored for each level: Face Threshold, Edge Threshold, Bias, Max Edge Len, Material Boundaries, and Smooth Boundaries.

## Interface

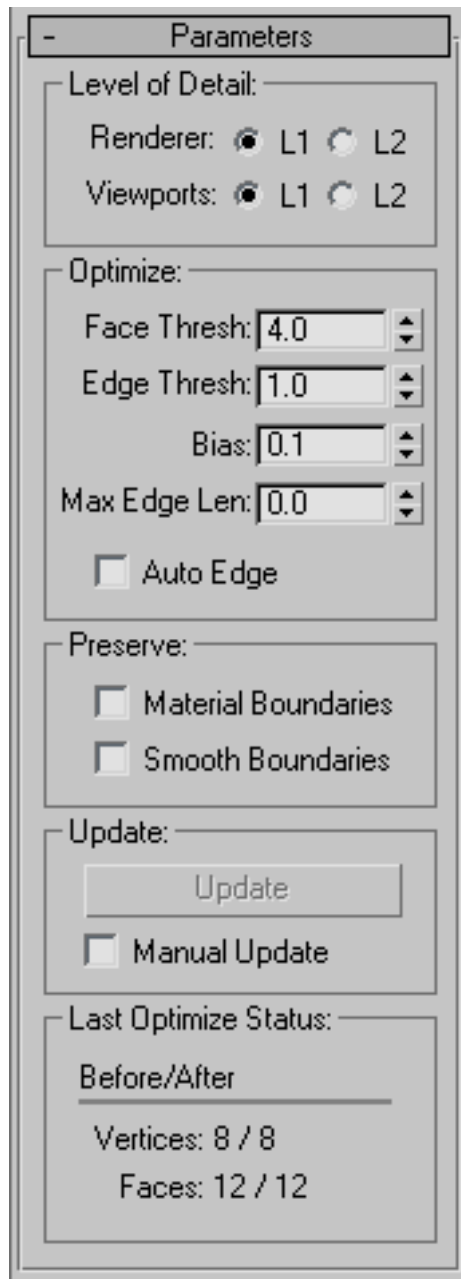



## Level of Detail group

**Renderer L1, L2** Set the level of display for the default scanline renderer. Use Viewports L1 and L2 to change the stored optimization level. Default=L1.

**Viewports L1, L2** Set the optimization level for both viewport and renderer. Also toggles the level of display for the viewport. Default=L1.

## Optimize group

Adjusts the degree of optimization.

**Face Thresh** Sets the threshold angle used to determine which faces are collapsed. Low values produce less optimization but better approximations of the original shape. Higher values improve optimization, but are more likely to result in faces that render poorly (see Bias). Default=4.0.

**Edge Thresh** Sets a different threshold angle for open edges (those that bound only one face). A low value preserves open edges. At the same time you can apply a high face threshold to get good optimization. Default=1.0.

**Bias** Helps eliminate the skinny or degenerate triangles that occur during optimization, which can cause rendering artifacts. Higher values keeps triangles from becoming degenerate. The default of 0.1 is enough to eliminate the skinniest triangles. Range=0.0 to 1.0 (a 0 value turns Bias off).

**Max Edge Len** Specifies the maximum length, beyond which an edge cannot be stretched when optimized. When Max Edge Len is 0, it has no effect. Any value greater than 0 specifies the maximum length of the edges. Default=0.0.

Along with Bias, this control helps you avoid creating long skinny faces while optimizing.

**Auto Edge** Turns edges on and off following optimization. Turns on any open edges. Turns off any edges between faces whose normals are within the face threshold; such edges beyond the threshold are not turned on. Default=off.

## Preserve group

Maintains clean separation at the face level between material and smoothness boundaries.

**Material Boundaries** Prevents face collapse across material boundaries. Default=off.

**Smooth Boundaries** Optimizes an object and maintain its smoothing. When turned on, allows only faces that share at least one smoothing group to collapse. Default=off.

## Update group

**Update** Updates the viewports with the current optimization settings. Available only when Manual Update is turned on.

**Manual Update** Enables the Update button. When turned off, Optimize works as it does by default, updating the viewport display dynamically.

---

**NOTE** When using Manual Update, if you make any changes that cause the reevaluation of the stack, the existing optimization display disappears. Click the Update button again to restore it.

---

The Renderer ignores the optimization display in the viewport, using the Optimize settings, regardless of the state of the Manual Update.

## Last Optimize Status group

Displays numerical results of optimization with exact before-and-after counts for vertices and faces.

# Patch Select Modifier

Make a selection. > Modify panel > Modifier List > Patch Select

Make a selection. > Modifiers menu > Selection Modifiers > Patch Select

The Patch Select modifier lets you pass a sub-object selection up the stack to subsequent modifiers. It provides a superset of the selection functions available in the [Edit Patch modifier](#) on page 1290 . You can select vertices, edges, patches, and elements. You can also change the selection from sub-object level to object level.

---

**NOTE** When you apply the Patch Select modifier and then go to any sub-object level, the select-and-transform buttons in the toolbar are unavailable, and the Select Object button is automatically activated.

---

## Using XForm Modifiers to Animate a Patch Selection

When you apply a Patch Select modifier, there are no animation controllers assigned to the sub-object selection. This means that the selection has no way to "carry" the transform information needed for animation.

To animate a sub-object selection using Patch Select, apply either an XForm or Linked XForm modifier to the selection. These modifiers provide the

necessary controllers for animating the effects of transforms. In a sense, they give "whole-object status" to the sub-object selection.

- [XForm](#) on page 1922  
Animates transforms directly on a sub-object selection. Creates a gizmo and center for the sub-object selection. You can animate both, with the center acting as a pivot point for the selection.
- [Linked XForm](#) on page 1440  
Lets you choose another object to control the animation. The sub-object selection is linked to the "control object." When you transform the control object, the sub-object selection follows accordingly.

## Procedures

### To use the patch select modifier:

- 1 Create or select a patch object.

- 2  Go to the Modify panel and choose Patch Select from the modifier list.

- 3 Select vertices, handles, edges, patches, or elements.

- 4 Add another modifier to affect only the selection from step 3.

## Interface

### Modifier Stack

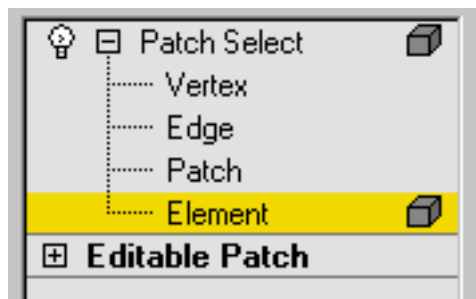

**Vertex** Selects vertices.

**Handle** Selects handles.

**Edge** Selects edges.

**Patch** Selects patches.

**Element** Selects elements.

For more information on the stack display, see [Modifier Stack](#) on page 7427 .

### Parameters rollout

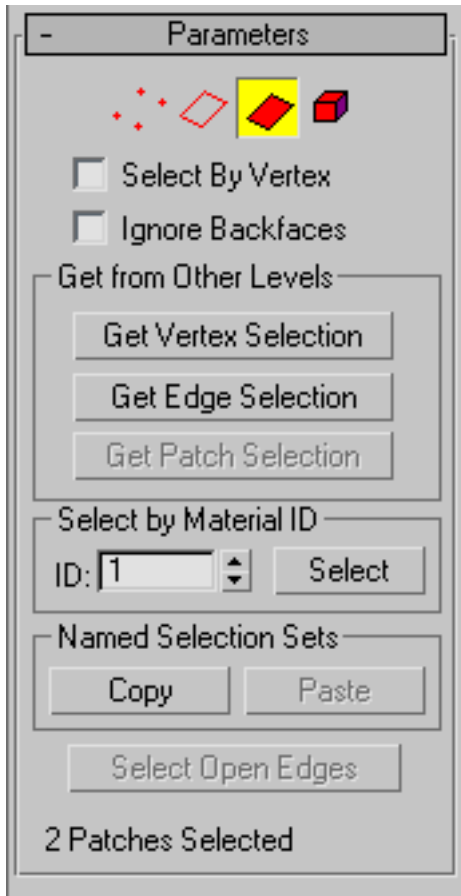

Provides buttons for turning different sub-object modes on and off, working with named selections and handles, display settings, and information about selected entities.

The icons at the top of the Selection rollout let you specify the method of face selection. Clicking a button here is the same as selecting a sub-object type in the modifier stack. Click the button again to turn it off and return to the object selection level.



**Vertex** Selects a vertex beneath the cursor; region selection selects vertices within the region.



**Handle** Selects a handle beneath the cursor; region selection selects multiple handles within the region.



**Edge** Selects an edge beneath the cursor; region selection selects multiple edges within the region.



**Patch** Selects a patch beneath the cursor; region selection selects multiple patches within the region.



**Element** Selects all contiguous faces in an object; region selection selects the same.

**Select By Vertex** Selects any sub-objects at the current level that use a vertex you click. Applies to all sub-object levels except Vertex. Also works with Region Select.

**Ignore Backfaces** Selects only those edges, patches, or elements whose normals make them visible in the viewport. When turned off (the default), selection includes all sub-objects, regardless of the direction of their normals.

---

**NOTE** The state of the Backface Cull setting in the Display panel doesn't affect sub-object selection. Thus, if Ignore Backfacing is turned off, you can select sub-objects even if you can't see them.

---

**NOTE** The state of the Ignore Backfaces check box also affects edge selection at the Edge sub-object selection level.

---

### **Get from Other Levels group**

Applies selections from one sub-object level to another.

**Get Vertex Selection** Selects edges, patches, or elements based on the last vertex selection. The selection is added to the current selection. Available only when Vertex is not the current sub-object level.

**Get Edge Selection** Selects vertices, patches, or elements based on the last edge selection. Selects those vertices, patches, or elements that contain the edge. Available only when Edge is not the current sub-object level.

**Get Patch Selection** Selects vertices, edges, or elements based on the last patch selection. This selection is added to the current selection. Available only when Patch is not the current sub-object level.

### Select by Material ID group

Selects faces based on their material ID.

**ID** Set the spinner to the ID number you want to select, and then click the Select button. Press Ctrl while clicking to add to the current selection, or press Alt to remove from the current selection.

### Named Selection Sets group

These functions are primarily for copying [named selection sets](#) on page 179 of sub-objects between similar objects, and between comparable modifiers and editable objects. For example, you can apply a patch select modifier to a sphere, create a named selection set of edges, and then copy the selection to a different sphere that's been converted to an editable patch object. You can even copy the selection set to a different type of object, because the selection is identified by the entities' ID numbers.

The standard procedure is to create a selection set, name it, and then use Copy to duplicate it into the copy buffer. Next, select a different object and/or modifier, go to the same sub-object level as you were in when you copied the set, and click Paste.

---

**NOTE** Because sub-object ID numbers vary from object to object, the results of copying named selection sets between different objects can be unexpected. For example, if the buffered set contains only entities numbered higher than any that exist in the target object, no entities will be selected when the set is pasted.

---

**Copy** Places a named selection into the copy buffer.

**Paste** Pastes a named selection from the copy buffer.

**Select Open Edges** Selects all edges with only one face. In most objects, this will show you where missing patches exist. Available only at the Edge sub-object level.

### Selection Info

At the bottom of the Patch Select Parameters rollout is a text display giving you information about the current selection. If 0 or more than one sub-object is selected, the text gives the number and type selected. If one sub-object is selected, the text gives the ID number and type of the selected item.

---

**NOTE** When the current sub-object type is Patch or Element, selection information is given in Patches.

---

### Soft Selection rollout

See [Soft Selection Rollout](#) on page 1926 for information on the Soft Selection rollout settings.

## PatchDeform Modifier

Select an object. > Modify panel > Modifiers List > Object-Space Modifiers > PatchDeform

Select an object. > Modifiers menu > Animation Modifiers > Patch Deform

The PatchDeform modifier deforms an object based on the contours of a patch object. This modifier works similarly to the [PathDeform modifier](#) on page 1528 , but uses a *quad-based patch object* instead of a spline shape or NURBS curve path.

To use the PatchDeform modifier, apply it to the object you want to deform, click the Pick Patch button, and then select a patch object. Deform the object by manipulating the patch object or adjusting the various controls in the Patch Deform panel.

Not all objects can be used with PatchDeform. Objects that are valid PatchDeform targets include: Plane, Cylinder, Cone and Torus.

This modifier is also similar to the [SurfDeform modifier](#) on page 1707 , except that it uses a patch surface instead of a NURBS Point or CV surface.

There's also a world-space version of the PatchDeform modifier. See [PatchDeform \(WSM\)](#) on page 1123 . Generally, the PatchDeform object-space modifier leaves the object in place while moving the patch to the object, while

the PatchDeform world-space modifier leaves the patch in place while moving the object to the patch. Also, the WSM version has a Move to Patch button, while the object-space version does not.

## **Procedures**

### **To use the PatchDeform modifier:**

- 1 Select an object.
- 2 Apply PatchDeform.
- 3 On the Parameters rollout, click Pick Patch.
- 4 Select a patch object.  
Deform the object by adjusting the controls in the Patch Deform panel and by manipulating the patch object.

## **Interface**

### **Modifier Stack**

**Gizmo** At this sub-object level, you can transform and animate the gizmo like any other object, altering the effect of the modifier. The PatchDeform gizmo is a representation of the deforming patch object, so transforming it determines which part of the patch affects the modified object.



## Parameters rollout

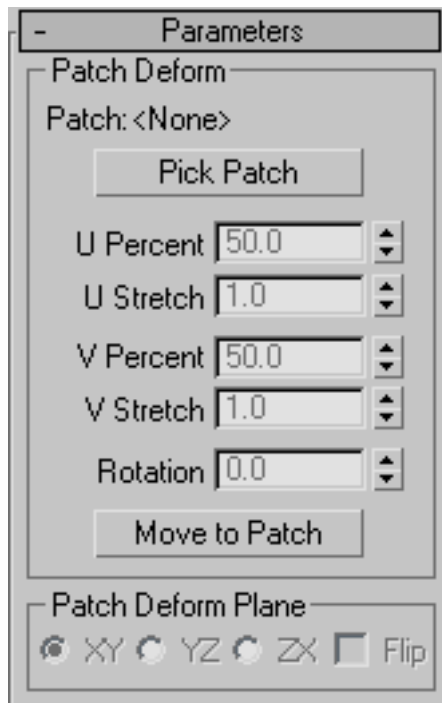

### Patch Deform group

Provides controls that let you pick the patch and adjust the object's position and deformation along the gizmo copy of the patch.

**Patch** Displays the name of the selected patch object.

**Pick Patch** Click this button, and then select the patch object you want to use for the deformation. A gizmo is created for the object that matches the patch. Once you assign the patch gizmo, you can adjust the deformation using the remaining controls in this rollout.

---

**NOTE** Patch Deform can be used only with a rectangular quad patch form. The software makes no distinction between quad-style patches and certain primitive meshes. Examples of suitable patches are the primitive [quad patch object](#) on page 1984 , the primitive [cylinder](#) on page 364 , and the primitive [torus](#) on page 370 . (The cylinder actually has tri-patches at each end, but since they are at the end of the list of patches, PatchDeform just ignores these extra faces.)

---

**U Percent** Moves the object along the U (horizontal) axis of the gizmo patch, based on a percentage of the U distance. This spinner defaults to a setting of 50 percent, which places the object at the center of the gizmo patch. A setting of 0 percent places the object at the left edge of the gizmo patch, as seen from the viewport where the patch was created.

**U Stretch** Scales the object along the U (horizontal) axis of the gizmo patch.

**V Percent** Moves the object along the V (vertical) axis of the gizmo patch, based on a percentage of the V distance. A setting of 0 percent places the object at the bottom of the gizmo patch.

**V Stretch** Scales the object along the V (vertical) axis of the gizmo patch.

**Rotation** Rotates the modified object with respect to the gizmo patch.

**Move To Patch** Clicking this button moves the object from its original position to the patch object you are using for deformation. This button is only available with the PatchDeform (WSM).

### **Patch Deform Plane group**

**XY/YZ/ZX** Choose a two-axis plane of the object to make parallel with the XY plane of the gizmo patch.

**Flip** Reverses the gizmo direction.

## **PathDeform Modifier**

Select an object. > Modify panel > Modifier List > Object-Space Modifiers > PathDeform

Select an object. > Modifiers menu > Animation Modifiers > Path Deform

The PathDeform modifier deforms an object using a spline or NURBS curve as a path. You can move and stretch the object along the path, and rotate and twist it about the path. There's also a world-space modifier version. See

[PathDeform \(WSM\)](#) on page 1123 .

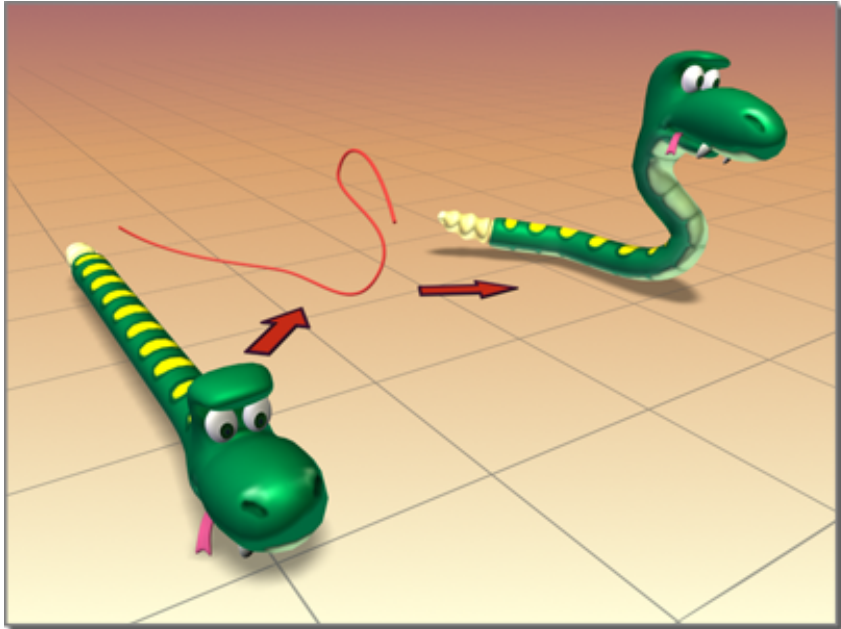

PathDeform creates a wiggle for the snake.

### Using a Path to Deform an Object

Generally, you use the PathDeform modifier when you want to keep an object in place while deforming to a path. Use the PathDeform world-space modifier when you want to move an object to a path while keeping the path in the same world space.

The PathDeform (WSM) modifier replaces the space-warp version that shipped with previous versions of 3ds Max, and is incompatible with previous versions. See [PathDeform \(WSM\)](#) on page 1123 for details on how to fix incompatibilities from the previous version.

To use the PathDeform modifier, you apply it, then click the Pick Path button and select a shape or curve consisting of a single open or closed spline. Once the object is assigned to the path, you can adjust the parameters to deform or animate the object along a gizmo copy of the path.

## Procedures

### To use the PathDeform modifier:

- 1 Select an object.
- 2 Apply PathDeform.
- 3 On the Parameters rollout, click Pick Path.
- 4 Select a spline or NURBS curve.  
Deform the object by adjusting the various controls in the Path Deform panel and by editing the path object.

### Example: To use the PathDeform modifier to curve text:

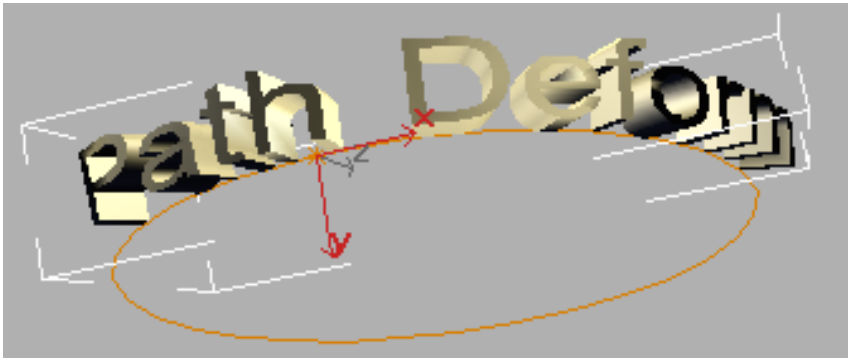

- 1 In the Top viewport, create a circle with a radius of 100 units.
- 2 In the Front viewport, create a text shape with six or seven letters, and a size of 25. (You can use the default "MAX Text".)
- 3 Apply an [Extrude modifier](#) on page 1377 to the text shape and set Amount to **-5.0**.
- 4 On the main toolbar, set the Reference Coordinate System to Local.  
Looking at the axis tripod for the extruded text object, you can see that its Z axis runs from back to front, relative to world space.
- 5 Apply a PathDeform object-space modifier to the text object, click the Pick Path button, and then select the circle.  
A circular gizmo is displayed. The circle runs through the local Z axis of the text object. Because of its orientation, its effect is minimal, but you can see a slight wedge-shaped deformation from the top view.

- 6 In the Path Deform Axis group, choose the Y option, and then the X option.

The circle gizmo rotates to run through the specified axes, deforming the text object differently with each change.

- 7 Adjust the Percent spinner to view its effect, and then set it to **0**. Try the same with Stretch, Rotation, and Twist, and then restore them to their original values. (Tip: Use the Ctrl key with Twist to amplify the effect.)

- 8 Turn Flip on and off to switch the direction of the path.

- 9 In the stack display, choose the Gizmo sub-object level, and move the gizmo path around.

The text object is further deformed by its relative position to the gizmo.

- 10 In the stack display, turn off sub-object selection by selecting the original circle shape.

- 11 Adjust the circle's radius.

The deformation of the text object changes because its gizmo is an instance of the shape object.

## Interface

### Modifier Stack

**Gizmo** At this sub-object level, you can transform and animate the gizmo like any other object, altering the effect of the modifier. The PathDeform gizmo is a representation of the deforming path object, so transforming it determines which part of the path affects the modified object.

## Parameters rollout

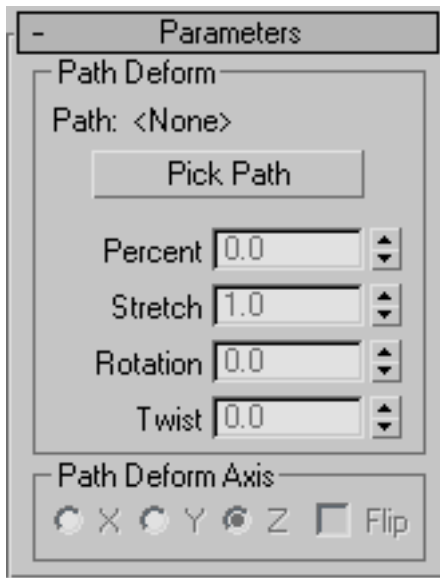

### Path Deform group

Provides controls that let you pick a path and adjust an object's position and deformation along the path.

**Path** Displays the name of the selected path object.

**Pick Path** Click this button and then select a spline or NURBS curve to use as the path. The gizmo that appears is shaped like the path and is aligned with the local Z axis of the object. Once you assign the path, you can adjust the deformation of the object using the remaining controls in this rollout. The path you pick should contain a single, open or closed curve. If you use a path object consisting of multiple curves, only the first one is used.

**Percent** Moves the object along the gizmo path based on a percentage of the path length.

**Stretch** Scales the object along the gizmo path, using the object's pivot point as the base of the scale.

**Rotation** Rotates the object about the gizmo path.

**Twist** Twists the object about the path. The twist angle is based on the rotation of one end of the overall length of the path. Typically, the deformed object takes up only a portion of the path, so the effect can be subtle.

### **Path Deform Axis group**

**X/Y/Z** Choose one to rotate the gizmo path to align with a specified local axis of the object.

**Flip** Reverses the gizmo path 180 degrees about the specified axis.

## **Point Cache Modifier**

Select an object. > Modify panel > Modifier List > Object-Space Modifiers > Point Cache

Select an object. > Modifiers menu > Cache Tools > Point Cache

The Point Cache modifier lets you store modifier and sub-object animation to a disk file that records only changes in vertex positions, and then play back the animation using the information in the disk file instead of the modifier keyframes. This is useful when the computation required for vertex animation becomes so excessive that it causes animation playback to run slowly or drop frames.

Another use for this modifier is to apply the same animation to a number of objects, varying the Start Time and Strength settings for each so they don't all move identically.

The Point Cache modifier is also available in a world-space version, for which usage is the same.



### **New Features in Point Cache**

New features in Point Cache modifier include:

- You can now save animation files in XML and MC formats for greater compatibility with other applications, such as Autodesk Maya, as well as the legacy PC2 format.
- When recording to XML, you can save each animation frame in a separate file.

Cache files for large meshes and long animations can be very large. Saving as a file per frame lets you manage data more easily and replace single frames if you find errors.

### **Compatibility with Autodesk Maya**

Following is a suggested workflow for using Point Cache for working on an animation project in both 3ds Max and Autodesk Maya:

- 1 Create a deforming mesh (Skin, Cloth, etc.).
- 2 Apply the Point Cache modifier.
- 3 Save the cache in XML format with referenced MC files.
- 4 Save the mesh in FBX format.
- 5 Bring the mesh into Maya.
- 6 In Maya, load the cache data onto the onto the mesh using the XML file to load the referenced MC files.
- 7 Modify the animation in Maya and save it, overwriting the XML and MC files.

In 3ds Max, use the Point Cache > Reload command; this updates the animation to that saved from Maya.

### **Special Features in Point Cache**

Both versions of the Point Cache modifier provide enhanced animation capabilities, including:

- Adjustable playback ranges and a playback graph, to animate which cache frame is played back. This lets you load a cache and then animate it, slowing down, stopping, reversing, etc.
- Nth-frame sampling, so you can sample every few frames to save disk space if sampling every frame is unnecessary, or record multiple samples per frame for improved motion blurring.
- The "strength" is adjustable in Absolute mode, so you can easily blend the cache with what is below in the stack.
- Improved cache file management.
- Pre-loaded caches to speed up playback.



## Procedures

### To use the Point Cache modifier:

- 1 Use one or more modifiers to animate an object. For example, you might apply a [Bend modifier](#) on page 1139 , and then set keyframes for the Angle parameter to make the object bend back and forth.
- 2 Click Play Animation.  
If the animation is a good candidate for caching, the playback will drop many frames with Real Time Playback turned on, and will run slowly with Real Time Playback turned off.
- 3  From the Modify panel > Modifier List, choose Object-Space Modifiers > Point Cache.
- 4 On the Parameters rollout > Record group, set values for Start Time and End Time.
- 5 If you plan to render the cached animation using motion blur, decrease the Sample Rate setting.
- 6 Click the Record button, and use the Save Cache dialog to specify a cache file. To export the animation to another program, such as Autodesk Maya, use the XML file format; otherwise, use the PC2 file format.  
The software records the animation to the cache file. When finished, the cache file name appears in the Cache File group.
- 7 In the Record group, click Disable Modifiers Below.  
This turns off all the object's modifiers below Point Cache so that only the cached vertex animation will appear when you play back the animation.
- 8 Click Play Animation again.  
This time the animation plays back quickly and smoothly.

## Interface

### Parameters rollout

**Parameters**

Cache File  
<none>

Cache Info  
Error:  
Cache file not found  
OR  
Cache not yet recorded.

Record

One File  
 One File Per Frame

Start Frame

End Frame

Sample Rate:  
Sample Every Nth Frame

Load Type

Local

Slave

0.00 megs pre-loaded.

Playback Options

Strength

Relative Offset

Apply To Whole Object

Playback Type

Start Frame

End Frame

Frame

Clamp Graph

## Cache File group

Contains settings for recording vertex animation.

**[file name]** After you specify or load a cache file, its name appears in this field.

**New** Creates a new, empty cache file. After setting a new file, use Record to create the cache data.

You can save the file in either of two formats:

- **XML:**Saves the basic cache information in an XML file, and the animation data in one or more MC files (The XML file includes references to the MC files). The modifier uses multiple MC files if you set the Record group option to One File Per Frame. When recording multiple MC files, the modifier gives them the name *[file name]Frame[frame number].mc*; for example, *Cylinder01Frame10.mc*. If you set a non-integer value for Sample Rate, the modifier appends the sub-frame cache file names with *Tick[tick number]*.
- **PC2:**Saves all cache information and data in a single PC2 file. When you use this format, the One File Per Frame option is unavailable.

**Load** Loads a vertex animation from a cache file on disk into the Point Cache modifier. If the number of vertices in the cache does not match the number of vertices in the object, the Cache Info group reports an error, and the animation doesn't take effect.

Load supports these file formats: XML, PC2, PTS.

**Unload** Temporarily frees the current cache file, so it can be edited or deleted externally.

**Reload** Reopens the current cache file, if previously unloaded.

## Cache Info group

Displays cache statistics in read-only format, including the number of files, point count, evaluations (number of samples), sample rate, start and end frames, and errors, if any.

## Record group

Contains settings for recording cached animation.

**One File/One File Per Frame** Choose whether to save the cache in a single file, or in a separate file for each frame of recorded animation. The latter option is available only when using the XML file format.

**Start Frame** Sets the first frame for recording the vertex animation. Default=first frame of the active time segment.

Using decimal fractions lets you start at a sub-frame setting when using a Frame:Ticks time display.

**End Frame** Sets the last frame for recording the vertex animation. Default=last frame of the active time segment.

Using decimal fractions lets you start at a sub-frame setting when using a Frame:Ticks time display.

**Sample Rate** Sets the number of frames between each recorded sample. When rendering with motion blur, which uses sub-frame sampling, decrease this value. Default=1.0.

At the default value of 1.0, Point Cache records one sample per frame. Increasing the value causes a sample to be recorded every Nth frame. For example, a value of 10.0 records every tenth frame. Decreasing the value causes multiple samples to be recorded for each frame. For example, if you set Sample Rate to 0.1, Point Cache records 10 samples per frame at evenly spaced intervals.

**Record** Stores the vertex animation to a disk file. If no cache file is specified, or the specified file doesn't exist, activates the Save Points dialog, which lets you specify a path and file name for the cache file. Click Save to record the file, and then load it into the Point Cache modifier, ready for playback.

---

**TIP** To change the path or file name, use Cache File group > New and specify a different cache file.

---

**Enable Modifiers Below** Turns on all stack modifiers below the Point Cache modifier. Use this when you want to change modifier settings.

**Disable Modifiers Below** Turns off all the object's stack modifiers below Point Cache so that only the cached vertex animation appears when you play back the animation.

### **Load Type group**

These options apply only to PC2 and PTS files; when the cache file type is XML they are unavailable.

**Local** The method the modifier uses to load the cache file. The options are:

- **Stream** Keeps the cache file open for fast access, but loads only a single frame at a time to conserve memory. This is the default mode.
- **Per-Sample** Opens the cache file, reads a single frame, and then immediately closes the file. This is slower than the Stream method, but is useful if many users are reading/writing the same set of cache files since the cache files won't be locked open as you read from them.
- **Pre-Load** Loads the entire cache file into memory for fast access, and then closes the file. This is particularly useful in networked situations, or when a few cache files are used by many objects in one scene. In the latter case, using this option prevents each object from thrashing the disk on playback.  
Be conservative in using this, as it can consume a great deal of memory. However, if one cache file is used by several objects, the cache is loaded into memory only once.

**Slave** These options apply if 3ds Max is running as a network-rendering client; see the preceding for details. In this situation, only Per-Sample and Pre-Load are available, and the default option is Per-Sample, so the clients don't lock files.

**[label]** This read-only field displays the size of the pre-loaded data when Local is set to Pre-Load.

### **Playback Options group**

**Strength** Affects the motion relative to the original animation. Applies only when Relative Offset is on. Default=1.0. Range=-10.0 to 10.0.

At 1.0, the animation plays back the same as recorded. With strengths between 0.0 and 1.0, the animation is relatively restrained. At strengths greater than 1, the animation is exaggerated. With negative Strength settings, the motion is reversed.

**Relative Offset** Enables offsetting the animated vertex positions relative to their positions as recorded, based on the Strength setting. Default=off.

---

**NOTE** When you turn on Relative Offset and play back a cached animation with the modifiers turned on, the cached vertex positions are calculated relative to their positions as calculated by the modifiers. For example, if you record a Bend animation to a cache file, and then play it back with both Relative Offset and the Bend modifier on and Strength=1.0, all vertex positions are doubled, resulting in exaggerated motion.

---

**Apply To Whole Object** When off, only the active vertex selection is animated. In this case, for the cache animation to be visible, the selection must include at least some of the originally animated vertices.

## **Playback Type group**

**Playback Type** Specifies how playback occurs:

- **Original Range** Plays back the cache over the range it was originally recorded, so the animation will always be the same as the original.
- **Custom Start** Plays back the cache from a custom start time, set by Start Frame, but the animation length and playback speed will be the same as the original animation.
- **Custom Range** Lets you set start and end frames within which the current cache plays back. Using a range that is smaller than the original record range plays the cache back faster, while specifying a larger range plays the cache back slower.
- **Playback Graph** Lets you animate which cache frame is played at any given time.  
For example, if you record a cache from frames 0 to 100 and then want it to play back twice as fast forward and then in reverse, choose this option, turn on Auto Key, set the Frame parameter to 0.0 at frame 0, 100.0 at frame 50, and then back to 0.0 at frame 100. The function curve of this parameter in Track View shows how the cache is played back. Animating the Frame value lets you achieve unusual effects such as slowing a cache down over time, creating a ping-pong effect during playback, etc.

**Start Frame** The frame number at which the cached animation starts playing back. Using decimal fractions lets you start at a sub-frame setting when using a Frame:Ticks time display. Available only when Playback Type is set to Custom Start or Custom Range. Default=0.0.

**End Frame** The frame number at which the cached animation starts playing back. Using decimal fractions lets you start at a sub-frame setting when using a Frame:Ticks time display. Available only when Playback Type is set to Custom Range. Default=0.0.

**Frame** Lets you animate playback of the cache; for details, see Playback Graph, above.

**Clamp Graph** Controls what gets loaded when the Playback Graph frame is out of the original recorded range.

Take an example in which the playback frame is set to 105, but the original cache was recorded over frames 0-100. With Clamp Graph on, the loaded frame will be 100. If it's off (the default), the cache will "wrap around" and load frame 5.

This lets you loop caches more easily. In the above example, you could simply have a two-key playback graph. The first key would be at frame 0 with a value of 0.0, and the second would be at frame 100 with a value of 100.0. You would then set the [out-of-range type](#) on page 3523 for the Frame parameter (Playback Frame in Track View) to Linear, and the cache would loop back smoothly to the beginning at frame 101.

## Poly Select Modifier

Make a selection. > Modify panel > Modifier List > Poly Select

Make a selection. > Modifiers menu > Selection Modifiers > Poly Select

The Poly Select modifier lets you pass a sub-object selection up the stack to subsequent modifiers. It provides a superset of the selection functions available in [Editable Poly](#) on page 2038. You can select vertices, edges, borders, polygons, and elements. You can change the selection from sub-object level to object level.

When you apply the Poly Select modifier and then go to any sub-object level, the select-and-transform buttons in the toolbar are unavailable, and the Select Object button is automatically activated.

### Using XForm Modifiers to Animate a Poly Selection

When you apply a Poly Select modifier, there are no animation controllers assigned to the sub-object selection. This means that the selection has no way to "carry" the transform information needed for animation.

To animate a sub-object selection using Poly Select, apply either an XForm or Linked XForm modifier to the selection. These modifiers provide the necessary controllers for animating the effects of transforms. In a sense, they give "whole-object status" to the sub-object selection.

- [XForm](#) on page 1922  
Animates transforms directly on a sub-object selection. Creates a gizmo and center for the sub-object selection. You can animate both, with the center acting as a pivot point for the selection.
- [Linked XForm](#) on page 1440

Lets you choose another object to control the animation. The sub-object selection is linked to the "control object." When you transform the control object, the sub-object selection follows accordingly.

## Procedures

### To use the Poly Select modifier:

- 1 Create or select an object.

---

**NOTE** Applying a Poly Select modifier to an object other than a polymesh type will convert the object to a polymesh object. If you want more control over the conversion, add a [Turn To Poly modifier](#) on page 1761 before applying the Poly Select modifier. The Turn To Poly modifier provides conversion options that aren't available with the Poly Select modifier.

---

- 2 Apply the Poly Select modifier.
- 3 Select vertices, faces, or polygons.
- 4 Add another modifier to affect only the selection from step 3.



## Interface

### Modifier Stack

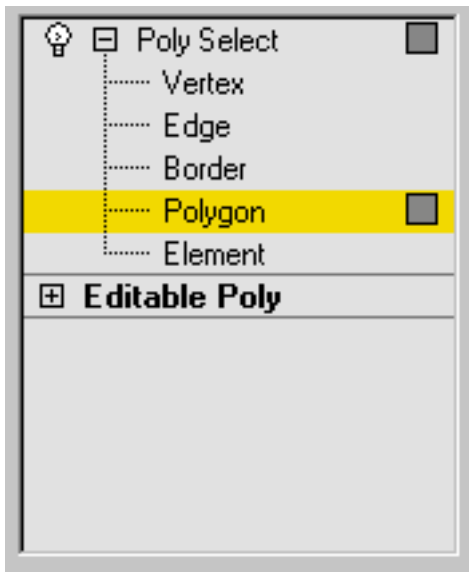

**Vertex** Selects vertices.

**Edge** Selects edges.

**Border** Selects borders.

**Polygon** Selects polygons.

**Element** Selects elements.

For more information on the stack display, see [Modifier Stack](#) on page 7427 .

## Parameters rollout

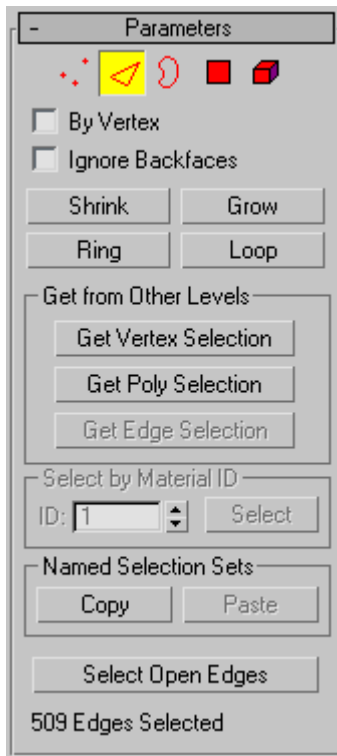

Provides buttons for accessing different sub-object levels, working with named selections and handles, display settings, and information about selected entities.

The icons at the top of the Selection rollout let you specify the method of face selection.

Clicking a button here is the same as choosing a sub-object type in the modifier stack. Click the button again to turn it off and return to the Object selection level.

---

**NOTE** You can convert sub-object selections in two different ways with the use of the Ctrl and Shift keys:

- Clicking a sub-object button in the Selection rollout with Ctrl held down converts the current selection to the new level, selecting all sub-objects in the new level that touch the previous selection. For example, if you select a vertex, and then Ctrl+click the Polygon button, all polygons that use that vertex are selected.
- To convert the selection to only sub-objects all of whose source components are originally selected, hold down both Ctrl and Shift as you change the level. For example, if you convert a vertex selection to a polygon selection with Ctrl+Shift+click, the resultant selection includes only those polygons all of whose vertices were originally selected.



**Vertex** Selects a vertex beneath the cursor; region selection selects vertices within the region.



**Edge** Selects a polygon edge beneath the cursor; region selection selects multiple edges within the region.



**Border** Turns on Border sub-object mode, which lets you select an area on a mesh that can generally be described as a *hole*. Areas like this are usually sequences of edges with faces on only one side. For example, a box doesn't have a border, but the Teapot object has several of them: on the lid, on the body, on the spout, and two on the handle. If you create a cylinder, then delete the top face, the top row of edges forms a border.

When the Border sub-object level is active, you can't select edges that aren't on borders. Clicking a single edge on a border selects that whole border.

Borders can be capped (either in editable poly or by applying the cap holes modifier). They can also be connected to another object (compound object connect).



**Polygon** Selects all coplanar polygons beneath the cursor. Usually, a polygon is the area you see within the visible wire edges. Region selection selects multiple polygons within the region.



**Element** Selects all contiguous polygons in an object; region selection selects the same.

**By Vertex** Selects any sub-objects at the current level that use a vertex you click. Applies to all sub-object levels except Vertex. Also works with Region Select.

**Ignore Backfaces** Selecting sub-objects selects only those whose normals make them visible in the viewport. When turned off (the default), selection includes all sub-objects, regardless of the direction of their normals.

---

**NOTE** The state of the [Display properties](#) on page 124 > Backface Cull setting doesn't affect sub-object selection. Thus, if Ignore Backfacing is turned off, you can select sub-objects even if you can't see them.

---

**NOTE** The state of the Ignore Backfaces check box also affects edge selection at the Edge sub-object selection level.

---

**Shrink** Reduces the sub-object selection area by deselecting the outermost sub-objects. If the selection size can no longer be reduced, the remaining sub-objects are deselected.

**Grow** Expands the selection area outward in all available directions.

For this function, a border is considered to be an edge selection.

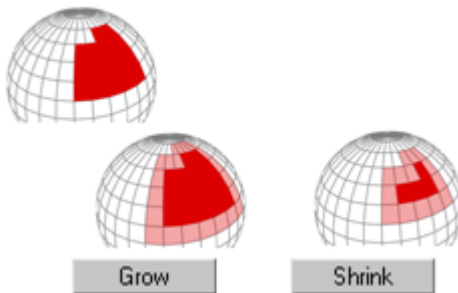

With Shrink and Grow, you can add or remove neighboring elements from the edges of your current selection. This works at any sub-object level.

**Ring** Expands an edge selection by selecting all edges parallel to the selected edges. Ring applies only to edge and border selections.

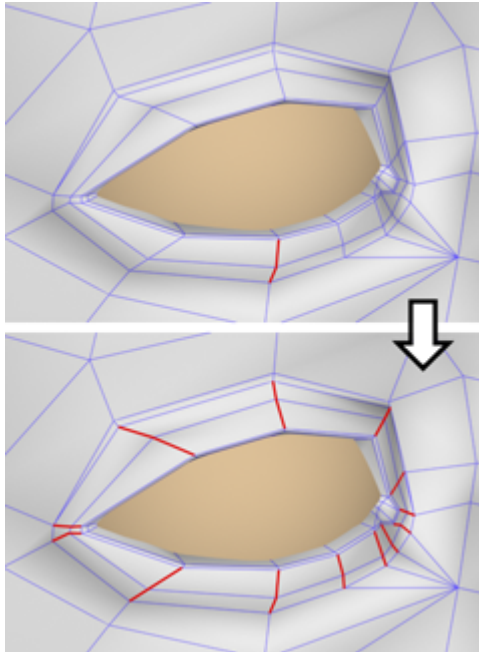

**Ring selection** adds to the selection all the edges that are parallel to the ones selected originally.

**Loop** Expands the selection as far as possible, in alignment with selected edges.

Loop applies only to edge and border selections, and propagates only through four-way junctions.

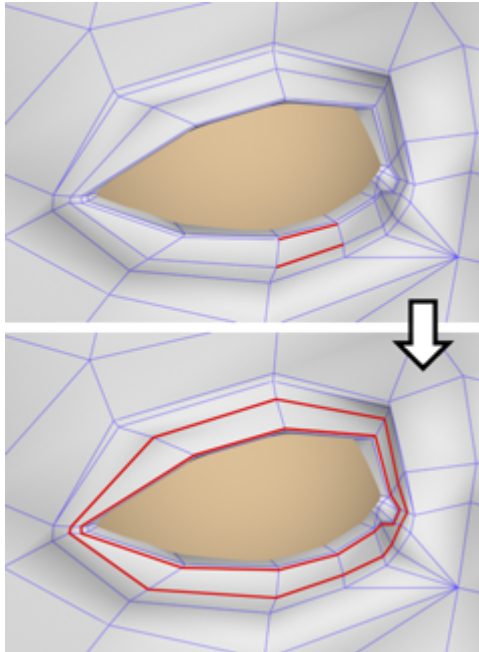

**Loop selection extends your current edge selection by adding all the edges aligned to the ones selected originally.**

### **Get from Other Levels group**

Applies selections from one sub-object level to another.

**Get Vertex Selection** Selects faces based on the last vertex selection. Selects all faces shared by any selected vertex. The selection is added to the current selection. Available only when the current sub-object level is not Vertex.

**Get Poly Selection** Selects vertices based on the last polygon/element selection. This selection is added to the current selection. Available only when the current sub-object level is not Polygon or Element.

**Get Edge Selection** Selects faces based on the last edge selection. Selects those faces that contain the edge. Available only when the current sub-object level is not Edge or Border.

### **Select by Material ID group**

Selects faces based on their material ID.

**ID** Set the spinner to the ID number you want to select, and then click the Select button. Press Ctrl while clicking to add to the current selection, or press Alt to remove from the current selection.

### **Named Selection Sets group**

These functions are primarily for copying [named selection sets](#) on page 179 of sub-objects between similar objects, and between comparable modifiers and editable objects. For example, you can apply a Poly Select modifier to a sphere, create a named selection set of edges, and then copy the selection to a different sphere that's been converted to an editable mesh object. You can even copy the selection set to a different type of object, because the selection is identified by the entities' ID numbers.

The standard procedure is to create a selection set, name it, and then use Copy to duplicate it into the copy buffer. Next, select a different object and/or modifier, go to the same sub-object level as you were in when you copied the set, and click Paste.

---

**NOTE** Because sub-object ID numbers vary from object to object, the results of copying named selection sets between different objects can be unexpected. For example, if the buffered set contains only entities numbered higher than any that exist in the target object, no entities will be selected when the set is pasted.

---

**Copy** Places a named selection into the copy buffer.

**Paste** Pastes a named selection from the copy buffer.

**Select Open Edges** Selects all edges with only one face. In most objects, this will show you where missing faces exist. Available only at the Edge or Border sub-object level.

### **Selection Info**

At the bottom of the Parameters rollout for Mesh Select is a text display giving you information about the current selection. If 0 or more than one sub-object is selected, the text gives the number and type selected. If one sub-object is selected, the text gives the ID number and type of the selected item.

---

**NOTE** When the current sub-object type is Element, selection information is given in polygons. When the current sub-object type is Border, selection information is given in edges.

---

## Soft Selection rollout

Soft Selection controls affect the action of sub-object Move, Rotate, and Scale functions. When these are on, 3ds Max applies a spline curve deformation to unselected vertices surrounding the transformed selected sub-object. This provides a magnet-like effect with a sphere of influence around the transformation.

For more information, see [Soft Selection Rollout](#) on page 1926 .

## Preserve Modifier

Modify panel > Make a selection. > Modifier List > Object-Space Modifiers > Preserve

Make a selection. > Modifiers menu > Parametric Deformers > Preserve

The Preserve modifier lets you retain, as much as possible, the edge lengths, face angles, and volume of an edited and deformed mesh object using an unmodified copy of the object before it was deformed. When you push and pull vertices at the sub-object level, the process typically stretches the edges and often alters the face angles, resulting in irregular topology. You can use the Preserve modifier to generate more regular edge lengths, and a "cleaner" mesh.

### Procedures

#### Using the Preserve modifier:

- 1 Create an object. Before you edit it, create a copy.
- 2 Edit the copy at the sub-object level, pushing and pulling vertices, faces, and so on.
- 3 Apply the Preserve modifier to the copy, click the Pick Original button, and then select the original, unmodified object.
- 4 Adjust controls in the Preserve modifier to fine-tune the mesh.

#### Example: Use the Preserve modifier on a geosphere:

- 1 Create a [GeoSphere](#) on page 361 and use Shift+Move to make a copy of it.



---

**TIP** If you want to see the effect of Preserve on mapping, apply a checker-mapped material to the sphere and display it in the viewports before making the copy.

---

- 2 Convert the copy to an [editable mesh](#) on page 1990 .
- 3 At the Vertex sub-object level, select a third of the vertices at the top of the sphere, and move them upward (as seen from the front) about one radius in distance.  
Notice the stretched edges between the moved vertices and the remaining vertices.
- 4 While still at the Vertex sub-object level, apply the Preserve modifier.
- 5 Click the Pick Original button, and then select the original (unedited) sphere.  
The selected vertices move back toward the sphere in an attempt to maintain the original volume and edge lengths.
- 6 Turn on Invert Selection.  
The selected vertices return to their moved position, and the unselected vertices (the inverted selection) move up toward the selected vertices.
- 7 Turn off Invert Selection and slowly reduce the Iterations to 0.  
The object now looks as it did before you applied Preserve.
- 8 Increase Iterations to the default 25, and then increase it to approximately 75.  
The object is now almost completely spherical again.
- 9 Set Iterations back to 25, and then try different Edge Lengths, Face Angles, and Volume settings. (You can restore the defaults by settings Edge Lengths to 1.0, and Face Angles and Volume to 0.3.

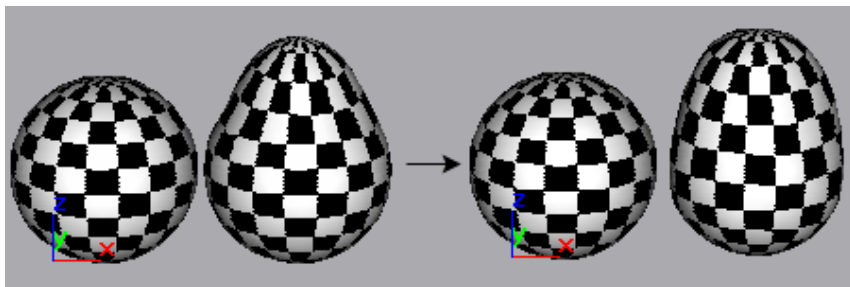
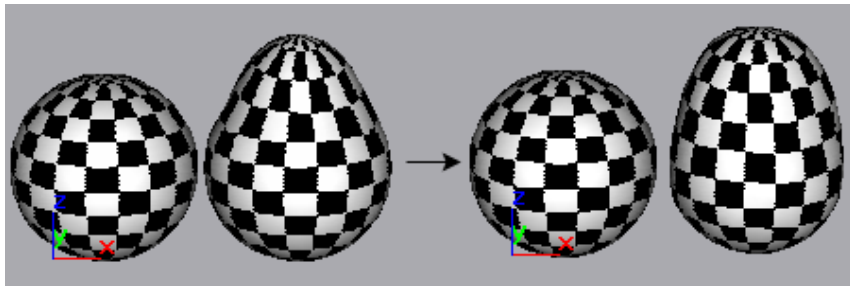
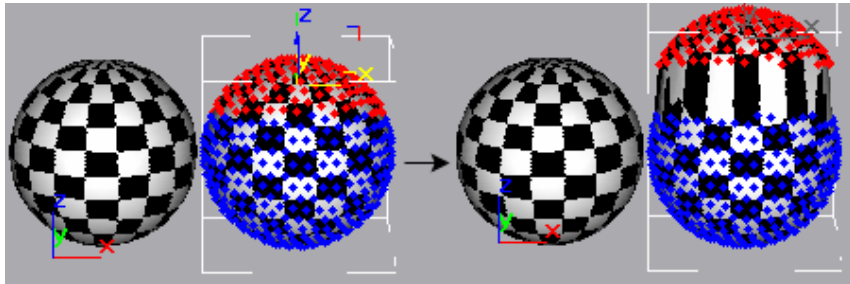
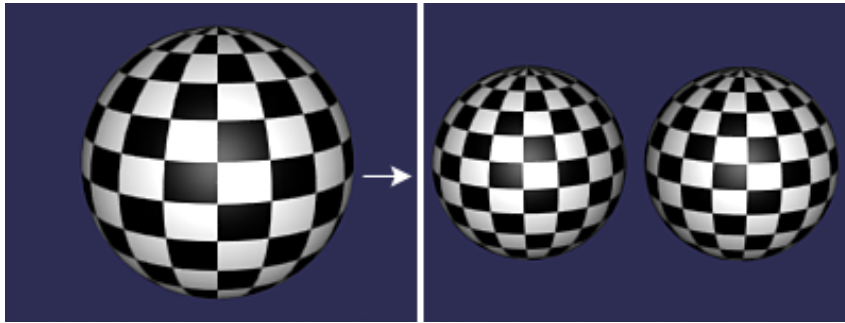

Steps in applying the Preserve modifier to a geosphere

### Example: Animating a preserved object:

You can animate the Preserve parameters, but the following procedure shows you how to use Morph and Preserve together.

- 1 Remove the Preserve modifier from the copied sphere, and go to object level (instead of sub-object level).



- 2 With the copied (and deformed) sphere still selected, choose Create panel > Compound Objects > Morph to make it into a Morph object.
- 3 Make sure Instance is chosen in the Pick Targets rollout.
- 4 At frame 0, click Pick Target, and then select the original sphere.



- 5 In the Modify panel, go to frame 100, select sphere02 in the Morph Targets list, and click Create Morph Key.

The object now morphs from a sphere to a deformed sphere.

- 6 Apply Preserve to the morph object.
- 7 Click Pick Original, and select the original sphere.

The object now morphs from the sphere to a preserved and deformed sphere. Note that because the object selection is passed up the stack, the Preserve effect is applied to the entire sphere.

- 8 Choose Selected Verts Only in the Selection group.

Now, only the selected vertices are affected by Preserve. The morph still works, however.

### Example: Using the Selection check boxes:

- 1 Reset the program, create a box, and convert it to an editable mesh.
- 2 Use Shift+Move to make a copy.



- 3 Use the Modify panel to select the top four vertices in the second box. Move them upward in Z, making the copied box taller than the original.
- 4 Apply Preserve, and pick the first box as the original.

The selected vertices move down to match the original edge lengths.

- 5 Set Iterations to **0** to move the vertices back up, then turn on Invert Selection, and set iterations back up to **25**.  
The selected vertices stay in their original locations, but the unselected vertices move upward to restore the original edge lengths.
- 6 Turn Iterations back down to **0**. Turn on Apply To Whole Mesh (Invert Selection becomes unavailable), and then turn Iterations back up to **25**.  
Preserve is now applied to the whole mesh. Since all vertices are affected, the top and bottom of the box approach each other.
- 7 Turn off Apply To Whole Mesh.  
All vertices are translated, but maintain the same positions relative to each other.
- 8 Turn off Invert Selection and turn on Selected Verts Only.  
You're back to the original effect. You can move the Iterations spinner up and down to see that you're affecting only the selected vertices.

**Example: Simulating cloth:**

- 1 Reset the program, create a Quad Patch Grid, and convert it to an editable mesh.
- 2 Make a copy, and then make a reference of the copy.  
You should have a total of three objects in the scene.
- 3 Apply Preserve to the third patch, using the first as the original.
- 4 Select Selected Verts Only and Invert Selection.
- 5 Set Iterations to **100**.
- 6 Select the second patch and go to the Sub-Object > Vertex level.
- 7 Select a single vertex in the middle of the patch and move it upward in Z.  
The third patch becomes a floating handkerchief.
- 8 Undo the vertex move.
- 9 Select the far two corner vertices of the second patch, and drag them upward in Z.  
Now, you've got the beginnings of a sheet hanging on the line.

## Interface

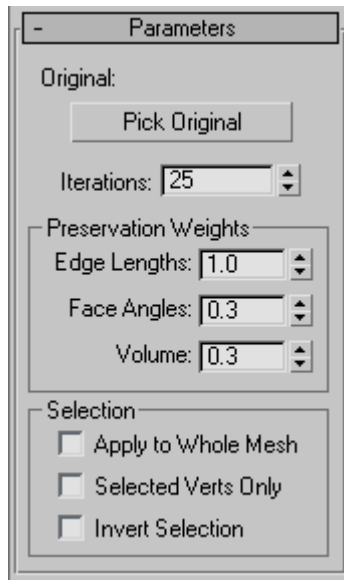

**Original** Displays the name of the selected original object. (Note that the so-called "original" object doesn't actually have to be the original. It's simply a copy of the object that represents its unmodified topology.)

**Pick Original** Click this, and then select an unmodified copy of the current object. You should pick an object with the same topology as the current object, which has the same number of vertices. While you can select a completely different object with equal vertices, the results are unpredictable.

**Iterations** Specifies the number of calculations toward the solution. The higher this number, the closer the object comes to matching the original object and the slower the process. When this is set to zero, the original object has no effect, as if the Preserve modifier were never applied.

### Preservation Weights group

**Edge Lengths, Face Angles, Volumes** Adjusts the relative importance of the three components you're attempting to preserve: edge lengths, face angles, and volume. In most cases, you'd leave these at their default settings, but you can achieve some interesting effects by altering them. Higher face angles, for example, produce stiffer meshes.

## Selection group

Provides options that let you specify which selection level to take from previous selection modifiers in the stack. The Preserve modifier acts on the specified selection.

**Apply to Whole Mesh** Applies Preserve to the entire object, regardless of the selection passed from previous levels of the stack. Disables the other two check boxes.

**Selected Verts Only** Uses previous sub-object vertex selections. Note that it doesn't matter if the Vertex sub-object level is active in a previous stack item. As long as vertices have been selected, Preserve will use that selection.

**Invert Selection** Inverts the selection passed up the stack.

---

**NOTE** If all of the check boxes are turned off, Preserve uses whatever active selection is passed up the stack. Thus, if a Mesh Select modifier is set to the Vertex level, then that vertex selection is used. If the same Mesh Select modifier is set to the top (object) level, then the entire object is affected.

---

## Projection Modifier

Select an object. > Modify panel > Modifier List > Object-Space Modifiers > Projection

The Projection modifier is used primarily to manage objects for producing [normal bump maps](#) on page 6182 . You apply it to the low-resolution object, and then pick a high-resolution object as the source for the projected normals. When you use the [Render To Texture dialog](#) on page 6195 to set up projection, Render To Texture applies the Projection modifier to the low-resolution object automatically. You can also explicitly apply the Projection modifier to set up the projection before you use Render To Texture.

---

**NOTE** The low-resolution object requires UV coordinates, but the high-resolution source object does not need to have them. When the normals map is rendered, you can choose to have Render To Texture apply an [“Automatic Flatten UVs” \(Unwrap UVW\) modifier](#) on page 1769 to the top of the low-res object's stack; or you can use existing mapping, if such exists.

---

You can apply more than one instance of the Projection modifier to the same object, and you can instance it across multiple objects.

The Projection modifier is a [topology-dependent modifier](#) on page 7951 , so when you select an item in the stack that is lower than the Projection modifier, you see a warning dialog that asks if you want to proceed. (The same is true of the Automatic Flatten UVs modifier.)

## Projection and Sub-Object Selections

You can match geometry to sub-object selections. There are two ways to do so: matching material IDs, or matching named selections of sub-object geometry.

### Matching Material IDs

Here is a sample workflow for using material IDs to match portions of the low-res object to different high-res objects:

- 1 At the level of the low-res object itself, assign differing material IDs to different face selections.  
To do so, the low-res object must be a surface model; that is, an editable mesh, editable poly, editable patch, or NURBS surface. Use the Surface Properties rollout to change the material ID of sub-object selections.
- 2 For the high-res target objects, assign corresponding material IDs.  
An easy way to do this is to apply the [Material modifier](#) on page 1445 .
- 3 In the Resolve Hit group of the [Projection Options dialog](#) on page 6214 , turn on Hit Only Matching Material ID.
- 4 Render to texture.  
The texture for faces of the low-res object receive texture element information only from the source object that had the corresponding material ID.

### Matching Selected Geometry

Here is a sample workflow for using sub-object selections to match portions of the low-res object to different high-res objects.

- 1 In the Projection modifier, go to the Face or Element sub-object level.  
See [Selection Rollout \(Projection Modifier\)](#) on page 1558 .
- 2 Make a sub-object selection, then on the [Reference Geometry rollout](#) on page 1560 , enter a descriptive name in the Name field.

- 3  Click the Add button or press Enter.  
The name of the sub-object selection set is added to the list.
- 4 Click in the list to highlight the selection-set name, click Pick or Pick List, and then select the high-res source object to associate with the sub-object selection.
- 5 Repeat steps 2 through 4 to associate different sub-object selections with different source objects.
- 6 Choose Rendering > Render To Texture.  
The Render To Texture dialog appears.
- 7 In the Projection group of the [Objects To Bake rollout](#) on page 6199, turn off Object Level and turn on Sub-Object Levels.
- 8 Click Render.  
Render To Texture renders a separate texture for each of the named sub-object selections contained in the Projection modifier.

## Interface

The interface to the Projection modifier includes these rollouts:

[Selection Rollout \(Projection Modifier\)](#) on page 1558

[Soft Selection Rollout](#) on page 1926

[Reference Geometry Rollout \(Projection Modifier\)](#) on page 1560

[Cage Rollout \(Projection Modifier\)](#) on page 1563

[Selection Check Rollout \(Projection Modifier\)](#) on page 1567

[Projection Rollout \(Projection Modifier\)](#) on page 1568

## Selection Rollout (Projection Modifier)

Select an object. > Modify panel > Modifier List > Object-Space Modifiers > Projection > Selection rollout

The Projection modifier's Selection rollout is for managing sub-object selections.



## Interface

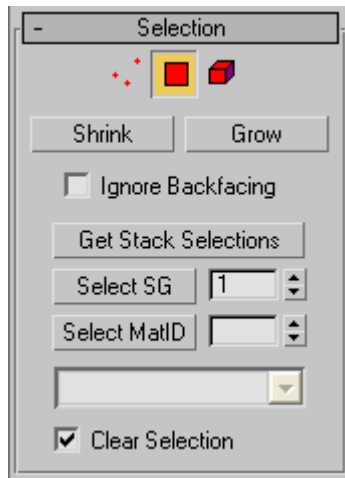

**Cage** Click to turn on the Cage sub-object level.

The Cage is the surface from which normals are projected. At the Cage sub-object level, you can adjust the cage manually by transforming sub-object selections of cage vertices.



**Face** Click to turn on the Face sub-object level.

The Face sub-object level lets you assign different source geometry to different portions of a surface.



**Element** Click to turn on the Element sub-object level.

The element sub-object level lets you assign different source geometry to individual elements. (An element is a group of contiguous faces.)

**Shrink** Reduces the sub-object selection area by deselecting the outermost sub-objects. If the selection size can no longer be reduced, the remaining sub-objects are deselected.

**Grow** Expands the selection area outward in all available directions.

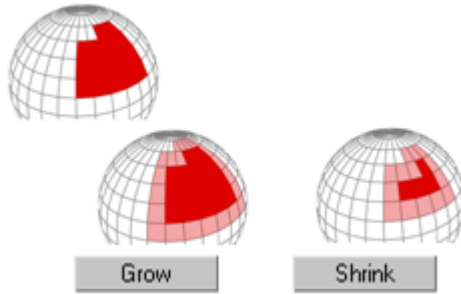

With **Shrink** and **Grow**, you can add or remove neighboring elements from the edges of your current selection. **Shrink** and **Grow** work at any sub-object level.

**Ignore Backfacing** When on, selection of sub-objects affects only those facing you. When off, you can select any sub-objects under the mouse cursor, regardless of visibility or facing. If multiple sub-objects lie under the cursor, repeated clicking cycles through them. Likewise, with **Ignore Backfacing** off, region selection includes all sub-objects, regardless of the direction they face. Default=off.

**Get Stack Selections** Click to collect sub-object selections from modifiers that are below the **Projection** modifier on the stack.

**Select SG** To select by smoothing group value, use the spinner to set the number of the smoothing group, and then click **Select SG**.

**Select MatID** To select by material ID, use the spinner to set the ID number, and then click **Select MatID**.

- **Sub-material drop-down list** When a multi/sub-object material is applied to the low-res object, this list shows the names and numbers of sub-materials that are assigned to faces or elements of the object. When you have selected by material ID, the corresponding sub-material appears in the field above the list.

**Clear Selection** When on, each stack, smoothing group, or material ID selection you make replaces the previous selection. When off, each new selection is added to the previous selection set. Default=on.

## Reference Geometry Rollout (Projection Modifier)

Select an object. > **Modify** panel > **Modifier List** > **Object-Space Modifiers** > **Projection** > **Reference Geometry** rollout

On the Reference geometry rollout, you can create named sub-object selection sets, and associate them with high-resolution geometry.

## Interface



**Name** Lets you enter a name for the current set of selected sub-objects.



**Delete** Click to delete the sub-object selection set whose name is highlighted in the list.



**Add** Click to add the named sub-object selection set to the list.

Keyboard shortcut: Enter.



**Select** Click to select the sub-objects in the selection set whose name is highlighted in the list.



**Delete All** Click to delete all named sub-object selection sets in the list.

**Reference geometry window** This window shows a list of named sub-object selection sets, and the high-resolution source geometry with which they're associated. If you have picked a high-res object at the object level, it also shows "Object Level" followed by the name of the source object.

**Proportion Multiplier** When Proportional is chosen for sub-object normal bump mapping in the Projection Mapping group of the [Objects To Bake rollout](#) on page 6199 for Render To Texture, this value multiplies the default size of the normal bump map. Range=0.0 to 2.0. Default=1.0.

For example, if Proportional rendering of a sub-object were to render a sub-object selection at 16 x 16 pixels, changing Proportion Multiplier to 2.0 would change the size of the normal bump map to 32 x 32 pixels.

This control is unavailable unless a sub-object selection is active.



**Pick** To associate high-res geometry with the current selection, click Pick to turn it on, then click a source object in a viewport.

**Pick List** To associate high-res geometry with the current selection, click Pick List, then use the Add Objects dialog, which works like the [Select From Scene dialog](#) on page 168 , to choose a source object.

### Display Toggle group

The Display Toggle group is useful when you want to compare the hi—res to your low-res geometry. You can quickly toggle between your low-res geometry and your hi-res geometry to compare versions. You can show selected or all hi-res geometry.

**Enable** When on, makes it possible to show or hide reference geometries. Default=off.

**Hide Reference Geometry/Hide Working Geometry** When Enabled is on, click Hide Reference Geometry to hide your hi-res geometry. Conversely, click Hide Working Geometry to hide your low-res geometry. You can also selectively show and hide high-res geometries in your Pick List. Click Off  to hide a geometry. Click Hide  to show a geometry.

## Cage Rollout (Projection Modifier)

Select an object. > Modify panel > Modifier List > Object-Space Modifiers > Projection > Cage rollout

These settings adjust the cage and its display. The cage is the nonrenderable geometry that the Projection modifier uses as the surface from which it ray-traces normals.

---

**NOTE** Special export/import functionality available on this rollout lets you convert the cage into standard geometry of the same type and topology as the cage and modified object, which you can edit using standard methods and then use to define a new shape for the cage. This provides access to the full range of mesh-editing tools available in 3ds Max for shaping the cage to your precise requirements. For example, with editable poly, you can take advantage of tools such as Loop, Ring, Grow, and Shrink, and quickly switch among sub-object levels such as Face and Vertex.

---

### Procedures

#### To use Export and Import with a cage:

- 1 Create a cage:
  - 1 Create low-resolution and high-resolution objects. In most cases, for best results they should be arranged concentrically.
  - 2 Apply the Projection modifier to the low-resolution object.  
This creates the cage with the same shape and position as the low-resolution object.
  - 3 Use the Reference Geometry rollout controls to specify one or more high-resolution objects.
  - 4 On the Cage rollout, click Update.  
This reshapes the cage, roughly enveloping the high-resolution object(s).
- 2 On the Cage rollout, click Export.  
This creates a separate geometrical object in the same shape as the cage, with the same type and topology as the low-resolution object. We'll call this the *cage object*.

For example, if the low-resolution object is an editable poly, or has an Edit Poly modifier at the top of the modifier stack, the resultant cage object is of editable poly type.

- 3 Use standard object-editing tools to modify the cage object's shape. Do not alter its topology by adding or removing vertices, edges, etc., because that would invalidate its usage for reshaping the cage. Also, for best results, do not move the cage object. If you wish, you can temporarily hide any overlapping objects.
- 4 Select the low-resolution object.
- 5 On the Cage rollout, click Import and then select the cage object.

If the cage object type and topology are the same as the low-resolution object, the software reshapes the cage to match the cage object's shape. Alternatively, if the cage object can be converted to the same type as the low-resolution object without a change in topology, it is also accepted. If not, a warning appears and no reshaping takes place.

---

**IMPORTANT** The resultant cage matches the imported cage object's shape, position, orientation, and size exactly.

---

If the import is successful, the cage object can be deleted, or retained for possible future cage modification.

## Interface

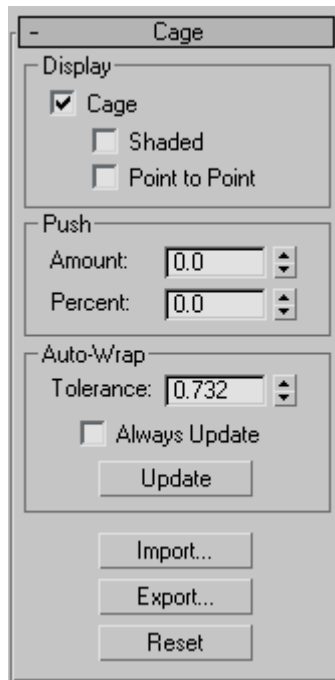

### Display group

**Cage** When on, the cage is displayed. When off, the cage is hidden except at the Cage sub-object level. Default=on.

The cage is always displayed at the Cage sub-object level, regardless of this toggle's setting. See [Selection Rollout \(Projection Modifier\)](#) on page 1558 .

■ **Shaded** When on, the cage is shaded with a transparent gray. When off, the cage is displayed as a blue lattice. Default=off.

The Shaded option can be useful when you need to tell whether or not high-resolution source geometry is within the cage, and when you need to expand the cage to include more geometry.

■ **Point to Point** When on, additional lines connect vertices in the cage to points on the target object, showing how the projection will be done. Default=off.

## Push group

These controls let you adjust the size of the cage as a whole, or on a sub-object selection if one is currently chosen (see [Reference Geometry Rollout \(Projection Modifier\)](#) on page 1560 ).

**Amount** Change to adjust the size of the cage in 3ds Max units. Positive values increase the size of the cage; negative values decrease the size. Default=0.0.

**Percent** Change to adjust the size of the cage as a percentage. Positive values increase the size of the cage; negative values decrease the size. Default=0.0.

## Auto-Wrap group

By default, the Projection modifier does not automatically create a cage that wraps around the geometry. To change the cage, use the settings in this group or the Push group, or adjust cage vertices manually at the Cage sub-object level.

**Tolerance** The distance in 3ds Max units, between the cage and the target geometry. Positive values are outside the high-res source geometry; negative values are inside the source geometry. Default=varies, depending on the geometry.

**Always Update** When on, the cage automatically expands around high-res geometry as it is added to the list (see [Reference Geometry Rollout \(Projection Modifier\)](#) on page 1560 ). When off, the initial cage is not updated automatically. Default=off.

**Update** Click to update the cage. Use this when Always Update is off.

**Import** Lets you specify a mesh object to define the cage shape. This is typically an object that was created with Export (see following) and then modified using standard mesh-editing methods. After clicking Import, select the object to import. After importing the object, the cage conforms to its shape. You can then delete the imported object if you wish.

---

**IMPORTANT** The imported object should be of the same type (for example, editable mesh) as the projection object (that is, the object with the Projection modifier), or be convertible to that type without topology change, and must have the identical topology. If it doesn't meet either or both of those criteria, an alert appears requesting that you select an object of the same type and identical topology.

---



**Export** Creates a geometry object from the cage, with the same type and topology as the modified object. Clicking Export causes the Export Cage dialog to open. Accept the default “Export as” object name or enter a new one, and then click OK.

For a detailed description of the export/import process, see [To use Export and Import with a cage](#): on page 1563 .

**Reset** Click to reset the cage to a wrapping that is the same size as the low-resolution target geometry.

## Selection Check Rollout (Projection Modifier)

Select an object. > Modify panel > Modifier List > Object-Space Modifiers > Projection > Selection Check rollout

This rollout lets you check selections to see if any are overlapping; that is, if a material ID or a face or element is assigned to more than one selection.

### Interface

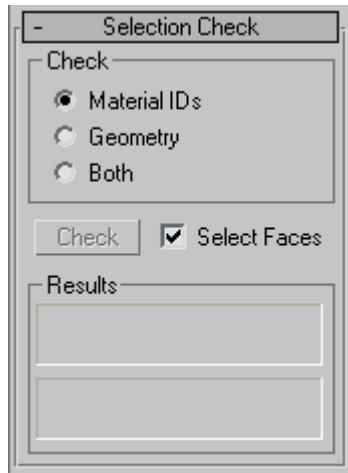

### Check group

- **Material IDs** Checks for material IDs being assigned to more than one selection.

- **Geometry** Checks for faces or elements being assigned to more than one selection.
- **Both** (The default.) Checks for both material ID and sub-object overlap.

**Check** Click to run the check.

**Select Faces** When on, if running the selection check detects “bad” selections, the “bad” faces are selected by the Projection modifier automatically. When off, “bad” selections are not selected automatically. Default=on.

### **Results group**

After you click Check, the fields in this group display the results. The first field is for material IDs, and the second is for sub-object selections. If there is no conflict, the first field says “No conflicting Mat IDs detected,” and the second says “No conflicting face selections detected.” If there is a conflict, the results say something such as, “6 Mat IDs are assigned to more than one selection.”

## **Projection Rollout (Projection Modifier)**

Select an object. > Modify panel > Modifier List > Object-Space Modifiers > Projection > Projection rollout

The Projection rollout has controls for projecting data from the object with the Projection modifier *to* a different object. This data flow is the reverse of what it is when you project normals from a high-resolution object to a low-resolution object.

## Interface

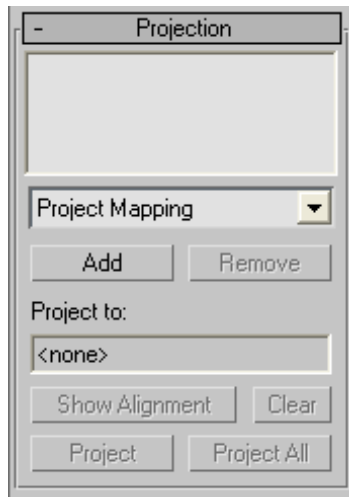

**Projector list** Shows the active projector plug-ins.

**Projector plug-in drop-down list** Lets you choose a projector plug-in. Only one projector, Project Mapping, is provided with 3ds Max. See [Project Mapping Rollout \(Projection Modifier\)](#) on page 1570 . Additional projectors might be available from third-party sources.

---

**NOTE** Multiple instances of the Project Mapping plug-in can be active.

---

**Add** Adds a projector of the type chosen in the drop-down list.

**Remove** Removes the projector that is currently highlighted in the projector list.

**Project to** Shows the name of the geometry to which you're projecting. To choose this geometry, use the [Reference Geometry rollout](#) on page 1560 .

**Show Alignment** Click to display the faces of the geometry selection that will project to the selected faces of the object that has the Projection modifier. This shows which hi-res faces will be projected to the selected low-res faces.

This works only for selected faces, not selected vertices: you can lock a face selection and then make adjustments to the cage, then click Show Alignment to see the effects of the cage modification.

This button is unavailable if no selection has been made in the Reference Geometry rollout.

**Clear** Click to turn off the Show Alignment display.

**Project** Click to perform the projection.

**Project All** Click to perform all projections that are in the projector list.

## Project Mapping Rollout (Projection Modifier)

Select an object. > Modify panel > Modifier List > Object-Space Modifiers > Projection > Projection rollout > Choose Project Mapping in the plug-in drop-down list (this is the only available choice unless third-party plug-ins have been installed). > Click Add > Project Mapping rollout.

Select an object. > Modify panel > Modifier List > Object-Space Modifiers > Projection > Projection rollout > Highlight a Project Mapping projector in the Projector list. > Project Mapping rollout.

The Project Mapping rollout contains controls for the Project Mapping projector plug-in. This rollout is visible when a Project Mapping instance is highlighted in the Projector list on the [Projection rollout](#) on page 1568 . Use Project Mapping to project a map channel value, material IDs, or vertex attributes from the object that has the Projection modifier applied, onto other geometry.

## Interface

**Project Mapping**

Project Mapping 1

Projection Holder

Projection Holder 1

Create New Holder

Same Topology

Always Update

Source Channel

Map Channel 1

Vertex Color

Vertex Illum

Vertex Alpha

Vertex Position

Target Channel

Same as Source

Map Channel 1

Vertex Color

Vertex Illum

Vertex Alpha

Vertex Position

Project Material IDs

Projection Mapping Quality

Ignore Backfaces

Test Seams

Check Edge Ratios

Threshold: 0.1

Weld UVs

Threshold: 5.0

**Projector name field** Shows the name of the Project Mapping projector. If you edit this field, the change is reflected on the [Projection rollout](#) on page 1568 .

### Projection Holder group

**Projection Holder name field** Shows the name of the Projection Holder modifier. If you edit this field, the change is reflected in the target object's stack, but not until you click Project on the Projection rollout.

**Create New Holder** When you click the Project button in the Project rollout, a Projection Holder modifier is added to the geometry selection. When Create New Holder is on, 3ds Max creates and adds a new modifier each time you click Project. When Create New Holder is off, clicking Project simply updates the data in the existing Projection Holder; it creates a new Projection Holder modifier only if none was present, before. Default=off.

**Same Topology** When on, the source object's topology is transferred to the target object. Default=off.

---

**IMPORTANT** You need to turn on Same Topology when you project to the target object's Vertex Position.

---

**Always Update** When on, changing the object with the Projection modifier automatically re-projects and updates the Projection Holder modifiers on the geometry selections. When off, projection is recalculated only when you click Project. Default=off.

This toggle is available only when Create New Holder is off and Same Topology is on.

When Always Update is on, changes to the geometry with the Projection modifier can manipulate UVW channels or animate vertex colors of the objects with the Projection Holder modifiers.

### Source Channel group

- **Map Channel** (The default.) Projects a [map channel](#) on page 7836 value. Use the spinner to set the channel value.
- **Vertex Color** Projects vertex color values.
- **Vertex Illum** Projects vertex illumination (grayscale) values.
- **Vertex Alpha** Projects vertex alpha values.
- **Vertex Position** Projects vertex positions.

## Target Channel group

**Same as Source** When on, the radio buttons in this group are disabled, and the Project Mapping projector projects to the same channel that is chosen in the Source Channel group. When off, the radio buttons in this group are enabled. Default=on.

The radio buttons are the same as the ones in the Source Channel group. When Same As Source is off, the chosen map channel or vertex data of the target geometry derives its value from the channel or vertex data chosen in the Source Channel group.

The projection does not take place until you click Project or Project All on the Projection rollout.

**Project Material IDs** When on, projects values. Default=off.

The projection does not take place until you click Project or Project All on the Projection rollout.



## Projection Mapping Quality group

Use these settings to improve the quality of the mapping when projecting texture mapping from one object to another.

**Ignore Backfaces** When on, does not take backfaces into account when calculating the projection. In the case of overlapping faces, this can prevent projection, resulting in undesirable erroneous faces. In almost all cases this should remain off.

**Test Seams** Tests for seams by walking around the neighboring faces and then will try to fix the faces

**Check Edge Ratios** Attempts to correct UVW faces that look abnormal; that is, that are not similar to their geometry faces. This compares edge ratio lengths and angle ratio. It typically finds the sliver faces generated by projections across seams. The larger the Threshold value, the more likely a face is to be tagged as abnormal and fixed.

**Weld UVs** Welds all the UVs at the end of the projection and combines them into groups, based on the Threshold value. The Threshold value is based on edges, so it welds UVs based on the the closest N edges. In most cases this should be on.

## Projection Holder Modifier

Select an object. > Modify panel > Modifier List > Object-Space Modifiers > Projection modifier > Geometry rollout > Choose target geometry > Projection rollout > Click Add. > Click Project. > Projection Holder is applied to the target geometry.

The Projection Holder modifier appears for objects being used by the Projection modifier's [Project Mapping feature](#) on page 1568 . It contains the data generated by the Project Mapping operation, much as UVW Mapping Add or UVW Mapping Clear do for Channel Info manipulations.

### Interface

The Projection Holder modifier has no parameters.

## Push Modifier

Modify panel > Make a selection. > Modifier List > Object-Space Modifiers > Push

Make a selection. > Modifiers menu > Parametric Deformers > Push

The Push modifier lets you "push" object vertices outward or inward along the average vertex normals. This produces an "inflation" effect that you can't otherwise obtain.



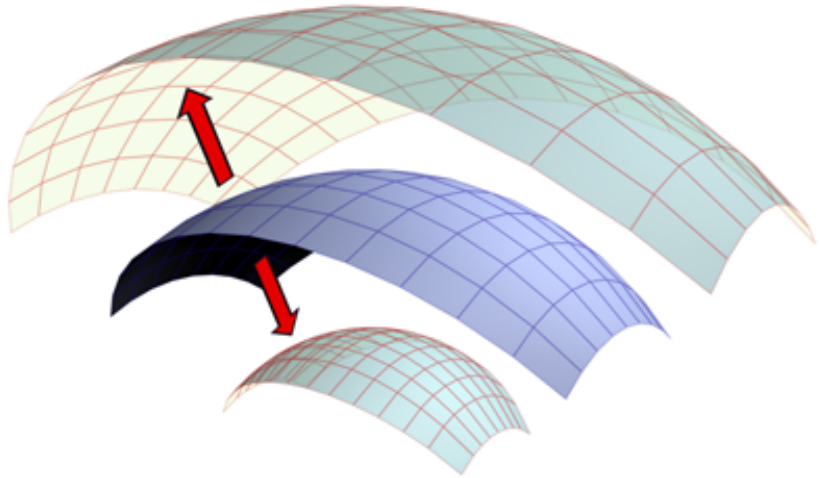

Positive and negative amounts of push applied to an object.

### Interface

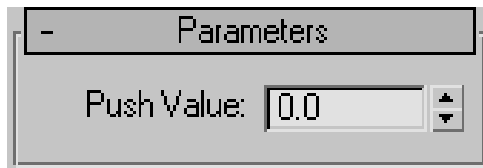

**Push Value** Sets the distance in world units by which vertices are moved with respect to the object center. Use a positive value to move vertices outward, or a negative value to move vertices inward.

## Relax Modifier

Modify panel > Make a selection. > Modifier List > Object-Space Modifiers > Relax

Make a selection. > Modifiers menu > Parametric Deformers > Relax

The Relax modifier changes the apparent surface tension in a mesh by moving vertices closer to, or away from, their neighbors. The typical result is that the object gets smoother and a little smaller as the vertices move toward an averaged center point. You can see the most pronounced effects on objects with sharp corners and edges.

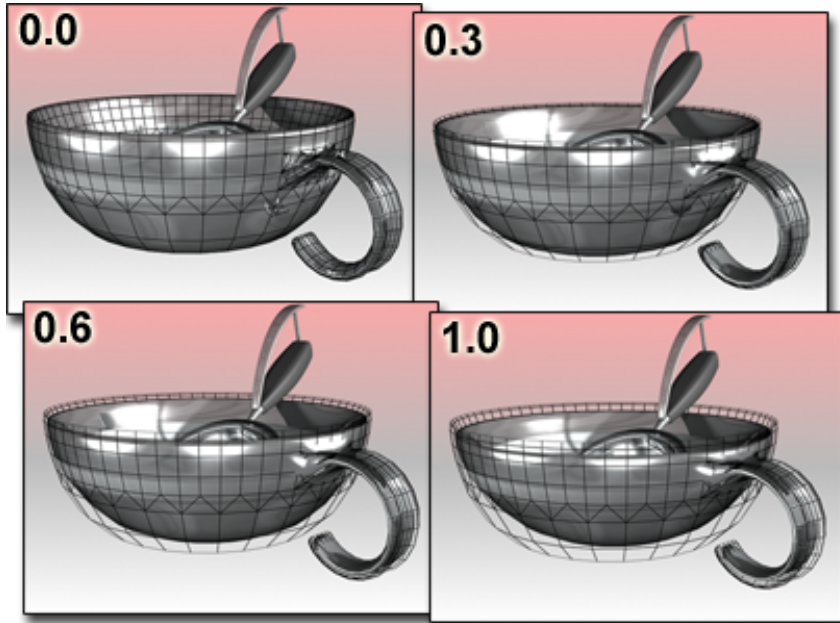

**Relax moves the bowl away from its original contours.**

When you apply Relax, each vertex is moved toward the average position of its neighboring vertices. A neighboring vertex is one that shares a visible edge with the current vertex.

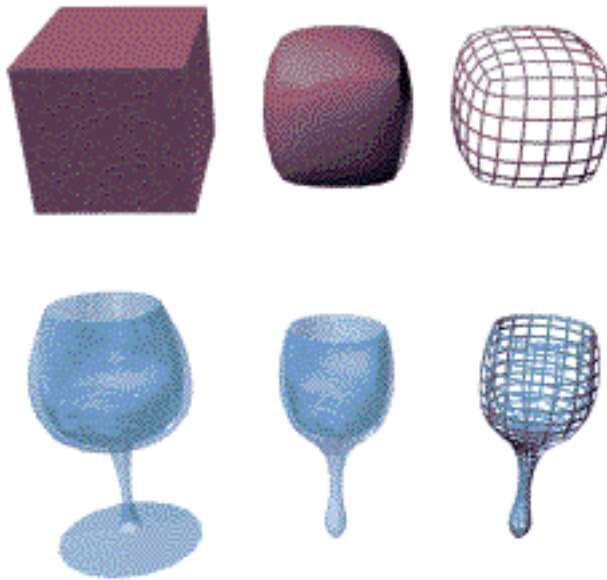

Original objects compared to relaxed objects

### Patches

As of version 4, a patch object coming up the modifier stack is not converted to a mesh by this modifier. A patch object input to the Relax modifier retains its patch definition. If a file created by a previous version of 3ds Max contains a patch object applied with the Relax modifier, it will be converted to a mesh to maintain backward compatibility.

### Interface

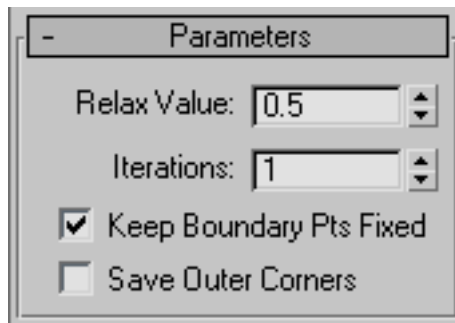

**Relax Value** Controls how far a vertex moves for each iteration. The value specifies a percentage of the distance from the original location of a vertex to the average location of its neighbors. Range=-1.0 to 1.0. Default=0.5.

- Positive Relax values move each vertex in closer to its neighbors. The object becomes smoother and smaller.
- When the Relax value=0.0, vertices do not move and Relax has no affect on the object.
- Negative Relax values move each vertex away from its neighbors. The object becomes more irregular and larger.

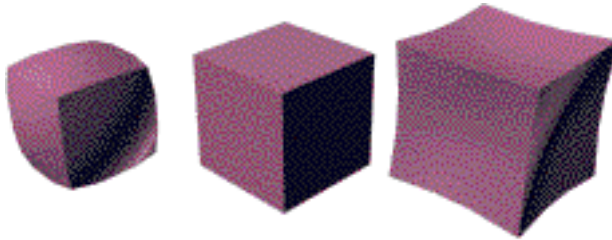

Relax Values=1.0, 0.0, -1.0

Iterations=1 (default)

**Iterations** Sets how many times to repeat the Relax process. For each iteration, average locations are recalculated and the Relax Value is reapplied to every vertex. Default=1.

- For 0 iterations, no relaxation is applied.
- Increasing iterations for positive Relax Value settings smooths and shrinks an object. With very large iteration values, the object shrinks to a point.
- Increasing iterations for negative Relax Value settings exaggerates and expands an object. With relatively few iterations, the object becomes jumbled and almost unusable.

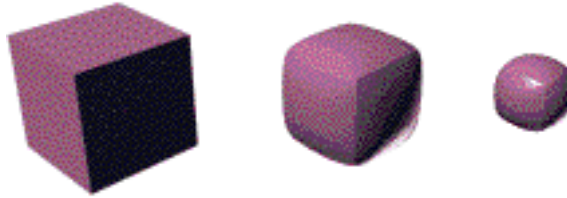

Iterations=0, 10, 50

Relax Value=0.5 (default)

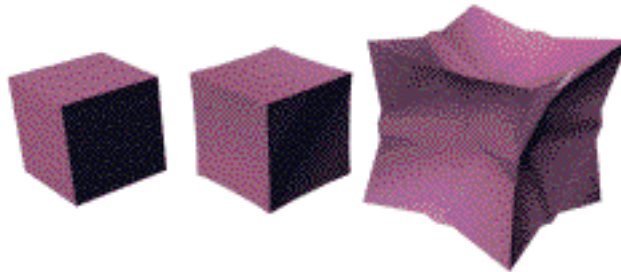

Iterations=0,1, 5

Relax Value=-0.5

**Keep Boundary Pts Fixed** Controls whether vertices at the edges of open meshes are moved. Default=on.

When Keep Boundary Pts Fixed is on, boundary vertices do not move while the rest of the object is relaxed. This option is particularly useful when working with multiple objects, or multiple elements within a single object, that share open edges.

When this check box is off, all vertices of the object are relaxed.

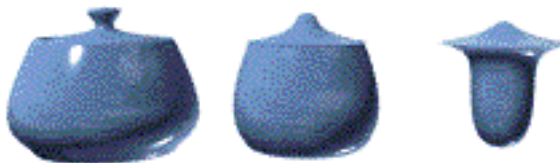

Keep Boundary Pts Fixed=on

Iterations=0, 10, 50



**Keep Boundary Pts Fixed=off**  
**Iterations=0, 10, 50**

**Save Outer Corners** Preserves the original positions of vertices farthest away from the object center.

## Renderable Spline Modifier

Select a shape. > Modify panel > Modifier List > Renderable Spline

The Renderable Spline modifier lets you set the renderable properties of a spline object, without collapsing the spline to an editable spline. This is particularly useful with splines you have linked to from AutoCAD. It also lets you apply the same rendering properties to multiple splines at once.

---

**NOTE** This modifier cannot be applied to NURBS curves.

---

## Interface

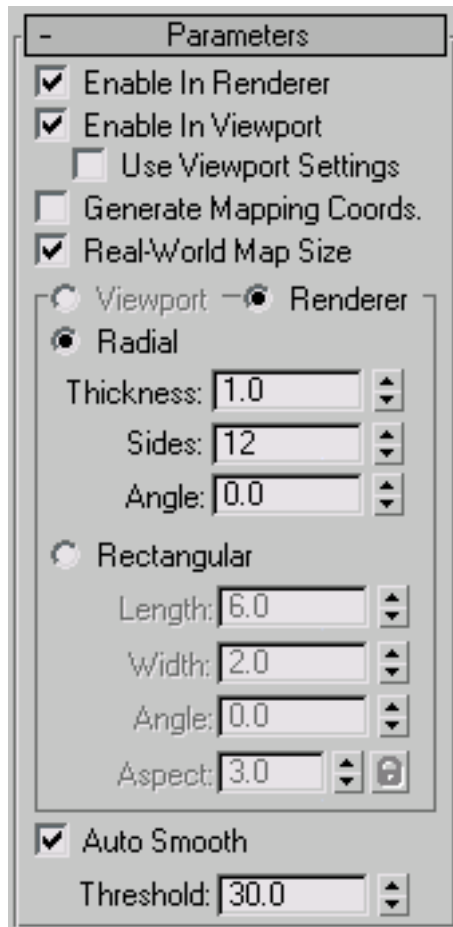

**Enable In Renderer** When on, the shape is rendered as a 3D mesh using the Radial or Rectangular parameters set for Renderer. In previous versions of the program, the Renderable switch performed the same operation.

**Enable In Viewport** When on, the shape is displayed in the viewport as a 3D mesh using the Radial or Rectangular parameters set for Renderer. In previous versions of the program, the Display Render Mesh performed the same operation.

**Use Viewport Settings** Lets you set different parameters for viewport display and rendering, and displays the mesh generated by the Viewport settings in the viewports. Available only when Enable in Viewport is turned on.

**Generate Mapping Coords** Turn this on to apply mapping coordinates. Default=off.

3ds Max generates the mapping coordinates in the U and V dimensions. The U coordinate wraps once around the spline; the V coordinate is mapped once along its length. Tiling is achieved using the Tiling parameters in the applied material. For more information, see [Mapping Coordinates](#) on page 5183 .

**Real-World Map Size** Controls the scaling method used for texture mapped materials that are applied to the object. The scaling values are controlled by the Use Real-World Scale settings found in the applied material's [Coordinates rollout](#) on page 5620 . Default=on.

**Viewport** Choose this to specify Radial or Rectangular parameters for the shape as it will display in the viewport when Enable In Viewport is on. Available only when Use Viewport Settings is on

**Renderer** Choose this to specify Radial or Rectangular parameters for the shape as it will display when rendered or displayed in the viewport when Enable in Viewport is turned on.

**Radial** Displays the spline as a 3D object with a circular cross-section.

- **Thickness** Specifies the cross-section diameter. Default=1.0. Range=0.0 to 100,000,000.0.
- **Sides** Sets the number of sides for the spline mesh in the viewports or renderer. For example, a value of 4 produces a square cross-section.
- **Angle** Adjust the rotational position of the cross section in the viewports or renderer. For example, if you have a square cross section you can use Angle to position a "flat" side down.

**Rectangular** Displays the spline as a 3D object with a rectangular cross-section.

- **Length** Specifies the size of the cross-section along the local Y axis.
- **Width** Specifies the size of the cross-section along the local X axis.
- **Angle** Adjusts the rotational position of the cross-section in the viewport or renderer. For example, if you have a square cross-section you can use Angle to position a "flat" side down.



- **Aspect** Sets the aspect ratio for rectangular cross-sections. The Lock check box lets you lock the aspect ratio. When Lock is turned on, Width is locked to Depth that results in a constant ratio of Width to Depth.

**Auto Smooth** When on, the spline is auto-smoothed using the smoothing angle specified by the Threshold setting. Auto Smooth sets the smoothing based on the angle between spline segments. Any two adjacent segments are put in the same smoothing group if the angle between them is less than the threshold angle.

---

**NOTE** Turning Auto Smooth on for every situation does not always give you the best smoothing quality. Altering the Threshold angle may be necessary or turning Auto Smooth off may produce the best results.

---

**Threshold** Specifies the threshold angle in degrees. Any two adjacent spline segments are placed in the same smoothing group if the angle between them is less than the threshold angle.

## Ripple Modifier

Modify panel > Make a selection. > Modifier List > Object-Space Modifiers > Ripple

Make a selection. > Modifiers menu > Parametric Deformers > Ripple

The Ripple modifier lets you produce a concentric rippling effect in an object's geometry. You can set either of two ripples or a combination of both. Ripple uses a standard gizmo and center, which you can transform to increase the possible ripple effects.

The [Ripple](#) on page 2699 space warp has similar features. It is useful for applying effects to a large number of objects.

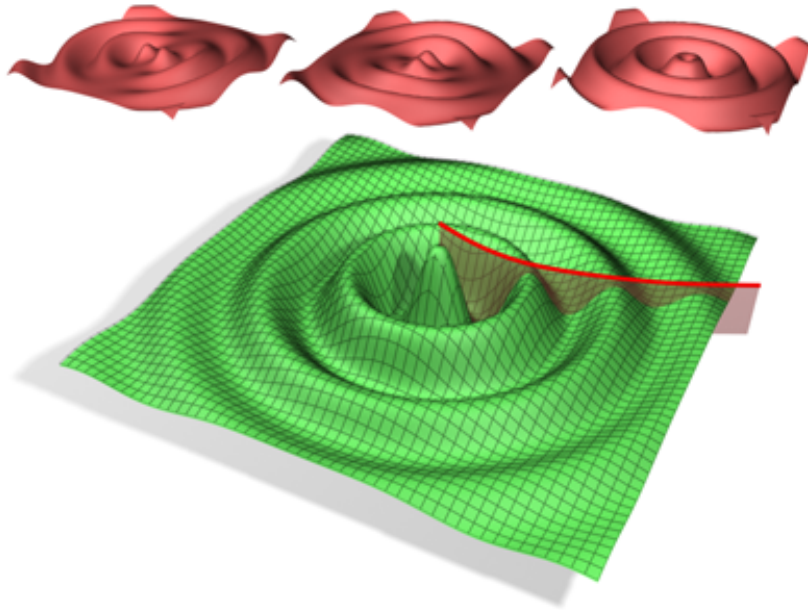

An object with the Ripple modifier applied.

Top (from left to right): Amplitude 1 only, Amplitude 2 only and both amplitudes.

Bottom: Both amplitudes with the Decay effect.

See also:

- [Wave Modifier](#) on page 1918

## Procedures

**Example: To use the Ripple modifier:**

- 1 Start with an empty scene, and add a [Plane object](#) on page 380 in the Perspective viewport. Set Length and Width both to **100.0**, and set Length Segs and Width Segs both to **10**.

The Plane object is useful as the basis for the surface of a body of water in which ripples form.

- 2  Go to the Modify panel, click Modifier List, and, from the Object-Space Modifiers list, choose Ripple.

This applies the modifier to the Plane object.

- 3 On the Parameters rollout, set Amplitude 1 to **10.0**.

A large ripple forms in the Plane object.

You can change the horizontal scale by adjusting the wave length.

- 4 Set Wave Length to **20.0**. The waves become smaller, but now it's apparent that the Plane object needs greater geometric resolution to properly display the number of waves.

- 5 In the modifier stack, click the Plane item, and then set Length Segs and Width Segs both to **30**.

The smaller waves become more apparent. The Ripple modifier needs a relatively high number of subdivisions in the geometry it's applied to in order to work properly.

You can use the Amplitude 2 parameter to add complexity to the wave forms created by Ripple.

- 6 Return to the Ripple level of the modifier stack, and then click and hold on the Amplitude 2 and drag downward.

As you drag, a new set of wave forms are combined with the existing ones. The farther you drag, the more dominant the second set becomes. Using a negative value for Amplitude 2 (or a positive one if Amplitude 1 is negative) produces more of an interference effect between the two sets of waves.

You can animate the waves with the Phase control.

- 7 Drag slowly upward or downward on the Phase spinner.

Increasing the Phase value moves the waves inward, and decreasing it moves the outward. To animate the waves, create [keyframes](#) on page 7344 for the Phase value.

To simulate an object dropping in liquid, use the Decay setting.

- 8 Drag slowly upward on the Decay spinner.

The farther you drag, the more the wave sizes decrease with the distance from the center of the effect. This is the effect you get when an object perturbs the water surface, and the waves lose energy as they move away from the point of impact.

## Interface

### Modifier Stack

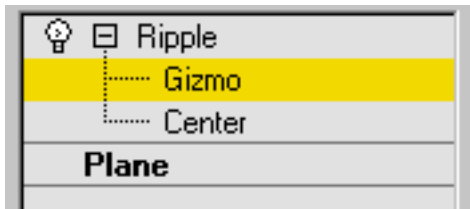

**Gizmo** At this sub-object level, you can transform and animate the gizmo like any other object, altering the effect of the Ripple modifier. Translating the gizmo translates its center an equal distance. Rotating and scaling the gizmo takes place with respect to its center.

**Center** At this sub-object level, you can translate and animate the center of the ripple effect, and thus the shape and positions of the ripples.

For more information on the stack display, see [Modifier Stack](#) on page 7427 .

### Parameters rollout

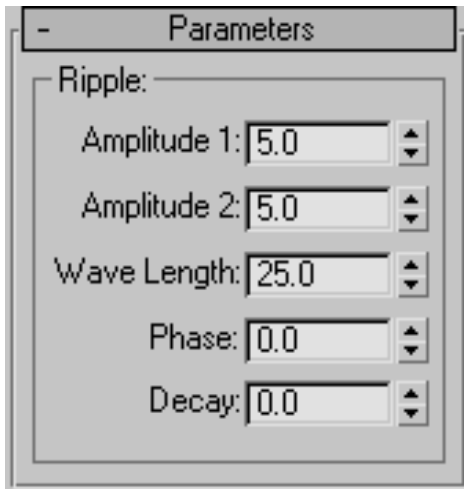

**Amplitude 1 / Amplitude 2** Amplitude 1 produces a ripple across the object in one direction, while Amplitude 2 creates a similar ripple at right angles to the first (that is, rotated 90 degrees about the vertical axis).

**Wave Length** Specifies the distance between the peaks of the wave. The greater the length, the smoother and more shallow the ripple for a given amplitude. Default=50.0.

**Phase** Shifts the ripple pattern over the object. Positive numbers move the pattern inward, while negative numbers move it outward. This effect becomes especially clear when animated.

**Decay** Limits the effect of the wave generated from its center.

The default value of 0.0 means that the wave will generate infinitely from its center. Increasing the Decay value causes the wave amplitudes to decrease with distance from the center, thus limiting the distance over which the waves are generated.

## Select By Channel Modifier

Select an object. > Modify panel > Modifier List > Select By Channel

The Select By Channel modifier works in conjunction with the [Channel Info utility](#) on page 5858 . After you store a vertex selection into a subcomponent with Channel Info, use Select By Channel to quickly access the selection.

### Procedures

#### To use Select By Channel:

- 1 Use Channel Info to store one or more vertex selections in a map channel subcomponent.
- 2 Apply the Select By Channel modifier to the object with the stored vertex selection(s).
- 3 Choose the selection type.
- 4 Choose the selection channel.
- 5 To “bake” the new selection into the object, collapse the stack.

## Interface

**Selection Type** Lets you choose how to combine the stored vertex selection with an existing vertex selection.

- **Replace** Replaces the existing selection with the stored selection.
- **Add** Adds the stored selection to the existing selection.
- **Subtract** Subtracts the stored selection from the existing selection. Has no effect if there's no overlap between the stored selection and the existing selection.

**Selection Channel** Lets you choose which stored, named vertex-selection channel to apply to the modified object. Click the arrow to the right of the name field to open the drop-down list, and then click a channel in the list.

## Shell Modifier

Modify panel > Make a selection. > Modifier List > Object-Space Modifiers > Shell

Make a selection. > Modifiers menu > Parametric Deformers > Shell

The Shell modifier “solidifies” or gives thickness to an object by adding an extra set of faces facing the opposite direction of existing faces, plus edges connecting the inner and outer surfaces wherever faces are missing in the original object. You can specify offset distances for the inner and outer surfaces, characteristics for edges, material IDs, and mapping types for the edges.

Also, because the Shell modifier doesn't have sub-objects, you can use the [Select options](#) on page 1595 to specify a face selection for passing up the stack to other modifiers. Please note that the Shell modifier doesn't recognize existing sub-object selections, nor does it pass such selections up the stack.

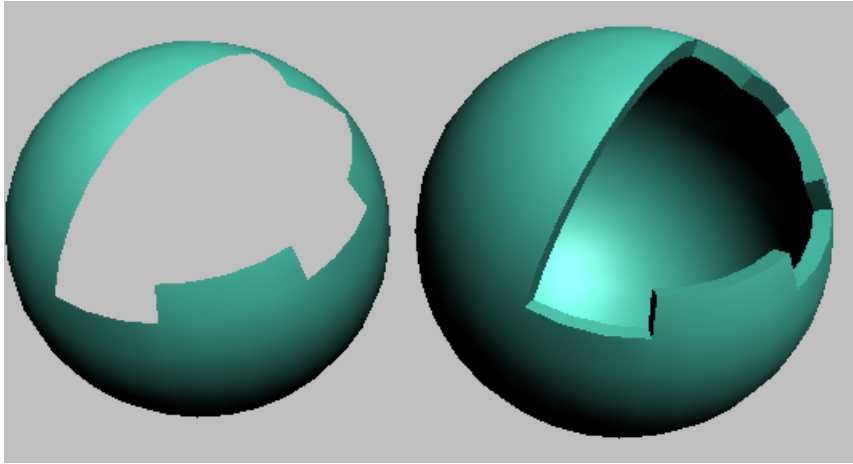

**Left: Sphere with part of surface removed; Right: Sphere with Shell applied**

You'd typically use Shell on an object with part of its surface removed, such as a sphere with several deleted vertices or faces, as illustrated above. For best results, the original polygons should face outward. If an object has no faces with at least one free edge, Shell will not create any edges.

### **Examples of Shell Usage**

Following are some examples of modeling tasks for which the Shell modifier would be appropriate:

- An artist is modeling a vehicle such as a car, a tank, or, in this case, a helicopter. The artist builds a solid external shell as the body of the copter. When done, the modeler breaks up his model: he selects window areas and detaches them as new objects, followed by the area for the doors (also detached as new objects). The modeler now has open objects representing the body, windows, and doors. The modeler applies Shell to the body, and sets it to extrude both outward and inward a set number of units, setting the inward extrusion to be greater than the outward. Shell is applied to the windows next; these are set to extrude inward only. The modeler then copies the Shell modifier from the body to the doors, and reduces the doors' outward extrusion somewhat. The result is a solid body with an interior that can accept additional modeling, inset windows, and doors that are slightly less thick than the shell of the helicopter.
- A designer is modeling a manufactured object that will need to be shown in an exploded view. It might be a cell phone, an engine, a mouse, shaped

glass, or something similar; this example will use part of a cell phone. When working on the phone keypad area, if the modeler builds with detail in mind, she might accurately model the shell with a moderately dense mesh, using [ShapeMerge](#) on page 681 to create the shapes for the holes where the keys will poke through, and then deleting those faces. When satisfied, the modeler applies the Shell modifier, sets Segments to 2, and then turns on the Bevel Edges option to use a curve for the profile of the holes' edges. She then applies a MeshSmooth modifier on top. The extra segment helps control the curve of the edges where the outer surface curves down to the keypad holes. The modeler then goes back to the cage portion of the stack and refines the base mesh details to her liking.

- A modeler is creating a suit of futuristic armor for a character. The modeler copies a selection of polygons from the character mesh to a new object; for example, the polygons that make up the arm. The modeler deletes some faces from the copied arm, and perhaps cuts some holes from it. He then applies the Shell modifier, followed by a MeshSmooth modifier, resulting in form-fitting armor.

## Procedures

### To solidify an object:

- 1 Create an object to solidify. The object should have some holes in its surface. For example, start with a primitive sphere, convert it to Editable Poly, and delete some vertices or polygons.
- 2 Optionally create an open spline to serve as the profile for the edges connecting the inner and outer surfaces. For example, go to Create panel > Shapes and click Line. Then, in the Top viewport, draw the spline in the Top viewport from top to bottom. Where the spline protrudes to the right, the edge surface will be convex, and where it protrudes to the left, the surface will be concave.
- 3 Apply the Shell modifier to the object from step 1.
- 4 To use custom edges, turn on Bevel Edges, click the Bevel Spline button, and then select the spline from step 2.
- 5 By default, Shell keeps the material IDs of the new surfaces consistent with those of the original object. To change these, turn on the different Override options, specify appropriate material IDs, and apply a [Multi/Sub-Object material](#) on page 5558 .



- 6 Likewise, Shell keeps the texture coordinates of the new surfaces consistent with those of the original object. To change these on the new edges, change the Edge Mapping choice, and with the Strip and Interpolate choices, optionally change the TV Offset setting.

## Interface

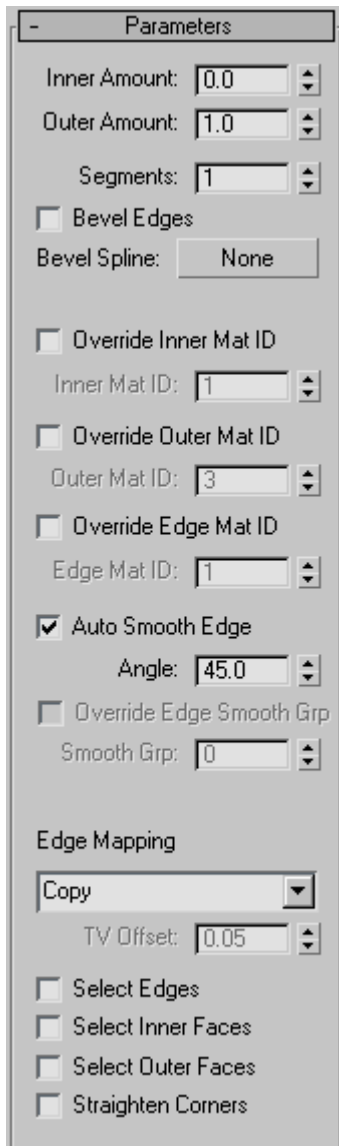

**Inner/Outer Amount** Distance in 3ds Max generic units by which the inner surface is moved inward and the outer surface is moved outward from their original positions. Defaults=0.0 / 1.0.

The sum of the two Amount settings determines the thickness of the object's shell, as well as the default width of the edges. If you set both to 0, the resultant shell has no thickness, and resembles an object set to display as 2-sided.

**Segments** The number of subdivisions across each edge. Default=1.

Change this setting if you need greater resolution on the edge for use by subsequent modeling or modifiers.

---

**NOTE** When you use a Bevel Spline, the spline's properties override this setting.

---

**Bevel Edges** When on, and you specify a Bevel Spline, the software uses the spline to define the edges' profile and resolution. Default=off.

After you define a Bevel Spline, use Bevel Edges to switch between a flat edge whose resolution is defined by the Segments setting and a custom profile defined by the Bevel Spline.

**Bevel Spline** Click this button and then select an *open* spline to define the edge shape and resolution. Closed shapes such as Circle or Star will not work.

The original spline is instanced to the Bevel Spline, so changing the spline's shape and properties are reflected in the Bevel Spline. With non-corner vertices, you can change the edge resolution with the spline's Interpolation rollout settings.

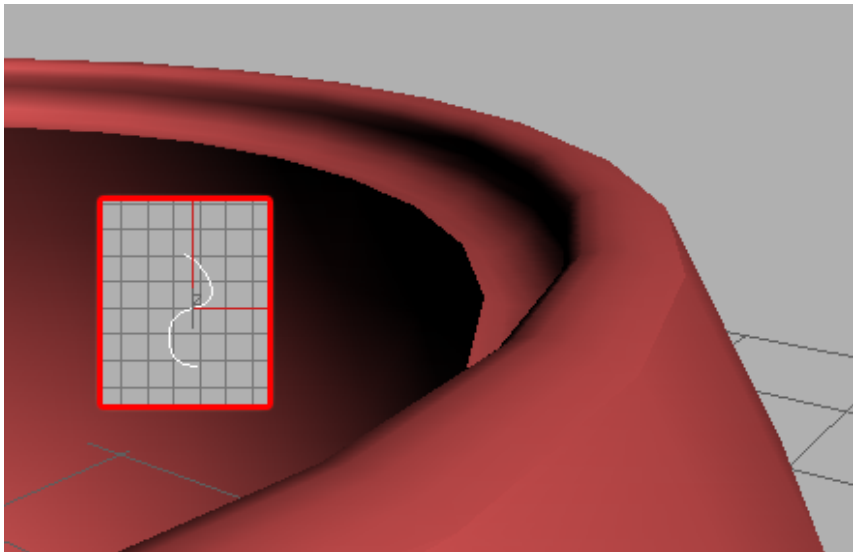

A bevel spline as viewed from the top (inset) and the resulting bevel

---

**TIP** For best results, create the spline in the Top viewport, and draw it from top to bottom. The top point on the spline is applied to the outside edge, and the bottom point to the inside edge. Displacements to the right will create outward protrusions on the edge profile, and displacements to the left create inward protrusions.

---

**Override Inner Mat ID** Turn on to specify a material ID for all of the inner surface polygons using the Inner Mat ID parameter. Default=off.

If you don't specify a material ID, the surface uses the same material ID or IDs as the original faces.

**Inner Mat ID** Specifies the material ID for inner faces. Available only when Override Inner MatID is on.

**Override Outer Mat ID** Turn on to specify a material ID for all of the outer surface polygons using the Outer Mat ID parameter. Default=off.

If you don't specify a material ID, the surface uses the same material ID or IDs as the original faces.

**Outer Mat ID** Specifies the material ID for outer faces. Available only when Override Outer MatID is on.

**Override Edge Mat ID** Turn on to specify a material ID for all of the new edge polygons using the Edge Mat ID parameter. Default=off.

If you don't specify a material ID, the surface uses the same material ID or IDs as the original faces from which the edges are derived.

**Edge Mat ID** Specifies the material ID for edge faces. Available only when Override Edge MatID is on.

**Auto Smooth Edge** Applies automatic, angle-based smoothing across the edge faces using the Angle parameter. When off, no smoothing is applied. Default=on.

This doesn't apply smoothing across the junction between the edge faces and the outer/inner surface faces.

**Angle** Specifies the maximum angle between edge faces that will be smoothed by Auto Smooth Edge. Available only when Auto Smooth Edge is on. Default=45.0.

Faces that meet at an angle greater than this value will not be smoothed.

**Override Smooth Group** Lets you specify a [smoothing group](#) on page 7932 for the new edge polygons using the Smooth Grp setting. Available only when Auto Smooth Edge is off. Default=off.

**Smooth Grp** Sets the smoothing group for the edge polygons. Available only when Override Smooth Group is on. Default=0.

When Smooth Grp is set to the default value of 0, no smoothing group is assigned to the edge polygons. To specify a smoothing group, change the value to a number between 1 and 32.

---

**NOTE** When Auto Smooth Edge and Override Smooth Group are both off, the software assigns smoothing group 31 to the edge polygons.

---

**Edge Mapping** Specifies the type of texture mapping that is applied to the new edges. Choose a mapping type from the drop-down list:

- **Copy** Each edge face uses the same UVW coordinates as the original face from which it's derived.
- **None** Each edge face is assigned a U value of 0 and a V value of 1. Thus, if a map is assigned, the edges will take the color of the upper-left pixel.
- **Strip** The edges are mapped in a continuous strip.
- **Interpolate** The edge mapping is interpolated from the mapping of the adjacent inner and outer surface polygons.

**TV Offset** Determines the spacing of the texture vertices across the edges. Available only with the Edge Mapping choices Strip and Interpolate. Default=0.05.

Increasing this value increases the repetition of the texture map across the edge polygons.

**Select Edges** Selects the edge faces. This selection is passed up the stack to other modifiers. Default=off.

**Select Inner Faces** Selects the inner faces. This selection is passed up the stack to other modifiers. Default=off.

**Select Outer Faces** Selects the outer faces. This selection is passed up the stack to other modifiers. Default=off.

**Straighten Corners** Adjusts corner vertices to maintain straight-line edges.

If you apply Shell to a subdivided object with straight edges, such as a box set to 3x3x3 segments, you might find that the corner vertices don't stay in a straight line with the other edge vertices. This gives the edges a bulging look. To resolve this, turn on Straighten Corners.

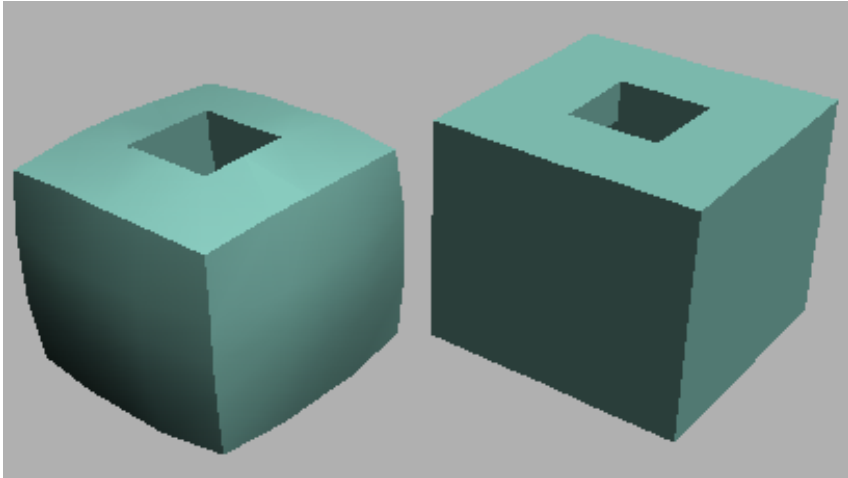

Box with Straighten Corners off (left) and on (right)

## Skew Modifier

Modify panel > Make a selection. > Modifier List > Object-Space Modifiers > Skew

Make a selection. > Modifiers menu > Parametric Deformers > Skew

The Skew modifier lets you produce a uniform offset in an object's geometry. You can control the amount and direction of the skew on any of three axes. You can also limit the skew to a section of the geometry.

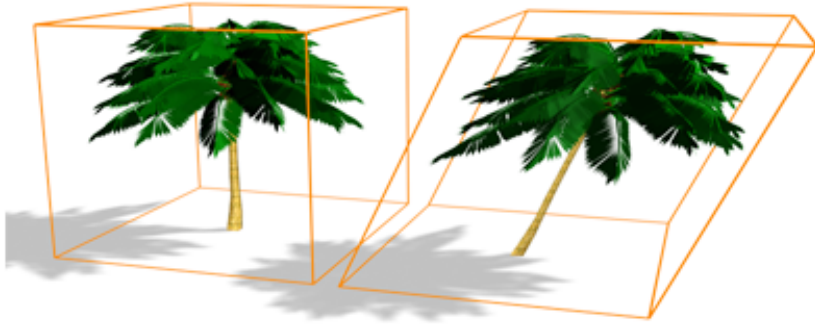

Skew modifier applied



Effect of moving modifier center with limits set

## Procedures

To skew an object:

- 1  Select an object, go to the Modify panel, and choose Skew from modifier list.
- 2 On the Parameters rollout, set the axis of the skew to X, Y, or Z. This is the axis of the Skew gizmo, not the axis of the selected object.

You can change the axis at any time, but only one axis setting is carried with the modifier.

- 3 Set the amount of the skew. The amount is an offset in current units parallel with the axis.  
The object skews to this amount beginning at the lower limit, by default the location of the modifier's center.
- 4 Set the direction of the skew.  
The object swivels around the axis.  
You can reverse the amount and direction by changing a positive value to a negative value.

#### To limit the skew:

- 1 Turn on Limits group > Limit Effect.
- 2 Set values for the upper and lower limits. These are distances in current units above and below the modifier's center, which is at zero on the gizmo's Z axis. The upper limit can be zero or positive, the lower limit zero or negative. If the limits are equal, the result is the same as turning off Limit Effect.  
The skew offset is applied between these limits. The surrounding geometry, while unaffected by the skew itself, is moved to keep the object intact.
- 3 At the sub-object level, you can select and move the modifier's center.  
The limit settings remain on either side of the center as you move it. This lets you relocate the skew area to another part of the object.

## Interface

### Modifier Stack

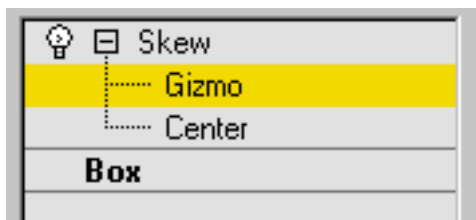



**Gizmo** At this sub-object level, you can transform and animate the gizmo like any other object, altering the effect of the Skew modifier. Translating the gizmo translates its center an equal distance. Rotating and scaling the gizmo take place with respect to its center.

**Center** At this sub-object level, you can translate and animate the center of the Skew effect.

For more information on the stack display, see [Modifier Stack](#) on page 7427 .

### Parameters rollout

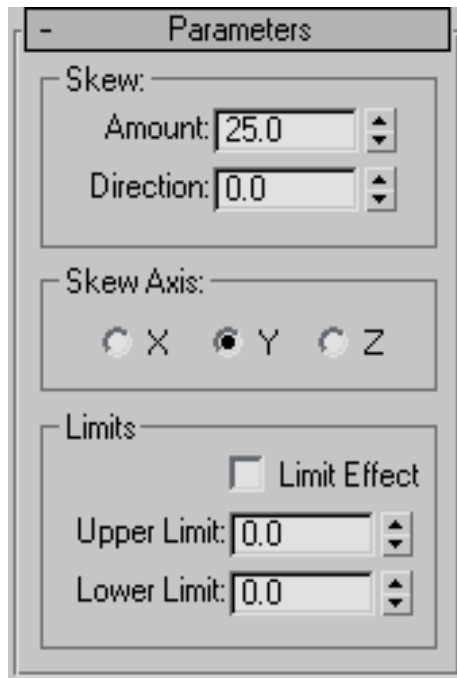

#### Skew group

**Amount** Sets the angle to skew from the vertical plane.

**Direction** Sets the direction of the skew relative to the horizontal plane.

#### Skew Axis group

**X/Y/Z** Specify the axis that will be skewed. Note that this axis is local to the Skew gizmo and not related to the selected entity. Default=Z.

## Limits group

**Limit Effect** Applies limit constraints to the Skew modifier.

**Upper Limit** Sets the upper limit boundaries in world units from the skew center point, beyond which the skew no longer affects the geometry. Default=0.

**Lower Limit** Sets the lower limit boundaries in world units from the skew center point, beyond which the skew no longer affects the geometry. Default=0.

## Skin Modifier

Select a mesh, patch, or NURBS object. > Modify panel > Modifier List > Object-Space Modifiers > Skin

Select a mesh, patch, or NURBS object. > Modifiers menu > Animation Modifiers > Skin

The Skin modifier is a skeletal deformation tool that lets you deform one object with another object. Mesh, patch, or NURBS objects can be deformed by bones, splines, and other objects.

Applying the Skin modifier and then assigning bones gives each bone a capsule-shaped "envelope." Vertices of the modified object within these envelopes move with the bones. Where envelopes overlap, vertex motion is a blend between the envelopes.

By default, each vertex that's affected by a single bone is given a *weight* value of 1.0, which means it's affected by that bone only. Vertices within the intersection of two bones' envelopes have two weight values: one for each bone. And you can use Skin modifier toolsets such as the [Weight Tool dialog](#) on page 1627 to arbitrarily assign vertices to any number of bones. The ratio of a vertex's weight values, which always total 1.0, determine the relative extent to which each bone's motion affects the vertex. For example, if a vertex's weight with respect to *bone 1* is 0.8 and its weight with respect to *bone 2* is 0.2, then the motion of *bone 1* will have four times greater influence on the vertex than will the motion of *bone 2*.

The initial envelope shape and position depends on the type of bone object. Bones create a linear envelope that extends along the longest axis of the bone geometry. Spline objects create envelopes that follow the curve of the spline. Primitive objects create an envelope that follows the longest axis of the object.

You can also deform the mesh based on the angle of the bones. Three deformers let you shape the mesh based on bone angles:

- The Joint and Bulge Angle deformers use a lattice similar to an [FFD lattice](#) on page 1383 to shape the mesh at a specific angle.
- The Morph Angle Deformer morphs the mesh at specified angles. Morph targets are created by using modifiers above the Skin modifier in the stack, or by using the [Snapshot tool](#) on page 921 to create a copy of the mesh and deforming the mesh using standard tools.

You can apply the Skin modifier to several objects at the same time.

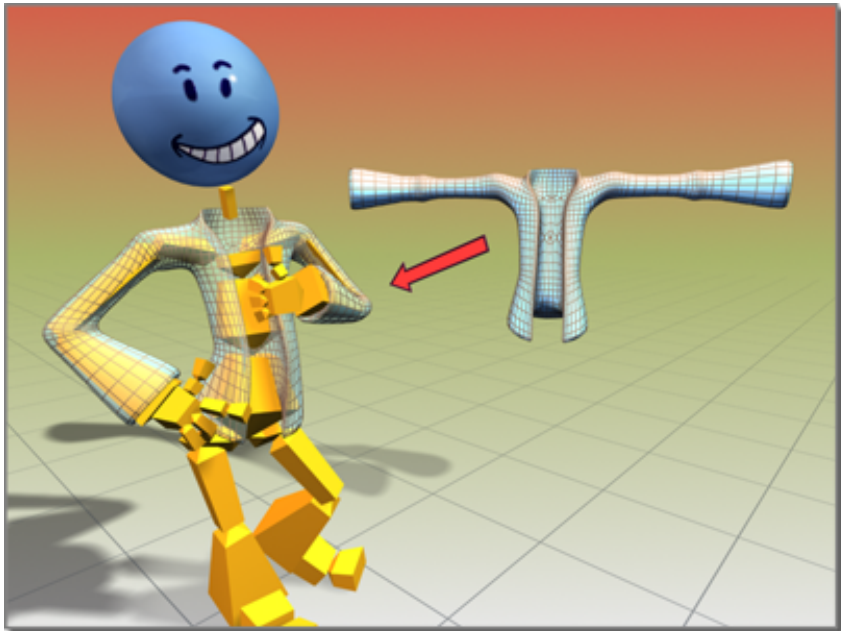

**Jacket object deformed using the Skin modifier**

In 3ds Max you can mirror envelope and vertex assignments from one side of the mesh to the other with commands on the Mirror Parameters rollout.

## **Procedures**

### **To use the Skin modifier:**

- 1 Prepare the skin (mesh or patch object) and skeleton (bones or other objects). Carefully place the skeleton inside the mesh or patch object so that its elements are able to influence polygons or patches in their immediate vicinity.
- 2 Select the mesh or patch object and apply the Skin modifier.
- 3 In the Parameters rollout, click Add and choose the skeleton objects.
- 4 Click Edit Envelopes and select an envelope to modify the volume in which each bone can influence the surrounding geometry.

### **To weight vertices manually:**

- 1 On the Parameters rollout, turn on Vertices.
- 2 On the mesh, select the vertices you would like to weight manually. Each selected vertex is surrounded by a small white rectangle.
- 3 highlight the name of the bone for which you want to change the vertex weights.
- 4 In the Weight Properties group, change the Abs. Effect parameter to the new vertex weight.





### **To mirror envelope or vertex weight settings:**

- 1 Adjust envelopes and vertex weights on one side of the mesh.
- 2 On the Mirror Parameters rollout, click Mirror Mode.  
The mirror plane appears at the position and orientation of the mesh's pivot point.
- 3 If the mirror plane is not at the center of the mesh, change the Mirror Offset parameter to move the plane to the center.
- 4 If some vertices in the left or right side of the mesh are red rather than blue or green, increase the Mirror Thresh value until all vertices are blue or green.
- 5 On the Mirror Parameters rollout, click the appropriate Paste button to paste green or blue envelopes or vertex weights to the other side of the mesh.

### To adjust the skin and/or bones without affecting the envelopes:

- 1 Save the scene.  
This is a potentially destructive operation, so it's best not to take any chances with your data.
- 2 Select the object to which the Skin modifier is applied.
- 3 In the Advanced Parameters rollout, turn off Always Deform.
- 4 Apply any necessary transforms to the mesh/patch object or bones objects.
- 5 Turn Always Deform back on.  
To adjust the bones only, you can also use [skin pose](#) on page 244 .

### Example: To apply the Skin modifier to a cylinder with a bones skeleton:

- 1   On the Create panel, under Standard Primitives, click Cylinder.
- 2 In the middle of the Top viewport, click and drag 20 units to create the base of the cylinder.
- 3 Release the mouse button and drag up 130 units to establish the height of the cylinder.
- 4 On the parameters rollout, set Height Segments to **20**.  
This provides mesh detail for a smooth surface deformation.
- 5   On the Create panel, under Systems, click Bones.  
Make sure an IK Solver is chosen in the IK Solver list. Turn on Assign To Children. (This should turn on Assign To Root as well.)
- 6 In the Front viewport, click successively three times: below the cylinder, in the middle of the cylinder, and above the top of the cylinder.
- 7 Right-click to end Bones creation.  
Three bones display. Two of them are within the middle of the cylinder.
- 8  Select the cylinder.

- 9  On the Modify panel, choose Skin from the Modifier List.
- 10 On the Skin modifier's Parameters rollout, click Add, and use the Select Bones dialog to select the three bones.  
The names of the bones are now displayed in the list.
- 11 In the Front viewport, select the bone end effector (IK Chain01) and move it around.  
The cylinder deforms to follow the bones. To adjust envelopes to refine the surface deformation, choose the Skin modifier's Envelope sub-object level, and use the Edit Envelopes controls to resize envelopes and change vertex weights.

**Example: To use a morph angle deformer:**

Create the cylinder and bones from the preceding procedure before you continue with this procedure.

- 1 At frame 50, animate bone 2 so that bones 1 and 2 represent a 90-degree angle.
- 2 At frame 0, the bones should be straight at about a 180-degree angle.
- 3 Move to frame 0.
- 4 Turn on Edit Envelopes in the Parameters rollout.
- 5 Select the child bone (bone 2) in the modifier's list of bones.
- 6 In the Select group, turn on Vertices.  
This allows you to select vertices.
- 7 In the viewports, region-window select a good portion of the vertices that are controlled by both bones.
- 8 In the Gizmos rollout, select the Morph Angle Deformer in the drop-down list, and then click Add Gizmo.  
The Deformer Parameters rollout displays. A base morph target is the first and only target in the list.

---

**TIP** if the Deformer doesn't assign, make sure that bone 2 and not bone 1 is selected in the list.

---

- 9 Scrub the Time Slider to frame 50.

- 10 Add an Edit Mesh modifier above the Skin modifier in the modifier stack.
- 11 Turn on Vertex and Soft Selection in the Edit Mesh modifier.
- 12 Edit the mesh to the shape you want.
- 13 Go back down in the stack to the Skin modifier. If the topology warning dialog appears, click Yes.
- 14 In the Deformer Parameters rollout, click Add From Stack.  
A new morph target is added at about 90 degrees.
- 15 Delete the Edit Mesh modifier from the stack.  
There is a doubling effect of the morph if you don't delete or deactivate the Edit Mesh modifier.
- 16 Scrub the time slider. The mesh morphs as the bone angle changes.

## Interface

The Skin Modifier interface includes the following rollouts:

- [Parameters rollout](#) on page 1606
- [Mirror Parameters rollout](#) on page 1612
- [Display rollout](#) on page 1614
- [Advanced Parameters rollout](#) on page 1616
- [Gizmos rollout](#) on page 1618
- [Deformer Parameters rollout](#) on page 1621
- [Joint Angle and Bulge Angle parameters](#) on page 1623

Some of the Skin modifier commands are also available from the [quad menu](#) on page 7300 .

## Modifier Stack

**Envelope** Turn on this sub-object level to work on envelopes and vertex weights.

---

**TIP** You can use the quad menu to choose this sub-object level.

---

## Parameters rollout

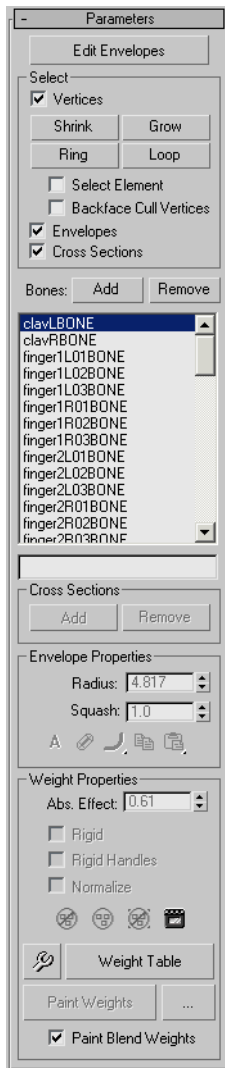

**Edit Envelopes** Use this sub-object level to work on envelopes and vertex weights.



## Select group

The following filtering options are grouped together to help you work on a particular task, by preventing you from accidentally selecting the wrong item in the viewports.

**Vertices** Turn on for vertex selection.



You can rotate around selected vertices using [Arc Rotate SubObject](#) on page 7395 from the [Arc Rotate flyout](#) on page 7394 . You can also rotate around a selected envelope as long as no vertices are selected, as they have precedence.

---

**NOTE** You must choose [Use Selection Center](#) on page 907 from the [User Center flyout](#) on page 904 to center on your selection. If you choose [Use Pivot Point Center](#) on page 905 , arc rotate is centered on the selected bone/cross section.



You can zoom on selected vertices using [Zoom Extents Selected](#) on page 7387 from the Zoom Extents flyout. You can also zoom on an envelope if no vertices are selected.

- 
- **Shrink** Modifies the current vertex selection by progressively subtracting the outermost vertices from the selected object. Has no effect if all the vertices from an object are selected.
  - **Grow** Modifies the current vertex selection by progressively adding neighborhood vertices of the selected object. You must start with at least one vertex to be able to grow your selection.
  - **Ring** Expands the current vertex selection to include all vertices part of parallel edges.

---

**NOTE** You must select at least two vertices to use the Ring selection.

---

- **Loop** Expands the current vertex selection to include all vertices part of continuing edges.

---

**NOTE** You must select at least two vertices to use the Ring selection.

---

- **Select Element** When on, selects all vertices of the element you select, as long as you select at least one vertex from that element.

---

**TIP** You can edit your selection by holding Ctrl or Alt, and then select vertices. This adds or removes, respectively, vertices to or from your selection.

---

- **Backface Cull Vertices** When on, you cannot select vertices pointing away from the current view (on the other side of the geometry).

**Envelopes** Turn on for envelope selection.

**Cross Sections** Turn on for cross-section selection.

The first step, after applying the Skin modifier to an object, is to determine which bones participate in the object's weighting. Every bone you choose influences the weighted object with its envelope, which you can configure in the [Envelope Properties group](#) on page 1609 .

**Add** Click to add one or more bones from the Select Bones dialog.

**Remove** Choose a bone in the list, and then click Remove to remove it.

**[list window]** Lists all bones in the system. Highlighting a bone in the list displays that bone's envelope and the vertices influenced by the envelope.

An horizontal scroll bar appears if a bone's name is longer than the window's width.

---

**NOTE** If an older scene containing long bone names is loaded in 3ds Max, its name is truncated to fit in the window. You can overwrite this by setting the MAXScript `shortenBoneNames` property of your Skin modifier to false.

---

Example: `$'Sphere01'.modifiers[#Skin].shortenBoneNames = false`

For detailed information about the MAXScript utility, open the MAXScript Reference, available from Help menu > MAXScript Reference.

**[bone name type-in field]** Enter a bone name to highlight it in the bone list above. The highlighting goes to the first matching bone.

Use these methods for finding bone names faster:

- Narrow the list by typing the first few characters in the name of the bone you want to highlight.
- Use the wildcard (\*) key. For example, you can find *Robot R Index Finger* by typing `* R In`

## Cross Sections group

By default, each envelope has two round, lateral cross sections, one at each end of the envelope. These options add and remove cross sections from envelopes.

**Add** Choose a bone in the list, click Add, and click a position on the bone in a viewport to add a cross section.

**Remove** Select an envelope cross section and click Remove to delete it.

Before you can select a cross section, the Cross Sections option in the Select group must be on.

You can delete only extra cross sections that you have added; not the default cross sections.

## Envelope Properties group

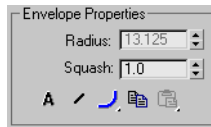

**Radius** Select an envelope cross section, and use Radius to resize it. In order to select a cross section, the Cross Sections option in the Select group must be checked.

You can also click and drag a cross section control point in a viewport to resize it.

**Squash** A squash multiplier for bones that stretch. This is a single value that reduces or increases the amount of squash applied to a bone when it is stretched with Freeze Length off, and Squash on.

---

**NOTE** You can set Freeze Length and Squash in the [Bone Tools dialog](#) on page 851 .

---

**Absolute/Relative** This toggle determines how vertex weights are calculated for vertices between inner and outer envelopes.





-  **Absolute** A vertex must merely fall inside the brown outer envelope to have 100% assignment weight to that particular bone. A vertex falling inside more than one outer envelope will be assigned multiple weights summing to 100% based on where it falls in the gradients of each envelope.

-  **Relative** A vertex falling only within an outer envelope will not receive 100% weighting. A vertex must either fall inside two or more outer envelopes whose gradients sum to 100% or greater or the vertex must fall within a red inner envelope to have 100% weight. Any points within a red inner envelope will be 100% locked to that bone. Vertices falling within multiple inner envelopes will receive weighting distributed over those bones.

 **Envelope Visibility** Determines the visibility of unselected envelopes. Choose a bone in the list and click Envelope Visibility, then choose another bone in the list. The first bone selected remains visible. Use this to work on two or three envelopes.



**Falloff Flyouts** Choose a falloff curve for the displayed envelopes.

Weight falls off in the area between the inner and outer envelope boundaries if envelopes overlap and Absolute is turned on. This setting lets you specify how the falloff is handled:

-  **Falloff Fast Out** Weight falls off quickly.
-  **Falloff Slow Out** Weight falls off slowly.
-  **Falloff Linear** Weight falls off in a linear way.
-  **Falloff Sinual** Weight falls off in a sinusoidal way.

 **Copy** Copies the currently selected envelope size and shape to memory. Turn on sub-object Envelopes, choose one bone in the list, click Copy, then choose another bone in the list and click Paste to copy an envelope from one bone to another.

Paste commands are on a flyout with the following options:

-  **Paste** Pastes the copy buffer to the current selected bone.
-  **Paste to All Bones** Pastes the copy buffer to all bones in the modifier.

-  **Paste to Multiple Bones** Pastes the copy buffer to selected bones. A dialog allows you to choose the bones to paste to.

## Weight Properties group

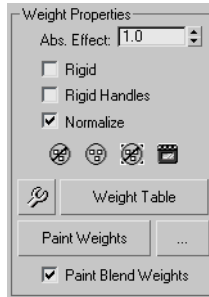

**Abs. Effect** Enter an absolute weight for the selected bone to selected vertices.

Choose the Envelope sub-object level, turn on Vertices in the Parameters rollout > Select group, select a vertex or vertices, and then use the Abs. Effect spinner to assign weight. Selected vertices move in the viewports as their weight changes.

**Rigid** Causes selected vertices to be influenced only by one bone, the one with the most influence.

**Rigid Handles** Causes the handles of selected patch vertices to be influenced by only one bone, the one with the most influence.

**Normalize** Forces the total weights of each selected vertex to add up to 1.0.



**Exclude Selected Verts** Adds the currently selected vertices to the exclusion list for the current bone. Any vertices in this exclusion list will not be affected by this bone.



**Include Selected Verts** Takes the selected vertices out of the exclusion list for the selected bone. The bone can then affect these vertices.



**Select Excluded Verts** Selects all vertices excluded from the current bone (see Exclude Selected Verts, preceding).



**Bake Selected Verts** Click to bake the current vertex weights. Baked weights are not affected by envelope changes, only by changes to [Abs. Effect](#) on page 1611 or weights in the [Weight Table](#) on page 1633 .



**Weight Tool** Displays the [Weight Tool dialog](#) on page 1627 , which offers control tools to help you assign and blend weights on selected vertices.

**Weight Table** Displays a table for viewing and changing weights for all bones in the skeletal structure. See [Weight Table](#) on page 1633 .

**Paint Weights** Click and drag the cursor over vertices in the viewports to brush on weights for the selected bone.

---

**TIP** Streamline the painting process by using the [Brush Presets tools](#) on page 7293 .

---



**Painter Options [ellipsis]** Opens the [Painter Options dialog](#) on page 1907 , where you can set parameters for weight painting.

**Paint Blend Weights** When on, blends painted values by averaging the weights of neighboring vertices and then applying the average weight based on the brush strength. Default=on.

## Mirror Parameters rollout

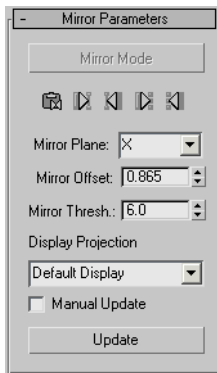

**Mirror Mode** Activates Mirror mode, which lets you mirror the envelopes and vertex assignments from one side of the mesh to the other. This mode is available only at the Envelope sub-object level.

Mirror mode uses the Mirror Plane setting to determine the “left side” and “right side” of the mesh. When you turn on Mirror Mode, the vertices on the left side of the mirror plane turn blue, while the vertices on the right turn green. Vertices that are neither left nor right turn red, including vertices at the mirror plane. If vertices don't change color appropriately, you might have to increase the Mirror Thresh value to expand the range used to determine the left and right sides.

If you select vertices or bones, the selected vertices or bones turn yellow, and the corresponding match on the other side of the mesh turns a brighter blue or green. This can help you check for matches.



**Mirror Paste** Pastes selected envelope and vertex assignments to the opposite side of the body.



**Paste Green to Blue Bones** Pastes the envelope settings from green bones to blue.



**Paste Blue to Green Bones** Pastes the envelope settings from blue bones to green.



**Paste Green to Blue Verts** Pastes the individual vertex assignments from all green vertices to the corresponding blue vertices.



**Paste Blue to Green Verts** Pastes the individual vertex assignments from all blue vertices to the corresponding green vertices.

**Mirror Plane** Determines the plane that will be used to determine the left and right sides. The plane appears in the viewport at the mesh's pivot point when you turn on Mirror mode. The selected mesh's local axes are used as the basis for the plane. If several objects are selected, one object's local axes are used. Default=X.

---

**TIP** For the easiest workflow with mirroring tools for the Skin modifier, set the pivot points for character meshes to align with the World before applying Skin.

---

**Mirror Offset** Shifts the mirror plane along the Mirror Plane axis.

**Mirror Thresh** Sets the relative distance the mirroring tools will look when setting vertices as left or right. If some vertices in the mesh (other than those at the mirror plane) are not colored blue or green when you turn on Mirror mode, increase the Mirror Thresh value to include a larger area of the character.

You can also increase this value to compensate for lack of symmetry in asymmetrical models.

**Display Projection** When Display Projection is set to Default Display, selecting vertices on one side of the mirror plane automatically projects the selection to the opposite side. The Positive and Negative options allow selection of vertices on one side of the character only. The None option does not project selected vertices to either side. Default=Default Display.

---

**TIP** You can use the Positive and Negative options to temporarily project the display of one side's vertices to the other side so you can see how the vertices align. This can be helpful when determining the correct Mirror Plane settings for an asymmetrical mesh.

---

**Manual Update** When on, you can update the display manually rather than automatically after each mouse-up.

**Update** When Manual Update is on, use this button to update the display with your new settings.

### Display rollout

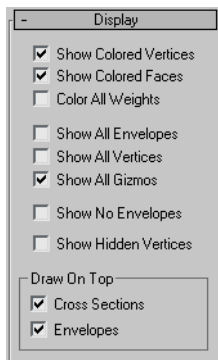

**Show Colored Vertices** Colors vertices in viewports according to their weights.

**Show Colored Faces** Colors faces in viewports according to their weights.

**Color All Weights** Assigns a color to every bone in the envelope. The vertex weighting blends the colors together.

---

**TIP** You can toggle this feature to get a global view of all weight regions across your model at once.

---



---

**TIP** You can also assign a color to unweighted vertices: Open the Customize User Interface dialog and, on the Colors panel, choose Skin Colors from the Elements drop-down list.

---

**Show All Envelopes** Displays all envelopes at the same time.

**Show All Vertices** Draws a small tick at every vertex. On a patch surface, it will also draw all the handles.

**Show All Gizmos** Displays all the gizmos in addition to the currently selected gizmo.

**Show No Envelopes** Causes no envelopes to be displayed even when an envelope is selected.

**Show Hidden Vertices** When on, hidden vertices are visible. Otherwise, they remain hidden until you enable the option or go into the object's modifier ( [Editable Mesh](#) on page 1990 or [Editable Poly](#) on page 2055 ), and then click Unhide All on the Selection rollout or Edit Geometry rollout, respectively. Default=off.

### **Draw On Top group**

These options determine which elements will be drawn on top of all other objects in viewports.

**Cross Sections** Forces cross sections to be drawn on top.

**Envelopes** Forces envelopes to be drawn on top.

## Advanced Parameters rollout

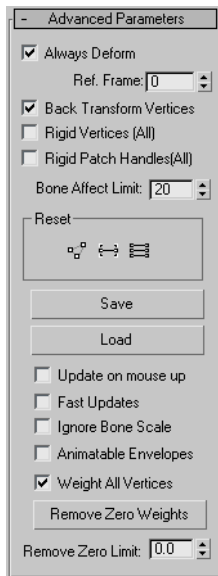

**Always Deform** A toggle useful for editing the transformation relationship between bones and the controlled points. This relationship is initially set when Skin is applied. To change the relationship the user can deactivate Always Deform, move the object or the bones and reactivate. The new transformation relationship is now used.

**Ref. Frame** Sets the frame where the bones and the mesh are in a reference position.

Normally this is frame 0. Start your animation at frame 1 or later if frame 0 is the reference frame. If bones need to be adjusted relative to the mesh, move the time slider to frame 0; turn off Always Deform, move the bones into the correct position and turn on Always Deform.

**Back Transform Vertices** Allows you to link the mesh to the bone structure. Ordinarily, when you do this, any movement of the bones causes the mesh to move twice as far as it should, because it moves once with the bones and once with the link. Checking this option prevents the mesh from moving twice under these circumstances.

**Rigid Vertices (All)** Causes vertices to have assignments to only one bone as if weighted 100% to the bone whose envelope has the most influence. Vertices will not have weight distributed over more than one bone and the deformation

of the skinned object is rigid. This is mainly used for games that do not support weighted point transformation.

**Rigid Patch Handles (All)** On a patch model, forces patch handle weights to equal the knots weights.

**Bone Affect Limit** Limits the number of bones that can affect one vertex.

## Reset group

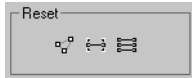

**Reset Selected Verts** Resets the weight of selected vertices to the envelope defaults. After manually changing vertex weight, use this to reset weights if necessary.



**Reset Selected Bone** Resets associated vertex weights back to the original weights calculated for the selected bone's envelope.



**Reset All Bones** Resets all vertex weights back to the original weights calculated for all bone's envelopes.

**Save/Load** Allows you to save and load the envelope position and shape, as well as the vertex weights. If you load a saved file onto a different system of bones, you can use the [Load Envelopes dialog](#) on page 1624 to match the incoming bones to the current bones.

**Update on mouse up** When on and the mouse button is pressed down, no updates take place. When the mouse button is released, updates occur. This option helps keep workflow moving quickly by avoiding unnecessary updates.

**Fast Updates** Turns off viewport display of weighted deformation and gizmos and uses rigid deformation when not rendering.

**Ignore Bone Scale** Turn this option on to leave a skinned mesh unaffected by a scaled bone. Default=off.

---

**NOTE** To scale a bone's length, you first need to turn off its Freeze Length option on the [Object Properties rollout](#) on page 851 of the [Bone Tools floater dialog](#) on page 845 .

---

**Animatable Envelopes** Toggles the possibility of creating keys on all animatable envelope parameters while Auto Key is active. Default=off.

---

**NOTE** This does not affect keyable track settings.

---

**Weight All Vertices** When on, forces all vertices that are not under the control of an envelope to be weighted to the bone closest to them. Has no effect on vertices that are manually weighted. Default=on.

---

**TIP** If you want to revert vertices to their original weight value, click Reset Selected Verts (in the Reset group) or open the [Weight Table](#) on page 1633 , and change the Modified weight status (M) of your selected vertices.

---

**Remove Zero Weights** Strips a vertex from its weight if it is less than the Remove Zero Limit value. This helps making your skinned model lighter (in games for instance) because less unnecessary data is stored in the geometry. Also accessible from the Weight Table.

**Remove Zero Limit** Sets the weight threshold that determines if a vertex is stripped of its weight when you click Remove Zero Weights. Default=0.0.

## Gizmos rollout

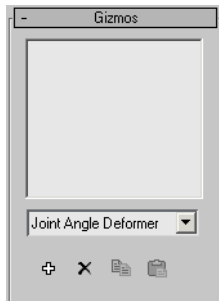

Controls in the Gizmos rollout allow you to deform the mesh according to the angle of the joint, and to add gizmos to selected points on the object. The rollout consists of a list box containing all the gizmos for this modifier, a drop-down list of the current types of gizmos, and four buttons (Add, Remove, Copy and Paste).

The workflow for adding a gizmo is to select the vertices that you want to affect, select the bones that will drive the deformation, and then click the Add button.

There are three deformer available:

- The Joint Angle deformer has a lattice that can deform vertices on the parent and child bones.
- The Bulge Angle deformer has a lattice that only works on vertices on the parent bone.
- The Morph Angle deformer works on vertices of the parent and child bones. Keep these distinctions in mind when you select vertices to deform. For example, if you want to use the Joint Angle deformer, then select vertices close to the joint that will drive the deformation. If you want the parent bone vertices to deform like a biceps muscle, then select vertices that are only assigned to the parent bone before adding the Bulge Angle deformer. If all the vertices of the parent and child bone must deform, then select all of the vertices and add the Morph Angle deformer.

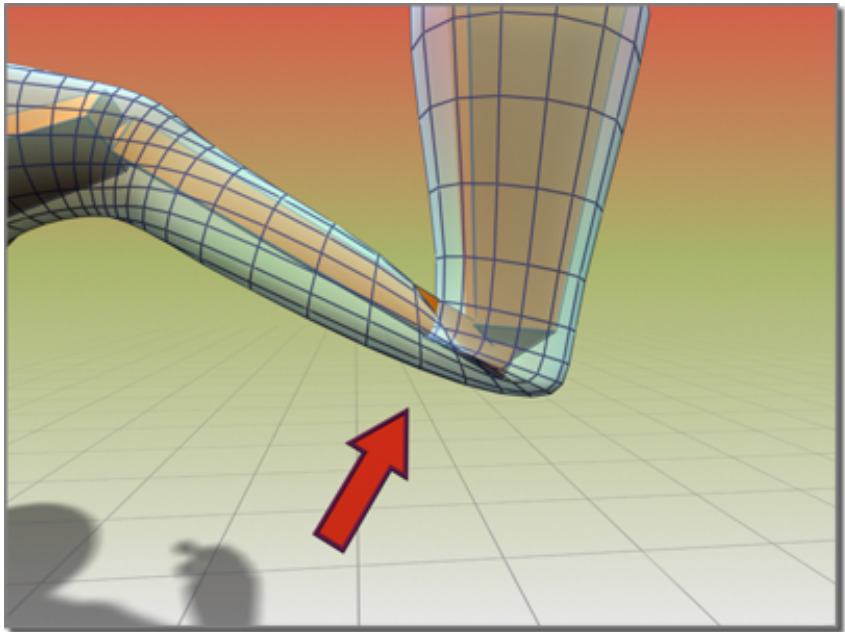

**Bending the arm without the Morph Angle deformer causes the sleeve to crumple.**

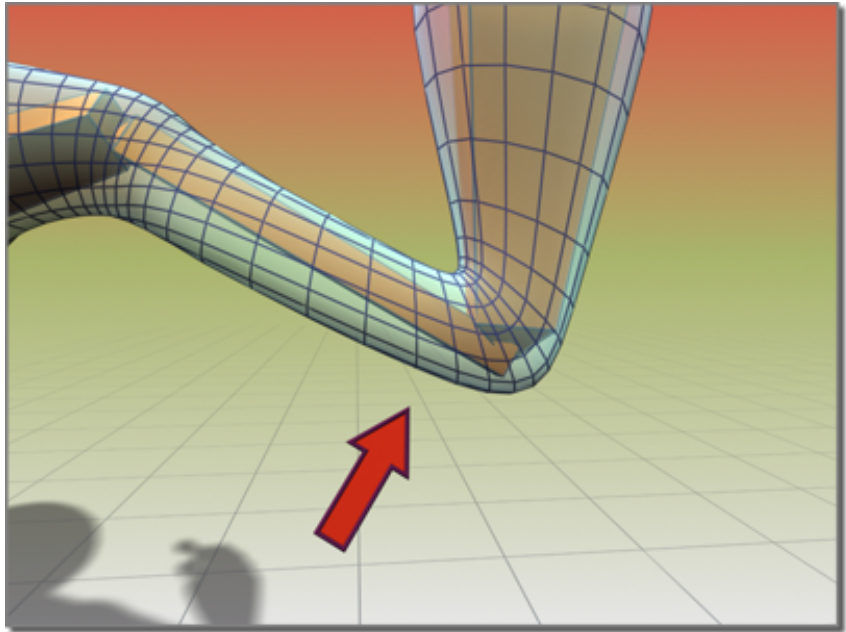

Using the Morph Angle deformer creates a smooth bend in the sleeve.

**Gizmo List Window** Lists the current Angle Deformers.

The Deformer Parameters rollout changes depending on the type of gizmo selected.

**Deformer drop-down list** Lists the available deformers.



**Add Gizmo** Adds the current Gizmo to the selected vertices.

To add a gizmo, you must first select the child bone for the joint you want to deform. Then you must select the vertices that you want to deform. You can then add a gizmo.

After a gizmo is added, a Deformer Parameters rollout displays that contains gizmo parameters that you can adjust.



**Remove Gizmo** Remove the selected gizmo from the list.



**Copy Gizmo** Copy the selected gizmo.



**Paste Gizmo** Paste the gizmo.

The Paste button pastes the current copy buffer into the currently selected gizmo. You can only paste to like gizmos. For instance, you can't paste from a bulge gizmo to a joint gizmo.

### Deformer Parameters rollout

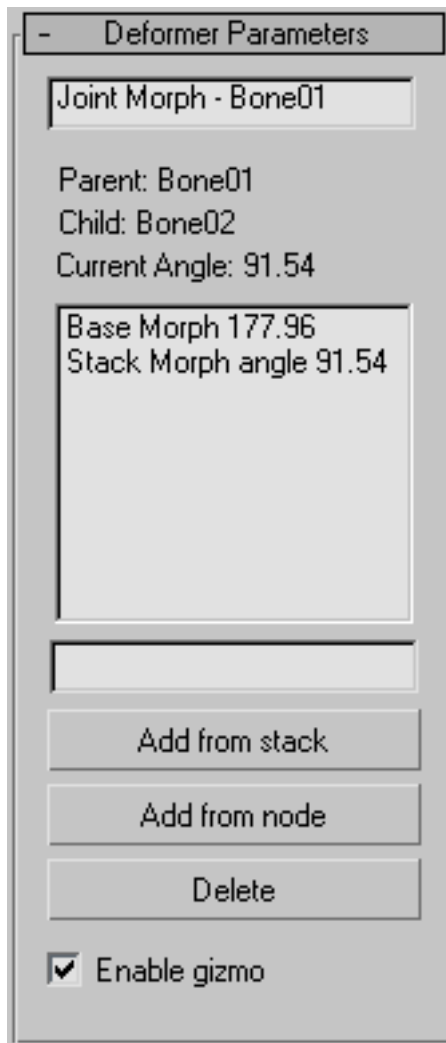

The following parameters are for the Morph Angle deformer. One way to create morph targets, after the morph gizmo is added, is to add an Edit Mesh modifier to the stack above the Skin modifier. Use the vertex controls in the Edit Mesh modifier to shape the geometry. Then go back in the stack to the Skin modifier and click Add From Stack. You can then delete the Edit Mesh modifier. Add From Stack looks at the last modifier in the stack to get the morph target. Note that when you go back down to the Skin modifier, the morph effect is doubled; you can rectify this by deleting or deactivating the Edit Mesh modifier.

**Joint Field** Displays the type of Deformer and the associated bone.

**List Window** Contains the current morph targets and associated bone angles.

**Naming Field** Select a morph target and rename it in this field.

**Add from stack** Uses the current state of the stack to get the morph target. Ideally, you have put an Edit Mesh modifier on top of the stack and done your edits before you click Add From Stack.

**Add from node** Uses another object as your morph target for this angle. This is like a regular morph target, but instead of being driven by a field, it is driven by the joint angle.

---

**TIP** You can use Snap Shot on the main toolbar to create a new target for morphing.

---

**Delete** Deletes the currently selected morph target from the list.

**Enable gizmo** Toggles the effect of the gizmo.



## Joint Angle and Bulge Angle parameters

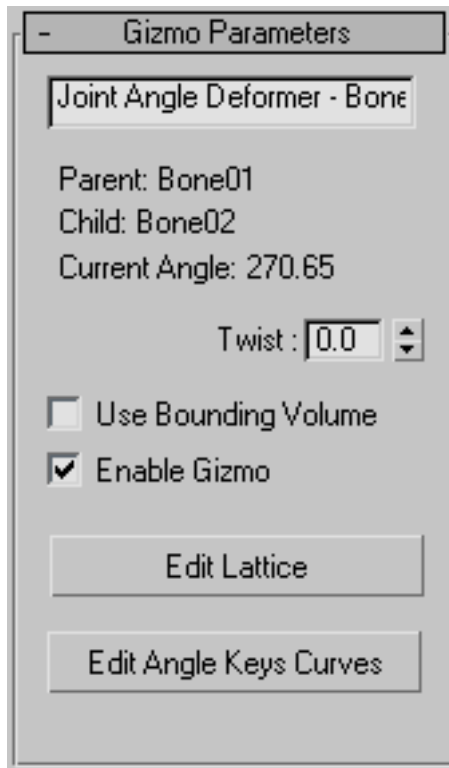

The following parameters are for the Joint Angle and Bulge Angle deformers. These two deformers are almost identical in the way they operate. The difference is that the Bulge Angle deformer only works on vertices of the parent bone, while the Joint Angle deformer works on vertices on both the child and parent bone.

To apply either of these deformers, first select the child link, then select vertices on the mesh, and then apply the deformer. Remember to turn on Vertices in the Parameters rollout > Select group before region-selecting vertices in the viewports.

Once the deformer is applied, turn on Edit Lattice and move the lattice control points in the viewports to deform the mesh at different bone angles.

**Name Field** Allows you to change the name of the deformer.

**Twist** Allows you to spin the gizmo around the mesh to place control points appropriately.

**Use Bounding Volume** Turn this on if you plan to change the geometry, like increasing segments on a cylinder. If the geometry changes, the mesh will still deform inside the lattice if this is turned on.

**Enable Gizmo** Toggles the effect of the gizmo on and off.

**Edit Lattice** Allows you to move the lattice control points in the viewports.

**Edit Angle Keys Curves** Brings up a curve editor that lets you manipulate the shape of the lattice at a particular angle. This curve is position vs. angle. It will show you the curves of the current selected points. The red curves are X, green curves are Y, and blue curves are Z.

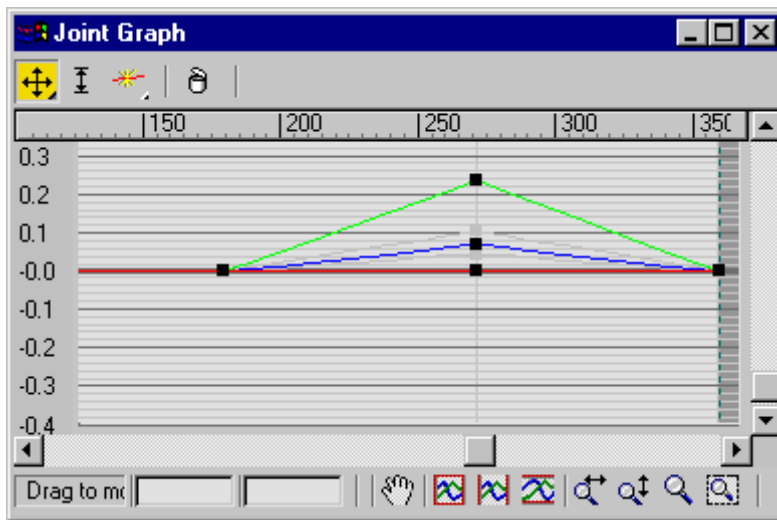

## Load Envelopes Dialog (Skin Modifier)

Select a mesh, patch, or NURBS object. > Apply Skin modifier. > Advance Parameters rollout > Load button

The Load Envelopes dialog associated with the [Skin modifier](#) on page 1600 allows you to load [saved envelopes](#) on page 1617 to specific bones. This resizable dialog shows the current envelopes in your scene and the incoming envelopes. Use the controls to manipulate the incoming envelopes so they align with the current envelopes.

## Interface

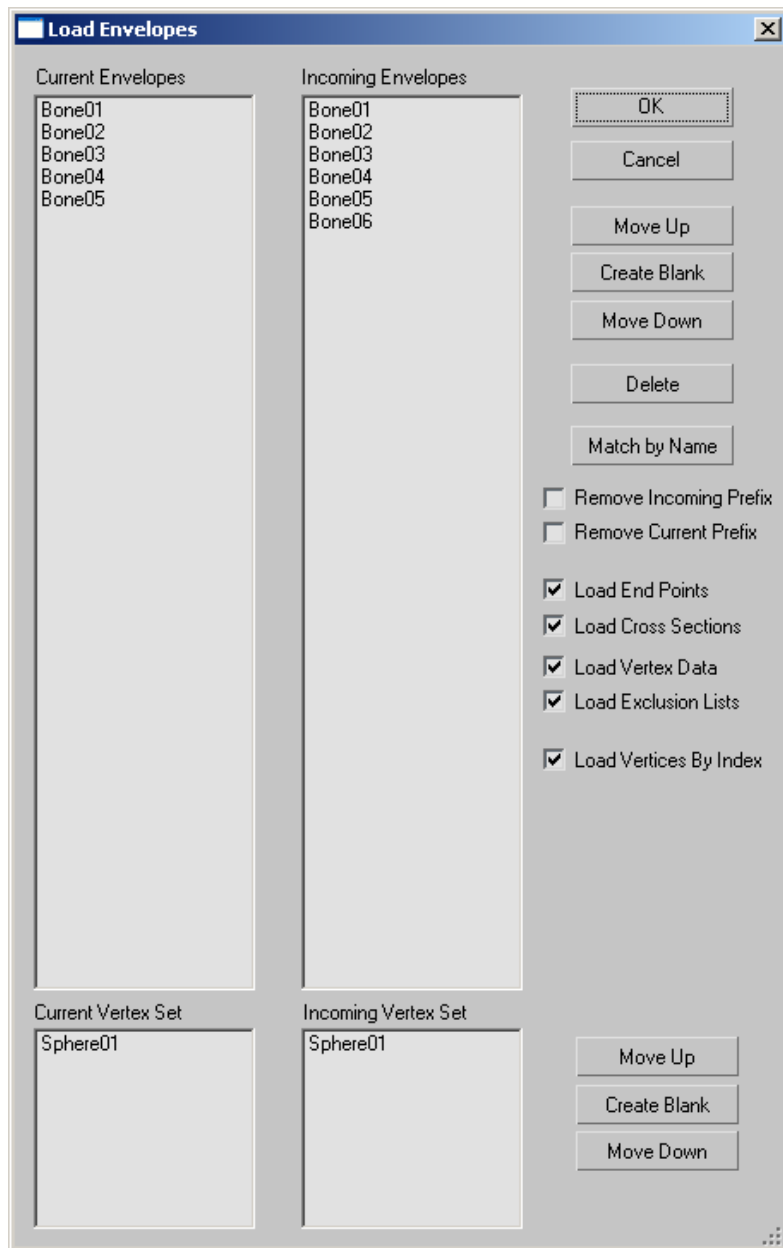

**OK** Accepts any changes and closes the dialog.

**Cancel** Discards any changes and closes the dialog.

**Move Up/Down** Move the current selection in the incoming list up or down.

**Create Blank** Creates space in the Incoming list.

Use this when loading data onto a skeleton that is not identical as the one from which the data was saved. For example, if your original skeleton had three fingers and the new one has only two fingers, you might need to add spaces in the list to line up the fingers correctly.

**Delete** Removes the current selected incoming envelopes.

**Match by Name** Resorts the Incoming list and matches any bones that have the same name in the list of current envelopes.

**Remove Incoming Prefix** Removes any prefixes on the names of the incoming envelopes.

**Remove Current Prefix** Removes any prefixes on the names of the current envelopes.

**Load End Points** Loads the envelope end point positions.

**Load Cross Sections** Loads the envelope cross sections.

**Load Vertex Data** When on, loads weights at the vertex level. Normally only the envelope data is loaded so any manual adjustments to the vertex data are lost. This option lets you load those manual edits.

**Load Exclusion Lists** Lets you also load user-generated exclusion-list data, which specifies that certain vertices should not be affected by certain bones. See [Exclude Selected Verts](#) on page 1611 and [Show Exclusions](#) on page 1635 .

**Load Vertices By Index** Lets you load vertices by index rather than vertex position. You would typically use this option with identical meshes that have not undergone any type of topology change. This should be off if you've changed the topology, by, for instance, deleting or adding vertices or changing their order.

### **Current Incoming Vertex Set**

When Load Vertex Data is on, use these controls to match vertex sets in cases where the Skin modifier is instanced. In such cases you might need to set up several vertex sets.

The Move Up/Create Blank/Move Down buttons have the same functions as in the Envelopes lists.

## **Weight Tool Dialog**

Select an object that has the Skin modifier applied to it. > Modify panel > Skin modifier > Parameters rollout > Weight Properties group > Weight Tool button

This dialog is launched from the [Skin modifier](#) on page 1600 and provides tools to select vertices and assign them weights. You can also copy, paste, and blend weights between vertices. Each vertex you select displays the objects contributing to its weighting in the dialog list.

To use these tools, Parameters rollout > Edit Envelopes must be on, Parameters rollout > Select group > Vertices must be on, and at least one vertex must be selected.

---

**IMPORTANT** The controls on this dialog adjust vertex weighting with respect to the active bone; that is, the object highlighted in the Bones list on the Parameters rollout. When you select a vertex and then change its weighting, if the active bone does not already influence the vertex, the bone is added to the list of bones influencing the vertex. You can ensure that bone assignments don't change by highlighting the bone in the Weight Tool dialog list after selecting the vertex and before changing weighting.

---



Also, the total weighting for all bones influencing a vertex is always 1.0, so if multiple bones influence a vertex and you change the weight value for one bone, the weight values for the others change as well.

### **Procedures**

#### **Example: To Set and Blend Weights on Selected Vertices:**

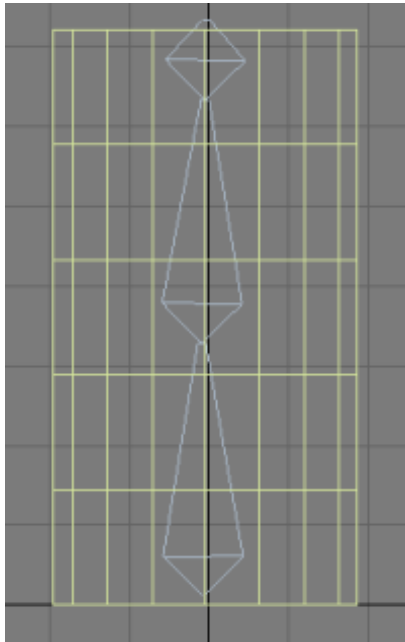
- 1 Prepare a cylinder skinned to a bone chain.



- 2 On Parameters rollout of the Modify panel, turn on Edit Envelopes.
- 3 Turn on Vertices in the Select group.
- 4  In the Weight Properties group, click Weight Tool.  
The Weight Tool dialog opens.
- 5  Select a few vertices and then click the .25 weight button.  
The selected vertices are weighted at 0.250 for the active bone (highlighted in the Parameters rollout list), coloring them yellow.

---

**NOTE** The active bone is added to the list of bones influencing each of the selected vertices, if necessary.

---

**NOTE**  You might need to toggle the vertex weighting to Relative in the [Envelope Properties group](#) on page 1600 .

---

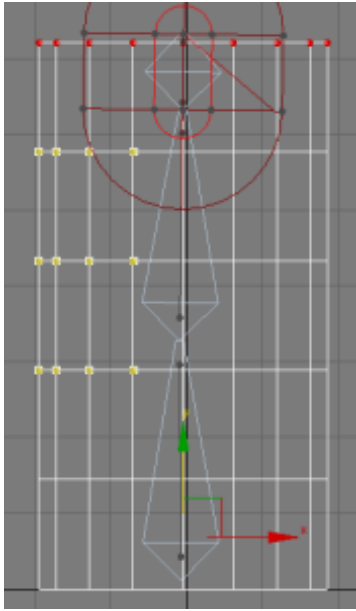

- 6  Click the + button directly under the .9 weight button repeatedly until the vertices are red (that is, the weight is 1.0).  
As you increase the vertices' weight, they gradually change color.
- 7  Select a few other vertices, and assign them a weight of 0.250.

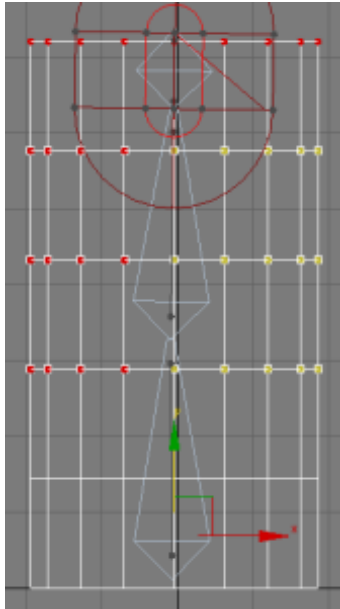

The left vertices are weighted 1.0 and the right vertices are weighted 0.25.

- 8 Select all weighted vertices and repeatedly click Blend. Every time you click Blend, each vertex's weight is adjusted to blend with other selected neighborhood weights. This creates a smooth weighting transition among all selected vertices.



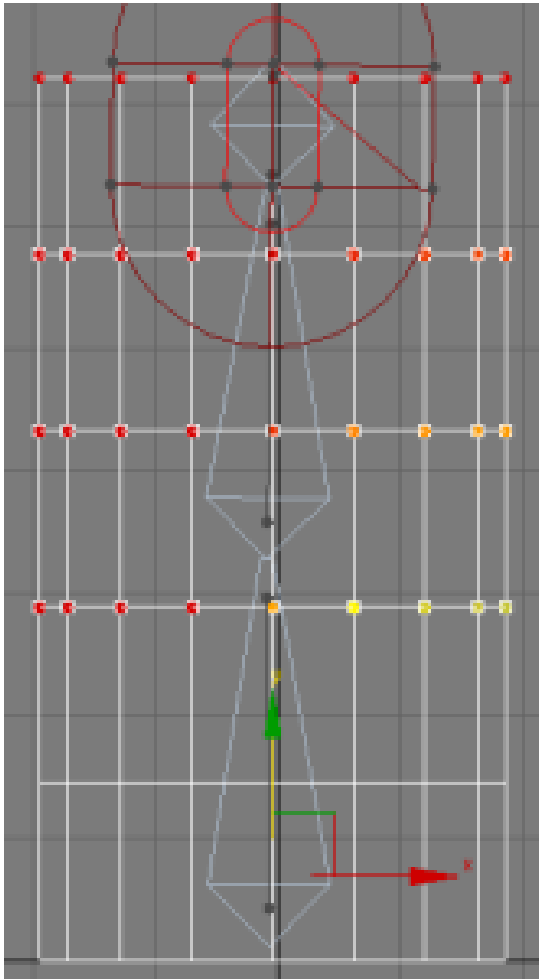

The two separate colors blend into a smooth gradient.

## Interface

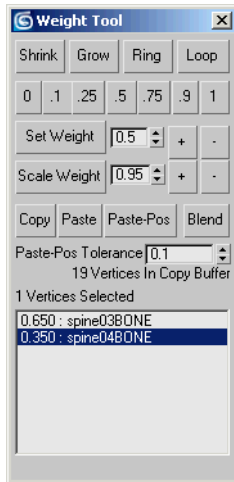

**Shrink** Modifies the current vertex selection by progressively subtracting the outermost vertices from the selection. Has no effect if all vertices in an object are selected.

**Grow** Modifies the current vertex selection by progressively adding neighborhood vertices of the selected object. You must start with at least one vertex to be able to grow your selection.

**Ring** Expands the current vertex selection to include all vertices in parallel edges.

---

**NOTE** You must select at least two vertices to use the Ring selection.

---

**Loop** Expands the current vertex selection to include all vertices in continuing edges.

---

**NOTE** You must select at least two vertices to use the Loop selection.

---

 **[specific weight values]** Assigns an absolute weight value between 0 and 1 for the active bone to the selected vertices.

---

**NOTE** When you click one of these buttons, the active bone is added to the list of bones influencing each of the selected vertices, if necessary.

---

**Set Weight** Sets an absolute weight based on the field value. Default=0.5.

---

**NOTE** The spinner increments the field value by steps of 0.05.

---

+/- Increases/decreases each selected vertex's weight by 0.05.

**Scale Weight** Multiplies each selected vertex's weight value by the field value, resulting in a relative weight change. Default=0.95.

---

**NOTE** The spinner increments the field value in steps of 0.05.

---

+/- Increases/decreases each selected vertex's weight by five percent.

**Copy** Stores the current weight value(s) in the copy buffer.

**Paste** Retrieves the weight values from the copy buffer and assigns them to the selected vertices.

**Paste-Pos** Assigns the weight values currently in the copy buffer to the selected vertices based on the distance between them and the copied vertices, which is determined by the Paste-Pos Tolerance value.

This is useful when you need to match weights between two juxtaposed skinned meshes sharing the a common bone.

**Blend** Modifies the selected weight values to smooth out the transition between them and their surrounding vertices.

**Paste-Pos Tolerance** Determines the radius influence of the Paste-Pos. Default=0.1.

### **Vertex information**

Below the Paste-Pos Tolerance field is a text display displaying information on the amount of copied and selected vertices.

**[First Vertex Weight list]** Displays the selected vertex weight along with the bone envelopes contributing to its weighting. You can select individual envelopes in the current viewport by highlighting the respective bone in the list.

---

**NOTE** If you select multiple vertices, the list only displays the weighting of the first selected vertex.

---

## **Weight Table (Skin Modifier)**

Select an object that has the Skin modifier applied to it. > Modify panel > Skin modifier > Weight Properties group > Weight Table

The weight table for the Skin modifier is used to change vertex weights for several vertices and bones at a time. This table appears when you click the Weight Table button.

## Interface

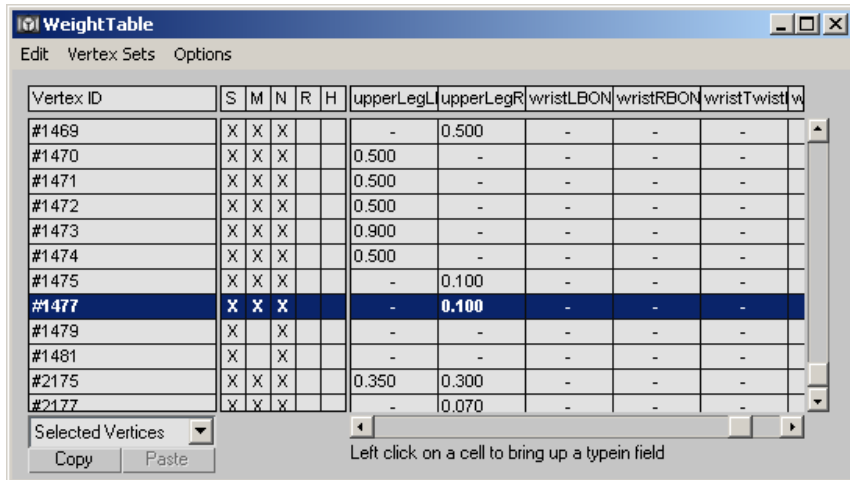

Vertex numbers appear down the left column, while bone names appear across the top. Vertex weights for each bone are displayed in the chart. You can change vertex weights in a number of ways:

- Click and drag a vertex weight to the left or right.
- Highlight a weight and type in a new weight.
- Select vertices by dragging over vertex IDs, then click and drag one weight to change all selected weights for the bone.
- Right-click to enter a value of 0.
- Ctrl+right-click to enter a value of 1.0.

### Menu options:

**Edit menu** Copy/paste vertex weights, and choose vertices to edit.

- **Copy:** Copies weights for highlighted vertices.
- **Paste:** Pastes the copied weights.

- **Remove Zero Weights:** All vertices with a weight less than the [Remove Zero Limit](#) on page 1618 field value are stripped from their weight. Also available on the [Advanced Parameters rollout](#) on page 1616 .

Vertex ID	S	M	N	R	H	Backpack	L Finger0	L Finger01	L Hand
#979	X	X	X	X		-	0.409	0.990	0.001
#980	X	X	X	X		-	0.950	0.040	0.010

No weight values

- **Select All/None/Invert:** Changes the selection of vertices.

**Vertex Sets menu** Select vertices in the left column by holding down Ctrl while clicking vertices. Create a named selection set, which can then be picked from the drop-down menu at the lower left of the dialog.

**Options menu** Customizes the weight table display.

- **Flip UI:** Flips the UI to show vertex IDs across the top and bone names down the left side.
- **Update On Mouse Up:** When the mouse button is pressed down, no updates will take place. When the mouse button is released, updates will occur. This option helps keep workflow moving quickly by avoiding unnecessary updates.
- **Show Affected Bones:** Displays only bones that affect the displayed vertices.
- **Show Attributes:** Toggles display of the S/M/N/R/H attributes.
- **Show Exclusions:** Toggles display of small check box areas in each vertex weight field. Clicking the check box toggles exclusion of the vertex from the bone (a red X appears in the check box when the exclusion is in effect).
- **Show Global:** Shows values for all displayed vertices.
- **Show Set Sets UI:** Displays info about vertex sets.

### Dialog options

**Vertex ID** Vertices are displayed by number down the left column of the weight table. Double-click a vertex number to cause the vertex to display in pink in viewports. To display only selected vertices, choose Selected Vertices from the drop-down menu at the bottom left of the dialog.

**S** Indicates vertex is selected.

**M** Indicates vertex weight has been modified.

**N** Indicates vertex weights are normalized (total of all vertex weights is always 1.0).

**R** Indicates vertex is rigid (affected only by one bone, the one with the most influence).

**H** Indicates patch handles are rigid (affected only by one bone, the one with the most influence).

**Vertex selection drop-down** Choose to display all vertices, selected vertices or only vertices affected by the selected bone.

**Copy** Copies weights for highlighted vertices.

**Paste** Pastes copied weights.

## Skin Morph Modifier

The Skin Morph modifier lets you use a bone's rotation to drive a morph; that is, a deformation of the object mesh. Skin Morph is intended for use with a Skin or comparable modifier (e.g., Physique); add the Skin Morph modifier after the skin-type modifier. You create the morph at the frame in which the effect should be greatest, and then Skin Morph automatically animates the affected vertices into and out of the morph, based on the rotation of the bone that drives the morph.

This lets you fine-tune mesh deformation at any frame, using a bone to drive the morph that is fixing a problem area. Typically, when animating a character with bones, an artist has to create extra bones to handle problem areas such as armpits and groin areas. With Skin Morph, instead of using extra bones, you can simply create a morph, and then transform vertices into the exact shape you want. Skin Morph lets you easily create muscle bulges and many other effects.

---

**NOTE** When working with Skin Morph, it's important to be familiar with the concept of *delta*. The frame at which you apply the modifier determines the base position for each vertex that's used in a morphing animation controlled by Skin Morph. After applying the modifier, go to a frame at which the bone driving the morph is rotated an amount that will cause the greatest deformation, and then transform vertices to produce the morph. The amount by which you transform the vertices is called the *delta*: the difference between the base pose and the morphed position.

---

## Procedures

### To use Skin Morph (basic usage):

- 1** Create an animated character with bones and a skinned body mesh, using a modifier such as [Skin](#) on page 1600 or [Physique](#) on page 4054 .
- 2** Go to the “pose frame” and apply the Skin Morph modifier.  
The pose frame contains the initial pose; typically a standing character with arms outstretched and legs apart. This is often frame 0, but it can be any frame, even a negative-numbered one. This is the frame from which the modifier measures delta: the change in the vertex position between this pose and the morph.
- 3** Determine which bones are driving deformations that you want to modify with Skin Morph.  
For example, bending an arm might cause the inside of the elbow to indent too far, or you might want to add a bulging bicep. In this case, the forearm bone is driving the deformation.
- 4** Use Add to bind the deformation-driving bones to the modifier.  
The modifier overlays an orange line along the length of each bone you add.
- 5** Go to the frame where you wish to create the morph. Using the arm-bending example, this might be the frame where the forearm is at a 90-degree angle to the upper arm.
- 6** In the list box, click one of the bones.  
In the viewport, the orange line representing the bone becomes a thicker yellow line to indicate that this bone will drive the morph.
- 7** On the Local Properties rollout, click Create Morph.  
The modifier adds a morph to the highlighted bone and sets the morph to 100% at this frame, as reflected by the number next to the morph's name in the list.
- 8** On the Local Properties rollout, click Edit.  
This temporarily freezes the skin deformation at the current frame.
- 9** Move vertices to where they should be at the current frame.
- 10** Click Edit again to exit this mode, and then test the animation.

## Interface

### Skin Morph modifier stack

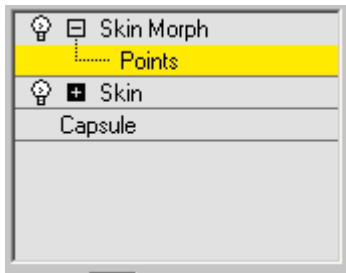

**Points sub-object level** At the Points sub-object level, you can view and select vertices on the skin mesh. However, you can transform these vertices only when [Edit mode](#) on page 1643 is on. The ability to select points when not in Edit mode lets you make the selection when the points are more easily accessible, and then go to the pose to transform them in Edit mode.



## Parameters rollout



**[list window]** Lists all attached bones and their morphs in a hierarchical view. You can expand or contract a bone's morph listing by clicking the + or - box next to its name in the list. The number in parentheses next to the morph name shows its relative influence as a percentage at the current frame.

Highlighting a bone in the list highlights the bone in the viewports as a yellow line, and lets you create a morph for it. Alternatively, you can select the bone in the viewport while the modifier's Points sub-object level is active by clicking the orange line through its center.

Highlighting a morph in the list lets you edit the morph. To change the morph's name, edit the Local Properties rollout > Morph Name field.

**Add Bone** Click to add one or more bones from the Select Bones dialog.

---

**TIP** To keep things simple, add only bones that will drive morphs. There's no point in adding any other bones.

---

**Pick Bone** Lets you add bones by selecting them in a viewport.

Click Pick Bone, and then select bones in any viewport. While Pick Bone is active, the cursor resembles a cross with the words ADD BONE attached. To exit Pick Bone mode, right-click the active viewport or click Pick Bone again.

**Remove Bone** Removes a bone and its morphs from the list. Click a bone name in the list, and then click Remove.

If a morph name is highlighted when you click Remove, its bone is removed. To remove the morph only, highlight it and then click Local Properties rollout > Delete Morph.

### Selection rollout

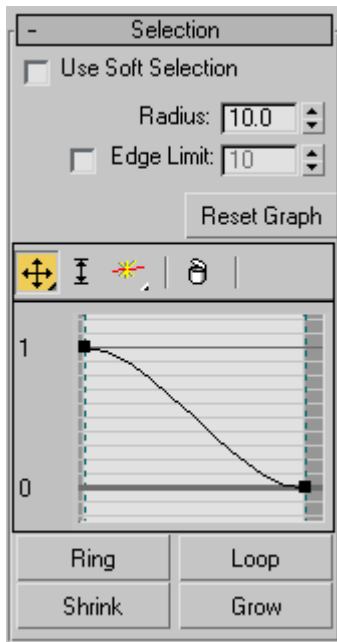

**Use Soft Selection** Enables soft selection for editing vertices.

Soft Selection in Skin Morph works much like [Soft Selection](#) on page 1926 in other parts of 3ds Max, except that instead of Pinch and Bubble settings you can adjust the graph shape directly, and it uses a Radius setting instead of Falloff to determine the extent of the soft-selection area.

**Radius** Determines the extent of the soft-selection area in system units.

**Edge Limit** When on, Skin Morph uses the Edge Limit numeric setting to determine the extent of the soft-selection area in terms of the number of edges from the selected vertex or vertices.

**Reset Graph** Sets the soft-selection graph to default values. Use this if a vertex or handle is no longer visible and thus cannot be manipulated.

**[graph]** Skin Morph provides a small, full-functioned curve graph for editing soft-selection characteristics globally; it works much like other such graphs in 3ds Max, such as [Curve Editor](#) on page 3441 . The toolbar above the graph offers functions for moving and scaling points on the graph, as well as inserting new ones. The same functions are available by right-clicking the graph: If you right-click a graph point, you can set it to Corner or one of two different Bezier types. If you select a Bezier point, you can reshape the curve by moving its handles.

**Ring** Expands a vertex selection by first converting the selection to an edge selection, selecting all edges parallel to the selected edges, and then converting the new edge selection back to a vertex selection. Use of Ring requires that a qualifying vertex selection exist; that is, at least two vertices on the same edge.

**Loop** Expands a vertex selection by first converting the selection to an edge selection, selecting all aligned edges, and then converting the new edge selection back to a vertex selection. Use of Loop requires that a qualifying vertex selection exist; that is, at least two vertices on the same edge.

**Shrink** Reduces the vertex selection area by deselecting the outermost vertices. If the selection size can no longer be reduced, the remaining vertices are deselected.

**Grow** Expands the vertex selection area outward in all available directions.

## Local Properties rollout



This rollout contains functions for creating and editing individual morphs. The settings, such as Morph Name and Influence Angle, are specific to each morph.

**Create Morph** Sets a morph at the current frame for the highlighted bone. Also sets the “pose” for this morph, using the bone's current orientation, and sets the bone to 100%, as shown in the list window hierarchical view. When you edit the morph, the skinned object returns to and stays at this orientation.

When you create a morph, the modifier displays, in orange, all vertices that are part of the current pose (that is, they're offset from the initial pose). Also, the modifier creates a default name for the morph and adds it as a child to the highlighted bone in the list window.

---

**TIP** By default, the Show Edges switch is on, which might make it difficult to see the vertices themselves. To see only the vertices, turn off Options rollout > Show Edges.

---

**TIP** To help keep track of morphs, use the Local Properties rollout to rename each morph as you create it.

---

**Delete Morph** Deletes the highlighted morph, removing it from its parent bone in the list window. Available only when a morph is highlighted.

**Edit** Lets you shape the current morph by transforming vertices. To exit Edit mode, click the Edit button again.

Transforming a vertex in Edit mode creates a morph target. Each transformed vertex moves into the morph target position (or orientation or scale) as the morph value increases to 100.0, and then out of it as the morph value decreases, based on the angle of the bone driving the morph.

Transforming a vertex in Edit mode also changes its color from orange to yellow. This lets you easily see which vertices are part of the current morph.

Choosing Edit places the skinned object at the 100% “pose” orientation for this morph (see Create Morph, above). It also activates the Points sub-object level so you can transform vertices using the standard 3ds Max transform tools.

**Clear Verts** Keeps selected vertices in the morph, but resets their deltas (changes from the initial pose) to 0.

**Reset Orient(ation)** Sets the morph orientation to current orientation of the bone that controls the morph.

This lets you change the angle at which the morph has its greatest effect. For example, if you create a bulging bicep at frame 120, and later decide that the muscle should be largest at frame 150 instead, go to frame 150, choose the morph in the list box, and then click Reset Orientation.

**Remove Verts** Removes selected vertices from the current morph, which deletes any animation applied as part of the morph.

Use this command to save memory by removing vertices not part of the morph animation.

**Enabled** When on, the morph is active; when off, the morph doesn't appear in the animation, and is indicated in the list box with the text “Disabled.”  
Default=on.

The ability to enable and disable each morph individually lets you isolate the effect of each or test them in combination.

**Morph Name** Displays and lets you change the name of the current morph.

**Influence Angle** The angle around the bone's current orientation within which the morph takes place. Default=90.0.

This is an important parameter. Think of the influence angle as a cone around the bone at its orientation when you create the morph. Consider an example in which Influence Angle is set to the default value of 90.0 degrees. If the bone starts its rotation beyond 45 degrees away from the orientation at which the morph was created, the morph has no effect at that time. As the bone moves from 45 degrees away to the morph orientation, the morph increases to its full value. As the bone then rotates away, the morph gradually decreases until, at 45 degrees or more away from the morph orientation, the morph no longer appears.

---

**TIP** Influence Angle is useful for isolating morphs; that is, to prevent overlapping of different morphs on the same bone. Reduce the value until one morph's contribution percent value (shown in the list box) falls off to 0.0 before the next one begins.

---

**Falloff** Determines the rate of change of the morph as the bone moves within the influence angle. Use the drop-down list to choose one of four different falloff types: Linear, Sinual, Fast, or Slow. If you choose Custom Falloff, you can then click the G (for Graph) button and edit the falloff using standard curve-graph controls.

---

**NOTE** The default graph, displayed when you first access the falloff graph, shows the Sinual falloff type.

---

**Joint Type** Determines how the modifier tracks the angular motion of the bone. This is a per-bone setting, not per-morph. Default=Ball Joint.

- **Ball Joint** Tracks all rotation of the bone. Use this setting in most cases.
- **Planar Joint** Tracks rotation of the bone only in the plane of its parent bone.

**External Mesh** Lets you use a different mesh as a morph target. Click the button (default label=-none-) and then select the target object. The target object should have the same mesh structure as the Skin Morph object. After specifying an external mesh, its name appears on the button.

Using an external mesh makes it easier to set up morph targets in a target mesh that uses a reference pose, rather than the skinned, animated mesh of which sections might be interpenetrating, making it difficult to select the specific vertices to be morphed. In this situation, it's probably best to turn Reload Only Selected Verts.

---

**NOTE** The external-mesh connection is not live; if you edit vertices in the external mesh, Skin Morph doesn't automatically recognize the changes. To update the vertex positions after editing the external mesh, use Reload Target (see following).

---

**Reload Target** Updates the Skin Morph object with edited vertex positions from the external mesh.

**Reload only selected verts** When on, Reload Target copies only the positions of vertices selected in the Skin Morph mesh from the target mesh. When off, Reload Target copies the positions of all vertices. Default=off.

### Copy and Paste rollout

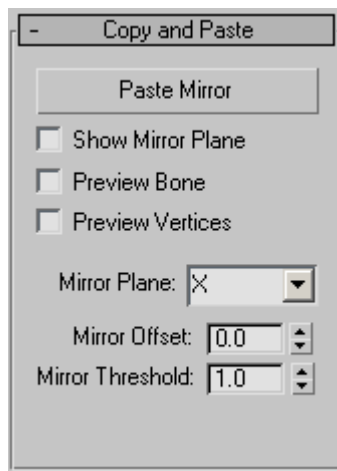

These functions let you copy all morph targets for a specific bone from one side of the object to the other. Indicate the morphs to copy by highlighting the bone or any of its morphs in the Parameters rollout > list box.

**Paste Mirror** Copies the morphs from the highlighted bone to the target on the other side of the mirror gizmo. A qualified target bone must exist and be present in the list box.

---

**NOTE** This copies the morph data only; the rotation of the target bone must be comparable to that of the source bone for the morphing to appear in the animation.

---

**Show Mirror Plane** Displays the mirror plane as a red, rectangular gizmo in the viewports. The target bone must be on the opposite side of the mirror plane from the highlighted bone, and must be present in the Parameters rollout > list box.

**Preview Bone** Highlights the target bone in red in the viewports.

**Preview Vertices** Displays the morphing-qualified vertices in red in the viewports, as well as any animation present in the source vertices.

**Mirror Plane** The axis for the mirror plane. The plane is perpendicular to the indicated axis. Default=X.

**Mirror Offset** The position for the mirror plane on the Mirror Plane axis. Default=0.0.

**Mirror Threshold** The radius, in system units, within which Skin Morph looks for a qualifying target bone on the other side of the mirror plane. Default=1.0.



## Options rollout

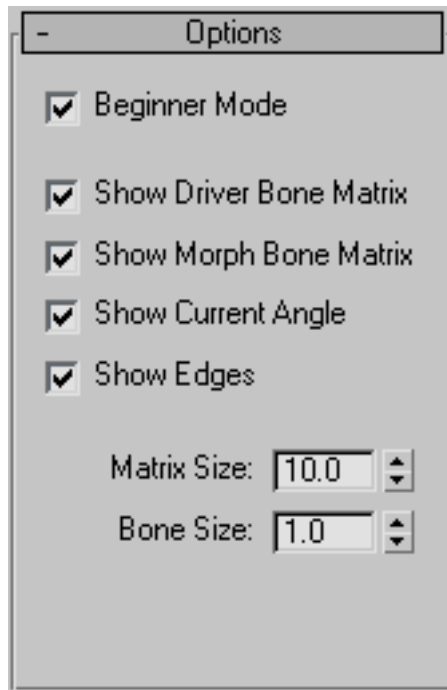

**Beginner Mode** When on, you must use the Create Morph button to create a morph and the Edit button to edit a morph.

When off, you can create and edit morphs on the fly. In this mode, when you select and move vertices at the Points sub-object level, the software first determines whether a morph exists for the selected bone at 100%; if so, all edits will go to that morph. Otherwise, the software creates a new morph automatically and applies the edits to that morph.

**Show Driver Bone Matrix** Shows the matrix tripod of the current bone.

**Show Morph Bone Matrix** Shows the tripod of the orientation of the active morph.

**Show Current Angle** Shows pie wedges depicting the angles between the driver bone matrix and the morph bone matrix. These are color coded: red for the angle about the X axis; blue for the angle about the Y axis; and green for the angle about the Z axis.

**Show Edges** Highlights the edges connected to morphable vertices in orange.

This is useful when a tessellating modifier such as MeshSmooth is applied to the skinned mesh above the Skin Morph modifier, to see the actual mesh being affected by Skin Morph.

**Matrix Size** The size of each tripod.

**Bone Size** The size of the bone display.

## Skin Wrap Modifier

Make a selection. > Modify panel > Modifier List > Object-Space Modifiers > Skin Wrap

The Skin Wrap modifier allows one or more objects to deform another. While Skin Wrap is flexible enough to serve a variety of needs, it's primarily intended for animating a high-resolution object, such as a character mesh, with a low-resolution one.

The low-resolution object doing the deforming is called a *control object*, and the high-resolution object it's affecting (that is, the one with the Skin Wrap modifier) is the *base object*. A base object can be any type of deformable object. Also, in this topic, *control vertex* refers to a vertex on the control object, and *point* refers to a vertex on the base object.

With Skin Wrap, you can modify the structure and topology of the high-resolution object after setting up the animation. The animation remains intact because it is actually contained in the control object.

In most cases, when using Skin Wrap, the control object is positioned near the modified base object, and then bound to the latter using the modifier's Add function. By default, moving a vertex in the control object affects nearby vertices in the base object. Additional options allow faces in the control object to affect the nearest points in the base object instead (Blend To Base Object). Conversely, points in the control object can affect faces in the base object (Face Deformation).

Skin Wrap offers a great deal of control in that you can set a different strength value for each control vertex, as well as the shape of its volume of influence. You can also convert the Skin Wrap effect to a Skin modifier applied to the high-res model, suitable for use with game engines. And the ability to animate with multiple control objects lets a technical director assign animation of different parts of a complex character mesh to various artists.

---

**TIP** If you use a control object to which non-uniform scaling has been applied, its vertices will have non-spherical volumes of influence, which can lead to unexpected results. In such a case, before adding the control object to the modifier, apply [Reset XForm](#) on page 886 and then collapse the stack.

---

**See also:**

- [Skin Wrap Patch Modifier](#) on page 1657

## Procedures

**To use Skin Wrap (basic method):**

- 1 Create a high-resolution base object and one or more low-resolution control objects, which will deform the base object. In general, each control object should have an overall shape similar to the part of the base object that it will deform, and be positioned near that part of the base object.
- 2 Apply Skin Wrap to the high-resolution base object. The modifier transfers animation or modeling from the control object to the base object.
- 3 On the Skin Wrap > Parameters rollout, use Add to assign the control object(s).
- 4 Choose a deformation engine: Vertex or Face.
- 5 Set global parameters as desired. These parameters affect all control vertices, and include Deformation Engine, Falloff, Distance Influence, and Face Limit.
- 6 To set local parameters, including strength and influence distances, access the Control Vertices sub-object level of the Skin Wrap. Select one or more control vertices, and then change the settings as necessary.
- 7 Edit or animate the control object with modifiers and/or sub-object transforms; the high-resolution (base) object deforms accordingly.
- 8 Repeat steps 5, 6, and 7 as necessary. Occasionally you might need to reset the modifier as well, by clicking the Reset button. Before doing so, always return to a non-deformed point (or “skin pose”) in the animation; typically, frame 0.

## Interface

### Skin Wrap modifier stack

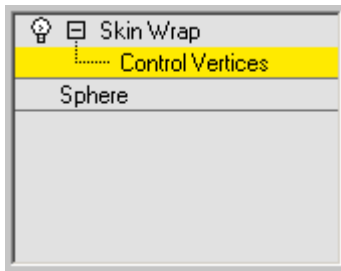

**Control Vertices sub-object level** At the Control Vertices sub-object level, you can view and select vertices on the control object(s), and set [local parameters](#) on page 1653 for any selected vertices. By default, each selected vertex is surrounded by [loops](#) on page 1656 that depict its volume of influence. This sub-object level also uses color coding on affected points in the base object to show each selected vertex's relative effect on points within the volume of influence. Colors range from orange for the strongest influence to blue for the weakest influence. Red is for vertices that are within its range of influence but that it's not influencing.

By default, at this level, control vertices appear as small orange squares. To prevent this, turn off Display Parameters rollout > Display Control Vertices.

## Parameters rollout

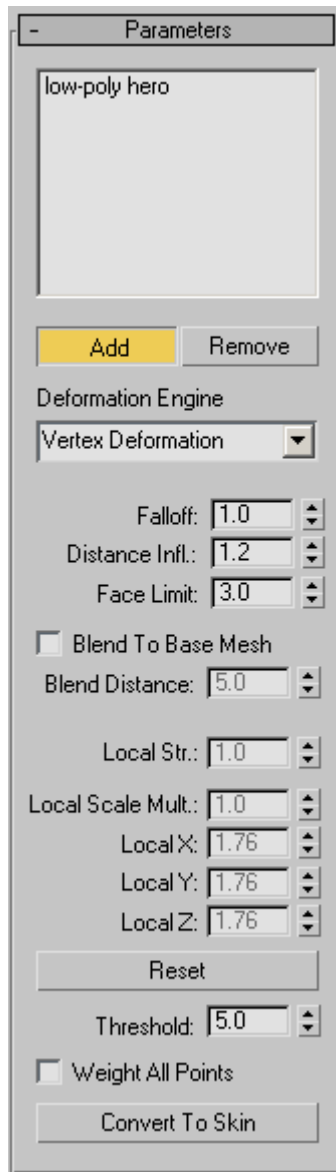

**[control object list]** Lists object(s) that deform the modified object. Use the Add and Remove functions to edit the list contents.

**Add** Adds control objects to the list. Click Add, and then click each control object in turn. To stop adding, right-click in the viewport or click Add again.

You can use as a control object anything that can be converted to a triangle mesh, such as a mesh, patch, or a NURBS object. However, avoid using objects that change topology, such as a deforming NURBS object with adaptive tessellation.

**Remove** Removes control objects from the list. Click an object in the list, and then click Remove.

**Deformation Engine** Determines which engine drives the deformation. Default=Vertex Deformation.

- The Vertex Deformation engine is a weighted engine; it uses vertex proximity to drive the deformation. That is, each vertex in the control object affects nearby points in the high-resolution (base) mesh.
- With the Face Deformation engine, each control vertex is tied to the closest face in the base object. Face deformation can use falloff, or be a rigid deformation by setting Falloff to 0.001, the lowest possible value.

**Falloff** Determines the extent to which the control vertices affect nearby points in the base object. This is a global setting. Default=1.0. Range=0.001 to 10.0.

Higher values pull nearby points closer to the control vertex. In Face Deformation mode, setting Falloff to the lowest value, 0.001, causes rigid deformation so that there's no falloff; the control vertex either affects the base-object face or it doesn't. For best results, use Falloff values between 1.0 and 2.0, or with Face Deformation, 0.001 for rigid mode.

**Distance Infl(uence)** Determines the distance of influence, in system units, of control vertices in the control object. This is a global setting, and is available only in Vertex Deformation mode. Default=1.2. Range=0.001 to 10.0.

Distance Influence is a multiplier. It looks at the length of each edge that touches each control vertex. For each vertex, it averages all the lengths and then multiplies the average by the Distance Influence value. This lets vertices that are touching only small faces to affect a small area, and vice-versa. The higher the influence value, the smoother the deformation, but the less individual control each vertex has. For best results, keep this value between 1.0 and 2.0.

**Face Limit** Determines the extent of influence, in control-object faces, of control vertices in the control object. This is a global setting, and is available only in Vertex Deformation mode. Default=3. Range=0 to 10.

Beyond this limit, no base-object points can be influenced by the control vertex, even if they're within the Distance Influence radius.

Face Limit is useful for preventing the control-object influence from bridging gaps in the mesh; for example, between fingers in a character mesh.

**Blend To Base Mesh** Causes the modifier to base deformation on the distance from each affected point to the closest face in the control object. Turning on this option makes the Blend Distance setting available.

**Blend Distance** Determines the relative distance between control-object faces and vertices in the base object for deformation to take effect. Available only when Blend To Base Mesh is on. Default=5.0.

Increasing this setting effectively causes a stronger deformation effect and broadens the area on the control that affects the base object.

### **[local parameters]**

The Local parameters are available only at the Control Vertices sub-object level (see [Skin Wrap modifier stack](#) on page 1650 ), and affect only selected points. If you select a single point, the numeric fields reflect its current parameter values. If you select multiple points, 3ds Max displays only those values common to all selected points; parameters with differing values are blank. With multiple points selected, changing a value sets all selected points to that value.

**Local Str(ength)** Determines the power and direction by which the control-object vertex affect points under its influence in the base object. A positive value pulls the points toward the vertex; a negative value pushes them away. Default=1.0.

**Local Scale Mult(iplier)** Scales each selected control-object vertex's volume of influence uniformly. Default=1.0.

Use the scale settings to increase or decrease the area of the base object that the selected control vertex affects.

**Local X/Y/Z** Scales each selected control-object vertex's volume of influence along the indicated axis. Default=1.0.

Change these parameters to produce a non-spherical volume of influence.

**Reset** Resets all control-object vertices' local values to 1.0 and resamples the mesh. It recalculates the control vertices' influence on the base object using the current modifier settings.

Use Reset if you alter a parameter but don't see any change in the deformation. For example, always use Reset after changing the Threshold value. Or, if you want the control object to affect a different part of the base object, move the former, and then use Reset so the modifier accounts for the change in positional relationship between the two. You might also need to reset after changing the topology of the base object or a control object.

---

**IMPORTANT** Use Reset at a point in the animation where no deformation is in effect; typically, frame 0.

---

**Threshold** Determines the distance in system units that the software uses to find the closest face to a control vertex. The greater the distances by which the control object's and base object's surfaces deviate, the higher the Threshold value needs to be. Default=5.0.

---

**NOTE** Threshold is recomputed only when you add a base mesh or click Reset.

---

**WARNING** Be careful about increasing this setting. High values can result in excessive computation times, especially with complex base objects.

---

**Weight All Points** Forces all base-object points to have weights. Each weight is calculated from a combination of three factors: control vertex scale, control vertex strength, and base-object point position.

By default, not all base-object points are necessarily influenced by the control object. Turning on Weight All Vertices causes all points to be influenced by one or more control vertices. If a large number of base-object points are unassigned, this can take a long time to calculate.

**Convert To Skin** Applies a new [Skin modifier](#) on page 1600 to the base object that replicates the animation in the Skin Wrap modifier. Using this function requires that a Skin modifier already be applied to each control object.

Basically, Convert To Skin intelligently “bakes” the animation from skinned low-res control objects to the high-res base object. The Skin modifier that it creates contains all the bone assignments from the original Skin modifier, but with completely rebuilt weight settings based on the base-object weights created by the Skin Wrap modifier.

This function is useful in game-development settings where the game engine recognizes the Skin modifier settings but not the Skin Wrap modifier.



## Advanced Parameters rollout



The Mirror tools in Skin Wrap let you apply local settings (Strength and Scale) from control vertices on one side of a control object to the other, mirroring them across a plane aligned with the X, Y, or Z axis. This is useful for setting up character meshes.

---

**NOTE** Mirror copies only Skin Wrap settings from control vertices; it doesn't copy animation data. Thus, when using Skin Wrap with a character model, first make local settings for control vertices on one side of the control object, select the vertices to copy, mirror them, and then animate the control object.

---

The Bake/Retrieve Control Vertices functions let you store control-vertex settings into the base object and then retrieve them. This is useful for sharing data among artists working on the same project.

**Show Mirror Data** Turns on display of the mirror plane gizmo as well as a small circle showing the projected location for each selected control vertex. Move the gizmo and the projected locations with the Mirror Offset control (see following).

---

**NOTE** For mirror data to be visible, the Skin Wrap > Control Vertices sub-object level must be active.

---

**Mirror Plane** Choose the X, Y, or Z axis for mirroring.

**Mirror Offset** Moves the mirror plane as well as all mirrored vertices.

**Mirror Threshold** Sets the distance, in system units, that Skin Wrap uses to find a control vertex near a projected vertex. Increase this if vertex locations are not the same on either side of the mirror plane.

**Mirror Selected** Copies the local settings from each selected control vertex to any control vertices within the threshold distance of its projected location on the other side of the mirror plane.

**Bake Control Verts** Stores the Local Strength/Scale and the global Falloff, Distance Infl., and Face Limit settings on the control objects for later retrieval with Retrieve Control Vertices.

---

**NOTE** This data is static; any changes to the base-object topology invalidates it.

---

**Retrieve Control Verts** Takes any control-vertex data stored on the control objects with Bake Control Vertices and copies them into the modifier.

### Display Parameters rollout

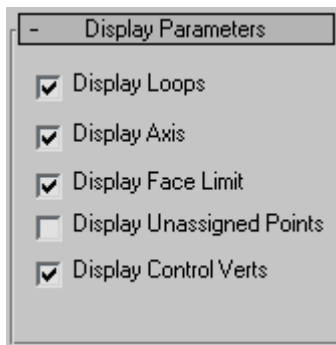

These settings determine whether or not the software displays different elements in the Skin Wrap modifier.

**Display Loops** Displays volumes of influence for selected control vertices as red loops. Default=on.

**Display Axis** Displays the axis tripods for selected control vertices. Default=on.

**Display Face Limit** Shows all base-object points that the selected control vertex or vertices can affect. This is a visualization of the [Face Limit setting](#) on page 1652 . Default=on.

**Display Unassigned Points** Draws a red circle around each base-object point that the system did not find a closest face for and draws a red box around

each point that has a closest face but is not weighted by any control vertex.  
Default=off.

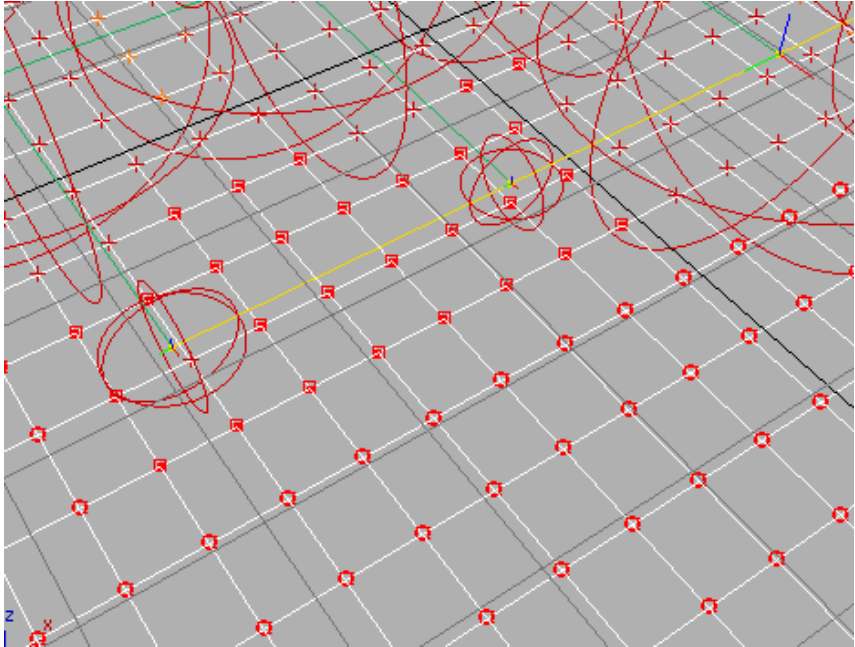

**Unassigned points:** The circled points (bottom) have no closest face, while the points with red boxes (center) have a closest face but aren't weighted by control vertices.

This is an important debugging tool because any vertex that is not assigned a closest face will never be weighted. To do so, you need to increase the Threshold value and click Reset, or turn on Weight All Points. Any points that are not weighted to a control vertex can be fixed by increasing the Local Scale of a control vertex near that point.

**Display Control Verts** Toggles display of all control vertices. Default=on.

## Skin Wrap Patch Modifier

Make a selection. > Modify panel > Modifier List > Object-Space Modifiers > Skin Wrap Patch

Skin Wrap Patch is a simple modifier that allows a patch object to deform a mesh object. It's very easy to use: just assign the modifier to a mesh object, and then use the modifier to specify a deforming patch object. Each point on

the patch object influences a surrounding volume of points on the mesh object.

**See also:**

- [Skin Wrap Modifier](#) on page 1648

### Interface

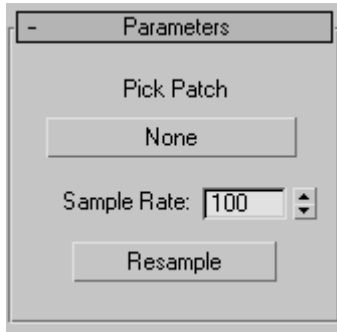

**Pick Patch** Click this button, labeled “None” by default, and then select a patch object to deform the mesh object. After picking the patch object, its name appears on the button.

**Sample Rate** Determines the accuracy with which the modifier samples the patch object. The higher the rate, the more accurate the resulting animation will be, but the longer it will take to calculate.

**Resample** Forces the system to resample the data. This should be done at a point in the animation at which no deformation takes place; typically, frame 0.

## Slice Modifier

Select an object. > Modify panel > Modifier List > Object-Space Modifiers > Slice

Select an object. > Modifiers menu > Parametric Deformers > Slice

The Slice modifier lets you create a cutting plane that slices through a mesh, creating new vertices, edges and faces based on the location of the slice plane gizmo. The vertices can either refine or split the mesh according to the selected options.

The Slice modifier slices through groups, selected objects or sub-object selections of faces. It works similarly to the Editable mesh > Edge > Slice function but does not require the objects to be editable meshes.



**Slice cuts through the cake.**

You can animate the cutting plane, changing its position and rotation over time. You can also use the Remove Top and Remove Bottom options to create the appearance and disappearance of objects by animating the Slice Plane gizmo.



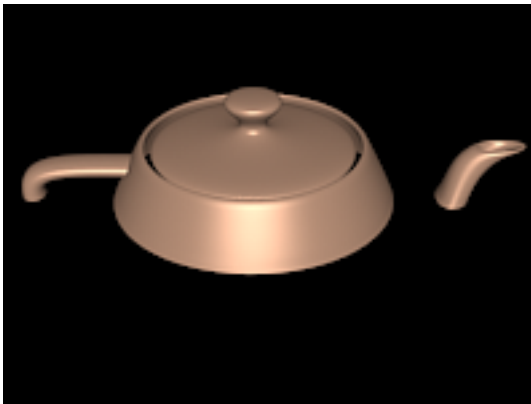
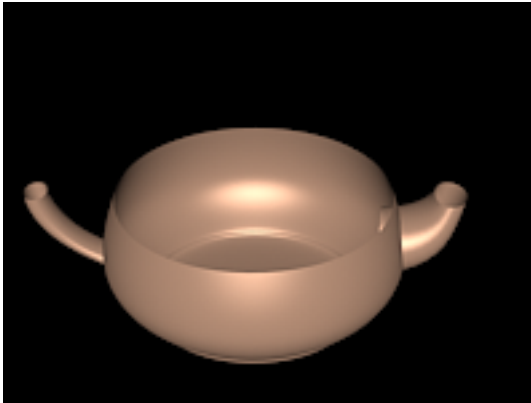

**Top:** Original object

**Middle:** Object without top

**Bottom:** Object without bottom, respectively

### **Multiple Slices**

To create multiple slices in an object you need to apply multiple Slice modifiers. If the geometry doesn't need to remain parametric, you can collapse it into an editable mesh and use the Slice tool available under [Editable Mesh \(Edge\)](#) on page 2007 . This tool is easier to use when you need to make multiple slices in an object, but it does not stay parametric.

## **Warning: Slice and Sub-Object Selections**

You can use Slice on sub-object selection sets by slicing or removing only the selected faces. However, because selected faces are sliced and unselected adjacent faces are not, there may be "holes" in the mesh on the edge where the slice occurs. These holes can be problematic, creating discontinuities in smoothing and rendering. Holes are created only when Operate On Faces is on.

## **Procedures**

### **Example: To animate the appearance of a teapot using the Slice modifier:**

- 1** Create a [teapot](#) on page 377 primitive. Set the viewport to wireframe.
- 2** Apply a Slice modifier.  
The Slice Plane gizmo appears at the base of the teapot.
- 3** On the stack display, choose the Slice Plane gizmo.
- 4** Turn on the Auto Key button, and move the time slider to frame 100.
- 5** Move the Slice Plane gizmo above the top of the teapot. Play the animation to verify that the slice plane is animated.
- 6** Change the Slice type from Refine Mesh (the default) to Remove Top. Play the animation again.
- 7** Make a copy of the teapot in the same position (choose Edit menu > Clone and click OK to accept the default settings).
- 8** Put a Wireframe material on the clone and change the Slice type on the clone to Remove Bottom.
- 9** Play the animation.  
The wireframe teapot magically becomes a fully shaded one.

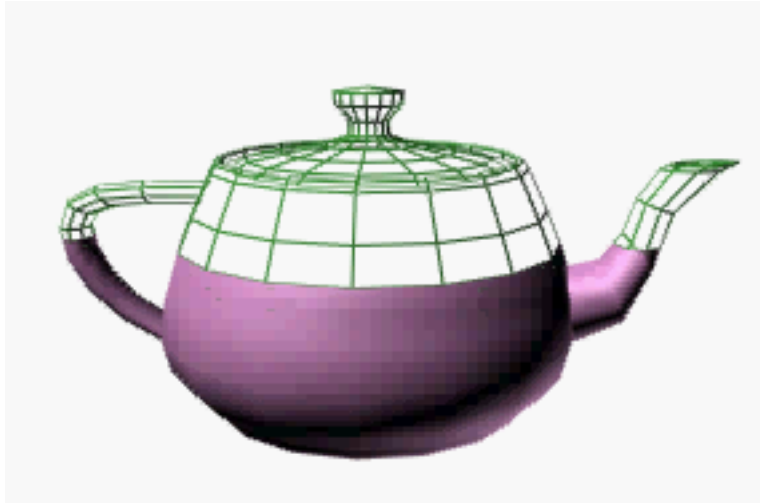

**Example: To slice vertically through an object:**

- 1 Create a [teapot](#) on page 377 primitive.
- 2 Apply a Slice modifier.  
The Slice Plane gizmo appears at the base of the teapot.
- 3 On the stack display, open the Slice modifier and choose the Slice Plane gizmo.
- 4 Move the Slice Plane gizmo so it intersects the middle of the teapot.
- 5 Rotate the Slice Plane gizmo so it is vertical.
- 6 Turn on Remove Top.  
The back of the teapot is sliced away.
- 7 Turn on Remove Bottom.  
The front half of the teapot is sliced away.



## Interface

### Modifier Stack

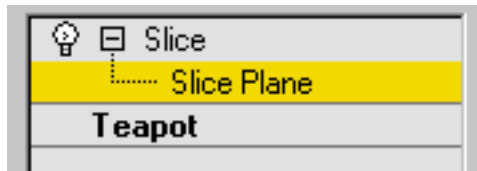

**Slice Plane** At this sub-object level, you can transform and animate the gizmo like any other object to determine where the slice occurs. Scaling the gizmo has no effect, because its extents are effectively infinite. If you need to limit the extent of the slice, use it on a sub-object selection set of faces, rather than on the entire object.

For more information on the stack display, see [Modifier Stack](#) on page 7427 .

### Slice Parameters rollout

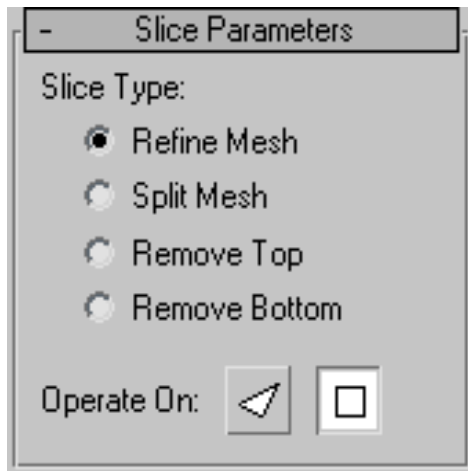



**Slice Type** Defines how the slice plane will affect the geometry to which it has been applied.

- **Refine Mesh** Adds new vertices and edges along the intersection of the geometry with the slicing plane. Faces cut by the plane are subdivided into new faces.

- **Split Mesh** Adds a double set of vertices and edges along the plane boundary producing two separate meshes (one on either side of the slice plane), which you can modify differently if desired. Use this to break a mesh in two.
- **Remove Top** Deletes all the faces and vertices above the Slice Plane.
- **Remove Bottom** Deletes all the faces and vertices below the Slice Plane.

**Operate On** Choose one of these buttons to specify how the slice handles quads and other polygons.

-  **Faces** Treats the selection set as a set of triangular faces, slicing each one in turn. Outputs a [mesh-type object](#) on page 1990 .
-  **Polygons** Converts the object to a polygon mesh based on visible edges, eliminating hidden edges. Outputs a [polymesh-type object](#) on page 2038 .

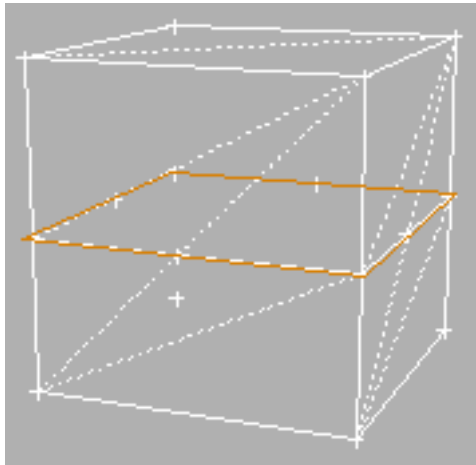

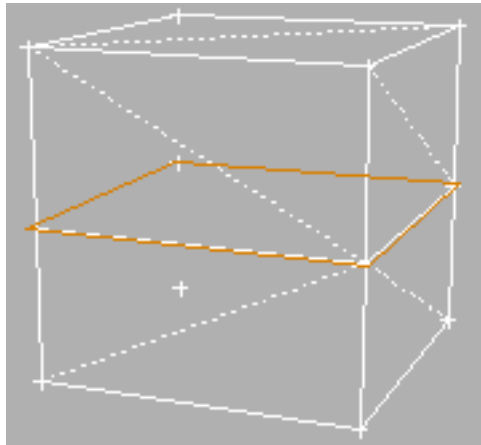

Operate On Face vs. Operate On Polygon

## Smooth Modifier

Select an object. > Modify panel > Modifier List > Object-Space Modifiers > Smooth

Select an object. > Modifiers menu > Mesh Editing > Smooth

The Smooth modifier provides auto-smoothing based on the angle of adjacent faces. You can apply new smoothing groups to objects.

Smoothing eliminates the facets on geometry by grouping faces into smoothing groups. At render time, faces in the same smoothing group appear as a smooth surface.



**Curved surfaces gradually smoothed:**

**Left: No smoothing**

**Center: Smoothing but some edges on the corners**

**Right: Full smoothing**

## **Patches**

As of 3ds Max 4, patch objects coming up the modifier stack are not converted to a mesh by this modifier. A patch object input to the Material modifier retains its patch definition. Files that contain patch objects with the Material modifier from previous versions of the software will be converted to meshes to maintain backward compatibility.

## **Procedures**

**To smooth an object:**

- 1 Select the object to be smoothed.

- 2  On the Modifiers menu, choose Mesh Editing > Smooth.

- 3 On the Modify panel, choose Object-Space Modifiers > Smooth from the Modifier List.
- 4 Turn on Auto Smooth and adjust the Threshold for the desired smoothing effect.

**To apply smoothing groups manually:**

- 1 Select an object.
- 2  Use a [Mesh Select modifier](#) on page 1455 to select the faces to be smoothed.
- 3 Click a numbered button to apply the corresponding smoothing group to the selected faces.

**Interface**

**Parameters rollout**



**Auto Smooth** If Auto Smooth is selected, the object is auto-smoothed using the (animatable) threshold specified by the Threshold setting below it. Auto Smooth sets the smoothing groups based on the angle between faces. Any two adjacent faces are put in the same smoothing group if the angle between their normals is less than the threshold angle.

**Prevent Indirect Smoothing** Turn on to prevent smoothing "leaks" when using Auto Smooth. If you apply Auto Smooth to an object, and portions of

that object that should not be smoothed become smoothed, then turn on Prevent Indirect Smoothing to see if it corrects the problem.

---

**NOTE** This option has an effect only when Auto Smooth is selected. The problem it corrects is rare, and turning on Prevent Indirect Smoothing slows the Auto Smooth process. Don't use this option unless you see something wrong with your existing smoothing.

---

**Threshold** Specifies the threshold angle in degrees. Any two adjacent faces are put in the same smoothing group if the angle between their normals is less than the threshold angle.

### **Smoothing Groups group**

The grid of 32 buttons shows which smoothing groups are used by the selected faces, and are used to assign smoothing groups manually to selected faces.

## **Spherify Modifier**

Select an object. > Modify panel > Modifier List > Object-Space Modifiers > Spherify

Select an object. > Modifiers menu > Parametric Deformers > Spherify

The Spherify modifier distorts an object into a spherical shape. This modifier has only one parameter: a Percent spinner that deforms the object, as much as possible, into a spherical shape.

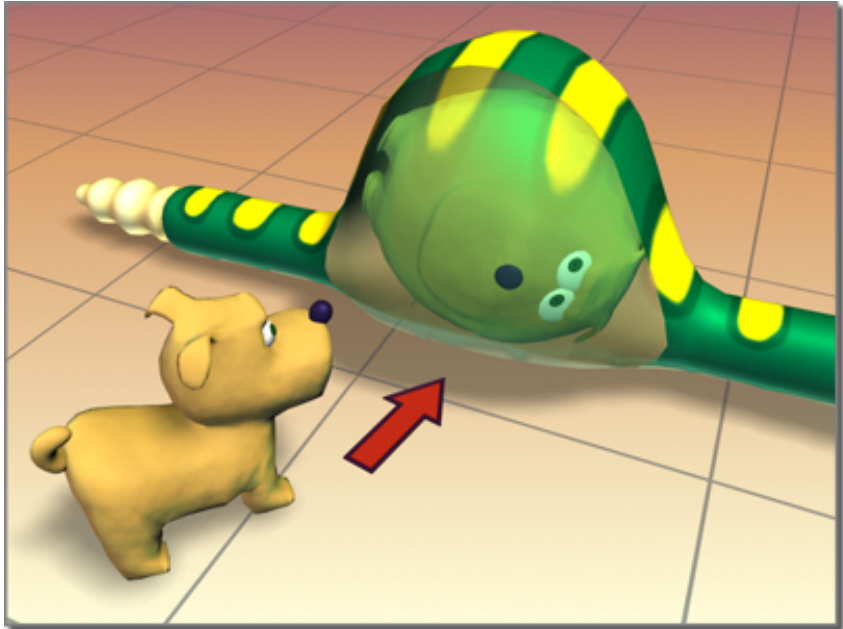



**Spherify shapes the dog inside the snake.**

The success of the operation depends on the topology of the geometry to which it's applied. For example, a cylinder with no height segments will result in little change. Adding height segments will result in a barrel at 100 percent. Adding cap segments will produce a sphere.





Try this on a [teapot](#) on page 377 .

### **Procedures**

**Example: To use the spherify modifier to distort a teapot:**

- 1  Click Create > Geometry > Standard Primitives > Teapot.
- 2 Create a teapot in the viewports.
- 3  On the Modify panel, choose Spherify from the Modifier List. The teapot should now look like a sphere.
- 4 Adjust the Percent setting to less than 100%.

**Example: To animate spherifying a teapot:**

- 1  Click Create >Geometry > Standard Primitives > Teapot.
- 2 Create a teapot in the viewports.
- 3  On the Modify panel, choose Spherify from the Modifier List.
- 4  Turn the Auto Key button on.
- 5 Set the Spherify Percent to **0**.
- 6 Move the time slider ahead to frame 30.
- 7 Set the Spherify Percent to **100**.
- 8  Turn the Auto Key button off.
- 9 Drag the time slider to play the animation, or click Play.

### Interface

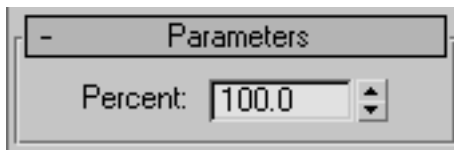

**Percent** Sets the percentage of spherical distortion to apply to an object.

## Spline IK Control Modifier

Select a spline or NURBS curve > Modify panel > Modifier List > Spline IK Control

When the Spline IK Control modifier is applied to a spline, you can select and transform its vertices without having to access the vertex sub-object level. It can also place helpers at each vertex location to aid in moving vertices.



The Spline IK Control modifier works by placing *knots* (control points) at each vertex. The knots can then be used to control vertices, which in turn reshape the spline.

This modifier also works on NURBS curves, placing a knot at each control point or control vertex (CV).

Use the Spline IK Control modifier to prepare a spline or NURBS curve for use with the Spline IK Solver.

**See also:**

- [Spline IK](#) on page 3369

**Interface**



**Control Objects** When helpers are created, knot numbers and their corresponding names appear here. Knot #1 is placed at the [first vertex](#) on page 7785 on the spline, and additional knots are numbered in sequence.

**Create Helpers** Places a helper at each knot, and displays knot numbers and helper names in the Control Objects area. Helper display is based on selections in the Helper Display group. Helpers are linked upon creation if a linking option is selected in the Link Types group.

## Link Types group

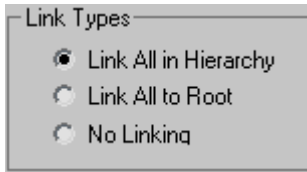

These options cause helpers to be linked upon creation.

**Link All in Hierarchy** Links each helper to its immediately previous helper. For example, the helper at knot #3 is linked to the helper at knot #2, while the helper at knot #2 is linked to the helper at knot #1.

**Link All to Root** Links each helper to the helper at knot #1.

**No Linking** Helpers are not linked.

## Helper Display

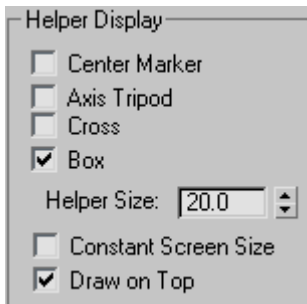

When you click Create Helpers, the software can place one or more Point helper objects at each knot, making it easier to move and animate the knots. You can enable more than one type of helper.

**Center Marker** Places a small X-shaped Point helper at each knot.

**Axis Tripod** Places a small tripod-axis-shaped Point helper at each knot.

**Cross** Places a small cross-shaped Point helper at each knot.

**Box** Places a small box-shaped Point helper at each knot.

**Size** Sets the size for helpers.

**Constant Screen Size** Keeps the sizes of helpers constant regardless of the zoom extent of the viewports.

**Draw On Top** Displays the helpers on top of all other objects in the scene for improved visibility in busy scenes.

---

**TIP** To change the display of helpers after creation, select each helper and change selections on the Modify panel.

---

## Spline Select Modifier

Select a shape. > Modify panel > Modifier List > Object-Space Modifiers > Spline Select

Select a shape. > Modifiers menu > Selection Modifiers > Spline Select

The Spline Select modifier passes a sub-object selection of shapes up the stack to subsequent modifiers. It provides much of the same set of selection functions available in the [Edit Spline modifier](#) on page 1376 . You can select vertices, segments, or splines, and you can change the selection from sub-object level to object level.

This modifier is similar to the [Mesh Select](#) on page 1455 and [Poly Select modifiers](#) on page 1541 , except for the type of sub-object components.

### Procedures

**To use the Spline Select modifier:**

- 1 Create a multi-spline shape.
- 2 Apply a Spline Select modifier.  
By default, the Vertex sub-object level is active.
- 3 If you wish to work at a different sub-object level, use the modifier stack display to choose it.
- 4 In the viewports, select vertices, segments, or splines.

---

**TIP** You can transform the selection using an [XForm modifier](#) on page 1922 or [Linked XForm modifier](#) on page 1440 .

---

## Interface

### Modifier Stack

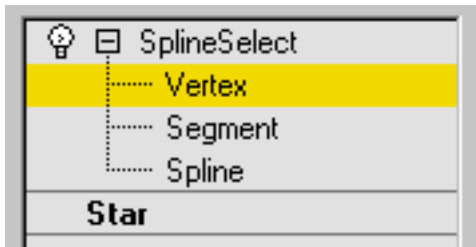

The sub-object level you choose for the spline select modifier determines which rollout appears. (There are no parameters at the top, object level.)

**Vertex** Creates a sub-object selection of vertices.

**Segment** Creates a sub-object selection of segments.

**Spline** Creates a sub-object selection of splines.

For more information on the stack display, see [Modifier Stack](#) on page 7427 .

### Select Vertex rollout

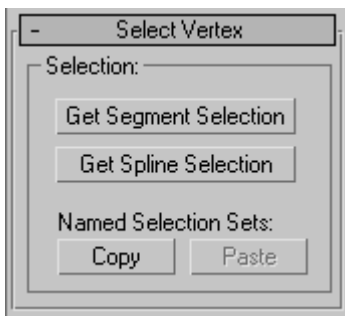

**Get Segment Selection, Get Spline Selection** Select vertices based on the last Segment or Spline selection. This selection is added to the current selection. Available only when Vertex is not the current sub-object level.

## Select Segment rollout

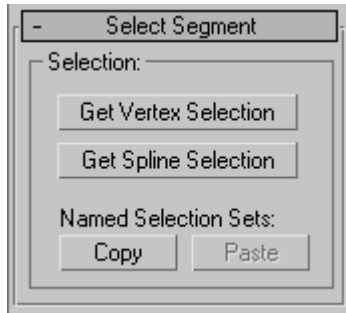

**Get Vertex Selection, Get Spline Selection** Select segments based on the last vertex or spline selection. The selection is added to the current selection. Available only when Segment is not the current sub-object level.

## Select Spline rollout

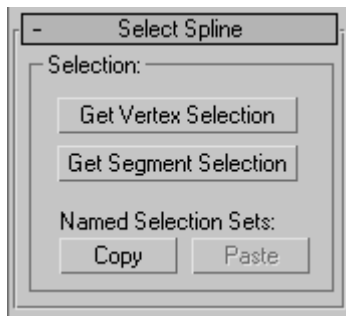

**Get Vertex Selection, Get Segment Selection** Select splines based on the last vertex or segment selection. The selection is added to the current selection. Available only when Spline is not the current sub-object level.

## Copy/Paste Selection controls (all rollouts)

**Copy** Places a named selection into the copy buffer.

**Paste** Pastes a named selection from the copy buffer.

You can copy a named selection from one object to another or one modifier to another. You must copy and paste in the same sub-object level.

# Squeeze Modifier

Modify panel > Make a selection. > Modifier List > Object-Space Modifiers > Squeeze

Make a selection. > Modifiers menu > Parametric Deformers > Squeeze

The Squeeze modifier lets you apply a squeezing effect to objects, in which the vertices closest to the object's [pivot point](#) on page 7895 move inward. The squeeze is applied around the Squeeze gizmo's local Z axis. You can also use Squeeze to create a bulge on the vertical axis, to accentuate the squeeze effect.

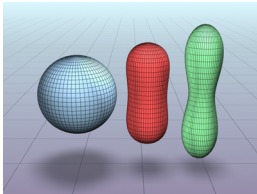

Left: Original object

Middle and Right: Varying squeeze amounts

## Interface

### Modifier Stack

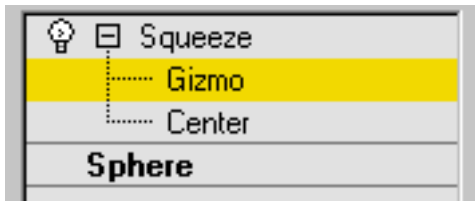

**Gizmo** At this sub-object level, you can transform and animate the gizmo like any other object, altering the effect of the Squeeze modifier. Translating the gizmo translates its center an equal distance. Rotating and scaling the gizmo takes place with respect to its center.

**Center** At this sub-object level, you can translate and animate the center, altering the Squeeze gizmo's shape, and thus the shape of the squeezed object.

For more information on the stack display, see [Modifier Stack](#) on page 7427 .

## Parameters rollout

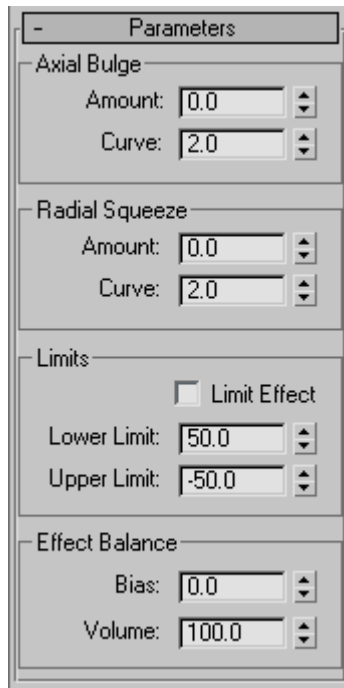

### Axial Bulge group

These controls let you apply a bulge effect along the Squeeze gizmo's local Z axis, which is aligned by default with the object's local Z axis.

**Amount** Controls the magnitude of the bulging effect. Higher values effectively elongate the object and cause the ends to curve outward.

**Curve** Sets the degree of curvature on the bulging ends. You can use this to control whether the bulge is smooth or pointy.

### Radial Squeeze group

These controls let you apply a squeeze effect around the Squeeze gizmo's local Z axis, which is aligned by default with the object's local Z axis.

**Amount** Controls the magnitude of the squeezing action. Values larger than zero tend to constrict the "waist" of the object, and values less than zero tend to bulge the waistline out, as if the object had been stepped on.

**Curve** Sets the degree of curvature into the squeeze. Low values cause a sharp squeezing effect, while high values create a gradual, less pronounced squeeze.

### **Limits group**

These controls let you limit the squeeze effect's extents along the local Z axis.

**Limit Effect** Limits the extent of the squeeze effect as defined by the Lower and Upper Limit settings.

**Lower Limit** Sets the limit in the positive direction along the Z axis.

**Upper Limit** Sets the limit in the negative direction along the Z axis.

### **Effect Balance group**

**Bias** Changes the relative amounts of bulge and squeeze while retaining a constant object volume.

**Volume** Increases or decreases the effects of both Squeeze and Bulge in parallel.

## **STL Check Modifier**

Select an object. > Modify panel > Modifier List > STL Check

Select an object. > Modifiers menu > Mesh Editing > STL check

The STL Check modifier checks an object to see if it's correct for [exporting to an STL \(stereolithography\) file format](#) on page 7076 . Stereolithography files are used by specialized machines to produce prototype physical models based on the data in the STL file.

To create a physical model, an STL file must have a complete and closed surface. Using STL Check to test your geometry before you export it can save time and money when the file is used to create the physical model.



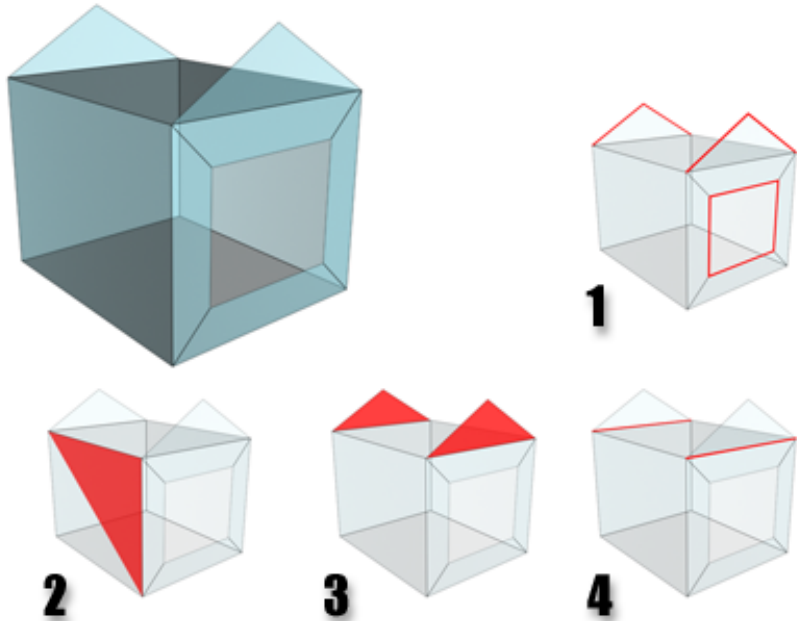

#### STL Check errors.

1. Open edges
2. Double face
3. Spikes
4. Multiple edges

#### Procedures

To check an object for STL compatibility:

- 1  Select the object, then on the Modify panel, choose Mesh Editing > STL Check from the Modifier List.
- 2 Turn on Check.  
The message in the Status group shows if errors are found. STL Check indicates errors by selecting the problem geometry, assigning it a special material ID, or both.

## Interface

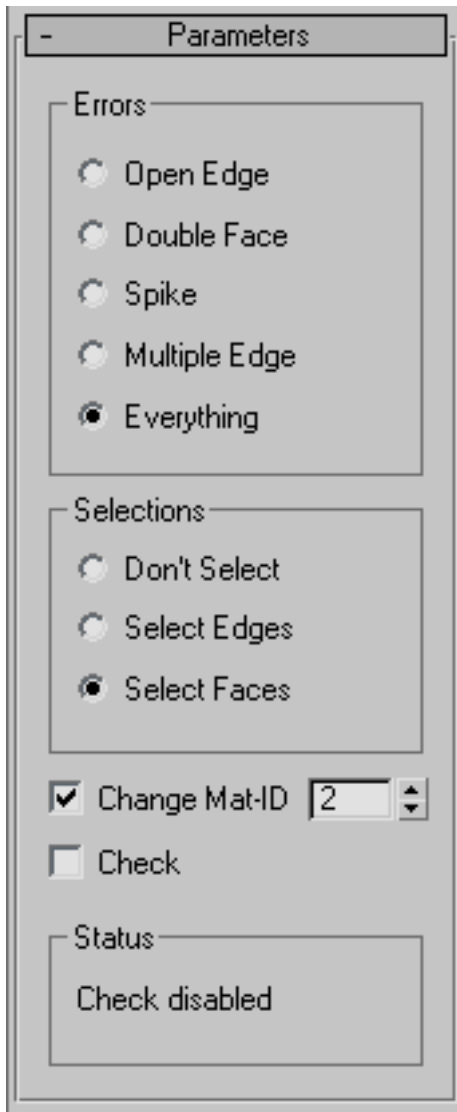

### Errors group

Choosing one of these options selects incorrect geometry specific to the choice, and selects it depending on the option chosen in the Selections group.

**Open Edge** Checks for open edges (holes).

**Double Faces** Checks for faces that share the same 3D space.

**Spike** Checks for spikes, which are isolated faces that share only one edge with the object.

**Multiple Edges** Checks for faces that share more than one edge.

**Everything** Checks for all of the above.

---

**TIP** While checking Everything takes the longest amount of time, it is recommended if you plan to use the STL file for generating a physical model.

---

### **Selections group**

These options specify the level of incorrect geometry that's selected, based on the settings in the Errors group.

**Don't Select** When on, STL Check doesn't select any part of objects in error.

**Select Edges** When on, STL Check marks the edges of faces in error by selecting them. The selection of erroneous edges is visible in viewports.

**Select Faces** When on, STL Check marks the faces of any object in error by selecting them. The selection of erroneous faces is visible in viewports.

**Change Mat-ID** When on (the default), STL Check also marks faces in error by assigning them a unique material ID. Use the spinner to choose the value of the material ID that STL Check uses.

**Check** Turn on to perform the STL check. For complex models, expect a pause between the time you turn this on, and the time you see the reported errors in the Status group. Default=off.

**Status** Displays the number of errors when Check is on.

---

**TIP** If Select Edges is turned off, you can see faces in error by applying an [Edit Mesh modifier](#) on page 1283 and selecting by material ID at the Face sub-object level. You can also assign a [Multi/Sub-Object material](#) on page 5558 to the object to help you see where the errors are.

---

## **Stretch Modifier**

Select an object. > Modify panel > Modifiers List > Object-Space Modifiers > Stretch

Select an object. > Modifiers menu > Parametric Deformers > Stretch

The Stretch modifier simulates the traditional animation effect of "squash-and-stretch." Stretch applies a scale effect along a specified stretch axis and an opposite scale along the two remaining minor axes.

The amount of opposite scaling on the minor axes varies, based on distance from the center of the scale effect. The maximum amount of scaling occurs at the center and falls off toward the ends.

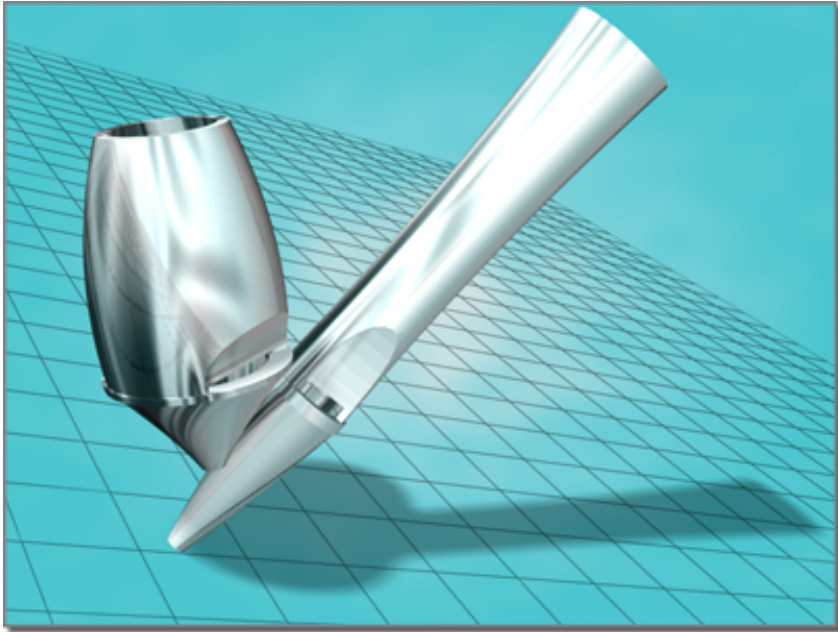

Applying a Stretch modifier to the object on the left creates the object on the right.

### **Procedures**

**To stretch an object:**

- 1 Select an object.
- 2 Apply Stretch.
- 3 On the Parameters rollout > Stretch Axis group, choose X, Y, or Z.
- 4 On the Parameters rollout > Stretch group, enter a value in the Stretch field.

- 5 Adjust the Parameters rollout > Stretch group > Amplify setting to change the amount of scaling along the minor axes.

#### **To limit a stretch:**

- 1 Apply a Stretch modifier to an object and specify the stretch amounts and stretch axis.
- 2 On the Parameters rollout > Limits group, turn on Limit Effect.
- 3 Set values for the Upper and Lower Limits to define the Stretch boundaries on either side of the Stretch center.
- 4 In the stack display, choose the Center sub-object level, and move the center to locate the limited stretch effect.

### **Interface**

#### **Modifier stack**

**Gizmo** At this sub-object level, you can transform and animate the gizmo like any other object, altering the effect of the Stretch modifier. Translating the gizmo translates its center an equal distance. Rotating and scaling the gizmo takes place with respect to its center.

**Center** At this sub-object level, you can translate and animate the center, altering the Stretch gizmo's shape, and thus the shape of the stretched object.

## Parameters rollout

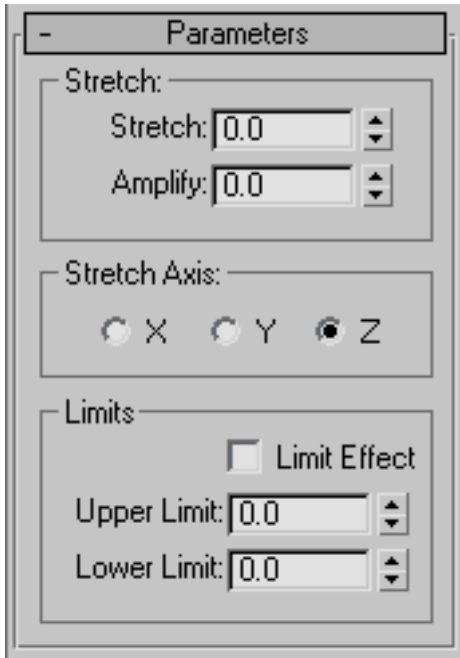

Use options in the Parameters rollout to set the following:

- Amount of stretch
- Major stretch axis
- Area affected by the stretch

### Stretch group

The Stretch group of the Parameters rollout has two fields that control the amount of stretch scaling applied.

**Stretch** Sets the base scale factor for all three axes. The scale factor derived from the Stretch value varies according to the sign of the value.

- Positive stretch values define a scale factor equal to  $\text{Stretch}+1$ . For example, a stretch value of 1.5 yields a scale factor of  $1.5+1=2.5$ , or 250 percent.

- Negative stretch values define a scale factor equal to  $-1/(\text{Stretch}-1)$ . For example, a stretch value of -1.5 yields a scale factor of  $-1/(-1.5-1)=0.4$ , or 40 percent.  
The calculated scale factor is applied to the selected stretch axis and the inverse scale is applied to the minor axes.

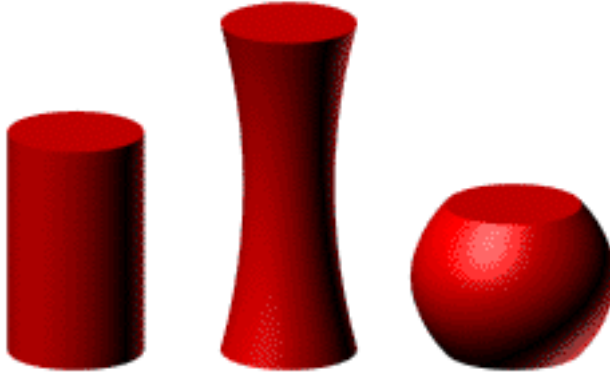

Stretch values of 0.0, 0.5, and -0.5

**Amplify** Changes the scale factor applied to the minor axes. Amplify generates a multiplier using the same technique as stretch. The multiplier is then applied to the Stretch value before the scale factor for the minor axes is calculated.

Amplify values affect scaling along the minor axes in the following way:

- A value of 0 has no effect. It uses the default scale factor calculated from the Stretch amount.
- Positive values exaggerate the effect.
- Negative values reduce the effect.

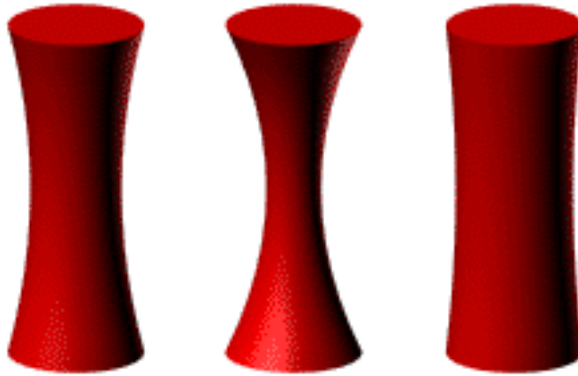

Stretched objects with Amplify values of 0.0, 1.0, and -1.0.

### Stretch Axis group

You select which of the object's local axes is the Stretch Axis using options in the Stretch Axis group of the Parameters rollout.

- The scale factor calculated from the Stretch Amount is applied to the Stretch Axis.
- The inverse scale factor is applied to the remaining minor axes.

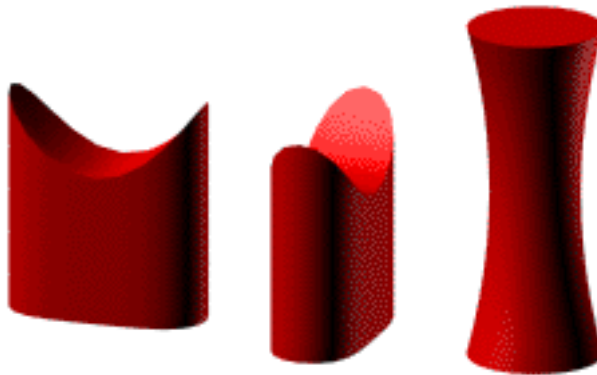

Effects of changing the Stretch axis



## Limits group

You can apply the stretch effect to the entire object, or limit it to a portion of the object, using controls in the Limits group of the Parameters rollout. The limits restrict the stretch effect along the positive and negative Stretch Axis as measured from the modifier's center.

**Limit Effect** Limits the stretch effect. When Limit Effect is turned off, values in the Upper and Lower Limit fields are ignored.

**Upper Limit** Sets the boundary of the stretch effect along the positive Stretch Axis. The Upper Limit can be 0 or any positive number.

**Lower Limit** Sets the boundary of the stretch effect along the negative Stretch Axis. The Lower Limit can be 0 or any negative number.

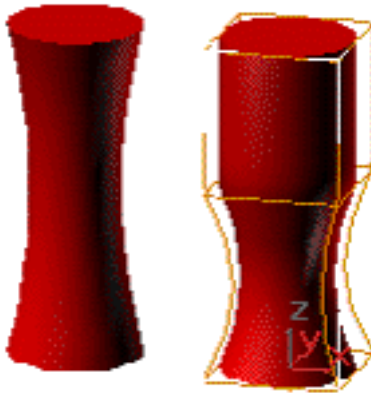

### Limiting the effect of Stretch

Click Sub-Object and move the modifier's center to change the location of the limited stretch areas. The Upper and Lower Limit boundaries move with the modifier center to maintain their specified distances.

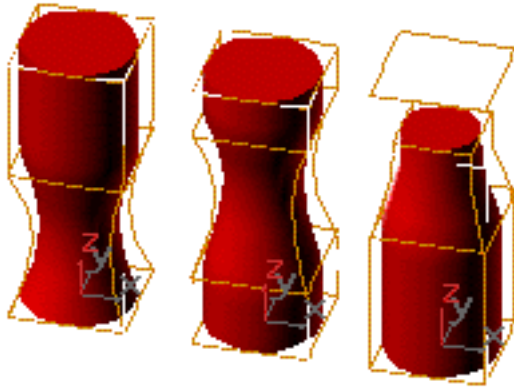

Effects of moving the Stretch center

---

**NOTE** You can also limit the stretch effect by using an Edit or Select modifier, defining a sub-object selection, and then applying Stretch. If the modifier's Sub-Object button is active, only the selected sub-objects will be stretched.

---

## Subdivide Modifier

Make a selection. > Modify panel > Modifier List > Subdivide

Make a selection. > Modifiers menu > Radiosity Modifiers > Subdivide

The Subdivide modifier provides an algorithm for creating meshes used for [radiosity](#) on page 5976 processing. Processing radiosity requires meshes that have elements shaped as close as possible to equilateral triangles. The density of the mesh also needs to be considered in determining the resolution of the lighting details that need to be captured. The denser the mesh is, the finer the lighting detail and accuracy will be. The trade-off is a larger memory requirement and slower rendering times. The Subdivide modifier works on a whole object and does not work on selected faces in a mesh.

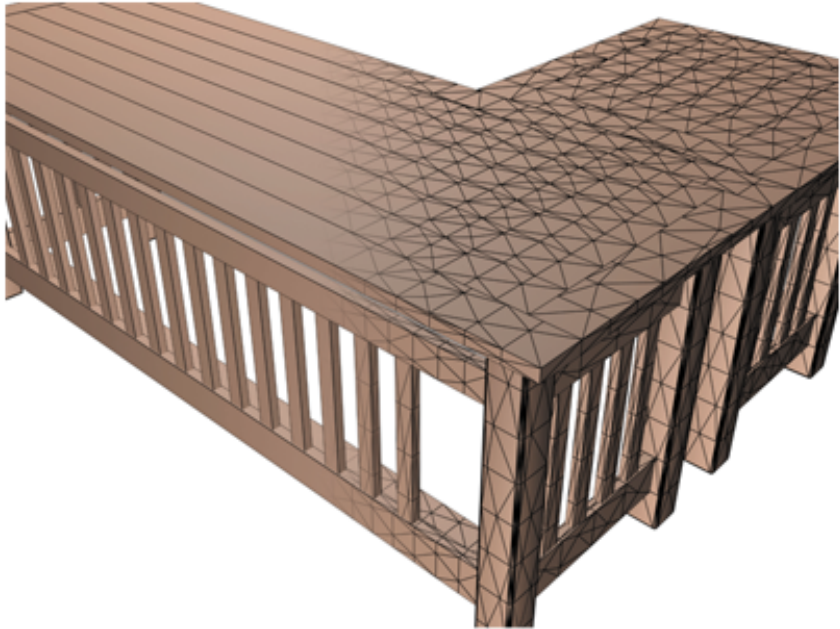

**Subdivide modifier breaks flat surfaces into meshes.**

Although it is primarily developed for increasing the quality of radiosity solutions, the Subdivide modifier can also be used by any application that requires well-formed meshes. For example, irregular mesh elements generated for [Terrain](#) on page 703 compound objects can be improved.

The modifier has world space and object space variants. In the world space modifier the size limit is on the mesh after it is transformed into world space coordinates. The object space modifier limits the size in object space coordinates.

---

**NOTE** Typically, the Subdivide modifier is applied automatically to objects in the scene when a radiosity solution is processed. Meshing parameters can be set on a global basis in the [radiosity control panel](#) on page 5995 or for individual objects in the [Object Properties dialog](#) on page 245 .

---

**TIP** When you are satisfied with the subdivision settings on one object, you can drag the modifier to other objects to propagate it.

---

## Interface

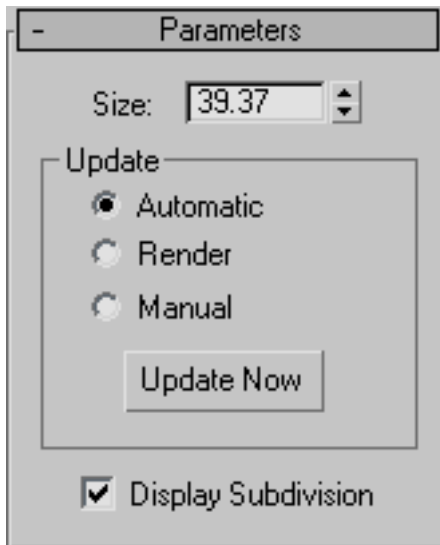

**Size** Controls the size of triangles in the subdivided mesh. The length of the longest edge of any triangle will not exceed the square root of 2 times the size in the Subdivide modifier. The square root of 2 factor is used, so that a square whose edges are the size will not be subdivided.

### Update group

The radio buttons in the Update group control when the meshing is done.

**Automatic** Updates immediately when changes are made to the controls or the mesh.

**Render** Updates only for rendering.

**Manual** Updates only when Update Now is pressed. Subdivision can be interrupted using the Esc key. If the subdivision is interrupted the Update mode is changed to Manual.

**Update Now** Updates the mesh when Manual is turned on.

**Display Subdivision** Controls whether all of the triangles are visible, or only the edges where face properties are changing. Allows you to reduce the visible triangles in the scene if it appears cluttered.

# Substitute Modifier

Make a selection. > Modify panel > Modifier List > Object-Space Modifiers > Substitute

Typically, designers use two-dimensional shapes to represent objects, such as furniture, in their AutoCAD designs. However, when they link their [DWG files](#) on page 7762 into 3ds Max for visualization, they want to see how the objects will look in their design.

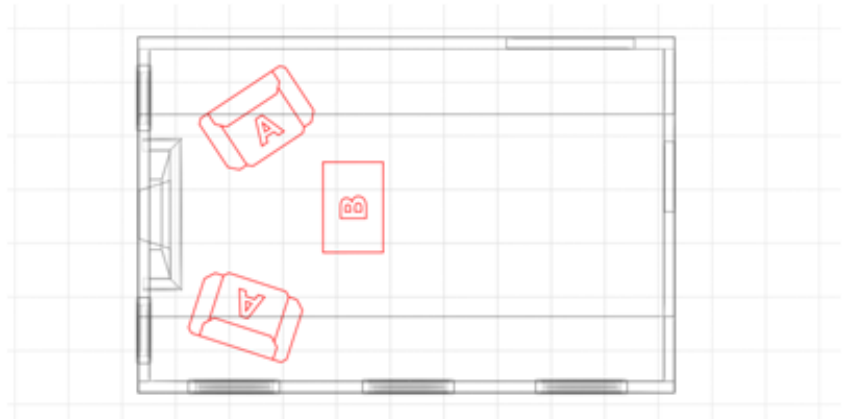

**Top view of 2D symbols used to represent 3D objects**

The Substitute modifier lets you quickly replace one or more objects with another in the viewports or at render time. The substitute object can be instanced from the current scene or can be referenced from an external file.

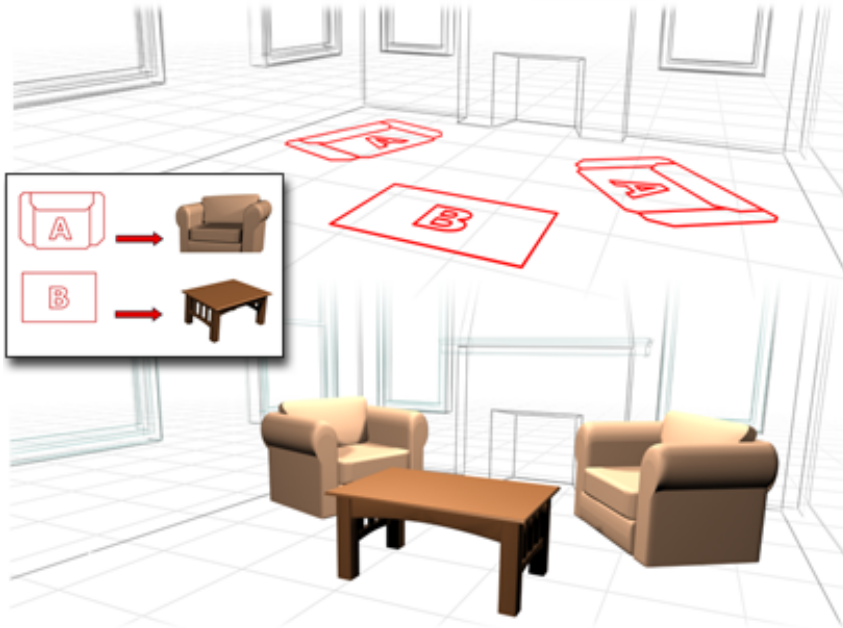

The Substitute modifier replaces the 2D objects with their 3D counterparts.

To get rid of the substitute object, simply remove the modifier from the stack. This frees up the memory required to store it.

---

**TIP** When you file link to a DWG file, the file is imported to 3ds Max as groups of [VIZBlocks](#) on page 7967 . If the pivot points of the VIZBlock and the substituted geometry do not match, you may not obtain the desired results. Adjust the pivot point of the VIZBlock object using the Adjust Geometry button to align the substituted geometry correctly.

---

**See also:**

- [XRef Objects](#) on page 6732
- [XRef Scene](#) on page 6755

## Procedures

**To use an object from the current scene as a substitute:**

- 1 Select an object, and then apply the Substitute modifier.

- 2 Click Pick Scene Object, and then in the viewport, select an object to substitute for the selection.  
Alternatively, click the ... button to the right of Pick Scene Object and select an object from the dialog that is displayed.  
The original object is replaced by an instance of the substitute object.
- 3 To see the original object in the viewport, turn off In Viewport. To see the original object in the final rendering, turn off In Render. To permanently disable the substitution, delete the modifier.

**To use an externally referenced object as a substitute:**

- 1 Select an object, and then apply the Substitute modifier.
- 2 Click Select XRef Object.
- 3 Use the Open File dialog to designate the file that contains the substitute object you want to use.
- 4 Use the [XRef Merge dialog](#) on page 6752 to designate the object to use as a substitute.

The original object is replaced by an instance of the substitute object.

To see the original object in the viewport, turn off Display group > In Viewport. To see the original object in the final rendering, turn off Display group > In Render. To permanently disable the substitution, delete the modifier.

## **Interface**

### **Modifier Stack**

**Substitute Object** At this sub-object level, you can transform the substitute object without affecting the original, changing the offset distance between them. Otherwise, transforming the substitute object affects both equally.

## Parameters rollout

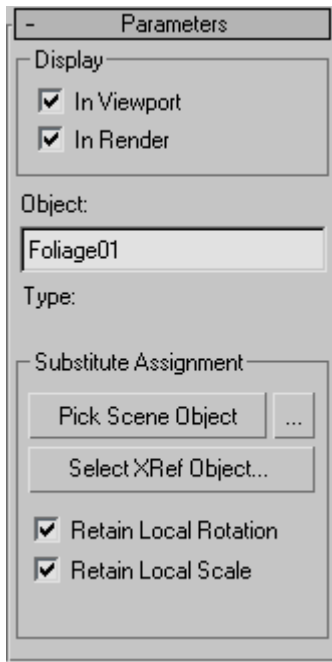

### Display group

**In Viewport** Replaces the original object with the substitute in the viewports.

**In Render** Replaces the original object with the substitute when you render the scene.

**Object** This editable text field displays the name of the substitute object and lets you rename it.

---

**NOTE** The name, if changed, appears only on the Modify panel at the current stack level. That is, the name is local to the current application of the Substitute modifier.

---

**Type (label)** Displays the type of object used as a substitute. If you use a scene object, the type is shown as Instance. If you use an XRef object, the type is shown as XRef Object. Appears only after you designate a substitute object.



## Substitute Assignment group

**Pick Scene Object** Lets you choose an object from the current scene to be instanced as a substitute for the selected object. Click Pick Scene Object, and then select the object from a viewport to use as a substitute. If In Viewport is on and Retain Current Position is off (the default settings), an [instance](#) on page 7818 of the substitute object appears in the place of the original object.

The mouse cursor changes to a plus sign (+) when over an object that can be used as a substitute. You cannot use an object to which the Substitute modifier is applied as a substitute object.

Use the button labeled "... " to the right of Pick Scene Object to choose a substitute object using the Select Substitute Object dialog, which works like the [Select From Scene dialog](#) on page 168 . In the dialog's list window, highlight the object to use as a substitute, and then click Select.

**Select XRef Object** Lets you specify an object to be instanced from an external scene file as the substitute. Click Select XRef Object, and then, in the Open File dialog, open the file containing the substitute object. On the [XRef Merge dialog](#) on page 6752 , select the substitute object and then click OK. Objects to which the Substitute modifier is applied don't appear in the list.

---

**NOTE** Because the object used as a substitute is referenced from an external file, any changes to the object in that file apply to the substitute after reloading. For example, if you apply a Bend modifier to the substitute object in the external file, then the next time you load the file containing the object with the Substitute modifier, it appears bent.

---

**Retain Local Rotation/Scale** When on, rotates or scales the new object instance in the same place as the substitute object you select. In this case, the two objects coincide in space, and you must move one to see both. When off, 3ds Max positions the instanced substitute object in the same place as the object containing the Substitute modifier.

You must specify the Retain Local Rotation/Scale setting before designating the substitute object. Changing this setting afterward has no effect.

## Surface Modifier

Select a spline object. > Modify panel > Modifier List > Object-Space Modifiers > Surface

Select a spline object. > Modifiers menu > Patch/Spline Editing > Surface

[Procedures](#) on page 1703   [Interface](#) on page 1706

The Surface modifier generates a patch surface based on the contours of a spline network. A patch is created wherever the segments of the interwoven splines form a three- or four-sided polygon. The Surface modifier and the CrossSection modifier, taken together, are referred to as Surface Tools. They allow you to create complex or organic surfaces, like the fuselage of a plane, or a three-dimensional character.



**Applying the Surface modifier to create a patch surface.**

The [CrossSection modifier](#) on page 1259 can be applied before the Surface modifier to connect splines representing cross-sections. Once the basic spline network is created and the Surface modifier is applied, the model can be adjusted by editing the splines using an Edit Spline modifier below the Surface modifier in the modifier stack. Since the Surface modifier creates a Patch surface, further refinements can be made to the patch model by adding an Edit Patch modifier above the Surface modifier.

The bulk of the work in using Surface tools to model lies in creating and editing splines in an Editable Spline or Edit Spline modifier. One of the benefits to modeling using splines and Surface Tools is the ease of editing the model. At almost any stage of modeling, you can add a nostril, ear, limb or body by

simply adding splines. This lends itself to a free-form approach to organic modeling: you have a mental image of what you want, then you create and edit the spline network until you are satisfied.

---

**NOTE** 3ds Max offers a simplified workflow for this modeling technique, using Edit/Editable Spline and the Edit Patch modifier. For details, see [To create a patch object using the Cross Section and Spline Surface tools](#): on page 1291 .

---

### Surface Modifier Basics

- 1 Create a spline object.
- 2 Make sure that the Spline vertices form valid three-sided or four-sided, closed regions. Vertices on splines that cross one another should be coincident.  
To make spline vertices coincident, drag vertices over each other with 3D Snap turned on. 3D Snap must have the Vertex or End Point option turned on. With 3D Snap turned on, you can snap to vertices on existing splines as you create new splines. You can also select vertices and use the Fuse option in an Editable Spline to make vertices co-incident.
- 3 Use the CrossSection modifier to connect spline cross-sections, unless you plan on manually creating the splines that connect the model's cross-sections.
- 4 Apply the Surface modifier, then adjust the weld threshold to generate a patch object. Ideally all spline vertices that will form a patch surface are coincident; the Threshold parameter allows patch creation even if vertices are not quite coincident.
- 5 Optionally, add an Edit Patch modifier to edit the patch surface.

---

**TIP** Make a reference copy of the spline object, then add the Surface modifier to the copy and edit the original. As you edit the original spline object, patches appear on the reference copy as splines form three- or four-sided shapes. This allows you to view a shaded surface as you model.

You can take this a step further and add a Mirror modifier to the reference copy. As you create splines for one side of a head or body, the reference copy displays an entire model.

---

## Modeling with Surface Tools

There are two primary methods of using the Surface modifier to create patch models.

- Create splines that represent a model's cross sections, add the CrossSection modifier to connect the cross sections, and apply the Surface modifier to create the patch surface. This approach works for models like the body of an airplane.

Alternatively, use the [editable spline Cross Section function](#) on page 605 to connect the cross sections, and then use the [editable patch Spline Surface tools](#) on page 1292 to create the surface.

- Create a network of splines manually, and then apply the Surface modifier or editable patch Spline Surface tools to create the patch surface. This approach works for modeling a face or body of a character.

## Modeling Examples

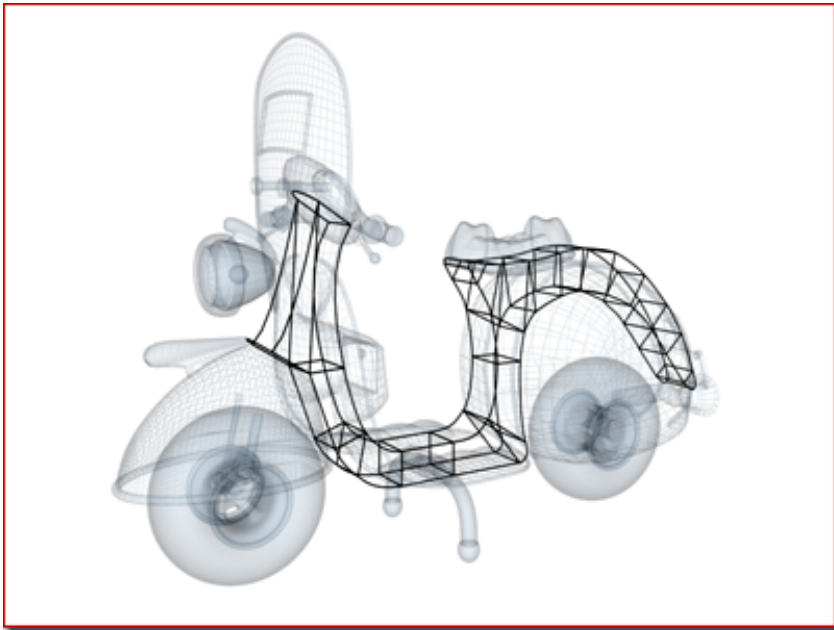

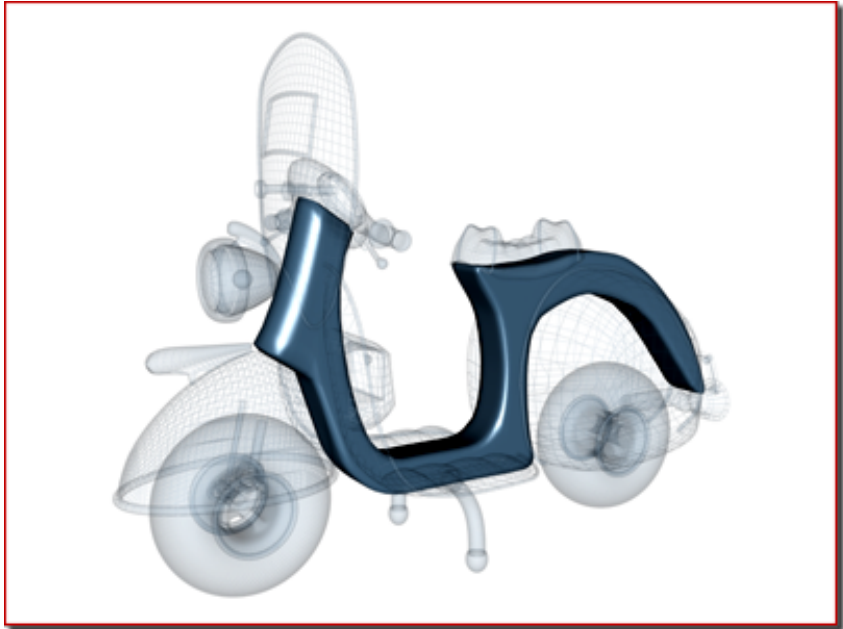

**Scooter: Splines form cross sections of the body**

One method of using Surface Tools is to create splines that represent a model's cross sections, then the CrossSection and Surface modifiers are applied to create the patch surface.

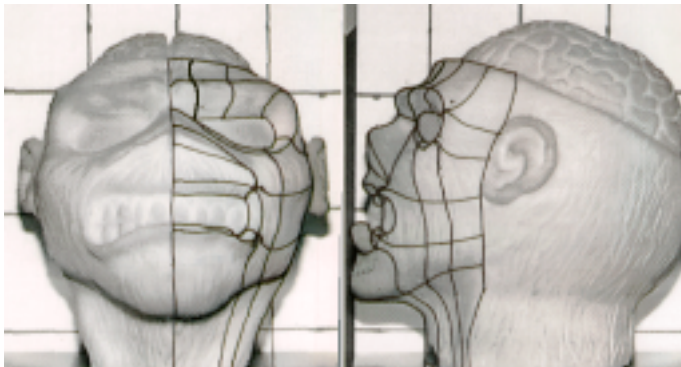

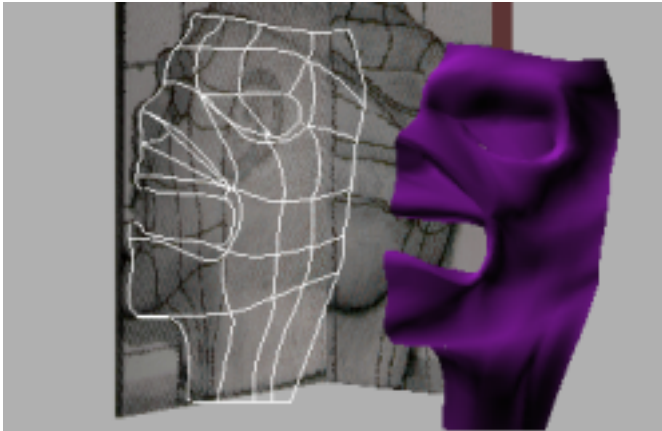

**Face: Spline network based on front and profile reference images**

Two intersecting texture-mapped polygons are used as a reference to create a network of splines manually. Drawing lines on the physical sculpture is used as an added visual aid to position the splines in this case. The CrossSection modifier is not necessary if you create the spline network manually.

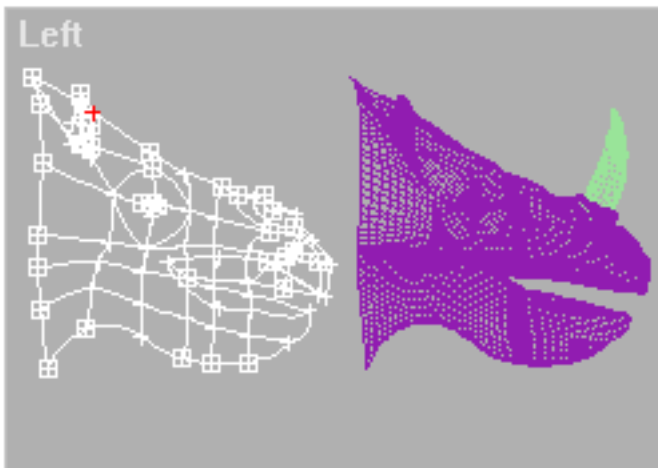



**Rhino head: Spline network begins with the profile.**

In the top image, the head of a rhinoceros is modeled by creating a network of splines. The first spline created is the profile of the rhino; other splines are added and edited to complete the model. In this case, a reference copy of the spline model was created and a Surface modifier was added to the copy.

As the spline network is edited, the patch surface of the reference copy is updated dynamically. This allows you to view a shaded patch model as you manipulate the spline network, any surface anomalies can be spotted and corrected.



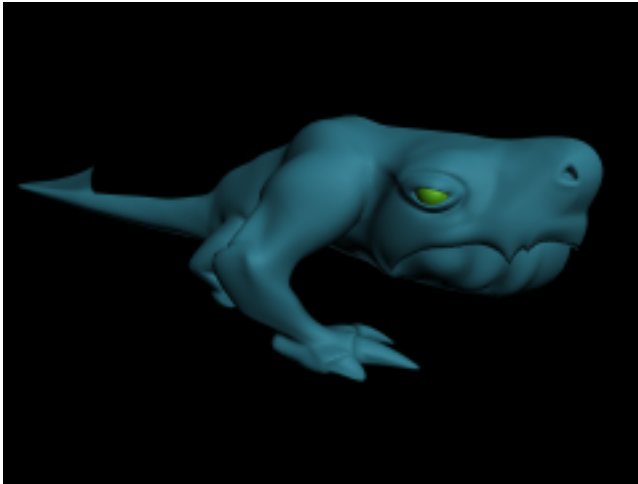
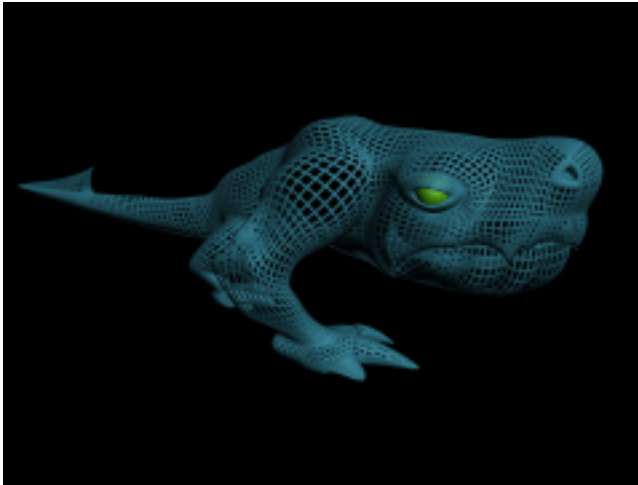

Sequence of images showing the spline network, the patches created by the Surface modifier, and a shaded view of an alien character.

### Additional Details



- Splines are initially created using the tools in Create panel > Shapes > Splines > Object Type rollout, such as [Line](#) on page 551 , [Circle](#) on page 557 , [Arc](#) on page 560 , and [Section](#) on page 576 . Splines can also be created using the Create Line command in an Editable Spline or and Edit Spline modifier.



- Splines are edited by applying an Edit Spline modifier to the selected spline object or editing parameters in an Editable Spline. Editing splines changes the patch surface created by the Surface modifier.
- To add splines to a spline object, use the Attach command in the Edit Spline modifier.
- Within a spline object, splines need not be continuous. A spline object may consist of ten splines, for example. As long as the spline vertices are coincident, or close enough for the Threshold parameter in the Surface modifier to weld them together, a surface will be generated.

## Procedures

### Example: Understanding valid splines:

- 1   In the Top viewport, use Create panel > Shape > NGon to create three NGons: a three-sided, four-sided, and five-sided NGon, each about 100 units wide.
- 2  Make sure that all the splines form one object. Do this by applying an Edit Spline modifier to one of the NGons and using Attach to add the remaining NGon objects.

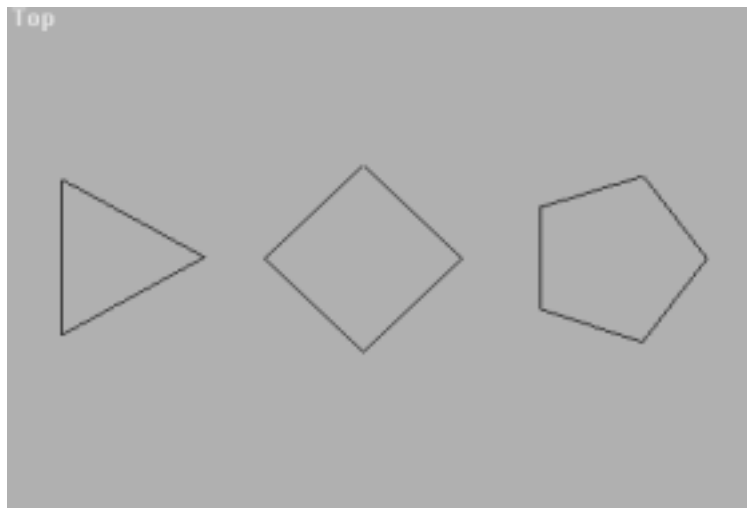

- 3 Choose Modifiers menu > Patch/Spline Editing > Surface from the Modifier List.

Notice that the three- and four-sided splines formed patches but the five-sided NGon did not. The five-sided spline does not form a three- or four-sided closed region. To make it a valid spline, a line must bisect the NGon to form a three- and four-sided region.

- 4 In the stack display, choose the Edit Spline modifier again. Turn on Create Line on the Geometry rollout, and create a line that bisects the five-sided NGon.

The start and end points of the line should overlap the vertices on the NGon. Being exact is not critical; the Threshold parameter fuses spline vertices based on their proximity.

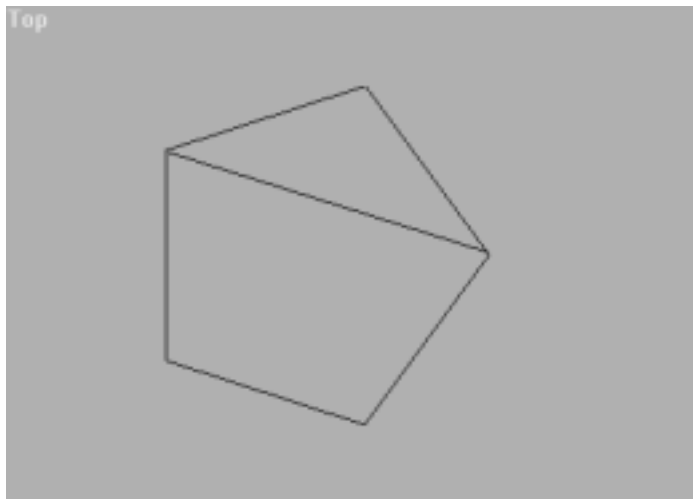

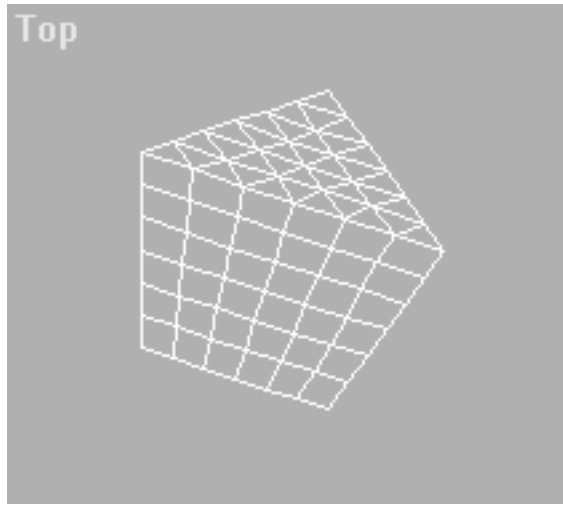

- 5 In the stack display, choose the Surface modifier again. Now the five-sided NGon is a patch object, consisting of a quad patch and a tri patch.

---

**NOTE** If the spline object did not turn into a patch, increase the Surface modifier's Threshold parameter until the patches appear.

---

#### Example continued: Adjusting the shape of the spline:

- 1  In the stack display, expand the Edit Spline modifier's hierarchy, and choose the Vertex sub-object level.
- 2 In the Top viewport, select the top vertex of the five-sided NGon. Two vector handles are displayed. These handles can be moved on any axis.

- 3  Turn on Select and Move on the toolbar, then drag the handles around in the Top viewport.  
The shape of the spline changes.

- 4  Below the stack display, turn on the Show End Result On/Off Toggle button.  
The patch changes shape to fit the spline.

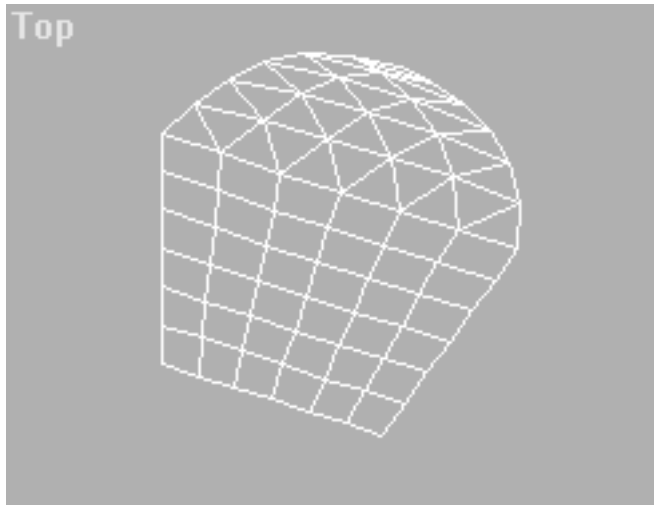

### Interface

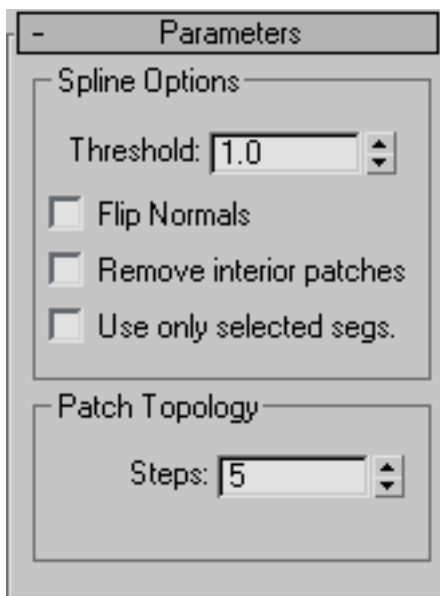

## Spline Options group

**Threshold** Determines the overall distance that is used to weld the vertices of the spline object. All vertices/vectors within the threshold of each other are treated as one. Threshold uses units set in the [Units Setup dialog](#) on page 7601 .

---

**NOTE** Spline control handles are also treated as vertices, so setting high Threshold levels can produce unexpected results.

---

**Flip Normals** Flips the normal direction of the patch surface.

**Remove Interior Patches** Removes interior faces of an object that you would not normally see. These are the faces created within the caps or other interior patches of the same type of a closed polygon.

**Use only selected segs** Only segments selected in the Edit Spline modifier will be used by the Surface modifier to create patches.

---

**NOTE** Segment Sub-Object does not have to be left on in the Edit Spline modifier.

---

## Patch Topology group

**Steps** The steps field spinner determines how many steps are used between each vertex. The higher the step count, the smoother the curve you will get between vertices.

# SurfDeform Modifier

Select an object. > Modify panel > Modifiers List > Object-Space Modifiers > SurfDeform

Select an object. > Modify panel > Modifiers List > World-Space Modifiers > SurfDeform

Select an object. > Modifiers menu > Animation Modifiers > SurfDeform

Select an object. > Modifiers menu > Animation Modifiers > SurfDeform (WSM)

The SurfDeform modifier works the same way as the [PatchDeform modifier](#) on page 1525 , except that it uses a NURBS Point or CV surface instead of a patch surface to apply surface deformation.

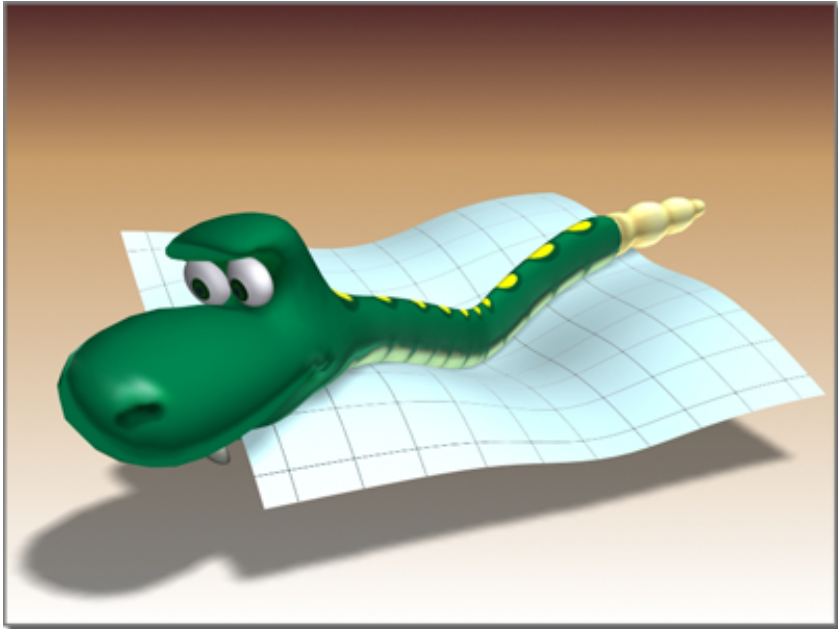

SurfDeform shapes how the snake rests.

## Procedures

To use the SurfDeform modifier:

- 1 Select an object.
- 2  From the Modify panel > Modifier List, choose Object-Space Modifiers > SurfDeform.
- 3 On the Parameters rollout, click Pick Surface.
- 4 Select a NURBS Point or CV surface.
- 5 Deform the object by adjusting the controls in the Surface Deform group.

## Interface

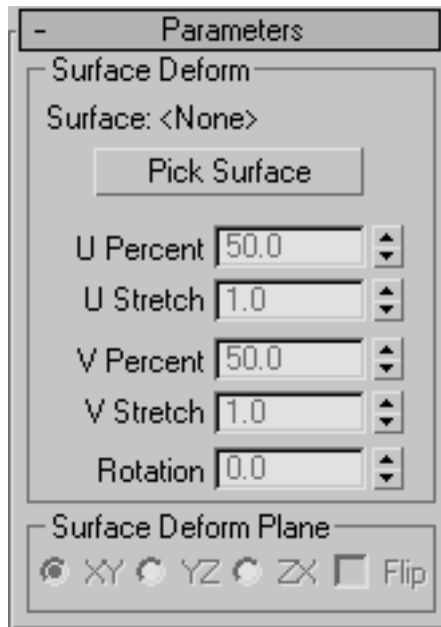

See [PatchDeform modifier](#) on page 1525 for a description of the user interface.

## Sweep Modifier

Modify panel > Select a 2D shape. > Modifier List > Sweep

Select a 2D shape. > Modifiers menu > Patch/Spline Editing > Sweep

The Sweep modifier is used to extrude a cross-section along an underlying spline or NURBS curve path. It is similar to the Loft compound object but is a more efficient method. The Sweep modifier allows you to work with a series of pre-made cross-sections such as angles, channels and wide flanges. You can also use your own splines or NURBS curves as custom sections that you create in 3ds Max or import from other MAX files.

---

**NOTE** This modifier is similar to the Extrude modifier in that once the Sweep is applied to a spline, the end result is a 3D mesh object. Both sections and paths can contain multiple splines or multiple NURBS curves.

---

This modifier is very useful for creating structural steel details, molding details, or in any situation where you need to extrude a section along a spline.

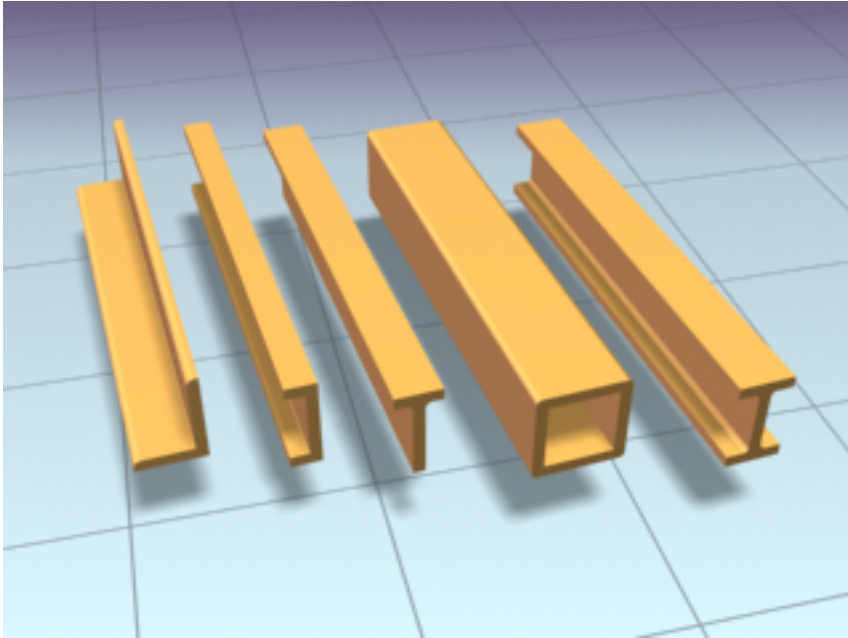

**Examples of extrusions created with the Sweep modifier**

### **Procedures**

**To apply the Sweep modifier to a line:**

- 1 Create a line in the perspective viewport.
- 2 Apply the Sweep modifier to the line.  
The line takes on the shape of an angled extrusion.
- 3 Open the Built-In Section list and choose a different section.  
The line now has the new section swept along its length.

**To use a custom section with the Sweep modifier:**

- 1 Create a line and a six sided NGon in the perspective viewport.
- 2 Apply the Sweep modifier to the line.  
The line takes on the shape of an angled extrusion.



- 3 Click the Use Custom Section radio button.  
The line displays as a line again.
- 4 Click the Pick button in the Custom Section Types group and choose the NGon in the viewport.  
The hexagonal shape is swept along the line's length.

---

**NOTE** If you find that you need to rescale the Custom Section shape, the effects of using a transform like Select and Squash or Non-Uniform Scale will not be reflected when swept. You need to apply an [XForm modifier](#) on page 1922 to the section and then rescale the XForm modifier's gizmo.

---

## Interface

### Section Type rollout

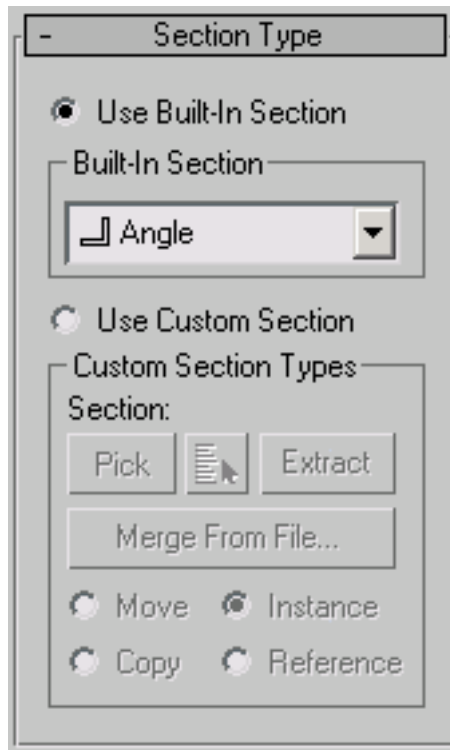







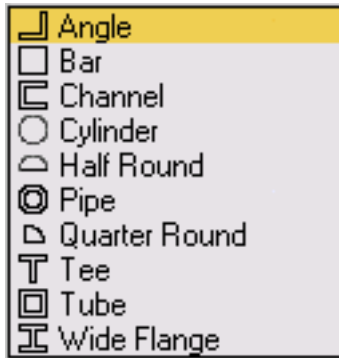



**Use Built-In Section** Choose this to use one of the included stock sections.

## Built-In Section group

**Built-In Section list** Clicking the arrow button for this list displays common structural sections.



-  **Angle** **Angle section** Sweeps a structural angle section along the spline. Default section=Angle.
-  **Bar** **Bar section** Sweeps a 2D rectangular section along the spline.
-  **Channel** **Channel section** Sweeps a structural channel section along the spline.
-  **Cylinder** **Cylinder section** Sweeps a solid 2D circle section along the spline.
-  **Half Round** **Half Round section** This section produces a half round extrusion along the spline.
-  **Pipe** **Pipe section** Sweeps a circular hollow tube section along the spline.
-  **Quarter Round** **Quarter Round section** Useful for molding details; this section produces a quarter round extrusion along the spline.
-  **Tee** **Tee section** Sweeps a structural tee section along the spline.

-  **Tube** **Tube section** Based on a square, this sweeps a hollow tube section along the spline. Similar to the Pipe section.
-  **Wide Flange** **Wide Flange section** Sweeps a structural wide flange section along the spline.

**Use Custom Section** Choose this if you've created your own section or there is another shape in the current scene or in another MAX file that you'd like to use as your section.

---

**NOTE** Using a 2D shape as the Sweep modifier's custom section will yield the most predictable results. If using a 3D shape as the custom section, for the most predictable results the base object should be a straight line or smooth path like a circle or an arc. The same applies to custom sections made up of multiple splines. You'll get the best results attained by insuring that all vertices in all the shapes are coplanar.

---

### Custom Section Types group

**Section** Displays the name of the custom shape you've selected. This area is blank until you select a custom shape.

---

**NOTE** You can switch from a custom section to a built-in section and back without having to pick the custom-section shape again from the viewports.

---

**Pick** If the custom shape you want to use is visible in the viewport, click the Pick button and then pick the shape directly from the scene.

**Pick Shape** Click the Pick Shape button to open the [Pick Shape dialog](#) on page 1728 . This dialog shows only valid shapes that are currently in the scene.

**Extract** Lets you create a new shape in the scene that is either a copy, instance, or reference of the current custom section. Opens the [Extract Shape dialog](#) on page 1730 .

**Merge From File** Lets you choose a section that is stored in another MAX file. Opens the [Merge File dialog](#) on page 1731 .

---

**NOTE** When you use the Merge from File option, you will not be able to Undo your work.

---

**Move** Sweeps the custom section along the specified spline. Unlike the Instance, Copy and Reference switches, the selected section is moved to the

spline. Editing the original shape in the viewports has no effect on the Sweep mesh.

**Copy** Sweeps a copy of the selected section along the specified spline.

**Instance** Sweeps an [instance](#) on page 7818 of the selected section to the specified spline.

**Reference** Sweeps a [reference](#) on page 7910 of the selected section along the specified spline.

---

**NOTE** When using Instance or Reference, adding modifiers to or editing the original section in the viewports will change the Sweep mesh.

---

### Interpolation rollout (Sweep modifier)

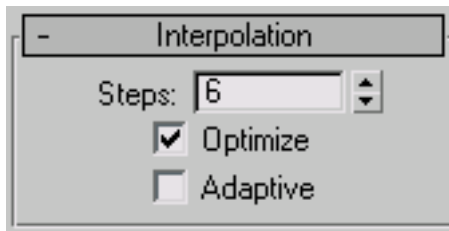

The controls in the Interpolation rollout of the Sweep modifier work exactly as they do for any other spline. However, the controls affect only the built-in section you've chosen, not the spline that the section is swept along.

---

**NOTE** If you want to change the interpolation settings of the underlying spline path, you need to select the path object in the modifier stack.

---

In general, all spline curves are divided into small straight lines that approximate a true curve. The number of divisions between each vertex on the spline are called *steps*. The more steps used, the smoother the curve appears.

---

**NOTE** The Interpolation rollout is only active when built-in sections are used.

---

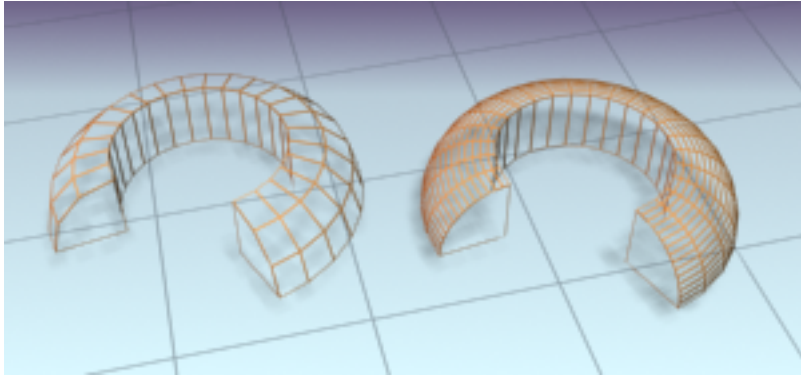

**Left:** The quarter-round section is set to zero steps.

**Right:** The same section on the right is set to four steps.

**Steps** Sets the number of divisions, or steps, the program uses between each built-in section's vertices. Splines with tight curves require many steps to look smooth while gentle curves require fewer steps. Range=0 to 100.

Spline steps can be either adaptive or manually specified. The method used is set by the state of the Adaptive switch. The main use for manual interpolation is to create splines for morphing or other operations where you must have exact control over the number of vertices created.

**Optimize** When on, removes unneeded steps from straight segments in the spline. Default=on.

---

**NOTE** Optimize is not available when Adaptive is on.

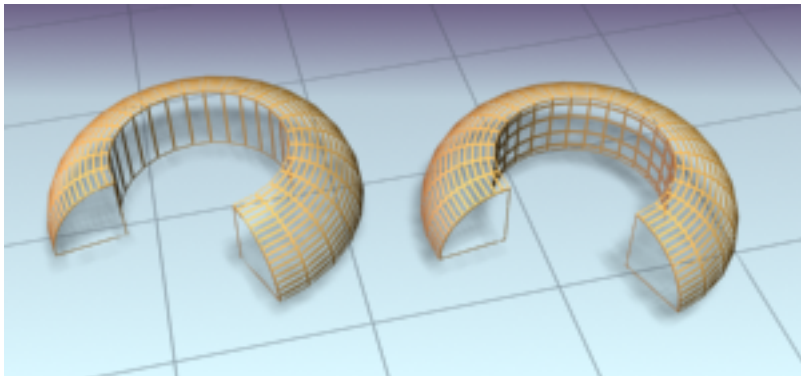

**Left:** Optimize is on for the left-hand sweep.

**Right:** Optimize is off for the right-hand sweep.

**Adaptive** When on, automatically sets the number of steps for each spline to produce a smooth curve. Straight segments always receive 0 steps. When off, enables manual interpolation control using Optimize and Steps. Default=off.

### Parameters rollout

The Parameters rollout is context-sensitive and displays different settings depending upon the built-in section you've chosen to sweep along a spline. For example, more complex sections such as the Angle have seven settings that you can change whereas the Quarter-Round has only one setting.

### Parameters rollout – Angle

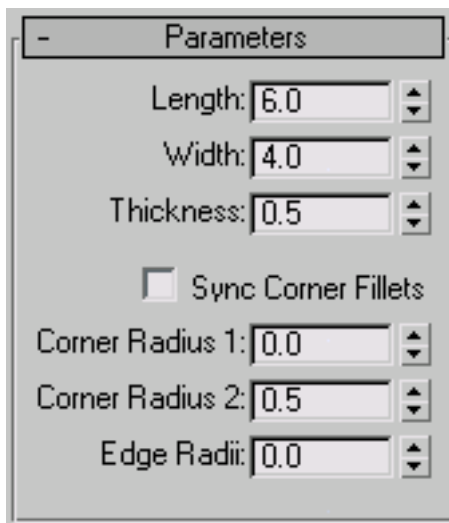

**Length** Controls the height of the vertical leg of the angle section. Default=6.0.

**Width** Controls the width of the horizontal leg of the angle section. Default=4.0.

**Thickness** Controls the thickness of both legs of the angle. Default=0.5.

**Sync Corner Fillets** When turned on, Corner Radius 1 controls the radius of both the interior and exterior corners between the vertical and horizontal legs. It also maintains the thickness of the section. Default=off.

**Corner Radius 1** Controls the exterior radius between the vertical and horizontal legs of the angle section. Default=0.0.

**Corner Radius 2** Controls the interior radius between the vertical and horizontal legs of the angle section. Default=0.5.

**Edge Radii** Controls the interior radius at the outermost edges of the vertical and horizontal legs. Default=0.0.

---

**NOTE** Be cautious when adjusting these settings. There are no constraining relationships between them. Therefore, it's possible to set an inside radius (Corner Radius 2) that is greater than the length or width of the legs of the angle.

---

### Parameters rollout – Bar

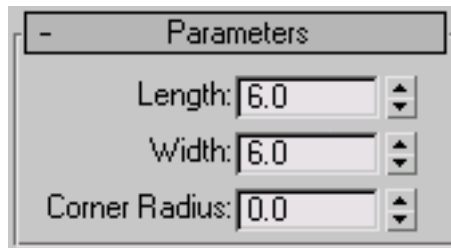

**Length** Controls the height of the bar section. Default=6.0.

**Width** Controls the width of the bar section. Default=6.0.

**Corner Radius** Controls the radius of all four corners of the section. Default=0.0.

## Parameters rollout – Channel

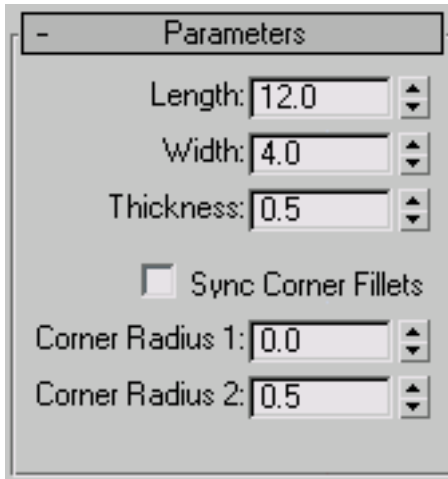

**Length** Controls the height of the vertical web of the channel section. Default=12.0.

**Width** Controls the width of the top and bottom horizontal legs of the channel section. Default=4.0.

**Thickness** Controls the thickness of both legs of the channel. Default=0.5.

**Sync Corner Fillets** When on, Corner Radius 1 controls the radius of both the interior and exterior corners between the vertical web and horizontal legs. It also maintains the thickness of the section. Default=off.

**Corner Radius 1** Controls the exterior radius between the vertical web and horizontal legs of the channel. Default=0.0.

**Corner Radius 2** Controls the interior radius between the vertical web and horizontal legs of the channel. Default=0.5.

---

**NOTE** Be cautious when adjusting these settings. There are no constraining relationships between them. Therefore, it's possible to set an inside radius (Corner Radius 2) that is greater than the length of the web or width of the legs.

---



### Parameters rollout – Cylinder

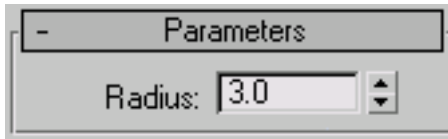

**Radius** Controls the radius of the cylinder section. Default=3.0.

### Parameters rollout – Half-Round

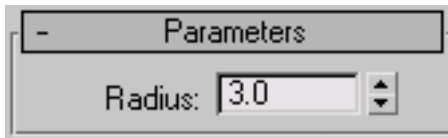

**Radius** Controls the radius of the half round section. Default=3.0.

### Parameters rollout – Pipe

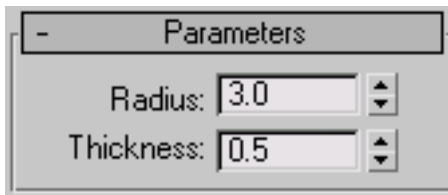

**Radius** Controls the exterior radius of the pipe section. Default=3.0.

**Thickness** Controls the thickness of the wall of the pipe. Default=0.5.

### Parameters rollout – Quarter-Round



**Radius** Controls the radius of the quarter round section. Default=3.0.

### Parameters rollout – Tee

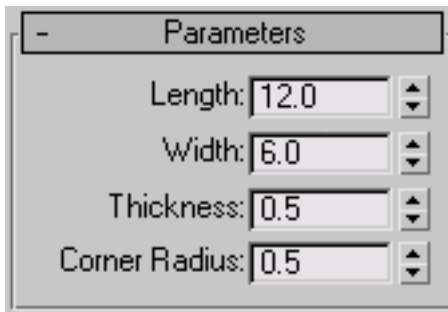

**Length** Controls the height of the vertical web of the tee section. Default=12.0.

**Width** Controls the width of the flange crossing the tee section. Default=6.0.

**Thickness** Controls the thickness of the web and flange. Default=0.5.

**Corner Radius** Controls the radius of the two interior corners between the vertical web and horizontal flange of the section. Default=0.5.

---

**NOTE** Be cautious when adjusting these settings. There are no constraining relationships between them. Therefore, it's possible to set a radius (Corner Radius) that is greater than the length of the web or width of the flange.

---

### Parameters rollout – Tube

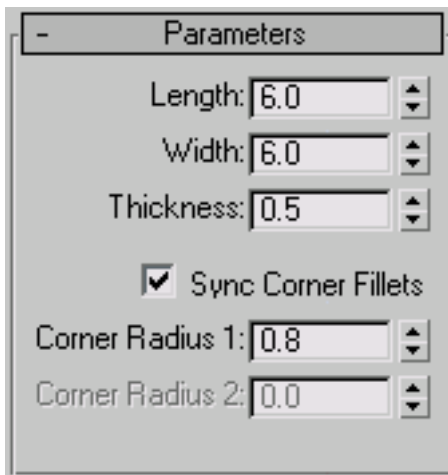

**Length** Controls the height of the tube section. Default=6.0.

**Width** Controls the width of the tube section. Default=6.0.

**Thickness** Controls the thickness of the walls of the tube. Default=0.5.

**Sync Corner Fillets** When turned on, Corner Radius 1 controls the radius of both the interior and exterior corners of the tube. It also maintains the thickness of the section. Default=on.

**Corner Radius 1** Controls the radius of all four interior and exterior corners of the section. Default=0.8.

If Sync Corner Fillets is turned off, Corner Radius 1 controls the radius of the four exterior corners of the tube.

**Corner Radius 2** Controls the radius of the four interior corners of the tube. Default=0.0.

Corner Radius 2 is only available when Sync Corner Fillets is turned off.

---

**NOTE** Take care when adjusting these settings. There are no constraining relationships between them. Therefore, it's possible to set an inside radius (Corner Radius 2) that is greater than the length and width of the sides.

---

### Parameters rollout – Wide Flange

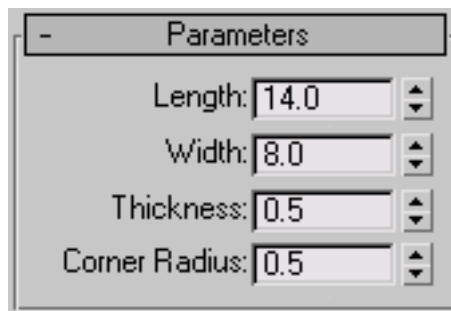

**Length** Controls the height of the vertical web of the wide flange section. Default=14.0.

**Width** Controls the width of the horizontal flanges crossing the section. Default=8.0.

**Thickness** Controls the thickness of the web and flanges. Default=0.5.

**Corner Radius** Controls the radius of the four interior corners between the vertical web and horizontal flanges. Default=0.5.

---

**NOTE** Be cautious when adjusting these settings. There are no constraining relationships between them. Therefore, it's possible to set a radius (Corner Radius) that is greater than the length of the web or width of the flanges.

---

### Sweep Parameters rollout

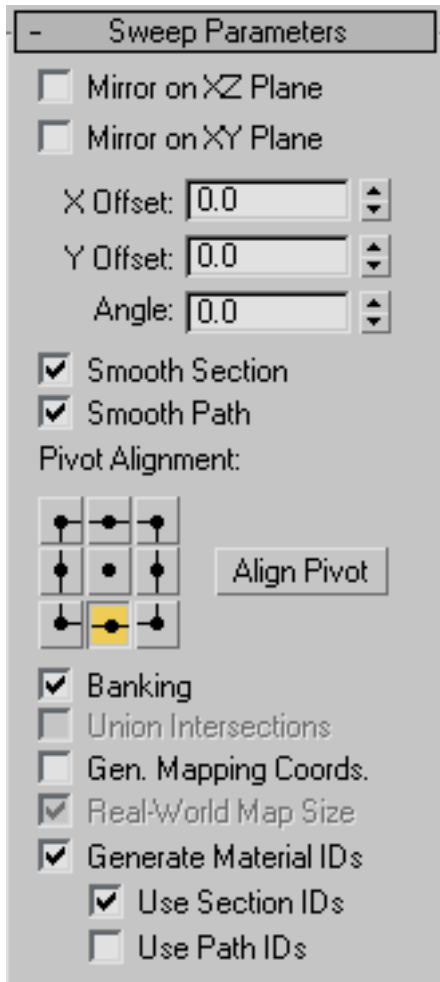

**Mirror On XZ Plane** When turned on, the section is flipped vertically in relation to the spline to which the Sweep modifier is applied. Default=off.

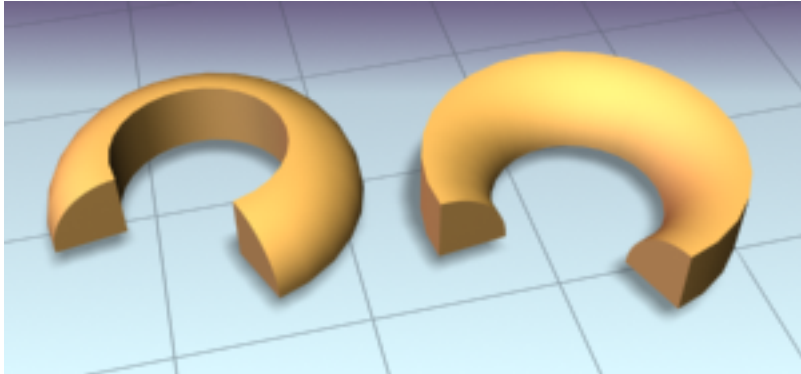

**Left:** The object shows the default state.

**Right:** The object has Mirror On XZ Plane turned on.

**Mirror On XY Plane** When turned on, the section is flipped horizontally in relation to the spline to which the Sweep modifier is applied. Default=off.



**Left:** The object shows the default state.

**Right:** The object has Mirror On XY Plane turned on.

**X Offset** Lets you shift the horizontal position of the section relative to the underlying spline.

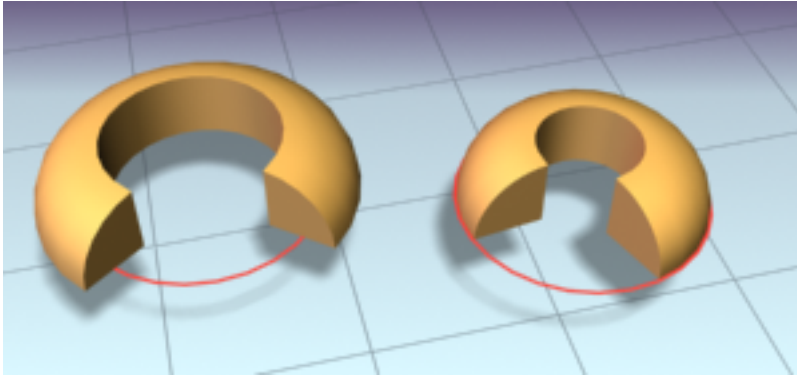

**Left:** The section is in the default position.

**Right:** The section is offset  $-10$  relative to the underlying spline path (red).

**Y Offset** Lets you shift the vertical position of the section relative to the underlying spline.

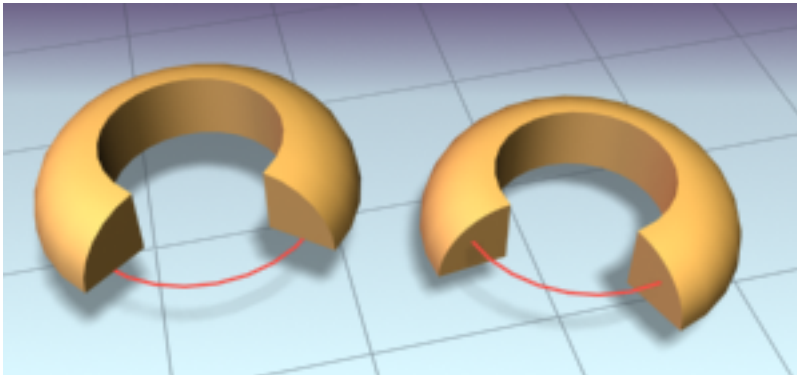

**Left:** The section is in the default position.

**Right:** The section is offset  $-10$  relative to the underlying spline path (red).

---

**NOTE** The X and Y Offsets let you fine tune the section position while the Pivot Alignment settings allow for a quick initial adjustment.

---

**Angle** Allows you to rotate the section relative to the plane on which the underlying spline is located.

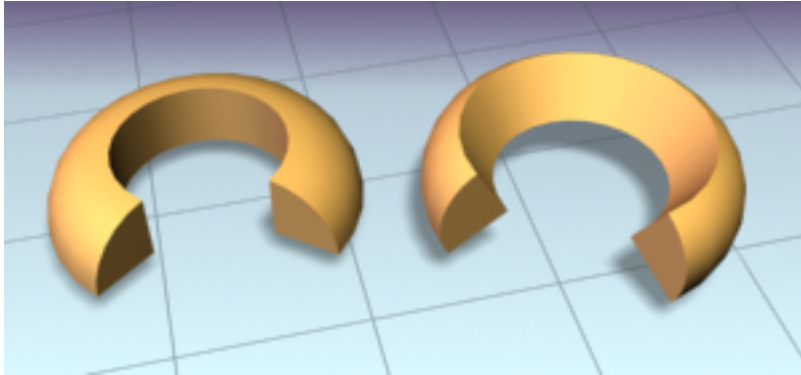

**Left:** The section is in the default position.

**Right:** The section is rotated 30 degrees.

**Smooth Section** Provides a smooth surface around the perimeter of the section that is swept along the underlying spline. Default=on.

**Smooth Path** Provides a smooth surface along the length of the underlying spline. This type of smoothing is useful when for curved paths. Default=off.

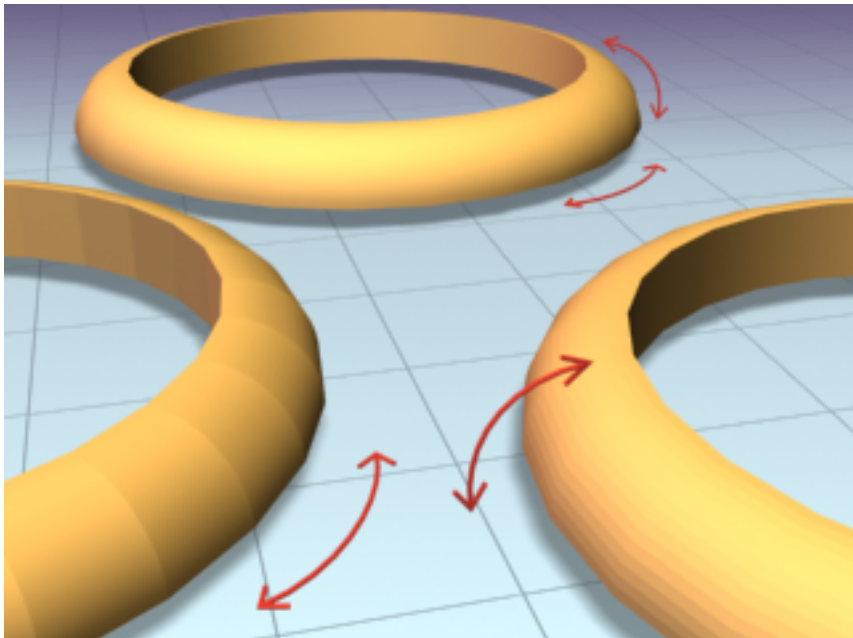

**Left:** Smoothing the path

**Right: Smoothing the section**

**Rear: Smoothing both path and section**

**Pivot Alignment** This is 2D grid that helps you align the section to the underlying spline path. Selecting one of the nine buttons shifts the section's pivot around the spline path.

---

**NOTE** When none of the Pivot Alignment buttons is depressed the pivot point of the section is used as the alignment point.

---

**Align Pivot** When turned on, a 3D representation of the Pivot Alignment grid appears in the viewport. You only see the 3x3 alignment grid, the section and the underlying spline path. Once you're satisfied with the alignment, turn off the Align Pivot button or right-click to see the sweep.

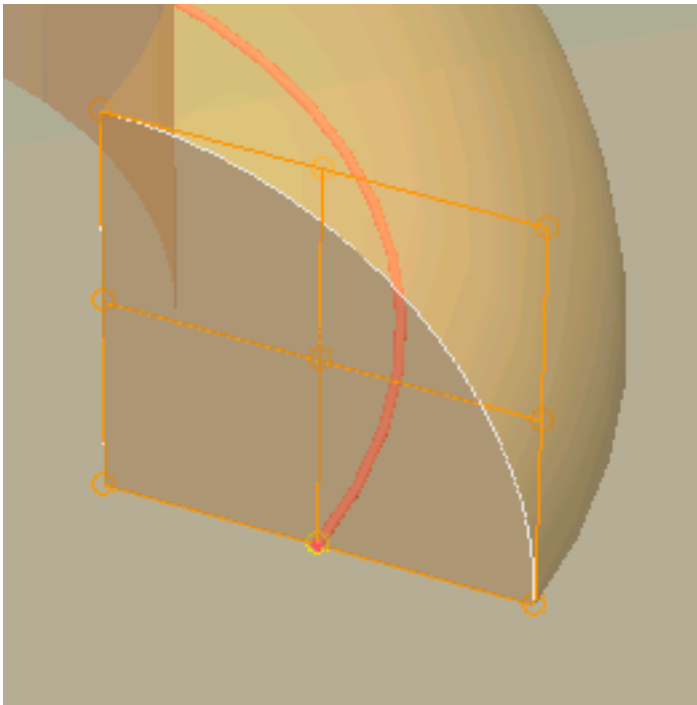

**Align Pivot grid showing control points (in orange) superimposed over a duplicate sweep.**

**Banking** When on, sections rotate about the spline path whenever the path bends and changes height in the path's local Z axis. Banking is ignored if the



spline path is 2D. When off, shapes do not rotate about their Z axis as they traverse a 3D path. Default=on.

**Union Intersections** If working with multiple intersecting splines, like a grid, turn this switch on to produce cleaner intersections with fewer artifacts.

---

**NOTE** Union Intersections takes additional time to compute the intersections, so leave this switch off if you don't have intersecting splines. Furthermore, this setting will only calculate intersections of separate splines contained in one shape object. So a figure X (separate, intersecting splines) will be properly intersected, but a figure 8 (a single, self-intersecting spline) will not.

---

**Gen. Mapping Coords** Applies mapping coordinates to the extruded object. Default=off.

**Real-World Map Size** Controls the scaling method used for texture mapped materials that are applied to the object. The scaling values are controlled by the Use Real-World Scale settings found in the applied material's [Coordinates rollout](#) on page 5620 . Default=on.

**Generate Mapping IDs** Assigns different material IDs to the sides and the caps of the sweep. Specifically, if both Use Section IDs and Use Path IDs are both turned off the sides receive ID 3, the front cap receives ID 1, and the rear cap receives ID 2. Default=on.

**Use Section IDs** Uses the material ID values assigned to segments of the section that is swept along the underlying [spline](#) on page 542 or [NURBS](#) on page 2152 curve. Default=on.

By applying an [Edit Spline modifier](#) on page 1376 to a Custom Section, different material IDs can be assigned to each segment that makes up the section.

---

**NOTE** Built-in sections do not benefit from the Use Section IDs switch.

---

**Use Path IDs** Uses the material ID values assigned to segments of the underlying spline or curve sub-objects in the underlying curve.

By applying an Edit Spline modifier to the underlying spline, each segment can be assigned its own material ID.

---

**NOTE** Use Section IDs and Use Path IDs does not control the material IDs of the front and rear caps of the sweep.

---

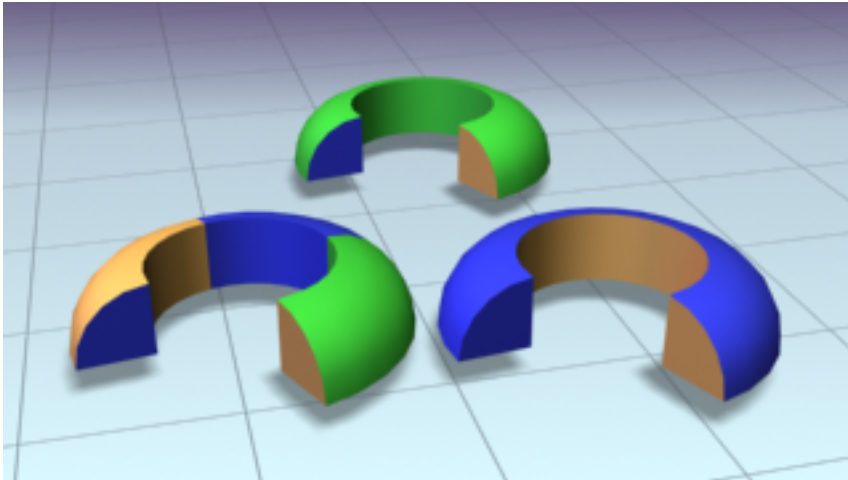

**Left:** Materials set by path IDs

**Right:** Materials set by section IDs

**Rear:** Section and Path IDs turned off

## Pick Shape Dialog

Select a shape that already has a Sweep modifier applied. > Modify Panel > Section Type rollout > Turn on Use Custom Section > Click Pick Shape.

The Pick Shape dialog is displayed when you select a custom shape in the scene. This shape can be any of the splines, extended splines or NURBS curves.

### Procedures

**To pick a custom section using the Pick Shape dialog:**

- 1 In the viewport, pick a shape you want to use as the underlying path of the sweep.
- 2 From the Modifiers menu, open the Patch/Spline Editing menu and choose Sweep.
- 3 On the Modify panel, turn on Use Custom Section in the Section Types rollout.
- 4  Click the Pick Shape button.

The Pick Shape dialog is displayed.

- 5 Select a shape in the list and click the Pick button.

### Interface

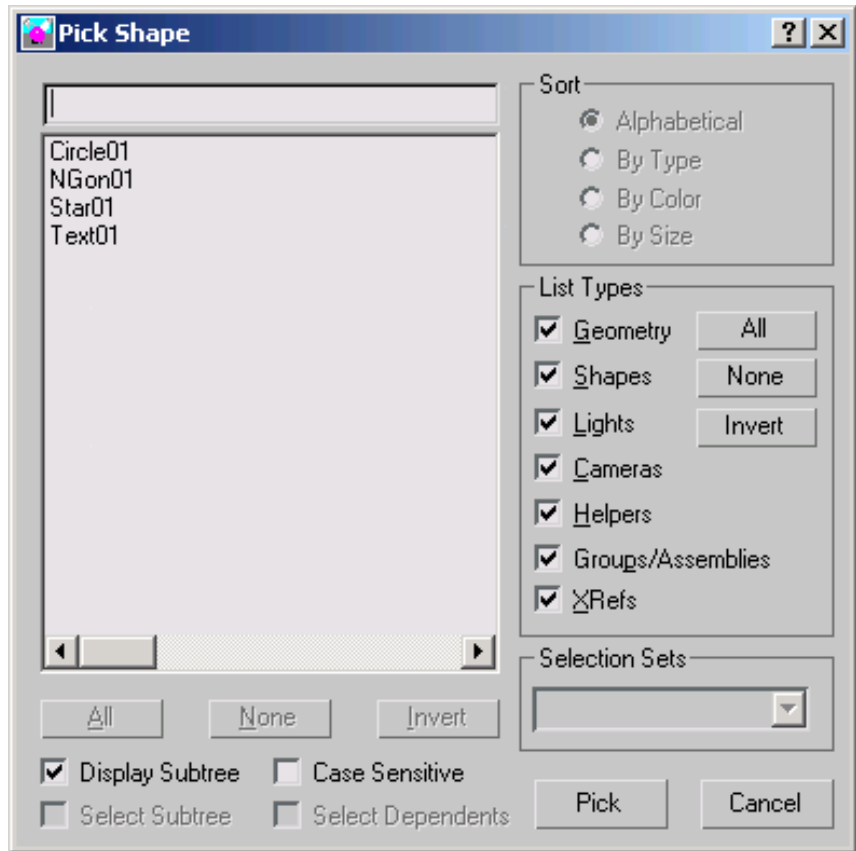

If the scene contains multiple shapes, you can choose only one shape to be swept along the underlying spline in your scene.

**All/None/Invert** These buttons are unavailable in the Pick Shape dialog.

**Display Subtree** Displays the shapes in the list in an indented format. Turn this switch off to activate the Sort group options.

**Select Subtree** Unavailable in the Pick Shape dialog.

**Case Sensitive** When on, distinguishes between upper case and lower case for item names.

### **Sort group**

Options allow you to sort the list on the left. When Display Subtree is on, these options are not available.

**Alphabetical** Sorts from A at the top to Z at the bottom.

**By Type** While this switch is available, it has no effect because only shapes are listed in the Pick Shape dialog.

**By Color** Sorts by object wireframe color. The sorting order is arbitrary; shapes of the same color are grouped together.

**By Size** This switch is available but has no effect on sorting.

### **List Types group**

Because this dialog is specifically designed to work with the Sweep modifier, the List Type group is locked to only display Shapes. Shapes is the only switch in this group that affects what is displayed.

**All/None/Invert** These buttons alter the pattern of activation of the List Types options.

### **Selection Sets group**

The Selection Sets group is unavailable in the Pick Shape dialog.

## **Extract Shape Dialog**

Select a shape that already has a Sweep modifier using a Custom Section applied. > Modify Panel > Section Type rollout > Click Extract.

The Extract functionality allows you to recover custom cross-sections that may have been deleted from the scene. As long as you have a sweep in the scene that uses the deleted shape as a custom cross-section, Extract can be used to restore it to the scene.

In a large scene that has many objects and shapes, you can also use Extract if you want to quickly duplicate a section used by the sweep instead of searching for the original shape you used as the section.

## Procedures

### To extract a section from a sweep:

- 1 In the viewport, pick a swept shape.
- 2 Open the Modify panel and click the Extract button from the Custom Section Types group of the Section Types rollout.  
The Extract Shapes dialog is displayed.
- 3 Enter a new name for the extracted section if you want.
- 4 Specify the type of cloned shape you want extracted; a copy, an instance or a reference.
- 5 Click OK.

## Interface

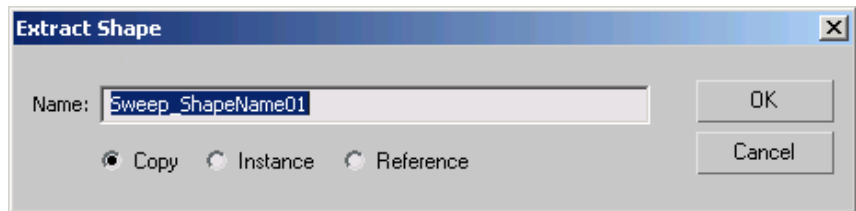

**Name** This field shows the default name that will be given to the extracted section. By default, it always has the naming convention of *Sweep\_ShapeName01*, *Sweep\_ShapeName02*, etc.

For example, if your missing section was named Roman-Ogee, the extracted shape will be named *Sweep\_Roman-Ogee01*.

**Copy** Places a copy of the extracted section at the global origin (0,0,0).

**Instance** Places an instance of the extracted section at the global origin.

**Reference** Places a reference of the extracted section at the global origin.

## Merge File (Sweep Modifier)

Select a shape that already has a Sweep modifier using a Custom Section applied. > Modify Panel > Section Type rollout > Click Merge From File.

The Merge File dialog for the Sweep modifier appears when you click the Merge From File button. Merge From File allows you to bring shapes or section profiles from other scene files into the current scene.

### **Automatic Unit Conversion**

When Respect System Units in Files is turned on in the [Units Setup dialog](#) on page 7601 in the System Unit Scale group, merged objects from a file with a different scene-unit scale are scaled to maintain their correct size in the new scene.

---

**NOTE** If Respect System Units is off (which is not recommended), a 10-foot square tube that was created in a 1 unit = 1 foot scene becomes a 10-inch square tube in a 1 unit = 1 inch scene.

---

### **Resolving Conflicts When Merged Shapes Have the Same Name**

When an incoming shape has the same name as a shape in the scene, an alert gives you the following options:

**Merge** Merges the incoming shape using the name in the field at the right. To avoid having two shapes with the same name, type a new name before proceeding.

**Skip** This button is unavailable when Merge From File is used in the Sweep modifier.

**Delete Old** This button is unavailable when Merge From File is used in the Sweep modifier.

**Auto Rename** The merged shape's name is left intact except it is given a numeric suffix that is one number higher than any duplicates found in the scene.

**Cancel** Cancels the merge operation.

### **Interface**

In the standard file selector dialog, select the scene file to merge. You can only merge MAX files.

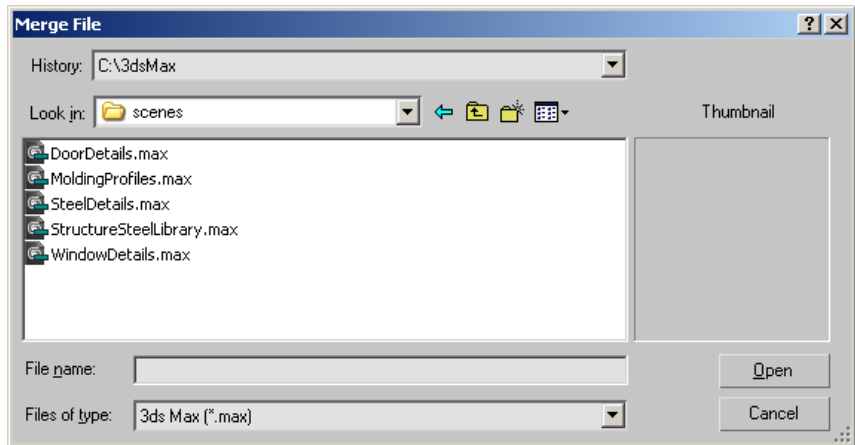

This dialog has the same functionality as the [Merge File dialog](#) on page 6854 that appears when you choose File menu > Merge with one minor exception.

If you choose a MAX file that does not include a valid 2D shape that can be used as a custom section, you will receive a warning.

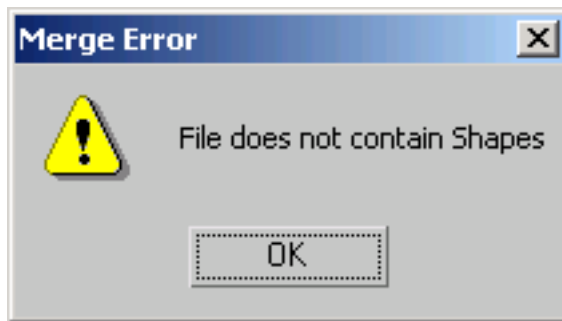

Once the scene file is selected, you can choose the shape or section profile that you want the Sweep modifier to use.

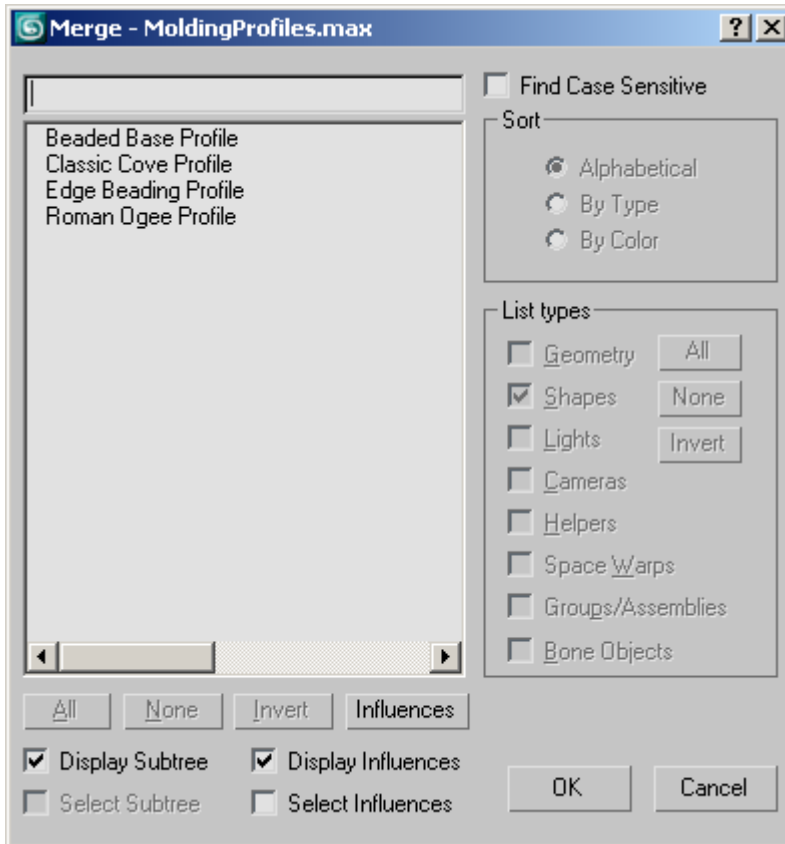

If the scene file you selected contains multiple shapes, keep in mind that you can only choose one shape to be swept along the spline in your current scene.

**All/None/Invert** These buttons are unavailable when Merge From File is used in the Sweep modifier.

**Display Subtree** Displays the shapes in the list in an indented format. Turn off this option to activate the Sort group options.

**Select Subtree** This switch is unavailable when Merge From File is used in the Sweep modifier.

**Case Sensitive** Distinguishes between uppercase and lowercase for item names.



### **Sort group**

Options allow you to sort the list on the left. If the Display Subtree switch is on, these options are not available.

**Alphabetical** Sorts from A at the top to Z at the bottom.

**By Type** This switch is unavailable when Merge From File is used in the Sweep modifier.

**By Color** Sorts by object wireframe color.

### **List Types group**

Because this dialog is specifically designed to work with the Sweep modifier, the List Type group is locked to display only Shapes. None of the switches or buttons in this group can be activated.

## **Symmetry Modifier**

Modify panel > Make a selection. > Modifier List > Symmetry

Make a selection. > Modifiers menu > Mesh Editing > Symmetry

The Symmetry modifier is especially useful when modeling characters or building ships or aircraft. This modifier is unique in that it allows you to perform three common modeling tasks:

- Mirror a mesh about the X, Y, or Z plane.
- Slice a mesh, removing parts if necessary.
- Automatically weld vertices along a common seam.

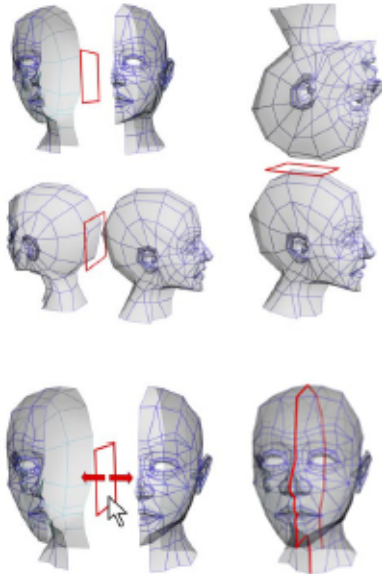

**Examples of using Symmetry with different mirror axes or by moving the mirror gizmo**

You can apply the Symmetry modifier to any geometry, and you can animate the mirror or slicing effect by animating the modifier's gizmo.

When the Symmetry modifier is applied to a mesh, any edits you make to the original half of the mesh *below the Symmetry modifier in the stack* also occur interactively to the other half. For an example, see the second procedure, below.

---

**NOTE** The Symmetry modifier converts patch and NURBS objects to mesh format in the modifier stack; editable poly and editable mesh objects remain in their original format.

---

**Procedures**

**Example: To apply the Symmetry modifier to an object:**

- 1 Create a teapot in the Perspective viewport.
- 2 Apply the Symmetry modifier.  
The teapot appears to have two spouts.
- 3 In the modifier stack, click the + button to see the Mirror gizmo, and then select Mirror.

The mirror gizmo acts as a slice plane when it is within the boundaries of the object

- 4 With Mirror Axis set to X, click and drag the mirror gizmo along the X axis.

Dragging right slices more of the teapot until there is nothing visible. Dragging left causes a second teapot to appear. When the mirror gizmo is moved beyond the boundaries of the original mesh, it acts as a mirror plane showing you two complete teapots.

**Example: To perform box modeling with the Symmetry modifier:**

- 1 Create a box primitive in the Perspective viewport, and then convert it to Editable Poly or apply the Edit Poly modifier.

- 2 If necessary, press F4 to activate Edged Faces display mode in the Perspective viewport.

- 3 Apply the Symmetry modifier.

Other than the new edge loop created by the modifier, the box's appearance doesn't change, because it's already symmetrical.

- 4 In the modifier stack, click the + button to see the Mirror gizmo, and then click Mirror.

- 5 In the Front viewport, with Mirror Axis set to X, drag the Mirror gizmo in either direction on the X axis.

Only the left-hand box moves; this is the copy created by the Symmetry modifier.

- 6 Position the Mirror near the left side of the original box, so the two copies are merged.

- 7 In the modifier stack, go to the Edit/Editable Poly level and access the Vertex sub-object level.



If you no longer see the Symmetry copy of the box, turn on Show End Result.

With Show End Result on, you might see an orange wireframe “cage” that shows the edges of original object. This is on by default for editable poly objects, but off by default for the Edit Poly modifier. The Show Cage toggle for editable poly objects is on the Subdivision Surface rollout, and for Edit Poly it's on the Edit Poly Mode rollout.

You can also see that only the vertices of the original object are visible; the vertices of the symmetry object can't be transformed directly.

**8** Move one of the visible vertices on the right side of the box.

As you do so, its counterpart on the symmetry object moves symmetrically in real time.

As you can see, the Symmetry modifier not only creates a mirror image of an object for you, but also lets you manipulate both sides in tandem in an intuitive way.

**9** Now move one of the vertices on the left side of the box, where it overlaps the symmetry box.

Because you're also moving its counterpart vertex, which is invisible, the apparent result is motion of the corresponding point on the plane of symmetry. This isn't as intuitive as moving a non-overlapping point, so for best results, position the Mirror gizmo so as to cause as little overlap as possible; that way you can edit the center vertices directly on the plane of symmetry.

## Interface

### Modifier Stack

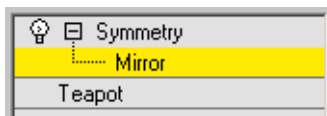

**Mirror** The placement of the mirror gizmo delegates how the object will be affected by symmetry. You can move or rotate, as well as animate the gizmo.

For more information on the stack display, see [Modifier Stack](#) on page 7427 .

## Parameters rollout

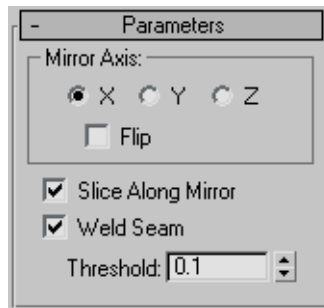

### Mirror Axis group

**X, Y, Z** Specify the axis about which the symmetry takes place. You can see the effect in the viewport as you select the axis.

**Flip** Turn on Flip if you want to flip the direction of the symmetry effect. Default=off.

**Slice Along Mirror** Turning on Slice Along Mirror causes the mirror gizmo to act as a slice plane when it is located inside the boundaries of a mesh. When the gizmo is outside the boundaries of a mesh, the symmetrical reflection is still treated as part of the originating mesh. If Slice Along Mirror is turned off, the symmetrical reflection is treated as a separate element of the originating mesh. Default=on.

**Weld Seam** Turning on Weld Seam assures that the vertices along the mirror axis will be automatically welded if they are within the Threshold. Default=on.

**Threshold** The value of the Threshold setting delegates how close vertices can be before being automatically welded together. Default=0.1.

---

**NOTE** Setting the Threshold value too high may result in some distortion of the mesh, especially when the mirror gizmo is outside the boundaries of the originating mesh.

---

## Taper Modifier

Modify panel > Make a selection. > Modifier List > Object-Space Modifiers > Taper

Make a selection. > Modifiers menu > Parametric Deformers > Taper

The Taper modifier produces a tapered contour by scaling both ends of an object's geometry; one end is scaled up, and the other is scaled down. You can control the amount and curve of the taper on two sets of axes. You can also limit the taper to a section of the geometry.

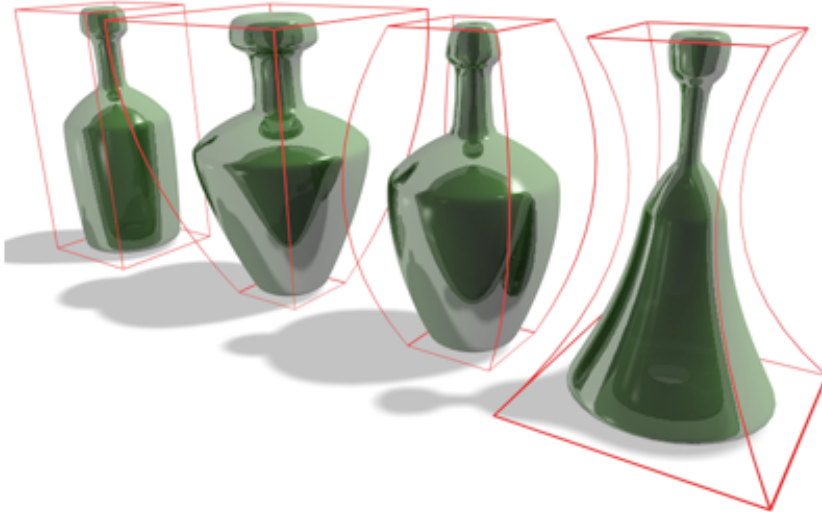

Examples of default tapers

## Interface

### Modifier Stack

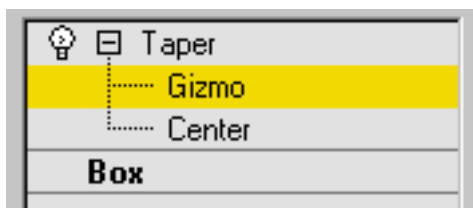

**Gizmo** At this sub-object level, you can transform and animate the gizmo like any other object, altering the effect of the Taper modifier. Translating the gizmo translates its center an equal distance. Rotating and scaling the gizmo takes place with respect to its center.

**Center** At this sub-object level, you can translate and animate the center, altering the Taper gizmo's shape, and thus the shape of the tapered object.

For more information on the stack display, see [Modifier Stack](#) on page 7427 .

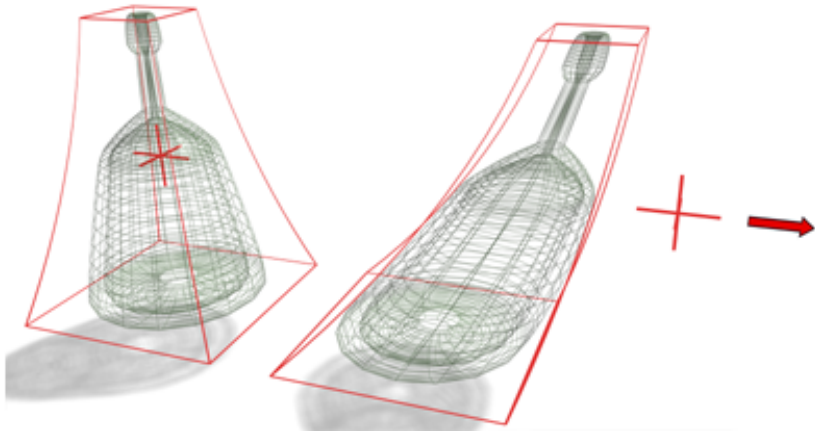

Moving the modifier's center changes the gizmo shape.

### Parameters rollout

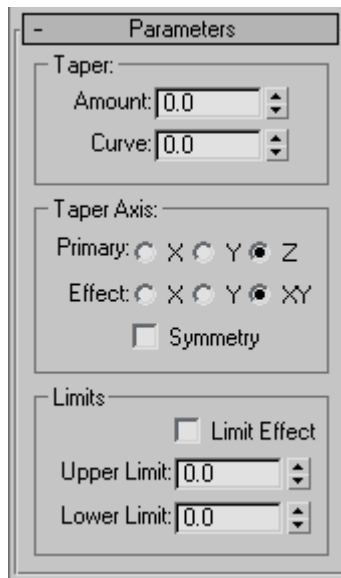

The Taper modifier provides two sets of axes and a symmetry setting in the Taper Axis group box of the Parameters rollout. As with other modifiers, these axes refer to the Taper gizmo, not the object itself.

### Taper group

**Amount** The extent to which the ends are scaled. Amount is a relative value with a maximum of 10.

**Curve** Applies a curvature to the sides of the Taper gizmo, thus affecting the shape of the tapered object. Positive values produce an outward curve along the tapered sides, negative values an inward curve. At 0, the sides are unchanged. Default=0.

### Taper Axis group

**Primary** The central axis or spine of the taper: X, Y, or Z. Default=Z.

**Effect** The axis, or pair of axes, indicating the direction of the taper from the primary axis. The available choices are determined by the choice of primary axis. The effect axis can be either of the two remaining axes, or their combination. If the primary axis is X, the effect axis can be Y, Z, or YZ. Default=XY.

**Symmetry** Produces a symmetrical taper around the primary axis. A taper is always symmetrical around the effect axis. Default=off.

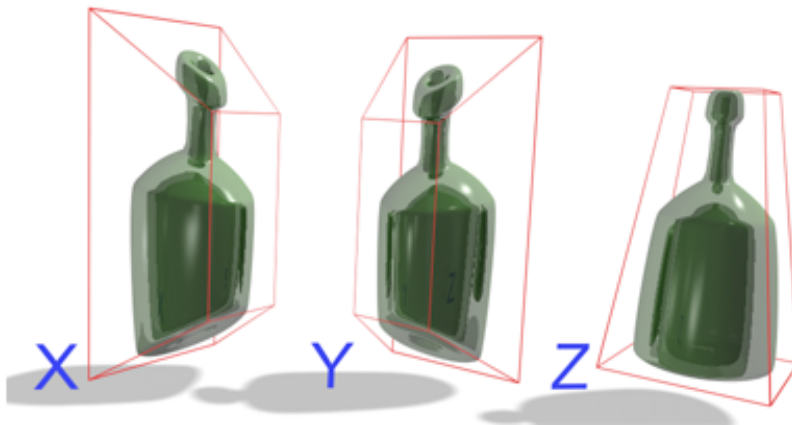

Changing the effect axis changes the effects of the modifier.



## Limits group

The taper offset is applied between the upper and lower limits. The surrounding geometry, while unaffected by the taper itself, is moved to keep the object intact.

**Limit Effect** Enables upper and lower limits for the taper effect.

**Upper Limit** Sets the upper limit boundaries in world units from the taper center point, beyond which the taper no longer affects the geometry.

**Lower Limit** Sets the lower limit boundaries in world units from the taper center point, beyond which the taper no longer affects the geometry.

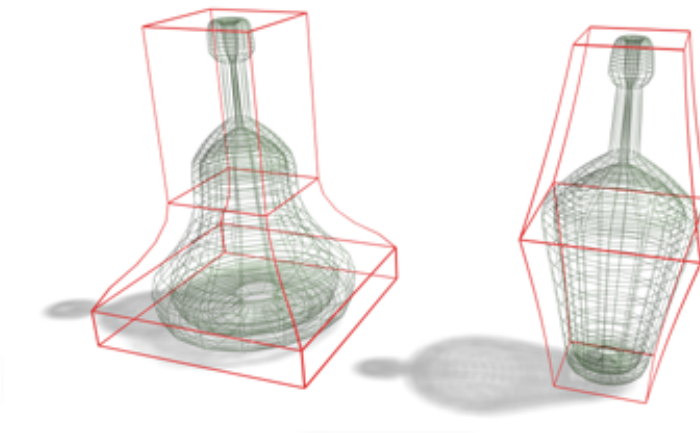

**Left: Limiting the effect of the taper.**

**Right: Using symmetry.**

## Tessellate Modifier

Modify panel > Make a selection. > Modifier List > Object-Space Modifiers > Tessellate

Make a selection. > Modifiers menu > Mesh Editing > Tessellate

The Tessellate modifier subdivides faces in the current selection. It's particularly useful for smoothing curved surfaces for rendering, and creating additional mesh resolution for other modifiers to act on. If no sub-object selection has been passed up the stack, then the entire object is tessellated. This modifier lets you tessellate polygonal faces; the tessellation available in an [editable](#)

[mesh](#) on page 2014 does not (it works on faces, even at the Polygon selection level).

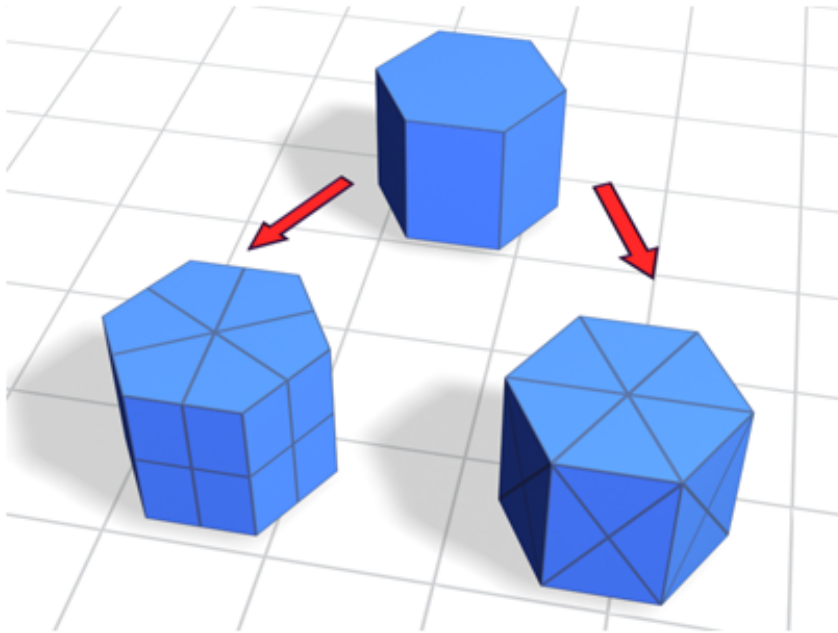

**Top:** Original mesh object

**Lower left:** Tessellation applied to polygonal facets

**Lower right:** Tessellation applied to triangular faces

---

**WARNING** Tessellating an object retains any UVW mapping that exists in the stack before the Tessellate modifier. However, in some cases, the mapping might be altered, depending on the type of mapping and the tessellation settings. Typically, this happens when the applied mapping uses extreme compound angles.

---

## Interface

### Parameters rollout

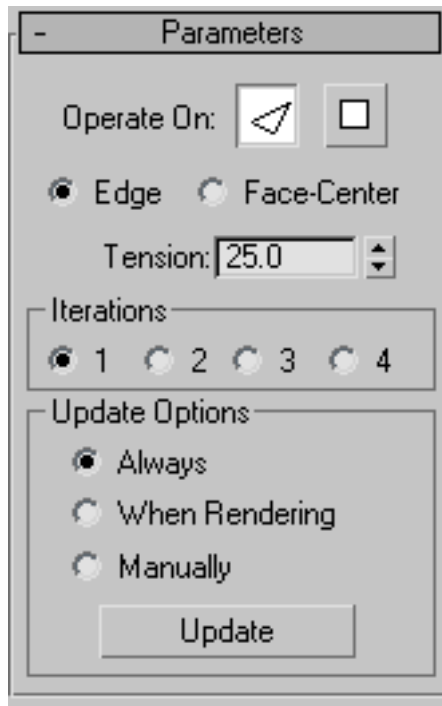

**Operate On** Specifies whether to perform the tessellation on the triangular faces or on the polygonal facets (the areas bound by visible edges).



**Faces** Treats the selection as a set of triangular faces.



**Polygons** Divides the polygonal facets. For example, using the polygonal method on the side of a box results in cross-shaped edges using the Edge method, and X-shaped edges using the Face-Center method.

**Edge** Divides the face or polygon from its center to the middle of each edge. When applied to a triangular face, it also divides unselected faces that share edges with the selected faces.

**Face-Center** Select this to divide the face from the center to the vertex corners.

**Tension** Determines if the new faces are flat, concave, or convex after Edge tessellation. A positive value rounds faces by pushing vertices outward. A negative value creates concave faces by pulling vertices inward. A setting of 0 keeps the faces flat. Also works with the Edge/Polygon method. Default=25.

### **Iterations group**

**Iterations** Specifies how many times the tessellation is applied. For example, setting Iterations to 2 is similar to clicking the Tessellation button twice in an editable mesh, except that you can easily back out at any time while using the Tessellate modifier. If you want more than four iterations, apply another Tessellate modifier.

### **Update Options group**

**Always** Tessellation is updated whenever the base geometry changes.

**When Rendering** Tessellation is updated only when the object is rendered.

**Manually** Tessellation is updated only when the user clicks Update.

**Update** Click to update tessellation. Has no effect unless Manually is the active update option.

## **Trim/Extend Modifier**

Select a shape. > Modify panel > Modifier List > Object-Space Modifiers > Trim/Extend

Select a shape. > Modifiers menu > Patch/Spline Editing > Trim/Extend

The Trim/Extend modifier is used primarily to clean up overlapping or open splines in a multi-spline shape so that lines meet at a single point. As with the Fillet/Chamfer modifier, this modifier operates on the splines at the sub-object level in the shape. When applied to a selection of multiple splines, Trim/Extend works as it does on a single spline.

To trim, you need intersecting splines. Click the portion of the spline you want to remove. The spline is searched along its length until it hits an intersecting spline, and deleted up to the intersection. If the section intersects at both ends, the entire section is deleted up to the two intersections. If the section is open on one end and intersects at the other, the entire section is

deleted up to the intersection and the open end. If the section is not intersected, nothing happens.

To extend, you need an open spline. The end of the spline nearest the picked point is extended until it reaches an intersecting spline. If there is no intersecting spline, nothing happens. Curved splines extend in a direction tangent to the end of the spline. If the end of a spline lies directly on a boundary (an intersecting spline), then it looks for an intersection further along.

---

**NOTE** As of version 3 of 3ds Max, [Edit/Editable Spline](#) on page 590 includes interactive trim/extend functions. The only reason to use this modifier is to apply it at a specific location on the stack.

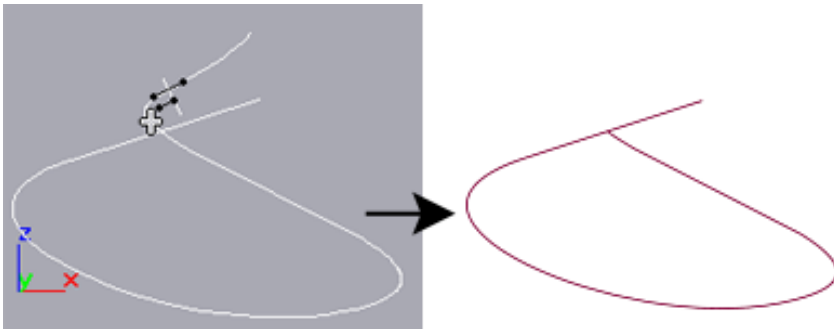

Before and after initial use of Trim

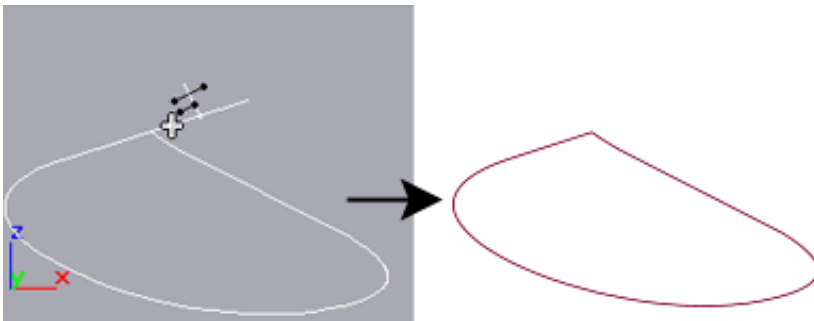

Before and after second use of Trim on above spline



Before and after using Extend

---

## Procedures

To trim a shape using the Trim/Extend modifier:

- 1 Create an open [Line shape](#) on page 551 in the form of roughly concentric overlapping circles.
- 2 Apply the Trim/Extend modifier.
- 3 Click Pick Locations.
- 4 Click the inner spline sections of the concentric shape to trim them away, or click the open spline segment to extend the spline.

## Interface

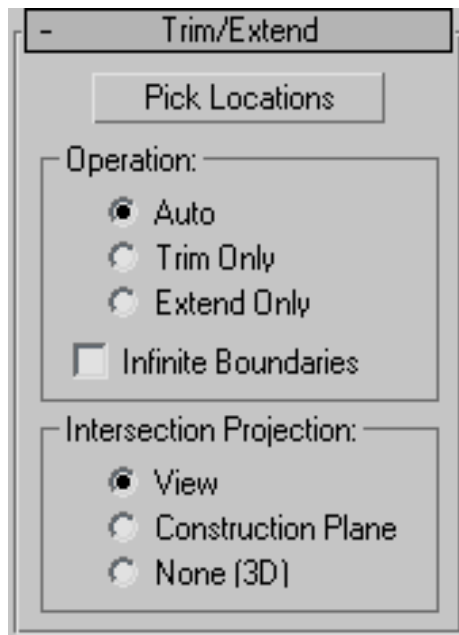

**Pick Locations** Click to turn on Pick mode. While in this mode, the mouse cursor changes in appearance when over part of the spline that can be affected by the Trim/Extend modifier. Click to either trim or extend the spline, based on the settings below. Default=Auto.

## Operation group

Specifies the type of operation that's performed on the selected spline.

**Auto** When this is chosen, a Trim is first looked for and, if not found, an Extend is attempted. In most cases, a Trim will occur when Auto is chosen. An Extend can occur, however, in cases where an open spline exists without intersecting other splines.

**Trim Only** Performs only trims. Turn on Pick Locations, and then click the spline section you want to trim.

**Extend Only** Performs only extends. Click Pick Locations, and then select the open spline section you want to extend.

**Infinite Boundaries** For the purposes of calculating intersections, turn this on to treat open splines as infinite in length. For example, this lets you trim one linear spline against the extended length of another line that it doesn't actually intersect.

---

**NOTE** As the number of open splines in the shape increases, the chance of finding an intersection, when using Infinite Boundaries, increases as well. This can produce results you might not have expected because of projected spline intersections you hadn't considered, particularly if you're in Auto mode. For predictable results, avoid using Auto mode when using Infinite Boundaries.

---

## Intersection Projection group

These options specify how the Trim and Extend functions determine a valid intersection.

**View** Projects the lines onto the active viewport, and judges the intersections accordingly. These are the intersections as you see them in the active viewport.

**Construction Plane** Projects the lines onto the current construction plane.

**None (3D)** Considers only true intersections as the splines exist in 3D space. They must physically intersect to be considered.

# TurboSmooth Modifier

Make a selection. > Modify panel > Modifier List > Object-Space Modifiers > TurboSmooth



The TurboSmooth modifier, like [MeshSmooth](#) on page 1460 , smoothes geometry in your scene. The differences between the two are as follows:

- TurboSmooth is considerably faster and more memory-efficient than MeshSmooth. TurboSmooth also has an option for Explicit Normals, unavailable in MeshSmooth. See [Explicit Normals](#) on page 1755 .
- TurboSmooth provides a limited subset of MeshSmooth functionality. In particular, TurboSmooth uses a single smoothing method (NURMS), can be applied only to an entire object, has no sub-object levels, and outputs a triangle-mesh object.

TurboSmooth lets you subdivide the geometry while interpolating the angles of new faces at corners and edges, and apply a single smoothing group to all faces in the object. The effect of TurboSmooth is to round over corners and edges as if they had been filed or planed smooth. Use TurboSmooth parameters to control the size and number of new faces, and how they affect the surface of the object.

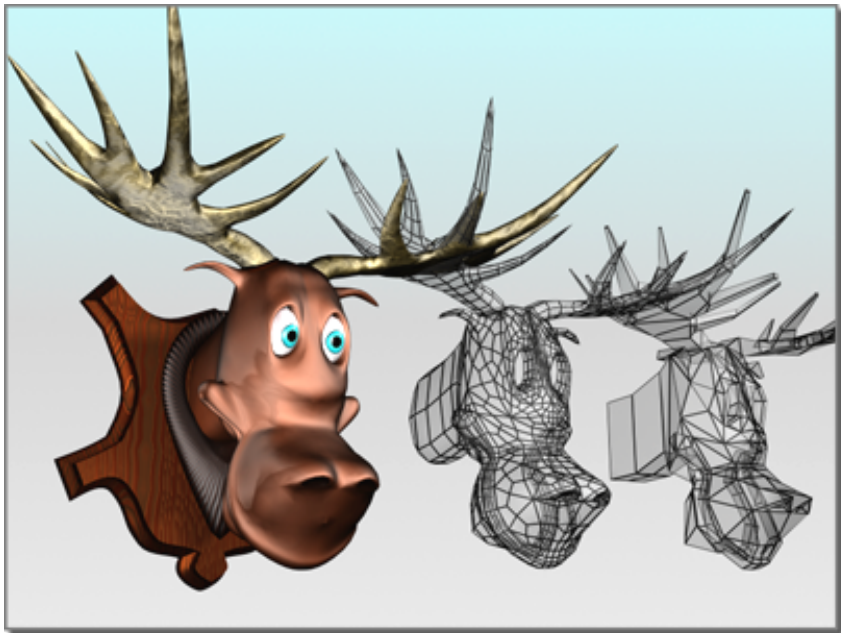

Angular model (shown on the right) changed to a smooth model with TurboSmooth

You use TurboSmooth to produce a Non-Uniform Rational MeshSmooth object (NURMS for short). A NURMS object is similar to a NURBS object in that you can set different weights for each control vertex.

TurboSmooth's effect is most dramatic on sharp corners and least visible on rounded surfaces. Use TurboSmooth on boxes and geometry with crisp angles. Avoid using it on spheres and similar objects.

---

**TIP** To better understand TurboSmooth, create a sphere and a cube and apply TurboSmooth to both. The cube's sharp corners become rounded, while the sphere's geometry becomes more complex without changing shape significantly.

---

## Procedures

### To apply TurboSmooth to an object:

- 1 Select an angular object.
- 2 Apply the TurboSmooth modifier.
- 3 Set TurboSmooth parameters.

### Example: To compare the speeds of TurboSmooth and MeshSmooth:

- 1 Create a Box primitive with Length/Width/Height Segs=3. Convert the box to editable poly format.
- 2 Apply MeshSmooth.
- 3 Set Iterations=5.  
This creates a heavily subdivided mesh.
- 4 Go to the Editable Poly > Vertex sub-object level, and turn on Show End Result.
- 5 Move one of the corner vertices outward.  
There is a significant delay before you see the result of the Move operation.
- 6 Perform a few more Move operations on vertices, observe the delays, and then undo (Ctrl+Z) repeatedly until the MeshSmooth modifier goes away.
- 7 Apply TurboSmooth.
- 8 Set Iterations=5.  
This creates a heavily subdivided mesh.

- 9 Go to the Editable Poly > Vertex sub-object level, and turn on Show End Result.
- 10 Move one of the corner vertices outward.  
The response is much faster.

### Interface

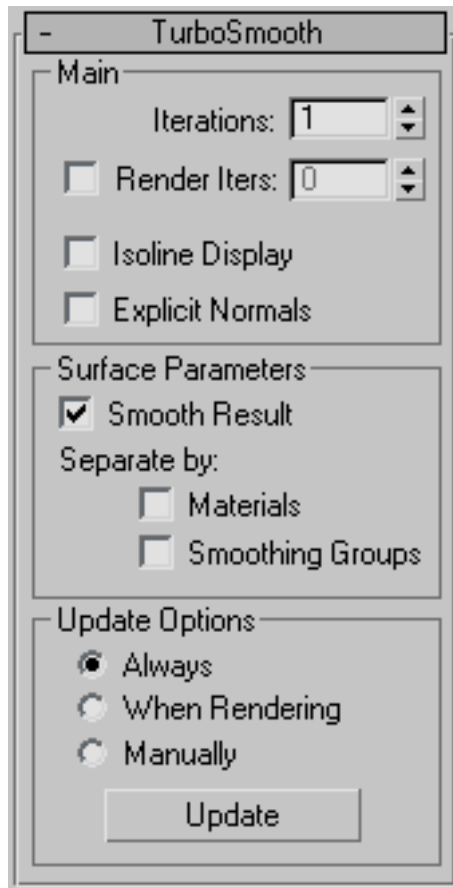

### Main group

Lets you set the basic parameters for TurboSmooth.

**Iterations** Sets the number of times the mesh is subdivided. When you increase this value, each new iteration subdivides the mesh by creating smoothly interpolated vertices for every vertex, edge, and face from the iteration before. The modifier then subdivides the faces to use these new vertices. Default=1. Range=0 to 10.

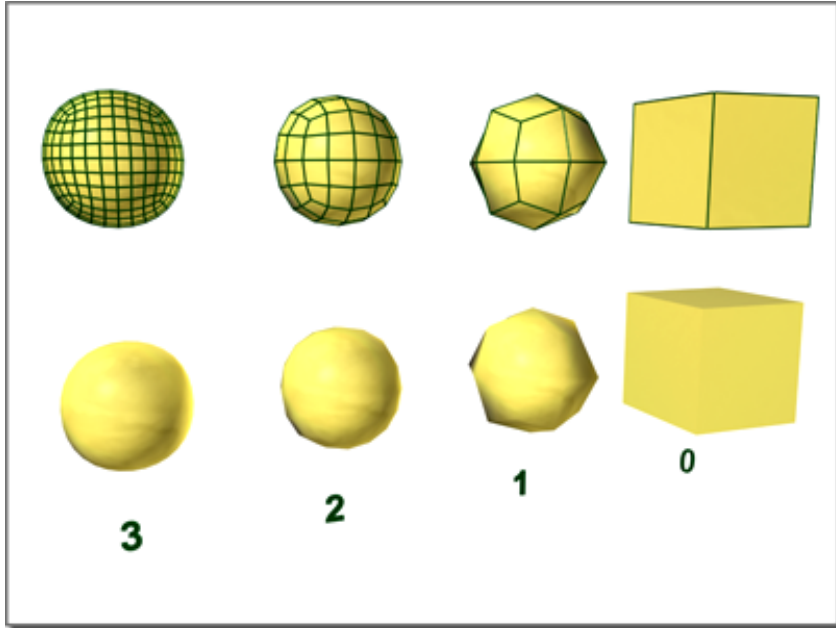

From right to left, effect of increasing the number of iterations

---

**NOTE** Be cautious when increasing the number of iterations. The number of vertices and faces in an object (and thus the calculation time) can increase as much as four times for each iteration. Applying four iterations to even a moderately complex object can take a long time to calculate.

---

**Render Iter(ation)s** Lets you choose a different number of [smoothing iterations](#) on page 1754 to be applied to the object at render time. Turn on Render Iters, and then use the field to its right to set the number of render iterations.

**Isoline Display** When on, the software displays only isolines: the object's original edges, before smoothing. The benefit of using this option is a less cluttered display. When off, the software displays all faces added by TurboSmooth; thus, higher Iterations values result in a greater number of lines. Default=off.

---

**WARNING** If you're going to collapse the model or apply further modifiers after the TurboSmooth, you should first turn off Isoline Display. Unlike in MeshSmooth, isoline display is achieved by making all the edges "invisible," joining large groups of faces together in single "polygons." This can be especially problematic if you apply a PolyObject-based modifier afterwards, because all vertices in the interior of these "polygons" will be lost.

---

**Explicit Normals** Lets the TurboSmooth modifier compute normals for its output, which is faster than the standard method 3ds Max uses to compute normals from the mesh object's smoothing groups. Default=off.

Consequently, if the TurboSmooth result is used directly for display or rendering, it will generally be faster with this option turned on. Also, the quality of the normals will be slightly higher. However, if you apply any topology-affecting modifiers, such as Edit Mesh, above the TurboSmooth modifier, these normals will be lost and new ones computed, potentially affecting performance adversely. So it's important to remember to turn on Explicit Normals only if no modifiers change the object topology after TurboSmooth takes effect.

### **Surface Parameters group**

Lets you apply smoothing groups to the object and restrict the smoothing effect by surface properties.

**Smooth Result** Applies the same smoothing group to all faces.

**Separate by Materials** Prevents the creation of new faces for edges between faces that do not share Material IDs.

**Separate by Smoothing Groups** Prevents the creation of new faces at edges between faces that don't share at least one smoothing group.

### **Update Options group**

Sets manual or render-time update options, for situations where the complexity of the smoothed object is too high for automatic updates. Note that you can also set a greater degree of smoothing to be applied only at render time, in the Main group.

**Always** Updates the object automatically whenever you change any TurboSmooth settings.

**When Rendering** Updates the viewport display of the object only at render time.

**Manually** Turns on manual updating. When manual updating is selected, any settings you change don't take effect until you click the Update button.

**Update** Updates the object in the viewport to match the current TurboSmooth settings. Works only when you choose When Rendering or Manually.

## Turn To Mesh Modifier

Make a selection. > Modify panel > Modifier list > Object-Space Modifiers > Turn to Mesh

Make a selection. > Modifiers menu > Conversion > Turn to Mesh

The Turn To Mesh modifier lets you apply object conversions in the modifier stack. As another example, you could use this modifier on a sophisticated patch model to which you might want to apply a tool that applies only to meshes, or convert the object to a mesh. Also, when you apply general-purpose modifiers such as Normal, Material, or UVW Map, it can be helpful to explicitly control the type of object beforehand.

---

**NOTE** Converting from one object type to another causes a complete caching in the modifier stack. When you have large objects in your scene, this can take up a lot of space. For example, an object that starts as a mesh, converts to a patch, and then back to a mesh takes three times as much space as a mesh that just has ordinary modifiers like Bend or UVW Map applied.

---

**TIP** Turn To Mesh can be useful on meshes, allowing you to invert a selection or change the selection level in a modifier that doesn't depend on topology.

---

### Procedures

**Example: To translate a patch sub-object selection to a polygon sub-object selection:**

- 1 Select a patch model and turn on wireframe mode.
- 2 In the stack display, choose the Patch sub-object level.
- 3 Select a patch on the model.
- 4 Apply the Turn To Mesh modifier from the Modifier list.
- 5 In the stack display, right-click the Turn To Mesh modifier and choose Collapse All.

- 6 Click Yes in the dialog that warns you about the possibility of undesirable topological effects.
- 7 In the stack display (or in the selection rollout), choose the Polygon sub-object mode. The original patch selection has been preserved.

## Interface

### Parameters rollout

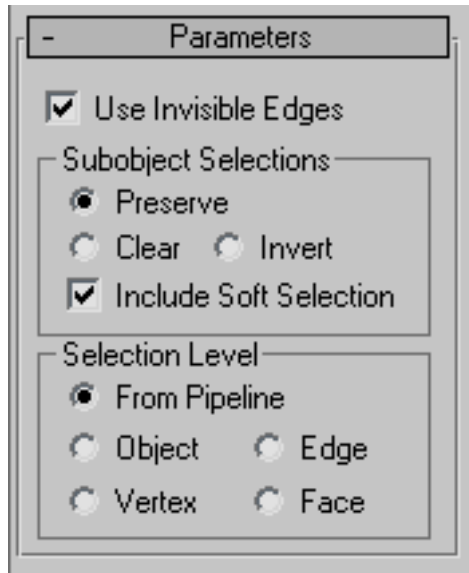

**Use Invisible Edges** When on, uses invisible edges to represent polygons. When off, produces a completely triangulated mesh with all visible edges. Default=on.

### Sub-object Selections group

These options control the selection of sub-objects.

**Preserve** Passes the sub-object selection up the stack. For example, if you have an object that you have converted to an editable mesh, and you've selected a polygon, then when you apply a Turn To Mesh modifier, the polygon remains selected. Default=on.

**Clear** Clears the sub-object selection so that nothing is selected. Default=off.

**Invert** Inverts the sub-object selection. All sub-objects not currently selected are selected, and all sub-objects currently selected are deselected. Default=off.

**Include Soft Selection** Affects the action of sub-object Move, Rotate, and Scale functions. When these are on, 3ds Max applies a spline curve deformation to unselected vertices surrounding the transformed selected sub-object. This provides a magnet-like effect, with a sphere of influence around the transformation. Use this when you want to preserve the soft selection from beneath. For example, if Use Soft Selection is on when you select vertices on an editable poly, and you apply Turn To Mesh with Include Soft Selection on, then the same soft selection will apply to the mesh vertices. Default=on.

For more information, see [Soft Selection Rollout](#) on page 1926 .

### **Selection Level group**

These options set the sub-object selection level for passing up the rest of the stack.

**From Pipeline** Uses the equivalent of whatever the input object uses (patch level becomes face level, and so on). For example, if you create a box, convert it to an editable patch in patch mode, and apply a Turn To Mesh modifier to it, 3ds Max passes a sub-object selection in patch mode up the stack. The Turn To Mesh modifier takes the sub-object patch selection into account and selects the mesh faces that derive from the patch selection.

**Object** Uses Object as the selection level for passing up the rest of the stack.

**Edge** Uses Edge as the sub-object selection level for passing up the rest of the stack.

**Vertex** Uses Vertex as the sub-object selection level for passing up the rest of the stack.

**Face** Uses Face as the sub-object selection level for passing up the rest of the stack.

## **Turn To Patch Modifier**

Make a selection. > Modify panel > Modifier List > Object-Space Modifiers > Turn to Patch

Make a selection. > Modifiers menu > Conversion > Turn to Patch



The Turn To Patch modifier lets you apply object conversions in the modifier stack. Using the Turn To Patch modifier, you can fine-tune the conversion process such as turning quads into quad patches.

---

**NOTE** Converting from one object type to another causes a complete caching in the modifier stack. When you have large objects in your scene, this can take up a lot of space. For example, an object that starts as a mesh, converts to a patch, and then back to a mesh takes 3 times as much space as a mesh which just has ordinary modifiers like Bend or UVW Map applied.

---

**TIP** Turn To Patch can be useful on patches, allowing you to invert a selection or change the selection level in a modifier that doesn't depend on topology.

---

## **Procedures**

### **Example: To collapse to quad patches:**

- 1** Create a chamfer box in wireframe: Create panel > Geometry > Extended Primitives > Object Type rollout > ChamferBox button.
- 2** Apply a Turn To Patch modifier: Modify panel > Modifier List > Turn To Patch.
- 3** Right-click the stack display and choose Collapse All.

## Interface

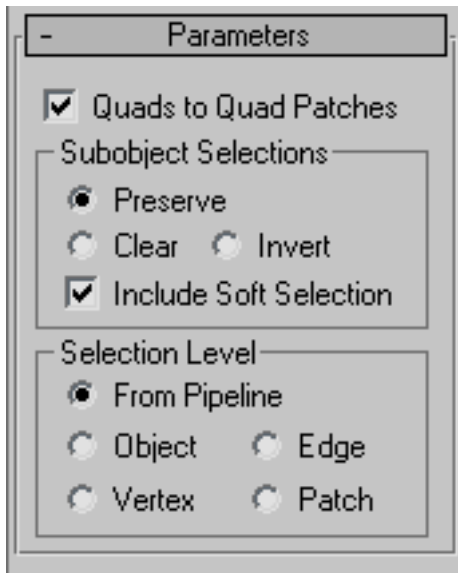

**Quads to Quad Patches** Turns quad faces in meshes or polymeshes into quad patches.

---

**NOTE** When you turn this option off, 3ds Max triangulates quads when the Turn To Patch modifier is applied to a mesh or poly object.

---

### Sub-object Selections group

These options control the selection of sub-objects.

**Preserve** Passes the sub-object selection up the stack. For example, if you have an object that you have converted from an editable mesh, and you've selected a polygon, then when you apply a Turn To Patch modifier, the patch, which is derived from the selected polygon, remains selected. Default=on.

**Clear** Clears the sub-object selection so that nothing is selected. Default=off.

**Invert** Inverts the sub-object selection. All sub-objects not currently selected are selected, and all sub-objects currently selected are deselected. Default=off.

**Include Soft Selection** When these are on, 3ds Max applies a spline curve deformation to unselected vertices surrounding the transformed selected sub-object. This provides a magnet-like effect, with a sphere of influence around the transformation. Use this when you want to preserve the soft

selection from beneath. For example, if Use Soft Selection is on when you select vertices on an editable mesh, and you apply Turn To Patch with Include Soft Selection on, then the same soft selection will apply to the patch vertices. Default=on.

For more information, see [Soft Selection Rollout](#) on page 1926 .

## Selection Level group

These options set the sub-object selection level for passing up the rest of the stack.

**From Pipeline** Uses the equivalent of whatever the input object uses (patch level becomes face level, and so on.). For example, if you create a box, convert it to an editable mesh in face mode, and apply a Turn To Patch modifier to it, 3ds Max passes a sub-object selection in patch mode up the stack. The Turn To Patch modifier takes the sub-object face selection into account and selects the patches that derive from the face selection.

**Object** Uses object as the selection level for passing up the rest of the stack.

**Edge** Uses edge as the sub-object selection level for passing up the rest of the stack.

**Vertex** Uses vertex as the sub-object selection level for passing up the rest of the stack.

**Patch** Uses patch as the sub-object selection level for passing up the rest of the stack.

## Turn To Poly Modifier

Make a selection. > Modify panel > Modifier List > Object-Space Modifiers > Turn to Poly

Make a selection. > Modifiers menu > Conversion > Turn to Poly

The Turn To Poly modifier lets you apply object conversions in the modifier stack. Also, when you apply the general-purpose modifiers, such as Normal, Material, or UVW Map, it can be helpful to explicitly control the type of object beforehand.

When you use Turn To Poly, you're joining triangles into polygons, so you might need to have restrictions on polygon convexity, size, and planarity. All conversions from patches produce quads and triangles. Conversions from

meshes can produce arbitrarily large polygons. Mesh polygons are controlled as usual by joining together faces that are separated by invisible edges.

---

**NOTE** Converting from one object type to another causes a complete caching in the modifier stack. When you have large objects in your scene, this can take up a lot of space. For example, an object that starts as a mesh, converts to a patch, and then back to a mesh takes three times as much space as a mesh that has only ordinary modifiers like Bend or UVW Map applied.

---

**TIP** Turn To Poly can be useful on polymeshes, allowing you to invert a selection or change the selection level in a modifier that doesn't depend on topology.

---

## Procedures

**Example: To prevent interior vertices from being passed up the stack:**

- 1 Create an NGon in wireframe mode: Create panel > Shapes > Splines > Object Type rollout > NGon.
- 2  Open the Modify panel and convert the NGon to an editable mesh by right-clicking the stack display and choosing Convert to > Editable Mesh.
- 3 In the stack display (or in the Selection rollout), choose the Polygon sub-object mode.
- 4 Choose Edit > Object Properties to display the Object Properties dialog.
- 5 In the Display Properties group, turn off By Layer.
- 6 Turn on Vertex Ticks. Choose OK to close the dialog.
- 7 Click Cut under the Edit Geometry rollout, and make a cut from one side of the NGon to the other. Notice that an interior vertex now exists.

---

**NOTE** Doing this on an NGon doesn't always generate an interior vertex.

---

- 8 Apply the Turn To Poly modifier: Modify panel > Modifier List > Turn To Poly. Notice the interior vertex clears.

## Interface

### Parameters rollout

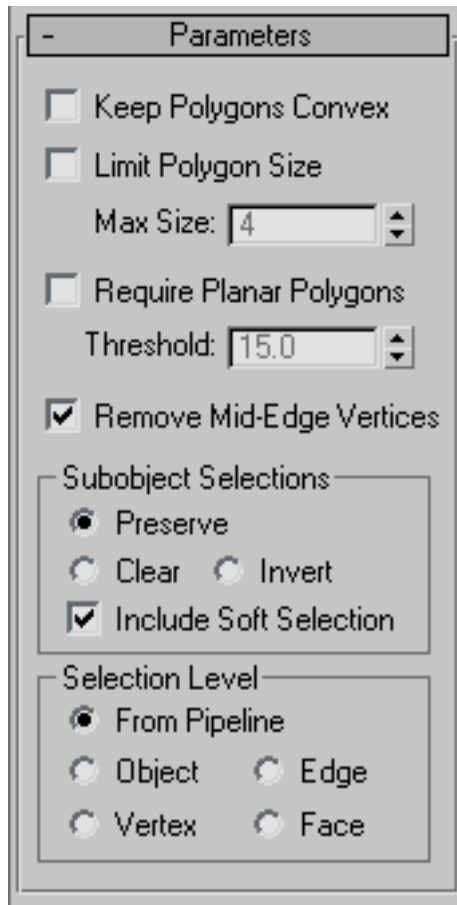

**Keep Polygons Convex** Does not join across edges if the resulting polygon would not be convex. "Convex" means that you can connect any two points in the polygon with a line that doesn't go outside the polygon. A polygon is not convex if you can draw a line between vertices and that line lays outside of the polygon.

Problems that can occur with non-convex polygons include the fact that changes in the geometry of the input object can result in a different topology for the Turn To Poly result. For instance, in a box, if you drag one of the top corners across the middle of the top face, the box becomes non-convex. Turn

To Poly would then see this as two triangles instead of one quad, and the number of points in the result would change.

**Limit Polygon Size** Limits the number of sides to a polygon so that the surface is better defined. For example, you might want to produce a polymesh of triangles and quads, or one composed of all triangles, rather than joining together more than two triangles into pentagons, hexagons, and so on.

**Max Size** The maximum number of sides to a polygon.

**Require Planar Polygons** Creates polygons composed of flat planes. Does not join faces together across an edge if the edge has a sharper angle than the threshold listed.

**Threshold** Controls the threshold of the angle between polygonal planes.

**Remove Mid-Edge Vertices** Eliminates divisions that result from intersections with invisible edges.

### **Sub-object Selections group**

These options control the selection of sub-objects.

**Preserve** Passes the sub-object selection up the stack. For example, if you have an object that you have converted to an editable mesh, and you've selected a polygon, then when you apply a Turn To Poly modifier, the polygon remains selected. Default=on.

**Clear** Clears the sub-object selection so that nothing is selected. Default=off.

**Invert** Inverts the sub-object selection. All sub-objects not currently selected are selected, and all sub-objects currently selected are deselected. Default=off.

**Include Soft Selection** Affects the action of sub-object Move, Rotate, and Scale functions. When these are on, 3ds Max applies a spline curve deformation to unselected vertices surrounding the transformed selected sub-object. This provides a magnet-like effect, with a sphere of influence around the transformation. Use this when you want to preserve the soft selection from beneath. For example, if Use Soft Selection is on when you select vertices on an editable mesh, and you apply Turn To Poly with Include Soft Selection on, then the same soft selection will apply to the polymesh vertices. Default=on.

For more information, see [Soft Selection Rollout](#) on page 1926 .

### **Selection Level group**

These options set the sub-object selection level for passing up the rest of the stack.

**From Pipeline** Uses the equivalent of whatever the input object uses (patch level becomes face level, and so on). For example, if you create a box, convert it to an editable mesh in face mode, and apply a Turn To Poly modifier to it, 3ds Max passes a sub-object selection in face mode up the stack. The Turn To Poly modifier takes the sub-object face selection into account and selects the polygons that derive from the face selection.

**Object** Uses object as the selection level for passing up the rest of the stack.

**Edge** Uses edge as the sub-object selection level for passing up the rest of the stack.

**Vertex** Uses vertex as the sub-object selection level for passing up the rest of the stack.

**Face** Uses face as the sub-object selection level for passing up the rest of the stack.

## Twist Modifier

Modify panel > Make a selection. > Modifier List > Object-Space Modifiers > Twist

Make a selection. > Modifiers menu > Parametric Deformers > Twist

The Twist modifier produces a twirling effect (like wringing out a wet rag) in an object's geometry. You can control the angle of the twist on any of three axes, and set a bias that compresses the twist effect relative to the pivot point. You can also limit the twist to a section of the geometry.

---

**NOTE** When you apply the Twist modifier, the Twist gizmo's center is placed at the object's pivot point, and the gizmo lines up with the object's local axis.

---

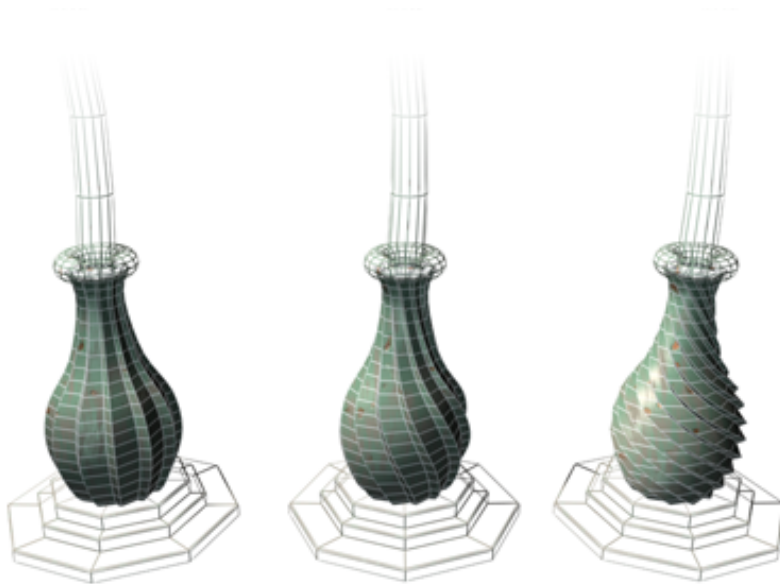

**Left: Original model**

**Middle: A moderate twist**

**Right: An extreme twist**

## **Procedures**

### **To twist an object:**

- 1 Select an object and apply Twist.
- 2 On the Parameters rollout, set Twist Axis to X, Y, or Z. This refers to the axis of the Twist gizmo, not the axis of the selected object.  
You can switch between axes at any time, but only one axis setting is carried with the modifier.
- 3 Set the angle of the twist. Positive values produce a clockwise twist, negative values a counterclockwise twist. An angle of 360 produces a complete revolution.  
The object twists to this amount beginning at the lower limit (by default, the location of the modifier's center).
- 4 Set the bias of the twist.



A positive value compresses the twist at the end away from the pivot point, a negative value toward the pivot point.

#### To limit the twist:

- 1 Turn on Limits group > Limit Effect.
- 2 Set values for the upper and lower limits. These are distances in current units above and below the modifier's center, which is at zero on the gizmo's Z axis. The upper limit can be zero or positive, the lower limit zero or negative. If the limits are equal, the result is the same as turning off Limit Effect.

The twist offset is applied between these limits. The surrounding geometry, while unaffected by the twist itself, is moved to keep the object intact.

- 3 At the sub-object level, you can select and move the modifier's center. The limit settings remain on either side of the center as you move it. This lets you relocate the twist area to another part of the object.

## Interface

### Modifier Stack

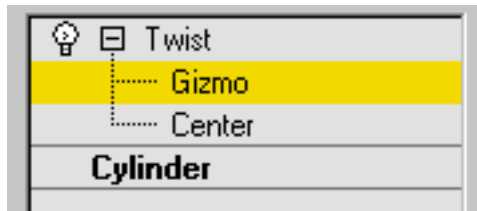

**Gizmo** You can transform and animate the gizmo like any other object at this sub-object level, altering the effect of the Twist modifier. Translating the gizmo translates its center an equal distance. Rotating and scaling the gizmo takes place with respect to its center.

**Center** You can translate and animate the center at this sub-object level, altering the Twist gizmo's shape, and thus the shape of the twisted object.

For more information on the stack display, see [Modifier Stack](#) on page 7427 .

## Twist Parameters rollout

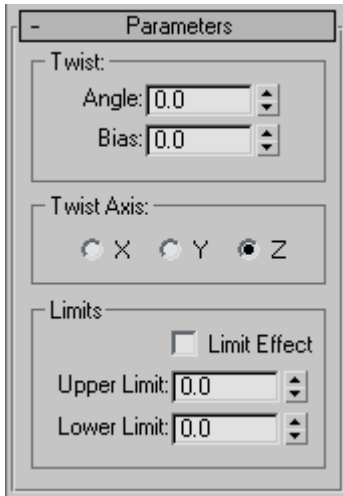

### Twist group

**Angle** Determines the amount of twist around the vertical axis. Default=0.0.

**Bias** Causes the twist rotation to bunch up at either end of the object. When the parameter is negative, the object twists closer to the gizmo center. When the value is positive, the object twists more away from the gizmo center. When the parameter is 0, the twisting is uniform. Range=100 to -100. Default=0.0.

### Twist Axis group

**X/Y/Z** Specify the axis along which the twist will occur. This is the local axis of the Twist gizmo. Default=Z.

### Limits group

Applies the twist effect only to vertices that lie between the lower and upper limits. The two spinners represent distance along the gizmo's Z axis (Z=0 is at the gizmo's center). When they are equal, it is the same as disabling the twist effect.

**Limit Effect** Applies limit constraints to the Twist modifier.

**Upper Limit** Sets the upper limit for the twist effect. Default=0.

**Lower Limit** Sets the lower limit for the twist effect. Default=0.

# Unwrap UVW Modifier

Select one or more objects. > Modify panel > Modifier List > Object-Space Modifiers > Unwrap UVW

Select one or more objects. > Modifiers menu > UV Coordinates > Unwrap UVW

The Unwrap UVW modifier lets you assign mapping coordinates to sub-object selections, and to edit the UVW coordinates of those selections. You can also use it to unwrap and edit existing UVW coordinates on an object. Maps can be adjusted to the proper fit on a Mesh, Patch, Polygon, HSDS, or NURBS model.

The Unwrap UVW modifier can be used as a self-contained UVW mapper and UVW coordinate editor, or in conjunction with the [UVW Map modifier](#) on page 1849 . If you use Unwrap UVW in conjunction with the UVW Map modifier, it is usually so you can use a mapping method unavailable in Unwrap UVW, such as Shrink Wrap. You can animate UVW coordinates by turning on the Auto Key button and transforming the coordinates at different frames.

---

**NOTE** After applying the Unwrap UVW modifier, open mapping edges, or seams, appear on the modified object in the viewports. This helps you visualize the locations of mapping clusters on the object surface. You can toggle this feature and set the line thickness with the [Display setting](#) on page 1783 .

---

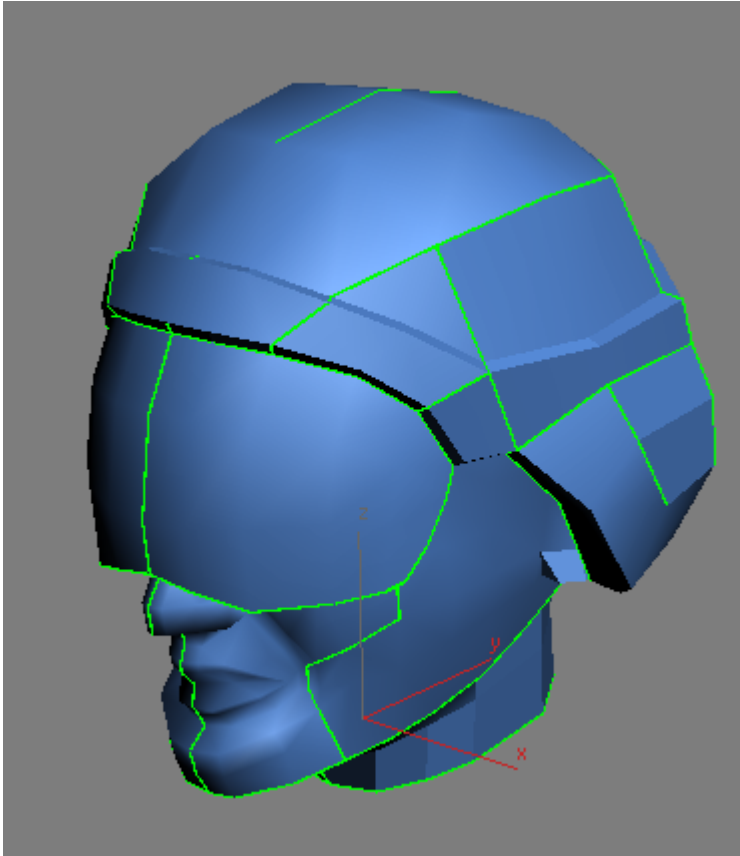

Open UVW mapping edges (seams) shown on head model in viewport

### **Self-Contained Mapper and UVW Coordinate Editor**

Rather than creating a large modifier stack by first making a sub-object selection of faces and then adding a UVW Map modifier to specify the type of mapping, you can use the Unwrap UVW modifier to do both. You can select sub-object vertices, edges, or faces/patches, store sub-object selections as named selections, map them using planar and other methods, and then edit the UVW coordinates for each sub-object selection, all from within the Unwrap UVW modifier. For example, to map a character's face using three planar maps, you could create three sub-object selections of the front and sides of the face, planar-map the selections individually, and then edit the UVW coordinates for each selection, all without leaving the Unwrap UVW modifier.



## Support for Multiple Unwrap Objects

New instancing capabilities in Unwrap UVW make it easy to map a texture across several objects. You simply make your selection and then apply Unwrap UVW. When you open the editor, you'll see the mapping coordinates for all selected objects containing the instanced modifier. The editor shows each object's [wireframe color](#) on page 7423 so you can distinguish the different objects.

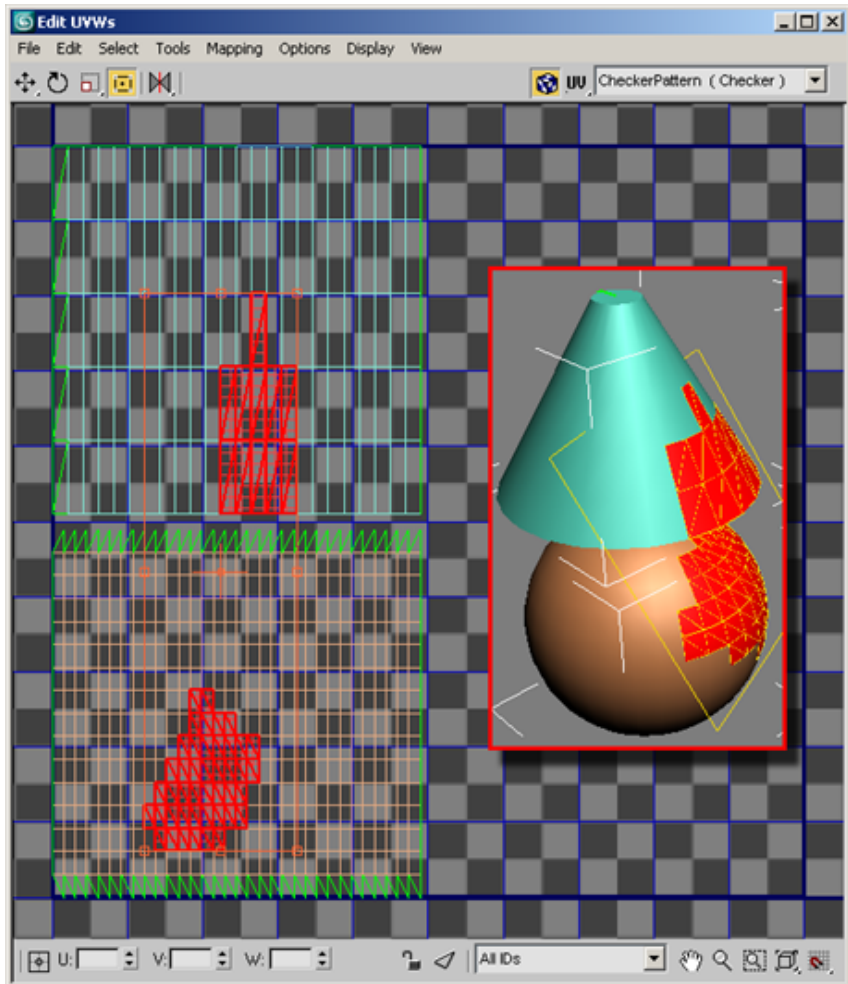

Left: Two objects' UVW coordinates in the editor, showing wireframe colors.

**Right (inset): The objects with a shared Unwrap UVW modifier in the viewport.**

---

**TIP** The UVWs of different objects typically start out in the same location in the editor, so it's a good idea to separate them before editing. To save time, use the Pack UVs function on the Tools menu.

---

## **What Happens to Existing UVW Coordinates**

When you apply the Unwrap UVW modifier, it stores the object's current mapping coordinates in the modifier. If the object has no mapping coordinates, the modifier creates new ones by applying planar mapping. If the incoming data on the stack is a face-level or polygon-level sub-object selection, then only the UVWs for the selected faces are brought into the modifier, and the modifier's sub-object levels are unavailable.

When the modifier is evaluated, its UVWs are reassigned to the object flowing down the pipeline. So if the UVWs upstream are changed, the changes won't make it past the Unwrap UVW modifier. If the Unwrap modifier is operating on a selection of faces, then upstream changes to unselected faces will still be able to flow past the Unwrap modifier.

## **Native Support for HSDS, Polygon Object, and Patch mapping**

Unwrap UVW supports polygon faces and Bezier quad and tri patch faces in addition to triangles and quads.

Below is a sample of what the various face types look like based on the incoming type. For HSDS and Poly surfaces, the basic interface remains the same, except that the maximum number of sides per polygon increases from 4 to over two billion. HSDS supports only one level of detail: the level at which the mapping was. Patches have handles on nonlinear vertices. These handles work just like regular patch handles.

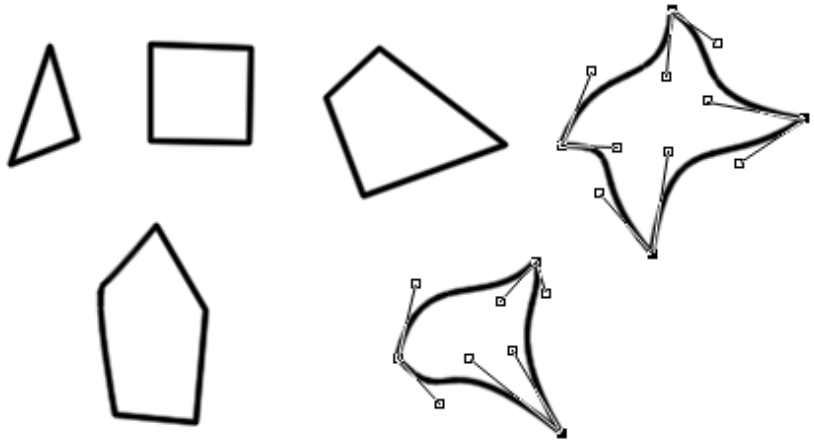

## Pinning Textures

Although not its primary purpose, you can use the Unwrap UVW modifier to freeze UVWs. You can apply mapping after an animated deformation and have the mapping stick to the object. For example, you can apply Unwrap UVW above a Morpher modifier in the modifier stack, apply planar maps and edit the UVW coordinates. The mapping will follow the morphing geometry.

## Procedures

### To use Unwrap UVW with the non-Pelt mapping methods:

This is a general overview of using the basic Unwrap UVW tools available on the Modify panel and the [Edit UVWs dialog](#) on page 1788 . Unwrap UVW provides many additional tools, particularly in the editor.

- 1 Apply the modifier and a texture-mapped material to an object. Set the material to display in the viewports, set at least one viewport to be shaded (e.g., press F3 to toggle between Wireframe and Smooth+Highlights), and, if necessary, turn off Shade Selected Faces (press F2) for that viewport so the texture mapping is visible.
- 2 Go to the Face sub-object level of the Unwrap modifier and make a selection of contiguous faces. You'll use a single mapping type on this selection.

Within the single modifier, you can apply as many different mappings as you like to different face selections.

- 3 It is recommended that you name the selection using the [Named Selection Sets](#) on page 179 function on the main toolbar. This makes it easy to return to the selection set in the viewports for subsequent mapping adjustments. For example, if you're working on a house, you could use names such as **roof**.

---

**IMPORTANT** Be sure to press Enter after typing the selection set name.

---

- 4 On the Map Parameters rollout, click the appropriate mapping type button (Planar, Box, etc.) and then adjust the gizmo using any combination of the transform tools (Move, Rotate, Scale) in the viewports and the Align buttons (Align X, etc.) on the Map Parameters rollout.

---

**TIP** You can often save time by starting with the Best Align command and then adjusting manually from there.

---

After each adjustment of the mapping gizmo, the texture display in the viewports updates to reflect the mapping changes, as do the green seam lines on the object that show where the open edges lie (depending on the object shape and mapping type; the seam lines don't change with Planar mapping). To cause the viewports to update in real time, turn on Edit UVWs dialog > [Constant Update](#) on page 1799 .

You can also open the editor (Parameters rollout > Edit) to view the changes in the generated texture coordinates as you adjust the gizmo.

- 5 Click the mapping type button again to turn it off and exit mapping for this face selection.
- 6 Continue making and naming selections and applying mapping until the entire mesh is mapped. Use the green seam display lines as a guide. If you don't see them, make sure Parameters rollout > Display Group > Thin Seam Display or Thick Seam Display is active.
- 7 Open the [Edit UVWs dialog](#) on page 1788 (Parameters rollout > Edit). By default, the editor displays a checkered background. To view the map in the material on the object, you need to change a setting.
- 8 At the right end of the editor upper toolbar, click the drop-down list that currently reads CheckerPattern (Checker) and choose the map that's applied to the material.

The map appears as the background.

By default, all the UVW clusters display. To work on one cluster at a time, you need to filter the UVWs.



- 9  On the Edit UVWs dialog > lower toolbar, click Filter Selected Faces. At this point, only faces you select in the viewport will appear in the editor. You can select them directly, or choose a named selection set. In the next step, you'll use the latter method.
- 10 On the main toolbar, open the Named Selection Sets drop-down list, and choose one of your named selection sets. The viewports show the selection as active, and the UVW coordinates for the selection appear in Edit UVWs window.

- 11  In the Edit UVWs window, select and move a UVW face. In the viewports, the texture slides around the selected portion of the object mesh.
- 12 Choose a different selection set and edit its UVW coordinates. Again, the viewport display reflects the editing changes.
- 13 In a viewport, drag to select a group of faces by region. The faces' UVW coordinates display in the Edit UVWs window. This is another way of choosing what you want to work on. As you can see, from within the Unwrap UVW modifier you can assign multiple mapping types to different, named face selections, and then edit the UVW coordinates to fine-tune map placement on the geometry.

### To perform quick planar mapping:

You'll find the Quick Planar Map controls on the Map Parameters rollout of the Unwrap UVW modifier.

- 1 Apply Unwrap UVW to an object.
- 2 Go to the Face sub-object level.
- 3 Select the faces to map. The Quick Map gizmo appears juxtaposed over the face selection, showing the default Averaged Normals mapping.
- 4 If you prefer a different orientation for the mapping, choose X, Y, or Z.
- 5 Click Quick Planar Map to apply the mapping. To map additional faces, proceed from step 3.

## To use Pelt mapping:

[Pelt mapping](#) on page 1785 is useful for mapping organic models such as characters and creatures. This feature gives you a special editor with a virtual stretcher and springs that let you easily “pull” a complex UVW map flat. The result more closely approximates the actual shape of the object than other mapping methods, making it easier to create convincing texture maps.

- 1 Apply Unwrap UVW to the object.
- 2 Make an edge selection that you can later convert to pelt seams. It's not absolutely necessary to do this at this point, but the Edge sub-object level of the modifier gives you handy Ring and Loop tools as well as buttons to expand and shrink the edge selection automatically.

---

**TIP** Creating the pelt seams is more art than exact science. Visualize the way the mesh should lie flat, and then select edges so the UVs can split in a natural way.

---

- 3 Go to the Face sub-object level of the modifier and select the faces to pelt map. To select all faces, press Ctrl+A. If you're not pelt-mapping the entire mesh, you can skip this step.
- 4 If you made an edge selection in step 2, click Map Parameters rollout > Edge Sel To Pelt Seams. This copies the edge selection to pelt seams. If you didn't specify the pelt seams at the Edge sub-object level of the modifier, turn on Edit Seams or Point To Point Seam and then specify seams in the viewports.

The pelt seams appear on the mesh as blue lines.

- 5 If you're not pelt-mapping the entire mesh, you probably want to map a region enclosed by a pelt seam. Click a face within the region to map and then click Exp. Face Sel to Pelt Seams.

This expands the face selection to the full size of the region defined by the pelt seam.

---

**NOTE** You can pelt map only one such region at a time.

---

- 6 Turn on Pelt, and then adjust the planar map gizmo the way you want. You can do so manually or automatically with one of the Align buttons on the Map Parameters rollout. For a vertical humanoid character facing the Y axis, try using the Align X button. The ideal result in the Edit UVWs dialog (see step 7) is an outline of the object as viewed from the front or back.

---

**TIP** For best results with cylindrical areas such as limbs, align the plane at right angles to the seam of the area to pelt map. For example, if the seam runs down the back side of a leg, orient the plane along a line running from the right side to the left side of the leg.

---

- 7 On the Map Parameters rollout, click Edit Pelt Map.

This opens the Edit UVWs dialog, if necessary, and displays the pelt UVWs and the stretcher in the editor window. By default, the stretcher appears as a circle of points centered on the pelt UVWs, with only the stretcher vertices selected. Also, springs, represented as dashed lines, connect the stretcher points and the pelt-seam vertices.

- 8 If necessary, rotate the Pelt UVs so that the mapping coordinates are oriented correctly, and rotate the stretcher so that the springs form a symmetrical pattern. Typically you're looking for left-right symmetry.

---

**TIP** Using Ctrl+click adds to the existing selection, as in the viewports.

---

- 9 On the Pelt Map Parameters dialog, click Simulate Pelt Pulling.

The springs contract, pulling the pelt seam vertices toward the stretcher points. The internal UV vertices are also affected by this action. You can adjust the extent to which they're affected with the Decay setting.

- 10 Continue adjusting the stretcher points, mapping vertices, dialog settings, etc., and re-running the solution until you get the desired results. If things get out of hand, simply undo, or click Reset Stretcher and start over.

#### **To export texture coordinates to a paint program:**

- 1 Apply the Unwrap UVW modifier to your object and use the modifier tools to set up the mapping. Texture-coordinate clusters that will use the same texture area should overlap.

- 2 From the Edit UVWs dialog menu bar, choose Tools > Render UVW Template.

This opens the Render UVs dialog:

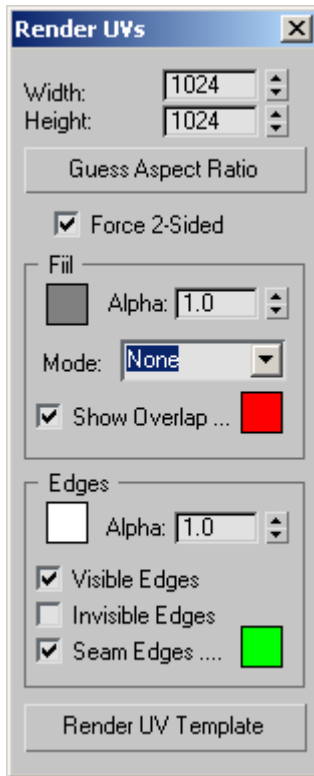

- 3 Set the Width and Height values to the output resolution you want in the rendered template. You'll usually get good results by setting the desired width and then clicking Guess Aspect Ratio.

---

**TIP** When creating texture maps for gaming and other real-time 3D engines, be sure to set both dimensions to powers of 2: 256, 512, 1024, etc.

---

- 4 Change the remaining values as needed. By default, the template is rendered with the edges as white and opaque (alpha=1.0), and background is empty and transparent (background alpha=0.0), but you have a variety of choices here, as detailed in [Render UVs Dialog](#) on page 1835 .
- 5 At the bottom of the dialog, click Render UV Template.  
This opens a new [rendered frame window](#) on page 5885 containing the rendered template as a bitmap. Inspect the output, and if changes are necessary, make them on the Render UVs dialog and re-render.

- 6  When you're satisfied with the results, click Save Bitmap on the rendered frame window toolbar, and then use the file dialog to specify the file type and name. Click Save to export the file.  
If you want to use the rendered transparency information in the paint program, be sure to save in a format that supports the alpha channel, such as TIF or Targa.
- 7 Open the exported image in a paint program and use the rendered edges as a guide for painting the texture map. Save the image when done.  
Be sure to paint over or erase all the edges so they don't appear in the final texture.
- 8 Back in 3ds Max, create a material, set the Diffuse map to Bitmap, and open the file from the previous step.
- 9 Apply the material to your mesh object.  
The painted texture map follows the outlines set up by the exported UVs.

## Interface

After applying the modifier, its panel appears, consisting of the modifier stack plus two rollouts:

### Modifier Stack display

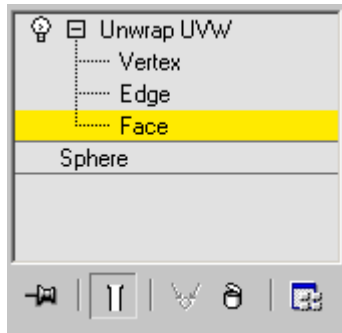

Normally, when you apply Unwrap UVW to an object, the modifier stack provides access to Vertex, Edge, and Face sub-object levels. These are synchronized with the corresponding selection modes on the [Edit UVWs dialog](#) on page 1788 . The Vertex and Edge sub-object levels are useful for making UVW vertex and edge selections in the viewports, where texture mapping on

the object surface is more readily visible, and the Edge level is also useful for setting up edge selections that you can later convert to pelt seams.

If you apply Unwrap UVW to an active face selection of an Editable/Edit Mesh/Poly object, or to an active patch selection of an Editable/Edit Patch object, no sub-object levels are available in the Unwrap UVW modifier. You can use Unwrap UVW to edit only the selection that was active when you applied the modifier. Changing the sub-object selection in the object doesn't affect the Unwrap modifier contents, because the modifier obtains the face selection when you first apply it.

All three sub-object levels are synchronized between the modifier stack and the [Selection Modes group](#) on page 1796 on the Edit UVWs dialog. When you activate a sub-object level in one, it's also activated in the other. Similarly, selecting sub-objects in a viewport selects them in the editor and vice-versa.

### Selection Parameters rollout

Use these settings to make or modify a sub-object selection for use by the modifier. If you've passed a face selection up the stack, for example from the Poly Select modifier, Unwrap UVW uses that instead, and makes these controls unavailable.

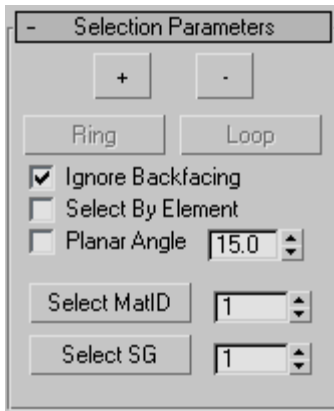

**+ button** Expands the selection by selecting all faces adjacent to selected faces.

**- button** Reduces the selection by deselecting all faces adjacent to non-selected faces.

**Ring** Expands an edge selection by selecting all edges parallel to the selected edges. Ring applies only to edge selections.

**Loop** Expands the selection as far as possible, in alignment with selected edges. Loop applies only to edge selections, and propagates only through junctions of even numbers of edges.

**Ignore Backfacing** When region selecting, prevents the selection of faces not visible in the viewport.

**Select By Element** Lets you select [elements](#) on page 7766 .

**Planar Angle** Lets you select contiguous coplanar faces with one click. Turn this on, and then set the threshold angle value that determines which faces are coplanar. Then click a face to select it and all contiguous faces whose angles are less than the threshold value.

Planar Angle is available only at the Face sub-object level.

**Select MatID** Enables face selection by [material ID](#) on page 7842 . Specify the material ID to select, and then click Select MatID.

Select MatID is available only at the Face sub-object level.

**Select SG** Enables face selection by [smoothing group](#) on page 7932 . Specify the smoothing group to select, and then click Select SG.

Select SG is available only at the Face sub-object level.

## Parameters rollout

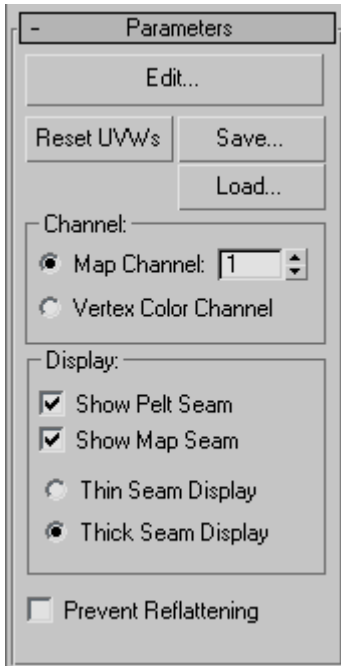

**Edit** Displays the [Edit UVWs dialog](#) on page 1788 .

**Reset UVWs** Resets the UVW coordinates in the Edit UVWs dialog.

Clicking this is almost the same as removing and reapplying the modifier, except that a map assigned in the Edit UVWs dialog is not deleted. For example, if you forgot to turn on the Generate Mapping Coordinates check box for an object, and then applied the Unwrap UVW modifier, the modifier would have no UVW coordinates to use and its settings would be wrong. If you then go back in the Stack and turn on Generate Mapping Coordinates, you'd need to click the Reset UVWs button. When you click this button, an alert warns you that you're losing any edits you've made.

**Save** Saves the UVW coordinates to a UVW (.uvw) file.

**Load** Loads a previously saved UVW file.



## Channel group

This option lets you choose a specific map channel by number, or the vertex color channel. For more information, see [UVW Map modifier > Channel group](#) on page 1868 .

When you change channels, the software copies the current edits to the new channel without alerting you. If you already have edits in that channel from another modifier (Unwrap UVW or other), those edits could be overwritten. To ensure preservation of your edits, save them before changing channels and reload the saved edits as necessary.

## Display group

This setting determines whether and how pelt seams and mapping cluster boundaries, also known as map seams, appear in the viewports:

**Show Pelt Seam** When on, pelt boundaries appear in the viewports as blue lines.

**Show Map Seam** When on, mapping cluster boundaries appear in the viewports as green lines.

The display thickness setting applies to both pelt seams and map seams:

- **Thin Seam Display** Displays map seams and pelt seams on object surfaces in the viewports with relatively thin lines. The line thickness remains constant as you zoom the view in and out. Uses the [Display seams color](#) on page 1847 .
- **Thick Seam Display** Displays map seams and pelt seams on object surfaces in the viewports with relatively thick lines. The line thickness increases when you zoom the view in and decreases when you zoom out. Uses the [Display seams color](#) on page 1847 . This is the default choice.

**Prevent Reflattening** This option is used mainly for texture baking. When turned on, the version of the Unwrap UVW modifier automatically applied by [Render To Texture](#) on page 6169 , named, by default, Automatic Flatten UVs, will not reflaten the faces. Also, make sure that both Render To Texture and the modifier are using the same map channel.

## Map Parameters rollout

You can apply any map type to selected faces, patches, or surfaces, and align the mapping gizmo in any of a variety of ways.

The mapping controls on the upper part of the rollout are available only at the Face sub-object level. Also, the Quick Map controls are available only when no mapping mode button (Planar, Pelt, etc.) is active. However, the [Pelt controls](#) on page 1786 are available at all sub-object levels.

---

**NOTE** When a mapping type button is active, you cannot change the selection without first exiting the mapping operation.

---

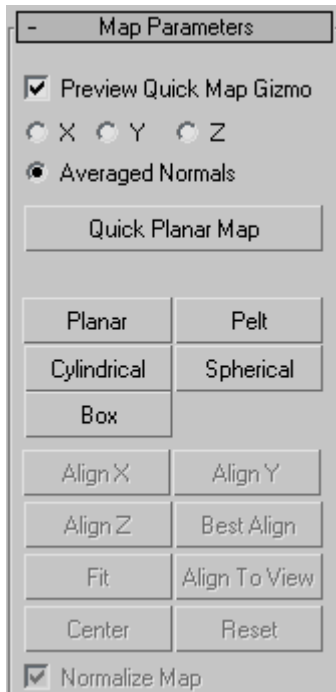

**Preview Quick Map Gizmo** When on, a rectangular planar mapping gizmo, applicable to the Quick Planar Map tool only, appears juxtaposed over the face selection in the viewports. This gizmo is not manually adjustable, but you can use the following control to reorient it.

**X/Y/Z/Averaged Normals** Choose the alignment for the quick map gizmo: perpendicular to the object's local X, Y, or Z axis, or based on the faces' average normals.

**Quick Planar Map** Applies planar mapping to the face selection based on the orientation of the Quick Map gizmo.

**Planar** Applies planar mapping to the selected faces.

Make the selection, click Planar, adjust the mapping using the transform tools and Align buttons on the Map Parameters panel, and then click Planar again to exit.

**Pelt** Applies pelt mapping to the selected faces. Clicking this button activates Pelt mode, in which you can adjust the mapping and [edit the pelt map](#) on page 1787 .

---

**NOTE** Pelt mapping always uses a single planar mapping for the entire pelt. If you've applied a different type of mapping, such as Box, and then switch to Pelt, the previous mapping is lost.

---

**Cylindrical** Applies cylindrical mapping to the currently selected faces.

Make the selection, click Cylindrical, adjust the cylinder gizmo using the transform tools and Align buttons on the Map Parameters panel, and then click Cylindrical again to exit.

---

**NOTE** When you apply Cylindrical mapping to a selection, the software maps each face to the side of the cylinder gizmo that most closely matches its orientation. For best results, use Cylindrical mapping with cylinder-shaped objects or object parts.

---

**Spherical** Applies spherical mapping to the currently selected faces.

Make the selection, click Spherical, adjust the sphere gizmo using the transform tools and Align buttons on the Map Parameters panel, and then click Spherical again to exit.

**Box** Applies box mapping to the currently selected faces.

Make the selection, click Box, adjust the box gizmo using the transform tools and Align buttons on the Map Parameters panel, and then click Box again to exit.

---

**NOTE** When you apply Box mapping to a selection, the software maps each face to the side of the box gizmo that most closely matches its orientation. For best results, use Box mapping with box-shaped objects or object parts.

---

**Align X/Y/Z** Aligns the gizmo to the X, Y, or Z axis of the object's local coordinate system.

**Best Align** Adjusts the mapping gizmo's position, orientation, and scale to fit that of the face selection, based on the selection's extents and average normals.

**Fit** Scales the gizmo to the extents of the selection and centers it on the selection. Does not change the orientation.

**Align To View** Reorients the mapping gizmo to face the active viewport and adjusts its size and position as necessary to fit the extents of the selection.

**Center** Moves the mapping gizmo so that its pivot coincides with the center of the selection.

**Reset** Scales the gizmo to fit the selection and aligns it with the object's local space.

**Normalize Map** When on, scales the mapping coordinates to fit into the standard coordinate mapping space: 0 to 1. When off, the mapping coordinates are the same size as the object. The map is always tiled once in the 0-1 coordinate space; the part of the map based on its Offset and Tiling values on

For example, if you take a sphere of 25 units that's planar mapped from the top, and then apply Unwrap UVW and turn off Normalize Map, then when you open the editor, the radius of the sphere's mapping coordinates is 25 units. As a result, the texture map is tiled onto the sphere surface many times. With Normalize Map on, both the sphere and the map fit into the 0-1 coordinate space, so they're the same size.

In general, for best results, leave Normalize Map on. One reason to turn it off would be to turn it off is if you want to map several elements of different proportions with a texture of a specific aspect ratio, such as brick, keeping the texture the same size on each object.

### [Pelt controls]

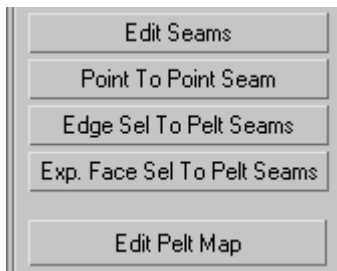

These tools, which give you different ways of specifying pelt seams, are available at all sub-object levels of the modifier.

**Edit Seams** Lets you specify a pelt seam by selecting edges with the mouse in the viewports.

This process is similar but not identical to standard edge selection:

- Click an edge to add it to the current selection.
- Alt+click an edge to remove it from the current selection.
- Drag to select a region.

**Point To Point Seam** Lets you specify pelt seams by selecting vertices with the mouse in the viewports. Pelt seams specified with this tool are always added to the current seam selection.

In this mode, after you click a vertex, a rubber-band line extends from the vertex you clicked to the mouse cursor. Click a different vertex to create a pelt seam, and then continue clicking vertices to create a seam from each vertex to the previous one. To start at a different point in this mode, right-click, and then click a different vertex. To stop drawing seams, click the button again to turn it off.

---

**NOTE** While Point To Point Seam is active, you can pan, rotate, and zoom the viewport at any time using contextual controls (middle-button drag, Alt+middle-button drag, turn mouse wheel, respectively) to access a different part of the mesh surface. After doing so, the software still remembers the last vertex you clicked and draws an accurate seam at the next click. Similarly, you can adjust the viewport using the [viewport control buttons](#) on page 7366 and then return to selecting the seam. If the control requires more than a single click, such as Pan, exiting the control by right-clicking in the viewport restores the rubber-band line, extending from the last vertex you clicked.

---

**TIP** The algorithm Point To Point Seam uses to calculate a path might create a different seam than what you have in mind. If this happens, undo (Ctrl+Z) and specify the desired path by plotting points closer together.

---

**Edge Sel To Pelt Seams** Converts the current edge selection to pelt seams. These seams are added to any existing seams.

**Exp(and) Face Sel to Pelt Seams** Expands the current face selection to meet the pelt seam border(s). If multiple seam outlines contain selected faces, the expansion takes place only for the last-selected face; all others are deselected.

**Edit Pelt Map** Opens the Edit UVWs dialog in a special Pelt mode, with the [Pelt Map Parameters dialog](#) on page 1826 active. This command also initializes the mapping coordinates according to the pelt seams. Available only when [Pelt mapping mode](#) on page 1785 is active.

When the editor is open in Pelt mode you can use the editor and dialog controls to “stretch” out the mapping coordinates, resulting in coordinates that are easier to texture map.

## Edit UVWs Dialog

Select an object. > Modify panel > Modifier List > Object-Space Modifiers > Unwrap UVW > Edit button (on Parameters rollout)

The heart of the Edit UVWs dialog is a window that displays a lattice made up of UVW faces and UVW vertices. Each UVW face, which has three or more vertices, corresponds to a face in the mesh.

The view window displays the UVWs in the 2D-image space of the map, superimposed over a grid. Thicker grid lines show the boundaries of a texture map as it would appear in image space; the lower-left corner of the rectangle has the coordinates (0,0) and the upper-right has the coordinates (1,1). Within this window, you manipulate the UVW coordinates relative to the map (or mesh) by selecting the lattice vertices, edges, or faces (collectively known as *sub-objects*), and transforming them.

The state of the Edit UVWs dialog, including buttons and selected options, is stored and recalled the next time you open the Edit dialog.

---

**NOTE** You can edit patch object texture coordinates as well as mesh coordinates in the Edit UVWs dialog. When editing a patch object, you can also edit the vertex handles. In addition, you can edit the manual interior handles. However, you must enable the manual interior handles *before* applying the Unwrap UVW modifier. To do so, at the Patch sub-object level, select one or more patches, right-click a selected patch, and then, from the quad menu > tools 1 quadrant, choose Manual Interior. The manual interior handles appear in the editor window as isolated vertices.

---

**NOTE** Certain modeling operations can leave unused (isolated) map vertices that show up in the editor window, but cannot be used for mapping. If the model is an Editable Poly or Edit Poly object, you can use the [Remove Unused Map Verts button](#) on page 2063 at the Vertex sub-object level to automatically delete these vertices.

---

**TIP** The editor can display the number of selected sub-objects. This option is available as an [Unwrap UVW shortcut](#) on page 1807 as Show Subobject Counter.

---

## Interface

Besides the window, the editor interface consists of a menu bar, a toolbar, a lower toolbar, and, docked below the main dialog, the [Options panel](#) on page 1795 .

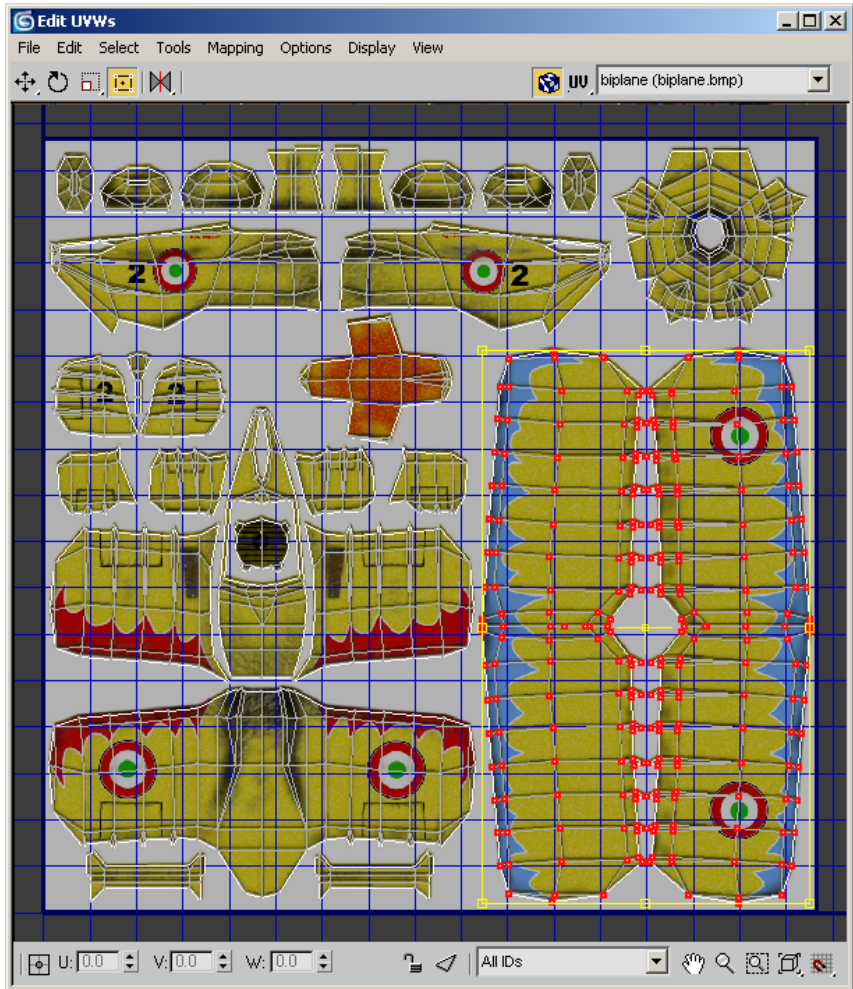

## Menu bar

The menu bar provides access to a wide range of Edit UVWs functions. See [Edit UVWs Dialog Menu Bar](#) on page 1799 .

## Toolbar

Contains all the controls for manipulating the texture sub-objects in the view window, navigating within the window, and setting other options. When transforming with Rotate and Scale, pressing Ctrl+Alt will allow you to transform the selection from the point of the mouse click, instead of the selection center. The initial click specifies the center of the transform.



**Move** Lets you select and move sub-objects. Flyout options are Move, Move Horizontal, and Move Vertical. Press Shift to constrain the movement to a single axis.



**Rotate** Lets you select and rotate sub-objects.



**Scale** Lets you select and scale sub-objects. Flyout options are Scale, Scale Horizontal, and Scale Vertical.

Pressing Shift as you scale constrains the transform to a single axis.



**Freeform Mode** Lets you select and move, rotate, or scale vertices, depending on where you drag. After you make a selection, the Freeform gizmo appears as a rectangular bounding box around the selected vertices. As you move the cursor over the gizmo's various elements and inside the gizmo, the cursor's appearance, and the result of starting to drag in this location, change:



- **Move** Position the cursor anywhere inside the gizmo and then drag to move the selection. To constrain movement to the vertical or horizontal axis, depending on how you begin dragging, press and hold Shift before dragging.



- **Rotate** Position the cursor over a gizmo edge center point, and then drag to rotate the selection about the pivot. As you drag, the amount of rotation is shown in the center of the gizmo. Ctrl+drag to rotate in five-degree increments; Alt+drag to rotate in one-degree increments. Freeform rotation respects the [angle snap](#) on page 2570 status.





- **Scale** Position the cursor over a gizmo corner and then drag to scale the selection. By default, scaling is non-uniform; if you press and hold Ctrl before dragging, scaling is uniform on the horizontal and vertical axes. Press and hold Shift before dragging to constrain scaling to the vertical or horizontal axis, depending on how you begin dragging. By default, scaling takes place about the gizmo center. If you've moved the pivot (see following item), you can scale about the transform center instead by pressing and holding Alt before dragging.



- **Move pivot** Position the cursor over the pivot, a wireframe cross that appears by default at the center of the gizmo. When this cursor appears, drag to move the pivot. Rotation always occurs about the pivot; scaling takes place about the pivot if you press and hold Alt before dragging.

---

**TIP** By default, the pivot always resets to the center of the gizmo when you make a new selection. If you prefer to retain the offset from selection to selection, you can toggle this feature with the Reset Pivot On Selection command. This command is not available in the editor interface by default; you must use the [Customize User Interface dialog](#) on page 7489 to add it.

---

If you Ctrl+select one or more vertices outside the gizmo, the gizmo expands to encompass the entire selection.



- **Mirror** Mirrors selected vertices and flips UVs. Flyout options are Mirror Vertical, Mirror Horizontal, Flip Horizontal, and Flip Vertical.

Flip first detaches the selection along its boundary edges and then applies a Mirror Horizontal or Vertical depending on the mode.

Turn on Target Weld, and then drag one vertex to another vertex, or one edge to another edge. As you drag, the cursor changes in appearance to cross hairs when it's over a valid sub-object. While this command is active, you can continue welding sub-objects, and change the sub-object level. To exit Target Weld mode, right-click in the editor window.



- **Show Map** Toggles the display of the map in the editor window.



**UV/VW/UW** By default, the UV portion of the UVW coordinates is displayed in the view window. However, you can switch the display to edit the UWs or the VWs.

**[texture list drop-down]** Contains all the maps of the material assigned to the object.

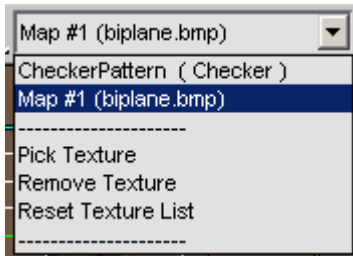

The names of the maps assigned in the Material Editor and in the Edit UVWs dialog (via Pick Texture) appear in the list.

Below the map names are several commands:

- **Pick Texture** Lets you use the Material/Map Browser to add and display textures that are not in the object's material.
- **Remove Texture** Eliminates the currently displayed texture from the editor.
- **Reset Texture List** Returns the texture list to the current state of the applied material, removing any added textures and restoring any removed textures that were part of the original material, if they still exist in the material. This command also adds any new maps in the material, so it essentially updates the UVW editor to the current state of the material.

Choose a map you want to use in the view window. For example, you might use a bump or texture map as a reference to move UVW vertices.

A checker texture named CheckerPattern (Checker), useful for checking for distorted areas of the texture mapping, is built in to the Edit UVWs dialog. By default, this texture appears as the background texture when you first open the editor after applying Unwrap UVW to an object. To cause the pattern to appear on the object in viewports set to display textures, choose it from the drop-down list, even if it's already active in the editor.

## Edit UVWs window

The Edit UVWs window allows you to edit UVW sub-objects to adjust the mapping on a model. For example, a texture map might contain the side, top, and front views of a car. By first planar mapping the top, side, and front faces of the model at the Face sub-object level, you can adjust the texture coordinates for each selection to fit the different parts of texture map to the corresponding areas on the car.

To edit the UVW vertices, first choose a transform tool and sub-object mode, make a selection, and then click and drag in the window to transform the selection.

**Quad menu** Right-click in the window to display the quad menu, which provides access to all the transform tools, as well as a number of editor commands.

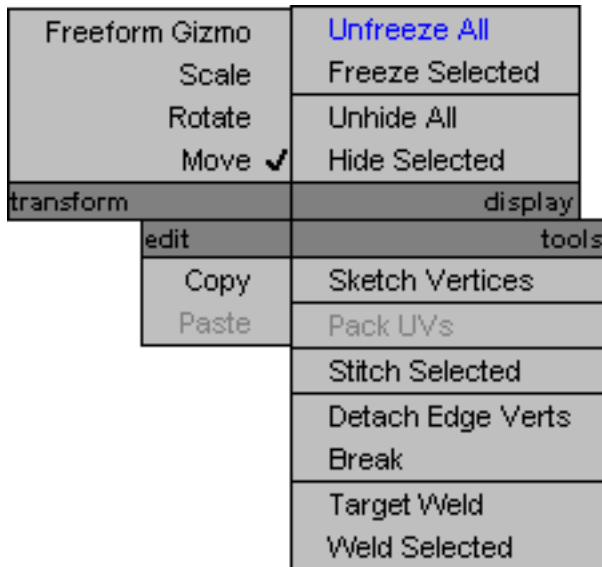

Commands to freeze and hide selected sub-objects and unfreeze/unhide all sub-objects are found only in the quad menu.

## Lower Toolbar



**Absolute/Offset Mode** When this is off, the software treats values you enter into the U, V, and W fields (see following) as absolutes. When

this is on, the software applies transform values you enter as relative to current values; that is, as offsets. Default=off.

**U, V, and W** These fields display the UVW coordinates for the current selection. Use the keyboard or the spinners to edit them.

These fields are active at all sub-object levels, but they always apply to vertices. With a single vertex selected, they display the current coordinates. With multiple vertices (or one or more edges or faces) selected, they display any coordinates the vertices belonging to the selection have in common; otherwise, they're blank.



**Lock Selection** Locks selection. You can move selected sub-objects without touching them.



**Filter Selected Faces** Displays UVW vertices of the object's selected faces in the viewport, and hides the rest.

**All ID's (drop-down)** Filters the object's material IDs. Displays texture faces that match the ID drop-down.



**Pan** Click Pan, and then drag in the window to change the visible portion.

---

**TIP** With a three-button mouse, you can also pan the window by dragging with the middle mouse button held down.

---



**Zoom** Click Zoom, and then click+drag to zoom the window.

---

**TIP** With a wheel mouse, you can also zoom by turning the wheel.

---



**Zoom Region** Click Zoom Region, and then region-select part of the window to zoom in.



**Zoom Extents** Zooms in or out to fit the texture coordinates in the window. The flyout buttons, from top to bottom, let you zoom to all texture

coordinates, to the current selection, and to all clusters/elements containing any selected sub-objects.



**Grid Snap** When on, moving sub-objects tends to snap the vertex closest to the mouse cursor, which is highlighted by a square outline, to the nearest grid line or intersection.

This is the default tool on this flyout; Pixel Snap is also available.

You can set the snap strength in the [Unwrap Options dialog](#) on page 1849 .



**Pixel Snap** Snaps to the nearest pixel corner when you have a bitmap in the background. Available from the Grid Snap flyout.

Combine this with [Center Pixel Snap](#) on page 1799 to snap to the center of pixels rather than the corner.

---

**NOTE** With multiple vertices selected, all vertices snap to the nearest pixel, relatively; this can slightly alter the spatial relationships among them.

---

## Options panel

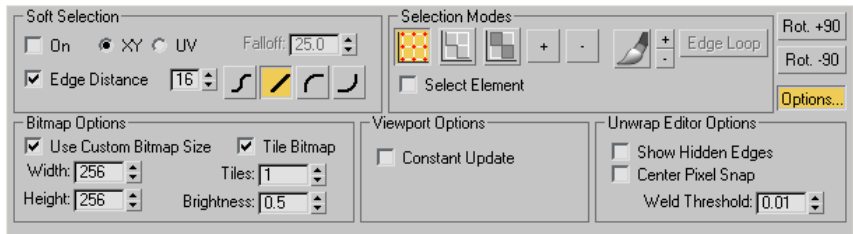

By default, the Options panel, docked to the bottom of the Edit UVWs dialog, provides controls for using soft selection, specifying selection modes, and rotating the selection. The Options button lets you toggle the display of additional settings for bitmaps, viewports, and the editor.

## Soft Selection group

The Soft Selection controls make a sub-object selection behave as if surrounded by a "magnetic field." Unselected sub-objects within the field are drawn along smoothly while you transform the sub-object selection, the effect diminishing with distance. You can adjust this distance, or "falloff," whether it applies to

object space, texture space, or edge space, and the formula by which it diminishes.

First, set a value that encompasses sub-objects to be moved or scaled, and then transform sub-objects with a falloff effect.

**On** Activates or deactivates soft selection.

**XY/UV** Specifies object or texture space for the falloff distance. XY selects object space, UV selects texture space.

**Falloff** Sets the falloff distance. As values increase, unselected vertex colors change gradually from the selected vertex to reflect the area of influence.

**Edge Distance** Turn on to limit the falloff region by the specified number of edges between the selection and the affected vertices. The affected region is measured in terms of "edge-distance" space rather than absolute distance.

**Falloff Type** Transforming with soft selection affects non-selected vertices within the falloff area based on the falloff type.

The icons depict how their buttons affect falloff. The options are:

■  Smooth

■  Linear

■  Slow Out

■  Fast Out

### Selection Modes group

[**sub-object mode**] Specifies the type of sub-object that you can select by clicking or dragging in the window. Default=Vertex.

One of the three sub-object modes can be active at a time:

■  Vertex



---

**NOTE** Selected sub-objects are colored red by default. Also, in Edge and Face sub-object modes, any shared edges are blue by default. A shared edge is one both of whose endpoints are shared by a selected edge or face; thus, it is, in effect, also selected. You can change these colors using [Customize User Interface > Colors panel](#) on page 7505 .

---

The three sub-object levels are synchronized between the [modifier stack](#) on page 1779 of the Unwrap UVW modifier and the Selection Modes group. When you choose a sub-object level in one, it's also activated in the other. Similarly, selecting sub-objects in a viewport selects them in the editor and vice-versa.



**Expand Selection** Adds sub-objects to the selection.

Vertex and face expansion proceeds outwards in all available directions. Edge expansion proceeds along available UV paths. For example, to select a cluster outline, select one outer edge, and then click Expand Selection repeatedly.



**Contract Selection** Shrinks the selection by deselecting the outermost sub-objects.



**Paint Select Mode** Lets you “paint” a sub-object selection by dragging in the editor window. After activating this mode, move the cursor into the editor window, and then drag to select sub-objects. To exit Paint Select mode, right-click or choose a transform tool.

Paint mode selects only sub-objects that are fully inside the selection brush. The dotted circle attached to the mouse shows the size of the brush. Use the +/- buttons next to the paintbrush button to change its size.

+/- Increases and decreases the size of the Paint Select mode “brush”: the circle attached to the mouse cursor.

**Edge Loop** Expands an existing edge selection to select all edges in the loop attached to the selected edges. Select one or more edges, and then click Edge Loop.

Edge Loop uses a “center-path” method to calculate loop selection. To be able to expand a selection, there must be an odd number of edges attached to either end of a selected edge in the editor window. The software then selects the middle connected edge, and then continues selecting as long as it can using each newly selected edge. When it encounters an edge connected to an even number of edges, or to which the middle edge is already selected, it stops.

**Select Element** Selecting a sub-object in a cluster causes the entire cluster to become selected. Works in all sub-object modes.

**Rot(ate) +90** Rotates the selection 90 degrees about its center.

**Rot(ate) -90** Rotates the selection -90 degrees about its center.

### **Bitmap Options group**

Click the Options Button to make this group available.

**Use Custom Bitmap Size** When turned on, scales the bitmap texture to the values specified by Width and Height. You can adjust these settings to scale and reportion the bitmap texture in relation to the texture coordinates. This scaling doesn't affect the bitmap in the material, but only as viewed in the editor.

---

**TIP** When working with large textures, reduce the bitmap size for faster feedback. And when working with disproportionate textures, setting the dimensions closer to each other in the editor can make it easier to work.

---

**Width** Scales the bitmap along the horizontal axis.

**Height** Scales the bitmap along the vertical axis.

**Tile Bitmap** When turned on, you can repeat the bitmap in the editor, displaying tiling set in the material. You can use any part of the tiled image for setting texture coordinates. This is helpful when the sections of the texture image are packed tightly together and the mesh contains many different areas to map.

**Tiles** The number of times the texture image is repeated, counting outward in eight directions (the four corners and the four sides).

With Tiles=1, the result is a 3 x 3 grid. With Tiles=2, the result is a 5 x 5 grid, and so on.

**Brightness** Sets the brightness of the tiled bitmap. At 1.0, the brightness equals that of the original image; at 0.5 it's half the brightness; and at 0, it's black.



---

**TIP** Turning off Affect Center Tile, available in the [Unwrap Options dialog](#) on page 1845 > Display Preferences group, prevents the Brightness setting from affecting the center tile, so it's easier to find if you've turned down the brightness.

---

### **Viewport Options group**

**Constant Update** When on, the viewports update in real-time, reflecting any changes to the texture coordinates as you make them. When off, the viewports update only after you finish transforming texture coordinates (that is, when you release the mouse button).

### **Unwrap Editor Options group**

**Show Hidden Edges** Toggles the display of face edges. When turned off, only faces appear. When turned on, all mesh geometry appears.

**Center Pixel Snap** When [Pixel Snap](#) on page 1795 is turned on, snaps to the center of pixels of the background images instead of pixel edges.

**Weld Threshold** Sets the radius within which welding using Weld Selected takes effect. The setting is in UV-space distance. Default=0.01. Range=0 to 10.

## **Edit UVWs Dialog Menu Bar**

Select an object. > Modify panel > Modifier List > Object-Space Modifiers > Unwrap UVW > Edit button (on Parameters rollout) > Menu bar

The [Edit UVWs dialog](#) on page 1788 menu bar provides access to a number of important editing commands. Some of these commands are replicated on the dialog toolbar and the Unwrap UVW command panel; others, such as the Mapping, Stitch, and Sketch tools, are available only from the menus.

---

**TIP** Several commands are not available in the editor interface by default; you can use the [Customize User Interface dialog](#) on page 7489 to add them.

---

### **Interface**

#### **File menu**

**Load UVs** Loads a previously saved UVW (texture coordinates) file.

**Save UVs** Saves the UVW coordinates to a UVW file.

**Reset All** Restores the UVW coordinates to their original status.

Reset All has almost the same effect as removing and reapplying the modifier, except that a map assigned in the Edit UVWs dialog is not deleted. For example, if you forgot to turn on the Generate Mapping Coordinates check box for an object, and then applied the Unwrap UVW modifier, the modifier would have no UVW coordinates to use and its settings would be wrong. If you then go back in the modifier stack and turn on Generate Mapping Coordinates, you'd need to choose the Reset All command. When you do so, an alert warns you that you're losing any edits you've made.

## **Edit menu**

These commands provide access to the different transform functions, and copy and paste selections.

**Copy** Copies the current selection (i.e., texture coordinates) into the paste buffer.

**Paste** Applies the texture mapping coordinates in the paste buffer to the current selection. Using Paste repeatedly with the same target coordinates causes the coordinates to rotate by 90 degrees each time.

Use Copy and Paste to apply the same mapping coordinates (i.e., image) to a number of different geometry faces. A typical example of usage would be in designing a game level, where you're working with a multi-image texture map, part of which is a door image. You might want to apply the same door image to several different door polygons. First, you would select one of the door polys and position it over the door image. Next, use Copy to place its texture coordinates in the paste buffer. Then select another door poly and choose Paste or Paste Weld. The door's texture coordinates move to the same location as the original poly. Continue selecting other door polys and pasting until all the doors are mapped.

---

**TIP** For best results, use comparable sets of texture coordinates for the source and destination. For example, copy a single four-sided face, and then paste another four-sided face.

---

**Paste Weld** Applies the contents of the paste buffer to the current selection and then welds coincident vertices, effectively fusing the source and destination selections together.

Use this function to end up with a single set of texture coordinates that's applied to multiple geometry elements. Adjusting these texture coordinates changes the mapping for all geometry to which they're applied.

**Move Mode** Lets you select and move sub-objects.

**Rotate Mode** Lets you select and rotate sub-objects.

**Scale Mode** Lets you select and scale sub-objects.

**Freeform Gizmo** Lets you select and transform vertices. See [Freeform Mode](#) on page 1790 .

## Select menu

These commands let you copy a viewport selection to the editor, and transfer selections among the three different sub-object modes.

**Convert Vertex to Edge** Converts the current vertex selection to an edge selection and places you in Edge sub-object mode. For an edge to be selected, both of its vertices must be selected.

**Convert Vertex to Face** Converts the current vertex selection to a face selection and places you in Face sub-object mode. For a face to be selected, all of its vertices must be selected.

**Convert Edge to Vertex** Converts the current edge selection to a vertex selection and places you in Vertex sub-object mode.

**Convert Edge to Face** Converts the current edge selection to a face selection and places you in Face sub-object mode. For a face to be selected, the current edge selection must include all of its vertices. For example, if two opposite edges of a four-sided face are selected, the edge selection includes all four of the face's vertices, so this command will select the face.

**Convert Face to Vertex** Converts the current face selection to a vertex selection and places you in Vertex sub-object mode.

**Convert Face to Edge** Converts the current face selection to an edge selection and places you in Edge sub-object mode.

**Select Inverted Faces** Selects any faces facing away from the current mapping. Available only in [Face selection mode](#) on page 1797 .

This is useful in complex models for finding faces on a surface that folds in under itself, thus causing potential problems with bump mapping.

For example, add a sphere, turn off Generate Mapping Coords, and then apply Unwrap UVW. This causes the modifier to apply planar mapping from the top down, so that all faces on the bottom half of the sphere are “inverted”; that is, they face away from the mapping. In the modifier stack display, highlight the Select Face sub-object level, and then click the Edit button to open the UVW editor. Choose the Face selection mode, and then choose Select > Select Inverted Faces. In the viewports, the bottom half of the sphere turns red to indicate that the inverted faces are now selected.

**Select Overlapped Faces** Selects any faces that overlap other faces. If no face is selected, this selects all overlapping faces. If a face selection exists, this selects only overlapping faces within the selection. Available only in [Face selection mode](#) on page 1797 .

When working with complex meshes, it's common for texture-coordinate faces to overlap one another, with the result that they use the same portion of the texture map. Use this command to find overlapping faces in order to separate them as needed.

## Tools menu

Tools on this menu let you flip and mirror texture coordinates, weld vertices, combine and separate sets of texture coordinates, and sketch outlines for multiple selected vertices.

**Flip Horizontal/Vertical** Detaches the selected sub-objects along their boundary edges and then applies Mirror Horizontal or Vertical, depending on the mode.

**Mirror Horizontal/Vertical** Reverses the direction of selected sub-objects along the indicated axis and flips UVs accordingly.

**Weld Selected** Welds selected sub-objects to a single vertex, based on the Weld Threshold setting. You can set the threshold on the Options panel > Unwrap Editor Options group, as well as on the [Unwrap Options dialog](#) on page 1845 > Misc. Preferences group.

**Target Weld** Welds pairs of vertices or edges. Not available at the Face sub-object level.

Turn on Target Weld, and then drag one vertex to another vertex, or one edge to another edge. As you drag, the cursor changes in appearance to cross hairs when it's over a valid sub-object. While this command is active, you can continue welding sub-objects, and change the sub-object level. To exit Target Weld mode, right-click in the editor window.

**Break** Applies to the current selection; works differently in the three sub-object modes. At the Vertex sub-object level, Break replaces each shared vertex with two vertices. With edges, Break requires at least two contiguous edges to be selected, and separates each edge into two. With faces, Break splits the selection off from the rest of the mesh into a new element, exactly as does Detach Edge Verts.

**Detach Edge Verts** Tries to split off the current selection into a new element. Any invalid vertices or edges are removed from the selection set before the detach.

**Stitch Selected** For the current selection, finds all the texture vertices that are assigned to the same geometric vertex, brings them all to the same spot, and welds them together. With this tool you can automatically connect faces that are contiguous in the object mesh but not in the editor.

To use **Stitch Selected**, first select sub-objects along an edge you want to connect (by default, this causes the shared edges to highlight), and then choose the command. In the [Stitch Tool dialog](#) on page 1841 , adjust the settings, and then click OK to accept or Cancel to abort.

**Pack UVs** Distributes all texture-coordinate clusters through the texture space using one of two methods and spacing you specify. This is useful if you have several overlapping clusters and wish to separate them.

Choosing **Pack UVs** opens the [Pack dialog](#) on page 1825 .

**Sketch Vertices** Lets you draw outlines for vertex selections with the mouse. This is useful for matching coordinate cluster outlines to sections of the texture map *en masse*, without having to move vertices one at a time.

Choosing **Sketch Vertices** opens the [Sketch Tool dialog](#) on page 1839 . **Sketch Vertices** is available only in the Vertex sub-object mode.

**Relax Dialog** Opens the non-modal [Relax Tool dialog](#) on page 1831 , which lets you change the apparent surface tension in a selection of texture vertices by moving vertices closer to, or away from, their neighbors. Relaxing texture vertices can make them more evenly spaced, resulting in easier texture mapping. Available at all sub-object levels.

---

**NOTE** This command, as well as a **Relax** command that lets you apply the default settings to the current selection without opening the dialog, are available as assignable [keyboard shortcuts](#) on page 1807 .

---

**Render UVW Template** Opens the [Render UVs dialog](#) on page 1835 , which lets you export texture mapping data as an image file that you can then import into 2D paint software.

## Mapping menu

Lets you apply one of three different types of automatic, procedural mapping methods to a model. Each method provides settings so you can adjust the mapping to the geometry you're using.

With each method, the mapping is applied to the current face selection; if there is no face selection it is applied to the entire mesh.

Here's a quick overview of the three methods:

- Flatten mapping prevents overlap of mapping clusters, but can still cause texture distortion.
- Normal mapping is the most straightforward method, but can result in even greater texture distortion than with Flatten mapping.
- Unfold mapping eliminates texture distortion, but can result in overlapping coordinate clusters.

---

**TIP** In many cases, one of the automatic mapping functions will provide useful results. But with certain custom or complex objects, you might get the best results with manual mapping; use a variation of the [basic procedure](#) on page ?, or use a procedural method as a starting point for custom mapping.

---

**Flatten Mapping** Applies planar maps to groups of contiguous faces that fall within a specified angle threshold.

Choosing Flatten Mapping opens the [Flatten Mapping dialog](#) on page 1821 .

**Normal Mapping** Applies planar maps based on different vector-projection methods.

Choosing Normal Mapping opens the [Normal Mapping dialog](#) on page 1823 .

**Unfold Mapping** Unfolds the mesh so you get no face distortion, but does not guarantee that faces will not overlap.

Choosing Unfold Mapping opens the [Unfold Mapping dialog](#) on page 1843 .

## Options menu

**Load Defaults** Loads the editor settings from the file *unwrapuvw.ini* in the *plugcfg* directory.

**Save Current Settings as Default** Saves the editor settings to the file *unwrapuvw.ini* in the *plugcfg* directory. Settings saved in this way persist between sessions.

**Always Bring Up The Edit Window** When on, selecting an object with the Unwrap UVW modifier active automatically opens the Edit UVWs dialog. By default, this is off, so you must click the Parameters rollout > Edit button to open the dialog.

**Preferences** Opens the [Unwrap Options dialog](#) on page 1845 .

## Display menu

**Hide Selected** Hides all selected sub-objects and associated faces.

**Unhide All** Reveals any hidden sub-objects.

**Unfreeze All** Unfreezes any frozen sub-objects.

---

**NOTE** You can freeze a sub-object selection with Freeze Selected, available from the right-click menu > Display quadrant.

---

**Filter Selected Faces** When on, the editor displays UVW vertices of the viewport selection at the Face sub-object level of the modifier, and hides the rest.

This is a quick way to work on a limited selection of the texture coordinates of a complex mesh while ignoring the rest. You can turn this on, go to the Face sub-object level of the Unwrap UVW modifier, and select the portion of the object whose texture coordinates you want to edit; only those coordinates appear in the editor, and remain visible even when you change the sub-object level. To work on a different portion, return to the Face level and change the selection in the viewport; the editor window updates to the new selection automatically.

**Show Hidden Edges** Toggles the display of hidden face edges.

**Show Edge Distortion** Uses a green-to-red color range to depict distortion: how far in length texture edges are from their corresponding geometry edges. The greater the disparity in lengths (that is, the greater the distortion), the redder the edge appears in the Edit UVW dialog window. Also draws end segments of edges that are too long as white, showing the difference in length from that of the geometry edge.

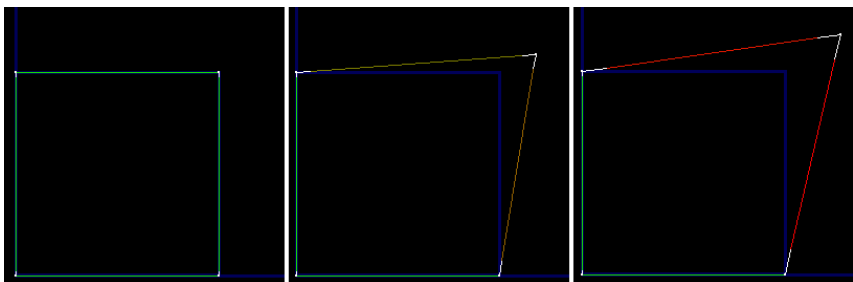

**Left:** Texture edges the same as or very close to geometry edges in length are green.

**Center:** Texture edges slightly different from geometry edges in length are brown.

**Right:** Texture edges very different from geometry edges in length are red.

**When texture edges are longer than geometry edges, white end segments depict length disparity.**

Use this display as a way to view where the areas of greatest distortion are in your texture mesh. If an edge is brown or red but doesn't have white end segments, it's too short. If it's brown or red and has white end segments, it's too long, by the total length of the white segments.

**Show Vertex Connections** In Vertex sub-object mode, toggles the display of numeric labels for all selected vertices. Shared vertices are indicated by the appearance of multiple same-numbered labels.

**Show Shared Sub-objects** When turned on, for the current selection, highlights any shared vertices and/or edges. You can change the highlight color on the [Unwrap Options dialog](#) on page 1845 .

## **View menu**

**Pan** Activates the Pan tool, which lets you move horizontally and vertically in the window by dragging the mouse.

As with the viewports, if you use a three-button mouse, you can also pan by middle-button dragging.

**Zoom** Choose Zoom, and then drag downward in the editor window to zoom out and upward to zoom in. Zooming is centered about the point you click before dragging.

If you have a wheel mouse, you can also turn the wheel to zoom. Zooming is centered about the mouse cursor location.

**Zoom Region** To zoom to a specific area, choose Zoom Region, and then drag a rectangle in the editor window.

**Zoom Extents** Zooms in or out to fit all UVW vertices in the editor window.

**Zoom Extents Selected** Zooms in or out to fit all selected UVW vertices in the editor window.

**Zoom To Gizmo** Zooms the active viewport to the current selection.

**Zoom Extents Selected** Zooms in or out to fit all selected UVW vertices in the window.

**Show Grid** Displays a grid in the background of the editor window. Default=on.

**Show Map** Displays a texture map in the background of the editor window. Set the image via the drop-down list at the right end of the editor toolbar.



**Update Map** Causes the displayed texture map to reflect any changes to the texture, such as tiling settings or a different bitmap.

## Unwrap UVW Shortcuts

To use keyboard shortcuts for the Unwrap UVW modifier, the [Keyboard Shortcut Override Toggle](#) on page 7646 must be on.

**See also:**

- [Unwrap UVW Modifier](#) on page 1769
- [Keyboard Shortcuts](#) on page 7645
- [Keyboard Panel](#) on page 7489
- [Customize User Interface Dialog](#) on page 7489

In general, this table includes only functions that have default keyboard shortcuts and functions with descriptions that are not documented in the Unwrap UVW reference topics.

Unwrap UVW Function	Keyboard Shortcut	Description
Allow Selections Inside Transform Gizmo		Lets you select vertices inside the gizmo by CTRL+clicking or ALT+clicking a vertex. When turned on, you can move only by dragging over empty space.
Always Bring Up The Edit Window		When on, the Edit UVWs dialog automatically opens when you access the Unwrap UVW modifier.
Blend Tiles To Background		Lets you blend the image in the Edit UVWs dialog with the background color. At 0 the image will be hid-

Unwrap UVW Function	Keyboard Shortcut	Description
		den while at 1 it will be at full intensity.
Box Map		
Break Selected Vertices	Ctrl+B	Breaks selected vertices so no face shares them; the same as breaking a vertex in Edit Mesh.
Brightness Affects Center Tile		The brightness control for the tile of image at 0,0 of the Edit UVWs dialog.
Contract Geom. Faces		Shrinks the face selection in the viewport.
Copy		Copies the current face selection texture data into the paste buffer.
Cylindrical Map		
Detach Edge Vertices	D, CTRL+D	Detaches the selected vertices into a separate element.
Display Seams		Highlights edges that are seams in texture space in the Edit UVWs dialog. A seam is an edge that has only one face attached to it.
Edge Sel to Pelt Seam (Add)		Converts the edge selection to pelt seams, adding to the current pelt seams.

<b>Unwrap UVW Function</b>	<b>Keyboard Shortcut</b>	<b>Description</b>
Edge Sel to Pelt Seam (Replace)		Converts the edge selection to pelt seams, replacing the current pelt seams.
Edge Snap		
Edge to Face Select		Converts an edge selection into a face selection.
Edge to Vertex Select		Converts an edge selection into a vertex selection.
Edit UVWs	Ctrl+E	Opens the Edit UVWs dialog.
Expand Geom. Faces		Grows the face selection in the viewport.
Face to Edge Select		Converts a face selection into an edge selection.
Face to Vertex Select		Converts a face selection into a vertex selection.
Filter Selected Faces	Alt+F	When on, only faces that are selected in the viewport will be displayed in the Edit UVWs dialog.
Flatten Map		Lays out the UV space so that no texture faces overlap.
Flatten Map Dialog		Opens the dialog for Flatten Mapping settings.

<b>Unwrap UVW Function</b>	<b>Keyboard Shortcut</b>	<b>Description</b>
Flip Horizontal		Detaches the current selection and then mirrors it in the U direction.
Flip Vertical		Detaches the current selection and then mirrors it in the V direction.
Freeform Mode		Toggles freeform editing tool in the Edit UVWs dialog.
Freeze Selected	Ctrl+F	Locks the current selection so you cannot select it anymore.
Geom. Edge Loop Selection		
Geom. Edge Ring Selection		
Geom. Element Select Mode		Puts you in an element-select mode for selecting faces in the viewport.
Get Face Selection From Stack	Alt+Shift+Ctrl+F	Copies the face selection from the modifier stack into the face selection that Unwrap UVW uses.
Get Selection From Faces	Alt+Shift+Ctrl+P	Transfers the face selection in the viewport to the selection in the Edit UVWs dialog.
Grid Snap		Turns on grid snapping.
Grid Visible		Toggles grid visibility.

Unwrap UVW Function	Keyboard Shortcut	Description
Hide Selected	Ctrl+H	Hides the current selection in the Edit UVWs dialog.
Ignore Back Faces		When on you can select only faces in the viewport that are facing you.
Load Defaults		Loads the UI defaults from an <i>.ini</i> file.
Load UVW	Alt+Shift+Ctrl+L	Lets you load a <i>.uvw</i> file onto a mesh. The mesh must have similar topology as the source.
Lock Selected Vertices	Spacebar	Locks the selection so you cannot add to or remove from it.
Mapping Align Normals		
Mapping Align To View		
Mapping Align X		Aligns the mapping gizmo to the X axis of the object's local coordinate system.
Mapping Align Y		Aligns the mapping gizmo to the Y axis of the object's local coordinate system.
Mapping Align Z		Aligns the mapping gizmo to the Z axis of the object's local coordinate system.
Mapping Center		Moves the mapping gizmo so that its pivot coincides

<b>Unwrap UVW Function</b>	<b>Keyboard Shortcut</b>	<b>Description</b>
		with the center of the selection.
Mapping Fit		Scales the gizmo to the extents of the selection and centers it on the selection. Does not change the orientation.
Mapping Reset		Scales the gizmo to fit the selection and aligns it with the object's local space.
Mirror Horizontal	Alt+Shift+Ctrl+N	Mirrors the current selection along the U axis.
Mirror Vertical	Alt+Shift+Ctrl+M	Mirrors the current selection along the V axis.
Move Horizontal	Alt+Shift+Ctrl+J	
Move Vertical	Alt+Shift+Ctrl+K	
Normal Map		This creates a mapping based on the face normals.
Normal Map Dialog		Opens a dialog for making Normal Mapping settings.
Open Edge Mode		When turned on, selecting an open edge selects all attached open edges.
Open Edge Select		Selects all open edges connected to the current selection.

<b>Unwrap UVW Function</b>	<b>Keyboard Shortcut</b>	<b>Description</b>
Pack		Lays out all selected elements so they don't overlap.
Pack Dialog		Opens the Pack dialog.
Paint Select Decrement Cursor Size		Applies to the Sketch tool.
Paint Select Increment Cursor Size		Applies to the Sketch tool.
Paint Select Mode		Applies to the Sketch tool.
Pan	Ctrl+P	
Paste		Pastes the contents of the paste buffer onto the selection. For best results the source and target should have similar topology.
Paste Instance		The pasted and source UVs will share the same vertices.
Pelt Always Show Seams		Toggles display of the pelt seams in the viewports.
Pelt Dialog		Opens the Pelt Map Parameters dialog
Pelt Dialog Mirror Stretcher		Mirrors the stretcher points from one side of the mirror axis to the other.
Pelt Dialog Relax Simulation Heavy		Causes a relatively strong normalization of the dis-

<b>Unwrap UVW Function</b>	<b>Keyboard Shortcut</b>	<b>Description</b>
		tances between mapping vertices.
Pelt Dialog Relax Simulation Light		Causes a relatively weak normalization of the distances between mapping vertices.
Pelt Dialog Reset Stretcher		Returns the stretcher and the pelt UVs to their default shape and orientation.
Pelt Dialog Run Simulation		Runs the simulation, pulling the pelt seam vertices towards the stretcher points.
Pelt Dialog Select Pelt UVs		Selects all pelt UVs.
Pelt Dialog Select Stretcher		Selects all stretcher UVs.
Pelt Dialog Snap Seams		Aligns all the stretcher points to the edge seams on the pelt UVs.
Pelt Dialog Straighten Stretcher		Lets you specify a polygonal outline for the stretcher by moving points.
Pelt Edit Seams		Lets you specify a pelt seam by selecting edges with the mouse in the viewports.
Pelt Expand Selection To Seams		Expands the current face selection to meet the pelt seam border(s).



<b>Unwrap UVW Function</b>	<b>Keyboard Shortcut</b>	<b>Description</b>
Pelt Map		Activates pelt-mapping mode.
Pelt Seam to Edge Sel (Add)		Converts the pelt seam to an edge selection, adding to the current edge selection.
Pelt Seam to Edge Sel (Replace)		Converts the pelt seam to an edge selection, replacing the current edge selection.
Pivot Snap ... (nine shortcuts)		Snaps the Freeform gizmo pivot to the specified gizmo edge.
Planar Map Faces/Patches	Enter	Applies a planar map to the current selection.
Planar Threshold		Turns on the Modify panel > Planar Angle check box.
Point to Point Edge Selection		Lets you specify pelt seams by selecting vertices with the mouse in the view-ports.
Polygon Mode		Applies only to triangle meshes. When turned on (the default), if you select a triangular face, the software will select all faces that belong to the poly that owns that face.
Polygon Select		Expands the current face selection to the poly.

Unwrap UVW Function	Keyboard Shortcut	Description
Prevent Reflattening		When on, keeps Render To Texture from reflattening the mapping.
Relax		Applies the default Relax Tool settings to the current texture vertex selection.
Relax Dialog		Opens the Relax Tool dialog.
Render UVW Template		Renders the UVW coordinates to a bitmap.
Reset Pivot On Selection		When turned on (the default), the Freeform gizmo pivot is reset to the center every time the selection changes, otherwise the pivot maintains its offset.
Reset UVWs		Sets texture coordinates to the original values before Unwrap was applied.
Save Current Settings As Default		Saves current UI values to the default <i>.ini</i> file.
Save UVW		Lets you save the UVW data to disk as a <i>.uvw</i> file, which can be read in later or onto another mesh if they have similar topology.
Scale Horizontal		Scales the selection along the U axis.

<b>Unwrap UVW Function</b>	<b>Keyboard Shortcut</b>	<b>Description</b>
Scale Vertical		Scales the selection along the V axis.
Select Inverted Faces		Selects any faces in the Edit UVWs dialog that are not facing you.
Select Overlapped Faces		Selects overlapping faces in the Edit UVWs dialog.
Show Edge Distortion		Uses a green-to-red color range to depict distortion.
Show Hidden Edges		Toggles display of all edges.
Show Map		Toggles display of the image map.
Show Seams in Viewport	Alt+E	Toggles display of cluster seams in the viewport. Works only when Edit UVWs dialog has focus.
Show Shared Sub-objects		Shows sub-objects that share edges/vertices.
Show Subobject Counter		Displays the number of selected objects in the editor window.
Show Vertex Connections		Tags all texture vertices that share the same geometry vertex with a unique ID.
Sketch		Activates Sketch Vertices.

<b>Unwrap UVW Function</b>	<b>Keyboard Shortcut</b>	<b>Description</b>
Sketch Dialog		
Sketch Reverse Vertex Order		Reverses the order of the selected vertices for Sketch mode. Applies to the Use Current Selection option for Sketch.
Snap	Ctrl+S	Toggles snapping.
Snap to Grid/Vertex/Edge		Sets the snap type.
Soft Selection Edge Distance		Equivalent to turning on Edge Distance.
Soft Selection Edge Distance Range 1		Set Edge Distance to the specified value.
Soft Selection Edge Distance Range 2		Set Edge Distance to the specified value.
Soft Selection Edge Distance Range 3		Set Edge Distance to the specified value.
Soft Selection Edge Distance Range 4		Set Edge Distance to the specified value.
Soft Selection Edge Distance Range 5		Set Edge Distance to the specified value.
Soft Selection Edge Distance Range 6		Set Edge Distance to the specified value.
Soft Selection Edge Distance Range 7		Set Edge Distance to the specified value.

<b>Unwrap UVW Function</b>	<b>Keyboard Shortcut</b>	<b>Description</b>
Soft Selection Edge Distance Range 8		Set Edge Distance to the specified value.
Spherical Map		Applies spherical mapping.
Stitch		Stitches together shared edges of a polygon.
Stitch Dialog		Opens the properties for the Stitch command.
Sync Selection Mode		Same as Sync to Viewport
Sync Texture Selection to Viewport		Synchronizes the selection in the Edit UVWs dialog to the selection in the viewport.
Sync Viewport Selection to Texture		Synchronizes the selection in the viewport to the selection in the Edit UVWs dialog.
Texture Vertex Contract Selection	- (minus sign), - (on numeric keypad)	Shrinks the selection in the Edit UVWs dialog.
Texture Vertex Expand Selection	= (equal sign), + (on numeric keypad)	Grows the selection in the Edit UVWs dialog.
Texture Vertex Move Mode	Q	Lets you move vertices in editor.
Texture Vertex Rotate Mode	Ctrl+R	Lets you rotate vertices in editor.
Texture Vertex Scale Mode		Lets you scale vertices in editor.

<b>Unwrap UVW Function</b>	<b>Keyboard Shortcut</b>	<b>Description</b>
Texture Vertex Weld Selected	Ctrl+W	Welds selected vertices in editor.
Texture Vertex Target Weld	Ctrl+T	Lets you target-weld selected vertices in editor.
TV Edge Sub-object Mode		TV=Texture Vertex
TV Element Mode		TV=Texture Vertex
TV Face Sub-object Mode		TV=Texture Vertex
TV Vertex Sub-object Mode		TV=Texture Vertex
Unfold Map		
Unfold Map Dialog		
Unfreeze All		Unfreezes all frozen elements.
Unhide All		Unhides all hidden elements.
Unwrap Options	Ctrl+O (letter "o")	
Update Map	Ctrl+U	Updates map in editor.
UV Edge Mode		When on, selecting an edge expands the selection to include all edges in its <a href="#">loop</a> on page 1797 .
UV Edge Select		Expands an existing edge selection to include all

Unwrap UVW Function	Keyboard Shortcut	Description
		edges in its <a href="#">loop</a> on page 1797 .
Vertex Snap		
Vertex To Edge Select		Converts vertex selection to an edge selection and puts you in Edge mode.
Vertex To Face Select		Converts vertex selection to a face selection and puts you in Face mode.
Zoom	Z	
Zoom Extents	X	
Zoom Extents Selected	Alt+Ctrl+Z	
Zoom Region	Ctrl+X	
Zoom Selected Element		
Zoom to Gizmo	Shift+Spacebar	

## UVW Editor Dialogs

### Flatten Mapping Dialog

Select an object. > Modify panel > Modifier List > Object-Space Modifiers > Unwrap UVW > Edit button (on Parameters rollout) > Mapping menu > Flatten Mapping

The Flatten Mapping method of procedural mapping applies planar maps to groups of contiguous faces that fall within a specified angle threshold. It

prevents overlap of mapping clusters, but can still cause texture distortion. The Flatten Mapping dialog lets you control how clusters are defined and mapped.

**See also:**

- [Normal Mapping Dialog](#) on page 1823
- [Unfold Mapping Dialog](#) on page 1843

## Interface

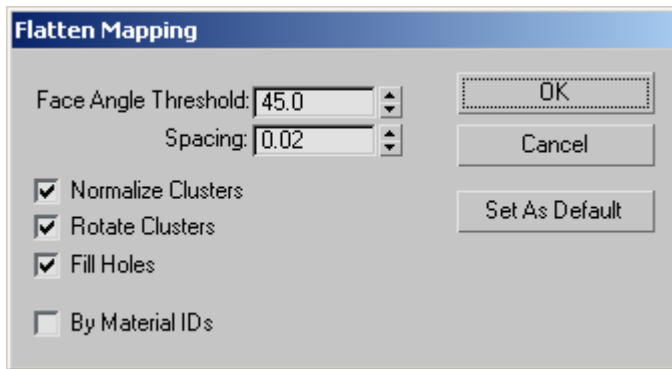

**Face Angle Threshold** The angle used to determine the clusters to be mapped. As the Flatten Map gathers faces to be mapped, it uses this parameter to determine which faces get put in a cluster. This is the maximum angle that can exist between faces in a cluster.

The higher this number, the larger the clusters will be, with consequently greater distortion introduced as a result of texture faces' proportions deviating from their geometry-equivalent faces.

**Spacing** Controls the amount of space between clusters.

The higher this setting, the larger the gap that appears between clusters.

**Normalize Clusters** Controls whether the final layout will be scaled down to 1.0 unit to fit within the standard editor mapping area. If this is turned off, the final size of the clusters will be in object space, and they'll probably be much larger than the editor mapping area. For best results, leave this turned on.



**Rotate Clusters** Controls whether clusters are rotated to minimize the size of their bounding box. For instance, the bounding box of a rectangle rotated 45 degrees occupies more area than one rotated 90 degrees.

**Fill Holes** When turned on, smaller clusters will be placed in empty spaces within larger clusters to take the most advantage of the available mapping space.

**By Material IDs** When on, ensures that no cluster contains more than one material ID after flattening.

**OK** Accepts the settings, closes the dialog, and performs the mapping as specified.

**Cancel** Undoes any changes and closes the dialog.

**Set As Default** Makes the current settings the defaults for the current session.

## Normal Mapping Dialog

Select an object. > Modify panel > Modifier List > Object-Space Modifiers > Unwrap UVW > Edit button (on Parameters rollout) > Mapping menu > Normal Mapping

The Normal Mapping method of procedural mapping applies planar maps based on different vector-projection methods. It is the most straightforward method, but can result in even greater texture distortion than with [Flatten mapping](#) on page 1821 . The Normal Mapping dialog lets you control how clusters are defined and mapped.

**See also:**

- [Flatten Mapping Dialog](#) on page 1821
- [Unfold Mapping Dialog](#) on page 1843

## Interface

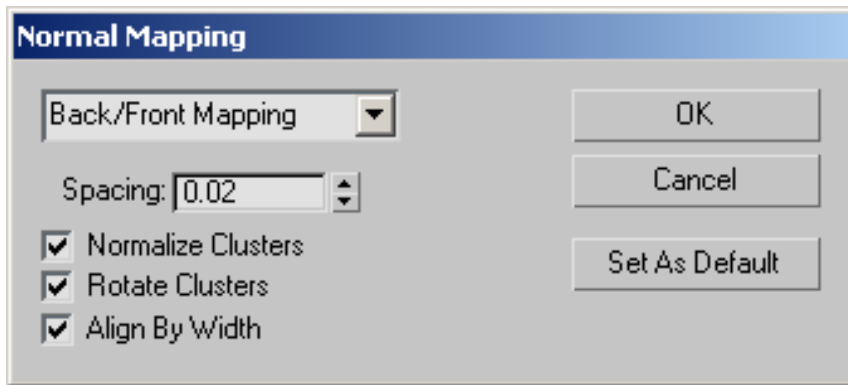

**(drop-down)** Sets the mapping method:

- Back/Front
- Left/Right
- Top/Bottom
- Box No Top
- Box
- Diamond

**Spacing** Controls the amount of space between clusters.

The higher this setting, the larger the gap that appears between clusters.

**Normalize Clusters** Controls whether the final layout will be scaled down to 1.0 unit to fit within the standard editor mapping area. If this is turned off, the final size of the clusters will be in object space, and they'll probably be much larger than the editor mapping area. For best results, leave this turned on.

**Rotate Clusters** Controls whether clusters are rotated to minimize the size of their bounding box. For instance, the bounding box of a rectangle rotated 45 degrees occupies more area than one rotated 90 degrees.

**Align By Width** Controls whether the width or the height of the clusters is used to control the layout of the clusters.

**OK** Accepts the settings, closes the dialog, and performs the mapping as specified.

**Cancel** Undoes any changes and closes the dialog.

**Set As Default** Makes the current settings the defaults for the current session.

## Pack UVs Dialog

Select an object. > Modify panel > Modifier List > Object-Space Modifiers > Unwrap UVW > Edit button (on Parameters rollout) > Tools menu > Pack UVs

The Pack UVs dialog contains controls for clusters.

### Interface

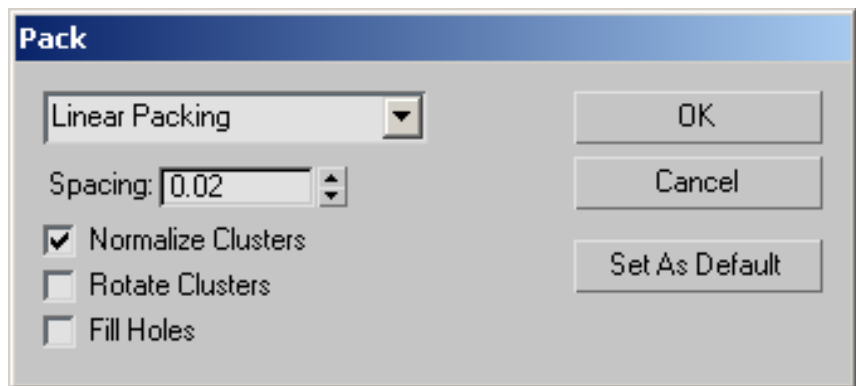

**(drop-down)** Sets the packing method:

- **Linear Packing** Uses a linear method to lay out the faces. This method is fast but not very efficient, and tends to leave a lot of unused UV space.
- **Recursive Packing** Slower than the Linear method, but packs the faces more efficiently.

**Spacing** Controls the amount of space between clusters.

The higher this setting, the larger the gap that appears between clusters.

**Normalize Clusters** Controls whether the final layout will be scaled down to 1.0 unit to fit within the standard editor mapping area. If this is turned off, the final size of the clusters will be in object space, and they'll probably be much larger than the editor mapping area. For best results, leave this turned on.

**Rotate Clusters** Controls whether clusters are rotated to minimize the size of their bounding box. For instance, the bounding box of a rectangle rotated 45 degrees occupies more area than one rotated 90 degrees.

**Fill Holes** When turned on, smaller clusters will be placed in empty spaces within larger clusters to take the most advantage of the available mapping space.

**OK** Accepts the settings, closes the dialog, and performs the packing as specified.

**Cancel** Undoes any changes and closes the dialog.

**Set As Default** Makes the current settings the defaults for the current session.

## Pelt Map Parameters Dialog

Unwrap UVW Modifier > Face sub-object level > Map Parameters rollout > Pelt > Edit Pelt Map

The primary function of the Pelt Map Parameters dialog is to let you stretch out the UVW coordinates into a flat, unified map that you can then use for texturing. When the dialog is open, the *stretcher* appears in the Edit UVWs dialog window as a circle of points, each of which is attached to a vertex on a pelt seam. You can manipulate these vertices exactly as any other vertex in the editor, selecting, rotating, moving, etc. Other special functions available on the dialog let you straighten out stretcher vertices, snap them to the pelt seams, and so on.

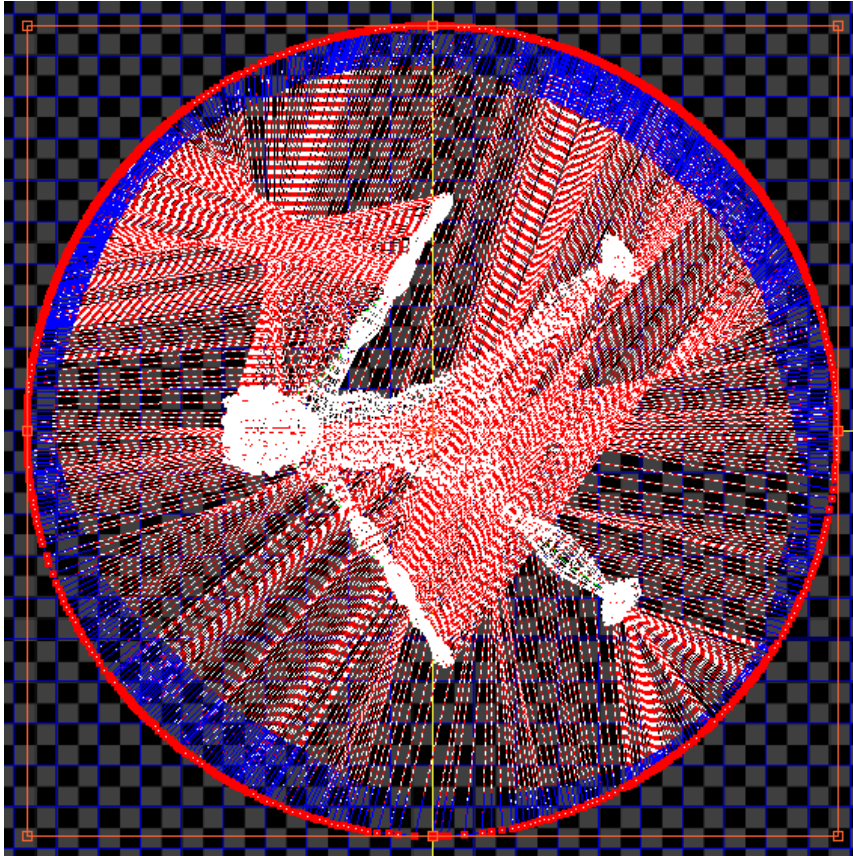

The stretcher points surround the pelt UVs in the Edit UVWs dialog window.

The lines connecting the stretcher vertices to the pelt-seam vertices function as springs that pull the pelt seams outward in an animated simulation. After you set up the pelt UVs and the stretcher shape, you run the simulation by clicking the Simulate Pelt Pulling button. Depending on the results, further adjustment and simulation might be required.

While Pelt mode is active and the Edit UVWs dialog is open, most standard UVWs editing functions are also available. So, for example, instead of stretching the entire pelt, you could select a subset of UVs to stretch. To access any commands that are unavailable in Pelt mode, such as Mapping menu commands, simply close the Pelt Map Parameters dialog.

## Interface

The primary Pelt Map commands are activated via the buttons in the Simulation group. Other functions on this dialog let you adjust various stretching parameters.

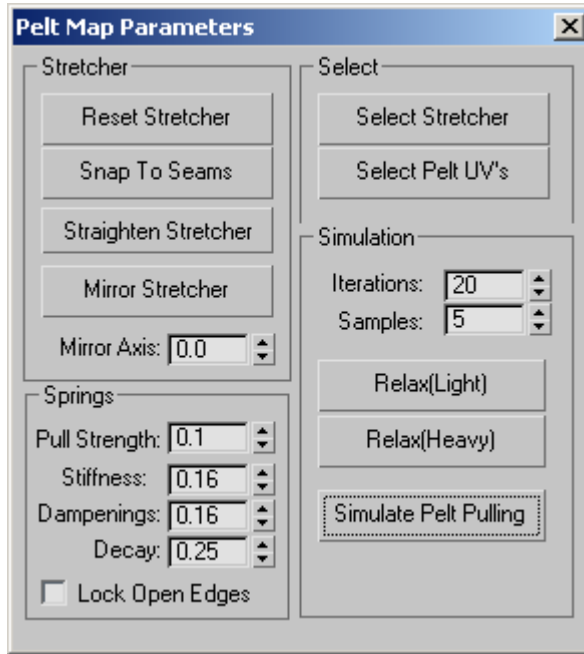

### Stretcher group

These tools help adjust the stretcher shape.

**Reset Stretcher** Returns the stretcher and the pelt UVs to their default shape and orientation, losing any stretching or editing of the stretcher or mapping coordinates.

**Snap To Seams** Aligns all the stretcher points to the edge seams on the pelt UVs. This causes the stretcher to take on the pelt outline.

For best results, use this command only after stretching.

**Straighten Stretcher** Lets you specify a polygonal outline for the stretcher by moving points. When this mode is active, move one stretcher vertex, and then move a second, non-adjacent point to line up all intervening vertices in a straight line between the two. This process is fully interactive; as you move

the second vertex, the intervening vertices continually change position to maintain the straight line. Continue moving vertices to create a polygonal outline; to quit, click Straighten Stretcher again.

---

**NOTE** While Straighten Stretcher is active, you can pan and zoom the editor window at any time using contextual controls (middle-button drag or turn mouse wheel, respectively) to access a different part of the window. After doing so, the software still remembers the last vertex you dragged and draws a straight line between it and the next one you drag. Similarly, you can adjust the window using the [control buttons](#) on page 1794 and then return to straightening the stretcher. If the control requires more than a single click, such as Pan, exit the control by right-clicking in the window and then return to straightening the stretcher.

---

**TIP** To create a symmetrical outline for the stretcher, create the outline on one side and then use Mirror Stretcher (following).

---

**Mirror Stretcher** Mirrors the stretcher points from one side of the mirror axis (see following) to the other. By default, Mirror Stretcher mirrors the points from the right side to the left.

**Mirror Axis** Lets you specify the orientation of the mirror axis. The axis takes the form of three yellow lines forming a T. The leg of the T indicates the side that will be mirrored when you use Mirror Stretcher (see preceding), and the crossbar indicates the axis across which the mirroring will occur. Default=0.0. Range=0.0 to 360.0.

## Select group

These commands let you select all the stretcher points or the pelt UVs. As with other selection methods, you can press and hold Ctrl when you use either of these to add to the current selection. That is, to select all stretcher points and pelt UVs, click one button, press and hold Ctrl, and then click the other button.

**Select Stretcher** Selects all stretcher points.

**Select Pelt UVs** Selects all pelt UVs.

## Springs group

These parameters control the springs that are used to stretch the pelt. In most cases you won't need to change these values, except possibly for Pull Strength.

**Pull Strength** The magnitude of the stretching action when you click Simulate Pelt Pulling. Default=0.1. Range=0.0 to 0.5.

If the stretching is too gradual, increase Pull Strength for a more forceful stretching action.

**Stiffness** Sets the rate at which the springs pull. The higher the Stiffness value, the more abrupt the pulling action. Default=0.16. Range=0.0 to 0.5.

**Dampening** Applies a dampening or inhibiting factor to the pulling action. The higher the Dampening value, the greater the inhibition of the stretcher. Default=0.16. Range=0.0 to 0.5.

**Decay** The rate of falloff of the influence of each pelt-seam vertex on the other mapping vertices. Higher Decay values typically result in significantly greater stretching, or undesirable results. For best results, keep the Decay value low. Default=0.25. Range=0.0 to 0.5.

**Lock Open Edges** Locks the open edges in place. This typically applies to using the stretcher on a partial selection of mapping vertices in the pelt region. When Lock Open Edges is on, selected vertices next to unselected vertices tend to stay in place during stretching. When Lock Open Edges is off, the selected vertices tend to pull away from the unselected vertices.

### **Simulation group**

These are the main controls for the simulation, in which the springs attached to the stretcher pull the pelt seam vertices out, flattening the UVs. For best results, alternate between running the simulation (click Simulate Pelt Pulling) and relaxing the mesh.

**Iterations** The number of times the simulation will run through when you click Simulate Pelt Pullings. Default=20. Range=1 to 100.

Often, you'll need to run repeated simulations to get the desired result.

**Samples** The number of samples around each pelt-seam point used in the simulation. A higher value results in a greater pulling effect. Default=5. Range=1 to 50.

**Relax (Light)** Causes a relatively weak normalization of the distances between mapping vertices.

**Relax (Heavy)** Causes a relatively strong normalization of the distances between mapping vertices.

**Simulate Pelt Pulling** Runs the simulation, pulling the pelt seam vertices towards the stretcher points. To abort the simulation process, press Esc.



## Relax Tool Dialog

Select an object. > Modify panel > Modifier List > Object-Space Modifiers > Unwrap UVW > Edit button (on Parameters rollout) > Edit UVWs dialog > Make a selection. > Tools menu > Relax Dialog

The Relax Tool dialog offers an advanced toolset for modifying the spacing of selected texture coordinates parametrically, for the purpose of eliminating or minimizing distortion in texture maps. The dialog provides three different methods for relaxing vertices, plus several numeric parameters and two check boxes. You can use Relax to separate texture vertices that are too close together to texture easily, and to resolve overlapping areas.

The dialog is non-modal, which means that you can work directly in the editor while keeping the dialog open. You can make a selection of texture vertices, apply relaxation, make a different selection, apply relaxation, and so on, without having to close the Relax Tool dialog.

---

**TIP** When using Relax with complex objects, you might find that vertices in interior sections of the texture mesh don't relax properly because they have nowhere to go. In such cases, try making a seam: Select an edge loop or part of a loop, and then use the [Break](#) on page 1802 function to separate the mesh at the seam. Alternatively, you could make a face selection and then use Detach Edge Verts. For example, Select Overlapped Faces > Expand Selection > Detach Edge Verts will break the selection away from the mesh into a new UV element.

---



**TIP** Effective use of the Relax tools requires that the geometry and texture vertices be in the same order. If you get unexpected results using Relax, try mirroring the texture vertices to reverse their order.

---

### Procedures

#### To relax texture coordinates:

- 1 Use the Edit UVWs dialog to select the texture-coordinate vertices to relax.  
You can make this selection at any sub-object level (Vertex, Edge, or Face), but Relax always works on vertices.
- 2 On the Tools menu, choose Relax Dialog.

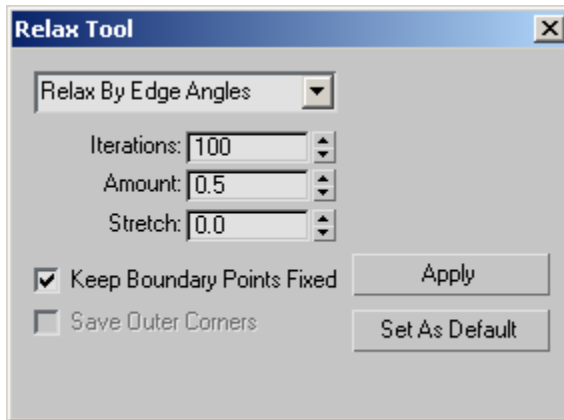

This opens the Relax Tool dialog.

- 3 Choose the relax method. Three are available from the drop-down list:
  - Relax By Face Angles
  - Relax By Edge Angles
  - Relax By Centers

The default method is Relax By Edge Angles; this most often gives the best results.

- 4 Set the other options and then click Apply.

As the relaxing progresses, a message appears showing you which frame is being processed. A frame is equivalent to an iteration.

The appropriate method and other settings to use depend on a variety of conditions, including the complexity and topology of the mesh, so experimentation is usually required. Relaxing is undoable, so if one method doesn't work, undo and try another.

#### To use Relax to fix overlapping faces:

This procedure provides general guidelines for resolving overlapping texture faces. It might not work in every case, but it should give you a starting point for correcting most situations.



- 1 Open the Edit UVWs dialog and in the Selection Modes group, click Face Sub-object Mode.

- 2 From the Edit UVWs dialog > Select menu, choose Select Overlapping Faces.

Only the overlapping faces are selected.



- 3 Click Expand Selection to select faces surrounding the overlapping faces.

This gives the overlapping faces a larger area in which to spread out.

- 4 From the Tools menu, choose Relax Dialog.
- 5 On the Relax Tool dialog, set Stretch to an intermediate value. If the overlapping is considerable, use **0.5** or higher. If it's relatively small, try **0.1** to **0.3**.
- 6 Click Apply.

If this seems to be helping, continue clicking Apply until the overlapping is resolved. If not, undo (Ctrl+Z) and try using Relax By Face Angles instead, or increase the Amount value, or change the Stretch value, or use combinations of the above.

## Interface

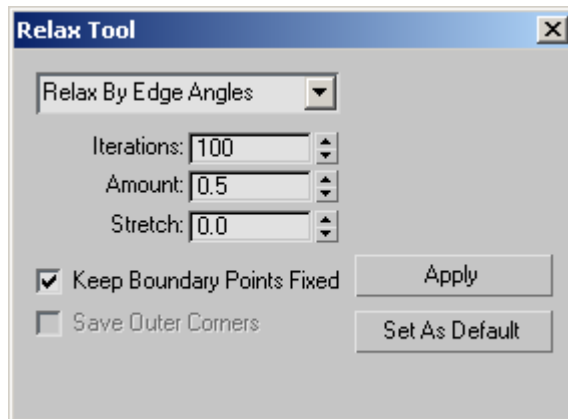

**[relax method]** The method used to relax the texture vertices. Choose from the drop-down list:

- **Relax By Face Angles** Relaxes the vertices based on the shape of the faces. It tries to align the geometric shape of the face to the UV face. This

algorithm is mainly used to remove distortion and not so much to remove overlap, and is best suited for simpler shapes.

- **Relax By Edge Angles** This default method is similar to Relax By Face Angles except that it uses the edges that are attached to the vertices as the shape to match. It typically works better than Relax By Face Angles but tends to take longer to reach a solution. This method is best suited for more complex shapes.
- **Relax By Centers** The original Relax method from previous versions of 3ds Max. It relaxes vertices based off the centroids (centers of mass) of their faces. It does not take into account the face or edge shapes/angles so it is mainly useful for removing overlap or for faces that are mostly rectangular.

**Iterations** The number of times the Relax settings are applied when you click Apply. Each iteration is applied successively, to the results of the previous iteration. Range=0 to 100000. Default=100.

**Amount** The strength of the relaxation applied per iteration. Range=0.0 to 1.0. Default=0.1.

**Stretch** The amount of stretching that can occur. Stretching is useful mainly to resolve overlapping texture vertices, at the cost of reintroducing distortion into the texture mesh. Range=0.0 to 1.0. Default=0.0.

**Keep Boundary Points Fixed** Controls whether vertices at the outer edges of the texture coordinates are moved. Default=off.

When off, the outer edge of the texture mesh can float, allowing a wider range of the available texture-mapping space to be used. Typically you would keep this off when relaxing an entire element or cluster, so the software can minimize distortion by moving the edges.

When relaxing an interior subset of vertices, it is recommended you turn this on to prevent the selected vertices from overlapping unselected vertices. For Relax By Edge and Face Angles, turn this off until you get a good solution for the outer boundaries of the mesh and then turn it on to resolve the interior sections.

**Save Outer Corners** Preserves the original positions of texture vertices farthest away from the center. Available only with the Relax By Centers method.

**Apply** Begins the relaxation process using the current settings. As relaxation takes place, a textual progress indicator appears at the bottom of the dialog, showing the current iteration (Process frame) and the total number of iterations being processed.

To abort the relaxation process, press Esc. You can then use Undo (Ctrl+Z) to return to the prior state, if necessary.

**Set As Default** Saves all current settings as the Relax defaults, so they are recalled from session to session.

## Render UVs Dialog

Unwrap UVW modifier > Edit button (on Parameters rollout) > Tools menu > Render UVW Template

The Render UVs dialog, part of the [Unwrap UVW editor](#) on page 1788 , lets you export a model's texture mapping data as a template; a bitmapped image file. you can then import this template into a 2D paint program, apply color as needed, and then bring it back into 3ds Max as a texture map to apply to the model. The exported file looks like a screen shot of the editor window, but without any background texture, and has the added options of setting color and alpha options for both the edges and the area they cover.

For a procedure that covers usage of this dialog, see [To export texture coordinates to a paint program](#): on page 1777 .

## Interface

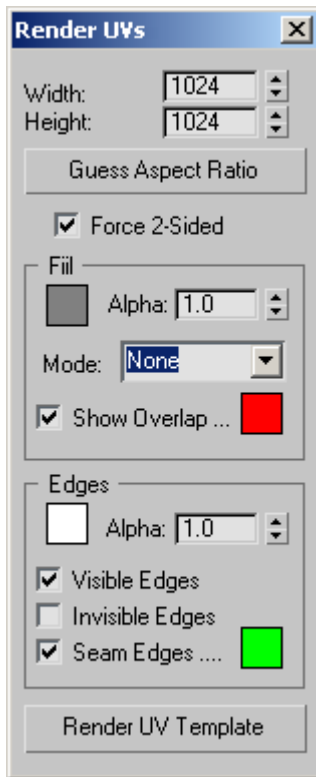

**Width/Height** The horizontal and vertical dimensions of the output (rendered) template image in pixels.

**Guess Aspect Ratio** Adjusts the Height value to produce an output aspect ratio based on the Width value and the dimensions of the UV grid.

For instance, if a rectangular UV grid measures 20 x 100 units and you click Guess Aspect Ratio, it would try to keep the bitmap at the 1:5 aspect ratio. This makes painting on the bitmap easier because the bitmap is at the correct aspect ratio for the mesh.

---

**WARNING** Using this function can result in Height value that is not a power of 2. If your mesh is destined for a real-time renderer, adjust the resulting Height value to the nearest power of 2 after using Guess Aspect Ratio. For example, if it sets Height to 650, change it to 512 before rendering the template.

---

**Force 2-Sided** When on, all UV edges are rendered into the template. When off, only UV edges of faces facing the viewer are included; edges of back-facing faces are not rendered.

### Fill group

Fill is the coloring applied to the rendered bitmap in the face areas between edges. By default, there's no fill; the bitmap color is black, and the alpha channel is fully transparent. You can change this to a solid color or to shading derived from the mesh and lighting in the scene, or from the normal directions.

---

**NOTE** The overlap color overrides the fill color. For example, if Show Overlap is on and all visible faces overlap other faces, all faces will show the overlap color, ignoring the fill color.

---

**[color swatch]** Shows the fill color used for faces when Mode is set to Solid. To change the color, click the swatch.

**Alpha** Sets the alpha-channel value for the fill areas when Mode=Solid, Normal, or Shaded. When Mode=None, the fill alpha is always 0.0 (transparent). Range=0.0 (transparent) to 1.0 (opaque). Default=1.0.

The alpha channel is included with the rendered image only when you save in a format that supports transparency, such as TIF or Targa.

**Mode** Specifies the method used for filling faces in the rendered template.

- **None:** No fill is rendered. This setting ignores the Alpha value, and sets fill alpha to 0.0; that is, fully transparent.
- **Solid:** Renders faces using the fill color specified by the swatch at the top of the Fill group.
- **Normal:** Renders each vertex's normals into the bitmap. The result looks similar to a normal map.
- **Shaded:** Uses a simple lighting setup to render shading across the UV surface.

**Show Overlap** When on, fills faces that overlap other faces with the overlap color, shown in the color swatch to the right. Default=on.

To change the overlap color, click the color swatch.

## Edges group

**[color swatch]** Shows the color used for rendered edges. To change the color, click the swatch.

**Alpha** Sets the alpha-channel value for edges. Range=0.0 (transparent) to 1.0 (opaque). Default=1.0.

The alpha channel is included with the rendered image only when you save in a format that supports transparency, such as TIF or Targa.

**Visible Edges** When on, edges are rendered using the specified edge color. Default=on.

**Invisible Edges** When on, hidden edges are rendered using the specified edge color. Default=off.

Hidden edges are most often found dividing mesh polygons into triangles. They aren't present in polygon objects.

**Seam Edges** When on, seam (outside) edges are rendered using the specified seam color. Default=on.

To change the seam color, click the color swatch. The default color (green) is the same as that used for seam edges in the Edit UVWs dialog, but the two can be changed separately.

**Render UV Template** Renders the template bitmap in a new [rendered frame window](#) on page 5885 .



To save the rendered frame, click the Save Bitmap button.

---

**NOTE** This command renders the normalized UV space, from (0,0) to (1,1), as depicted in the editor by a dark blue outline. For best results, make sure the texture UVs fill this space but don't exceed its bounds.

---

**TIP**  To turn off the background texture, which tends to obscure the UV space outline, click the Show Map button on the upper toolbar.

---



## Sketch Tool Dialog

Select an object. > Modify panel > Modifier List > Object-Space Modifiers > Unwrap UVW > Edit button (on Parameters rollout) > Tools menu > Sketch Vertices

If you need to match a contiguous selection of texture vertices to an outline in a bitmap, whether an irregular shape, a straight line, or a geometric shape, you can use the Sketch tool to perform the operation quickly, rather than dragging the vertices one at a time.

### Procedures

#### Example: To sketch texture vertices free form:

You can start with the vertices already selected, or use the Sketch tool to select them. In this example, we'll assume the latter.

- 1 Choose Sketch Vertices.
- 2 In the Sketch Tool dialog, next to Select By, choose Drag Selection, if necessary.
- 3 Next to Align To, choose Free Form, if necessary.
- 4 Make sure Show Vertex Order and Interactive Mode are turned on. Leave Drag Cursor Size at the default setting.
- 5 Click OK to close the dialog.  
The mouse cursor takes the form of a circle, which means you're in "drag select" mode.
- 6 In the editor window, drag the cursor over the vertices to select, and then release the mouse button.  
As you drag, each vertex is assigned a consecutive number. When you release the mouse button, the cursor turns into a pencil, which means you're in "sketch" mode.

---

**NOTE** Before you start sketching, each successive mouse click alternates between drag and sketch modes.

---

- 7 In the editor window, drag a wavy line.  
The selected vertices follow the line in numeric order, spreading out evenly over its length. To start the sketch over, release the mouse button, and then drag again.

Alternatively, if you press and hold Alt, and then press and release the mouse button, you'll draw a straight line by moving the mouse. Click and move again to draw connected straight-line segments.

You can combine free-form and straight-line sketching freely:

- To append a free-form line to a straight-line segment, release the Alt key and then begin dragging.
- To append a straight-line segment to a free-form line, press and hold Alt as you drag, and then release the mouse button and move the mouse.

8 To exit the Sketch tool, right-click in the editor window.

## Interface

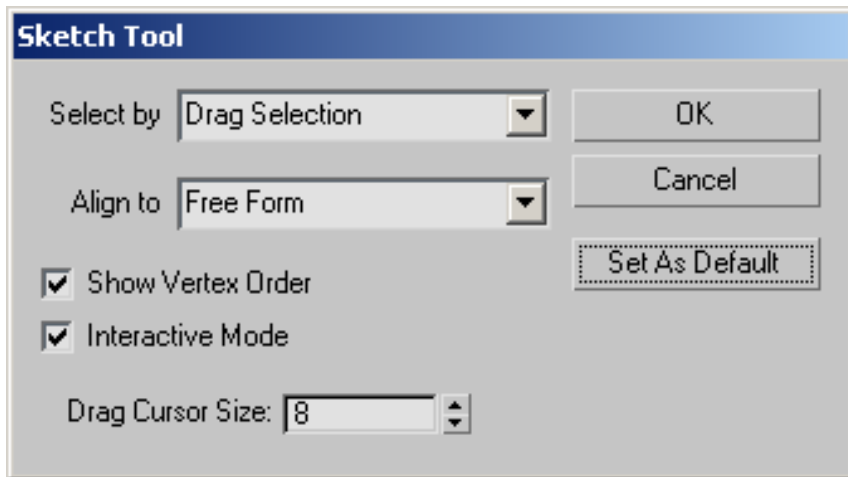

**Select by** Lets you choose how to select the vertices to sketch:

- **Pick Selection** Lets you pick the vertices one by one. When you click OK, a Pick cursor appears comprising a + sign and the letter P; when the cursor is over a vertex, the + sign becomes larger. To finish picking, right-click, and then drag to sketch. After sketching, you return to Pick mode, and so on. To exit, right-click.
- **Drag Selection** Lets you pick multiple vertices by dragging. When you click OK, the mouse cursor appears as a circle. After you drag to select vertices, release the mouse button, and then drag (or Alt+click) to sketch.

As with Pick Selection, the mouse cursor continues to alternate between Select and Sketch modes until you right-click to exit.

- **Use Current Selection** Uses the current selection; you cannot change the selection while using the tool. If the current selection is edges or faces, Sketch uses all vertices attached to selected sub-objects.

**Align To** Lets you choose how to sketch:

- **Free Form** Drag to sketch free form (like drawing with a pencil), or Alt+click to sketch connected
- **Line** Drag to sketch a single, straight line segment.
- **Box** Drag diagonally to sketch a rectangle.
- **Circle** Drag outward to sketch a circle, and then move the mouse in a circle to rotate the circle.

**Show Vertex Order** Displays numbered labels that indicate the order in which vertices were selected and will spread out during sketching.

**Interactive Mode** Shows vertex positioning as you sketch. Turn off for faster feedback.

**Drag Cursor Size** Sets the size of the mouse cursor used while dragging a selection. Default=8. Range=1 to 15.

**OK** Accepts the changes and closes the dialog.

**Cancel** Undoes any changes and closes the dialog.

**Set As Default** Makes the current settings the defaults for the current session.

## Stitch Tool Dialog

Select an object. > Modify panel > Modifier List > Object-Space Modifiers > Unwrap UVW > Edit button (on Parameters rollout) > Tools menu > Stitch Selected

After you've separated your object's UVW coordinates into clusters, either manually or using one of the automatic tools on the [Mapping menu](#) on page 1803 , you can use the Stitch tool to recombine specific clusters by merging corresponding edges.

---

**NOTE** You can stitch together only two clusters at a time. If the current sub-object selection is shared by more than one cluster, then “majority rules”: Stitch attaches the cluster that shares the most sub-objects. If the number of sub-objects shared by multiple other clusters is the same, the software attaches the cluster whose shared sub-objects were chosen first.

---

## Procedures

### To stitch two clusters together:

- 1 In the “source” cluster, select sub-objects along an edge you want to connect.  
By default, this causes the shared edges to highlight in the “target” object(s).
- 2 Choose Stitch Selected.  
The clusters are connected.
- 3 Adjust the settings on the Stitch Tool dialog.  
Feedback takes place in real time.
- 4 Click OK to accept or Cancel to abort.

## Interface

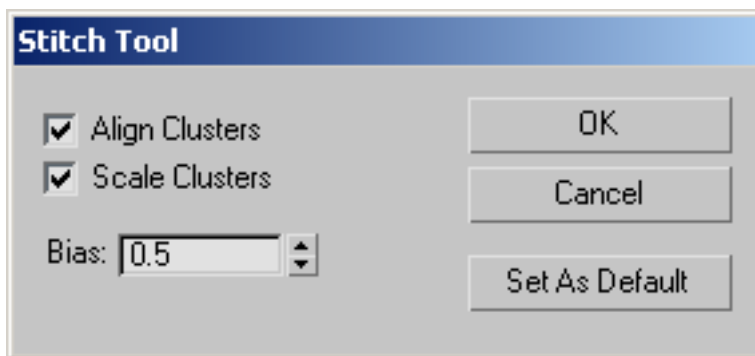

**Align Clusters** Moves the target cluster to the source cluster, and rotates the target cluster into place if necessary. When off, the target cluster remains in its original position and orientation. Default=on.

---

**TIP** If your clusters overlap after stitching with Align Clusters turned on, cancel the stitching, and then position and align them as you want them after stitching. Then use the Stitch tool with Align Clusters turned off.

---

**Scale Clusters** Resizes the target cluster to a size comparable to that of the source cluster. Takes effect only when Align Clusters is on. Default=on.

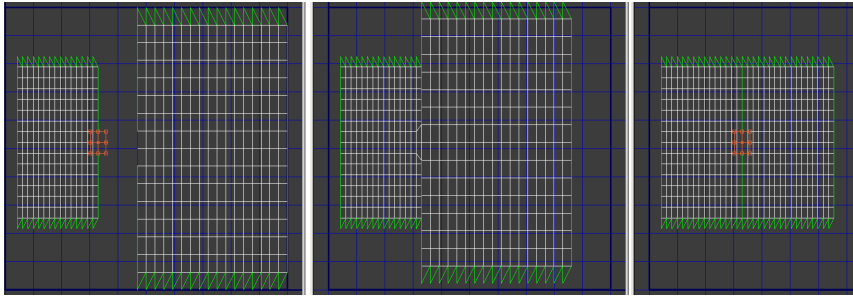

Edges chosen to stitch (left); Clusters aligned (center); Clusters aligned and scaled, with Bias=0 (right)

**Bias** When Scale Clusters is off, Bias sets the extent to which attached sub-objects are moved from their original positions. At Bias=0, the sub-objects remain in their original positions in the source cluster. At Bias=1, sub-objects remain in their original positions in the target cluster. At in-between settings, their positions are averaged between the two.

When Scale Clusters is on, Bias sets where the software derives the scaling of the target cluster(s). At Bias=0, the scale is fully derived from the stitched edges on the source. At Bias=1, the scale is fully derived from the stitched edges on the target. At in-between settings, the scaling is averaged between the two.

**OK** Accepts the changes and closes the dialog.

**Cancel** Undoes any changes and closes the dialog.

**Set As Default** Makes the current settings the defaults for the current session.

## Unfold Mapping Dialog

Select an object. > Modify panel > Modifier List > Object-Space Modifiers > Unwrap UVW > Edit button (on Parameters rollout) > Mapping menu > Unfold Mapping

The Unfold Mapping method of procedural mapping eliminates texture distortion, but can result in overlapping coordinate clusters. The Unfold Mapping dialog lets you control how faces are unfolded.

**See also:**

- [Flatten Mapping Dialog](#) on page 1821
- [Normal Mapping Dialog](#) on page 1823

## Interface

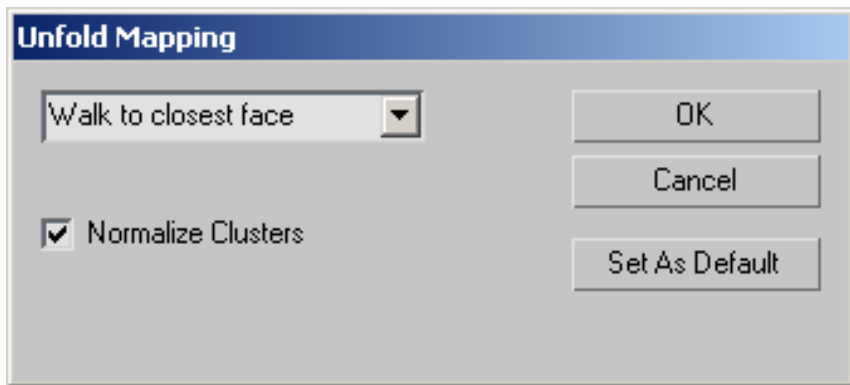

**(drop-down)** Sets the unfold method by specifying whether the software will start unfolding with the closest or farthest face angle, with respect to distance. In almost all cases, you'll get better results with Walk To Closest Face.

- **Walk To Closest Face**
- **Walk to Farthest Face**

**Normalize Clusters** Controls whether the final layout will be scaled down to 1.0 unit to fit within the standard editor mapping area. If this is turned off, the final size of the clusters will be in object space, and they'll probably be much larger than the editor mapping area. For best results, leave this turned on.

**OK** Accepts the settings, closes the dialog, and performs the mapping as specified.

**Cancel** Undoes any changes and closes the dialog.

**Set As Default** Makes the current settings the defaults for the current session.

## **Unwrap Options Dialog**

Select an object. > Modify panel > Modifier List > Object-Space Modifiers > Unwrap UVW > Edit button (on Parameters rollout) > Edit UVWs dialog > Options menu > Advanced Options

Set preferences for the Unwrap UVW editor using controls in the Unwrap Options dialog.

## Interface

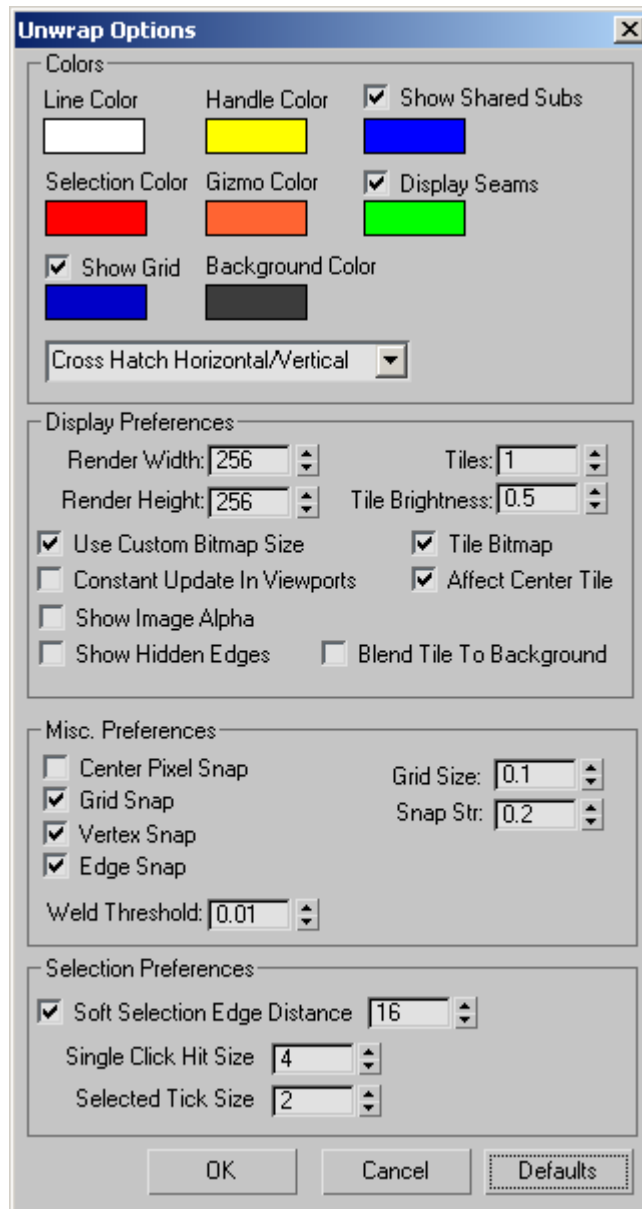



## Colors group

Contains color swatches to customize the display of the UVW lattice. With certain maps, the default colors may become difficult to see. Use these swatches to choose colors that work better for your specific map.

To change a color, click its swatch, and then use the [Color Selector](#) on page 331 to choose a new one.

**Line Color** Specifies the color of the UVW lattice lines. Default=white.

**Handle Color** The color assigned to patch handles. Default=yellow.

**Show Shared Subs** When turned on, non-selected sub-objects shared by the current selection are highlighted in this color. In most cases, the shared sub-objects are edges. With a single vertex, the shared sub-objects are vertices. Defaults=on, blue.

**Selection Color** Specifies the color of selected UVW sub-objects. Default=red.

**Gizmo Color** The color assigned to the [Freeform gizmo](#) on page 1790 . Default=orange.

**Display Seams** When on, lets you assign a distinctive color to coordinate clusters' boundaries that appears in the viewports. Defaults=on, green.

**Show Grid** When on, the grid lines are visible. Defaults=on, dark blue.

You can also set the [grid size](#) on page 1849 .

**Background Color** The color assigned to the background where the texture map isn't displayed. Default=dark gray.

**(drop-down)** Lets you assign a fill pattern to selected faces. Default=Cross Hatch Horizontal/Vertical.

## Display Preferences group

Contains controls affecting the map display in the view window.

**Render Width** Specifies the width resolution of the image displayed in the view window. This does not change the size of the image, but only the resolution.

**Render Height** Specifies the height resolution.

**Use Custom Bitmap Size** When turned on, scales the bitmap texture to the values specified by Width and Height. You can adjust these settings to scale and reportion the bitmap texture in relation to the texture coordinates.

This scaling doesn't affect the bitmap in the material, but only as viewed in the editor.

---

**TIP** When working with large textures, reduce the bitmap size for faster feedback. And when working with disproportionate textures, setting the dimensions closer to each other in the editor can make it easier to work.

---

**Tiles** The number of times the texture image is repeated, counting outward in eight directions (the four corners and the four sides).

With Tiles=1, the result is a 3 x 3 grid. With Tiles=2, the result is a 5 x 5 grid, and so on.

You can toggle the tiling feature with the Tile Bitmap check box, described below.

**Tile Brightness** Sets the brightness of the tiled bitmap. At 1.0, the brightness equals that of the original image; at 0.5 it's half the brightness; and at 0, it's black.

This is the same setting as Brightness in the UVWs editor > Bitmap Options group (available with Show Options).

**Tile Bitmap** When turned on, you can repeat the bitmap in the editor, displaying tiling set in the material.

You can use any part of the tiled image for setting texture coordinates. This is helpful when the sections of the texture image are packed tightly together and the mesh contains many different areas to map.

**Affect Center Tile** When turned on, the Brightness setting affects all tiles equally. When off, the center, or "home," tile always remains at full brightness, so you can easily distinguish the home tile from the copies.

**Constant Update in Viewports** Affects the adjusting of UVW vertices in the viewport while you move the mouse. Default=off (the effect of adjusting the UVW vertices does not appear in the viewport until you release the mouse).

**Show Image Alpha** Displays the alpha channel of the background image in the editor, if it exists.

**Show Hidden Edges** Toggles the display of face edges. When turned off, only faces appear. When turned on, all mesh geometry appears.

**Blend Tile to Background** Affects the color to which tiles set to Brightness less than 1.0 blend. When turned off, tiles blend to black. When turned on, tiles blend to the [background color](#) on page 1847 .

## Misc. Preferences

**Center Pixel Snap** When turned on, snaps to the center of pixels of the background images instead of pixel edges.

**Grid Snap** When on, snaps to grid edges and intersections.

**Vertex Snap** When on, snaps to texture-coordinate vertices.

**Edge Snap** When on, snaps to texture-coordinate edges.

**Weld Threshold** Sets the radius within which welding using [Weld Selected](#) on page 1802 takes effect. The setting is in UV-space distance. Default=0.01. Range=0 to 10.

**Grid Size** Sets the spacing of horizontal and vertical grid lines. Default=0.1. Setting Grid Size to 0 effectively turns off the grid. At the highest value, 1.0, the grid is the same size as the texture.

**Snap Str(ength)** Sets the [grid snap](#) on page 1795 strength. Default=0.2. Range=0 to 0.5.

Setting the strength to 0 effectively turns off snapping. At values less than 0.3, grid snapping tends to go to grid edges. At the highest value, 0.5, grid snapping goes only to grid intersections.

## Selection Preferences

**Soft Selection Edge Distance** When [Soft Selection](#) on page 1795 is turned on, limits the falloff region by the specified number of edges between the selection and the affected vertices. The affected region is measured in terms of "edge-distance" space rather than absolute distance. Default=16.

**Single Click Hit Size** Sets how far away you can click from a sub-object to select it. Default=4. Range=1 to 10.

**Selected Tick Size** Sets the size of the square icon the editor window uses to indicate selected vertices. Default=2. Range=1 to 10.

**OK/Cancel/Defaults** Click OK to accept, or Cancel to cancel the changes in the dialog. Click Defaults to restore all settings in this dialog to default values.

# UVW Map Modifier

Select an object. > Modify panel > Modifier List > Uvw Map

Select an object. > Modifiers menu > UVW Map

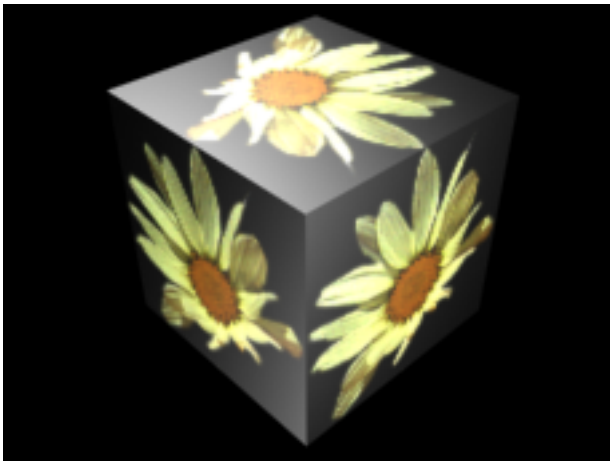
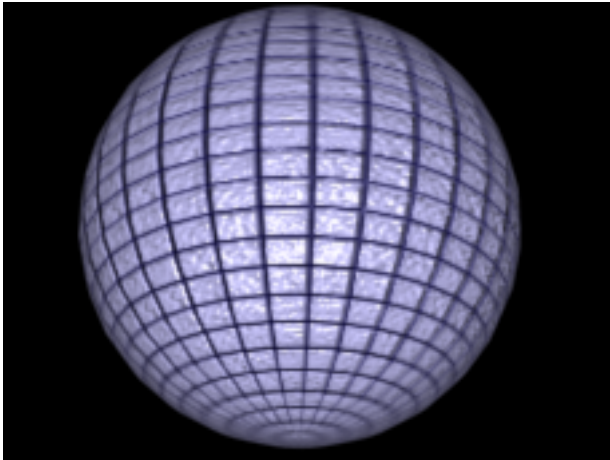

**Mapping a sphere and a box.**

By applying mapping coordinates to an object, the UVW Map modifier controls how mapped and procedural materials appear on the surface of an object. Mapping coordinates specify how bitmaps are projected onto an object. The UVW coordinate system is similar to the XYZ coordinate system. The U and V axes of a bitmap correspond to the X and Y axes. The W axis, which corresponds to the Z axis, is generally only used for procedural maps. A bitmap's coordinate system can be switched in the Material Editor to VW or WU, in which case the bitmap is rotated and projected so that it is perpendicular to the surface.

Primitive objects, like spheres and boxes, can generate their own mapping coordinates, as can loft objects and NURBS surfaces. Scanned, imported, or hand-constructed polygonal or patch models do not have mapping coordinates until a UVW Map modifier is applied.

---

**NOTE** Drawings that are imported or linked from Autodesk Architectural Desktop and Autodesk Revit do retain the mapping coordinates that were assigned to objects by those products.

---

If you apply a UVW Map modifier to an object with built-in mapping coordinates, the applied coordinates take precedence if [map channel](#) on page 7836 1 in the UVW Map modifier is used. The Generate Mapping Coordinates option, available during the creation of primitives, uses map channel 1 by default.

You use the UVW Map modifier to:

- Apply one of the seven types of mapping coordinates to an object on a specified map channel. A diffuse map on map channel 1 and a bump map on map channel 2 can have different mapping coordinates and can be controlled separately by using two UVW Map modifiers in the modifier stack
- Apply one of the seven types of mapping coordinates to an object.
- Transform the mapping gizmo to adjust map placement. Objects with built-in mapping coordinates lack a gizmo.
- Apply mapping coordinates to an object with no mapping coordinates, an imported mesh, for example.
- Apply mapping at the sub-object level.

## Map Channels

You can control the type of mapping coordinates and the placement of the mapping gizmo for each bitmap in a material that uses multiple bitmaps by assigning explicit map channels to the bitmaps. In the Material Editor you assign each map a different channel number, then you add multiple UVW Map modifiers to the object's modifier stack, each UVW Map modifier is set to a different map channel. To change the type of mapping or gizmo placement for a particular bitmap, you select one of the UVW Map modifiers in the modifier stack and change the parameters. You can change the name of a UVW Map modifier in the Edit Modifier Stack dialog to correlate the modifier to the bitmap.

## Transforming UVW Map Gizmos

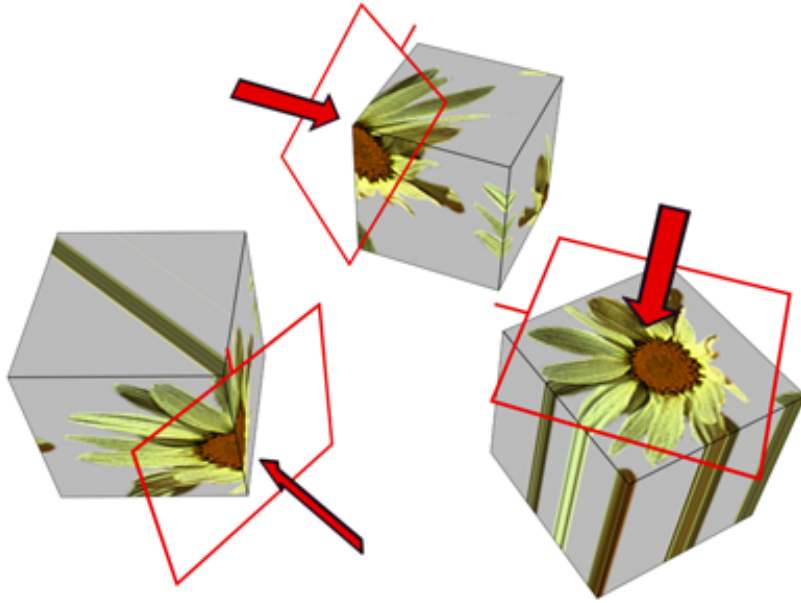

Changing a map's location by moving the gizmo.

The UVW Map gizmo projects mapping coordinates onto an object. You can position, rotate, or scale a gizmo to adjust map coordinates on an object; you can also animate the gizmo. Gizmo transformations remain in effect if you select a new map type. For example, if you scale a spherical mapping gizmo and then switch to planar mapping, then the planar mapping gizmo is also scaled.

### Gizmo Display for Different Map Types

For planar, spherical, cylindrical and shrink wrap maps, a short yellow line indicates the top of the map. The green edge of the gizmo indicates the right side of the map. On a spherical or cylindrical map the green edge is the seam where the left and right edge meet. Gizmo must be selected in the modifier display hierarchy to display the gizmo.

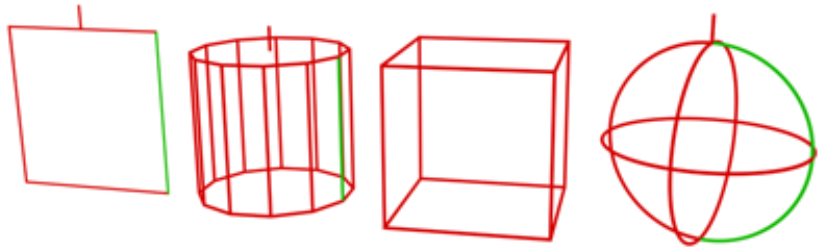

### Gizmos for different projection types

Left to right: planar, cylindrical, box, and spherical

### Effects of Transforming the UVW Map Gizmo

Moving the gizmo changes the center of projection and affects all types of mapping. Rotating the gizmo changes the orientation of the map, which affects all types of mapping. Uniform scaling does not affect spherical or shrink-wrap mapping. Non-uniform scaling affects all types of mapping.

If you scale a gizmo smaller than the geometry, then a tiling effect is created, unless scaling has no effect on the map type in use. Tiling based on gizmo size is in addition to tiling values set in the Material Editor Coordinates rollout for the map or the UVW Map modifier tile controls.

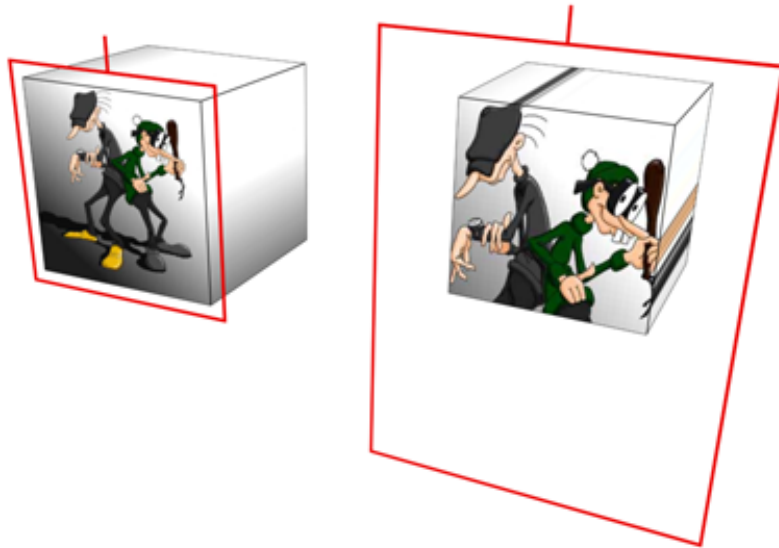

The size of the gizmo affects how the mapping is applied to an object.

### Manipulators for UVW Map

The UVW Map modifier has graphic manipulators to help you adjust the mapping dimensions and tiling when Real-World Map Size is off. When Real-World Map Size is on, you can adjust positioning only for the Planar and Box mapping types.



Manipulators are visible and usable while the [Select And Manipulate button](#) on page 2529 is active. This button is on the default [toolbar](#) on page 7283 . When you move the mouse over a manipulator, the manipulator turns red to show that dragging or clicking it will have an effect. Also, a tooltip appears, showing the object name, the parameter, and its value.

For more information on using the UVW Map manipulators, see [the Procedures section](#) on page 1856 .

**UV width/length manipulators** In a viewport, drag the edges of the UVW Map gizmo to change the width or height.



**UV tiling manipulators** In a viewport, drag the small circle next to the U edge or V edge to adjust the tiling in that dimension.

## **Tile Controls**

Use the UVW Tile controls if you want a map to repeat. Tiled maps are useful for bricks on a wall, or tiles on a floor. Rather than creating one large map, seamless maps can be tiled to surface a large area without visible seams, to give the illusion of a large map.

Tiling in the UVW Map modifier affects only the objects that use this modifier. Tiling a map in the Material Editor affects tiling on all the objects that use the material.

Material and UVW Map tiling are multiplied. For example, if a map in the Material Editor has a tile value of 2 on one axis, and a UVW Map modifier has a tiling value of 3 on the same axis, then the result is a tiling value of 6.

## **Objects with No Mapping Coordinates**

If you render an object that doesn't have mapping coordinates or a UVW Map modifier, and the object uses a material with 2D bitmaps or 3D procedural maps that use explicit map channels, then a [Missing Map Coordinates](#) on page 5618 alert is displayed. The alert lists both the name of the object and the UVW channels or Vertex Color channels that are missing the coordinates. For example: (UVW 2): Torus01.

## **Mapping Selection Sets or Grouped Objects**

You can apply one UVW Map modifier to a selection of objects. One large mapping gizmo will encompass the entire selection unless the Use Pivot Points option is turned on in the modifiers rollout before applying the UVW Map modifier. If the Use Pivot Points option is used then each object is encompassed with its own mapping gizmo.

If any of the objects in the selection has had its pivot point shifted in the Hierarchy > Pivot panel, and you use the Use Pivot Points option with the UVW Map modifier, then the mapping gizmos are centered to the pivot points rather than the object center and the mapping may be tricky to position the way you want.

## **Real-World Mapping**

The idea behind real-world mapping is to simplify the use of texture mapped materials which are scaled correctly with the geometry in the scene. This

feature gives you the ability to create a material and specify the actual width and height of a 2D texture map in the material editor. When you assign that material to an object in the scene, the texture map appears in the scene with the correct scaling.

There are two parts to the equation in order for real-world mapping to work. First, the correct style of UV texture coordinates must be assigned to the geometry. Basically, the size of the UV space needs to correspond to the size of the geometry. Therefore, a new switch, called *Real-World Map Size*, has been added to many of the dialogs and rollouts where you can generate texture coordinates. Any dialog or rollout in which you have the option to turn on *Generate Mapping Coords*, also has a switch where you can turn on *Real-World Map Size*.

---

**NOTE** There are a few primitive objects that do not have a Real-World Map Size switch. These are Torus Knot, Hedra, Prism and RingWave.

---

The other part of the equation is in the material editor. When you create a material and use a 2D texture map, you now see a new switch in the Coordinates rollout called *Use Real-World Scale*. When this switch is turned on, the default, the Width and Height spinners are enabled that let you specify the horizontal/vertical offsets and size of the texture map in current [display units](#) on page 7601 .

---

**NOTE** Autodesk VIZ scenes with objects using real-world mapping coordinates will display differently when opened in 3ds Max. This is because real-world mapping coordinates is not the default method of generating mapping coordinates in 3ds Max.

---

## Procedures

To apply the UVW Map modifier:

- 1 Assign a mapped material to an object.



- 2 On the Modify panel, choose UVW Map from the Modifier List.

- 3 Adjust the mapping parameters.

By default, the UVW Map modifier uses planar mapping on map channel 1. You can change the type of mapping and the map channel to suit your needs. There are seven types of mapping coordinates, ninety-nine map channels, tiling controls, and controls to size and orient the mapping gizmo in the UVW Map modifier.

---

**NOTE** If a UVW Map modifier is applied to multiple objects, the UVW Map gizmo is defined by the selection, and the mapping that results is applied to all the objects.

---

**To use multiple UVW channels in the same object:**

- 1 Assign Map channel 1 to an object. You can do this by either turning on Generate Mapping Coordinates in the Parameters rollout of any primitive, or by assigning a UVW Map modifier with channel 1 chosen.  
Generate Mapping Coordinates uses map channel 1 by default.
- 2 Assign a UVW Map modifier (or a second one, if you're using the first to assign channel 1). Choose channel 2 for this modifier.  
Both coordinate channels are now assigned to the geometry. The next step is to assign a mapped material that uses both channels.
- 3 Create a material with two maps. You can do this using a Composite map, or a Blend material with two maps, or you can have one map assigned to Diffuse and another assigned to Bump. Perhaps the easiest way to see the effect is to composite two maps, with the second map containing an alpha channel.
- 4 Go to the level of one of the maps and, in the Mapping list, choose Explicit Map Channel 2.  
The other map is already assigned channel 1 by default.
- 5 Assign the mapped material to the object.  
You can switch between viewing the maps in the viewport using the Show Map In Viewport control in the Material Editor. You can adjust the mapping of channel 2 without altering the mapping of channel 1 if you've assigned two UVW Map modifiers. Render the scene to see the effect.

**To use the XYZ to UVW option:**

The XYZ to UVW option is used to make a 3D procedural texture, like Cellular, follow the animated surface of an object. If the object stretches, so does the 3D procedural texture. Currently, it cannot be used with NURBS objects and is unavailable if a NURBS object is selected.

- 1 In the Top viewport, create a box.

- 2  Create a material with a Cellular diffuse map.

3 In the Material Editor, on the Coordinates rollout of the Cellular map, open the Source drop-down list, and choose Explicit Map Channel.  
On the Coordinates rollout, the Map Channel parameter activates, leave the value at 1.

4 Assign the material to the box.



5 On the Modify panel, choose UVW Map from the Modifier List.

6 On the UVW Map modifier, turn on XYZ to UVW.  
By default, the Map Channel value is 1.

7 Render the Front viewport.

The cellular pattern renders normally on the surface of the box.

8 Right-click over the object and choose Convert To: > Convert to Editable Mesh from the Transform (lower-right) quadrant of the quad menu.

The box is converted to an editable mesh.



9 On the Modify panel, click to turn on Vertex on the Selection rollout.

10 In the Front viewport, select the top vertices of the box, and move them up.

11 Render the Front viewport again.

The cellular pattern stretches with the box. This effect is enabled by the XYZ to UVW option. To see the difference, we will change the Source option in the Coordinates rollout in the Material Editor.



12 In the Material Editor, locate the diffuse Cellular material.

13 On the Coordinates rollout of the Cellular diffuse map, open the Source drop-down list and choose Object XYZ.



14 Render the Front viewport.

The cellular pattern is no longer stretched.

### To transform the UVW Map gizmo:

- 1  On the Modify panel, choose the UVW Map modifier in the stack display.
- 2 In the stack display, choose the Gizmo sub-object level.  
The gizmo changes to a yellow color, with one green edge.  
The green edge indicates the right edge of the texture.
- 3 Move, scale, or rotate the gizmo in the viewports, or use the Length and Width controls in the UVW Map modifier.  
Transforming the map gizmo shifts the bitmap, allowing you to orient and move the map on the object's surface.

### To use manipulators to control the width and length:

- 1  On the Modify panel, choose the UVW Map modifier in the stack display.  
You can also be at the Gizmo level of the modifier.
- 2  On the default main toolbar, click to turn on Select And Manipulate.  
The UVW Map modifier's gizmo turns green, showing it is now a manipulator. Also, two small circles appear next to two of the gizmo's edges.
- 3 Drag an edge of the gizmo to adjust the width or length.  
A tooltip shows the new width or length value.

### To use manipulators to control tiling:

- 1  On the Modify panel, choose the UVW Map modifier in the stack display.  
You can also be at the Gizmo level of the modifier.



- 2 On the default main toolbar, click to turn on Select And Manipulate.  
The UVW Map modifier's gizmo turns green, showing it is now a manipulator. Also, two small circles appear next to two of the gizmo's edges.
- 3 Drag one of the circles to adjust tiling in the U or V dimension.  
A tooltip shows which dimension you are adjusting, and the new tiling value in that dimension.

## Interface

### Modifier Stack

**Gizmo sub-object level** Enables gizmo transformations. At this sub-object level you can move, scale, and rotate the gizmo in the viewports to position the mapping. In the Material Editor, you turn on the Show Map in Viewport option to make the map visible in a shaded viewport, the map moves on the surface of the object as you transform the gizmo.

## Mapping group

Determines the type of mapping coordinates used. Different kinds of mapping are distinguished by how the map is geometrically projected onto the object and how the projection interacts with the object's surfaces.

**Planar** Projects the map from a single plane flat against the object, somewhat like projecting a slide.

Planar projection is useful when only one side of an object needs to be mapped. It is also useful for obliquely mapping multiple sides, and for mapping two sides of a symmetrical object.

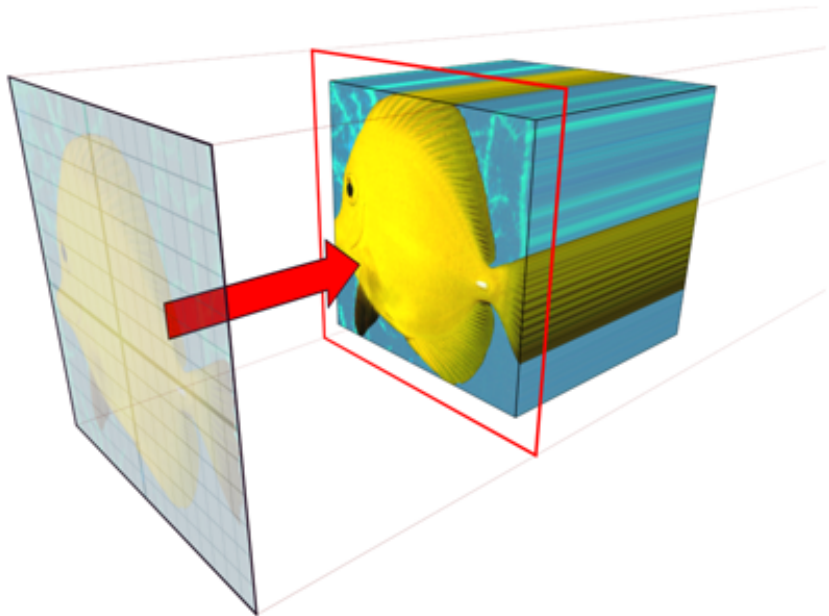

### Planar map projection

**Cylindrical** Projects the map from a cylinder, wrapping it around an object. Seams where the edges of the bitmap meet are visible unless a seamless map is used. Cylindrical projection is useful for objects that are roughly cylindrical in shape.

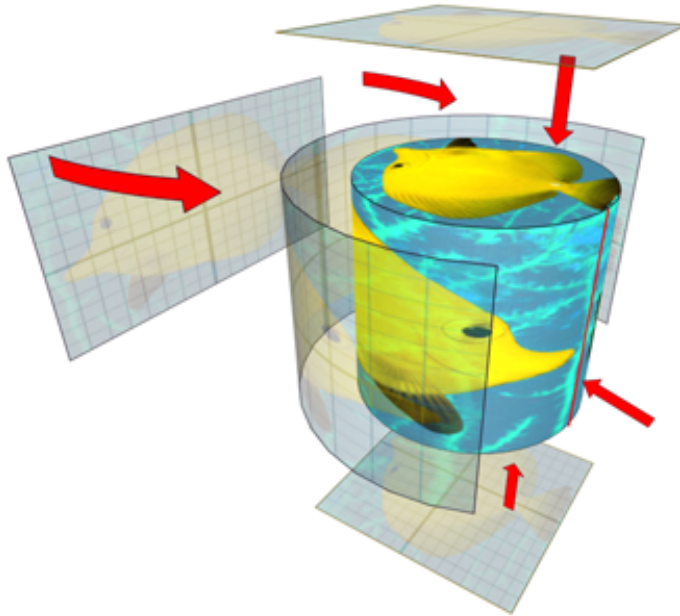

### Cylindrical map projection

**Cap** Applies planar mapping coordinates to the caps of the cylinder.

---

**NOTE** If the ends of the object geometry are not at right angles to the sides, the Cap projection bleeds onto the sides of the object.

---

**Spherical** Surrounds the object by projecting the map from a sphere. You see a seam and mapping singularities at the top and bottom of the sphere where the bitmap edges meet at the sphere's poles. Spherical mapping is useful for objects that are roughly spherical in shape.



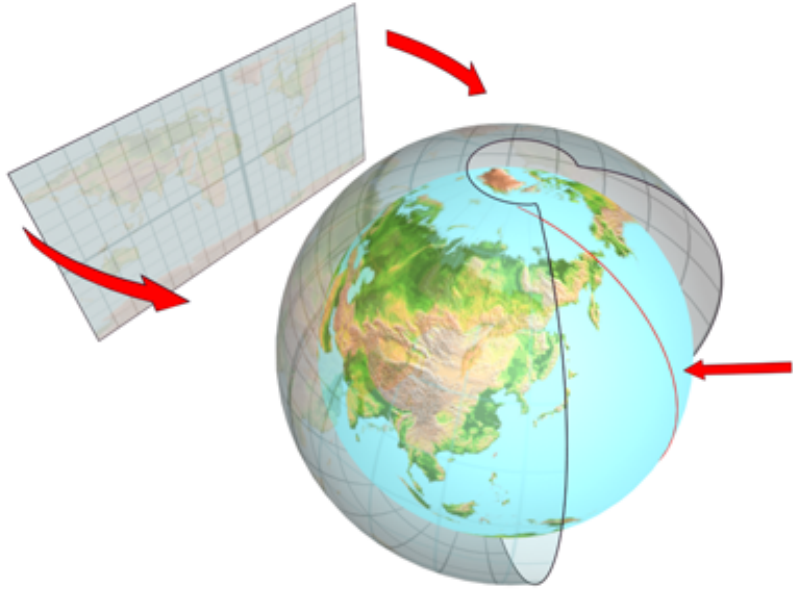

### Spherical map projection

**Shrink Wrap** Uses spherical mapping, but truncates the corners of the map and joins them all at a single pole, creating only one singularity. Shrink-wrap mapping is useful when you want to hide the mapping singularity.

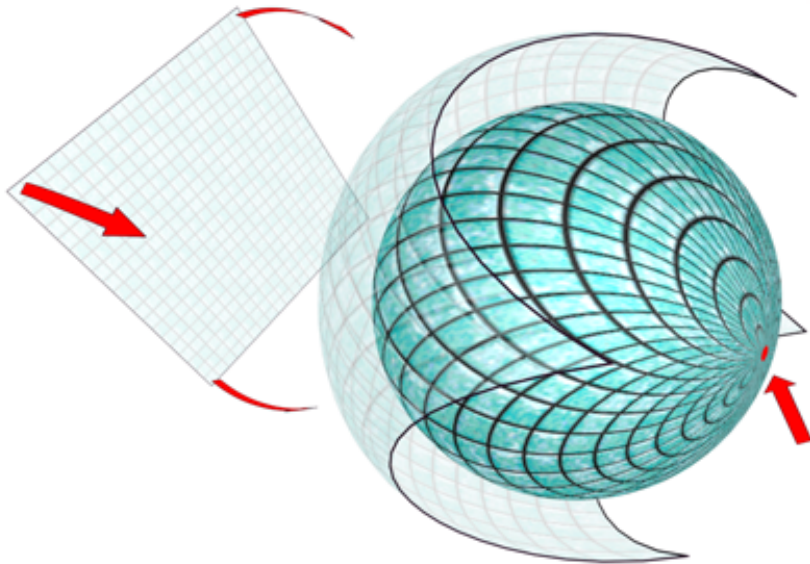

### Shrink-wrap projection

**Box** Projects the map from the six sides of a box. Each side projects as a planar map, and the effect on the surface depends on the surface normal. Each face is mapped from the closest box surface whose normal most closely parallels its own normal.

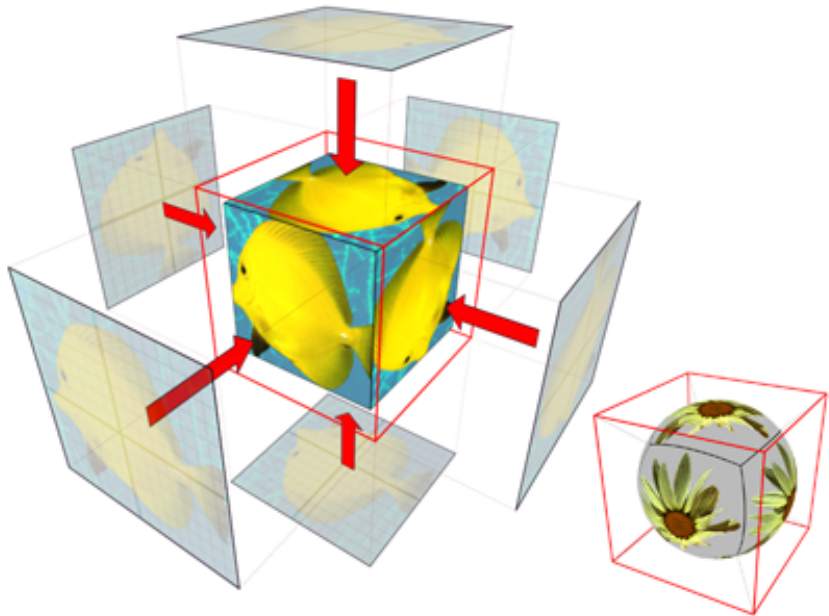

**Box projection (shown on a box and on a sphere)**

**Face** Applies a copy of the map to every face of an object. Pairs of faces sharing a hidden edge are mapped with the full rectangular map. Single faces with no hidden edge are mapped with a triangular portion of the map.

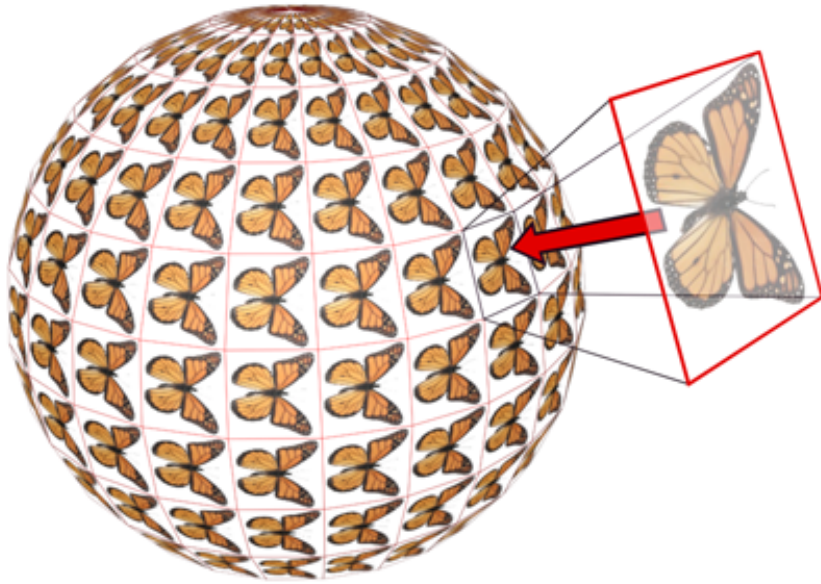

### Face projection

**XYZ to UVW** Maps 3D procedural coordinates to UVW coordinates. This "sticks" the procedural texture to the surface. If the surface stretches, so does the 3D procedural map. Use this option with procedural textures, like [Cellular](#) on page 5700 , on objects with animated topologies. Currently, XYZ to UVW cannot be used with NURBS objects and is disabled if a NURBS object is selected.

---

**NOTE** In the Material Editor's Coordinates rollout for the map, set Source to Explicit Map Channel. Use the same map channel in the material and UVW Map modifier.

---

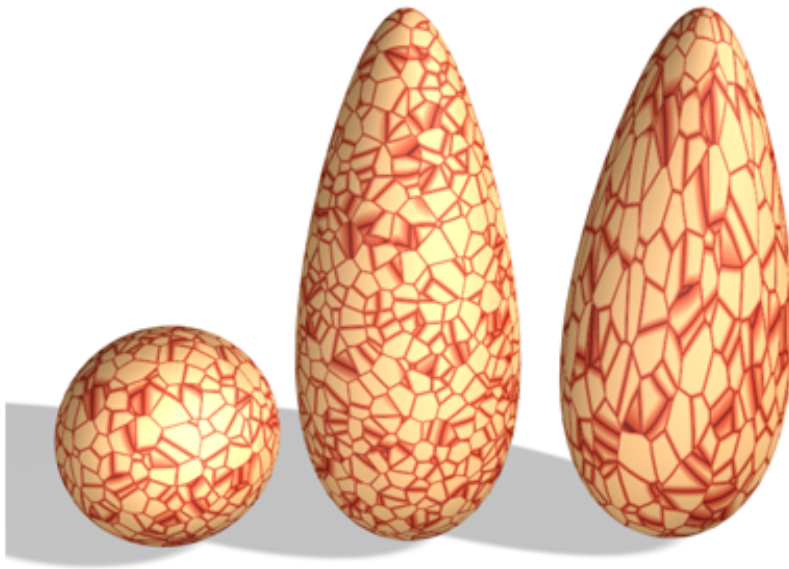

A sphere with a 3D procedural texture is copied, and the copies are stretched.

Right: Using XYZ to UVW on the object enables the 3D procedural texture to stick and stretch with the surface.

**Length, Width, Height** Specify the dimensions of the UVW Map gizmo. The default scale of the mapping icon is defined by the largest dimension of the object when you apply the modifier. You can animate the projection at the gizmo level. Note the following facts about these spinners:

- The dimensions are based on a bounding box of the gizmo. The Height dimension is unavailable for the Planar gizmo: It does not have depth. Likewise, the dimensions for Cylindrical, Spherical, and Shrink Wrap mapping all display the dimensions of their bounding box and not their radiuses. No dimensions are available for the Face map: Each face on the geometry contains the entire map.
- The three dimensions are set to 1 or 2, depending on map type and dimensions, when you load files created in Autodesk VIZ or earlier versions of 3ds Max. (This maintains compatibility with files from previous releases, in which gizmos were scaled non-uniformly to adjust their dimensions.). The dimensions essentially become scale factors rather than measurements. You can reset the values to dimensions by clicking the Fit or Reset buttons, which will lose the original non-uniform scaling.

**U Tile, V Tile, W Tile** Let you specify the dimensions of the UVW map, for tiling the image. These are floating-point values, which you can animate to displace the map's tiling over time.

**Flip** Reverses the image about the given axis.

**Real-World Map Size** Controls the scaling method used for texture mapped materials that are applied to the object. The scaling values are controlled by the Use Real-World Scale settings found on the applied material's [Coordinates rollout](#) on page 5620 . Default=on.

When on, the Length, Width, Height and Tiling spinners are unavailable.

## Channel group

Each object can have up to 99 UVW mapping coordinate channels. The default mapping (from the Generate Mapping Coordinates toggle) is always channel 1. The UVW Map modifier can send coordinates to any channel. This lets you have many different sets of coordinates on the same face simultaneously.

**Map Channel** Sets the map channel. The UVW Map modifier defaults to channel 1, so mapping behaves in the default fashion (and in the fashion of earlier software releases) unless you explicitly change to another channel. Default=1. Range=1 to 99

To use the additional channels, you must not only choose a channel in the UVW Map modifier, but also assign an explicit map channel at the map level of the material assigned to the object. You can use many UVW Map modifiers in the modifier stack, each one controlling the mapping coordinates of different maps in a material.

**Vertex Color Channel** Define the channel as a vertex color channel by choosing this option. Be sure to match any material mapping in the coordinates rollout to be Vertex Color as well, or by using the [Assign Vertex Colors utility](#) on page 5849 .

The Map channels are accessed in various places in the software, as follows:

- **Generate Mapping Coords** This check box, in the creation parameters of most objects, assigns Map channel 1 when turned on.
- **UVW Map Modifier** Contains options for channels 1 through 99. This lets you specify which UVW coordinates are used by this UVW Map modifier. The modifier stack can pass these channels simultaneously for any face.
- **UVW XForm and Unwrap UVWs** These two modifiers also contain Channel option buttons.

- **Material Editor Channel Assignment** You assign the channel to be used by a map in the Coordinates rollout at the map level in the Material Editor.
- The assignment varies depending on the type of map:
  - 2D Maps** In the Mapping list for the Texture option, you can choose Explicit Map channel, Vertex Color Channel, Planar from Object XYZ, or Planar from World XYZ.
  - 3D Maps** At the top of the Coordinates rollout, there is a Source list where you can choose an Explicit Map Channel, Vertex Color Channel, Object XYZ, or World XYZ. Use the Map Channel spinner to define the channel number.
- **NURBS Surface Objects and Sub-Objects** Let you specify which Map channel the surface uses.

### Alignment group

**X/Y/Z** Select one of these to flip the alignment of the mapping gizmo. Each specifies which axis of the gizmo is aligned with the local Z axis of the object.

---

**NOTE** These options aren't the same as the Flip check boxes beside the U/V/W Tile spinners. The Alignment option buttons actually flip the gizmo orientation, while the Flip check boxes flip an assigned map's orientation.

---

**Manipulate** When on, a gizmo appears on the object that lets you change parameters in the viewport. When Real-World Map Size is on, Manipulate is available only with the Planar and Box mapping types. For more information, see [Manipulators for UVW Map](#) on page 1854 .

---

**TIP** Turn on snapping to adjust the mapping precisely.

---

**Fit** Fits the gizmo to the extents of the object and centers it so that it's locked to the object's extents. Unavailable when Real-World Map Size is on.

**Center** Moves the gizmo so that its center coincides with the center of the object.

**Bitmap Fit** Displays the standard bitmap file browser so that you can pick an image. Unavailable when Real-World Map Size is on.

For planar mappings, the map icon is set to the aspect ratio of the image. For cylindrical mapping, the height (rather than the radius of the gizmo) is scaled to match the bitmap. For best results, first use the Fit button to match the radius of the object and gizmo, and then use Bitmap Fit.

**Normal Align** Click and drag on the surface of the object to which the modifier is applied. The origin of the gizmo is placed at the point on the surface where the mouse is pointing; the XY plane of the gizmo is aligned to the face. The X axis of the gizmo lies in the object's XY plane.

Normal Align respects smoothing groups and uses the interpolated normal based on face smoothing. As a result, you can orient the mapping icon to any part of the surface, rather than having it "snap" to face normals.

**View Align** Reorients the mapping gizmo to face the active viewport. The size of the icon is unchanged.

**Region Fit** Activates a mode in which you can drag in the viewports to define the region of the mapping gizmo. The orientation of the gizmo is not affected. Unavailable when Real-World Map Size is on.

**Reset** Deletes the current controller controlling the gizmo and plugs in a new one initialized using the Fit function. Any animation to the gizmo is lost. As with all the alignment options, you can cancel the reset operation by clicking Undo.

**Acquire** Effectively copies the UVW coordinates from other objects. When you pick an object from which you want to acquire UVWs, a dialog prompts you whether the acquire should be done in an absolute or relative fashion.

If you choose Absolute, the acquired mapping gizmo is positioned exactly on top of the mapping gizmo you pick. If you choose Relative, the acquired mapping gizmo is positioned over the selected object.

### Display group



This setting determines whether and how mapping discontinuities, also known as seams, appear in the viewports. The seams appear only when the Gizmo sub-object level is active. The default seam color is green; to change it, go to Customize menu > Customize User Interface > Colors tab, and then from the Elements drop-down list, choose UVW Map.



The options are:

- **Show No Seams** Mapping boundaries don't appear in the viewports. This is the default choice.
- **Thin Seam Display** Displays mapping boundaries on object surfaces in the viewports with relatively thin lines. The line thickness remains constant as you zoom the view in and out.
- **Thick Seam Display** Displays mapping boundaries on object surfaces in the viewports with relatively thick lines. The line thickness increases when you zoom the view in and decreases when you zoom out.

## UVW Mapping Add Modifier

Select an object. > Modify panel > Modifier List > Uvw Mapping Add

Select an object. > [Channel Info](#) on page 5858 > Add a channel.

The Uvw Mapping Add modifier is added to an object's modifier stack when you add a channel in the [Channel Info utility](#) on page 5858 . You can also add the modifier explicitly by choosing it from the Modifier List. It has no user interface.

To merge the results of the add operation into the object's geometry, collapse the modifier stack after adding.

## UVW Mapping Clear Modifier

Select an object. > Modify panel > Modifier List > Uvw Mapping Clear

Select an object. > [Channel Info](#) on page 5858 > Clear a channel.

The Uvw Mapping Clear modifier is added to an object's modifier stack when you clear a channel with the [Channel Info utility](#) on page 5858 . You can also add the modifier explicitly by choosing it from the Modifier List.

To merge the results of the deletion into the object's geometry, collapse the modifier stack after deleting.

## Interface

**Map Channel** Specifies the map channel to clear. This is equivalent to clearing a specific channel in the Channel Info utility. If the specified map channel doesn't exist, the modifier has no effect.

# UVW Mapping Paste Modifier

Select an object. > [Channel Info](#) on page 5858 > Copy and then paste a channel.

The UVW Mapping Paste modifier is added to an object's modifier stack when you paste a channel in the [Channel Info utility](#) on page 5858 . It isn't available from the modifier list, and has no user interface.

To merge the results of the paste operation (for example, a vertex selection) into the object's geometry, collapse the modifier stack after pasting.

# UVW XForm Modifier

Modify panel > Make a selection. > Modifier List > Object-Space Modifiers > UVW XForm

Select an object. > Modifiers menu > UV Coordinates > UVW XForm

Use the UVW XForm modifier to adjust tiling and offset in existing [UVW coordinates](#) on page 7962 . If you have an object with complex UVW coordinates already applied (such as a Loft object, or a parametric object with generated coordinates), you can apply this modifier to adjust those coordinates further.

For example, if you create a torus and turn on Generate Mapping Coordinates, the UVW coordinates work perfectly with the torus, but if you want to tile or move the coordinates, you would previously have needed to do it at the material/map level. Now you can apply a UVW XForm modifier to alter the built-in coordinates. You can use a Mesh Select or Edit Mesh modifier to apply a UVW Adjust to sub-object selections, as well. This is handy if you want to rotate the mapping on a particular portion of an object.

## Interface

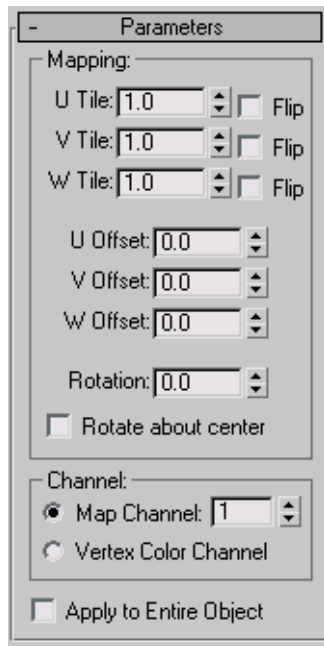

### Mapping group

**U Tile, V Tile, W Tile** Alter the tiling along any of the three coordinate axes.

**Flip** Reverses the direction of the map along the specified axis.

**U Offset, V Offset, W Offset** Move the map in the direction of the specified axis coordinate.

**Rotation** Rotates the map.

**Rotate About Center** When active, the map rotates about the center of the object. If this is applied to a sub-object selection, it uses the center of that selection.

When this is turned off, the map rotates about the corner of the U and V coordinate gizmo.

## Channel group

Specifies whether to apply the transform to a mapping channel or a vertex color channel, and which channel to use. For more information on these channels, see [UVW Map Modifier](#) on page 1849 .

**Map Channel** Specifies a UVW channel to use for the mapping, and use the spinner to its right to set the channel number.

**Vertex Color Channel** Uses the vertex color channel for the mapping.

**Apply To Entire Object** If the UVW Xform modifier is applied to an active sub-object selection, such as face or patch, this switch controls whether the settings of the UVW Xform modifier affect only the original sub-object selection or affect the entire object.

## Vertex Weld Modifier

Select a mesh, patch, or PolyMesh object. > Modify panel > Modifier List > Vertex Weld

Select a mesh, patch, or PolyMesh object. > Modifiers menu > Mesh Editing > Vertex Weld

The Vertex Weld modifier behaves like the Weld feature in Editable Mesh or Editable Patch and welds all vertices that fall within the threshold setting. Vertex Weld is very useful for cleaning up meshes that have vertices that are close or overlapping, but not welded.

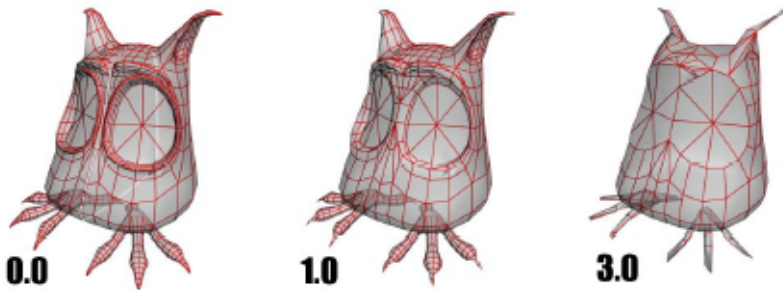

The results of three Vertex Weld threshold settings

## Procedures

**Example: To apply the Vertex Weld modifier to a mesh:**

- 1 Create a box with Length, Width, and Height set to **40**.
- 2 Right-click the box and choose Convert to > Convert to Editable Poly.
- 3 Set the sub-object mode to polygon, and select Polygon 6.

---

**TIP** Watch the listing at the bottom of the Selection rollout to see which polygon is selected.

---

- 4 Delete polygon 6.  
By deleting the polygon, you create an open mesh.
- 5 Apply a Turn To Poly modifier, and set the Selection Level to Object.
- 6 Apply a Mirror modifier, and set Mirror Axis to X.
- 7 Turn on Copy, and set Offset to **-40**.  
The reflection of the box shares a common seam but the vertices along the seam are not welded.
- 8 Apply a Vertex Weld modifier to cement the two boxes into one element.

---

**NOTE** This combination of steps can be streamlined by using the [Symmetry modifier](#) on page 1735 , which will mirror the mesh and weld it in a single operation.

---

## Interface

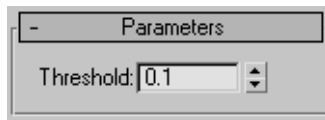

**Threshold** The value of the Threshold setting delegates how close vertices can be before they are automatically welded together. Default=0.1

---

**NOTE** A higher threshold setting will result in welding more vertices, thus removing smaller faces and details. If the threshold is set too high, the mesh will begin to deform.



**5.5**

A threshold setting of 5.5 removes all detail, making the model unrecognizable.

---

## VertexPaint Modifier

Select an object. > Modify panel > Modifier List > VertexPaint

Select an object. > Modifiers menu > Mesh Editing > Vertex Paint

Select an object. > Utilities panel > More > Assign Vertex Colors > Click Assign To Selected. > Modify panel

The VertexPaint modifier lets you paint vertex colors onto an object. You're not restricted to only vertex-level painting. Using sub-object selection, you can also control which vertices get painted, face-by-face. All faces sharing a vertex have the adjacent corner shaded as well. The resulting painted object receives a coarse gradient across each face.

The amount of color that 3ds Max applies to a vertex depends on the distance of the vertex from the position of the paint cursor on the face. The more you select a face, the more it changes to the new color. The Opacity button also controls the strength of the color. 3ds Max shades the color, so if you have one green vertex and two white vertices for one face, for example, you'll see a gradient on that face.

VertexPaint modifier also lets you paint values for the vertex alpha and illumination channels. These channels affect the transparency and shading of vertex colors, respectively.

## Notes and Tips

For best results with VertexPaint, keep the following in mind:

- VertexPaint is automatically applied to the selected object when you click [Assign Vertex Colors](#) on page 5849 > Assign To Selected. It is not available directly from the Modify panel or Modifiers menu.
- To render vertex colors, assign a [Vertex Color map](#) on page 5770 , as described in [To render vertex colors](#) on page ? .
- If you select faces using the selection tools of the VertexPaint modifier, you restrict your painting to the selected faces, as opposed to all faces. This allows you to sharply define the edges of your painted selection.
- You can streamline the painting process by using the [Brush Presets tools](#) on page 7293 .
- Each VertexPaint modifier works internally to itself, and cannot modify existing vertex coloring. To paint over existing coloring, use the [Condense to single layer](#) on page 1899 function.

## About Map Channels and Vertex Color, Vertex Alpha, and Vertex Illum

When using vertex paint, it is helpful to understand how 3ds Max manages vertex color, alpha, illumination, and map channels. The software stores and manages all of these different pieces of information using the same underlying system.

The map channels are defined as triple-value channels (tuples) with a unique integer ID number ranging from -2 to 99. The first five map channels have specific and familiar usages:

- **Channel (-2):** UVW “second pass” texture mapping coordinates
- **Channel (1):** UVW standard texture mapping coordinates
- **Channel (0):** RGB vertex color
- **Channel (-1):** FLOAT vertex alpha (really only 1 value needed)
- **Channel (-2):** RGB vertex illumination

Every geometric vertex of a mesh or poly object can be assigned up to 102 channel values (99 + 3).

The reason for the negative numbering scheme for the vertex alpha and illumination channels is actually historic: It serves to preserve the meaning of existing map-channel data in older scene files before vertex alpha and illumination were added.

You can paint on any arbitrary channel, and to use one or more channels for any arbitrary meaning for a given vertex. It is useful in development of content for games to paint on arbitrary map channels numbered higher than those used for texture mapping (such as channels 3, 4, 5). These can be used to store logical information about a vertex: for example, whether it is “slippery” or “explosive.”

You can assign a single vertex a stack of map channels that carry different meanings. When you collapse the modifier stack, the software preserves these map channels.

The VertexPaint modifier takes this into consideration through its simple exposure of map channel IDs for display and painting.

### **About Painting in Layers**

The layer system allows you to paint changes on a single layer, then make another layer on top of that, and paint additional changes. This can be used to store different versions or variations of your vertex color painting.

Every layer has a blending mode that it uses to determine how it combines with the other layers. You can assign vertex colors using the [Assign Vertex Colors utility](#) on page 5849 , then add another layer, change the layer mode operator to Lighten, and paint with a white paintbrush to lighten up areas. Fifteen different modes are available, and many tasks can be accomplished using paint layers.

One of the primary advantages of VertexPaint is its use of the modifier stack as a kind of image-composite stack. Each VertexPaint modifier serves as a single layer in the composite. You can move layers up and down the stack, enable and disable them, and flatten the stack using [Condense to single layer](#) on page 1899 .

### **Backward Compatibility**

If you load an older file that uses a previous version of the VertexPaint modifier, then the legacy modifier will be loaded when the file is opened.

The legacy modifier has not been changed, and the two modifiers are not inherently compatible in terms of their data format during loading and saving.



If you have vertex color data in a legacy VertexPaint modifier, you can use the [Condense to single layer tool](#) on page 1899 of the new modifier to migrate the vertex colors into the new modifier.

## Procedures

### To add scene lighting into an object's vertex color:

- 1 Select the objects in the scene that you want to color.
- 2 On the Modify panel, choose VertexPaint from the modifier list.  
The floating [Paintbox](#) on page 1886 appears, docked to the left edge of the viewports.
- 3 Open the Assign Vertex Colors rollout.

---

**NOTE** This rollout provides the same tools as found in the Assign Vertex Colors utility.

---

- 4 In the Light Model group, turn on Lighting.
- 5 In the Shadows group, turn on Calculate Shadows, if you want shadows added.

---

**TIP** Turn on Shaded and choose Use Maps if you want to mix the texture map information with the lighting and shades.

---

- 6 Click Assign To Selected



- 7 On the Vertex Paintbox, turn on Vertex Color Display Shaded to see the vertex lighting in the vertex color map.

### To paint vertex colors on an object:

- 1 Select the scene objects to paint.



- 2 On the Modify panel, choose VertexPaint from the Modifier List.  
The Vertex Paintbox appears.
- 3 Choose the color you want to paint with by clicking the large color swatch below the Paintbrush button. This opens the Color Selector.

- 4 Change the color using controls on the Color Selector.
- 5 Adjust the strength of the color by entering a percentage value in the Opacity field.



- 6 Click Vertex Color Display Unshaded to see the vertex colors without shading.
- 7 Click the Paint button and move the cursor over the selected object in the viewport.
- 8 When the cursor displays over the object, press and hold down the left mouse button and drag to paint the object.

---

**TIP** The cursor displays the size of the brush. Use the Size spinner to change to a larger or smaller brush.

---

**To see vertex colors in a viewport:**

- 1 Right-click the object with painted vertices, and choose Properties from the quad menu.
- 2 In the Display Properties group, turn on the toggle for Vertex Color . Vertex Color is one item on a drop-down list. The other items are Vertex Illumination, Vertex Alpha, Map Channel Color (which uses the spinner immediately below the list), and Soft Selection Color. Viewports can display only one of these vertex channels at a time.
- 3 Click OK.

**To render vertex colors:**



- 1 Open the Material Editor, and apply a Standard material to the object.
- 2 Click the map button for the Diffuse component.
- 3 In the Material/Map Browser, choose Vertex Color as the map, and then click OK.  
Now, when you render the scene, the rendering shows the painted vertices.

### To animate the opacity of a vertex color layer

- 1 Choose the layer you wish to animate, by highlighting the Vertex Paint modifier in the stack that corresponds to that layer.
- 2 Turn on the Auto Key button.
- 3 On the floating vertex paintbox, in the Layer group move the Opacity slider.  
This sets a key for the opacity.
- 4 Move the time slider to another frame and again change the value using the Opacity slider.
- 5 Click Play to see the animated opacity in the viewport.

### To animate vertex color using UVW XForm modifier:

You can use the UVW XForm modifier in conjunction with a specific vertex paint layer to modulate vertex color effects in the viewport.

- 1 Apply a UVW XForm modifier directly above the VertexPaint layer (modifier) you want to modulate.
- 2 Set the Channel type on the UVW XForm modifier to Vertex color.
- 3 Animate the U, V, and W spinners using identical values. For example, animate UVW from 1 to 0 over the length of the animation.  
This will attenuate the RGB values of the underlying vertex color results uniformly. It will effectively dim out the vertex color result directly below the UVW XForm modifier.

---

**NOTE** Any additional vertex paint layers applied above the UVW XForm modifier in the stack for the selected object(s) will be unaffected

---

---

**TIP** You can add multiple UVW XForm modifiers in your stack in this way, giving some progressive control over modulated vertex colors. The effect is always additive, however, and cannot be weight-blended.

---

### To paint under an existing layer and view the result:

- 1 Select an object that has several VertexPaint modifiers displayed in the stack.
- 2 In the modifier stack, activate the VertexPaint modifier that is the layer you want to paint on.

- 3  Turn on the Show End Result toggle.

Now, when you paint on the layer, you will see the painting taking place under the top layer.

## Interface

### Parameter rollout

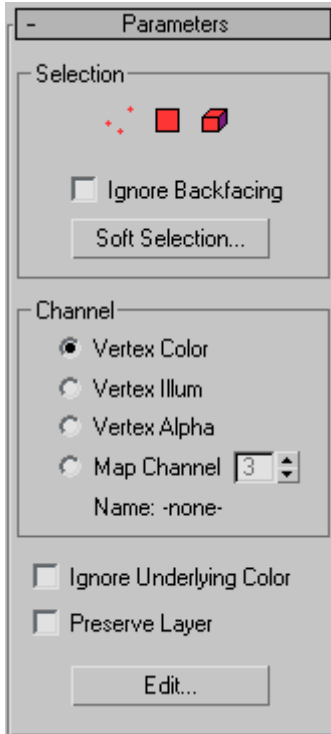

### Selection group

The controls in this group are identical to the selection controls found in the [Selection group](#) on page 1894 of the Paintbox rollout.

## Channel group

These controls specify which channel type the vertex paint layer will affect, and which map channel number you'll paint on.

- **Vertex Color** Choose this to paint on a vertex color layer.
- **Vertex Illum** Choose this to paint on a vertex illumination layer.
- **Vertex Alpha** Choose this to paint on a vertex transparency layer.
- **Map Channel** Choose this to paint on a specifically named or numbered map channel.
  - Map channel spinner** Specifies the channel number. Available only when Map Channel is chosen.

---

**NOTE** If you have painted on a layer and then change the channel setting, the painted information will be moved to the new channel. For example if you select Vertex Color and paint, then turn on Vertex Illum, the painted information will be removed from the Vertex Color channel and applied to the Vertex Illum channel instead.

---

**Name** If a channel has a name defined it will appear here. Channels can be named using the [Channel Info Utility](#) on page 5858 .

**Ignore underlying color** When turned on, VertexPaint ignores whatever vertex colors it receives from below it on the stack. As a result, you will see the layer's raw colors on an otherwise white object. The blend mode has no effect (it behaves like Normal mode) because the base color is considered transparent, so the layer is not blended with anything.

The purpose of this toggle is to isolate a layer from the colors below, to help the user visualize the layer's raw data. The layer is not completely isolated when this is on, because layers above it can still affect the result. The user needs to disable those layers or turn off Show End Result to see the current layer in complete isolation.

The Ignore Base Color toggle should *only* be needed when the object at the bottom of the stack already has some vertex colors baked in. In other cases, you can just disable the paint layers or whichever modifiers are adding vertex colors to the object. In that case, the active paint layer would not receive any vertex colors from below itself on the stack. As a result, it treats all base color as transparent and the layer colors are displayed in the raw (not blended with anything).

---

**NOTE** Per-vertex layer opacity is *not* passed up the stack. A paint layer modifier makes a yes/no decision about whether an object below it has vertex colors or not, and will subsequently treat all base colors as transparent or all as opaque. So if you paint even a single vertex using Edit Mesh, for example, the object is considered to have vertex colors, and a paint layer will blend its colors with the (predominantly white) mesh instead of treating the mesh as transparent.

---

**Preserve Layer** When on, the modifier will not be deleted by any Condense To Single Layer operation. Since Condense To Single Layer performs two independent actions (creating a new baked-color modifier and then deleting existing modifiers), this option allows access to only the first part of the functionality when necessary. That is, you can bake colors into a new paint layer, without being forced to have the old modifiers deleted.

**Edit** Displays the [Vertex Paintbox floater](#) on page 1886 if it has been closed.

## Assign Vertex Color rollout

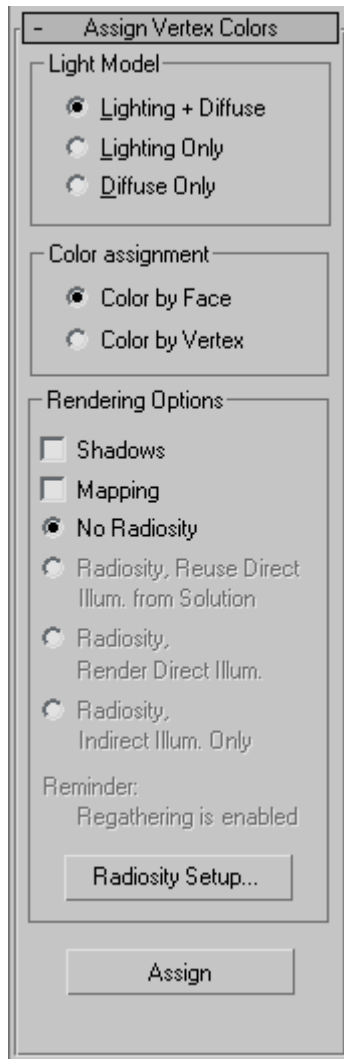

This rollout gives you access to the same controls found in the [Assign Vertex Colors utility](#) on page 5849 . They let you take the scene lighting information and bake it into the vertex channel system.



## VertexPaint Paintbox

Select an object. > Modify panel > Modifier List > VertexPaint > Paintbox dialog (Click Edit in the Parameters rollout if it isn't displayed.)

Select an object. > Modifiers menu > Mesh Editing > Vertex Paint > Paintbox dialog (Click Edit in the Parameters rollout if it isn't displayed.)

Select an object. > Utilities panel > More > Assign Vertex Colors > Click Assign To Selected > Modify panel > Modifier List > VertexPaint > Paintbox dialog (Click Edit in the Parameters rollout if it isn't displayed.)

The VertexPaint modifier's Paintbox is a floating toolbox with various vertex painting tools. The Paintbox is launched automatically after the [VertexPaint modifier](#) on page 1876 has been applied to one or more objects. You can close the Paintbox by clicking the X button in the upper-right corner of its window. To open it again, click the Edit button in the Parameters rollout of the VertexPaint Modifier

---

**NOTE** If a VertexPaint modifier is assigned to the object, you can also display the Paintbox by clicking Edit in the Assign Vertex Color utility.

---



## Interface

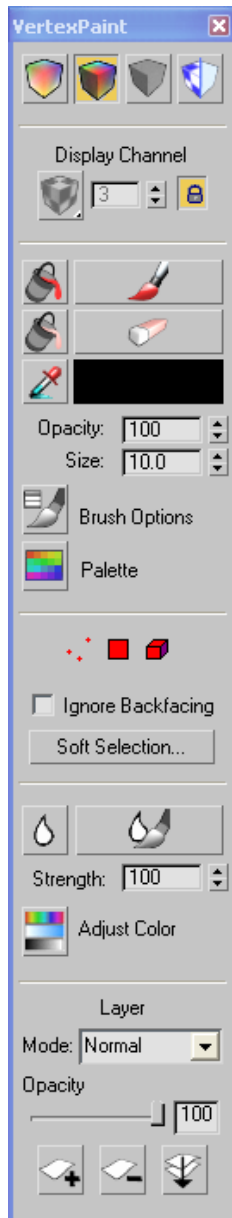

## Vertex Color Display controls



Control the display of the vertex paint in the viewport by using the four icons at the top of the floating panel. You can easily switch between shaded and unshaded vertex color modes, or turn off the display of vertex color and or texture maps.

---

**NOTE** The first three of these buttons stay highlighted when you click them, to indicate which shading mode is active. Toggle Texture Display simply performs the action without becoming highlighted.

---

**NOTE** These controls have no effect on wireframe viewports, but work for all shaded viewports, including Lit Wireframe.

---



**Vertex color display – unshaded** Displays the currently selected object in vertex color display mode. This mode is identical to the one offered by the Object Properties menu (right click on object, select Properties > Turn On Vertex Color in the Display Properties group, making sure that Shaded is off.)

This has no effect on wireframe, but works on lit wireframe and all other shaded display modes.



**Vertex color display – shaded** Displays the currently selected object in vertex color display mode, with viewport lighting (shading). This mode is identical to the one offered by the Object Properties menu (right click on object, select Properties > Turn On Vertex Color in the Display Properties group, making sure that Shaded is on.)



**Disable vertex color display** Displays the currently selected object in its current shading mode without showing vertex colors.



**Toggle texture display** Displays or hides texture maps on the currently selected object.

### Viewport Channel Display selector



This menu allows you to select which one of the map channels to paint on:



- **Vertex colors** Choosing this lets you display the vertex color channel in the viewport.



- **Vertex alpha** Choosing this lets you display and paint the vertex transparency channel in the viewport.



- **Vertex Illum** Choosing this lets you display and paint the vertex lighting channel in the viewport.



- **Map Channel** Choosing this lets you define a numbered map channel to paint on. Define the channel ID number with the Map Channel Display spinner.



### Map channel display in viewport flyout

What you see is what you paint, so whatever you select will both be displayed and activated for painting.

---

**NOTE** You cannot paint on all channels simultaneously as you could in the previous version of the vertex paint modifier.

---

**Map Channel Display Spinner** This control lets you to numerically select a channel other than the 3 conventional ones listed above, for display only. If the channel you select is currently used for mapping coordinates, you'll see red/yellow/green colors corresponding to the UVW values.

You might choose map channels above the standard channel 1, 2, 3 that do typically get used for texture mapping. But you will need to keep track of your own conventions, and/or use the Channel Info utility to track what has been allocated for each object.

The Map Channel Display Spinner is only available when the Map Channel display button. If you assign a new vertex paint modifier or create a new layer and choose a particular numeric map channel, then select Map Channel display, the spinner will become available.



**Lock button** The Lock button makes the Display Channel setting unavailable, and automatically sets Display Channel to whatever channel you choose on the Modify panel > Channel rollout. Keep this turned on, to ensure that you're always displaying what you're painting.

If you want to glance at another channel without stopping your current paint session, turn off the lock and then switch the display channel. When you are finished, switch back and turn the lock back on.

## Vertex Paintbrush group

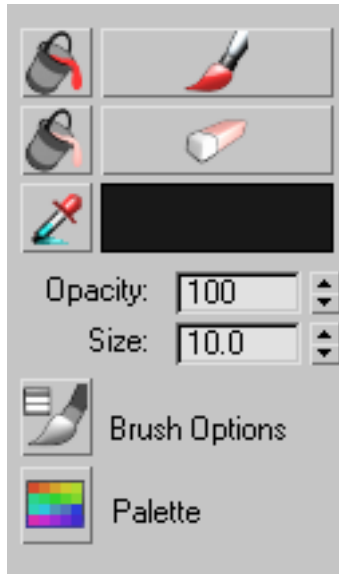

### Vertex paint controls

Here are the controls that let you access the paintbrush and the paint. You can choose color to paint with, from a color selector or from the scene. Choose to adjust the brush size or envelope, or launch advanced paintbrush options such as pressure sensitivity.



**Paint All** Performs a traditional paint fill operation on the current object or sub-object selection. In the case of sub-object selections (vertices, faces, elements) the fill will honor those selections. In the case of soft-selections Paint all will do a “faded” fill, slowly tapering off the opacity based on the soft selection settings.

As with the Paint button, this will either paint on the current layer, if one is open in the Modify panel, or else it will create a new vertex paint layer instanced across the selected objects.



**Paint** Starts the painting process. Once it is turned on, you can start painting on the current selection, by moving the cursor into the viewport and over the object.

If there is a Vertex Paint modifier highlighted in the Modify panel, you will be painting into that layer. But if the selected objects do not currently have a vertex paint layer highlighted in the modify panel, then a dialog appears letting you create a new modifier. This will be instanced across all the selected objects.

You will not see the results of your brush strokes, unless the proper display mode is set (above) Be sure your display mode and your paint target match. For example – if you are painting on the alpha channel, be sure you are displaying the alpha channel. If you are painting on the color channel, display the color channel. Brush strokes will use the color specified in the color swatch directly below the Paint button.

See [Painter Options Dialog](#) on page 1907 for more painting options.



**Erase all** Erases all painting applied to the currently selected objects via the current VertexPaint modifier. This allows you to see through the underlying color of the object's vertices. This underlying color might come from the object's original vertex color, or from another vertex paint layer directly below it in the modifier stack. This supports soft selection as well.

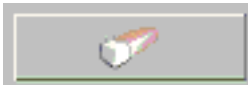

**Erase** Turns the brush into an eraser that will remove paint from the currently selected objects. Erase mode will actually erase any painting applied to the currently selected objects for the current layer of paint (allowing the true color of the original objects vertices to be seen, or the vertex paint layer immediately below the current one).



**Pick color from object** Allows you to choose a color from the currently selected objects. The color is taken from a single vertex; region selection is not supported. The choice must occur near a vertex, or no color will be chosen. You can drag across a vertex of interest to pick up its color. Because this button enters a mode, it must be clicked to leave the mode, or you can choose another mode to turn it off.



**Color swatch** The color swatch indicates the current color that will be used when painting begins. Clicking the swatch launches the standard color selector. Here you can change the color that will be used

on the next brush stroke. It provides standard Hue, Saturation, and Brightness selection, along with Red, Green, and Blue selection and numerical entry.

**Opacity** Controls the opacity of paint being applied to the currently selected objects in a single paint stroke (actually, any time before mouse up). This value represents the percentage of new paint that will blend into the color already applied to the selected objects. Successive paint strokes will continue to add this color until it overpowers the underlying color completely. The maximum value is 100% and 0% is the minimum value. A value of 50 percent will blend equally with the underlying vertex color in a single stroke (before mouse up).

The brush opacity serves to clamp the effect of each brush stroke, taken as a whole. If you pick a low opacity amount, then a single brush stroke will have only a small effect, no matter how much you scrub. This allows improved control over the density of a glaze of color, with an even glazing across all the painted vertices.

**Size** Controls the diameter of the brush, as seen in the viewport. Size values range from zero to 9,999,999 and must be chosen appropriately for the size and resolution of geometry you are painting.



**Brush Options** Opens the [Painter Options dialog](#) on page 1907 , where you can access advanced paintbrush controls. These are the standard set of Painter Interface options. The same options can be seen, for example in the Skin modifier, for painting weights.

Here you will find a rich selection of brush configuration tools that change the way your brush strokes apply color to the selection. Includes tools for mirror painting mode and using pressure sensitivity.



**Palette** Click to display the [Color Palette](#) on page 1902 , which lets you create, edit, and manage custom palettes for use with VertexPaint.

## Selection group



Tools in this group let you choose sub-object selection levels. You can select vertices, faces or elements. Includes the option to ignore backfacing so you can limit your selection to sub-objects that face toward you, and also provides access to standard soft selection options.

This creates a mask that will let you determine what is being affected by your paint strokes, and any other operations you might apply, such as blurring or color adjustment. Erase functionality will also honor this mode selection.

---

**NOTE** Soft Selection is supported on the various sub-object selection modes.

---



**Select vertex** Allows you to select vertices from the currently selected objects. Once selected, only these vertices will be available for painting.



**Select face** Allows you to select faces in the currently selected objects. Once selected, only these faces will be available for painting.



**Select element** Allows you to select elements in the currently selected objects. Once selected, only these elements will be available for painting.

**Ignore Backfacing** When this is on, prevents you from mistakenly selecting sub-objects facing away from the user.

**Soft Selection** The same [soft-selection options](#) on page 1926 found in Editable Mesh and Editable Poly are available by clicking this button.



## Image Adjustment group

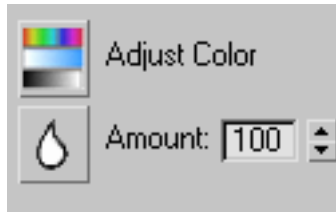

Tools in this group allow you to perform overall color adjustment or image blurring without using the paint brush in the viewport.



**Adjust Color** Displays the [Adjust Color dialog](#) on page 1900 , where you can find sliders for adjusting HLS or RGB values, preview the adjustment effect, and apply it.



**Blur** Smooths the pixels in the image so there is less contrast and color difference. Use this to get rid of harsh edges such as shadows created by the Assign Vertex Colors utility.

**Blur Amount spinner** Blurs currently selected channel values (for example, vertex color, alpha) for the currently selected objects. Also supports sub-object selection of vertices, faces, and elements. With soft selections, the final blurred value is computed, and then combined with the original color according to the selection; a 50 percent soft selection means that a vertex will become a fifty-fifty combination of its original color and the blurred color. Successive clicks of the Blur button will successively blur the previous results, eventually washing out painting effects entirely.

Blur is useful for softening vertex color lighting information that is automatically generated by the Assign Vertex Color utility or rollout. Assign Vertex Color computes intensities per vertex. This is especially useful for low-resolution geometry and high-frequency lighting changes.



**Blur Brush** Lets you apply blurring by using the same brush techniques and settings that you use to apply color. The Blur Brush respects sub-object selection and the Blur Strength setting.

## Layers group

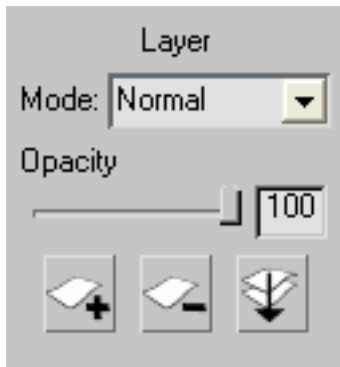

**Mode** The layer mode drop-down list allows you to select a specific operator for this paint layer. The operator selected affects base color, alpha, illumination, and other information coming up from layers below it, or from the base object itself. The chosen operator controls how the incoming color is combined with any newly painted colors for the current level.

This mode is changeable at any time, without destroying previously painted information in layers above, below, or in the current paint layer. The following modes are supported per paint layer:

- **Normal** The layer color completely overwrites the base color.
- **Overlay** The color cast is shifted towards the layer color and contrast might be increased.  
It's useful when you want to make an object appear a different color but in the same lighting conditions. A fully bright or dark channel is never affected however, so if Red=100% and Green=0% in the base color, then neither the red nor green channels can be affected by the layer color.
- **Screen** Each RGB channel is moved towards full brightness, depending on the layer color. The result is at least as bright (never darker) than the original. Black is transparent in this mode.
- **Multiply** Each RGB channel is moved towards zero, depending on the layer color. The result is at least as dark (never brighter) than the original. White is transparent in this mode.
- **Lighten** Whichever color is brighter, the layer or the base, is used as the output. It operates on the whole color, and *not* channel-by-channel.

- **Darken** Whichever color is darker, the layer or the base, is used as the output. It operates on the whole color, and *not* channel-by-channel.
- **Color dodge** Emulates the effect of "dodging" a color print in a darkroom; the result is at least as bright (never darker) than the original. For each RGB channel, if the layer is at full value in that channel, the output channel will be at full value. Even if the layer value is less than full value, the output is still strongly brightened in that channel. For example, a medium-red layer color will add a significant red brightness to the output.
- **Color burn** Emulates the effect of "burning" a color print in a darkroom; the result is at least as dark (never brighter) than the original. For each RGB channel, if the layer is zero in that channel, the output channel will be zero. Even if the layer value is above zero, the output is still be strongly darkened in that channel. For example, a medium red layer color will significantly reduce blue and green brightness in the output.

The next four Light modes essentially offer compromises between the destructive effect of Normal Mode and the toning effect of Overlay mode. Try using medium-value desaturated layer colors, since the light modes can be too destructive with bright, vivid layer colors. A neutral grey layer color is transparent in any of the light modes.

- **Soft light** Very similar to Overlay, but even more gentle, and it does not tend to increase contrast as much.
- **Hard light** More like Normal mode than Overlay, it will change color cast somewhat. It is fairly destructive like Normal mode, especially with bright layer colors.
- **Vivid light** Brighter layer colors produce a Color Dodge effect, while darker layer colors produce a Color Burn effect, although the effect is generally weaker than Dodge or Burn.
- **Linear light** For each RGB channel, if the layer color is more than 50 percent bright in that channel, the output will be brightened, and if the layer is less than 50 percent bright, the output will be darkened. As an example, if you want the top of your image to be twice as bright, and the bottom to be half as bright, use a gradient from 75 percent gray to 25 percent gray, top to bottom.

The next four modes are used to control the HSV channel values of the image instead of using RGB channel value.

- **Hue** The output color has the saturation and value of the base color, with the hue of the layer color.
- **Saturation** The output has the hue and value of the base color, and the saturation of the layer color.
- **Color** The output has the value of the base color, and the hue and saturation of the layer color.
- **Luminosity** The output has the hue and saturation of the base color, and the brightness value of the layer color.

---

**NOTE** Using the show end result button in the modifier stack for the current paint layer will allow you to interactively paint under any over laying paint layers (vertex paint modifiers that are above the current one in the object's modifier stack). This allows you to see the final results of your paint strokes for any paint layer in the stack.

---

**Opacity Slider** Allows you to set the opacity of the current vertex paint layer, from 0 to 100 percent. 100 percent Opacity means that the current layer is entirely opaque: you cannot see through it to the layer directly under it or to the base vertex colors of the objects being painted.

The opacity of a layer is animatable. Simply turn on Auto Key, move the time slider and adjust the spinner value. This will set a keyframe.

---

**NOTE** If you painted on the layer with a brush opacity less than 100 percent, then colors stored in the layer can already be less than full opacity, and the final opacity at any vertex is a product of the two values. If you vertex had only 50 percent opacity worth of paint applied to it, and the layer is 50 percent opaque, then the vertex will appear 25 percent opaque overall.

---

Be aware that the paint opacity is different from the vertex alpha channel. Values less than 100 percent incrementally reveal any vertex color, alpha information, and so on, coming from vertex paint layers beneath it, or the base object's original information. Opacity values can be changed for the current layer at any time. Since vertex paint layers are preserved in the modifier stack you can return to a particular layer at any time and adjust its opacity to tune an object's final appearance.

---

**NOTE** The opacity for a specific paint layer should not be confused with “alpha” information for a given vertex. Opacity controls the mixing of painted information in the modifier stack for the currently active map channel (whether it be color information, alpha, illumination, or any arbitrary map channel from 1 to 99). Alpha Channel information (by convention) is intended to be used specifically to indicate the transparency of all combined color information for a given vertex.

---

Another way to think about the opacity slider is that it is identical to the amount spinner. The difference between them is that opacity is for the entire layer, where as amount is for the current brush stroke (between a mouse down and mouse up period when painting). Changing the amount spinner after painting does not affect what is already displayed on the screen; where changing the opacity layer does. In the end, the current vertex paint layer being applied generates a final color that is the combine result of amount and opacity. The whole concept should be quite natural to any Adobe Photoshop user. However, Photoshop is able to display a light grey and dark grey quilt as a background to give a visual cue about layer opacity, whereas 3ds Max does not support this same display cue. So in 3ds Max, more attention is required of the artist to understand the opacity of each vertex on each layer.

**Opacity numeric entry field** Allows you to enter an opacity amount. Range=0 (completely transparent) to 100 (totally opaque).



**New Layer** Click to create a new VertexPaint layer. Clicking new layer displays a New Layer dialog.



**Delete Layer** Click to delete the current VertexPaint layer. This removes the modifier from the stack.



**Condense to single layer** Click to condense all vertex coloring into a single layer in the current VertexPaint modifier. Use this to modify existing vertex coloring within the current modifier.

Condensing layers is a two-part operation: First 3ds Max adds a new VertexPaint modifier to the stack, combining vertex coloring applied directly with Editable Mesh/Polygon and from previous VertexPaint layers according to the settings described above. Second, it deletes any prior VertexPaint modifiers.

If Preserve Layer has been turned on for a particular VertexPaint layer, then its colors are “baked” into the new VertexPaint modifier, but the preserved layer isn't deleted from the stack.

## **Adjust Color Dialog (VertexPaint Modifier)**

Select an object. > Modify panel > Modifier List > VertexPaint > VertexPaint Paintbox > Click the Adjust Color button.

Select an object. > Modifiers menu > Mesh Editing > Vertex Paint > VertexPaint Paintbox > Click the Adjust Color button.

Select an object. > Utilities panel > More > Assign Vertex Colors > Click Assign to Selected > Modify panel > Modifier List > VertexPaint > VertexPaint Paintbox > Click the Adjust Color button.

The Adjust Color dialog lets you adjust the color of currently selected vertices. If there is no active vertex sub-object selection, it affects all vertices equally.

## Interface

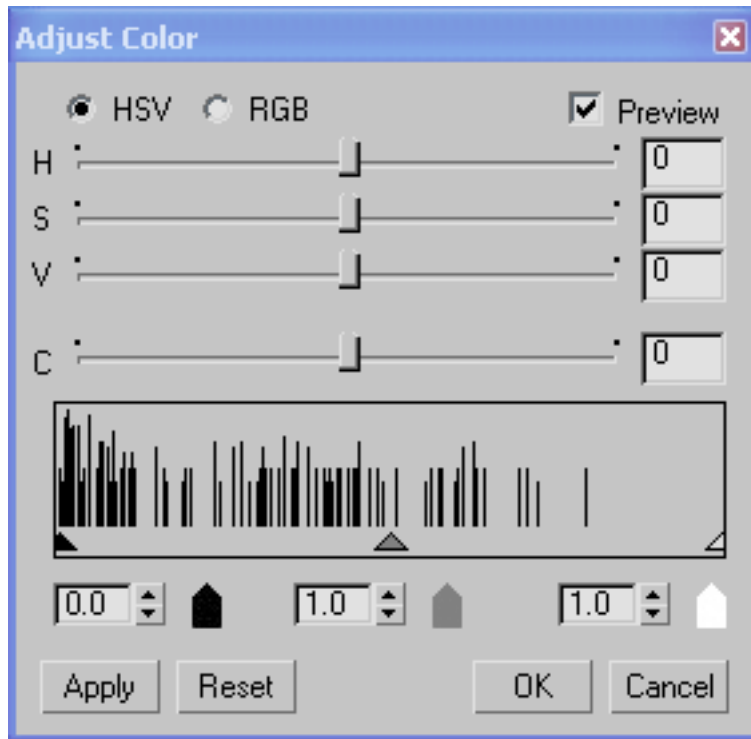

- **HSV** (The default.) When chosen, the first three sliders are labeled HSV, and adjust the colors' hue, saturation, and value.
- **RGB** When chosen, the first three sliders are labeled RGB, and adjust the colors' red, blue, and green components.

See [Red, Green, Blue / Hue, Saturation, Value](#) on page 7908 .

**Preview** When on, vertex color adjustments are previewed interactively in shaded viewports (provided that on the Paintbox, Vertex Color Display - Unshaded or Vertex Color Display - Shaded is active). Default=on.

**Contrast slider** Lets you adjust the contrast of the vertex colors.

### Histogram and Input-Level Spinners

**Histogram** Graphically shows the distribution of colors in the vertex selection, as well as the current shadow, gamma, and highlight input levels.

The shadow, gamma, and highlight input levels can help you adjust 3ds Max viewport color to better match your target hardware display (such as a game engine).

**Shadow level** Adjusts the level of shadow display.

**Gamma level** Adjusts the gamma display. This value is a [gamma correction](#) on page 7798 value.

**Highlight level** Adjusts the level of highlight display.

When you adjust a level, the corresponding arrow moves on the histogram, to indicate the current setting. (However, you can't graphically drag the arrows.)

**Apply** Click to apply the current settings to vertex colors, without closing the dialog.

**Reset** Click to restore dialog settings to their defaults.

## Color Palette (VertexPaint Modifier)

Select an object. > Modify panel > Modifier List > VertexPaint > VertexPaint Paintbox > Click the Palette button.

Select an object. > Modifiers menu > Mesh Editing > Vertex Paint > VertexPaint Paintbox > Click the Palette button.

Select an object. > Utilities panel > More > Assign Vertex Colors > Click Assign to Selected > Modify panel > Modifier List > VertexPaint > VertexPaint Paintbox > Click the Palette button.

The VertexPaint modifier's Color Palette lets you create and maintain color palettes for use with vertex paints. You can save or load palettes as Color Clipboard (CCB) files, which are also used by the [Color Clipboard utility](#) on page 337 .

---

**NOTE** The Palette remembers the last palette you used. This is not affected by File > Reset. However, the active palette is saved in the file [3dsmax.ini](#) on page 51 so deleting the INI file causes the palette to revert to the default grayscale palette.

---



## Procedures

### To use the palette to choose a color:

- On the List or Swatch panel, click the color.  
The color appears as the active color on the VertexPaint Paintbox, in the swatch just below the Erase button.

### To change the color of a color swatch:

- 1 Double-click the swatch.  
A [Color Selector](#) on page 331 appears.
- 2 Use the Color Selector to change the swatch's color.  
This version of the Color Selector is [modeless](#) on page 7849 , so after choosing a color you can either close it, or leave it open to change another swatch.

### To use the color picker:

- 1 In the Palette's List panel, highlight the name of a color.
- 2  Click the Color Picker button to turn it on.  
The cursor changes to an eyedropper icon.
- 3 Without depressing the mouse button, drag to an area where you want to pick a color.  
You can obtain colors from viewports, the 3ds Max user interface, or anywhere on the Windows desktop.
- 4 When you depress the mouse button, the picker obtains the color below the cursor. You can drag while the mouse button is depressed. While you do, the color swatch in the palette and the larger swatch on the Paintbox update.
- 5 *Release the mouse* to pick the color you want.  
The color in the Palette and the active color in the Paintbox are both updated.

### To change a color's name:

- 1 In the List panel, click the name twice (more slowly than a double-click).

The name changes to an editable field.

- 2 Enter a new name or edit the existing one, and then press Enter.  
Press Esc to cancel the name change.

**To save a palette to a file:**

- 1 Right-click the List panel or the Swatch panel.  
The Palette's [pop-up menu](#) on page 1907 appears.
- 2 Choose Save As from the menu.  
A Save Color Clipboard File dialog appears.
- 3 Use the dialog to give the palette a name (and optionally, a directory location other than the default), and then click OK to save the CCB file.

**To load a palette from a file:**

- 1 Right-click the List panel or the Swatch panel.  
The Palette's [pop-up menu](#) on page 1907 appears.
- 2 Choose Load from the menu.  
A Load Color Clipboard File dialog appears.
- 3 Choose the CCB palette file you want to load, and then click OK.

## Interface

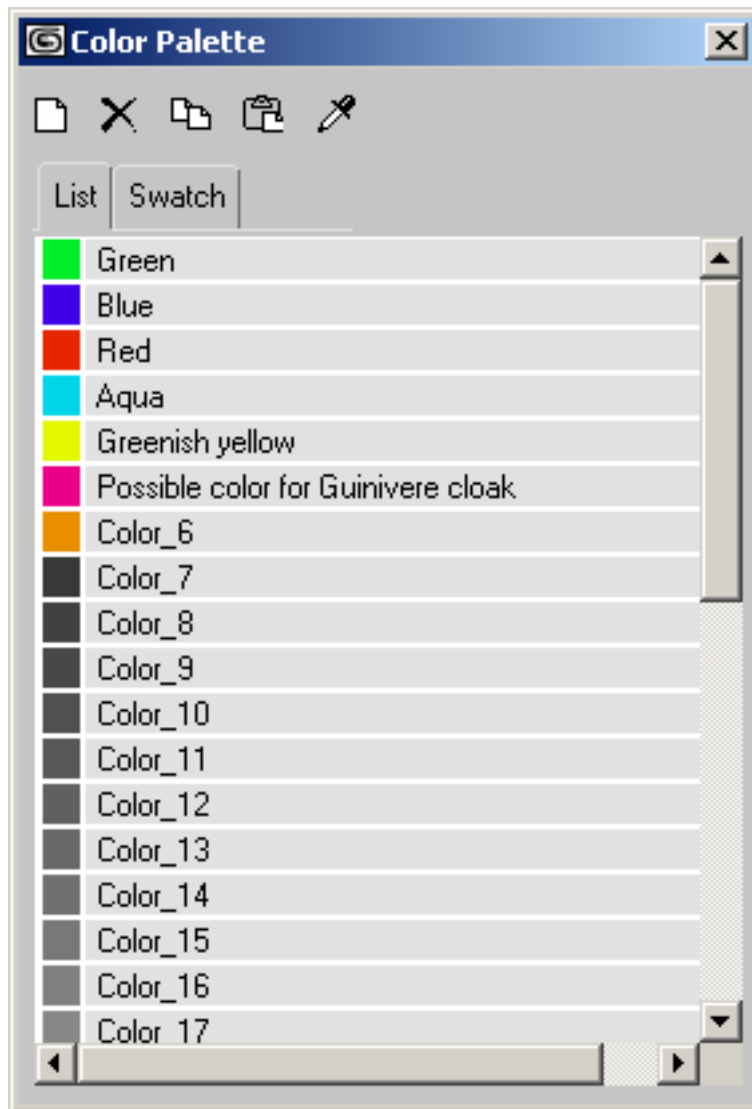

**New** Click to add a new color to the palette.

The only limit to the number of colors a palette can have is a file size or memory limitation.



**Delete** Click to delete the active color.



**Copy** Click to copy the active color.



**Paste** Click to paste a copied color to the active swatch.



**Color Picker** Highlight a color in the palette, turn this button on to activate the picker, then drag anywhere on the Windows desktop. The color is picked when you *release the mouse*. (See the procedure “To use the color picker,” above.)

**List panel** Displays the colors in the palette, along with their names.

**Swatch panel** Displays the colors in the active palette. The swatch panel doesn't list the names of colors, but each color's name appear as a tooltip when the mouse is over the swatch.

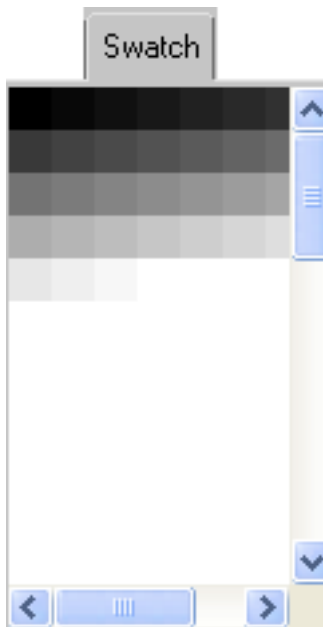

Swatch panel showing default grayscale palette

## List and Swatch Panel Right-Click Menu

When you right-click the List panel or the Swatch panel, a pop-up menu appears.

**Copy** Copies the active color.

This is the same as clicking Copy.

**Paste** Pastes a color to the active swatch.

This is the same as clicking Paste.

**New** Adds a color to the palette.

This is the same as clicking New.

**Delete** Deletes the active color.

This is the same as clicking Delete.

**Save As** Displays a [Save As dialog](#) on page 6724 that lets you enter a name for the CCB file, then save it.

By default, Color Clipboard files are saved in the `\images` directory below the 3ds Max root directory.

**Load** Displays a file open dialog that lets you choose a CCB palette file to load.

**View** Displays a text-editor window with the current CCB palette file. If no CCB file has been loaded or saved, choosing View has no effect.

The first 12 lines of a CCB file contain integer RGB values. This part of the file is used by the [Color Clipboard utility](#) on page 337 and ignored by the Color Palette dialog. The remaining lines of the file include floating-point RGB values and color names.

## Painter Options Dialog

Modify panel > Skin modifier > Parameters rollout > Weight Properties group > Painter Options button

VertexPaint modifier > Floating Vertex Paintbox > Brush Options button

Edit/Editable Poly object or Poly Select modifier > Soft Selection rollout > Paint Soft Selection group > Brush Options button

Edit/Editable Poly object > Paint Deformation rollout > Brush Options button



The Painter Options dialog for the Skin modifier appears when you click the Painter Options button.



This same dialog is used by the VertexPaint modifier to control the brush envelope, use pressure sensitivity, or enter mirror painting mode. The dialog is accessed through the Brush Options button on the floating Vertex Paintbox.

The dialog is also used by the Paint Soft Selection and Paint Deformation tools available for poly objects.

## Interface

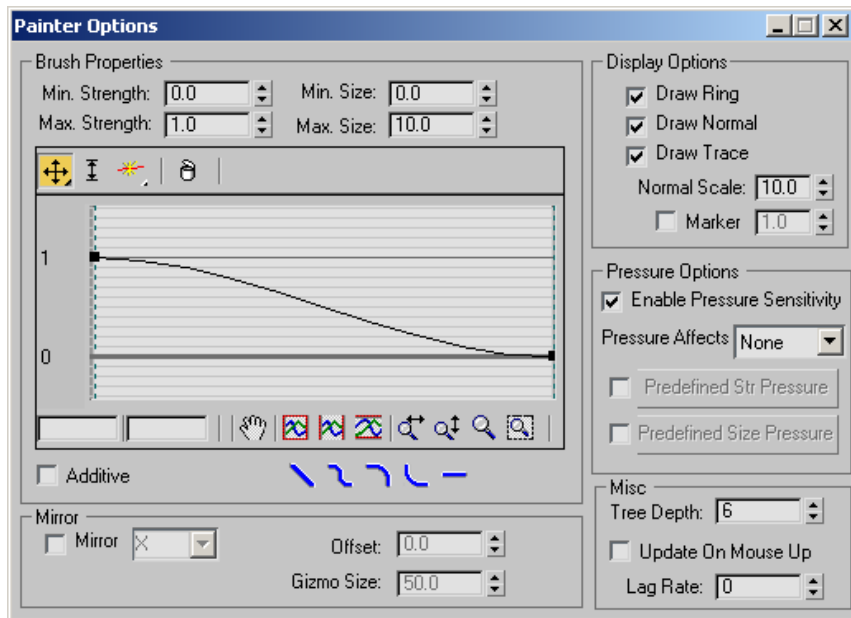

### Brush Properties group

**Min. Strength** Sets the minimum vertex weight to paint.

**Max. Strength** Sets the maximum vertex weight to paint.

**Min. Size** Sets the minimum size for the paint gizmo.

**Max. Size** Sets the maximum size for the paint gizmo.

**Brush strength falloff curve** This graph determines how the brush weight falls off as the distance increases from the center of the brush. The controls on this graph are similar to those on a [loft deformation dialog](#) on page 756 .

**Additive** When on, brush strokes add to existing vertex weights.

**Quick Brush Falloff Types** Set the brush falloff to linear, smooth, slow, fast, or flat.

### **Display Options group**

The options in this group determine the appearance of the paint gizmo.

**Draw Ring** A ring appears as part of the paint gizmo.

**Draw Normal** A normal arrow appears as part of the paint gizmo.

**Draw Trace** Draws a trace (temporary mark) that shows the path of the brush stroke on the surface.

**Normal Scale** Sets the scale of the normal arrow in the paint gizmo.

**Marker** Displays a circular marker at the end of the normal arrow. The value next to Marker sets the height of the marker.

### **Pressure Options group**

**Enable Pressure Sensitivity** Turns on pressure sensitivity for the paint gizmo brush.

**Pressure Affects** Selects the brush parameter to be affected by pressure sensitivity. Choose from four options: None, Strength, Size, or both size and strength (Size/Str).

**Predefined Str Pressure** Turn this option on to use a predefined strength pressure. Click the button to view and edit the falloff curve for the strength.

**Predefined Size Pressure** Turn this option on to use a predefined size pressure. Click the button to view and edit the falloff curve for the size.

### **Mirror group**

**Mirror** Turn this option on to mirror the paint gizmo on the other side of the object. Choose an axis from the drop-down menu. The paint gizmo is mirrored about the selected axis in the world coordinate system.

**Offset** Offsets the mirror plane by the value you specify.

**Gizmo Size** Changes the mirror gizmo size to a value you specify.

### **Misc group**

**Tree Depth** Determines the size of the quad tree used for hit testing. Tree Depth relates to the amount of memory set aside for weight painting. Larger values mean faster interaction but more memory use.

**Update On Mouse Up** Prevents the system from updating viewports when the mouse button is pressed. This can save time in your workflow.

**Lag Rate** Determines how often the stroke updates the painted surface. Higher values update the surface less often.

## **Volume Select Modifier**

Modify panel > Make a selection. > Modifier List > Vol. Select

Make a selection. > Modifiers menu > Selection Modifiers > Volume Select

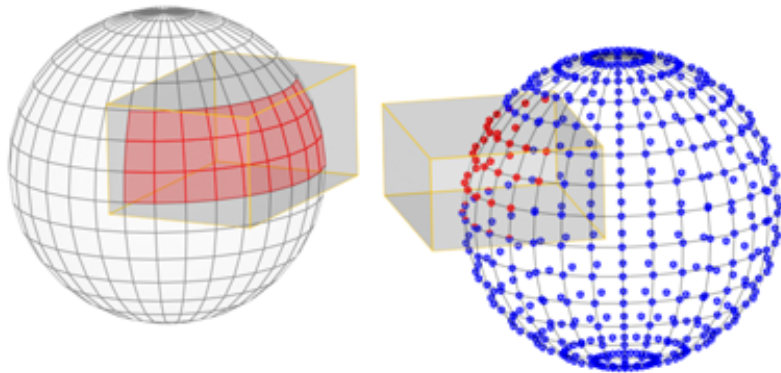

Faces and vertices selected using box volumes.



The Volume Select modifier lets you make a sub-object selection of vertices or faces for passing up the stack to another modifier or modifiers. The sub-object selection is completely separate from the underlying parametric geometry of the object. Like other selection methods, Volume Select works with single or multiple objects.

Volume Select lets you use one of three gizmos or another object to define a volume of space as the selection area, to which you can then apply modifiers. You can move the selection over an object and animate it.

When applied, Volume Select begins with the current geometry in the object's stack, whether it's a whole object or a sub-object selection (for example, from an [Edit Mesh](#) on page 1283 or another Volume Select modifier).

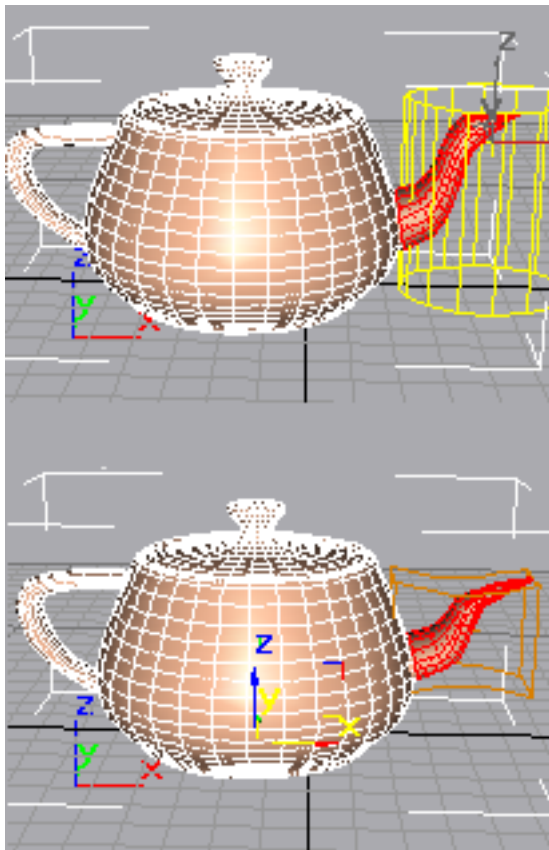

Top: Original mesh with select gizmo showing

Bottom: Modification made after applying Volume Select modifier

## Patches

As of version 4, patch objects coming up the modifier stack are not converted to a mesh by this modifier. A patch object input to the Volume Select modifier retains its patch definition. Files that contain patch objects with the Volume Select modifier from previous versions of the software will be converted to meshes to maintain backward compatibility.

## Scaling Compatibility

The Volume Select gizmo scales along with its object. Thus, if you apply a Volume Select modifier, and then change the scale of your object (with the toolbar [Scale function](#) on page 892 ) the selection doesn't change. In other words, all three transforms affect the Volume Select gizmo and its object identically.

## Volume Select Center

The Volume Select modifier has a center as well as a gizmo. This lets you alter the center for non-animated transforms. However, if you animate a rotation about the offset center, you achieve animation of both rotation and translation.

## Procedures

### To apply and use volume selection:

- 1 Select an object and apply the Vol. Select modifier.  
The Parameters rollout appears.
- 2 In the Stack Selection Level group, choose Object, Vertex, or Face to specify the kind of geometry you want to work with.
- 3 In the Select By group, choose one of the four volume types: Box, Sphere, Cylinder, or Mesh Object.  
If you choose Mesh Object, you should then click the None button and select an object to use as the selection volume.
- 4 Choose a selection method and type (defined in the following Interface section). You can change these choices as you work, depending on the particular selection you're trying to make.

- 5 Once the selection is complete, you can do the following:
  - Apply modifiers to the selection.
  - Transform the Volume Select gizmo at the sub-object level, changing the selection in the process.
  - Combine these options. See the following example.

**Example: To animate a volume selection:**

- 1 Apply Volume Select to an object.
- 2 Make a sub-object selection of the object's geometry at Face or Vertex level, and apply a geometric modifier, such as [Bend](#) on page 1139 , to the selection.
- 3 Move to a nonzero frame and begin animation. Adjust parameters on the geometric modifier, then move to another frame.
- 4 In the stack, return to the Volume Select modifier. Choose the Volume Select gizmo sub-object. Move the gizmo and its geometry selection to another part of the object.
- 5 Repeat this process on other frames. Optionally, you can return to the geometric modifier and change its parameters at any frame.

During playback, you see the effect of an animated geometric modifier moving over the object.

## Interface

### Modifier Stack

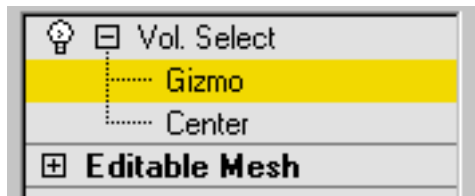

**Gizmo sub-object** You can transform and animate the gizmo to change the selection. Translating the gizmo translates its center an equal distance. Rotating and scaling the gizmo takes place with respect to its center.

**Center sub-object** You can translate and animate the center, which affects rotation or scaling of the Volume Select modifier's gizmo.

For more information on the Stack Display, see [Modifier Stack](#) on page 7427 .

## Parameters rollout

**Parameters**

Stack Selection Level:

- Object
- Vertex
- Face

Selection Method:

- Replace
- Add
- Subtract
- Invert

Selection Type:

- Window
- Crossing

Select By:

Volume:

- Box
- Sphere
- Cylinder
- Mesh Object

Surface Features:

- Material ID:
- Sm Group:
- Texture Map

Mapping Channel

- Map
- Vertex Color

Alignment:

Auto Fit

## Stack Selection Level group

**Object/Vertex/Face** Volume Select provides three selection levels. Vertex and Face levels put the modifier stack in sub-object selection. You can make one sub-object selection for each Volume Select modifier. You can then toggle the one selection between Face and Vertex level to send either up the stack. Object (top) level lets you modify the whole object while retaining any sub-object selection.

## Selection Method group

**Replace** Clears any selection passed up the stack to the Volume Select modifier, and then selects geometry within the volume.

**Add** Selects all geometry within the volume, adding to any previous selection.

**Subtract** Deselects all geometry within the volume.

**Invert** Reverses the entire selection set. Geometry that was unselected becomes selected, and vice versa.

## Selection Type group

Lets you determine whether selected faces are wholly or partially within the defined volume when you set Stack Selection Level to Face.

**Window** Selects only faces with all three vertices within the selection volume.

**Crossing** Selects faces with only one vertex within the selection volume.

## Select By group

These controls let you define the selection with a primitive, a mesh object, or by surface characteristics.

**Volume: Box/Sphere/Cylinder** To define the selection space using a standard primitive-shaped gizmo, choose one of these. You can then scale, rotate, or move the gizmo anywhere around the object.

**Volume: Mesh Object** Choose this option to use another object to define the selection space. After choosing Mesh Object, click the button below it (labeled "None" by default), and then select an object to use as the volume.

Besides mesh objects, you can use patch objects and NURBS objects. In addition, if you turn on Soft Selection rollout > Use Soft Selection, you can use spline objects and particle systems to define the selection. This latter option is quite powerful because the selection changes as the particles move.

**Mesh object button** Click this button, then select an object to define the selection space. You don't need to choose Mesh Object first, but you do need to choose Mesh Object to use the object as a volume. After you select an object, its name appears on the button.

This button is labeled "None" if no object has been chosen.

---

**NOTE** The selection depends on a volume intersecting the object. If a gizmo or object is scaled down and moved inside an object, no selection occurs because no geometry is within the volume of the gizmo.

---

**Surface Features** Defines the selection by surface characteristics instead of a geometric volume. While this doesn't have much to do with volume, it was added because Volume Select is a procedural modifier, whereas [Mesh Select](#) on page 1455 is explicit. Now, even if your topology changes, Volume Select will consistently select the faces or vertices using a particular material or smoothing group.

Indicate which type of surface characteristic to base selection on by choosing one of the following:

**Material ID** Specifies a material ID. All faces or vertices using the ID indicated by the spinner value are selected.

**Sm Group** Specifies a smoothing group. All faces or vertices using the ID indicated by the spinner value are selected.

**Texture Map** Specifies a texture map from the scene. Click the map button (labeled "None" by default) to choose a texture map to use for selection. All faces or vertices using that texture map will be selected. When using the Texture Map option, you can also specify a mapping channel or the vertex color channel using the Map/Vertex Color radio buttons and spinner.

---

**NOTE** You must apply mapping to the object below Vol. Select in its stack for the Texture Map selection to work. That is, the Vol. Select modifier must have mapping coordinates passed up the stack so it can use a texture map for selection.

---

**NOTE** If you set Selection Type to Window, vertices will be selected if all the faces they touch use the specified material or smoothing group. If you set Selection Type to Crossing, vertices will be selected if they touch any face using the specified material or smoothing group.

---

## **Alignment group**

These controls are generally used when the gizmo has been transformed out of its original orientation to the object.

**Fit** Resizes the gizmo to fit around the object or previous selection in the stack. Maintains any previous rotation.

**Center** Recenters the gizmo on the object or previous selection in the stack. Maintains any previous scale or rotation.

**Reset** Returns the gizmo to its default size and orientation. Cancels the effect of all previous transforms.

**Auto Fit** When on, automatically adjusts the gizmo size and shape to fit the object as you change the underlying topology (for example, transforming vertices).

### **Soft Selection rollout**

These controls, available only at the Vertex stack selection level, let you set a gradual falloff of influence between selected and unselected vertices. See [Soft Selection Rollout \(Edit/Editable Mesh\)](#) on page 1926 .

---

**NOTE** Soft Selection does not apply to materials or smoothing groups. However, if there was already a weighted selection passed up the stack, a Volume Select set to Material or Smoothing Group mode and *not* set to Replace will preserve the selection.

---

## **Wave Modifier**

Modify panel > Make a selection. > Modifier List > Object-Space Modifiers > Wave

Make a selection. > Modifiers menu > Parametric Deformers > Wave

The Wave modifier produces a wave effect in an object's geometry. You can use either of two waves, or combine them. Wave uses a standard gizmo and center, which you can transform to increase the possible wave effects.

The [Wave](#) on page 2695 space warp has similar features, and is useful for applying effects to a large number of objects.



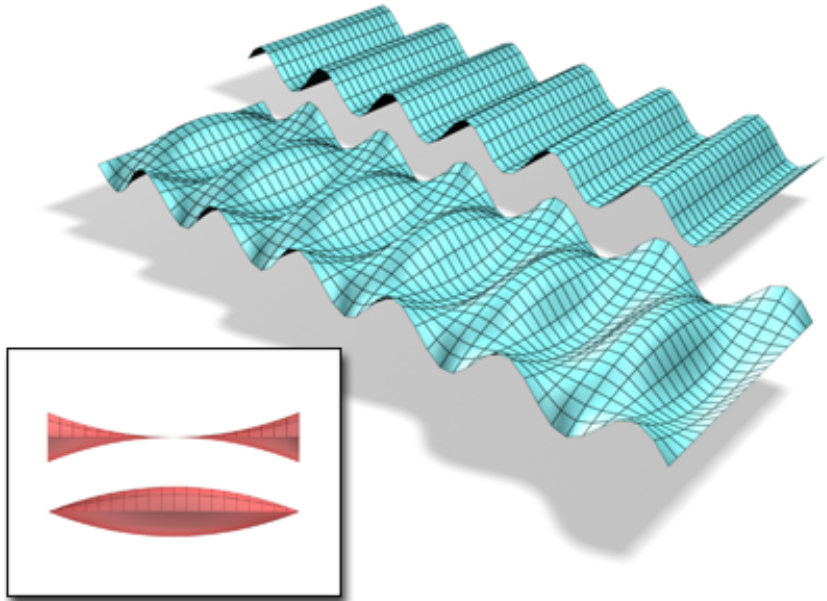

An object with the Wave modifier applied. Amplitude 1 and 2 can be changed, creating different profiles.

See also:

- [Ripple Modifier](#) on page 1583

## Procedures

To make an object wavy:

- 1 Select an object and apply the Wave modifier.

---

**TIP** To see the effect clearly, apply Wave to a broad, flat object that has many segments.

---

- 2 Set one or both values for amplitude, or the vertical height of the wave in current units.

Amplitude 1 produces a sine wave from one edge to the other, while Amplitude 2 creates a wave between the opposite edges. Switching a value from positive to negative reverses the position of peaks and troughs.

- 3 Set the length of the wave and the distance in current units between crests of both waves.  
The greater the length, the smoother and more shallow the wave for a given amplitude.

**To add a phase effect:**

- Set a phase value to shift the wave pattern over the object. Positive numbers move the pattern in one direction, while negative numbers move them in the other. This effect is especially clear when animated.

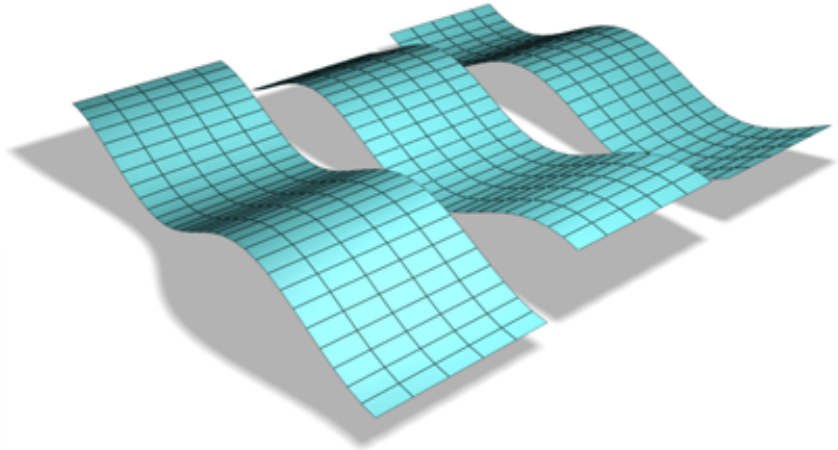

**Phase effect on a wave**

**To add a decay effect:**

- Set a decay value to increase or decrease the amplitude.  
A decay value decreases the amplitude as the distance from the center increases. As the Decay value increases, the wave is concentrated at the center and flattens until it disappears (completely decays).

## Interface

### Modifier Stack

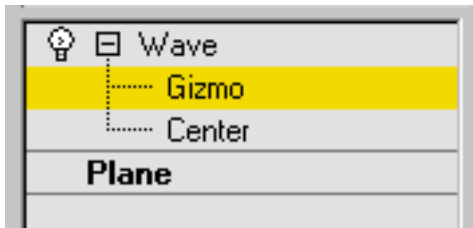

**Gizmo** At this sub-object level, you can transform and animate the gizmo like any other object, altering the effect of the Wave modifier. Translating the gizmo translates its center an equal distance. Rotating and scaling the gizmo takes place with respect to its center.

**Center** At this sub-object level, you can translate and animate the center, altering the Wave gizmo's shape, and thus the shape of the wavy object.

For more information on the stack display, see [Modifier Stack](#) on page 7427 .

### Parameters rollout

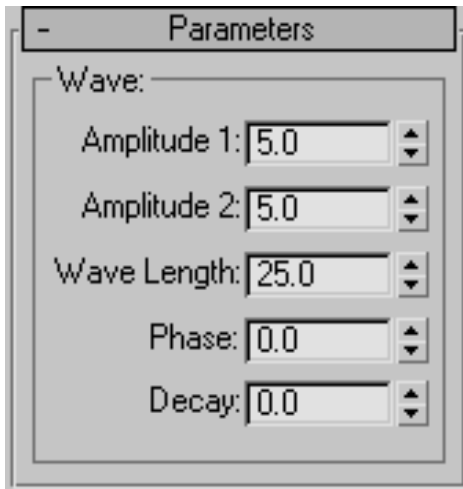

**Amplitude 1/Amplitude 2** Amplitude 1 produces a sine wave along the gizmo's Y axis, while Amplitude 2 creates a wave along the X axis (although peaks and troughs appear in the same direction with both). Switching a value from positive to negative reverses the positions of peaks and troughs.

**Wave Length** Specifies the distance in current units between the crests of both waves.

**Phase** Shifts the wave pattern over the object. Positive numbers move the pattern in one direction, while negative numbers move it in the other. This effect is especially clear when animated.

**Decay** Limits the effect of the wave generated from its origin. A decay value decreases the amplitude at increasing distance from the center. As this value increases, the wave is concentrated at the center and flattened until it disappears (completely decays).

## XForm Modifier

Modify panel > Make a selection. > Modifier List > Object-Space Modifiers > XForm

Make a selection. > Modifiers menu > Parametric Deformers > XForm

Use the XForm (short for Transform) modifier to apply transformations (Move, Rotate, Scale) to objects. The XForm has two main functions:

- To animate transformations of a sub-object selection. You can also animate the position of the modifier's center.
- To transform an object at any point in the stack.

---

**NOTE** The [Linked XForm modifier](#) on page 1440 is a variant of XForm. Linked XForm has no gizmo or center of its own. Instead, a given selection is "linked" to another object, which supplies its gizmo and center. Using Linked XForm, you can link a sub-object selection directly to the coordinate system of another object.

---

### Using XForm

XForm provides a gizmo and center for any geometry it receives from the stack whether it's a sub-object selection or the whole object. XForm has no parameters. When you move the XForm modifier gizmo, the center moves with it, along with the geometry.

You can reposition the XForm center separately from the gizmo.

## Offsetting XForm Center

At the XForm Center sub-object selection level, only the Move transform is available. This lets you reposition the center. When you return to the Gizmo level, you can rotate or scale the selection around the offset center. The center position and gizmo transformations are all animatable.

## Scaling with XForm

When you scale an object with a toolbar Scale tool, the software applies the effect to the object after all the modifiers in the stack. In some cases you might want to squash or stretch an object before applying geometric or edit modifiers. XForm makes this possible.

By applying XForm and scaling its gizmo, you can place the scaling operation anywhere in the stack.

## Using XForm with Volume Select

You can combine the XForm and [Volume Select modifiers](#) on page 1910 to animate sub-object selections. This combination makes it possible to animate both the effect of a modifier on the selection (Volume Select) and a transformation of that selection (XForm).

## Procedures

### To use the XForm modifier:

- 1 Choose a location in an object's stack and apply the XForm modifier.  
The Gizmo sub-object level is automatically activated. All transform buttons are available on the toolbar.
- 2  Move to a nonzero frame and turn on Auto Key to animate the next step.
- 3 Transform the gizmo.  
As you transform the gizmo, the selected geometry is transformed with it.

### To use XForm as a scaling modifier:

- 1 Apply XForm to an object or a sub-object selection.

## 2 Scale the gizmo.

The rescaled geometry becomes "part of the stack" because the scale transform is carried with XForm, instead of being applied after the modifiers.

### Interface

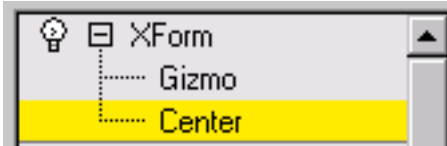

This modifier has no parameters, but you can transform the XForm gizmo and the XForm center. If you switch the selection level to the XForm center, only the Move transform is available. This lets you offset the center and transform the gizmo around it. Both offset and gizmo transformations are animatable.

# Surface Modeling

# 10

Surface modeling is more free form than geometric (parametric) modeling. Although you can create Patch and NURBS primitives from the Create panel, more often a surface model begins when you use the [quad menu](#) on page 7300 or the [modifier stack](#) on page 7427 to “collapse” a parametric model to some form of editable surface. Once you have done so, a variety of tools let you shape the surface. A lot of surface modeling work is done by editing [sub-objects](#) on page 7939 of the surface object.

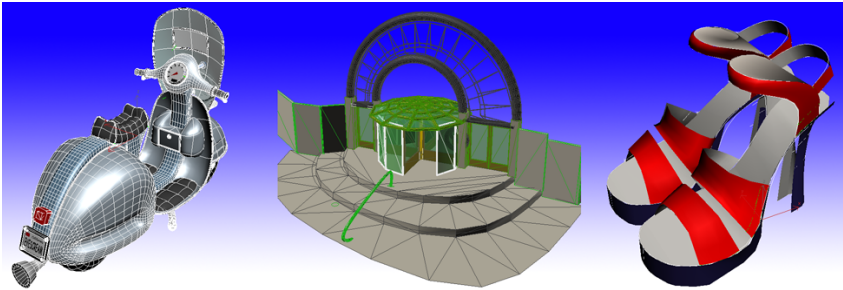

Three types of surface models: patch (left); mesh (center); NURBS (right)

See also:

- [Patch Grids](#) on page 1982
- [Editable Patch Surface](#) on page 1934
- [Editable Mesh Surface](#) on page 1990
- [Editable Poly Surface](#) on page 2038
- [NURBS Modeling](#) on page 2152
- [Subdivision Surfaces](#) on page 1926
- [Tool for Low-Polygon Modeling](#) on page 2492

# Subdivision Surfaces

A subdivision surface is a surface that has been divided into more faces while retaining the object's general shape. You perform subdivision to add more detail to an object, or to smooth it out.

You can create a subdivision surface by applying a modifier to an object. 3ds Max supports two kinds of subdivision surfaces:

- The [HSDS modifier](#) on page 1420 provides hierarchical subdivision surfaces.
- The [MeshSmooth modifier](#) on page 1460 and [TurboSmooth modifier](#) on page 1750 provide smoothing.

Both these modifiers work best as finishing tools for models.

The [Interface](#) on page 2119 for an [Editable Poly object](#) on page 2038 allows you to add a subdivision surface to this type of object without the use of a modifier.

# Soft Selection Rollout

Select an editable patch, editable mesh, editable poly, editable spline, an object that has an Edit Mesh, Edit Patch, or Edit Spline modifier applied to it, or an object that has a comparable Select modifier applied to it. > Modify panel > Choose a sub-object level. > Soft Selection rollout

The Soft Selection controls allow you to partially select sub-objects in the vicinity of an explicit selection. This causes the explicit selection to behave as if surrounded by a "magnetic field." Partially selected sub-objects within the field are drawn along smoothly as you transform the sub-object selection; the effect diminishes with distance or the "strength" of the partial selection.

This falloff is visible in the viewports as a color gradient surrounding the selection, conforming to the first part of the standard color spectrum: ROYGB (red, orange, yellow, green, blue). Red sub-objects are those you select explicitly. The highest-value soft-selected sub-objects are reddish-orange; they have the same selection value as red sub-objects, and respond the same way to manipulation. Orange sub-objects have a slightly lower selection value, and respond to manipulation a bit less strongly than do red and reddish-orange vertices. Yellow-orange sub-objects have an even lower selection value, and then yellow, green-yellow, and so on. Blue sub-objects are effectively unselected



and don't respond to manipulation, except as required by neighboring soft-selected sub-objects.

Normally, you designate a soft selection procedurally, by setting parameters and then selecting sub-objects. You can also “paint” a soft selection explicitly on poly objects. See [Paint Soft Selection group](#) on page 1930 .

By default, the soft-selection region is spherical without regard to geometric structure. Alternatively, you can use the [Edge Distance option](#) on page 1928 to limit the selection to vertices in contiguous faces.

If a sub-object selection is passed up the modifier stack, and Use Soft Selection is on, the results of modifiers that deform the object, such as Bend and XForm, are affected by the Soft Selection parameter values.

The controls in this dialog let you modify Soft Selection parameters. All sub-object levels share the same Soft Selection parameter values. Soft Selection is available for NURBS, mesh, poly, patch, and spline objects.

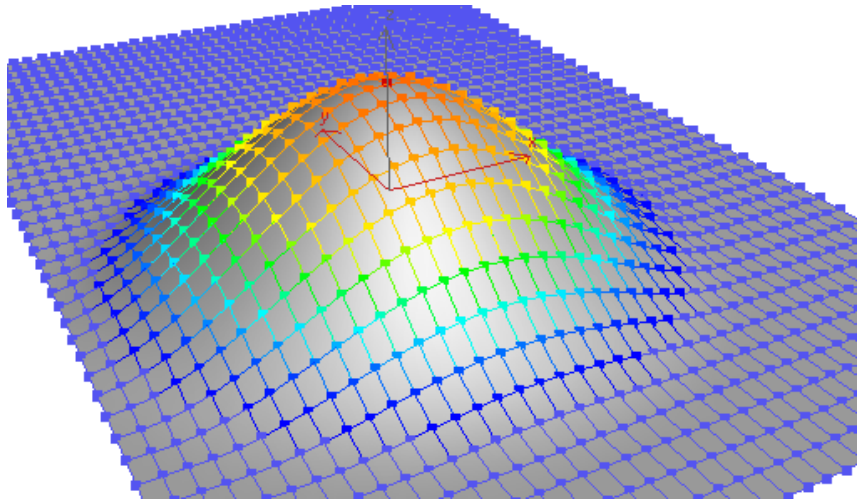

**Soft selection colors and effect on the surrounding area**

## Interface

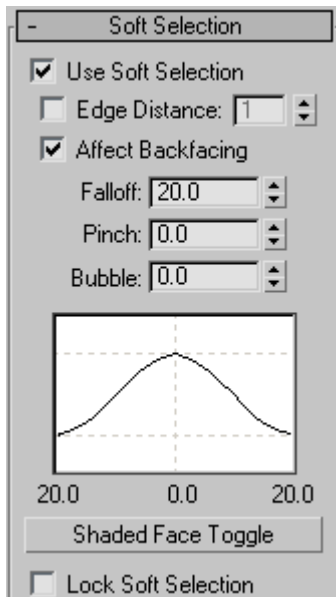

**Use Soft Selection** Affects the action of Move, Rotate, and Scale functions at sub-object levels of the editable object or Edit modifier, as well as the action of deformation modifiers applied to the object if they are operating on a sub-object selection (the latter also applies to the Select modifiers). When on, the software applies a spline curve deformation to the unselected sub-objects surrounding the selection you transform. To take effect, this check box must be on before transforming or modifying the selection.

**Edge Distance** When on, limits the soft-selection region to the specified number of edges between where you select and the maximum extent of the soft selection. The affected region is measured in terms of "edge-distance" space, along the surface, rather than real space.

This option is useful in cases where you want to select only contiguous sections of geometry. For example, if a bird's wing is folded back against its body, selecting the wing tip with Soft Selection would affect body vertices as well. But if you turn on Edge Distance, set the numeric value to the distance (in edges) along the wing that you wish to affect, and then set Falloff to an appropriate value, selecting and then moving the wing tip would move only the wing geometry.

**Affect Backfacing** When on, deselected faces whose normals face in the opposite direction to the average normal of the selected sub-objects are affected

by the soft-selection influence. In the case of vertices and edges, this applies to the normals of faces to which they're attached. Turn off Affect Backfacing when you want to manipulate faces of a thin object, such as a thin box, but don't want to affect faces on the other side of the object.

---

**NOTE** Affect Backfacing is not available when editing splines.

---

**Falloff** Distance in current units from the center to the edge of a sphere defining the affected region. Use higher falloff settings to achieve more gradual slopes, depending on the scale of your geometry. Default=20.

---

**NOTE** The region specified by the Falloff setting is depicted graphically in the viewports as a color gradient in vertices and/or edges (or, with editable polys and patches, optionally in faces). The gradient ranges from the selection color (normally red) to the non-selected sub-object color (normally blue). In addition, this gradient is updated in real time as you change the Falloff setting.

---

**NOTE** If [Edge Distance](#) on page 1928 is on, the Edge Distance setting limits the maximum falloff amount.

---

**Pinch** Raises and lowers the top point of the curve along the vertical axis. Sets the relative "pointedness" of the region. When negative, a crater is produced instead of a point. At a setting of 0, Pinch produces a smooth transition across this axis. Default=0.

**Bubble** Expands and contracts the curve along the vertical axis. Sets the relative "fullness" of the region. Limited by Pinch, which sets a fixed starting point for Bubble. A setting of 0 for Pinch and 1.0 for Bubble produces the smoothest bulge. Negative values for Bubble move the bottom of the curve below the surface, creating a "valley" around the base of the region. Default=0.

**(soft selection curve)** Graphically displays how Soft Selection will work. You can experiment with a curve setting, undo it, and try another setting with the same selection.

**Shaded Face Toggle** Displays a color gradient corresponding to the soft selection weights on faces within the soft selection range. Available only when editing patch and poly objects.

If the [Vertex Color display property](#) on page 252 of an editable poly or editable patch object is off, clicking the Shaded Face Toggle button will turn on Soft Selection Color shading. If the object already has an active Vertex Color setting, clicking the Shaded Face Toggle overrides the previous setting and changes it to Soft Selection Color.

---

**NOTE** Use the Undo command if you do not want to change your vertex color shading properties.

---

**Lock Soft Selection** Locks the soft selection in order to prevent changes to the procedural selection.

Using Paint Soft Selection (see following) turns on Lock Soft Selection automatically. If you turn it off after using Paint Soft Selection, the painted soft selection is lost. You can restore it with Undo.

### Paint Soft Selection group

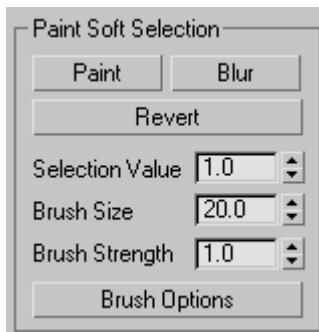

Paint Soft Selection lets you specify a soft selection explicitly by dragging the mouse over the selection. The Paint Soft Selection functionality is available at sub-object levels with Editable Poly objects, as well as with objects with the Edit Poly or Poly Select modifier applied. You can work in one of three painting modes: Paint, Revert, and Blur.

---

**TIP** You can streamline the painting process by using the [Brush Presets tools](#) on page 7293 .

---

**Paint** Lets you paint a soft selection on the active object using the current settings. Drag the mouse cursor over the object surface to paint the selection.

**Blur** Lets you paint to soften the outlines of an existing painted soft selection.

**Revert** Lets you paint to reverse a soft selection on the active object using the current settings. Drag the mouse cursor over the object surface to reverse the selection.

---

**NOTE** Revert affects only a painted soft selection, not a soft selection made by normal means. Also, Revert uses only the Brush Size and Brush Strength settings, not the Selection Value setting.

---

**Selection Value** The maximum relative selection of the painted or reverted soft selection. The values of surrounding vertices within the brush radius fall off towards a value of 0. Default=1.0.

**Brush Size** The radius of the circular brush used for painting the selection.

**Brush Strength** The rate at which painting a soft selection sets the painted sub-objects to the maximum value. A high Strength value reaches the full value quickly, while a low value requires repeated applications to reach full value.

**Brush Options** Opens the [Painter Options dialog](#) on page 1907 , with settings for brush-related properties.

## Collapse Utility

Utilities panel > Utilities rollout > Collapse button

Menu bar > Modify > Collapse

The Collapse utility lets you combine the stack operations of one or more selected objects into an [Editable Mesh](#) on page 1990 or the stack result, and, optionally, perform a [Boolean](#) on page 686 operation on them at the same time.

---

**IMPORTANT** You can't undo the results of using the Collapse utility. Before you use it, save a copy of your work file, or use [Hold](#) on page 204 .

---

**NOTE** You can also collapse an object's stack from the [modifier stack right-click menu](#) on page 7440 , and convert a selection to [editable surfaces](#) on page 1925 with the transform quadrant of the [quad menu](#) on page 7300 . These changes *are* undoable.

---

### Procedures

**To collapse the stack of an object into an editable mesh:**

- 1 On the Utilities panel, click the Collapse button.
- 2 Select the object or objects that you want to collapse.
- 3 Click the Collapse Selected button.

All modifiers are removed from the modifier stack and the object becomes an editable mesh.

### To collapse the stack of an object into an editable surface other than mesh:

- 1 On the Utilities panel, click the Collapse button.
- 2 On the Collapse rollout, set Output Type to Modifier Stack Result.
- 3 Select the object or objects that you want to collapse.
- 4 Apply a modifier that outputs the desired ultimate surface type, such as [Turn To Poly](#) on page 1761 or [Turn To Patch](#) on page 1758 .
- 5 Click the Collapse Selected button.

All modifiers are removed from the modifier stack and the object becomes an editable surface of the type indicated by the modifier.

### To subtract multiple objects from another object:

The Boolean compound object restricts you to combining objects one at a time. With the Collapse utility, you can perform Boolean operations on several objects simultaneously.

- 1 For the purposes of this procedure, we'll call the object to have shapes subtracted from *Main*. Create and arrange *Main* and the objects to subtract from it. For example, you might have several boxes penetrating a sphere (*Main*) in different places; subtracting them will produce box-shaped cutouts in the sphere's surface.
- 2 Select *Main*, and then select the objects to be subtracted from it.  
The first object you select before collapsing is the one from which the others are subtracted.
- 3 On the Utilities panel, click the Collapse button.
- 4 On the Collapse rollout, set Output Type to Mesh, if necessary.
- 5 In the Collapse To group, choose Single Object.
- 6 Turn on Boolean, and then choose Subtraction.
- 7 Click the Collapse Selected button.

All objects you selected after *Main*, the first object, are subtracted from *Main*.

## Interface

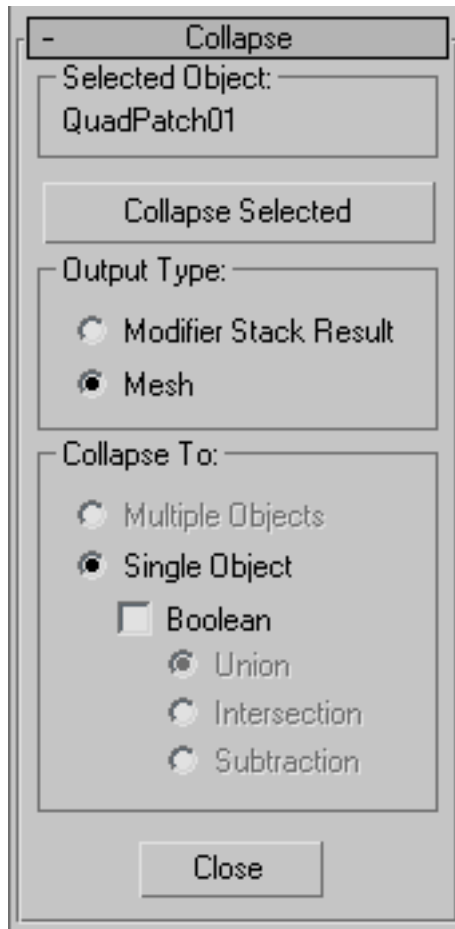

### Selected Object group

Displays the name of the current selection. If more than one object is selected, "[Number] Objects Selected." displays.

**Collapse Selected** Collapses the selected objects. The method of collapse depends on the settings of the options below this button.

### Output Type group

Specifies the type of object that results from the collapse.

**Modifier Stack Result** The resultant object will be the same as if you had collapsed its stack. In most cases, this results in a mesh object, as when using the Mesh option. However, if the object has an Edit Patch modifier so that its stack produces a patch, then the result will be a patch object rather than a mesh. Likewise, a shape with Edit Spline modifiers becomes an editable spline. When this option is used, the Collapse To options are unavailable, and all selected objects remain independent objects.

**Mesh** All selected objects become editable meshes regardless of their type before they were collapsed.

### **Collapse To group**

Specifies how the selected objects are combined. These options are available only when you choose the Mesh option.

**Multiple Objects** Collapses each object in the selection but maintains each as an independent object. When this option is selected, the Boolean options are disabled.

**Single Object** Collapses all selected objects into a single, editable mesh object.

**Boolean** Performs Boolean operations on the selected objects. During the Boolean calculation, a progress bar appears along with a Cancel button. If any objects in the Boolean operation fail, that object is skipped, but the Collapse proceeds. The result is not a Boolean compound object, but a single editable mesh. The type of Boolean is specified by the following option.

**Union** Combines the several objects, removing intersecting geometry.

**Intersection** Removes all but the intersecting geometry.

**Subtraction** Maintains the first object selected while subtracting the subsequently selected objects. For example, to subtract several cylinders from a box, click to select the box, hold down Ctrl, and region-select the cylinders.

**Close** Exits the Collapse utility.

## **Editable Patch Surface**

Create or select an object > Modify panel > Right-click object's entry in the stack display > Convert To: Editable Patch

Create or select an object > Right-click the object > Transform (lower-right) quadrant of the quad menu > Convert To: > Convert to Editable Patch



Editable Patch provides controls for manipulating an object as a patch object and at five sub-object levels: vertex, handle, edge, patch, and element.

Editable Patch objects provide the same basic functionality as the [Edit Patch modifier](#) on page 1290 . Because working with them requires less processing and memory, we recommend you use Editable Patch objects rather than the Edit Patch modifier whenever possible.

When you convert an object to Editable Patch format or apply an Edit Patch modifier, 3ds Max converts the object's geometry into a collection of separate Bezier [patches](#) on page 7888 , each patch made up of a framework of vertices and edges, plus a surface.

- The *framework* of control points and connecting tangents defines the surface. Transforming the components of this framework is the primary technique in patch modeling. The framework does not appear in scanline renderings.
- The *surface* is the Bezier patch surface, whose shape is controlled by the vertices and edges. The surface is the renderable geometry of the object.

Prior to version 3 of the software, some patch objects contained a lattice that appeared separate from the surface. This is no longer the case: The control framework conforms exactly to the surface, making it easier to visualize the results of patch modeling.

The output of the [Surface modifier](#) on page 1695 is a patch surface. If you are modeling with splines and are using the Surface modifier to generate a patch surface from the spline cage, you can use an [Edit Patch modifier](#) on page 1290 for further modeling.

### Show End Result



Turn on Show End Result on the Modify panel if you have modifiers above the Editable Patch modifier and want to see the result of all the modifiers in the modifier stack. This function will remain on until you turn it off.

### See also:

- [Edit Modifiers and Editable Objects](#) on page 1027
- [Modifying at the Sub-Object Level](#) on page 1029
- [Modifier Stack Controls](#) on page 7427

## Procedures

### To work at a sub-object level:

- 1 In the modifier stack display, choose a selection level: Element, Patch, Edge, or Vertex.
- 2 Select the sub-object geometry you want to edit.

### To attach an object using Edit Patch:

- 1 Select an editable patch object, or an object with the Edit Patch modifier applied.
- 2 In the Modify panel > Geometry rollout > Topology group, click Attach.
- 3 Turn off Reorient, if necessary.
- 4 Select an object to attach.  
The object takes on a patch structure and stays in its original location.  
The attached object is now part of the editable patch object. The Tessellation settings for the original object affect attached objects as well.

### To attach and reorient an object:

- Turn on Reorient before attaching the object.  
The object is both attached and moved to align with the patch object. The pivot of the attached object matches the pivot of the Edit Patch object.

### To detach a patch surface:

- 1 Make a selection at the Patch sub-object level.
- 2 If you want to reorient the detached surface, turn on Reorient.
- 3 Click Detach.  
A Detach dialog appears.
- 4 Name the detached surface.  
The detached surface remains in place if you chose not to reorient it. It is deselected and assigned a different color.

### To copy a patch surface:

- 1 Make a selection at the Patch sub-object level.

- 2 In the Geometry rollout > Topology group, turn on Copy.
- 3 If you want to reorient the copied surface, turn on Reorient.
- 4 Click Detach.  
A Detach dialog appears.
- 5 Name the patch copy.  
The copied object remains in place if you chose not to reorient it.

**To delete patches:**

- 1 Make a selection at the Patch sub-object level.
- 2 Click Delete.  
The patches disappear.

**To subdivide a patch:**

- 1 Make a selection at the Patch sub-object level.
- 2 Turn on Propagate to maintain surface continuity.
- 3 Click Subdivide.

The patch selection is subdivided, increasing the number of patches.

You can repeat this process, subdividing multiple times. Each subdivision increases the number of patches, which become increasingly smaller. The following figure is an example of modeling a highly subdivided surface.

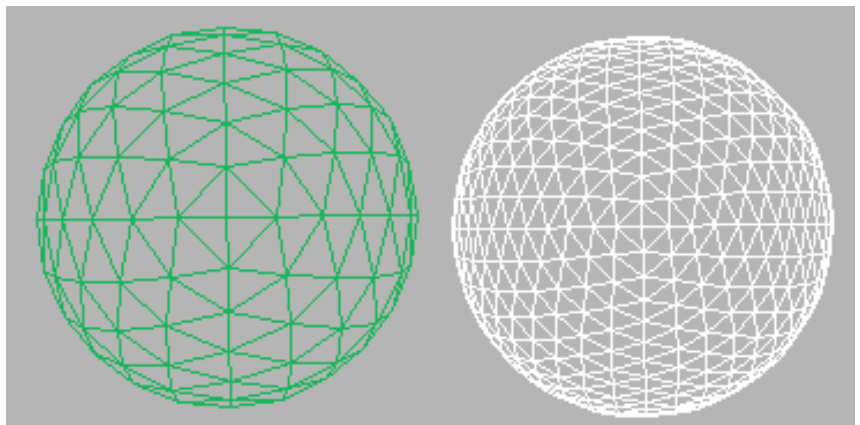

**To subdivide an edge:**

- 1 At the Edge sub-object level, make an edge selection.  
A single edge is indicated by its coordinate axis or transform gizmo at the center of the edge. For multiple edges, the axis icon is at the center of the selection set.
- 2 Optionally, turn on Propagate to maintain surface continuity.
- 3 Click Subdivide.  
The edge selection is subdivided. Each new edge is on the boundary of a new, smaller patch.

**To add a patch:**

- 1 At the Edge sub-object level, select an open edge (one that bounds a single patch, and therefore is not shared with another patch).
- 2 Click Add Tri or Add Quad.  
A new patch is added to the surface.

**To unlock interior edges of selected patches:**

- 1 At the Patch sub-object level, select one or more patches.
- 2 Right-click the selection and choose Manual Interior from the pop-up menu.  
The check mark moves from Auto Interior, the default, to Manual Interior. Interior edges and their vertices are now unlocked. If you now transform the patch, the interior edges remain static. To transform the interior vertices, see the following procedure.

**To transform interior vertices:**

- 1 At the Patch sub-object level, select one or more patches.
- 2 Right-click the selection and choose Manual Interior from the pop-up menu.  
The check mark moves from Auto Interior, the default, to Manual Interior.
- 3 Switch to Handle level.  
The interior vertices appear as yellow squares.
- 4 Transform the interior vertices of the selected patches.

### **To anchor a patch:**

By default, the welding process shifts the geometry of both patches to a common center. You can anchor one patch so that the other patch moves to its location when the weld occurs.

- 1 At the Patch (Patch) level, before you begin the weld, select the patch you want anchored.
- 2 Return to Vertex level and weld the vertices.  
When the weld occurs, the anchor patch remains fixed while the other patch moves to make the weld.

### **To create a new element, do one of the following:**

- 1 Shift+drag one or more patches.
- 2 Shift+extrude one or more patches.
- 3 Shift+extrude one or more edges.
- 4 Shift+drag an element.

## **Interface**

### **Selection rollout**

For information about these settings, see [Selection Rollout \(Editable Patch\)](#) on page 1940 .

### **Soft Selection rollout**

For information on the Soft Selection rollout settings, see [Soft Selection Rollout](#) on page 1926 .

### **Geometry and Surface Properties rollouts**

The [Geometry rollout](#) on page 1968 provides functions for editing a patch object and its sub-objects, and the Surface Properties controls let you modify the object's rendering characteristics. For detailed information on sub-object-specific controls, select any of the links below:

[Editable Patch \(Object\)](#) on page 1944

[Editable Patch \(Vertex\)](#) on page 1947

[Editable Patch \(Handle\)](#) on page 1954

[Editable Patch \(Edge\)](#) on page 1956

[Editable Patch \(Patch\)](#) on page 1959

## Selection Rollout (Editable Patch)

Create or select an object > Modify panel > Right-click object's entry in the stack display > Convert To: Editable Patch > Selection rollout

Create or select an object > Right-click the object > Transform (lower-right) quadrant of the quad menu > Convert To: > Convert to Editable Patch > Selection rollout

The Selection rollout provides buttons for selecting the sub-object level, working with named selections, display and filter settings, and displays information about selected entities.

Editable Patch has five levels of sub-object editing: Vertex, Handle, Edge, Patch, and Element. The selection you make at each level appears in the viewport as a component of the patch object. Each level maintains its own sub-object selection. When you return to a level, the selection reappears.

Clicking a sub-object level button here is the same as clicking a sub-object type in the Modifier Stack rollout. Click the button again to turn it off and return to the object selection level.

## Interface

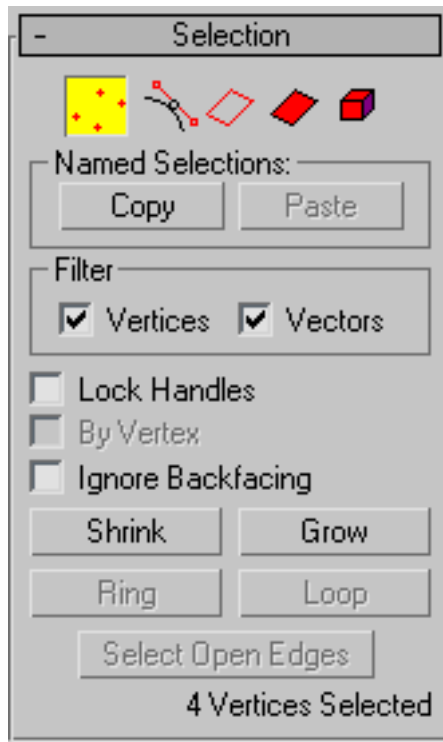

**Vertex** Lets you select vertex control points and their vector handles on a patch object. At this level, vertices can be welded and deleted.

By default, a transform gizmo or axis tripod appears at the geometric center of the selected vertices. If you turn on [Gizmo Preferences](#) on page 7570 > Allow Multiple Gizmos, however, gizmos or tripods appear at all selected vertices.

Vector handles appear as small green squares around selected vertices. Also, with certain objects you may see interior vertices represented as yellow squares.



**Handle** Lets you select vector handles associated with each vertex. This level lets you manipulate the handles without needing to deal with vertices.

A Transform gizmo or axis tripod appears at the geometric center of the selected handles.

At this level, vector handles appear as small green squares around all vertices. Also, with certain objects you may see interior vertices represented as yellow squares.



**Edge** Selects a bounding edge of the patch object. At this level, edges can be subdivided, and new patches added to open edges.

A Transform gizmo or axis tripod appears in the middle of a single selected edge. For multiple selected edges, the icon is at the selection center.



**Patch** Selects an entire patch. At this level, a patch can be detached, deleted, or its surface subdivided. When a patch is subdivided, the surface is broken into smaller patches, each with its own vertices and edges.



**Element** Select and edit an entire element. An element has contiguous faces.

---

**TIP** You can highlight selected patches in a shaded display by turning on Shade Selected Faces in the Viewport Properties dialog. Right-click over the viewport name and choose Configure in the menu to display the Viewport Properties dialog. You can also use the default keyboard shortcut, **F2**, to toggle this feature.

---

### Named Selections group

These functions work with named sub-object selection sets. To create a named sub-object selection, make the selection, and then enter a name in the Named Selection Sets field on the toolbar. For more information, see [Named Selection Sets](#) on page 179 .

**Copy** Places a named sub-object selection into the copy buffer. After clicking this button, choose the named sub-object selection from the Copy Named Selection dialog that appears.

**Paste** Pastes the named sub-object selection from the copy buffer.

You can use Copy and Paste to copy sub-object selections between different objects.

### Filter group

These two check boxes, available only at the Vertex sub-object level, let you select and transform vertices, vectors (handles on the vertices), or both. When a check box is turned off, you can't select the corresponding element type.



Thus, for example, if you turn off Vertices, you can manipulate vectors without accidentally moving a vertex.

---

**TIP** For easier editing of vectors only, use the [Handle sub-object level](#) on page 1954 .

---

You can't turn off both check boxes. When you turn off either check box, the other one becomes unavailable. At that point, you can manipulate the element corresponding to the check box that's on, but you can't turn it off.

**Vertices** When on, you can select and move vertices.

**Vectors** When on, you can select and move vectors.

**Lock Handles** Affects only Corner vertices. Locks the tangent vectors together so that when you move one, you move them all. Available only at the Vertex sub-object level.

**By Vertex** When you click a vertex, any handles, edges, or patches that use that vertex, depending on the current sub-object level, are selected. Available only at the Handle, Edge, and Patch sub-object levels.

This also works with Region Select.

**Ignore Backfacing** When on, selection of sub-objects selects only those sub-objects whose normals are visible in the viewport. When off (the default), selection includes all sub-objects, regardless of the direction of their normals. Use this on a complex patch model where you want to select only visible patches.

---

**NOTE** The state of the Backface Cull setting in the Display panel does not affect sub-object selection. Thus, if Ignore Backfacing is off, you can still select sub-objects, even if you can't see them.

---

**Shrink** Reduces the sub-object selection area by deselecting the outermost sub-objects. If the selection size can no longer be reduced, the remaining sub-objects are deselected. Unavailable at the Handle sub-object level.

**Grow** Expands the selection area outward in all available directions. Unavailable at the Handle sub-object level.

**Ring** Expands an edge selection by selecting all edges parallel to the selected edges. Available only at the Edge sub-object level.

**Loop** Expands the selection as far as possible, in alignment with selected edges. Available only at the Edge sub-object level.

**Select Open Edges** Selects all edges that are used by only one patch. Available only at the Edge sub-object level.

You can use this to troubleshoot a surface; open edges will be highlighted.

**Selection Information** At the bottom of the Selection rollout is a text display giving information about the current selection. If multiple sub-objects are selected, or none is selected, the text gives the number and type selected. If one sub-object is selected, the text gives the identification number and type of the selected item.

## Editable Patch (Object)

Select an editable patch > Modify panel > Editable patch (not a sub-object level) selected in the modifier stack

Select an editable patch > Right-click the patch > Tools 1 (upper-left) quadrant of the quad menu > Sub-objects > Top-level

The functions available at the editable patch object level (that is, when no sub-object level is chosen) are also available at all sub-object levels, and work exactly the same at each level.

### Interface

#### Selection rollout

For information on these settings, see [Editable Patch Surface](#) on page 1934 .

## Geometry rollout

**Geometry**

Subdivision

Subdivide  Propagate

Bind Unbind

Topology

Add Tri Add Quad

Create

Detach  Reorient  
 Copy

Attach  Reorient

Delete Break

Hide Unhide All

Weld

Selected 0.1

Target 4 pixels

Extrude & Bevel

Extrude Bevel

Extrusion: 0.0

Outlining: 0.0

Normal:  Group  Local

Bevel Smoothing:

Start End

Smooth  Smooth

Linear  Linear

None  None

Tangent

Copy Paste

Paste Length

Surface

View Steps: 5

Render Steps: 5

Show Interior Edges

Use True Patch Normals

Miscellaneous

Create Shape

Patch Smooth

See [Geometry Rollout \(Patch\)](#) on page 1968 for detailed descriptions of these controls.

### Surface Properties rollout

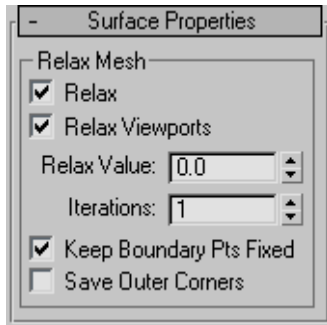

The Relax Mesh controls on the Surface Properties rollout change the apparent surface tension by moving vertices closer to, or away from, their neighbors. The typical result is that the object gets smoother and a little smaller as the vertices move toward an averaged center point. You can see the most pronounced effects on objects with sharp corners and edges.

**Relax** Turns on the relax function for renderings.

**Relax Viewports** Turns on the relax function for viewports.

**Relax Value** Sets the distance a vertex moves as a percentage of the distance between a vertex and the average location of its neighbors. Range=-1.0 to 1.0. Default=0.5.

**Iterations** Sets how many times Relax is repeated. Each iteration recalculates average vertex locations based on the result of the previous iteration. Default=1.

**Keep Boundary Points Fixed** Vertices at the edge of open patches do not relax. Default=on.

**Save Outer Corners** Preserves the original positions of vertices farthest away from the object center.

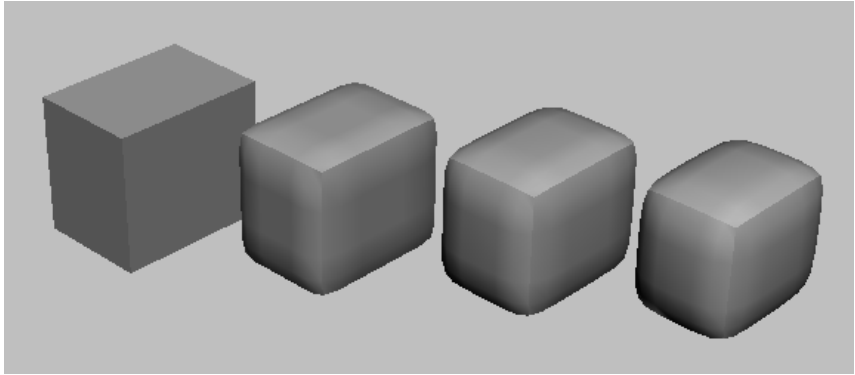

A patch box with Relax off (left), and Relax Value=1.0, with 1, 2, and 3 iterations (left to right)

## Editable Patch (Vertex)

Select an editable patch > Modify panel > Expand Editable Patch in the stack display > Vertex sub-object level

Select an editable patch > Modify panel > Selection rollout > Vertex button

Select an editable patch > Right-click the patch > Tools 1 (upper-left) quadrant of the quad menu > Sub-objects > Vertex

At the Editable Patch (Vertex) level, you can select single and multiple vertices and move them using standard methods. You can also move and rotate [vector handles](#) on page 7964 , thus affecting the shapes of any patches connected to the vertex.

### Procedures

**To transform either vertices or vectors:**

- 1 At Patch (Vertex) level, with Selection rollout > Filter group > Vertices turned on, select vertices in the patch object you want to transform. Vertices and their vectors both appear.
- 2 Turn off one of the filters, leaving the other on, and choose a transform. A transform cursor appears when you move onto a vertex or vector in the selection set. You can toggle between filters to alternatively transform either component.

### To switch vertex types:

- 1 Right-click a patch vertex.
- 2 Choose from commands on the quad menu. The Tools 1 (upper-left) quadrant includes two options specific to patch vertices:
  - **Coplanar:** If you set a patch control point's property to be coplanar, it's like locking the handle of the outgoing vector for that point. Moving a handle attached to a coplanar vertex causes the opposite vectors to adjust their positions to maintain a coplanar surface. This option is the default and gives smooth transitions between patches.
  - **Corner:** If you set a patch control point's property to be corner, it unlocks the handle of the outgoing vector, so you can create a discontinuous break in the patch surface.

### To switch vertex types from Coplanar to Corner, do one of the following:

- 1 Hold down Shift as you move a handle of a Coplanar vertex.  
This switches the vertex type to Corner.  
If Lock Handles is off (the default), Shift+Move "breaks" the handle, allowing it to move independently.  
If Lock Handles is on, the handles remain locked in their coplanar relationship. However, the vertex is still switched to Corner, and turning off Lock Handles lets you move the handles separately.
- 2 Right-click the vertex, and choose Corner from the quad menu.

### To delete a vertex:

- 1 At Patch (Vertex) level, select a vertex.
- 2 Click Delete.  
The vertex and all patches sharing this control point are deleted.

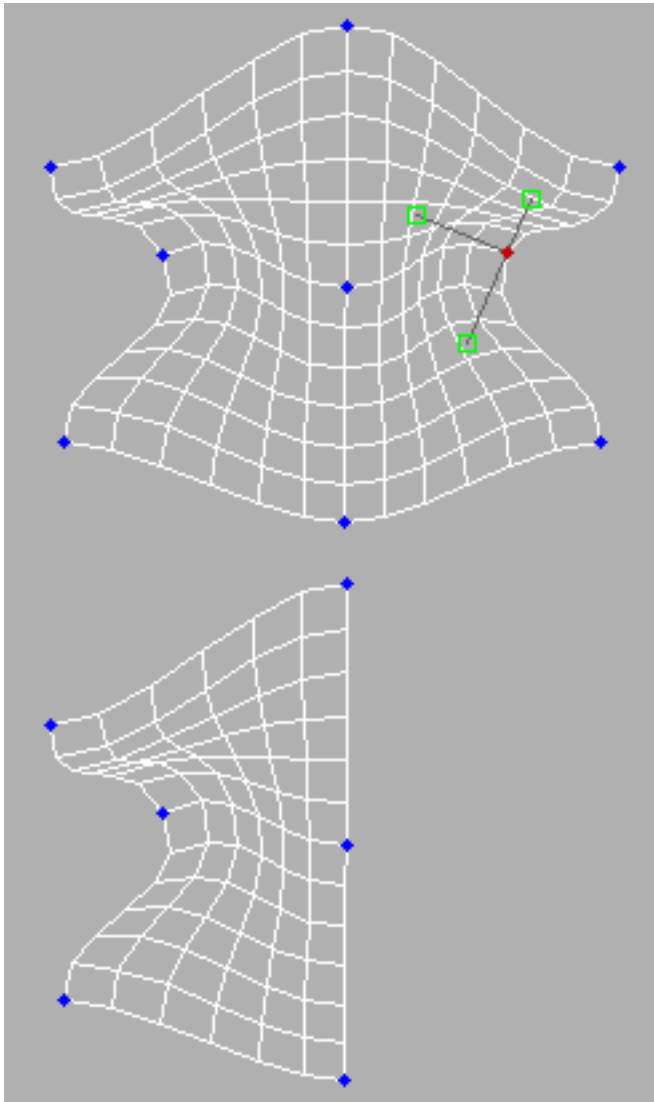

Deleting vertices

**To weld vertices:**

- 1 At Patch (Vertex) level, select two valid vertices on different patches.

- 2 Set Weld Threshold to a value at least equal to the distance between the selected vertices.
  - 3 Click Selected.
- The two vertices move together and join.

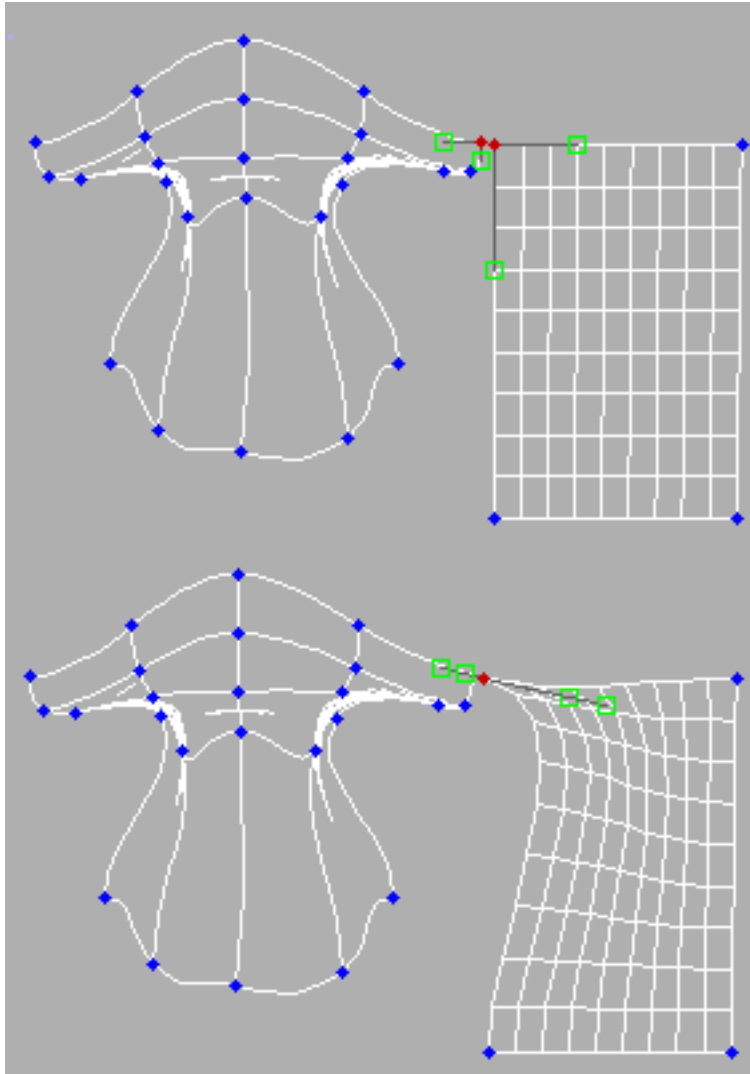

Welding vertices



### To transform interior vertices:

Using program defaults, you can select only vertices and vectors on the outer edge or boundary of a patch. This default is known as Auto Interior.

In some cases, you might want to move the interior vertices. For example, you might want to tweak a patch's curvature without having to subdivide the patch.

- At [Patch level](#) on page 1959 , you can change the default on a patch-by-patch basis by right-clicking a patch and choosing Manual Interior from the shortcut menu. This lets you select and transform individual interior vertices. These vertices appear as yellow squares in the viewports.

---

**WARNING** If you return a patch to the default, changes due to Manual Interior are lost.

---

---

**NOTE** Certain objects are automatically set to Manual Interior when converted to patch objects. In such cases, you can see all interior vertices when you go to the Vertex sub-object level.

---

## Interface

### Selection rollout

For information on the controls in this rollout, see [Selection Rollout \(Editable Patch\)](#) on page 1940 .

### Soft Selection rollout

See [Soft Selection Rollout](#) on page 1926 for information on the Soft Selection rollout settings.

## Geometry rollout

**Geometry**

**Subdivision**

Subdivide  Propagate

Bind Unbind

**Topology**

Add Tri Add Quad

Create

Detach  Reorient  
 Copy

Attach  Reorient

Delete Break

Hide Unhide All

**Weld**

Selected 0.1

Target 4 pixels

**Extrude & Bevel**

Extrude Bevel

Extrusion: 0.0

Outlining: 0.0

Normal:  Group  Local

Bevel Smoothing:

Start	End
<input checked="" type="radio"/> Smooth	<input checked="" type="radio"/> Smooth
<input type="radio"/> Linear	<input type="radio"/> Linear
<input type="radio"/> None	<input type="radio"/> None

**Tangent**

Copy Paste

Paste Length

**Surface**

View Steps: 5

Render Steps: 5

Show Interior Edges

Use True Patch Normals

**Miscellaneous**

Create Shape

Patch Smooth

See [Geometry Rollout \(Patch\)](#) on page 1968 for detailed descriptions of these controls.

## Surface Properties rollout

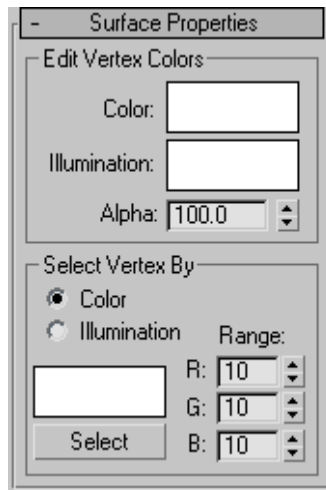

### Edit Vertex Colors group

Use these controls to assign the color, illumination color (shading), and alpha (transparency) values of selected vertices.

**Color** Click the color swatch to change the color of selected vertices.

**Illumination** Click the color swatch to change the illumination color of selected vertices. This lets you change the color of shadows without changing the vertex colors.

**Alpha** Lets you assign an alpha (transparency) value to selected vertices.

The spinner value is a percentage; zero is completely transparent and 100 is completely opaque.

### Select Vertex By group

**Color and Illumination radio buttons** These buttons determine whether to select vertices by vertex color values or vertex illumination values.

**Color Swatch** Displays the Color Selector, where you can specify a color to match.

**Select** Depending on which radio button is selected, selects all vertices whose vertex color or illumination values either match the color swatch, or are within the range specified by the RGB spinners.

**Range** Specifies a range for the color match. All three RGB values in the vertex color or illumination must either match the color specified by the Color swatch in Select By Vertex Color, or be within plus or minus the values in the Range spinners. Default=10.

## Editable Patch (Handle)



Select an editable patch > Modify panel > Expand the editable patch in the stack display > Handle sub-object level

Select an editable patch > Modify panel > Selection rollout > Handle button

Select an editable patch > Right-click the patch > Tools 1 (upper-left) quadrant of the quad menu > Sub-objects > Handle

The Handle sub-object level in Editable Patch provides direct access to vertex handles, or vectors, without going through the Vertex sub-object level. Handles are still accessible at the Vertex sub-object level, but the Handle level provides enhanced functionality as follows:

- The ability to select multiple handles for transformation and application of operations such as Patch Smooth to them.
- Usage of the transform gizmo when manipulating handles.
- Elimination of the possibility of inadvertently transforming vertices.
- Support for named selection sets of handles.
- Copying and pasting handles.
- Use the [Align tool](#) on page 938 for aligning handles.

## Interface

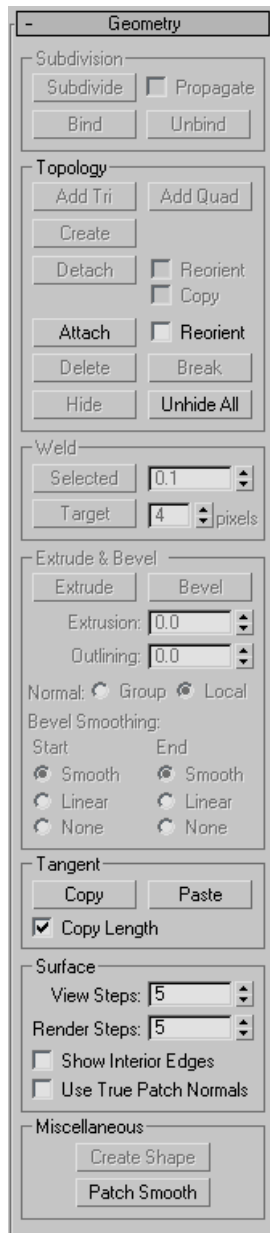

See [Geometry Rollout \(Patch\)](#) on page 1968 for detailed descriptions of these controls.

## Editable Patch (Edge)

Select an editable patch > Modify panel > Expand the editable patch in the stack display > Edge sub-object level

Select an editable patch > Modify panel > Selection rollout > Edge button

Select an editable patch > Right-click the patch > Tools 1 (upper-left) quadrant of the quad menu > Sub-objects > Edge

An edge is the portion of a patch object between two adjacent vertices. When at the Editable Patch (Edge) level, you can select single and multiple segments and move, rotate, and scale them using standard methods. You can also hold down the Shift key and drag an edge to create a new patch. Holding down the Shift key during edge extrusion creates a new element.

### Procedures

#### To unlock interior edges:

When you move an outer or boundary edge of a patch, the adjacent interior edges are normally “locked” so that they move in parallel with the boundary edge. This is often useful, because it provides a uniform transition across the patch. This default is known as Auto Interior.

- At [Patch level](#) on page 1959, you can change the default on a patch-by-patch basis by right-clicking a patch and choosing Manual Interior from the Tools 1 (upper-left) quadrant of the quad menu. Thereafter, when you move a boundary edge, interior edges are affected in a nonlinear way. The interior edges are no longer locked to the boundary edge.

---

**WARNING** If you return a patch to the default, changes caused by Manual Interior are lost.

---

## **Interface**

### **Selection rollout**

**Select Open Edges** Selects all edges that are used by only one patch. You can use this to troubleshoot a surface; open edges will be highlighted.

For information on the other controls in this rollout, see [Selection Rollout \(Editable Patch\)](#) on page 1940 .

### **Soft Selection rollout**

See [Soft Selection Rollout](#) on page 1926 for information on the Soft Selection rollout settings.

## Geometry rollout

**Geometry**

**Subdivision**

Subdivide  Propagate

Bind Unbind

**Topology**

Add Tri Add Quad

Create

Detach  Reorient  
 Copy

Attach  Reorient

Delete Break

Hide Unhide All

**Weld**

Selected 0.1

Target 4 pixels

**Extrude & Bevel**

Extrude Bevel

Extrusion: 0.0

Outlining: 0.0

Normal:  Group  Local

Bevel Smoothing:

Start	End
<input checked="" type="radio"/> Smooth	<input checked="" type="radio"/> Smooth
<input type="radio"/> Linear	<input type="radio"/> Linear
<input type="radio"/> None	<input type="radio"/> None

**Tangent**

Copy Paste

Paste Length

**Surface**

View Steps: 5

Render Steps: 5

Show Interior Edges

Use True Patch Normals

**Miscellaneous**

Create Shape

Patch Smooth



See [Geometry Rollout \(Patch\)](#) on page 1968 for detailed descriptions of these controls.

## Editable Patch (Patch)

Select an editable patch > Modify panel > Expand the editable patch in the stack display > Patch sub-object level

Select an editable patch > Modify panel > Selection rollout > Patch button

Select an editable patch > Right-click the patch > Tools 1 (upper-left) quadrant of the quad menu > Sub-objects > Patch

A patch is an area of a patch object, defined by three or four surrounding edges and vertices. Controls described in this topic let you manipulate a patch object at the patch level. As well as moving and rotating patches, you can create a separate element by holding down the Shift key during a move operation. This creates a separate element of the selected patches.

### **Texture Mapping Patches: Interpolation in Curved Space**

Patches can now be mapped in curved space; this means simplified texture mapping for patches. A planar map on a complex patch object will not be distorted. At the Patch sub-object level there is a parameter in the right-click quad menu (Tools 1 quadrant) called Linear Mapping. If you leave Linear Mapping off, then textures are interpolated in curved space and behave much like texture mapping a mesh object, predictably.

In the old method, patch mapping is interpolated between the knot points. This works well with procedural maps but not so well with bitmaps, since each patch is linear in UV space.

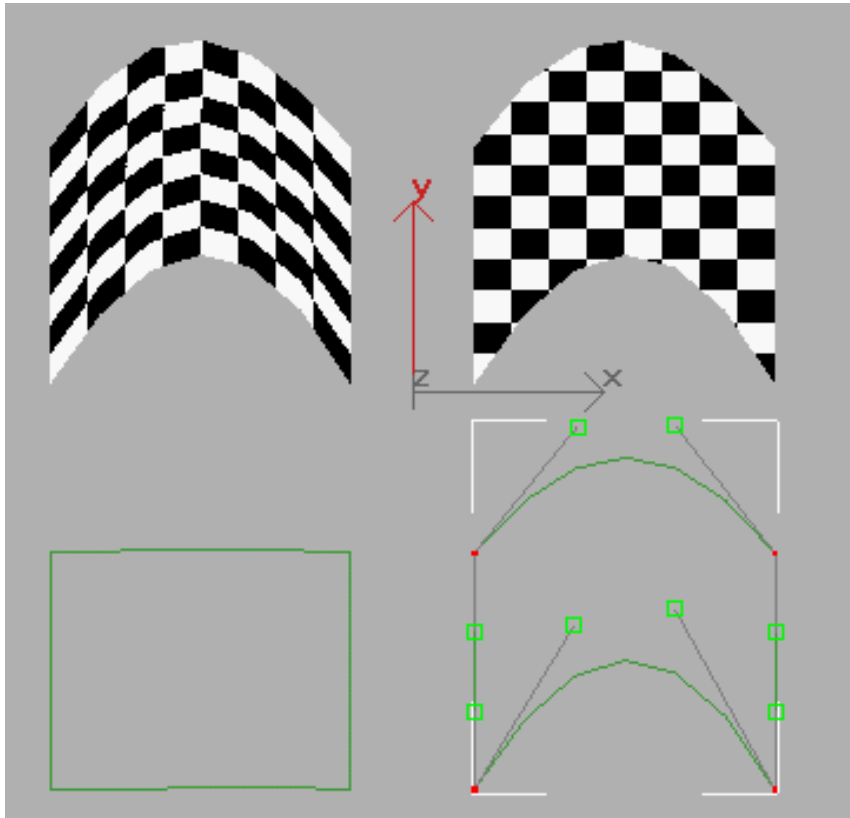

**A complex patch (on right) no longer deforms a bitmap**

The two leftmost patches show Linear patch mapping. The top left patch is a patch with planar mapping and the bottom left shows its UVW space representation. The patch on the right is a curved projection where the vectors are used in UVW space projection. Notice the bottom right represents the UVW space and notice how the handles and knots contribute to the shape of the UVW space.

In short, leave the Linear option off for predictable planar maps. Leave the linear mapping option on for backward compatibility.

---

**NOTE** The Unwrap UVW modifier now supports the new patch curve mapping. Spline handles can be manipulated in the Edit dialog in the Unwrap UVW modifier.

---

## **Interface**

### **Selection rollout**

For information on the controls in this rollout, see [Selection Rollout \(Editable Patch\)](#) on page 1940 .

### **Soft Selection rollout**

See [Soft Selection Rollout](#) on page 1926 for information on the Soft Selection rollout settings.

## Geometry rollout

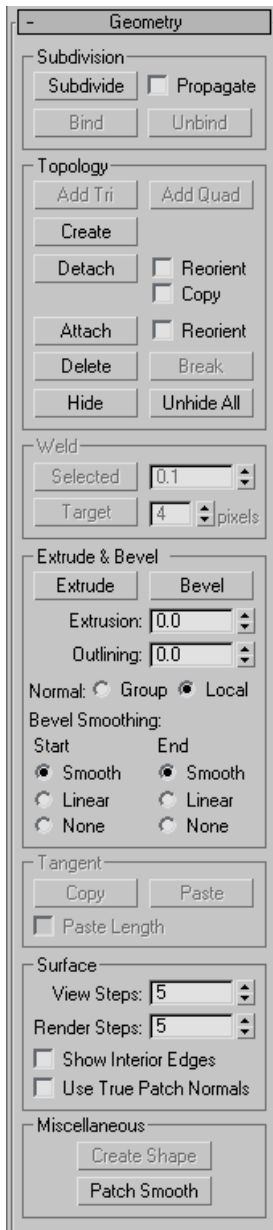

See [Geometry Rollout \(Patch\)](#) on page 1968 for detailed descriptions of these controls.

### Surface Properties rollout



These controls let you work with patch normals, material IDs, smoothing groups and vertex colors.

### Normals group

**Flip** Reverses the direction of the surface normals of the selected patches.

**Unify** Flips the normals of an object so that they all point in the same direction, usually outward. This is useful for setting an object's patches to appropriate orientations, thus eliminating apparent holes in the object surface.

**Flip Normal Mode** Flips the normal of any patch you click. To exit, click this button again or right-click anywhere in the program interface.

---

**TIP** The best way to use Flip Normal Mode is to set up your viewport to display with Smooth+Highlight and Edged Faces on. If you use Flip Normal Mode with default settings, you'll be able to flip a patch away from you, but you won't be able to flip it back. For best results, turn off Ignore Backfacing in the Selection rollout. This lets you click any patch and flip the direction of its normal, regardless of its current direction.

---

## Material group

These controls let you use [multi/sub-object materials](#) on page 5558 with patches.

**Set ID** Lets you assign a particular [material ID](#) on page 7842 number to selected patches for use with multi/sub-object materials and other applications. Use the spinner or enter the number from the keyboard. The total number of available IDs is 65,535.

**Select ID** Selects patches or elements corresponding to the Material ID specified in the adjacent ID field. Type or use the spinner to specify an ID, then click the Select ID button.

**[Select By Name]** This drop-down list shows the names of sub-materials if an object has a Multi/Sub-Object material assigned to it. Click the drop arrow and choose a sub-material from the list. The patches or elements that are assigned that material are selected. If an object does not have a Multi/Sub-Object material assigned, the name list is unavailable. Likewise, if multiple objects are selected that have an Edit Patch, Edit Spline, or Edit Mesh modifier applied, the name list is inactive.

---

**NOTE** Sub-material names are those specified in the Name column on the material's Multi/Sub-Object Basic Parameters rollout; these are not created by default, and must be specified separately from any material names.

---

**Clear Selection** When on, choosing a new ID or material name deselects any previously selected patches or elements. When off, selections are cumulative, so new ID or sub-material name selections add to the existing selection set of patches or elements. Default=on.

## Smoothing Groups group

Use these controls to assign selected patches to different [smoothing groups](#) on page 7932 , and to select patches by smoothing group.

To assign patches to one or more smoothing groups, select the patches, and then click the number(s) of the smoothing group(s) to assign them to.

**Select by SG (Smoothing Group)** Displays a dialog that shows the current smoothing groups. Select a group by clicking the corresponding numbered button and clicking OK.

**Clear All** Removes any smoothing group assignments from selected patches.

## Edit Vertex Colors group

Use these controls to assign the color, illumination color (shading), and alpha (transparency) values of vertices on the selected patch(es).

**Color** Click the color swatch to change the color of vertices on the selected patch(es).

**Illumination** Click the color swatch to change the illumination color of vertices on the selected patch(es). This lets you change the color of shadows without changing the vertex colors.

**Alpha** Lets you assign an alpha (transparency) value to vertices on the selected patch(es).

The spinner value is a percentage; zero is completely transparent and 100 is completely opaque.

## Editable Patch (Element)

Select an editable patch > Modify panel > Expand the editable patch in the stack display > Element sub-object level

Select an editable patch > Modify panel > Selection rollout > Element button

Select an editable patch > Right-click the patch > Tools 1 (upper-left) quadrant of the quad menu > Sub-objects > Element

Use the Element sub-object level when you want to select and work on all contiguous faces in an element. The Element sub-object level is essential when you are Shift+cloning and Shift+extruding patches, because doing so creates separate elements. For example, if you select a patch, hold down the Shift key,

and move the patch to a new location, a new element is created separate from the original. This also applies to extrusion. If you hold the Shift key down while you extrude, a new element is created.

---

**NOTE** In some cases, you might find that moving a patch element causes parts of it to move by differing amounts. This typically occurs because the object is set to Manual Interior. It happens, for instance, when you convert a sphere primitive to an editable patch object. To remedy this, select the element, and then right-click it to display the quad menu, and in the Tools1 quadrant, choose Auto Interior.

---

## **Interface**

### **Selection rollout**

For information on the controls in this rollout, see [Selection Rollout \(Editable Patch\)](#) on page 1940 .

### **Soft Selection rollout**

See [Soft Selection Rollout](#) on page 1926 for information on the Soft Selection rollout settings.



## Geometry rollout

**Geometry**

Subdivision

Subdivide  Propagate

Bind Unbind

Topology

Add Tri Add Quad

Create

Detach  Reorient  
 Copy

Attach  Reorient

Delete Break

Hide Unhide All

Weld

Selected

Target  pixels

Extrude & Bevel

Extrude Bevel

Extrusion:

Outlining:

Normal:  Group  Local

Bevel Smoothing:

Start End

Smooth  Smooth

Linear  Linear

None  None

Tangent

Copy Paste

Paste Length

Surface

View Steps:

Render Steps:

Show Interior Edges

Use True Patch Normals

Miscellaneous

Create Shape

Patch Smooth

See [Geometry Rollout \(Patch\)](#) on page 1968 for detailed descriptions of these controls.

## Geometry Rollout (Patch)

Select an editable patch > Modify panel > Geometry rollout

The Geometry rollout for Patches contains most of the controls that let you alter the geometry of the patch, at either the Object (top) level, or one of the sub-object levels. The controls that the rollout displays can vary, depending on which level is active; if a control is not available for the active level, it might be grayed out, or simply might not appear at all. The descriptions below indicate the levels at which controls are available.

## Interface

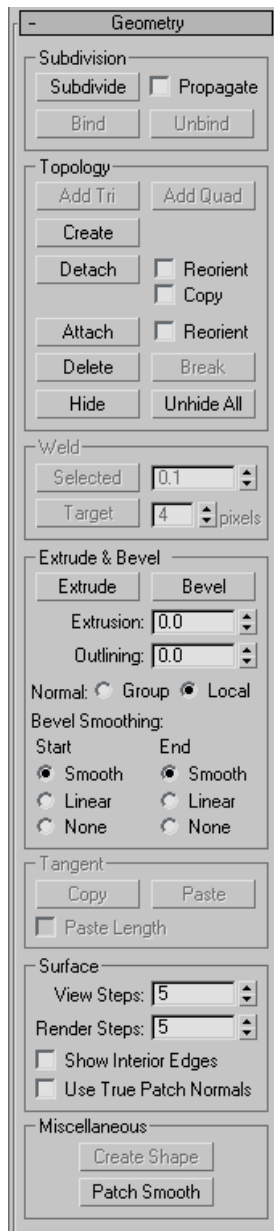

## Subdivision group (Vertex, Edge, Patch, and Element levels only)

**Bind (Vertex level only)** Lets you create a seamless, gapless connection between two patch edges that have unequal numbers of vertices. The two patches must belong to the same object, and the vertex need not be selected first. Click Bind, then drag a line from an edge-based vertex (not a corner vertex) to the edge you want to bind it to. The cursor turns into a white cross when over a legal edge.

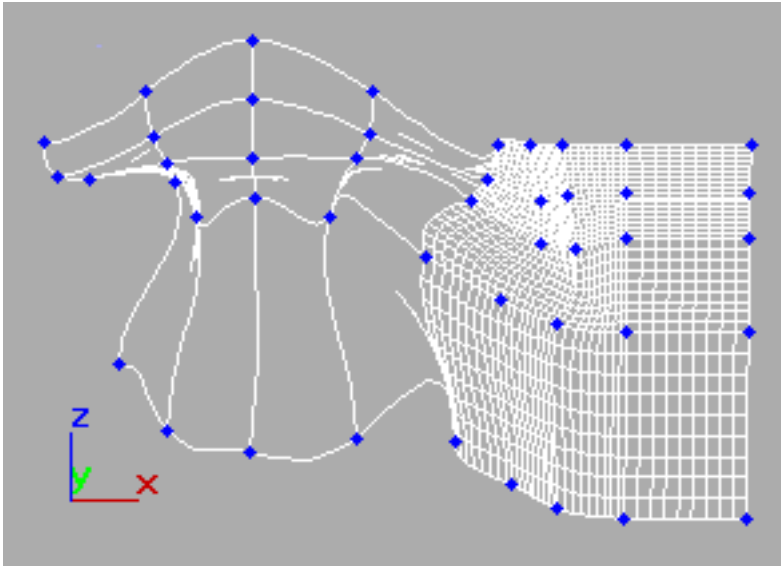

Binding patch edges

To exit Bind mode, click the Bind button again, or right-click in the active viewport.

---

**TIP** When connecting two patches edge-to-edge, first line up as many pairs of vertices as possible, and use Weld to connect them. Then use Bind to connect the remaining vertices. Bound vertices cannot be manipulated directly, although their handles can.

---

**NOTE** Bind is useful for connecting patch objects with different patch resolutions, such as a head and a neck, without the need to create additional patches in the lower-resolution object.

---

**Unbind (Vertex level only)** Disconnects a vertex connected to a patch with Bind. Select the vertex, and then click Unbind.

**Subdivide (Edge, Patch, and Element levels only)** Subdivides the selected sub-objects.

- **Propagate** When on, extends the subdivision to neighboring patches. Propagating the subdivisions along all contiguous patches prevents patch cracks where you have attached patches together.

### **Topology group**

**Add Tri / Add Quad (Edge level only)** You can add Tri and Quad patches to any open edge of an object. On closed objects such as spheres, you can delete one or more existing patches to create open edges, and then add new patches.

The new patches adapt to the existing geometry. For example, when you add a patch to a curved edge, the new patch follows that curve and seamlessly extends it.

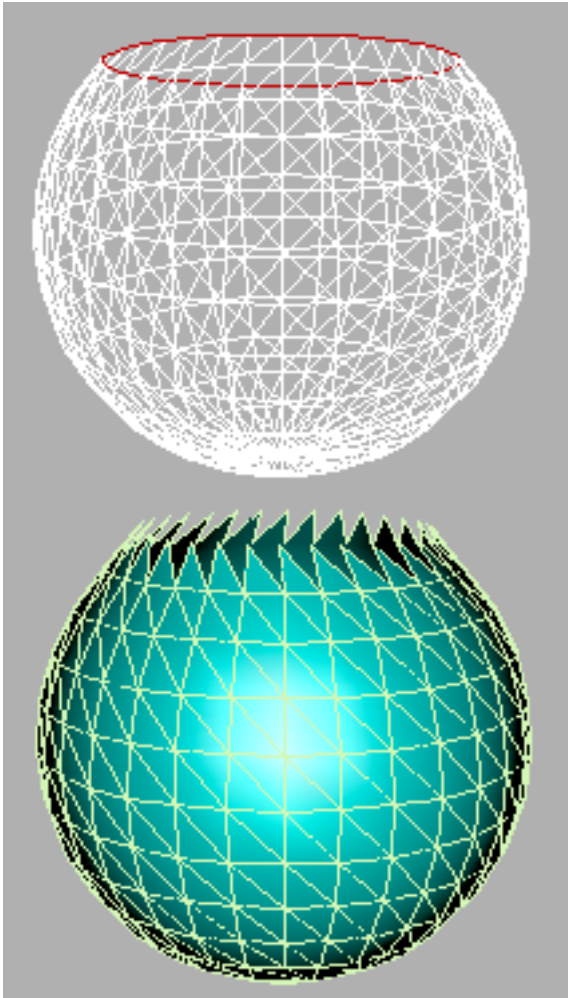

**Original patch with edges selected (top) and three-sided patches added (bottom)**

Add Tri adds a three-sided patch to each selected edge. Select one or more edges, then click Add Tri to add the patch or patches.

Add Quad adds a four-sided patch to each selected edge. Select one or more edges, and then click Add Quad to add the patch or patches.

**Create (Vertex, Patch, and Element levels only)** Lets you add geometry to the patch object. Available at Vertex, Patch, and Element sub-object levels only.

At the Vertex sub-object level, turn on Create and then click anywhere to add vertices to the object.

At the Patch and Element levels, you can add three- and four-sided patches. The cursor changes to white cross hairs when over an existing patch vertex. Select an existing vertex by clicking it. Click in free space to create a new vertex at that location; this vertex is included in the sequence of vertices for the new patch.

- *To create a Tri Patch:* Click three times in free space or on existing vertices. Right-click anywhere, or left-click one of the vertices in the current sequence to complete the creation of a Tri Patch.
- *To create a Quad Patch:* Click four times in free space or on existing vertices. The Quad Patch is automatically created at the fourth click.

No operation takes place if you right-click or select a vertex in the current sequence with only one or two vertices in the sequence.

**Detach (Patch and Element levels only)** Lets you select one or more patches or elements within the current object and then detach them (or copy them) to form a separate patch object.

- **Reorient** When on, the detached patch or element copies the position and orientation of the source object's Local coordinate system (when the source object was created). The new detached object is moved and rotated so that its Local coordinate system is positioned and aligned with the origin of the current active grid.
- **Copy** When on, the detached patches or elements are copied to a new patch object, leaving the originals intact.

**Attach** Lets you attach an object to the currently selected patch object. Click the object you want to attach to the currently selected patch object.

If you attach a non-patch object, the object is converted to a patch object.

When you attach an object, the materials of the two objects are combined in the following way:

- If the object being attached does not have a material assigned, it inherits the material of the object it is being attached to.
- Likewise if the object you're attaching to doesn't have a material, it inherits the material of the object being attached.

- If both objects have materials, the resulting new material is a [multi/sub-object material](#) on page 5558 that encompasses the input materials. A dialog appears offering three methods of combining the objects' materials and material IDs. For more information, see [Attach Options Dialog](#) on page 2031 .

Attach remains active in all sub-object modes, but always applies to objects.

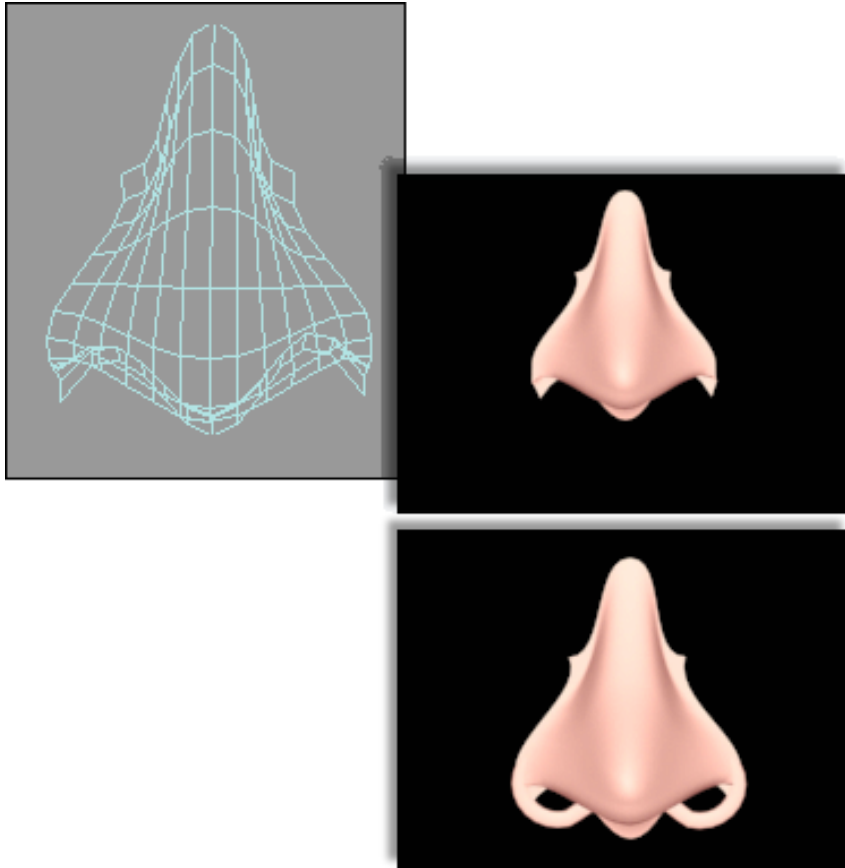

**Top:** Original patch object with rendering

**Bottom:** Rendering with another patch attached

**Reorient** When on, reorients the attached element so that each patch's creation local coordinate system is aligned with the creation local coordinate system of the selected patch.



**Delete (Vertex, Edge, Patch, and Element levels only)** Deletes the selected sub-objects.

---

**WARNING** Delete vertices or edges with caution. Deleting a vertex or edge also deletes the patches that share them. For example, if you delete the single vertex at the top of a spherical patch, the top four patches are also deleted.

---

**Break (Vertex and Edge levels only)** For vertices, breaks a vertex into multiple vertices. Use this if you need to split open an edge to add another patch or for general modeling operations. Select a vertex, and then click Break. After the break, select the individual vertices and move them to separate the edges.

For edges, splits an edge. Use this if you need to split open an edge for general modeling operations. Select one or more edges, and then click Break. After the break, move the handles of adjacent vertices to create a gap in the patch.

**Hide (Vertex, Edge, Patch, and Element levels only)** Hides the selected sub-objects. For vertices and edges, Hide also hides the patches that are attached to them.

---

**NOTE** At least one patch in the object must remain visible.

---

**Unhide All** Restores any hidden sub-objects to visibility.

### **Weld group (Vertex and Edge levels only)**

**Selected** Welds selected vertices that fall within the tolerance specified in the Weld Threshold spinner (to the right of the Weld button). Select the vertices you want to weld between two different patches, set the spinner to a sufficient distance, and click Selected.

At the Edge sub-object level, clicking Selected welds two edges that share vertices. You can use this to eliminate gaps on a surface.

**Target (Vertex level only)** Turn on and drag from one vertex to another to weld the vertices together. The dragged vertex fuses to the target vertex.

The **pixels** spinner to the right of the Target button sets the maximum distance in screen pixels between the mouse cursor and the target vertex.

### **Extrude & Bevel group (Edge, Patch, and Element levels only)**

These controls let you extrude and bevel edges, patches, or elements. Extruding patches moves them along a normal and creates new patches that form the sides of the extrusion, connecting the selection to the object. Beveling adds a second step that lets you scale the extruded patches. You can extrude and

bevel patches by dragging or by direct entry. You can also hold down the Shift key during extrusion, which creates a separate element.

---

**NOTE** Sides created by beveling or extrusion are assigned to smoothing group 1.

---

**Extrude** Click this button, and then drag any edge, patch, or element to extrude it interactively. Hold down the Shift key during this operation to create a new element.

When the mouse cursor is over a selected patch or element, it changes to an Extrude cursor.

**Bevel (Patch and Element levels only)** Click this button, and then drag any patch or element to extrude it interactively, then click and release the mouse button, and drag again to bevel the extrusion. Hold down the Shift key during this operation to create a new element.

When the mouse cursor is over a selected element, it changes to a Bevel cursor.

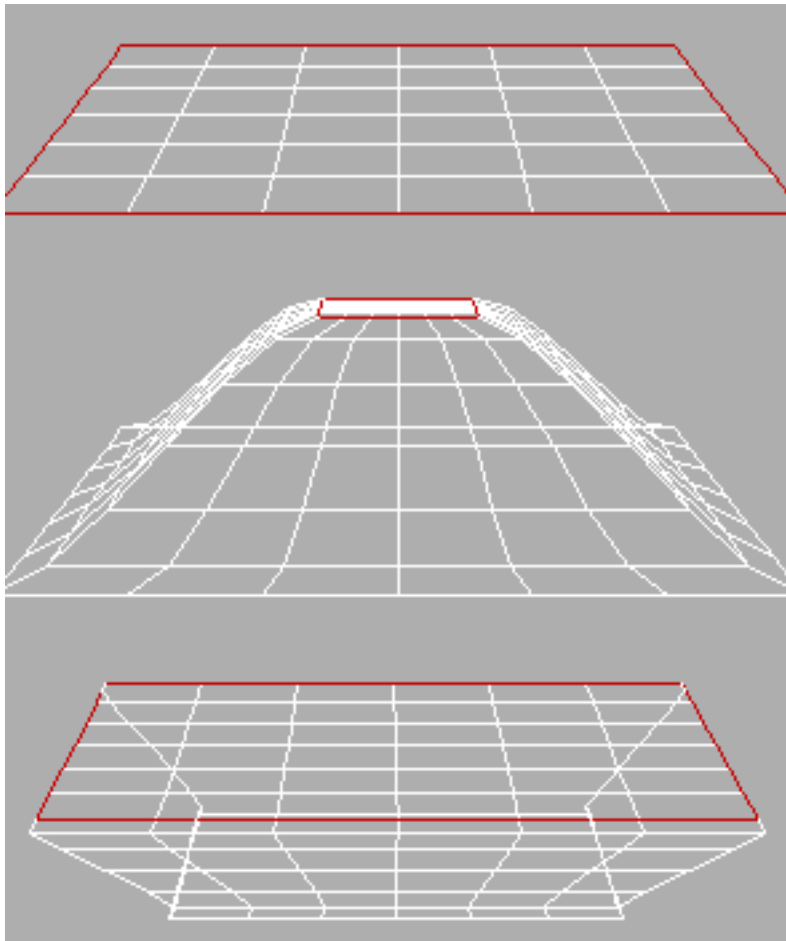

**Original patch (top) and inward and outward extrusions**

---

**NOTE** In some cases, particularly with closed objects (objects with no holes or open edges), the second bevel step might not produce visible results.

---

**Extrusion** This spinner sets whether the extrusion is outward or inward, depending on whether the value is positive or negative.

**Outlining (Patch and Element levels only)** This spinner lets you scale selected patches or elements bigger or smaller, depending on whether the value is positive or negative. It is normally used after an extrusion for beveling the extruded patches.

**Normal** If Normal is set to **Local** (the default), extrusion takes place along the normal of each selected edge, patch, or individual patch in an element. If normal is set to **Group**, extrusion takes place along the averaged normal of each contiguous group in a selection. If you extrude multiples of such groups, each group moves along its own averaged normal.

**Bevel Smoothing (Patch and Element levels only)** These settings let you set the shape of the intersection between the surface created by a beveling operation and the neighboring patches. The shapes are determined by the handle configurations of vertices at the intersections. **Start** refers to the intersection between the sides and the patches surrounding the beveled patch. **Finish** refers to the intersection between the sides and the beveled patch or patches. The following settings are available for each:

- **Smooth** Vertex handles are set so the angles between the new patches and their neighbors are relatively small.
- **Linear** Vertex handles are set to create linear transitions.
- **None** Vertex handles are not modified.

---

**WARNING** Set Bevel Smoothing before the bevel is performed; changing the setting has no effect on existing beveled patches.

---

### **Tangent group (Vertex and Handle levels only)**

These controls let you copy orientation, and optionally length, between handles on the same object, or on different objects applied with instances of the same Edit Patch modifier. The tool doesn't support copying handles from one patch object to another, or between spline and patch objects.

**Copy** Copies a patch handle's transform settings to a copy buffer.

When you click Copy, 3ds Max displays all handles on the selected object. When the mouse cursor is over a handle end, the cursor image changes to the one shown below. Click a handle end to copy its direction and length to the paste buffer; this also exits Copy mode.



**Paste** Pastes orientation information from the copy buffer to a vertex handle. If Paste Length is on, it also pastes the length of the copied handle.

When you click Paste, the software displays all handles on the selected object. When the mouse cursor is over a handle end, the cursor image changes to the

one shown below. Click a handle end to paste the information from the buffer to the handle. You can continue clicking other handle ends to paste the information repeatedly. To exit Paste mode, right-click in the viewport or click the Paste button.



**Copy Length / Paste Length** When on and you use Copy, the length of the handle is also copied. When on and you use Paste, the length of the originally copied handle is pasted as well as its orientation. When off, only the orientation is copied or pasted.

### **Surface group**

**View Steps** Controls the grid resolution of the patch model surface as depicted in the viewports. Range=0 to 100. Default=5.

**Render Steps** Controls the grid resolution of the patch model surface when rendered. Range=0 to 100. Default=5.

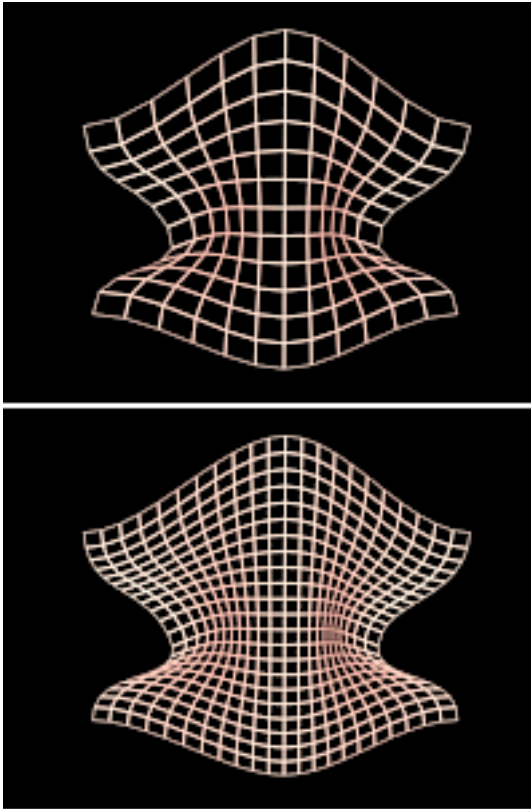

Original mesh display of model (top) and with increased steps (bottom)

**Show Interior Edges** Enables the display of the patch object's interior edges in wireframe views. When off, only the object's outline is visible. Turn on to simplify the display for faster feedback.

**Use True Patch Normals** Determines how the software smoothes the edges between patches. Default=off.

When the check box is off, the software computes the surface normals from the smoothing groups of the mesh object to which the patch object is converted before rendering. These normals are not accurate, especially with a low View/Render Steps setting. When the check box is on, the software computes true patch normals directly from the patch surfaces, which can generate more accurate shading.

In the illustration below, a sphere was converted to Editable Patch format, and then a vertex was moved toward the center and rotated. The sphere on

the left has Use True Patch Normals turned off, and the one on the right has it turned on. In both cases, View Steps was set to 8.

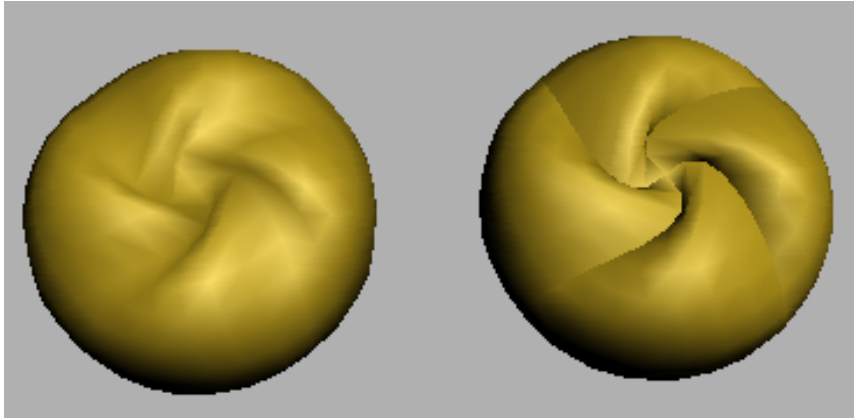

A patch sphere with Use True Patch Normals off (left) and on (right).

### Miscellaneous group

**Create Shape (Edge level only)** Creates splines based on the selected edges. If no edges are selected, then splines are created for all the patch edges. 3ds Max prompts you for a name: type in a name for the new shape object, and then click OK.

Each patch edge forms an individual spline. You can use this to create a spline cage based on patch edges. This is useful for spline modeling or working with surface tools.

**Patch Smooth** At the sub-object level, adjusts the tangent handles of the vertices of selected sub-objects to smooth the surface of the patch object. At the object level, adjusts *all* tangent handles to smooth the surface.

Patch Smooth sets the handles to absolute positions based on the patch object geometry; repeated applications have no effect.

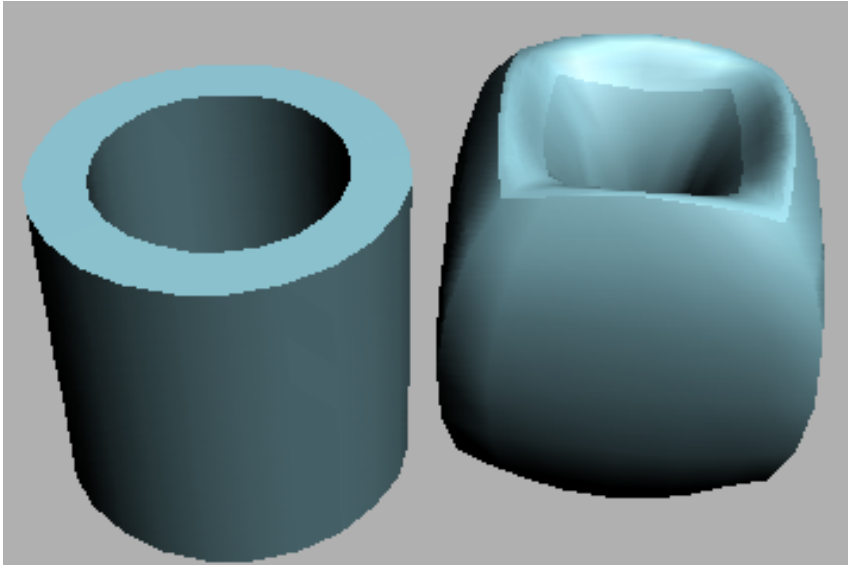

A patch tube before smoothing (left) and after using Patch Smooth (right)

## Patch Grids

Create panel > Geometry > Patch Grids

Create menu > Patch Grids

You can create two kinds of patch surfaces in grid form: Quad Patch and Tri Patch. Patch grids begin as flat plane objects but can be modified into arbitrary 3D surfaces by either using an Edit Patch modifier or collapsing the grid's modifier stack down to an Editable Patch in the Modify panel.

Patch grids provide convenient "building material" for custom surfaces and objects, or for adding patch surfaces to existing patch objects.

You can animate the surface of a Patch object using various modifiers such as the Flex and Morph modifiers. Control vertices and tangent handles of a patch surface can be animated with an Editable Patch modifier.

### Surface Tools

The output of the [Surface modifier](#) on page 1695 is a Patch object. Patch objects offer a flexible alternative to mesh and NURBS modeling and animation.



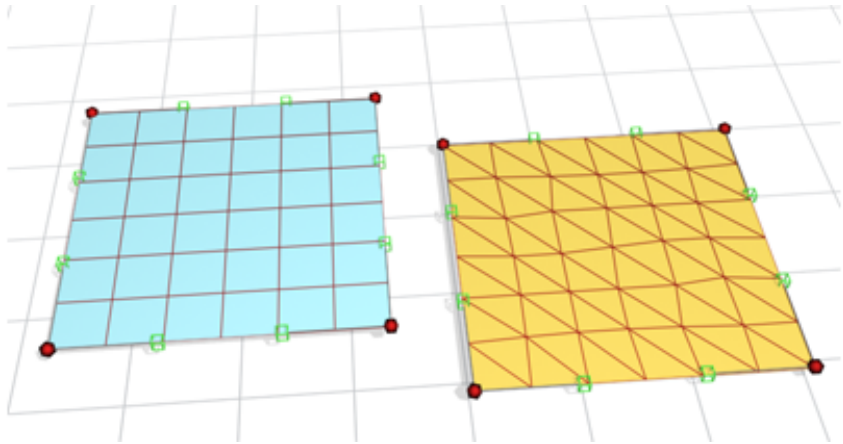

Quad patch and tri patch

## Editable Patches

You can convert a basic patch grid to an [editable patch object](#) on page 1934 . The editable patch has a variety of controls that let you directly manipulate it and its sub-objects. For example, at the Vertex sub-object level, you can move vertices or adjust their Bezier handles. Editable patches let you create surfaces that are less regular, more free-form than the basic, rectangular patches.

When you convert a patch to an editable patch, you lose the ability to adjust or animate its creation parameters.

### See also:

- [Edit Modifiers and Editable Objects](#) on page 1027
- [Modifying at the Sub-Object Level](#) on page 1029
- [Modifier Stack Controls](#) on page 7427

## Procedures

### To create a patch grid:

- 1 On the Create panel > Geometry > Patch Grids > Object Type rollout, click either Quad Patch or Tri Patch.
- 2 Drag over any viewport to create a patch.

## Interface



**AutoGrid** Uses surface normals as a plane to create patches. Click a patch type and then click and drag the cursor over a face in the viewports.

Detailed information about the two patch grid types is available in these topics:

[Quad Patch](#) on page 1984

[Tri Patch](#) on page 1987

## Quad Patch

Create panel > Geometry > Patch Grids > Quad Patch

Create menu > Patch Grids > Quad Patch

Quad Patch creates a flat grid with a default of 36 visible rectangular facets. A hidden line divides each facet into two triangular faces for a total of 72 faces.

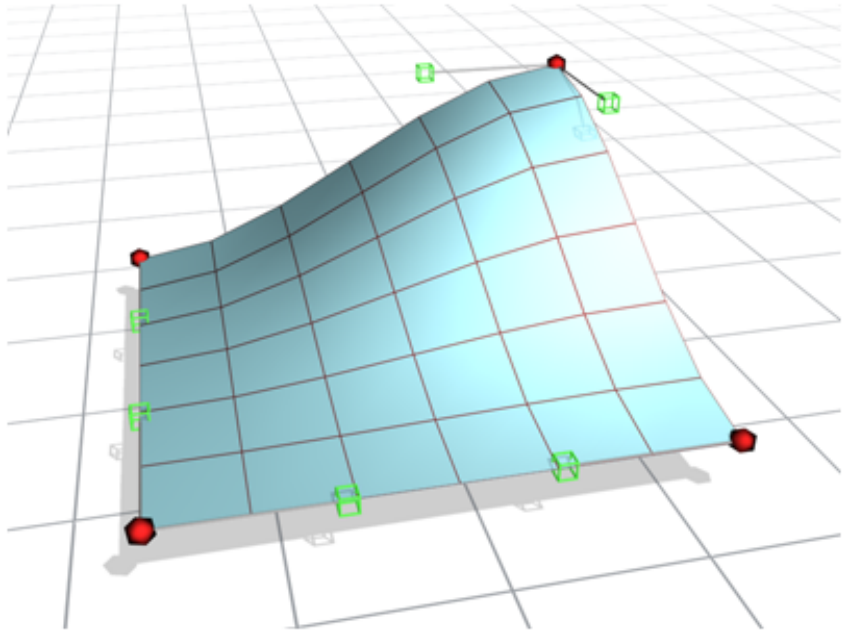

## Quad Patch

### Procedures

#### To create a patch grid:

- 1 On the Create panel > Geometry > Patch Grids > Object Type rollout, click either Quad Patch or Tri Patch.
- 2 Drag over any viewport to define a length and width for the patch.

#### To edit a Quad Patch:

- 1 Select a Quad Patch.
- 2 On the Modify panel, right-click Quad Patch in stack view and choose Editable Patch.  
The Quad Patch collapses to an Editable Patch.
- 3 On the Editable Patch Selection rollout, click Vertex.
- 4 In any viewport, select a vertex on the patch object, and move the vertex to change the surface topology.

Vertices and vectors can be animated with an Editable Patch modifier.

At the sub-object Edge level, you can add patches along any edge. You can create complex patch models beginning from a single patch.



An ear is created by adding patches and editing patch vertices

### Interface

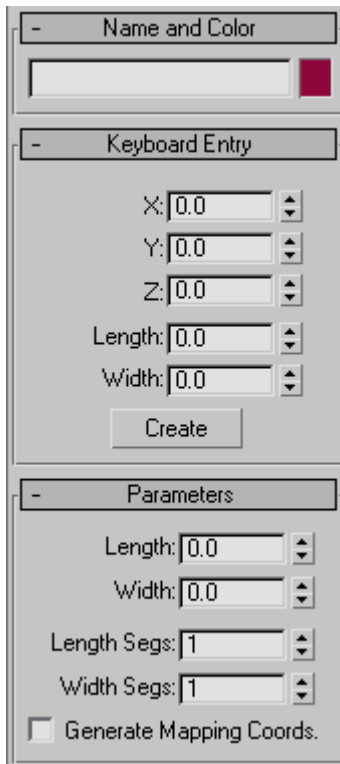

## **Name and Color rollout**

The [Name and Color rollout](#) on page 7423 lets you rename objects and change their wireframe color.

## **Keyboard Entry rollout**

**X/Y/Z** Sets the patch center.

**Length** Sets the patch length.

**Width** Sets the patch width.

**Create** Creates a patch based on the XYZ, Length, and Width values.

## **Parameters rollout**

**Length, Width** Sets the grid dimensions in current units.

**Length, Width Segments** Determines the number of facets along the length and width of the grid. Default=1.

The density of a Quad Patch rises sharply as you increase the segments. A Quad Patch of two segments on a side contains 288 faces. The maximum is 100 segments. High segment values can slow performance.

**Generate Mapping Coordinates** Creates map coordinates for applying mapped materials. Default=off.

# **Tri Patch**

Create panel > Geometry > Patch Grids > Tri Patch

Create menu > Patch Grids > Tri Patch

Tri Patch creates a flat grid with 72 triangular faces. The face count remains at 72, regardless of its size. The faces become larger to fill the area as you increase the size of the grid.

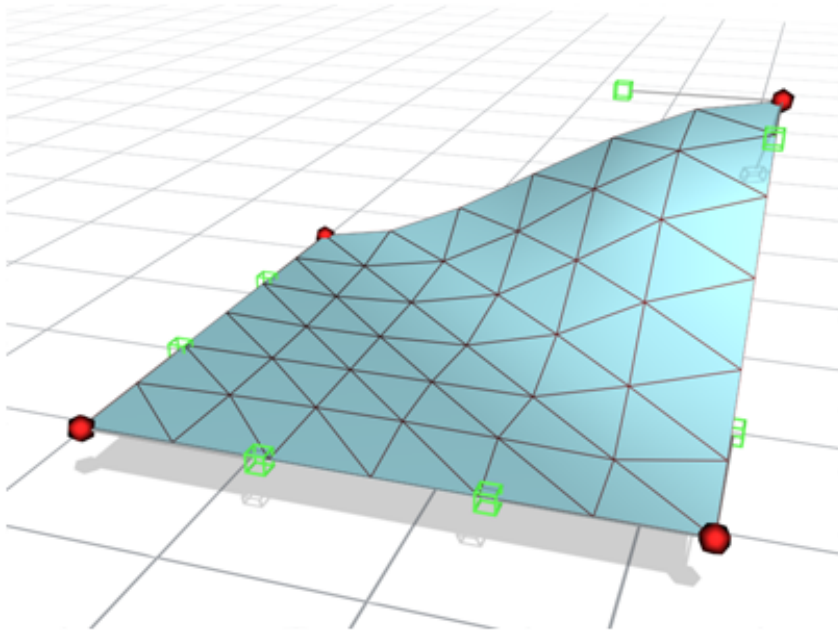

Tri Patch

## Procedures

### To create a Tri Patch:

- 1 On the Create panel > Geometry > Patch Grids > Object Type rollout, click Tri Patch.
- 2 Drag over any viewport to create the patch.

### To edit a Tri Patch:

- 1 Select a Tri Patch.
- 2 On the Modify panel, right-click TriPatch in stack view, and choose Editable Patch.  
The Tri Patch collapses to an Editable Patch.
- 3 In the Editable Patch Selection rollout, click Vertex.
- 4 In any viewport, select a vertex on the patch object and move the vertex to change the surface topology.

You can animate vertices and vectors with an Editable Patch modifier.

### Interface

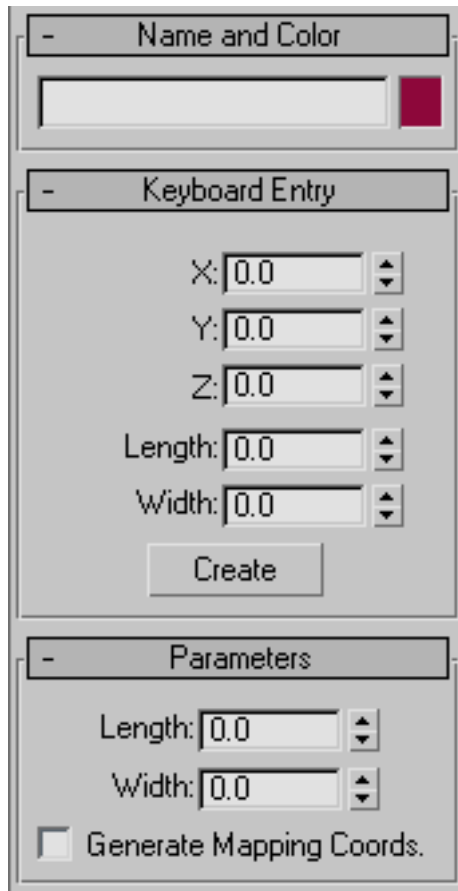

#### Name and Color rollout

The [Name and Color rollout](#) on page 7423 lets you rename objects and change their wireframe color.

#### Keyboard Entry rollout

X/Y/Z Sets the patch center.

**Length** Sets the patch length.

**Width** Sets the patch width.

**Create** Creates a patch based on the XYZ, Length, and Width values.

#### **Parameters rollout**

**Length, Width** Sets dimensions of grid in current units.

**Generate Mapping Coordinates** Creates map coordinates for applying mapped materials. Default=off.

## **Editable Mesh Surface**

Create or select an object. > Quad menu > Transform quadrant > Convert To: submenu > Editable Mesh

Create or select an object. > Modify panel > Right-click the base object in the stack. > Convert to: Editable Mesh

Create or select an object. > Utilities panel > Collapse button > Collapse Selected button

[Editable Mesh](#) on page 7765, like the Edit Mesh modifier, provides controls for manipulating a mesh object made up of triangular faces as an object and at three sub-object levels: vertex, edge and face. You can convert most objects in 3ds Max to editable meshes, but for open spline objects, only vertices are available, because open splines have no faces or edges when converted to meshes.

To make a sub-object selection on a non-editable mesh object (for example, a primitive) for passing up the stack to a modifier, use the [Mesh Select modifier](#) on page 1455.

Once you make a selection with Editable Mesh, you have these options:

- Use the options supplied on the Edit Geometry rollout to modify the selection. Later topics discuss these options for each of the mesh components.
- Transform or Shift+clone the selection, as with any object.
- Pass the selection to a later modifier in the stack. You can apply one or more standard modifiers to the selection.



- Use the options on the Surface Properties rollout to alter the surface characteristics of selected mesh components.

---

**NOTE** Because Edit Mesh modifier functionality is almost identical to that of editable mesh objects, features described in the Editable Mesh topics also apply to objects with Edit Mesh applied, except as noted.

---

**TIP** [Editable Poly](#) on page 2038 is similar to Editable Mesh, but lets you work with polygons of four or more sides, and provides a greater range of functionality.

---

**TIP** You can exit most Editable Mesh command modes, such as Extrude, by right-clicking in the active viewport.

---

**See also:**

- [Edit Modifiers and Editable Objects](#) on page 1027
- [Modifying at the Sub-Object Level](#) on page 1029
- [Modifier Stack Controls](#) on page 7427
- [Edit Mesh Modifier](#) on page 1283
- [Mesh Select Modifier](#) on page 1455

**Procedures**

**To produce an editable mesh object:**

First select the object, and then do one of the following:

- 1 Right-click the object and choose Editable Mesh from the Convert To submenu in the transform quadrant.



- 2 Use the [Collapse utility](#) on page 1931 .
- 3 Apply a modifier to a parametric object that turns the object into a mesh object in the stack, and then collapse the stack. (For example, you can apply a Mesh Select modifier.)
- 4 Apply an Edit Mesh or Mesh Select modifier to an object.
- 5 Import a non-parametric object, such as that found in a 3DS file.
- 6 Import a 3ds Max object using File menu > Merge.

Converting an object to an editable mesh removes all parametric controls, including the creation parameters. For example, you can no longer increase the number of segments in a box, slice a circular primitive, or change the number of sides on a cylinder. Any modifiers you apply to an object are collapsed as well. After conversion, the only entry left on the stack is "Editable Mesh."

### **Maintaining an object's creation parameters:**

As described in the above procedure, you can convert an existing object to an editable mesh, which replaces the creation parameters in the stack with "Editable Mesh." The creation parameters are no longer accessible or animatable. If you want to maintain the creation parameters, you can use the following modifiers:

- [Edit Mesh Modifier](#) on page 1283
- [Mesh Select Modifier](#) on page 1455
- [Delete Mesh Modifier](#) on page 1266
- [Tessellate Modifier](#) on page 1743
- [Face Extrude Modifier](#) on page 1381
- [Affect Region Modifier](#) on page 1133

## **Interface**

### **Modifier Stack display**

**Show End Result** Normally, if you apply a modifier such as Twist to an editable-mesh object and then return to the Editable Mesh stack entry, you cannot see the effect of the modifier on the object's geometry. But if you turn on Show End Result while in sub-object level, you can see the original sub-object selection as a yellow mesh, the final object as a white mesh, and the original editable mesh as an orange mesh.

### **Selection rollout**

See [Selection Rollout \(Editable Mesh\)](#) on page 1995 .

### **Named Selections**

**Copy** Places a named selection into the copy buffer.

**Paste** Pastes a named selection from the copy buffer.

For more information, see [Named Selection Sets](#) on page 179 .

### **Selection Information**

At the bottom of the Selection rollout is a text display giving information about the current selection. If no objects or more than one sub-object are selected, the text gives the number of objects and the type selected. If a single sub-object is selected, the text gives its identification number and type.

---

**NOTE** When the current sub-object level is Polygon or Element, selection information is given in faces.

---

### **Soft Selection rollout**

Soft Selection controls affect the action of sub-object Move, Rotate, and Scale functions. When these are on, 3ds Max applies a spline curve deformation to unselected vertices surrounding the transformed selected sub-object. This provides a magnet-like effect with a sphere of influence around the transformation.

For more information, see [Soft Selection Rollout](#) on page 1926 .

### **Edit Geometry rollout**

The [Edit Geometry rollout](#) on page 2018 provides various controls for editing an editable mesh object and its sub-objects. For information specific to the different sub-object levels, click any of the links below:

[Editable Mesh \(Object\)](#) on page 1998

[Editable Mesh \(Vertex\)](#) on page 2001

[Editable Mesh \(Edge\)](#) on page 2007

[Editable Mesh \(Face/Polygon/Element\)](#) on page 2014

## **Working with Mesh Sub-Objects**

This topic describes how to work with sub-object selections when you are editing an [Editable Mesh](#) on page 1990 .

**See also:**

- [Edit Modifiers and Editable Objects](#) on page 1027

- [Modifying at the Sub-Object Level](#) on page 1029
- [Modifier Stack Controls](#) on page 7427
- [Editable Mesh](#) on page 7765
- [Editable Poly](#) on page 7765

## Selecting and Transforming

In selecting and transforming sub-object geometry, you use standard techniques:

- Clicking any vertex, edge, or face/polygon/element selects it.
- Holding down Ctrl lets you add to or subtract from the selection with single clicks.
- Holding down Alt lets you subtract from the selection with single clicks, or with Window/Crossing selections.
- Beginning a selection outside the object starts a region selection. Holding down Ctrl during region selection lets you add to the selection.

Once you've made a sub-object selection, you can use the Spacebar to lock the selection while you're working with it.

## Using Sub-Object Selection

With either an editable mesh (or Edit Mesh modifier) or a Mesh Select modifier, you can store three separate sub-object selections: one for each selection level (vertex, face, and edge). These selection sets are saved with the file. With sub-object selections, you have these options:

- Choose one of the selection sets to pass geometry up the stack to other modifiers. Only one selection set is active at a time.
- Change to one of the other selection sets at any time.
- Use [named selection sets](#) on page 179 for sub-object geometry you want to reuse.  
In modeling a head, for example, you might have a number of different vertex selections for forehead, nose, and chin. Such selections can be difficult to re-create, so named sets give you easy access to the original selection when you want to rework a particular area.

## Cloning Sub-Object Geometry

Using Shift+transform with a selection of vertices or faces displays the Clone Part Of Mesh dialog. This lets you determine whether you want to "Clone To Object" or "Clone To Element." Click the desired option, optionally giving the cloned object a new name, then click OK.

- If you choose Clone To Object, the cloned copy becomes a plain mesh object, entirely separate from the original object. The new object is given the name in the field to the right of the Clone To Object radio button.
- If you choose Clone To Element, the selection is cloned in its new position and remains part of the original object.

## Animating Sub-Object Geometry

When you work with an editable mesh, you can directly transform and animate a sub-object selection. In effect, the selection works like any other object.

# Selection Rollout (Editable Mesh)

The Selection rollout provides buttons for turning different sub-object levels on and off, working with named selections and handles, display settings, and information about selected entities.

When you first access the Modify panel with an editable mesh selected, you're at the Object level, with access to several functions available as described in [Editable Mesh \(Object\)](#) on page 1998 . You can toggle the various sub-object levels, and access relevant functions by clicking the buttons at the top of the Selection rollout.

Clicking a button here is the same as selecting a sub-object type in the Modifier Stack display. Click the button again to turn it off and return to the Object selection level.

The Selection rollout also allows you to display and scale vertex or face [normals](#) on page 7863

## Interface

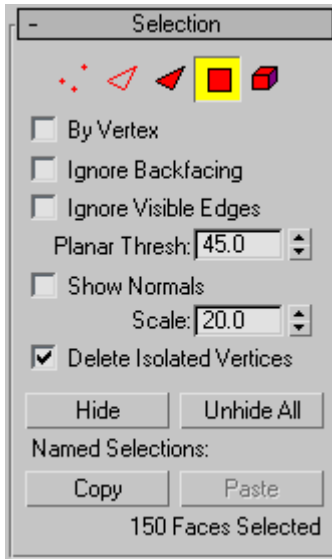

**Vertex** Turns on Vertex sub-object level, which lets you select a vertex beneath the cursor; region selection selects vertices within the region.



**Edge** Turns on Edge sub-object level, which lets you select the edge of a face or polygon beneath the cursor; region selection selects multiple edges within the region. At the Edge sub-object level, selected hidden edges are displayed as dashed lines, allowing for more precise selection.



**Face** Turns on Face sub-object level, which lets you select a triangular face beneath the cursor; region selection selects multiple triangular faces within the region. If a selected face has a hidden edge and [Shade Selected Faces](#) on page 7616 is off, the edge is displayed as a dashed line.



**Polygon** Turns on Polygon sub-object level, which lets you select all coplanar faces (defined by the value in the Planar Threshold spinner) beneath the cursor. Usually, a polygon is the area you see within the visible wire edges. Region selection selects multiple polygons within the region.



**Element** Turns on Element sub-object level, which lets you select all contiguous faces in an object. Region selection lets you select multiple elements.

**By Vertex** When on, and you click a vertex, any sub-objects (at the current level) that use that vertex are selected. Also works with Region Select.

---

**NOTE** When By Vertex is on, you can select sub-objects only by clicking a vertex, or by region.

---

**Ignore Backfacing** When on, selection of sub-objects selects only those sub-objects whose normals are visible in the viewport. When off (the default), selection includes all sub-objects, regardless of the direction of their normals.

---

**NOTE** The state of the Backface Cull setting in the Display panel does not affect sub-object selection. Thus, if Ignore Backfacing is off, you can still select sub-objects, even if you can't see them.

---

**Ignore Visible Edges** This is enabled when the Polygon face selection method is chosen. When Ignore Visible Edges is off (the default), and you click a face, the selection will not go beyond the visible edges no matter what the setting of the Planar Thresh spinner. When this is on, face selection ignores the visible edges, using the Planar Thresh setting as a guide.

Generally, if you want to select a "facet" (a coplanar collection of faces), you set the Planar Threshold to 1.0. On the other hand, if you're trying to select a curved surface, increase the value depending on the amount of curvature.

- **Planar Thresh** (Planar Threshold) Specifies the threshold value that determines which faces are coplanar for Polygon face selection.

**Show Normals** When on, the program displays [normals](#) on page 7863 in the viewports. Normals are displayed as blue lines.

Show normals is not available in Edge mode.

- **Scale** Specifies the size of the normals displayed in the viewport when Show is on.

**Delete Isolated Vertices** When on, 3ds Max eliminates any isolated vertices when you delete a contiguous selection of sub-objects. When off, deleting a selection leaves all vertices intact. Not Available at the Vertex sub-object level. Default=on.

An isolated vertex is one that has no associated face geometry. For example, if Delete Isolated Vertices is off and you delete a rectangular selection of four polygons, all clustered about a single central point, the point remains, suspended in space.

**Hide** Hides any selected sub-objects. Edges and entire objects cannot be hidden.

---

**TIP** The Select Invert command on the 3ds Max Edit menu is useful for selecting faces to hide. Select the faces you want to focus on, choose Edit > Select Invert, then click the Hide button.

---

**Unhide All** Restores any hidden objects to visibility. Hidden vertices can be unhidden only when in Vertex sub-object level.

## Editable Mesh (Object)

Select an editable mesh object or object with the Edit Mesh modifier applied.  
> Modify panel

Select an editable mesh object. > Quad menu > Tools 1 quadrant > Top-Level

Editable Mesh (Object) controls are available when no sub-object levels are active. These controls are also available at all sub-object levels, and work the same at each level, except as noted in [Edit Geometry Rollout \(Mesh\)](#) on page 2018 .



## Interface

### Edit Geometry rollout

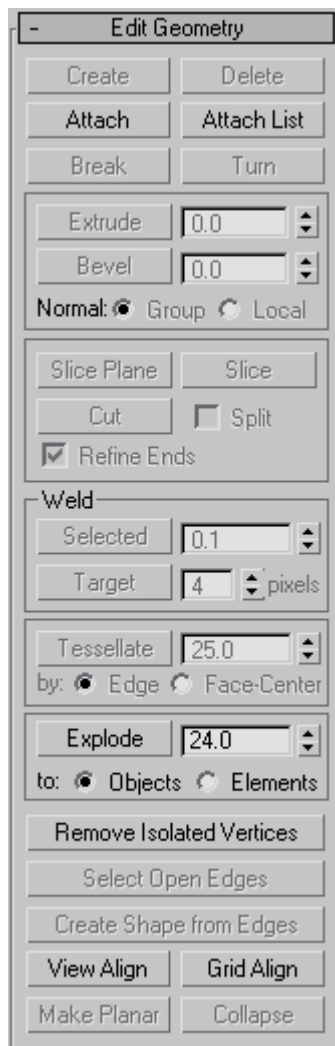

See [Edit Geometry Rollout \(Mesh\)](#) on page 2018 for detailed descriptions of these controls.

## Surface Properties rollout

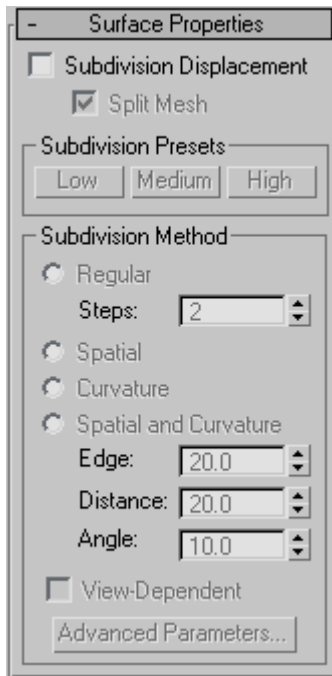

Specifies surface approximation settings for subdividing the editable mesh. These controls work like the surface approximation settings for [NURBS surfaces](#) on page 2152. They are used when you apply a [displacement map](#) on page 5391 to the editable mesh.

---

**NOTE** The Surface Properties rollout is available only for editable mesh objects; it does not appear in the Modify panel for an object to which the Edit Mesh modifier is applied. With Edit Mesh-modified objects, you can use the [Disp Approx modifier](#) on page 1270 to the same effect.

---

**Subdivision Displacement** When on, faces are subdivided to accurately displace the mesh, using the method and settings you specify in the Subdivision Presets and Subdivision Method group boxes. When off, the mesh is displaced by moving existing vertices, the way the [Displace modifier](#) on page 1274 does. Default=off.

**Split Mesh** Affects the seams of displaced mesh objects; also affects texture mapping. When on, the mesh is split into individual faces before it is displaced;

this helps preserve texture mapping. When off, the mesh is not split and an internal method is used to assign texture mapping. Default=on.

---

**TIP** This parameter is required because of an architectural limitation in the way displacement mapping works. Turning Split Mesh on is usually the better technique, but it can cause problems for objects with clearly distinct faces, such as boxes, or even spheres. A box's sides might separate as they displace outward, leaving gaps. And a sphere might split along its longitudinal edge (found in the rear for spheres created in the Top view) unless you turn off Split Mesh. However, texture mapping works unpredictably when Split Mesh is off, so you might need to add a [Displace Mesh modifier](#) on page 1045 and make a [snapshot](#) on page 921 of the mesh. You would then apply a [UVW Map modifier](#) on page 1849 and then reassign mapping coordinates to the displaced snapshot mesh.

---

### **Subdivision Presets group & Subdivision Method group**

The controls in these two group boxes specify how the displacement map is applied when Subdivision Displacement is on. They are identical to the [Surface Approximation controls](#) on page 2469 used for NURBS surfaces.

## **Editable Mesh (Vertex)**

Select an editable mesh object. > Modify panel > Selection rollout > Vertex

Select an editable mesh object. > Modify panel > Modifier Stack display > Expand Editable Mesh. > Vertex

Select an editable mesh object. > Quad menu > Tools 1 quadrant > Vertex

Vertices are points in space: they define the structure of faces. When vertices are moved or edited, the faces they form are affected as well. Vertices can also exist independently; such isolated vertices can be used to construct faces but are otherwise invisible when rendering.

At the Editable Mesh (Vertex) sub-object level, you can select single and multiple vertices and move them using standard methods.

#### **See also:**

- [Editable Mesh Surface](#) on page 1990

## Procedures

### To weld mesh vertices:

You can use either of two methods to combine several vertices into one, also known as welding. If the vertices are very close together, use the Weld function. You can also use Weld to combine a number of vertices to the average position of all of them.

Alternatively, to combine two vertices that are far apart, resulting in a single vertex that's in the same position as one of them, use Target Weld.

---

**TIP** Welding vertices is considerably easier with poly objects. See this procedure: [To weld polygon vertices](#): on page 2055

---

#### 1 To use Weld:

- On the Selection rollout, turn on Ignore Backfacing, if necessary. This ensures that you're welding only vertices you can see.
- Select the vertices to weld.
- If the vertices are very close together, go to the Edit Geometry rollout > Weld group and click Selected. If that doesn't work (you get a "No vertices within weld threshold." message), proceed to the next step.
- Increase the numeric value to the right of the Selected button. This is the threshold value; the minimum distance that vertices can be apart from each other to be welded.
- Click Selected again.  
At this point, one of three things happens: None, some, or all of the vertices are welded. If the latter, you're done. If either of the others occurs, proceed to the next step.
- Continue increasing the threshold value and clicking Selected until all of the vertices are welded.

#### 2 To use Target Weld:

- 1 On the Selection rollout, turn on Ignore Backfacing, if necessary. This ensures that you're welding only vertices you can see.
- 2 Find two vertices you want to weld, and determine the ultimate location of the resulting vertex. You can weld any two vertices, but for best results the two should be contiguous; that is, they should be connected by a single edge.

For this example, we'll call the vertices A and B, and the resulting vertex will be at vertex B's location.

- 3 Click the Target button.

The button stays highlighted, to indicate that you're now in Target Weld mode.

- 4 Drag vertex A to Vertex B.

While you're dragging, the mouse cursor image is a four-headed, +-shaped arrow. When over an eligible target vertex, the cursor changes to a crosshairs.

---

**TIP** If you have trouble dragging in the proper direction, open the [Axis Constraints toolbar](#) on page 7288 and click the XY button.

---

- 5 Release the mouse button.

The pair is welded. The resulting vertex remains at vertex B's position, and you exit Target Weld mode.

---

**TIP** If you have trouble combining the two vertices, try increasing the Pixels value with the spinner to the right of the Target button.

---

You remain in Target Weld mode, and can continue to weld pairs of vertices.

- 6 Exit Target mode by right-clicking in the active viewport or clicking the Target button again.

### To select vertices by color:

- 1 On the Surface Properties rollout, click the Existing Color swatch, and specify the color of vertex you want in the Color Selector.
- 2 Specify ranges in the RGB Range spinners. This lets you select vertices that are close to the specified color, but don't match exactly.
- 3 Click the Select button.

All vertices matching the color, or within the RGB range, are selected.

You can add to the selection by holding Ctrl as you click the Select button, and you can subtract from the selection by holding the Alt key.

---

**TIP** You can select all vertices of the same color by first selecting the vertex you want matched, dragging a copy of the Edit Color swatch to the Existing Color swatch, and then clicking the Select button. (If you want an exact match, be sure to set the RGB Range spinners to 0 first.)

---

## **Interface**

### **Selection rollout**

For information on the Selection rollout settings, see [Editable Mesh](#) on page 1992 .

### **Soft Selection rollout**

Soft Selection controls affect the action of sub-object Move, Rotate, and Scale functions. When these are on, the program applies a spline curve deformation to unselected vertices surrounding the transformed selected sub-object. This provides a magnet-like effect with a sphere of influence around the transformation.

For more information, see [Soft Selection Rollout](#) on page 1926 .

## Edit Geometry rollout

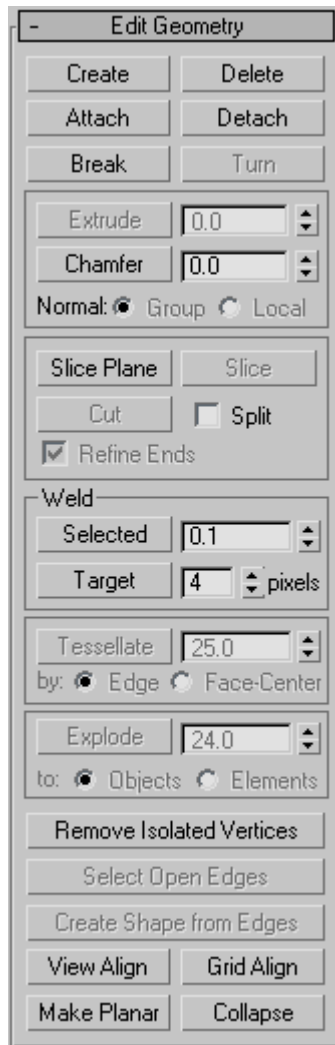

See [Edit Geometry Rollout \(Mesh\)](#) on page 2018 for detailed descriptions of these controls.

## Surface Properties rollout

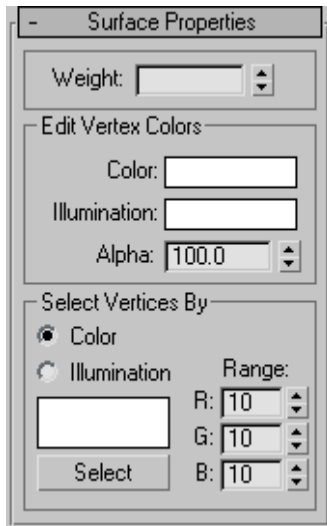

These controls let you set the weight and color for vertices.

**Weight** Displays and lets you change vertex weights for NURMS operations (see [MeshSmooth Modifier](#) on page 1460 ).

### Edit Vertex Colors group

Use these controls to assign the color, illumination color (shading), and alpha (transparency) values of selected vertices.

**Color** Click the color swatch to change the color of selected vertices.

**Illumination** Click the color swatch to change the illumination color of selected vertices. This lets you change the illumination of a vertex without changing the vertex's color.

**Alpha** Lets you assign an alpha (transparency) value to selected vertices.

The spinner value is a percentage; zero is completely transparent and 100 is completely opaque.

### Select Vertices By group

**Color/Illumination** These radio buttons let you choose to select vertices by vertex color value or vertex illumination value. Set the desired options and then click Select.



**Color Swatch** Displays the current color to match. Click to open the Color Selector, where you can specify a different color.

**Select** Depending on which radio button is selected, selects all vertices whose vertex color or illumination values either match the color swatch, or are within the range specified by the RGB spinners.

**Range** Specifies a range for the color match. All three RGB values in the vertex color or illumination color must either match the color specified by the Color swatch in Select By Vertex Color, or be within a range determined by adding and subtracting the Range values from the displayed color. Default=10.

For example, if you've chosen Color and set the color swatch to medium gray (R=G=B=128), and are using the default Range values of 10,10,10, then clicking the Select button selects only vertices set to RGB color values between 118,118,118 and 138,138,138.

## Editable Mesh (Edge)



Select an editable mesh object. > Modify panel > Selection rollout > Edge

Select an editable mesh object. > Modify panel > Modifier Stack display > Editable Mesh rollout > Edge

Select an editable mesh object. > Quad menu > Tools 1 quadrant > Edge

An edge is a line, visible or invisible, forming the side of a face and connecting two vertices. Two faces can share a single edge.

At the Editable Mesh (Edge) sub-object level, you can select single and multiple edges and transform them using standard methods.

### See also:

- [Editable Mesh Surface](#) on page 1990

### Procedures

#### To create a shape from one or more edges:

- 1 Select the edges you want to make into shapes.
- 2 On the Edit Geometry rollout, click Create Shape From Edges.

- 3 Make changes, as needed, on the Create Shape dialog that appears.
  - Enter a curve name or keep the default.
  - Choose Smooth or Linear as the Shape Type.
  - Turn on Ignore Hidden Edges to exclude hidden edges from the calculation, or turn this feature off.
- 4 Click OK.

The resulting shape consists of one or more splines whose vertices are coincident with the vertices in the selected edges. The Smooth option results in vertices using smooth values, while the Linear option results in linear splines with corner vertices.

When you region-select edges, all edges are highlighted, including hidden edges, which are displayed as dashed lines. As a default, the Create Shape function ignores the hidden edges, even though they're selected. Turn off Ignore Hidden Edges if you want to include the hidden edges in the calculation.

If the selected edges are not continuous, or if they branch, the resulting shape will consist of more than one spline. When the Create Shape function runs into a branching 'Y' in the edges, it makes an arbitrary decision as to which edge produces which spline. If you need to control this, select only those edges that will result in a single spline, and perform Create Shape repeatedly to make the correct number of shapes. Finally, use Attach in the Editable Spline to combine the shapes into one.

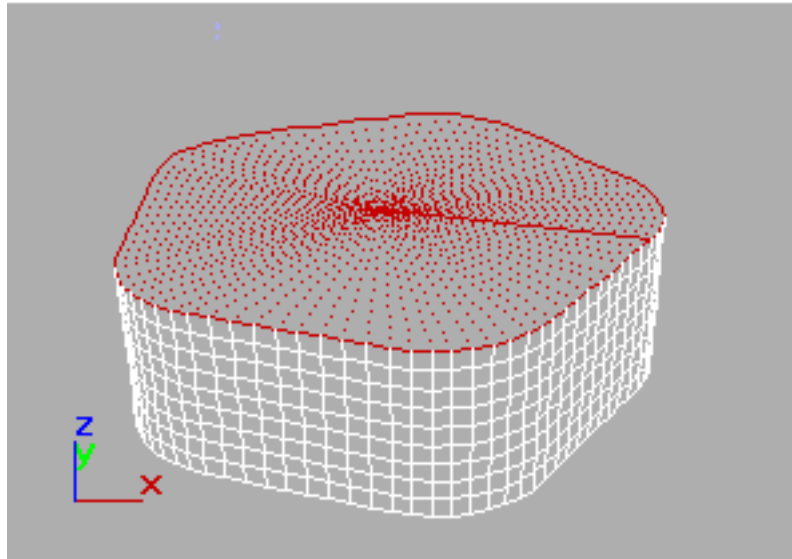
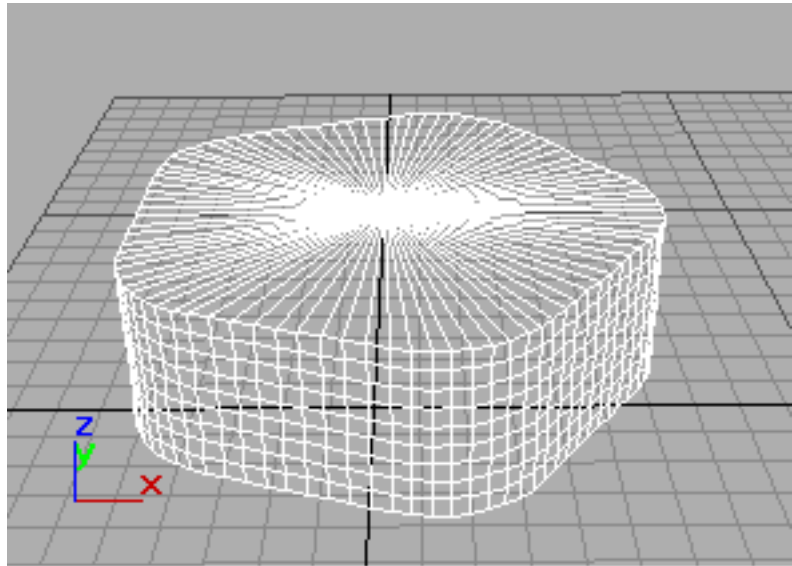

Top: Original object

Bottom: Object with edges selected

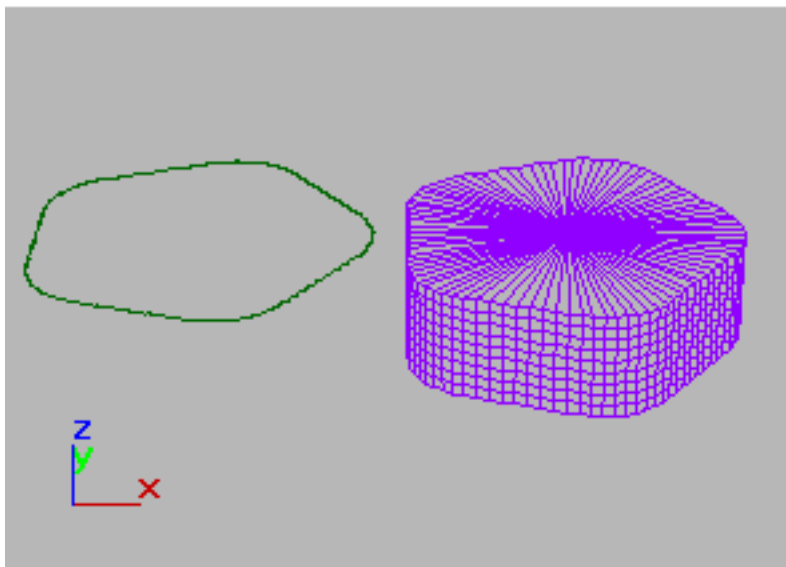
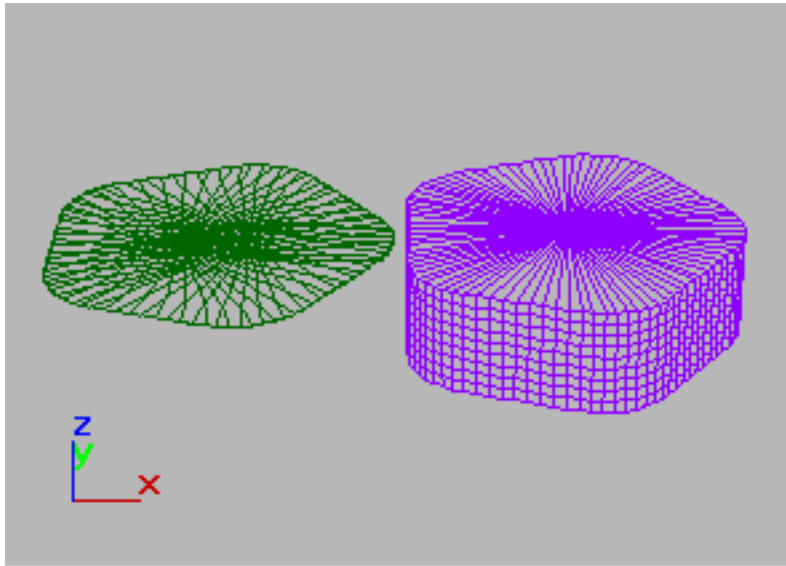

Top: Selected edges removed from original object

Bottom: Unwanted edges removed

## **Interface**

### **Selection rollout**

See [Editable Mesh](#) on page 1992 for information on the Selection rollout settings.

### **Soft Selection rollout**

Soft Selection controls affect the action of sub-object Move, Rotate, and Scale functions. When these are on, the software applies a spline curve deformation to unselected vertices surrounding the transformed selected sub-object. This provides a magnet-like effect with a sphere of influence around the transformation.

For more information, see [Soft Selection Rollout](#) on page 1926 .

## Edit Geometry rollout

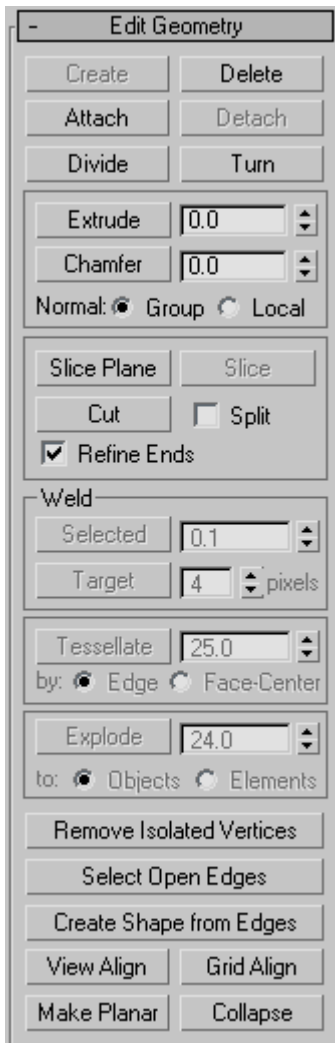

See [Edit Geometry Rollout \(Mesh\)](#) on page 2018 for detailed descriptions of these controls.

## Surface Properties rollout

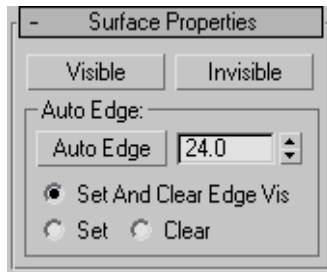

These controls affect the visibility of the edges. Invisible edges (also called construction lines) appear in the viewports when Edges Only is turned off in the Display command panel, or when you're editing at the Edge sub-object level. The visibility of edges is primarily of importance when an object is being rendered using a wireframe material.

**Visible** Makes selected edges visible.

**Invisible** Makes selected edges invisible, so they won't be displayed in Edges Only mode.

### Auto Edge group

**Auto Edge** Automatically determines edge visibility based on the angle between the faces that share the edge, with the angle set by the Threshold spinner to its right.

Clicking Auto Edge can have one of three effects, depending on which radio button is active (Set means to make an invisible edge visible; Clear means to make a visible edge invisible):

- **Set and Clear Edge Vis** Can change the visibility of all selected edges depending on the Threshold setting.
- **Set** Makes previously invisible edges visible only if they exceed the Threshold setting; does not clear any edges.
- **Clear** Makes previously visible edges invisible only if they are less than the Threshold setting; does not make any edges visible.

# Editable Mesh (Face/Polygon/Element)



Select an editable mesh object. > Modify panel > Selection rollout > Face/Polygon/Element

Select an editable mesh object. > Modify panel > Modifier Stack display > Editable Mesh rollout > Face/Polygon/Element

Select an editable mesh object. > Quad menu > Tools 1 quadrant > Face/Polygon/Element

A *face* is the smallest possible mesh object: a triangle formed by three vertices. Faces provide the renderable surface of an object. While a vertex can exist as an isolated point in space, a face cannot exist without vertices.

At the Editable Mesh (Face) level, you can select single and multiple faces and transform them using standard methods. This is also true for the Polygon and Element sub-object levels; for the distinctions between face, polygon, and element, see [Editable Mesh > Selection rollout](#) on page 1992 .

## See also:

- [Editable Mesh Surface](#) on page 1990

## Interface

### Selection rollout

For information on the Selection rollout settings, see [Editable Mesh](#) on page 1992 .

### Soft Selection rollout

Soft Selection controls affect the action of sub-object Move, Rotate, and Scale functions. When these are on, 3ds Max applies a spline curve deformation to unselected vertices surrounding the transformed selected sub-object. This provides a magnet-like effect with a sphere of influence around the transformation.

For more information, see [Soft Selection Rollout](#) on page 1926 .



## Edit Geometry rollout

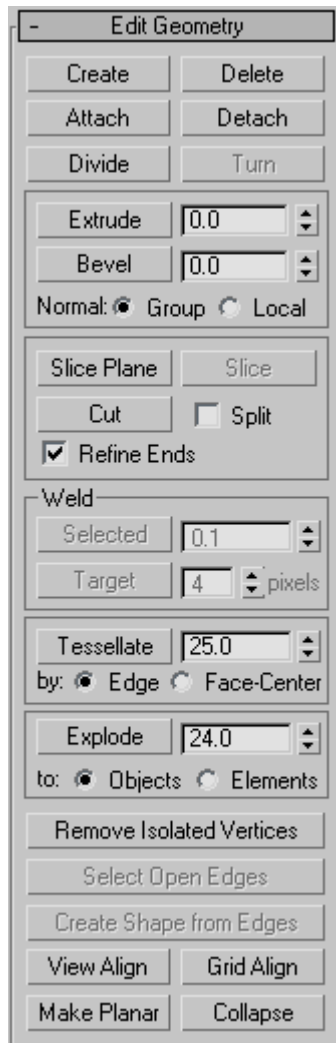

See [Edit Geometry Rollout \(Mesh\)](#) on page 2018 for detailed descriptions of these controls.

## Surface Properties rollout

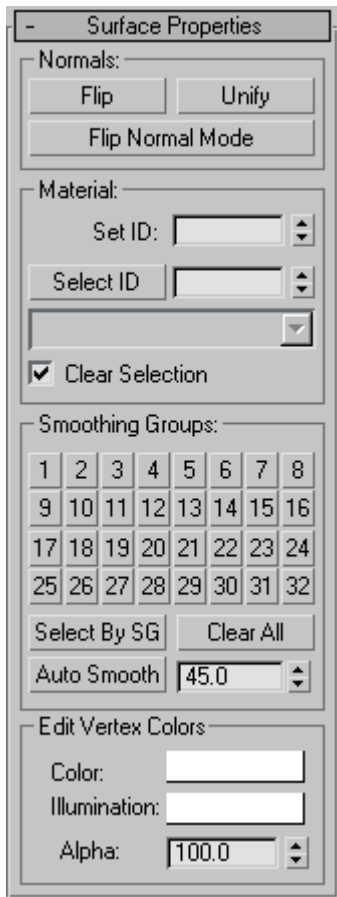

These controls let you work with face normals, material IDs, smoothing groups and vertex colors.

### Normals group

**Flip** Reverses the direction of the surface normals of the selected faces.

**Unify** Flips the normals of an object so that they all point in the same direction, usually outward. This is useful for restoring an object's faces to their original orientations. Sometimes normals of objects that have come into 3ds Max as part of a DXF file are irregular, depending on the methods used to create the objects. Use this function to correct them.

**Flip Normal Mode** Flips the normal of any face you click. To exit, click this button again or right-click anywhere in the program interface.

---

**TIP** The best way to use Flip Normal mode is to set up your viewport to display with Smooth+Highlight and Edged Faces on. If you use Flip Normal mode with default settings, you'll be able to flip a face away from you, but you won't be able to flip it back. For best results, turn off Ignore Backfacing in the Selection rollout. This lets you click any face and flip the direction of its normal, regardless of its current direction.

---

### **Material group**

**Set ID** Lets you assign a particular [material ID](#) on page 7842 number to selected sub-objects for use with [multi/sub-object materials](#) on page 5558 and other applications. Use the spinner or enter the number from the keyboard. The total number of available IDs is 65,535.

**Select ID** Selects sub-objects corresponding to the Material ID specified in the adjacent ID field. Type or use the spinner to specify an ID, then click the Select ID button.

**[Select By Name]** This drop-down list shows the names of sub-materials if an object has a Multi/Sub-Object material assigned to it. Click the drop arrow and choose a sub-material from the list. The sub-objects that are assigned that material are selected. If an object does not have a Multi/Sub-Object material assigned, the name list is unavailable. Likewise, if multiple objects are selected that have an Edit Patch, Edit Spline, or Edit Mesh modifier applied, the name list is inactive.

---

**NOTE** Sub-material names are those specified in the Name column on the material's Multi/Sub-Object Basic Parameters rollout; these are not created by default, and must be specified separately from any material names.

---

**Clear Selection** When on, choosing a new ID or material name deselects any previously selected sub-objects. When off, selections are cumulative, so new ID or sub-material name selections add to the existing selection set of patches or elements. Default=on.

### **Smoothing Groups group**

Use these controls to assign selected faces to different [smoothing groups](#) on page 7932 , and to select faces by smoothing group.

To assign faces to one or more smoothing groups, select the faces, and then click the number(s) of the smoothing group(s) to assign them to.

**Select by SG (Smoothing Group)** Displays a dialog that shows the current smoothing groups. Select a group by clicking the corresponding numbered button and clicking OK. If Clear Selection is on, any previously selected faces are first deselected. If Clear Selection is off, the new selection is added to any previous selection set.

**Clear All** Removes any smoothing group assignments from selected faces.

**Auto Smooth** Sets the smoothing groups based on the angle between faces. Any two adjacent faces will be put in the same smoothing group if the angle between their normals is less than the threshold angle, set by the spinner to the right of this button.

**Threshold** This spinner (to the right of Auto Smooth) lets you specify the maximum angle between the normals of adjacent faces that determines whether those faces will be put in the same smoothing group.

### **Edit Vertex Colors group**

Use these controls to assign the color, illumination color (shading), and alpha (transparency) values of vertices on the selected face(s).

**Color** Click the color swatch to change the color of vertices on the selected face(s). Assigning vertex colors at the face level prevents blending across the face(s).

**Illumination** Click the color swatch to change the illumination color of vertices on the selected face(s). This lets you change the illumination without changing the vertex's color.

**Alpha** Lets you assign an alpha (transparency) value to vertices on the selected face(s).

The spinner value is a percentage; zero is completely transparent and 100 is completely opaque.

## **Edit Geometry Rollout (Mesh)**

Select an editable mesh object. > Modify panel > Selection rollout > Choose any sub-object level.

Select an editable mesh object. > Modify panel > Modifier Stack display > Expand Editable Mesh. > Choose any sub-object level.

Select an editable mesh object. > Quad menu > Tools 1 quadrant > Choose any sub-object level.

The Edit Geometry rollout for Meshes contains most of the controls that let you alter the geometry of the mesh, at either the Object (top) level, or one of the sub-object levels. The controls that the rollout displays can vary, depending on which level is active; if a control is not available for the active level, it might be grayed out, or simply might not appear at all. The descriptions below indicate the levels at which controls are available.

## Interface

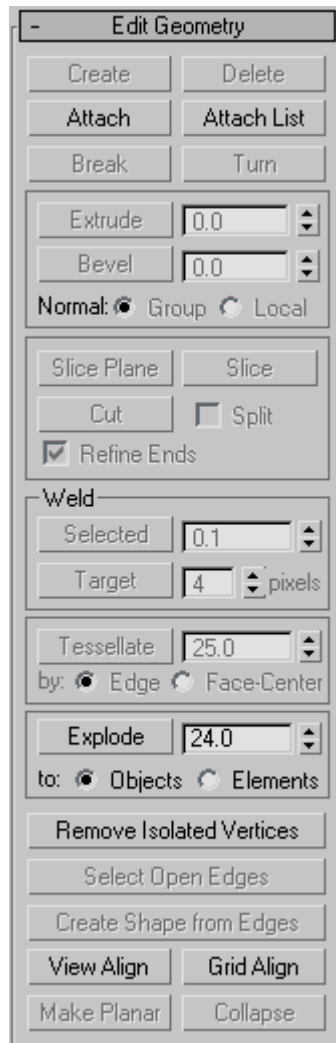

## Editing buttons

**Create** Lets you add sub-objects to a single selected mesh object. Select an object, choose a sub-object level, click Create, and then click to add sub-objects. Available only at the Vertex, Face, Polygon, and Element levels only.

For example, at the Vertex sub-object level, Create lets you add free-floating vertices to the object. The new vertices are placed on the active construction plane.

To create faces at the Face, Polygon, or Element level, click Create. All vertices in the object are highlighted, including isolated vertices left after deleting faces. Click three existing vertices in succession to define the shape of the new face. (The cursor changes to a cross when it is over a vertex that can legally be part of the face.)

You can also create new faces at the Polygon and Element sub-object levels. At the Face and Element sub-object levels, a new face is created after every third click. At the Polygon sub-object level, you can continue clicking as many times as you like to add vertices to the new polygon. To finish drawing a new polygon, click twice, or click again on any existing vertex in the current polygon.

At the Face, Polygon, and Element levels, you can add vertices while Create is on by Shift+clicking in an empty space; these vertices are incorporated into the face or polygon you're creating.

You can start creating faces or polygons in any viewport, but all subsequent clicks must take place in the same viewport.

---

**TIP** For best results, click vertices in counterclockwise (preferred) or clockwise order. If you use clockwise order, the new polygon will be facing away from you, and you won't be able to see it unless you've turned on Force 2-Sided or are using a two-sided material.

---

**Delete (sub-object levels only)** Deletes selected sub-objects and any faces attached to them.

**Attach** Lets you attach another object in the scene to the selected mesh. You can attach any type of object, including splines, patch objects, and NURBS surfaces. Attaching a non-mesh object converts it to a mesh. Click the object you want to attach to the currently selected mesh object.

When you attach an object, the materials of the two objects are combined in the following way:

- If the object being attached does not have a material assigned, it inherits the material of the object it is being attached to.

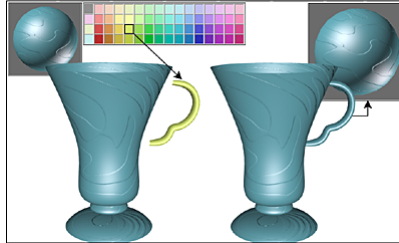

**Handle inherits material from the cup it is being attached to.**

- Likewise, if the object you're attaching to doesn't have a material, it inherits the material of the object being attached.
- If both objects have materials, the resulting new material is a [multi/sub-object material](#) on page 5558 that encompasses the input materials. A dialog appears offering three methods of combining the objects' materials and material IDs. For more information, see [Attach Options Dialog](#) on page 2031 .



Shaded view of model (upper left); wireframe view of model (upper right); model with objects attached (lower left); and subsequent multi/sub-object material (lower right)

Attach remains active in all sub-object levels, but always applies to objects.

**Attach List (Object level only)** Lets you attach other objects in the scene to the selected mesh. Click to open the Attach List dialog, which works like [Select From Scene](#) on page 168 to let you choose multiple objects to attach.

**Detach (Vertex and Face/Polygon/Element levels only)** Detaches the selected sub-object as a separate object or element. All faces attached to the sub-object are detached as well.



A dialog appears, prompting you to enter a name for the new object. The dialog has a Detach As Clone option that copies the faces rather than moving them.

Detached faces leave a hole in the original object when you move them to a new position.

**Break (Vertex level only)** Creates a new vertex for each face attached to selected vertices, allowing the face corners to be moved away from each other where they were once joined at the original vertex. If a vertex is isolated or used by only one face, it is unaffected.

**Turn (Edge level only)** Rotates the edge within its bounding. All mesh objects in 3ds Max are composed of triangular faces, but by default, most polygons are depicted as quadrilaterals, with a hidden edge dividing each quad into two triangles. Turn lets you change the direction in which the hidden edge (or any other) runs, thus affecting how the shape changes when you transform sub-objects directly, or indirectly with a modifier.

**Divide (Face/Polygon/Element levels only)** Subdivides faces into three smaller faces. This function applies to faces even if you're at the Polygon or Element sub-object level. Click Divide, and then select a face to be divided. Each face is subdivided where you click it. You can click as many faces as you want divided, in sequence. To stop dividing, click Divide again to turn it off, or right-click.

### **Extrude, Chamfer, and Bevel group**



The Extrude controls let you extrude edges or faces. Edge extrusion works in a fashion similar to face extrusion. You can apply extrusion interactively (by dragging on sub-objects) or numerically (using spinners).

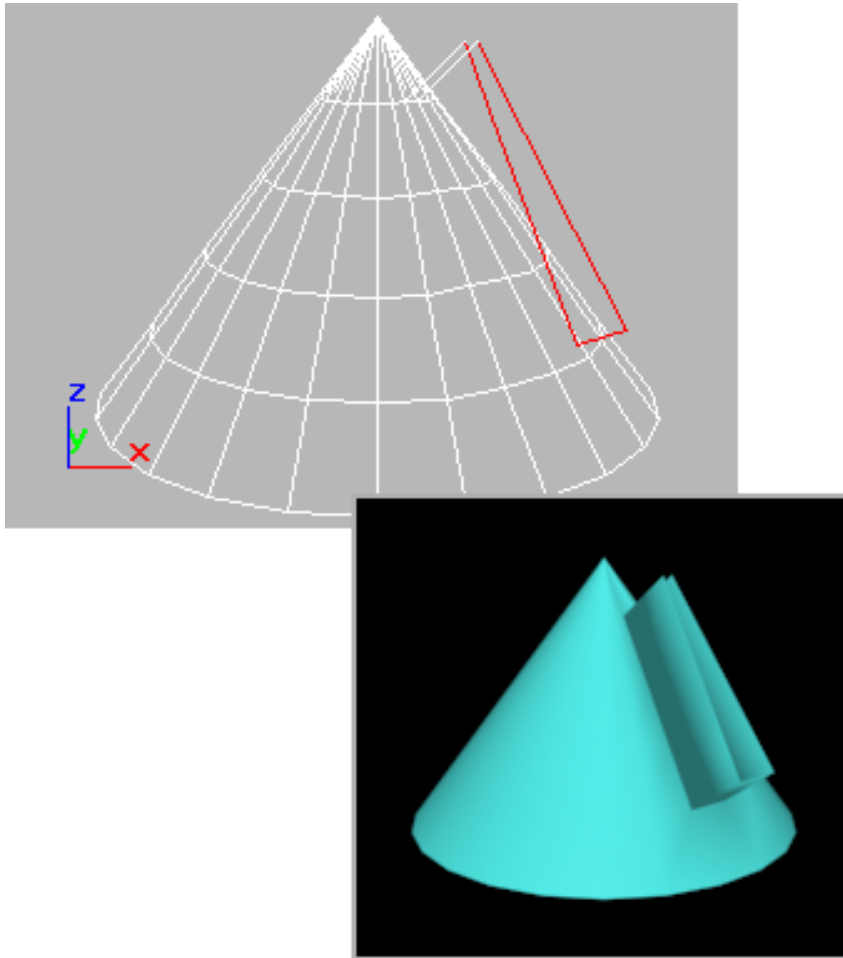

Extruded edges seen in viewport and rendered image

**Extrude (Edge and Face/Polygon/Element levels only)** Click this button and then either drag to extrude the selected edges or faces, or adjust the Extrude spinner to perform the extrusion. You can select different sub-objects to extrude while Extrude is active.

- **Extrude Amount** This spinner (to the right of the Extrude button) lets you specify the amount to extrude the edge. Select one or more edges, and then adjust the spinner.

The Chamfer controls are available only at the Vertex and Edge sub-object levels. They let you bevel object corners using a chamfer function. You can apply this effect interactively (by dragging vertices) or numerically (using the Chamfer spinner).

**Chamfer (Vertex and Edge levels only)** Click this button, and then drag vertices or edges in the active object. The Chamfer Amount spinner updates to indicate the chamfer amount as you drag.

If you drag one or more selected vertices or edges, all selected sub-objects are chamfered identically. If you drag an unselected vertex or edge, any selected sub-objects are first deselected.

A chamfer "chops off" the selected sub-objects, creating a new face connecting new points on all *visible* edges leading to the original sub-object. Chamfer Amount specifies the exact distance from the original vertex along each of these edges. New chamfer faces are created with the material ID of one of the neighboring faces (picked at random) and a smoothing group that is an intersection of all neighboring smoothing groups.

For example, if you chamfer one corner of a box, the single corner vertex is replaced by three vertices moving along the three visible edges that lead to the corner. The software rearranges and splits the adjacent faces to use these three new vertices, and creates a new triangle at the corner.

- **Chamfer Amount** Adjust this spinner (to the right of the Chamfer button) to apply a chamfer effect to selected vertices.
- **Normal (Edge and Face/Polygon/Element levels only)** Determines how a selection of more than one edge is extruded. With Normal set to Group (the default), extrusion takes place along the averaged normal of each continuous group (line) of edges. If you extrude multiples of such groups, each group moves along its own averaged normal. If you set Normal to Local, extrusion takes place along each selected edge's normal.

Beveling, available only at the Face/Polygon/Element levels, is a second step to extrusion: it lets you scale the faces you have just extruded.

---

**TIP** A similar operation is [Inset](#) on page 2097, which Editable Poly has but Editable Mesh doesn't. When you inset a polygon, you create another, smaller polygon of the same proportions inside the borders of an original polygon, in the plane of the original. Essentially, it's a bevel with no height. You can achieve this in Editable Mesh with the following procedure:

- 1 Select the polygon to inset.
- 2 Right-click the spinner all the way to the right of the Extrude button. This performs an extrusion with no height, thus creating a new polygon plus connecting polygons in the same position as the original.
- 3 Set a negative Bevel value using the numeric field or the spinner. This insets the new polygon created by the extrusion without changing its height.

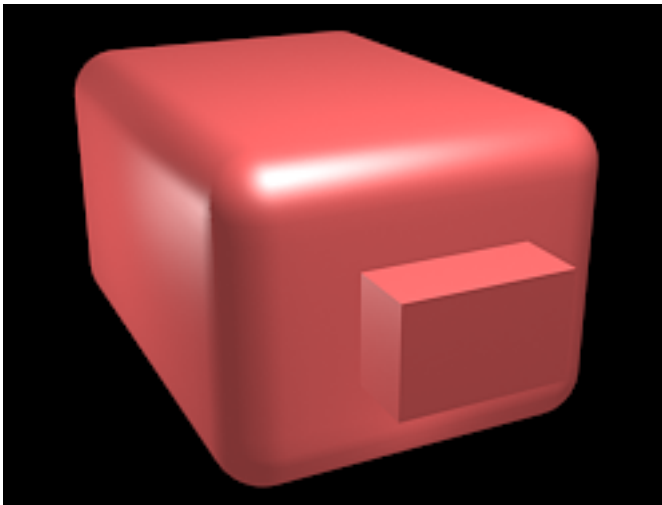

Chamfer box showing extruded face

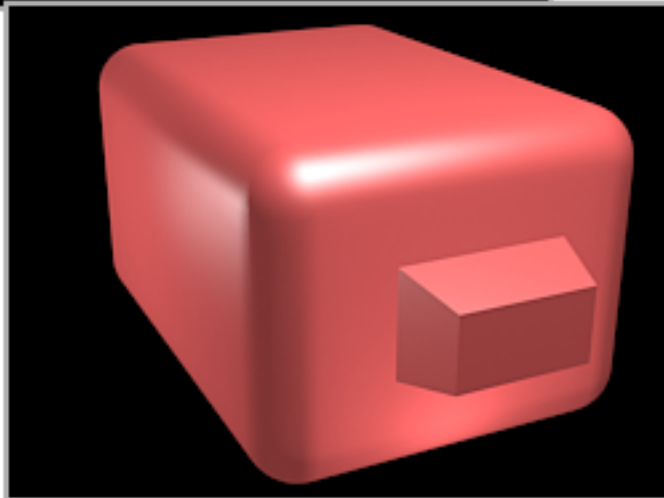
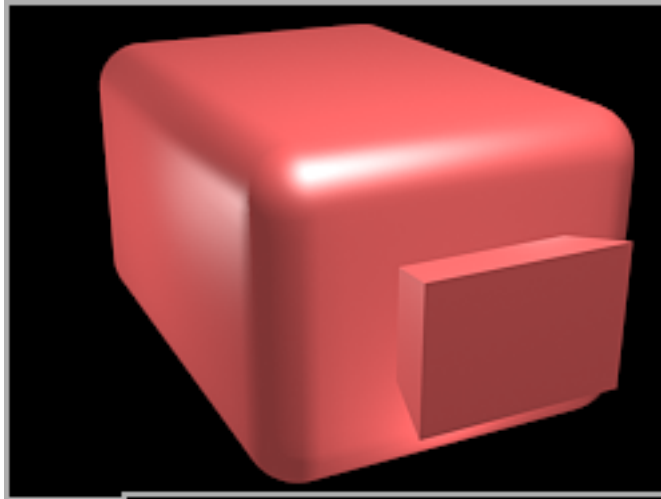

#### Extruded face beveled in two different directions

You can bevel faces by dragging or by using keyboard/spinner entry.

**Bevel (Face/Polygon/Element levels only)** Click this button, and then drag vertically on any face to extrude it. Release the mouse button and move the mouse vertically to bevel the extrusion. Click to finish.

- When over a selected face, the mouse cursor changes to a Bevel cursor.

- With multiple faces selected, dragging on any one bevels all selected faces equally.
- You can drag other faces in turn to bevel them while the Bevel button is active. Click Bevel again or right-click to end the operation.

**Outlining** This spinner (to the right of the Bevel button) lets you scale selected faces bigger or smaller, depending on whether the value is positive or negative. It is normally used after an extrusion for beveling the extruded faces.

### Cut and Slice group

Lets you subdivide edges with either cut or slice tools to create new vertices, edges, and faces. For details, see [Cut and Slice](#) on page 2033 .

---

**NOTE** At the Vertex sub-object level, Slice is available but Cut is not.

---

### Weld group (Vertex level only)

**Selected** Welds selected vertices that fall within the tolerance specified in the Weld Threshold spinner (to the button's right). All line segments become connected to the resulting single vertex.

**Target** Enters weld mode, which allows you to select vertices and move them around. While moving, the cursor changes to the Move cursor as usual, but when you position the cursor over an unselected vertex the cursor changes to a + cursor. Release the mouse at that point to weld all selected vertices to the target vertex they were dropped on.

The pixels spinner to the right of the Target button sets the maximum distance in screen pixels between the mouse cursor and the target vertex.

### Tessellate group (Face/Polygon/Element levels only)

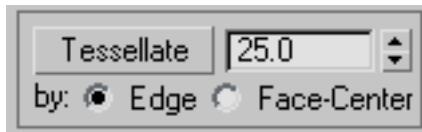

Use these controls to tessellate (subdivide) selected faces. Tessellation is useful for increasing local mesh density while modeling. You can subdivide any selection of faces. Two tessellation methods are available: Edge and Face-Center.

**Tessellate** Click to tessellate selected faces, based on the Edge, Face-Center, and Tension (spinner) settings.

**Top: Original selection**

**Middle: Tessellated once**

**Bottom: Tessellated twice**

**Tension** (Active only when Tessellate by Edge is active.) This spinner, to the right of the Tessellate button, lets you increase or decrease the Edge tension value. A negative value pulls vertices inward from their plane, resulting in a concave effect. A positive value pulls vertices outward from their plane, resulting in a rounding effect.

**By Edge/Face-Center** Edge inserts vertices in the middle of each edge and draws three lines connecting those vertices. As a result, four faces are created out of one face. (To see this at the Polygon or Element sub-object level, turn off Display panel > Display Properties rollout > Edges Only.)

Face-Center adds a vertex to the center of each face and draws three connecting lines from that vertex to the three original vertices. As a result, three faces are created out of one face.

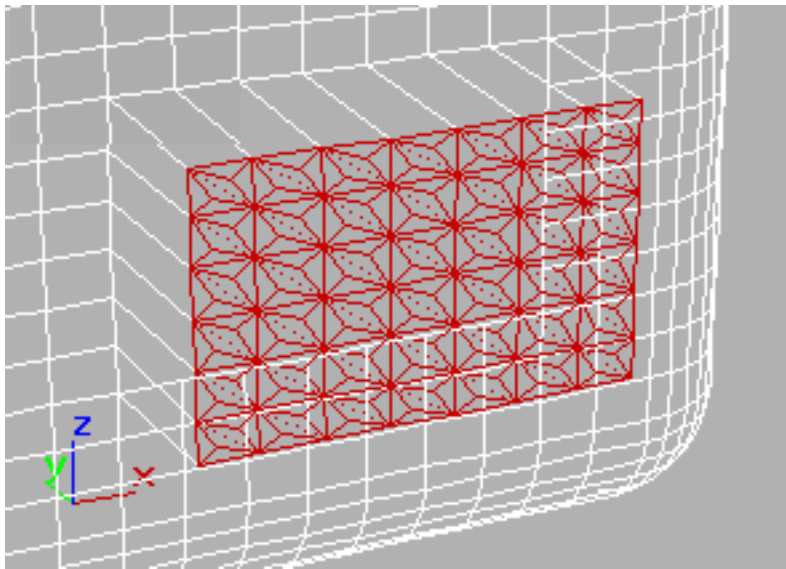

Set of polygons showing Face-Center tessellation

## Explode group (Object and Face/Polygon/Element levels only)

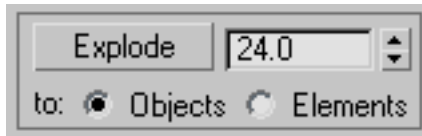

**Explode** Breaks up the current object into multiple elements or objects based on the angles of its edges. This function is available in Object mode as well as all sub-object levels except Vertex and Edge.

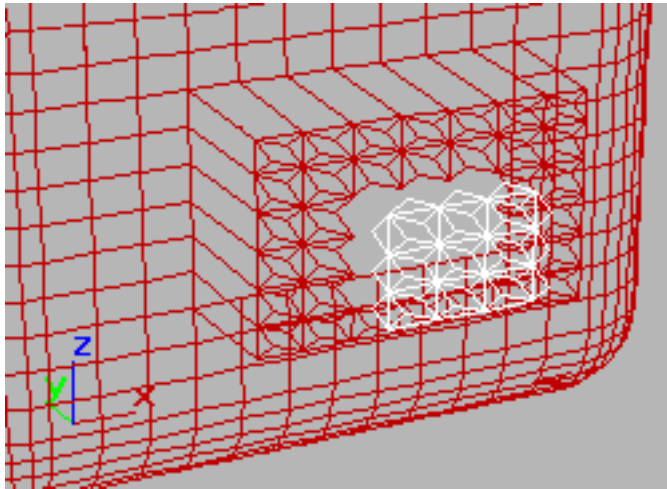

Exploded faces (white) removed from tessellated faces

The angle threshold spinner, to the right of the Explode button, lets you specify the angle between faces below which separation will not occur. For example, all sides of a box are at 90-degree angles to each other. If you set the spinner to 90 or above, exploding the box changes nothing. However, at any setting below 90, the sides all become separate objects or elements.

**To Objects/Elements** Specifies whether the exploded faces become the separate objects or elements of the current object.

**Remove Isolated Vertices** Deletes all isolated vertices in the object regardless of the current selection.

**Select Open Edges (Edge level only)** Selects all edges with only one face. In most objects, this shows you where missing faces exist.



**Create Shape from Edges (Edge level only)** After selecting one or more edges, click this button to create a spline shape from the selected edges. A Create Shape dialog appears, letting you name the shape, set it to Smooth or Linear, and ignore hidden edges. The new shape's pivot is placed at the center of the mesh object.

**View Align** Aligns all vertices in selected objects or sub-objects to the plane of the active viewport. If a sub-object level is active, this function affects only selected vertices or those belonging to selected sub-objects.

In the case of [orthographic viewports](#) on page 7877 , using View Align has the same effect as aligning to the construction grid when the home grid is active. When aligning to a perspective viewport (including camera and light views), the vertices are reoriented to be aligned to a plane that is parallel to the camera's viewing plane. This plane is perpendicular to the view direction that is closest to the vertices' average position.

**Grid Align** Aligns all vertices in selected objects or sub-objects to the plane of the current view. If a sub-object level is active, function aligns only selected sub-objects.

This function aligns the selected vertices to the current construction plane. The current plane is specified by the active viewport in the case of the home grid. When using a grid object, the current plane is the active grid object.

**Make Planar (sub-object levels only)** Forces all selected sub-objects to become coplanar. The plane's normal is the average surface normal of all faces attached to the selected sub-objects.

**Collapse (sub-object levels only)** Collapses selected sub-objects into an averaged vertex.

## Attach Options Dialog

Select an editable mesh object. > Modify panel > Attach button

The Attach Options dialog appears when you attach two or more objects to which materials have been assigned. It provides three different methods of combining the sub-materials and the material IDs in the two objects.

## Interface

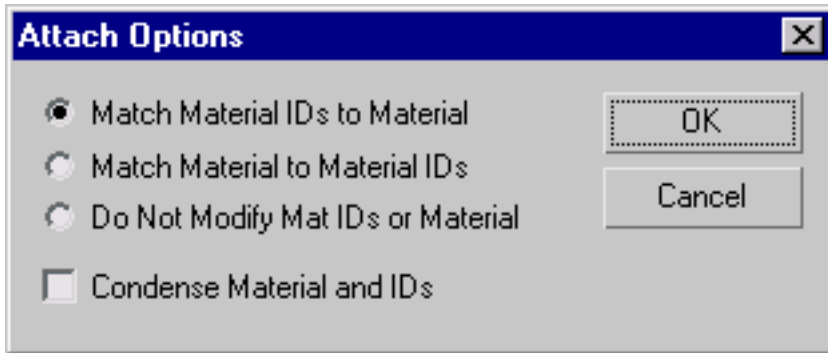

**Match Material IDs to Material** The number of material IDs in the attached objects are modified so they are no greater than the number of sub-materials assigned to those objects. For example, if you have a box with only two sub-materials assigned to it, and you attach it to another object, the box will have only two material IDs, instead of the six it was assigned on creation.

**Match Material to Material IDs** Maintains the original ID assignment in the attached objects by adjusting the number of sub-materials in the resulting multi/sub-object material. For example, if you attach two boxes, both assigned single materials, but with their default assignment of 6 material IDs, the result would be a multi/sub-object material with 12 sub-materials (six containing instances of one box's material, and six containing instances of the other box's material). Use this option when it's important to maintain the original material ID assignments in your geometry.

---

**NOTE** If you want to make the instanced sub-materials unique, select them in Track View, and click the Make Unique button on the Track View toolbar. You can also make them unique one at a time with the [Make Unique button](#) on page 5250 in the Material Editor.

---

**Do Not Modify Mat IDs or Material** Does not adjust the number of sub-materials in the resulting sub-object material. Note that, if the number of material IDs in an object is greater than the number of sub-materials in its multi/sub-object material, then the resulting face-material assignment might be different after the attach.

**Condense Material IDs** Affects the Match Material IDs To Material option. When this is on, duplicate sub-materials or sub-materials that aren't used in the objects are removed from the multi/sub-object material that results from the attach operation. Default=on.

## Tips

- In most cases, use the first option (Match Material IDs to Material) while keeping Condense Material IDs selected. This maintains the appearance of the objects, and results in the fewest additional sub-materials or IDs.
- Use the second option (Match Material to Material IDs) when you need to maintain the original material ID assignments.
- Avoid using the third option, unless you need to repeat a 3ds Max version 1 attachment for compatibility with a previous project.
- Leave Condense Material IDs selected unless you have an unassigned sub-material that you want to keep for future assignment.
- Perform Edit menu > Hold before performing the attach.

## Cut and Slice

Select an editable mesh object. > Modify panel > Selection rollout > (Optional: Choose a sub-object level.) > Edit Geometry rollout > Cut and Slice group box

The tools available in the Cut and Slice group let you subdivide edges and faces to create new vertices, edges, and faces. You can slice an editable mesh object at any sub-object level; the Cut tool is available at every sub-object level except the Vertex sub-object level.

### Procedures

#### To create a new face using Cut:

- 1 Convert the geometry to an editable mesh.
- 2  On the Modify panel, choose the object's Edge (or Face, Polygon, or Element) sub-object level.
- 3 On the Selection rollout, turn on Ignore Backfacing.
- 4 On the Edit Geometry rollout, in the Cut and Slice group, click the Cut button.
- 5 Click the first edge you want to subdivide, and then move your cursor toward the second edge. The cursor changes to a plus sign when over an

edge, and a dotted line connects the initial point where the edge was clicked with the current cursor location.

- 6 Click the second edge. This edge can be anywhere, cutting across as many faces as you like. A new visible edge appears.
- 7 At this point, a new dotted line is connected to the mouse cursor, originating from the last point you clicked.
- 8 Continue clicking edges to cut. To start from a different point, right-click, and then select the new start point. To finish cutting, right-click twice.

You can use [Snaps](#) on page 2568 with Cut. To divide an edge in half, set Snaps to midpoint. To start or end a cut at a vertex, set snap to vertex or endpoint.

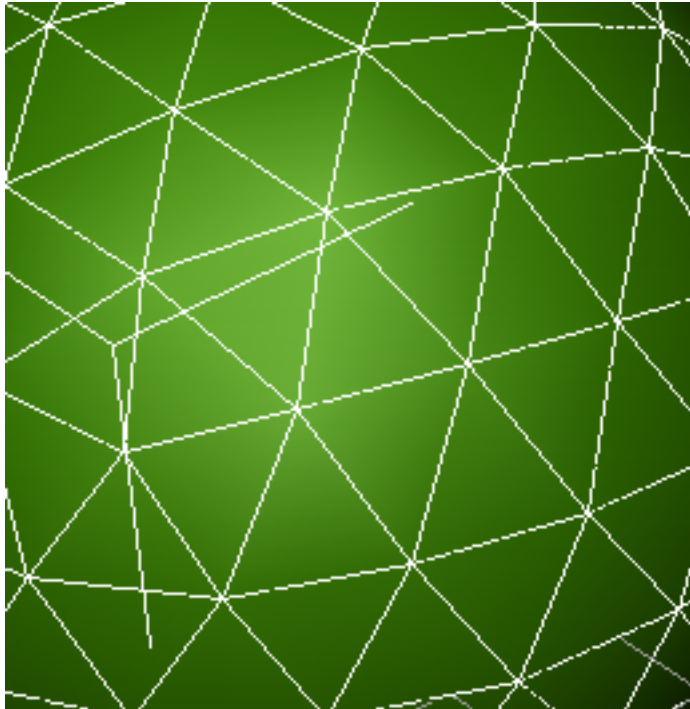

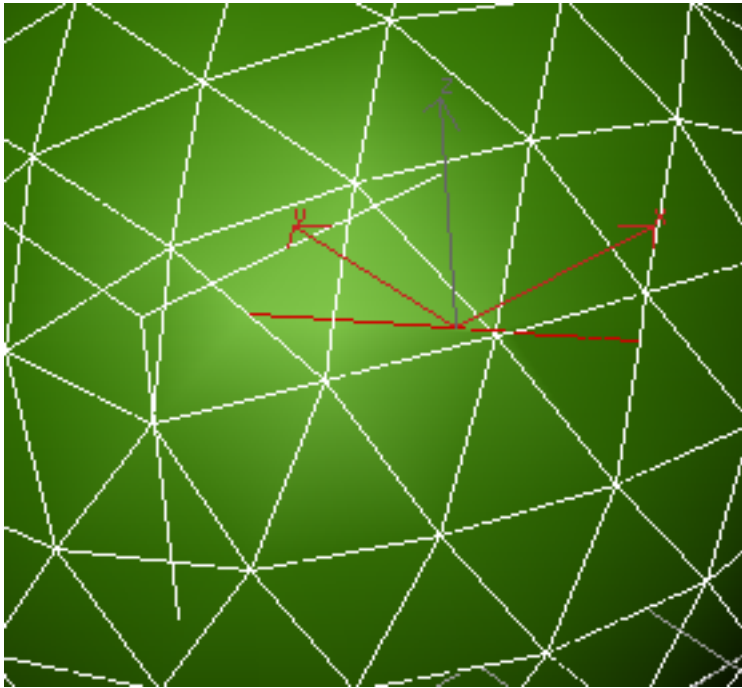

Before and after applying Cut to faces

#### To create multiple slices:

- 1 Select an editable mesh.
- 2  On the Modify panel, choose the object's Edge (or Face, Polygon, or Element) sub-object level.
- 3 Select one or more sub-objects. Slice affects only selected sub-objects.
- 4 In the Cut And Slice group box, click the Slice Plane button.
- 5 Position and rotate the Slice Plane gizmo to where you want the first slice.
- 6 Click the Slice button. The object is sliced.
- 7 If you want, move the Slice Plane to a second position and click the Slice button again.

- 8 Click the Slice Plane button again to turn it off and see the results.
- 9 To better understand what has happened, turn off Edges Only in the Display panel.

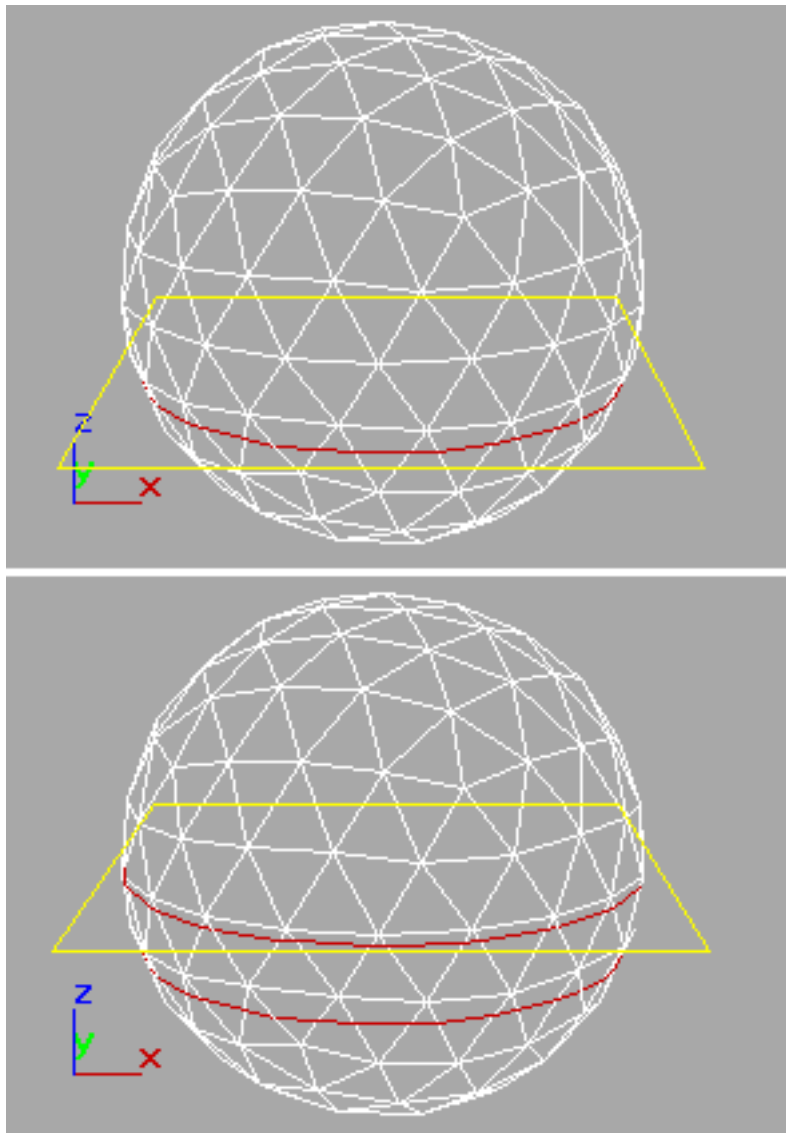

Slice gizmo placed for first slice (top) and second slice (bottom)

## Interface

---

**NOTE** The keyboard shortcuts listed here require that the [Keyboard Shortcut Override Toggle](#) on page 7646 be on.

---

### Cut and Slice group

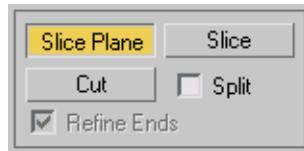

**Slice Plane** Creates a gizmo for a slice plane that can be positioned and rotated where you want to slice the edges. Also enables the Slice button.

**Slice** Performs the slice operation at the location of the slice plane. The Slice button is available only when the Slice Plane button is highlighted. This tool slices the mesh just like the [Slice modifier](#) on page 1658 in “Operate On: Face” mode.

---

**NOTE** Slice works only on a sub-object selection. Make the selection before activating Slice Plane.

---

**Cut** Lets you divide a edge at any point, then divide a second edge at any point, creating a new edge or edges between the two points. Clicking the first edge sets the first vertex. A dotted line tracks the cursor movement until you click a second edge. A new vertex is created at each edge division. Alternately, double-clicking an edge simply divides that edge at the point clicked, with invisible edges on either side.

You can use Cut to cut across any number of faces, even across an entire object. Click one edge to start the cut, and a second edge to end the cut.

Use [Snaps](#) on page 2568 with Cut for precision. Cut supports Midpoint, Endpoint, and Vertex snaps.

You can also use the keyboard shortcut Alt+C to toggle Cut mode.

---

**IMPORTANT** When using the Cut tool to add new edges, you should work in a non-Perspective viewport, such as Front or User. If you use Cut while working in a Perspective viewport, you may find that the created edges appear to jump or aren't placed correctly. Using an orthogonal viewport will allow the cuts to appear where you click.

---

---

**TIP** When performing a Cut, turn on Selection rollout > Ignore Backfacing to avoid accidentally selecting edges on the back side of the mesh.

---

**Split** When on, the Slice and Cut operations create double sets of vertices at the points where the edges are divided. This lets you easily delete the new faces to create holes, or animate the new faces as separate elements.

**Refine Ends** When on, adjacent faces at the ends of the cut are also divided by additional vertices, so that the surface stays contiguous. When Refine Ends is off, the surface will have a seam where the new vertex meets the adjacent face. For this reason, it's a good idea to keep Refine Ends turned on, unless you are sure that you don't want the extra vertices created.

Refine Ends affects only Cut. It does not affect Slice.

## Editable Poly Surface

Create or select an object. > Quad menu > Transform quadrant > Convert To submenu > Convert to Editable Poly

Create or select an object. > Modify panel > Right-click the base object in the stack. > Choose Convert to: Editable Poly.

[Editable Poly](#) on page 7765 is an editable object with five sub-object levels: vertex, edge, border, polygon, and element. Its usage is similar to that of an [editable mesh object](#) on page 1990, with controls for manipulating an object as a polygon mesh at various sub-object levels. Rather than triangular faces, however, the poly object's faces are polygons with any number of vertices.

Editable Poly gives you these options:

- Transform or Shift+Clone the selection, as with any object.
- Use the options supplied on the Edit rollouts to modify the selection or object. Later topics discuss these options for each of the polymesh components.
- Pass a sub-object selection to a modifier higher in the stack. You can apply one or more standard modifiers to the selection.
- Use the options on the [Interface](#) on page 2119 to alter surface characteristics.

---

**TIP** You can exit most Editable Poly command modes, such as Extrude, by right-clicking in the active viewport.

---





## Overriding Actions with Press/Release Keyboard Shortcuts

While working with editable poly objects, you can use a “press/release keyboard shortcut” to temporarily override the current operation and perform a different one. As soon as you release the keyboard shortcut, you return to the previous operation.

For example, you might be working at the Polygon sub-object level, moving polygons, and need to rotate the object to access a different part of it. Instead of having to exit the Polygon sub-object level, rotate the object and then re-enter the sub-object level, you could simply press and hold 6, rotate the object, release the key, and immediately return to moving polygons.

To see a list of press/release keyboard shortcuts for Editable Poly, go to Customize > Customize User Interface > Keyboard panel, open the Group drop-down list, and choose Editable Poly. The actions in boldface are the ones that you can assign as press/release shortcuts. Not all are assigned; for information about assigning keyboard shortcuts, see [Keyboard Panel](#) on page 7489 .

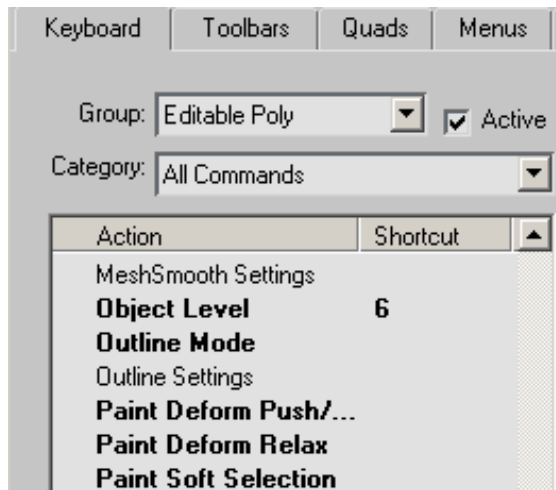

The actions in boldface can function as press/release shortcuts.

### Editable Poly Workflow

Sub-object-specific functions, such as [Remove](#) on page 2076 for edges, appear on their own rollouts in the Editable Poly user interface. This leaves the [Edit](#)

[Geometry rollout](#) on page 2105 with functions that you can apply at most sub-object levels, as well as at the object level.



Also, many commands are accompanied by a Settings button, which gives you a second way to use the command:

- In Direct Manipulation mode, activated by clicking the command button, you apply the command by manipulating sub-objects directly in the viewport. An example of this is Extrude: You click the Extrude button, and then click and drag sub-objects in the viewports to extrude them.

---

**NOTE** Some buttons, such as Tessellate, operate on the mesh immediately, with no viewport manipulation required.

---



- Interactive Manipulation mode is well suited to experimentation. You activate this mode by clicking the command's Settings button. This opens a non-modal settings dialog and places you in preview mode, where you can set parameters and see the results immediately in the viewport on the current sub-object selection. You can then accept the results by clicking OK, or reject them by clicking Cancel. You can also use this mode to apply the same or different settings to several different sub-object selections in a row. Make the selection, optionally change the settings, click Apply, and then repeat with a different selection.

---

**IMPORTANT** When you click Apply, the settings are “baked into” the selection, and then applied again to the selection as a preview. If you then click OK to exit, you will have applied the settings twice. If your intention is to apply them only once, simply click OK the first time, or click Apply, and then Cancel.

---

---

**NOTE** Changes implemented in Interactive Manipulation mode cannot be animated.

---

**See also:**

- [Edit Poly Modifier](#) on page 1293
- [Poly Select Modifier](#) on page 1541
- [Turn To Poly Modifier](#) on page 1761

## Procedures

### To produce an editable poly object:

First select an object, and then do one of the following:

- 1 If no modifiers are applied to the object, In the Modify panel, right-click in the modifier stack display and choose Editable Poly from the Convert To list on the pop-up menu.
- 2 Right-click the object and choose Convert To Editable Poly from the Convert To submenu in the Transform quadrant of the quad menu.
- 3 Apply a modifier to a parametric object that turns the object into a poly object in the stack display, and then collapse the stack. For example, you can apply a [Turn To Poly modifier](#) on page 1761 .  
To collapse the stack, use the [Collapse utility](#) on page 1931 and set Output Type to Modifier Stack Result, or right-click the object's modifier stack and then choose Collapse All.

Converting an object to Editable Poly format removes all parametric controls, including the creation parameters. For example, you can no longer increase the number of segments in a box, slice a circular primitive, or change the number of sides on a cylinder. Any modifiers you apply to an object are merged into the mesh as well. After conversion, the only entry left on the stack is "Editable Poly."

### To maintain an object's creation parameters:

- As noted in the previous procedure, if you convert an existing object to editable poly format, 3ds Max replaces the creation parameters in the stack with "Editable Poly." The creation parameters are no longer accessible or animatable. If you want to maintain the creation parameters, you can use the [Edit Poly modifier](#) on page 1293 or the [Turn To Poly modifier](#) on page 1761 .

## Interface

### Stack Display

For more information on the Stack Display, see [Modifier Stack](#) on page 7427 .

**Show End Result** Normally, if you apply a modifier such as [Symmetry](#) on page 1735 to an editable poly object and then return to the Editable Poly stack entry, you cannot see the effect of the modifier on the object's geometry. But

if you turn on Show End Result while in sub-object level, you can see the final object as a white mesh, the original sub-object selection as a yellow mesh, and the original editable polymesh as an orange mesh.

### **Selection rollout**

Lets you access the different sub-object levels. See [Selection Rollout \(Polymesh\)](#) on page 2043 .

### **Soft Selection rollout**

Soft Selection controls apply a smooth falloff between selected sub-objects and unselected ones. When Use Soft Selection is on, unselected sub-objects near your selection are given partial selection values. These values are shown in the viewports by means of a color gradient on the vertices, and optionally on the faces. They affect most types of sub-object deformations, such as the Move, Rotate, and Scale functions and any deformation modifiers (such as Bend) applied to the object. This provides a magnet-like effect with a sphere of influence around the selection.

For more information, see [Soft Selection Rollout](#) on page 1926 .

### **Edit (sub-object) rollout**

The Edit (sub-object) rollout provides sub-object-specific functions for editing an editable poly object and its sub-objects. For specific information, click any of the links below:

[Edit Vertices rollout](#) on page 2058

[Edit Edges rollout](#) on page 2075

[Edit Borders rollout](#) on page 2086

[Edit Polygons/Elements rollout](#) on page 2092

### **Edit Geometry rollout**

The Edit Geometry rollout provides global functions for editing an editable poly object and its sub-objects. For specific information, click any of the links below:

[Editable Poly \(Object\)](#) on page 2054

[Editable Poly \(Vertex\)](#) on page 2064

[Editable Poly \(Edge\)](#) on page 2084

[Editable Poly \(Border\)](#) on page 2090

[Editable Poly \(Polygon/Element\)](#) on page 2102

### **Subdivision Surface rollout**

Controls on this rollout apply subdivision to the polymesh in the style of the MeshSmooth modifier. See [Subdivision Surface Rollout \(Polymesh\)](#) on page 2118 .

### **Subdivision Displacement rollout**

Specifies surface approximation for subdividing the polymesh. See [Subdivision Displacement Rollout \(Polymesh\)](#) on page 2123 .

### **Subdivision Presets group & Subdivision Method group**

The controls in these two group boxes specify how the program applies the displacement map when Subdivision Displacement is on. They are identical to the [Surface Approximation controls](#) on page 2469 used for NURBS surfaces.

### **Paint Deformation rollout**

Paint Deformation lets you stroke elevated and indented areas directly onto object surfaces. For more information, see [Paint Deformation Rollout](#) on page 2125 .

## **Selection Rollout (Polymesh)**

Create or select an editable poly object. > Modify panel > Selection rollout

The Selection rollout provides tools for accessing different sub-object levels and display settings and for creating and modifying selections, and displays information about selected entities.

When you first access the Modify panel with an editable poly selected, you're at the Object level, with access to several functions available as described in [Editable Poly \(Object\)](#) on page 2053 . You can toggle the various sub-object levels, and access relevant functions, by clicking the buttons at the top of the Selection rollout.

Clicking a button here is the same as choosing a sub-object type in the modifier stack display. Click the button again to turn it off and return to the Object selection level.

---

**NOTE** You can convert sub-object selections in three different ways with the use of the Ctrl and Shift keys:

- To convert the current selection to a different sub-object level, clicking a sub-object button on the Selection rollout with Ctrl held down. This selects all sub-objects at the new level that touch the previous selection. For example, if you select a vertex, and then Ctrl-click the Polygon button, all polygons that use that vertex are selected.
- To convert the selection to only sub-objects all of whose source components are originally selected, hold down both Ctrl and Shift as you change the level. For example, if you convert a vertex selection to a polygon selection with Ctrl+Shift+click, the resultant selection includes only those polygons all of whose vertices were originally selected.
- To convert the selection to only sub-objects that border the selection, hold down Shift as you change the level. The selection conversion is inclusive, meaning:
  - When you convert faces, the resulting selection of edges or vertices all belong to selected faces that bordered unselected faces. Only the edges or vertices that bordered unselected faces are selected.

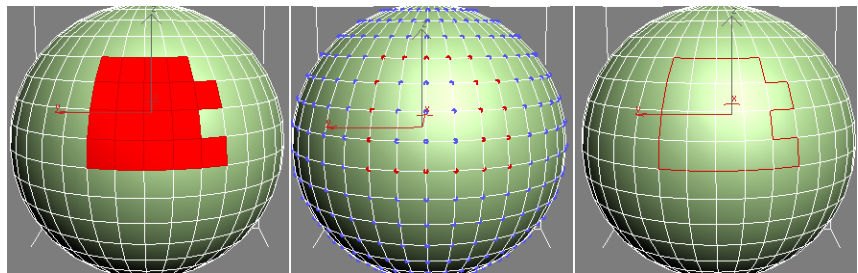

Face selection (left) converted to vertex border (center) and edge border (right)

- When you convert vertices to faces, the resulting selection of faces had all of their vertices selected and bordered unselected faces. When you convert vertices to edges, the resulting selection contains only edges all of whose vertices were previously selected and only edges of faces that did not have all vertices selected; that is, of faces around the border of the vertex selection.

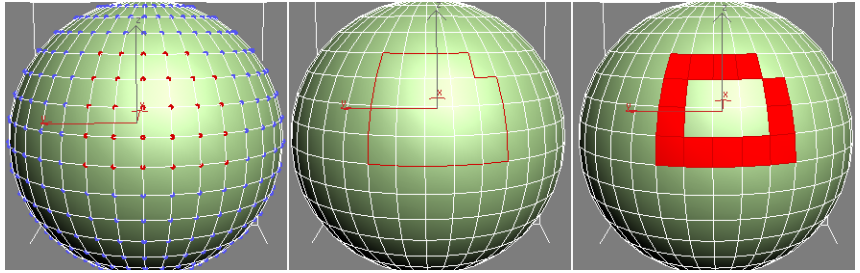

Vertex selection (left) converted to edge border (center) and face border (right)

- When you convert edges to faces, the resulting selection of faces had some but not all of their edges selected, and were next to faces with no edges selected. When you convert edges to vertices, the resulting vertices are on previously selected edges, but only at intersections where not all edges were selected.

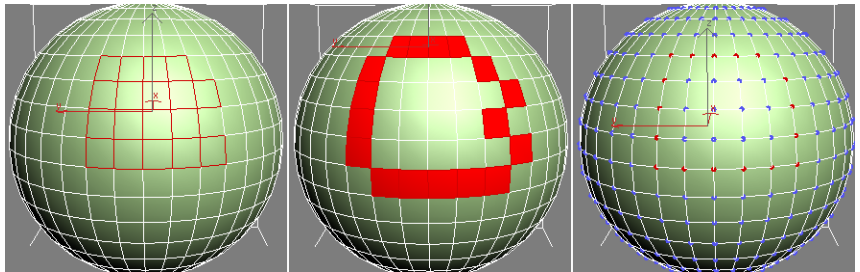

Edge selection (left) converted to face border (center) and vertex border (right)

Conversion commands are also available from the quad menu.

---

## Interface

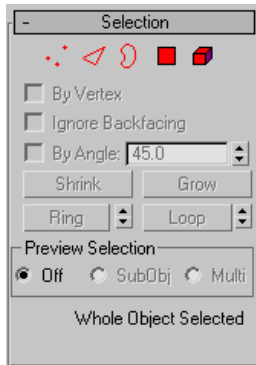

**Vertex** Turns on Vertex sub-object level, which lets you select a vertex beneath the cursor; region selection selects vertices within the region.



**Edge** Turns on Edge sub-object level, which lets you select a polygon edge beneath the cursor; region selection selects multiple edges within the region.



**Border** Turns on Border sub-object level, which lets you select a sequence of edges that borders a hole in the mesh. Borders are always composed of edges with faces on only one side of them, and are always complete loops. For example, a box doesn't have a border, but the teapot object has a couple of them: on the lid, on the body, on the spout, and two on the handle. If you create a cylinder, then delete one end, the row of edges around that end forms a border.

When Border sub-object level is active, you can't select edges that aren't on borders. Clicking a single edge on a border selects that whole border.

You can cap a borders, either in Editable Poly or by applying the [Cap Holes modifier](#) on page 1159 . You can also connect borders between objects with the [Connect compound object](#) on page 668 .



**Polygon** Turns on Polygon sub-object level, which lets you select polygons beneath the cursor. Region selection selects multiple polygons within the region.





**Element** Turns on Element sub-object level, which lets you select all contiguous polygons in an object. Region selection lets you select multiple elements.

**By Vertex** When on, you can select sub-objects only by selecting a vertex that they use. When you click a vertex, all sub-objects that use the selected vertex are selected.

**Ignore Backfacing** When on, selection of sub-objects affects only those facing you. When off (the default), you can select any sub-object(s) under the mouse cursor, regardless of their visibility or facing. If there are more than one sub-object under the cursor, repeated clicking cycles through them. Likewise, with Ignore Backfacing off, region selection includes all sub-objects, regardless of the direction they face.

---

**NOTE** The state of the Backface Cull setting in the Display panel does not affect sub-object selection. Thus, if Ignore Backfacing is off, you can still select sub-objects, even if you can't see them.

---

**By Angle** When on and you select a polygon, the software also selects neighboring polygons based on the angle setting to the right of the check box. This value determines the maximum angle between neighboring polygons to select. Available only at the Polygon sub-object level.

For example, if you click a side of a box and the angle value is less than 90.0, only that side is selected, because all sides are at 90-degree angles to each other. But if the angle value is 90.0 or greater, all sides of the box are selected. This function speeds up selection of contiguous areas made up of polygons that are at similar angles to one another. You can select coplanar polygons with a single click at any angle value.

**Shrink** Reduces the sub-object selection area by deselecting the outermost sub-objects. If the selection size can no longer be reduced, the remaining sub-objects are deselected.

**Grow** Expands the selection area outward in all available directions.

For this function, a border is considered to be an edge selection.

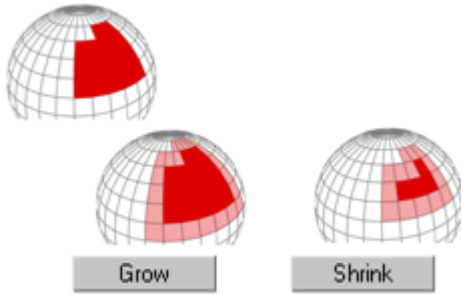

With **Shrink** and **Grow**, you can add or remove neighboring elements from the edges of your current selection. This works at any sub-object level.

**Ring** Expands an edge selection by selecting all edges parallel to the selected edges. Ring applies only to edge and border selections.

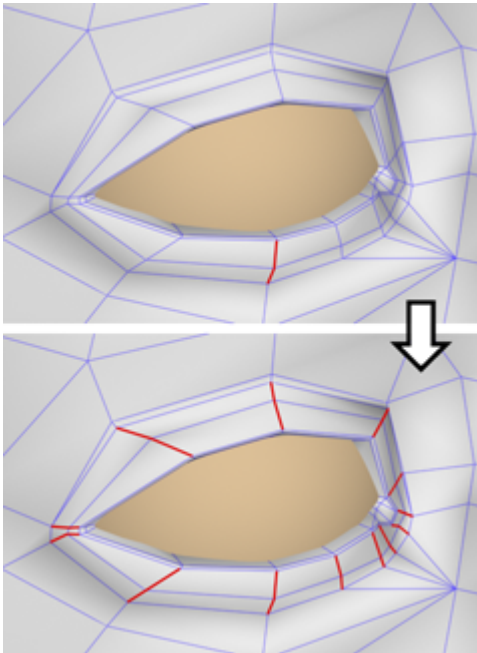

**Ring selection** adds to the selection all the edges that are parallel to the ones selected originally.

---

**TIP** After making a ring selection, you can use [Connect](#) on page 2080 to subdivide the associated polygons into new edge loops.

---



**[Ring Shift]** The spinner next to the Ring button lets you move the selection in either direction to other edges in the same ring; that is, to neighboring, parallel edges. If you have a loop selected, you can use this function to select a neighboring loop. Applies only to Edge and Border sub-object levels.

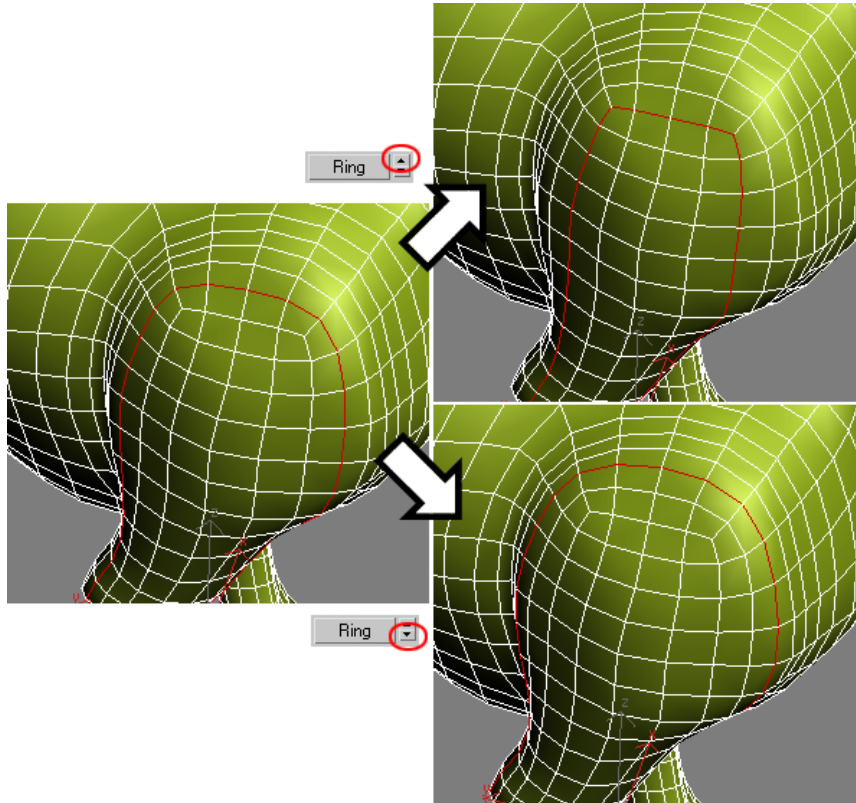

**Left: Original loop selection**

**Upper right: Ring Shift up moves selection outward (from center of model).**

**Lower right: Ring Shift down moves selection inward (toward center of model).**

To expand the selection in the chosen direction, Ctrl+click the up or down spinner button. To shrink the selection in the chosen direction, Alt+click the up or down spinner button.

**Loop** Expands the selection as far as possible, in alignment with selected edges.

Loop applies only to edge and border selections, and propagates only through four-way junctions.

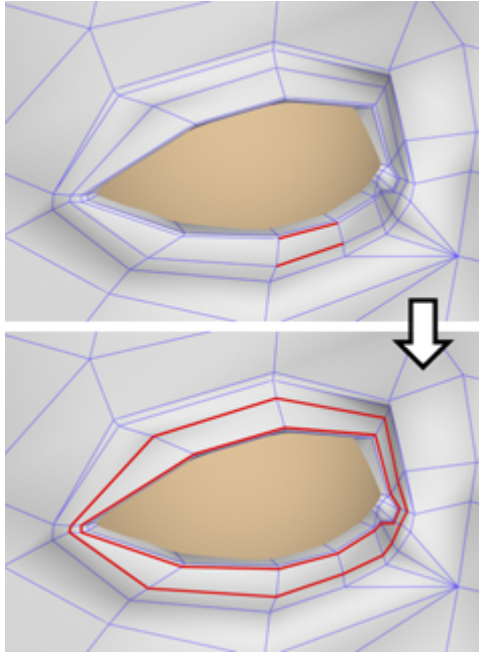

**Loop selection extends your current edge selection by adding all the edges aligned to the ones selected originally.**



**[Loop Shift]** The spinner next to the Loop button lets you move the selection in either direction to other edges in the same loop; that is, to neighboring, aligned edges. If you have a ring selected, you can use this function to select a neighboring ring. Applies only to Edge and Border sub-object levels.

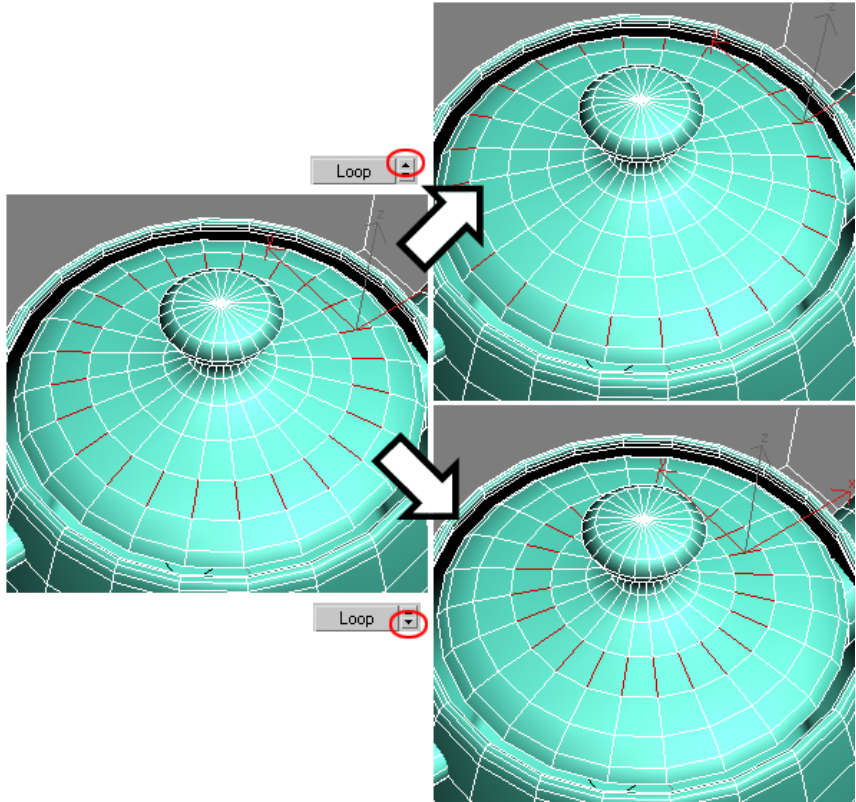

**Left: Original ring selection**

**Upper right: Loop Shift up moves selection outward.**

**Lower right: Loop Shift down moves selection inward.**

To expand the selection in the chosen direction, Ctrl+click the up or down spinner button. To shrink the selection in the chosen direction, Alt+click the up or down spinner button.



### **Preview Selection**



This option lets you preview a sub-object selection before committing to it. You can preview at the current sub-object level, or switch sub-object levels automatically based on the mouse position. The choices are:

- **Off** No preview is available.
- **SubObj** Enables previewing at the current sub-object level only. As you move the mouse over the object, the sub-object under the cursor highlights in yellow. To select the highlighted object, click the mouse. To select multiple sub-objects at the current level, press and hold Ctrl, move the mouse to highlight more sub-objects, and then click to select all highlighted sub-objects.

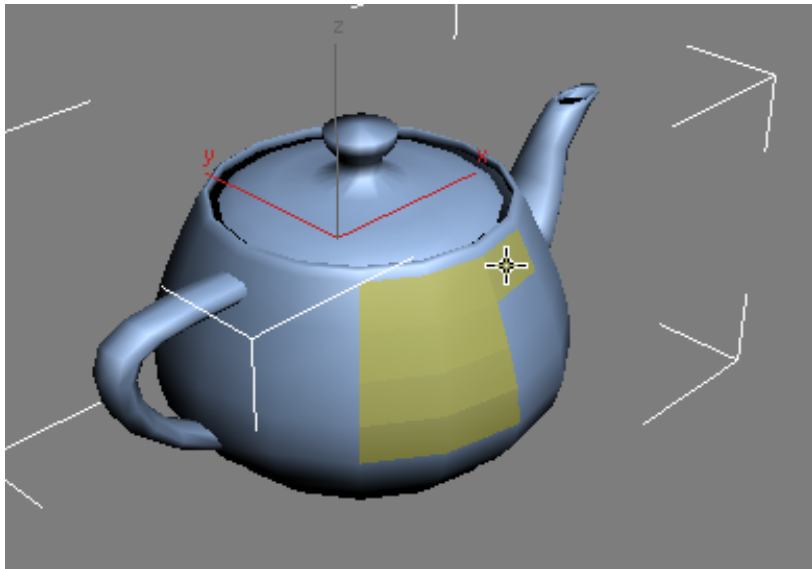

**Polygon sub-object selection preview with Ctrl held down**

To deselect multiple sub-objects at the current level, press and hold Ctrl+Alt, move the mouse to highlight more sub-objects, and then click a selected sub-object. This deselects all highlighted sub-objects.

- **Multi** Works like SubObj, but also switches among the Vertex, Edge, and Polygon sub-object levels on the fly, based on the mouse position. For example, if you position the mouse over an edge, the edge highlights, and then clicking activates the Edge sub-object level and selects the edge. To select multiple sub-objects of the same type, press and hold Ctrl after highlighting a sub-object, move the mouse to highlight more sub-objects,

and then click to activate that sub-object level and select all highlighted sub-objects.

To deselect multiple sub-objects *at the current sub-object level*, press and hold Ctrl+Alt, move the mouse to highlight more sub-objects, and then click a selected sub-object. This deselects all highlighted sub-objects. Note that this method does not switch sub-object levels.

---

**NOTE** When Ignore Backfacing is off, you'll see backfacing vertices and edges highlight while previewing a sub-object selection.

---

### Selection Information

At the bottom of the Selection rollout is a text display giving information about the current selection. If 0 or more than one sub-object is selected, the text gives the number and type selected; for example, "4 Polygons Selected." If one sub-object is selected, the text gives the identification number and type of the selected item; for example, "Polygon 73 Selected."



When using [Preview Selection](#) on page 2051, a second line gives additional information about the identity or number of highlighted sub-objects.

## Editable Poly (Object)

Select an editable poly object. > Modify panel

Select an editable poly object. > Quad menu > Tools 1 quadrant > Top-level

Editable Poly (Object) functions are available when no sub-object levels are active. These functions are also available at all sub-object levels, and work the same in each mode, except as noted below.

Use the [Selection rollout](#) on page 2046 or [modifier stack](#) on page 7427 to access the different sub-object levels.

## Interface

### Edit Geometry rollout



See [Edit Geometry Rollout \(Polymesh\)](#) on page 2105 for detailed descriptions of these controls.

### Subdivision Surface rollout

See [Interface](#) on page 2119 for information on the Subdivision Surface rollout settings.



## Subdivision Displacement rollout

See [Interface](#) on page 2124 for information on the Subdivision Displacement rollout settings.

## Paint Deformation rollout

Paint Deformation lets you stroke elevated and indented areas directly onto object surfaces. For more information, see [Paint Deformation Rollout](#) on page 2125 .

# Editable Poly (Vertex)



Select an editable poly object. > Modify panel > Selection rollout > Vertex

Select an editable poly object. > Modify panel > Modifier Stack display > Expand Editable Poly. > Vertex

Select an editable poly object. > Quad menu > Tools 1 quadrant > Vertex

Vertices are points in space: they define the structure of other sub-objects that make up the poly. When vertices are moved or edited, the geometry they form is affected as well. Vertices can also exist independently; such isolated vertices can be used to construct other geometry but are otherwise invisible when rendering.

At the Editable Poly (Vertex) sub-object level, you can select single and multiple vertices and move them using standard methods. This topic covers the Edit Geometry, Edit Vertices, and Vertex Properties rollouts; for other controls, see [Editable Poly](#) on page 2038 .

## Procedures

### To weld polygon vertices:

You can use either of two methods to combine several vertices into one, also known as welding. If the vertices are very close together, use the Weld function. You can also use Weld to combine a number of vertices to the average position of all of them.

Alternatively, to combine two vertices that are far apart, resulting in a single vertex that's in the same position as one of them, use Target Weld.

**1** To use Weld:

- On the Selection rollout, turn on Ignore Backfacing, if necessary. This ensures that you're welding only vertices you can see.
- Select the vertices to weld.
- If the vertices are very close together, simply click Weld. If that doesn't work, proceed to the next step.
-  Click the Settings button to the right of the Weld button. This opens the [Weld Vertices dialog](#) on page 2150 .
- Increase the Weld Threshold value gradually using the spinner (click and hold on the up-down arrow buttons to the right of the numeric field and then drag upward). If you need the value to change more quickly, hold down the Ctrl key as you drag. When the threshold equals or exceeds the distance between two or more of the vertices, the weld occurs automatically, and the resulting vertex moves to their average location.
- If not all the vertices are welded, continue increasing the Weld Threshold value until they are.
- Click OK to exit.

**2** To use Target Weld:

- 1** On the Selection rollout, turn on Ignore Backfacing, if necessary. This ensures that you're welding only vertices you can see.
- 2** Find two vertices you want to weld, and determine the ultimate location of the resulting vertex. The two vertices must be contiguous; that is, they must be connected by a single edge. For this example, we'll call the vertices A and B, and the resulting vertex will be at vertex B's location.
- 3** Click the Target Weld button. The button stays highlighted, to indicate that you're now in Target Weld mode.
- 4** Click vertex A and then move the mouse. A rubber-band line connects the vertex and the mouse cursor.

5 Position the cursor over vertex B, whereupon the cursor image changes from an arrow to a crosshairs. Reminder: Only vertices connected to the first vertex by a single edge qualify for target welding.

6 Click to weld the two.

The resulting vertex remains at vertex B's position, and you exit Target Weld mode.

### To select vertices by color:

1 In the Vertex Properties rollout > Select Vertices By group, click the color swatch, and specify the color of vertex you want in the [Color Selector](#) on page 331 .

2 Specify ranges in the RGB Range spinners. This lets you select vertices that are close to the specified color, but don't match exactly.

3 Click the Select button.

All vertices matching the color, or within the RGB range, are selected.

You can add to the selection by holding Ctrl as you click the Select button, and subtract from the selection by holding the Alt key.

---

**TIP** You can select all vertices of the same color by first selecting the vertex you want matched, dragging a copy of the Edit Color swatch to the Existing Color swatch, and then clicking the Select button. (If you want an exact match, be sure to set the RGB Range spinners to 0 first.)

---

## Interface

### Selection rollout

See [Editable Poly](#) on page 2046 for information on the Selection rollout settings.

### Soft Selection rollout

Soft Selection controls apply a smooth falloff between selected sub-objects and unselected ones. When Use Soft Selection is on, unselected sub-objects near your selection are given partial selection values. These values are shown in the viewports by means of a color gradient on the vertices, and optionally on the faces. They affect most types of sub-object deformations, such as the Move, Rotate, and Scale functions, as well as any deformation modifiers (such

as Bend) applied to the object. This provides a magnet-like effect with a sphere of influence around the selection.

For more information, see [Soft Selection Rollout](#) on page 1926 .

### Edit Vertices rollout

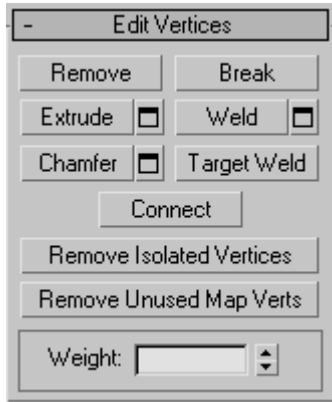

This rollout includes commands specific to vertex editing.

---

**NOTE** To delete vertices, select them and press the Delete key. This can create one or more holes in the mesh. To delete vertices without creating holes, use Remove (see below).

---

**Remove** Deletes selected vertices and combines the polygons that use them. The keyboard shortcut is Backspace.

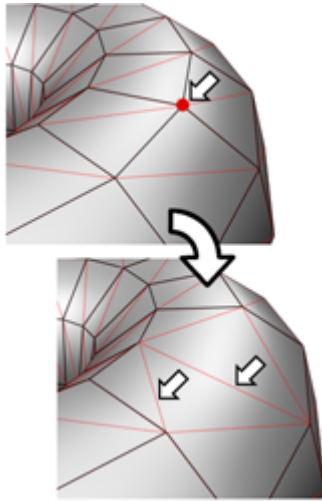

Removing one or more vertices deletes them and retriangulates the mesh to keep the surface intact. If you use Delete instead, the polygons depending on those vertices are deleted as well, creating a hole in the mesh.

---

**WARNING** Use of Remove can result in mesh shape changes and non-planar polygons.

---

**Break** Creates a new vertex for each polygon attached to selected vertices, allowing the polygon corners to be moved away from each other where they were once joined at each original vertex. If a vertex is isolated or used by only one polygon, it is unaffected.

**Extrude** Lets you extrude vertices manually via direct manipulation in the viewport. Click this button, and then drag vertically on any vertex to extrude it.

Extruding a vertex moves it along a normal and creates new polygons that form the sides of the extrusion, connecting the vertex to the object. The extrusion has the same number of sides as the number of polygons that originally used the extruded vertex.

Following are important aspects of vertex extrusion:

- When over a selected vertex, the mouse cursor changes to an Extrude cursor.
- Drag vertically to specify the extent of the extrusion, and horizontally to set the size of the base.

- With multiple vertices selected, dragging on any one extrudes all selected vertices equally.
- You can drag other vertices in turn to extrude them while the Extrude button is active. Click Extrude again or right-click in the active viewport to end the operation.

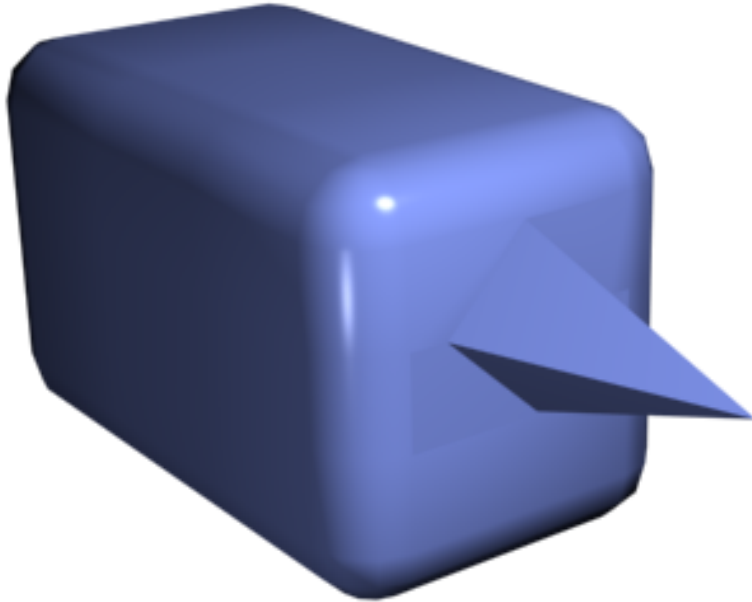

**Chamfer box showing extruded vertex**



**Extrude Settings** Opens the [Extrude Vertices dialog](#) on page 2142 , which lets you perform extrusion via interactive manipulation.

If you click this button after performing a manual extrusion, the same extrusion is performed on the current selection as a preview and the dialog opens with Extrusion Height set to the amount of the last manual extrusion.

**Weld** Combines contiguous, selected vertices that fall within the tolerance specified in [Weld dialog](#) on page 2150 . All edges become connected to the resulting single vertex.

Weld is best suited to automatically simplifying geometry that has areas with a number of vertices that are very close together. Before using Weld, set the

Weld Threshold via the [Weld dialog](#) on page 2150 . To weld vertices that are relatively far apart, use [Target Weld](#) on page 2062 instead.



**Weld Settings** Opens the [Weld dialog](#) on page 2150 , which lets you specify the weld threshold.

**Chamfer** Click this button and then drag vertices in the active object. To chamfer vertices numerically, click the Chamfer Settings button and use the Chamfer Amount value.

If you chamfer multiple selected vertices, all of them are chamfered identically. If you drag an unselected vertex, any selected vertices are first deselected.

Each chamfered vertex is effectively replaced by a new face that connects new points on all edges leading to the original vertex. These new points are exactly <chamfer amount> distance from the original vertex along each of these edges. New chamfer faces are created with the material ID of one of the neighboring faces (picked at random) and a smoothing group which is an intersection of all neighboring smoothing groups.

For example, if you chamfer one corner of a box, the single corner vertex is replaced by a triangular face whose vertices move along the three edges that led to the corner. Outside faces are rearranged and split to use these three new vertices, and a new triangle is created at the corner.

Alternatively, you can create open space around the chamfered vertices; for details, see [Chamfer Vertices dialog](#) on page 2136 .

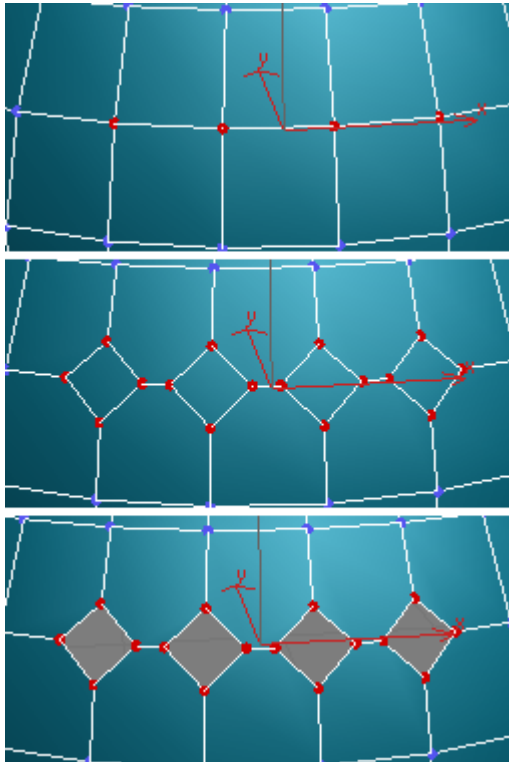

**Top:** The original vertex selection

**Center:** Vertices chamfered

**Bottom:** Vertices chamfered with Open on



**Chamfer Settings** Opens the [Chamfer Vertices dialog](#) on page 2136 , which lets you chamfer vertices via interactive manipulation and toggle the Open option.

If you click this button after performing a manual chamfer, the same chamfer is performed on the current selection as a preview and the dialog opens with Chamfer Amount set to the amount of the last manual extrusion.

**Target Weld** Allows you to select a vertex and weld it to a neighboring target vertex. Target Weld works only with pairs of contiguous vertices; that is, vertices connected by a single edge.

In Target Weld mode, the mouse cursor, when positioned over a vertex, changes to a + cursor. Click and then move the mouse; a dashed, rubber-band



line connects the vertex to the mouse cursor. Position the cursor over another, neighboring vertex and when the + cursor appears again, click the mouse. The first vertex is moved to the position of the second, the two are welded, and Target Weld mode is automatically exited.

**Connect** Creates new edges between pairs of selected vertices.

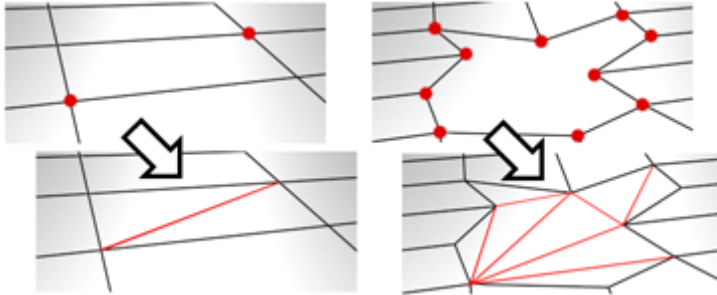

Connect will not let the new edges cross. Thus, for example, if you select all four vertices of a four-sided polygon and then click Connect, only two of the vertices will be connected. In this case, to connect all four vertices with new edges, use [Cut](#) on page 2113 .

**Remove Isolated Vertices** Deletes all vertices that don't belong to any polygons.

**Remove Unused Map Verts** Certain modeling operations can leave unused (isolated) map vertices that show up in the [Unwrap UVW editor](#) on page 1788 , but cannot be used for mapping. You can use this button to automatically delete these map vertices.

**Weight** Sets the weight of selected vertices. Used by the [NURMS subdivision option](#) on page 2119 and by the [MeshSmooth modifier](#) on page 1460 . Increasing a vertex weight tends to pull the smoothed result toward the vertex.

## Edit Geometry rollout



See [Edit Geometry Rollout \(Polymesh\)](#) on page 2105 for detailed descriptions of these controls.

## Vertex Properties rollout

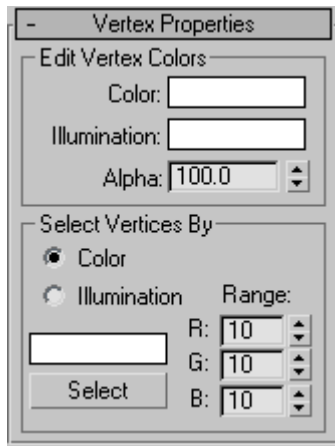

### Edit Vertex Colors group

Use these controls to assign the color, and illumination color (shading) of selected vertices.

**Color** Click the color swatch to change the color of selected vertices.

**Illumination** Click the color swatch to change the illumination color of selected vertices. This lets you change the illumination without changing the vertex's color.

**Alpha** Lets you set specific alpha values of selected vertices. These alpha values are maintained by the pipeline and can be used in conjunction with vertex color to provide full RGBA data for export.

### Select Vertices By group

**Color/Illumination** Determines whether to select vertices by vertex color values or vertex illumination values.

**Color Swatch** Displays the [Color Selector](#) on page 331 , where you can specify a color to match.

**Select** Depending on which radio button is chosen, selects all vertices whose vertex color or illumination values either match the color swatch, or are within the range specified by the RGB spinners.

**Range** Specifies a range for the color match. All three RGB values in the vertex color or illumination must either match the color specified by the color

swatch in Select By Vertex Color, or be within plus or minus the values in the Range spinners. Default=10.

### **Subdivision Surface rollout**

See [Interface](#) on page 2119 for information on the Subdivision Surface rollout settings.

### **Subdivision Displacement rollout**

See [Interface](#) on page 2124 for information on the Subdivision Displacement rollout settings.

### **Paint Deformation rollout**

Paint Deformation lets you stroke elevated and indented areas directly onto object surfaces. For more information, see [Paint Deformation Rollout](#) on page 2125 .

## **Editable Poly (Edge)**



Select an editable poly object. > Modify panel > Selection rollout > Edge

Select an editable poly object. > Modify panel > Modifier Stack display > Expand Editable Poly. > Edge

Select an editable poly object. > Quad menu > Tools 1 quadrant > Edge

An edge is a line connecting two vertices that forms the side of a polygon. An edge can't be shared by more than two polygons. Also, the normals of the two polygons should be adjacent. If they aren't, you wind up with two edges that share vertices.

At the editable poly Edge sub-object level, you can select single and multiple edges and transform them using standard methods. This topic covers the Edit Geometry and Edit Edges rollouts; for other controls, see [Editable Poly](#) on page 2038 .

---

**NOTE** Besides edges, each polygon has one or more internal [diagonals](#) on page 7757 that determine how the polygon is triangulated by the software. Diagonals can't be manipulated directly, but you can use the [Turn](#) on page 2083 and [Edit Triangulation](#) on page 2083 functions to change their positions.

---

## Procedures

### Example: To use the Cut and Turn features:

3ds Max provides a convenient function for turning edges, which, along with the Cut feature, streamlines the custom modeling process considerably. Specifically, cutting a new polygon into existing geometry minimizes the number of extra visible edges, typically adding none or one. And after using cut, the Turn function lets you adjust any diagonal with a single click.

- 1 In the Perspective viewport, add a Plane object. This object is available from the Create panel > Standard Primitives > Object Type rollout. By default, the Plane object is divided into 4 x 4 polygons. If you don't see the polygons in the Perspective viewport, press F4 to activate Edged Faces view mode.

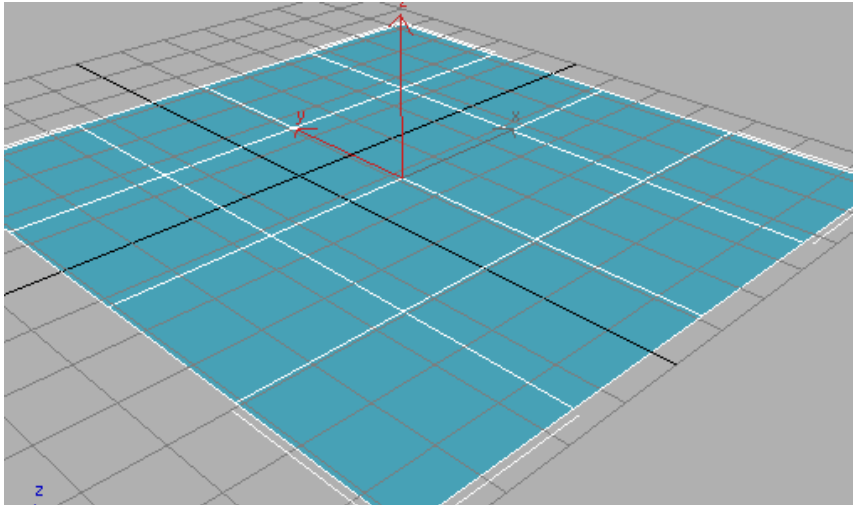

- 2 Convert the Plane object to Editable Poly format. If you're not sure how, continue in this step; otherwise, skip to the next step after converting. To convert the object, right-click once in the Perspective viewport to exit create mode. This leaves the object selected. Right-click again in the Perspective viewport, and then at the bottom of the Transform quadrant, choose Convert To > Convert To Editable Poly. Alternatively, apply the Edit Poly modifier.

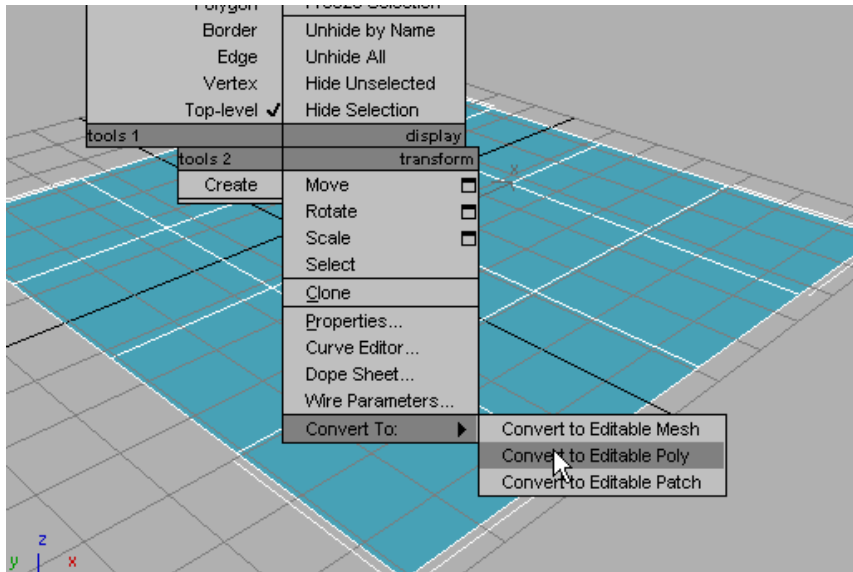

The object is now an editable poly and the command panel switches to the Modify panel.

- 3 Cut is available at the object level as well as at every sub-object level. On the Edit Geometry rollout, find the Cut button, and then click it.
- 4 In the Perspective viewport, position the mouse cursor in the center of a corner polygon, such as the one closest to you, click once, and then move the mouse around the viewport.

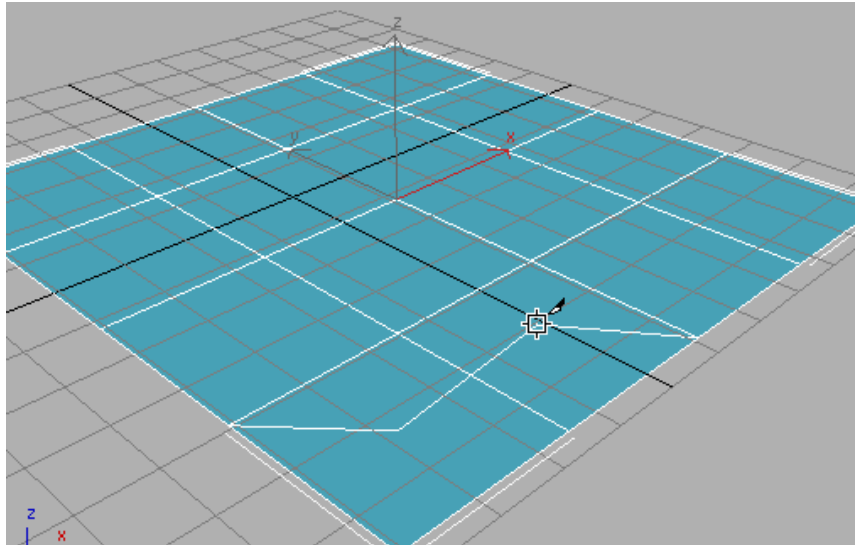

Two or three lines appear and move as you move the mouse. One line connects the mouse cursor to the original click location, and indicates where the next cut will appear when you click the mouse button. Another connects to a corner of the polygon; this connection changes depending on the mouse position. And, if the cursor isn't over an edge or a vertex (it changes appearance if it is, depending on which), a third line connects the mouse cursor to another vertex.

This demonstrates one aspect of the new Cut functionality; in previous versions, the first click in a Cut operation connected to two corners of the polygon.

- 5 Continue cutting in a rectangular pattern, clicking once at the center of a different polygon, finish by clicking once more at the starting point, and then right-click to exit Cut mode.

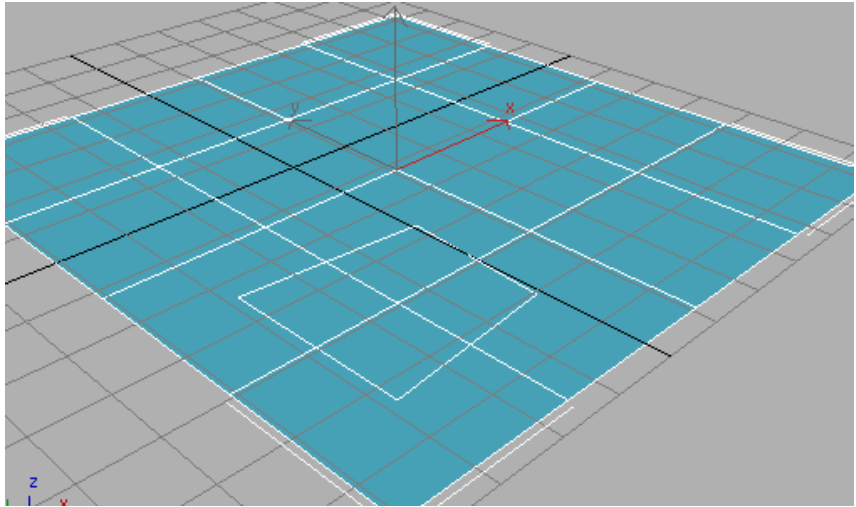

The result is a rectangle across four polygons, without any connecting visible edges. In previous versions, you would have had eight connecting visible edges: two in each of the original polygons. Note that all the edges you created are selected, and ready for further transformation or editing.

**6** Cut a rectangle into the center of a single polygon.

In this case you end up with a single, additional visible edge instead of seven, as in previous versions. The edge connects corner of the new polygon with a corner of the original one. This new edge is not selected, but the ones you created explicitly are.



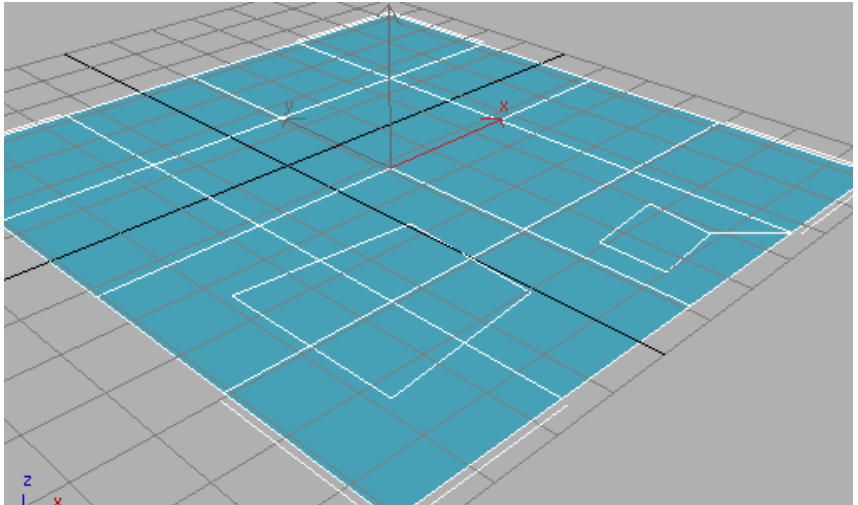

Connecting the remaining corners are a number of [diagonals](#) on page 7757 , which serve to fully triangulate the polygons. The new Turn function lets you manipulate each of these with a single click.

- 7 Go to the Edge sub-object level, and then, on the Edit Edges rollout, click Turn.

All diagonals, including those created from the Cut operations, appear as dashed lines.

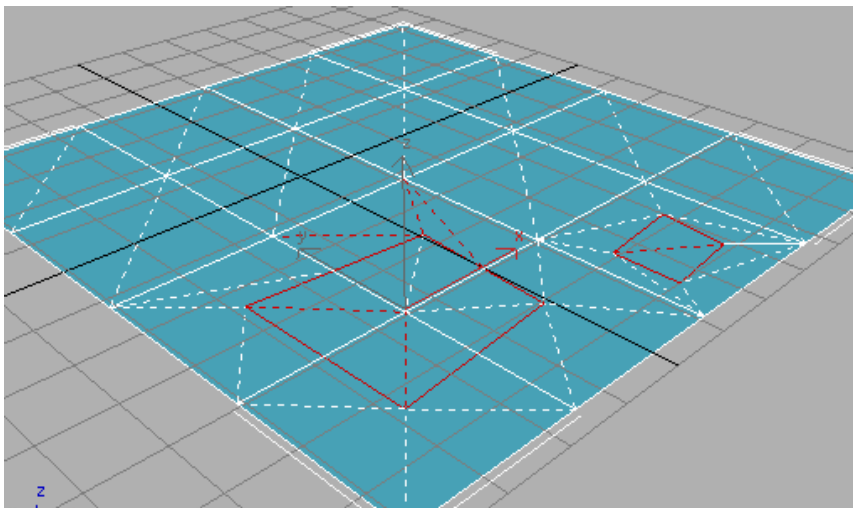

- 8 Click a diagonal to turn it, and then click it again to return it to its original status.

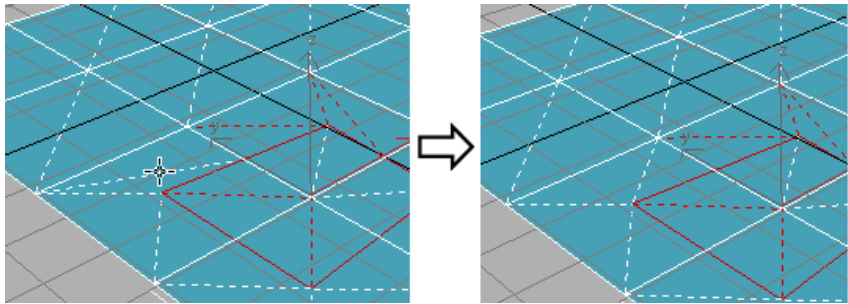

**In Turn mode, click a diagonal (dashed line) once to turn it.**

Each diagonal has only two different available positions, given no changes in any other diagonals' or edges' positions.

Compare this with the Edit Triangulation tool, with which you must click two vertices to change a diagonal's position.

This simple demonstration shows how, when manually subdividing a polygon mesh for modeling and animation purposes, you can save a good deal of time by using the Cut and Turn tools in 3ds Max.

#### **To create a shape from one or more edges:**

- 1 Select the edges you want to make into shapes.
- 2 On the Edit Edges rollout, click Create Shape From Selection.
- 3 Make changes, as needed, on the Create Shape dialog that appears.
  - Enter a curve name or keep the default.
  - Choose Smooth or Linear as the shape type.
- 4 Click OK.

The resulting shape consists of one or more splines whose vertices are coincident with the vertices in the selected edges. The Smooth option results in vertices using smooth values, while the Linear option results in linear splines with corner vertices.

If the selected edges are not continuous, or if they branch, the resulting shape will consist of more than one spline. When the Create Shape function runs into a branching 'Y' in the edges, it makes an arbitrary decision as to which edge produces which spline. If you need to control

this, select only those edges that will result in a single spline, and perform a Create Shape operation repeatedly to make the correct number of shapes. Finally, use [Attach](#) on page 627 in the Editable Spline to combine the shapes into one.

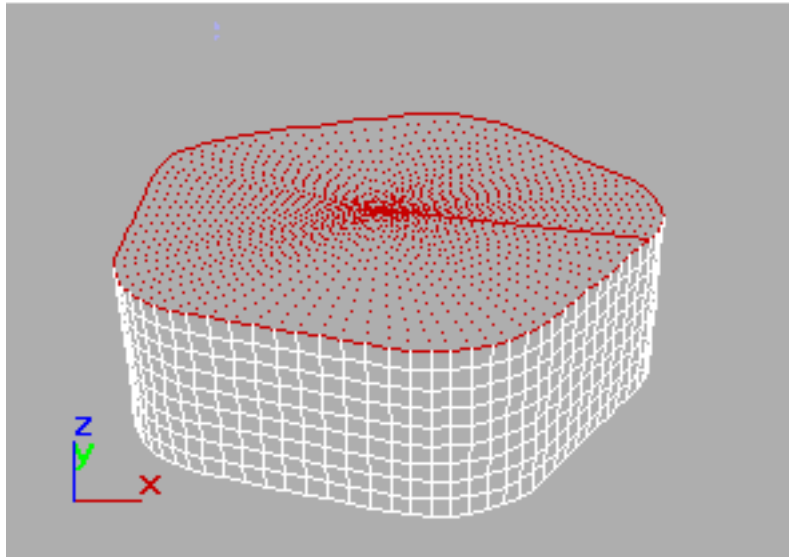
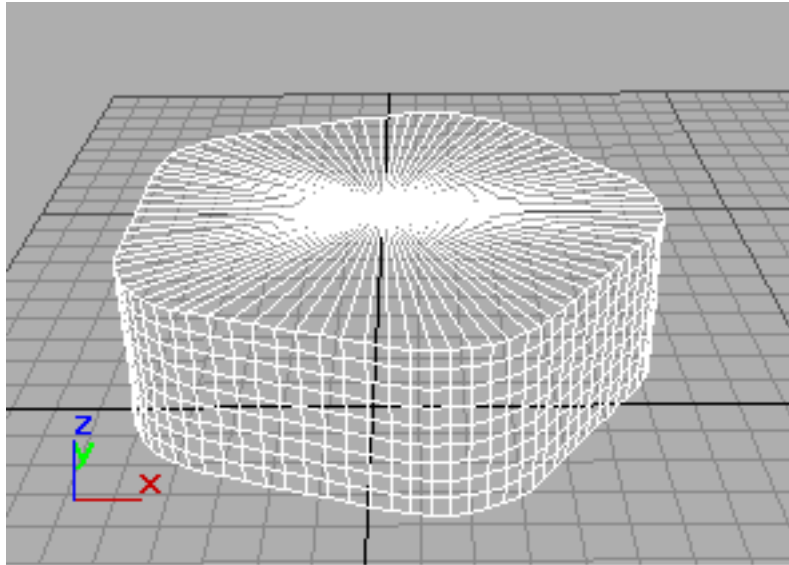

Above: Original object

Below: Object with edges selected

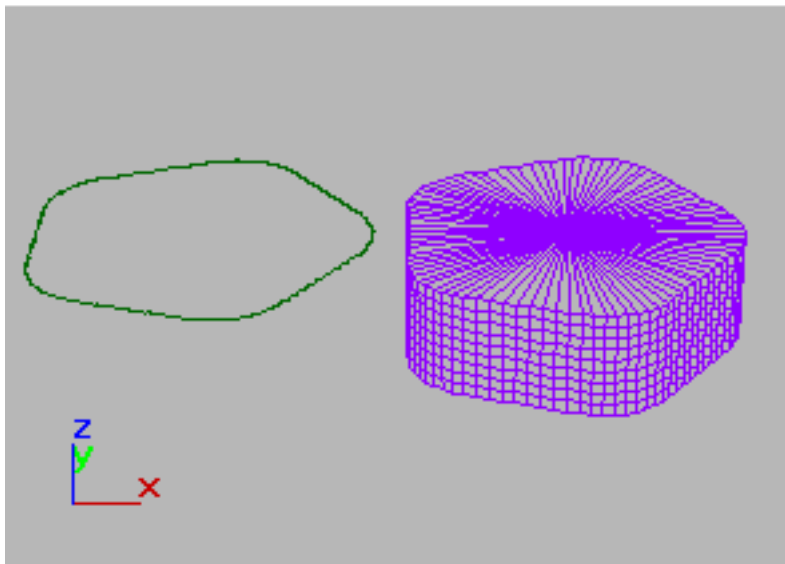
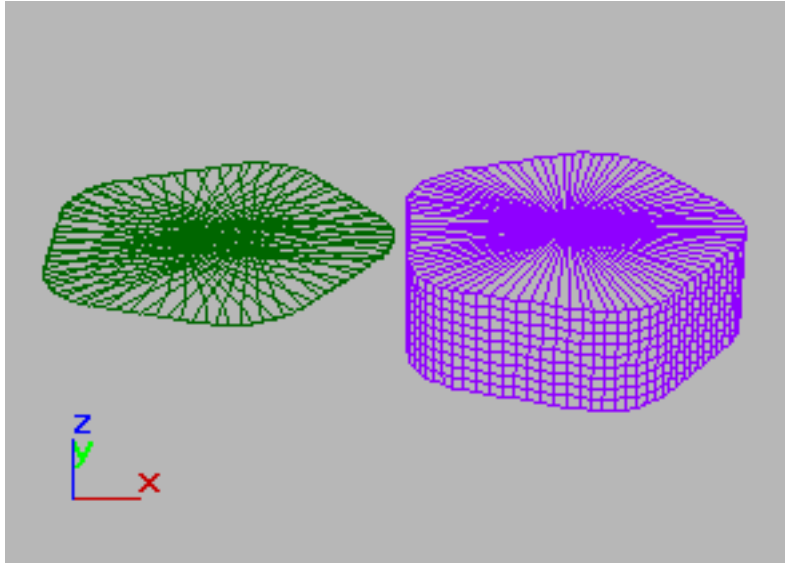

Above: Selected edges removed from original object

Below: Unwanted edges removed

## Interface

### Selection rollout

See [Editable Poly](#) on page 2046 for information on the Select rollout settings.

### Soft Selection rollout

Soft Selection controls apply a smooth falloff between selected sub-objects and unselected ones. When Use Soft Selection is on, unselected sub-objects near your selection are given partial selection values. These values are shown in the viewports by means of a color gradient on the vertices, and optionally on the faces. They affect most types of sub-object deformations, such as the Move, Rotate, and Scale functions, as well as any deformation modifiers (such as Bend) applied to the object. This provides a magnet-like effect with a sphere of influence around the selection.

For more information, see [Soft Selection Rollout](#) on page 1926 .

### Edit Edges rollout

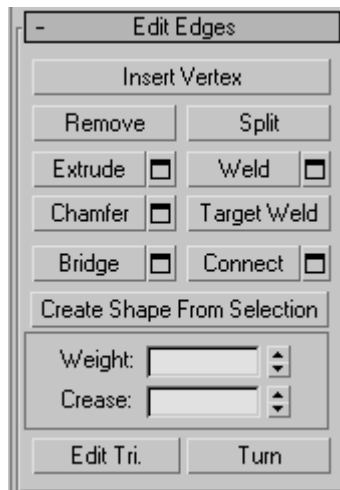

This rollout includes commands specific to edge editing.

---

**NOTE** To delete edges, select them and press the Delete key. This deletes all selected edges and attached polygons, which can create one or more holes in the mesh. To delete edges without creating holes, use [Remove](#) on page 2076 .

---

**Insert Vertex** Lets you subdivide visible edges manually.

After turning on Insert Vertex, click an edge to add a vertex at that location. You can continue subdividing polygons as long as the command is active.

To stop inserting edges, right-click in the viewport, or click Insert Vertex again to turn it off.

---

**NOTE** In previous versions of the software, this command was called Divide.

---

**Remove** Deletes selected edges and combines the polygons that use them.

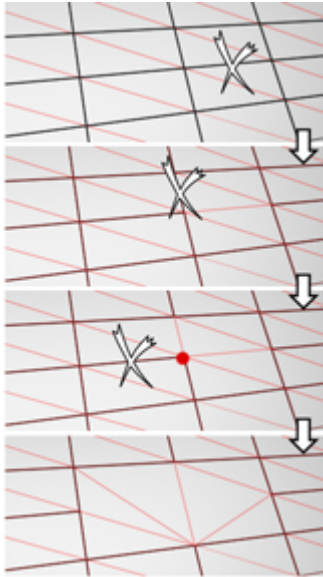

Removing one edge is like making it invisible. The mesh is affected only when all or all but one of the edges depending on one vertex are removed. At that point, the vertex itself is deleted and the surface is retriangulated.

To delete the associated vertices when you remove edges, press and hold Ctrl while executing a Remove operation, either by mouse or with the Backspace key. This option, called Clean Remove, ensures that the remaining polygons are planar.

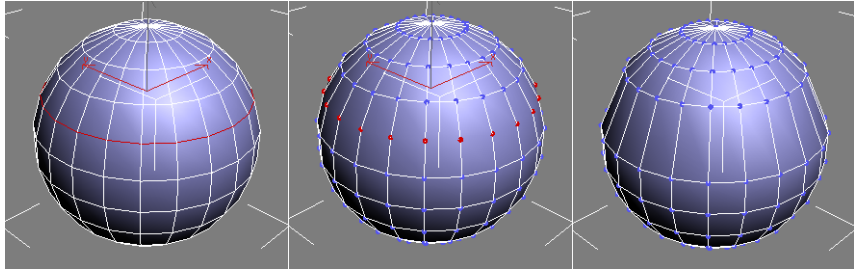

**Left:** The original edge selection

**Center:** Standard Remove operation leaves extra vertices.

**Right:** Clean Remove with **Ctrl+Remove** deletes the extra vertices.

Edges with the same polygon on both sides usually can't be removed.

---

**WARNING** Use of Remove can result in mesh shape changes and non-planar polygons.

---

**Split** Divides the mesh along the selected edges.

This does nothing when applied to a single edge in the middle of a mesh. The vertices at the end of affected edges must be separable in order for this option to work. For example, it would work on a single edge that intersects an existing border, since the border vertex can be split in two. Additionally, two adjacent edges could be split in the middle of a grid or sphere, since the shared vertex can be split.

**Extrude** Lets you extrude edges manually via direct manipulation in the viewport. Click this button, and then drag vertically on any edge to extrude it.

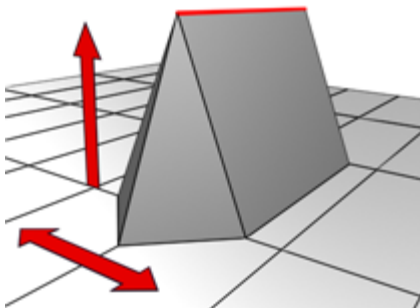

When extruding a vertex or edge interactively in the viewport, you set the extrusion height by moving the mouse vertically and the base width by moving the mouse horizontally.

Extruding an edge moves it along a normal and creates new polygons that form the sides of the extrusion, connecting the edge to the object. The extrusion has either three or four sides; three if the edge was on a border, or four if it was shared by two polygons. As you increase the length of the extrusion, the base increases in size, to the extent of the vertices adjacent to the extruded edge's endpoints.

Following are important aspects of edge extrusion:

- When over a selected edge, the mouse cursor changes to an Extrude cursor.
- Drag vertically to specify the extent of the extrusion, and horizontally to set the size of the base.
- With multiple edges selected, dragging on any one extrudes all selected edges equally.
- You can drag other edges in turn to extrude them while the Extrude button is active. Click Extrude again or right-click in the active viewport to end the operation.

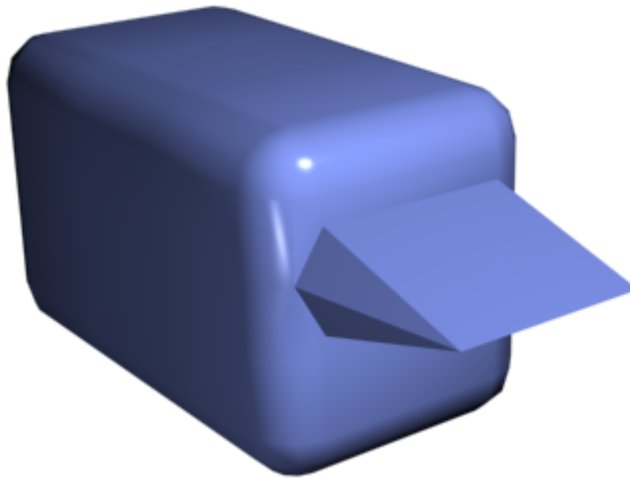

Chamfer box showing extruded edge



**Extrude Settings** Opens the [Extrude Edges dialog](#) on page 2142 , which lets you perform extrusion via interactive manipulation.



If you click this button after performing a manual extrusion, the same extrusion is performed on the current selection as a preview and the dialog opens with Extrusion Height set to the amount of the last manual extrusion.

**Weld** Combines selected edges that fall within the threshold specified in [Weld dialog](#) on page 2150 .

You can weld only edges that have one polygon attached; that is, edges on a border. Also, you cannot perform a weld operation that would result in illegal geometry (e.g., an edge shared by more than two polygons). For example, you cannot weld opposite edges on the border of a box that has a side removed.

**Weld Settings** Opens the [Weld dialog](#) on page 2150 , which lets you specify the weld threshold.

**Chamfer** Click this button and then drag edges in the active object. To chamfer vertices numerically, click the Chamfer Settings button and change the Chamfer Amount value.

If you chamfer multiple selected edges, all of them are chamfered identically. If you drag an unselected edge, any selected edges are first deselected.

An edge chamfer "chops off" the selected edges, creating a new polygon connecting new points on all visible edges leading to the original vertex. The new edges are exactly <chamfer amount> distance from the original edge along each of these edges. New chamfer faces are created with the material ID of one of the neighboring faces (picked at random) and a smoothing group which is an intersection of all neighboring smoothing groups.

For example, if you chamfer one edge of a box, each corner vertex is replaced by two vertices moving along the visible edges that lead to the corner. Outside faces are rearranged and split to use these new vertices, and a new polygon is created at the corner.

Alternatively, you can create open space around the chamfered edges; for details, see [Chamfer Edges dialog](#) on page 2136 .



**Chamfer Settings** Opens the [Chamfer Edges dialog](#) on page 2136 , which lets you chamfer edges via interactive manipulation and toggle the Open option.

If you click this button after performing a manual chamfer, the same chamfer is performed on the current selection as a preview and the dialog opens with Chamfer Amount set to the amount of the last manual chamfer.

**Target Weld** Allows you to select an edge and weld it to a target edge. When positioned over an edge, the cursor changes to a + cursor. Click and move the mouse and a dashed line appears from the vertex with an arrow cursor at the

other end of the line. Position the cursor over another edge and when the + cursor appears again, click the mouse. The first edge is moved to the position of the second, and the two are welded.

You can weld only edges that have one polygon attached; that is, edges on a border. Also, you cannot perform a weld operation that would result in illegal geometry (e.g., an edge shared by more than two polygons). For example, you cannot weld opposite edges on the border of a box that has a side removed.

**Bridge** Connects border edges on an object with a polygon “bridge.” Bridge connects only border edges; that is, edges that have a polygon on only one side. This tool is particularly useful when creating edge loops or profiles.

There are two ways to use Bridge in Direct Manipulation mode (that is, without opening the Bridge Edges settings dialog):

- Select two or more border edges on the object, and then click Bridge. This immediately creates the bridge between the pair of selected borders using the current Bridge settings, and then deactivates the Bridge button.
- If no qualifying selection exists (that is, two or more selected border edges), clicking Bridge activates the button and places you in Bridge mode. First click a border edge and then move the mouse; a rubber-band line connects the mouse cursor to the clicked edge. Click a second edge on a different border to bridge the two. This creates the bridge immediately using the current Bridge settings; the Bridge button remains active for connecting more edges. To exit Bridge mode, right-click the active viewport or click the Bridge button.

---

**NOTE** Bridge always creates a straight-line connection between edges. To make the bridge connection follow a contour, apply modeling tools as appropriate *after* creating the bridge. For example, bridge two edges, and then use [Bend](#) on page 1139 .

---



**Bridge Settings** Opens the [Bridge Edges dialog](#) on page 2133 , which lets you add polygons between pairs of edges via interactive manipulation.

**Connect** Creates new edges between pairs of selected edges using the current Connect Edges dialog settings. Connect is particularly useful for creating or refining edge loops.

---

**NOTE** You can connect only edges on the same polygon. Also, Connect will not let the new edges cross. For example, if you select all four edges of a four-sided polygon and then click Connect, only neighboring edges are connected, resulting in a diamond pattern.

---

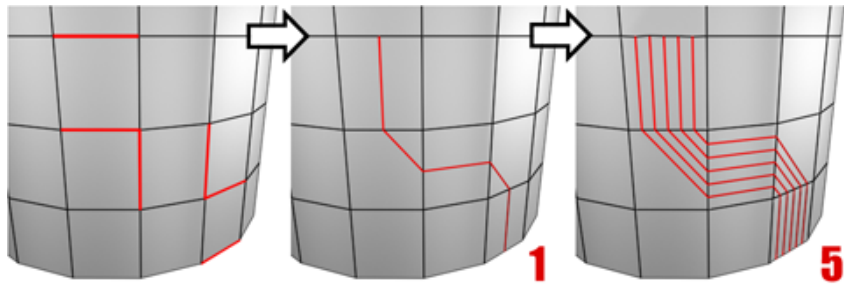

Connecting two or more edges using the Settings dialog creates equally spaced edges. The number of edges is set in the dialog. When you click the Connect button, the current dialog settings are applied to the selection.



**Connect Settings** Opens the [Connect Edges dialog](#) on page 2137 , which lets you preview the Connect results, specify the number of edge segments created by the operation, and set spacing and placement for the new edges.

**Create Shape From Selection** After selecting one or more edges, click this button to create a spline shape from the selected edges. A Create Shape dialog appears, letting you name the shape and set it to Smooth or Linear. The new shape's pivot is placed at the center of the poly object.

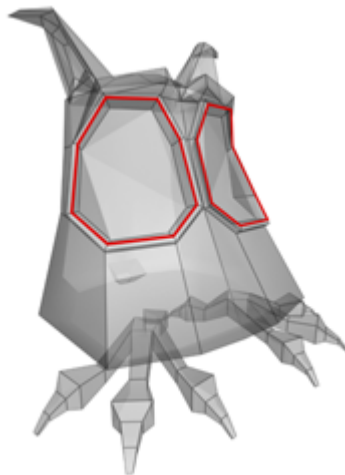



An edge selection (top); a smooth shape (center); a linear shape (bottom)

**Weight** Sets the weight of selected edges. Used by the [NURMS subdivision option](#) on page 2119 and by the [MeshSmooth modifier](#) on page 1460 .

Increasing an edge weight tends to push the smoothed result away.

**Crease** Specifies how much creasing is performed on the selected edge or edges. Used by the [NURMS subdivision option](#) on page 2119 and by the [MeshSmooth modifier](#) on page 1460 .

At low settings, the edge is relatively smooth. At higher settings, the crease becomes increasingly visible. At 1.0, the highest setting, the edge becomes a hard crease.

**Edit Tri[angulation]** Lets you modify how polygons are subdivided into triangles by drawing internal edges, or [diagonals](#) on page 7757 .

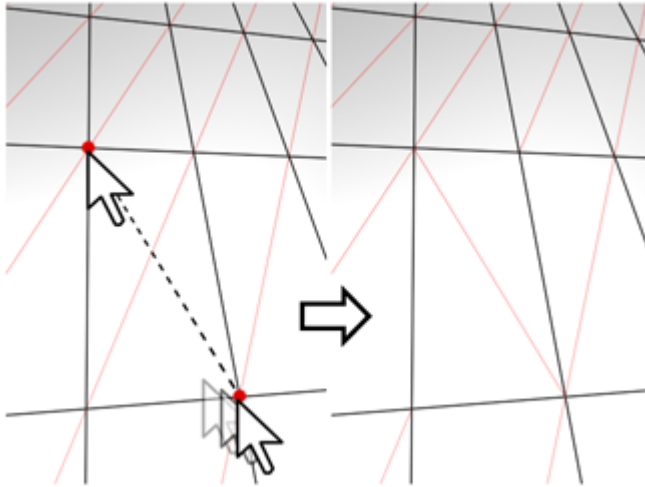

**In Edit Triangulation mode, you can see the current triangulation in the viewport, and change it by clicking two vertices on the same polygon.**

To edit triangulation manually, turn on this button. The hidden edges appear. Click a polygon vertex. A rubber-band line appears, attached to the cursor. Click a non-adjacent vertex to create a new triangulation for the polygon.

---

**TIP** For easier editing of triangulation, use the Turn command instead (see following).

---

**Turn** Lets you modify how polygons are subdivided into triangles by clicking diagonals. When you activate Turn, the [diagonals](#) on page 7757 become visible as dashed lines in wireframe and edged-faces views. In Turn mode, click a diagonal to change its position. To exit Turn mode, right-click in the viewport or click the Turn button again.

Each diagonal has only two available positions at any given time, so clicking a diagonal twice in succession simply returns it to its original position. But changing the position of a nearby diagonal can make a different alternate position available to a diagonal.

For more information on how to use Turn with the enhanced Cut tool, see [this procedure](#) on page ? .

### **Edit Geometry rollout**

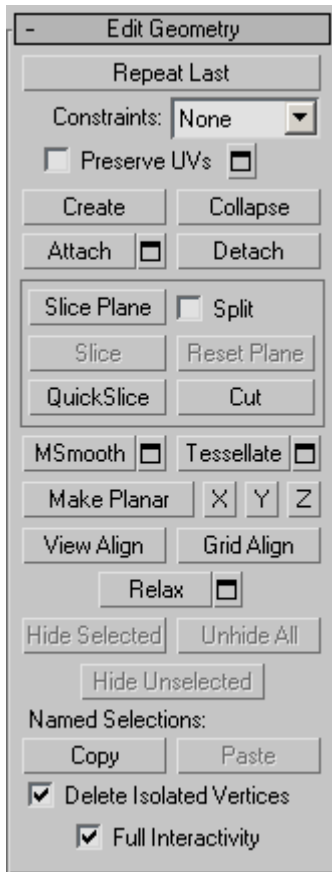

See [Edit Geometry Rollout \(Polymesh\)](#) on page 2105 for detailed descriptions of these controls.

### **Subdivision Surface rollout**

See [Interface](#) on page 2119 for information on the Subdivision Surface rollout settings.

## Subdivision Displacement rollout

See [Interface](#) on page 2124 for information on the Subdivision Displacement rollout settings.

## Paint Deformation rollout

Paint Deformation lets you stroke elevated and indented areas directly onto object surfaces. For more information, see [Paint Deformation Rollout](#) on page 2125 .

# Editable Poly (Border)

Select an editable poly object. > Modify panel > Selection rollout > Border

Select an editable poly object. > Modify panel > Modifier Stack display > Expand Editable Poly. > Border

Select an editable poly object. > Quad menu > Tools 1 quadrant > Border

A border is a linear section of a mesh that can generally be described as the edge of a hole. This is usually a sequence of edges with polygons on only one side. For example, a box doesn't have a border, but the teapot object has several: on the lid, on the body, on the spout, and two on the handle. If you create a cylinder, and then delete an end polygon, the adjacent row of edges forms a border.

At the editable poly Border sub-object level, you can select single and multiple borders and transform them using standard methods. This topic covers the Edit Geometry and Edit Borders rollouts; for other controls, see [Editable Poly](#) on page 2038 .

## Procedures

### To create a polygon that closes the surface at the selected border:

- 1 At the Border sub-object level, select any open edge.  
This selects the entire closed loop of continuous open edges that make up the border selection.
- 2 Click Cap.

## Interface

### Selection rollout

See [Editable Poly](#) on page 2046 for information on the Selection rollout settings.

### Soft Selection rollout

Soft Selection controls apply a smooth falloff between selected sub-objects and unselected ones. When Use Soft Selection is on, unselected sub-objects near your selection are given partial selection values. These values are shown in the viewports by means of a color gradient on the vertices, and optionally on the faces. They affect most types of sub-object deformations, such as the Move, Rotate, and Scale functions, as well as any deformation modifiers (such as Bend) applied to the object. This provides a magnet-like effect with a sphere of influence around the selection.

For more information, see [Soft Selection Rollout](#) on page 1926 .

### Edit Borders rollout

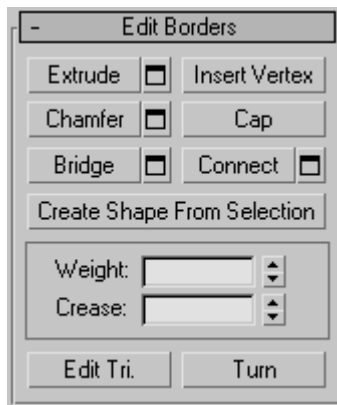

This rollout includes commands specific to editing borders.

---

**NOTE** To delete a border, select it and press the Delete key. This deletes the border and all attached polygons.

---

**Extrude** Lets you extrude a border manually via direct manipulation in the viewport. Click this button, and then drag vertically on any border to extrude it.



Extruding a border moves it along a normal and creates new polygons that form the sides of the extrusion, connecting the border to the object. The extrusion can form a varying number of additional sides, depending on the geometry near the border. As you increase the length of the extrusion, the base increases in size, to the extent of the vertices adjacent to the extruded border's endpoints.

Following are important aspects of border extrusion:

- When over a selected border, the mouse cursor changes to an Extrude cursor.
- Drag vertically to specify the extent of the extrusion, and horizontally to set the size of the base.
- With multiple borders selected, dragging on any one extrudes all selected borders equally.
- You can drag other borders in turn to extrude them while the Extrude button is active. Click Extrude again or right-click in the active viewport to end the operation.



**Extrude Settings** Opens the [Extrude Edges dialog](#) on page 2142 , which lets you perform extrusion via interactive manipulation.

If you click this button after performing a manual extrusion, the same extrusion is performed on the current selection as a preview and the dialog opens with Extrusion Height set to the amount of the last manual extrusion.

**Insert Vertex** Lets you subdivide border edges manually.

After turning on Insert Vertex, click a border edge to add a vertex at that location. You can continue subdividing border edges as long as the command is active.

To stop inserting vertices, right-click in the viewport, or click Insert Vertex again to turn it off.

---

**NOTE** In previous versions of the software, this command was called Divide.

---

**Chamfer** Click this button and then drag a border in the active object. The border need not be selected first.

If you chamfer multiple selected borders, all of them are chamfered identically. If you drag an unselected border, any selected borders are first deselected.

A border chamfer essentially “frames” the border edges, creating a new set of edges paralleling the border edges, plus new diagonal edges at any corners. These new edges are exactly <chamfer amount> distance from the original edges. New chamfer faces are created with the material ID of one of the neighboring faces (picked at random) and a smoothing group which is an intersection of all neighboring smoothing groups.

Alternatively, you can create open space around the chamfered borders, essentially cutting away at the open edges; for details, see [Chamfer Edges dialog](#) on page 2136 .



**Chamfer Settings** Opens the [Chamfer Edges dialog](#) on page 2136 , which lets you chamfer borders via interactive manipulation and toggle the Open option.

If you click this button after performing a manual chamfer, the same chamfer is performed on the current selection as a preview and the dialog opens with Chamfer Amount set to the amount of the last manual chamfer.

**Cap** Caps an entire border loop with a single polygon.

Select the border, and then click Cap.

**Bridge** Connects two borders on an object with a polygon “bridge.” There are two ways to use Bridge in Direct Manipulation mode (that is, without opening the Bridge Settings dialog):

- Select an even number of borders on the object, and then click Bridge. This immediately creates the bridge between each pair of selected borders using the current Bridge settings, and then deactivates the Bridge button.
- If no qualifying selection exists (that is, two or more selected borders), clicking Bridge activates the button and places you in Bridge mode. First click a border edge and then move the mouse; a rubber-band line connects the mouse cursor to the clicked edge. Click a second edge on a different border to bridge the two. This creates the bridge immediately using the current Bridge settings; the Bridge button remains active for connecting more pairs of borders. To exit Bridge mode, right-click the active viewport or click the Bridge button.

---

**NOTE** Bridge always creates a straight-line connection between border pairs. To make the bridge connection follow a contour, apply modeling tools as appropriate *after* creating the bridge. For example, bridge two borders, and then use [Bend](#) on page 1139 .

---



**Bridge Settings** Opens the [Bridge dialog](#) on page 2131 , which lets you connect pairs of borders via interactive manipulation.

**Connect** Creates new edges between pairs of selected border edges. The edges are connected from their midpoints.

You can connect only edges on the same polygon.

Connect will not let the new edges cross. Thus, for example, if you select all four edges of a four-sided polygon and then click Connect, only neighboring edges are connected, resulting in a diamond pattern.



**Connect Settings** Lets you preview the Connect and specify the number of edge segments created by the operation. To increase the mesh resolution around the new edge, increase the Connect Edge Segments setting.

**Create Shape From Selection** After selecting one or more borders, click this button to create a spline shape from the selected edges. A Create Shape dialog appears, letting you name the shape and set it to Smooth or Linear. The new shape's pivot is placed at the center of the poly object.

**Weight** Sets the weight of selected borders. Used by the [NURMS subdivision option](#) on page 2119 .

Increasing an edge weight tends to push the smoothed result away.

**Crease** Specifies how much creasing is performed on the selected border or borders. Used by the [NURMS subdivision option](#) on page 2119 .

At low settings, the border is relatively smooth. At higher settings, the crease becomes increasingly visible. At 1.0, the highest setting, the border is not smoothed at all.

**Edit Tri[angulation]** Lets you modify how polygons are subdivided into triangles by drawing internal edges, or [diagonals](#) on page 7757 .

To edit triangulation manually, turn on this button. The hidden edges appear. Click a polygon vertex. A rubber-band line appears, attached to the cursor. Click a non-adjacent vertex to create a new triangulation for the polygon.

---

**TIP** For easier editing of triangulation, use the Turn command instead (see following).

---

**Turn** Lets you modify how polygons are subdivided into triangles by clicking diagonals. When you activate Turn, the [diagonals](#) on page 7757 become visible as dashed lines in wireframe and edged-faces views. In Turn mode, click a

diagonal to change its position. To exit Turn mode, right-click in the viewport or click the Turn button again.

Each diagonal has only two available positions at any given time, so clicking a diagonal twice in succession simply returns it to its original position. But changing the position of a nearby diagonal can make a different alternate position available to a diagonal.

For more information on how to use Turn with the enhanced Cut tool, see [this procedure](#) on page ? .

### Edit Geometry rollout

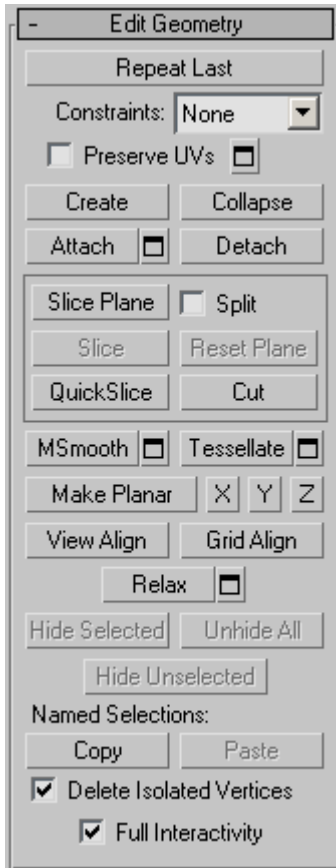

See [Edit Geometry Rollout \(Polymesh\)](#) on page 2105 for detailed descriptions of these controls.

## Subdivision Surface rollout

See [Interface](#) on page 2119 for information on the Subdivision Surface rollout settings.

## Subdivision Displacement rollout

See [Interface](#) on page 2124 for information on the Subdivision Displacement rollout settings.

## Paint Deformation rollout

Paint Deformation lets you stroke elevated and indented areas directly onto object surfaces. For more information, see [Paint Deformation Rollout](#) on page 2125 .

# Editable Poly (Polygon/Element)

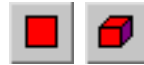

Select an editable poly object. > Modify panel > Selection rollout > Polygon or Element

Select an editable poly object. > Modify panel > Modifier Stack display > Expand Editable Poly. > Polygon/Element

Select an editable poly object. > Quad menu > Tools 1 quadrant > Polygon or Element

A *polygon* is a closed sequence of three or more edges connected by a surface. Polygons provide the renderable surface of editable poly objects.

At the Editable Poly (Polygon) sub-object level, you can select single and multiple polygons and transform them using standard methods. This is also true for the Element sub-object level; for the distinctions between polygon and element, see [Editable Poly > Selection rollout](#) on page 2046 . This topic covers the Edit Polygons/Elements rollout and Edit Geometry rollout functions for these sub-object types; for other controls, see [Editable Poly](#) on page 2038 .

---

**NOTE** Workflow enhancements in the Editable Poly user interface give you a choice of editing methods. See [Editable Poly Workflow](#) on page 2039 for more information.

---

## Interface

### Selection rollout

See [Editable Poly > Selection rollout](#) on page 2046 for information on the Selection rollout settings.

### Soft Selection rollout

Soft Selection controls apply a smooth falloff between selected sub-objects and unselected ones. When Use Soft Selection is on, unselected sub-objects near your selection are given partial selection values. These values are shown in the viewports by means of a color gradient on the vertices, and optionally on the faces. They affect most types of sub-object deformations, such as the Move, Rotate, and Scale functions, as well as any deformation modifiers (such as Bend) applied to the object. This provides a magnet-like effect with a sphere of influence around the selection.

For more information, see [Soft Selection Rollout](#) on page 1926 .

### Edit Polygons/Elements rollout

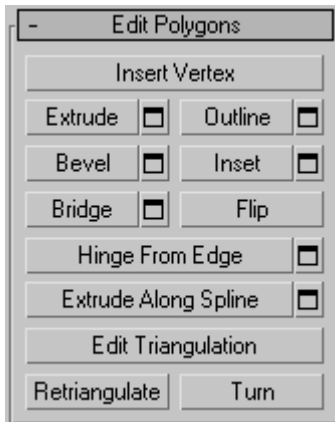

At the element sub-object level, this rollout includes commands that are common to both polygons and elements. At the polygon level, it contains those as well as a number more that are unique to polygons. The commands available at both levels are Insert Vertex, Edit Triangulation, Retriangulate, and Flip.

---

**NOTE** To delete polygons or elements, select them and press the Delete key. A dialog might appear asking if you want to delete isolated vertices, which are vertices that are used only by polygons or elements that are to be deleted. Click Yes to delete them; click No to retain them.

---

**Insert Vertex** Lets you subdivide polygons manually. Applies to polygons, even if at the element sub-object level.

After turning on Insert Vertex, click a polygon to add a vertex at that location. You can continue subdividing polygons as long as the command is active.

To stop inserting vertices, right-click in the viewport, or click Insert Vertex again to turn it off.

---

**NOTE** In previous versions of the software, this command was called Divide.

---

**Extrude** Lets you perform manual extrusion via direct manipulation in the viewport. Click this button, and then drag vertically on any polygon to extrude it.

Extruding polygons moves them along a normal and creates new polygons that form the sides of the extrusion, connecting the selection to the object.

Following are important aspects of polygon extrusion:

- When over a selected polygon, the mouse cursor changes to an Extrude cursor.
- Drag vertically to specify the extent of the extrusion, and horizontally to set the size of the base.
- With multiple polygons selected, dragging on any one extrudes all selected polygons equally.
- You can drag other polygons in turn to extrude them while the Extrude button is active. Click Extrude again or right-click in the active viewport to end the operation.

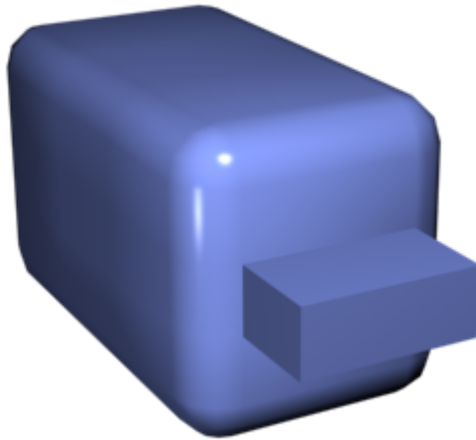

**Chamfer box showing extruded polygon**



**Extrude Settings** Opens the [Extrude Faces dialog](#) on page 2141 , which lets you perform extrusion via interactive manipulation.

If you click this button after performing an extrusion, the same extrusion is performed on the current selection as a preview and the dialog opens with Extrusion Height set to the amount of the last manual extrusion.

**Outline** Lets you increase or decrease the outside edge of each contiguous group of selected polygons.



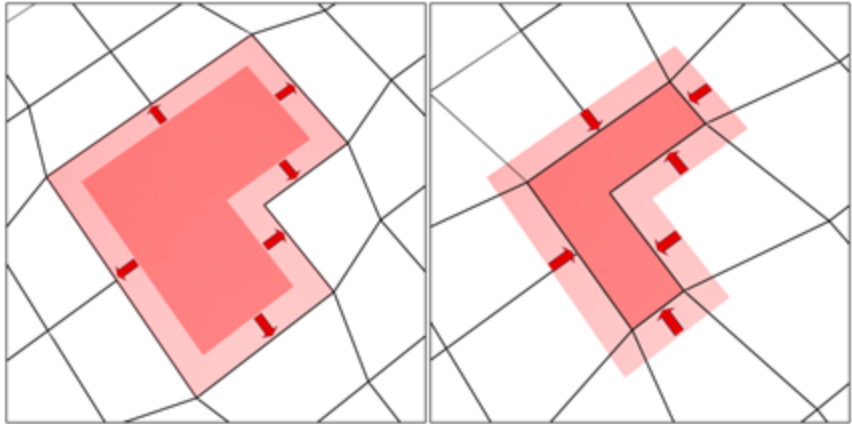

Outline is often used after an extrusion or bevel to adjust the size of the extruded faces. It doesn't scale the polygons; only changes the size of the outer edge. For example, in the following illustration, note that the sizes of the inner polygons remain constant.



Click the Outline Settings button to open the Outline Selected Faces dialog, which lets you perform outlining by a numeric setting.

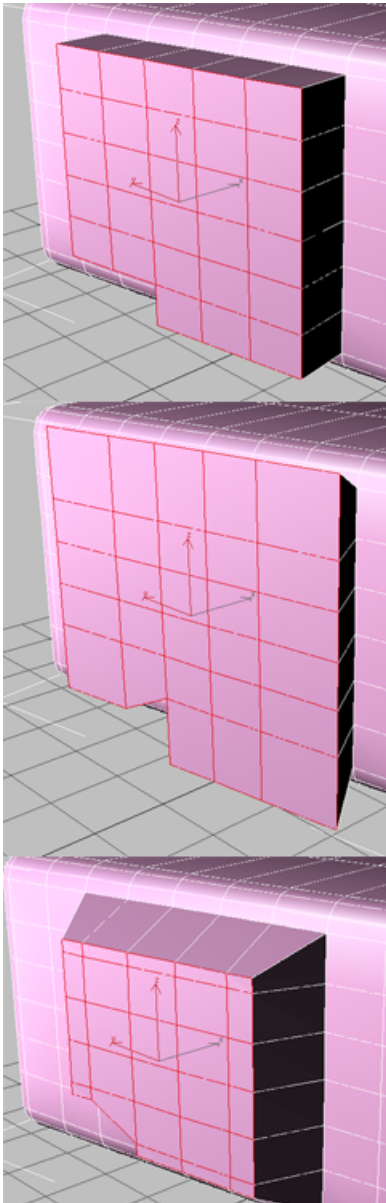

Extruded polygons (top), outline expanded (middle), outline reduced (bottom)  
Note that size of inner polygons doesn't change.

**Bevel** Lets you perform manual beveling via direct manipulation in the viewport. Click this button, and then drag vertically on any polygon to extrude it. Release the mouse button and then move the mouse vertically to outline the extrusion. Click to finish.

- When over a selected polygon, the mouse cursor changes to a Bevel cursor.
- With multiple polygons selected, dragging on any one bevels all selected polygons equally.
- You can drag other polygons in turn to bevel them while the Bevel button is active. Click Bevel again or right-click to end the operation.

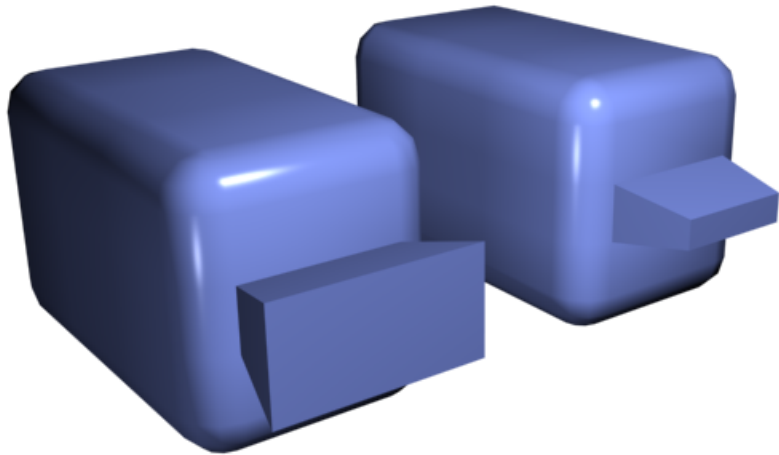

Polygon beveled outward (left) and inward (right)



**Bevel Settings** Opens the [Bevel Selection dialog](#) on page 2129 , which lets you perform beveling via interactive manipulation.

If you click this button after performing a bevel, the same bevel is performed on the current selection as a preview and the dialog opens with the same settings used for the previous bevel.

**Inset** Performs a bevel with no height; that is, within the plane of the polygon selection. Click this button, and then drag vertically on any polygon to inset it.

- When over a selected polygon, the mouse cursor changes to an Inset cursor.

- With multiple polygons selected, dragging on any one insets all selected polygons equally.
- You can drag other polygons in turn to inset them while the Inset button is active. Click Inset again or right-click to end the operation.

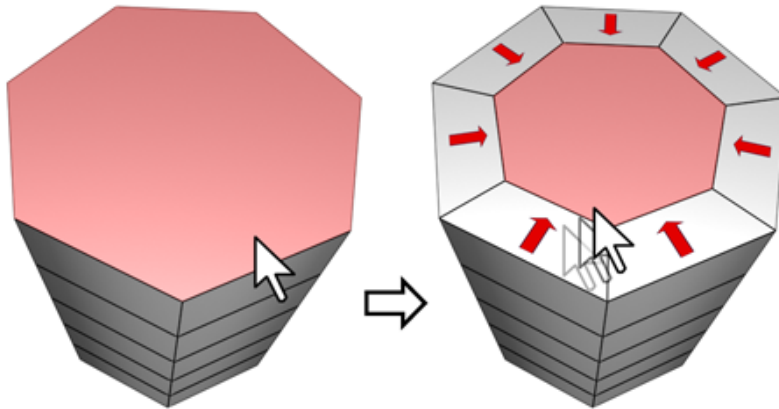

**Inset** works on a selection of one or more polygons. As with **Outline**, only the outer edges are affected.



**Inset Settings** Opens the [Inset Selected Faces dialog](#) on page 2144 , which lets you inset polygons via interactive manipulation.

If you click this button after performing a manual inset, the same inset is performed on the current selection as a preview and the dialog opens with Inset Amount set to the amount of the last manual inset.

**Bridge** Connects two polygons or polygon selections on an object with a polygon “bridge.” There are two ways to use Bridge in Direct Manipulation mode (that is, without opening the Bridge Settings dialog):

- Make two separate polygon selections on the object, and then click Bridge. This creates the bridge immediately using the current Bridge settings, and then deactivates the Bridge button.
- If no qualifying selection exists (that is, two or more discrete polygon selections), clicking Bridge activates the button and places you in Bridge mode. First click a polygon and move the mouse; a rubber-band line connects the mouse cursor to the clicked polygon. Click a second polygon to bridge the two. This creates the bridge immediately using the current

Bridge settings; the Bridge button remains active for connecting more pairs of polygons. To exit Bridge mode, right-click the active viewport or click the Bridge button.

---

**NOTE** Bridge always creates a straight-line connection between polygon pairs. To make the bridge connection follow a contour, apply modeling tools as appropriate *after* creating the bridge. For example, bridge two polygons, and then use [Bend](#) on page 1139 .

---



**Bridge Settings** Opens the [Bridge dialog](#) on page 2131 , which lets you connect pairs of polygon selections via interactive manipulation.

**Flip** Reverses the directions of the normals of selected polygons, hence their facing.

**Hinge From Edge** Lets you perform a manual hinge operation via direct manipulation in the viewport. Make a polygon selection, click this button, and then drag vertically on any edge to hinge the selection. The mouse cursor changes to a cross when over an edge.

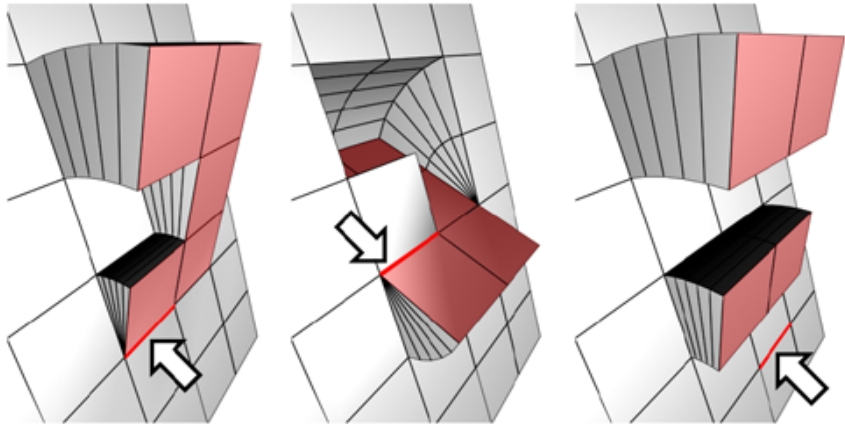

The hinge edge needn't be part of the selection. It can be any edge of the mesh. Also, the selection needn't be contiguous.

Hinging polygons rotates them about an edge and creates new polygons that form the sides of the hinge, connecting the selection to the object. It's essentially an extrusion with rotation, with the exception that, if the hinge edge belongs to a selected polygon, that side is not extruded. The manual version of Hinge From Edge works only with an existing polygon selection.

---

**TIP** Turn on Ignore Backfacing to avoid inadvertently hinging about a backfacing edge.

---



**Hinge Settings** Opens the [Hinge From Edge dialog](#) on page 2143 , which lets you hinge polygons via interactive manipulation.

If you click this button after performing a manual hinge, the dialog opens with Angle set to the extent of the last manual hinge.

**Extrude Along Spline** Extrudes the current selection along a spline.

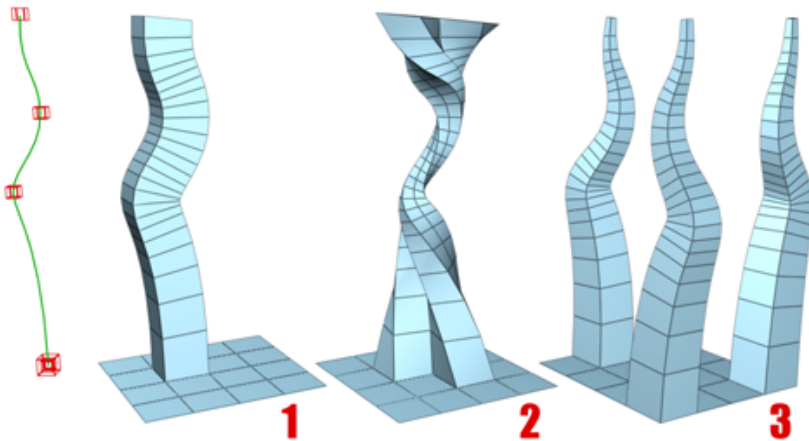

You can extrude a single face (1) or a selection of contiguous (2) or non-contiguous faces (3). Extrusion 2 uses Taper Curve and Twist. Extrusion 3 uses Taper Amount; each extrusion has a different curve rotation.

Make a selection, click this button, and then select a spline in the scene. The selection is extruded along the spline, using the spline's current orientation, but as though the spline's start point were moved to the center of each polygon or group.



**Extrude Along Spline Settings** Opens the [Extrude Polygons Along Spline dialog](#) on page 2139 , which lets you extrude along splines via interactive manipulation.

**Edit Triangulation** Lets you modify how polygons are subdivided into triangles by drawing internal edges.

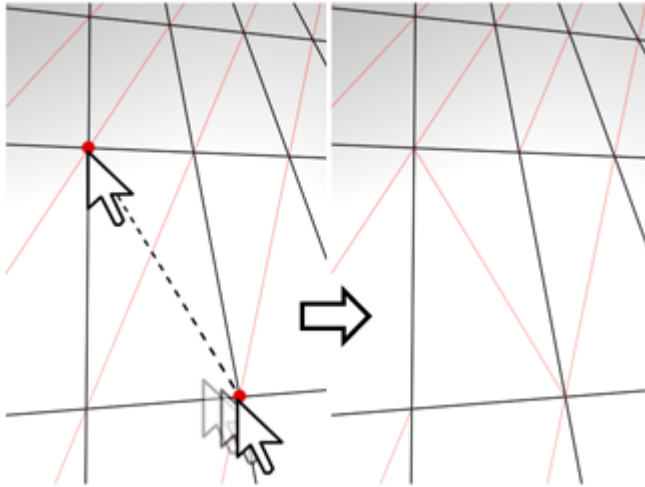

In Edit Triangulation mode, you can see the current triangulation in the viewport, and change it by clicking two vertices on the same polygon.

To manually edit triangulation, turn on this button. The hidden edges appear. Click a polygon vertex. A rubber-band line appears, attached to the cursor. Click a non-adjacent vertex to create a new triangulation for the polygon.

**Retriangulate** Lets the software automatically do its best triangulation on the polygon or polygons currently selected.

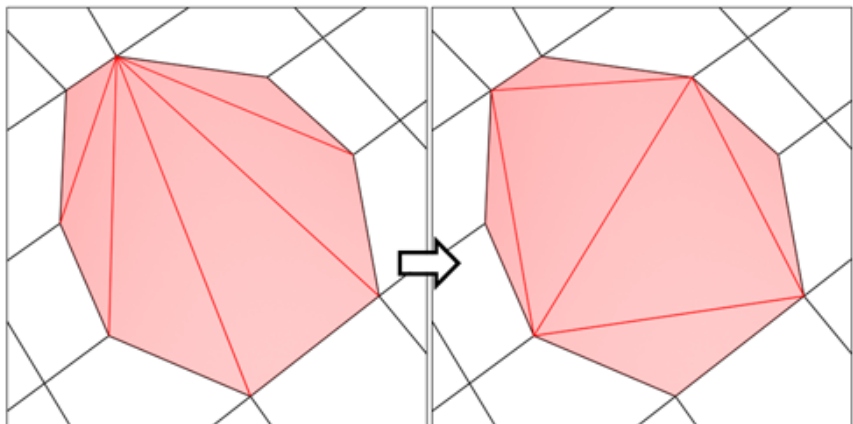

Retriangulate attempts to optimize how selected polygons are subdivided into triangles.

**Turn** Lets you modify how polygons are subdivided into triangles by clicking diagonals. When you activate Turn, the [diagonals](#) on page 7757 become visible as dashed lines in wireframe and edged-faces views. In Turn mode, click a diagonal to change its position. To exit Turn mode, right-click in the viewport or click the Turn button again.

Each diagonal has only two available positions at any given time, so clicking a diagonal twice in succession simply returns it to its original position. But changing the position of a nearby diagonal can make a different alternate position available to a diagonal.

For more information on how to use Turn with the enhanced Cut tool, see [this procedure](#) on page ? .

### Edit Geometry rollout





See [Edit Geometry Rollout \(Polymesh\)](#) on page 2105 for detailed descriptions of these controls.

### Polygon Properties rollout



These controls let you work with material IDs, smoothing groups, and vertex colors.

### Material group

**Set ID** Lets you assign a particular [material ID](#) on page 7842 number to selected sub-objects for use with [multi/sub-object materials](#) on page 5558 and other applications. Use the spinner or enter the number from the keyboard. The total number of available IDs is 65,535.

**Select ID** Selects sub-objects corresponding to the Material ID specified in the adjacent ID field. Type or use the spinner to specify an ID, then click the Select ID button.

**[Select By Name]** This drop-down list shows the names of sub-materials if an object has a Multi/Sub-Object material assigned to it. Click the drop arrow and choose a sub-material from the list. The sub-objects that are assigned that material are selected. If an object does not have a Multi/Sub-Object material assigned, the name list is unavailable. Likewise, if multiple objects are selected that have an Edit Patch, Edit Spline, or Edit Mesh modifier applied, the name list is inactive.

---

**NOTE** Sub-material names are those specified in the Name column on the material's Multi/Sub-Object Basic Parameters rollout; these are not created by default, and must be specified separately from any material names.

---

**Clear Selection** When on, choosing a new ID or material name deselects any previously selected sub-objects. When off, selections are cumulative, so new ID or sub-material name selections add to the existing selection set of patches or elements. Default=on.

### **Smoothing Groups group**

Use these controls to assign selected polygons to different [smoothing groups](#) on page 7932 , and to select polygons by smoothing group.

To assign polygons to one or more smoothing groups, select the polygons, and then click the number(s) of the smoothing group(s) to assign them to.

**Select By SG (Smoothing Group)** Displays a dialog that shows the current smoothing groups. Select a group by clicking the corresponding numbered button and clicking OK. If Clear Selection is on, any previously selected polygons are first deselected. If Clear Selection is off, the new selection is added to any previous selection set.

**Clear All** Removes any smoothing group assignments from selected polygons.

**Auto Smooth** Sets the smoothing groups based on the angle between polygons. Any two adjacent polygons will be put in the same smoothing group if the angle between their normals is less than the threshold angle, set by the spinner to the right of this button.

**Threshold** This spinner (to the right of Auto Smooth) lets you specify the maximum angle between the normals of adjacent polygons that determines whether those polygons will be put in the same smoothing group.

### **Edit Vertex Colors group**

Use these controls to assign the color, illumination color (shading), and alpha (transparency) values of vertices on selected polygons or elements.

**Color** Click the color swatch to change the color of vertices on selected polygons or elements.

**Illumination** Click the color swatch to change the illumination color of vertices on selected polygons or elements. This lets you change the illumination without changing the vertex's color.

**Alpha** Lets you assign an alpha (transparency) value to vertices on selected polygons or elements.

The spinner value is a percentage; zero is completely transparent and 100 is completely opaque.

### **Subdivision Surface rollout**

See [Interface](#) on page 2119 for information on the Subdivision Surface rollout settings.

### **Subdivision Displacement rollout**

See [Interface](#) on page 2124 for information on the Subdivision Displacement rollout settings.

### **Paint Deformation rollout**

Paint Deformation lets you stroke elevated and indented areas directly onto object surfaces. For more information, see [Paint Deformation Rollout](#) on page 2125 .

## **Edit Geometry Rollout (Polymesh)**

Create or select an editable poly object. > Modify panel > Edit Geometry rollout

The Edit Geometry rollout provides global controls for changing the geometry of the polymesh, at either the top (Object) level or the sub-object levels. The control are the same at all levels, except as noted in the descriptions below.

## Interface



**Repeat Last** Repeats the most recently used command.

For example, if you extrude a polygon, and want to apply the same extrusion to several others, select the others, and then click Repeat Last.

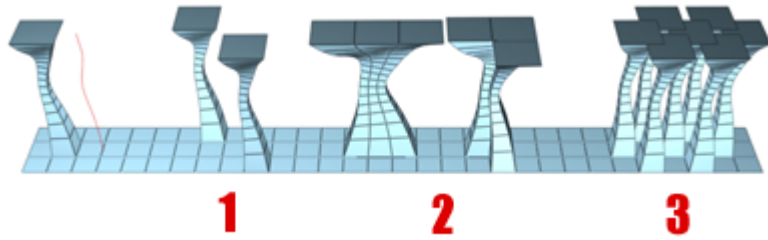

You can apply a spline extrusion of a single polygon (left) repeatedly to other single polygons (1) or to multiple polygon selections, contiguous (2) or not (3).

---

**NOTE** Repeat Last does not repeat all operations. For example, it does not repeat transforms. To determine which command will be repeated when you click the button, check the button's tooltip, which gives the name of the last operation that can be repeated. If no tooltip appears, nothing will happen when you click the button.

---

**Constraints** Lets you use existing geometry to constrain sub-object transformation. Choose the constraint type:

- **None:** No constraints. This is the default option.
- **Edge:** Constrains sub-object transformations to edge boundaries.
- **Face:** Constrains sub-object transformations to individual face surfaces.
-  **Normal:** Constrains each sub-object's transformations to its normal, or the average of its normals. In most cases, this causes sub-objects to move perpendicular to the surface.

---

**NOTE** This constraint works like the [Push modifier](#) on page 1574 , including the fact that it operates on unmodified base normals. Edited normals are unsupported.

---

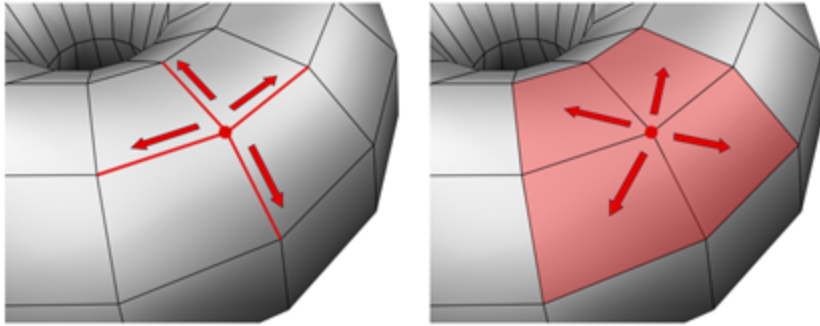

When set to **Edge**, moving a vertex will slide it along one of the existing edges, depending on the direction of the transformation. If set to **Face**, the vertex moves only on the polygon's surface.

---

**NOTE** You can set constraints at the Object level, but their use pertains primarily to sub-object levels. The Constraints setting persists at all sub-object levels.

---

**Preserve UVs** When on, you can edit sub-objects without affecting the object's UV mapping. You can choose any of an object's mapping channels to preserve or not; see [Preserve UVs Settings](#), following. Default=off.

Without **Preserve UVs**, there is always a direct correspondence between an object's geometry and its UV mapping. For example, if you map an object and then move vertices, the texture moves along with the sub-objects, whether you want it to or not. If you turn on **Preserve UVs**, you can perform minor editing tasks without changing the mapping.

---

**TIP** For best results with **Preserve UVs** at the vertex level, use it for limited vertex editing. For example, you'll usually have no trouble moving a vertex within edge or face constraints. Also, it's better to perform one big move than several smaller moves, as multiple small moves can begin to distort the mapping. If, however, you need to perform extensive geometry editing while preserving mapping, use the [Channel Info utility](#) on page 5858 instead.

---



**Preserve UVs Settings** Opens the [Preserve Map Channels dialog](#) on page 2146, which lets you specify which vertex color channels and/or texture channels (map channels) to preserve. By default, all vertex color channels are off (not preserved), and all texture channels are on (preserved).

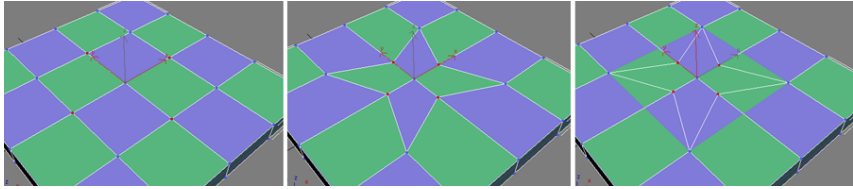

**Original object with texture map (left); Scaled vertices with Preserve UVs off (center); Scaled vertices with Preserve UVs on (right)**

**Create** Lets you create new geometry. How this button behaves depends on which level is active:

- **Object, Polygon, and Element levels** Lets you add polygons in the active viewport. After you turn on Create, click three or more times in succession anywhere, including on existing vertices, to define the shape of the new polygon. To finish, right-click. While creating a polygon at the Polygon or Element level, you can delete the most recently added vertex by pressing Backspace. You can do this repeatedly to remove added vertices in reverse order of placement. You can start creating polygons in any viewport, but all subsequent clicks must take place in the same viewport.

---

**TIP** For best results, click vertices in counterclockwise (preferred) or clockwise order. If you use clockwise order, the new polygon will face away from you.

---

- **Vertex level** Lets you add vertices to a single selected poly object. After selecting the object and clicking Create, click anywhere in space to add free-floating (isolated) vertices to the object. The new vertices are placed on the active construction plane unless object snapping is on. For example, with face snapping on, you can create vertices on object faces.
- **Edge and Border levels** Lets you create an edge between a pair of non-adjacent vertices on the same polygon. Click Create, click a vertex, and then move the mouse. A rubber-band line extends from the vertex to the mouse cursor. Click a second, non-adjacent vertex on the same polygon to connect them with an edge. Repeat, or, to exit, right-click in the viewport or click Create again. Edges you create separate the polygons. For example, by creating an edge inside a quadrilateral polygon, you turn it into two triangles.

**Collapse (Vertex, Edge, Border, and Polygon levels only)** Collapses groups of contiguous selected sub-objects by welding their vertices to a vertex at the selection center.

**Attach** Lets you attach another object in the scene to the selected editable poly. You can attach any type of object, including splines, patch objects, and NURBS surfaces. Attaching a non-mesh object converts it to editable-poly format. Click the object you want to attach to the currently selected poly object.

When you attach an object, the materials of the two objects are combined in the following way:

- If the object being attached does not have a material assigned, it inherits the material of the object it is being attached to.
- Likewise, if the object you're attaching to doesn't have a material, it inherits the material of the object being attached.
- If both objects have materials, the resulting new material is a [multi/sub-object material](#) on page 5558 that includes the input materials. A dialog appears offering three methods of combining the objects' materials and material IDs. For more information, see [Attach Options Dialog](#) on page 2031 .  
Attach remains active in all sub-object levels, but always applies to objects.



**Attach List** Lets you attach other objects in the scene to the selected mesh. Click to open the Attach List dialog, which works like [Select From Scene](#) on page 168 to let you choose multiple objects to attach.



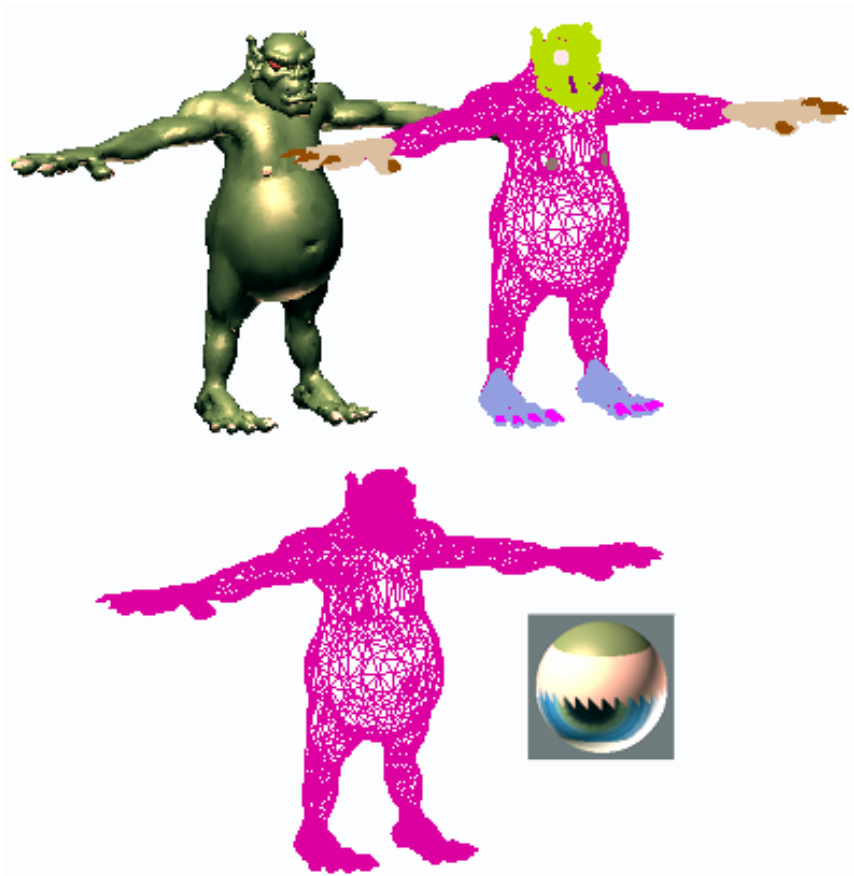

Shaded view of model (upper left); wireframe view of model (upper right); model with objects attached (lower left); and subsequent multi/sub-object material (lower right)

**Detach (sub-object levels only)** Detaches the selected sub-objects and the polygons attached to them as a separate object or element. The Detach As Clone option copies the sub-objects rather than moving them.

You're prompted to enter a name for the new object. Detached faces leave a hole in the original object when you move them to a new position, unless you use the Detach As Clone option.

### **Cut and Slice group**

These knife-like tools let you subdivide the poly mesh along a plane (Slice) or in a specific area (Cut). Also see [Full Interactivity](#) on page 2117 .

**Slice Plane (sub-object levels only)** Creates a gizmo for a slice plane that you can position and rotate to specify where to slice. Also enables the Slice and Reset Plane buttons.

If snapping is turned off, you see a preview of the slice as you transform the slice plane. To perform the slice, click the Slice button.

**Split** When on, the QuickSlice and Cut operations create double sets of vertices at the points where the edges are divided. This lets you easily delete the new polygons to create holes, or animate the new polygons as separate elements.

**Slice (sub-object levels only)** Performs the slice operation at the location of the slice plane. Available only when Slice Plane is on. This tool slices the poly just like the “Operate On: Polygons” mode of the [Slice modifier](#) on page 1658.

**Reset Plane (sub-object levels only)** Returns the Slice plane to its default position and orientation. Available only when Slice Plane is on.

**QuickSlice** Lets you quickly slice the object without having to manipulate a gizmo. Make a selection, click QuickSlice, and then click once at the slice start point and again at its endpoint. You can continue slicing the selection while the command is active.

To stop slicing, right-click in the viewport, or click QuickSlice again to turn it off.

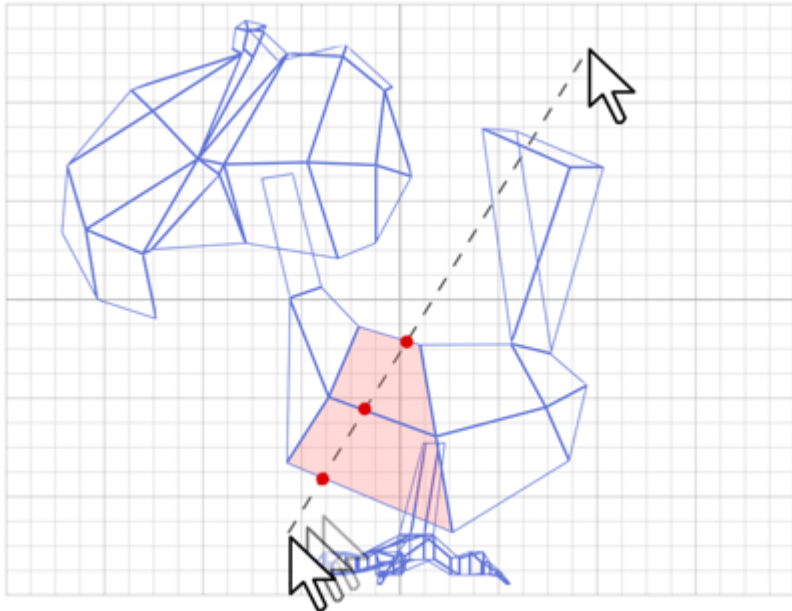

**With Quickslice on, you can draw a line across your mesh in any viewport, including Perspective and Camera views. The mesh is sliced interactively as you move the line endpoint.**

---

**NOTE** At the Object level, QuickSlice affects the entire object. To slice only specific polygons, use QuickSlice on a polygon selection at the Poly sub-object level.

---

**NOTE** At the Polygon or Element sub-object level, QuickSlice affects only selected polygons. To slice the entire object, use QuickSlice at any other sub-object level, or at the object level.

---

**Cut** Lets you create edges from one polygon to another or within polygons. Click at the start point, move the mouse and click again, and continue moving and clicking to create new connected edges. Right-click once to exit the current cut, whereupon you can start a new one, or right-click again to exit Cut mode.

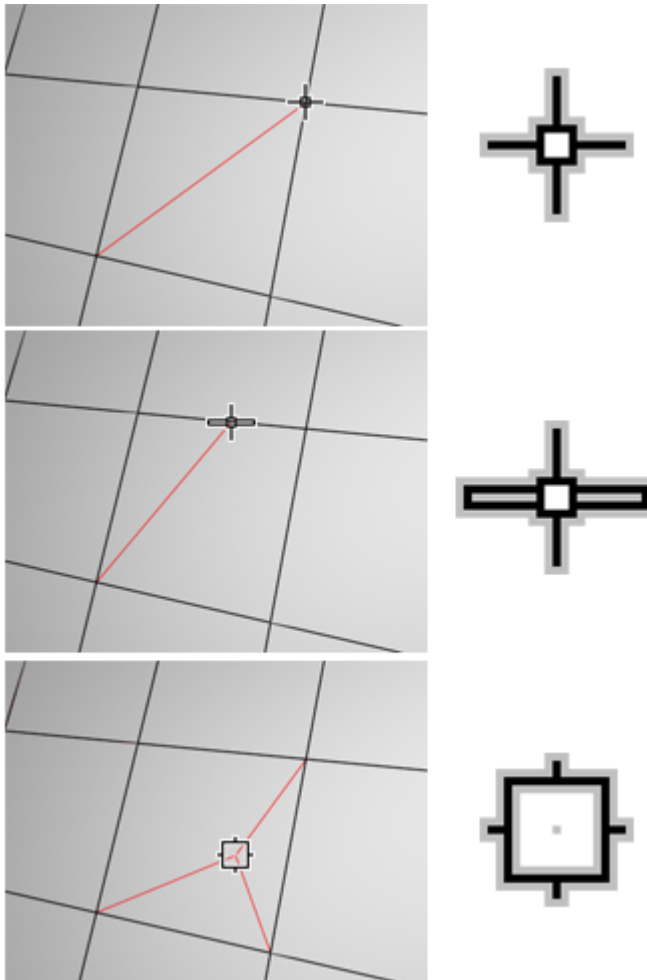

**Cutting to a vertex (top); cutting an edge (center); cutting a polygon (bottom).** Cut is available at the object level and all sub-object levels.

---

**NOTE** You can use Cut with Turn for enhanced productivity. For more information, see [this procedure](#) on page ? .

---

**MSmooth** Smooths the object using the current settings. This command uses subdivision functionality similar to that of the [MeshSmooth modifier](#) on page 1460 with NURMS Subdivision, but unlike NURMS Subdivision, it applies the smoothing instantly to the selected area of the control mesh.



**MSmooth Settings** Opens the [MeshSmooth Selection dialog](#) on page 2145 , which lets you specify how smoothing is applied.

**Tessellate** Subdivides all polygons in the object based on the [Tessellation settings](#) on page 2149 .

Tessellation is useful for increasing local mesh density while modeling. You can subdivide any selection of polygons. Two tessellation methods are available: Edge and Face.



**Tessellate Settings** Opens the [Tessellate Selection dialog](#) on page 2149 , which lets you specify how smoothing is applied.

**Make Planar** Forces all selected sub-objects to be coplanar. The plane's normal is the average surface normal of the selection.

At the Object level, forces *all* vertices in the object to become coplanar.

---

**TIP** One application for Make Planar is making a flat side on an object. Normally, you would use a contiguous selection set. If the selection includes vertices on various parts of the object, the vertices are still made planar, but with distorting effects on the rest of the geometry.

---

**X/Y/Z** Makes all selected sub-objects planar and aligns the plane with the corresponding plane in the object's local coordinate system. The plane used is the one to which the button axis is perpendicular; so, for example, clicking the X button aligns the object with the local YZ axis.

At the Object level, makes *all* vertices in the object planar.

**View Align** Aligns all vertices in the object to the plane of the active viewport. If a sub-object mode is active, this function affects only selected vertices or those belonging to selected sub-objects. In the case of orthographic viewports, using View Align has the same effect as aligning to the construction grid when the home grid is active. When aligning to a perspective viewport (including camera and light views), the vertices are reoriented to be aligned to a plane that is parallel to the camera's viewing plane. This plane is perpendicular to the view direction that is closest to the vertices' average position.

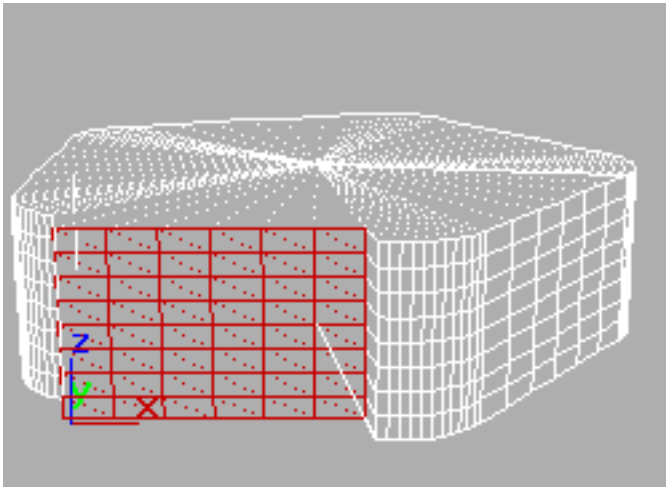
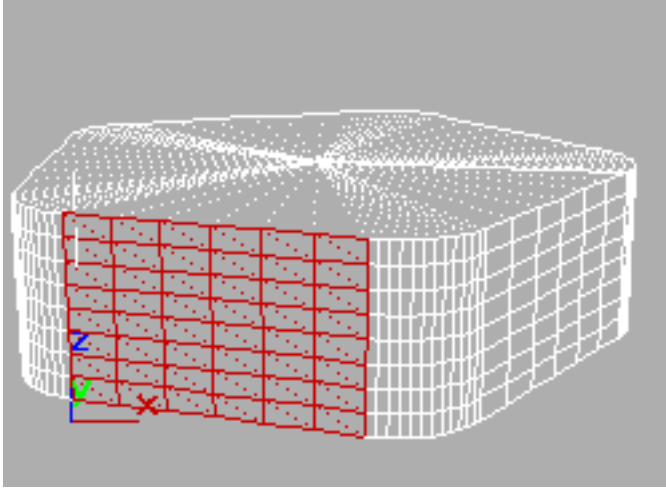

**Above: Selected polygons in Perspective view**

**Below: Same polygons aligned to Front view**

**Grid Align** Aligns all vertices in the selected object to the plane of the current view. If a sub-object mode is active, function aligns only selected sub-objects. This function aligns the selected vertices to the current construction plane. The current plane is specified by the active viewport in the case of the home grid. When using a grid object, the current plane is the active grid object.

**Relax** Applies the Relax function to the current selection, using the Relax dialog settings (see following). Relax normalizes mesh spacing by moving each

vertex toward the average location of its neighbors. It works the same way as the [Relax modifier](#) on page 1575 .

---

**NOTE** At the object level, Relax applies to the entire object. At any sub-object level, Relax applies only to the current selection.

---



**Relax Settings** Opens the [Relax dialog](#) on page 2148 , which lets you specify how the Relax function is applied.

**Hide Selected (Vertex, Polygon, and Element levels only)** Hides any selected sub-objects.

**Unhide All (Vertex, Polygon, and Element levels only)** Restores any hidden sub-objects to visibility.

**Hide Unselected (Vertex, Polygon, and Element levels only)** Hides any unselected sub-objects.

### **Named Selections (sub-object levels only)**

Lets you copy and paste named selection sets of sub-objects between objects. Start by creating one or more named selection sets, copy one, select a different object, go to the same sub-object level, and then paste the set.

---

**NOTE** This function uses sub-object IDs, so if the target object's geometry differs from that of the source object, the pasted selection will probably comprise a different set of sub-objects.

---

For more information, see [Named Selection Sets](#) on page 146 .

**Copy** Opens a dialog that lets you specify a named selection set to place into the copy buffer.

**Paste** Pastes the named selection from the copy buffer.

**Delete Isolated Vertices (Edge, Border, Polygon, and Element levels only)** When on, deletes isolated vertices when you delete a selection of contiguous sub-objects. When off, deleting sub-objects leaves all vertices intact. Default=on.

**Full Interactivity** Toggles the level of feedback for the QuickSlice and Cut tools, as well as all settings dialogs.

When on (the default), the final result is always visible as you use the mouse to manipulate the tool or change a numeric setting. With Cut and QuickSlice, when Full Interactivity is turned off, only the rubber-band line is visible until

you click. Similarly, with numeric settings in dialogs, the final result is visible only when you release the mouse button after changing the setting.

The state of Full Interactivity doesn't affect changing a numeric setting from the keyboard. Whether it's on or off, the setting takes effect only when you exit the field by pressing Tab or Enter, or by clicking a different control in the dialog.

## Subdivision Surface Rollout (Polymesh)

Create or select an editable poly object. > Modify panel > Subdivision Surface rollout

Applies subdivision to the object in the style of [MeshSmooth](#) on page 1460, so you can work on a lower-resolution "cage" mesh and simultaneously see a smoother, subdivided result. This rollout is available at all sub-object levels, as well as at the object level, and always affects the entire object.



## Interface

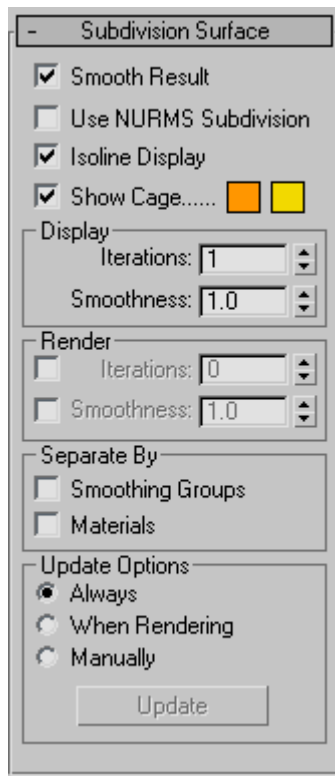

**Smooth Result** Applies the same smoothing group to all polygons.

**Use NURMS Subdivision** Applies smoothing via the NURMS method. See [NURMS](#) on page 1463 . The difference between NURMS in Editable Poly and MeshSmooth is that the latter gives you access to control vertices, but the former does not.

You control the degree of smoothing with the Iterations controls in the Display and Render groups.

---

**NOTE** The remaining controls on this rollout take effect only when Use NURMS Subdivision is on.

---

**Isoline Display** When on, the software displays only isolines: the object's original edges, before smoothing. The benefit of using this option is a less cluttered display. When off, the software displays all faces added by NURMS

Subdivision; thus, higher Iterations settings (see [Display group](#) on page 2121 ) result in a greater number of lines. Default=on.

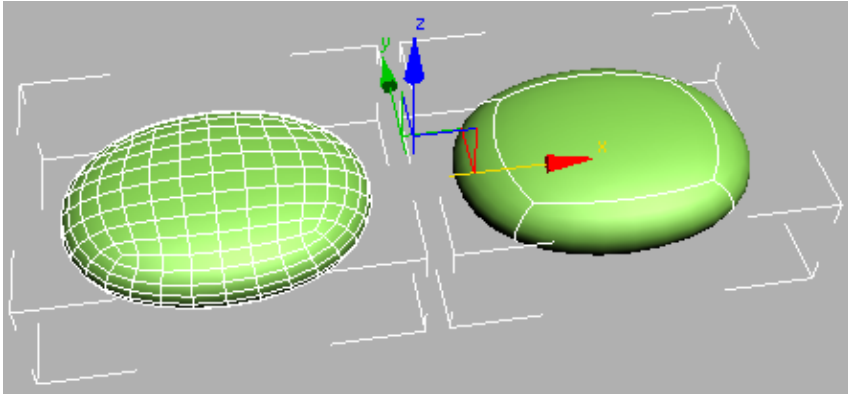

Smoothed box with Isoline Display off (left) and Isoline Display on (right).

---

**NOTE** Applying a modifier to an Editable Poly object cancels the effect of the Isoline Display option; the wireframe display reverts to showing all polygons in the object. This is not, however, always the case with the MeshSmooth modifier. Most deformation and mapping modifiers maintain the isoline display, but others, such as the selection modifiers (except Volume Select) and the Turn To ... modifiers, cause the interior edges to be displayed.

---

**Show Cage** Toggles the display of a two-color wireframe that shows the editable poly object before modification or subdivision. The cage colors are shown as swatches to the right of the check box. The first color represents unselected sub-objects, and the second color represents selected sub-objects. Change a color by clicking its swatch.

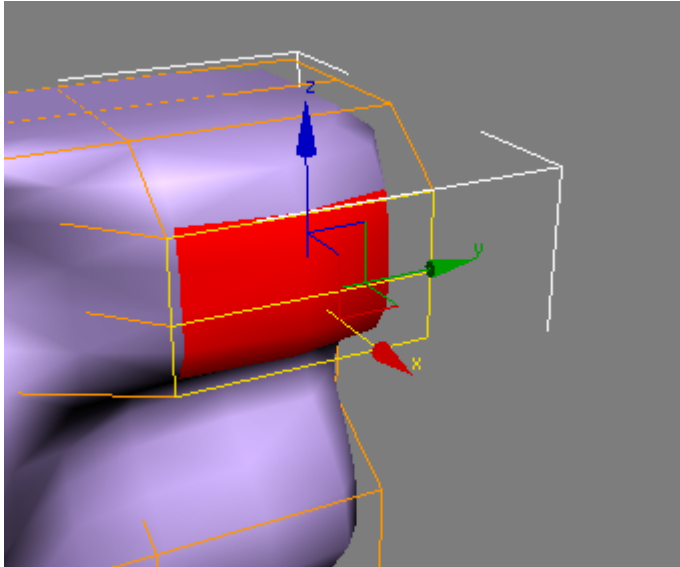

The cage displays the original structure of the edited object.

Typically this feature is used in conjunction with the NURMS Subdivision feature, or with the [MeshSmooth modifier](#) on page 1460 , because it lets you easily toggle visibility of the unsmoothed base object while simultaneously viewing the smoothed result, but it works with any modifier. When used with a modifier, turn on Show End Result to make Show Cage available.

---

**TIP** Show Cage is particularly helpful when used with the [Symmetry modifier](#) on page 1735 .

---

### Display group

**Iterations** Sets the number of iterations used to smooth the poly object. Each iteration generates all polygons using the vertices created from the previous iteration. Range=0 to 10.

When the Iterations check box in the Render group (see below) is off, this setting controls iterations both in the viewports and at render time. When the check box is on, this setting controls iterations only in the viewports.

---

**TIP** Use caution when increasing the number of iterations. The number of vertices and polygons in an object (and thus the calculation time) can increase as much as four times for each iteration. Applying four iterations to even a moderately complex object can take a long time to calculate. You can press Esc to stop calculation and revert to the previous iteration setting.

---

**Smoothness** Determines how sharp a corner must be before polygons are added to smooth it. A value of 0.0 prevents the creation of any polygons. A value of 1.0 adds polygons to all vertices even if they lie on a plane.

When the Smoothness check box in the Render group (see below) is off, this setting controls smoothness both in the viewports and at render time. When the check box is on, this setting controls smoothness only in the viewports.

### **Render group**

Applies a different number of smoothing iterations and/or a different Smoothness value to the object at render time.

---

**TIP** Use a low number of iterations and/or a lower Sharpness value for modeling, and higher values for rendering. This lets you work quickly with a low-resolution object in the viewports, while producing a smoother object for rendering.

---

**Iterations** Lets you choose a different number of smoothing iterations to be applied to the object at render time. Turn on Iterations, and then use the spinner to its right to set the number of iterations.

**Smoothness** Lets you choose a different Smoothness value to be applied to the object at render time. Turn on Smoothness, and then use the spinner to its right to set the smoothness value.

### **Separate By group**

**Smoothing Groups** Prevents the creation of new polygons at edges between faces that don't share at least one smoothing group.

**Materials** Prevents the creation of new polygons for edges between faces that do not share Material IDs.

### **Update Options group**

Sets manual or render-time update options, for situations where the complexity of the smoothed object is too high for automatic updates. Note that you can also choose Iterations under the Render group to set a greater degree of smoothing to be applied only at render time.

**Always** Updates the object automatically whenever you change any MeshSmooth settings.

**When Rendering** Updates the viewport display of the object only at render time.

**Manually** Turns on manual updating. When manual updating is selected, any settings you change don't take effect until you click the Update button.

**Update** Updates the object in the viewport to match the current MeshSmooth settings. Works only when you choose When Rendering or Manually.

## Subdivision Displacement Rollout (Polymesh)

Create or select an editable poly object. > Modify panel > Subdivision Displacement rollout

Specifies surface approximation settings for subdividing the editable poly. These controls work like the surface approximation settings for [NURBS](#) on page 2152 surfaces. They are used when you apply a [displacement map](#) on page 5391 to the editable poly.

---

**NOTE** These settings differ from the Subdivision Surface settings in that, while the latter are applied at the same modifier-stack level as the mesh, subdivision displacement is always applied at the top of the stack, when the mesh is used for rendering. Thus, a Symmetry modifier applied to an object using surface subdivision would affect the subdivided mesh, but would not affect an object that uses subdivision displacement only.

---

## Interface

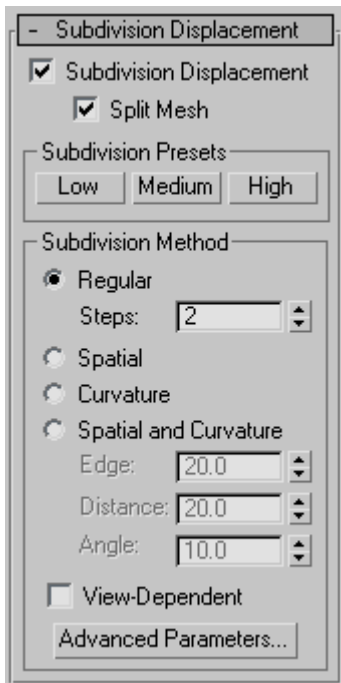

**Subdivision Displacement** When on, polygons are subdivided to accurately displace the poly object, using the method and settings you specify in the Subdivision Presets and Subdivision Method group boxes. When off, the poly is displaced by moving existing vertices, the way the [Displace modifier](#) on page 1274 does. Default=off.

**Split Mesh** Affects the seams of displaced poly objects; also affects texture mapping. When on, the poly object is split into individual polygons before it is displaced; this helps preserve texture mapping. When off, the poly is not split and an internal method is used to assign texture mapping. Default=on.

---

**TIP** This parameter is required because of an architectural limitation in the way displacement mapping works. Turning Split Mesh on is usually the better technique, but it can cause problems for objects with clearly distinct faces, such as boxes, or even spheres. A box's sides might separate as they displace outward, leaving gaps. And a sphere might split along its longitudinal edge (found in the rear for spheres created in the Top view) unless you turn off Split Mesh. However, texture mapping works unpredictably when Split Mesh is off, so you might need to add a [Displace Mesh modifier](#) on page 1045 and make a [snapshot](#) on page 921 of the poly. You would then apply a [UVW Map modifier](#) on page 1849 and then reassign mapping coordinates to the displaced snapshot poly.

---

### **Subdivision Presets group & Subdivision Method group**

The controls in these two group boxes specify how the program applies the displacement map when Subdivision Displacement is on. They are identical to the [Surface Approximation controls](#) on page 2469 used for NURBS surfaces.

## **Paint Deformation Rollout**

Edit/Editable Poly object > Paint Deformation rollout

Paint Deformation lets you push, pull, or otherwise affect vertices by dragging the mouse cursor over the object surface. At the object level, Paint Deformation affects all vertices in the selected object. At sub-object levels, it affects only selected vertices (or vertices that belong to selected sub-objects), and recognizes soft selection.

By default, deformation occurs in the [normal](#) on page 7863 direction of each vertex. 3ds Max continues to use a vertex's original normal for the direction of deformation, but you can opt to use the altered normal direction for a more dynamic modeling process, or even deform along a specific axis.

---

**NOTE** Paint Deformation cannot be animated.

---

---

**TIP** You can streamline the painting process by using the [Brush Presets tools](#) on page 7293 .

---

## Procedures

### To paint deformation onto a mesh object:

- 1 Apply an [Edit Poly modifier](#) on page 1293 to an object, or convert the object to [Editable Poly](#) on page 2038 format. Paint Deformation uses existing geometry, so the object should have enough mesh resolution for the desired deformation.
- 2 Do either of the following:
  - To deform anywhere on the object, remain at the object level, or work at a sub-object level with no sub-objects selected.
  - To deform only specific areas of an object, go to a sub-object level and then select the sub-objects in the area to deform.
- 3 On the Paint Deformation rollout, click Push/Pull.
- 4 Set Push/Pull value to a negative value to push into the object surface, or to a positive value to pull the surface outward. The higher the absolute value, the greater the effect.
- 5 Set Brush Size and Brush Strength.
- 6 Position the mouse cursor over the surface to be deformed.

As you move the mouse, the “brush” reorients dynamically to show the normal direction of the portion of the mesh currently under the cursor. You can use the normal direction of deformed surfaces as the push/pull direction by choosing Deformed Normals.
- 7 Press the mouse button and drag to deform the surface. If you paint in the same spot repeatedly without lifting the mouse button, the effect is cumulative up to the maximum Push/Pull Value setting.



## Interface

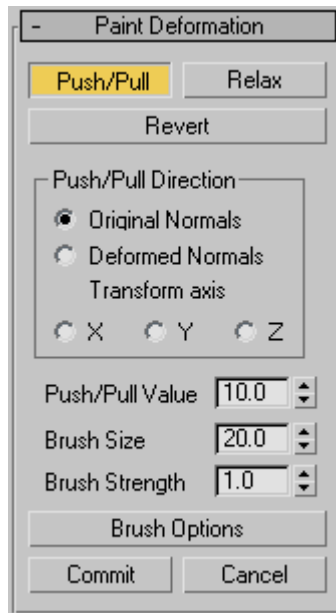

Paint Deformation has three modes of operation: Push/Pull, Relax, and Revert. Only one of these modes can be active at a time. The remaining settings control the effect of the active deformation mode.

For any mode, choose the mode, change settings as necessary, and then drag the cursor over the object to paint the deformation.

To paint deformation anywhere on the object, remain at the object level, or work at a sub-object level with no sub-objects selected. To deform only specific areas of an object, go to a sub-object level and select the sub-objects in the area to deform.

**Push/Pull** Moves vertices into the object surface (push) or out of the surface (pull). The direction and extent of pushing or pulling is determined by the Push/Pull Value setting.

---

**TIP** To reverse the Push/Pull direction while painting, press and hold Alt.

---

**NOTE** Push/Pull supports soft selection in that effective strength falls off with the selection value of soft-selected sub-objects.

---

**Relax** Normalizes the distances between vertices by moving each vertex to a position calculated from the average of its neighbors. Relax uses the same method as the [Relax modifier](#) on page 1575 .

Use Relax to push apart vertices that are too close together, or to pull together vertices that are too far apart.

**Revert** Lets you gradually “erase” or reverse the effects of Push/Pull or Relax by painting. Affects only vertices deformed since the most recent Commit operation. If no vertices qualify for reversion, the Revert button is unavailable.

---

**TIP** You can switch to Revert mode temporarily by pressing and holding the Ctrl key while painting deformation in Push/Pull or Relax mode.

---

### **Push/Pull Direction group**

This setting lets you specify whether pushing or pulling vertices occurs with respect to surface normals, original or deformed, or along a specific axis. Default=Original Normals.

Painting deformations with Original Normals typically moves vertices perpendicular to the original surface; using Deformed Normals tends to move vertices outward after their initial deformation, resulting in a “puffy” effect.

**Original Normals** When chosen, pushing or pulling a vertex moves it in the direction of its normal before deformation. Repeated applications of Paint Deformation always move each vertex in the same direction it moved originally.

**Deformed Normals** When chosen, pushing or pulling a vertex moves it in the current direction of the normal; that is, after deformation.

**Transform axis X/Y/Z** When chosen, pushing or pulling a vertex moves it along the specified axis, using the current [reference coordinate system](#) on page 896 .

**Push/Pull Value** Determines the direction and maximum extent of a single application of the push/pull operation. Positive values “pull” vertices out of the object surface, and negative values “push” vertices into the surface. Default =10.0.

A single application is defined as painting (that is, dragging once or more over the same area) without lifting the mouse button.

---

**TIP** You can use Alt to switch between pushing and pulling with the same value while painting. For example, if you're pulling with a value of 8.5, press and hold Alt to start pushing with a value of -8.5.

---

**Brush Size** Sets the radius of the circular brush. Only vertices inside the brush circle are deformed. Default=20.0.

---

**TIP** To change the brush radius interactively, release the mouse button, press and hold Shift+Ctrl+left mouse button, and then drag the mouse. This also works with all other painter-interface features in 3ds Max such as Skin > Paint Weights and VertexPaint.

---

**Brush Strength** Sets the rate at which the brush applies the Push/Pull value. A low Strength value applies the effect more slowly than a high value. Range=0.0 to 1.0. Default=1.0.

---

**TIP** To change the brush strength interactively, release the mouse button, press and hold Shift+Alt+left mouse button, and then drag the mouse. This also works with all other painter-interface features in 3ds Max such as Skin > Paint Weights and VertexPaint.

---

**Brush Options** Click this button to open the [Painter Options dialog](#) on page 1907 , where you can set various brush-related parameters.

**Commit** Makes any deformation changes permanent, “baking” them into the object geometry. After using Commit, you can no longer apply Revert to changes up to that point.

**Cancel** Eliminates all changes since the initial application of Paint Deformation or the most recent Commit operation.

## Editable Poly Settings Dialogs

### Bevel Polygons Dialog

Select an Edit Poly or editable poly object. > Modify panel > Polygon sub-object level > Edit Polygons rollout > Bevel Settings button

Select an Edit Poly or editable poly object. > Polygon sub-object level > Quad menu > tools 2 quadrant > Bevel Settings button

Beveling involves first extruding and then scaling the extruded polygon(s). Use these settings for beveling polygons in Interactive Manipulation mode.

## Interface

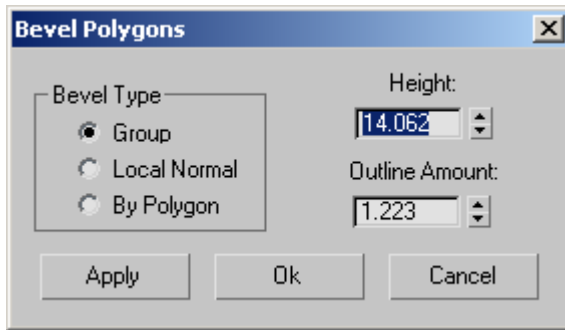

### Bevel Type group

**Group** Beveling takes place along the average normal of each contiguous group of polygons. If you bevel multiples of such groups, each group moves along its own averaged normal.

**Local Normal** Beveling takes place along each selected polygon's normal.

**By Polygon** Bevels each polygon individually.

**Height** Specifies the extent of the extrusion in scene units. You can extrude selected polygons outward or inward, depending on whether the value is positive or negative.

**Outline Amount** Makes the outer border of selected polygons bigger or smaller, depending on whether the value is positive or negative.

**Apply** Applies the settings to the current selection, retaining them if you then make another selection.

**OK** Applies the settings to the current selection and closes the dialog.

**Cancel** Closes the dialog without applying the settings to the current selection. Does not reverse previous uses of Apply.

## Bridge Borders/Polygons Dialog

Select an Edit Poly or editable poly object. > Modify panel > Polygon or Border sub-object level > Edit Polygons rollout > Bridge Settings button

Select an Edit Poly or editable poly object. > Polygon or Border sub-object level > Quad menu > tools 2 quadrant > Bridge Settings button

Use these settings for bridging pairs of polygons, polygon selections, or borders in Interactive Manipulation mode.

---

**NOTE** Bridge calculates which way the bridge polygons should face. If you bridge two sub-objects so that the bridge goes through the object, the bridge polygons face inward. But if you create a bridge that goes through empty space, such as when connecting sub-objects between two elements, the polygons face outward. To make the bridge polygons face differently, use the Flip function.

---

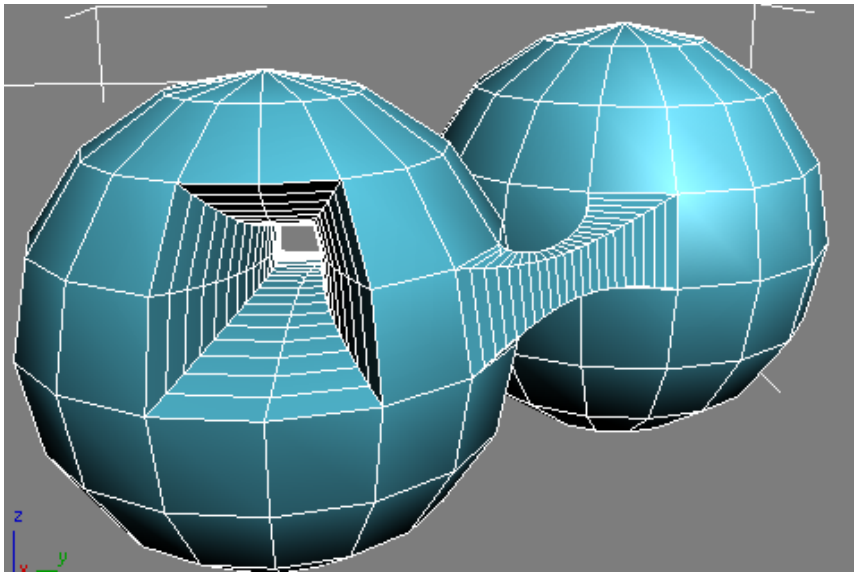

Examples of an internal bridge (left) and an external bridge (right), the latter connecting two elements

---

**NOTE** Bridging two elements makes them contiguous, combining them into a single element.

---

## Interface

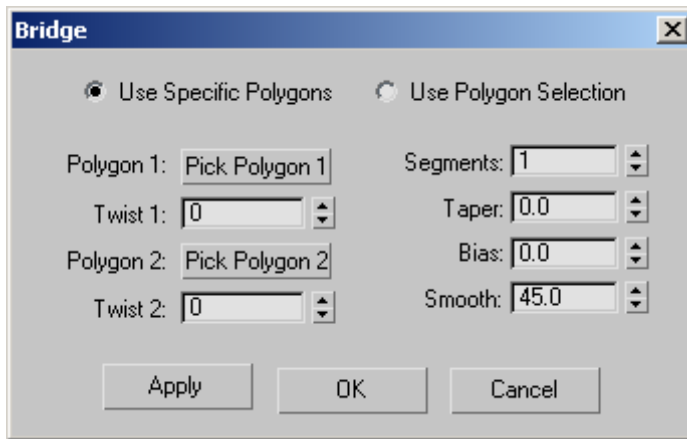

Bridge lets you use existing poly/border selections, or pick them from the dialog. Choose one of the following:

**Use Specific Polygons/Borders** In this mode, use the Pick buttons to designate polygons or borders for bridging.

**Use Polygon/Border Selection** If one or more qualifying selection pairs exist, choosing this option connects them immediately. If not, you can select pairs of sub-objects in a viewport to connect them.

If you make more than two qualifying selections, Bridge connects them in increasing order of ID. For example, if you select polygon 12, 35, and 89, Bridge connects polygons 12 and 35. But if you then deselect polygon 35, Bridge then connects polygons 12 and 89.

**Polygon/Edge 1/2** Click each Pick button in turn, and then click a polygon or border edge in a viewport. At the Border sub-object level, clicking any edge on a border designates the entire border for bridging. Also, the edges you pick on each border are connected directly, and the remaining edges are connected in consecutive order. You can change the order of the edge correspondences with the Twist settings. Available only in Use Specific mode.

After clicking a sub-object, the Pick button shows its ID number. You can change the selection at any time by clicking a Pick button and picking a different sub-object.

**Twist 1/2** Rotates the order of connection between the edges of the two selections. The two controls let you set a different twist amount for each end of the bridge.

**Segments** Specifies the number of polygons along the length of the bridge connection. This setting also applies to manually bridged polygons.

---

**TIP** When using Taper, set Segments to a value greater than 1.

---

**Taper** Sets the extent to which the bridge width becomes smaller or larger toward its center. Negative settings taper the bridge center smaller; positive settings taper it larger.

---

**NOTE** To change the location of maximum taper, use the Bias setting.

---

**Bias** Determines the location of maximum taper amount.

The range of the Bias value is -99.0 to 99.0. At the default value of 0.0, the taper amount is greatest at the center of the bridge. At -99.0, the taper amount is greatest near the first selected polygon or border; at 99.0, it's greatest near the second selected polygon or border.

**Smooth** Determines the maximum angle between columns across which smoothing can occur. A column is a string of polygons extending along the length of the bridge.

**Apply** Applies the settings to the current selection, retaining them if you then make another selection.

**OK** Applies the settings to the current selection and closes the dialog.

**Cancel** Closes the dialog without applying the settings to the current selection. Does not reverse previous uses of Apply.

## Bridge Edges Dialog

Select an Edit Poly or editable poly object. > Modify panel > Polygon or Border sub-object level > Edit Polygons rollout > Bridge Settings button

Select an Edit Poly or editable poly object. > Polygon or Border sub-object level > Quad menu > tools 2 quadrant > Bridge Settings button

Use these settings for bridging pairs of edges in Interactive Manipulation mode.

---

**NOTE** Bridge calculates which way the bridge polygons should face. If you bridge two edges so that the bridge goes through the object, the bridge polygons face inward. But if you create a bridge that goes through empty space, such as when connecting edges between two elements, the polygons face outward, in general. To make the bridge polygons face differently, use the Flip function.

---

---

**NOTE** Bridging edges of two elements makes them contiguous, combining them into a single element.

---

## Interface

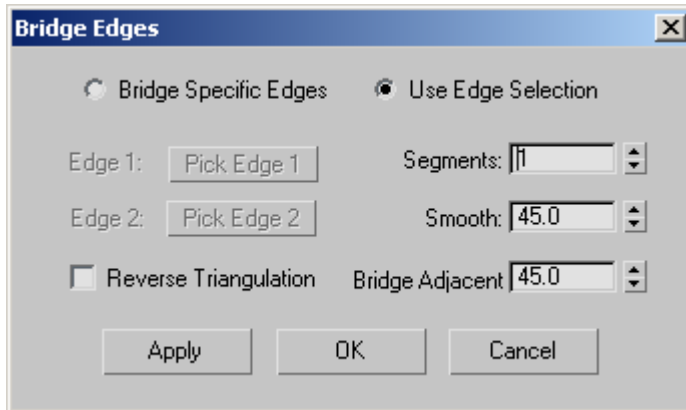

Bridge lets you use existing edge selections, or pick them from the dialog. Choose one of the following:

**Bridge Specific Edges** In this mode, use the Pick buttons to designate polygons or borders for bridging.

**Use Edge Selection** If one or more qualifying selection pairs exist, choosing this option connects them immediately. If not, you can select pairs of sub-objects in a viewport to connect them.

**Edge 1/Edge 2** Click each Pick button in turn, and then click a border edge in a viewport. Available only in Bridge Specific Edges mode.

After clicking an edge, the Pick button shows its ID number. You can change the selection at any time by clicking a Pick button and picking a different sub-object.

**Segments** Specifies the number of polygons along the length of the bridge connection. This setting also applies to manually bridged edges.

**Smooth** Specifies the maximum angle between columns across which smoothing can occur. A column is a string of polygons extending along the length of the bridge.

**Reverse Triangulation** When bridging two edge selections each of which contains different numbers of edges, two ways of triangulating the bridge polygons are possible. This check box lets you toggle between them.



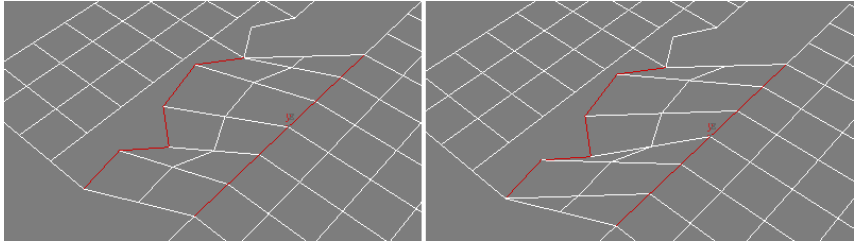

**Left:** Reverse Triangulation on

**Right:** Reverse Triangulation off

**Bridge Adjacent** Specifies the minimum angle between adjacent edges across which bridging can occur. Edges less than this angle will not be bridged, and instead will be skipped.

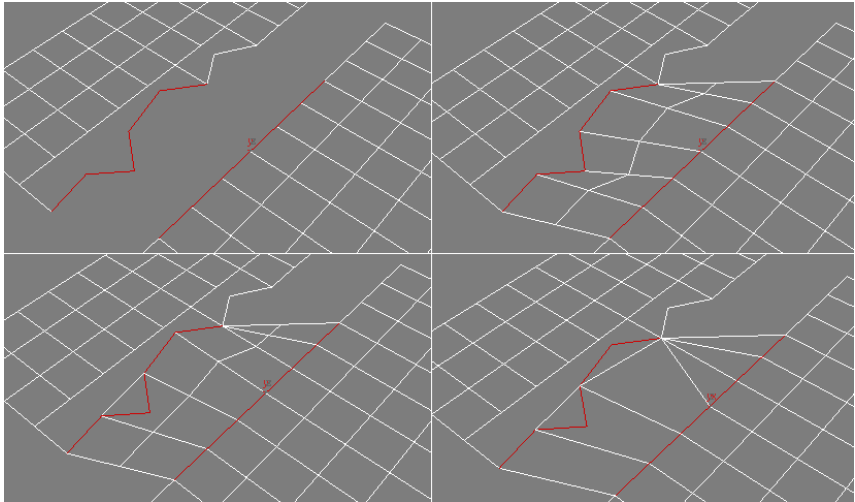

**Top Left:** Edge selections before bridging

**Top Right:** Segments=2, Bridge Adjacent<83.0

**Bottom Left:** Bridge Adjacent=83.0

**Bottom Right:** Bridge Adjacent=126.5

---

**NOTE** The above illustration shows, among other things, how setting Bridge Adjacent too high can cause overlapping polygons (left side of the two bottom images), which is undesirable.

---

**Apply** Applies the settings to the current selection, retaining them if you then make another selection.

**OK** Applies the settings to the current selection and closes the dialog.

**Cancel** Closes the dialog without applying the settings to the current selection. Does not reverse previous uses of Apply.

## Chamfer Vertices/Edges/Borders Dialog

Select an Edit Poly or editable poly object. > Modify panel > Vertex/Edge/Border sub-object level > Edit Vertices/Edges/Borders rollout > Chamfer Settings button

Select an Edit Poly or editable poly object. > Vertex/Edge/Border sub-object level > Quad menu > tools 2 quadrant > Chamfer Settings button

Chamfering creates new faces around the chamfered entity, along with connecting edges. Or, with the Open option, you can create an open (empty) area instead. This dialog is the same for chamfering vertices, edges, and borders of poly objects. You can use it to set the chamfer amount numerically, and to toggle the Open option.

### Interface

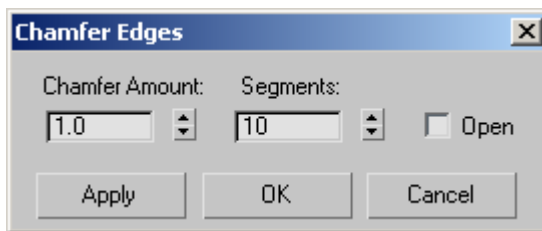

**Chamfer Amount** The extent of the chamfer. Default=1.0.

**Segments** (edges only) Adds edges and polygons over the area of the chamfer, and, with single chamfered edges, rounds off the chamfer. By default, the chamfer uses a single segment, which covers the chamfered area with a new polygon positioned diagonally with respect to the original corner. The higher the Segments value you use, the more the chamfer is rounded off.

If you chamfer two or more adjacent, open edges at a time, the rounding off takes place only at open ends of the edges. No rounding takes place where the edges meet.

**Open** When on, the chamfered area is deleted, leaving open space.  
Default=off.

This setting stays active during the current session. If you turn on Open and then later chamfer sub-objects interactively, the Open option remains in effect.

## Connect Edges Dialog

Select an Edit Poly or editable poly object. > Modify panel > Edge sub-object level > Edit Edges rollout > Connect Settings button

Select an Edit Poly or editable poly object. > Edge sub-object level > Quad menu > tools 2 quadrant > Connect Settings button

Connecting edges creates new edges between adjacent pairs of selected edges. The Connect Edges dialog settings let you specify the number of new edges, the amount of separation from each other, and their general location.

---

**TIP** Connecting edges, and in particular the Slide function, work best with [ring selections](#) on page 2048 .

---

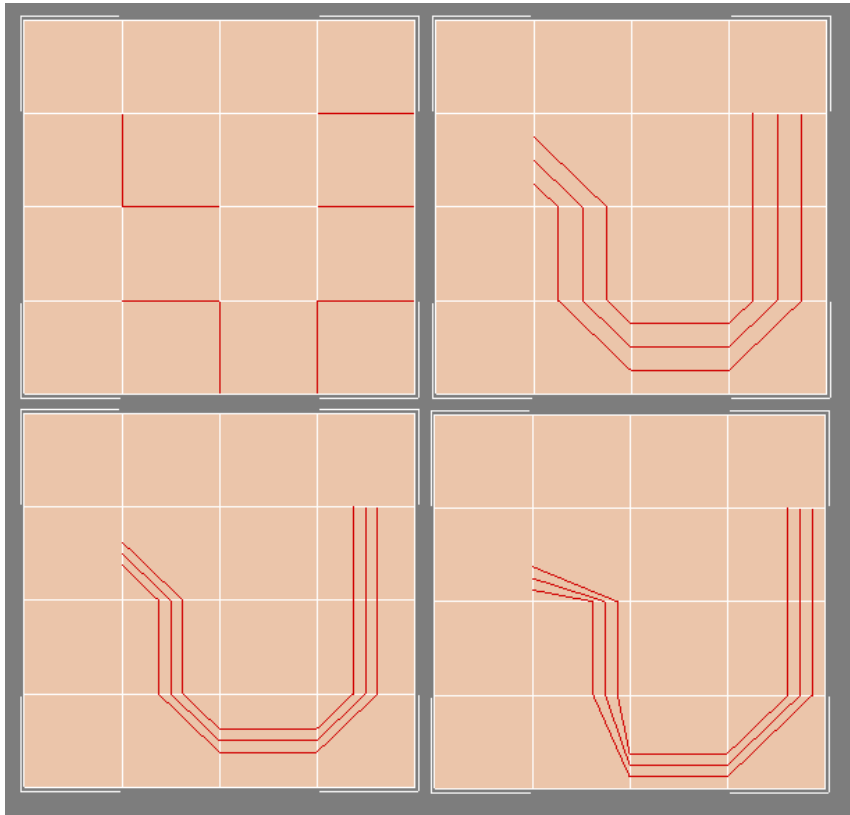

**Top left: Original edge selection**

**Top right: Segments=3, Pinch=Slide=0**

**Bottom left: Segments=3, Pinch=-50, Slide=0**

**Bottom right: Segments=3, Pinch=-50, Slide=-200**

## Interface

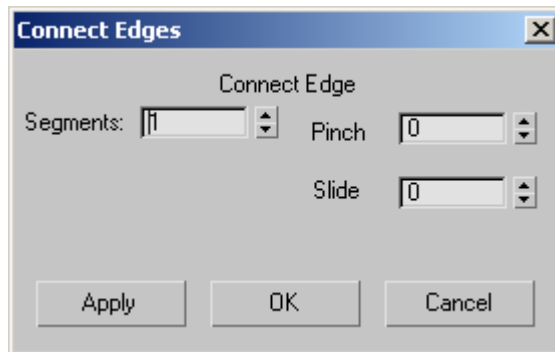

**Segments** The number of new edges between each adjacent pair of selected edges. Default=1.

**Pinch** The relative spacing between the new, connecting edges. Negative values move the edges closer together; positive values move them farther apart. Default=0.

If Segments=1, the Pinch setting has no effect.

**Slide** The relative positioning of the new edges. Default=0.

By default, the new edges are centered. Positive values move them in one direction, while negative values move them in the opposite direction. The new edges cannot move beyond existing edges.

## Extrude Polygons Along Spline Dialog

Select an Edit Poly or editable poly object. > Modify panel > Polygon sub-object level > Edit Polygons rollout > Extrude Along Spline Settings button

Select an Edit Poly or editable poly object. > Polygon sub-object level > Quad menu > tools 2 quadrant > Extrude Along Spline Settings button

Use these settings for extruding polygons along splines in Interactive Manipulation mode.

## Interface

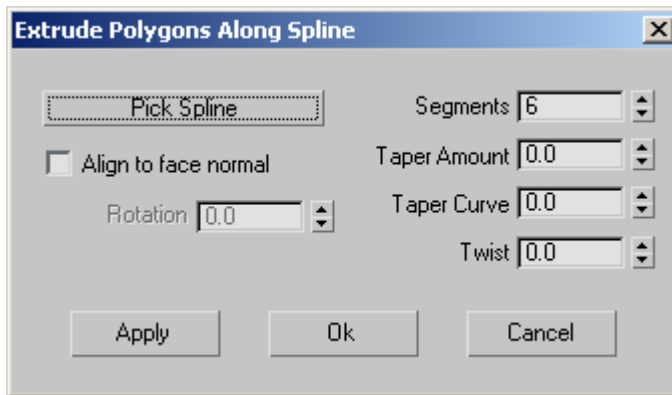

**Pick Spline** Click this button and then select a spline along which to extrude in the viewport. The spline object's name then appears on the button.

If you open this dialog after performing a manual Extrude Along Spline, the name of the spline you used appears on the button.

**Align to face normal** Aligns the extrusion with the face normal, which, in most cases, makes it perpendicular to the extruded polygon(s). When turned off (the default), the extrusion is oriented the same as the spline.

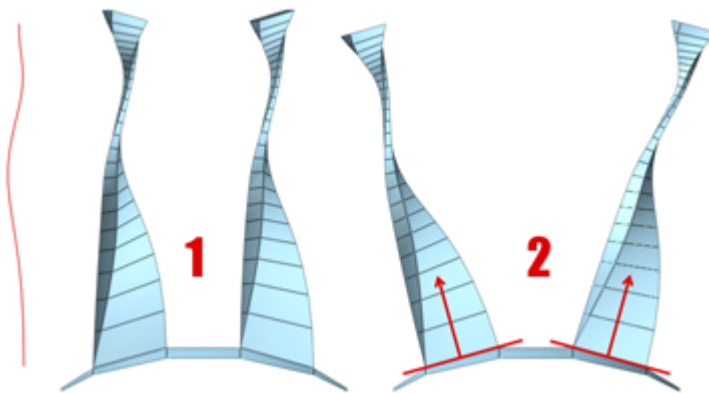

With **Align To Face Normal**, the extrusion does not follow the original orientation of the spline (1); it's reoriented to match the face normals (2), or averaged normals for contiguous selections. The **Rotation** option is available only when **Align To Face Normal** is on.

**Rotation** Sets the rotation of the extrusion. Available only when Align To Face Normal is on. Default=0. Range=-360 to 360.

**Segments** Specifies the number of polygons into which each extruded side is subdivided. This setting also applies to manually extruded polygons.

**Taper Amount** Sets the extent to which the extrusion becomes smaller or larger along its length. Negative settings taper the extrusion smaller; positive settings taper it larger.

**Taper Curve** Sets the rate at which the tapering proceeds. Lower settings result in a more gradual taper; large settings result in a more abrupt taper.

Taper Curve affects the thickness of the extrusion between its endpoints, but not the size of the ends.

**Twist** Applies a twist along the length of the extrusion.

When using this option, increasing the number of segments will improve the smoothness of the extrusion.

**Apply** Applies the settings to the current selection, retaining them if you then make another selection.

**OK** Applies the settings to the current selection and closes the dialog.

**Cancel** Closes the dialog without applying the settings to the current selection. Does not reverse previous uses of Apply.

## Extrude Polygons Dialog

Select an Edit Poly or editable poly object. > Modify panel > Polygon sub-object level > Edit Polygons rollout > Extrude Settings button

Select an Edit Poly or editable poly object. > Polygon sub-object level > Quad menu > tools 2 quadrant > Extrude Settings button

Use these settings for extruding polygons in Interactive Manipulation mode.

## Interface

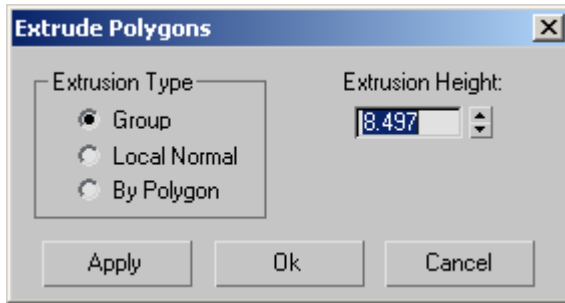

### Extrusion Type group

**Group** Extrusion takes place along the average normal of each contiguous group of polygons. If you extrude multiples of such groups, each group moves along its own averaged normal.

**Local Normal** Extrusion takes place along each selected polygon's normal.

**By Polygon** Extrudes or bevels each polygon individually.

**Extrusion Height** Specifies the amount of the extrusion in scene units. You can extrude selected polygons outward or inward, depending on whether the value is positive or negative.

**Apply** Applies the settings to the current selection, retaining them if you then make another selection.

**OK** Applies the settings to the current selection and closes the dialog.

**Cancel** Closes the dialog without applying the settings to the current selection. Does not reverse previous uses of Apply.

## Extrude Vertices/Edges Dialog

Select an Edit Poly or editable poly object. > Modify panel > Vertex/Edge/Border sub-object level > Edit Vertices/Edges/Borders rollout > Extrude Settings button

Select an Edit Poly or editable poly object. > Vertex/Edge/Border sub-object level > Quad menu > tools 2 quadrant > Extrude Settings button

Use this dialog for extruding vertices, edges, and borders in Interactive Manipulation mode.



---

**NOTE** At the Border sub-object level, this dialog is named Extrude Edges.

---

## Interface

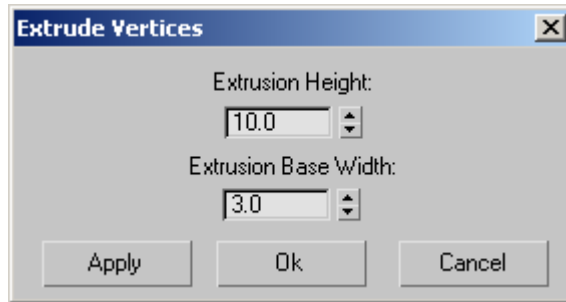

**Extrusion Height** Specifies the amount of the extrusion in scene units.

You can extrude sub-objects outward or inward, depending on whether the value is positive or negative.

**Extrusion Base Width** Specifies the size of the extrusion base in scene units.

You can set this as high as you want, but the actual size cannot extend beyond the vertices adjacent to the extruded sub-object(s).

**Apply** Applies the settings to the current selection, retaining them if you then make another selection.

**OK** Applies the settings to the current selection and closes the dialog.

**Cancel** Closes the dialog without applying the settings to the current selection. Does not reverse previous uses of Apply.

## Hinge Polygons From Edge Dialog

Select an Edit Poly or editable poly object. > Modify panel > Polygon sub-object level > Edit Polygons rollout > Hinge From Edge Settings button

Select an Edit Poly or editable poly object. > Polygon sub-object level > Quad menu > tools 2 quadrant > Hinge From Edge Settings button

Use these settings for hinging polygons in Interactive Manipulation mode.

## Interface

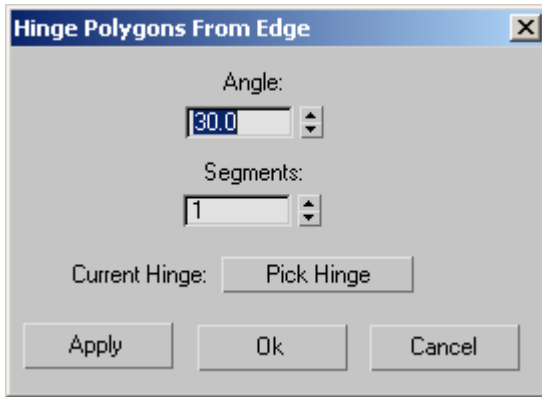

**Angle** Quantifies the rotation about the hinge. You can hinge selected polygons outward or inward, depending on whether the value is positive or negative.

**Segments** Specifies the number of polygons into which each extruded side is subdivided. This setting also applies to manually hinged polygons.

**Current Hinge** Click Pick Hinge, and then click an edge to be the hinge. After you designate a hinge, the “Pick Hinge” button text is replaced with “Edge #” where # is the ID number of the hinge edge.

All subsequent hinge operations created via the dialog will use this hinge. To hinge multiple polygons, each from one of its own sides, you must reselect the hinge each time.

**Apply** Applies the settings to the current selection, retaining them if you then make another selection.

**OK** Applies the settings to the current selection and closes the dialog.

**Cancel** Closes the dialog without applying the settings to the current selection. Does not reverse previous uses of Apply.

## Inset Polygons Dialog

Select an Edit Poly or editable poly object. > Modify panel > Polygon sub-object level > Edit Polygons rollout > Inset Settings button

Select an Edit Poly or editable poly object. > Polygon sub-object level > Quad menu > tools 2 quadrant > Inset Settings button

Use these settings for insetting polygons in Interactive Manipulation mode.

## Interface

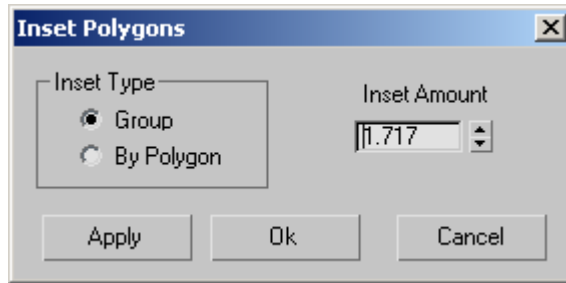

### Inset Type group

This setting affects how Inset works with selections of more than one polygon.

**Group** The inset takes place across multiple, contiguous polygons.

**By Polygon** Insets each polygon individually.

**Inset Amount** Specifies the amount of the inset in scene units.

**Apply** Applies the settings to the current selection, retaining them if you then make another selection.

**OK** Applies the settings to the current selection and closes the dialog.

**Cancel** Closes the dialog without applying the settings to the current selection. Does not reverse previous uses of Apply.

## MeshSmooth Selection Dialog

Select an Edit Poly or editable poly object. > Modify panel > Polygon sub-object level > Edit Geometry rollout > MSmooth Settings button

This dialog lets you specify how mesh smoothing affects editable poly and Edit Poly objects.

## Interface

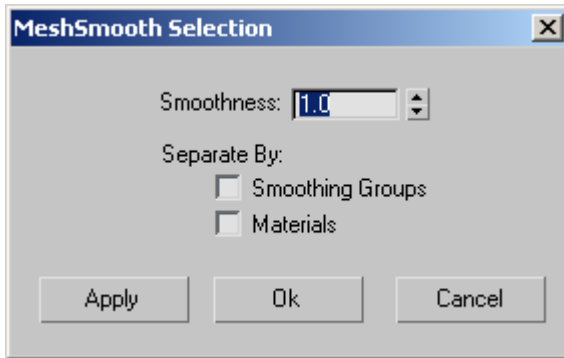

**Smoothness** Determines how sharp a corner must be before polygons are added to smooth it. Smoothness is calculated as the average angle of all edges connected to a vertex. A value of 0.0 prevents the creation of any polygons. A value of 1.0 adds polygons to all vertices even if they lie on a plane.

**Separate by Smoothing Groups** Prevents the creation of new polygons at edges between polygons that don't share at least one smoothing group.

**Separate by Materials** Prevents the creation of new polygons for edges between polygons that do not share Material IDs.

**Apply** Applies the settings to the current selection, retaining them if you then make another selection.

**OK** Applies the settings to the current selection and closes the dialog.

**Cancel** Closes the dialog without applying the settings to the current selection. Does not reverse previous uses of Apply.

## Preserve Map Channels Dialog

Select an Edit Poly or editable poly object. > Modify panel > any sub-object level > Edit Geometry rollout > Preserve UVs button

Use these settings for specifying which map channels to preserve when editing sub-objects with the Preserve UVs option on. A preserved map channel doesn't respond to minor editing that changes vertex locations, but a channel whose UVs aren't preserved allows mapping to be changed by changes in vertex locations.

## Interface

The dialog contains buttons for all available, data-containing vertex color channels and texture channels. The number and type of buttons displayed vary depending on the state of the object; they can be changed, for example, with the [VertexPaint modifier](#) on page 1876 and the [Channel Info utility](#) on page 5858 .

Click a button to toggle its state. When off, a button is gray and appears higher than the dialog surface. When on, a button is orange and appears pressed in.

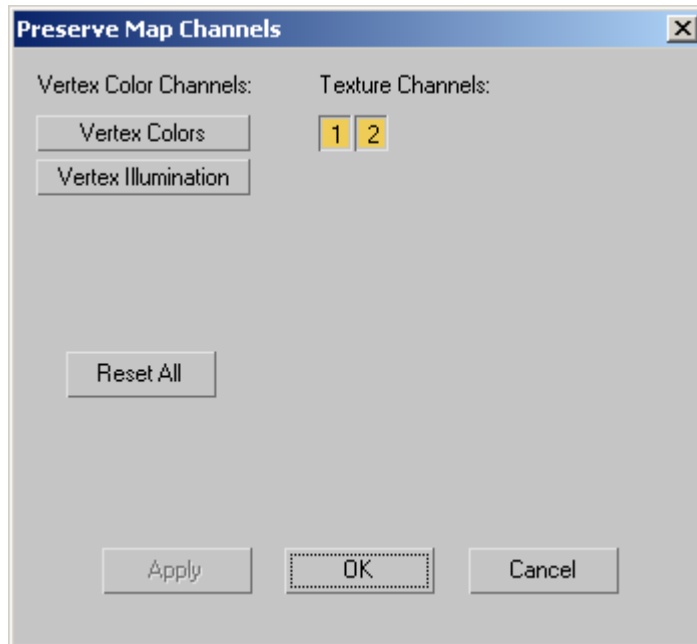

**Vertex Color Channels** Displays buttons for any vertex-color channels that contain data. These can be Vertex Colors, Vertex Illumination, and Vertex Alpha. By default, all vertex-color buttons are off, so that associated UVs *are* affected by sub-object editing. To prevent a channel from being affected by sub-object editing, click its button.

**Texture Channels** Displays buttons for any texture (mapping) channels that contain data. These are identified by number. By default these are on, so that associated UVs *are not* affected by sub-object editing. To allow a channel to be affected by sub-object editing, click its button.

**Reset All** Returns all channel buttons to their default states: all vertex color channels off, all texture channels on.

**Apply** Applies the settings to the current selection, retaining them if you then make another selection.

**OK** Applies the settings to the current selection and closes the dialog.

**Cancel** Closes the dialog without applying the settings to the current selection. Does not reverse previous uses of Apply.

## Relax Dialog

Select an Edit Poly or editable poly object. > Modify panel > object level or any sub-object level > Edit Polygons rollout > Relax Settings button

Select an Edit Poly or editable poly object. > object level or any sub-object level > Quad menu > tools 2 quadrant > Relax Settings button

Use these settings for relaxing vertices in Interactive Manipulation mode. Relax in Edit/Editable Poly works much like the [Relax modifier](#) on page 1575 : It normalizes the distance between each affected vertex and its neighbors by moving the vertex toward the average position of its neighbors.

---

**NOTE** At the object level, Relax applies to the entire object. At any sub-object level, Relax applies to selected sub-objects only.

---

### Interface

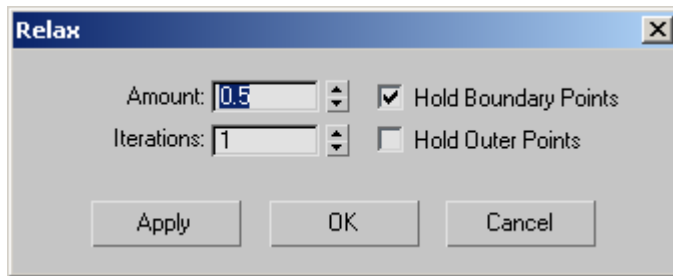

**Amount** Controls how far a vertex moves for each iteration. The value specifies a percentage of the distance from the original location of a vertex to the average location of its neighbors. Range=-1.0 to 1.0. Default=0.5.

**Iterations** Sets how many times to repeat the Relax process. For each iteration, average locations are recalculated and the Relax Value is reapplied to every vertex. Default=1.

**Hold Boundary Points** Controls whether vertices at the edges of open meshes are moved. Default=on.

When on, boundary vertices do not move while the rest of the object is relaxed. This option is particularly useful when working with multiple elements within a single object that share open edges.

When this check box is off, all vertices of the object are relaxed.

**Hold Outer Points** When on, preserves the original positions of vertices farthest away from the object center.

**Apply** Applies the settings to the current selection, retaining them if you then make another selection.

**OK** Applies the settings to the current selection and closes the dialog.

**Cancel** Closes the dialog without applying the settings to the current selection. Cancel does not reverse previous uses of Apply.

## Tessellate Selection Dialog

Select an Edit Poly or editable poly object. > Modify panel > Polygon sub-object level > Edit Polygons rollout > Tessellate Settings button

This dialog lets you specify how Tessellate should subdivide polygons.

### Interface

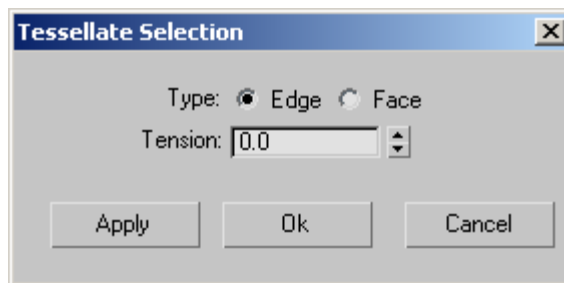

**Edge** Inserts vertices in the middle of each edge and draws lines connecting those vertices. The number of polygons created will equal the number of sides of the original polygon.

**Face** Adds a vertex to the center of each polygon and draws connecting lines from that vertex to the original vertices. The number of polygons created will equal the number of sides of the original polygon.

**Tension** Lets you increase or decrease the Edge tension value. Available only when Type: Edge is active.

A negative value pulls vertices inward from their plane, resulting in a concave effect. A positive value pulls vertices outward from their plane, resulting in a rounding effect.

**Apply** Applies the settings to the current selection, retaining them if you then make another selection.

**OK** Applies the settings to the current selection and closes the dialog.

**Cancel** Closes the dialog without applying the settings to the current selection. Does not reverse previous uses of Apply.

## **Weld Vertices/Edges Dialog**

Select an Edit Poly or editable poly object. > Modify panel > Vertex or Edge sub-object level > Edit Vertices/Edges rollout > Weld Settings button

Select an Edit Poly or editable poly object. > Vertex or Edge sub-object level > Quad menu > tools 2 quadrant > Weld Settings button

Use this dialog for setting the weld threshold for vertices and edges.



## Interface

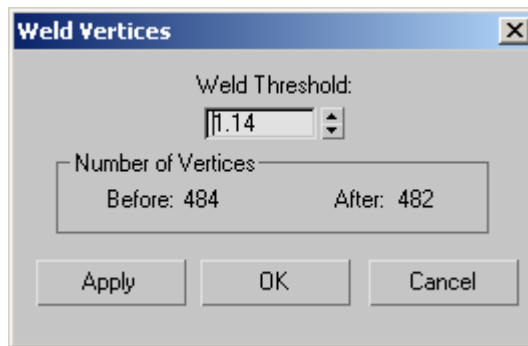

**Weld Threshold** Specifies the maximum distance, in scene units, within which selected sub-objects will be welded.

Any vertex or edge that lies outside this threshold (that is, it's farther than this from the nearest vertex or edge) will not be welded.

**Number of Vertices** Shows the number of vertices before and after the weld.

The After quantity updates dynamically as you change the setting with the spinner.

**Apply** Applies the settings to the current selection, retaining them if you then make another selection.

**OK** Applies the settings to the current selection and closes the dialog.

**Cancel** Closes the dialog without applying the settings to the current selection. Does not reverse previous uses of Apply.

# NURBS Modeling



**Fountain created as a NURBS model**

3ds Max provides NURBS surfaces and curves. NURBS stands for *Non-Uniform Rational B-Splines*. NURBS have become an industry standard for designing and modeling surfaces. They are especially suited for modeling surfaces with complicated curves. The tools for modeling with NURBS do not require an understanding of the mathematics that produces these objects. NURBS are popular because they are easy to manipulate interactively, and because the algorithms that create them are both efficient and numerically stable.

You can also model surfaces using polygonal meshes or patches. Compared to NURBS surfaces, meshes and patches have these shortcomings:

- Using polygons can make it more difficult to create complicated curved surfaces.
- Because meshes are faceted, facets appear at the edge of rendered objects. You must have a large number of small faces to render a smoothly curved edge.

NURBS surfaces, on the other hand, are analytically generated. They are more efficient to calculate, and you can render a NURBS surface that appears to be seamless. (A rendered NURBS surface is actually approximated by polygons, but the NURBS approximation can be very fine grained.)

[NURBS Models: Objects and Sub-Objects](#) on page 2153

[NURBS and Modifiers](#) on page 2172

[NURBS and Animation](#) on page 2175

[NURBS Concepts](#) on page 2176

## NURBS Models: Objects and Sub-Objects

Like [Shape](#) on page 536 objects, a NURBS model can be an assemblage of multiple NURBS sub-objects. For example, a NURBS object might contain two surfaces that are separate in space. NURBS curves and NURBS surfaces are controlled by either point or control vertex (CV) sub-objects. Points and CVs behave somewhat like the vertices of spline objects, but there are differences.

The parent object in a NURBS model is either a NURBS surface or a NURBS curve. Sub-objects can be any of the objects listed here. A NURBS curve remains a Shape object unless you add a surface sub-object to it when you convert it to a NURBS surface (without changing its name).

**Surfaces** There are two kinds of NURBS surfaces. A [point surface](#) on page 2192 is controlled by points, which always lie on the surface. A [CV surface](#) on page 2195 is controlled by control vertices (CVs). Instead of lying on the surface, CVs form a [control lattice](#) on page 7745 that surrounds the surface. (This is similar to the lattice used by the FFD [free-form deformation] modifiers.)

See [Creating Surface Sub-Objects](#) on page 2337 and [Editing Surface Sub-Objects](#) on page 2264 .

**Curves** There are also two kinds of NURBS curves. These correspond exactly to the two kinds of surfaces. A [point curve](#) on page 2201 is controlled by points, which always lie on the curve. A [CV curve](#) on page 2208 is controlled by CVs, which don't necessarily lie on the curve.

See [Creating Surface Sub-Objects](#) on page 2337 and [Editing Curve Sub-Objects](#) on page 2252 .

**Points** Point surfaces and point curves have [point](#) on page 2429 sub-objects. You can also create separate point sub-objects that are not part of a surface or a curve.

See [Creating and Editing Point Sub-Objects](#) on page 2428 .

**CVs** CV surfaces and CV curves have CV sub-objects. Unlike points, CVs are always part of a surface or a curve.

See [Editing Curve CV Sub-Objects](#) on page 2238 and [Editing Surface CV Sub-Objects](#) on page 2244 .

**Imports** Imports are 3ds Max objects, including other NURBS objects. Within the NURBS model, they render as NURBS; but they retain their original parameters and modifiers.

See [Attaching and Importing 3ds Max Objects](#) on page 2225 .

Sub-objects can be [dependent](#) on page 2169 sub-objects whose geometry is related to the geometry of other sub-objects.

**See also:**

- [Creating NURBS Models](#) on page 2154
- [Working with NURBS Models](#) on page 2155
- [Modifying NURBS Models and Creating Sub-Objects](#) on page 2159
- [Sub-Object Selection](#) on page 2164
- [CV Sub-Objects and Point Sub-Objects](#) on page 2165
- [Rigid Surfaces](#) on page 2172
- [Dependent Sub-Objects](#) on page 2169
- [Nonrelational NURBS Surfaces](#) on page 2219

## Creating NURBS Models

There are a variety of ways to create NURBS models. This is a summary of how you create a top-level, parent NURBS object:

- You can create a [NURBS curve](#) on page 2199 on the [Shape](#) on page 536 panel of the Create panel.
- You can create a [NURBS surface](#) on page 2190 on the [Geometry](#) on page 317 panel of the Create panel. When you use this technique, the NURBS surface is initially a flat rectangle. You can alter it using the Modify panel.

- You can turn a [standard geometry primitive](#) on page 348 into a NURBS object.
- You can turn a [torus knot](#) on page 389 into a NURBS object.
- You can turn a [prism](#) on page 423 extended primitive into a NURBS object.
- You can turn a [spline](#) on page 542 object (Bezier spline) into a NURBS object.
- You can turn a [patch grid](#) on page 1982 object (Bezier patch) into a NURBS object.
- You can turn a [loft](#) on page 715 object into a NURBS object.

To turn objects other than NURBS curves and surfaces into NURBS objects, use the Modify panel. Right-click the object's name in the stack display (see [Modifier Stack](#) on page 7427 ) and choose Convert To: NURBS.

In viewports, the [quad menu](#) on page 7300 also lets you convert objects to NURBS. Select and then right-click the object, and in the Transform (lower-right) quadrant, choose Convert To: > Convert to NURBS.

- In addition, the modifiers [Extrude](#) on page 1377 and [Lathe](#) on page 1430 let you choose NURBS output, which creates a NURBS object.

## Working with NURBS Models

When you work with NURBS models, usually you follow these overall steps:

- Create one NURBS object as the "starter" object. This can be a surface object, a curve object, or a converted geometry primitive, as described in [Creating NURBS Models](#) on page 2154 .  
Often modelers like to identify a single, master surface as the main component of the model. Converted geometry primitives are good if you want the starter surface to become the master surface. See [Creating NURBS Surfaces from Geometric Primitives](#) on page 2218 . Point and CV surfaces are good as starters for rectangular surfaces.
- On the Modify panel, you can edit the original object, or you can create additional sub-objects.  
See [Using the NURBS Toolbox to Create Sub-Objects](#) on page 2162 .  
You might even choose to delete the original, starter object once you have built a model from newer sub-objects.

Going immediately to the Modify panel avoids the problem of creating additional top-level NURBS objects, which you can't use to build relational, dependent sub-objects. (The exception is using curves for loft and sweep surfaces. See [U Loft Surface](#) on page 2380 , [UV Loft Surface](#) on page 2390 , [1-Rail Sweep Surface](#) on page 2397 , or [2-Rail Sweep Surface](#) on page 2407 .)

Two general references for modeling with NURBS are *Curves and Surfaces for Computer-Aided Geometric Design: A Practical Guide* by Gerald Farin (Academic Press, fourth edition 1996) and *Interactive Curves and Surfaces: A Multimedia Tutorial on Computer Aided Graphic Design* by Alyn Rockwood and Peter Chambers (Morgan Kaufman Publishers, 1996).

## Surface Trimming

To trim a surface is to use a curve on the surface to cut away part of the surface, or to cut a hole in the surface.

Before you trim a surface, you must create a curve on that surface. These are the kinds of curves that can trim surfaces:

- [U iso and V iso curves](#) on page 2318
- [Surface-surface intersection curve](#) on page 2312
- [Normal projected curve](#) on page 2320
- [Vector projected curve](#) on page 2323
- [CV curve on surface](#) on page 2327
- [Point curve on surface](#) on page 2331

Once you've created the curve, you trim the surface by turning on Trim in the curve sub-object's parameters. A Flip Trim control inverts the trim direction.

The direction of the curve determines the initial direction of the trim. For example, a closed curve on surface created in a clockwise direction trims inward, creating a hole in the surface; while a closed curve on surface created in a counterclockwise direction trims outward, creating a curve-shaped portion of the surface.

When a surface is trimmed, its untrimmed version is still present in the 3ds Max scene. You can select it for the purposes of editing it, or replacing it as a parent to a [dependent sub-object](#) on page 2169 . For details, see [Sub-Object Selection](#) on page 2164 .

## Procedures

### Example: To cut a hole in a CV surface:

- 1 Create a CV surface in the Top viewport.
- 2 Create a closed CV curve sub-object that lies on top of (or above) the surface.
- 3 In the toolbox, turn on Normal Projected Curve, then in the Top viewport select first the CV curve, then the surface.  
This creates a projection of the CV curve that lies on the surface, and can trim it.
- 4 In the normal projected curve's parameters, click to turn on Trim.  
A hole appears in the surface. Depending on the orientation of the Normal Projected curve, you might see everything but the hole.
- 5 Use the Flip Trim toggle to invert the trim.

---

**NOTE** Trims aren't displayed in viewports if the NURBS surface's Surface Trims toggle is turned off on the General rollout's Display group box.

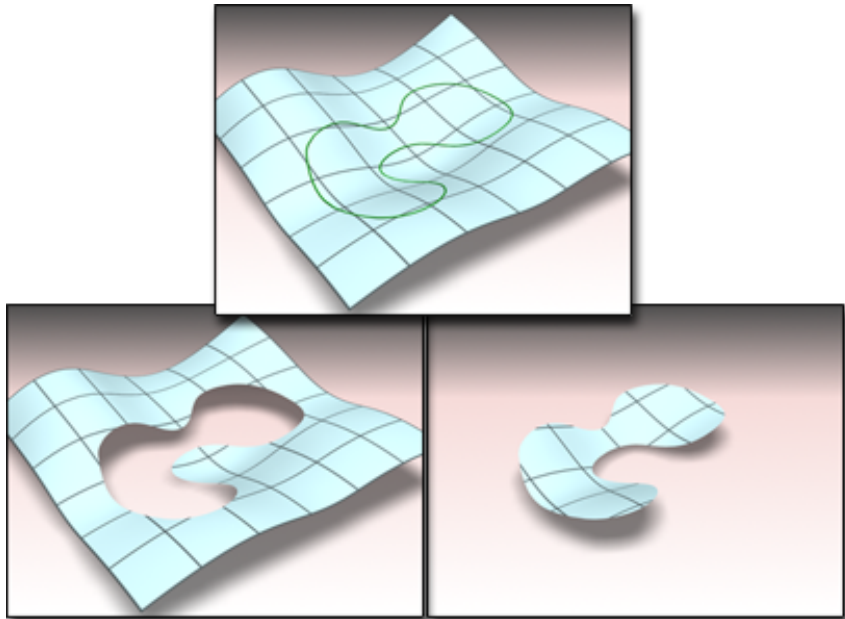

Above: CV curve on surface

Below left: Using the curve to trim the surface

Below right: Using Flip Trim to change the trimming direction

---

**To select an untrimmed surface:**

- 1 Make sure the [Keyboard Shortcut Override toggle](#) on page 7646 is on.
- 2 At the appropriate sub-object level or during a replace parent operation, press H. This opens the Select Sub-Objects dialog, which is a subset of the [Selection Floater](#) on page 171 that you can use during sub-object creation as well as sub-object selection.
- 3 If the untrimmed version is selectable at this level, the trimmed version appears as a "tree," with a plus sign next to it. Click the plus sign to expand



the tree. The child is the untrimmed version. Highlight its name to select it.

## Modifying NURBS Models and Creating Sub-Objects

You can edit NURBS immediately when you enter the Modify panel. You don't have to apply a modifier, as you do for most kinds of 3ds Max objects.

While you are editing a NURBS object on the Modify panel, you can create sub-objects "on the fly," without having to go back to the Create panel. This is an exception to the way you usually use 3ds Max. The Modify panel for NURBS curve and NURBS surface objects includes rollouts that let you create new NURBS sub-objects.



Example: Rollout for creating NURBS surface sub-objects

---

**TIP** Another way to create curve and surface sub-objects is to use the [NURBS Creation Toolbox](#) on page 2162 .

This is a summary of how to create sub-objects:

- An individual point sub-object is either an independent point or a dependent point tied to other NURBS geometry.
- Curve sub-objects are either independent point curves or CV curves, or they are [dependent](#) on page 7756 curves whose geometry is based on other curves or surfaces already present in the model. For example, a blend curve is a dependent curve sub-object that connects the endpoints of two other curves.
- Surface sub-objects are either independent point surfaces or CV surfaces, or they are [dependent](#) on page 7756 surfaces whose geometry is based on other surfaces or curves already present in the model. For example, a blend surface is a dependent surface sub-object that connects the edges of two other surfaces.
- You can attach 3ds Max objects. If the attached object is not already a NURBS object, it is converted to NURBS geometry. You can attach a NURBS curve, another NURBS surface, or a convertible 3ds Max object. The attached object becomes one or more curve or surface sub-objects.
- You can import 3ds Max objects. The imported object retains its parameters. While it is part of the NURBS object it renders as a NURBS, but you can still edit it parametrically at the Imports sub-object level. At this sub-object level, viewports display its usual geometry, not its NURBS form. A NURBS curve can import NURBS curves or spline curves. A NURBS surface can import curves, surfaces, or convertible 3ds Max objects.

---

**NOTE** You can detach a NURBS sub-object to make it a new, top-level NURBS object, and you can extract an imported object to create an independent, top-level object once again.

---

---

## Quad Menu for NURBS Objects

While a NURBS object is selected and the Modify panel is active, the [quad menu](#) on page 7300 displays two quadrants that are specifically for NURBS editing.

Transform Degrade	
Display Shaded Lattice	Isolate Selection
Display Lattices	Unfreeze All
Display Surfaces	Freeze Selection
Display Curves	Unhide by Name
Surface	Unhide All
Surface CV	Hide Unselected
Top-level ✓	Hide Selection
tools 1	display
tools 2	transform
Create CV Surface	Move <input type="checkbox"/>
Create CV Curve	Rotate <input type="checkbox"/>
Create Point Surface	Scale <input type="checkbox"/>
Create Point Curve	Select
Insert CV Row	Clone
Insert CV Column	Properties...
Refine CV Curve	Curve Editor...
Refine CV Row	Dope Sheet...
	Wire Parameters...
	Convert To: ▶

Quad menu for modifying NURBS models

### Tools I (upper-left) Quadrant

These options are general display and sub-object level shortcuts.

**Transform Degrade** Toggles [Degradation Override](#) on page 83 .

**Display Shaded Lattice, Display Lattices, Display Surfaces, and Display Curves** See [Display Controls for NURBS Models](#) on page 2221 .

**Sub-objects** Displays the sub-object choices for the selected object, as well as a Top-level choice.

## Tools 2 (lower-left) Quadrant

These options are creation and editing shortcuts.

**Create CV Surface, Create CV Curve, Create Point Surface, Create Point Curve** These create a new NURBS sub-object.

**Insert CV Row, Insert CV Column, Refine CV Curve, Refine CV Row** These add CVs to a CV Surface sub-object by inserting or refining. For the difference between inserting and refining, see [Editing Surface CV Sub-Objects](#) on page 2244 . See [NURBS Concepts](#) on page 2176 for more information about refining.

## Using the NURBS Toolbox to Create Sub-Objects



Modify panel > Select NURBS object. > General rollout > NURBS Creation Toolbox button

Keyboard > Ctrl+T (Keyboard Shortcut Override Toggle must be on.)

Besides using rollouts at the NURBS object level, you can use the NURBS toolbox to create sub-objects.

## Interface



### Toolbox for NURBS objects

The toolbox contains buttons for creating NURBS sub-objects. In general, the toolbox behaves like this:

- While the button is on, the toolbox is visible whenever a NURBS object or sub-object is selected and you are on the Modify panel. It disappears whenever you deselect the NURBS object or make a different panel active. When you return to the Modify panel and select a NURBS object, it reappears.
- You can use the toolbox to create sub-objects from either the top, object level, or from any NURBS sub-object level.
- When you turn on a toolbox button, you go into creation mode, and the Modify panel changes to show the parameters (if there are any) for the kind of sub-object you are creating. Other NURBS rollouts aren't displayed while you create the new sub-object. This differs from using the NURBS object's Create rollouts or the NURBS [right-click menu](#) on page 2160 .

- If you are at the top, object level and use the toolbox to create a sub-object, you must then go to the sub-object level to edit the new sub-object. (This is the same as using the buttons on the rollouts.)
- If you are at a sub-object level and use the toolbox to create an object of the same sub-object type, you can edit it immediately after you turn off the create button (or right-click to end object creation).
- If you are at a sub-object level and use the toolbox to create an object of a different sub-object type, you must change to that sub-object level before you can edit the new sub-object.

The individual creation buttons are described in these topics:

[Creating and Editing Point Sub-Objects](#) on page 2428

[Creating Curve Sub-Objects](#) on page 2283

[Creating Surface Sub-Objects](#) on page 2337

## Sub-Object Selection

When you work with NURBS models, you often work with sub-objects. While you are at the sub-object level, you use the usual selection techniques, such as clicking, dragging a region, or holding down Ctrl, to choose one or more sub-objects.

You can also select NURBS point, curve, and surface sub-objects by name. Turn on the [Keyboard Shortcut Override Toggle](#) on page 7646, go to a NURBS sub-object level, and then press the H key. This opens the Select Sub-Objects dialog, which is a subset of the [Selection Floater](#) on page 171 that lists only sub-objects at the current level. Choose one or more objects in the list, and then click Select. You can assign your own names to NURBS sub-objects (aside from CVs) that you want to edit frequently.

---

### TIP

Press Ctrl+H to have the Select Sub-Objects dialog list only sub-objects directly beneath the mouse cursor.

---

### TIP

The H shortcut is also a convenient way to choose parent objects while you're creating dependent sub-objects.

---

## Workflow Tips

When you work with NURBS, you switch frequently between the object and sub-object levels, or from one sub-object level to another. Keyboard shortcuts and pop-up menus can help you do this.

- The Sub-Object Selection Toggle (default: Ctrl+B) switches between object and sub-object levels.
- The Cycle Sub-Object Level shortcut (default: Insert) switches from one sub-object level to another.
- When you right-click in a viewport while a NURBS object is selected and the Modify panel is active, the quad menu lets you switch between various levels of the NURBS model: Top Level, Surface CV Level, Surface Level, Curve CV Level, Point Level, Curve Level, and Imports Level.
- The command panel's right-click popup menu (available whenever the mouse cursor becomes a pan hand) helps you navigate the rollouts on the current command panel.  
If you have a three-button or wheel mouse, rolling the wheel scrolls the command panel.
- Sub-object selection sets are persistent. If you go to a different sub-object level, when you return to the previous level, your selection is still available. However, refining or inserting points or CVs makes the sub-object selection sets invalid for that object.
- You can move a sub-object selection set among sub-objects at the active level of the NURBS model by holding down Ctrl while you press the arrow keys.
- When you select surface CV sub-objects that are "on top of" each other in a 3D view, sometimes all the selected CVs fail to highlight. To fix this, choose Customize > [Viewport Configuration](#) on page 7610, and turn on Z-buffer Wireframe Objects.

## CV Sub-Objects and Point Sub-Objects

Independent curves and independent surfaces both come in two varieties: they are either CV sub-objects or point sub-objects. This topic describes the differences between the two.

## CV Curves and CV Surfaces

CV curves and CV surfaces have control vertices (CVs) as do splines. The position of the CVs controls the shape of the curve or the surface. However, unlike spline vertices, CVs don't necessarily lie on the curve or surface they define. The CVs define a [control lattice](#) on page 7745 that connects the CVs and surrounds the NURBS curve or surface. The control lattice displays in lines that are yellow by default.

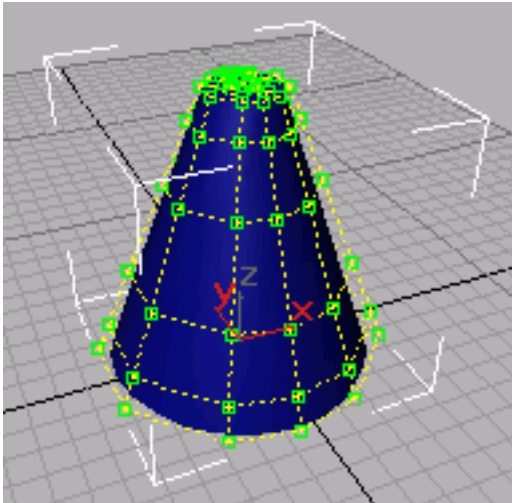

**Cone-shaped NURBS surface with its control lattice (CVs are displayed as green squares)**

---

**TIP** When you use Zoom Extents, the entire extents of a NURBS object are displayed, including its control lattice. Because CVs can be located some distance from an object, the curve or surface itself (the object's renderable geometry) is sometimes hard to see. If this happens, use Zoom Region or Field of View to zoom in.

---

You can move a CV at the Curve CV or Surface CV sub-object level on the Modify panel. Other transforms, rotate and scale, work as well. Rotate and scale are useful mainly when you have selected multiple CVs.



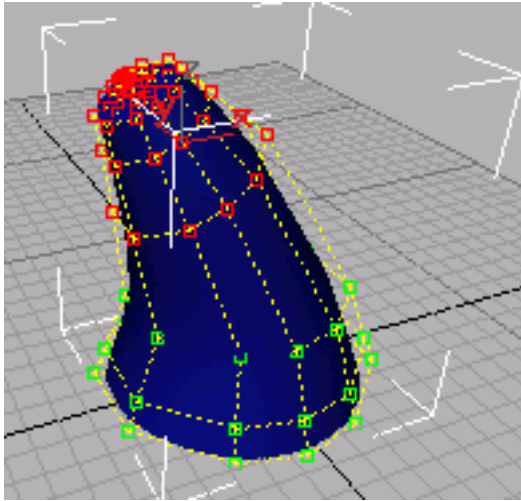

Moving and rotating CVs to change a surface (selected CVs are displayed in red)

Each CV also has a *weight*, which you can use to adjust the CV's effect on the curve or surface. Increasing the weight pulls the surface toward the CV. Decreasing the weight relaxes the surface away from the CV.

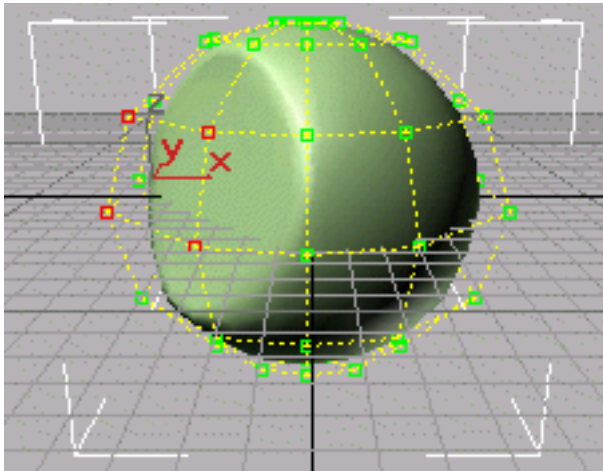

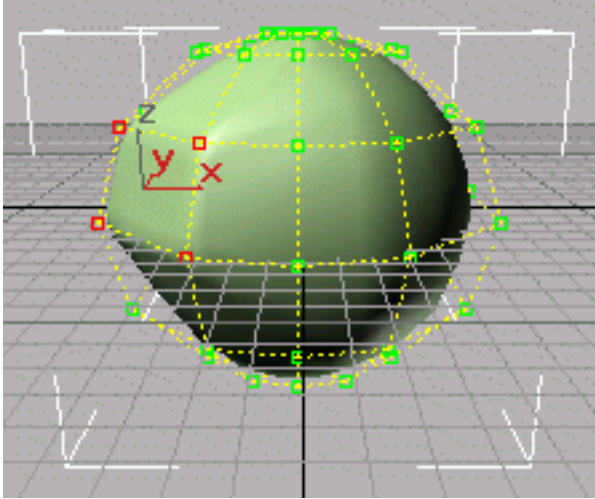

Above: Weights=0.0

Below: Weights=40.0

Changing a spherical surface by decreasing or increasing the weight of four CVs (selected CVs are at the left, in red)

Weights can be a useful way to "tune" the appearance of a NURBS curve or surface.

The weight value of a CV is rational (as in a "rational number"). That is, it is relative to other CVs in the curve or surface. Changing the weight of all CVs at once has no effect, because it doesn't change the ratio between weights.

### Points, Point Curves, and Point Surfaces

Point curves and point surfaces are similar to CV curves and surfaces, but the points that control them are required to lie *on* the curve or surface. Unlike CVs, points do not have a weight.

Point curves and point surfaces can be more intuitive to create and work with. However, working with point sub-objects is slower than working with CV sub-objects. You can think of a point curve or point surface as being dependent on the points to which it fits.

Points that you create individually are the same as the points on point curves and surfaces, except that initially they aren't part of a curve or surface. You can create a point curve by fitting it to points that you select. When you fit the new point curve, you can use points that are part of curves or surfaces, and individual point sub-objects.

## Dependent Sub-Objects

NURBS sub-objects are either independent or dependent. A dependent sub-object is based on the geometry of other sub-objects. For example, a blend surface smoothly connects two other surfaces. Transforming or animating either of the original, parent surfaces causes the shape of the blend to change as it maintains a connection between the parents.

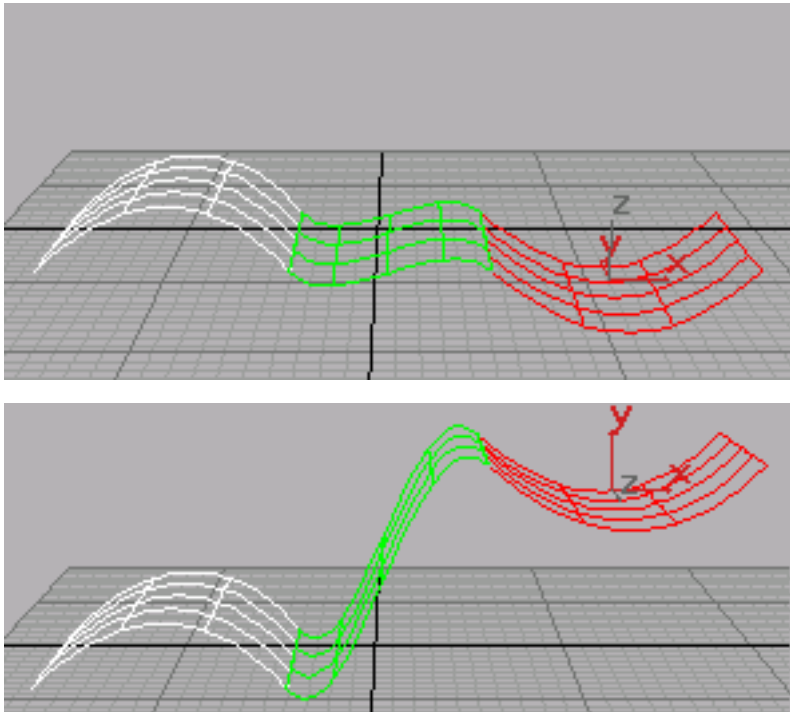

**Moving a parent surface changes the blend surface (the blend surface is displayed in green)**

The immediate, interactive relation between the parent and dependent sub-objects is known as *relational modeling*. Relational modeling is one of the reasons NURBS models can be particularly easy to change or to animate.

---

**IMPORTANT** Dependent sub-objects must have parents that are also sub-objects of the same NURBS model. Dependent relationships can't exist between object-level NURBS curves or surfaces. If you want to use a top-level NURBS object to create a dependent object, first you must attach or import the top-level object. See [Attaching and Importing 3ds Max Objects](#) on page 2225 .

---

You have the option of making a dependent sub-object independent. After you do so, the sub-object is no longer related to its parents. Changes to the former parents don't affect it, but you can edit and transform it as an independent sub-object in its own right.

At the appropriate sub-object level, dependent NURBS are displayed in green in wireframe viewports. (You can change the display color using the Colors panel of the [Customize User Interface dialog](#) on page 7489 .)

Relational modeling does add computation time to a model, so when you transform or edit dependent sub-objects in other ways, often you will notice a slowdown in performance. Once a dependent surface sub-object has the shape you want, you can improve performance by making it into a [rigid surface](#) on page 2172 .

### **Transforming Dependent Sub-Objects**

In general, you can select and transform dependent sub-objects, but the effect of the transform depends on the sub-object type. Some dependent objects have a gizmo, similar to the gizmo used with modifiers. Sub-objects that don't have gizmos can't change relative to their parent objects. For these kinds of sub-objects, transforms apply equally to the sub-object and its parents. For example, moving a blend sub-object moves its parents as well. Sub-objects that have gizmos can change relative to their parent objects. In this case, as with modifiers that use gizmos, you are really transforming the gizmo. For example, rotating a mirror sub-object changes the mirror axis, and therefore the mirror's position relative to its parent curve or surface.

When you [Shift+Clone](#) on page 2466 a dependent NURBS sub-object, by default the parent objects are also cloned. For example, if you Shift+Clone a UV loft, all the lofting curves are copied as well. This means that the new object has the same type as the original object. The cloned object keeps its parents, so you can edit it just as you do the original. When you Shift+Clone a NURBS sub-object, you can also choose to remove dependencies in order to improve performance.

### **Error Condition for Dependent Sub-Objects**

Sometimes changes you make to the parent objects make it no longer possible to correctly update the dependent object's geometry. For example, a fillet between two curves requires the curves to be coplanar. If you move one curve (or its CVs or points) so that the curves are no longer coplanar, the fillet cannot update correctly. In this case, the dependent object's geometry reverts to a default position, and it is displayed in orange to indicate an error condition.

(You can change the error color using the [Colors panel](#) on page 7505 of the [Customize User Interface dialog](#) on page 7489 .)

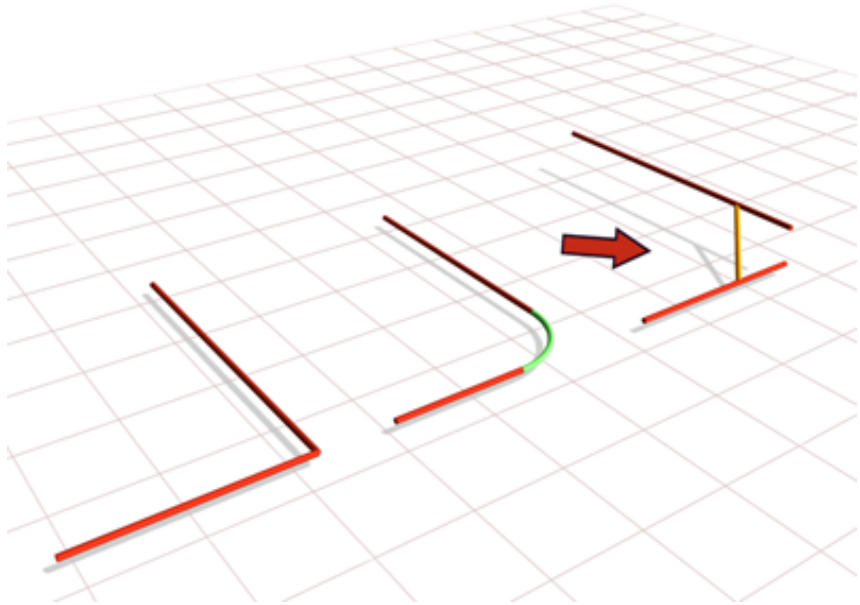

The arrow points to the segment indicating an error condition.

### Seed Values

Some kinds of dependent sub-objects depend on geometry that might have more than one solution. For example, if you want to create a surface-curve intersection point, and the curve intersects the surface more than once, the software must decide which intersection is to be the location of the point.

For these kinds of objects, [seed value](#) on page 7922 parameters control the decision. The seed location is on a parent object, and the software chooses the location nearest to the seed value that satisfies the creation condition. You can alter the seed value when you edit these dependent sub-objects. The seed location is displayed as a yellow square.

For example, the seed location for a surface-curve intersection point is a U position along the length of the parent curve. The surface-curve intersection closest to the seed is chosen as the location of the dependent point.

The seed location for a surface is a pair of UV coordinates in the surface's [parameter space](#) on page 7882 .

## Replacing Parent Sub-Objects

Dependent sub-objects have controls that let you replace the object or objects on which they depend. For example, Offset Surface has a button called Replace Base Surface. You can click this button and then click a different surface to act as the base of the offset.

This capability lets you replace a trimmed surface with its untrimmed version, or vice versa. To do so, you need to use the Select Sub-Objects dialog, which is a subset of the [Selection Floater](#) on page 171 that you can use during sub-object creation as well as sub-object selection. For example, select the trimmed surface sub-object and turn on the [Keyboard Shortcuts Override toggle](#) on page 7646. Click the replacement button, press the H key, expand the surface's tree, and then highlight the name of the untrimmed version.

## Rigid Surfaces

To improve performance, you can make any kind of surface sub-object into a rigid surface. The only editing allowed on a rigid surface is to transform it at the Surface sub-object level. You can't move a rigid surface's points or CVs, or change the number of points or CVs.

Rigid surfaces reduce the amount of memory used by the NURBS model. Making surfaces rigid improves performance, especially for large and complex models.

When a surface is rigid, you can't see its points or CVs when you are at the Point or Surface CV sub-object levels. If the model has only rigid surfaces and no point curves, the Point and Surface CV sub-object levels aren't available at all.

To make a rigid surface editable again, click Make Point, Make Independent, Make Loft, or Convert Surface.

## NURBS and Modifiers

In general, you can apply modifiers to NURBS models as you do to other objects.

You can apply [Edit Patch](#) on page 1290 and [Edit Mesh](#) on page 1283 modifiers to NURBS surface objects.

---

**TIP** To improve performance while you animate your scene, make the surfaces in your NURBS model [nonrelational surfaces](#) on page 2219 . Modifiers treat nonrelational surfaces as if they were independent CV surfaces: you can animate the scene more efficiently, and then turn relational modeling back on before you render.

---

## Deforming NURBS Objects

Deform modifiers such as [Bend](#) on page 1139 and [Twist](#) on page 1765 operate on CV and point sub-objects. They don't change the NURBS model into an editable mesh object. This means that you can use a deform modifier, collapse the stack, and still have a NURBS object that you can edit further. However, because the deform modifiers directly affect CVs and points (and not the mesh approximation of the NURBS model), they can produce unexpected results. For example, a [Ripple](#) on page 1583 modifier does not ripple the surface if the CVs are farther apart than the wavelength of the ripples. If you want the modifier to affect the mesh approximation instead of the CVs, you can apply a [Mesh Select](#) on page 1455 modifier first. Then when you collapse the stack, you get an editable mesh, not a NURBS object.

These are the deform modifiers that collapse to NURBS:

- Modifiers in the Parametric Deformers set, except for Lattice (which collapses to an editable mesh) and Slice (which collapses to an editable poly or an editable mesh).
- Modifiers in the Animation Modifiers set, except for the world-space modifier (WSM) versions of PatchDeform, PathDeform, and SurfDeform, which don't collapse.

---

**TIP** While the Morpher and Skin modifiers collapse to a NURBS object, they are meant to be used with their own controls, and lose their usefulness when you collapse them.

---

The modifiers with Soft Selection controls treat NURBS models the same way they treat editable meshes. As with editable mesh vertices, CVs are colored proportionally according to how much the region affects them.

If Relational Stack is turned off (see [Nonrelational NURBS Surfaces](#) on page 2219 ), the Affect Neighbors toggle can affect all surface CVs, curve CVs, and points in neighboring sub-objects. If Relational Stack is on, Soft Selection affects neighboring sub-objects only if they are at the same sub-object level.

Soft Selection works with Scale and Rotate as well as with the Move transform.

## NURBS Objects and the UVW Map Modifier

When you apply a [UVW Map](#) on page 1849 modifier, it affects the NURBS object the same way it affects a mesh. If you then collapse the stack, UVW mapping is still in effect. However, you can override the mapper for individual surface sub-objects. To do so, turn on the surface's Generate Mapping Coords check box, if necessary. When the check box is on, you get the natural mapping of the surface; when it is off, you get the mapping from the collapsed UVW modifier.

---

**TIP** Don't use UVW Map to assign a texture to an animated surface. The texture will shift as the surface animates.

---

## NURBS Selection Modifier

The [NURBS Surface Selection \(NSurf Sel\)](#) on page 1513 lets you place a NURBS sub-object selection on the modifier stack. This lets you modify only the selected sub-objects. Also, selected curve sub-objects are [Shape](#) on page 536 objects that you can use as paths and motion trajectories.

NSurf Sel can select any kind of NURBS sub-object except imports. Each sub-object selection is of one sub-object level only.

## Procedures

### To use a NURBS select modifier:

- 1 With a NURBS object selected, go to the Modify panel and apply NSurf Sel.

The selection modifier has no controls at the object level.

- 2 Click to open the modifier's hierarchy, and choose a sub-object level.  
The selection modifier has the same selection controls you see for the corresponding sub-object type.

While applying the modifier, you can also select NURBS sub-objects by name. Turn on the Keyboard Shortcut Override Toggle button on the status bar, and then press the H key. This opens the Select Sub-Objects dialog, which is a subset of the [Selection Floater](#) on page 171 that you can use during sub-object creation as well as sub-object selection. Choose one or more objects in the list, and then click Select. Press Ctrl+H to have the Select Sub-Objects dialog list only sub-objects (for example, points) directly under the mouse cursor.



- 3 Use the selection controls to create a selection set of the chosen sub-object type.

With the NSurf Sel modifier, you can select NURBS sub-objects at any level except imports.

---

**NOTE** To select point, curve, or curve CV sub-objects, you must go to the NURBS object and turn on Relational Stack.

---

Once you have used the modifier to create the selection, you can apply other modifiers to it. If the selected sub-object is a curve, you can also use it as a path or trajectory.

---

**NOTE** NSurf Sel doesn't support copy and paste of selections as Mesh Select does. Copying and pasting mesh selections is based on vertex indexes. NURBS selections are based on object IDs, which are unique to each model.

---

## NURBS and Animation

In general, you animate NURBS curves and NURBS surfaces by turning on the Auto Key button and transforming sub-object attributes such as CV or point positions, by animating the parameters that control dependent NURBS objects, and so on. You can't animate NURBS object creation or creation parameters, or fundamental changes to NURBS geometry such as adding or deleting CVs or points, attaching objects, and so on.

---

**TIP** To improve performance while you animate your scene, make the surfaces in your NURBS model [nonrelational surfaces](#) on page 2219 . Modifiers treat nonrelational surfaces as if they were independent CV surfaces: you can animate the scene more efficiently, and then turn relational modeling back on before you render.

Some NURBS editing operations remove animation controllers.

---

### Operations that Remove Animation

The following operations remove animation from a NURBS object or sub-object:

- **Make Independent**  
This operation removes the animation of anything directly dependent on the object.

- Break, Extend, Join and Zip, Refine, Delete, Rebuild, Reparameterize, Close, Make Loft, Convert Curve, and Convert Surface  
Any operation that changes the number of points or CVs in a curve or surface removes the animation of all points or CVs that are lost.
- Fuse  
The animation of the point or CV being fused to the other point or CV (the second one chosen) is lost. The first point or CV acquires the animation of the second.

## NURBS Concepts

NURBS curves and surfaces did not exist in the traditional drafting world. They were created specifically for 3D modeling using computers. Curves and surfaces represent contours or shapes within a 3D modeling space. They are constructed mathematically. NURBS mathematics is complex, and this section is simply an introduction to some NURBS concepts that might help you understand what you are creating, and why NURBS objects behave as they do. For a comprehensive description of the mathematics and algorithms involved in NURBS modeling, see *The NURBS Book* by Les Piegl and Wayne Tiller (New York: Springer, second edition 1997).

### Definition and Parameter Space

The term NURBS stands for *Non-Uniform Rational B-Splines*. Specifically:

- *Non-Uniform* means that the extent of a control vertex's influence can vary. This is useful when modeling irregular surfaces.
- *Rational* means that the equation used to represent the curve or surface is expressed as a ratio of two polynomials, rather than a single summed polynomial. The rational equation provides a better model of some important curves and surfaces, especially conic sections, cones, spheres, and so on.
- A *B-spline* (for *basis spline*) is a way to construct a curve that is interpolated between three or more points.  
Shape curves such as the Line tool and other Shape tools are Bezier curves, which are a special case of B-splines.

The non-uniform property of NURBS brings up an important point. Because they are generated mathematically, NURBS objects have a [parameter space](#) on page 7882 in addition to the 3D geometric space in which they are displayed.

Specifically, an array of values called [knots](#) on page 7825 specifies the extent of influence of each control vertex (CV) on the curve or surface. Knots are invisible in 3D space and you can't manipulate them directly, but occasionally their behavior affects the visible appearance of the NURBS object. This topic mentions those situations. Parameter space is one-dimensional for curves, which have only a single U dimension topologically, even though they exist geometrically in 3D space. Surfaces have two dimensions in parameter space, called U and V.

NURBS curves and surfaces have the important properties of not changing under the standard geometric affine transformations (Transforms), or under perspective projections. The CVs have local control of the object: moving a CV or changing its weight does not affect any part of the object beyond the neighboring CVs. (You can override this property by using the [Soft Selection](#) on page 2275 controls.) Also, the control lattice that connects CVs surrounds the surface. This is known as the [convex hull](#) on page 7747 property.

### Degree and Continuity

All curves have a [degree](#) on page 7755 . The degree of a curve is the highest exponent in the equation used to represent it. A linear equation is degree 1; a quadratic equation is degree 2. NURBS curves typically are represented by cubic equations and have a degree of 3. Higher degrees are possible, but usually unnecessary.

Curves also have [continuity](#) on page 7743 . A continuous curve is unbroken. There are different [levels of continuity](#) on page 7744 . A curve with an angle or cusp is C0 continuous: that is, the curve is continuous but has no derivative at the cusp. A curve with no such cusp but whose curvature changes is C1 continuous. Its derivative is also continuous, but its second derivative is not. A curve with uninterrupted, unchanging curvature is C2 continuous. Both its first and second derivatives are also continuous.



Levels of curve continuity:

Left: C0, because of the angle at the top

**Middle: C1, at the top a semicircle joins a semicircle of smaller radius**

**Right: C2, the difference is subtle but the right side is not semicircular and blends with the left**

A curve can have still higher levels of continuity, but for computer modeling these three are adequate. Usually the eye can't distinguish between a C2 continuous curve and one with higher continuity.

Continuity and degree are related. A degree 3 equation can generate a C2 continuous curve. This is why higher-degree curves aren't generally needed in NURBS modeling. Higher-degree curves are also less stable numerically, so using them isn't recommended.

Different segments of a NURBS curve can have different levels of continuity. In particular, by placing CVs at the same location or very close together, you reduce the continuity level. Two coincident CVs sharpen the curvature. Three coincident CVs create an angular cusp in the curve. This property of NURBS curves is known as [multiplicity](#) on page 7858. In effect, the additional one or two CVs combine their influence in that vicinity of the curve.

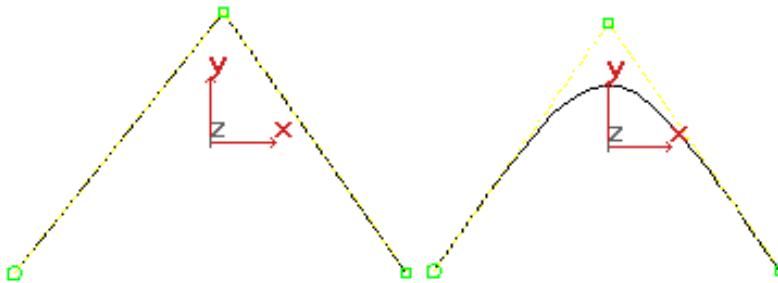

**Effects of multiplicity: there are three CVs at the apex on the left, two CVs at the apex on the right.**

By moving one CV away from the other, you increase the curve's continuity level again. Multiplicity also applies when you fuse CVs. Fused CVs create a sharper curvature or a cusp in the curve. Again, the effect goes away if you unfuse the CVs and move one away from the other.

Degree, continuity, and multiplicity apply to NURBS surfaces as well as to curves.

## Refining Curves and Surfaces

*Refining* a NURBS curve means adding more CVs. Refining gives you finer control over the shape of the curve. When you refine a NURBS curve, the

software preserves the original curvature. In other words, the shape of the curve doesn't change, but the neighboring CVs *move away from* the CV you add. This is because of multiplicity: if the neighboring CVs didn't move, the increased presence of CVs would sharpen the curve. To avoid this effect, first refine the curve, and then change it by transforming the newly added CVs, or adjusting their weights.



**Refining a NURBS curve.**

NURBS surfaces have essentially the same properties as NURBS curves, extended from a one-dimensional parameter space to two dimensions.

### **Reparameterizing CV Curves and Surfaces**

When you refine a NURBS curve or surface, it is a good idea to reparameterize it. Reparameterizing adjusts the parameter space so the curve or surface will behave well when you edit it in viewports. There are two ways to reparameterize:

- **Chord-length**  
Chord-length reparameterization spaces knots in parameter space based on the square root of the length of each curve segment.
- **Uniform**  
Uniform reparameterization spaces knots uniformly. A uniform knot vector has the advantage that the curve or surface changes only locally when you edit it.

CV curve and surface sub-objects give you the option of reparameterizing automatically whenever you edit the curve or surface.

### **Point Curve and Surface Concepts**

You can work with point curves and point surfaces as well as with CV curves and surfaces. The points that control these objects are constrained to lie *on* the curve or surface. There is no control lattice, and no weight control. This is a simpler interface that you might find easier to work with. Also, point-based

objects give you the ability to construct curves based on dependent (constrained) points, and then use these to construct dependent surfaces.

You can think of point curves and surfaces as an interface to CV curves and surfaces, which are the fully defined NURBS objects. The underlying representation of the curve or surface is still constructed using CVs.

You can also think of a point curve or surface as dependent on its points. You can use the Convert Curve button to convert a point curve or surface to the CV form, or vice versa.

## NURBS Tips and Techniques

These topics contain suggestions on how to work with NURBS. They include tips collected from various NURBS modeling users.

[How to Make Objects with NURBS Modeling](#) on page 2180

[How to Fix NURBS Objects](#) on page 2186

[How to Improve Performance](#) on page 2188

[Animation, Textures, and Rendering](#) on page 2189

## How to Make Objects with NURBS Modeling

These are tips on using NURBS to create models.

### Objects and Sub-Objects

- In 3ds Max, a NURBS model is a single, top-level [NURBS object](#) on page 2153 that can contain a variety of sub-objects. Get in the habit of creating a single object at the top level, then going immediately to the Modify panel and adding sub-objects by using rollouts or the [NURBS Creation Toolbox](#) on page 2162 .
- Sub-objects are either independent or dependent. [Dependent sub-objects](#) on page 2169 use relational modeling to build NURBS geometry that is related to other geometry. However, understand that the more dependencies a model has, the slower interactive performance becomes.
- In general, point curves and surfaces are slower than CV curves and surfaces. Trims are the slowest kind of dependency, and texture surfaces are the slowest kind of dependent sub-object.

- If a dependent sub-object doesn't change during animation, you can improve performance by making the sub-object independent after you finish creating it.
- You can use [NSurf Sel](#) on page 1513 to apply modifiers to a sub-object selection. However, before you do so make sure that Relational Stack is on; [Relational Stack](#) on page 2219 is on the General rollout for NURBS models. Otherwise, NSurf Sel can select only the Surface and Surface CV sub-object levels.

## Converting Other Objects to NURBS

- Remember that you can collapse [splines](#) on page 542 to NURBS objects. A spline Shape or a NURBS curve can be a good starter object for a NURBS model.
- Shapes with sharp angles collapse to multiple NURBS curves. You can control this before NURBS conversion by first converting the Shape to an [editable spline](#) on page 590 . Modify the editable spline so that all its vertices are Bezier or Smooth vertices. Then when you collapse the spline to a NURBS curve, you obtain a single curve.
- If you want a single NURBS curve, *don't* change vertices to Bezier Corner vertices. These always convert to a junction between two different NURBS curves.
- Collapsing a [primitive](#) on page 348 into a NURBS object is one of the quickest ways to start building a NURBS model. After collapsing the primitive, you can select various CVs and transform them. Other objects you can convert to NURBS are [prisms](#) on page 423 , [torus knots](#) on page 389 , [lofts](#) on page 715 , and [patch grids](#) on page 1982 .
- You can also change the NURBS surface by applying modifiers. The modifiers act on the points or CVs of the surface, and not on the surface itself. After applying the modifiers, collapse the [modifier stack](#) on page 7427 . This removes the modifiers from the stack without changing the position of the modified points or CVs, making for a simpler and quicker model.
- Another way to create a NURBS surface object is to apply a [Lathe](#) on page 1430 or [Extrude](#) on page 1377 modifier to a NURBS curve. Set the modifier's Output Type to NURBS, and then collapse when you're done adjusting the parameters.  
(There are also NURBS lathe and extrude surface sub-object types, which you can apply to curve sub-objects.)

## Shortcuts, Snaps, and User Interface Tips

- Remember to turn on the [Plug-In Keyboard Shortcut Toggle](#) on page 7646 . While it is on, you can use all the NURBS keyboard shortcuts.
- One of the most useful NURBS keyboard shortcuts is H, which opens the Select Sub-Objects dialog. This is a subset of the [Selection Floater](#) on page 171 that you can use during sub-object creation as well as sub-object selection. This is handy when sub-objects are crowded or hard to see. A variant is Ctrl+H, which also displays the Select Sub-Objects dialog, but lists only those NURBS sub-objects beneath the mouse cursor position.
- There are special NURBS Snaps in the [Grid and Snap Settings dialog](#) on page 2577 (right-click the 3D Snap toggle to display this). When you use NURBS snaps, turn off Options/Axis Constraints; otherwise, snaps work only in the current axis.  
Also, remember that snaps work in a viewport only when you have made the viewport active. And choosing your snap settings does *not* turn on snaps. You must also turn on the [3D Snap Toggle button](#) on page 2568 (on the status bar).  
Snaps are especially important when you create the curves for building [1-rail](#) on page 2397 and [2-rail](#) on page 2407 sweep surfaces.
- Remember that without leaving the viewport, you can right-click to display a [quad menu](#) on page 7300 with shortcuts for changing the sub-object level, creating some sub-objects, and using some other edit commands.
- When you work with NURBS, there are a lot of rollouts in the Modify panel. Minimize the rollouts you don't need. For example, minimizing the Modifiers rollout helps unless you're applying Modifiers, and minimizing the Surface Common rollout is useful when you're creating U loft, UV loft, and 1-rail or 2-rail sweep surfaces.
- Don't set viewports to display edged faces. Displaying edges is almost twice as slow as displaying a simple shaded viewport.

## Creating Curves

- When drawing a CV curve, click three times to get a sharp corner. Be aware, however, that multiple CVs increase the amount of calculation and therefore reduce the performance and stability of your model. However, if you want to use the curve to construct a U Loft, and so on, this is the best technique.



- You can also create sharp corners by fusing the ends of two separate NURBS curve sub-objects. This is the recommended method if you aren't using the curves to construct a surface.
- While creating curves, you can turn on the Draw in All Viewports toggle. This lets you draw curves in 3D. Begin drawing a curve in one viewport, go to another viewport, and continue drawing. If your mouse has a middle mouse button, Alt+middle mouse button lets you use [arc rotate](#) on page 7395 to change a viewport's orientation while you are creating the curve.
- To create a transform curve along a specific axis, turn on the appropriate axis constraints, and then Shift+move a copy of the transform curve.

### Curves and Direction

- NURBS curves show their direction in viewports. A small circle indicates the first vertex. If the curve is closed, a plus sign (+) indicates the direction of the curve.  
Be aware of curve direction when you use curves to construct [blend surfaces](#) on page 2348, [U loft](#) on page 2380 and [UV loft](#) on page 2390 surfaces, and [1-rail](#) on page 2397 and [2-rail](#) on page 2407 sweeps. If the curves don't have the same direction, you can get strange twisting. Make sure curves have the same direction before you construct the surface. On the Curve Common rollout, the controls Reverse and Make First let you control the direction of the curve, and where its starting point or CV is located.  
Another good way to make sure curves are aligned is to draw one curve and then use Shift+Clone to create the others. After creating the aligned curves, you can transform CVs to vary the curves on which the surface will be based.

### Curves for Sweeps

- Besides expecting cross-section curves to be all in the same direction, [1-rail](#) on page 2397 and [2-rail](#) on page 2397 sweep surfaces work best if the cross sections intersect the rail or rails. To achieve this, draw the rails first, then draw the cross sections using the NURBS [Snaps](#) on page 2578 Curve End and Curve Edge turned on.
- 2-rail sweeps have the additional requirement that the endpoints of the first cross section intersect the endpoints of the rails. Again, NURBS Snaps help you do this.

If the endpoints of the first cross-section don't coincide with the rail endpoints, the resulting surface might not follow the rails.

- While you're editing a sweep, the Edit Curve button lets you directly transform the CVs of a rail or cross section, without changing the sub-object level. Edit Curve also gives you access to all the rollouts that control the curve. You can use Refine or Make First, for example, without changing levels.

### Curves on Surfaces and Projected Curves

- You can use a viewport to draw a [curve on a surface](#) on page 2327 (COS), but this works only for visible portions of the surface. To see the entire surface and the curve or curves on it projected into a flat plane, use Edit Curve.  
If your mouse has a middle mouse button, Alt+middle mouse button lets you use [arc rotate](#) on page 7395 to change a viewport's orientation while you draw the curve on surface.
- Neither curves on surfaces nor projected curves can cross the edge of a surface. This includes the seam on surfaces with fused CVs. If you try to project across the seam, only part of the curve's projection is created.

### Creating Blend Surfaces

- You can blend between curves or between surface edges. (You can't blend from a trimmed edge. In that situation, you are blending from the curve that trimmed the surface.)
- If you want a controllable tangent or tension, you must blend to a surface edge or a curve on a surface. Adjusting tension changes the flatness or "bulginess" of that end of the blend.  
When a curve and a surface (or two surfaces) are near each other, sometimes it can be hard to tell which edge you are selecting. To assist you, the currently selected surface turns yellow, and the edge that will be used for the blend turns blue. Make sure you have selected the right surface before you choose the edge.
- If the edges you are blending have different numbers of points (usually due to different surface approximation settings), then sometimes rendering shows gaps between the blend and the original surface. If this happens, go to the [Surface Approximation rollout](#) on page 2469 and increase the value of Merge until the gaps disappear when you render.

The Merge setting affects only the production renderer. It has no effect on viewport display.

## Lofts

- If you need a surface between only two curves, use a [ruled surface](#) on page 2374 instead of a U loft. This is faster.
- If loft creation seems slow, make sure the Display While Creating check box (in the [U Loft Surface rollout](#) on page 2380 ) is turned off.
- If the U loft doesn't come out as you expected, try reparameterizing the curves. Click Reparam. at the Curve sub-object level. This button is on the CV Curve rollout. In the [Reparameterize dialog](#) on page 2465 , choose Chord Length reparameterization.  
If a curve is dependent or a point curve, first you will have to make it independent (this also improves performance).  
Curves that are made of two joined curves have this problem more often than others. If you have a joined curve as one of the curves to construct the loft, reparameterize it before you create the loft, or set the curves to reparameterize automatically.
- The Edit Curve button lets you directly transform the CVs of a curve within a U loft or [UV loft](#) on page 2390 , without changing the sub-object level. Edit Curve also gives you access to all the rollouts that control the curve. You can use Refine or Make First, for example, without changing levels.
- To close a UV loft, you can pick the first V curve again to make it the last curve in the loft. Sometimes a seam is visible at this location in the UV loft.

## Multisided Blend Surfaces

- If the program doesn't create the [multisided blend](#) on page 2417 , fuse the CVs at the three or four corners. Snapping CVs to each other doesn't always succeed, because of rounding off.

## Multicurve Trimmed Surfaces

- Multicurve trimmed surfaces are the only way to create a trimmed hole that contains sharp angles.

## Displacement Mapping

- In general, the default tessellation settings aren't suitable for displaced surfaces. With these default settings, displacement mapping can create an *extremely* high face count, which performs very slowly. Change the surface approximation to the lowest necessary resolution. A good rule of thumb is to start with Spatial approximation and an Edge value of 20. If that is too low, reduce the Edge value until the model looks as it should.
- Use the [Displace NURBS world space modifier](#) on page 1047 to convert the displacement map into an actual displaced mesh so you can see the effect of displacement in viewports. To make a displaced mesh copy of the NURBS model, use [Snapshot](#) on page 921 .

## Connecting an Arm to a Shoulder

- The easiest approach is to create a [CV curve on surface](#) on page 2327 or [normal projected curve](#) on page 2320 on the shoulder. Then create the arm as a [U loft](#) on page 2380 . For the last curve of the U loft, select the CV curve on surface or the normal projected curve. Then turn on Use COS Tangents, which makes the loft surface tangent to the other surface where the arm joins the shoulder.
- If the blend appears twisted, use the Start Point spinner to change the location of the first point of the curves that make up the U loft surface.
- Another way to connect a U loft to another surface is to project the last curve in the U loft onto the other surface. Click Make COS to convert the projected curve into a curve on surface, and then on the U Loft Surface rollout click Insert to make the new curve on surface the last curve in the U loft. You can scale the curve on surface or move its CVs to get the curvature and blending you want.

## How to Fix NURBS Objects

These are tips on fixing problems with NURBS models.

- If you create a surface but it isn't visible in viewports, click Flip Normals. Flip Normals is available on the surface's creation rollout, or at the Surface sub-object level on the Surface Common rollout.

- If you create a [blend surface](#) on page 2348 and it looks like a bow tie, use Flip End 1 or Flip End 2 to correct the twist.
- If a CV curve gives you unexpected or incorrect results, try reparameterizing it. Click **Reparam.** at the Curve sub-object level. This button is on the CV Curve rollout. In the [Reparameterize dialog](#) on page 2465, choose Chord Length reparameterization.  
If the curve still gives you trouble, try rebuilding it. The Rebuild button is on the same rollout.
- If a blend between a surface and a curve gives you unexpected or incorrect results, try reparameterizing the parent surface. Click **Reparam.** at the Surface sub-object level. This button is on the CV Surface rollout. In the [Reparameterize dialog](#) on page 2465, choose Chord Length reparameterization.
- If you see a seam in a shaded viewport, render the viewport first before you try to fix the seam. What you see in viewports might not be what you get in a render, and the viewport shader is less accurate than the production renderer. Seams in viewports can also result from different [surface approximation settings](#) on page 2469 for the viewport and the renderer, so check these as well.
- If you see gaps between faces in the rendered model, increase the Merge value for the renderer in the surface approximation settings.
- Sometimes gaps between faces appear after you convert a NURBS model into a mesh. (For example, by using [Mesh Select](#) on page 1455.) If this happens, increase the Merge value for the renderer in the [surface approximation](#) on page 2469 settings.
- If you see odd twists in a [1-rail](#) on page 2397 or [2-rail](#) on page 2407 sweep, add more cross sections at the areas of change in the surface. For example, if your rail looks like a box with rounded corners, placing cross sections at the corners helps to control the shape of the sweep. On the other hand, you don't need more cross sections for a rail shaped like an 'S', because the curvature is more constant.
- If a U loft or UV loft doubles back on itself unexpectedly, make sure that all the curves are going in the same direction. Click **Reverse** to change a curve's direction. Use the Start Point spinner to align the curve's initial points.

## How to Improve Performance

These are tips on improving the performance of your NURBS models.

- Avoid using point curves and point surfaces. These are slower than CV curves and CV surfaces. Use the point forms only when you need them for construction; for example, when you use Curve Fit to create a curve that interpolates specific points.
- Use the [nonrelational stack](#) on page 2219 feature in conjunction with the Shaded Lattice toggle to improve performance while you animate your NURBS model.
- Use Transform Degrade to hide surfaces while you are moving, rotating, and scaling NURBS sub-objects. The shortcut Ctrl+X toggles this option. You can use Ctrl+X in the middle of a transform, to turn on degradation if things are happening slowly.
- Turn off the display of dependent surfaces while you are creating new dependent surfaces or moving, rotating, or scaling NURBS sub-objects. The shortcut Ctrl+D toggles dependent surface display.
- Trim holes only when you need to. For example, when you connect an arm to a torso, you don't need to create a hole beneath the arm, as it won't be visible anyway. You can also speed up performance by turning off the Display Trims toggle. The shortcut Shift+Ctrl+T toggles trim display. The trims still appear in renderings.
- For symmetrical models, create only half the geometry, and then mirror it. You can then use a [blend](#) on page 2348 surface or [ruled](#) on page 2374 surface to connect the two halves.
- Restart 3ds Max when performance begins to slow down. If your NURBS model needs to page, then working with it for a long time causes performance to slow. If you notice this, save your work, close 3ds Max, and then restart.
- Convert point surfaces to CV surfaces whenever possible.
- When you use texture surfaces, use the [Edit Texture Surface dialog](#) on page 2453 (click Edit Texture Surface on the [Material Properties rollout](#) on page 2278 ) to rebuild the texture surface with the minimum necessary number of UV rows and columns.
- U lofts are faster than UV lofts.

- Every type of surface is faster if you can make it independent.
- Set the [surface approximation](#) on page 2469 for viewports to use the lowest possible resolution. Set the renderer to use higher resolution, and turn on View Dependent for the renderer so objects far from the camera render more quickly.
- You can customize and save [surface approximation](#) on page 2469 presets by using the [Surface Approximation utility](#) on page 2480 . This utility also lets you set surface approximation values for a selection set of multiple NURBS models.

## Animation, Textures, and Rendering

These are tips about animating NURBS models and using textures with animated NURBS models.

- An easy way to animate a growing surface is to put a [curve point](#) on page 2432 with trimming on a curve, then animate the U position of the curve point, and then use this curve as the rail of a [1-rail sweep](#) on page 2397 . As the trimmed rail grows, so does the sweep surface. (You must trim the curve before you create the sweep surface.)
- If you see gaps between surfaces in rendered images, increase the value of Merge for the renderer in the [surface approximation](#) on page 2469 settings.
- If a texture slides around on the surface during animation, this is because you are using the default Chord-Length parameterization of the texture surface. Select the surface, then on the [Material Properties rollout](#) on page 2278 change the parameterization to User Defined. Now the texture should stick to the surface better.
- Don't use the [UVW Map modifier](#) on page 1849 to apply a texture to an animated NURBS surface.
- If a surface seems to glitter or jump around as you move toward it in an animation, this is because View Dependent tessellation is on (on the [Surface Approximation rollout](#) on page 2469 ) so the tessellation is constantly changing. Usually View Dependent creates no visible changes, but if it does, turn it off.
- If a surface seems to glitter or jump around while it changes during animation, this is because the tessellation is changing as the surface animates. Changing surface approximation (on the Surface Approximation

rollout) to Regular fixes this in all cases. Parametric tessellation also solves this problem for every kind of surface except [U lofts](#) on page 2380 and [UV lofts](#) on page 2390 .

- If the View Dependent setting doesn't seem to be doing much, change the tessellation (on the Surface Approximation rollout) from Curvature to Spatial. You will then get a much more drastic change in face count.
- To get a map to smoothly cover two or more surface without tiling, create another surface whose shape covers and roughly conforms to the original surfaces. Apply the texture to the larger surface. In the [Material Properties rollout](#) on page 2278 for the original surfaces, set Texture Surface to Projected, click Pick Source Surface, and pick the larger surface. Adjust the larger surface to fine-tune the map projection. Hide the larger surface before you render.
- To have different maps on a surface sub-object, use different [mapping coordinates](#) on page 7838 , and multiple [map channels](#) on page 7836 . On the [Material Properties rollout](#) on page 2278 , change the Map Channel value and then turn on Generate Mapping Coordinates. (Each map channel requires its own set of mapping coordinates.)  
NURBS surface sub-objects let you set the map channel directly, and don't require you to apply UVW Map modifiers as other objects do.
- If a map doesn't align to a surface sub-object the way you want it to, on the [Material Properties rollout](#) on page 2278 choose User Defined as the Texture Surface, and then use Edit Texture Points or the Edit Texture Surface dialog to move the points of the texture surface.
- To adjust how the map aligns to the edges of a surface sub-object, use the Texture Corner settings on the [Material Properties rollout](#) on page 2278 .

## NURBS Surfaces

Create panel > Geometry > NURBS Surfaces

Create menu > NURBS > CV Surface/Point Surface

[NURBS](#) on page 7864 surface objects are the basis of NURBS models. The initial surface you create using the Create panel is a planar segment with points or CVs. It is meant simply to be "raw material" for creating a NURBS model. Once you have created the initial surface, you can modify it on the Modify panel by moving CVs or NURBS points, attaching other objects, creating sub-objects, and so on.



There are two kinds of NURBS surfaces:

[Point Surface](#) on page 2192

[CV Surface](#) on page 2195

You can also [create a NURBS surface from a geometric primitive](#) on page 2218

.

NURBS surfaces can contain multiple sub-objects, including NURBS points, NURBS curves, and other NURBS surfaces. These sub-objects are either dependent or independent.

[Creating Curve Sub-Objects](#) on page 2283

[Creating Surface Sub-Objects](#) on page 2337

[Creating and Editing Point Sub-Objects](#) on page 2428

[Common Sub-Object Controls](#) on page 2229

[Editing Point Sub-Objects](#) on page 2231

[Editing Curve CV Sub-Objects](#) on page 2238

[Editing Surface CV Sub-Objects](#) on page 2244

[Editing Curve Sub-Objects](#) on page 2252

[Editing Surface Sub-Objects](#) on page 2264

You can also create NURBS surface sub-objects by [attaching or importing other 3ds Max objects](#) on page 2225 .

Both NURBS curves and NURBS surfaces have a Display area in the General rollout on the Modify panel. These controls affect which portions of the NURBS geometry are displayed. Next to the Display area is the button that turns on the toolbox for creating sub-objects.

[Display Controls for NURBS Models](#) on page 2221

---

**WARNING** When you move CV sub-objects, the effect must be calculated over a region of the surface. Although the calculations are optimized, this is a more involved process than simply moving vertices in an editable mesh. Because of this, if you manipulate large numbers of a NURBS surface's CVs by transforming, animating, applying modifiers, and so on, you will notice a drop in interactive performance.

---

You can use MAXScript to control NURBS objects. See "Working with NURBS in MAXScript" in the MAXScript help file. Choose Help > Additional Help, and then choose MAXScript from the list of additional help files.

## Point Surface

Create panel > Geometry > NURBS Surfaces > Point Surf

Create menu > NURBS > Point Surface

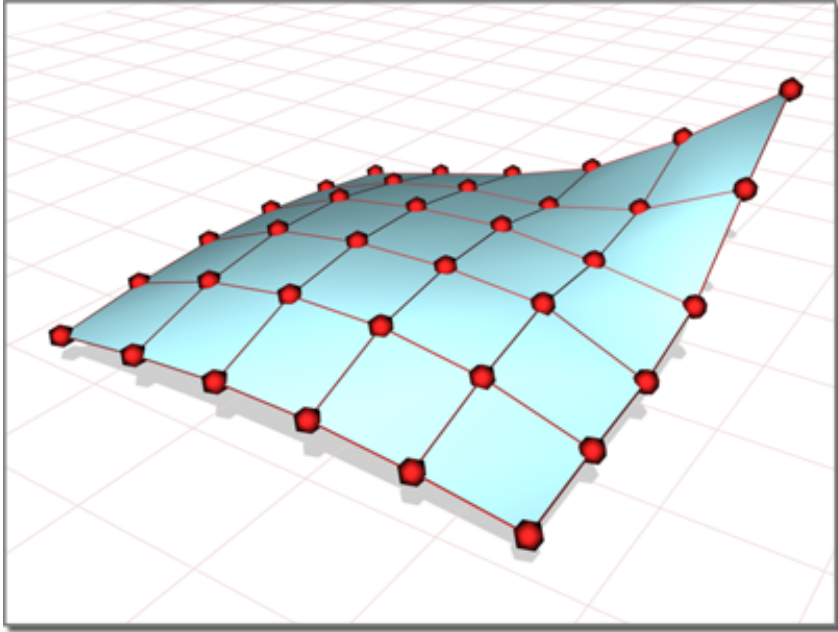

Points shape the surface they lie on.

Point surfaces are [NURBS surfaces](#) on page 2190 whose points are constrained to lie on the surface.

Because an initial NURBS surface is meant to be edited, the surface creation parameters *do not appear* on the Modify panel. In this respect, NURBS surface objects are different from other objects. The Modify panel provides other ways to change the values you set in the Create panel.

### Procedures

To create a point surface:

- 1  Go to the Create panel.

-  Turn on Geometry, and choose NURBS Surfaces from the drop-down list.
- Turn on Point Surf.
- In a viewport, drag to specify the area of the planar segment.
- Adjust the surface's creation parameters.

### Interface

The creation parameters are the same for both point surfaces and CV surfaces, except that the labels indicate which kind of basic NURBS surface you are creating.

### Keyboard Entry rollout

The Keyboard Entry rollout lets you create a point surface by typing. Use the Tab key to move between the controls on this rollout. To click the Create button from the keyboard, press Enter while the button is active.

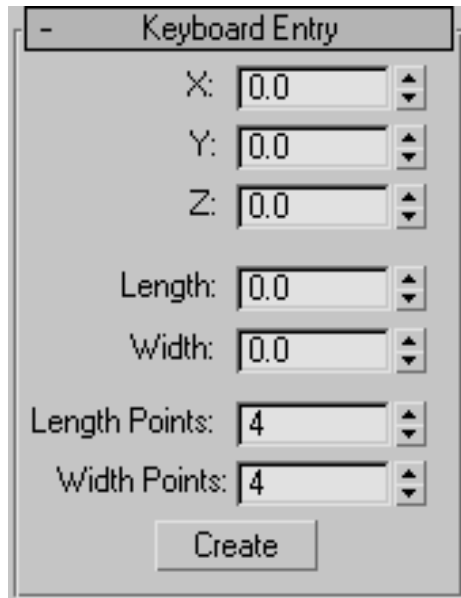

The image shows a dialog box titled "Keyboard Entry" with a close button (-) in the top-left corner. It contains several input fields with spinners on the right side, and a "Create" button at the bottom. The fields are: X: 0.0, Y: 0.0, Z: 0.0, Length: 0.0, Width: 0.0, Length Points: 4, and Width Points: 4.

**X, Y, and Z** Let you enter the coordinates of the center of the surface.

**Length and Width** Let you enter the dimensions of the surface in current 3ds Max units.

**Length Points** Lets you enter the number of points along the length of the surface (this is the initial number of point columns).

**Width Points** Lets you enter the number of points along the width of the surface (this is the initial number of point rows).

**Create** Creates the surface object.

### Create Parameters rollout

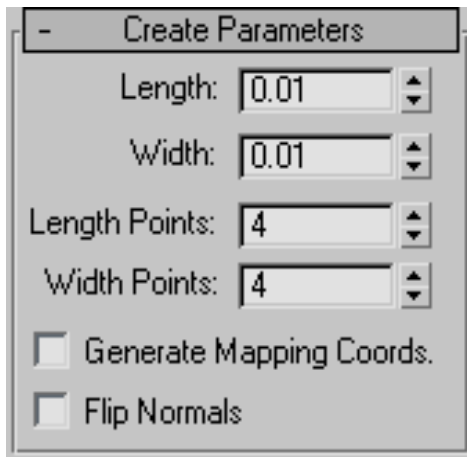

**Length** The length of the surface in current 3ds Max units.

**Width** The width of the surface in current 3ds Max units.

On the Modify panel, the Length and Width spinners are no longer available. You can change the length or width of the surface by scaling the surface at the Surface sub-object level. Moving point sub-objects also alters the length and width of the surface.

**Length Points** The number of points along the length of the surface. In other words, the initial number of point columns in the surface. Range=2 to 50. Default=4.

**Width Points** The number of points along the width of the surface. In other words, the initial number of point rows in the surface. Range=2 to 50. Default=4.

On the Modify panel, the point Length and Width spinners are no longer available. You can change the number of rows and columns by deleting existing

rows and columns, or by adding new rows and columns using the Refine controls at the Point sub-object level.

**Generate Mapping Coordinates** Generates mapping coordinates so you can apply mapped materials to the surface.

The Generate Mapping Coordinates control is present on the Modify panel. It is at the Surface sub-object level.

**Flip Normals** Turn on to reverse the direction of the surface normals.

The Flip Normals control is present on the Modify panel. It is at the Surface sub-object level.

When you modify a point surface, a rollout lets you change its [surface approximation settings](#) on page 2469 .

## CV Surface

Create panel > Geometry > NURBS Surfaces > CV Surf

Create menu > NURBS > CV Surface

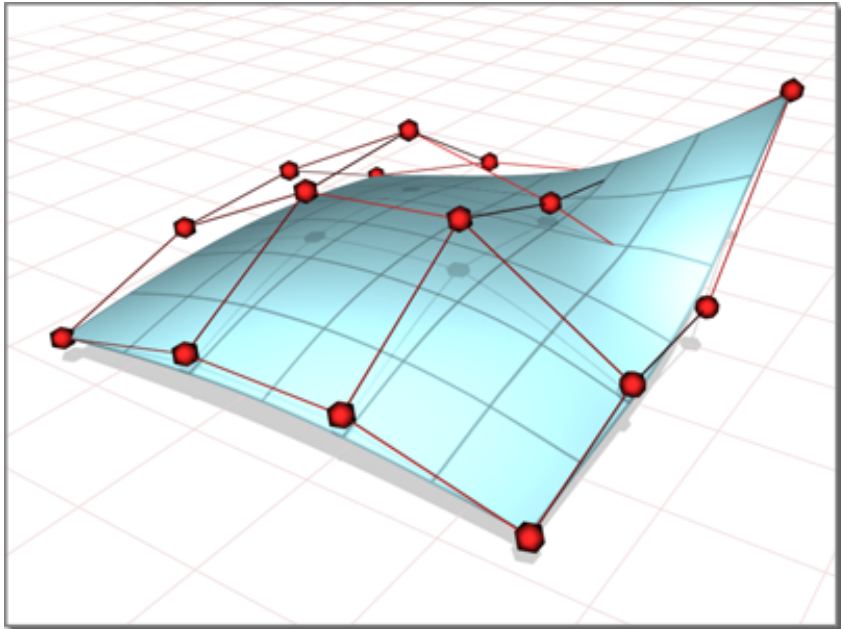



The CVs in a control lattice shape the surface it defines.

CV surfaces are [NURBS surfaces](#) on page 2190 controlled by control vertices ( [CVs](#) on page 7750 ). The CVs don't lie on the surface. They define a [control lattice](#) on page 7745 that encloses the surface. Each CV has a weight that you can adjust to change the shape of the surface.

Because an initial NURBS surface is meant to be edited, the surface creation parameters *do not appear* on the Modify panel. In this respect, NURBS surface objects are different from other objects. The Modify panel provides other ways to change the values you set in the Create panel.

## Procedures

To create a CV surface:

- 1  Go to the Create panel.
- 2  Turn on Geometry, and choose NURBS Surfaces from the drop-down list.
- 3 Turn on CV Surf.
- 4 In a viewport, drag to specify the area of the planar segment.
- 5 Adjust the surface's creation parameters.

---

**NOTE** When you edit a CV surface you can add or move CVs so that more than one CV is at the same location (or close to it) to increase the influence of the CVs in that region of the surface. Two coincident CVs sharpen the curvature. Three coincident CVs create an angular peak in the surface. This technique can help you shape the surface. However, if you later move the CVs individually, you lose this effect. (You can also obtain the influence of multiple CVs by [fusing](#) on page 7794 CVs.)

---

## Interface

The creation parameters are the same for both point surfaces and CV surfaces, except that the labels indicate which kind of basic NURBS surface you are creating.

## Keyboard Entry rollout

The Keyboard Entry rollout lets you create a CV surface by typing. Use the Tab key to move between the controls on this rollout. To click the Create button from the keyboard, press Enter while the button is active.

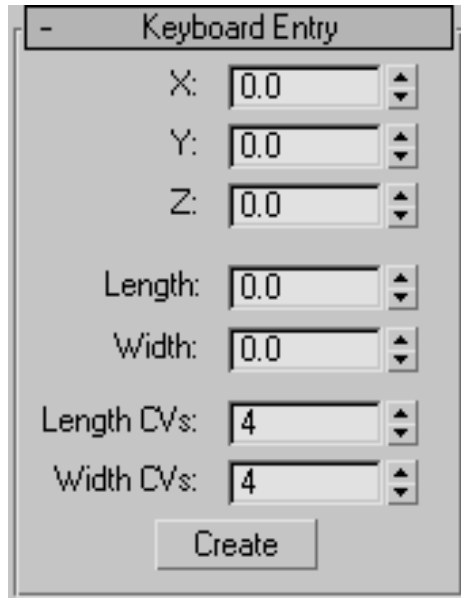

**X, Y, and Z** Let you enter the coordinates of the center of the surface.

**Length and Width** Let you enter the dimensions of the surface, in current 3ds Max units.

**Length CVs** Lets you enter the number of CVs along the length of the surface (this is the initial number of CV columns).

**Width CVs** Lets you enter the number of CVs along the width of the surface (this is the initial number of CV rows).

**Create** Creates the surface object.

## Create Parameters rollout

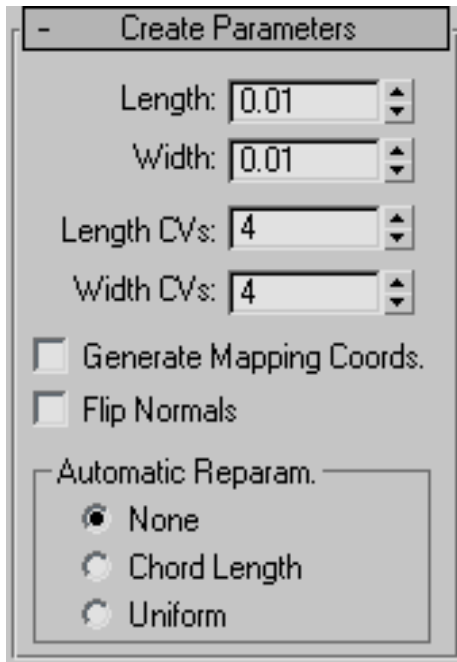

**Length** The length of the surface in current 3ds Max units.

**Width** The width of the surface in current 3ds Max units.

On the Modify panel, the Length and Width spinners are no longer available. You can change the length or width of the surface by scaling the surface at the Surface sub-object level. Moving CV sub-objects also alters the length and width of the surface.

**Length CVs** The number of CVs along the length of the surface. In other words, the initial number of CV columns in the surface. Can range from 4 to 50.

**Width CVs** The number of CVs along the width of the surface. In other words, the initial number of CV rows in the surface. Can range from 4 to 50.

On the Modify panel, the CV Length and Width spinners are no longer available. You can change the number of rows and columns by deleting existing rows and columns, or by adding new rows and columns using the Refine controls at the Surface CV sub-object level.



**Generate Mapping Coordinates** Generates mapping coordinates so you can apply mapped materials to the surface.

The Generate Mapping Coordinates control is present on the Modify panel. It is at the Surface sub-object level.

**Flip Normals** Turn on to reverse the direction of the surface normals.

The Flip Normals control is present on the Modify panel. It is at the Surface sub-object level.

When you modify a CV surface, a rollout lets you change its [surface approximation settings](#) on page 2469 .

### **Automatic Reparameterization group**

The radio buttons in this group box let you choose automatic reparameterization. With reparameterization, the surface maintains its parameterization as you edit it. Without reparameterization, the surface's parameterization doesn't change as you edit it, and can become irregular.

**None** Do not reparameterize.

**Chord Length** Chooses the chord-length algorithm for reparameterization.

Chord-length reparameterization spaces knots (in [parameter space](#) on page 7882 ) based on the square root of the length of each curve segment.

Chord-length reparameterization is usually the best choice.

**Uniform** Spaces the knots uniformly.

A uniform knot vector has the advantage that the surface will change only locally when you edit it. With the other two forms of parameterization, moving any CV can change the entire surface.

## **NURBS Curves**

Create panel > Shapes button > NURBS Curves

**NURBS** on page 7864 curves are [Shape objects](#) on page 536 , and you can use them as you do splines. You can use the Extrude or Lathe modifiers to generate a 3D surface based on a NURBS curve. You can use NURBS curves as the path or the shape of a loft. (Lofts created using NURBS curves are loft objects, *not* NURBS objects.)

You can also use NURBS curves as Path Constraint and Path Deform paths or as motion trajectories.

You can assign thickness to a NURBS curve so it renders as a cylindrical object. (The thickened curve renders as a polygonal mesh, not as a NURBS surface.)



**A curve and the same curve rendered with thickness**

There are two kinds of NURBS curve objects:

[Point Curve](#) on page 2201

[CV Curve](#) on page 2208

Like other Shape objects, NURBS curves can contain multiple sub-objects, which are either dependent or independent.

[Creating Curve Sub-Objects](#) on page 2283

[Creating Surface Sub-Objects](#) on page 2337

[Creating and Editing Point Sub-Objects](#) on page 2428

[Common Sub-Object Controls](#) on page 2229

[Editing Point Sub-Objects](#) on page 2231

[Editing Curve CV Sub-Objects](#) on page 2238

[Editing Surface CV Sub-Objects](#) on page 2244

[Editing Curve Sub-Objects](#) on page 2252

[Editing Surface Sub-Objects](#) on page 2264

---

**NOTE** Like an object-level [NURBS surface](#) on page 2190 , an object-level NURBS curve is a top-level [NURBS model](#) on page 7865 that can contain NURBS curve, NURBS surface, and NURBS point sub-objects. A NURBS curve remains a Shape object unless you add a surface sub-object to it; if you do, it converts to a NURBS surface (without changing its name).

---

[Creating Independent Surfaces from NURBS Curve Objects](#) on page 2216

You can also create NURBS curve sub-objects by attaching or importing other objects such as other NURBS curves or spline shapes.

[Attaching and Importing 3ds Max Objects](#) on page 2225

[Display Controls for NURBS Models](#) on page 2221

Both NURBS curves and NURBS surfaces have a Display area in the Modify panel. These controls affect which portions of the NURBS geometry are displayed. Next to the Display area is the button that turns on the toolbox for creating sub-objects.

## **Point Curve**

Create panel > Shapes button > NURBS Curves > Point Curve button

Create menu > NURBS > Point Curve

Point curves are [NURBS curves](#) on page 2199 whose points are constrained to lie on the curve.

A point curve can be the basis of a full [NURBS model](#) on page 7865 .

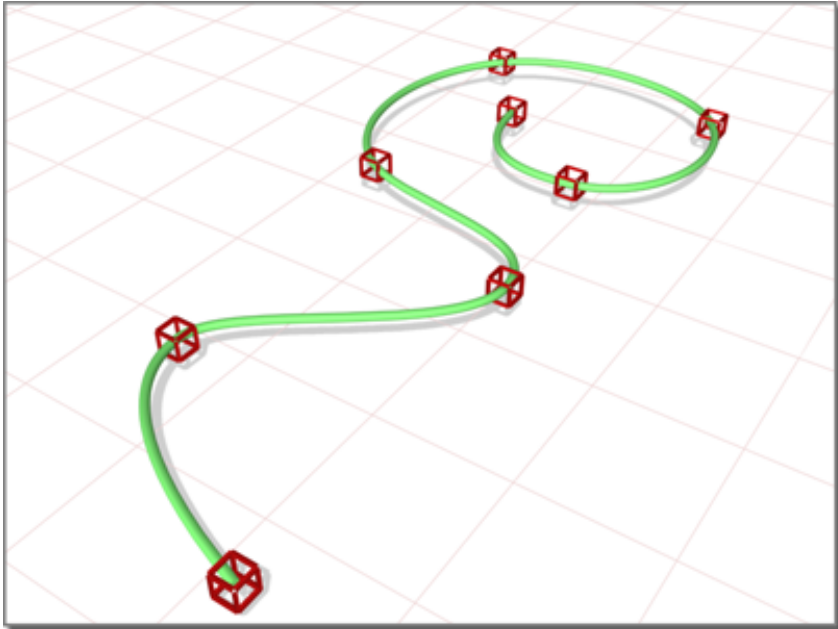

Points lie on the curve they define.

### **Drawing Three-Dimensional Curves**

When you create a point curve, you can draw it in three dimensions. There are two ways to do this:

- **Draw In All Viewports:** This toggle lets you use any viewport to draw the curve, enabling you to draw three dimensionally.
- **Using Ctrl to drag points:** While you draw a curve, you can use the Ctrl key to drag a point off of the construction plane.

With the Ctrl-key method, further mouse movement lifts the latest point off the construction plane. There are two ways to use this:

- **Click-drag.** If you hold down Ctrl and also hold down the mouse button, you can drag to change the height of the point. The point's location is set when you release the mouse button.  
This method is probably more intuitive.



- Click-click. If you Ctrl+click and then release the mouse button, the height changes as you drag the mouse. Clicking the mouse a second time sets the point's location.  
This method is less prone to repetitive stress injury.

While you are offsetting the point, a red dotted line is drawn between the original point on the construction plane and the actual point offset from the plane. You can move the mouse into an inactive viewport, in which case the software sets the height of the point using the point's Z axis in the inactive viewport. This lets you set the height of the point with accuracy.

**Snaps** on page 2578 also work when you change the height of a point. For example, if you turn on Point snapping, you can set a point to have the same height as another point by snapping to that other point in an inactive viewport.

## Procedures

To create a NURBS point curve:

- 1  Go to the Create panel.
- 2  Turn on Shapes, and choose NURBS Curves from the drop-down list.
- 3 Turn on Point Curve.
- 4 In a viewport, click and drag to create the first point, as well as the first curve segment. Release the mouse button to add the second point. Each subsequent location you click adds a new point to the curve. Right-click to end curve creation.

---

**NOTE** If you begin the curve by clicking without dragging, this also creates the curve's first point. However, if you release the mouse button more than five pixels away from where you initially pressed it, this creates an additional point.

---

While you are creating a point curve, you can press Backspace to remove the last point you created, and then previous points in reverse order.

If Draw In All Viewports is on, you can draw in any viewport, creating a 3D curve.

To lift a point off the construction plane, use the Ctrl key as described earlier in this topic under "Drawing Three-Dimensional Curves."

As with splines, if you click over the curve's initial point, a [Close Curve dialog](#) on page 2462 is displayed. This dialog asks whether you want the curve to be closed. Click No to keep the curve open or Yes to close the curve. (You can also close a curve when you edit it at the Curve sub-object level.) When a closed curve is displayed at the Curve sub-object level, the initial point is displayed as a green circle, and a green tick mark indicates the curve's direction.

- 5 Adjust the curve's creation parameters.
- 6 (Optional.) To add a new NURBS curve sub-object, you can turn off the Start New Shape check box, and then repeat the preceding steps.

### **Interface**

The creation parameters are the same for both point curves and CV curves.

## Rendering rollout

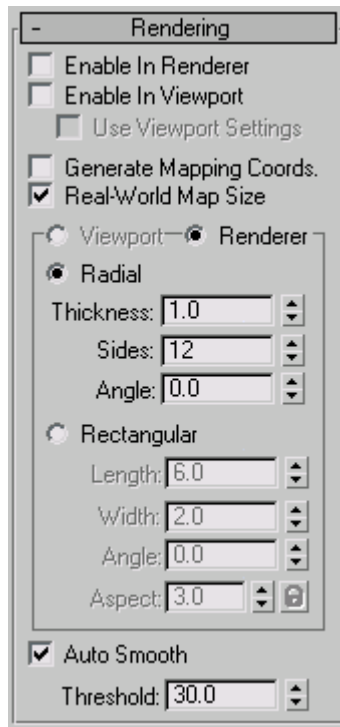

Lets you turn on and off the renderability of the curve, specify its thickness in the rendered scene, and apply mapping coordinates.

Render parameters can be animated. For example, you can animate the number of sides.

**Enable In Renderer** When on, the shape is rendered as a 3D mesh using the Radial or Rectangular parameters set for Renderer. In previous versions of the program, the Renderable switch performed the same operation.

**Enable In Viewport** When on, the shape is displayed in the viewport as a 3D mesh using the Radial or Rectangular parameters set for Renderer. In previous versions of the program, the Display Render Mesh performed the same operation.

**Use Viewport settings** Lets you set different rendering parameters, and displays the mesh generated by the Viewport settings. Available only when Enable in Viewport is turned on.

**Generate Mapping Coords** Turn this on to apply mapping coordinates. Default=off.

The U coordinate wraps once around the thickness of the spline; the V coordinate is mapped once along the length of the spline. Tiling is achieved using the Tiling parameters in the material itself.

**Real-World Map Size** Controls the scaling method used for texture mapped materials that are applied to the object. The scaling values are controlled by the Use Real-World Scale settings found in the applied material's [Coordinates rollout](#) on page 5620 . Default=on.

**Viewport** Turn this on to specify Radial or Rectangular parameters for the shape as it will display in the viewport when Enable in Viewport is turned on.

**Renderer** Turn this on to specify Radial or Rectangular parameters for the shape as it will display when rendered or viewed in the viewport when Enable in Viewport is turned on.

**Radial** Displays the 3D mesh as a cylindrical object.

**Thickness** Specifies the diameter of the viewport or rendered spline mesh. Default=1.0. Range=0.0 to 100,000,000.0.



Splines rendered at thickness of 1.0 and 5.0, respectively

**Sides** Sets the number of sides (or facets) for the spline mesh in the viewport or renderer. For example, a value of 4 results in a square cross section.

**Angle** Adjusts the rotational position of the cross-section in the viewport or renderer. For example, if the spline mesh has a square cross section you can use Angle to position a "flat" side down.

**Rectangular** Displays the spline's mesh shape as rectangular.



**Aspect** Sets the aspect ratio for rectangular cross-sections. The Lock check box lets you lock the aspect ratio. When Lock is turned on, Width is locked to Depth that results in a constant ratio of Width to Depth.

**Length** Specifies the size of the cross-section along the local *Y* axis.

**Width** Specifies the size of the cross-section along the local *X* axis.

**Angle** Adjusts the rotational position of the cross-section in the viewport or renderer. For example, if you have a square cross-section you can use Angle to position a "flat" side down.

**Auto Smooth** If Auto Smooth is turned on, the spline is auto-smoothed using the threshold specified by the Threshold setting below it. Auto Smooth sets the smoothing based on the angle between spline segments. Any two adjacent segments are put in the same smoothing group if the angle between them is less than the threshold angle.

**Threshold** Specifies the threshold angle in degrees. Any two adjacent spline segments are put in the same smoothing group if the angle between them is less than the threshold angle.

### Keyboard Entry rollout

The Keyboard Entry rollout lets you create a NURBS curve by typing. Use the Tab key to move between the controls in this rollout. To click a button from the keyboard, press Enter while the button is active.

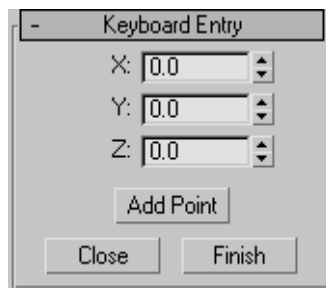

**X, Y, and Z** Let you enter the coordinates of the next point to add.

**Add Point** Adds the point to the curve.

**Close** Ends creation of the curve and creates a segment between the last point and the initial point to close the curve.

**Finish** Ends creation of the curve, leaving it open.

## Create Point Curve rollout

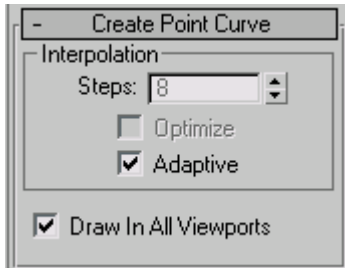

This rollout contains the controls for curve approximation.

### Interpolation group

The controls in this group box change the accuracy and type of [curve approximation](#) on page 2468 used to generate and display the curve.

**Draw In All Viewports** Lets you use any viewport while you are drawing the curve. This is one way to create a 3D curve. When off, you must finish drawing the curve in the viewport where you began it. Default=on.

While Draw In All Viewports is on, you can also use [snaps](#) on page 2578 in any viewport.

## CV Curve

Create panel > Shapes button > NURBS Curves > CV Curve button

Create menu > NURBS > CV Curve

CV curves are [NURBS curves](#) on page 2199 controlled by control vertices ( [CVs](#) on page 7750 ). The CVs don't lie on the curve. They define a [control lattice](#) on page 7745 that encloses the curve. Each CV has a weight that you can adjust to change the curve.

While you're creating a CV curve you can click to create more than one CV at the same location (or close to it), increasing the influence of the CVs in that region of the curve. Creating two coincident CVs sharpens the curvature. Creating three coincident CVs creates an angular corner in the curve. This technique can help you shape the curve; however, if you later move the CVs individually, you lose this effect. (You can also obtain the influence of multiple CVs by [fusing](#) on page 7794 CVs.)

A CV curve can be the basis of a full [NURBS model](#) on page 7865 .

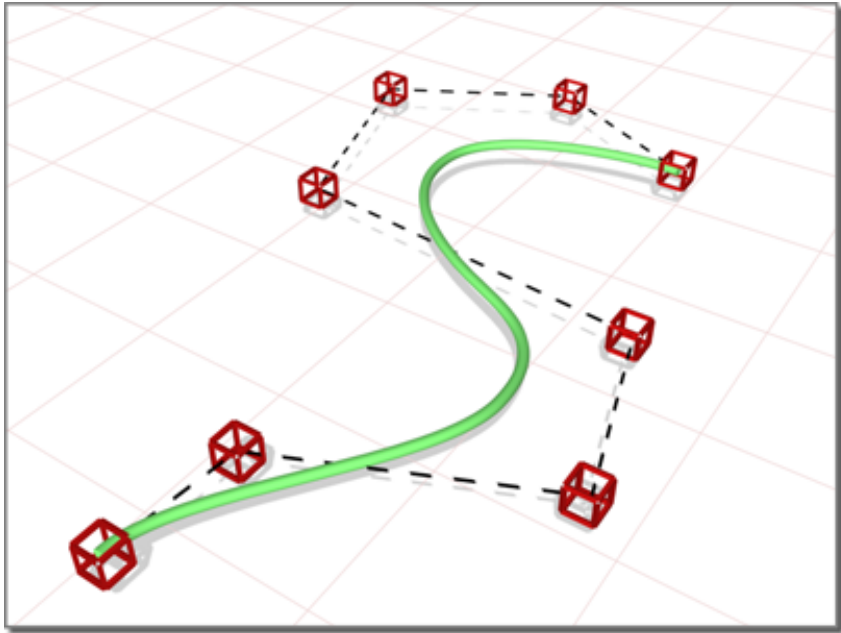

CVs shape the control lattice that defines the curve.

### **Drawing Three-Dimensional Curves**

When you create a CV curve, you can draw it in three dimensions. There are two ways to do this:

- **Draw In All Viewports:** This toggle lets you use any viewport to draw the curve, enabling you to draw three dimensionally.
- **Using Ctrl to drag CVs:** While you draw a curve, you can use the Ctrl key to drag a CV off of the construction plane.

With the Ctrl-key method, further mouse movement lifts the latest CV off the construction plane. There are two ways to use this:

- **Click-drag.** If you hold down Ctrl and also hold down the mouse button, you can drag to change the height of the CV. The CV's location is set when you release the mouse button.  
This method is probably more intuitive.

- Click-click. If you Ctrl+click and then release the mouse button, the height changes as you drag the mouse. Clicking the mouse a second time sets the CV's location.



This method is less prone to repetitive stress injury.

While you are offsetting the CV, a red dotted line is drawn between the original CV on the construction plane and the actual CV offset from the plane. You can move the mouse into an inactive viewport, in which case the software sets the height of the CV using the CV's Z axis in the inactive viewport. This lets you set the height of the CV with accuracy.

[Snaps](#) on page 2578 also work when you change the height of a CV. For example, if you turn on CV snapping, you can set a CV to have the same height as another CV by snapping to that other CV in an inactive viewport.

## Procedures

To create a NURBS CV curve:

- 1  Go to the Create panel.
- 2  Turn on Shapes, and choose NURBS Curves from the drop-down list.
- 3 Turn on CV Curve.
- 4 In a viewport, click and drag to create the first CV, as well as the first curve segment. Release the mouse to add the second CV. Each subsequent location you click adds a new CV to the curve. Right-click to end curve creation.

---

**NOTE** If you begin the curve by clicking without dragging, this also creates the curve's first CV. However, if you release the mouse more than five pixels away from where you initially pressed it, this creates an additional CV.

---

While you are creating a CV curve, you can press **Backspace** to remove the last CV you created, and then previous CVs in reverse order.

If **Draw In All Viewports** is on, you can draw in any viewport, creating a 3D curve.

To lift a CV off the construction plane, use the **Ctrl** key as described earlier in this topic under "Drawing Three-Dimensional Curves."

As with splines, if you click over the curve's initial CV, a [Close Curve dialog](#) on page 2448 is displayed. This dialog asks whether you want the curve to be closed. Click No to keep the curve open or Yes to close the curve. (You can also close a curve when you edit it at the Curve sub-object level.) When a closed curve is displayed at the Curve sub-object level, the initial CV is displayed as a green circle, and a green tick mark indicates the curve's direction.

- 5 Adjust the curve's creation parameters.
- 6 (Optional) To add a new NURBS curve sub-object, you can turn off the Start New Shape check box, and then repeat the preceding steps.

## Interface

The creation parameters are the same for both point curves and CV curves.

## Rendering rollout

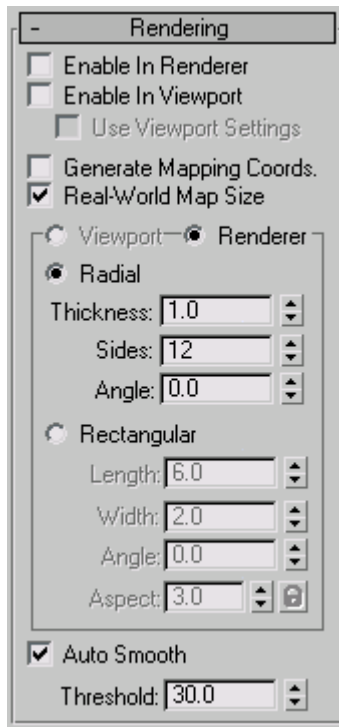

**Enable In Renderer** When on, the shape is rendered as a 3D mesh using the Radial or Rectangular parameters set for Renderer. In previous versions of the program, the Renderable switch performed the same operation.

**Enable In Viewport** When on, the shape is displayed in the viewport as a 3D mesh using the Radial or Rectangular parameters set for Renderer. In previous versions of the program, the Display Render Mesh performed the same operation.

**Use Viewport settings** Lets you set different rendering parameters, and displays the mesh generated by the Viewport settings. Available only when Enable in Viewport is turned on.

**Generate Mapping Coords** Turn this on to apply mapping coordinates. Default=off.

The U coordinate wraps once around the thickness of the spline; the V coordinate is mapped once along the length of the spline. Tiling is achieved using the Tiling parameters in the material itself.

**Real-World Map Size** Controls the scaling method used for texture mapped materials that are applied to the object. The scaling values are controlled by the Use Real-World Scale settings found in the applied material's [Coordinates rollout](#) on page 5620 . Default=on.

**Viewport** Turn this on to specify Radial or Rectangular parameters for the shape as it will display in the viewport when Enable in Viewport is turned on.

**Renderer** Turn this on to specify Radial or Rectangular parameters for the shape as it will display when rendered or viewed in the viewport when Enable in Viewport is turned on.

**Radial** Displays the 3D mesh as a cylindrical object.

**Thickness** Specifies the diameter of the viewport or rendered spline mesh. Default=1.0. Range=0.0 to 100,000,000.0.



**Splines rendered at thickness of 1.0 and 5.0, respectively**

**Sides** Sets the number of sides (or facets) for the spline mesh in the viewport or renderer. For example, a value of 4 results in a square cross section.

**Angle** Adjusts the rotational position of the cross-section in the viewport or renderer. For example, if the spline mesh has a square cross section you can use Angle to position a "flat" side down.

**Rectangular** Displays the spline's mesh shape as rectangular.

**Aspect** Sets the aspect ratio for rectangular cross-sections. The Lock check box lets you lock the aspect ratio. When Lock is turned on, Width is locked to Depth that results in a constant ratio of Width to Depth.

**Length** Specifies the size of the cross-section along the local  $Y$  axis.

**Width** Specifies the size of the cross-section along the local  $X$  axis.

**Angle** Adjusts the rotational position of the cross-section in the viewport or renderer. For example, if you have a square cross-section you can use Angle to position a "flat" side down.

**Auto Smooth** If Auto Smooth is turned on, the spline is auto-smoothed using the threshold specified by the Threshold setting below it. Auto Smooth sets the smoothing based on the angle between spline segments. Any two adjacent segments are put in the same smoothing group if the angle between them is less than the threshold angle.

**Threshold** Specifies the threshold angle in degrees. Any two adjacent spline segments are put in the same smoothing group if the angle between them is less than the threshold angle.



A curve and the same curve rendered with thickness

### Keyboard Entry rollout

The Keyboard Entry rollout lets you create a NURBS curve by typing. Use the Tab key to move between the controls in this rollout. To click a button from the keyboard, press Enter while the button is active.

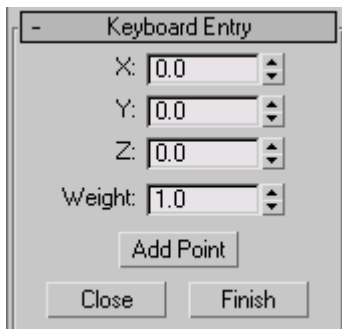

**X, Y, and Z** Let you enter the coordinates of the next CV to add.

**Add Point** Adds the CV to the curve.

**Weight** Enter a weight for the CV.

**Close** Ends creation of the curve and creates a segment between the last CV and the initial CV, to make the curve a closed curve.

**Finish** Ends creation of the curve, leaving it open ended.



## Create CV Curve rollout

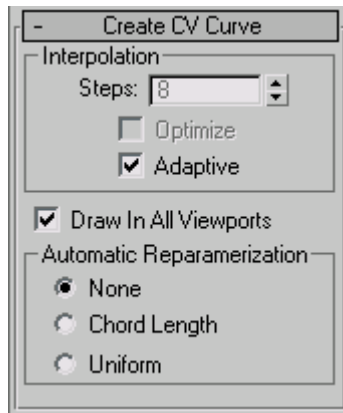

This rollout contains the controls for curve approximation.

### Interpolation group

The controls in this group box change the accuracy and kind of [curve approximation](#) on page 2468 used to generate and display the curve.

**Draw In All Viewports** Lets you use any viewport while you are drawing the curve. This is one way to create a 3D curve. When off, you must finish drawing the curve in the viewport where you began it. Default=On.

While Draw In All Viewports is on, you can also use [snaps](#) on page 2578 in any viewport.

### Automatic Reparameterization group

The controls in this group box let you specify automatic reparameterization. They are similar to the controls in the [Reparameterize dialog](#) on page 2465 , with one addition: all choices except for None tell the software to reparameterize the curve automatically; that is, whenever you edit it by moving CVs, refining, and so on.

**None** Do not reparameterize automatically.

**Chord Length** Chooses the chord-length algorithm for reparameterization.

Chord-length reparameterization spaces knots (in [parameter space](#) on page 7882 ) based on the square root of the length of each curve segment.

Chord-length reparameterization is usually the best choice.

**Uniform** Spaces the knots uniformly.

A uniform knot vector has the advantage that the curve or surface changes only locally when you edit it. With the other two forms of parameterization, moving any CV can change the entire sub-object.

## Creating NURBS Curve and Surface Objects

### Creating Independent Surfaces from NURBS Curve Objects

To create independent surfaces from top-level NURBS curve objects, use the [Extrude](#) on page 1377 and [Lathe](#) on page 1430 modifiers. Extrude adds height to the curve, creating a shape by sweeping it along the curve's local Z axis. Lathe creates a surface of rotation, revolving the shape along a specified axis. You can also use the [Bevel](#) on page 1142 and [Bevel Profile](#) on page 1150 modifiers on NURBS curves.

These modifiers treat NURBS curves the same way they treat [shapes](#) on page 536 . The advantage of using NURBS curves instead of shapes is in the different possible shapes that NURBS geometry and editing provide.

---

**TIP** When you create a complicated surface, especially with the Lathe modifier, you often want to render both sides of the surface. Turn on Force 2-Sided in the Render Scene dialog to see both sides of the extruded or lathed surface. To see both sides in viewports, turn on Force 2-Sided in the Viewport Configuration dialog.

---

By default, an object with Extrude or Lathe collapses to an [editable mesh](#) on page 1990 object. To have Extrude or Lathe output collapse to a NURBS object, change the setting to NURBS in the Output group box of the Extrude or Lathe rollout, and then collapse the [modifier stack](#) on page 7427 .

### Creating NURBS Curves from Splines

Select Spline object. > Modify panel > Right-click the spline name. > Convert To: NURBS

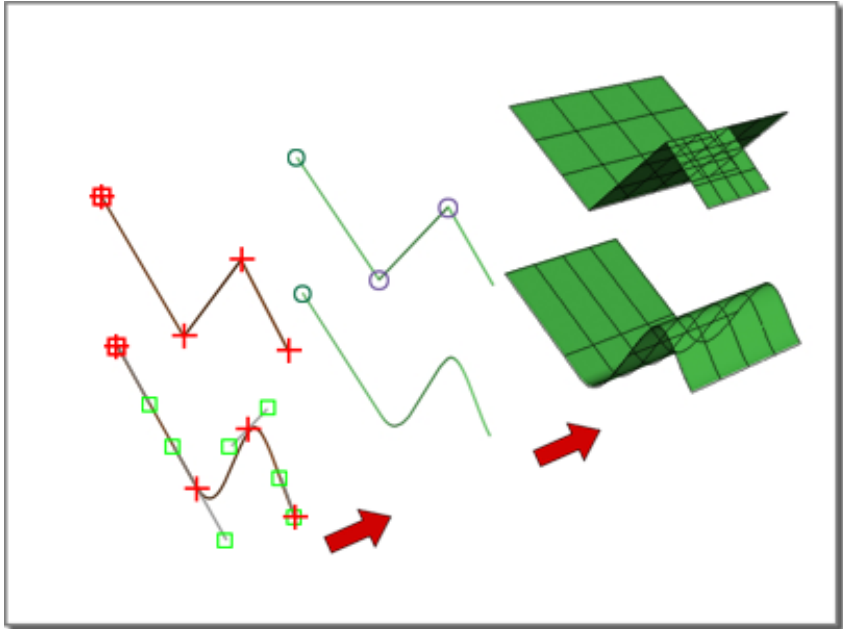

**Splines become NURBS curves that then become NURBS surfaces.**

You can turn a [spline](#) on page 542 into a NURBS object formed of [CV curves](#) on page 2199 . Once converted, you can no longer edit the spline shape parametrically, but you can edit it as a NURBS object, moving CVs and so on.

When you convert a spline [circle](#) on page 557 to a NURBS curve, the direction of the curve is reversed. This facilitates using the curve to trim a surface: if the direction weren't reversed, usually the circle would trim outward instead of inward.

### **Procedures**

**To turn a spline into NURBS curves:**

- 1 Create the spline.

- 2  Go to the Modify panel.

- 3 In the stack display, right-click the name of the spline.

- 4 On the pop-up menu, choose Convert To: NURBS.

The spline is converted to one or more CV curves.

Smoothly curved splines, such as circles and arcs, convert to a single CV curve.

Splines with sharp angles, such as rectangles and stars, convert to multiple CV curves whose endpoints are at the angles in the original spline. These endpoints are fused except for the initial CV in the spline (for a star, the initial segment is unfused at both ends).

"Sharp angles" doesn't apply to smooth splines to which you have given angles by changing vertex tangents using the [Edit Spline](#) on page 1376 modifier. These still convert to a single NURBS curve.

## Creating NURBS Surfaces from Geometric Primitives

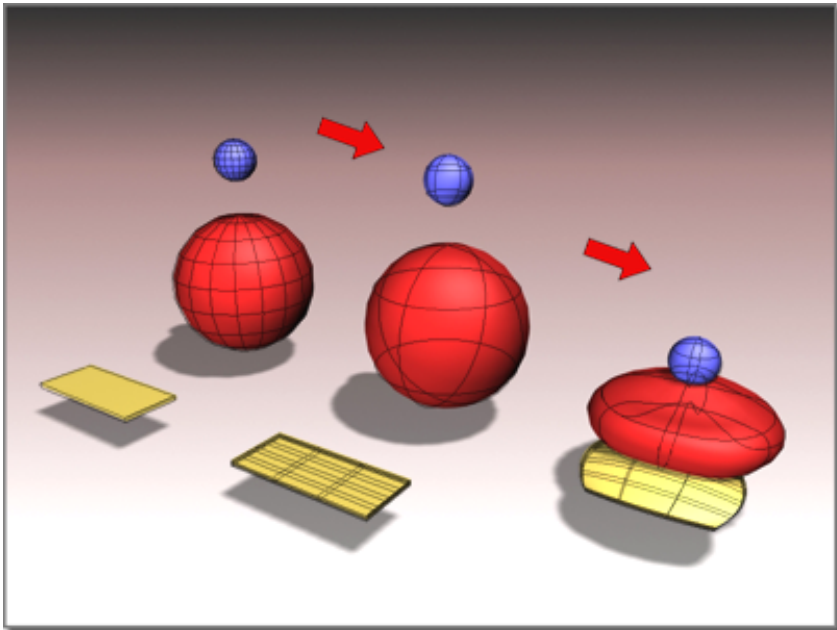

Primitive objects become NURBS surfaces that you can then edit in various ways.

You can turn a [standard primitive](#) on page 348 into a NURBS object formed of [CV surfaces](#) on page 2340. Once converted, you can no longer edit the object parametrically, but you can edit it as a NURBS object, moving CVs and so on.

You can't convert most extended primitive objects in this way, but you can convert the [torus knot](#) on page 389 and [prism](#) on page 423 extended primitives to NURBS objects.

You can also convert [patch](#) on page 1982 objects and [loft](#) on page 715 compound objects.

## Tips

- Geospheres are good for creating rounded models with no sharp edges.
- Boxes are good for creating models that have sharp edges.
- Flattened cones work well for models whose contours are roughly triangular.

If the primitive is closed, the converted surface is a closed CV surface, which has no visible seams. Also, relational [cap surfaces](#) on page 2377 are used to cap surfaces that aren't closed.

## Procedures

### To turn a primitive into a NURBS object:

- 1 Create the primitive object.

- 2  Go to the Modify panel.

- 3 In the stack display, right-click the name of the object.

- 4 On the pop-up menu, choose Convert To: NURBS.

The object is converted to one or more CV surfaces. The surfaces can be independent surface sub-objects, or dependent surface sub-objects such as Lathe.

## Nonrelational NURBS Surfaces

Select NURBS object. > Modify panel > General rollout > Relational Stack toggle

Nonrelational NURBS surfaces provide a way to improve the performance of NURBS with modifiers. These are controlled by the Relational Stack toggle on the General rollout for NURBS objects.

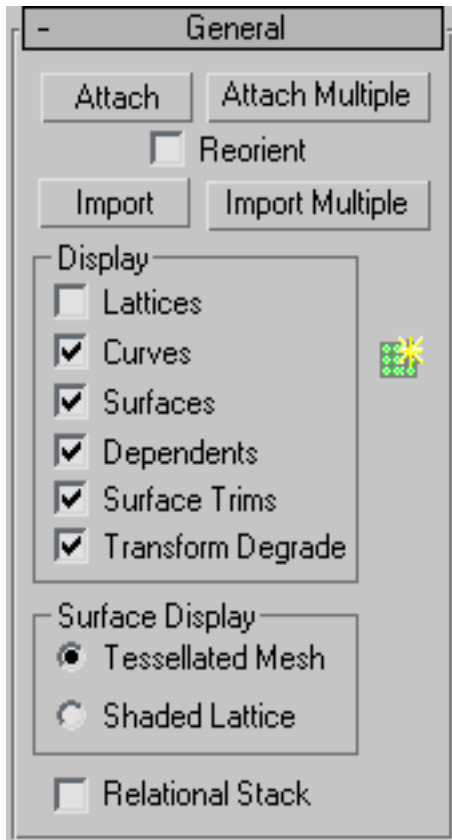

When Relational Stack is on, NURBS maintain full relational modeling on the [modifier stack](#) on page 7427 . When this toggle is off (the default), then using the modifier stack converts surfaces into independent CV surfaces before applying modifiers. Surfaces on the stack behave in a nonrelational way. If your NURBS model contains no dependent surfaces, then it behaves the same on the stack regardless of the Relational Stack setting. However, the results are still faster if Relational Stack is turned off.

When Relational Stack is off, there is no overhead of copying the data from the relational model, and no need to compute the relational surfaces, so performance is faster.

---

**TIP** To improve performance still further, display surfaces as shaded lattices (see [Display Controls for NURBS Models](#) on page 2221 ). With Relational Stack off and Shaded Lattice chosen, NURBS objects perform on the stack about as well as mesh objects do.

---

## Procedures

### To use nonrelational NURBS surfaces:

- 1 Make sure Relational Stack is off and Shaded Lattice is chosen.
- 2 Set up your modifiers and animation.
- 3 If your model has only independent CV surfaces, you can render it now. If it has relational surfaces such as blends or lofts, then before you render, choose the NURBS model at the bottom of the stack, and turn on Relational Stack.

When you return to the top of the modifier stack, performance is slower but dependent surfaces are accurate. The modified NURBS model looks different than it did with the nonrelational stack. Usually the difference in appearance isn't great, but the nonrelational stack can show anomalies such as cracks between Blend surfaces.

## Display Controls for NURBS Models

Modify panel > Select NURBS object. > General rollout > Display group, Surface Display group, and NURBS Creation Toolbox button

Modify panel > Select NURBS object. > Right-click in viewport. > Display commands on the Tools 1 (upper-left) quadrant of the quad menu

The check boxes on the General rollout for a NURBS curve or surface control how the object is displayed in viewports. If all check boxes are turned off, the NURBS object is invisible (except for the white bounding-box indicators displayed in shaded viewports when the object is selected).

An additional rollout, [Display Line Parameters](#) on page 2224 , contains controls for how surfaces display in viewports.

## Interface

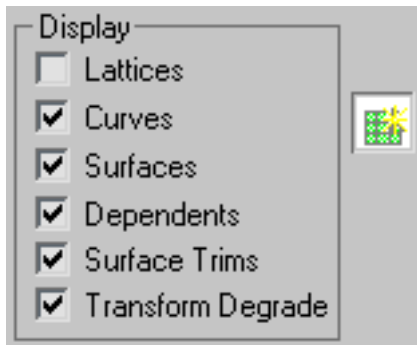

### Display group

**Lattices** When on, displays control lattices in yellow lines. (You can change the lattice color using the [Colors panel](#) on page 7505 of the Customize User Interface dialog.) The Curve CV and Surface CV sub-object levels also have a local Display Lattice toggle, which overrides this global setting at the sub-object level. The Curve CV and Surface CV settings are independent. In other words, at the sub-object level you can turn on the lattice for an object's curves but not its surfaces, or vice versa.

Keyboard shortcut (while Keyboard Shortcut Override Toggle is on): Ctrl+L

At the object level, this shortcut is equivalent to turning Lattice on or off. At the sub-object level, Ctrl+L overrides the setting of Lattice, toggling the local Display Lattice setting.

**Curves** When on, displays curves.

Keyboard shortcut (while Keyboard Shortcut Override Toggle is on): Ctrl+Shift+C

**Surfaces** When on, displays surfaces.

Keyboard shortcut (while Keyboard Shortcut Override Toggle is on): Ctrl+Shift+S

**Dependents** When on, displays dependent sub-objects.

Keyboard shortcut (while Keyboard Shortcut Override Toggle is on): Ctrl+D

**Surface Trims** When on, displays [surface trimming](#) on page 2156. When turned off, displays the entire surface, even if it's trimmed.

Keyboard shortcut (while Keyboard Shortcut Override Toggle is on): Ctrl+Shift+T



**Transform Degrade** When on, transforming a NURBS surface can degrade its display in shaded viewports, to save time. This is similar to the [Degradation Override](#) on page 83 button for playing animations. You can turn off this toggle so surfaces are always shaded while you transform them, but transforms can take longer.

Keyboard shortcut (while Keyboard Shortcut Override Toggle is on): Ctrl+X

---

**TIP** You can toggle Ctrl+X during a transform, as well as before you begin the transform.

---



**NURBS Creation Toolbox** Turn on to display the NURBS sub-object creation toolbox. See [Using the NURBS Toolbox to Create Sub-Objects](#) on page 2162 .

Keyboard shortcut (while Keyboard Shortcut Override Toggle is on): Ctrl+T

### Surface Display group



This group box, for surfaces only, lets you choose how to display surfaces in viewports.

**Tessellated Mesh** When chosen, NURBS surfaces display as fairly accurate tessellated meshes in shaded viewports. In wireframe viewports, they appear as either iso curves or wire meshes, depending on the settings you've chosen on the [Display Line Parameters rollout](#) on page 2224 .

**Shaded Lattice** When chosen, NURBS surfaces appear as shaded lattices in shaded viewports. Wireframe viewports display the surface's lattice without shading. A shaded lattice shades the CV [control lattice](#) on page 7745 of the NURBS surface. This displays more quickly than a tessellated mesh. The shading is not accurate. It gives you a fairly good idea of lofts, but is less accurate for free-form surfaces. The shading is always as large or larger than the actual surface, because of the [convex hull property](#) on page 7747 .

Shaded lattice display doesn't show [surface trimming](#) on page 2156 or texture mapping.

---

**TIP** Shaded Lattice is a good option to choose when you use the modifier stack with [nonrelational NURBS surfaces](#) on page 2219 .

---

Keyboard shortcut: Alt+L

(You can use this keyboard shortcut without having to turn on the Keyboard Shortcut Override Toggle.)

## Display Line Parameters for NURBS Surfaces

Select NURBS object. > Modify panel > Display Line Parameters rollout

These parameters are contained on a single rollout at the top level of a NURBS object.

### Interface

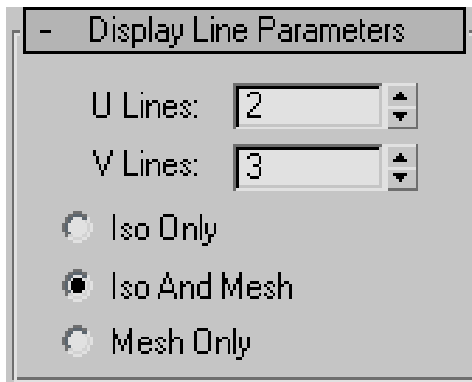

**U Lines and V Lines** The number of lines used to approximate the NURBS surface in viewports, along the surface's local U and V dimensions, respectively. Reducing these values can speed up the display of the surface, but reduce accuracy of the display. Increasing these values increases accuracy at the expense of time. Setting one of these values to 0 displays only the edge of the object in the corresponding dimension.

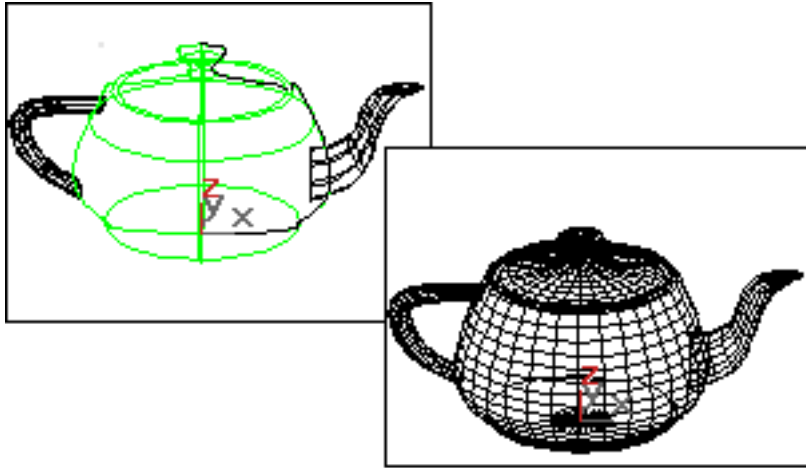

Iso and mesh displays of a NURBS teapot

**Iso Only** When chosen, all viewports display [iso line](#) on page 7822 representations of the surface. Iso(parametric) lines are similar to contour lines. The lines show where the NURBS surface has a constant U value or V value or both. Iso line representations can be less crowded and easier to visualize than wire mesh representations.

**Iso and Mesh** (The default.) When chosen, wireframe viewports display iso line representations of the surface, and shaded viewports display the shaded surface.

**Mesh Only** When chosen, wireframe viewports display the surface as a wire mesh, and shaded viewports display the shaded surface. In wireframe viewports, this option lets you see the [surface approximation](#) on page 2469 used for viewports.

## Creating and Editing NURBS Sub-Objects

### Attaching and Importing 3ds Max Objects

Modify panel > Select NURBS object. > General rollout > Attach button, Import button, and related controls

There are two ways to bring other 3ds Max objects into a NURBS object:

- **Attach**, which works like Attach for meshes and splines. It converts the attached object to NURBS format. Once the object is attached, you can edit it as a NURBS surface or curve. However, the attached object's history is lost.

---

**NOTE** For NURBS surfaces, you can attach other NURBS objects, [standard primitive](#) on page 348 objects, or [quad patch](#) on page 1984 and [tri patch](#) on page 1987 surfaces. The patch is converted to a NURBS surface. Quad patches convert more successfully than Tri Patches. A converted Tri Patch has a collapsed internal edge, which gives irregular results when you manipulate its mesh.

---

When you convert a spline [circle](#) on page 557 to a NURBS curve, the direction of the curve is reversed. This facilitates using the curve to trim a surface: if the direction weren't reversed, usually the circle would trim outward instead of inward.

- **Import**, which works somewhat like the operand of a [Boolean](#) on page 686. The object is brought into the NURBS object without losing its history. You can select the imported object as a sub-object.

## Using Imports

Here are reasons to use Import instead of Attach:

- To maintain parametric control over primitives.  
For example, if you import a sphere, you can change its radius directly, which you can't do after using Attach.
- To use Bezier splines as NURBS curves.  
For example, if you want to use a Bezier spline as a curve in a NURBS model, import it. This allows you to edit it as a Bezier spline, and not as a NURBS curve.

Surfaces and curves created by an import are available in the NURBS model. For example, if you import a box, you can create a blend surface between one of its polygons and another surface in your NURBS object.

Once you have imported an object, the NURBS object has an Imports sub-object level. When you select an import, it is highlighted in red.

It is an error to apply a modifier to an import when the modifier converts the import into something that can't be converted to a NURBS object. For example, if you import a sphere and apply a [Bend](#) on page 1139 to it, the sphere converts

to an editable mesh, which can't automatically convert to a NURBS surface. In this case, the import sub-object is in an error state, and it is displayed in the error color (orange by default).

Imports are displayed in two different ways. While you work at the NURBS object level or at a sub-object level other than Imports, imports are displayed as NURBS curves or surfaces, and use the NURBS object's mesh tessellation (see [Surface Approximation](#) on page 2469 ). However, at the Imports sub-object level, the selected import is displayed using its native display format. In other words, it displays as it would if it were a top-level object. This is because the display must let you edit the imported object. For example, an imported Bezier spline needs to display its tangent handles. This wouldn't be possible if it were displayed as a converted NURBS curve. Leaving the Imports sub-object level returns to NURBS-style display.

You can extract an imported object. This creates an independent, top-level object again.

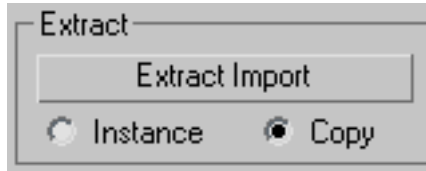

## Procedures

### To attach or import an object to a NURBS object:

- 1  Select the NURBS object and go to the Modify panel.
- 2 (Optional.) Turn on Reorient if you want to reorient and align the import with the center of the NURBS object.
- 3 Turn on Attach or Import.

---

**NOTE** At this step, you can click Attach Multiple or Import Multiple instead. These buttons open a [Select From Scene dialog](#) on page 168 so you can choose multiple objects to attach or import.

---

- 4 Click the object to attach or import.  
The mouse cursor changes shape to indicate a valid object. You can attach curves, NURBS surfaces, or objects convertible to NURBS.

### To extract an imported object:

- 1 Go to the Imports sub-object level and select the object to extract.
- 2 Click Extract Import on the Import sub-object rollout.

If Copy is set (the default), the extracted object is a top-level copy of the imported object. If Instance is set, the extracted object is an instance of the imported object. Initially the extracted object occupies the same space as the imported object: you must move either the extracted object, the import sub-object, or the whole NURBS model before you can see the extracted object.

### Interface

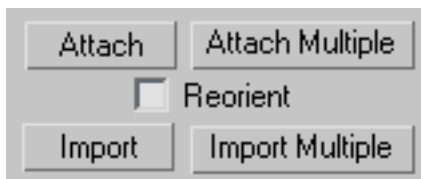

### Attach and Import controls

**Attach** Lets you attach another object to the NURBS object. Click to turn on Attach, and then click the object to attach. If the object you're attaching isn't already a NURBS object, it is converted to one or more NURBS curves or surfaces that are sub-objects of the object you're modifying.

**Attach Multiple** Lets you attach multiple objects to the NURBS surface. Opens a version of the [Select From Scene dialog](#) on page 168, listing the objects that can be attached. Use the dialog controls to select one or more objects by name, and then click Attach.

**Reorient** Moves and reorients the object you are attaching or importing so its creation local coordinate system is aligned with the creation local coordinate system of the NURBS object.

**Import** Lets you import another object to the NURBS object. Works the same way Attach does, but the imported object retains its parameters and modifiers.

**Import Multiple** Lets you import multiple objects. Works the same way Attach Multiple does, but the imported objects retain their parameters and modifiers.

## Common Sub-Object Controls

Many controls are common to the various kinds of sub-objects in NURBS models (with the exception of [Imports](#) on page 2225 ). This topic introduces the controls that are common to most NURBS sub-objects.

See also:

- [Editing Point Sub-Objects](#) on page 2231
- [Editing Curve CV Sub-Objects](#) on page 2238
- [Editing Surface CV Sub-Objects](#) on page 2244
- [Editing Curve Sub-Objects](#) on page 2252
- [Editing Surface Sub-Objects](#) on page 2264

### Transforming Sub-Objects

One way to alter a NURBS model is to transform its sub-objects. Transforming lets you interactively change the model's curvature and shape. Transforming points or CVs is especially useful for adjusting the shape of a NURBS curve or surface.

You can also Shift+Clone most kinds of sub-objects, except CVs. For curves and surfaces, Shift+Cloning displays a [Sub-Object Clone Options dialog](#) on page 2466 , which lets you reduce relational dependencies to improve performance.

### Selection Controls

There is a Selection group box on the rollout for all NURBS sub-objects except Imports. The buttons in this group let you control which sub-objects to select. The selection buttons let you select sub-objects individually, or multiple sub-objects at once. For example, Surface CV selection buttons give you the option of selecting individual CVs, or selecting a row of CVs on the surface, and so on.

---

**NOTE** There is no delete modifier for NURBS curves as there is for splines. There is a NURBS selection modifier, [NSurf Sel](#) on page 1513 . See [NURBS and Modifiers](#) on page 2172 .

---

Selection controls also include a Name field that lets you customize the name of individual NURBS sub-objects other than CVs. (The Name field is the only selection control for Import sub-objects.)

### **Visibility**

You can hide or unhide NURBS sub-objects as you do other objects. Hidden sub-objects are invisible in viewports, but remain renderable. (At the sub-object level, hiding doesn't affect the renderer.) You can't select hidden sub-objects. Hide and unhide by name is available for curve and surface sub-objects.

### **Make Independent**

You can make a dependent point, curve, or surface sub-object independent.

---

**WARNING** When you make an object independent, you lose the animation controllers for all objects that depend on it in turn. When you make point objects independent, you lose the animation controllers for all points on the curve or surface. Also, if you make a curve that trims a surface independent, you lose the trimming of the surface.

---

### **Remove Animation**

All sub-object rollouts have a Remove Animation button. This removes animation controllers from the selected sub-objects.

### **Detach and Copy**

You can create a new curve or surface object by detaching a curve or surface sub-object from a NURBS model. To do so, select the curve or surface and then click Detach. A dialog is displayed, which lets you enter a name for the new NURBS object. The new object is no longer part of the original NURBS object.

You can also use the Detach button to create a new NURBS object that is a copy of a curve or surface sub-object. To do so, select the curve or surface, and click to turn on Copy before you click Detach. A dialog is displayed, which lets you enter a name for the new object. The original curve or surface sub-object remains part of the NURBS object you were editing, but the copied curve or surface is now a NURBS object of its own.

**Relational** This toggle affects dependent objects. When off, detaching a dependent sub-object makes it an independent object. For example, detaching a U loft converts it to a CV surface. When on, detaching a dependent sub-object



also detaches the objects it depends on, so the object remains dependent. For example, detaching a U loft also detaches the curves that define it.

## Editing Point Sub-Objects

Modify panel > Select NURBS object or sub-object. > Point sub-object level > Select point sub-objects.

Modify panel > Select NURBS object or sub-object. > Right-click. > Tools 1 (upper-left) quadrant > Sub-objects > Point > Select point sub-objects.

This topic describes the controls for point sub-objects. A rollout labeled Point contains the point sub-object controls for NURBS models. In addition to the Point rollout described here, the Point sub-object level displays the [Soft Selection rollout](#) on page 2275 .

### Procedures

#### To transform point sub-objects:

- 1 At the Point sub-object level, select one or more points.  
The sub-object selection tools are the same as for other kinds of sub-objects. You can also use the H key while the [Keyboard Shortcut Override toggle](#) on page 7646 is on. See [Sub-Object Selection](#) on page 2164 .  
The Selection group box, described under "Interface" later in this topic, provides some additional options for selecting Point sub-objects.
- 2 Turn on Move or another transform and then drag in a viewport to transform the selection.  
The shape of the model changes as you interactively transform the points. Rotate and Scale are useful only when you've selected multiple points.

### Tips

-  The Lock Selection Set button is useful when you transform NURBS point sub-objects. You can make a selection in one viewport, click Lock Selection Set (or press the Spacebar), and then transform the selection in a different viewport.

- When you move point sub-objects, move them as systematically as possible to avoid "getting lost."
- On surfaces, avoid moving points so they cross over or under adjacent points. This can create odd-looking warps or overlaps in the surface.

**To Shift+Clone a point sub-object:**

- Hold down Shift while you transform the point.  
This works only for points that lie on curves or surfaces, independent [point](#) on page 2429 sub-objects, and [curve point](#) on page 2432 or [surface point](#) on page 2435 sub-objects that lie on the curve or surface (that is, that aren't displaced).

**To use the keyboard to select point sub-objects:**

You can select point sub-objects using the Ctrl key and the arrow keys. The arrows traverse the sub-objects in the order they were created. To do so, follow these steps:



- 1 Turn on the Keyboard Shortcut Override Toggle.
- 2 Click or drag to select points.
- 3 Hold down Ctrl and use the arrow keys to move among the point sub-objects.  
For points on curves, the arrow keys traverse the point selection along the length of the curve. The arrow keys don't move between curve sub-objects.  
For points on surfaces, the left and right arrow keys traverse the U dimension of a surface, while the up and down arrow keys traverse the V dimension of the surface. The arrow keys don't move between surface sub-objects.  
The arrow keys don't traverse individually created points that aren't part of a curve or surface.

You can also use the H keyboard shortcut (while the Keyboard Shortcut Override Toggle is on) to display a dialog and select points by name. Ctrl+H displays only the names of points directly beneath the mouse cursor.

**To remove a point from a curve:**

- 1 Select a point.
- 2 In the Delete group box, click Point.  
Keyboard shortcut: Delete  
The point is deleted and the shape of the curve is updated.

---

**NOTE** An open point curve must have at least two endpoints.

---

**To remove points from a surface:**

- 1 Select a point, row, or column.  
The appropriate Delete buttons are enabled.
- 2 In the Delete group box, click Point, Row, or Col.  
The point, row, or column is deleted. Deleting a "single" point actually deletes both the row and column to which the point belongs.

**To add a point to a curve:**

- 1 In the Refine group box, turn on Curve.
- 2 Click the curve where you want to add the point.  
A point is added at the location you clicked. The curvature can change.

**To add a point and extend the length of a curve:**

- 1 Click to turn on Extend.
- 2 Move the mouse over a point curve. The curve is highlighted in blue, and one of the curve's ends displays a box to show where the curve will be extended.
- 3 Drag from the highlighted end point, and then release the mouse button.  
A new point is added beyond the original length of the curve.

**To add points to a point surface:**

- 1 In the Refine group box, click Surf Row, Surf Col., or Surf Row & Col.
- 2 Click the surface.

A row, a column, or both are added close to the point where you clicked the surface. The new points are placed on the surface so they preserve the surface's curvature. The curvature can change, but only slightly.

**To fuse two points:**

- 1 Turn on Fuse.
- 2 Click a point without releasing the mouse button. Drag to another point, and then release the mouse button.

The first point you choose acquires the position of the second point, and becomes dependent to it. If the first point has an animation controller, the controller is discarded. If the second point has an animation controller, the first point acquires it too.

Fused points display in purple by default.

**To unfuse fused points:**

- 1 Select the fused point.
- 2 Click Unfuse.

Now you can move and edit the two points independently.

**To transform a region:**

- 1 Using sub-object selection, select one or more points for the center of transformation.
- 2 Turn on Soft Selection.
- 3 Transform the point.

A region around the selected point is transformed accordingly.

Move is the most common transform to use. Rotate and Scale can be used with a non-local transform center.

---

**TIP** If Soft Selection appears not to be working, the Falloff value might be too small for the size of your surface. On the [Soft Selection rollout](#) on page 2275 , increase the value of Falloff so it encompasses other points.

---

## Interface

In addition to the Point rollout described here, the Point sub-object level also displays the [Soft Selection rollout](#) on page 2275 .

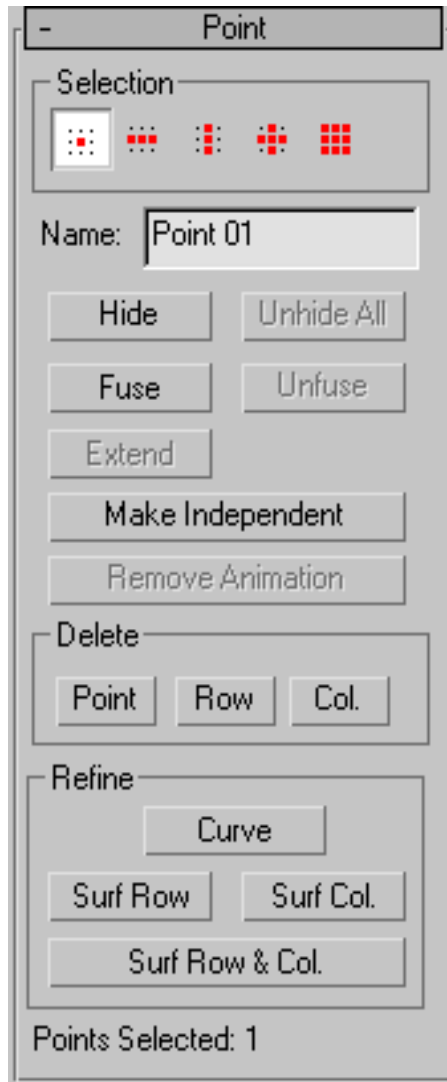

## Selection group



### Point sub-object selection controls

**Single Point** (The default.) When on, you can select individual points by clicking, or groups of points by dragging a region.

**Row of Points** When on, clicking a point selects the entire row the point belongs to. Dragging selects all rows in the region.

If the point is on a curve, Row of Points selects all points in the curve.

**Column of Points** When on, clicking a point selects the entire column the point belongs to. Dragging selects all columns in the region.

If the point is on a curve, Column of Points selects only a single point.

**Row and Column of Points** When on, clicking a point selects both the row and column the point belongs to. Dragging selects all rows and columns in the region.

**All Points** When on, clicking or dragging selects all the points in the curve or surface.

---

**TIP** Rows and columns are easily visible when the NURBS surface is planar, or nearly so. When the surface has a complicated curvature, rows and columns can be more difficult to see. The Row, Column, and Row/Column buttons can be especially useful in this situation.

---

**Name** Shows the name of the currently selected point. It is disabled if you have selected multiple points.

By default, the name is "Point" followed by a sequence number. You can use this field to give the point a name that you choose.

**Hide** Click to hide the currently selected points.

**Unhide All** Click to unhide all hidden points.

**Fuse** Fuses a point to another point. (You can't fuse a CV to a point, or vice versa.) This is one way to connect two curves or surfaces. It is also a way to change the shape of curves and surfaces.

Fusing points does *not* combine the two point sub-objects. They are connected but remain distinct sub-objects that you can unfuse later.

Fused points behave as a single point until you unfuse them.

Fused points are displayed in a distinct color. The default is purple. (You can change this color using the [Colors panel](#) on page 7505 of the [Customize User Interface dialog](#) on page 7489 .)

**Unfuse** Unfuses the fused points.

**Extend** Extends a point curve. Drag from the end of a curve to add a new point and extend the curve.

---

**WARNING** When you add points with Extend, you lose the animation controllers for all points on the curve or surface.

---

**Make Independent** Disabled if the point is independent. If the point is dependent, clicking this button makes it independent.

---

**WARNING** When you make a point independent, you lose the animation controllers for all objects that depend on it in turn.

---

**Remove Animation** Removes animation controllers from the selected points.

### **Delete group**

The buttons in this group box delete one or more points.

**Point** Deletes a single point (on a curve) or a row and column of points (on a surface).

**Row** Deletes a row from a surface.

**Col.** Deletes a column from a surface.

---

**WARNING** When you delete points, you lose the animation controllers for all points on the curve or surface.

---

### **Refine group**

The buttons in this box refine point curves or surfaces by adding points to them.

**Curve** Adds points to a point curve.

**Surf Row** Adds a row of points to a point surface.

**Surf Col.** Adds a column of points to a point surface.

**Surf Row & Col.** Adds both a row and a column to a point surface; their intersection is where you click the surface.

---

**WARNING** When you add points, you lose the animation controllers for all points on the curve or surface.

---

**Points Selected** This text field shows how many points are currently selected.

## Editing Curve CV Sub-Objects

Modify panel > Select NURBS object or sub-object. > Stack display > Curve CV sub-object level > Select CV sub-objects.

Modify panel > Select NURBS object or sub-object. > Right-click. > Tools 1 (upper-left) quadrant > Sub-objects > Curve CV > Select CV sub-objects.

This topic describes the controls for CV sub-objects that lie on curves. A rollout labeled CV contains the CV sub-object controls for NURBS models. In addition to the CV rollout described here, the Curve CV sub-object level displays the [Soft Selection rollout](#) on page 2275 .

In you can edit the CVs in [CV curves on surfaces](#) on page 2327 as you edit other kinds of curve CVs. You can transform CVs in CV curves on surfaces, but you can't move the CVs off the surface. Using the Curve CV sub-object level is an alternative to editing these CVs by using the [Edit Curve on Surface](#) on page 2450 dialog.

### Procedures

**To transform curve CV sub-objects:**

- 1 At the Curve CV sub-object level, select one or more CVs.  
The sub-object selection tools are the same as for other kinds of sub-objects. You can also use the H key while the [Keyboard Shortcut Override toggle](#) on page 7646 is on. See [Sub-Object Selection](#) on page 2164 .  
The Selection group box, described under "Interface" later in this topic, provides some additional options for selecting CV sub-objects.
- 2 Turn on Move or another transform and then drag in a viewport to transform the selection.  
The shape of the model changes as you interactively transform the CVs.



Rotate and Scale are useful only when you've selected multiple CVs.

## Tips



- When you transform NURBS CV sub-objects, the Lock Selection Set button can be useful. You can make a selection in one viewport, click Lock Selection Set (or press the Spacebar), and then transform the selection in a different viewport.
- When you move CV sub-objects, move them as systematically as possible to avoid "getting lost."

## To use the keyboard to select curve CV sub-objects:

You can select curve CV sub-objects using the Ctrl key and the arrow keys. The arrows traverse the sub-objects in the order they were created. To do so, follow these steps:



- 1 Turn on the Keyboard Shortcut Override Toggle.
- 2 Click or drag to select CVs.
- 3 Hold down Ctrl and use the arrow keys to move among the CV sub-objects. For CVs on curves, the arrow keys traverse the CV selection along the length of the curve. The arrow keys don't move between curve sub-objects.

You can also use the H keyboard shortcut (while the Keyboard Shortcut Override Toggle button is on) to display a dialog and select CVs by name. Ctrl+H displays only the names of CVs directly beneath the mouse cursor.

## To remove a CV from a curve:

- 1 Select a CV.
- 2 Click Delete.

Keyboard shortcut: Delete

The CV is deleted and the shape of the curve is updated.

---

**NOTE** A CV curve must have at least one more CV than the [degree](#) on page 7755 of the curve.

---

**To add a CV to a curve:**

- 1 Turn on Refine.
- 2 Click the curve where you want to add the CV.  
A CV is added at the location you clicked. Neighboring CVs move away from the new CV in order to preserve the original curvature.

**To add CVs and extend the length of a curve:**

- 1 Click to turn on Extend.
- 2 Move the mouse over a CV curve. The curve is highlighted in blue, and one of the curve's ends displays a box to show where the curve will be extended.
- 3 Drag from the highlighted end CV, and then release the mouse button.  
New CVs are added beyond the original length of the curve.

**To fuse two CVs:**

- 1 Turn on Fuse.
- 2 Click a CV without releasing the mouse button. Drag to another CV, and then release the mouse button.  
The first CV you choose acquires the position of the second CV, and becomes dependent to it. If the first CV has an animation controller, the controller is discarded. If the second CV has an animation controller, the first CV acquires it too.  
Fused CVs display in purple by default.

**To unfuse fused CVs:**

- 1 Select the fused CV.
- 2 Click Unfuse.  
Now you can move and edit the two CVs independently.

**To transform a region:**

- 1 Using sub-object selection, select one or more CVs for the center of transformation.
- 2 Turn on Soft Selection.

### 3 Transform the CV.

A region around the selected CV is transformed accordingly.

Move is the most common transform to use. Rotate and Scale can be used with a non-local transform center.

---

**TIP** If Soft Selection appears not to be working, the Falloff value might be too small for the size of your surface. On the [Soft Selection rollout](#) on page 2275 , increase the value of Falloff so it encompasses other points or CVs.

---

### Interface

In addition to the CV rollout described here, the Curve CV sub-object level also displays the [Soft Selection rollout](#) on page 2275 .

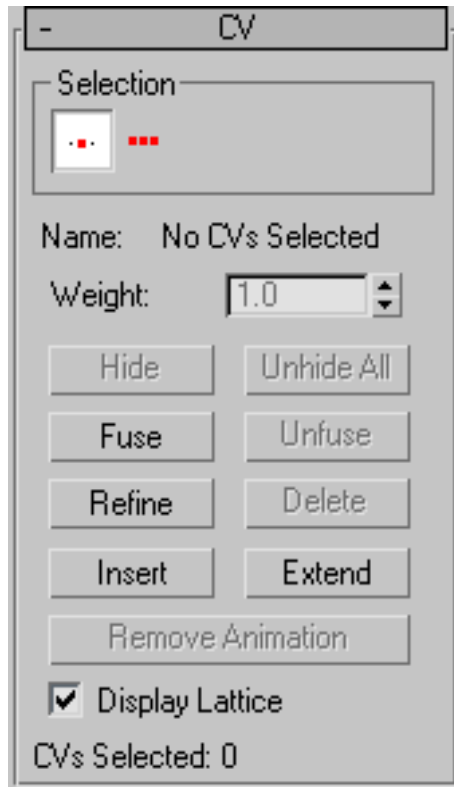

## Selection group

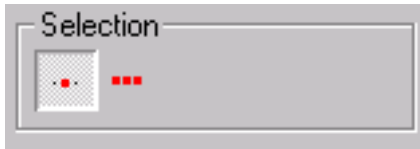

### Curve sub-object selection controls

**Single CV** (The default.) When on, you can select individual CVs by clicking, or groups of CVs by dragging a region.

**All CVs** When on, clicking or dragging selects all the CVs in the curve.

**Name** Shows either "No CVs selected", "Multiple CVs selected", or "CurveName(index)", where "CurveName" is the name of the CV's parent curve, and "index" is the CV's U location along the length of the curve. You can't edit the Name field to customize the names of CVs.

If CVs are fused, the Name field shows the name of the first CV.

**Weight** Adjusts the weight of the selected CVs. You can use a CV's *weight* to adjust the CV's effect on the curve. Increasing the weight pulls the curve toward the CV. Decreasing the weight relaxes the curve away from the CV.

Increasing weight is a way to harden a curve; that is, to sharpen its curvature at a particular location.

By default, the weight is 1.0 for the CVs of NURBS objects that you create on the Create panel or the NURBS sub-object creation rollouts. The weight of CVs in geometry that you convert to NURBS can vary, depending on the object's original shape.

You can change the weight when multiple CVs are selected. Using the Weight field or spinner while multiple CVs are selected assigns all of them the value you choose. Because weights are relative to each other (rational), using the Weight control when all CVs are selected has no visible effect.

**Hide** Click to hide the currently selected CVs.

**Unhide All** Click to unhide all hidden CVs.

**Fuse** Fuses a CV to another CV. (You can't fuse a CV to a point, or vice versa.) This is one way to connect two curves. It is also a way to change the shape of curves.

Fusing CVs does *not* combine the two CV sub-objects. They are connected but remain distinct sub-objects that you can unfuse later.

Fused CVs behave as a single CV until you unfuse them. Fused CVs behave similar to a single point, but the property of multiplicity for coincident CVs also applies. (See [NURBS Concepts](#) on page 2176 and [CV Curve](#) on page 2208 .) The fused CVs have proportionally more influence on the curve. The curve can become sharper in the fused CVs' vicinity, or even angular if more than two CVs are fused together.

Fused CVs are displayed in a distinct color. The default is purple. (You can change this color using the [Colors panel](#) on page 7505 of the [Customize User Interface dialog](#) on page 7489 .)

**Unfuse** Unfuses the fused CVs.

**Refine** Refines the curve by adding CVs.

---

**WARNING** When you add CVs with Refine, you lose the animation controllers for all CVs on the curve.

---

As you move the mouse over the CV curve, a preview of the CVs that will be added, and their locations, is displayed in blue.

---

**TIP** It is a good idea to reparameterize after you have added CVs to a curve by refining. See [Editing Curve Sub-Objects](#) on page 2252 .

---

**Delete** Deletes the selected CVs.

**Insert** Inserts CVs into the curve. Click Insert and then click the curve where you want to insert the new CV. Inserting CVs is similar to refining with CVs, except that other CVs in the curve do not move. This means that the shape of the curve changes when you insert.

Inserting CVs does not remove animation from the curve, as refining does.

---

**TIP** It is a good idea to reparameterize after you have added CVs to a curve by inserting. See [Editing Curve Sub-Objects](#) on page 2252 .

---

**Extend** Extends a CV curve. Drag from the end of a curve to add a new CV and extend the curve.

---

**WARNING** When you add points with Extend, you lose the animation controllers for all points on the curve.

---

**Remove Animation** Removes animation controllers from the selected CVs.

**Display Lattice** When on, displays the [control lattice](#) on page 7745 that surrounds CV curves. When off, the control lattice isn't shown in viewports. Default=on.

**CVs Selected** This text field shows how many CVs are currently selected.

## Editing Surface CV Sub-Objects

Modify panel > Select NURBS object or sub-object. > Stack display > Surface CV sub-object level > Select CV sub-objects.

Modify panel > Select NURBS object or sub-object. > Right-click a viewport. > Tools 1 (upper-left) quadrant > Sub-objects > Surface CV > Select CV sub-objects.

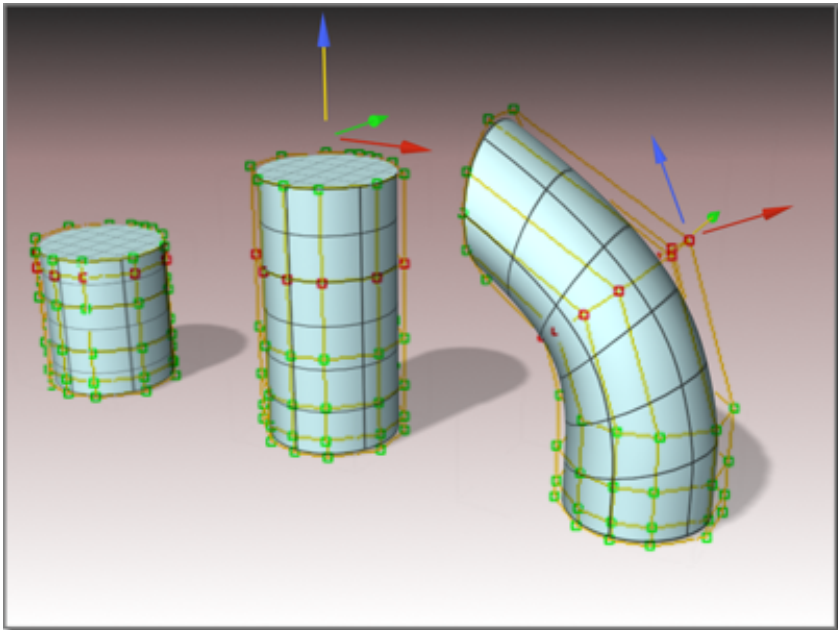

Transforming CVs changes the shape of the surface.

[Procedures](#) on page 2245

[Interface](#) on page 2247

This topic describes the controls for CV sub-objects that lie on surfaces. A rollout labeled CV contains the CV sub-object controls for NURBS models. In addition to the CV rollout described here, the Curve CV sub-object level displays the [Soft Selection rollout](#) on page 2275 .

## Procedures

### To transform surface CV sub-objects:

- 1 At the Surface CV sub-object level, select one or more CVs.  
The sub-object selection tools are the same as for other kinds of sub-objects. You can also use the H key while the [Keyboard Shortcut Override Toggle](#) on page 7646 button is on. See [Sub-Object Selection](#) on page 2164 .  
The Selection group box, described under "Interface" later in this topic, provides additional options for selecting CV sub-objects.
- 2 Turn on Move or another transform and then drag in a viewport to transform the selection.  
The shape of the model changes as you interactively transform the CVs.  
Rotate and Scale are useful only when you've selected multiple CVs.

### Tips



- The Lock Selection Set button is useful when you transform NURBS CV sub-objects. You can make a selection in one viewport, click Lock Selection Set (or press the Spacebar), and then transform the selection in a different viewport.
- When you move CV sub-objects, move them as systematically as possible to avoid "getting lost."
- On surfaces, avoid moving CVs so they cross over or under adjacent points. This can create odd-looking warps or overlaps in the surface.

### To **Shift+clone** surface sub-objects:

- Hold down Shift while you transform the surface selection. The [Sub-Object Clone Options](#) on page 2466 dialog appears. This dialog provides various ways to clone the surfaces, some of which reduce relational dependencies to improve performance.

### To use the keyboard to select surface CV sub-objects:

You can select surface CV sub-objects using the Ctrl key and the arrow keys. The arrows traverse the sub-objects in the order they were created. To do so, follow these steps:



- 1 Turn on the Keyboard Shortcut Override Toggle.
- 2 Click or drag to select CVs.
- 3 Hold down Ctrl and use the arrow keys to move among the CV sub-objects. For CVs on surfaces, the left and right arrow keys traverse the U dimension of a surface, while the up and down arrow keys traverse the V dimension of the surface. The arrow keys don't move between surface sub-objects.

You can also use the H keyboard shortcut (while the Keyboard Shortcut Override Toggle button is on) to display a dialog and select CVs by name. Ctrl+H displays only the names of CVs directly beneath the mouse cursor.

### To remove CVs from a surface:

- 1 Select a row, column, or a row and column. The appropriate Delete buttons are enabled.
- 2 In the Delete group box, click Row, Col., or Both. The row, the column, or both are deleted.

---

**NOTE** You can't delete a single CV from a CV surface. Nor can you delete a row or column if that would make the surface have fewer than four rows or columns.

---

### To add CVs to a CV Surface:

- 1 In the Refine group box, click Row, Col., or Both.
- 2 Click the surface. A row, a column, or both are added close to the point where you clicked the surface. Neighboring CVs move away from the new CVs in order to preserve the surface's original curvature.

### To fuse two CVs:

- 1 Turn on Fuse.



- 2 Click a CV without releasing the mouse button. Drag to another CV, and then release the mouse button.

The first CV you choose acquires the position of the second CV, and becomes dependent to it. If the first CV has an animation controller, the controller is discarded. If the second CV has an animation controller, the first CV acquires it too.

---

**NOTE** Fused CVs display in purple by default.

---

### To unfuse fused CVs

- 1 Select the fused CV.
- 2 Click Unfuse.

Now you can move and edit the two CVs independently.

### To transform a region:

- 1 Using sub-object selection, select one or more CVs for the center of transformation.
- 2 Turn on Soft Selection.
- 3 Transform the CV.

A region around the selected CV is transformed accordingly.

Move is the most common transform to use. Rotate and Scale can be used with a non-local transform center.

---

**TIP** If Soft Selection appears not to be working, the Falloff value might be too small for the size of your surface. On the [Soft Selection](#) on page 2275 rollout, increase the value of Falloff so it encompasses other CVs.

---

### Interface

In addition to the CV rollout described here, the Surface CV sub-object level also displays the [Soft Selection rollout](#) on page 2275 .

## CV rollout



Surface CV sub-object rollout

## Selection group



### Surface CV sub-object selection controls

**Single CV** (The default.) When on, you can select individual CVs by clicking, or groups of CVs by dragging a region.

**Row of CVs** When on, clicking a CV selects the entire row the CV belongs to. Dragging selects all rows in the region.

**Column of CVs** When on, clicking a CV selects the entire column the CV belongs to. Dragging selects all columns in the region.

**Row and Column of CVs** When on, clicking a CV selects both the row and column the CV belongs to. Dragging selects all rows and columns in the region.

**All CVs** When on, clicking or dragging selects all the CVs in the surface.

**Name** Shows either "No CVs selected", "Multiple CVs selected", or "SurfaceName(uIndex,vIndex)", where "SurfaceName" is the name of the CV's parent surface, and "uIndex,vIndex" is the CV's UV location on the surface. You can't edit the Name field to customize the names of CVs.

If CVs are fused, the Name field shows the name of the first CV.

**Weight** Adjusts the weight of the selected CVs. You can use a CV's *weight* to adjust the CV's effect on the surface. Increasing the weight pulls the surface toward the CV. Decreasing the weight relaxes the surface away from the CV.

Increasing weight is a way to harden a surface: that is, to sharpen its curvature at a particular location.

By default, the weight is 1.0 for the CVs of NURBS objects that you create on the Create panel or the NURBS sub-object creation rollouts. The weight of CVs in geometry that you convert to NURBS can vary, depending on the object's original shape.

You can change the weight when multiple CVs are selected. Using the Weight field or spinner while multiple CVs are selected assigns all of them the value you choose. Because weights are relative to each other (rational), using the Weight control when all CVs are selected has no visible effect.

---

**TIP** You can increase the curvature of an indentation in a surface by increasing the weight of the CVs surrounding the indented area. This is easier and often more effective than moving the indented area's CVs.

---

**Hide** Click to hide the currently selected CVs.

**Unhide All** Click to unhide all hidden CVs.

**Fuse** Fuses a CV to another CV. (You can't fuse a CV to a point, or vice versa.) This is one way to connect two surfaces. It is also a way to change the shape of surfaces.

Fusing CVs does *not* combine the two CV sub-objects. They are connected but remain distinct sub-objects that you can unfuse later.

Fused CVs behave as a single CV until you unfuse them. Fused CVs behave similar to a single point, but the property of multiplicity for coincident CVs also applies. (See [NURBS Concepts](#) on page 2176 and [CV Curve](#) on page 2208 .) The fused CVs have proportionally more influence on the curve, which can become sharper in the fused CVs' vicinity, or even angular if more than two CVs are fused together.

Fused CVs are displayed in a distinct color. The default is purple. (You can change this color using the [Colors panel](#) on page 7505 of the [Customize User Interface dialog](#) on page 7489 .)

**Unfuse** Unfuses the fused CVs.

**Remove Animation** Removes animation controllers from the selected CVs.

### **Constrained Motion group**

These buttons constrain CV motion. They are enabled when you select one or more CVs. When you finish dragging the CV selection, the active constraint button turns off.

**U** Constrains the CV selection to move in the surface's U dimension.

Keyboard shortcut (Keyboard Shortcut Override Toggle must be on): Alt+U

**V** Constrains the CV selection to move in the surface's V dimension.

Keyboard shortcut (Keyboard Shortcut Override Toggle must be on): Alt+V

**Normal** Constrains the CV selection to move normal to the original surface.

Keyboard shortcut (Keyboard Shortcut Override Toggle must be on): Alt+N

## Delete group

These buttons delete CVs from the surface. Select one or more CVs, and then click Row, Col., or Both.

You can't delete surface CVs if the deletion would give the surface fewer than four rows or fewer than four columns. Aside from that restriction, these buttons delete *all* rows, columns, or rows and columns that contain selected CVs. This means that you can't delete after you make a selection using the Row and Column or All selection buttons: that would imply deleting the entire CV surface.

These buttons are unavailable unless the deletion is possible.

---

**WARNING** When you delete CVs, you lose the animation controllers for all CVs on the surface.

---

**Row** Deletes rows of CVs from the surface.

**Col.** Deletes columns of CVs from the surface.

**Both** Deletes both rows and columns of CVs from the surface.

## Refine group

These buttons refine the surface by adding CVs. As you move the mouse over the surface, a preview of the CVs that will be added, and their locations, is displayed in blue.

---

**WARNING** When you add CVs with Refine, you lose the animation controllers for all CVs on the surface.

---

**Row** Adds a row of CVs to the surface.

**Col.** Adds a column of CVs to the surface.

**Both** Adds both a row and a column of CVs to the surface.

---

**TIP** It is a good idea to reparameterize after you have added CVs to a surface by refining. See [Editing Surface Sub-Objects](#) on page 2264 .

---

## Insert group

These buttons insert CVs into the curve. Click to turn on one of these buttons and then click the surface where you want to insert the new CVs. Inserting CVs is similar to refining with CVs, except that other CVs in the surface do

not move. This means that the shape of the surface can change when you insert.

Inserting CVs does not remove animation from the surface the way refining does.

**Row** Inserts a row of CVs into the surface.

**Col.** Inserts a column of CVs into the surface.

**Both** Inserts both a row and a column of CVs into the surface.

---

**TIP** It is a good idea to reparameterize after you have added CVs to a surface by inserting. See [Editing Surface Sub-Objects](#) on page 2264 .

---

**Display Lattice** When on, displays the [control lattice](#) on page 7745 that surrounds CV surfaces. When off, the control lattice isn't shown in viewports. Default=on.

**CVs Selected** This text field shows how many CVs are currently selected.

## Editing Curve Sub-Objects

Modify panel > Stack display > Open the NURBS object's hierarchy. > Curve sub-object level > Select curve sub-objects.

This topic describes the controls that are common to point and CV curves. A rollout labeled Curve Common contains the curve sub-object controls for NURBS models.

### Procedures

**To transform curves:**

- 1 At the Curve sub-object level, select one or more curves.

The sub-object selection tools are the same as for other kinds of sub-objects. You can also press the H key when the [Keyboard Shortcut Override toggle](#) on page 7646 is on. See [Sub-Object Selection](#) on page 2164 .

The Selection group box, described under "Interface" later in this topic, provides additional options for selecting curves.

- 2 Turn on Move or another transform and then drag in a viewport to transform the selection.

The shape of the model changes as you interactively transform the curves.



**TIP** The Lock Selection Set button is useful when you transform NURBS curve sub-objects. You can make a selection in one viewport, click Lock Selection Set (or press the Spacebar), and then transform the selection in a different viewport.



---

### To **Shift+Clone** curve sub-objects:

- Hold down Shift while you transform the curve selection. The [Sub-Object Clone Options](#) on page 2466 dialog is displayed. This dialog provides various ways to clone the curves, some of which reduce relational dependencies to improve performance.

### To use the keyboard to select curve sub-objects:

You can select curve sub-objects using the Ctrl key and the arrow keys. The arrows traverse the sub-objects in the order they were created. To do so, follow these steps:

- 1  Turn on the Keyboard Shortcut Override Toggle.
- 2  At the Curve sub-object level, set the selection controls to select curves individually.
- 3 Click or drag to select curves.
- 4 Hold down Ctrl and use the arrow keys to move among the curves in the current model.  
At the Curve sub-object level, the left and right arrow keys move forward and backward through individual curves in the order they were created. The up and down arrows are equivalent to left and right.

You can also use the H keyboard shortcut (while the Keyboard Shortcut Override Toggle is on) to display a dialog and select curves by name. Ctrl+H displays only the names of curves directly beneath the mouse cursor.

### To delete a curve:

- Select the curve and then click Delete.  
Keyboard shortcut: Delete

### To turn a CV curve into a point curve:

- 1 Select the curve sub-object, and then click Make Fit.  
The [Make Point Curve](#) on page 2462 dialog is displayed. This dialog asks how many points the new point curve should have.
- 2 Change the number of points, and then click OK.  
Reducing the number of points can change the shape of the curve.

If the selected curve is already a point curve, you can use Make Fit to change the number of points it has.

### To select a first vertex on the curve:

- Select the curve sub-object, turn on Make First, and then click a location on the curve.  
If the curve is closed and there is a vertex where you click, this vertex becomes the first vertex. If the curve is closed and there is no vertex where you click, a new vertex is created at the location you click. It becomes the new first vertex, and the curve's points or CVs adapt to maintain the curvature.  
If the curve is open, clicking it has no effect.

---

**WARNING** Using Make First discards any animation controllers for the points or CVs in the curve.

---

If the curve is open, the first vertex must be one of the endpoints (by default, it is the first you created). The Make First button has no effect, but you can use Reverse to change the curve's direction.



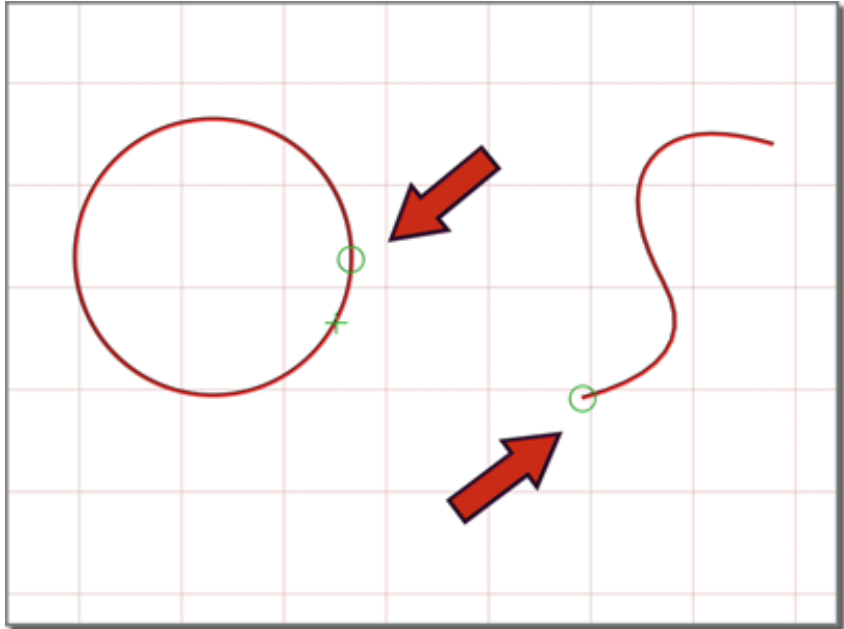

The small circle indicates the first vertex.

**To turn a curve that lies on a surface into a Point Curve on Surface:**

- 1 Select the curve sub-object, and then click Make COS.  
Make COS is unavailable unless the curve already lies on a surface; for example, it is a U Iso curve.
- 2 The [Convert Curve on Surface dialog](#) on page 2444 is displayed.

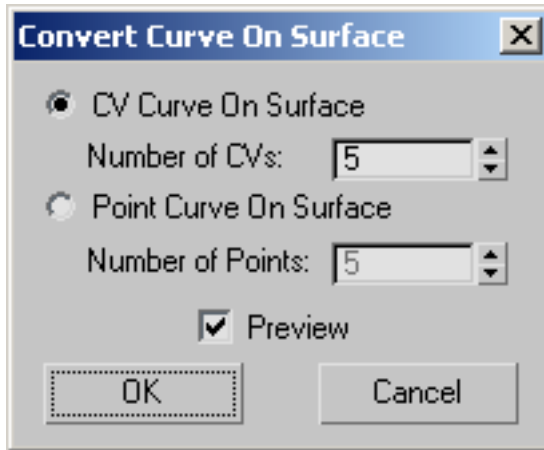

Choose CV Curve on Surface to create a CV curve, or Point Curve on Surface to create a point curve. The Number of CVs or Number of Points values let you specify the complexity and accuracy of the new curve on surface. If Preview is on, the new curve is previewed in viewports. This can help you choose the number.

**To reverse a curve:**

- Select a curve sub-object and then click Reverse.

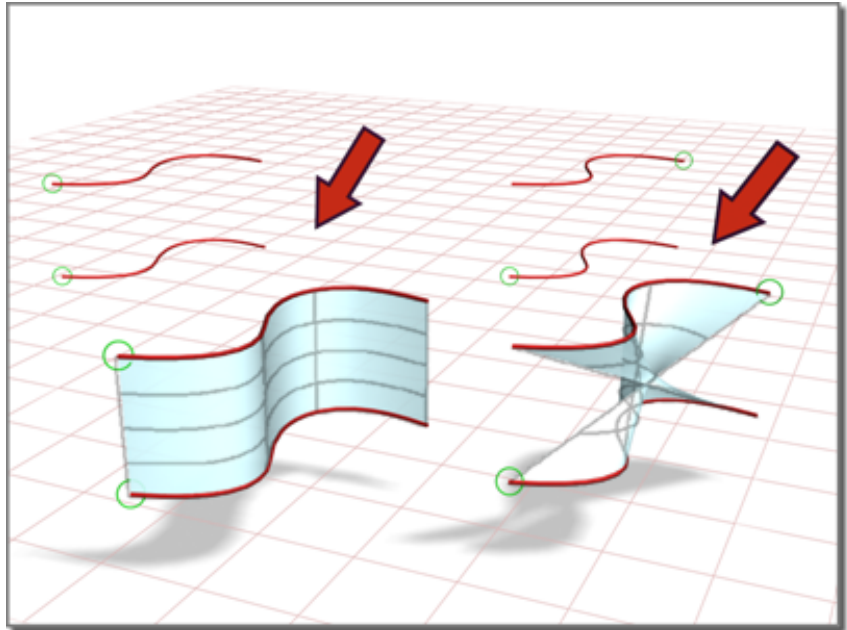

Reversing a curve affects the blend surface that depends on it.

**To join two curves:**

- 1 In a NURBS object that contains two curve sub-objects, turn on Join.
- 2 Click one curve near the end that you want to connect. Drag to near the end of the other curve, and then release the mouse.  
The [Join Curve dialog](#) on page 2456 is displayed. This dialog gives you a choice of methods for joining the curves. Whichever method you choose, the two original curves are replaced by a single curve.
- 3 If the gap between the curves is small (less than about 30 units), use the Join Curve dialog to set the Tolerance value greater than the distance of the gap.

**To break a curve:**

- Turn on Break and then click a curve.

The curve is split into two independent curve sub-objects. Two coincident (but independent) points or CVs are created at the location you clicked: each is the endpoint of one part of the original curve.

If the curve is a closed curve, Break creates a single curve object, with its new start and end points at the location you clicked. The new start and end points are coincident but independent.

**To close a curve:**

- Select the curve and then click Close.  
The software closes the curve by adding a segment between the curve's endpoints. The curvature of the new segment blends the curvature of the previous end segments.

Closing a curve does *not* add points or CVs. The curve retains its original number of points or CVs, and increases its number of segments by one.

## Interface

### Curve Common rollout



The controls on this rollout apply to all curve types. Depending on the type of curve, an additional rollout is displayed with controls specific to that type of curve.

### Selection group

The selection buttons for curve sub-objects let you select either individual curves, or curves that are connected in space.

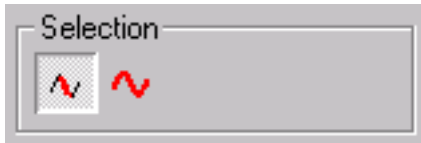

#### Curve sub-object selection controls

**Single Curve** Clicking or transforming a curve selects only a single independent curve sub-object.

**All Connected Curves** Clicking or transforming a curve selects all curve sub-objects that are connected within the NURBS object. To be connected, two curves must have fused points, or one curve must be a connected dependent (a blend, fillet, or chamfer) of the other.

**Name** Shows the name of the currently selected curve. It is disabled if you have selected multiple curves.

By default, the name is the name of the curve type ("CV Curve" or "Point Curve") followed by a sequence number. You can use this field to give the curve a name that you choose.

**Hide** Click to hide the currently selected curves.

**Unhide All** Click to unhide all hidden curves.

**Hide by Name** Click to display a Select Sub-Objects dialog that lists curves by name. Select the curves to hide, then click Hide.

**Unhide by Name** Disabled unless there are hidden curves. Click to display a Select Sub-Objects dialog that lists curves by name. Select the curves to make visible, then click Unhide.

**Delete** Deletes the selected curve sub-objects.

**Make Fit** Turns a CV curve into a point curve. This displays the [Make Point Curve dialog](#) on page 2462, which lets you set the number of points.

For a point curve, this button lets you change the number of points in the curve.

**Reverse** Reverses the order of the CVs or points in a curve, so that the first vertex becomes the last, and the last becomes the first.

The first point or CV is significant when you use the NURBS curve like a spline: as a [loft](#) on page 715 path or shape, as a [path constraint](#) on page 3222 path, or as a motion [trajectory](#) on page 3045 . For these purposes, the first vertex of the curve is significant. If the curve is a closed curve, you can use Make First to set the curve's first vertex.

The direction of the curve also determines the initial direction of normals on surfaces based on this curve.

**Make COS** This button is enabled only for the following kinds of curves:

- [U iso curves](#) on page 2318
  - [V iso curves](#) on page 2318
  - [Normal projected curves](#) on page 2320
  - [Vector projected curves](#) on page 2323
  - [Surface-surface intersection curves](#) on page 2312
  - [Surface edge curves](#) on page 2335
  - [CV curves on surfaces](#) on page 2327
  - [Point curves on surfaces](#) on page 2331
- This displays a [Make Curve on Surface dialog](#) on page 2444 , which turns the selected curve into a CV or point curve on surface. Once converted, you can edit the new curve on surface using the curve on surface controls, including the [Edit Curve on Surface dialog](#) on page 2450 .

If the curve is already a curve on surface, this button lets you change it from a point to CV curve on surface, or vice versa.

The new Curve on Surface preserves the trimming of the original curve.

**Convert Curve** Click to display the [Convert Curve dialog](#) on page 2442 . This dialog provides a more general way to convert a CV curve to a point curve, or a point curve to a CV curve. It also lets you adjust a number of other curve parameters.

**Make Independent** Disabled if the curve is independent. If the curve is dependent, clicking this button makes it independent.

---

**WARNING** When you make a curve independent, you lose the animation controllers for all objects that depend on it in turn. If you make a curve that trims a surface independent, you lose the trimming of the surface.

---

**Remove Animation** Removes animation controllers from the selected curves.

**Detach** Detaches the selected curve sub-object from the NURBS model, making it a new top-level [NURBS curve](#) on page 2199 object. The [Detach dialog](#) on page 2449 is displayed, which lets you name the new curve. The new object is no longer part of the original NURBS model.

To create a new top-level NURBS curve that is a copy of the selected curve, turn on Copy before you click Detach.

**Copy** When on, clicking Detach creates a copy of the selected curve instead of detaching it from the NURBS model. Default=off.

**Make First** For a closed curve, lets you choose a position that becomes the first vertex of the curve.

The first point or CV is significant when you use the NURBS curve like a spline: as a [loft](#) on page 715 path or shape, as a [path constraint](#) on page 3222 path, or as a motion [trajectory](#) on page 3045 . For these purposes, the first vertex of the curve is significant. If the curve is a closed curve, you can use Make First to set the curve's first vertex.

**Break** Breaks a single curve into two curves. Click in a viewport to choose the location to break the curve.

---

**WARNING** When you break a curve sub-object, you lose the animation controllers for all points or CVs on the curve.

---

**Join** Joins two curve sub-objects together. After you have joined the curves in a viewport, the [Join Curves dialog](#) on page 2456 is displayed. This dialog lets you choose the method for joining the two curves.

---

**WARNING** When you join two curve sub-objects, you lose the animation controllers for all points or CVs on both curves.

---

**Material ID** Lets you assign a material ID value to the curve. If the curve is renderable, material IDs let you assign a material to the curve using a [Multi/Sub-Object](#) on page 5558 material. In addition, the Select by ID button lets you select a curve or multiple curves by specifying a material ID number. Can range from 1 to 100. Default=1.

**Select by ID** Displays a [Select by Material ID](#) on page 2468 dialog.



## CV Curve rollout

This additional rollout is displayed when a CV curve is selected.

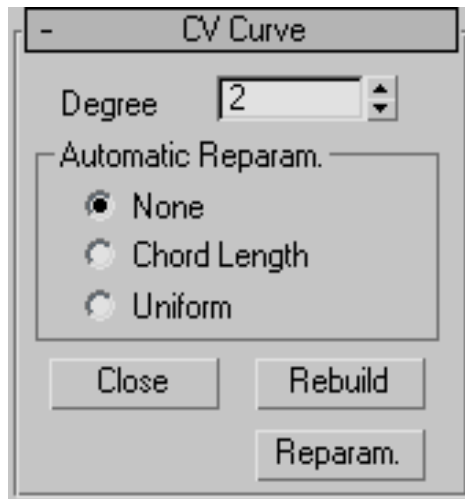

**Degree** Sets the degree of the curve. The higher the degree value, the greater the continuity. The lower the degree, the more discontinuous the curve segments become. The degree can't be less than one or greater than the number allowed by the number of CVs in the curve. Degree 3 curves are adequate to represent continuous curves, and are stable and well behaved. Default=3.

Setting the degree greater than 3 isn't recommended because higher-degree curves are slower to calculate and less stable numerically. Higher-degree curves are supported primarily to be compatible with models created using other surface modeling programs.

The number of CVs in a CV curve must be at least one greater than the curve's degree.

### Automatic Reparameterization group

The controls in this group box let you specify automatic reparameterization. They are similar to the controls in the [Reparameterize dialog](#) on page 2465 , with the addition that all choices except for None tell the software to reparameterize the curve automatically; that is, whenever you edit it by moving CVs, refining, and so on.

**None** Do not reparameterize automatically.

**Chord Length** Chooses the chord-length algorithm for reparameterization.

Chord-length reparameterization spaces knots (in [parameter space](#) on page 7882 ) based on the square root of the length of each curve segment.

Chord-length reparameterization is usually the best choice.

**Uniform** Spaces the knots uniformly.

A uniform knot vector has the advantage that the curve or surface changes only locally when you edit it. With chord-length parameterization, moving any CV can potentially change the entire curve.

**Close** Closes the curve. Disabled if the curve is already closed.

**Rebuild** Displays the [Rebuild CV Curve dialog](#) on page 2463 , which lets you specify how to rebuild the curve. Rebuilding the curve can change its appearance.

**Reparam.** Displays the [Reparameterize dialog](#) on page 2465 . Reparameterizing a curve changes the curve's [parameter space](#) on page 7882 to provide a better relation between control point locations and the shape of the curve.

---

**TIP** It is a good idea to reparameterize after you have added CVs to the curve by refining or inserting.

---

### Point Curve rollout

This additional rollout appears when a point curve is selected.

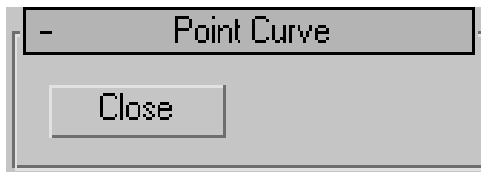

**Close** Closes the curve. Disabled if the curve is already closed.

## Editing Surface Sub-Objects

Modify panel > Stack display > Open the NURBS object's hierarchy. > Surface sub-object level > Select surface sub-objects.

This topic describes controls that are common to point surfaces, CV surfaces, and the various dependent surface types. A rollout labeled Surface Common contains the surface sub-object controls for NURBS surfaces. Another rollout, [Material Properties](#) on page 2278 , controls mapping on surface sub-objects, and

is described in its own topic. See [Surface Approximation](#) on page 2469 for a description of that rollout. The final rollout for surface sub-objects depends on the type of surface selected.

## Procedures

### To transform surface sub-objects:

- 1 At the Surface sub-object level, select one or more surface sub-objects.  
The sub-object selection tools are the same as for other kinds of sub-objects. In addition, you can use the H key when the [Keyboard Shortcut Override toggle](#) on page 7646 is on. See [Sub-Object Selection](#) on page 2164 .  
The Selection group box, described under "Interface" later in this topic, provides additional options for selecting surfaces.
- 2 Turn on Move or another transform and then drag in a viewport to transform the selection.  
The shape of the model changes as you interactively transform the surfaces.





**TIP** The Lock Selection Set button is useful when you transform NURBS sub-objects. You can make a selection in one viewport, click Lock Selection Set (or press the Spacebar), and then transform the selection in a different viewport.

---

### To use the keyboard to select surface sub-objects:

You can select surface sub-objects using the Ctrl key and the arrow keys. The arrows traverse the sub-objects in the order they were created. To do so, follow these steps:

- 1  Turn on the Keyboard Shortcut Override Toggle.
- 2  At the Surface sub-object level, set the selection controls to select surfaces individually.
- 3 Click or drag to select surfaces.

- 4 Hold down Ctrl and use the arrow keys to move among surfaces in the current model.

At the Surface sub-object level, the left and right arrow keys move forward and backward through individual surfaces in the order they were created. The up and down arrows are equivalent to left and right.

You can also use the H keyboard shortcut (while the Keyboard Shortcut Override Toggle is on) to display a dialog and select surfaces by name. Ctrl+H displays only the names of surfaces directly beneath the mouse cursor.

**To delete a surface:**

- Select the surface and then click Delete.  
Keyboard shortcut: Delete

**To make a surface a loft:**

- 1 Select the surface and then click Make Loft. A [Make Loft dialog](#) on page 2459 is displayed.

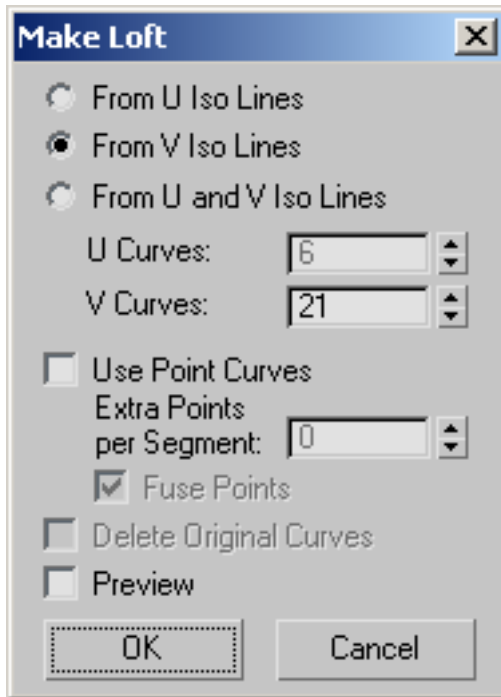

- 2 Use the Make Loft dialog controls to choose the settings for the new surface, and then click OK.

**To break a surface:**

- 1 Turn on Break Row, Break Col., or Break Both, and then drag over the surface.  
One or two blue curves appear on the surface to indicate where the break will occur.
- 2 When you have dragged to the location you want to break, click the surface.

---

**NOTE** If you break a dependent surface, the new "broken" surfaces are made independent.

---

You cannot break a trimmed surface.

**To extend a surface:**

- 1 Turn on Extend.
- 2 Move the mouse over the surface without depressing the mouse button. The edge that will be extended is highlighted in blue.
- 3 When the edge you want to extend is highlighted, press the mouse button, and then drag vertically to increase the length of the surface.

The surface extension is invalid and disappears if it would cause the surface to intersect itself or if the edge of the surface touches itself but is not closed. For example, you can't extend the top of a cylinder.

**To join two surfaces:**

- 1 In a NURBS object that contains two surface sub-objects, turn on Join.
- 2 If the gap between the surfaces is small (less than about 30 units), set the Tolerance value greater than the distance of the gap.
- 3 Click one surface near the edge that you want to connect. The edge that will be connected is highlighted in blue. Drag to choose the edge you want to connect. Without releasing the mouse button, drag to the other surface. The edge of the other surface is also highlighted in blue. Drag on the other surface to choose the edge to connect, and then release the mouse button.

The surface that owns the highlighted edge is highlighted in yellow, to help you distinguish which edge you are choosing when two surfaces have coincident edges.

The [Join Surfaces dialog](#) on page 2458 is displayed, which gives you a choice of methods for how to join the surfaces. Whichever method you choose, the software creates a single surface that replaces the two original surfaces.

**To close a surface:**

- Select the surface sub-object and then click Close Rows or Close Cols.

## Interface

### Surface Common rollout

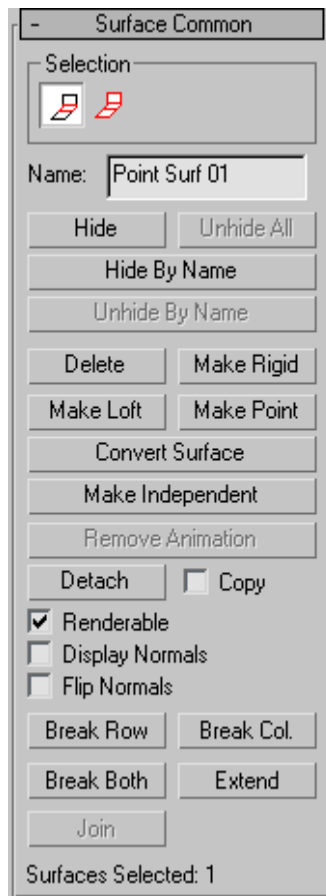

### Surface sub-object rollout

The controls on this rollout apply to all surface types. Depending on the type of surface, an additional rollout is displayed with controls specific to that type of surface.

### Selection group

The selection buttons for surface sub-objects let you select either individual surfaces, or surfaces that are connected in space.

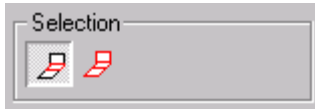

### Surface sub-object selection controls

**Single Surface** Clicking or transforming a surface selects only a single surface sub-object.

**All Connected Surfaces** Clicking or transforming a surface selects all surface sub-objects that are connected within the NURBS object. To be connected, two surfaces must have all the CVs on a shared edge fused between them, or one surface must be a connected dependent of the other (for example, a blend or a cap).

**Name** Shows the name of the currently selected surface. It is disabled if you have selected multiple surfaces.

By default, the name is the name of the surface type ("CV Surface," "Point Surface," "Blend Surface," and so on) followed by a sequence number. You can use this field to give the surface a name that you choose.

**Hide** Click to hide the currently selected surface.

**Unhide All** Click to unhide all hidden surfaces.

**Hide by Name** Click to display a Select Sub-Objects dialog that lists surfaces by name. Select the surfaces to hide, then click Hide.

**Unhide by Name** Disabled unless there are hidden surfaces. Click to display a Select Sub-Objects dialog that lists surfaces by name. Select the surfaces to make visible, then click Unhide.

**Delete** Deletes the selected surface sub-objects.

**Make Rigid** Makes the surface rigid. The only editing allowed on a rigid surface is to transform it at the Surface sub-object level. You can't move a rigid surface's points or CVs, or change the number of points or CVs.

Rigid surfaces reduce the amount of memory used by the NURBS model. Making surfaces rigid improves performance, especially for large and complex models.

When a surface is rigid, you can't see its points or CVs when you are at the Point or Surface CV sub-object levels. If the model has no nonrigid surfaces and no point curves, the Point and Surface CV sub-object levels aren't available at all.



To make a surface no longer rigid, click **Make Point** or **Make Independent**. Editing the surface with **Break**, **Join**, and so on also makes it no longer rigid.

**Make Loft** Displays a [Make Loft dialog](#) on page 2459 to convert the surface sub-object to a (dependent) U loft or UV loft surface. Can also change the dimension used to construct a U loft surface.

You can't use **Make Loft** if the surface sub-object is in an error condition.

---

**TIP** **Make Loft** creates a loft with uniformly spaced curves. To make a loft with adaptively spaced iso curves, manually create the curves and then loft them with U Iso Lines, V Iso Lines, or U and V Iso Lines.

---

**Make Point** Displays a [Make Point dialog](#) on page 2461 to convert any kind of surface to a point surface. You can also use **Make Point** to change the number of rows and columns if the surface is already a point surface.

**Convert Surface** Click to display the [Convert Surface dialog](#) on page 2445. This dialog provides a general way to convert a surface to a different type of surface. You can convert between lofts, point ("fit") surfaces, and CV surfaces. The dialog also lets you adjust a number of other surface parameters.

**Make Independent** Disabled if the surface is independent. If the surface is dependent, clicking this button makes it independent.

---

**WARNING** When you make a surface independent, you lose the animation controllers for all objects that depend on it in turn.

---

**Remove Animation** Removes animation controllers from the selected surfaces.

**Detach** Detaches the selected surface sub-object from the NURBS model, making it a new top-level [NURBS surface object](#) on page 2190. The [Detach dialog](#) on page 2449 is displayed, which lets you name the new surface. The new object is no longer part of the original NURBS model.

To create a new top-level NURBS surface that is a copy of the selected surface, turn on **Copy** before you click **Detach**.

**Copy** When on, clicking **Detach** creates a copy of the selected surface instead of detaching it from the NURBS model. Default=off.

**Renderable** When on, the surface renders. Turn off to make the surface invisible in renderings. Default=on.

**Display Normals** When on, the normal for each selected surface is displayed. There is *one* normal per surface sub-object. The normal is displayed at the surface's UV origin, so displaying normals can help you see how materials will

be mapped. On the other hand, the normal can be hard to see if you are zoomed out. Default=off.

**Flip Normals** Turn on to reverse the direction of the surface normals. Default=off.

---

**TIP** The Flip Normals control is useful for viewing a surface that is mostly concave or mostly convex. With more complicated NURBS surfaces, you often want to render both sides of the surface. Turn on Force 2-Sided in the [Render Scene dialog](#) on page 5878 to see both sides of the surface. To see both sides of the surfaces in viewports, turn on Force 2-Sided in the Rendering Method panel of the [Viewport Configuration dialog](#) on page 7610, or assign a [Double-Sided Material](#) on page 5551.

---

**Break Row** Breaks the surface into two surfaces in the direction of a row (the surface's U axis).

**Break Col.** Breaks the surface into two surfaces in the direction of a column (the surface's V axis).

**Break Both** Breaks the surface into four surfaces in both directions.

You cannot break a trimmed surface.

**Extend** Extends the surface by changing its length.

---

**WARNING** Extending a surface loses all animation controllers for the surface and its points or CVs.

---

**Join** Joins two surface sub-objects together. After you have joined the surfaces in a viewport, the [Join Surfaces dialog](#) on page 2458 is displayed. This dialog lets you choose the method for joining the two surfaces. You can join only original edges of surfaces; you *cannot* join edges created by trimming.

---

**WARNING** When you join two surface sub-objects, you lose the animation controllers for all point or CVs on both surfaces.

---

### **CV Surface rollout**

This additional rollout is displayed when a CV surface is selected.

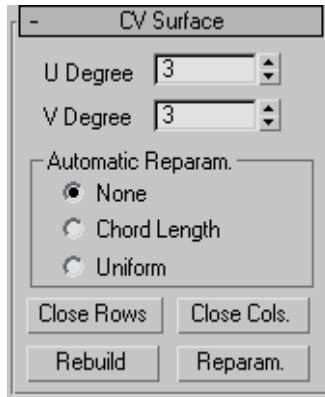

**U Degree and V Degree** Let you set the degree of the surface in either the U or V dimension. The higher the degree value, the greater the continuity. The lower the degree, the more discontinuous the surface segments become. The degree can't be less than one or greater than the number allowed by the number of CVs in the specified dimension. Degree 3 is adequate to represent continuous surfaces, and is stable and well behaved. Default=3.

Setting the degree greater than 3 isn't recommended because higher-degrees are slower to calculate and less stable numerically. Higher-degrees are supported primarily to be compatible with models created using other surface modeling programs.

The number of CVs in a given dimension must be at least one greater than that dimension's degree.

### **Automatic Reparameterization group**

The controls in this group box let you specify automatic reparameterization. They are similar to the controls in the [Reparameterize dialog](#) on page 2465 , with the addition that all choices except for None tell the software to reparameterize the curve automatically; that is, whenever you edit it by moving CVs, refining, and so on.

**None** Do not reparameterize automatically.

**Chord Length** Chooses the chord-length algorithm for reparameterization.

Chord-length reparameterization spaces knots (in [parameter space](#) on page 7882 ) based on the square root of the length of each curve segment.

Chord-length reparameterization is usually the best choice.

**Uniform** Spaces the knots uniformly.

A uniform knot vector has the advantage that the curve or surface changes only locally when you edit it. With chord-length parameterization, moving any CV can potentially change the entire surface.

The close controls let you close a surface. They are displayed on the CV Surface rollout while an independent CV surface sub-object is selected. They are disabled if the surface is already closed in that direction.

**Close Rows** Closes the surface by joining the ends of its rows.

**Close Cols.** Closes the surface by joining the ends of its columns.

**Rebuild** Displays the [Rebuild CV Surface dialog](#) on page 2464 , which lets you specify how to rebuild the surface. Rebuilding the surface can change its appearance.

---

**WARNING** When you rebuild a surface, you lose the animation controllers for all CVs on the surface.

---

**Reparam.** Displays the [Reparameterize dialog](#) on page 2465 . Reparameterizing a surface changes the surface's [parameter space](#) on page 7882 to provide a better relation between control point locations and the shape of the surface.

---

**TIP** It is a good idea to reparameterize after you have added CVs to the surface by refining or inserting.

---

**WARNING** When you reparameterize a surface, you lose the animation controllers for all CVs on the surface.

---

### Point Surface rollout

This additional rollout appears when a point surface is selected.

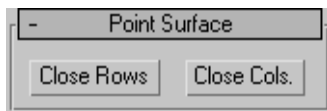

The close controls let you close a surface. They appear on the Point Surface rollout while an independent point surface sub-object is selected. They have no effect if the surface is already closed in that direction.

**Close Rows** Closes the surface by joining the ends of its rows.

**Close Cols.** Closes the surface by joining the ends of its columns.

## Soft Selection Rollout (NURBS)

Modify panel > Select NURBS point or CV sub-objects. > Soft Selection rollout

The soft selection controls for NURBS models are like the soft selection controls for [editable mesh](#) on page 1990 objects. Soft selection controls make a point or CV behave as if surrounded by a "magnetic field." Unselected points or CVs within the field are drawn along smoothly while you move the selected one.

With this feature, you can sculpt the points or CVs of a curve or surface. For example, you can draw a sphere into an egg, or gently curve a flat surface into hills and valleys.

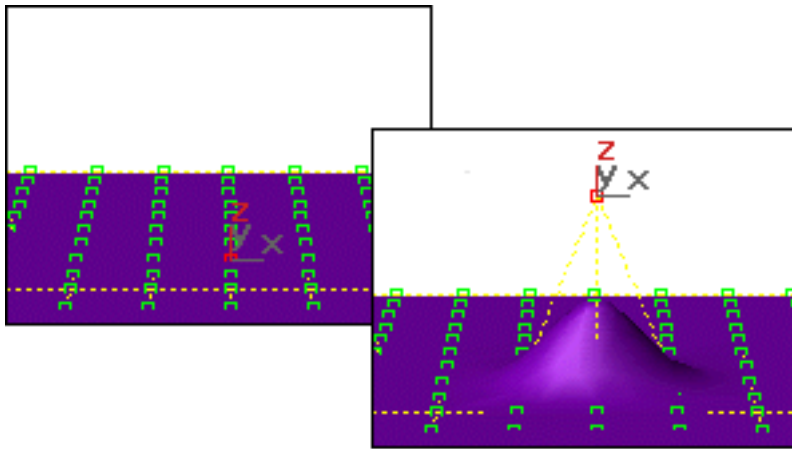

With soft selection, transforming a single vertex can move others.

The Soft Selection rollout for point and CV sub-objects contains the controls for this feature. The Soft Selection check box is turned off by default.

Before you begin, you might need to increase the number of CVs or points on the surface. This allows smoother and more complex reshaping effects.

A single point or CV works well for many purposes. Moving a point or CV along a single axis is the most useful for smoothly raising and lowering surfaces. For multiple points or CVs, you can also use Rotate or Scale.

## Interface

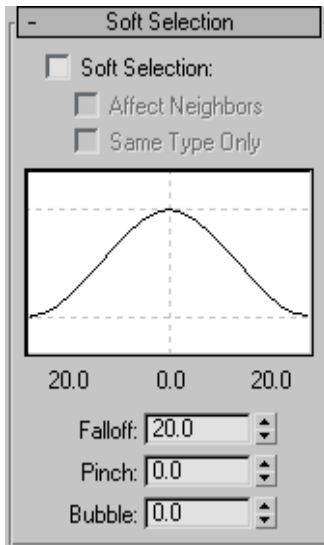

**Soft Selection** When on, point or CV transforms affect a region of the curve or surface.

**Affect Neighbors** When on, the transform affects points or CVs not only on this curve or surface but within the entire Falloff region of the NURBS object.

**Same Type Only** (for point curves and surfaces only) When on, the transform affects only neighboring points of the same type; that is, either curve points, surface points, or independent points.

**Soft Selection Curve** This curve display shows how Soft Selection will work. You can experiment with a curve setting, undo it, and try another setting with the same selection.

**Falloff** Distance in current units from the center to the edge of a sphere defining the region. Use higher falloff settings to achieve more gradual slopes, depending on the scale of your geometry. Default=20.

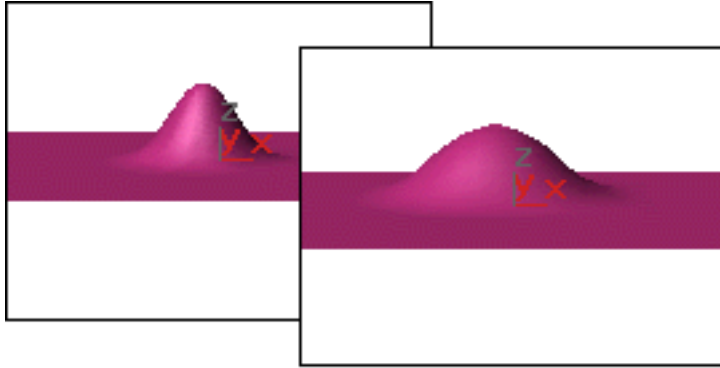

**Left: Falloff=20 (the default)**

**Right: Falloff=40**

**Pinch** Raises and lowers the top point of the curve along the vertical axis. Sets the relative "pointedness" of the region. When negative, a crater is produced instead of a point. At a setting of 0, Pinch produces a smooth transition across this axis. Default=0.

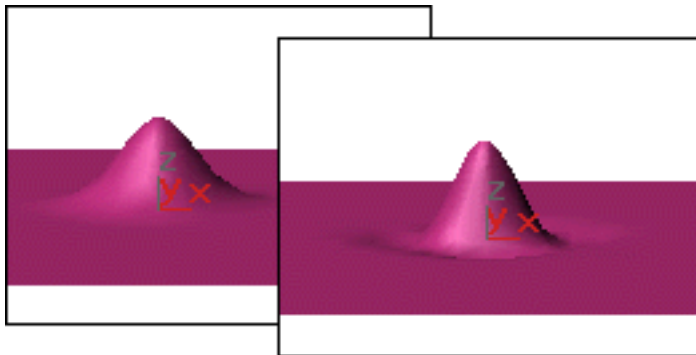

**Left: Pinch=.5**

**Right: Pinch=2**

**Falloff and Bubble have their default values.**

**Bubble** Expands and contracts the curve along the vertical axis. Sets the relative "fullness" of the region. Limited by Pinch, which sets a fixed starting point for Bubble. A setting of 0 for Pinch and 1.0 for Bubble produces a maximum smooth bulge. Negative values for Bubble move the bottom of the curve below the surface, creating a "valley" around the base of the region. Default=0.

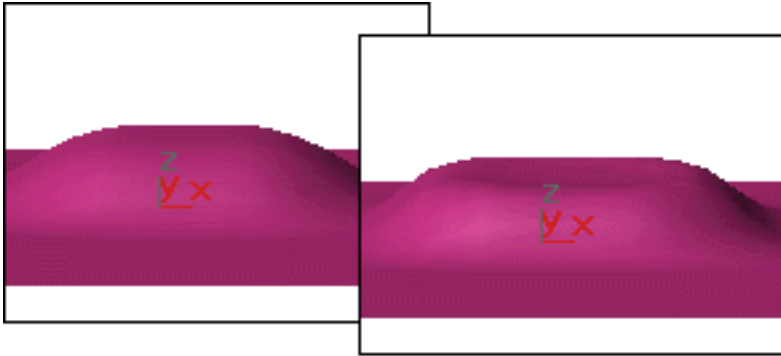

Left: Bubble=1

Right: Bubble=6

Falloff and Pinch have their default values.

## Material Properties Rollout

Modify panel > Select NURBS object. > Stack display > Surface sub-object level  
> Material Properties rollout

This rollout controls material mapping onto a NURBS surface sub-object.

### Procedures

To apply a mapped material to a surface sub-object:

- 1 On the Material Properties rollout, turn on Gen. Mapping Coordinates.



- 2 Use the [Material Editor](#) on page 5188 to assign a mapped material to the surface.

To use multiple map channels on a single surface sub-object (example):

- 1 On the Material Properties rollout, turn on Gen. Mapping Coordinates.
- 2 Change the Map Channel value to 2, and turn on Gen. Mapping Coordinates.
- 3 Change the U and V tiling values for map channel 2.



Now when you assign a mapped material, maps on map channel 1 use the default UV tiling, while maps on map channel 2 use the channel 2 tiling. An easy way to see this is to create a [checker](#) on page 5646 map on channel 1, and make one checker color another checker map on channel 2.

## Interface

### Material Properties rollout

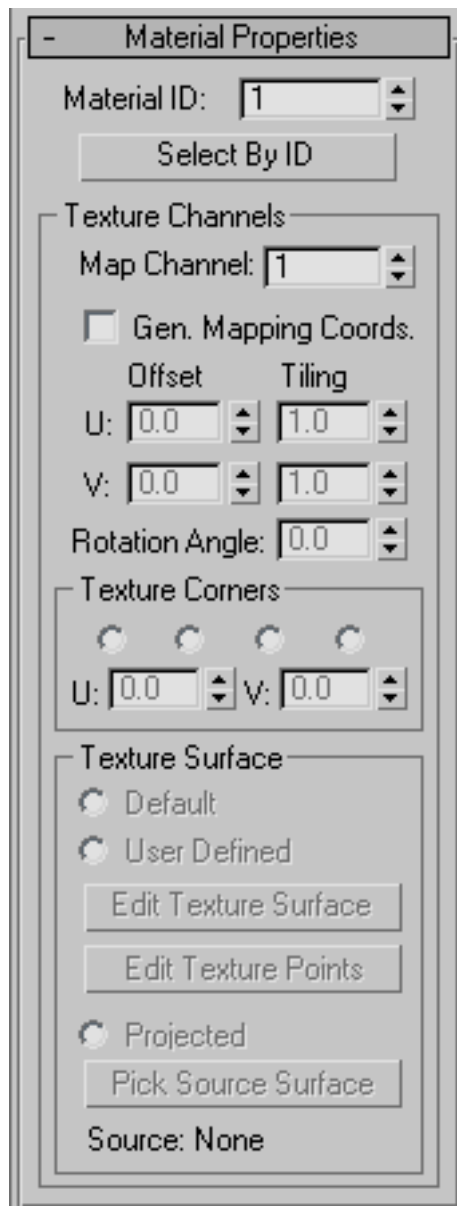

**Material ID** Use this to change the surface's material ID number. Multiple material IDs in a single NURBS object let you assign a [multi/sub-object material](#) on page 5558 to the NURBS object.

**Select by ID** Displays a [Select by Material ID dialog](#) on page 2468 .

### **Texture Channels group**

The controls in this group box support materials, including tiling and positioning mapping coordinates on the surface.

**Map Channel** Chooses a UV coordinates [map channel](#) on page 7836 . Range=1 to 99. A single surface can use up to 99 texture channels. Default=1.

**Gen. Mapping Coordinates** Generates mapping coordinates so you can apply mapped materials to the surface. Each surface in a NURBS object has its own set of mapping coordinates. Default=off.

**U and V Offset** Offset mapping coordinates along the surface's local U axis or V axis. That is, at 0.0 (the default), the map begins at the U or V origin. Increasing an Offset value moves the map forward along that axis, and decreasing it moves it backward. These parameters are animatable.

**U and V Tiling** Control the tiling of UV mapping coordinates; that is, the number of times a mapped material's map is repeated in the surface's local U axis or V axis. Default=1.0 for both axes (no tiling). These parameters are animatable.

**Rotation Angle** Lets you specify a rotation angle for the texture. This parameter is animatable.

### **Texture Corners group**

The controls in this group box let you explicitly set which texture surface UV values to use at the corners of a surface. These controls are especially useful when you are matching the textures of adjacent surfaces.

These controls are disabled unless Generate Mapping Coordinates is on.

**Corners radio buttons** The four buttons correspond to the four corners of the currently selected surface. When you choose a button, the corresponding corner is highlighted with a blue box in 3D viewports, and the U and V spinners are enabled.

**U and V** Unavailable unless you've chosen one of the Corners radio buttons. When available, you use these spinners to set the U and V texture values for the chosen corner.

By default, the U and V values for most surfaces range from 0.0 to 1.0. For some kinds of geometry converted to a NURBS surface, these ranges can vary.

### **Texture Surface group**

The controls in this group box let you choose a method for mapping texture to the currently selected NURBS surface sub-object, and to adjust the parameters for some of the chosen methods.

These controls are available when Generate Mapping Coordinates is on.

A texture surface is a surface associated with the surface sub-object. The texture surface controls how materials are mapped. In effect, changing the texture surface stretches or otherwise changes the UV coordinates for the surface, altering the mapping.

Maps can shift with certain surface approximation methods. This effect is especially noticeable when the surface has animated CVs. You can reduce or eliminate map shifting by changing the mapping method to User Defined.

---

**TIP** Don't use the UVW Map modifier to apply a texture to an animated NURBS surface.

---

**Default** Automatically generates a texture surface. This method evenly distributes the texture and attempts to compensate for stretching of the surface.

The default texture surface method has no additional controls.

**User Defined** Generates a texture surface that you can edit. You edit the user-defined texture surface either by using an Edit Texture Surface dialog (as you did in 3ds Max prior to v3), or by editing texture points directly in viewports.

**Edit Texture Surface** Click to display the [Edit Texture Surface dialog](#) on page 2453, which lets you control UV mapping on this surface. This button is available when you've chosen User Defined as the texture surface method.

**Edit Texture Points** Click to edit texture surface points directly in viewports. This button available when you've chosen User Defined as the texture surface method.

While Edit Texture Points is on, the points of the texture surface are displayed in viewports, where you can adjust their positions by using the selection and transform tools.

**Projected** Generates the texture surface by projecting the texture of another NURBS surface sub-object in the NURBS model. The projection travels along the direction of the normals of the source surface.

Projected texture surfaces are relational: if you update the source surface, the texture updates on all the surfaces it projects onto.

If you use the same source surface to project a texture onto several other connected surfaces, the textures will match along the boundaries where the mapped surfaces touch.

**Pick Source Surface** This button is available when you've chosen Projected as the texture surface method. To choose a source (projector) surface, choose Projected, click to turn on this button, and then click in a viewport to select another surface sub-object in the same NURBS model.

**Source text field** If Projected is the chosen texture surface method and you have picked a surface to project, this field displays the name of the projector (source) surface. Otherwise, this field says "None."

## Creating Curve Sub-Objects

Select NURBS object. > Modify panel > Create Curves rollout

Select NURBS object. > Modify panel > NURBS toolbox

Keyboard > Ctrl+T to toggle NURBS toolbox display (Keyboard Shortcut Override Toggle must be on)

Curve sub-objects are either independent point and CV curves (similar to the top-level point and CV curves described in [Point Curve](#) on page 2201 and [CV Curve](#) on page 2208 ), or they are dependent curves. Dependent curves are curve sub-objects whose geometry depends on other curves, points, or surfaces in the NURBS object. When you change the geometry of the original, parent sub-objects, the dependent curve changes as well.

You create curve sub-objects using the Create Curves rollout on the Modify command panel for a NURBS curve.

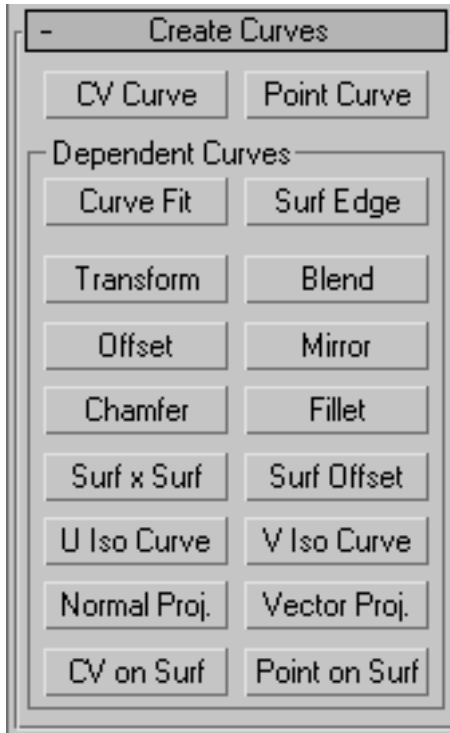

---

**TIP** Lathe and extrude surface sub-objects can be based on only a single curve; see [Creating Dependent Surfaces](#) on page 2337 . If you create dependent curves and then want to use the set of curves (for example, two parents and a fillet between them) as the basis of an extrude or loft surface, first go to the Curve sub-object level and use Join to connect the curves.

---

Creation operations for dependent sub-objects require you to select one or more parent objects. In general, you can click and drag, or click and then click again. You can also use the H keyboard shortcut to display the Select Sub-Objects dialog. This is a subset of the [Selection Floater](#) on page 171 for choosing the parent. (The [Keyboard Shortcut Override Toggle](#) on page 7646 must be on for H to work this way.)

### **Toolbox Buttons for Creating Curves**

These are the [toolbox](#) on page 2162 buttons for creating curve sub-objects:



Create an independent [CV curve sub-object](#) on page 2286 .

-  Create an independent [point curve sub-object](#) on page 2290 .
-  Create a dependent fit curve (as with the [Curve Fit](#) on page 2293 button).
-  Create a dependent [transform curve](#) on page 2294 .
-  Create a dependent [blend curve](#) on page 2296 .
-  Create a dependent [offset curve](#) on page 2299 .
-  Create a dependent [mirror curve](#) on page 2301 .
-  Create a dependent [chamfer curve](#) on page 2303 .
-  Create a dependent [fillet curve](#) on page 2308 .
-  Create a dependent [surface-surface intersection curve](#) on page 2312 .
-  Create a dependent [U iso curve](#) on page 2318 .
-  Create a dependent [V iso curve](#) on page 2318 .
-  Create a dependent [normal projected curve](#) on page 2320 .
-  Create a dependent [vector projected curve](#) on page 2323 .
-  Create a dependent [CV curve on surface](#) on page 2327 .
-  Create a dependent [point curve on surface](#) on page 2331 .
-  Create a dependent [surface offset curve](#) on page 2316 .



Create a dependent [surface edge curve](#) on page 2335 .

## CV Curve Sub-Object



Select NURBS object. > Modify panel > Create Curves rollout > CV Curve button

Select NURBS object. > Modify panel > NURBS toolbox > Create CV Curve button

CV curve sub-objects are similar to object-level [CV curves](#) on page 2208 . The main difference is that you can't give CV curves a renderable thickness at the sub-object level.

### Drawing Three-Dimensional Curves

When you create a CV curve, you can draw it in three dimensions. There are two ways to do this:

- **Draw In All Viewports:** This toggle lets you use any viewport to draw the curve, enabling you to draw three dimensionally.
- **Using Ctrl to drag CVs:** While you draw a curve, you can use the Ctrl key to drag a CV off of the construction plane.

With the Ctrl-key method, further mouse movement lifts the latest point off the construction plane. There are two ways to use this:

- **Click-drag.** If you hold down Ctrl and also hold down the mouse button, you can drag to change the height of the CV. The CV's location is set when you release the mouse button.  
This method is probably more intuitive.
- **Click-click.** If you Ctrl+click and then release the mouse button, the height changes as you drag the mouse. Clicking the mouse a second time sets the CV's location.  
This method is less prone to repetitive stress injury.

While you are offsetting the CV, a red dotted line is drawn between the original CV on the construction plane and the actual CV offset from the plane. You can move the mouse into an inactive viewport, in which case the software



sets the height of the CV using the CV's Z axis in the inactive viewport. This lets you set the height of the CV with accuracy.

[Snaps](#) on page 2578 also work when you change the height of a CV. For example, if you turn on CV snapping, you can set a CV to have the same height as another CV by snapping to that other CV in an inactive viewport.

## Procedures

To create a CV curve sub-object:

- 1  Turn on CV Curve.
- 2 In a viewport, click and drag to create the first CV, as well as the first curve segment. Release the mouse button to add the second CV. Each subsequent location you click adds a new CV to the curve. Right-click to end curve creation.

---

**NOTE** If you begin the curve by clicking without dragging, this also creates the curve's first CV. However, if you release the mouse button more than five pixels away from where you initially pressed it, this creates an additional CV.

---

While you are creating a CV curve, you can press Backspace to remove the last CV you created, and then previous CVs in reverse order.

If Draw In All Viewports is on, you can draw in any viewport, creating a 3D curve.

To lift a CV off the construction plane, use the Ctrl key as described earlier in this topic under "Drawing Three-Dimensional Curves."

As with splines, if you click over the curve's initial CV, a [Close Curve dialog](#) on page 2448 is displayed. This dialog asks whether you want the curve to be closed. Click No to keep the curve open or Yes to close the curve. (You can also close a curve when you edit it at the Curve sub-object level.) When a closed curve is displayed at the Curve sub-object level, the initial CV is displayed as a green circle, and a green tick mark indicates the curve's direction.

## Interface

### CV Curve rollout (creation time)

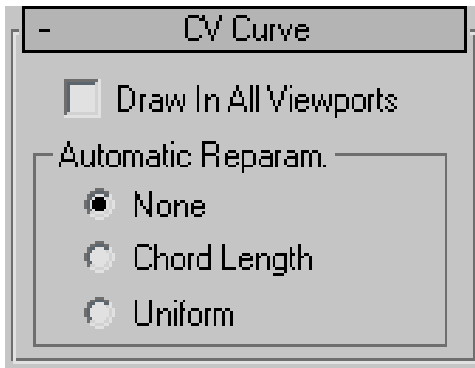

**Draw In All Viewports** Lets you use any viewport while you are drawing the curve. This is one way to create a 3D curve. When off, you must finish drawing the curve in the viewport where you began it. Default=on.

While Draw In All Viewports is on, you can also use [snaps](#) on page 2578 in any viewport.

### Automatic Reparameterization group

The controls in this group box let you specify automatic reparameterization. They are similar to the controls in the [Reparameterize dialog](#) on page 2465 , with one addition: all choices except for None tell the software to reparameterize the curve automatically; that is, whenever you edit it by moving CVs, refining, and so on.

**None** Do not reparameterize automatically.

**Chord Length** Chooses the chord-length algorithm for reparameterization.

Chord-length reparameterization spaces knots (in [parameter space](#) on page 7882 ) based on the square root of the length of each curve segment.

Chord-length reparameterization is usually the best choice.

**Uniform** Spaces the knots uniformly.

A uniform knot vector has the advantage that the curve or surface changes only locally when you edit it. With the other two forms of parameterization, moving any CV can change the entire sub-object.

## CV Curve rollout (modification time)

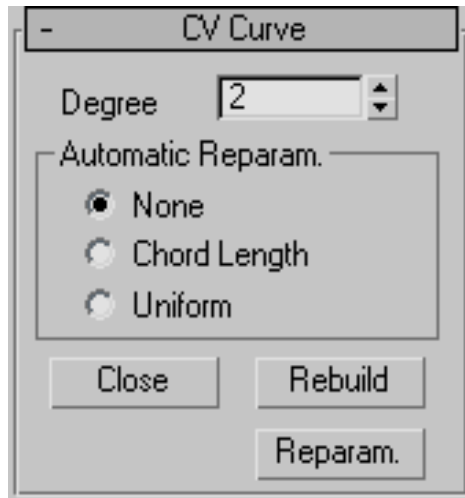

**Degree** Sets the degree of the curve. The higher the degree value, the greater the continuity. The lower the degree, the more discontinuous the curve segments become. The degree can't be less than one or greater than the number allowed by the number of CVs in the curve. Degree 3 curves are adequate to represent continuous curves, and are stable and well behaved. Default=3.

Setting the degree greater than 3 isn't recommended, because higher-degree curves are slower to calculate and less stable numerically. Higher-degree curves are supported primarily to be compatible with models created using other surface modeling programs.

The number of CVs in a CV curve must be at least one greater than the curve's degree.

### Automatic Reparameterization group

The controls in this group box let you specify automatic reparameterization. They are similar to the controls in the [Reparameterize dialog](#) on page 2465 , with one addition: all choices except for None tell the software to reparameterize the curve automatically; that is, whenever you edit it by moving CVs, refining, and so on.

**None** Do not reparameterize automatically.

**Chord Length** Chooses the chord-length algorithm for reparameterization.

Chord-length reparameterization spaces knots (in [parameter space](#) on page 7882 ) based on the square root of the length of each curve segment.

Chord-length reparameterization is usually the best choice.

**Uniform** Spaces the knots uniformly.

A uniform knot vector has the advantage that the curve or surface changes only locally when you edit it. With the other two forms of parameterization, moving any CV can change the entire sub-object.

**Close** Closes the curve. Disabled if the curve is already closed.

**Rebuild** Displays the [Rebuild CV Curve dialog](#) on page 2463 to let you rebuild the CV curve.

**Reparam** Displays the [Reparameterize dialog](#) on page 2465 to let you reparameterize the CV.

## Point Curve Sub-Object

Select NURBS object. > Modify panel > Create Curves rollout > Point Curve button

Select NURBS object. > Modify panel > NURBS toolbox > Create Point Curve button

Point curve sub-objects are similar to object-level [point curves](#) on page 2201 . Points are constrained to lie on the curve. The main difference is that you can't give point curves a renderable thickness at the sub-object level.

### Drawing Three-Dimensional Curves

When you create a point curve, you can draw it in three dimensions. There are two ways to do this:

- **Draw In All Viewports:** This toggle lets you use any viewport to draw the curve, enabling you to draw three dimensionally.
- **Using Ctrl to drag points:** While you draw a curve, you can use the Ctrl key to drag a point off of the construction plane.

With the Ctrl key method, further mouse movement lifts the latest point off the construction plane. There are two ways to use this:

- Click-drag. If you hold down Ctrl and also hold down the mouse button, you can drag to change the height of the point. The point's location is set when you release the mouse button.  
This method is probably more intuitive.
- Click-click. If you Ctrl+click and then release the mouse button, the height changes as you drag the mouse. Clicking the mouse a second time sets the point's location.  
This method is less prone to repetitive stress injury.

While you are offsetting the point, a red dotted line is drawn between the original point on the construction plane and the actual point offset from the plane. You can move the mouse into an inactive viewport, in which case the software sets the height of the point using the point's Z axis in the inactive viewport. This lets you set the height of the point with accuracy.

[Snaps](#) on page 2578 also work when you change the height of a point. For example, if you turn on Point snapping, you can set a point to have the same height as another point by snapping to that other point in an inactive viewport.

## Procedures

To create a point curve sub-object:



1 Turn on Point Curve.

2 In a viewport, click and drag to create the first point, as well as the first curve segment. Release the mouse button to add the second point. Each subsequent location you click adds a new point to the curve. Right-click to end curve creation.

---

**NOTE** If you begin the curve by clicking without dragging, this also creates the curve's first point. However, if you release the mouse button more than five pixels away from where you initially pressed it, this creates an additional point.

---

While you are creating a point curve, you can press Backspace to remove the last point you created, and then previous points in reverse order.

If Draw In All Viewports is on, you can draw in any viewport, creating a 3D curve.

To lift a point off the construction plane, use the Ctrl key as described earlier in this topic under [Drawing Three-Dimensional Curves](#) on page 2290 .

As with splines, if you click over the curve's initial point, a [Close Curve dialog](#) on page 2462 is displayed. This dialog asks whether you want the curve to be closed. Click No to keep the curve open or Yes to close the curve. (You can also close a curve when you edit it at the Curve sub-object level.) When a closed curve is displayed at the Curve sub-object level, the initial point is displayed as a green circle, and a green tick mark indicates the curve's direction.

## Interface

### Point Curve rollout (creation time)

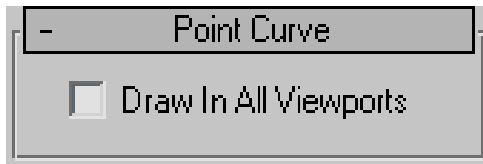

**Draw In All Viewports** Lets you use any viewport while you are drawing the curve. This is one way to create a 3D curve. When off, you must finish drawing the curve in the viewport where you began it. Default=on.

While Draw In All Viewports is on, you can also use [snaps](#) on page 2578 in any viewport.

### Point Curve rollout (modification time)

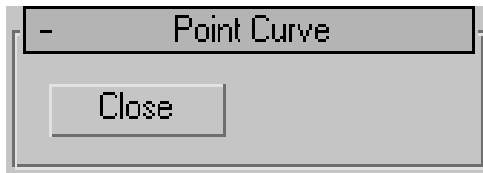

**Close** Closes the curve. Disabled if the curve is already closed.

## Curve Fit

Select NURBS object. > Modify panel > Create Curves rollout > Dependent Curves group box > Curve Fit button

Select NURBS object. > Modify panel > NURBS toolbox > Create Fit Curve button

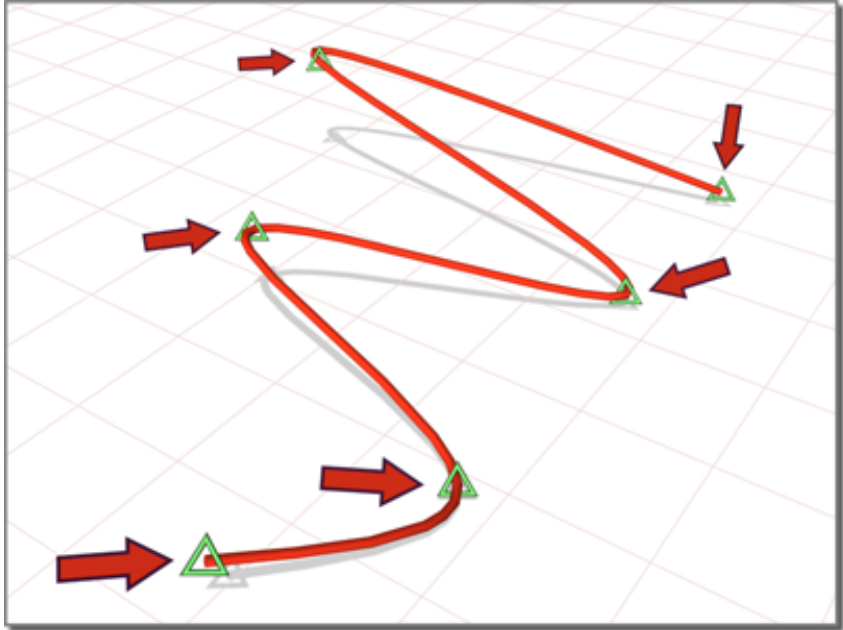

### Fitting a curve to selected points

This command creates a point curve fitted to points you select. The points can be part of previously created point curve and point surface objects, or they can be point sub-objects you created explicitly. They can't be CVs.

### Procedures

To create a point curve with Curve Fit:

- 1  Turn on Curve Fit.
- 2 Click to select two or more points.

A point curve is created. It runs through the points you select, in the order you select them.

You can use Backspace to undo point selection in reverse order.

- 3 Right-click to end creation.

## Interface

There are no parameters for a point curve created with Curve Fit.

## Transform Curve

Select NURBS object. > Modify panel > Create Curves rollout > Dependent Curves group box > Transform button

Select NURBS object. > Modify panel > NURBS toolbox > Create Transform Curve button

A transform curve is a copy of the original curve with a different position, rotation, or scale.



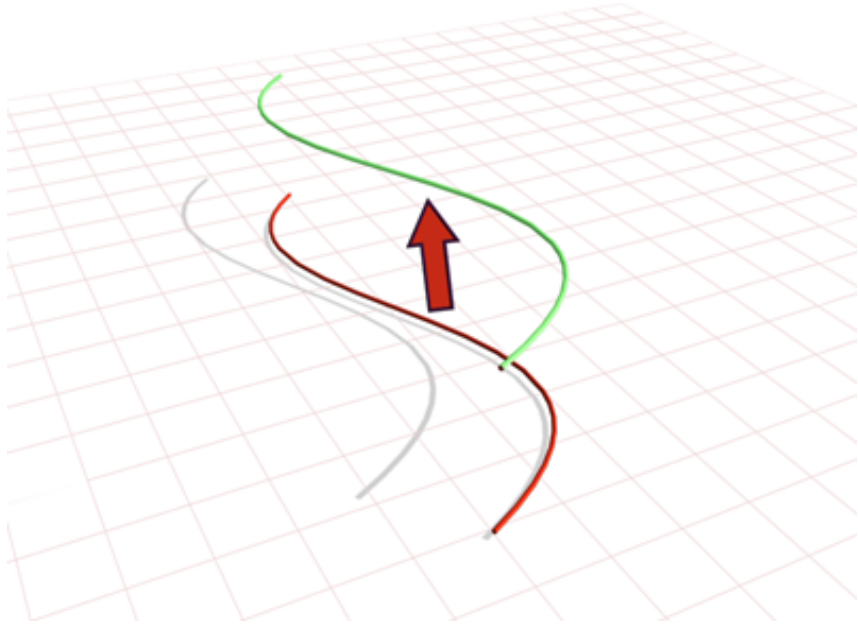

Curve used to create a transform curve

## Procedures

To create a transform curve:

-  In a NURBS object that contains at least one curve, turn on Transform. To move the transform curve, click and drag the curve you want to duplicate. To rotate or scale the transform curve, click the parent curve, click to turn on Sub-Object on the Modifier Stack rollout, choose Curve from the drop-down list, and then use a transform to rotate or scale the transform curve.

When you use Move to create the transform curve, it simply copies the parent. (It doesn't exaggerate curvature as an offset curve does.)

Axis constraints don't apply to the creation of transform curves. You can click to create the curve in place; then once it is created, transform it using constraints.

---

**TIP** You can also use axis constraints by using Shift+clone at the Curve sub-object level.

---

## Interface

### Creation time

At creation time, transform curves have no parameters.

### Transform Curve rollout (modification time)

At modification time, you can transform the transform curve as a curve sub-object, and you can animate curve sub-object transforms. Transform curves also have one control in the Modify panel.

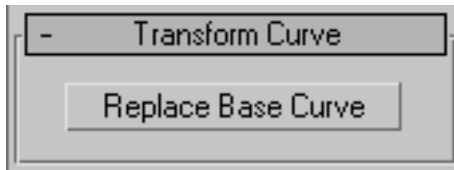

**Replace Base Curve** Lets you replace the parent curve. Click the button, then click the curve to replace the original curve.

## Blend Curve

Select NURBS object. > Modify panel > Create Curves rollout > Dependent Curves group box > Blend button

Select NURBS object. > Modify panel > NURBS toolbox > Create Blend Curve button

A blend curve connects the end of one curve to the end of another, blending the curvature of the parents to create a smooth curve between them. You can blend curves of the same type, a point curve with a CV curve (and vice versa), an independent curve with a dependent curve, and so on.

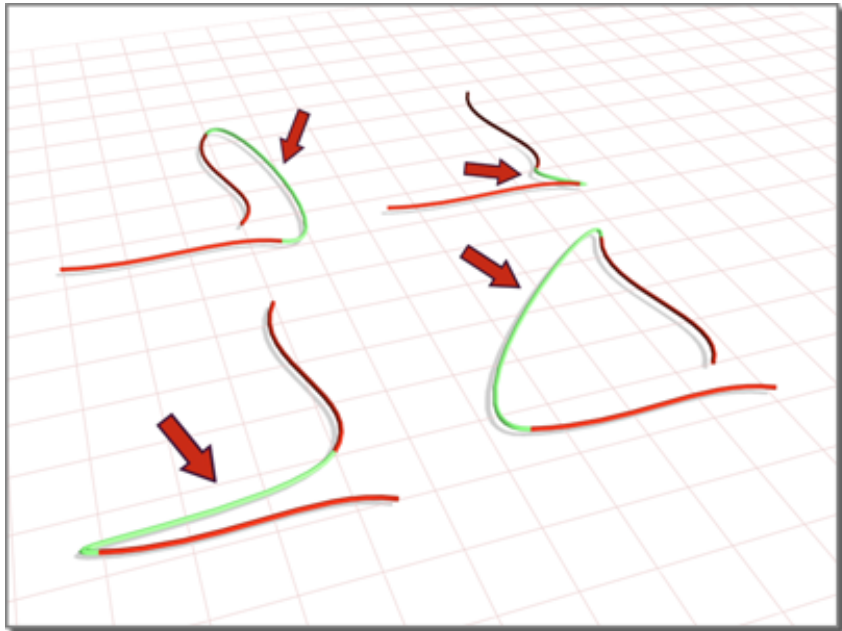

Blend curves connecting original curves

### Procedures

To create a blend curve:

- 1  In a NURBS object that contains two curves, turn on Blend.
- 2 Click one curve near the end that you want to connect. The end that will be connected is highlighted. Without releasing the mouse button, drag to the end of the other curve that you want to connect. The other end is highlighted as well. When the end that you want to connect is highlighted, release the mouse button.  
After the blend curve is created, changing the position or the curvature of either parent curve changes the blend curve as well.
- 3 Adjust the blend parameters.

## Interface

### Blend Curve rollout (creation time)

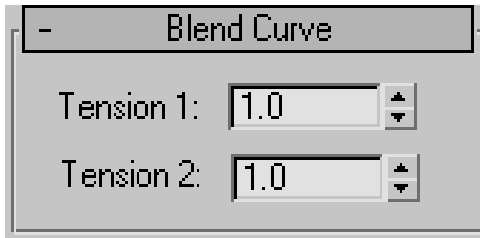

"Tension" affects the tangent between a parent curve and the blend curve. The greater the tension value, the more closely the tangent parallels the parent curve, and the smoother the transition. The lower the tension, the greater the tangent angle and the sharper the transition between parent and blend.

**Tension 1** Controls tension at the edge of the first curve you clicked.

**Tension 2** Controls tension at the edge of the second curve you clicked.

### Blend Curve rollout (modification time)

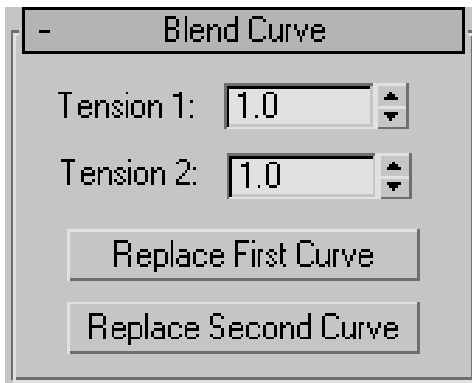

"Tension" affects the tangent between a parent curve and the blend curve. The greater the tension value, the more closely the tangent parallels the parent curve, and the smoother the transition. The lower the tension, the greater the tangent angle and the sharper the transition between parent and blend.

**Tension 1** Controls tension at the edge of the first curve you clicked.

**Tension 2** Controls tension at the edge of the second curve you clicked.

**Replace First Curve and Replace Second Curve** Let you replace the parent curves. Click the button, then click the curve to replace the original first or second curve.

## Offset Curve

Select NURBS object. > Modify panel > Create Curves rollout > Dependent Curves group box > Offset button

Select NURBS object. > Modify panel > NURBS toolbox > Create Offset Curve button

An Offset curve is offset from the original, parent curve. It is normal to the original. You can offset both planar and 3D curves.

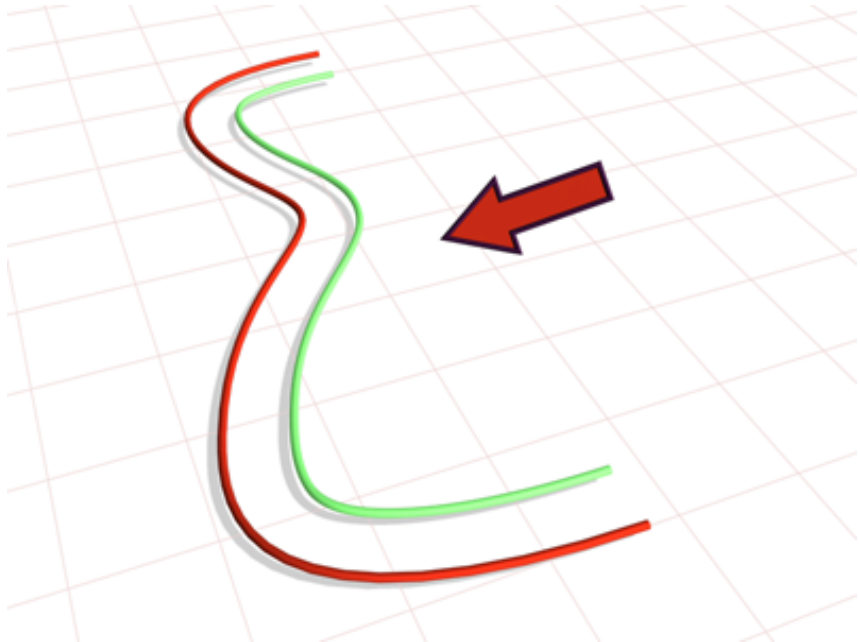

Curve used to create an offset curve

## Procedures

To create an offset curve:

- 1  In a NURBS object that contains at least one curve, turn on Offset.
- 2 Click the curve you want to offset, and drag to set the initial distance. An offset curve is created.
- 3 Adjust the Offset parameter.  
If the parent curve is not linear, increasing the distance increasingly exaggerates the curvature of the offset curve.

## Interface

### Offset Curve rollout (creation time)

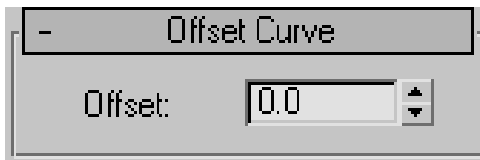

**Offset** The distance between the parent curve and the offset curve, in 3ds Max units.

This parameter is animatable.

### Offset Curve rollout (modification time)

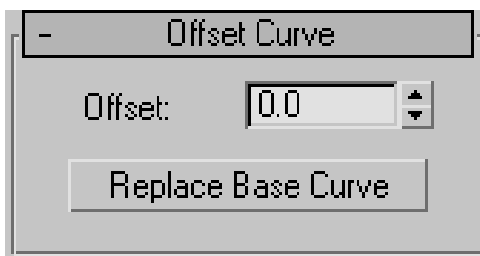

**Offset** The distance between the parent curve and the offset curve, in 3ds Max units.

**Replace Base Curve** Lets you replace the parent curve. Click the button, then click the curve to replace the original curve.

## Mirror Curve

Select NURBS object. > Modify panel > Create Curves rollout > Dependent Curves group box > Mirror button

Select NURBS object. > Modify panel > NURBS toolbox > Create Mirror Curve button

A mirror curve is a mirror image of the original curve.

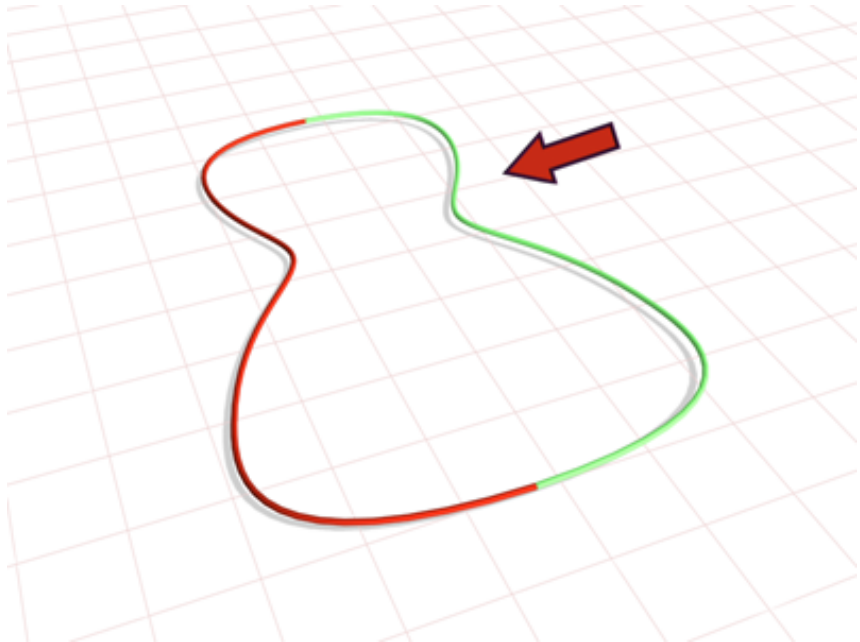

Curve used to create a mirror curve

### Procedures

To create a mirror curve:

- 1  In a NURBS object that contains at least one curve, turn on Mirror.
- 2 On the Mirror Curve rollout, choose the axis or plane you want to use.
- 3 Click the curve you want to mirror, and drag to set the initial distance.

A mirror curve is created. A gizmo (yellow by default) indicates the direction of mirroring. Transforming the mirror curve's gizmo changes the orientation of the mirror, letting you mirror along an axis that isn't aligned with a local coordinate axis.

- 4 Adjust the mirror parameters.

### Interface

In viewports a gizmo (yellow by default) indicates the mirror axis.

### Mirror Curve rollout (creation time)

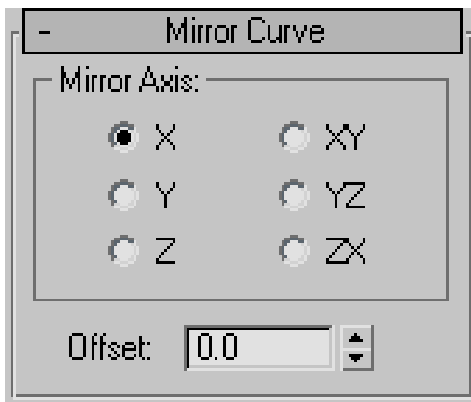

### Mirror Axis group

The Mirror Axis buttons control the direction in which the original curve is mirrored.

You can't transform the mirror curve directly (that would simply transform the mirror curve *and* its parent curve at the same time). You transform it by transforming its gizmo. By using transforms you can mirror about an arbitrary axis, rather than using one of the Mirror Axis presets. When you transform a mirror curve, you are actually transforming the mirror plane, so Rotate has the effect of rotating the plane about which the curve is mirrored. (This is like rotating the mirror gizmo in the Mirror modifier.)

**Offset** Controls the mirror's distance from the original curve.

This parameter is animatable.



## Mirror Curve rollout (modification time)

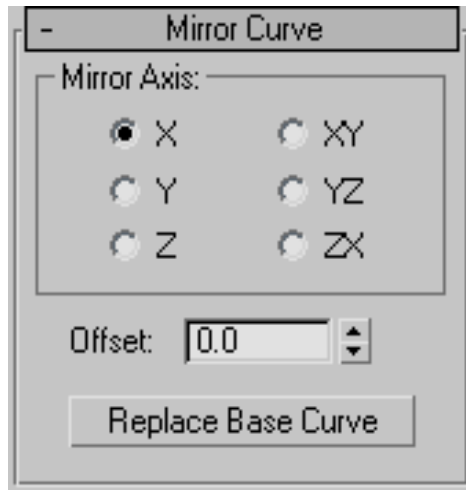

### Mirror Axis group

The Mirror Axis buttons control the direction in which the original curve is mirrored.

You can't transform the mirror curve directly (that would simply transform the mirror curve *and* its parent curve at the same time). You transform it by transforming its gizmo. By using transforms you can mirror about an arbitrary axis, rather than using one of the Mirror Axis presets. When you transform a mirror curve, you are actually transforming the mirror plane, so Rotate has the effect of rotating the plane about which the curve is mirrored. (This is like rotating the mirror gizmo in the Mirror modifier.)

**Offset** Controls the mirror's distance from the original curve.

This parameter is animatable.

**Replace Base Curve** Lets you replace the parent curve. Click the button, then click the curve to replace the original curve.

## Chamfer Curve

Select NURBS object. > Modify panel > Create Curves rollout > Dependent Curves group box > Chamfer button

Select NURBS object. > Modify panel > NURBS toolbox > Create Chamfer Curve button

Chamfer creates a curve that is a straight bevel between two parent curves.

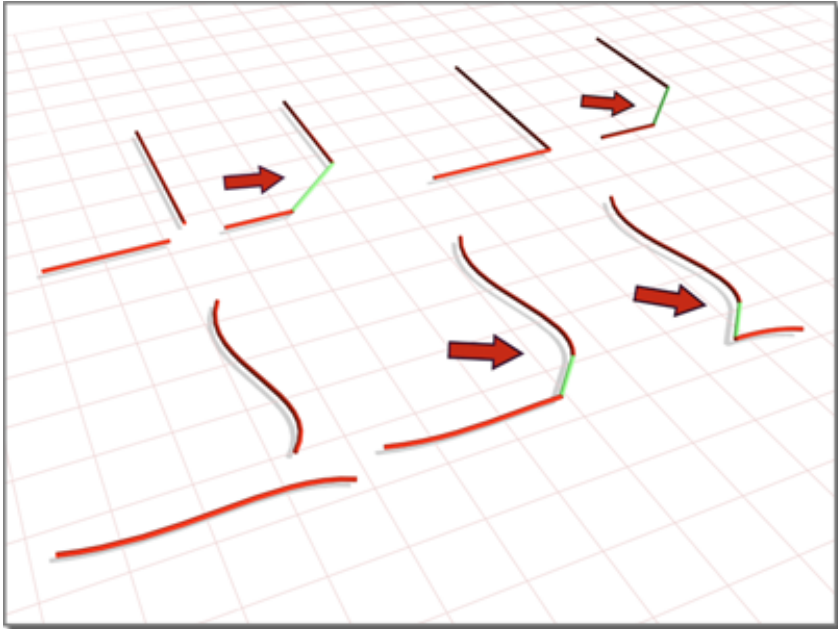

Creating chamfers between two original curves

## Procedures

To create a chamfer curve:

- 1  In a NURBS object that contains at least two curves, turn on Chamfer.

---

**TIP** Make sure the curves intersect before you begin to create the chamfer.

---

- 2 Click one curve near the end that you want to connect. The end that will be connected is highlighted. Without releasing the mouse button, drag to the end of the other curve that you want to connect. When the end that will be connected is highlighted, release the mouse button.

A chamfer curve is created. Changing the position or the curvature of either parent curve can change the chamfer as well.

The parent curves must be coplanar. The chamfer is not necessarily connected at the endpoints of the parent curves: you can adjust its position with the chamfer's Length parameters.

- 3 Adjust the chamfer parameters.

## Interface

### Chamfer Curve rollout (creation time)

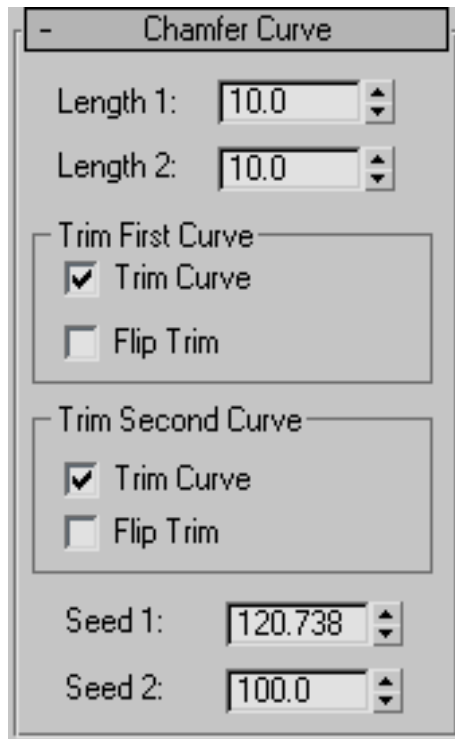

The lengths are the distances from the intersection (or apparent intersection) at which the chamfer segment is drawn.

**Length 1** The distance along the first curve you click.

This parameter is animatable.

**Length 2** The distance along the second curve you click.

This parameter is animatable.

Some length values make it impossible to construct the chamfer. If you set the length to an invalid value, the chamfer returns to a default position and is displayed in the error color (orange by default).

### **Trim First Curve and Trim Second Curve groups**

These two group boxes let you control how the parent curves are trimmed. The controls are the same in each. "First" and "second" refer to the order in which you picked the parent curves.

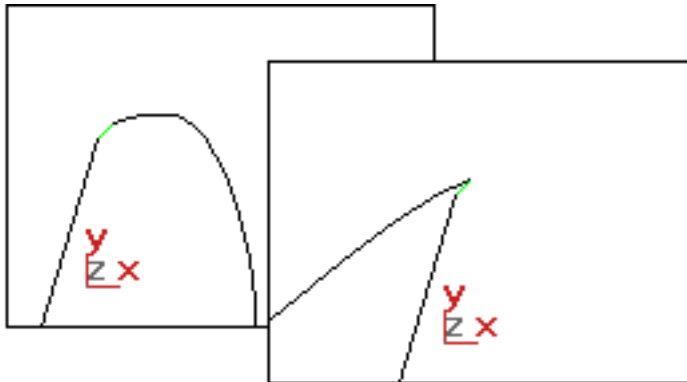

#### **Flipping the direction of a trim**

**Trim Curve** When on (the default), trims the parent curve against the fillet curve. When off, the parent isn't trimmed.

**Flip Trim** When on, trims in the opposite direction.

**Seed 1 and Seed 2** Change the U location of the seed value on the first and second curves. If there is a choice of directions, the direction indicated by the seed points is the one used to create the chamfer.

### Chamfer Curve rollout (modification time)

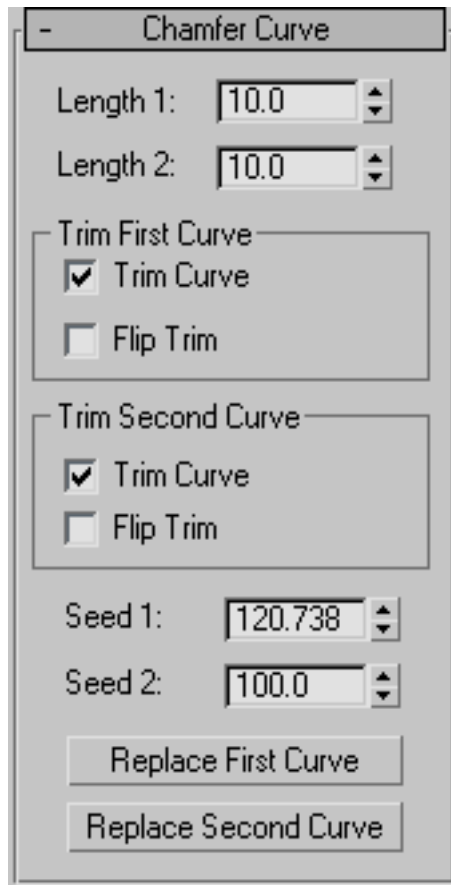

The lengths are the distances from the intersection (or apparent intersection) at which the chamfer segment is drawn.

**Length 1** The distance along the first curve you click.

**Length 2** The distance along the second curve you click.

Some length values make it impossible to construct the chamfer. If you set the length to an invalid value, the chamfer returns to a default position and is displayed in the error color (orange by default).

## Trim First Curve and Trim Second Curve groups

These two group boxes let you control how the parent curves are trimmed. The controls are the same in each. "First" and "second" refer to the order in which you picked the parent curves.

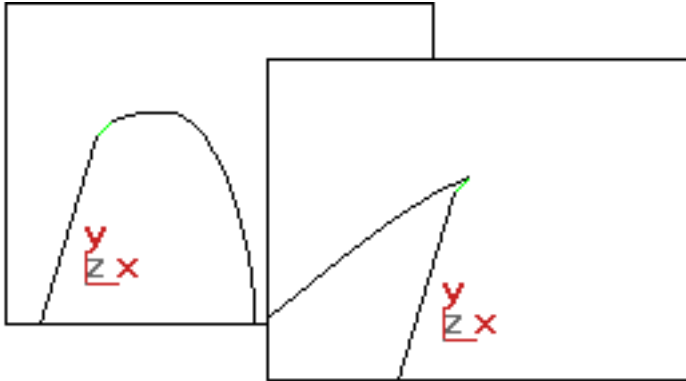

### Flipping the direction of a trim

**Trim Curve** When on (the default), trims the parent curve against the fillet curve. When off, the parent isn't trimmed.

**Flip Trim** When on, trims in the opposite direction.

**Seed 1 and Seed 2** Change the U location of the seed value on the first and second curves. If there is a choice of directions, the direction indicated by the seed points is the one used to create the chamfer.

**Replace First Curve and Replace Second Curve** Let you replace the parent curves. Click the button, then click the curve to replace the original first or second curve.

## Fillet Curve

Select NURBS object. > Modify panel > Create Curves rollout > Dependent Curves group box > Fillet button

Select NURBS object. > Modify panel > NURBS toolbox > Create Fillet Curve button

Fillet creates a curve that is a rounded corner between two parent curves.

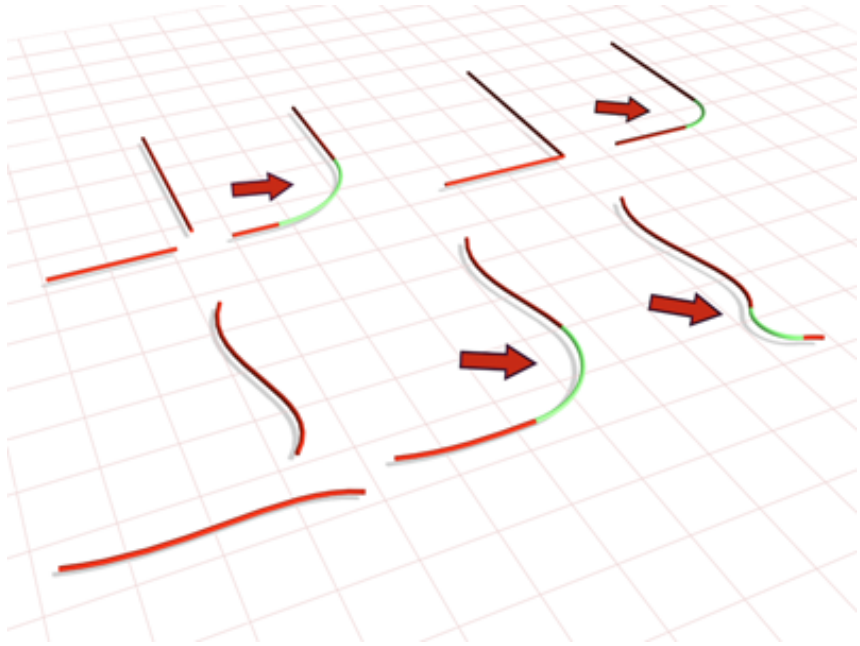

Above: Two simple fillets

Below: Flip Trim changes the direction of trimming and the shape the fillet.

## Procedures

To create a fillet curve:

- 1  In a NURBS object that contains at least two curves, turn on Fillet.
- 2 Click one curve near the end that you want to connect. The end that will be connected is highlighted. Without releasing the mouse button, drag to the end of the other curve that you want to connect. When the end that you want to connect is highlighted, release the mouse button.

A fillet curve is created. It trims the ends of the parent curve to match the fillet. The fillet is not necessarily placed at the endpoints of the parent curves: placement depends on the value of the Radius parameter.

Changing the position or the curvature of either parent curve can change the fillet as well.

The parent curves must be coplanar.

- 3 Adjust the fillet parameters.

## Interface

### Fillet Curve rollout (creation time)

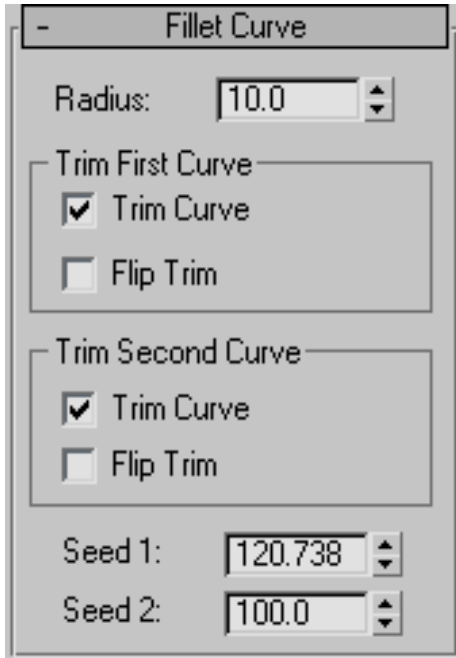

**Radius** The radius of the fillet arc in the current 3ds Max units. Default=10.0. This parameter is animatable.

---

**TIP** If the fillet you initially create is in an error state, often this is because the radius is not large enough to bridge the distance between the two curves. Increasing the Radius value gives you a correct fillet. The fillet becomes an arc displayed in the dependent object color (green by default). When the fillet is in an error state it is displayed as a straight line in the error color (orange by default).

---

### Trim First Curve and Trim Second Curve groups

These two group boxes let you control how the parent curves are trimmed. The controls are the same in each. "First" and "second" refer to the order in which you picked the parent curves.



**Trim Curve** When on (the default), trims the parent curve against the fillet curve. When off, the parent isn't trimmed.

**Flip Trim** When on, trims in the opposite direction.

**Seed 1 and Seed 2** Change the U location of the seed value on the first and second curves. If there is a choice of directions, the direction indicated by the seed points is the one used to create the fillet.

#### **Fillet Curve rollout (modification time)**

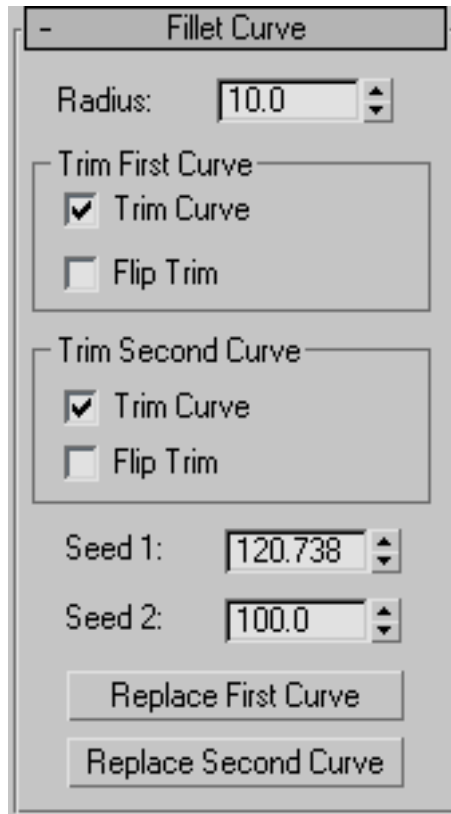

**Radius** The radius of the fillet arc in the current 3ds Max units. Default=10.0.

---

**TIP** If the fillet you initially create is in an error state, often this is because the radius is not large enough to bridge the distance between the two curves. Increasing the Radius value gives you a correct fillet. The fillet becomes an arc displayed in the dependent object color (green by default). When the fillet is in an error state it is displayed as a straight line in the error color (orange by default).

---

### **Trim First Curve and Trim Second Curve groups**

These two group boxes let you control how the parent curves are trimmed. The controls are the same in each. "First" and "second" refer to the order in which you picked the parent curves.

**Trim Curve** When on (the default), trims the parent curve against the fillet curve. When off, the parent isn't trimmed.

**Flip Trim** When on, trims in the opposite direction.

**Seed 1 and Seed 2** Change the U location of the seed value on the first and second curves. If there is a choice of directions, the direction indicated by the seed points is the one used to create the fillet.

**Replace First Curve and Replace Second Curve** Let you replace the parent curves. Click the button, then click the curve to replace the original first or second curve.

### **Surface-Surface Intersection Curve**



Select NURBS object. > Modify panel > Create Curves rollout > Dependent Curves group box > Surf x Surf button

Select NURBS object. > Modify panel > NURBS toolbox > Create Surface-Surface Intersection Curve button

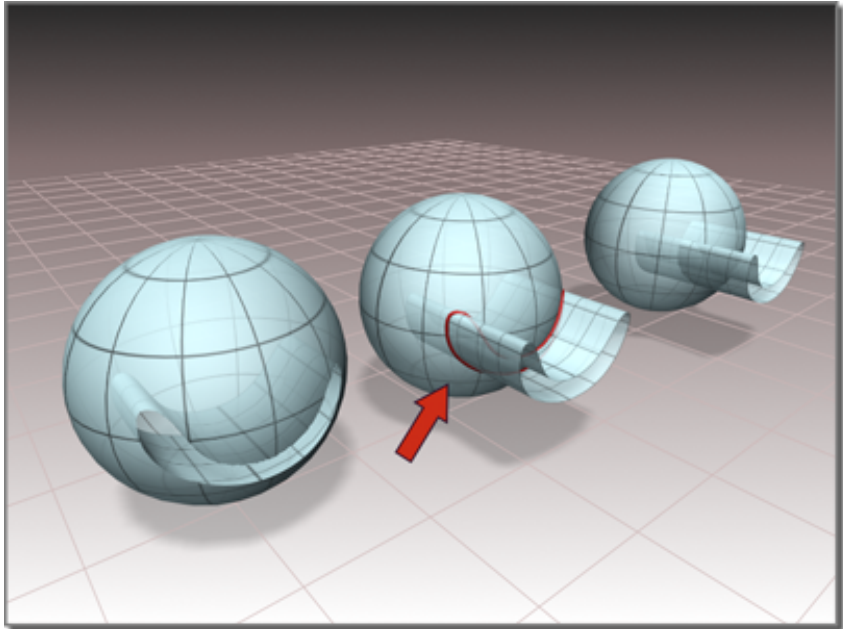

### Trimming a surface with a surface-surface intersection curve

This command creates a curve that is defined by the intersection of two surfaces. You can use surface-surface intersection curves for [trimming](#) on page 2156 .

If the surfaces intersect at two or more locations, the intersection closest to the seed point is the one that creates the curve.

### Procedures

To create a surface-surface intersection curve:

- 1  Turn on Create Surface-Surface Intersection Curve in the NURBS toolbox, or Surf x Surf on the Create Curves rollout.
- 2 Click the first surface, then the second.  
If the two surfaces intersect, a curve that lies along their intersection is created.

## Interface

### Surf-Surf Intersection Curve rollout (creation time)

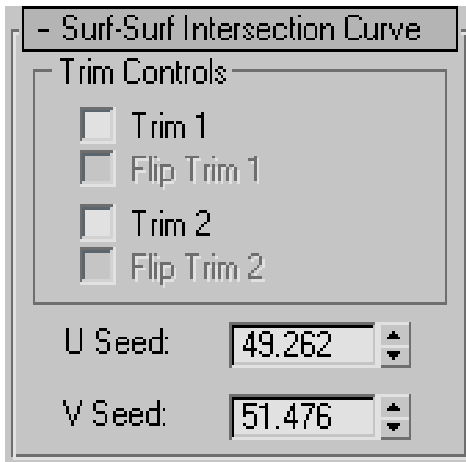

#### Trim Controls group

**Trim 1 and Trim 2** When on, trim a surface against the intersection curve. When off, the surface isn't trimmed. Trim 1 trims the first parent surface you clicked, and Trim 2 trims the second parent surface.

If the intersection curve does not pass completely across a surface, trimming is impossible, and the affected surface is displayed in the error color (orange by default).

**Flip Trim 1 and Flip Trim 2** When on, trim the associated surface in the opposite direction.

**U Seed and V Seed** Change the UV location of the seed value on surface 1, the first surface you clicked. If there is a choice of intersections, the intersection closest to the seed point is the one used to create the curve.

## Surf-Surf Intersection Curve rollout (modification time)

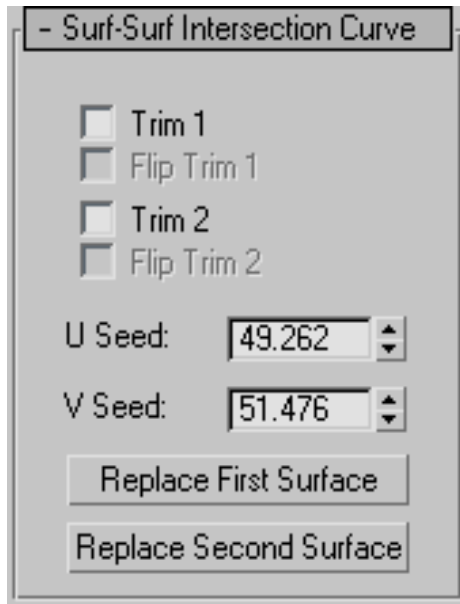

### Trim Controls group

**Trim 1 and Trim 2** When on, trim a surface against the intersection curve. When off, the surface isn't trimmed. Trim 1 trims the first parent surface you clicked, and Trim 2 trims the second parent surface.

If the intersection curve does not pass completely across a surface, trimming is impossible, and the affected surface is displayed in the error color (orange by default).

**Flip Trim 1 and Flip Trim 2** When on, trim the associated surface in the opposite direction.

**U Seed and V Seed** Change the UV location of the seed value on surface 1, the first surface you clicked. If there is a choice of intersections, the intersection closest to the seed point is the one used to create the curve.

**Replace First Surface and Replace Second Surface** Let you replace the parent surfaces. Click a button, then click the surface to replace the original first or second surface.

## Surface Offset Curve

Select NURBS object. > Modify panel > Create Curves rollout > Dependent Curves group box > Surf Offset button

Select NURBS object. > Modify panel > NURBS toolbox > Create Surface Offset Curve button

This command creates a curve that is offset from a curve that lies on a surface. In other words, the parent curve must have one of the following types: surface-surface intersection, U iso, V iso, normal projected, vector projected, CV curve on surface, or point curve on surface. The offset is normal to the surface. That is, the new curve is either above or below the surface by the offset amount.

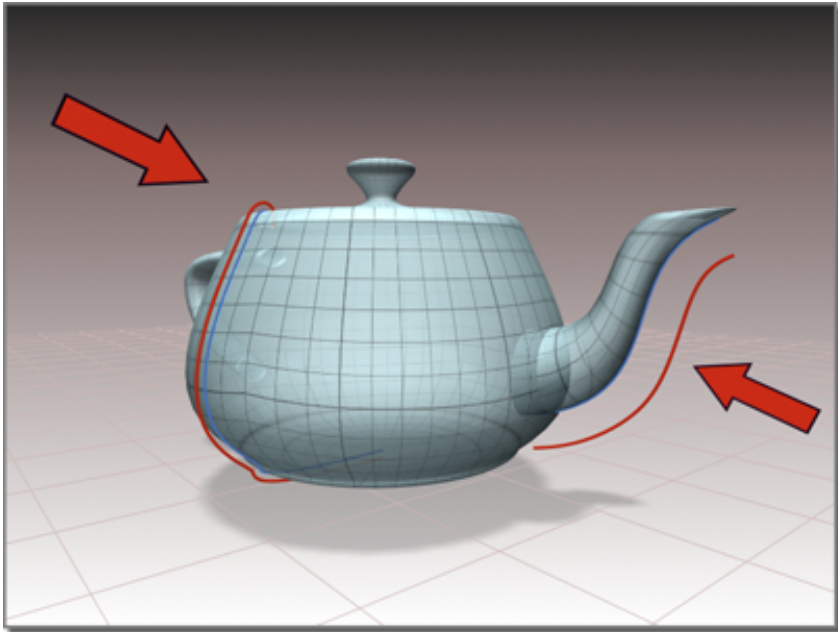

Creating surface offset curves

## Procedures

To create a surface offset curve:

-  1 In a NURBS object that contains at least one NURBS surface with a curve on it, turn on Create Surface Offset Curve in the NURBS toolbox, or Surf Offset on the Create Curves rollout.
- 2 Put the cursor over a curve that lies on a surface, and drag to set the offset amount. Release the mouse button to end curve creation.

## Interface

### Surface Offset Curve rollout (creation time)



**Offset** The amount by which the curve is offset from the surface on which the parent curve lies.

### Surface Offset Curve rollout (modification time)

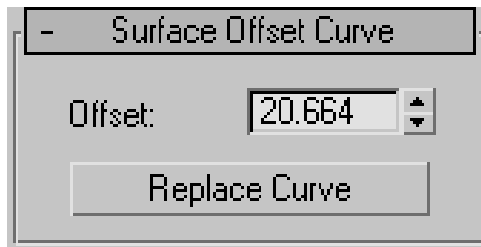

**Offset** The amount by which the curve is offset from the surface on which the parent curve lies.

This parameter is animatable.

**Replace Curve** Lets you replace the parent curve. Click the button, then click the curve to replace the original parent curve.

## U and V Iso Curves

Select NURBS object. > Modify panel > Create Curves rollout > Dependent Curves group box > U Iso Curve button or V Iso Curve button

Select NURBS object. > Modify panel > NURBS toolbox > Create U Iso Curve button or Create V Iso Curve button

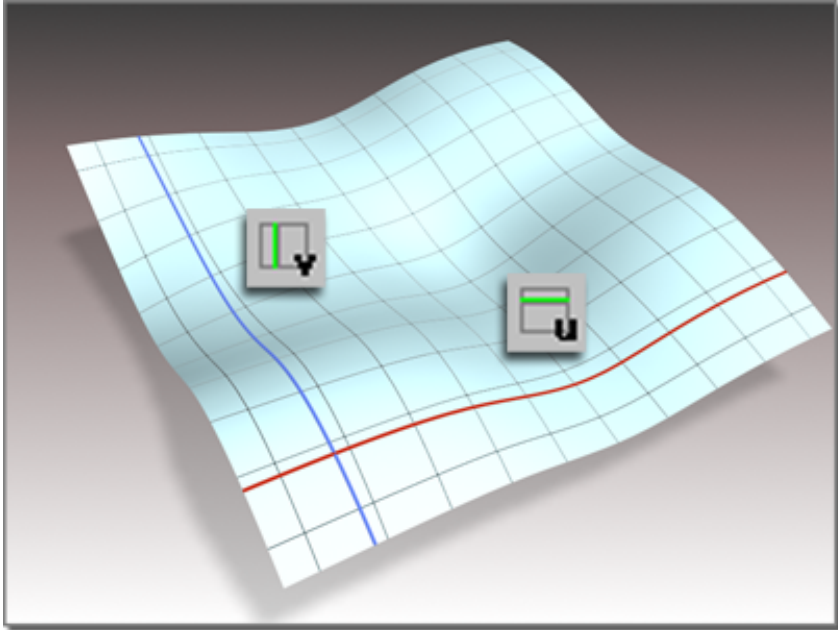



Iso curves in the U and V dimensions

U and V iso curves are dependent curves created from the iso (isoparametric) lines of a NURBS surface. You can use U and V iso curves to [trim surfaces](#) on page 2156 .

### Procedures

To create an iso curve:

-   Turn on U Iso Curve or V Iso Curve, then drag over the surface. The iso lines are highlighted in blue as you drag.



Click to create the curve from the highlighted iso line.

## Interface

### Iso Curve rollout (creation time)

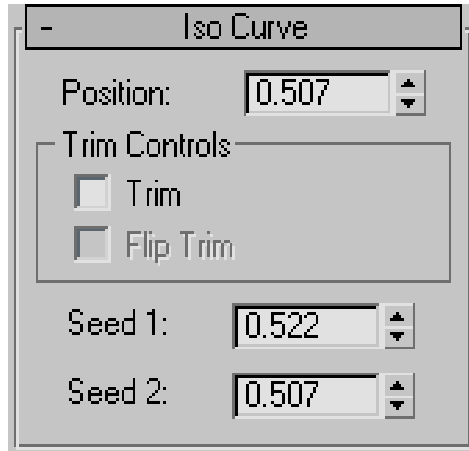

**Position** Sets the iso curve's position along the U or V axis of the surface. This parameter is animatable.

### Trim Controls group

**Trim** When on, trims the surface against the iso curve.

**Flip Trim** When on, flips the direction of the trim.

## Iso Curve rollout (modification time)

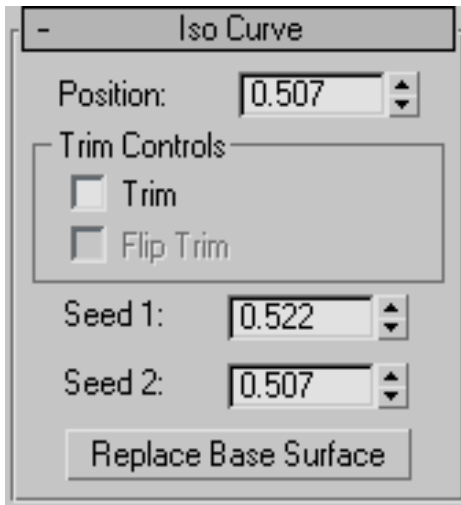

**Position** Sets the iso curve's position along the U or V axis of the surface. This parameter is animatable.

### Trim Controls group

**Trim** When on, trims the surface against the iso curve.

**Flip Trim** When on, flips the direction of the trim.

**Replace Base Surface** Lets you replace the parent surface. Click the button, then click the new surface on which to base the iso curve.

## Normal Projected Curve

Select NURBS object. > Modify panel > Create Curves rollout > Dependent Curves group box > Normal Proj. button

Select NURBS object. > Modify panel > NURBS toolbox > Create Normal Projected Curve button

A normal projected curve lies on a surface. It is based on an original curve, which is projected onto the surface in the direction of the surface's normals.

You can use normal projected curves for [trimming](#) on page 2156 .

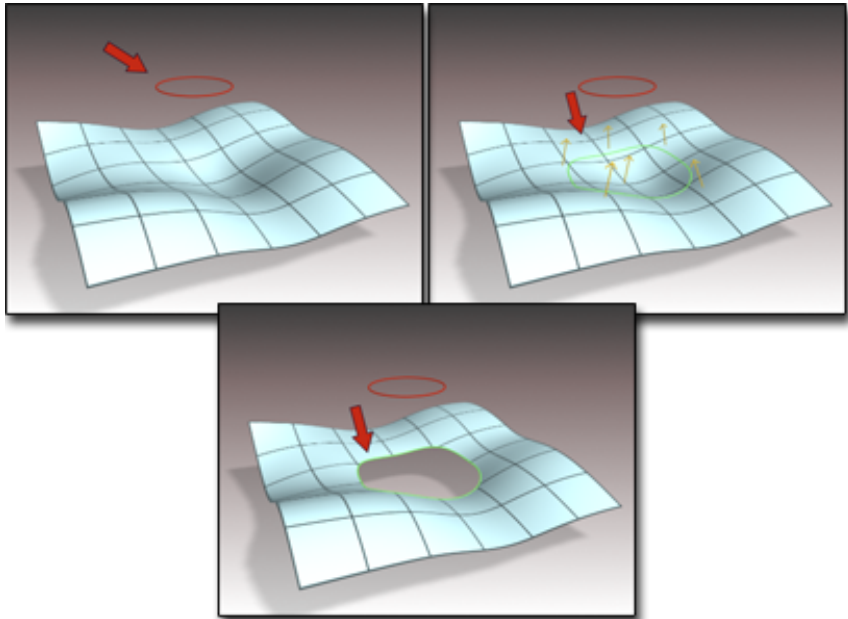

### Trimming a surface with a normal projected curve

If the projection intersects the surface in two or more locations, the intersection closest to the seed point is the one that creates the curve.

### Procedures

To create a normal projected curve:

- 1  In a NURBS object that contains at least one surface and one curve sub-object, turn on Normal Projected Curve in the NURBS toolbox or Normal Proj. on the Create Curves rollout.
- 2 Click the curve, then click the surface where you want the normal projected curve to lie.  
 If the curve can be projected onto the surface in the surface's normal direction, the projected curve is created. The original, parent curve can go "off the edge of the surface." The projected curve is created only where the projection and the surface intersect.

## Interface

### Normal Projected Curve rollout (creation time)

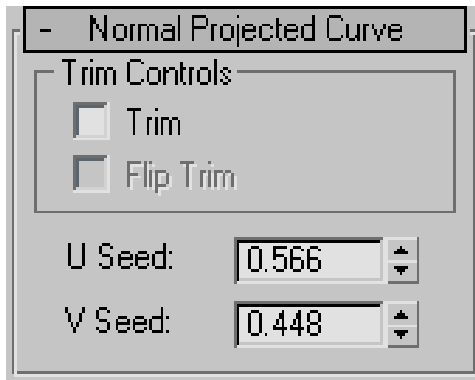

#### Trim Controls group

**Trim** When on, trims the surface against the curve. When off, the surface isn't trimmed.

If it's impossible to trim with this curve, the surface is displayed in the error color (orange by default). For example, the curve is unusable for trimming if it neither crosses the edge of the surface nor forms a closed loop.

**Flip Trim** When on, trims the surface in the opposite direction.

**U Seed and V Seed** Change the UV location of the seed value on the surface. If there is a choice of projections, the projection closest to the seed point is the one used to create the curve.

## Normal Projected Curve rollout (modification time)

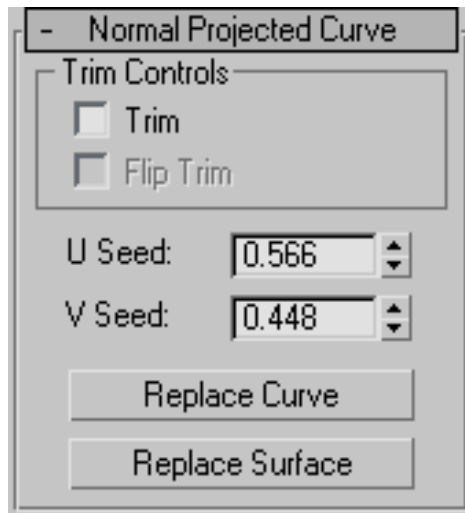

### Trim Controls group

**Trim** When on, trims the surface against the curve. When off, the surface isn't trimmed.

If it's impossible to trim with this curve, the surface is displayed in the error color (orange by default). For example, the curve is unusable for trimming if it neither crosses the edge of the surface nor forms a closed loop.

**Flip Trim** When on, trims the surface in the opposite direction.

**U Seed and V Seed** Change the UV location of the seed value on the surface. If there is a choice of projections, the projection closest to the seed point is the one used to create the curve.

**Replace Curve and Replace Surface** Let you replace the parent sub-objects. Click a button, then click a curve or surface to replace the original parent object.

## Vector Projected Curve

Select NURBS object. > Modify panel > Create Curves rollout > Dependent Curves group box > Vector Proj. button

Select NURBS object. > Modify panel > NURBS toolbox > Create Vector Projected Curve button

A Vector Projected curve lies on a surface. This is almost the same as a Normal Projected curve, except that the projection from the original curve to the surface is in the direction of a vector that you can control.

You can use vector projected curves for [trimming](#) on page 2156 .

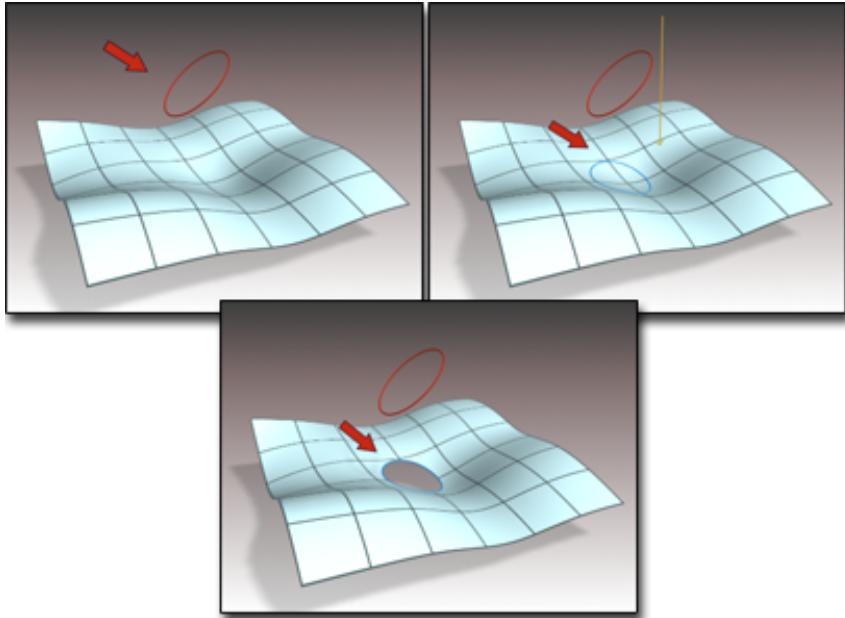

#### Trimming a surface with a vector projected curve

If the projection intersects the surface in two or more locations, the intersection closest to the seed point is the one that creates the curve.

#### Procedures

To create a vector projected curve:

- 1  In a NURBS object that contains at least one surface and one curve sub-object, click to turn on Vector Projected Curve in the NURBS toolbox or Vector Proj. in the Create Curves rollout.

- 2 Click the curve, then the surface where you want the vector projection curve to lie.

The initial vector direction is in the view direction. That is, the vector points away from you as you look at the viewport. If the curve can be projected onto the surface in this direction, the projection curve is created. The original, parent curve can go "off the edge of the surface." The projection curve is created only where the projection and the surface intersect.

## Interface

In viewports a gizmo (yellow by default) indicates the projection axis. Transforming the gizmo changes the projection onto the surface. Rotating the gizmo is the most useful transform. You can use rotation to adjust the distortion caused by projection.

## Vector Projected Curve rollout (creation time)

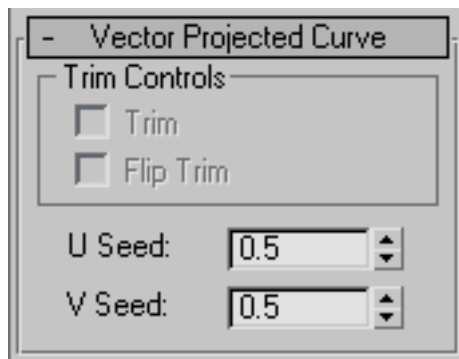

### Trim Controls group

**Trim** When on, trims the surface against the curve. When off, the surface isn't trimmed.

If it's impossible to trim with this curve, the surface is displayed in the error color (orange by default). For example, the curve is unusable for trimming if it neither crosses the edge of the surface nor forms a closed loop.

**Flip Trim** When on, trims the surface in the opposite direction.

**U Seed and V Seed** Change the UV location of the seed value on the surface. If there is a choice of projections, the projection closest to the seed point is the one used to create the curve.

### Vector Projected Curve rollout (modification time)

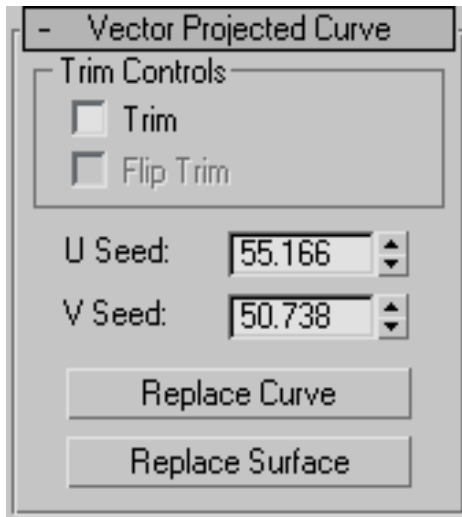

#### Trim Controls group

**Trim** When on, trims the surface against the curve. When off, the surface isn't trimmed.

If it's impossible to trim with this curve, the surface is displayed in the error color (orange by default). For example, the curve is unusable for trimming if it neither crosses the edge of the surface nor forms a closed loop.

**Flip Trim** When on, trims the surface in the opposite direction.

**U Seed and V Seed** Change the UV location of the seed value on the surface. If there is a choice of projections, the projection closest to the seed point is the one used to create the curve.

**Replace Curve and Replace Surface** Let you replace the parent sub-objects. Click a button, then click a curve or surface to replace the original parent object.



## CV Curve on Surface

Select NURBS object. > Modify panel > Create Curves rollout > Dependent Curves group box > CV on Surf button

Select NURBS object. > Modify panel > NURBS toolbox > Create CV Curve on Surface button

A CV curve on surface is similar to a plain CV curve, but it lies on a surface. You create it by drawing rather than projecting from a different curve. You can use this curve type for [trimming](#) on page 2156 the surface on which it lies.

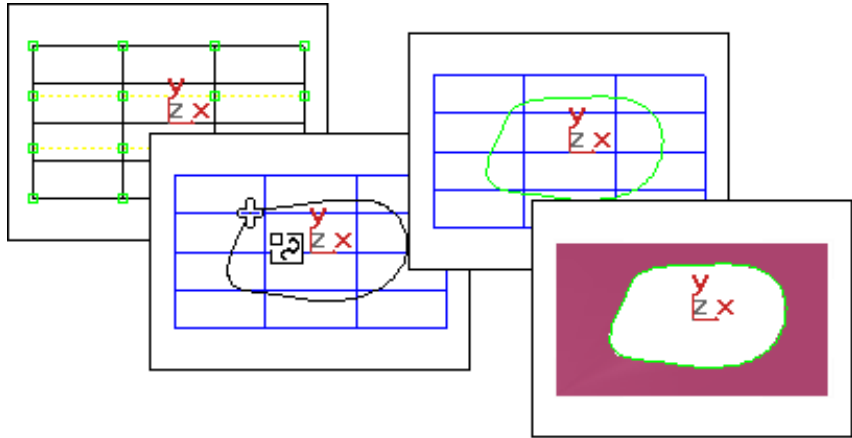

### Trimming a surface with a CV curve on surface

There are two methods for drawing and editing curves on surfaces: drawing in a viewport, or using the Edit Curve on Surface dialog. The choice is useful because you draw in two dimensions, with a mouse or other pointing device, while the curve on a surface can exist in three dimensions. The more complex the 3D surface, the more effort it can require to create and edit a curve on a surface.

Visual feedback can help you draw the curve. The point whose surface you first click is shown as a blue square, and the surface's minimum UV point is shown as a plus sign (+). As you draw the curve, it is displayed interactively in viewports.

## Drawing in a Viewport

When you click to position a CV, the click is projected in the viewport's Z dimension. That is, your click is projected "through the screen" and onto the surface. This is a straightforward way to create a curve on a surface if the portion of the surface where the curve will lie is clearly visible in the viewport. However, this method doesn't let you place CVs on surface locations that are not visible in the viewport (they are on back faces, lie behind other geometry, and so on).

## Using the Edit Curve on Surface Dialog

The [Edit Curve on Surface dialog](#) on page 2450 lets you edit curves on surfaces as you edit regular curves in a viewport. The main part of the dialog is a two-dimensional view of the surface. The controls provide typical curve editing functions. While you are creating a CV curve on surface, the 2D View toggle controls display of the Edit Curve on Surface dialog.

You can edit the CVs in CV curves on surfaces at the [Curve CV sub-object level](#) on page 2238 , as you edit other kinds of curve CVs. You can transform CVs in CV curves on surfaces, but you can't move the CVs off the surface. Using the Curve CV sub-object level is an alternative to editing these CVs by using the Edit Curve on Surface dialog.

## Procedures

To create a CV curve on surface:

- 1  In a NURBS object that contains at least one surface, turn on Create CV Curve on Surface in the NURBS toolbox, or CV on Surf on the Create Curves rollout.
- 2 Do one of the following:
  - Draw the curve in the viewport, using the mouse above the surface.
  - Turn on 2D View. This displays an Edit Curve on Surface dialog, which lets you create the curve in a two-dimensional (UV) representation of the surface.
- 3 Right-click to end curve creation.

## Interface

### CV Curve on Surface rollout (creation time)

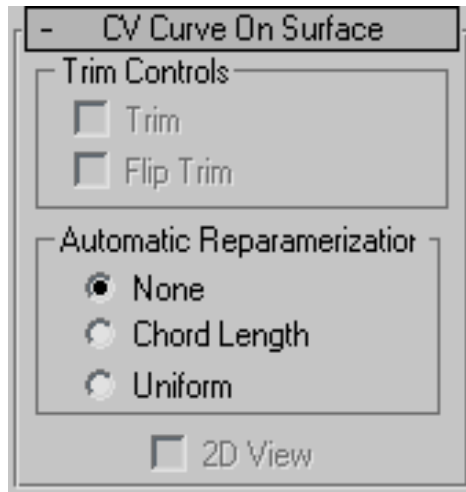

#### Trim Controls group

**Trim** When on, trims the surface against the curve. When off, the surface isn't trimmed.

If it's impossible to trim with this curve, the surface is displayed in the error color (orange by default). For example, the curve is unusable for trimming if it doesn't form a closed loop.

**Flip Trim** When on, trims the surface in the opposite direction.

#### Automatic Reparameterization group

The radio buttons in this group box let you choose automatic reparameterization. With reparameterization, the curve maintains its parameterization as you edit it. Without reparameterization, the curve's parameterization doesn't change as you edit it, and can become irregular.

**None** Do not reparameterize.

**Chord Length** Chooses the chord-length algorithm for reparameterization.

Chord-length reparameterization spaces knots (in [parameter space](#) on page 7882 ) based on the square root of the length of each curve segment.

Chord-length reparameterization is usually the best choice.

**Uniform** Spaces the knots uniformly.

A uniform knot vector has the advantage that the curve will change only locally when you edit it. With the other two forms of parameterization, moving any CV can change the entire curve.

**2D View** When on, displays the [Edit Curve on Surface dialog](#) on page 2450 , which lets you create the curve in a two-dimensional (UV) representation of the surface.

### **CV Curve on Surface rollout (modification time)**

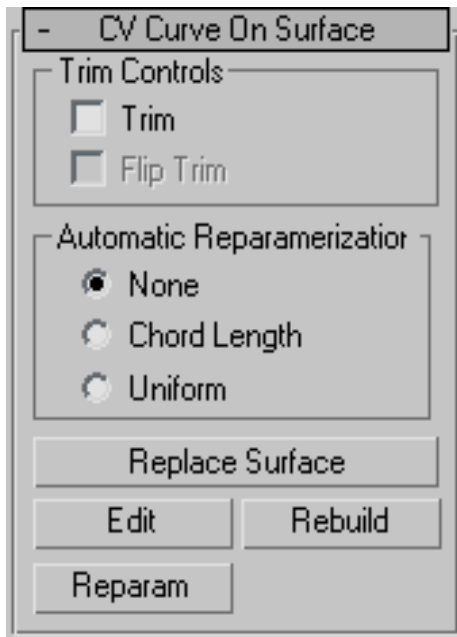

#### **Trim Controls group**

**Trim** When on, trims the surface against the curve. When off, the surface isn't trimmed.

If it's impossible to trim with this curve, the surface is displayed in the error color (orange by default). For example, the curve is unusable for trimming if it doesn't form a closed loop.

**Flip Trim** When on, trims the surface in the opposite direction.

## Automatic Reparameterization group

The radio buttons in this group box let you choose automatic reparameterization. With reparameterization, the curve maintains its parameterization as you edit it. Without reparameterization, the curve's parameterization doesn't change as you edit it, and can become irregular.

**None** Do not reparameterize.

**Chord Length** Chooses the chord-length algorithm for reparameterization.

Chord-length reparameterization spaces knots (in [parameter space](#) on page 7882 ) based on the square root of the length of each curve segment.

Chord-length reparameterization is usually the best choice.

**Uniform** Spaces the knots uniformly.

A uniform knot vector has the advantage that the curve will change only locally when you edit it. With the other two forms of parameterization, moving any CV can change the entire curve.

**Replace Surface** Lets you replace the parent surface. Click a button, then click a surface to replace the original parent surface.

**Edit** Click to display the [Edit Curve on Surface dialog](#) on page 2450 , which lets you edit the curve in a two-dimensional (UV) representation of the surface.

To edit multiple curves on a surface, select more than one CV curve sub-object on the same surface, then click Edit.

**Rebuild** Displays the [Rebuild CV Curve dialog](#) on page 2463 to let you rebuild the CV curve on surface.

**Reparam** Displays the [Reparameterize dialog](#) on page 2465 to let you reparameterize the CV curve on surface.

## Point Curve on Surface

Select NURBS object. > Modify panel > Create Curves rollout > Dependent Curves group box > Point on Surf button

Select NURBS object. > Modify panel > NURBS toolbox > Create Point Curve on Surface button

A point curve on surface is similar to a plain point curve, but it lies on a surface. You create it by drawing rather than projecting from a different curve. You can use this curve type for [trimming](#) on page 2156 the surface on which it lies.

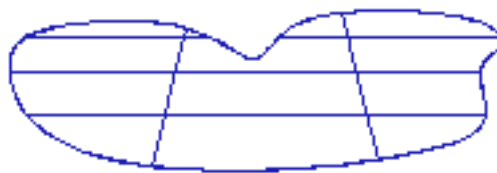
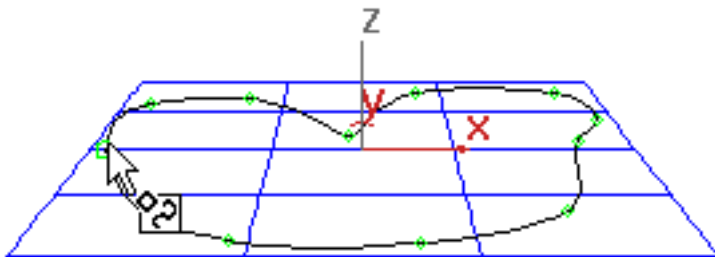
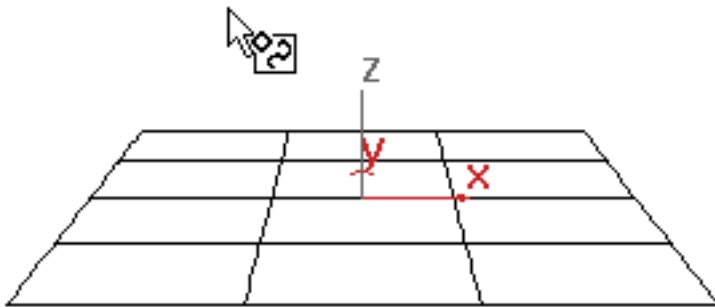

### Trimming a surface with a point curve on surface

There are two methods for drawing and editing curves on surfaces: drawing in a viewport, or using the Edit Curve on Surface dialog. The choice is useful because you draw in two dimensions, with a mouse or other pointing device,

while the curve on a surface can exist in three dimensions. The more complex the 3D surface, the more effort it can require to create and edit a curve on a surface.

Visual feedback can help you draw the curve. The point whose surface you first click is shown as a blue square, and the surface's minimum UV point is shown as a plus sign (+). As you draw the curve, it is displayed interactively in viewports.

### **Drawing in a Viewport**

When you click to position a point, the click is projected in the viewport's Z dimension. That is, your click is projected "through the screen" and onto the surface. This is a straightforward way to create a curve on a surface if the portion of the surface where the curve will lie is clearly visible in the viewport. However, this method doesn't let you place points on surface locations that are not visible in the viewport (they are on back faces, lie behind other geometry, and so on).

### **Using the Edit Curve on Surface Dialog**

The [Edit Curve on Surface dialog](#) on page 2450 lets you edit curves on surfaces as you edit regular curves in a viewport. The main part of the dialog is a two-dimensional view of the surface. The controls provide typical curve editing functions. While you are creating a point curve on surface, the 2D View toggle controls display of the Edit Curve on Surface dialog.

You can edit the points in point curves on surfaces at the [Point sub-object level](#) on page 2231, as you edit other kinds of points. You can transform points in point curves on surfaces, but you can't move the points off the surface. Using the Point sub-object level is an alternative to editing these points by using the Edit Curve on Surface dialog.

### **Procedures**

**To create a point curve on surface:**

- 1  In a NURBS object that contains at least one surface, turn on Create Point Curve on Surface in the NURBS toolbox, or Point on Surf on the Create Curves rollout.

- 2 Do one of the following:
  - Draw the curve in the viewport, using the mouse above the surface.
  - Turn on 2D View. This displays an Edit Curve on Surface dialog, which lets you create the curve in a two-dimensional (UV) representation of the surface.
- 3 Right-click to end curve creation.

## Interface

Point curves on surfaces have point sub-objects that you can transform and edit in viewports as you do with plain point curves.

(There is no special Move Surface Points button as there was prior to 3ds Max 3.)

### Point Curve on Surface rollout (creation time)

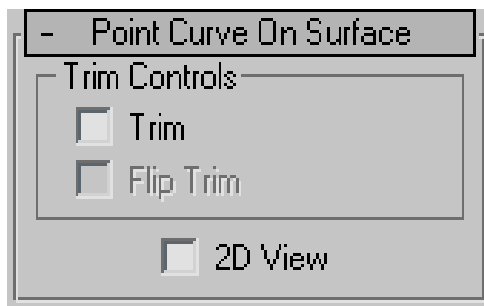

#### Trim Controls group

**Trim** When on, trims the surface against the curve. When off, the surface isn't trimmed.

If it's impossible to trim with this curve, the surface is displayed in the error color (orange by default). For example, the curve is unusable for trimming if it doesn't form a closed loop.

**Flip Trim** When on, trims the surface in the opposite direction.

**2D View** When on, displays the [Edit Curve on Surface dialog](#) on page 2450, which lets you create the curve in a two-dimensional (UV) representation of the surface.



## Point Curve on Surface rollout (modification time)

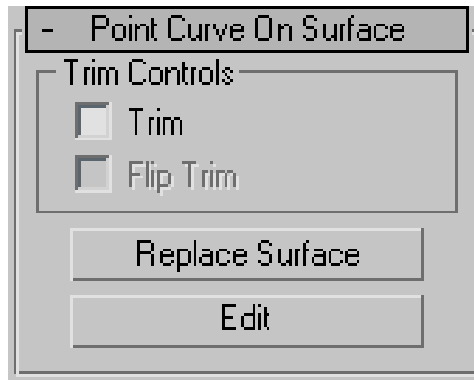

### Trim Controls group

**Trim** When on, trims the surface against the curve. When off, the surface isn't trimmed.

If it's impossible to trim with this curve, the surface is displayed in the error color (orange by default). For example, the curve is unusable for trimming if it doesn't form a closed loop.

**Flip Trim** When on, trims the surface in the opposite direction.

**Replace Surface** Lets you replace the parent surface. Click a button, then click a surface to replace the original parent surface.

**Edit** Click to display the [Edit Curve on Surface dialog](#) on page 2450 , which lets you edit the curve in a two-dimensional (UV) representation of the surface.

To edit multiple curves on a surface, select more than one point curve sub-object on the same surface, then click Edit.

## Surface Edge Curve

Select NURBS object. > Modify panel > Create Curves rollout > Dependent Curves group box > Surf Edge button

Select NURBS object. > Modify panel > NURBS toolbox > Create Surface Edge Curve button

A surface edge curve is a dependent curve type that lies on the boundary of the surface. It can be the original boundary of the surface, or a trim edge.

## Procedures

To create a surface edge curve:

- 1  Turn on Surf Edge.
- 2 As you move the mouse in the scene, NURBS surface edges are highlighted in blue. Click the edge where you want to create the curve.

## Interface

### Surface Edge Curve rollout (creation time)

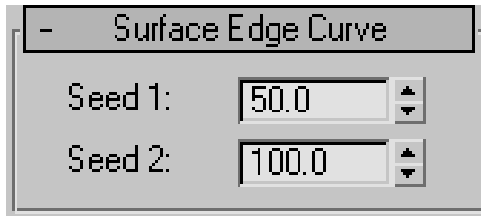

**Seed 1 and Seed 2** The curve resides on the edge closest to the two seed values. Adjust the seed values to change the edge on which the curve resides.

### Surface Edge Curve rollout (modification time)

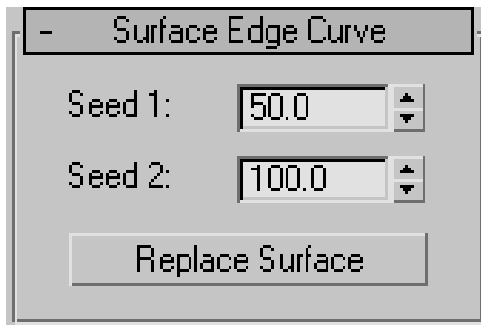

**Seed 1 and Seed 2** The curve resides on the edge closest to the two seed values. Adjust the seed values to change the edge on which the curve resides.

**Replace Surface** This lets you replace the parent surface. Click a button, then click a surface to replace the original parent surface.

## Creating Surface Sub-Objects

Select NURBS object. > Modify panel > Create Surfaces rollout

Select NURBS object. > NURBS toolbox

Keyboard > Ctrl+T to toggle NURBS toolbox display (Keyboard Shortcut Override Toggle must be on.)

Surface sub-objects are either independent point and CV surfaces (like the top-level point and CV surfaces described in Point Surface and CV Surface), or they are dependent surfaces. Dependent surfaces are surface sub-objects whose geometry depends on other surfaces or curves in the NURBS model. When you change the geometry of the original, parent surface or curve, the dependent surface changes as well.

You create surface sub-objects using the Create Surfaces rollout on the Modify panel for a NURBS surface, or using the NURBS [toolbox](#) on page 2162 .



---

**TIP** Lathe and extrude surface sub-objects can be based on only a single curve. If you have dependent curves and want to use the set of curves (for example, two parents and a fillet between them) as the basis of an extrude or lathe surface, first go to the Curve sub-object level and use Join to connect the curves.

Creation operations for dependent sub-objects require that you select one or more parent objects. In general, you can click and drag, or click and then click again. You can also use the H keyboard shortcut to open a Pick Object version of the [Selection Floater](#) on page 171 for choosing the parent. (The [Keyboard Shortcut Override Toggle](#) on page 7646 must be on for H to work this way.)

---

### Toolbox Buttons for Creating Surfaces

These are the toolbox buttons for creating surface sub-objects:





Create an independent [CV surface sub-object](#) on page 2340 .

 Create an independent [point surface sub-object](#) on page 2344 .

 Create a dependent [transform surface](#) on page 2346 .

 Create a dependent [blend surface](#) on page 2348 .

 Create a dependent [offset surface](#) on page 2355 .

 Create a dependent [mirror surface](#) on page 2358 .

 Create a dependent [extrude surface](#) on page 2362 .

 Create a dependent [lathe surface](#) on page 2365 .

 Create a dependent [ruled surface](#) on page 2374 .

 Create a dependent [cap surface](#) on page 2377 .

 Create a dependent [U loft surface](#) on page 2380 .

 Create a dependent [UV loft surface](#) on page 2390 .

 Create a dependent [1-rail sweep surface](#) on page 2397 .

 Create a dependent [2-rail sweep surface](#) on page 2407 .

 Create a dependent [multisided blend surface](#) on page 2417 .

 Create a dependent [multicurve trimmed surface](#) on page 2418 .

 Create a dependent [fillet surface](#) on page 2423 .

## CV Surface Sub-Object

Select NURBS object. > Modify panel > Create Surfaces rollout > CV Surf

Select NURBS object. > Modify panel > NURBS toolbox > Create CV Surface button

Select NURBS object. > Modify panel > Right-click a viewport. > Tools 2 (lower-left) quadrant > Create CV Surface

CV surface sub-objects are similar to object-level [CV surfaces](#) on page 2195 .

### See also:

- [Editing Surface Sub-Objects](#) on page 2264
- [Surface Approximation](#) on page 2469

### Procedures

To create a CV surface sub-object:

- 1  In a NURBS object, turn on CV Surf on the Create Surfaces rollout or Create CV Surface in the toolbox.
- 2 In a viewport, drag to specify the initial area of the CV surface.
- 3 Adjust the CV surface's creation parameters.

### Interface

The parameters that appear when you create a CV surface sub-object differ from those you see when you modify it as a sub-object.

## CV Surface rollout (creation time)

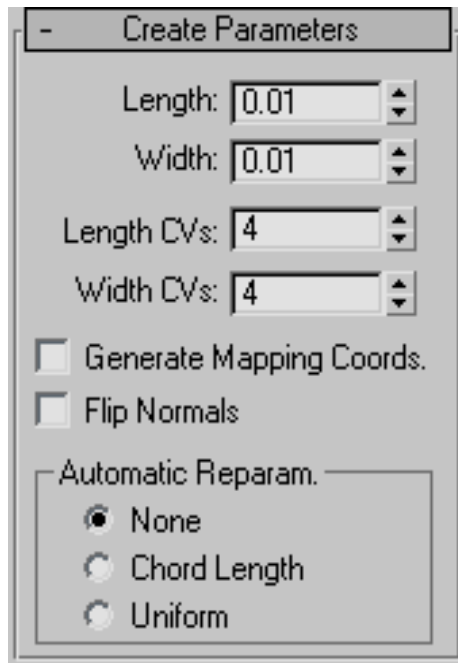

**Length** The length of the surface in current 3ds Max units.

**Width** The width of the surface in current 3ds Max units.

**Length Points** The number of points along the length of the surface. In other words, the initial number of point columns in the surface. Range=2 to 50. Default=4.

**Width Points** The number of points along the width of the surface. In other words, the initial number of point rows in the surface. Range=2 to 50. Default=4.

**Generate Mapping Coordinates** Generates mapping coordinates so you can apply mapped materials to the surface.

**Flip Normals** Turn on to reverse the direction of the surface normals.

### Automatic Reparameterization group

The radio buttons in this group box let you choose automatic reparameterization. With reparameterization, the surface maintains its

parameterization as you edit it. Without reparameterization, the surface's parameterization doesn't change as you edit it, and can become irregular.

**None** Do not reparameterize.

**Chord Length** Chooses the chord-length algorithm for reparameterization.

Chord-length reparameterization spaces knots (in [parameter space](#) on page 7882 ) based on the square root of the length of each curve segment.

Chord-length reparameterization is usually the best choice.

**Uniform** Spaces the knots uniformly.

A uniform knot vector has the advantage that the surface will change only locally when you edit it. With the other two forms of parameterization, moving any CV can change the entire surface.

### **CV Surface rollout (modification time)**

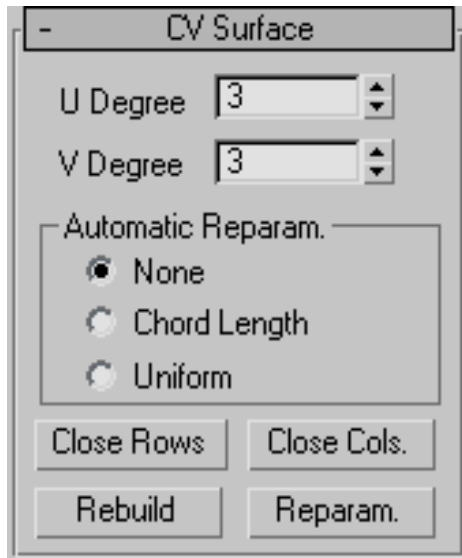

**U Degree and V Degree** Let you set the degree of the surface in either the U or V dimension. The higher the degree value, the greater the continuity. The lower the degree, the more discontinuous the surface segments become. The degree can't be less than one or greater than the number allowed by the number of CVs in the specified dimension. Degree 3 is adequate to represent continuous surfaces, and is stable and well behaved. Default=3.



Setting the degree greater than 3 isn't recommended, because higher degrees are slower to calculate and less stable numerically. Higher degrees are supported primarily to be compatible with models created using other surface modeling programs.

The number of CVs in a given dimension must be at least one greater than that dimension's degree.

### **Automatic Reparameterization group**

The radio buttons in this group box let you choose automatic reparameterization. With reparameterization, the surface maintains its parameterization as you edit it. Without reparameterization, the surface's parameterization doesn't change as you edit it, and can become irregular.

**None** Do not reparameterize.

**Chord Length** Chooses the chord-length algorithm for reparameterization.

Chord-length reparameterization spaces knots (in [parameter space](#) on page 7882 ) based on the square root of the length of each curve segment.

Chord-length reparameterization is usually the best choice.

**Uniform** Spaces the knots uniformly.

A uniform knot vector has the advantage that the surface will change only locally when you edit it. With the other two forms of parameterization, moving any CV can change the entire surface.

The close controls let you close a surface. They appear on the Point Surface rollout while an independent point surface sub-object is selected. They have no effect if the surface is already closed in that direction.

**Close Rows** Closes the surface by joining the ends of its rows.

**Close Cols.** Closes the surface by joining the ends of its columns.

**Rebuild** Displays the [Rebuild CV Surface dialog](#) on page 2464 , which lets you specify how to rebuild the surface. Rebuilding the surface can change its appearance.

**Reparameterize** Displays the [Reparameterize dialog](#) on page 2465 . Reparameterizing a surface changes the surface's [parameter space](#) on page 7882 to provide a better relation between control point locations and the shape of the surface.

---

**TIP** It is a good idea to reparameterize after you have added CVs to the surface by refining or inserting.

---

## Point Surface Sub-Object

Select NURBS object. > Modify panel > Create Surfaces rollout > Point Surf

Select NURBS object. > Modify panel > NURBS toolbox > Create Point Surface button

Select NURBS object. > Modify panel > Right-click a viewport. > Tools 2 (lower-left) quadrant > Create Point Surface

Point surface sub-objects are similar to object-level [point surfaces](#) on page 2192. The points are constrained to lie on the surface.

### See also:

- [Editing Surface Sub-Objects](#) on page 2264
- [Surface Approximation](#) on page 2469

### Procedures

To create a point surface sub-object:

-  1 In a NURBS object, turn on Point Surf on the Create Surfaces rollout or Create Point Surface in the toolbox.
- 2 In a viewport, drag to specify the initial area of the point surface.
- 3 Adjust the point surface's creation parameters.

### Interface

The parameters that appear when you create a point surface sub-object differ from those you see when you modify it as a sub-object.

### Point Surface rollout (creation time)

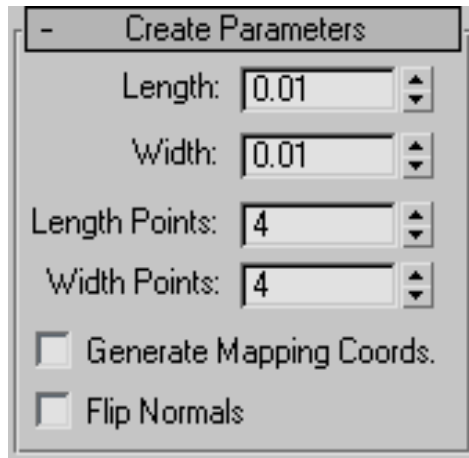

**Length** The length of the surface in current 3ds Max units.

**Width** The width of the surface in current 3ds Max units.

**Length Points** The number of points along the length of the surface. In other words, the initial number of point columns in the surface. Range=2 to 50. Default=4.

**Width Points** The number of points along the width of the surface. In other words, the initial number of point rows in the surface. Range=2 to 50. Default=4.

**Generate Mapping Coordinates** Generates mapping coordinates so you can apply mapped materials to the surface.

**Flip Normals** Turn on to reverse the direction of the surface normals.

### Point Surface rollout (modification time)

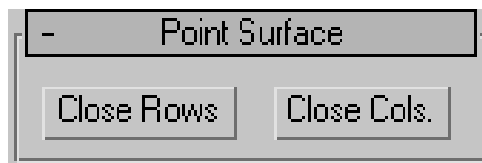

The close controls let you close a surface. They appear on the Point Surface rollout while an independent point surface sub-object is selected. They have no effect if the surface is already closed in that direction.

**Close Rows** Closes the surface by joining the ends of its rows.

**Close Cols.** Closes the surface by joining the ends of its columns.

## Transform Surface

Select NURBS object. > Modify panel > Create Surfaces rollout Dependent Surfaces group box > Transform

Select NURBS object. > Modify panel > NURBS toolbox > Create Transform Surface button

A transform surface is a copy of the original surface with a different position, rotation, or scale.

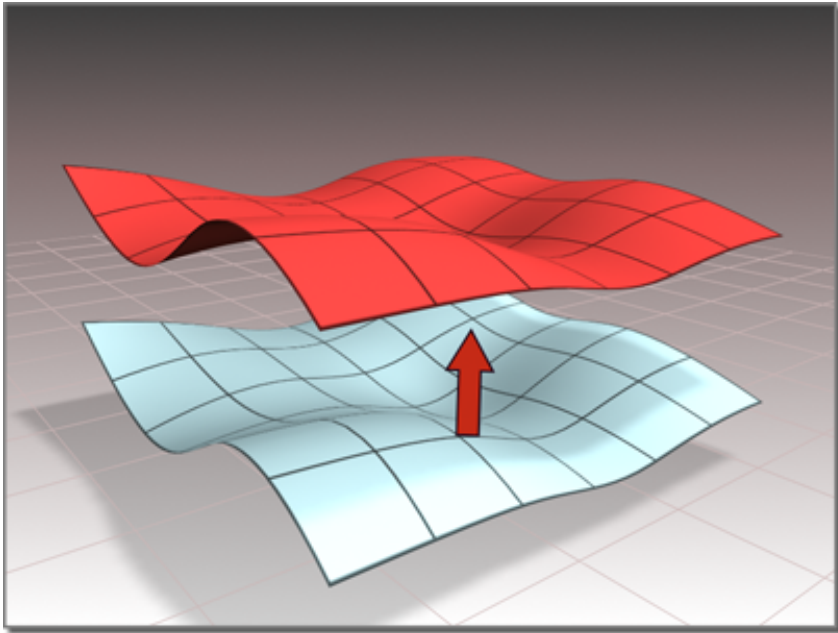

Surface created as a transform

## Procedures

### To create a transform surface:

-  In a NURBS object that contains at least one surface, turn on Transform.  
To move the transform surface, click and drag the surface you want to duplicate. To rotate or scale the transform surface, click the parent surface, click to turn on Sub-Object on the Modifier Stack rollout, choose Surface from the drop-down list, and then use a transform to rotate or scale the transform surface.  
When you use Move to create the transform surface, it simply copies the parent. (It doesn't exaggerate curvature as an offset surface does.)  
Axis constraints don't apply to the creation of transform surfaces. You can click to create the surface in place; then once it is created, transform it using constraints.

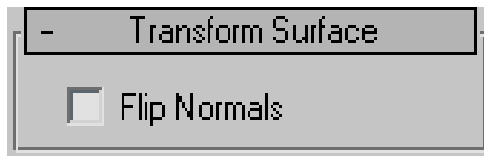

The Flip Normals control lets you flip the surface normals at creation time. (After creation, you can flip normals using controls on the Surface Common rollout.)

You can later transform the transform surface as a surface sub-object, and you can animate surface sub-object transforms.

## Interface

### Creation time

At creation time, transform surfaces have no parameters.

## Transform Surface rollout (modification time)



**Replace Base Surface** Lets you replace the parent surface. Click the button, then click the surface to replace the original surface.

## Blend Surface

Select NURBS object. > Modify panel > Create Surfaces rollout > Dependent Surfaces group box > Blend

Select NURBS object. > Modify panel > NURBS toolbox > Create Blend Surface button

A blend surface connects one surface to another, blending the curvature of the parent surfaces to create a smooth surface between them. You can also blend from a surface to a curve, or from a curve to a curve.

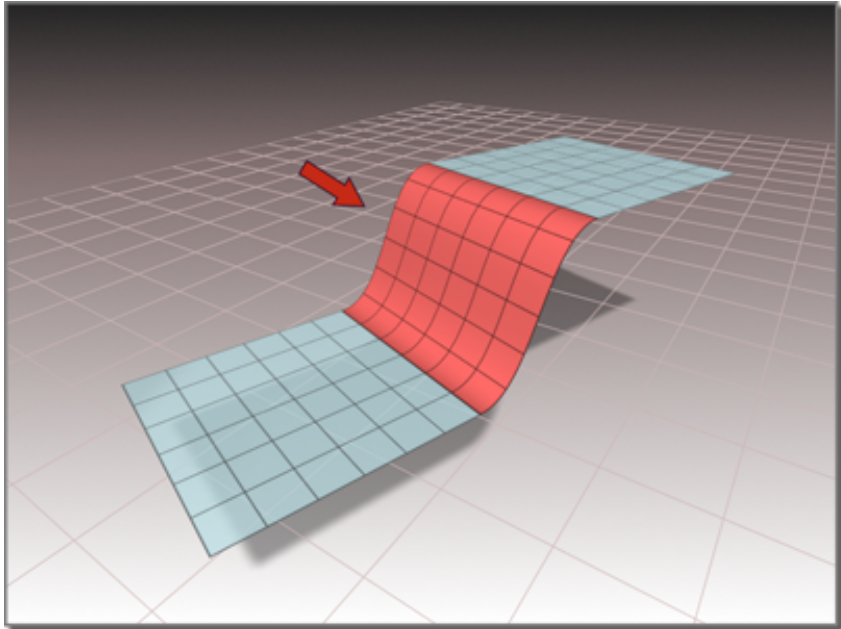

**Blend surface connecting two other surfaces**

## **Procedures**

**To create a blend surface:**

- 1  In a NURBS object that contains two surfaces, two curves, or a surface and a curve, turn on Blend.
- 2 Click one surface near the edge that you want to connect. The edge that will be connected is highlighted in blue. Drag to choose the other edge you want to connect. When the edge you want is highlighted, click and then drag to the other surface. The edge of the other surface is also highlighted in blue. Drag on the other surface to choose the edge to connect, and then release the mouse button to create the blend surface. The surface that owns the highlighted edge is highlighted in yellow, to help you distinguish which edge you are choosing when two surfaces have coincident edges.

The blend surface is created. Changing the position or the curvature of either parent surface will change the blend surface as well.

- 3 Adjust the blend parameters.

### Interface

While a blend surface sub-object is selected, a rollout with the blend parameters is displayed at the bottom of the Modify panel.

### Blend Surface rollout (creation time)

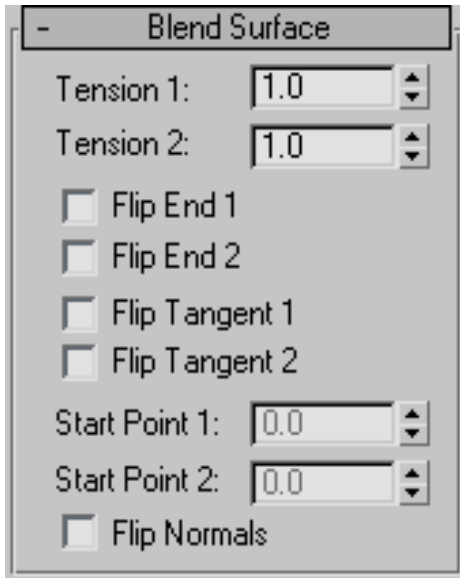

"Tension" affects the tangent between a parent surface and the blend surface. The greater the tension value, the more closely the tangent parallels the parent surface, and the smoother the transition. The lower the tension, the greater the tangent angle and the sharper the transition between parent and blend.

**Tension 1** Controls tension at the edge of the first surface you clicked. This value has no effect if the edge is a curve.

**Tension 2** Controls tension at the edge of the second surface you clicked. This value has no effect if the edge is a curve.



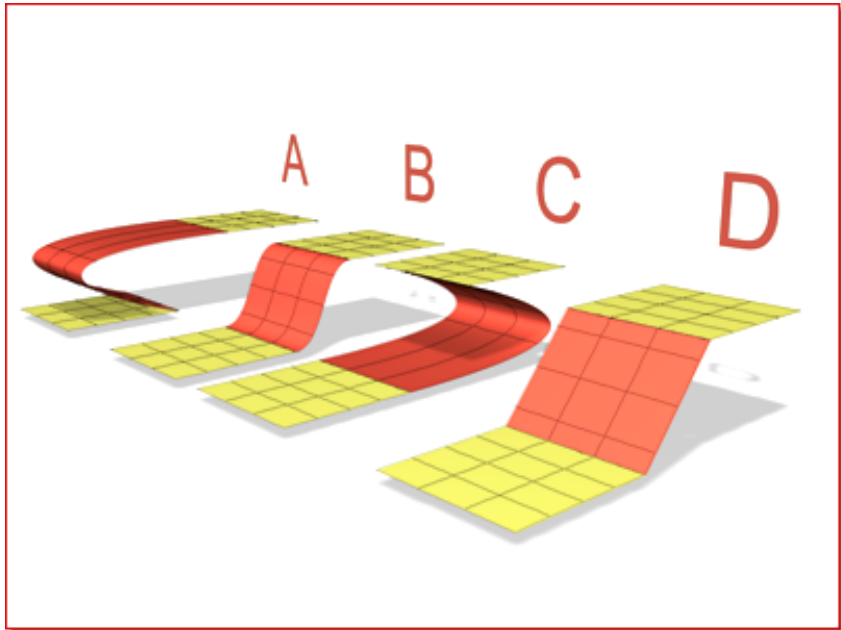

- A. Tension 1=0, Tension 2=10
- B. Tension 1=1, Tension 2=1
- C. Tension 1=10, Tension 2=0
- D. Tension 1=0, Tension 2=0

**Flip End 1 and Flip End 2** Flip one of the normals used to construct the blend. A blend surface is created using the normals of the parent surfaces. If the two parents have opposing normals, or if a curve has the opposite direction, the blend surface can be shaped like a bow tie. To correct the situation, use Flip End 1 or Flip End 2 to construct the blend using a normal opposite the corresponding parent surface's normal.

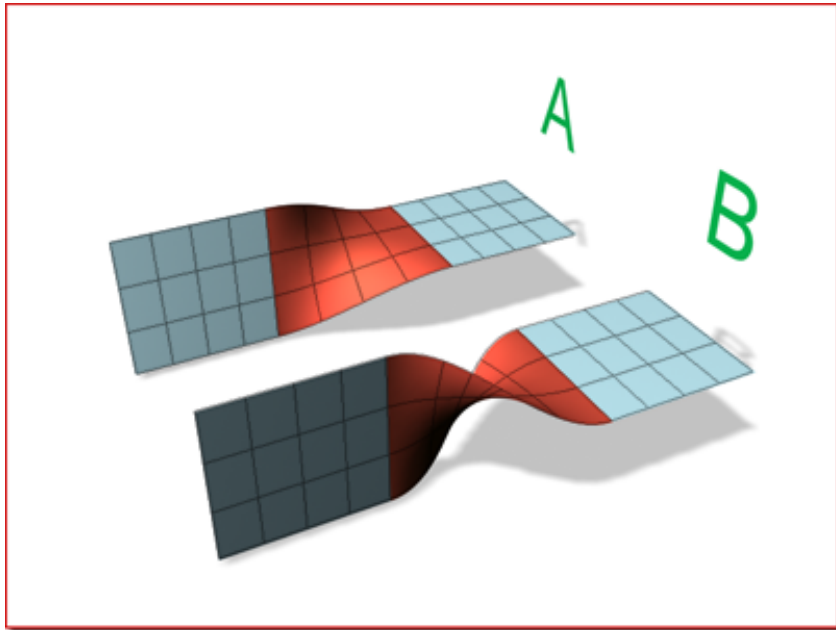

**A. No flipping**

**B. End 2 is flipped.**

**Flip Tangent 1 and Flip Tangent 2** Flip the tangent at the edge of the first or second curve or surface. Flipping the tangent reverses the direction in which the blend surface approaches the parent sub-object at that edge.

Flipping the tangent has no effect if the edge is a curve, unless the curve is a curve on surface.

When you blend to a CV or point curve on surface, the new blend surface is tangent to the surface on which the curve on surface lies. The Flip Tangent controls are especially useful in this situation.

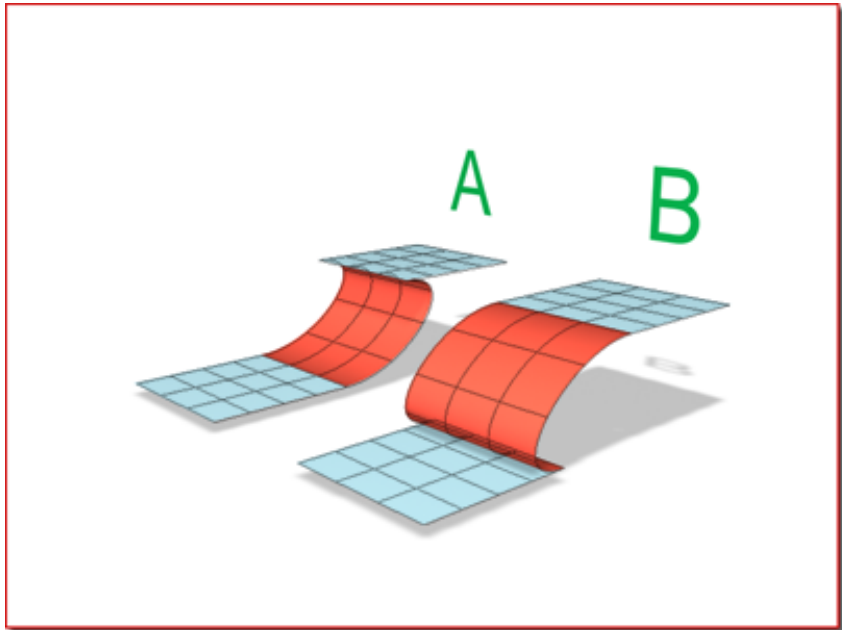

**A. Tangent 1 flipped**

**B. Tangent 2 flipped**

**Start Point 1 and Start Point 2** Adjust the position of the start point at the two edges of the blend. Adjusting the start points can help eliminate unwanted twists or "buckles" in the surface.

These spinners are unavailable if the edges or curves are not closed.

While you're adjusting start points, a dotted blue line is displayed between them, to show the alignment. The surface is not displayed, so it doesn't slow down adjustment. When you release the mouse button, the surface reappears.

**Flip Normals** Turn on to reverse the direction of the blend surface normals.

## Blend Surface rollout (modification time)

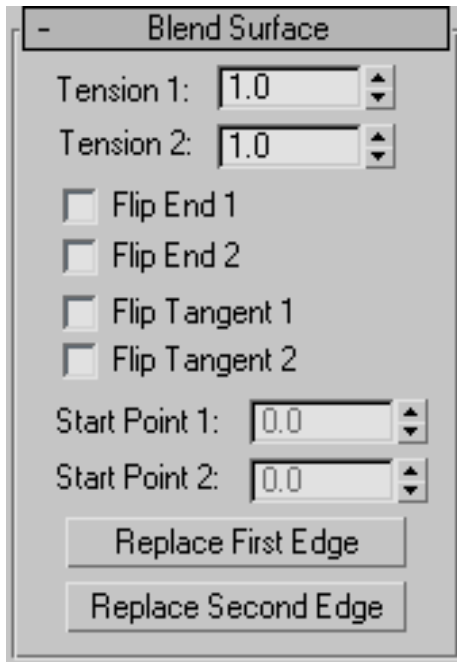

"Tension" affects the tangent between a parent surface and the blend surface. The greater the tension value, the more closely the tangent parallels the parent surface, and the smoother the transition. The lower the tension, the greater the tangent angle and the sharper the transition between parent and blend.

**Tension 1** Controls tension at the edge of the first surface you clicked. This value has no effect if the edge is a curve.

**Tension 2** Controls tension at the edge of the second surface you clicked. This value has no effect if the edge is a curve.

**Flip End 1 and Flip End 2** Flip one of the normals used to construct the blend. A blend surface is created using the normals of the parent surfaces. If the two parents have opposing normals, or if a curve has the opposite direction, the blend surface can be shaped like a bow tie. To correct the situation, use Flip End 1 or Flip End 2 to construct the blend using a normal opposite the corresponding parent surface's normal.

**Flip Tangent 1 and Flip Tangent 2** Flip the tangent at the edge of the first or second curve or surface. Flipping the tangent reverses the direction in which the blend surface approaches the parent sub-object at that edge.

Flipping the tangent has no effect if the edge is a curve, unless the curve is a curve on surface.

When you blend to a CV or point curve on surface, the new blend surface is tangent to the surface on which the curve on surface lies. The Flip Tangent controls are especially useful in this situation.

**Start Point 1 and Start Point 2** Adjust the position of the start point at the two edges of the blend. Adjusting the start points can help eliminate unwanted twists or "buckles" in the surface.

These spinners are unavailable if the edges or curves are not closed.

While you're adjusting start points, a dotted blue line is displayed between them, to show the alignment. The surface is not displayed, so it doesn't slow down adjustment. When you release the mouse button, the surface reappears.

**Replace First Edge and Replace Second Edge** Let you replace the parent edges or curves. Click a button, then click the edge to replace the original first or second edge. The edge can be on the same surface as the original edge, or on a different surface.

## Offset Surface

Select NURBS object. > Modify panel > Create Surfaces rollout > Dependent Surfaces group box > Offset

Select NURBS object. > Modify panel > NURBS toolbox > Create Offset Surface button

An Offset surface is offset a specified distance from the original along the parent surface's normals.

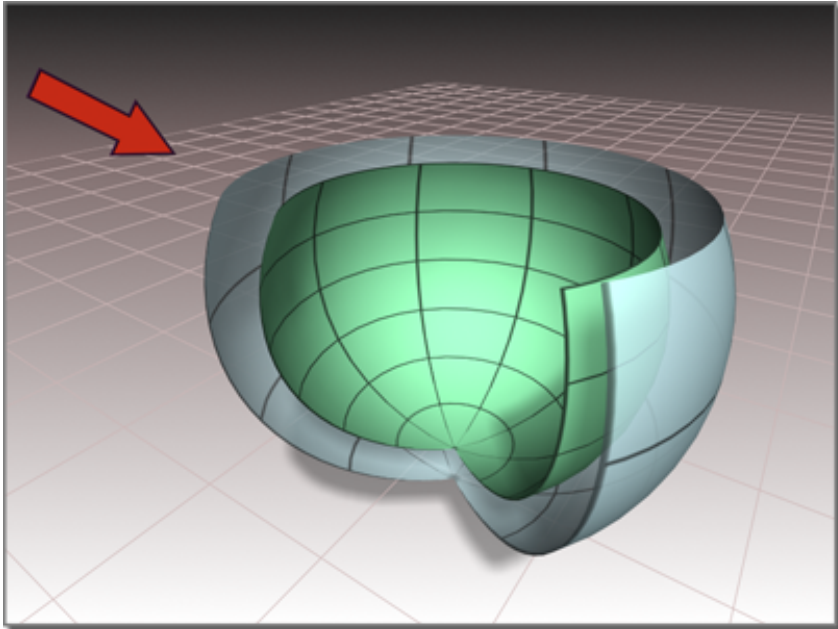

Surface created as an offset

## Procedures

To create an offset surface:

- 1  In a NURBS object that contains at least one surface, turn on Offset.
- 2 Click the surface you want to offset, and drag to set the initial distance of the offset surface.  
The offset surface is created.
- 3 Adjust the Offset parameter.

## Interface

While an offset surface sub-object is selected, a rollout with the offset Distance parameter is displayed at the bottom of the Modify panel.

### Offset Surface rollout (creation time)



**Offset** The distance between the parent surface and the offset surface, in 3ds Max units.

If the parent surface is planar, the appearance of the offset surface doesn't change with distance. If the parent surface is curved, increasing the offset value increasingly exaggerates the curvature of the offset surface.

**Flip Normals** Lets you flip the surface normals at creation time. (After creation, you can flip normals using controls on the Surface Common rollout.)

**Cap** When on, eight boundary curves are generated (four at the four edges of each surface), and then generates four ruled surfaces to connect the two original surfaces. While they are present, cap surfaces are maintained so they match the dimensions of the offset and its parent.

The Cap check box appears *only* on the creation rollout. If you want to remove the caps later, simply select them as surface sub-objects and delete them. Think of offset capping as a workflow shortcut rather than a property (or parameter) of offset surfaces.

To flip the normal of an offset cap, select it as a surface sub-object and use the Flip Normals toggle on the Surface Common rollout.

---

**NOTE** If you trim the original surface, or make the offset surface independent and then trim it, the capping surfaces will look strange.

---

### Offset Surface rollout (modification time)

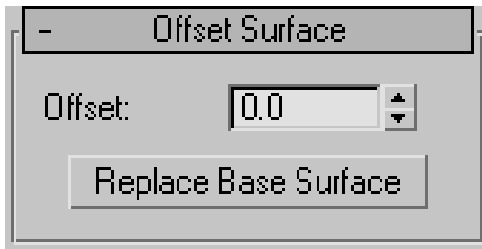

**Offset** The distance between the parent surface and the offset surface in 3ds Max units.

If the parent surface is planar, the appearance of the offset surface doesn't change with distance. If the parent surface is curved, increasing the offset value increasingly exaggerates the curvature of the offset surface.

**Replace Base Surface** Lets you replace the parent surface. Click the button, then click the new surface on which to base the offset.

### Mirror Surface

Select NURBS object. > Modify panel > Create Surfaces rollout > Dependent Surfaces group box > Mirror

Select NURBS object. > Modify panel > NURBS toolbox > Create Mirror Surface button

A mirror surface is a mirror image of the original surface.



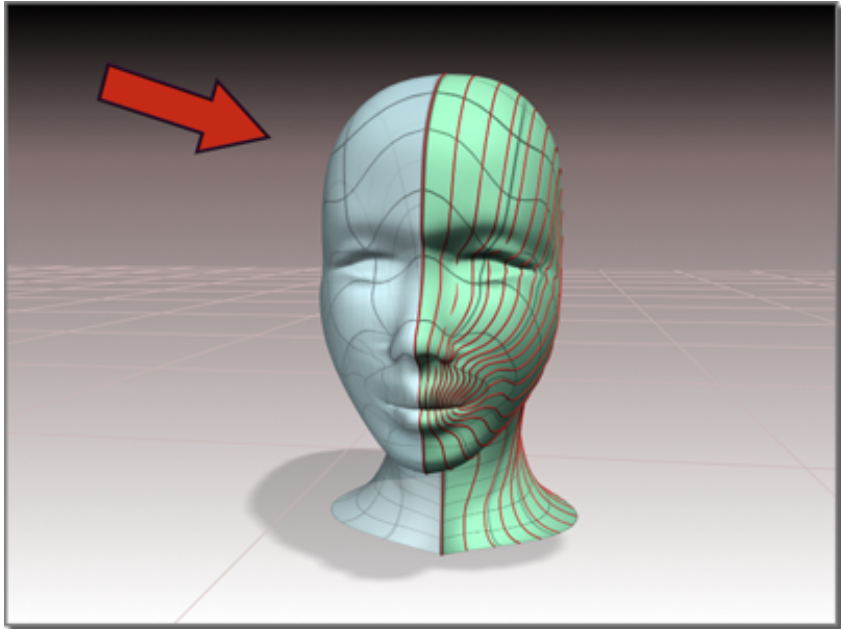

Surface created as a mirror

## Procedures

To create a mirror surface:

- 1  In a NURBS object that contains at least one surface, turn on Mirror.
- 2 On the Mirror Surface rollout, choose the axis or plane you want to use.
- 3 Click the surface you want to mirror, and drag to set the initial distance of the mirror surface.

The mirror surface is created. A gizmo (yellow by default) indicates the direction of mirroring. Transforming the mirror surface's gizmo changes the orientation of the mirror, letting you mirror along an axis that isn't aligned with a local coordinate axis.

The Flip Normals control lets you flip the surface normals at creation time. (After creation, you can flip normals using controls on the Surface Common rollout.)

- 4 Adjust the Offset parameter.

## Interface

While a mirror surface sub-object is selected, the Mirror Surface rollout appears at the bottom of the Modify panel. Also, a gizmo (yellow by default) indicates the mirror axis.

### Mirror Surface rollout (creation time)

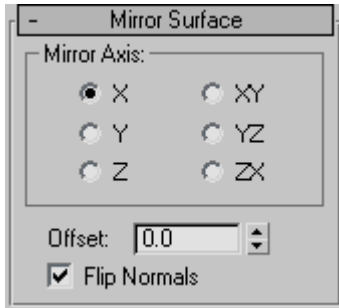

### Mirror Axis group

The Mirror Axis buttons control the direction in which the original surface is mirrored.

You can't transform the mirror surface directly (that would simply transform the mirror surface *and* its parent surface at the same time). You transform it by transforming its gizmo. By using transforms you can mirror about an arbitrary axis, rather than using one of the Mirror Axis presets. When you transform a mirror surface, you are actually transforming the mirror plane, so Rotate has the effect of rotating the plane about which the surface is mirrored. (This is like rotating the mirror gizmo in the Mirror modifier.)

---

**TIP** A convenient way to guarantee that a surface is symmetrical is to create one side of the surface, mirror that surface, and then create a blend between the two sides.

---

**Offset** Controls the mirror's distance from the original surface. This parameter is animatable.

**Flip Normals** Lets you flip the surface normals.

## Mirror Surface rollout (modification time)

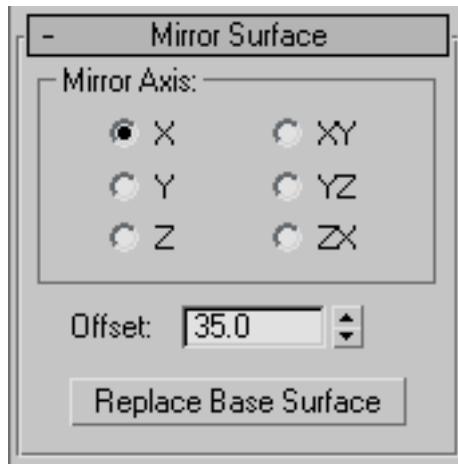

### Mirror Axis group

The Mirror Axis buttons control the direction in which the original surface is mirrored.

You can't transform the mirror surface directly (that would simply transform the mirror surface *and* its parent surface at the same time). You transform it by transforming its gizmo. By using transforms you can mirror about an arbitrary axis, rather than using one of the Mirror Axis presets. When you transform a mirror surface, you are actually transforming the mirror plane, so Rotate has the effect of rotating the plane about which the surface is mirrored. (This is like rotating the mirror gizmo in the Mirror modifier.)

---

**TIP** A convenient way to guarantee that a surface is symmetrical is to create one side of the surface, mirror that surface, and then create a blend between the two sides.

---

**Offset** Controls the mirror's distance from the original surface. This parameter is animatable.

**Replace Base Surface** Lets you replace the parent surface. Click the button, then click the new surface on which to base the mirror.

## Extrude Surface

Select NURBS object. > Modify panel > Create Surfaces rollout > Dependent Surfaces group box > Extrude

Select NURBS object. > Modify panel > NURBS toolbox > Create Extrude Surface button

An extrude surface is extruded from a curve sub-object. It is similar to a surface created with the Extrude modifier. The advantage is that an extrude sub-object is part of the NURBS model, so you can use it to construct other curve and surface sub-objects.

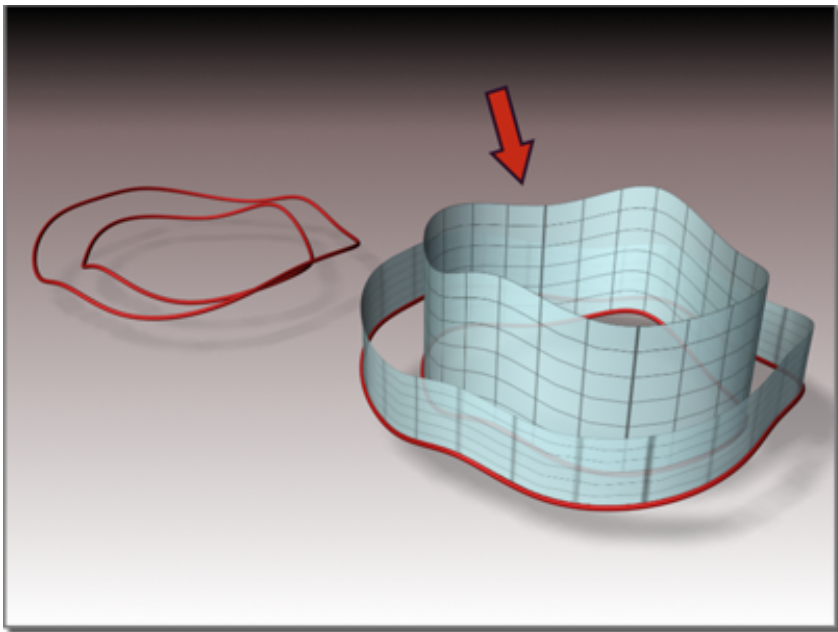

Surface extruded from a curve

### Procedures

To create an extrude surface:

- 1  In a NURBS object that contains at least one curve, turn on Extrude.

- 2 Move the cursor over the curve to extrude, and drag to set the initial amount.

By default, the surface extrudes along the NURBS model's local Z axis. A gizmo (yellow by default) indicates the direction of extrusion.

Transforming the extrude surface's gizmo changes the direction of the extrude, letting you extrude along an axis that isn't aligned with a local coordinate axis.

The Flip Normals control lets you flip the surface normals at creation time. (After creation, you can flip normals using controls on the Surface Common rollout.)

- 3 Adjust the extrusion parameters.

### Interface

While an extrude sub-object is selected, a rollout with the extrusion parameters is displayed at the bottom of the Modify panel.

#### Extrude Surface rollout (creation time)

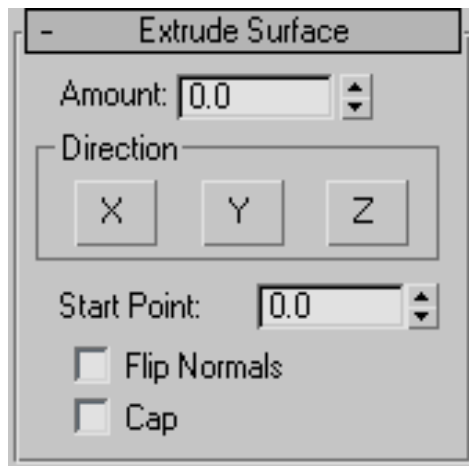

**Amount** The distance the surface is extruded from the parent curve in current 3ds Max units.

This parameter is animatable.

## Direction group

**X, Y and Z** Choose the axis of extrusion. Default=Z.

**Start Point** Adjusts the position of the curve's start point. This can help eliminate unwanted twists or "buckles" in the surface.

This control is disabled if the curve is not a closed curve.

The start point is displayed as a blue circle.

**Flip Normals** Lets you flip the surface normals at creation time. (After creation, you can flip normals using controls in the Surface Common rollout.)

**Cap** When on, two surfaces are generated to close the ends of the extrusion. While they are present, the cap surfaces are maintained so they match the dimensions of the extrude surface. The parent curve must be a closed curve.

The Cap check box appears *only* on the creation rollout. If you want to remove the caps later, simply select them as surface sub-objects and delete them. Think of extrude capping as a workflow shortcut rather than a property (or parameter) of extrude surfaces.

To flip the normal of an extrude cap, select it as a Surface sub-object and use the Flip Normals toggle on the Surface Common rollout.

## Extrude Surface rollout (modification time)

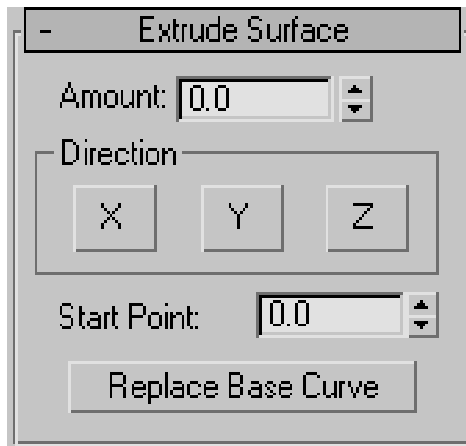

**Amount** The distance the surface is extruded from the parent curve in current 3ds Max units.

## Direction group

**X, Y and Z** Choose the axis of extrusion. Default=Z.

**Start Point** Adjusts the position of the curve's start point. This can help eliminate unwanted twists or "buckles" in the surface.

This control is disabled if the curve is not a closed curve.

The start point is displayed as a blue circle.

**Replace Base Curve** Lets you replace the parent curve. Click the button, then click the new curve on which to base the extruded surface.

## Lathe Surface

Select NURBS object. > Modify panel > Create Surfaces rollout > Dependent Surfaces group box > Lathe

Select NURBS object. > Modify panel > NURBS toolbox > Create Lathe Surface button

A lathe surface is generated from a curve sub-object. It is similar to a surface created with the Lathe modifier. The advantage is that a lathe sub-object is part of the NURBS model, so you can use it to construct other curve and surface sub-objects.

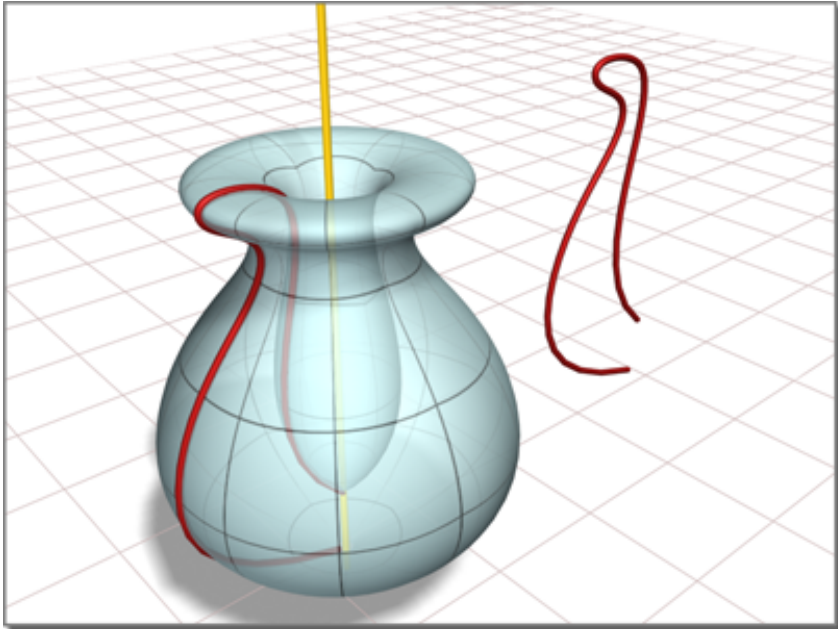

Surface created by lathing a curve

## Procedures

To create a lathe surface:

- 1  In a NURBS object that contains at least one curve, turn on Lathe.
- 2 Click the curve to lathe.

The lathe surface rotates about the NURBS model's local Y axis. The initial lathe amount is 360 degrees. A gizmo (yellow by default) indicates the axis of the lathe. Transforming the lathe surface's gizmo changes the shape of the lathe, and lets you lathe around an axis that isn't aligned with a local coordinate axis.



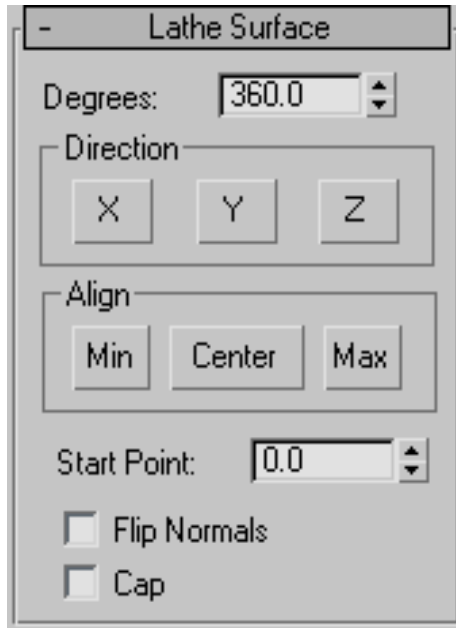

The Flip Normals control lets you flip the surface normals at creation time. (After creation, you can flip normals using controls on the Surface Common rollout.)

- 3 Adjust the lathe parameters.

### **Interface**

While a lathe sub-object is selected, a rollout with the lathe parameters is displayed at the bottom of the Modify panel.

### Lathe Surface rollout (creation time)

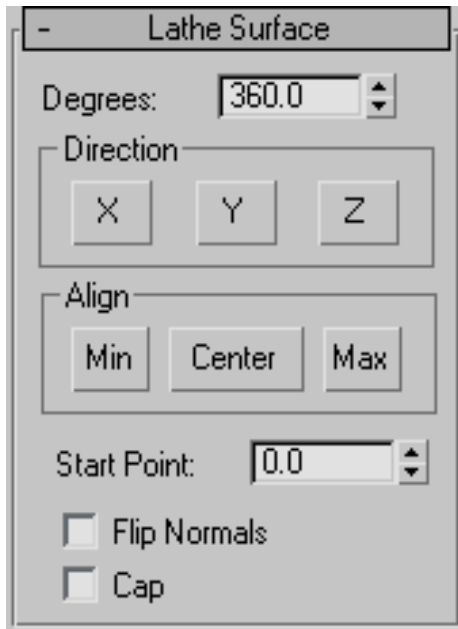

**Degrees** Sets the angle of rotation. At 360 degrees (the default), the surface completely surrounds the axis. At lower values, the surface is a partial rotation.

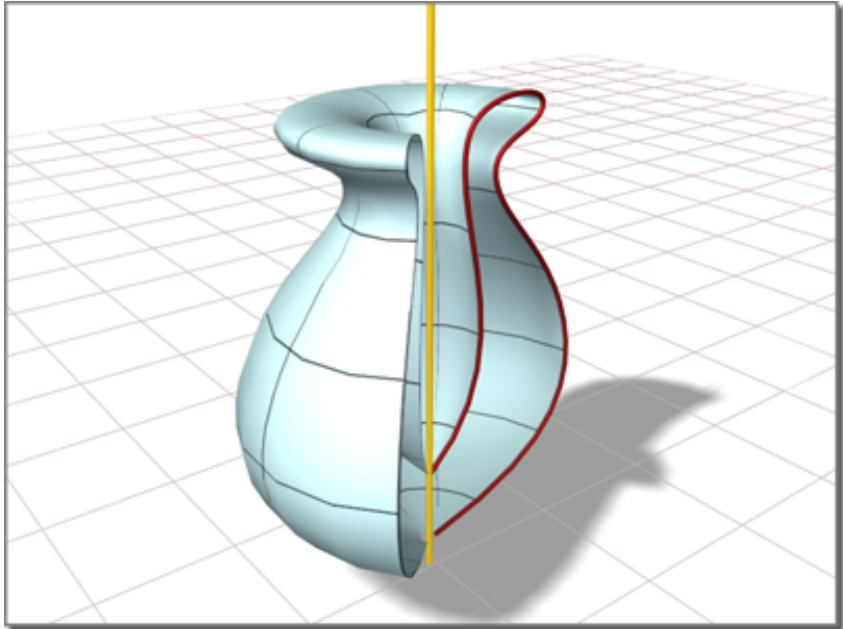

A partial lathe (degrees=225)

### **Direction group**

**X, Y, and Z** Choose the axis of rotation. Default=Y.

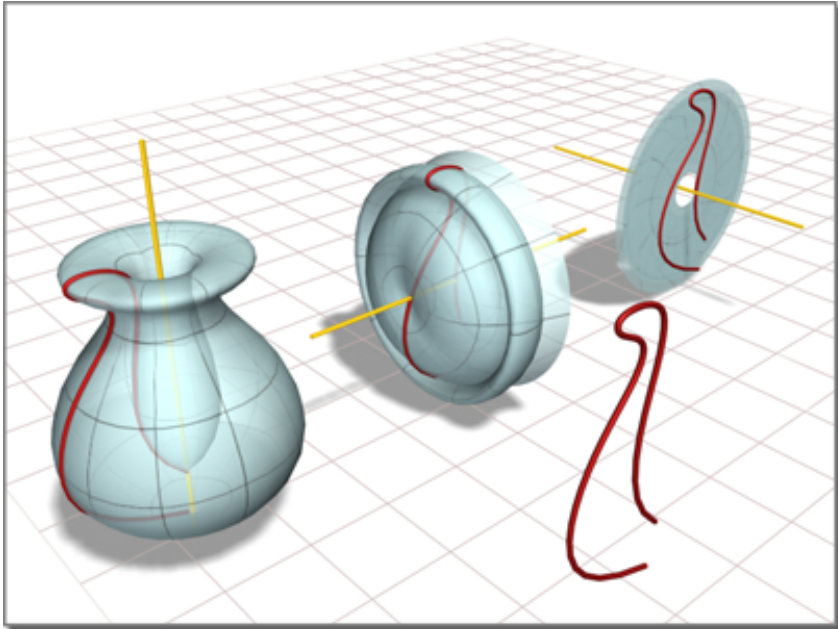

X, Y, and Z rotations of the same curve

### **Align group**

These buttons position the axis of rotation relative to the curve.

**Min** (The default.) Locates the lathe axis at the curve's negative local X-axis boundary.

**Center** Locates the lathe axis at the curve's center.

**Max** Locates the lathe axis at the curve's positive local X-axis boundary.

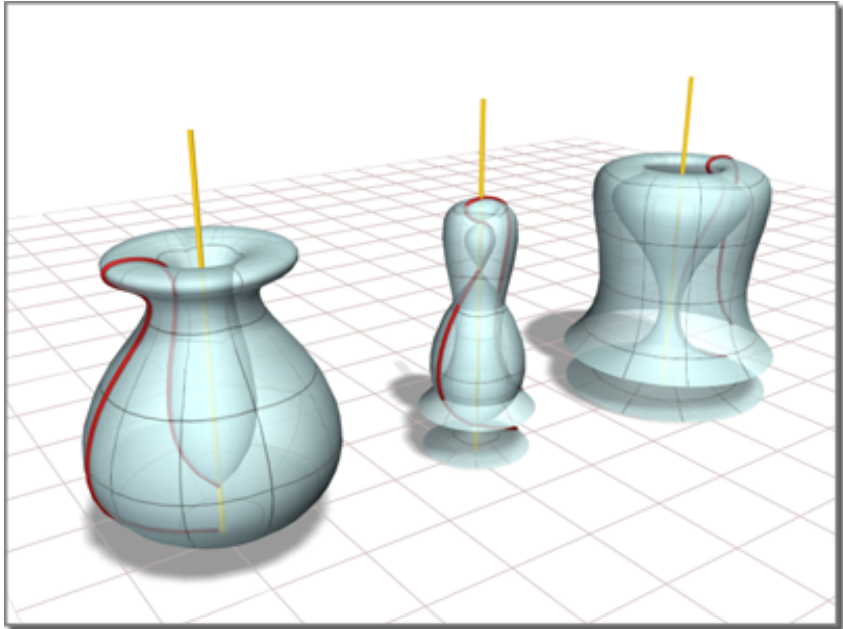

#### Min, Center, and Max lathes of the same curve

**Start Point** Adjusts the position of the curve's start point. This can help eliminate unwanted twists or "buckles" in the surface.

This control is disabled if the curve is not a closed curve.

The start point is displayed as a blue circle.

**Flip Normals** Lets you flip the surface normals at creation time. (After creation, you can flip normals using controls on the Surface Common rollout.)

**Cap** When on, two surfaces are generated to close the ends of the lathe. While they are present, the cap surfaces are maintained so they match the dimensions of the lathe surface. The lathe must be a 360-degree lathe.

The Cap check box appears *only* on the creation rollout. If you want to remove the caps later, simply select them as surface sub-objects and delete them. Think of lathe capping as a workflow shortcut rather than a property (or parameter) of lathe surfaces.

To flip the normal of a lathe cap, select it as a Surface sub-object and use the Flip Normals toggle on the Surface Common rollout.

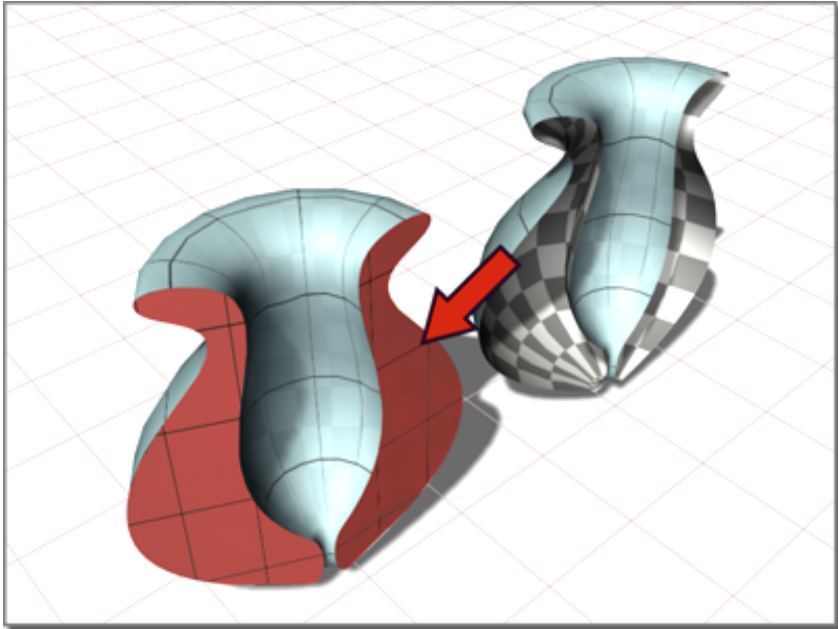

Adding a cap to a partial lathe

## Lathe Surface rollout (modification time)

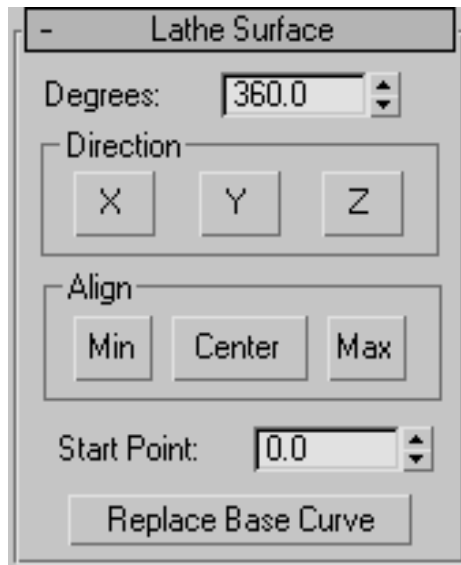

**Degrees** Sets the angle of rotation. At 360 degrees (the default), the surface completely surrounds the axis. At lower values, the surface is a partial rotation.

### Direction group

**X Y and Z** Choose the axis of rotation. Default=Y.

### Align group

These buttons position the axis of rotation relative to the curve.

**Min** (The default.) Locates the lathe axis at the curve's negative local X-axis boundary.

**Center** Locates the lathe axis at the curve's center.

**Max** Locates the lathe axis at the curve's positive local X-axis boundary.

**Start Point** Adjusts the position of the curve's start point. This can help eliminate unwanted twists or "buckles" in the surface.

This control is disabled if the curve is not a closed curve.

The start point is displayed as a blue circle.

**Replace Base Curve** Lets you replace the parent curve. Click the button, then click the new surface on which to base the lathed surface.

## Ruled Surface

Select NURBS object. > Modify panel > Create Surfaces rollout > Dependent Surfaces group box > Ruled

Select NURBS object. > Modify panel > NURBS toolbox > Create Ruled Surface button

A ruled surface is generated from two curve sub-objects. It lets you use curves to design the two opposite borders of a surface.

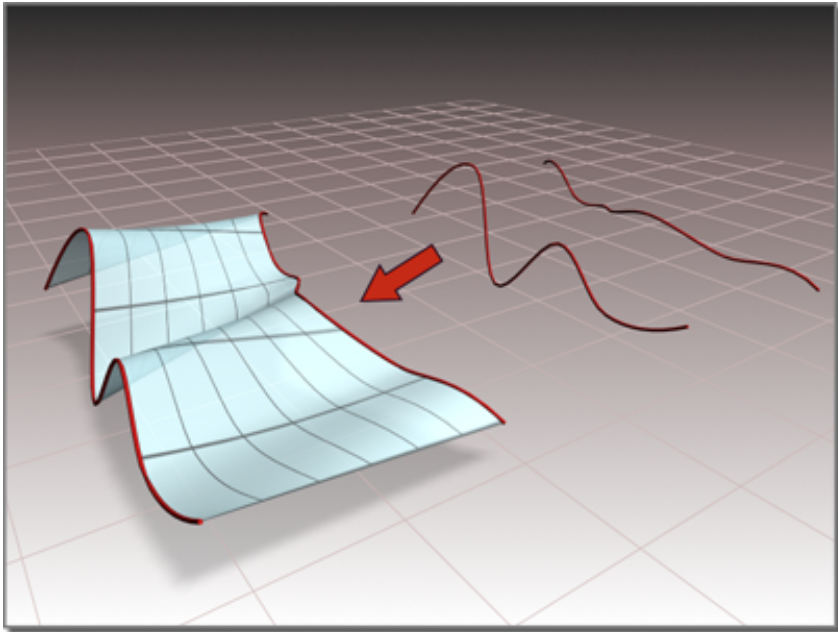

**Using two curves to create a ruled surface**

You can animate the parent curves or their CVs to change the ruled surface.



## Automatic Curve Attachment

When you create a ruled surface, you can select curves that are not already sub-objects of the active NURBS model. You can select another curve or spline Splines object in the scene. When you select that curve, it attaches to the current object as if you had used the [Attach button](#) on page 2225 .

---

**WARNING** If the curve you attach is a sub-object of another NURBS model, the entire model (that is, the curve's parent NURBS object) is attached as well.

---

As you move the mouse over a curve that is not part of the active NURBS object, the cursor changes shape to indicate that you can pick the curve, but the curve is not highlighted in blue.

## Procedures

To create a ruled surface:

- 1  In a NURBS object that contains at least two curves, turn on Ruled.
- 2 Drag from one curve to the other.

You can also click first one curve, then the other.

A dependent surface is generated, using the two curves as the surface's opposite edges. The perpendicular edges are generated automatically.

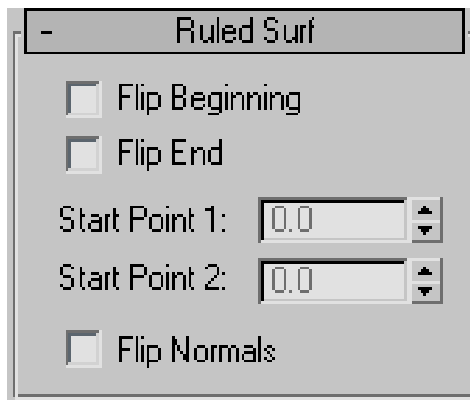

The Flip Normals control lets you flip the surface normals at creation time. (After creation, you can flip normals using controls on the Surface Common rollout.)

## Interface

When you turn on the Ruled button, and while a ruled surface sub-object is selected, a rollout with the ruled surface parameters is displayed at the bottom of the Modify panel.

### Ruled Surf rollout (creation time)

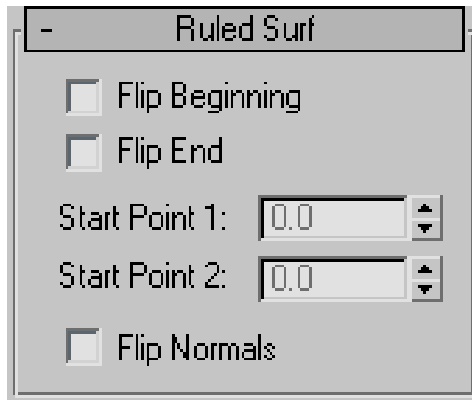

**Flip Beginning and Flip End** Flip one of the curve directions used to construct the ruled surface. A ruled surface is created using the directions of the parent curves. If the two parents have opposing directions, the ruled surface can be shaped like a bow tie. To correct the situation, use Flip Beginning or Flip End to construct the ruled surface using a direction opposite the corresponding parent curve's direction. These controls eliminate the need to reverse the curve.

**Start Point 1 and Start Point 2** Adjust the position of the start point at the two curves that specify the ruled surface. Adjusting the start points can help eliminate unwanted twists or "buckles" in the surface.

These spinners are disabled if the edges or curves are not closed.

While you're adjusting start points, a dotted blue line is displayed between them, to show the alignment. The surface is not displayed, so it doesn't slow down adjustment. When you release the mouse button, the surface reappears.

**Flip Normals** Turn on to reverse the direction of the ruled surface's normals.

## Ruled Surf rollout (modification time)

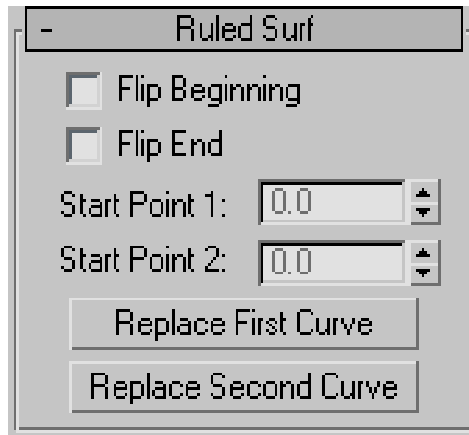

**Flip Beginning and Flip End** Flip one of the curve directions used to construct the ruled surface. A ruled surface is created using the directions of the parent curves. If the two parents have opposing directions, the ruled surface can be shaped like a bow tie. To correct the situation, use Flip Beginning or Flip End to construct the ruled surface using a direction opposite the corresponding parent curve's direction. These controls eliminate the need to reverse the curve.

**Start Point 1 and Start Point 2** Adjust the position of the start point at the two curves that specify the ruled surface. Adjusting the start points can help eliminate unwanted twists or "buckles" in the surface.

These spinners are disabled if the edges or curves are not closed.

While you're adjusting start points, a dotted blue line is displayed between them, to show the alignment. The surface is not displayed, so it doesn't slow down adjustment. When you release the mouse button, the surface reappears.

**Replace First Curve and Replace Second Curve** Let you replace the parent curves. Click a button, then click the curve to replace the original first or second curve.

## Cap Surface

Select NURBS object. > Modify panel > Create Surfaces rollout > Dependent Surfaces group box > Cap

Select NURBS object. > Modify panel > NURBS toolbox > Create Cap Surface button

This command creates a surface that caps a closed curve or the edge of a closed surface. Caps are especially useful with extruded surfaces.

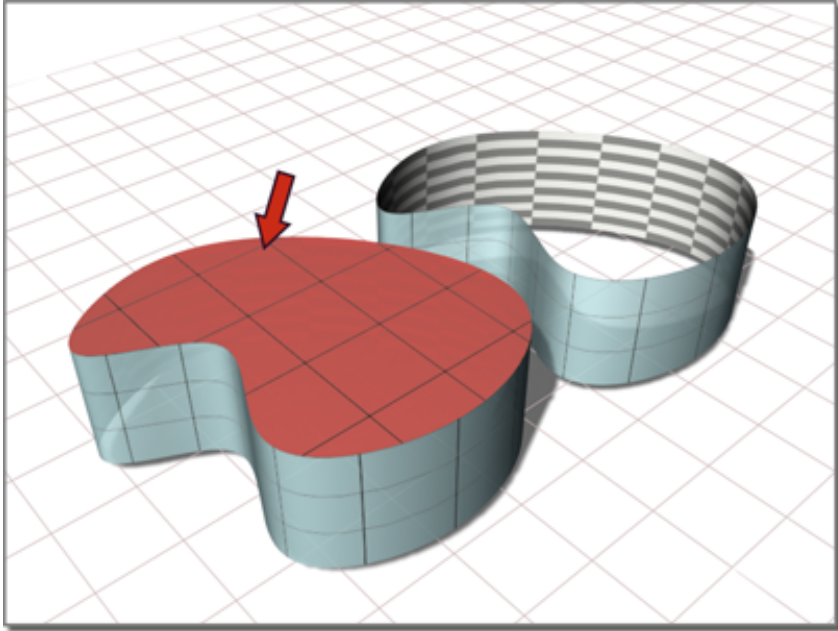

Capping an extrude surface

## Procedures

To create a cap surface:

- 1  In a NURBS object, turn on Cap.
- 2 Move the mouse over the closed curve or the closed edge of a closed surface.  
If the cap can be created, the curve or edge is highlighted in blue.
- 3 Click the highlighted curve or edge.

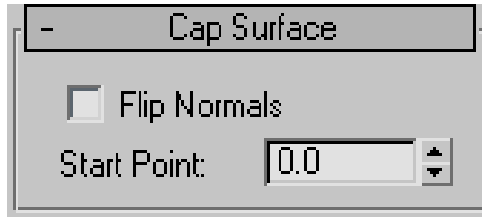

The Flip Normals control lets you flip the surface normals at creation time. (After creation, you can flip normals using controls on the Surface Common rollout.)

### Interface

While a cap surface sub-object is selected, a rollout with cap surface controls is displayed at the bottom of the Modify panel.

### Cap Surface rollout (creation time)

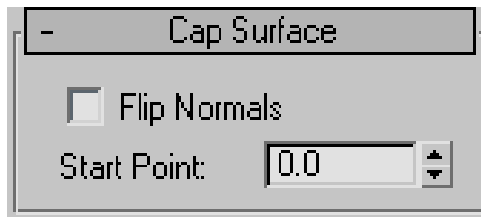

**Flip Normals** Turn on to reverse the direction of the cap surface's normals.

**Start Point** Adjusts the position of the edge or curve's start point.

The start point is displayed as a blue circle.

### Cap Surface rollout (modification time)

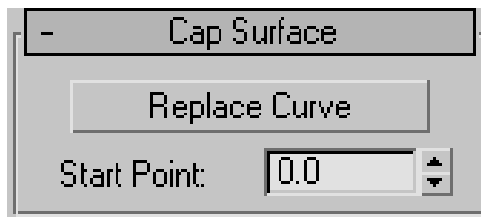

**Replace Curve** Lets you replace the parent curve or edge. Click the button, then click the new curve or edge on which to base the cap.

**Start Point** Adjusts the position of the edge or curve's start point.

The start point is displayed as a blue circle.

## U Loft Surface

Select NURBS object. > Modify panel > Create Surfaces rollout > Dependent Surfaces group box > U Loft

Select NURBS object. > Modify panel > NURBS toolbox > Create U Loft Surface button

A U loft surface interpolates a surface across multiple curve sub-objects. The curves become U-axis contours of the surface.

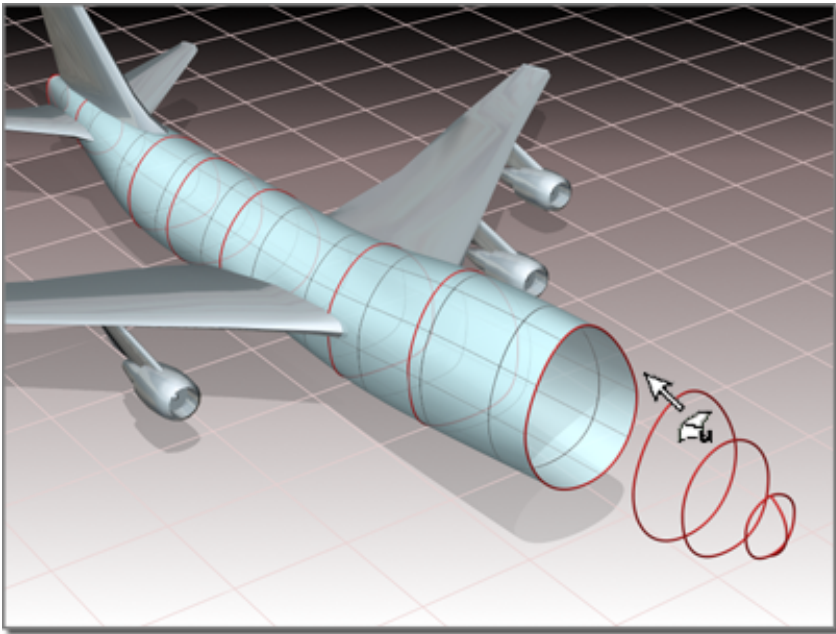

Using multiple curves to create a U Loft surface

### Tips

- A U loft can be an extremely dense surface. To improve performance while working with viewports, set the [surface approximation](#) on page 2469 for viewports to Curvature Dependent.

- You can speed up U loft creation by making sure that the curves you loft have the same number of CVs in the same order (that is, the curves point in the same direction). Also, CV curves have a performance advantage over point curves.
- Turning off display of dependent sub-objects, including the U loft itself, also speeds up interactive performance when you create a U loft. The default keyboard toggle for dependent sub-object display is Ctrl+D (the [Keyboard Shortcut Override Toggle](#) on page 7646 button must be on.)

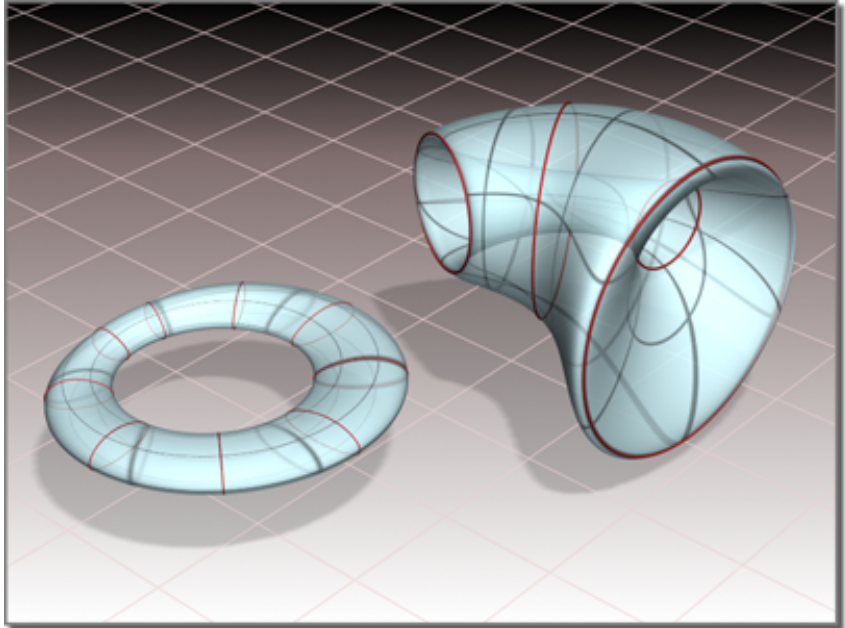

Closed U lofts

### Automatic Curve Attachment

When you create a U loft, you can select curves that are not already sub-objects of the active NURBS model. You can select another curve or [spline](#) on page 542 object in the scene. When you select that curve, it is automatically attached to the current object as if you had used the Attach button.

---

**WARNING** If the curve you attach is a sub-object of another NURBS model, the entire model (that is, the curve's parent NURBS object) is attached as well.

---

As you move the mouse over a curve that is not part of the active NURBS object, the cursor changes shape to indicate you can pick the curve, but the curve is not highlighted in blue.

### **Procedures**

**To create a U loft surface:**

- 1  In a NURBS object that contains at least two curves, turn on U Loft.
- 2 Click the first curve.
- 3 Click additional curves in succession.



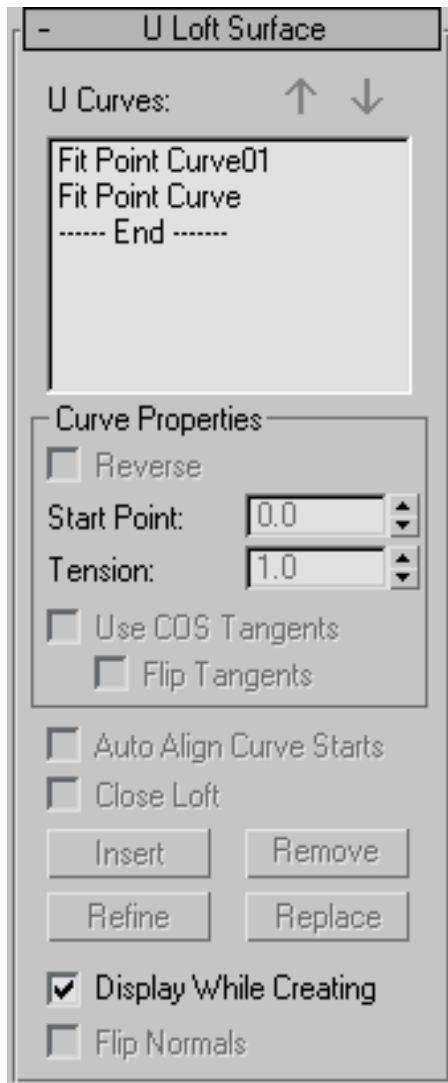

The U loft is created. It is "stretched" across the curves you click. The order in which you click the curves can affect the shape of the U loft surface. The names of the curves appear in the U Loft Surface creation rollout.

While creating a U loft, you can press Backspace to remove the last curve you clicked from the list of U loft curves.

The Flip Normals control lets you flip the surface normals at creation time. (After creation, you can flip normals using controls on the Surface Common rollout.)

- 4 Right-click to end U loft creation.

**To create a U loft with automatic attach (example):**

- 1 From the Create panel, create three or more independent CV or Point NURBS curves.
- 2 Go to the Modify panel, and click to turn on U Loft in the NURBS toolbox.
- 3 Select the curves in the appropriate order for the loft.

The U loft is created. You don't have to collapse the curves to a NURBS surface, or [attach them to an existing NURBS model](#) on page 2225 .

As you move the mouse over a curve that is not part of the active NURBS object, the cursor changes shape to indicate you can pick the curve, but the curve is not highlighted in blue.

## Interface

While a U loft sub-object is selected, a rollout with the U loft parameters is displayed at the bottom of the Modify panel. This rollout appears only when *one* U loft sub-object is selected. It isn't possible to edit more than one U loft at a time, so unlike some other NURBS sub-objects, the rollout doesn't appear when multiple U loft sub-objects are selected.

When you create lofted and swept surfaces, you have access to all the parameters, and some of the editing operations, of the surface. You can reverse and set start points on curves while you create the surface. You can also use the arrow buttons to change the order of the curves, and you can remove a curve with the Remove button.

---

**TIP** When you edit a U loft sub-object, close the Surface Common rollout to see the U Loft Surface rollout more easily.

---

## U Loft Surface rollout (creation time)

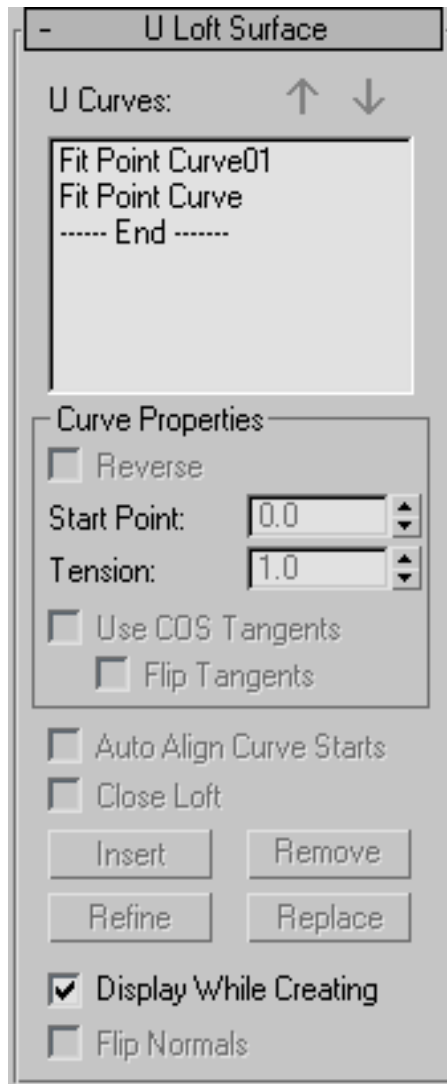

**U Curves** This list shows the name of the curves you click in the order you click them. You can select curves by clicking their names. Viewports display the selected curve in blue. Initially the first curve is the one selected.

You can also select more than one curve at a time. This is useful when you use the Edit Curves button.

**Arrow Buttons** Use these to change the order of curves used to construct the U loft. Select a curve in the list, and then use the arrows to move the selection up or down.

These buttons are available at creation time.

### **Curve Properties group**

These controls affect individual curves you select in the U Curves list, as opposed to properties of the loft surface in general. They are enabled only when you have selected a curve in the U Curves list.

**Reverse** When set, reverses the direction of the selected curve.

**Start Point** Adjusts the position of the curve's start point.

This control is disabled if the curve is not a closed curve.

While you're adjusting start points, a dotted blue line is displayed between them, to show the alignment. The surface is not displayed, so it doesn't slow down adjustment. When you release the mouse button, the surface reappears.

**Tension** Adjusts the tension of the loft where it intersects that curve.

**Use COS Tangents** If the curve is a curve on surface, turning on this toggle causes the U loft to use the tangency of the surface. This can help you blend a loft smoothly onto a surface. Default=off.

This toggle is disabled unless the curve is a point or CV curve on surface.

**Flip Tangents** Reverses the direction of the tangents for that curve.

This toggle is disabled unless the curve is a point or CV curve on surface and Use COS Tangents is on.

**Auto Align Curve Starts** (Disabled.)

**Close Loft** (Disabled.)

**Insert** (Disabled.)

**Remove** Removes a curve from the U loft surface. Select the curve in the list, and then click Remove.

This button is available at creation time.

**Refine** (Disabled.)

**Replace** (Disabled.)

**Display While Creating** When on, the U loft surface is displayed while you create it. When off, the loft is created more quickly. Default=off.

**Flip Normals** Reverses the direction of the U loft's normals.

**U Loft Surface rollout (modification time)**

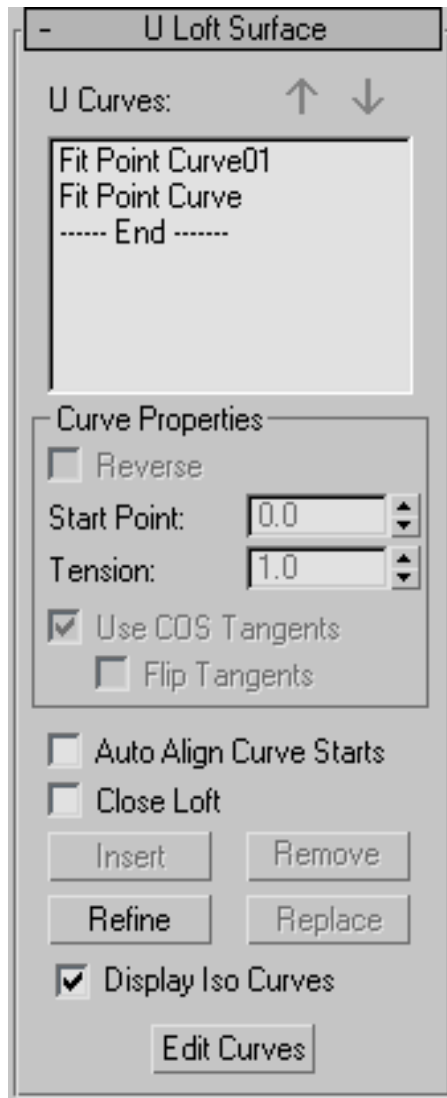

**U Curves** This list shows the name of the curves you click, in the order you click them. You can select curves by clicking their names in this list. Viewports display the selected curve in blue. Initially the first curve is the one selected.

You can also select more than one curve at a time. This is useful when you use the Edit Curves button.

**Arrow Buttons** Use these to change the order of curves used to construct the U loft. Select a curve in the list, and then use the arrows to move the selection up or down.

These buttons are available at creation time.

### **Curve Properties group**

These controls affect individual curves you select in the U Curves list, as opposed to properties of the loft surface in general. They are enabled only when you have selected a curve in the U Curves list.

**Reverse** When set, reverses the direction of the selected curve.

**Start Point** Adjusts the position of the curve's start point.

This control is disabled if the curve is not a closed curve.

While you're adjusting start points, a dotted blue line is displayed between them, to show the alignment. The surface is not displayed, so it doesn't slow down adjustment. When you release the mouse button, the surface reappears.

**Tension** Adjusts the tension of the loft where it intersects that curve.

**Use COS Tangents** If the curve is a curve on surface, turning on this toggle causes the U loft to use the tangency of the surface. This can help you blend a loft smoothly onto a surface. Default=off.

This toggle is disabled unless the curve is a point or CV curve on surface.

**Flip Tangents** Reverses the direction of the tangents for that curve.

This toggle is disabled unless the curve is a point or CV curve on surface and Use COS Tangents is on.

**Auto Align Curve Starts** When on, aligns the start points of all curves in the U loft. The software chooses the location of the start points. Using automatic alignment minimizes the amount of twisting in the loft surface. Default=off.

**Close Loft** If the loft was initially an open surface, turning on this toggle closes it by adding a new segment to connect the first curve and the last curve. Default=off.

**Insert** Adds a curve to the U loft surface. Click to turn on Insert, then click the curve. The curve is inserted *before* the selected curve. To insert a curve at the end, first highlight the "----End-----" marker in the list.

**Remove** Removes a curve from the U loft surface. Select the curve in the list, and then click Remove.

This button is available at creation time.

**Refine** Refines the U loft surface. Click to turn on Refine, then click a U-axis iso curve on the surface. (As you drag the mouse over the surface, the available curves are highlighted.) The curve you click is converted to a CV curve and inserted into the loft and the U Curves list. As when you refine a point curve, refining a U loft can change the curvature of the surface slightly. Once you've refined the surface by adding a U curve, you can use Edit Curve to change the curve.

**Replace** Replaces a U curve with a different curve. Select a U curve, click to turn on Replace, then click the new curve in a viewport. Available curves are highlighted as you drag the mouse.

This button is enabled only when you've selected a single curve in the U Curves list.

**Display Iso Curves** When set, the U loft's V-axis iso curves are displayed as well as the U-axis curves used to construct the loft. The V-axis curves are only for display. You can't use them for surface construction.

**Edit Curve** Lets you edit the currently selected curve without switching to another sub-object level. Click to turn on Edit Curve. The points or CVs of the curve are displayed, as well as the control lattice if the curve is a CV curve. You can now transform or otherwise change the points or CVs as if you were at the Point or Curve CV sub-object level. To finish editing the curve, click to turn off Edit Curve.

When you turn on Edit Curves, all applicable rollouts for the selected curves are displayed, including the Curve Common rollout, the CV or Point rollout (depending on the curve type), and the CV Curve or Point Curve rollout. These rollouts appear beneath the U Loft rollout. They let you edit the loft curves and their points or CVs without having to switch sub-object levels.

---

**TIP** When you edit curves in a U loft, turning off display of the U loft itself can make the curves easier to see and improve performance. Use Ctrl+D (while the [Keyboard Shortcut Override Toggle button](#) on page 7646 is on) to toggle display of dependent sub-objects, including U Lofts.

---

## UV Loft Surface

Select NURBS object. > Modify panel > Create Surfaces rollout > Dependent Surfaces group box > UV Loft

Select NURBS object. > Modify panel > NURBS toolbox > Create UV Loft Surface button

A UV loft surface is similar to a U loft surface, but has a set of curves in the V dimension as well as in the U dimension. This can give you finer control over the lofted shape, and require fewer curves to achieve the result you want.

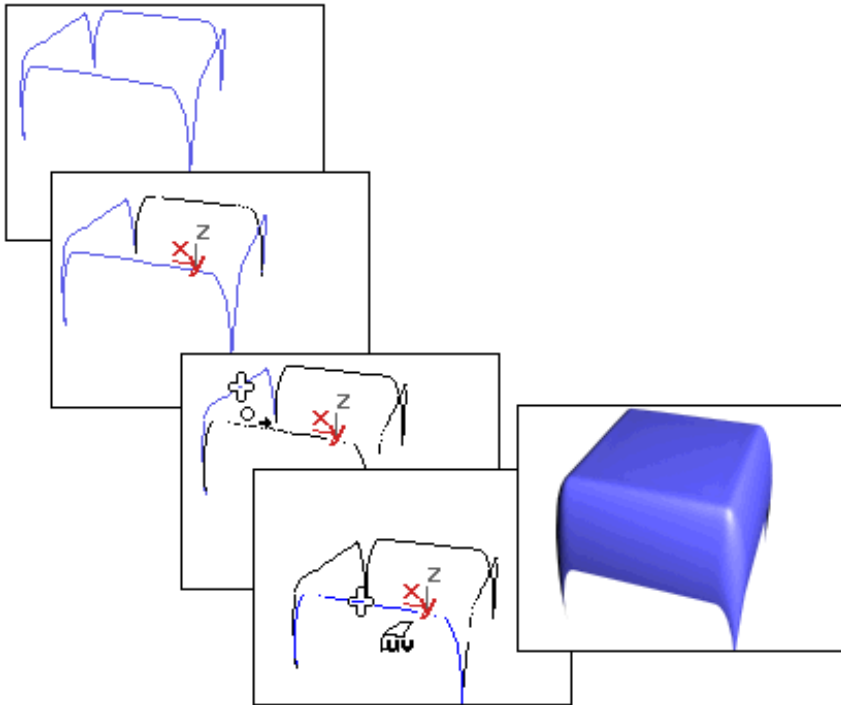

**Using perpendicular curves to create a UV loft surface**

If the U and V curves intersect, the UV loft surface interpolates all the curves. If the curves don't intersect, the lofted surface lies somewhere between the U and V curves. In general, UV loft works best if the ends of all the curves in one direction lie on the two end curves in the other direction, as in the illustration. UV loft does not work well if the curves in both directions are closed.



---

**NOTE** The [Make Loft](#) on page 2459 dialog (displayed by the Make Loft button on the Surface Common rollout for surface sub-objects) now lets you convert a surface to a UV loft as well as a U loft. In addition, you can use point curves instead of CV curves for the new loft lattice. If you use point curves for a UV loft, turning on the Fuse Points option guarantees that the U and V curves intersect.

---

## Automatic Curve Attachment

When you create a UV loft, you can select curves that are not already sub-objects of the active NURBS model. You can select another curve or [spline](#) on page 542 object in the scene. When you select that curve, it attaches to the current object as if you had used the [Attach button](#) on page 2225 .

---

**WARNING** If the curve you attach is a sub-object of another NURBS model, the entire model (that is, the curve's parent NURBS object) is attached as well.

---

As you move the mouse over a curve that is not part of the active NURBS object, the cursor changes shape to indicate that you can pick the curve, but the curve is not highlighted in blue.

## Procedures

**To create a UV loft:**



- 1 Create the curves that outline the surface you want to create.
- 2 Click to turn on UV Loft in the toolbox or on the Create Surfaces rollout.
- 3 Click each of the curves in the U dimension, then right-click. Click each of the curves in the V dimension, then right-click again to end creation.  
As you click curves, their names appear in the lists on the UV Loft Surface creation rollout. The order in which you click the curves can affect the shape of the UV loft surface.

In either dimension, you can click the same curve more than once. This can help you create a closed UV loft.

**To create a UV loft with automatic attach (example):**

- 1 From the Create panel, create three or more independent CV or point NURBS curves.
- 2 Go to the Modify panel, and click to turn on UV Loft in the NURBS toolbox.

- 3 Select the curves in the appropriate order for the loft.

The UV loft is created. You don't need to collapse the curves to a NURBS surface or Attach them to an existing NURBS model.

As you move the mouse over a curve that is not part of the active NURBS object, the cursor changes shape to indicate that you can pick the curve, but the curve is not highlighted in blue.

### **Interface**

While a UV Loft sub-object is selected, a rollout with the UV loft parameters appears. This rollout appears only when *one* UV loft sub-object is selected. It isn't possible to edit more than one UV loft at a time, so unlike some other NURBS sub-objects, the rollout doesn't appear when multiple UV loft sub-objects are selected.

---

**TIP** When you edit a UV loft sub-object, close the Surface Common rollout to see the U Loft Surface rollout more easily.

---

### UV Loft Surface rollout (creation time)

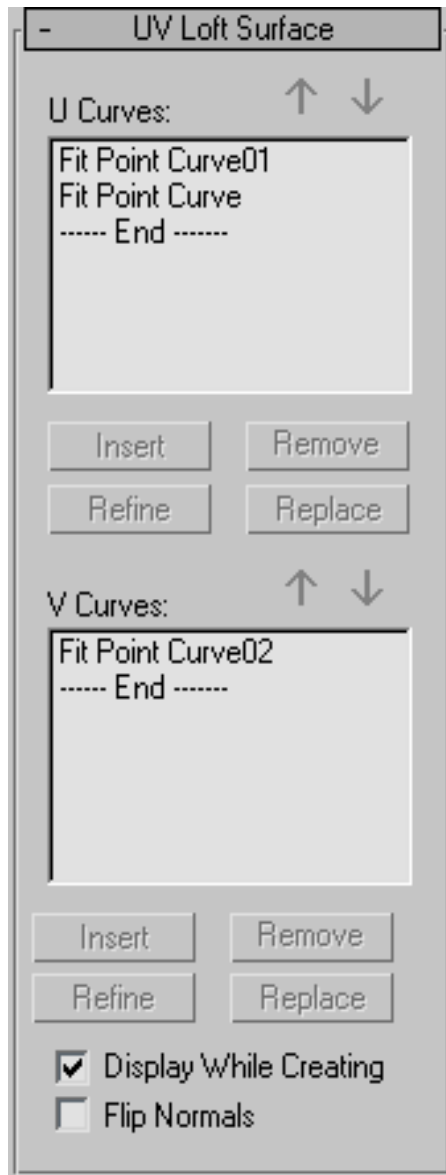

**U Curves and V Curves** These lists show the names of the curves you click, in the order you click them. You can select a curve by clicking its name in a list. Viewports display the selected curve in blue.

The two buttons above and the four below each list are identical for both lists.

While you create the loft, in either dimension you can click the same curve more than once. This can help you create a closed UV loft.

**Arrow Buttons** Use these to change the order of curves in the U Curve or V Curve list. Select a curve in the list, and then use the arrows to move the selection up or down.

**Insert** (Disabled.)

**Remove** Removes a curve from the U list or V list. Select the curve in the list, and then click Remove.

**Refine** (Disabled.)

**Replace** (Disabled.)

**Display While Creating** When on, the UV loft surface is displayed while you create it. When off, the loft can be created more quickly. Default=off.

**Flip Normals** Reverses the direction of the UV loft's normals.

**UV Loft Surface rollout (modification time)**

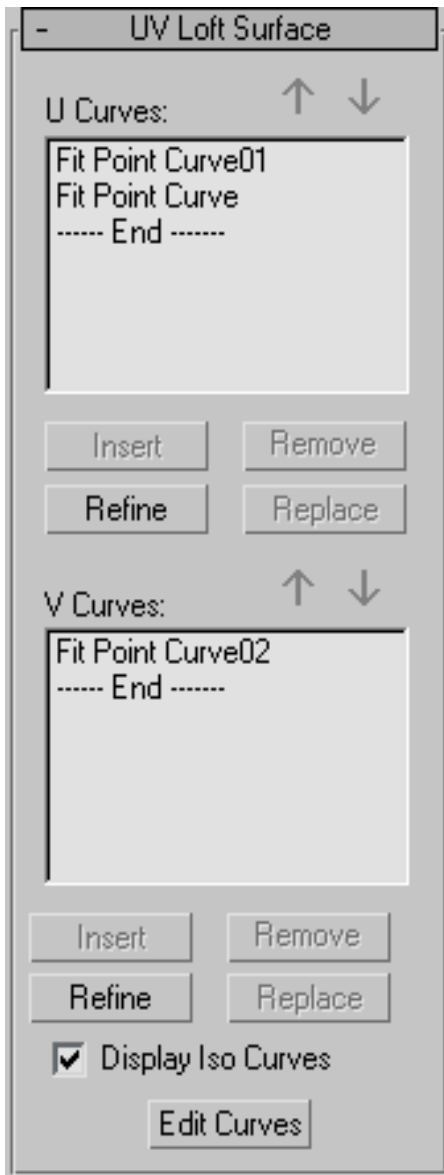

**U Curves and V Curves** These lists show the names of the curves you click, in the order you click them. You can select a curve by clicking its name in a list. Viewports display the selected curve in blue.

The two buttons above and the four below each list are identical for both lists.

**Arrow Buttons** Use these to change the order of curves in the U Curve or V Curve list. Select a curve in the list, and then use the arrows to move the selection up or down.

**Insert** Adds a curve to the U list or V list. Click to turn on Insert, then click the curve. The curve is inserted *before* the selected curve. To insert a curve at the end, first highlight the "----End----" marker in the list.

**Remove** Removes a curve from the U list or V list. Select the curve in the list, and then click Remove.

**Refine** Refines the UV loft surface. Click to turn on Refine, then click an iso curve on the surface. (As you drag the mouse over the surface, the available curves are highlighted.) The curve you click is converted to a CV curve and inserted into the loft and the U Curves or V Curves list. As when you refine a point curve, refining a UV loft can change the curvature of the surface slightly. Once you've refined the surface by adding a U curve or V curve, you can use Edit Curves to change the curve.

**Replace** Lets you replace the selected curve. Select a curve in the list, click this button, then select the new curve.

**Display Iso Curves** When set, the UV loft's iso curves are displayed as well as the U-axis and V-axis curves used to construct the loft. The iso curves are only for display. You can't use them for surface construction.

**Edit Curves** Lets you edit the currently selected curve without switching to another sub-object level. Click to turn on Edit Curve. The points or CVs of the curve are displayed, as well as the control lattice if the curve is a CV curve. You can now transform or otherwise change the points or CVs as if you were at the Point or Curve CV sub-object level. To finish editing the curve, click to turn off Edit Curves.

When you turn on Edit Curves, all applicable rollouts for the selected curves are displayed, including the Curve Common rollout, the CV or Point rollout (depending on the curve type), and the CV Curve or Point Curve rollout. These rollouts appear beneath the U Loft rollout. They let you edit the loft curves and their points or CVs without having to switch sub-object levels.

---

**TIP** When you edit curves in a UV loft, turning off display of the UV loft itself can make the curves easier to see and improve performance. Use Ctrl+D (while the [Keyboard Shortcut Override Toggle button](#) on page 7646 is on) to toggle display of dependent sub-objects, including UV lofts.

The UV loft surface can deviate from the curve if you edit a curve in a UV loft by increasing the weight of the curve CVs. You can work around this by refining the curve at the point where the surface deviates.

---

## I-Rail Sweep Surface

Select NURBS object. > Modify panel > Create Surfaces rollout > Dependent Surfaces group box > 1-Rail

Select NURBS object. > Modify panel > NURBS toolbox > Create 1-Rail Sweep button

Sweep surfaces are constructed from curves. A 1-rail sweep surface uses at least two curves. One curve, the "rail," defines one edge of the surface. The other curves define the surface's cross sections.

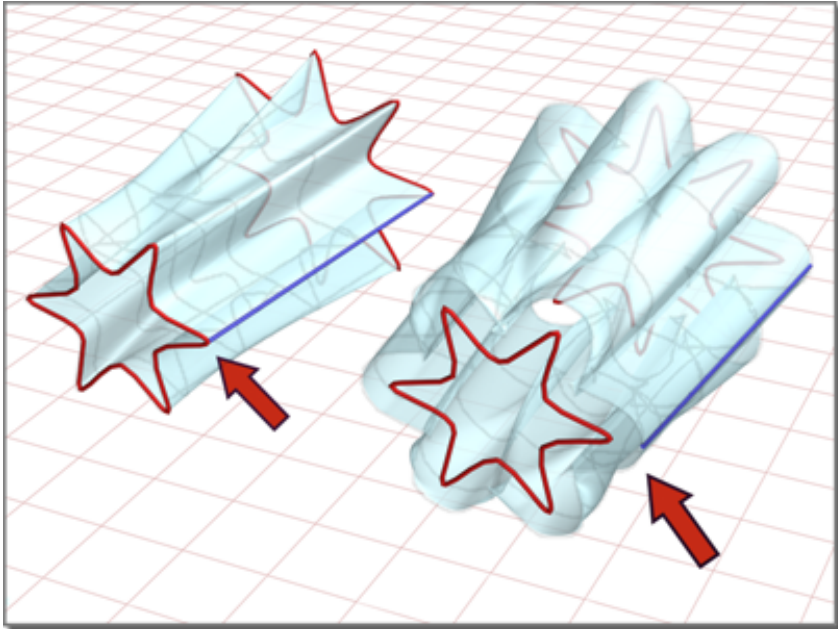

### 1-rail sweep surface

Changing the position of the rail can change the shape of the surface.

The cross-section curves should intersect the rail curve. If the cross-sections don't intersect the rail, the resulting surface is unpredictable. In addition, the initial point of the rail and the initial point of the first cross-section curve must be coincident. Use [NURBS Snaps](#) on page 2578 to accomplish this.

### Automatic Curve Attachment

When you create a 1-rail sweep, you can select curves that are not already sub-objects of the active NURBS model. You can select another curve or [spline](#) on page 542 object in the scene. When you select that curve, it attaches to the current object as if you had used the [Attach button](#) on page 2225 .

---

**WARNING** If the curve you attach is a sub-object of another NURBS model, the entire model (that is, the curve's parent NURBS object) is attached as well.

---

As you move the mouse over a curve that is not part of the active NURBS object, the cursor changes shape to indicate that you can pick the curve, but the curve is not highlighted in blue.



## Procedures

### To create a 1-rail sweep:

- 1 Create the curves that define the surface you want to create.

- 2  Click to turn on 1 Rail Sweep in the toolbox or on the Create Surfaces rollout.

- 3 Click the curve to use as the rail, then click each of the cross-section curves. Right-click to end creation.

The sweep is interpolated smoothly between the cross sections, following the outline defined by the rail.

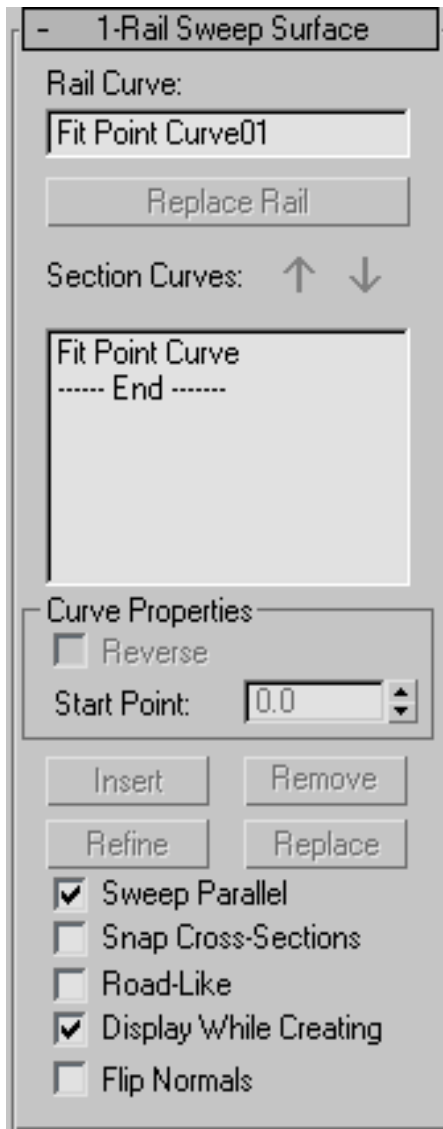

As you click curves, their names appear in the lists on the 1 Rail Sweep Surface creation rollout. The order in which you click the curves can affect the shape of the sweep surface.

**Example: To create a 1-rail sweep with automatic attach:**

- 1 From the Create panel, create two independent CV or Point NURBS curves.
- 2 Go to the Modify panel, and click to turn on 1-Rail Sweep in the NURBS toolbox.
- 3 Select the curves in the appropriate order for the sweep.

The sweep is created. You don't need to collapse the curves to a NURBS surface or Attach them to an existing NURBS model.

As you move the mouse over a curve that is not part of the active NURBS object, the cursor changes shape to indicate that you can pick the curve, but the curve is not highlighted in blue.

**Interface**

While a 1-rail sweep sub-object is selected, a rollout with the 1-rail sweep parameters appears. This rollout appears only when *one* 1-rail sweep sub-object is selected. It isn't possible to edit more than one 1-rail sweep at a time, so unlike some other NURBS sub-objects, the rollout doesn't appear when multiple 1-rail sweep sub-objects are selected.

---

**TIP** When you edit a 1-rail sweep sub-object, close the Surface Common rollout to see the 1-rail sweep Surface rollout more easily.

---

### I-Rail Sweep Surface rollout (creation time)

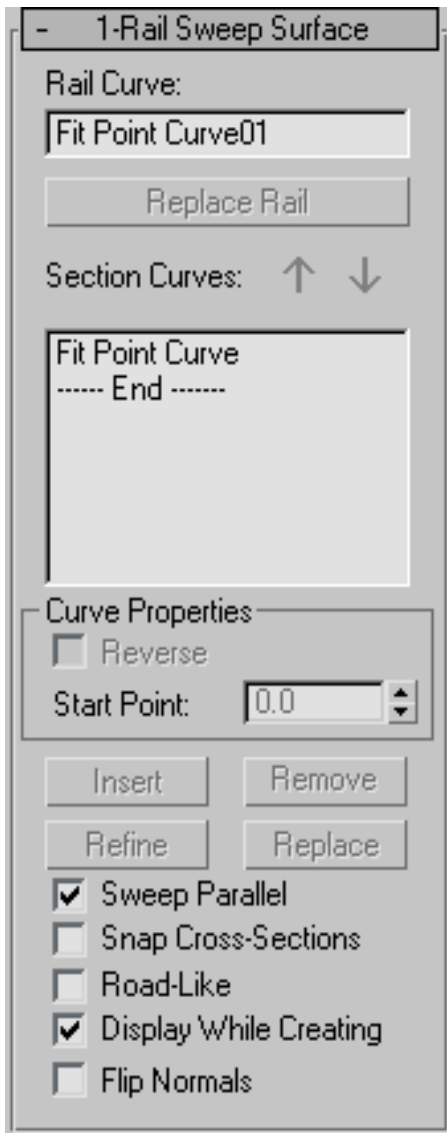

**Rail Curve** Shows the name of the curve you chose to be the rail.

**Replace Rail** (Disabled.)

**Section Curves** This list shows the names of the cross-section curves, in the order you click them. You can select a curve by clicking its name in the list. Viewports display the selected curve in blue.

**Arrow Buttons** Use these to change the order of section curves in the list. Select a curve in the list, and then use the arrows to move the selection up or down.

### **Curve Properties group**

These controls affect individual curves you select in the Section Curves list, as opposed to properties of the sweep surface in general. They are enabled only when you have selected a curve in the Section Curves list.

**Reverse** When set, reverses the direction of the selected curve.

**Start Point** Adjusts the position of the curve's start point. This can help eliminate unwanted twists or "buckles" in the surface.

This control is disabled if the curve is not a closed curve.

While you're adjusting start points, a dotted blue line is displayed between them, to show the alignment. The surface is not displayed, so it doesn't slow down adjustment. When you release the mouse button, the surface reappears.

**Insert** (Disabled.)

**Remove** Removes a curve from the list. Select the curve in the list, and then click Remove.

**Refine** (Disabled.)

**Replace** (Disabled.)

**Sweep Parallel** When on, ensures that the sweep surface's normal is parallel to the rail.

**Snap Cross-Sections** When on, cross-section curves are translated so they intersect the rail. The first cross section is translated to the start of the rail, and the last to the end of the rail. The cross sections in the middle are translated to touch the rail at the closest point to the end of the cross-section curves.

When Snap Cross-Sections is on, the sweep follows the rail curve exactly. This makes it easier to construct 1-rail sweep surfaces.

**Road-Like** When on, the sweep uses a constant up-vector so the cross sections twist uniformly as they travel along the rail. In other words, the cross sections bank like a car following a road, or a camera following a [path constraint](#) on page 3222 . Default=off.

When you edit the surface, you can control the angle of banking. The up-vector is displayed as a yellow gizmo (similar to the gizmo that lathe [surfaces](#) on page 2365 use for the center of rotation). To change the up-vector angle, use [Rotate](#) on page 889 to change the gizmo's angle.

**Display While Creating** When on, the sweep surface is displayed while you create it. When off, the sweep can be created more quickly. Default=off.

**Flip Normals** Reverses the direction of the sweep's normals.

### I-Rail Sweep Surface rollout (modification time)

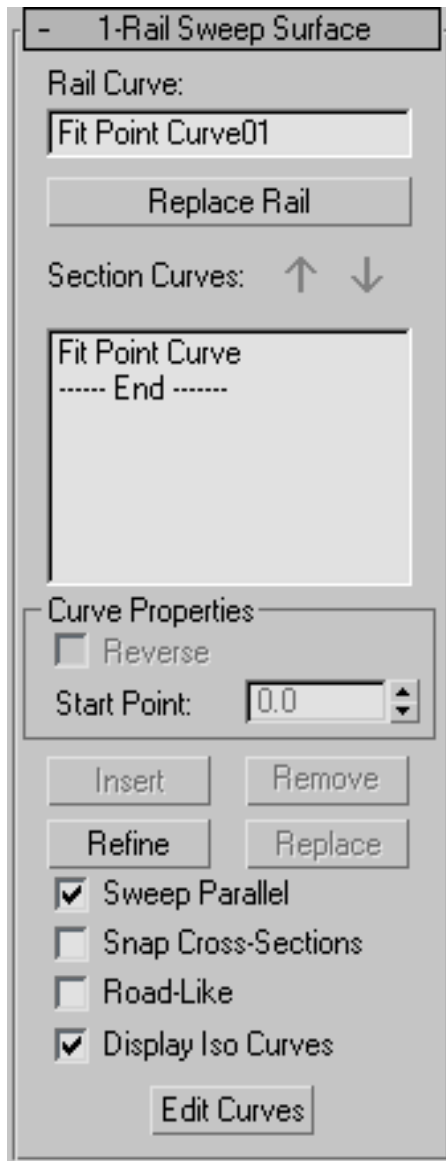

**Rail Curve** Shows the name of the curve you chose to be the rail.

**Replace Rail** Lets you replace the rail curve. Click this button, then in a viewport click the curve to use as the new rail.

**Section Curves** This list shows the names of the cross-section curves, in the order you click them. You can select a curve by clicking its name in the list. Viewports display the selected curve in blue.

**Arrow Buttons** Use these to change the order of section curves in the list. Select a curve in the list, and then use the arrows to move the selection up or down.

### **Curve Properties group**

These controls affect individual curves you select in the Section Curves list, as opposed to properties of the sweep surface in general. They are enabled only when you have selected a curve in the Section Curves list.

**Reverse** When set, reverses the direction of the selected curve.

**Start Point** Adjusts the position of the curve's start point. This can help eliminate unwanted twists or "buckles" in the surface.

This control is disabled if the curve is not a closed curve.

While you're adjusting start points, a dotted blue line is displayed between them, to show the alignment. The surface is not displayed, so it doesn't slow down adjustment. When you release the mouse button, the surface reappears.

**Insert** Adds a curve to the section list. Click to turn on Insert, then click the curve. The curve is inserted *before* the selected curve. To insert a curve at the end, first highlight the "----End----" marker in the list.

**Remove** Removes a curve from the list. Select the curve in the list, and then click Remove.

**Refine** Refines the 1-rail sweep surface. Click to turn on Refine, then click an iso curve on the surface. (As you drag the mouse over the surface, the available section curves are highlighted.) The curve you click is converted to a CV curve and inserted into the sweep and the section list. As when you refine a point curve, refining a sweep can change the curvature of the surface slightly. Once you've refined the surface by adding a cross-section curve, you can use Edit Curves to change the curve.

**Replace** Lets you replace the selected curve. Select a curve in the list, click this button, and then select the new curve.

**Sweep Parallel** When on, ensures that the sweep surface's normal is parallel to the rail.



**Snap Cross-Sections** When on, cross-section curves are translated so they intersect the rail. The first cross section is translated to the start of the rail, and the last to the end of the rail. The cross sections in the middle are translated to touch the rail at the closest point to the end of the cross-section curves.

When Snap Cross-Sections is on, the sweep follows the rail curve exactly. This makes it easier to construct 1-rail sweep surfaces.

**Road-Like** When on, the sweep uses a constant up-vector so the cross sections twist uniformly as they travel along the rail. In other words, the cross sections bank like a car following a road, or a camera following a [path constraint](#) on page 3222 . Default=off.

When you edit the surface, you can control the angle of banking. The up-vector is displayed as a yellow gizmo (similar to the gizmo that [lathe surfaces](#) on page 2365 use for the center of rotation). To change the up-vector angle, use [Rotate](#) on page 889 to change the gizmo's angle.

**Display Iso Curves** When set, the 1-rail sweep's V-axis iso curves are displayed as well as the U-axis curves used to construct the loft. The V-axis curves are only for display. You can't use them for surface construction.

**Edit Curves** Lets you edit the currently selected curve without switching to another sub-object level. Click to turn on Edit Curve. The points or CVs of the curve are displayed, as well as the control lattice if the curve is a CV curve. You can now transform or otherwise change the points or CVs as if you were at the Point or Curve CV sub-object level. To finish editing the curve, click to turn off Edit Curves.

---

**TIP** When you edit curves in a 1-rail sweep, turning off display of the sweep itself can make the curves easier to see and improve performance. Use Ctrl+D (while the [Keyboard Shortcut Override Toggle](#) on page 7646 is on) to toggle display of dependent sub-objects, including sweeps.

The sweep surface can deviate from the curve if you edit a curve in a sweep by increasing the weight of the curve CVs. You can work around this by refining the curve at the point where the surface deviates.

---

## 2-Rail Sweep Surface

Select NURBS object. > Modify panel > Create Surfaces rollout > Dependent Surfaces group box > 2-Rail

Select NURBS object. > Modify panel > NURBS toolbox > Create 2-Rail Sweep button

Sweep surfaces are constructed from curves. A 2-rail sweep surface uses at least three curves. Two curves, the "rails," define the two edges of the surface. The other curves define the surface's cross sections. A 2-rail sweep surface is similar to a 1-rail sweep. The additional rail gives you more control over the shape of the surface.

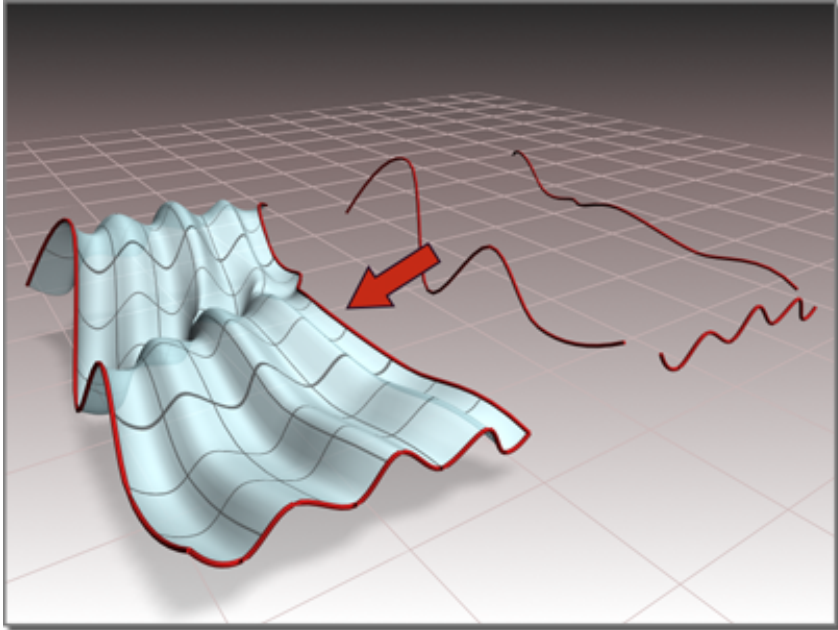

**Sweep surface created with two rails**

The cross-section curves should intersect the rail curves. If the cross sections don't intersect the rails, the resulting surface is unpredictable. In addition, the initial points of the rails and the endpoints of the first cross-section curve must be coincident. Use NURBS Snaps to accomplish this.

### **Automatic Curve Attachment**

When you create a 2-rail sweep, you can select curves that are not already sub-objects of the active NURBS model. You can select another curve or [spline object](#) on page 542 in the scene. When you select that curve, it attaches to the current object as if you had used the [Attach button](#) on page 2225 .

---

**WARNING** If the curve you attach is a sub-object of another NURBS model, the entire model (that is, the curve's parent NURBS object) is attached as well.

---

As you move the mouse over a curve that is not part of the active NURBS object, the cursor changes shape to indicate that you can pick the curve, but the curve is not highlighted in blue.

## Procedures

### To create a 2-rail sweep:

- 1 Create the curves that define the surface you want to create.

- 2  Click to turn on 2 Rail Sweep in the toolbox or on the Create Surfaces rollout.

- 3 Click the curve to use as the first rail, then click the curve to use as the second rail. Click each of the cross-section curves, and then right-click to end creation.

The sweep is interpolated smoothly between the cross sections, following the outlines defined by the two rails.

As you click curves, their names appear in the lists on the 2 Rail Sweep Surface creation rollout. The order in which you click the curves can affect the shape of the sweep surface.

### Example: To create a 2-rail sweep with automatic attach:

- 1 From the Create panel, create three independent CV or Point NURBS curves.
- 2 Go to the Modify panel, and click to turn on 2-Rail Sweep in the NURBS toolbox.
- 3 Select the curves in the appropriate order for the sweep.

The sweep is created. You don't need to collapse the curves to a NURBS surface or Attach them to an existing NURBS model.

As you move the mouse over a curve that is not part of the active NURBS object, the cursor changes shape to indicate that you can pick the curve, but the curve is not highlighted in blue.

## Interface

While a 2-rail sweep sub-object is selected, a rollout with the 2-rail sweep parameters appears. This rollout appears only when *one* 2-rail sweep sub-object is selected. It isn't possible to edit more than one 2-rail sweep at a time, so unlike some other NURBS sub-objects, the rollout doesn't appear when multiple 2-rail sweep sub-objects are selected.

---

**TIP** When you edit a 2-rail sweep sub-object, close the Surface Common rollout to see the 2-rail sweep surface rollout more easily.

---

## 2-Rail Sweep Surface rollout (creation time)

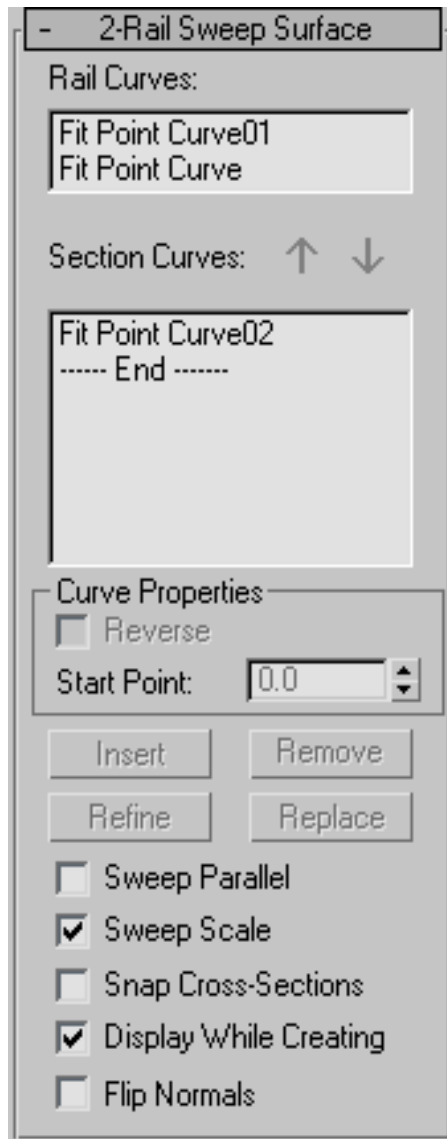

**Rail Curves** Shows the names of the two curves you chose to be the rails.

**Section Curves** This list shows the names of the cross-section curves, in the order you click them. You can select a curve by clicking its name in the list. Viewports display the selected curve in blue.

**Arrow Buttons** Use these to change the order of section curves in the list. Select a curve in the list, and then use the arrows to move the selection up or down.

### **Curve Properties group**

These controls affect individual curves you select in the Section Curves list, as opposed to properties of the sweep surface in general. They are enabled only when you have selected a curve in the Section Curves list.

**Reverse** When set, reverses the direction of the selected curve.

**Start Point** Adjusts the position of the curve's start point. This can help eliminate unwanted twists or "buckles" in the surface.

This control is disabled if the curve is not a closed curve.

While you're adjusting start points, a dotted blue line is displayed between them, to show the alignment. The surface is not displayed, so it doesn't slow down adjustment. When you release the mouse button, the surface reappears.

**Insert** (Disabled.)

**Remove** Removes a curve from the list. Select the curve in the list, and then click Remove.

**Refine** (Disabled.)

**Replace** (Disabled.)

**Sweep Parallel** When off, the rail curves define a ruled surface, and the cross sections describe lofting from this base ruled surface. When on, each cross section is associated with its best fitting plane. This plane moves along the rails and parallel to them. If the rails are curved, the plane can rotate. If the spacing between the rails changes, the section scales or stretches. In either case, the surface is blended from section to section along its entire length. Default=off.

**Sweep Scale** When off, the size of the plane is scaled only in the direction across the rails. When on, the plane is scaled uniformly in all directions. Default=off.

**Snap Cross-Sections** When on, cross-section curves are translated and scaled so they intersect both rails. The first cross section is translated to the start of the rails, and the last to the end of the rails. The cross sections in the middle

are translated to touch the rails at the closest point to the ends of the cross-section curves. Default=off.

When Snap Cross-Sections is on, the sweep follows the rail curves exactly. This makes it easier to construct 2-rail sweep surfaces.

**Display While Creating** When on, the sweep surface is displayed while you create it. When off, the sweep can be created more quickly. Default=off.

**Flip Normals** Reverses the direction of the sweep's normals.

## 2-Rail Sweep Surface rollout (Modification time)

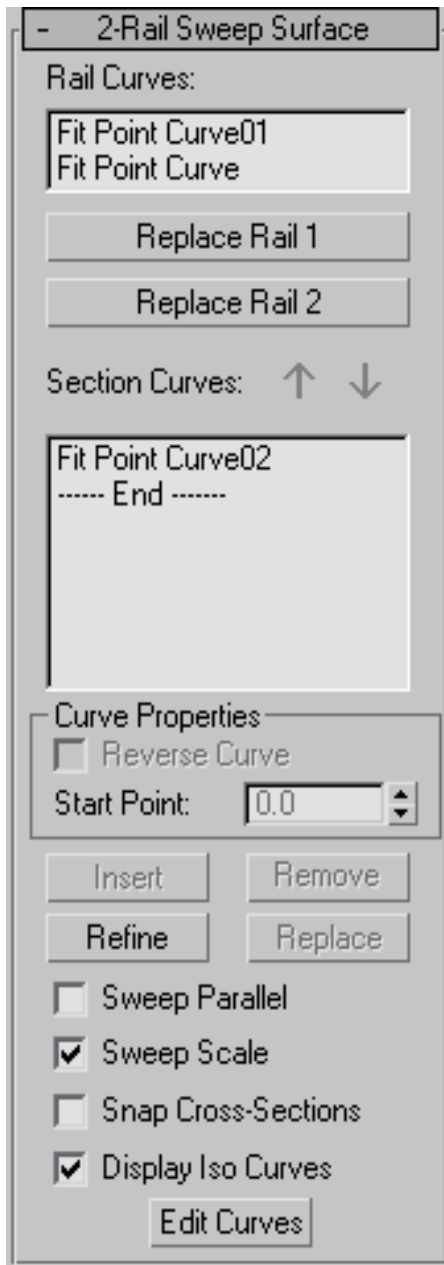



**Rail Curves** Shows the names of the two curves you chose to be the rails.

**Replace Rail 1 and Replace Rail 2** Let you replace the rail curves. Click one of these buttons, then in a viewport click the curve to use as the new rail.

**Section Curves** This list shows the names of the cross-section curves, in the order you click them. You can select a curve by clicking its name in the list. Viewports display the selected curve in blue.

**Arrow Buttons** Use these to change the order of section curves in the list. Select a curve in the list, and then use the arrows to move the selection up or down.

### **Curve Properties group**

These controls affect individual curves you select in the Section Curves list, as opposed to properties of the sweep surface in general. They are enabled only when you have selected a curve in the Section Curves list.

**Reverse** When set, reverses the direction of the selected curve.

**Start Point** Adjusts the position of the curve's start point. This can help eliminate unwanted twists or "buckles" in the surface.

This control is disabled if the curve is not a closed curve.

While you're adjusting start points, a dotted blue line is displayed between them, to show the alignment. The surface is not displayed, so it doesn't slow down adjustment. When you release the mouse button, the surface reappears.

**Insert** Adds a curve to the section list. Click to turn on Insert, then click the curve. The curve is inserted *before* the selected curve. To insert a curve at the end, first highlight the "----End-----" marker in the list.

**Remove** Removes a curve from the list. Select the curve in the list, and then click Remove.

**Refine** Refines the 2-rail sweep surface. Click to turn on Refine, then click an iso curve on the surface. (As you drag the mouse over the surface, the available section curves are highlighted.) The curve you click is converted to a CV curve and inserted into the sweep and the section list. As when you refine a point curve, refining a sweep can change the curvature of the surface slightly. Once you've refined the surface by adding a cross-section curve, you can use Edit Curves to change the curve.

**Replace** Lets you replace the selected curve. Select a curve in the list, click this button, then select the new curve.

**Sweep Parallel** When off, the rail curves define a ruled surface, and the cross sections describe lofting from this base ruled surface. When on, each cross section is associated with its best fitting plane. This plane moves along the rails and parallel to them. If the rails are curved, the plane can rotate. If the spacing between the rails changes, the section scales or stretches. In either case, the surface is blended from section to section along its entire length. Default=off.

**Sweep Scale** When off, the size of the plane is scaled only in the direction across the rails. When on, the plane is scaled uniformly in all directions. Default=off.

**Snap Cross-Sections** When on, cross-section curves are translated and scaled so they intersect both rails. The first cross section is translated to the start of the rails, and the last to the end of the rails. The cross sections in the middle are translated to touch the rails at the closest point to the ends of the cross-section curves. Default=off.

When Snap Cross-Sections is on, the sweep follows the rail curves exactly. This makes it easier to construct 2-rail sweep surfaces.

**Display Iso Curves** When set, the 2-Rail Sweep's V-axis iso curves are displayed as well as the U-axis curves used to construct the sweep. The V-axis curves are only for display. You can't use them for surface construction.

**Edit Curves** Lets you edit the currently selected curve without switching to another sub-object level. Click to turn on Edit Curve. The points or CVs of the curve are displayed, as well as the control lattice if the curve is a CV curve. You can now transform or otherwise change the points or CVs as if you were at the Point or Curve CV sub-object level. To finish editing the curve, click to turn off Edit Curves.

---

**TIP** When you edit curves in a 2-rail sweep, turning off display of the sweep itself can make the curves easier to see and improve performance as well. Use Ctrl+D (while the [Keyboard Shortcut Override Toggle](#) on page 7646 is on) to toggle display of dependent sub-objects, including sweeps.

The sweep surface can deviate from the curve if you edit a curve in a sweep by increasing the weight of the curve CVs. You can work around this by refining the curve at the point where the surface deviates.

---

## Multisided Blend Surface

Select NURBS object. > Modify panel > Create Surfaces rollout > Dependent Surfaces group box > N Blend

Select NURBS object. > Modify panel > NURBS toolbox > Create a Multisided Blend Surface button

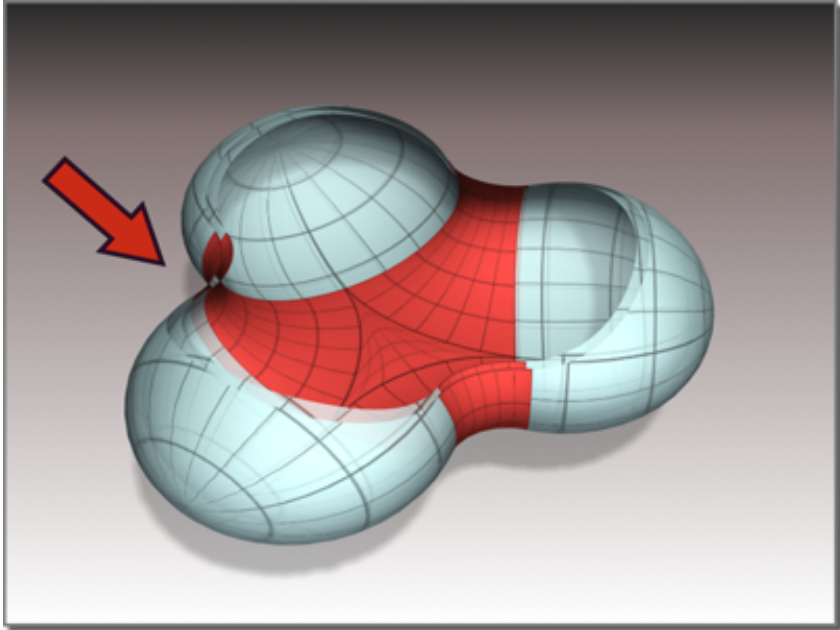

### Multisided blend between three other surfaces

A multisided blend surface "fills in" the edges defined by three or four other curve or surface sub-objects. Unlike a regular, two-sided blend surface, the curves' or surfaces' edges must form a closed loop; that is, they must completely surround the opening that the multisided blend will cover.

---

**TIP** If the multisided blend surface can't be created, fuse the points or CVs at the corners where the surfaces meet. Sometimes snapping the corners doesn't work, because of round-off error.

---

## Procedures

To create a multisided blend:

- 1  Click to turn on Multisided Blend in the toolbox or N Blend on the Create Surfaces rollout.
- 2 In turn, click the three or four surface sides or curves that surround the opening.

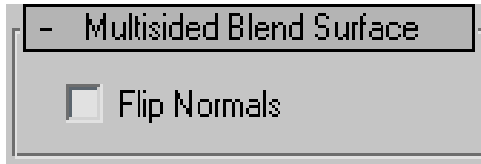

You can flip normals on the multisided blend while creating it.

- 3 Right-click to end creation.  
A new surface is created. It covers the opening.

## Interface

Multisided Blend surfaces have no parameters other than those on the [Surface Common rollout](#) on page 2264 .

## Multicurve Trimmed Surface

Select NURBS object. > Modify panel > Create Surfaces rollout > Dependent Surfaces group box > Multi-Trim

Select NURBS object. > Modify panel > NURBS toolbox > Create a Multicurve Trimmed Surface button

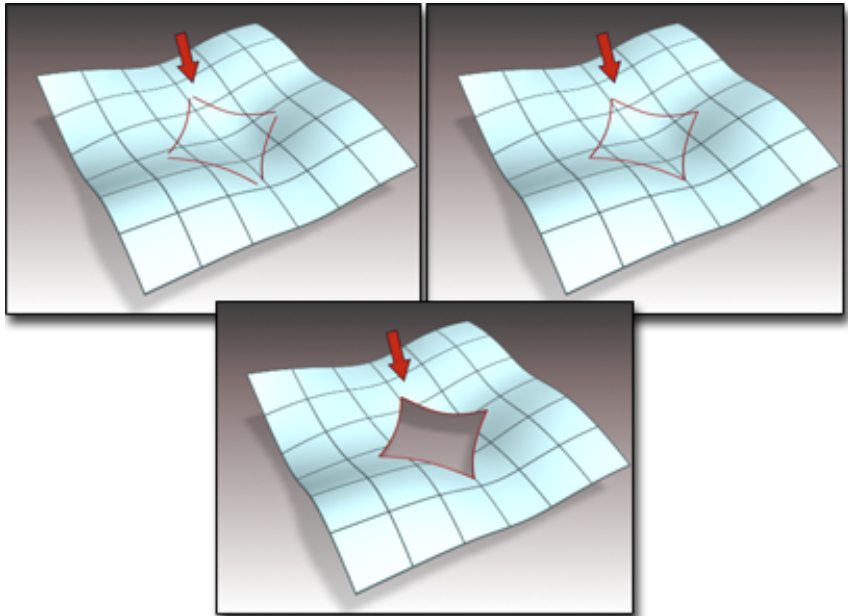

### Creating a multicurve trimmed surface

A multicurve trimmed surface is an existing surface trimmed by multiple curves that form a loop.

When you create a multicurve trimmed surface, you create only *one* trimmed hole. If you want to create multiple holes, first create holes in the surface using other techniques, and as the final step create the multicurve trim.

You can't trim across the edge between two surfaces, or across a "seam" where a surface touches itself, as at the back of a spherical surface created by converting a Sphere primitive.

### Procedures

To create a multicurve trim:

- 1 Create a loop out of multiple curve sub-objects.
- 2 At the Curve CV or Point sub-object level, use Fuse to connect the ends of the curves.  
The curves must form a single closed loop, or completely traverse the surface.

- 3 Project the curves onto the surface by creating a normal or vector projected curve for each curve in the loop.

---

**TIP** You can also use CV or point curve on surface for these curves.

---

- 4  Turn on Multicurve Trimmed Surface in the toolbox or Multi-Trim on the Create Surfaces rollout.
- 5 Click the surface to trim, then click each of the curves in the loop. Right-click to end creation.

The Trim list shows the names of the curves you select. Flip Trim inverts the direction of trimming. Flip Normals lets you flip the surface normals at creation time. (After you have created the surface, you can flip normals using controls on the Surface Common rollout.)

## Interface

While a multicurve trimmed sub-object is selected, a rollout with the multicurve trim parameters appears. This rollout appears only when *one* multicurve trimmed sub-object is selected. It isn't possible to edit more than one multicurve trimmed object at a time, so unlike some other NURBS sub-objects, the rollout doesn't appear when multiple multicurve trimmed sub-objects are selected.

---

**TIP** When you edit a multicurve trimmed sub-object, close the Surface Common rollout to see the Multicurve Trim Surface rollout more easily.

---

## Multicurve Trimmed Surface rollout (creation time)



**Trim Curves** This list shows the names of the curves used to trim the surface. You can select a curve by clicking its name. Viewports display the selected curve in blue.

**Insert** (Disabled.)

**Remove** Removes a curve from the list. Select the curve in the list, and then click Remove.

**Replace** (Disabled.)

**Flip Trim** Reverses the direction of the trim.

**Flip Normals** Turn on to reverse the direction of the trimmed surface's normals.

## Multicurve Trimmed Surface rollout (modification time)

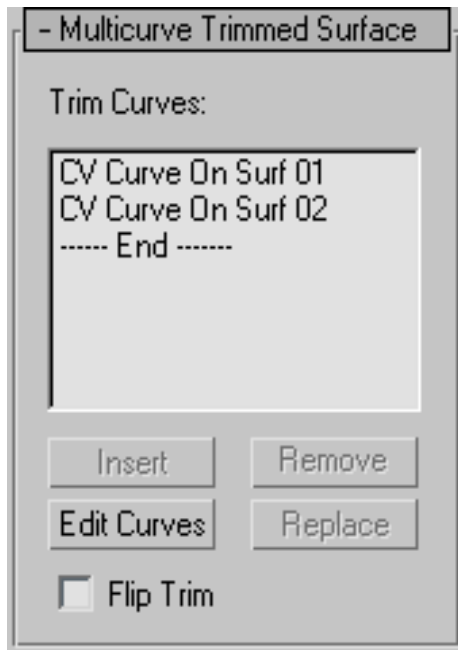

**Trim Curves** This list shows the names of the curves used to trim the surface. You can select a curve by clicking its name. Viewports display the selected curve in blue.

**Insert** Adds a curve to the Trim Curves list. Click to turn on Insert, then click the curve. The curve is inserted *before* the selected curve. To insert a curve at the end, first highlight the "----End----" marker in the list.

**Remove** Removes a curve from the list. Select the curve in the list, and then click Remove.

**Edit Curves** Lets you edit the currently selected curve without switching to another sub-object level. Click to turn on Edit Curve. The points or CVs of the curve are displayed, as well as the control lattice if the curve is a CV curve. You can now transform or otherwise change the points or CVs as if you were at the Point or Curve CV sub-object level. To finish editing the curve, click to turn off Edit Curves.

Don't edit the curve so you break the loop. If you do, the surface goes into an error condition.



**Replace** Lets you replace the selected curve. Select a curve in the list, click this button, and then select the new curve.

**Flip Trim** Reverses the direction of the trim.

Along with Edit Curves, the Insert, Remove, and Replace buttons let you alter the curves that trim the surface. While you are making changes, the surface will go into an error condition (orange display by default) until the curves you are working on once again form a closed loop.

## Fillet Surface

Select NURBS object. > Modify panel > Create Surfaces rollout > Dependent Surfaces group box > Fillet Surf

Select NURBS object. > Modify panel > NURBS toolbox > Create Fillet Surface button

A fillet surface is a rounded corner connecting the edges of two other surfaces.

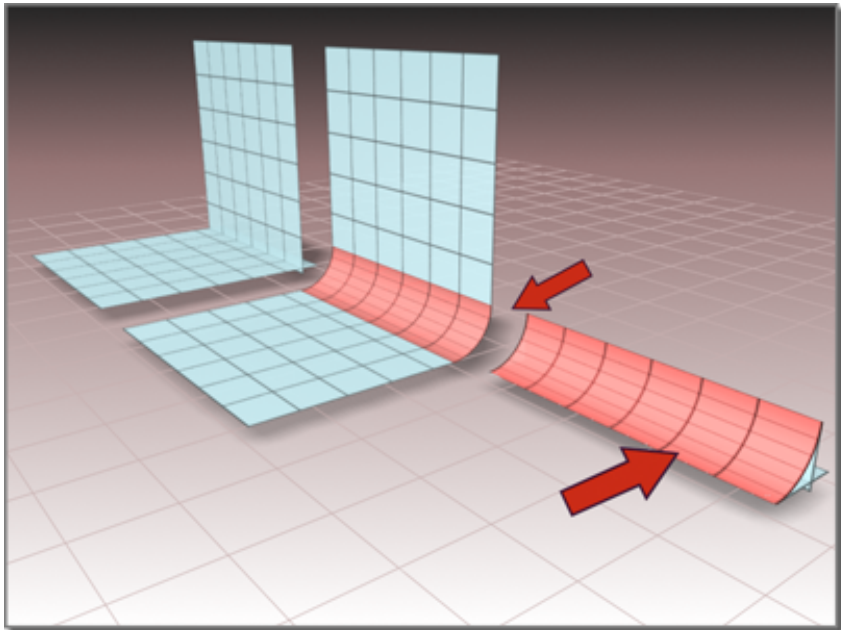

Fillet surface created from two parent surfaces

Usually you use both edges of the fillet surface to trim the parent surfaces, creating a transition between the fillet and its parents.

## Procedures

### To create a fillet surface:

- 1  In a NURBS object, turn on Fillet on the Create Surfaces rollout or Create Fillet Surface in the toolbox.
- 2 Click to choose the first parent surface, then click to choose the second parent surface. Potential parent surfaces are highlighted in blue as you move the mouse in a viewport.  
The fillet surface is created. If the fillet surface can't be created, a default error surface is displayed (by default, the error surface displays as orange).

## Interface

### Fillet Surface rollout (creation time)

The image shows a software interface for the 'Fillet Surface' rollout. It features several input fields and checkboxes. At the top, there is a title bar with a minus sign and the text 'Fillet Surface'. Below this, there are two input fields for 'Start Radius' and 'End Radius', both set to '1.0'. To the right of these fields is a 'Lock' button. Underneath is a 'Radius Interpolation' section with two radio buttons: 'Linear' (unselected) and 'Cubic' (selected). The 'Seeds' section contains four input fields: 'Surface 1 X' (38.007), 'Surface 1 Y' (43.911), 'Surface 2 X' (49.262), and 'Surface 2 Y' (51.476). Below the seeds are two sections for trimming surfaces. The 'Trim First Surface' section has two checkboxes: 'Trim Surface' and 'Flip Trim', both unselected. The 'Trim Second Surface' section has two checkboxes: 'Trim Surface' and 'Flip Trim', both unselected. At the bottom of the rollout is a checkbox for 'Flip Normals', which is also unselected.

**Start Radius and End Radius** Set the radius used to define the fillet at the first surface you chose and the second surface you chose, respectively. The radiuses control the size of the fillet surface. Default=1.0.

**Lock** Locks the Start and End radius values so they are identical. When on, the End Radius setting is unavailable. Default=on.

## Radius Interpolation group

This group box controls the radius of the fillet. The Radius Interpolation setting has no effect unless one or both surfaces that define the fillet have curvature to them.

**Linear** When chosen (the default), the radius is linear.

**Cubic** When chosen, the radius is treated as a cubic function, allowing it to change based on the parent surface's geometry.

## Seeds group

These spinners adjust the seed values for the fillet surface. If there is more than one way to construct the fillet, the software uses the seed values to choose the nearest edge for that surface.

**Surface 1 X** Sets the local X coordinate of the seed on the first surface you chose.

**Surface 1 Y** Sets the local Y coordinate of the seed on the first surface you chose.

**Surface 2 X** Sets the local X coordinate of the seed on the second surface you chose.

**Surface 2 Y** Sets the local Y coordinate of the seed on the second surface you chose.

## Trim First Surface and Trim Second Surface groups

For each of the parent surfaces, these controls affect trimming.

**Trim Surface** Trims the parent surface at the edge of the fillet.

**Flip Trim** Reverses the direction of the trim.

**Flip Normals** Turn on to reverse the direction of the fillet surface's normals.

### Fillet Surface rollout (modification time)

The image shows a software rollout window titled "Fillet Surface". It contains several sections:

- Start Radius:** A numeric input field with the value "1.0" and a "Lock" button to its right.
- End Radius:** A numeric input field with the value "1.0".
- Radius Interpolation:** A section with two radio buttons: "Linear" (unselected) and "Cubic" (selected).
- Seeds:** A section with four numeric input fields: "Surface 1 X" (38.007), "Surface 1 Y" (43.911), "Surface 2 X" (49.262), and "Surface 2 Y" (51.476).
- Trim First Surface:** A section with two checkboxes: "Trim Surface" and "Flip Trim", both of which are unchecked.
- Trim Second Surface:** A section with two checkboxes: "Trim Surface" and "Flip Trim", both of which are unchecked.
- Replace First Surface:** A button located below the Trim First Surface section.
- Replace Second Surface:** A button located below the Trim Second Surface section.

**Start Radius and End Radius** Set the radius used to define the fillet at the first surface you chose and the second surface you chose, respectively. The radiuses control the size of the fillet surface. Default=10.0.

**Lock** Locks the Start and End radius values so they are identical. When on, the End Radius setting is unavailable. Default=on.

## Radius Interpolation group

This group box controls the radius of the fillet. The Radius Interpolation setting has no effect unless one or both surfaces that define the fillet have curvature to them.

**Linear** When chosen (the default), the radius is always linear.

**Cubic** When chosen, the radius is treated as a cubic function, allowing it to change based on the parent surface's geometry.

## Seeds group

These spinners adjust the seed values for the fillet surface. If there is more than one way to construct the fillet, the software uses the seed values to choose the nearest edge for that surface.

**Surface 1 X** Sets the local X coordinate of the seed on the first surface you chose.

**Surface 1 Y** Sets the local Y coordinate of the seed on the first surface you chose.

**Surface 2 X** Sets the local X coordinate of the seed on the second surface you chose.

**Surface 2 Y** Sets the local Y coordinate of the seed on the second surface you chose.

## Trim First Surface and Trim Second Surface groups

For each of the parent surfaces, these controls affect trimming.

**Trim Surface** Trims the parent surface at the edge of the fillet.

**Flip Trim** Reverses the direction of the trim.

**Replace First Surface and Replace Second Surface** Let you replace the parent surfaces. Click a button, then click the surface to replace the original first or second surface.

## Creating and Editing Point Sub-Objects

Select NURBS object. > Modify panel > Create Points rollout

Select NURBS object. > Modify panel > NURBS toolbox

Keyboard > Ctrl+T to toggle NURBS toolbox display (Keyboard Shortcut Override Toggle must be on.)

In addition to the points that are an integral part of [point curve](#) on page 2201 and [point surface](#) on page 2192 objects, you can create "freestanding" points. Such points can help you construct point curves by using the [Curve Fit](#) on page 2293 button. You also use dependent points to trim curves.

You create individual points as NURBS sub-objects while you are modifying NURBS. To create points individually, use the Create Points rollout or the NURBS [toolbox](#) on page 2162 .

### Toolbox Buttons for Creating Points

These are the toolbox buttons for creating point sub-objects:



Create an independent [point](#) on page 2429 .



Create a dependent [offset point](#) on page 2430 .



Create a dependent [curve point](#) on page 2432 .



Create a dependent [curve-curve intersection point](#) on page 2438 .



Create a dependent [surface point](#) on page 2435 .



Create a dependent [surface-curve intersection point](#) on page 2441 .

### Point (NURBS)

Select NURBS object. > Modify panel > Create Points rollout > Point button

Select NURBS object. > Modify panel > NURBS toolbox > Create Point button

This command creates an independent, freestanding point.

## Procedures

**To create a freestanding point:**

- 1 Select a NURBS object.
- 2 In the Modify > Create Points rollout, turn on Point.
- 3 Click a viewport to position the point.

Independent point sub-objects have no additional parameters. You can use Curve Fit in the Create Curves rollout to create a curve from multiple freestanding points.

## Interface

There are no additional controls for independent points.

## Offset Point

Select NURBS object. > Modify panel > Create Points rollout > Dependent Points group box > Offset Point button

Select NURBS object. > Modify panel > NURBS toolbox > Create Offset Point button

This command creates a dependent point that is coincident to an existing point or at a relative distance from an existing point.

## Procedures

**To create a dependent offset point:**

- 1 Select a NURBS object
- 2 On the Modify > Create Points rollout, turn on Offset Point.
- 3 In a viewport, click an existing point.
- 4 In the Modify > Offset Points rollout, use the Offset spinners to adjust the point's position relative to the original point.



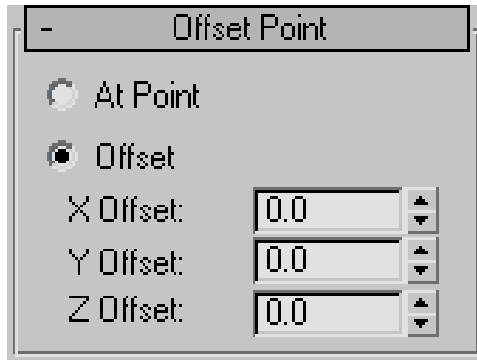

### Interface

While an offset point sub-object is selected, the Offset Point rollout appears.

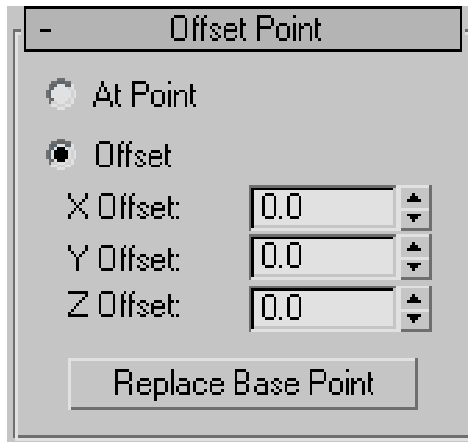

**At Point** When chosen, the dependent point has the same location as the original, parent point.

**Offset** Enables point offset. Use the X,Y,Z Offset spinners to set offset values (in object space coordinates).

**Replace Base Point** (Only at modification time.) Lets you replace the parent point. Click the button, then click the new point on which to base the offset point.

## Curve Point

Select NURBS object. > Modify panel > Create Points rollout > Dependent Points group box > Curve Point button

Select NURBS object. > Modify panel > NURBS toolbox > Create Curve Point button

This command creates a dependent point that lies on a curve or relative to it.

The point can be either on the curve or off the curve. If it is on the curve, the U Position is the only control of its location. The U Position specifies a location along the curve (based on the curve's local U axis). There are three ways to displace the point's location relative to the U position.

### Procedures

**To create a dependent curve point:**

- 1 Turn on Curve Point and then click along a curve to position the point.
- 2 The curve and cursor position are highlighted during this operation.
- 3 At the Point sub-object level, adjust the point's position relative to the curve by adjusting the curve point parameters on the Curve Point rollout.

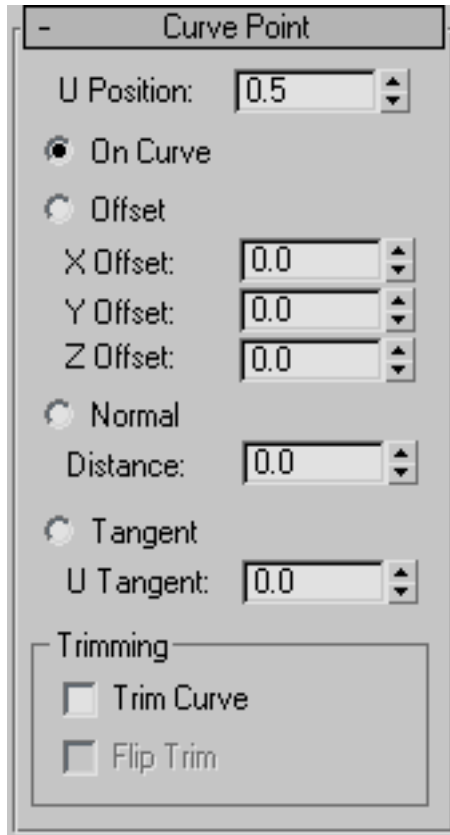

4 Right-click to end operation.

### Interface

While a curve point sub-object is selected, the Curve Point rollout appears.

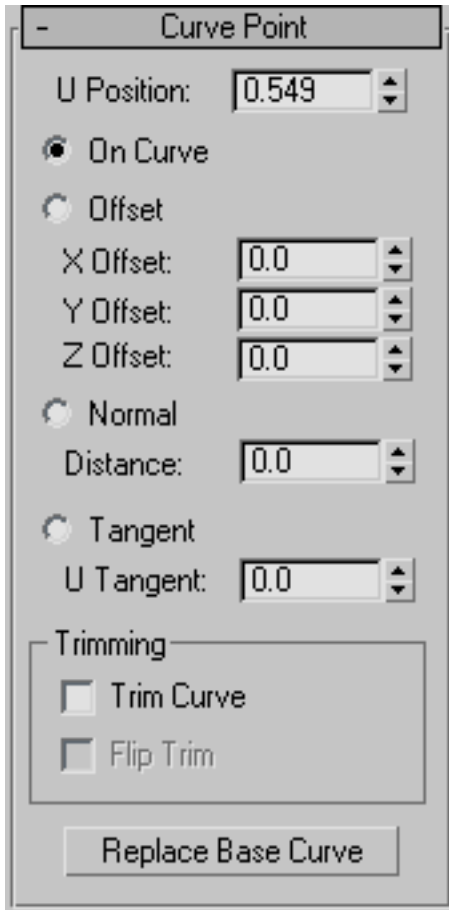

**U Position** Specifies the point's location on the curve or relative to the curve.

**On Curve** When on, the point lies on the curve at the U Position.

**Offset** Moves the point according to a relative (object space) X,Y,Z location.

This is relative to the U Position.

**X Offset, Y Offset, and Z Offset** Specify the object space location of the offset curve point.

**Normal** Moves the point along the direction of the curve's normal at the U Position.

**Distance** Specifies the distance along the curve's normal. Negative values move the point opposite to the normal.

**Tangent** Moves the point along the tangent at the U Position.

**U Tangent** Specifies the distance from the curve along the tangent.

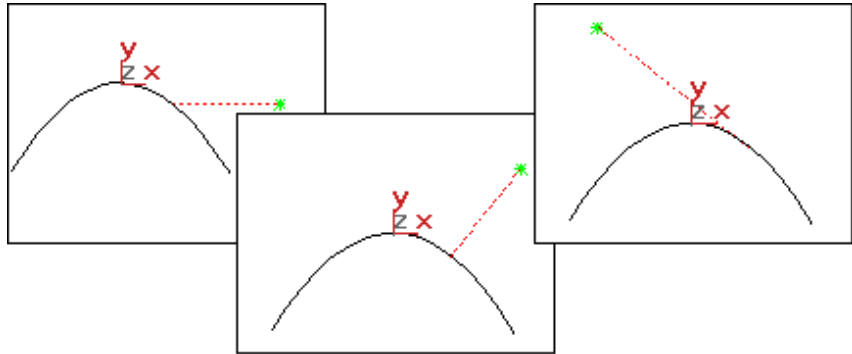

Offset, normal, and tangent displacement of a curve point

### Trimming group box

Controls in this group box let you trim the parent curve.

**Trim Curve** When on, trims the parent curve against the curve point's U position. When off (the default), the parent isn't trimmed.

**Flip Trim** When on, trims in the opposite direction.

**Replace Base Curve** (Only at modification time.) Lets you replace the parent curve. Click the button, then click the new curve on which to base the curve point.

### Surface Point

Select NURBS object. > Modify panel > Create Points rollout > Dependent Points group box > Surface Point button

Select NURBS object. > Modify panel > NURBS toolbox > Create Surf Point button

This command creates a dependent point that lies on a surface or relative to it. This is enabled with a NURBS object that contains a surface.

## Procedures

To create a dependent surface point:

- 1 Turn on Surf Point and then click over a NURBS surface to position the point.
- 2 The surface cross-section and cursor are highlighted during this operation.
- 3 Right-click to end the create operation.
- 4 At the Point sub-object level, adjust the point's position relative to the surface by adjusting the surface point parameters in the Surface Point rollout.

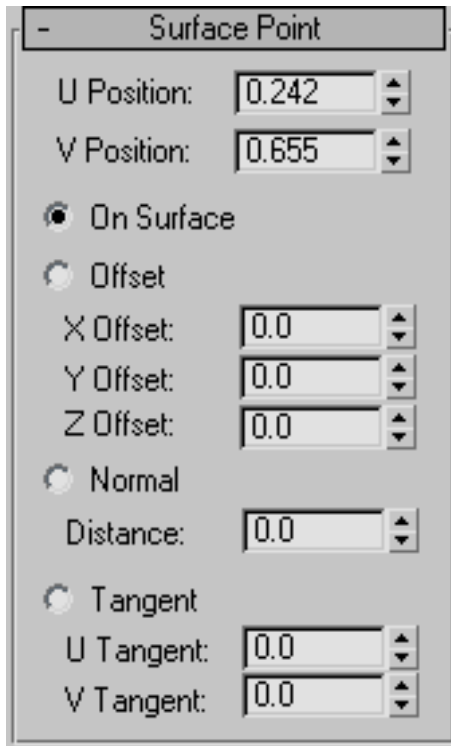

## Interface

While a surface point sub-object is selected, the Surface Point rollout appears. These controls are similar to the curve point controls.

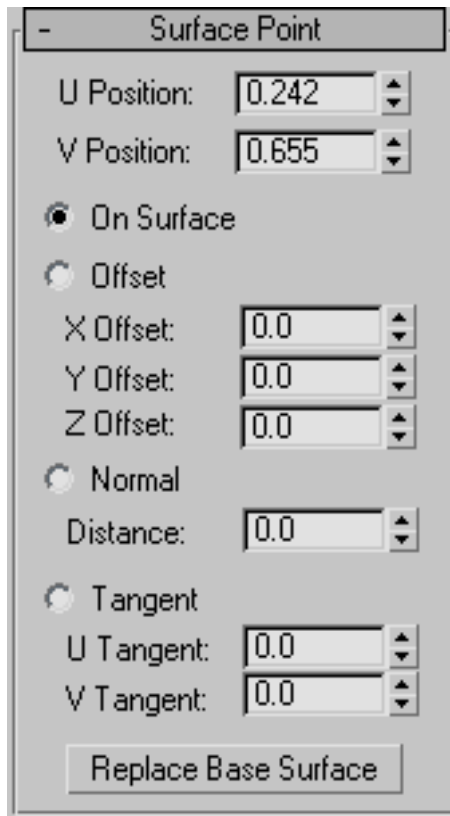

**U Position and V Position** If the point is on the surface, these coordinates specify the point's location, based on the surface's local UV coordinates.

**On Surface** Specifies that the point lies on the surface, at the location specified by U Position and V Position.

If the point lies on the surface, you can move it using the Move transform. You can also move it using the Move Surface Point button. See [Editing Point Sub-Objects](#) on page 2231 . Either way, this updates the U Position and V Position values.

**Offset** Moves the point according to a relative (object space) X,Y,Z location.

**X Offset, Y Offset, and Z Offset** Specify the object space location of the offset surface point.

**Normal** Moves the point along the direction of the surface's normal.

**Distance** Specifies the distance from the surface, along the normal. Negative values move the point opposite to the normal.

**Tangent** Moves the point along the tangent of the UV position.

**U Tangent and V Tangent** Specify the distance from the surface along the tangents at U and V.

**Replace Base Surface** (Only at modification time.) Lets you replace the parent surface. Click the button, then click the new surface on which to base the surface point.

## Curve-Curve Intersection Point

Select NURBS object. > Modify panel > Create Points rollout Dependent Points group box > Curve-Curve button

Select NURBS object. > Modify panel > NURBS toolbox > Create Curve-Curve Point button

This command creates a dependent point at the intersection of two curves.

### Procedures

**To create a dependent curve-curve point:**

- 1 Turn on Curve-Curve, then drag from the first curve to the second.  
If the curves do not intersect, the point is orange, an invalid dependent point.  
The point is created at the nearest intersection between the two curves.  
You can use the curve-curve parameters to trim the parent curves.
- 2 Right-click to end the create operation.



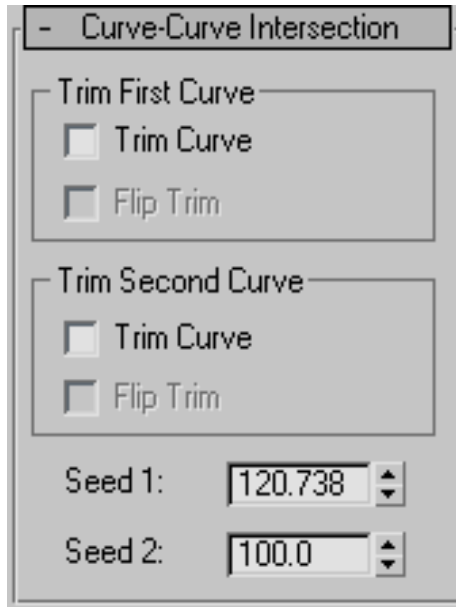

### **Interface**

While a curve-curve point sub-object is selected, the Curve-Curve Intersection rollout appears.

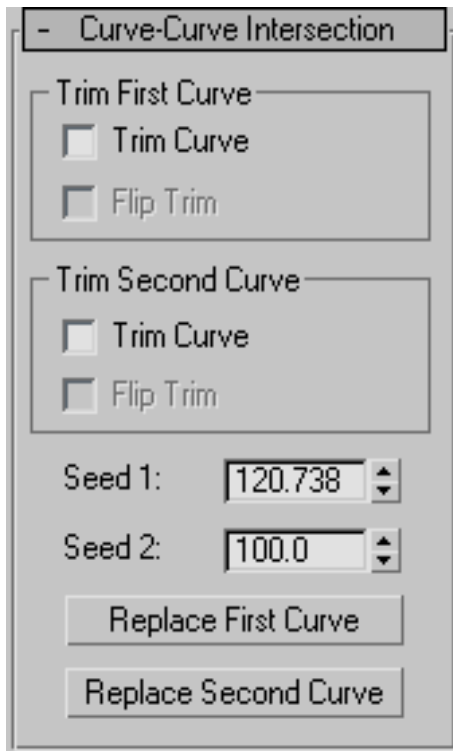

### **Trim First Curve and Trim Second Curve groups**

These two groups let you control how the parent curves are trimmed. The controls are the same in each. "First" and "second" refer to the order in which you picked the parent curves.

**Trim Curve** When on, the parent curve is trimmed against the curve-curve point. When off (the default), the parent isn't trimmed.

**Flip Trim** When on, trims in the opposite direction.

**Seed 1 and Seed 2** Change the U location of the seed value on the first and second curves. If there is a choice of intersections, the intersection closest to the seed points is the one used to create the point.

**Replace First Curve and Replace Second Curve** (Only at modification time.) Let you replace the parent curves. Click a button, then click the curve to replace the original first or second curve.

## Surface-Curve Intersection Point

Select NURBS object. > Modify panel > Create Points rollout > Dependent Points group box > Surf-Curve button

Select NURBS object. > Modify panel > NURBS toolbox > Create Surface-Curve Point button

This command creates a dependent point at the intersection of a surface and a curve.

### Procedures

**To create a dependent surface-curve point:**

- 1 In a NURBS object that has a curve that passes through a surface, click to turn on Create Surface Curve Point in the NURBS toolbox or Surf-Curve on the Create Points rollout.
- 2 Click the curve, then click the surface.

The point is created at the nearest intersection between the curve and the surface that is nearest the seed point. You can use the surface-curve parameters to trim the parent curve.

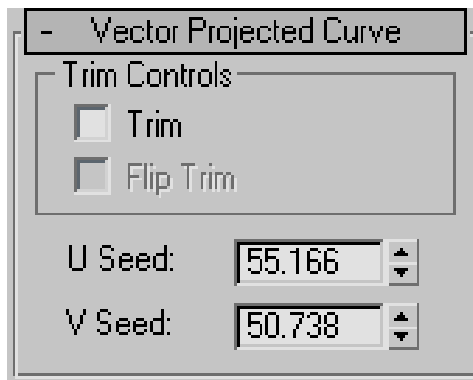

### Interface

While a surface-curve intersection point sub-object is selected, a rollout with its parameters appears.

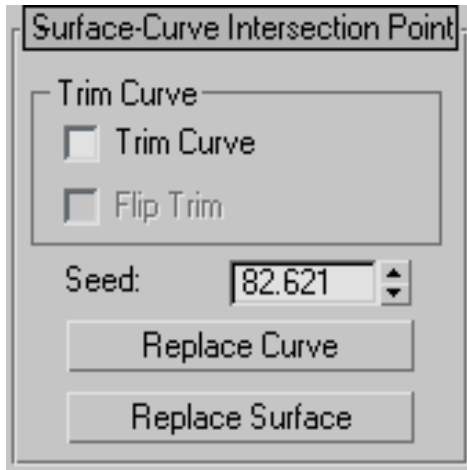

### **Trim Curve group**

**Trim** When on, trims the curve from the surface. When off, the curve isn't trimmed.

**Flip Trim** When on, trims the curve in the opposite direction.

**Seed** Changes the U location of the seed value on the curve. If there is a choice of intersections, the intersection closest to the seed point is the one used to create the point.

**Replace Curve and Replace Surface** (Only at modification time.) Let you replace the parent sub-objects. Click a button, then click a curve or surface to replace the original parent object.

## **NURBS Editing Dialogs**

### **Convert Curve Dialog**

Modify panel > Select NURBS curve sub-object. > Curve Common rollout > Convert Curve button

This dialog is a general way to convert one kind of a curve to another or to adjust a curve's parameters.

## Interface

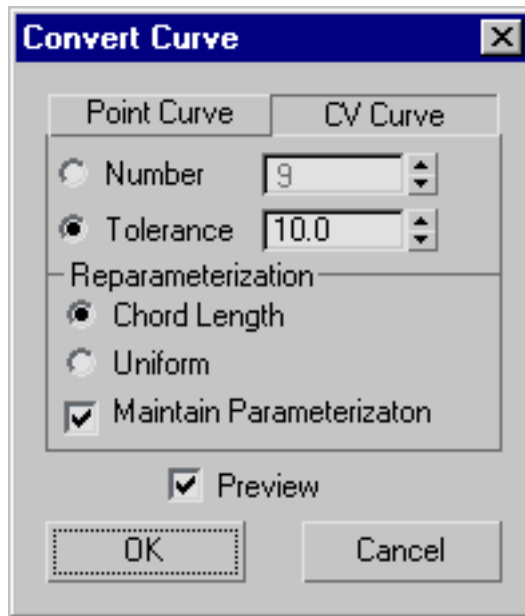

**Point Curve and CV Curve** Choose whether to convert to a point curve or a CV curve. If the curve is already of the type you chose, the settings in this dialog don't convert it, but do change its properties. Default=CV Curve.

### CV Curve options

These are the options when you choose CV Curve.

**Number** When chosen, the spinner sets the number of CVs in the CV curve.

**Tolerance** When chosen, the software calculates the number of CVs. This option rebuilds the curve according to accuracy. The lower the Tolerance value, the more accurate the rebuild. Increasing Tolerance enables the curve to be rebuilt using fewer CVs.

### Reparameterization group

These controls let you reparameterize the CV curve and turn on automatic reparameterization.

**Chord Length** Chooses the chord-length algorithm for reparameterization.

Chord-length reparameterization spaces knots (in [parameter space](#) on page 7882 ) based on the square root of the length of each curve segment.

Chord-length reparameterization is usually the best choice.

**Uniform** Spaces the knots uniformly.

A uniform knot vector has the advantage that the curve changes only locally when you edit it. With chord-length parameterization, moving any CV can potentially change the entire sub-object.

**Maintain Parameterization** When on, the curve is automatically reparameterized as you edit it, using the currently active method of reparameterization. When off, no reparameterization happens unless you use a dialog to specifically request it. Default=on.

### **Point Curve options:**

These are the options when you choose Point Curve.

**Number** Sets the number of points in the point curve.

**Tolerance** When chosen, the software calculates the number of points. This option rebuilds the curve according to accuracy. The lower the Tolerance value, the more accurate the rebuild. Increasing Tolerance enables the curve to be rebuilt using fewer points.

**Preview** When on, the effect of the conversion is previewed in viewports. Default=on.

## **Convert Curve on Surface Dialog**

Modify panel > Select NURBS object. > Stack display > Curve sub-object level > Select curve sub-object. > Curve Common rollout > Make COS button

This dialog converts a curve to a [point curve on surface](#) on page 2331 or [CV curve on surface](#) on page 2327 . The Make COS button that displays it is enabled only for the following types of curves:

- [U iso curves](#) on page 2318
- [V iso curves](#) on page 2318
- [Normal projected curves](#) on page 2320
- [Vector projected curves](#) on page 2323

- [Surface-surface intersection curves](#) on page 2312
- [Surface edge curves](#) on page 2335
- [CV curves on surfaces](#) on page 2327
- [Point curves on surfaces](#) on page 2331

If the curve is already a curve on surface, this dialog lets you change its type.

### Interface

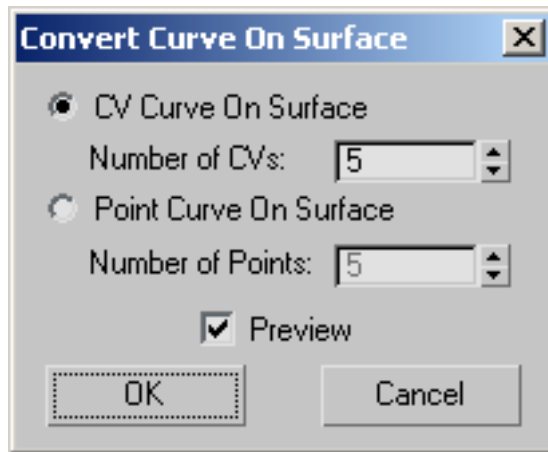

**CV Curve on Surface** Converts the curve to a CV curve on surface.

**Number of CVs** Specifies the number of CVs in the new curve.

**Point Curve on Surface** Converts the curve to a point curve on surface.

**Number of Points** Specifies the number of points in the new curve.

**Preview** When on, previews the effect of the conversion in viewports.  
Default=on.

## Convert Surface Dialog

Modify panel > Select NURBS surface sub-object. > Surface Common rollout  
> Convert Surface button

This dialog provides a general way to convert one kind of a surface to another or to adjust a surface's parameters.

## Interface

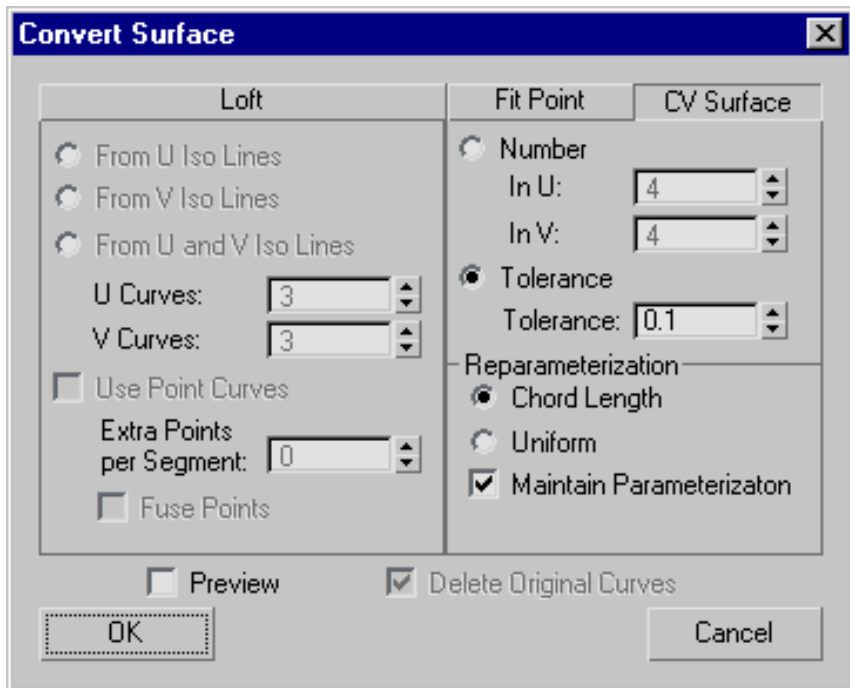

### Loft tab

If the surface isn't already a loft, this tab converts it to the kind of loft you indicate.

The controls are comparable to those in the [Make Loft dialog](#) on page 2459.

**From U Iso Lines** Uses curves along the surface's U dimension to construct a U loft.

**From V Iso Lines** Uses curves along the surface's V dimension to construct a U loft. If the surface was already a U loft, set this to change the lofting dimension.

**From U and V Iso Lines** Uses curves from both the U and V dimensions to construct a UV loft.

**U Curves** Sets the number of curves in U.

**V Curves** Sets the number of curves in V.



**Use Point Curves** When on, constructs the loft from point curves instead of the default CV curves. Default=off.

**Extra Points per Segment** This control is available only for UV lofts (From U and V Iso Lines). Lets you increase the number of points in each segment.

**Fuse Points** This control is available only for UV lofts (From U and V Iso Lines). When on, fuses points at curve intersections to ensure that the U and V curves continue to intersect when you edit the surface, and that the surface remains coincident with its parent curves. UV lofts constructed from intersecting curves behave more predictably. Default=on.

### **Fit Point tab**

If the surface isn't already a point surface, this tab converts it to a point surface.

**In U** Sets the number of point rows (in the surface's U axis).

**In V** Sets the number of point columns (in the surface's V axis).

**Tolerance** When chosen, the software calculates the number of points. This option rebuilds the surface according to accuracy. The lower the Tolerance value, the more accurate the rebuild. Increasing Tolerance enables the surface to be rebuilt using fewer points.

### **CV Surface tab**

If the surface isn't already a CV surface, this tab converts it to a CV surface.

This tab is the default.

**Number** When chosen, the spinners set the number of CVs in the CV surface.

**In U** Sets the number of CV rows (in the surface's U axis).

**In V** Sets the number of CV columns (in the surface's V axis).

**Tolerance** When chosen, the software calculates the number of CVs. This option rebuilds the surface according to accuracy. The lower the Tolerance value, the more accurate the rebuild. Increasing Tolerance enables the surface to be rebuilt using fewer CVs.

### **Reparameterization group**

These controls let you reparameterize the CV surface and turn on automatic reparameterization.

**Chord Length** Chooses the chord-length algorithm for reparameterization.

Chord-length reparameterization spaces knots (in [parameter space](#) on page 7882 ) based on the square root of the length of each segment.

Chord-length reparameterization is usually the best choice.

**Uniform** Spaces the knots uniformly.

A uniform knot vector has the advantage that the surface changes only locally when you edit it. With chord-length parameterization, moving any CV can potentially change the entire surface.

**Maintain Parameterization** When on, the surface is automatically reparameterized as you edit it, using the currently active method of reparameterization. When off, no reparameterization happens unless you use a dialog to specifically request it. Default=on.

**Preview** When on, viewports display a preview of the conversion. Turning off this toggle can speed up conversion, especially to lofts.

**Delete Original Curves** This is available only if the surface was already a U loft or UV loft. When on, Convert Surface deletes the original loft curves when you click OK. When off, the original curves remain where they are. Default=off.

## CV Curve: Close Curve Dialog

Create panel > Shapes button > CV Curve button > In viewports, draw a CV curve and click to create a CV in the same location as the first CV in the curve.

Modify panel > Select NURBS object. > NURBS toolbox > Create CV Curve > In viewports, draw a CV curve sub-object and click to create a CV in the same location as the first CV in the curve.

This dialog lets you create a closed CV curve when you click to create a CV in the same location as the curve's first CV.

### Interface

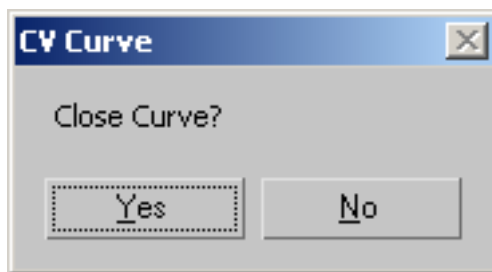

**Yes** Closes the curve and ends curve creation.

**No** Keeps the curve open and does *not* end curve creation.

## Detach Dialog (NURBS)

Modify panel > Select a NURBS sub-object. > Curve Common or Surface Common rollout > (optional) Copy toggle > Detach button

This dialog appears when you use Detach to create a new top-level NURBS curve or surface sub-object.

### Interface

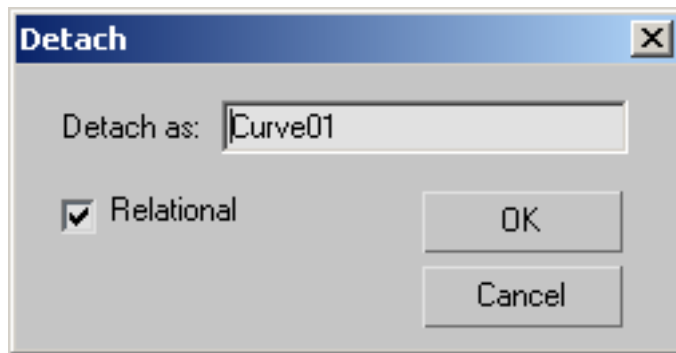

**Detach as** Lets you assign a name to the new object. By default, the name is "Curve" or "Surface" followed by a sequence number.

This option is unavailable when Detach To Element is on.

**Relational** This toggle affects dependent objects. When off, detaching a dependent sub-object makes it an independent object. For example, detaching a U loft converts it to a CV surface. When on, detaching a dependent sub-object also detaches the objects on which it depends, so the object remains dependent. For example, detaching a U loft also detaches the curves that define it. Default=on.

## Edit Curve on Surface Dialog

Select NURBS object. > Modify panel > Stack display > Curve sub-object level > Select NURBS curve on surface sub-object. > CV Curve on Surface or Point Curve on Surface rollout > Edit button

This dialog lets you edit curves on surfaces as you edit regular curves in a viewport. The main part of the dialog is a two-dimensional view of the surface. The controls provide typical curve editing functions.

This is a modeless dialog. You can use the main 3ds Max window while Edit Curve on Surface remains open. However, if you select a different kind of curve or a sub-object that isn't a curve, the dialog closes.

You can edit multiple [CV on surface](#) on page 2327 or [Point on surface](#) on page 2331 curves, but you can't edit both types of curves at the same time.

The point whose surface you first click is shown as a blue square in the dialog as well as in viewports. As you draw the curve, it appears interactively in viewports and a blue asterisk (\*) shows the current mouse location on the surface.

While you are creating a curve, you can press Backspace to remove the last point or CV you created, and then previous points or CVs in reverse order.

## Interface

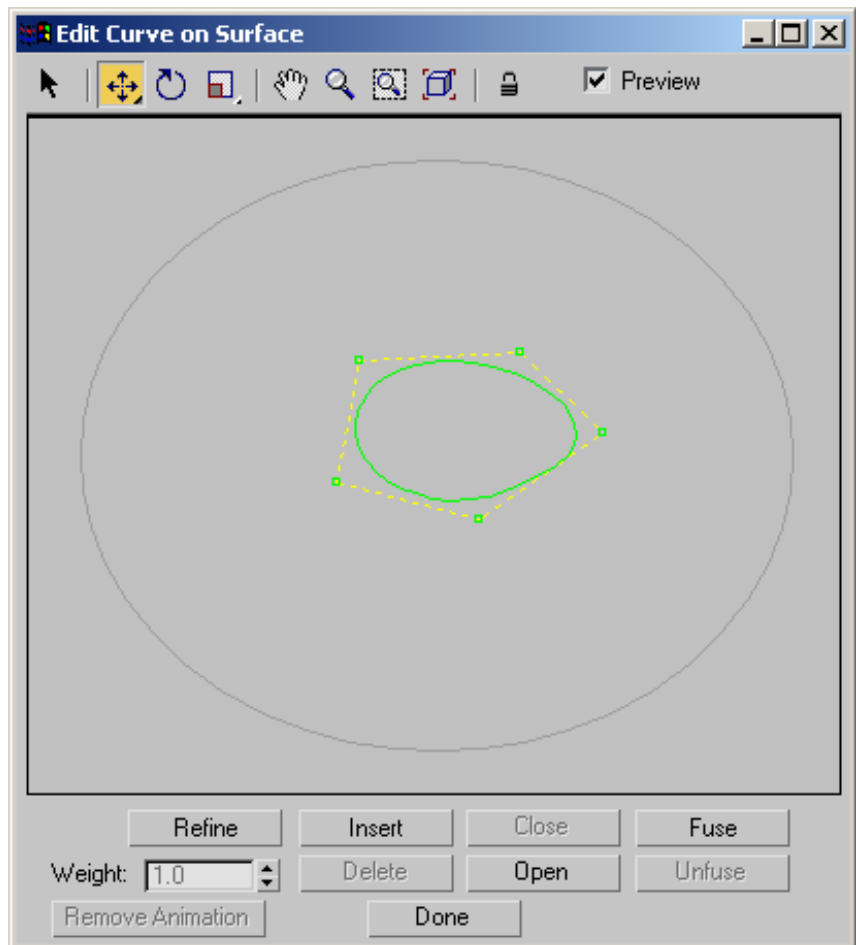

### Toolbar

The toolbar above the surface image provides selection, transform and viewing controls. These controls work the way their analogs do in the main 3ds Max viewports. The toolbar is disabled while you create a new curve on surface.

**Select** Selects one or more points. Drag a window to select multiple points.

**Move** Moves the selected points.

Move is a flyout. The alternative buttons constrain texture points to move either vertically or horizontally.

**Rotate** Rotates the selected points.

**Scale** Scales the selected points. This is a flyout that lets you choose between uniform scale, nonuniform scale in the surface's U dimension, or nonuniform scale in the surface's V dimension.

**Pan** Pans the surface view.

**Zoom** Zooms in or out on the surface view.

**Zoom Window** Zooms to a window you drag on the surface view.

**Zoom Extents** Zooms to the extents of the surface.

**Lock Selection** Locks the active selection set. You can turn this on to keep from accidentally selecting other points or CVs while you're transforming a selection set.

**Preview** When on (the default), edits you make in the dialog are also shown in viewports.

### **Curve on Surface Image**

Below the toolbar is a 2D image of the curve. This image shows the points or CVs of the curve, allowing you to edit it as you edit sub-objects in viewports.

If you right-click while in the image, a pop-up menu lets you switch between Select, Move, Rotate, and Scale. This is an alternative to using the toolbar.

If your mouse has a middle button, you can use it to pan in this window.

### **Buttons and Weight**

These controls are comparable to editing controls on the rollouts for point sub-objects. (The Open button works differently.) These controls are disabled while you create a new curve on surface.

**Refine** Adds points to the curve. This does not change curvature. For point curves, the curvature can change, but only slightly.

**Insert** (Not available for point curves on surfaces.)

**Close** Closes the curve.

**Fuse** Fuses two points.

**Weight** (Not available for point curves on surfaces.)

**Delete** Deletes the selected points.

**Open** Opens the curve by unfusing the points where the curve was originally closed.

**Unfuse** Unfuses the selected points.

**Remove Animation** Removes animation controllers from the selected points or CVs.

## Edit Texture Surface Dialog

Modify panel > Select NURBS surface sub-object. > Material Properties rollout > Texture Channels group box > Turn on Gen. Mapping Coords. > Texture Surface group box > Choose User-Defined. > Edit Texture Surface button

This dialog lets you edit the texture surface for a surface sub-object. It is available when you have chosen User Defined as the sub-object's texture surface method.

A texture surface is associated with the surface sub-object. The texture surface is used to control how materials are mapped. In effect, changing the texture surface stretches or otherwise changes the UV coordinates for the surface, altering the mapping.

The Edit Texture Surface dialog shows a 2D view of the texture surface. You can also edit user-defined texture surfaces directly in 3D viewports, using the Edit Texture Points button. See [Material Properties Rollout](#) on page 2278 .

Maps can shift with certain surface approximation methods. This effect is especially noticeable when the surface has animated CVs. You can reduce or eliminate map shifting by changing the mapping method to User Defined.

---

**TIP** Don't use the UVW Map modifier to apply a texture to an animated NURBS surface.

---

## Interface

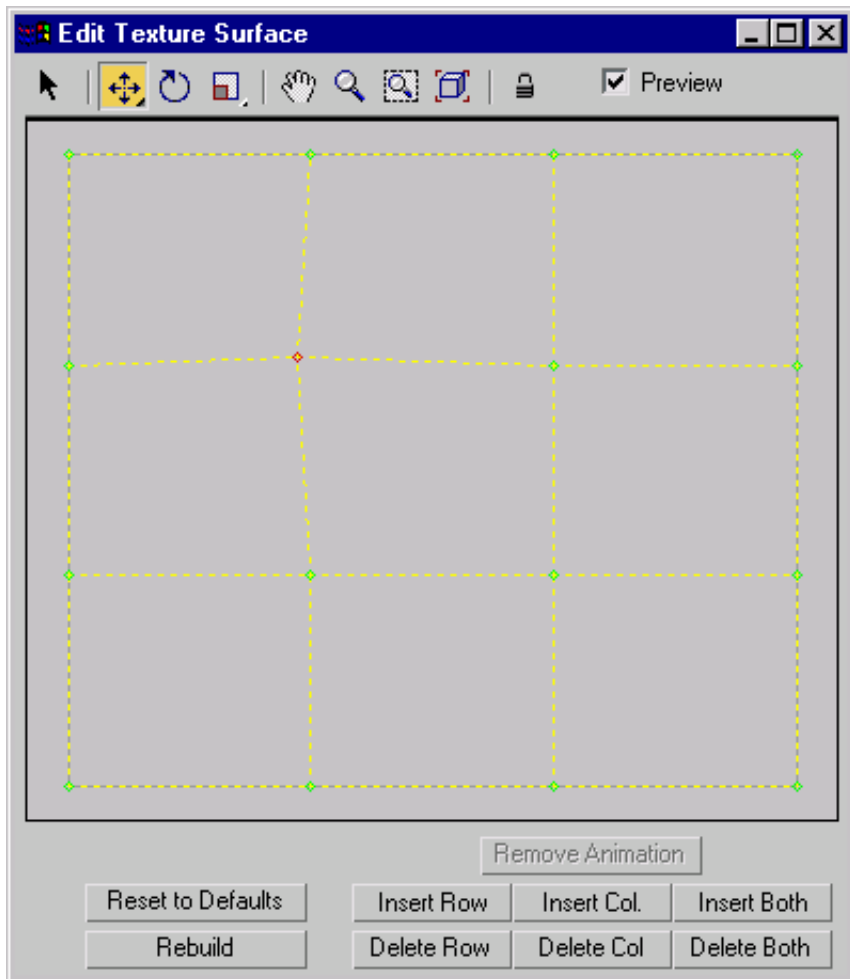

## Toolbar

The toolbar above the surface image provides selection, transform and viewing controls. These controls work the way their analogs do in viewports.

---

**NOTE** You can animate transforms to the texture surface points.

---

**Select** Selects one or more points. Drag a window to select multiple points or CVs.



**Move** Moves the selected points.

Move is a flyout. The alternative buttons constrain texture points to move either vertically or horizontally.

**Rotate** Rotates the selected points.

**Scale** Scales the selected points. This is a flyout that lets you choose between uniform scale, nonuniform scale in the surface's U dimension, or nonuniform scale in the surface's V dimension.

**Pan** Pans the surface view.

**Zoom** Zooms in or out on the surface view.

**Zoom Window** Zooms to a window you drag on the surface view.

**Zoom Extents** Zooms to the extents of the surface.

**Lock Selection** Locks the active selection set. You can turn this on so you don't accidentally select other points while you're transforming a selection set.

**Preview** When on (the default), your edits are also shown in viewports. In viewports, selected texture points are displayed in red, and the others are displayed in green.

## **Texture Surface Image**

Below the toolbar is a 2D image showing the points of the texture surface. You can edit the texture surface as you edit sub-objects in viewports.

If you right-click while in the image, the popup menu lets you switch between Select, Move, Rotate, and Scale. This is an alternative to using the toolbar.

If your mouse has a middle button, you can use it to pan in this window.

## **Texture Surface Controls**

The controls below the surface image edit the texture surface.

**Remove Animation** Removes animation controllers from the selected texture points.

**Reset to Defaults** Resets user-defined mapping to the default.

**Rebuild** Displays the [Rebuild Texture Surface dialog](#) on page 2465, which rebuilds the texture surface and lets you change the number of CV rows or columns.

**Insert Row, Insert Col., Insert Both** Click one of these buttons to insert a row or column of points, or both at once, into the surface. Insertion adds points without moving other rows and columns.

While you refine the surface, the operation is previewed the same way Insert is previewed in 3D viewports.

**Delete Row, Delete Col., Delete Both** Click one of these buttons to delete a row or column of points, or both at once.

## Join Curves Dialog

Modify panel > Select NURBS curve sub-object. > Curve Common rollout > Join button > Join two curves in a viewport.

This dialog lets you choose the way to join two curves.

### Interface

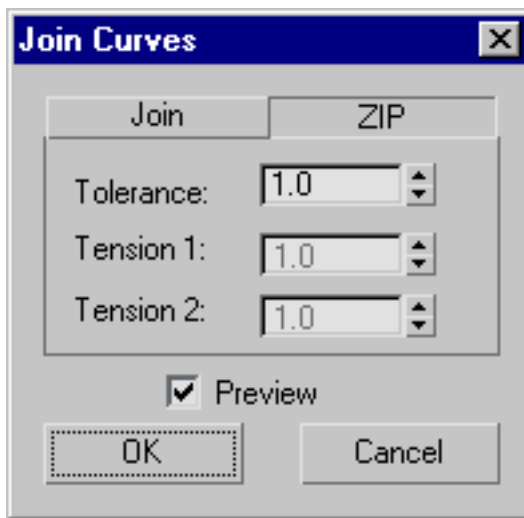

### ZIP tab

This tab chooses the zip algorithm. Zipping concatenates the CV lattices of the two original curves. Zipping can change the shape of the original curves, but usually it produces a better result than joining.

By default, the ZIP tab is active.

If both curves are untrimmed point curves, the result of zipping is a point curve. In all other cases, the result is a CV curve.

**Tolerance** A distance in 3ds Max units. If the ends of the two original curves are closer than this distance, zipping deletes one of the points or CVs in order to avoid creating coincident points or CVs in the new zipped curve.

**Tension 1** (Disabled.)

**Tension 2** (Disabled.)

### **Join tab**

This tab chooses the join algorithm. Joining first creates a blend curve between the two original curves, and then makes all three into a single curve. Joining does not change the shape of the two original curves.

If both curves are point curves, the result is a point curve. If one or both curves are CV curves, the result is a CV curve.

**Tolerance** A distance in 3ds Max units. If the gap between the curves you are joining is greater than this value, the join is created by first creating a blend curve and then joining the three parts. If the gap is less than this value, or if the curves are overlapping or coincident, the software doesn't create the blend.

Creating a blend and then joining the three curves into a single curve is the better technique. The result matches the parent curves well. Without the blend step, the resulting curve can deviate from the parent curves, in order to maintain smoothness. (The amount of deviation depends on how far from tangent the two input curves were at the join.)

A problem arises when the gap is too small. In this case, the software generates the blend but because there isn't enough room for it, the resulting curve has a loop. To avoid having this loop, set the Tolerance higher than the gap distance.

If you set the tolerance to 0.0, the software chooses a value to use for the Tolerance.

**Tension 1** Adjusts the tension of the new curve at the end of the first curve you picked.

**Tension 2** Adjusts the tension of the new curve at the end of the second curve you picked.

**Preview** When on, the effect of the zip or join is previewed in viewports. Default=on.

## Join Surfaces Dialog

Modify panel > Select NURBS surface sub-object. > Surface Common rollout > Join button > Join two surfaces in a viewport.

This dialog lets you choose the way to join two surfaces.

### Interface



### ZIP tab

This tab chooses the zip algorithm. Zipping concatenates the CV lattices of the two original surfaces. Zipping can change the shape of the original surfaces, but compared to joining it usually produces a simpler surface that is easier to edit.

By default, the ZIP tab is active.

If both curves are untrimmed point surfaces, the result of zipping is a point surface. In all other cases, the result is a CV surface.

**Tolerance** A distance in 3ds Max units. If the edges of the two original surfaces are closer than this distance, zipping deletes one row (or column) of the points or CVs in order to avoid creating a coincident point or CV row (or column) in the new zipped surface.

**Tension 1** (Disabled.)

**Tension 2** (Disabled.)

### **Join tab**

This tab chooses the join algorithm. (This method was the only way to join surfaces in 3ds Max prior to v3.) Joining first creates a blend surface between the two original surfaces, and then makes all three into a single surface. Joining does not change the shape of the two original surfaces.

If both surfaces are point surfaces, the result is a point surface. If one or both surfaces are CV surfaces, the result is a CV surface.

**Tolerance** A distance in 3ds Max units. If the gap between the surfaces you are joining is greater than this value, the join is created by first creating a blend surface and then joining the three parts. If the gap is less than this value, or if the surfaces are overlapping or coincident, the software doesn't create the blend.

Creating a blend and then joining the three surfaces into a single surface is the better technique. The result matches the parent surfaces well. Without the blend step, the resulting surface can deviate from the parent surfaces, in order to maintain smoothness. (The amount of deviation depends on how far from tangent the two input surfaces were at the join.)

A problem arises when the gap is too small. In this case, the software generates the blend but because there isn't enough room for it, the resulting surface has a loop. To avoid having this loop, set the Tolerance higher than the gap distance.

If you set the tolerance to 0.0, the software chooses a value to use for the Tolerance.

**Tension 1** Adjusts the tension of the new surface at the edge of the first surface you picked.

**Tension 2** Adjusts the tension of the new surface at the end of the second surface you picked.

**Preview** When on, the effect of the zip or join is previewed in viewports. Default=on.

## **Make Loft Dialog**

Modify panel > Select NURBS surface sub-object. > Surface Common rollout > Make Loft button

This dialog converts a surface sub-object to a (dependent) U loft or UV loft surface. You can also change the dimension used to construct a U loft surface.

### Interface

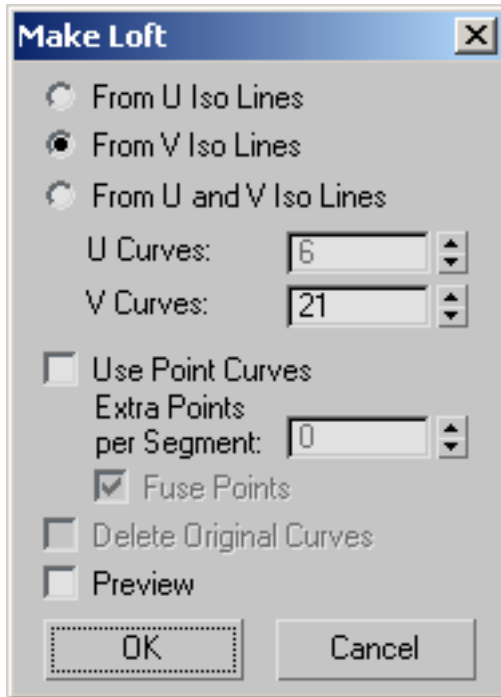

**From U Iso Lines** Uses curves along the surface's U dimension to construct a U loft.

**From V Iso Lines** Uses curves along the surface's V dimension to construct a U loft. If the surface was already a U loft, set this to change the lofting dimension.

**From U and V Iso Lines** Uses curves from both the U and V dimensions to construct a UV loft.

**U Curves** Sets the number of curves in U.

**V Curves** Sets the number of curves in V.

**Use Point Curves** When on, constructs the loft from point curves instead of the default CV curves. Default=off.

**Extra Points per Segment** This control is enabled only for UV lofts (From U and V Iso Lines). Lets you increase the number of points in each segment.

**Fuse Points** This control is enabled only for UV lofts (From U and V Iso Lines). When on, fuses points at curve intersections to ensure that the U and V curves continue to intersect when you edit the surface, and that the surface remains coincident with its parent curves. UV lofts constructed from intersecting curves behave more predictably. Default=on.

**Delete Original Loft Curves** This is available only if the surface was already a U loft or UV loft. When on, Make Loft deletes the original loft curves when you click OK. When off, the original curves remain where they are. Default=off.

**Preview** When on, displays a preview of the new loft surface. Loft creation is faster when Preview is off. Default=off.

## Make Point Dialog

Modify panel > Select NURBS surface sub-object. > Surface Common rollout > Make Point button

This dialog converts a CV surface sub-object to a point surface sub-object.

### Interface

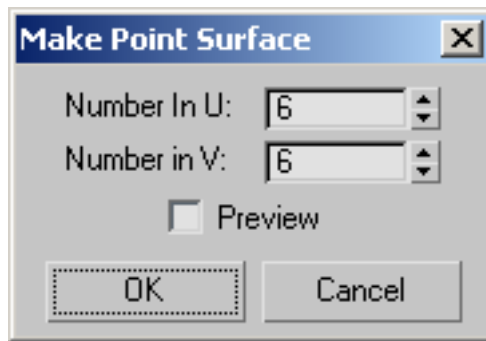

**Number in U** Sets the number of columns.

**Number in V** Sets the number of rows.

**Preview** When on, your changes are previewed in viewports. Point surface conversion is faster when Preview is off. Default=off.

## Make Point Curve Dialog

Modify panel > Select NURBS curve sub-object. > Curve Common rollout > Make Fit button

The Make Fit button for a NURBS curve sub-object turns a CV curve into a point curve. For point curves, it lets you change the number of points. It displays this dialog.

### Interface

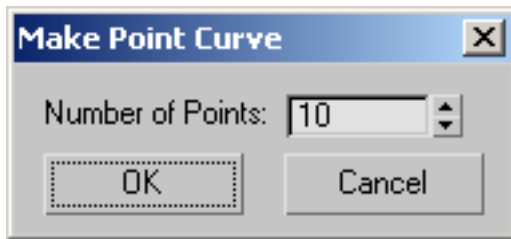

**Number of Points** Sets the number of points in the point curve.

## Point Curve: Close Curve Dialog

Create panel > Shapes button > Point Curve button > In viewports, draw a point curve and click to create a point in the same location as the first point in the curve.

Modify panel > Select NURBS object. > NURBS toolbox > Create Point Curve > In viewports, draw a point curve sub-object and click to create a point in the same location as the first point in the curve.

This dialog lets you create a closed point curve when you click to create a point in the same location as the curve's first point.



## Interface

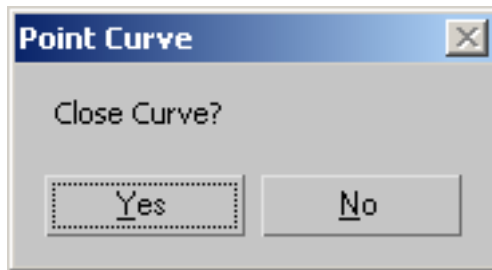

**Yes** Closes the curve and ends curve creation.

**No** Keeps the curve open and does *not* end curve creation.

## Rebuild CV Curve Dialog

Modify panel > Select NURBS object. > Stack display > Curve sub-object level > Select an independent CV curve sub-object. > CV Curve rollout > Rebuild button

The Rebuild button for CV curves displays this dialog. It lets you specify how to rebuild the curve. Rebuilding the curve can change its appearance.

## Interface

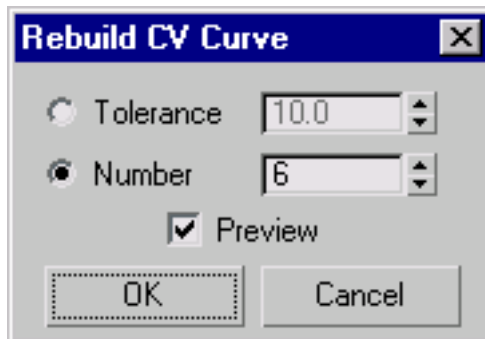

**Tolerance** Rebuilds the curve according to accuracy. The lower the Tolerance value, the more accurate the rebuild. Increasing Tolerance enables the curve to be rebuilt using fewer CVs.

**Number** (The default.) Lets you alter the number of CVs in the curve.

**Preview** When on (the default), your changes are previewed in viewports.

## Rebuild CV Surface Dialog

Modify panel > Select NURBS object. > Stack display > Surface sub-object level > Select an independent CV surface sub-object. > CV Surface rollout > Rebuild button

The Rebuild button for CV surfaces displays this dialog. It lets you specify how to rebuild the surface. Rebuilding the surface can change its appearance.

### Interface

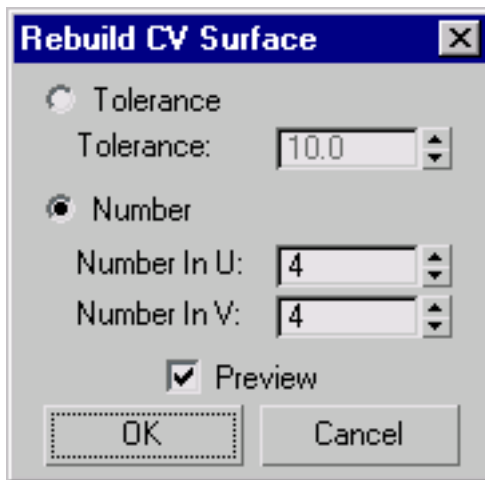

**Tolerance** Rebuilds the surface according to accuracy. The lower the Tolerance value, the more accurate the rebuild. Increasing Tolerance enables the surface to be rebuilt using fewer CVs.

**Number** (The default.) Lets you alter the number of CVs in the surface. Number in U specifies the number in the U dimension, and Number in V specifies the number in the V dimension. These values default to the numbers that already exist in the surface.

**Preview** When on (the default), your changes are previewed in viewports.

## Rebuild Texture Surface Dialog

Modify panel > Select NURBS surface sub-object. > Surface sub-object level > Material Properties rollout > Texture Channels group box > Turn on Gen. Mapping Coords. > Texture Surface group box > Choose User-Defined. > Edit Texture Surface button > Edit Texture Surface dialog > Rebuild button

This dialog rebuilds the texture surface and lets you change the number of CV rows or columns.

### Interface

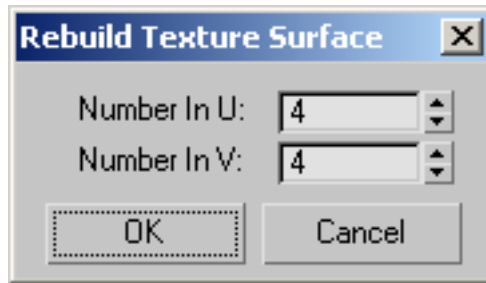

**Number in U** Sets the number of CV columns.

**Number in V** Sets the number of CV rows.

## Reparameterize Dialog

Modify panel > Select NURBS object. > Stack display > Curve sub-object level > Select an independent CV curve sub-object. > CV Curve rollout > Reparam. button

Modify panel > Select NURBS object. > Stack display > Curve sub-object level > Select an independent CV surface sub-object. > CV Surface rollout > Reparam. button

The Reparam. button for CV curves and surfaces displays this dialog. Reparameterizing a CV sub-object changes its [parameter space](#) on page 7882 to provide a better relation between control point locations and the shape of the sub-object.

---

**TIP** It is a good idea to reparameterize after you have added CVs to a curve or surface by refining or inserting.

---

## Interface

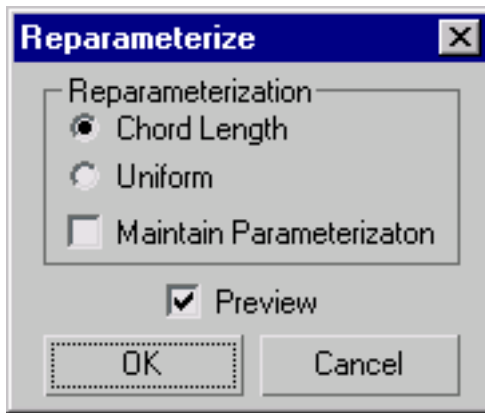

**Chord Length** Chooses the chord-length algorithm for reparameterization.

Chord-length reparameterization spaces knots (in [parameter space](#) on page 7882 ) based on the square root of the length of each curve segment.

Chord-length reparameterization is usually the best choice.

**Uniform** Spaces the knots uniformly.

A uniform knot vector has the advantage that the curve or surface changes only locally when you edit it. With chord-length parameterization, moving any CV can potentially change the entire sub-object.

**Maintain Parameterization** When on, the curve is automatically reparameterized as you edit it, using the currently active method of reparameterization. When off, no reparameterization happens unless you use this dialog. Default=off.

**Preview** If on (the default), displays the effects of reparameterizing in viewports.

## Sub-Object Clone Options Dialog

Modify panel > Select NURBS surface or curve sub-object. > Shift+Clone. > Clone Options dialog

When you [Shift+Clone](#) on page 968 a surface or curve sub-object, the Clone Options dialog appears. This dialog asks whether you want the clone to be a relational copy, an independent copy, or a transform.

## Interface

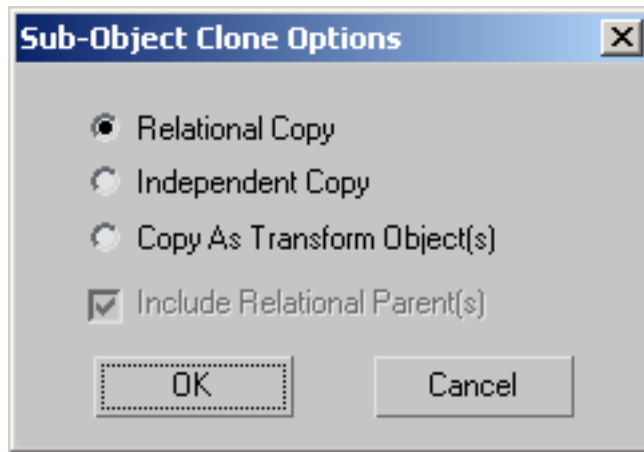

**Relational Copy** The cloned object is the same type as the original. If the original object was a dependent object, the clone includes copies of the parents. For example, when you clone a Blend surface, the clone remains a Blend surface and its two parent surfaces are copied along with it.

Because all related sub-objects are copied, Relational Copy can be time-consuming.

**Independent Copy** The cloned object is an independent CV curve or CV surface. It has the same shape as the original, but its relational dependencies aren't copied. This method of cloning uses less time and memory, although you lose the relational properties. For example, when you clone a Blend surface, the clone is an independent CV surface.

**Copy as Transform Object(s)** The "clone" is actually a transform curve or transform surface, based on the original object and still dependent on it. This lets you create transform curves and surfaces based on a rotation and scale as well as on translation.

**Include Parent(s)** (Available only for Independent Copy or Copy as Transform Object(s).) Tells the system whether or not to include the parents of the dependent object. For example, if Include Parent(s) is on when you clone a blend surface, the two parent surfaces are also cloned as independent CV surfaces. If Include Parent(s) is off, only the one curve or surface is cloned. Cloning is slower when Include Parent(s) is on, although quicker than Relational Copy.

## Select By Material ID Dialog

Modify panel > Select NURBS object. > Stack display > Curve sub-object level > Select By ID button.

This dialog lets you select curve sub-objects by the material ID number assigned to them.

### Interface

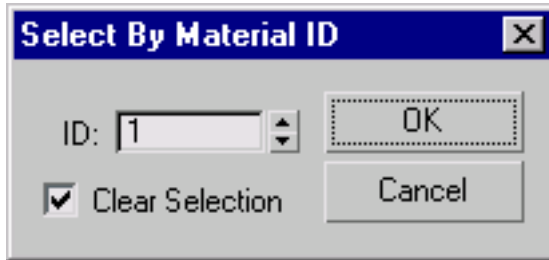

**ID** Specifies the material ID you want to select.

**Clear Selection** When on, replaces the current selection (if any) by the material ID selection. When off, adds the material ID selection to the current selection set.

## Curve and Surface Approximation

### Curve Approximation

Modify panel > Select top-level NURBS object. > Curve Approximation rollout

Although NURBS curves are analytically generated, in order to generate and display them they must be approximated by line segments.

Curve approximation controls are displayed in the creation parameters for curve objects, and on a Curve Approximation rollout for NURBS models (top-level NURBS objects). At the model level, approximation controls affect all curve sub-objects in the model.

Curve approximation is accomplished by *segments*. One or more line segments, or *steps*, are used to approximate each segment of the curve. For point curves, a segment of a curve is the portion between one point and the next. For CV

curves, the segment is determined by the CV's parametric [knot](#) on page 7825 . The transition from one CV curve segment to another isn't visible in viewports.

Curve approximation parameters aren't animatable.

## Interface

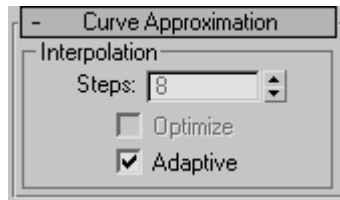

**Steps** The maximum number of line segments used to approximate each curve segment. If the curve displays or renders with angles, increase this value. This control is unavailable when Adaptive is on. Range=1 to 100.

**Optimize** Turn on this check box to optimize the curve. When on, interpolation uses the specified Steps value unless two segments are collinear, in which case they are converted to a single segment. This control is unavailable when Adaptive is on.

**Adaptive** (The default.) Segments the curve adaptively, based on its curvature. In other words, the curve is assigned more segments where its curvature is greatest, and fewer segments where its curvature is less.

## Surface Approximation

Modify panel > Select top-level NURBS object. > Surface Approximation rollout

Modify panel > Select NURBS surface sub-object. > Surface Approximation rollout

Although NURBS surfaces are analytically generated, in order to generate and display them they must be approximated by faces. You use the controls described in this section to set the type of approximation used and its parameters.

The Surface Approximation rollout controls how surface sub-objects in the NURBS model are approximated for purposes of rendering and viewport display. NURBS can be approximated differently in viewports and in the renderer. Typically you want viewport display to be clear and quick, while you want rendered display to be smooth, accurate, and "realistic." However, the approximation you choose for viewports creates a mesh, and the kind of

mesh you choose can affect the behavior of modifiers that you later apply to the NURBS model.

The first two controls on this rollout are radio buttons for selecting the kind of display output, viewport or render, these parameters control.

Surface approximation parameters are *not* animatable.

---

**NOTE** If the size or shape of a surface changes over time, the tessellation used to approximate it can change (automatically) as well. This has the advantage of improving render time in animations. It has the disadvantage that you can't apply [image motion blur](#) on page 7814 to NURBS objects whose tessellation changes during animation. The Regular method of tessellation is the exception: it doesn't change when animated, so you can use image motion blur with Regular tessellation.

---

### **Surface Approximation Per Surface**

By default, surface sub-objects use the same approximation settings as the top-level NURBS model. You can override these settings. Each surface sub-object now has a Surface Approximation rollout of its own. The controls on this rollout are disabled unless you turn off the Lock to Top Level toggle. With this toggle turned off, you can choose approximation settings specific to this surface sub-object.



## Interface

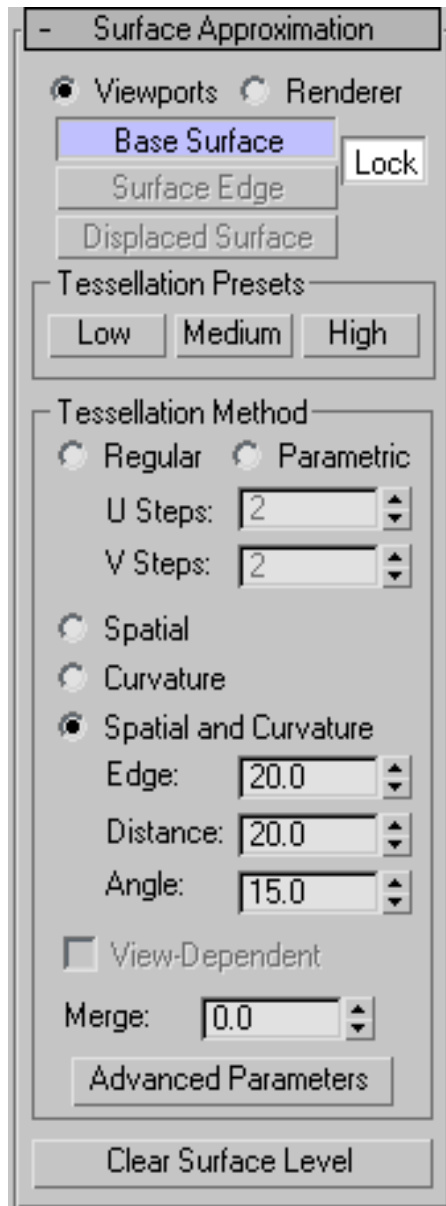

## Tessellation group

**Viewports** When chosen, the rollout affects how surfaces in the NURBS object are displayed interactively in viewports, including shaded viewports, and by the preview renderer.

The Viewports surface settings are also used when you apply a mesh modifier such as Mesh Select to the NURBS object. This is important because the modifier can affect the scene's geometry.

**Renderer** When chosen, the rollout affects how surfaces in the NURBS object are displayed by the renderer, and by the draft renderer for Quick Render.

The next cluster of buttons lets you choose which portions of the geometry are affected by the surface approximation settings.

**Base Surface** Settings affect the entire surface. This is the default.

**Surface Edge** Turn on to set approximation values for tessellating surface edges that are defined by trim curves. With Lock turned off, the surface and edge tessellation values are independent of each other.

For object-level surfaces, this is unavailable unless Lock (described below) is turned off.

**Displaced Surface** Turn on to set a third, independent approximation setting for surfaces that have a [displacement map](#) on page 5391 applied to them. Available only when Renderer is chosen.

Using a preset approximation setting (in the Presets group box) should give you faster results for displaced surfaces.

**Lock** (for object-level surfaces only) Locks the Base Surface settings to the Surface Edge settings. In other words, surfaces and surface edges have a relational tessellation setting unless Lock is turned off. Default=on.

## Tessellation Presets group

Lets you choose a preset low, medium, or high quality surface approximation. While a preset is chosen, the values it uses are displayed on the Tessellation Method rollout.

Preset values are saved in the [3dsmax.ini on page 51](#) file. You can customize the preset values by using the [Surface Approximation utility](#) on page 2480 .

**Low** Selects a (comparatively) low-quality surface approximation. These are the default values:

Viewports, Base Surface:

Method=Spatial and Curvature Edge=50.0 Distance=50.0 Angle=50.0 Merge=0.0  
Advanced Parameters > Minimum=0, Maximum=3

Renderer, Base Surface:

Method=Spatial and Curvature Edge=20.0 Distance=20.0 Angle=15.0  
Merge=0.01 Advanced Parameters > Minimum=0, Maximum=3

Renderer, Displaced Surface:

Method=Spatial and Curvature Edge=20.0 Distance=20.0 Angle=10.0  
Merge=(Unavailable) Advanced Parameters > Minimum=0, Maximum=2

Keyboard shortcut: Alt+1

**Medium** (The default for both viewports and rendering.) Selects a medium-quality surface approximation. These are the default values:

Viewports, Base Surface:

Method=Spatial and Curvature Edge=20.0 Distance=20.0 Angle=15.0 Merge=0.0  
Advanced Parameters > Minimum=0, Maximum=3

Renderer, Base Surface:

Method=Spatial and Curvature Edge=10.0 Distance=15.0 Angle=10.0  
Merge=0.01 Advanced Parameters > Minimum=0, Maximum=4

Renderer, Displaced Surface:

Method=Spatial and Curvature Edge=10.0 Distance=10.0 Angle=4.0  
Merge=(Unavailable) Advanced Parameters > Minimum=0, Maximum=3

Keyboard shortcut: Alt+2

**High** Selects a high-quality surface approximation. These are the default values:

Viewports, Base Surface:

Method=Spatial and Curvature Edge=5.0 Distance=15.0 Angle=10.0 Merge=0.0  
Advanced Parameters > Minimum=0, Maximum=3

Renderer, Base Surface:

Method=Spatial and Curvature Edge=5.0 Distance=5.0 Angle=3.0 Merge=0.01  
Advanced Parameters > Minimum=0, Maximum=4

Renderer, Displaced Surface:

Method=Spatial and Curvature Edge=5.0 Distance=5.0 Angle=2.0  
Merge=(Unavailable) Advanced Parameters > Minimum=0, Maximum=4

Keyboard shortcut: Alt+3

---

**NOTE** The keyboard shortcuts for surface approximation presets don't require that the Keyboard Shortcut Override Toggle be on. You can change the surface approximation of NURBS objects by selecting them in a viewport, and then using Alt+1, Alt+2, or Alt+3. This works for sub-objects as well, but the surface sub-object's Lock to Top Level toggle must be turned off.

---

### **Tessellation Method group**

The controls in this group affect the display of the NURBS surface in viewports if you have chosen Viewports above, or by the renderer if you have chosen Renderer above. You can choose between five algorithms. Each approximates NURBS surfaces by tessellating them in a different way.

Generally speaking, if the preset values you have chosen give good results, you don't need to adjust the controls on this rollout. Adjust them if you encounter problems with the preset alternative.

#### **Tips**

- **Viewport Tessellation:** The tessellation method creates the mesh. If you modify the NURBS object with [Mesh Select](#) on page 1455, choose the method that gives the result you need. If you use modifiers heavily, Spatial or Parametric might be better than Curvature, because of their regular tessellation. Curvature-dependent tessellation can cause problems with some modifiers.
- **Renderer Tessellation:** Spatial and Curvature usually obtains the most accurate rendering. Curvature can be the more efficient choice when you render animated surfaces.

**Lock to Top Level** (for sub-object surfaces only) When on, the surface sub-object uses the same surface approximation settings as the top-level NURBS model, and other controls on this rollout are disabled. When turned off, you can set the sub-object approximation to differ from the top-level model. Default=on.

**Regular** Generates a fixed tessellation across the surface based on U Steps by V Steps. Increasing these parameters increases accuracy at a cost of speed, and vice versa, but in general this can be the quickest and least accurate way to approximate a NURBS surface. Very low values for U and V Steps using the Regular method usually doesn't provide good results. Model complexity increases slowly as U and V Steps values increase.

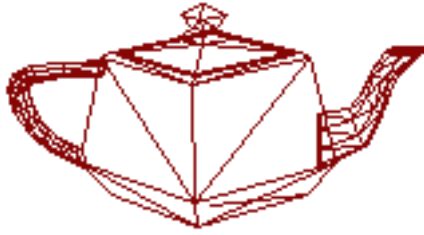

#### **Regular mesh of the NURBS teapot**

**Parametric** Generates an adaptive tessellation based on U Steps by V Steps. Low values for U and V Steps using the Parametric method often provide good results. Model complexity increases rapidly as U and V Steps values increase, so take care when you switch from Regular, which generally requires higher U and V values, to Parametric, where lower U and V values generally suffice.

For example, if you convert a teapot to NURBS and set the U and V steps to 15, the Regular method generates 4470 faces but the Parametric method generates 204960 faces.



#### **Parametric mesh of the NURBS teapot**

**Spatial** Generates a uniform tessellation made of triangular faces.

The Edge parameter specifies the maximum length of a triangular face in the tessellation. The value is a percentage of the object's bounding box. Decreasing this value increases accuracy but increases rendering time.



**Spatial mesh of the NURBS teapot**

**Curvature** (The default.) Generates a variable tessellation based on the curvature of the surface. The tessellation has a finer grain where the surface is more curved. Changing surface curvature dynamically changes the curvature tessellation.

The Distance parameter specifies how far the approximation can deviate from the actual NURBS surface. Distance is a percentage of the diagonal of each surface's bounding box. Each surface in an object is tessellated based on its size, independently of other surfaces. Scaling a surface doesn't change its tessellation. Decreasing this value increases accuracy but increases rendering time. When you set Distance to 0.0, the software ignores this parameter and uses the Angle to control accuracy.

The Angle parameter specifies the maximum angle between faces in the approximation. Decreasing this value increases accuracy but increases rendering time. When you set Angle to 0.0, the software ignores this parameter and uses Distance to control accuracy.

When both Distance and Angle are 0.0, the surfaces degenerate and can become flat surfaces.



**Curvature mesh of the NURBS teapot**

**Spatial and Curvature** Combines the spatial (edge-length) method and the curvature (distance and angle) methods, using all three values.

The Edge parameter specifies the maximum length of a triangular face in the tessellation. The value is a percentage of the object's bounding box. Decreasing this value increases accuracy but increases rendering time. When you set Edge to 0.0, the effect is equivalent to the Curvature method.

The Distance parameter specifies how far the approximation can deviate from the actual NURBS surface. Distance is a percentage of the diagonal of each surface's bounding box. Each surface in an object is tessellated based on its size, independently of other surfaces. Scaling a surface doesn't change its tessellation. Decreasing this value increases accuracy but increases rendering time. When you set Distance to 0.0, the software ignores this parameter and uses the Edge and Angle values to control accuracy.

The Angle parameter specifies the maximum angle between faces in the approximation. Decreasing this value increases accuracy but increases rendering time. When you set Angle to 0.0, the software ignores this parameter and uses the Edge and Distance values to control accuracy.

When Distance, Angle, and Edge are all 0.0, the surfaces degenerate and can become flat surfaces.



**Spatial and Curvature mesh of the NURBS teapot**

**View-Dependent** (for the Renderer only) When on, takes the object's distance from the camera into account while calculating tessellation. This can improve rendering time by not generating fine-grained tessellations for objects in the distance of the rendered scene. The view-dependent effect works only when you render camera or perspective views. It doesn't work in orthographic views. This control is disabled while Viewports is active.

For the Spatial, Curvature, and Spatial and Curvature methods, the Distance and Edge values specify pixels instead of 3ds Max units when View-Dependent is on.

---

**NOTE** When View-Dependent is on, tessellation quickly reaches the maximum subdivision limit. You might want to increase this value to 7 (the greatest value allowed). See the description of Advanced Parameters, below.

---

**Merge (sub-object surfaces only)** Controls the tessellation of surface sub-objects whose edges are joined or very nearly joined. When input to a modifier (such as Mesh Select) requires a mesh, and when NURBS surfaces are tessellated for production rendering, by default the software adjusts the tessellation of adjoining surfaces to match each other, in terms of the number of faces along the edges. The Merge parameter controls how this is done. If Merge is zero, adjoining faces are unchanged. Increasing the value of Merge increases the distance the software uses to calculate how edges should match, guaranteeing no gaps between the surfaces when they are rendered. Default=0.0.

In most cases, you don't need to adjust Merge. If rendering shows gaps between nearly adjoining faces, increase Merge to eliminate them.

Technically, the Merge value is 0.1 percent of the diagonal of the object's bounding box. In other words, a Merge value of 1.0 (higher than necessary for most purposes) is 0.1 percent of the length of the diagonal. Because Merge is based on the object's dimensions, you can scale the NURBS model without affecting the Merge setting.

**Advanced Parameters** Click to display the [Advanced Surface Approximation dialog](#) on page 2478 . The parameters in this dialog apply to the Spatial, Curvature, and Spatial and Curvature approximation methods.

**Clear Surface Level** (Appears only for top-level surfaces.) Clears all surface approximation settings assigned to individual surface sub-objects. When you click this button, all surface-specific approximations are lost, and Lock to Top Level is on for surface sub-objects.

## Advanced Surface Approximation Dialog

Modify panel > Select a NURBS surface object or surface sub-object. > Surface Approximation rollout > Tessellation Method group box > Turn off Lock to Top Level > Advanced Parameters button



Select an editable mesh object. > Modify panel > Surface Properties rollout > Advanced Parameters button

This dialog sets parameters that control the tessellation used in the Spatial, Curvature, and Spatial and Curvature approximation methods.

## Interface

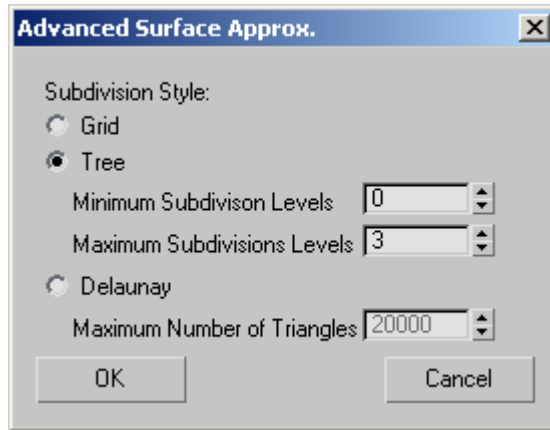

## Subdivision Style

Chooses the method used to subdivide the surface:

**Grid** Subdivides the surface using a regular grid.

**Tree** (The default.) Subdivides the surface using a binary tree.

**Delaunay** Subdivides the surface using nearly equilateral triangles.

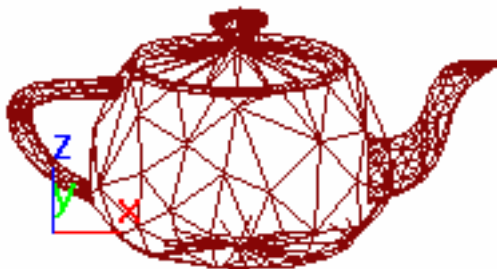

Delaunay surface subdivision style

## Subdivision Limits

For Grid or Tree subdivisions, the limits control the number of recursive decompositions that are performed during tessellation.

**Minimum Subdivision Levels** Sets the minimum number of recursions. Default=0.

**Maximum Subdivision Levels** Sets the maximum number of recursions. The maximum can be no greater than 7. Be careful: setting the maximum greater than 5 can result in massive face counts and poor performance. Default=3.

## Maximum Number of Triangles

For Delaunay subdivision, the Maximum Number of Triangles lets you specify the maximum number of triangles into which the surface will be divided. Default=20000.

# Surface Approximation Utility

Utilities panel > Utilities rollout > More button > Utilities dialog > Surface Approximation

The Surface Approximation utility lets you change approximation and display settings without going into the NURBS model, and is especially useful for changing settings on multiple NURBS objects at once.

It has two rollouts, one for surface approximation and the other for surface display controls.

[Surface Approximation Rollout](#) on page 2481

[Surface Display Rollout](#) on page 2491

## Procedures

**To use the Surface Approximation utility:**

- 1 On the Utilities panel, click the More button, and choose Surface Approximation from the list.
- 2 Set the desired options on the Surface Approximation and Surface Display rollouts.
- 3 Select the NURBS objects to apply the settings to.

- 4 On the Surface Display rollout, click Set Selected to apply the settings.

## Surface Approximation Rollout

Utilities panel > Utilities rollout > More button > Utilities dialog > Surface Approximation > Surface Approximation rollout

The controls in the Surface Approximation rollout are the same as the [surface approximation](#) on page 2469 controls for [NURBS](#) on page 2152 surface objects, with two additional buttons: Set Selected and Reset.

## Interface

- Surface Approximation

Iso Parametric Lines

U Lines:

V Lines:

Iso Only

Iso And Mesh

Mesh Only

Viewports  Renderer

Base Surface

Surface Edge

Displaced Surface

Load Tessellation Preset

Low Medium High

Save Tessellation Preset

Low Medium High

Tessellation Method

Regular

Parametric

U Steps:

V Steps:

Spatial

Curvature

Spatial and Curvature

Edge:

Distance:

Angle:

View-Dependent

Merge:

Advanced Parameters...

Clear Surfaces

Set Selected

Reset

## Iso Parametric Lines group

The controls in this group box affect the display of the NURBS surfaces in viewports.

**U Lines and V Lines** The number of lines used to approximate the NURBS surfaces in viewports, along the surface's local U and V dimensions, respectively. Reducing these values can speed up the display of the surface, but reduce accuracy of the display. Increasing these values increases accuracy at the expense of time. Setting one of these values to 0 displays only the edge of the object in the corresponding dimension.

**Iso Only** When chosen, all viewports display [iso line](#) on page 7822 representations of the surface. Iso (parametric) lines are similar to contour lines. The lines show where the NURBS surface has a constant U value or V value or both. Iso line representations can be less crowded and easier to visualize than wire mesh representations.

**Iso and Mesh** (The default.) When chosen, wireframe viewports display iso line representations of the surface, and shaded viewports display the shaded surface.

**Mesh Only** When chosen, wireframe viewports display the surface as a wire mesh, and shaded viewports display the shaded surface.

In wireframe viewports, this option lets you see the surface approximation used for viewports.

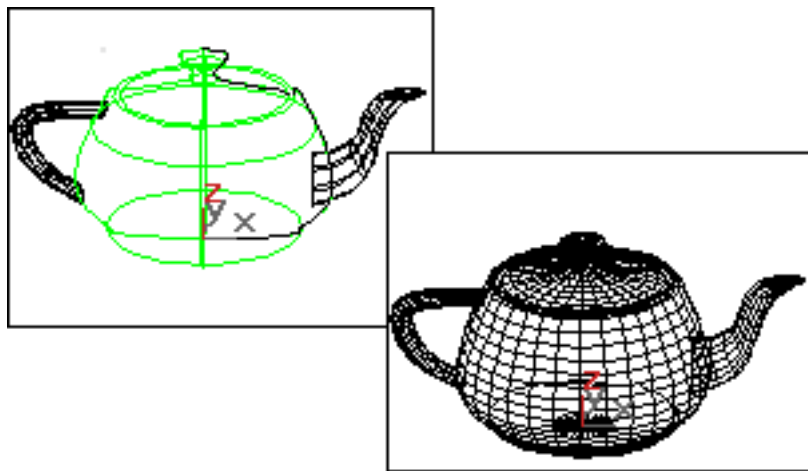

Iso and mesh displays of a NURBS teapot

**Viewports** When chosen, the utility affects how surfaces in the NURBS objects are displayed interactively in viewports, including shaded viewports, and by the preview renderer.

The Viewports surface settings are also used when you apply a mesh modifier such as Mesh Select to the NURBS objects. This is important because it can affect the scene's geometry.

**Renderer** When chosen, the utility affects how surfaces in the NURBS objects are displayed by the renderer, and by the draft renderer for Quick Render.

**Base Surface** When on, settings affect entire surfaces in the selection set. Default=on.

**Surface Edge** When on, settings affect the tessellation of surface edges that are defined by trim curves.

**Displaced Surface** Enabled only when Renderer is chosen. Turn on to set a third, independent approximation setting for surfaces that have a [displacement map](#) on page 5391 or [Displace](#) on page 1274 modifier applied to them.

### **Load Tessellation Preset group**

Lets you choose a preset low, medium, or high-quality level of surface approximation. While a preset is chosen, the values it uses are displayed in the Tessellation Method group box.

Preset values are saved in the *3dsmax.ini* file. You can customize the preset values by using the buttons in the following group box, Save Tessellation Preset.

**Low** Selects a (comparatively) low-quality level of surface approximation. These are the default values:

#### **Viewports, Base Surface:**

Method=Spatial and Curvature

Edge=50.0

Distance=50.0

Angle=50.0

Merge=0.0

Advanced Parameters > Minimum=0, Maximum=3

#### **Renderer, Base Surface:**

Method=Spatial and Curvature

Edge=20.0

Distance=20.0

Angle=15.0

Merge=0.01

Advanced Parameters > Minimum=0, Maximum=3

**Renderer, Displaced Surface:**

Method=Spatial and Curvature

Edge=20.0 Distance=20.0

Angle=10.0 Merge=(Unavailable)

Advanced Parameters > Minimum=0, Maximum=2

**Medium** (The default for both viewports and rendering.) Selects a medium-quality level of surface approximation. These are the default values:

**Viewports, Base Surface:**

Method=Spatial and Curvature

Edge=20.0

Distance=20.0

Angle=15.0

Merge=0.0

Advanced Parameters > Minimum=0, Maximum=3

**Renderer, Base Surface:**

Method=Spatial and Curvature

Edge=10.0

Distance=15.0

Angle=10.0

Merge=0.01

Advanced Parameters > Minimum=0, Maximum=4

**Renderer, Displaced Surface:**

Method=Spatial and Curvature

Edge=10.0

Distance=10.0

Angle=4.0

Merge=(Unavailable)

Advanced Parameters > Minimum=0, Maximum=3

**High** Selects a high-quality level of surface approximation. These are the default values:

**Viewports, Base Surface:**

Method=Spatial and Curvature Edge=5.0 Distance=15.0 Angle=10.0 Merge=0.0

Advanced Parameters > Minimum=0, Maximum=3

Renderer, Base Surface:

Method=Spatial and Curvature

Edge=5.0

Distance=5.0

Angle=3.0

Merge=0.01

Advanced Parameters > Minimum=0, Maximum=4

**Renderer, Displaced Surface:**

Method=Spatial and Curvature

Edge=5.0

Distance=5.0

Angle=2.0

Merge=(Unavailable)

Advanced Parameters > Minimum=0, Maximum=4

**Save Tessellation Preset group**

Click a button to save the current Tessellation Method settings as a new Low, Medium, or High preset. These values are saved in the *3dsmax.ini* file.

---

**NOTE** There is a separate Low, Medium, and High preset for Base Surface and Displaced Surface approximation. Check whether Base Surface or Displaced Surface is on before you use the buttons in this group box to save a custom preset.

---



Customizing preset values overwrites the default presets. To restore the defaults, you can re-enter the default preset values shown above, and then save them with the corresponding button. You can also restore defaults by editing the *3dsmax.ini* file to delete the custom preset values.

When you customize the preset values, there is no necessary correlation between the button names and the quality of surface approximation. The software has no way of knowing how "good" a tessellation is, and you can save a very high-quality surface approximation in the Low preset, for example.

### **Tessellation Method group**

The controls in this group box affect the display of the NURBS surfaces in either viewports, if Viewports is chosen, or by the renderer, if Renderer is chosen. You can choose between five algorithms. Each approximates NURBS surfaces by tessellating them in a different way.

---

**NOTE** When Viewports is chosen, you must also choose Mesh Only in order to see the effect of the Mesh Parameter settings in wireframe viewports.

---

Generally speaking, if the preset values you have chosen give good results, you don't need to adjust the controls in this rollout further. Use them if you encounter problems with the preset alternative.

#### **Tips**

- **Viewport Tessellation:** The tessellation method creates the mesh, so if you modify the NURBS object with Mesh Select, choose the method that gives the result you need. If you use modifiers heavily, Spatial or Parametric might be better than Curvature, because of their regular tessellation. Curvature-dependent tessellation can cause problems with some modifiers.
- **Renderer Tessellation:** Spatial and Curvature usually obtains the most accurate rendering. Curvature can be the more efficient choice when you render animated surfaces.

**Regular** Generates a fixed tessellation across the surface based on U Steps by V Steps. Increasing these parameters increases accuracy at a cost of speed, and vice versa, but in general this can be the quickest and least accurate way to approximate a NURBS surface. Very low values for U and V Steps using the Regular method usually doesn't provide good results. Model complexity increases slowly as U and V Steps values increase.

**Parametric** Generates an adaptive tessellation based on U Steps by V Steps. Low values for U and V Steps using the Parametric method often provide good

results. Model complexity increases rapidly as U and V Steps values increase, so take care when you switch from Regular, which generally requires higher U and V values, to Parametric, where lower U and V values generally suffice.

For example, if you convert a teapot to NURBS and set the U and V steps to 15, the Regular method generates 4470 faces but the Parametric method generates 204960 faces.



**Parametric mesh of the NURBS teapot**

**Spatial** Generates a uniform tessellation made of triangular faces.

The Edge parameter specifies the maximum length of a triangular face in the tessellation. The value is a percentage of the object's bounding box. Decreasing this value increases accuracy but increases rendering time.

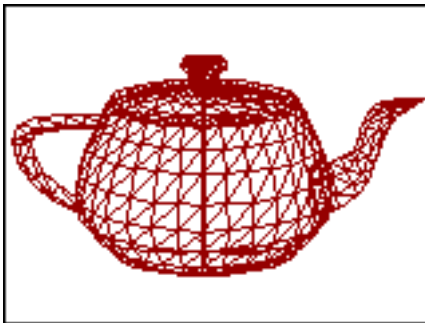

**Spatial mesh of the NURBS teapot**

**Curvature** Generates a variable tessellation based on the curvature of the surface. The tessellation has a finer grain where the surface is more curved. Changing surface curvature dynamically changes the curvature tessellation.

The Distance parameter specifies how far the approximation can deviate from the actual NURBS surface. Distance is a percentage of the diagonal of each

surface's bounding box. Each surface in an object is tessellated based on its size, independently of other surfaces, and scaling a surface doesn't change its tessellation. Decreasing this value increases accuracy but increases rendering time. When you set Distance to 0.0, the software ignores this parameter and uses the Angle to control accuracy.

The Angle parameter specifies the maximum angle between faces in the approximation. Decreasing this value increases accuracy but increases rendering time. When you set Angle to 0.0, the software ignores this parameter and uses the Distance to control accuracy.

When both Distance and Angle are 0.0, the surfaces degenerate and can become flat surfaces.



Curvature mesh of the NURBS teapot

**Spatial and Curvature** (The default.) Combines the spatial (edge-length) method and the curvature (distance and angle) methods, using all three values.

The Edge parameter specifies the maximum length of a triangular face in the tessellation. The value is a percentage of the object's bounding box. Decreasing this value increases accuracy but increases rendering time. When you set Edge to 0.0, the effect is equivalent to the Curvature method.

The Distance parameter specifies how far the approximation can deviate from the actual NURBS surface. Distance is a percentage of the diagonal of each surface's bounding box. Each surface in an object is tessellated based on its size, independently of other surfaces, and scaling a surface doesn't change its tessellation. Decreasing this value increases accuracy but increases rendering time. When you set Distance to 0.0, the software ignores this parameter and uses the Edge and Angle values to control accuracy.

The Angle parameter specifies the maximum angle between faces in the approximation. Decreasing this value increases accuracy but increases rendering

time. When you set Angle to 0.0, the software ignores this parameter and uses the Edge and Distance values to control accuracy.

When Distance, Angle, and Edge are all 0.0, the surfaces degenerate and can become flat surfaces.

**View-Dependent** (for the Renderer only): When on, takes the object's distance from the camera into account while calculating its tessellation. This can improve rendering time by not generating fine-grained tessellations for objects that are in the distance of the rendered scene. The view-dependent effect only works when you render camera or perspective views. It doesn't work in orthographic views. This control is disabled while Viewports is active.

For the Spatial, Curvature, and Spatial and Curvature methods, when View-Dependent is on, the Distance and Edge values specify pixels instead of the software's default units.

---

**NOTE** When View-Dependent is on, tessellation very quickly reaches the maximum subdivision limit. You might want to increase this value to 7 (the greatest value allowed). See the description of Advanced Parameters, below.

---

**Merge** Controls the tessellation of surface sub-objects whose edges are joined or very nearly joined. When input to a modifier (such as Mesh Select) that requires a mesh, and when NURBS surfaces are tessellated for production rendering, by default the software adjusts the tessellation of adjoining surfaces to match each other, in terms of the number of faces along the edges. The Merge parameter controls how this is done. If Merge is zero, adjoining faces are unchanged. Increasing the value of Merge increases the distance the software uses to calculate how edges should match, guaranteeing no gaps between the surfaces when they are rendered. Default=0.01.

In most cases, you don't need to adjust Merge. If rendering shows gaps between nearly adjoining faces, increase Merge to eliminate them.

Technically, the Merge value is one tenth of one percent of the diagonal of the object's bounding box. In other words, a Merge value of 1.0 (higher than necessary for most purposes) is 0.1 percent of the length of the diagonal. Because Merge is based on the object's dimensions, you can scale the NURBS model without affecting the Merge setting.

**Advanced Parameters** Click to display the [Advanced Surface Approximation dialog](#) on page 2478 . The parameters in this dialog apply to the Spatial, Curvature, and Spatial and Curvature approximation methods.

**Clear Surfaces** When on, the settings you choose in this utility override all sub-object specific surface approximation settings in the selected NURBS

models. When off, the utility affects top-level NURBS models but settings local to individual surface sub-objects remain unaffected. Default=Off.

**Set Selected** Applies the surface approximation values active in the utility to all selected NURBS objects.

**Reset** Resets the values in the utility to the default settings for a NURBS surface.

## Surface Display Rollout

Utilities panel > Utilities rollout > More button > Utilities dialog > Surface Approximation > Surface Display rollout

The controls in the Surface Display rollout are the same as the display controls for NURBS surface objects, with two additional buttons: Set Selected and Reset.

### Interface

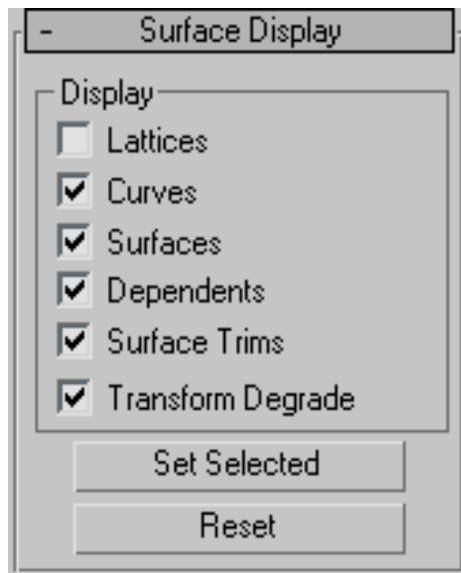

## Display group

**Lattices** When on, displays control lattices, in yellow lines. (You can change the lattice color by using the [Colors panel](#) on page 7505 of the Customize User Interface dialog. The Curve CV and Surface CV sub-object levels also have a local Display Lattice toggle, which overrides this global setting at the sub-object level. The Curve CV and Surface CV settings are independent. In other words, at the sub-object level, you can turn on the lattice for an object's curves but not its surfaces, or vice versa.

**Curves** When on, displays curves.

**Surfaces** When on, displays surfaces.

**Dependents** When on, displays dependent sub-objects.

**Surface Trims** When on, displays surface trimming. When turned off, displays all of a surface even if it's trimmed.

**Transform Degrade** When on, transforming a NURBS surface can degrade its display in shaded viewports, to save time. This is similar to using the Adaptive Degradation toggle for playing animations. You can turn off this toggle so surfaces are always shaded while you transform them, but transforms can take longer to create.

## Button set

**Set Selected** Applies the display settings active in the utility to all selected NURBS objects.

**Reset** Resets the values in the utility to the default settings for a NURBS surface.

# Tools for Low-Polygon Modeling

A couple of utilities help you manage the polygon count for scenes and animations that must not become too complex. Show Statistics, available from the viewport right-click menu, lets you monitor the number of polygons, vertices, etc., in the scene, as well as the frames per second displayed. The Level of Detail utility, available from the [Utilities panel](#) on page 7463, lets you manage the complexity of an object in the scene. For example, Level of Detail enables you to display a complex object as simple geometry when the object is at a distance from the camera.

[Show Statistics](#) on page 2493

## Show Statistics

Right-click a viewport label. > Show Statistics

Keyboard > 7

You can quickly access various statistics related to your current selection and entire scene.

---

**NOTE** These statistics are relevant primarily to mesh and poly objects. Some statistics information might be unavailable with certain other types of object.

---

### Procedures

To use the viewport statistics display:

- 1 Customize the statistics display on the Customize menu > Viewport Configuration dialog > Statistics panel.
- 2 Activate the viewport in which to display statistics.
- 3 Toggle the statistics display by pressing 7 or right-clicking the viewport label and choosing Show Statistics.

### Interface

You can customize the viewport statistics by turning on and off options on the [Statistics](#) on page 7628 panel of the Viewport Configuration dialog. The following statistics reflect all options turned on.

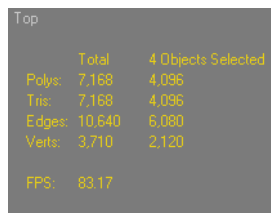

	Total	4 Objects Selected
Polys:	7,168	4,096
Tri:	7,168	4,096
Edges:	10,640	6,080
Verts:	3,710	2,120
FPS:	83.17	

The first column lists the statistics for the entire scene, while the second only refers to the selected objects.

**Polys** Displays the number of polygons in the scene and selection.

---

**NOTE** This is valid only for poly objects.

---

**Tris** Displays the number of triangle faces in the scene and selection.

---

**NOTE** If you select a polygon in a poly object, this option shows two or more triangles.

---

**Edges** Displays the number of edges in the scene and selection.

**Verts** Displays the number of vertices in the scene and selection.

**FPS** The frames per second displayed in the viewport.

## Level of Detail Utility

Utilities panel > Utilities rollout > More button > Utilities dialog > Level of Detail

The Level Of Detail utility lets you construct an object that alters its geometric complexity or level of detail based on its size in the rendered image. You create several versions of the same object each with different levels of detail, group them as one, and then run the Level Of Detail utility, which automatically creates a special LOD controller as a Visibility track. The LOD controller then hides and unhides the objects in the group, depending on their size in the rendered scene.

The main purpose of this utility is to save time in rendering complex objects and in manipulating objects in the viewports. Since a portion of rendering speed is directly related to the number of faces that must be rendered in a scene, using the Level Of Detail utility lets you reduce the number of rendered faces as an object reduces its apparent size. In addition, you can use this utility to display a simple stand-in for a more complex object in the viewports. Since the stack is not calculated for objects hidden in the viewports, you can speed up viewport manipulation by using this utility to substitute complex stack objects with simple stand-ins.

### Procedures

**To set up an object for the Level Of Detail utility:**

- 1 Create two or more objects that are identical except for their complexity.

---

**NOTE** It's best to assign materials and mapping coordinates, as well as all modifiers while the objects are still separate.

---



- 2 Select all of the objects, and use the Align tool to center all of them about a common center.
- 3 Group the objects.
- 4 Choose the Level Of Detail utility.
- 5 While the grouped object is selected, click the Create New Set button.  
The name of the objects within the group appear in the Level Of Detail list, in order of complexity; only the least complex object in the group is displayed in the viewports, while all other objects are made invisible.
- 6 Use the controls in the Level Of Detail rollout to adjust when the objects will switch their display in the rendered scene.

**To access an object's stack:**

- 1 Select the Level Of Detail object, and then choose Group menu > Open.
- 2 In the Level Of Detail utility, choose the object you want to access from the list window, and then turn on Display In Viewports (or double-click the object's name in the list window).
- 3 Select the object in the viewport.
- 4 Open the Modify panel to access that object's parameters.
- 5 When finished, choose Group menu > Close.

**To assign materials within the group:**

- 1 Select the grouped object.
- 2 Use Display In Viewports in the Level Of Detail utility to display the grouped object you want to assign the material to.
- 3 Drag the material from the Material Editor (or the Browser) over to the object in the viewport.
- 4 Choose Assign To Object in the Assign Material alert, and then click OK.

---

**NOTE** Be sure and choose Assign To Object. If you choose the default Assign To Selection, all objects in the group will be assigned the same material.

---

**To dismantle a Level Of Detail object:**

If you look at a Level Of Detail object in Track View, you'll see only the tracks for the sub-object that's currently displayed in the viewports. To see all sub-objects in Track View, you need to turn off Visible Objects.

If you need to dismantle a grouped Level Of Detail object, and restore its sub-objects to their independent states, follow these steps:

- 1 Open the Filters dialog in Track View, and turn off Visible Objects in the Show Only group box.
- 2 The tracks for all of the sub-objects in the Level Of Detail object are now visible.
- 3 Open the hierarchy of each of the sub-objects, and then select each of their Visibility tracks.
- 4 On the Track View toolbar, click the Delete Controller button.
- 5 If you also want to remove the grouping, select the grouped objects, and then choose Explode in the Group menu.

## Interface

The screenshot shows a software utility window titled "Level of Detail". It is organized into several sections:

- Level of Detail Set:** Contains three buttons: "Create New Set", "Add To Set", and "Remove From Set".
- Image Output Size:** Contains two spinners for "Width" (set to 640) and "Height" (set to 480), and a "Reset to Current" button.
- Display In Viewports:** A checkbox that is currently unchecked.
- Threshold Units:** Two radio buttons: "Pixels" (selected) and "% of Target Image".
- Thresholds:** Two spinners for "Min Size" (set to 0.0) and "Max Size" (set to 0.0), and a "Reset All" button.
- Close:** A button at the bottom of the window.

### Level of Detail Set group

Lets you create a new set, and add or remove objects from the current set.

**Create New Set** Creates a new Level of Detail set based on a currently selected group object.

**Add To Set** Adds an object to the Level of Detail set. You must first attach the object you want to add to the group object. To add an object to the set, use Align to center the object with the group object. Select the object you want to add, and then choose Attach from the Group menu, and then click the group object. Finally, click the Add to Set button, and then click the object you want added.

**Remove from Set** Removes the object highlighted in the list window from the current set. Note that the object then becomes visible in the viewports, but is still part of the group. To remove the object from the group, choose Group menu > Open, select the object you want removed, and choose Group menu > Detach. Select the group object again, and choose Group menu > Close.

### **Image Output Size group**

**Width/Height** The Width and Height spinners in this area are set to the current rendering output size each time you enter the Level of Detail utility. Using the spinners, you can change this to any resolution. If the percent of Target Image option is selected, as you change the Target Image Size, the threshold values change as well.

**Reset to Current** Resets both spinners to the current rendering output size.

**List window** Lists all of the objects in the group by complexity, with the least complex at the top of the list. The numbers at the left of each object name are the threshold values that indicate at what size the object will be displayed in the rendered scene. The numbers can be one of two types of units, pixels, or percentage of the target image. You set the type of unit in the Threshold Units group.

**Display in Viewports** Displays in the viewport the object highlighted in the list window. Only one object in the group is displayed in the viewports at any time. As a default, the least complex object is displayed, but you can look at the other objects by highlighting them in the list and selecting this item. Double-clicking the object name in the list performs the same function.

### **Threshold Units group**

The options in this group box let you choose between two types of threshold units. Switching between these two options does not alter the effect; it alters the method by which you set the thresholds.

**Pixels** The thresholds are determined by specifying the maximum pixel size of the image (measured diagonally). Use when you want to set the transfer thresholds using absolute rather than relative values.

**% of Target Image** Sets the thresholds based on the percentage of the size of the image (measured diagonally) relative to the size of the rendered output.

### **Thresholds group**

**Min Size/Max Size** Sets the minimum size of the object before it's replaced by the less complex object, and the maximum size of the object before it's replaced by the more complex object. The values vary depending on the current type of Threshold Unit. The default threshold values are initialized so that the most complex object is 100 percent of the image output size. The remaining thresholds are set using an algorithm based on a ratio of the number of faces between each object. It assumes that all faces are the same size, and then picks thresholds so that the faces would remain a constant size as displayed on the screen. Usually, this will provide the type of smooth transition you need, but you can customize the threshold values. The threshold values are interrelated between the objects, so altering the minimum size of one object, for example, will also alter the maximum size of the next object.

**Reset All** Resets all thresholds for all objects in the list, using the previously described algorithm.

---

**TIP** You can use the Level of Detail utility to create objects that display very simple geometry in the viewports, while displaying complex geometry in the rendered scene. Create a grouped Level of Detail object consisting of only two objects, the complex object and the simple object. Select the simple object in the list window and, in the Thresholds are, set its Min Size and its Max Size to 0. This will display the simple object in the viewports, but the complex object will always appear in the rendered scene, regardless of its apparent size.

---

### **Close button**

**Close** Closes the utility.



# Precision and Drawing Aids



3ds Max provides tools that give you control over the positioning and alignment of objects in 3D space. With these tools, you can do the following:

- Choose display units from the most common real-world measuring systems or define your own.
- Use the home grid as a construction plane, or use grid objects to position custom construction planes.
- Select different options to align objects with grids, points, and normals.
- Use 3D object snaps on a modeless dialog as you build and move geometry in your scene. Grid points and lines are among the many snap options.
- Use "helper objects" in your work. This category includes grid objects as well as objects used for positioning and measurement.

This section presents these brief topics designed to help you quickly start learning how to use the tools that make precision possible:

[Tools for Precision](#) on page 2502

[Using Units](#) on page 2504

[Using Grids](#) on page 2506

[Using the Home Grid](#) on page 2507

[Using Grid Objects](#) on page 2510

[Aligning Objects](#) on page 2516

[Aligning Normals](#) on page 2520

[Setting Standard Snaps](#) on page 2521

[Setting Snap Options](#) on page 2523

## Tools for Precision

A set of interrelated tools in the program gives you precise control of the scale, placement, and movement of objects in your scene. These are especially important tools for those who build precise models in real-world units of measurement.

### Basic Tools

The tools for precision are grouped as follows:

**Units** Define different measurement systems. Besides the generic unit, you have your choice of feet and inches in both decimals and fractions. Metric units range from millimeters to kilometers. You can also define other units.

**Grids** Include the home grid and special grid objects. Both types of grid can act as construction planes. The software constructs objects using the orientation and position of the active grid. While the home grid is fixed in world space, you can rotate grid objects and place them anywhere in a scene, and align them to other objects and surfaces. You can also give each grid object its own spacing, and display any grid as a dedicated viewport.

**Object alignment** Matches an object with the position, orientation, or normal of another object, or to a point in space.

**Object snaps** Ensure precise placement when creating and rearranging objects. Keyboard shortcuts let you change object snaps as you work. You can also set snaps to find grid lines and intersections. An angle snap sets the increment for rotation, and a percent snap sets the increment for scaling.

**Helpers** Provide useful assistance, as the name implies. These are specialized tools in the same category as grid objects. A Tape object measures distances in current units, and a Protractor object measure angles. A Grid object defines a construction plane, and a Point object marks a particular spot in 3D space.



## How the Tools Work Together

The tools themselves establish a general order of use and interaction, although you can always change settings as needed without following this sequence.

- Choose a measuring unit. The default is generic units, sufficient for many purposes.
- Set grid spacing (the size of the smallest square), based on the measuring unit. The home grid and grid objects can have their own spacing, separate from the grid spacing.
- Move and align grid objects to a useful orientation.
- Set or vary snap settings as needed in your work.
- Use other helper objects like Point and Tape as part of the precision process.

As you work, you can change your settings (including the measuring unit) without losing any precision.

## Helpers

Create panel > Helpers

Create menu > Helpers

Helper objects play a supporting role, like stage hands or construction assistants.

Several categories of helpers are available from the drop-down list on the Create panel:

[Standard helpers](#) on page 2530

[Atmospheric Apparatus](#) on page 6560

[Camera Helper](#) on page 5157

[Assembly Head Helper Object](#) on page 234

■ [Character Assembly](#) on page 217

■ [Luminaire Helper Object](#) on page 235

[Manipulator Helper Objects](#) on page 2552

Particle Flow ( [Speed By Icon Operator](#) on page 2796 and [Find Target Test](#) on page 2891 )

[VRML97 Helper Objects](#) on page 7093

[reactor](#) on page 3803

Other helper objects might be available, depending on your configuration.

## Using Units

Units are the key to connecting the three-dimensional world of 3ds Max with the physical world. You define the units you want to use from the [Units Setup dialog](#) on page 7601 .

### Changing Display Units

When you change display units, 3ds Max displays measurements in the new unit for your convenience. All dimensions are displayed in the new unit. Essentially, you're using a new "measuring stick." No object is changed in this process. As in the physical world, objects in the scene maintain their absolute size, regardless of how you measure them.

### Type-In Entry

When you enter any dimension, 3ds Max always assumes the number you enter is expressed in the current units. You can also enter a series of numbers: 3ds Max then converts their sum into the current unit. Here are some examples that assume the current units are in centimeters:

- When you enter a dimension of 1' (one US foot), it converts to 30.48cm.
- If you enter a series of numbers such as 14 286 175 (separated by spaces), the series is totaled to 475.0cm.
- If you enter 1' 1 (one US foot and 1 centimeter), this is converted and summed into 31.48cm.

When you use US Standard as the display unit scale, you can select either feet or inches as the default for type-in entry. If you select feet and enter 12, the result is 12' 0". However, if you enter 1' 2, the software identifies the second digit as inches, producing 1' 2" as the result.

In any unit system, you can enter fractional amounts. For example, assume you're working in US Standard with feet as the default:

- If you enter 18/3, the result is 6'0".
- If you enter 18/3", the result is 0'6".
- You can specify units in a different system, and they are converted on the fly. For example, if you enter 18/3cm, the result is 0'2.362".

## Understanding the System Unit

3ds Max keeps track of all measurements in its own internal system unit. No matter what kind of display units you use, measurements are stored in this absolute unit for storage and computation. The default system unit is defined as 1.000 inch. As long as the system unit is left at one inch, you can freely share models and change units on the fly with no effect on the underlying geometry. Except in rare circumstances, you never need to change this default scale. This means you can merge a model created with any standard unit into your scene at true scale.

You can change the system unit setting on the System Unit Setup dialog, available from the [Units Setup dialog](#) on page 7601. Changing the system unit is recommended only if your scene has very small (less than one inch) or very large dimensions. See [System Unit Setup Dialog](#) on page 7605 for more information.

If you do need to change the system unit, change it *before* you create or import geometry. Do not change the system unit in an existing scene.

# Using Grids

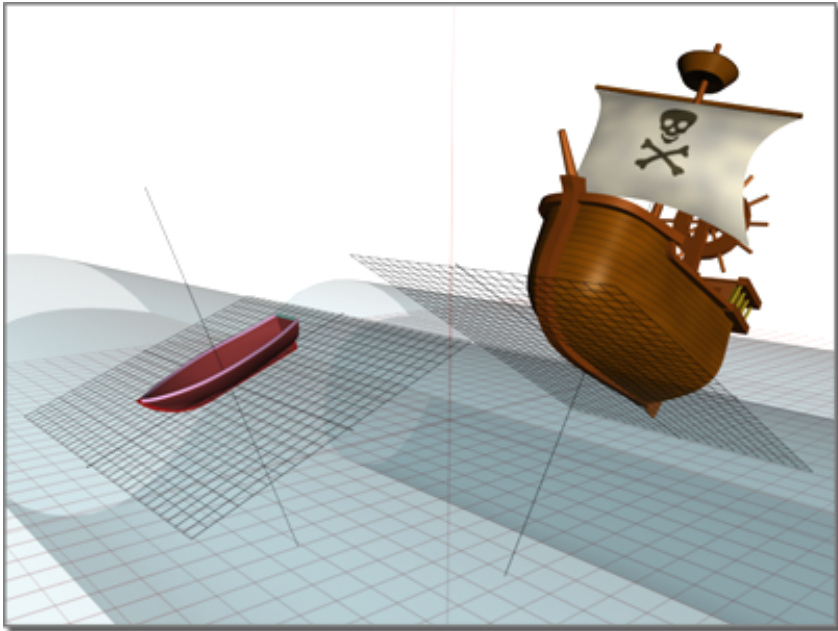

**One grid establishes the pitch of the boat, another the pitch of the ship**

Grids are two-dimensional arrays of lines similar to graph paper, except that you can adjust the spacing and other features of the grid to the needs of your work.

Grids have these primary uses:

- As an aid in visualizing space, scale, and distance.
- As *construction planes* where you create and align objects in your scene.
- As a reference system for using the Snap feature to align objects .

## **Home Grid and Grid Objects**

3ds Max provides two kinds of grids: the home grid and grid objects. In addition, it includes the AutoGrid feature, an automated way of creating grid objects.

**Home grid** The home grid is defined by three planes along the world X, Y, and Z axes. Each of these axes passes through the world coordinate system's origin point (0,0,0). The home grid is fixed; it cannot be moved or rotated.

- The home grid is visible by default when you start 3ds Max, but its display can be turned off.
- You can use any view of the home grid as a construction plane by drawing in the viewport in which the grid's view appears.

See [Viewing and Navigating 3D Space](#) on page 55 for a complete introduction to the home grid.

**Grid objects** A grid object is a helper object you can create whenever you need a local reference grid or construction plane somewhere other than the home grid.

- You can have any number of grid objects in your scene, but only one can be active at a time.
- When active, a grid object replaces the home grid in all viewports.
- Each grid object has its own set of XY, YZ, and ZX planes. You can freely move and rotate grid objects, placing them at any angle in space, or attach them to objects and surfaces.
- You can change a viewport to display a plan (top) view of any active grid object.
- Grid objects can be named and saved like other objects, or used once and deleted.

**AutoGrid** This feature lets you create new objects and grid objects off the surfaces of other objects on the fly. See [AutoGrid](#) on page 2513 .

## Using the Home Grid

The home grid provides ready-to-use construction planes, much like a leveled building site marked with stakes and strings. When you create an object in a viewport, the new object is placed on the home grid plane of that viewport.

To use the home grid effectively for construction, you often need to change the defaults to the job at hand, analogous to moving the stakes and strings to match your own site plan.

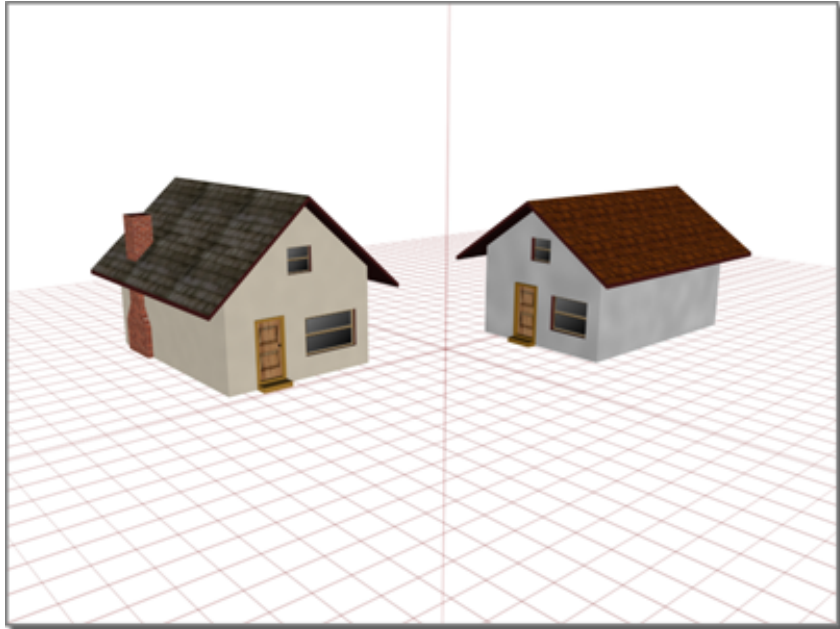

Using the home grid to position houses

### Changing Home Grid Settings

The home grid is a single system; its three planes use the same settings for grid spacing and major line divisions. You change these settings from a single panel of the Grid and Snap Settings dialog.

To access the Home Grid panel, do one of the following:

- 1 Choose Customize menu > Grid And Snap Settings, then click the Home Grid tab.
- 2 Right-click any [snap button](#) on page 2567 , then click the Home Grid tab.

### Setting Grid Spacing

Grid spacing is the size, in current units, of the grid's smallest square. The basic idea is to choose a grid spacing that corresponds to your unit of measurement, then choose a larger spacing for multiple units.

For example, if you have units set to centimeters, you might make one grid space equal to 1.000 (one unit, or one centimeter in this case).

## **Setting Major Grid Divisions**

The home grid displays heavier or "major" lines to mark groups of grid squares. You can use these to represent larger units of measurement.

For example, if you use a grid spacing of one centimeter, you might use a value of 10 so the major grid divisions represent one decimeter.

## **Setting Color and Intensity**

To improve grid visibility, you can change the intensity or color of the home grid. Choose Customize menu > Customize User Interface > [Colors panel](#) on page 7505 .

# Using Grid Objects

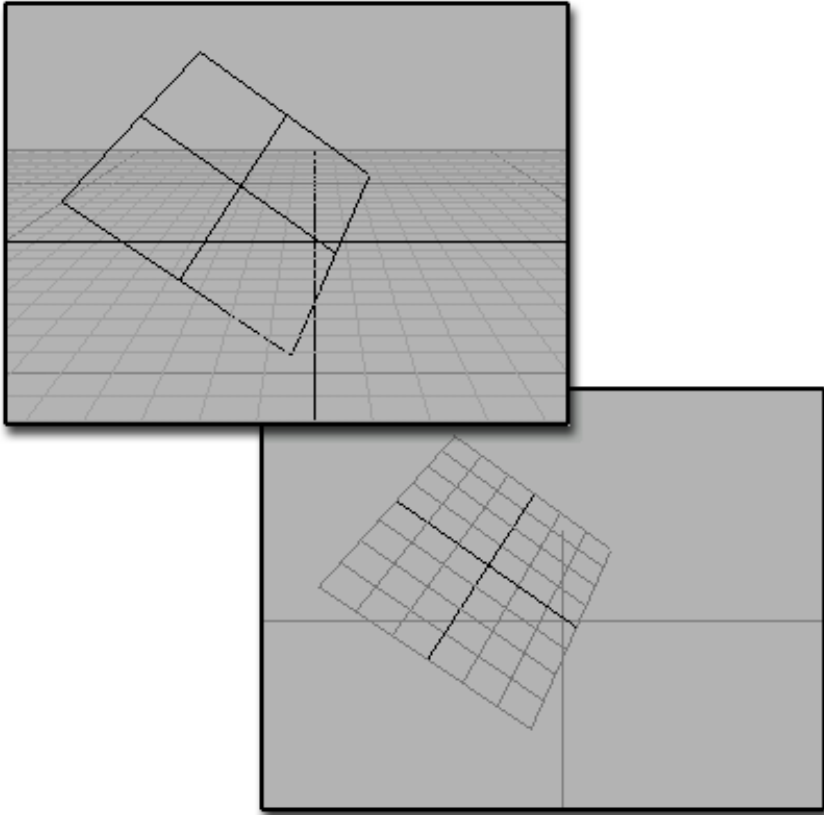

**Above: Inactive grid object in a scene**

**Below: Activated grid object**

Grid objects let you bypass the home grid and work on separately defined grids to create and position objects. You can use as many grid objects as you like, each serving as a custom construction plane with its own grid settings.

Grid objects are 2D parametric objects, with adjustments for overall size and grid spacing. You can adjust their orientation in world space, and match them to a particular surface or object.



### To activate a grid object:

- 1 Create or select a grid object.
- 2 Choose Views > Grids > Activate Grid Object.

### To deactivate a grid object, do one of the following:

- Select and activate another grid object.
- Choose Views > Grids > Activate Home Grid.
- Delete the grid object.

## Creating and Modifying Grid Objects

You find Grid objects in the Create panel > Helpers category.

When creating an object, you can also create a temporary "AutoGrid" grid object that's tangent to an existing object surface at the point you click. To do this, turn on the [AutoGrid](#) on page 2513 check box in the Object Type rollout. You can save this grid by holding the Alt key before you click.

Grid objects are named when you create them and are saved with the scene. You can delete them at any time.

Like other objects created in 3ds Max, standard grid objects are placed on the grid of the current viewport. By default, this is a plane of the home grid, but can also be another activated grid object.

For more information on grid object settings, see [Grid](#) on page 2538 .

# Viewing Grid Objects

An activated [grid helper object](#) on page 2538 creates a true plane in 3D space. No matter how small an activated grid object appears on the screen, its plane is effectively infinite, just as if it were a plane of the home grid. However, you can view a given grid object in different ways.

## Setting the Display Plane

You can adjust the visible plane of a selected or activated grid object on the Modify panel.

### To set the display plane:

- 1 Open the Modify panel to display the Parameters rollout for the selected grid.
- 2 In the Display group, choose any of the three planes: XY, YZ, or ZX.  
The grid rotates in world space to display the corresponding plane, always based on the grid's local axis.

You can move or rotate a grid, either before or after setting its display plane.

### Setting Grid Views

You can set the view in any viewport to an orthographic view as well as the display view.

#### To set grid view:

- 1 [Activate the grid object.](#) on page ?
- 2 Right-click a viewport label and choose Views > Grid to display a menu of possible views.
- 3 Choose Front, Back, Top, Bottom, Right, Left, or Display Planes. Display Planes corresponds to the current setting on the Parameters rollout (XY, YZ, or ZX).  
The viewport now shows this view of the grid.

You can set different viewports to different views of the grid. Objects are always created on a view's orthographic grid, even if you rotate the angle of view. In other words, you can set up a convenient view and still construct on the chosen plane.

### Deactivating Grid Objects

You can deactivate a grid object in any of the following ways:

- Select and activate another grid object.
- Choose Views > Grids > Activate Home Grid.
- Delete the grid object.

When you deactivate a grid object, any viewports based on that grid switch to the corresponding orthographic view. For example, a Grid (Front) viewport

becomes a Front viewport. A Grid (Display Planes) viewport always switches to Top view, regardless of the currently displayed plane.

## AutoGrid

Create panel > Any object category > Object Type rollout

Extras toolbar > AutoGrid

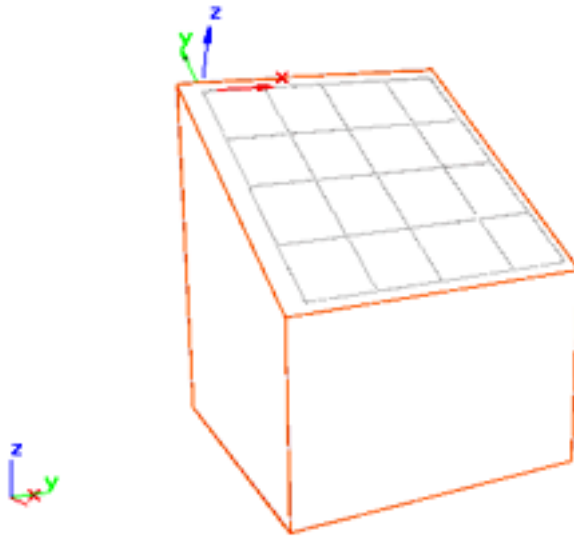



**AutoGrid used to position the second block on top of the first**

AutoGrid lets you automatically create, merge, or import objects on the surface of other objects by generating and activating a temporary construction plane based on normals of the face that you click. This serves as a more efficient way of stacking objects as you create them, rather than building objects and then aligning them as a separate step.



You can use objects within an XRef scene as reference when AutoGrid is on.

---

**NOTE** If the Smooth check box is turned on in the Parameters rollout of a parametric object, the construction plane is placed tangent to the face of the surface implied by any smoothing present on the surface, not the actual face of the surface.

---

## Procedures

**Example: To create a box aligned to another object using a temporary construction grid:**

- 1 Create or load a scene containing an object to which you want to align a new box .



- 2 On the Create panel > Standard Primitives > Object Type rollout, click Box.

- 3 Turn on AutoGrid .

- 4 Merge the object you want aligned.

- 5 Move your cursor over the object to which you want to orient the box you are about to create .

The cursor includes an X,Y,Z tripod to help you orient the position of the new object. As you move over the object, the cursor aligns the Z axis to the surface normal.

- 6 When the orientation is as you want it, click and use the standard drag-release-move-click method to create the box. The box will be created on the designated surface.

When you click, a temporary, automatic grid is created, and the newly created object is aligned to that grid.

## Interface

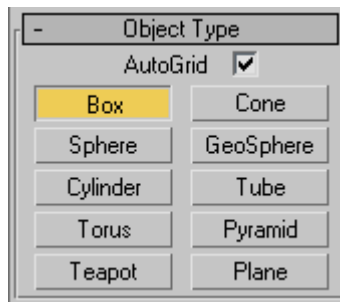

### Object Type rollout

**AutoGrid** AutoGrid is available only after you select an object button (such as Box). When you turn AutoGrid on, the cursor includes an axis tripod to

help you orient the grid. Before clicking and as you position the cursor over a visible mesh object, the cursor jumps to the nearest point on that surface. The tripod's X and Y axes form a plane tangent to the object surface (forming an implied construction grid), and the Z axis is perpendicular to the plane.

After creating the object, 3ds Max places it on the temporary construction grid. When creating an object, if the cursor isn't over another object, 3ds Max places the object on the current active grid.

---

**TIP** When you create an object that requires multiple clicks, AutoGrid applies only to the first click. So, for instance, if you want to create a [Line spline](#) on page 551 that snaps to the faces of a sphere, turn on [Snaps](#) on page 2568 (press the S key), and then open the [Grid And Snap Settings dialog](#) on page 2578 and turn on Face.

---

**NOTE** To make the grid permanent, hold down the Alt key before you click. The grid becomes active and 3ds Max turns AutoGrid off.

---

## Aligning Objects

You can align a selection consisting of one or more objects, called the *source*, with a *target* object. There are many uses for this feature. For precision, an important use is grid alignment. You can create a new grid object and align it to an existing object, either manually after creation or automatically during creation using the [AutoGrid](#) on page 2513 feature. Conversely, you can move an object onto a grid anywhere in your scene.



Aligning objects by the center, bottom, or top of their bounding boxes

### Source and Target Objects

Alignment involves two entities: one is the source object or selection set, where the process begins; the other is the target object, where the selection process ends.

**Source object** Object or objects you want to move into alignment with another object. You select one or more source objects to begin the alignment process.

**Target object** Object used to define the alignment. You select the target object during the alignment process. It cannot be selected beforehand.

After selecting the source, choose Tools menu > Align or click the Align button on the Main toolbar, and then select the target object.

Next, the Align dialog appears. For discussion of the Align options, see [Align](#) on page 938 .

## Setting a Coordinate System

The effects of alignment depend on the current reference coordinate system, such as View, World, or Local. You should decide which system you want to use before beginning alignment.

**Reference Coordinate System** Determines the axes used for positional alignment and the size of the bounding box for maximum and minimum positions.

### To align objects using active grid axes:

- Choose Grid as the reference coordinate system from the list on the toolbar.

### To align two objects using their own axes:

- Choose Local as the reference coordinate system. Alignment is then strictly between the two objects. Object bounding boxes determine maximum and minimum positions.

As a reminder to you during the alignment process, the current reference coordinate system appears in parentheses following the Align Position label in the Align Selection dialog.

## Basics of Aligning Objects

Alignment controls are on a single dialog. As you make a setting, the object being aligned moves immediately to the new position. This lets you experiment with alignment until you get what you want. Settings can be made in any order.

You can also work step-by-step, by applying position choices, for example, before deciding on final orientation. You can cancel at any time, returning the scene to its original state. You can also undo any alignment and start over.



## Aligning Multiple Objects



Aligning multiple objects to the arrow object (each photo is adjusted in a different correction)

When you select multiple objects for alignment, the same settings apply to all of them. However, the effect on each source object can be different. In practice, you're aligning separate objects at the same time with the same settings.

To align a collection of objects as a single unit, select the objects and [group](#) on page 206 them. The alignment now takes place relative to the pivot and bounding box of the entire group.

### Sub-Object Alignment

You can use Align with any selection that can be transformed. The tripod axis becomes the source for alignment. You do this by accessing the sub-object level of the object before clicking Align.

# Aligning Normals

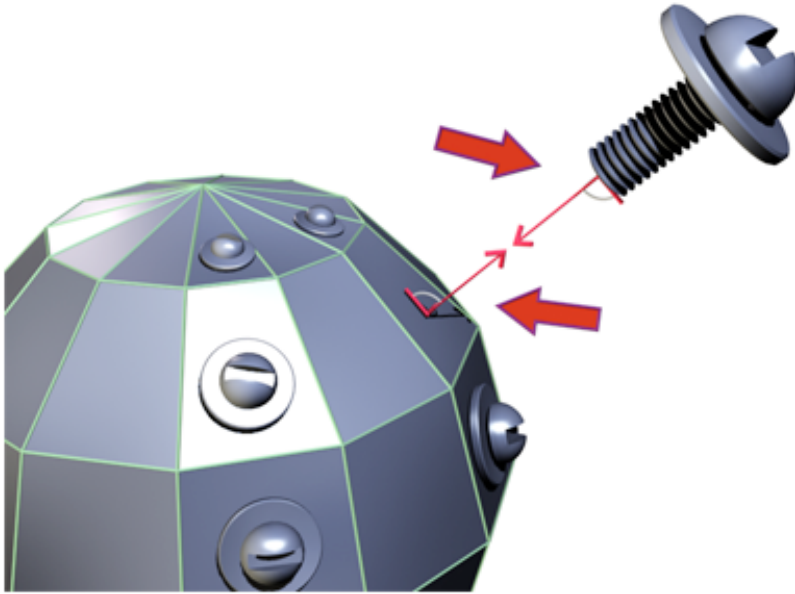

Normal on the front of the bolt is aligned with the normal of a face on the assembly.

3ds Max lets you align the normals between any two objects. In the case of mesh objects, the alignment is between individual faces, because each face has its own normal. See [Normal Align](#) on page 945 .

## Basics of Aligning Normals

Before you begin, select a view that lets you see both objects you want to align. If necessary, you can navigate the view after selecting the first normal. To see face normals clearly, work in a wireframe viewport.

For details on the procedure and dialog settings, see [Normal Align](#) on page 945 .

## Other Align Options

The Align flyout on the main toolbar has other buttons that provide specialized alignments.



**Align Camera** Orients a camera viewport to a selected face normal, with the normal in the center of the viewport and on the axis of the camera. See [Align Camera](#) on page 950 .



**Align to View** Orients a local axis of an object or sub-object selection with the current viewport. Options on the dialog are interactive, as they are on the Normal Align dialog. See [Align to View](#) on page 951 .



**Place Highlight** Orients a face normal to a light. See [Place Highlight](#) on page 948 and [Lighting in 3ds Max](#) on page 4904 .

## Setting Standard Snaps

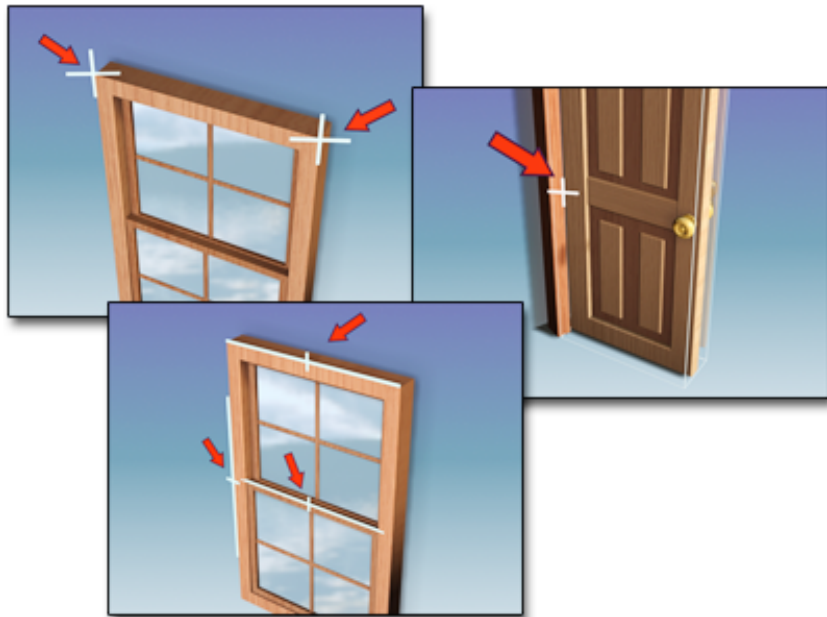

Snapping to: endpoints, midpoints, edges

Standard snaps give you control in creating, moving, rotating, and scaling objects. You access the snap features in the program from buttons on the main toolbar .

You make most snap settings on Grid And Snap Settings, a modeless dialog with four panels. You can move this dialog to any convenient location on your screen and turn options on and off as you work. Panels are reset to defaults for each new session.

You can also make commonly used snap settings on the [Snaps toolbar](#) on page 2579 .

Snap settings are stored in the [3dsmax.ini on page 51](#) file rather than in the MAX file. This means that the state of the snap settings persists from session to session without your having to modify the *maxstart.max* file.

### **Grid And Snap Settings Dialog and Snaps Toolbar**

The most commonly used grid and object snaps appear on the [Grid and Snap Settings dialog](#) on page 2577 . This is the general sequence for using these snaps:



- 1 Turn on snapping by clicking the Snaps Toggle button on the main toolbar, and then right-click this button to display the Grid And Snap Settings dialog.

Two sets of snap types are available: Standard (the default) and NURBS. Both are discussed in [Snap Settings](#) on page 2578 .

You can also make commonly used snap settings on the [Snaps toolbar](#) on page 2579 .

- 2 Turn on OSNAPS on the status bar, then right-click this button to display the Grid and Snap Settings dialog.

- 3 By default, only the Grid Points snap type is active. Turn on other snap types to activate them. When you create or move objects, these snaps are now in effect anywhere in 3D space, and unaffected by the current transform coordinate system.

As you move the cursor, each snap type is marked by a distinctive icon shown on the Snap panel. The current icon indicates the type and position of the next snap.

Grid points and grid lines are secondary to the other snap types. For example, if both Grid Point and Vertex are active, the software snaps to a vertex in preference to an equally close grid point.

- 4 Turn snaps on and off as needed; the easiest way is by pressing the S key.

For more information on snaps, see [2D Snap](#), [2.5D Snap](#), [3D Snap](#) on page 2568 and [Snap Settings](#) on page 2578 .

### Snap Override

Snap Override bypasses currently selected snaps. You use a keyboard-mouse combination or a keyboard shortcut to define a new snap for the next click. You can override on the fly, one snap at a time.

For example, while creating a spline between grid points, you might need to snap to a vertex or midpoint of an object. This is the general procedure:

- 1 As you use preset snaps to create or move an object, hold down Shift and right-click. This pops up a three-quadrant right-click menu, which you can use to override the current snap setting(s).

---

**NOTE** You can begin the creation or transformation process before accessing the override menu. This typically means that you'll be holding down the left button as you Shift+right-click.

---

- 2 From the Snap Override quadrant, choose the snap type you want to use. The cursor switches to this type.
- 3 Make the snap. After the snap, currently set snaps are back in effect.

In addition, the Snap Override quadrant lets you reuse the last override you used (listed by name), and gives you an option for None. None turns off snapping entirely on the next click. The Snap quad menu also contains an Options quadrant, with toggles for snapping within current transform constraints (default=off) and snapping to frozen objects (default=off).

## Setting Snap Options

You can access a number of snap features from the Options tab of the Grid and Snap Settings dialog. Right-click any of the snap buttons on the main toolbar to display the Grid And Snap Settings dialog or choose Customize menu > Grid And Snap Settings, then click the Options tab.

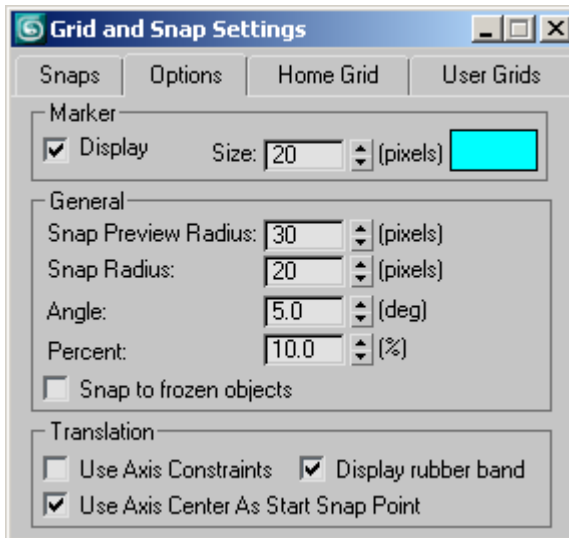

See also:

- [Snap Options](#) on page 2587

## Display and General Settings

**Marker settings** Determine the color and size of the snap cursor. To prevent the snap cursor from appearing, turn off Display.

**Snap Radius settings** Determines how close the cursor needs to approach a snap point before the snap preview or actual snap takes place. These are global settings, affecting all snap interactions, and are measured in terms of the pixels in a "search region" around the active point of the cursor.

**Snap to Frozen Objects** Normally, if an object is frozen you can't snap to it; this option lets you snap to frozen objects.

## Settings for Angle and Percent Snap

The following Options settings are for two snap buttons that operate independently of standard snaps.

**Angle (deg)** A global setting, in degrees, that determines the angle of rotation for a number of features in the program, including the standard Rotate transform. As you rotate an object (or group of objects), the object moves

around a given axis in the increment you set. Angle snap also affects the following:

- Pan/Orbit camera controls
- FOV and Roll camera settings
- Hotspot and Falloff light angles

For more information, see [Angle Snap](#) on page 2570 .

**Percent** Sets a percentage increment during a scaling operation.

For more information, see [Percent Snap](#) on page 2571 .

### Rotating and Scaling with Snaps

The effect of rotating and scaling with snaps depends on whether [Auto Key](#) on page 7344 is on or off:

- With Auto Key *on*, snap toggles are disabled, while Angle and Percent snaps remain active. Rotation and scaling occur around the pivot point of the object.
- With Auto Key *off*, rotations and scales occur around the snap point. For example, using Vertex snap, you can rotate a box about any of its corners.

### Translation Options

By default, the [Use Axis Constraints](#) on page 884 option is off. The current setting on the Axis Constraints toolbar (XY, for example) has no effect. Turning on this option lets you use snaps in conjunction with axis constraints.

The Translation group also lets you toggle display of a rubber band line between the start and end points during a snap operation.

### Settings for Spinner Snap

You set the spinner snap on the [General panel](#) on page 7536 of the Preferences dialog. Right-click the Spinner Snap button on the main toolbar to display this panel.



**Spinner snap** Sets a numerical increment for spinner fields. If you're using generic units of 1 inch, a setting of 12 would let you resize objects by one foot with every click, or add 12 segments to a sphere.

The same setting applies to all spinner fields. Since spinner snap is a toggle, you can easily turn it on when needed and use the default at other times. Spinner snap has no effect on dragging a spinner, only on single clicks.

For more information, see [Spinner Snap](#) on page 2572 .

## Measuring Distances

3ds Max provides several options for measuring various aspects of your scene. The tape, protractor and compass helpers measure distance, angles and direction respectively. The Measure utility has a floater to display various measurements of any selected object.

You can quickly measure the distance between two points with the [Measure Distance tool](#) on page 2529 .

### Helper Objects for Measurement

#### Tape Helper

You can create a [Tape helper](#) on page 2546 by dragging between any two points in 3D space, much like using a physical tape measure. You then read the length on the Parameters rollout.

If you turn on Specify Length, the length field lets you enter a value in current units. This is like locking a tape measure to a set length. You can position the tape object and snap to its ends.

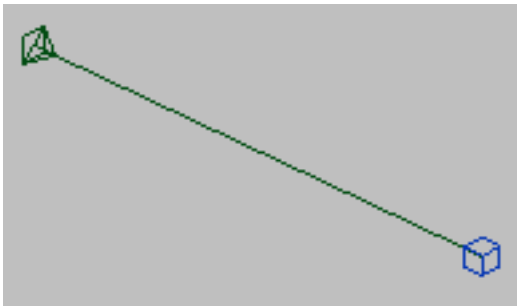

The pyramid icon is the tape helper object; the cube is the helper object's target.

- To display length and angle settings, select only the tape helper object (the pyramid icon).



- To move the entire tape including its target (the cube icon), select the connecting line.

Two sets of World Space Angles give you current readouts to the three world axes (X, Y, Z) and the three world planes (XY, YZ, ZX).

---

**TIP** When measuring with precision, it is helpful to use snaps to force the ends of the tape object to exact locations. If there are no specific points to snap to, you can use dummy or point helpers to set points.

---

#### To measure with a tape helper using snaps:

- 1 Locate points in the scene to which you can snap to accurately make a measurement. If no points like this exist, create [point objects](#) on page 2544 at measurement extremes.
- 2 Choose 3D from the Snap Toggle flyout.
- 3 Right-click the Snap Toggle button to display the Grid and Snap Settings dialog. On the Snaps tab, set the snap type to the type you will use for measurement. For example, if you are going to use point objects for measurement, check the Pivot option so you can snap to the point objects' pivot points. Close the dialog.
- 4  On the Create panel, click the Helpers button, then click Tape. Move the cursor over the first measurement point until the snap cursor appears, then click and drag to the other measurement point.
- 5 Read the length of the tape on the Parameters rollout.

#### Protractor

The [Protractor helper](#) on page 2549 measures the angle between pivot points of two objects and the protractor object.

As with the tape helper, point objects and snap tools can be used to aid in precise measurement of angles.

#### To measure an angle with a protractor:

- 1  On the Create panel, click the Helpers button, then click Protractor. Click in a viewport to place the protractor object.

- 2 On the Parameters rollout, click Pick Object 1 and select an object in your scene. The name of the selected object appears above the pick button. A line connects the protractor to the center of the object.
- 3 Click Pick Object 2 and pick a second object. The angle between the protractor and the two objects appears on the rollout.
- 4 To move either object while watching the Angle readout, turn on the Pin Stack button in the Modifier Stack rollout. This locks the stack to the Protractor's Parameters rollout.

## Compass

The [Compass helper](#) on page 2551 establishes an orientation for your scene. You create this object with a single click and drag to define the radius, usually in a Perspective or Top view. On its parameters rollout, you can adjust the apparent radius of the compass rose. Like all helper objects, this object is for reference only and does not render.

## Measure Utility

The [Measure Utility](#) on page 2597 provides measurements of a selected object or shape.

### To use the Measure utility:

- 1 On the Utilities panel, click Measure to display the Measure rollout.
- 2 Select any shape or object and read out the measurements. If you select multiple objects, the sum of the measurements is displayed.
- 3 Click New Floater to display a modeless Measure dialog with all the same information.
- 4 Use the Measure dialog to display the length of a spline, like a line or circle, as you create it.

## Measure Distance Tool

The Measure Distance tool quickly calculates the distance between two points.

### To measure the distance between two points:

- 1 Choose Tools menu > Measure Distance
- 2 Click in the viewport where you want to start measuring.

- 3 Click in the viewport where you want to measure to.  
A distance is returned in the Mini Listener. Additional information, detailing the distance along the X, Y, and Z coordinates is displayed in the status bar.

## Measure Distance Tool

Tools menu > Measure Distance

The Measure Distance tool lets you quickly calculate the distance between two points, using just two clicks. The calculated distance is displayed in [display units](#) on page 7601 in the status bar.

### Procedures

**To measure the distance between two points:**

- 1 Choose Tools menu > Measure Distance.
- 2 Click in the viewport where you want to start measuring from.
- 3 Click again in the viewport where you want to measure to.  
A distance is returned in the status bar. Additional information, detailing the distance along the X, Y, and Z coordinates is displayed as well.

## Select And Manipulate



Main Toolbar > Select And Manipulate button

The Select And Manipulate tool lets you edit the parameters of certain objects, modifiers, and controllers by dragging "manipulators" in viewports.

---

**NOTE** Unlike Select And Move and the other transforms, this button's state is non-exclusive. As long as Select mode or one of the transform modes is active, and Select And Manipulate is turned on, you can manipulate objects. However, you must turn off Select And Manipulate before you can select a manipulator helper.

---

You can add these custom manipulators to your scene:

[Cone Angle Manipulator](#) on page 2552

[Plane Angle Manipulator](#) on page 2556

[Slider Manipulator](#) on page 2559

These features have manipulators built in, which you can use to change parameters on these objects:

[IK Solver Properties Rollout \(HI Solver\)](#) on page 3336

[Reaction Controllers](#) on page 3147

[Target Spotlight](#) on page 4927

[Target Directional Light](#) on page 4932

[mr Area Spotlight](#) on page 4948

[Free Spotlight](#) on page 4930

[Spotlight Parameters](#) on page 5051

[UVW Map Modifier](#) on page 1849

[Primitives](#) on page 345 with a Radius parameter have a built-in manipulator for the radius.

## Standard Helper Objects

Create panel > Helpers > Standard > Object Type rollout

Create menu > Helpers

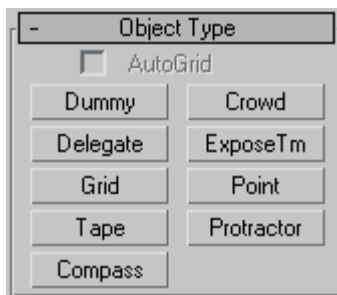

The standard set of helper objects includes the following:

[Dummy Helper](#) on page 2531

[Crowd Helper](#) on page 4738

[Delegate Helper](#) on page 4730

[Expose Transform Helper](#) on page 2532

[Grid Helper](#) on page 2538

[Point Helper](#) on page 2544

[Tape Helper](#) on page 2546

[Protractor Helper](#) on page 2549

[Compass Helper](#) on page 2551

**See also:**

- [Atmospheric Apparatus](#) on page 6560
- [Camera Helper](#) on page 5157
- [Assembly Heads Helper](#) on page 235
- [Manipulator Helper Objects](#) on page 2552
- Particle Flow helpers: [SpeedByIcon](#) on page 2796 and [Find Target](#) on page 2891
- [VRML97 Helper Objects](#) on page 7093
- [reactor Helpers](#) on page 3830

## Dummy Helper

Create panel > Helpers > Standard > Object Type rollout > Dummy

Create menu > Helpers > Dummy

A Dummy helper object is a wireframe cube with a pivot point at its geometric center. It has a name but no parameters, you can't modify it, and it doesn't render. Its only real feature is its pivot, used as a center for transforms. The wireframe acts as a reference for transform effects.

The dummy object is used primarily in hierarchical linkages. For example, you can use a dummy object as a center of rotation by linking a number of different objects to it. When you rotate the dummy, all of its linked children rotate with it. A dummy is often used this way to animate linked motion.

Another common usage of a dummy object is in the animation of target cameras. You can create a dummy and position a target camera within the dummy object. Then you can link both the camera and its target to the dummy, and animate the dummy with a path constraint. The target camera will follow the dummy along the path.

Dummy objects are always created as cubes. You can change the proportions of dummies by using non-uniform scaling, but avoid this on dummies that are within a hierarchical linkage; this can introduce unexpected results.

### **Procedures**

**To create a dummy object:**

- Click Dummy and drag a cube to any convenient size.

### **Interface**

Dummy objects don't have any parameter rollouts or settings.

## **Expose Transform Helper**

Create panel > Helpers > Standard > Object Type rollout > ExposeTm

Create menu > Helpers > Standard > ExposeTm

The Expose Transform helper exposes values of non-keyed objects for use in expressions and scripts. This lets riggers and animators access a select set of transforms for an object, and between an object and its parent, such as a bone in an IK chain. For example, using the Expose Transform helper, you could write a script or use parameter wiring that tests the angle of a character's arm bone that's controlled by IK (thus, has no keys), and once it exceeds a specific value, rotate the corresponding clavicle bone to deform the shoulder area.

In the viewports, the Expose Transform helper object looks just like a [Point helper](#) on page 2544 .

### **Procedures**

**To use the Transform helper:**

- 1 Click ExposeTm and choose the appearance characteristics from the Display rollout.

- 2 Adjust the size of the helper object by using the Size spinner on the Display rollout. Default=20.0
- 3 Click anywhere in your scene to add the helper object.  
The helper object's position has no bearing on its functionality.
- 4 On the Modify panel > Parameters rollout, click the Expose Node button (default label: None) and select the object whose transform values you want to expose.  
The object's name appears on the button, and its transform values appear in the fields on the Expose Values rollout.
- 5 Optionally, turn off Parent and choose a Local Reference Node object.  
This option is used by the Local Euler Angles, Distance To Reference, and Angle parameters. If the object has no parent and you don't specify a Local Reference Node object, these fields use the world center (0,0,0) as the reference node.
- 6 To use a transform value in a script or expression, first click the M button next to the parameter value.  
This copies the transform name, using MAXScript notation, to the copy buffer.
- 7 Paste the contents of the buffer to your script or expression.  
A sample result of this is "\$ExposeTransform01.localPositionX". 3ds Max interprets this as the local position, on the X axis, of the Expose Node object.

## Interface

### Parameters rollout

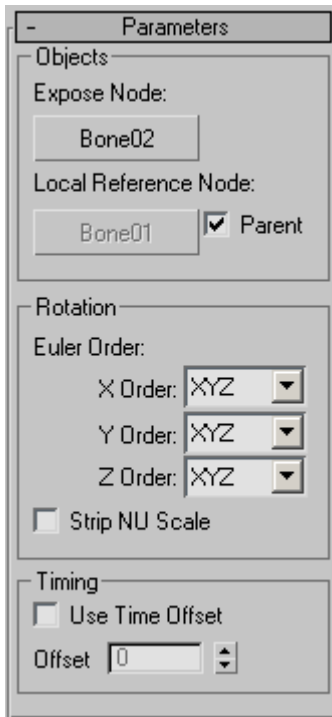

These settings let you specify the exposed node, a reference object other than the parent, and rotation and timing parameters.

**Expose Node** The object from which the values are generated. Click the button, and then select the object. Thereafter, the object name appears on the button.

**Local Reference Node** The object whose relationship with the Expose Node object is used to generate local data for rotation, distance, and angle. Click the button, and then select the object. Available only when Parent is off.

By default, this is the parent object, but you can turn off Parent and then specify a different object.

**Parent** When on, the Local Reference Node is set automatically to the parent of the Expose Node. When off, you can pick an object to refer to for local data. Default=on.



This is used by the Local Euler Angles, Distance To Reference, and Angle parameters. If the object has no parent and you don't specify a Local Reference Node object, these fields use the world center (0,0,0) as the reference node.

**Rotation Order** These three settings determine the order in which the Expose Transform helper will look for an Euler rotation.

This parameter corrects for anomalies that can be introduced when a local rotation value is generated in relation to other rotation values. For example, when Z Order is set to XYZ, the Z value is generated in reference to X and then Y. Or when X Order is set to ZXY, the Z value is generated directly in reference to the parent, regardless of X and Y rotations.

**Strip NU Scale** When on, removes any non-uniform scaling that could influence the rotation data. It does not strip non-uniform scaling from the object; only from the values generated.

**Use Time Offset** When on, lets you specify a frame other than the current one from which to gather data. The Offset value is added to the current frame to derive the frame from which data is gathered.

For example, if the current frame is 20 and you wish to gather data from frame 15, turn on Use Time Offset and set Offset to -5.

### Display rollout

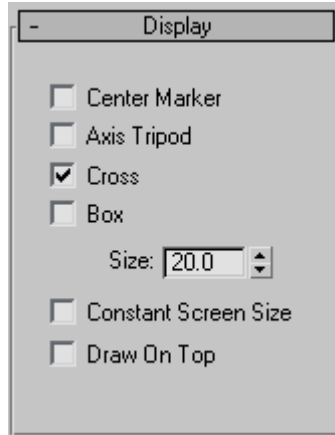

Lets you specify how the helper object appears in the viewports. By default, the display type is set to Cross only, and Size is set to 20.0. You can activate multiple display settings if you like.

**Center Marker** Displays a small X marker at the center of the helper object.

**Axis Tripod** Displays a tripod axis indicating the position and orientation of the helper object.

**Cross** Displays an axis-aligned cross.

**Box** Displays a small axis-aligned box at the center of the helper object.

**Size** Sets the size for the helper object. Use this setting to minimize the helper object, or increase its size to aid in locating it. Default=20.0.

**Constant Screen Size** Keeps the size of the helper object constant, regardless of how much you zoom in or out.

**Draw On Top** Displays the helper object on top (or in front) of all other objects in the scene.

## Exposed Values rollout

- Exposed Values

Display Exposed Values

Local Euler Angles

X:  M

Y:  M

Z:  M

World Euler Angles

X:  M

Y:  M

Z:  M

Local Position

X:  M

Y:  M

Z:  M

World Position

X:  M

Y:  M

Z:  M

Bounding Box

Length:  M

Width:  M

Height:  M

Distance To Reference

M

Angle

M

This rollout provides readouts of values for all transform values of the Expose Node object. Each value has a button labeled “M” next to it; click this button to copy the MAXScript associated with the value to the clipboard, which you can then paste into a script.

**Display Exposed Values** When on, transform values for the Expose Node object appear on this rollout, and update as the values change. When off, values don't appear, but the M buttons still function normally.

**Local Euler Angles** Rotation values with respect to the parent or Local Reference Node object.

**World Euler Angles** Rotation values in the world coordinate system.

**Local Position** Position values with respect to the Expose Node object's local coordinate system.

**World Position** Position values in the world coordinate system.

**Bounding Box** The maximum dimensions of the object.

**Distance to Reference** The distance between the Expose Node object and its parent or the designated Local Reference Node object. If neither exists, this shows the distance to the world center (0,0,0).

**Angle** The angle between the Expose Node object and its parent or the designated Local Reference Node object.

## Grid Helper

Create panel > Helpers > Standard > Object Type rollout > Grid

Create menu > Helpers > Grid

The grid, also called User Grid or Custom Grid, is a 2D parametric object with adjustments for overall size and grid spacing. You can move and orient user grids anywhere in world space.

You can create any number of grid objects in your scene. You name them when you create them and save them with the scene. You can delete them at any time.

Like other objects you create in the software, grid objects are placed on the grid of the current viewport. By default, this is a plane of the home grid, but it can also be another activated grid object.

---

**NOTE** You can use [AutoGrid](#) on page 2513 to create a temporary or permanent user grid off the surface of any object.

---

## Using the Grid Object

You can use the grid object as a construction plane on all three orthographic planes in both directions. Here's how it works:

In the Parameters rollout of each grid object is a Display group with three options: XY Plane, YZ Plane, and ZX Plane. These determine which of the three planes of the grid object is displayed in the viewport.

When you activate a grid object, the displayed plane is the construction plane for all viewports. When you create a grid viewport, you can choose from one of six orthographic views (Front, Top, Left, and so on), or you can choose a special Display Planes grid viewport. (When you press the G key to create a grid viewport, the Display Planes type becomes the default.) The Display Planes type of grid viewport always displays the plane chosen by the three option buttons under Display. Thus, as you switch between XY Plane, YZ Plane, and ZX Plane, the view through the grid viewport switches accordingly, and objects created in that viewport are created on the displayed plane.

When you right-click a viewport label (or go to the Layout tab of the Viewport Configuration dialog), you can choose six additional types of grid viewports, based on the six orthographic views. These are available by a cascading Grid menu that provides Left, Right, Front, Back, Top, Bottom, and Display Planes. Each of the orthographic directions is local to the grid object, regardless of its orientation in the scene.

When you choose a specific orthographic grid viewport (as opposed to the Display Planes viewport), the construction of objects in that viewport is on the plane specified in the viewport title regardless of the displayed plane of the grid object.

You can create more than one viewport based on the same grid object, with each using a different plane. For example, you can have a Grid (Front) viewport and a Grid (Top) viewport, as well as a Grid (Display Planes) viewport.

When you deactivate a grid object, its remaining viewports show the assigned orthographic view. Thus, a Grid (Front) viewport becomes a Front viewport, for example. A Grid (Display Planes) viewport always reverts to a Top view, regardless of the currently displayed plane.

## Scaling Not Advised

As a rule, don't use scaling to resize a grid object. Scaling enlarges or reduces the apparent size of the grid object but has no effect on grid spacing. A sphere 20 units in radius created on a grid object appears smaller than another 20-unit sphere created on a scaled-up version of the same grid.

If you want to change the actual size of the grid object, select it and go to the Modify panel > Parameters rollout > Grid Size group, and change the Length and Width settings.

## Locating Grid Tools

Grid tools are spread throughout the 3ds Max interface.

- In the Views menu, under Grids, are the commands to activate home and user grids.  
The same tools are available with a right-click anywhere in the viewport when a grid helper is selected.
- Right-click anywhere in the viewport while a grid object is selected and the Tools1 quadrant of the quad menu provides commands to activate the home and user grids.
- Choose Customize menu > Grid and Snap Settings to display the [Grid and Snap Settings dialog](#) on page 2577 . Two tabs are devoted to Grid tools, one for home, another for user grids. You can change parameters of any active grid using the Modify panel.

See also:

- [Viewing Grid Objects](#) on page 2511

## Procedures

To create a grid object:

- 1 Do one of the following:

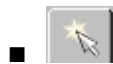

- Click Create panel > Helpers > Standard > Object Type rollout > Grid.
- Choose Create menu > Helpers > Grid.

The Parameters rollout appears on the Create panel.

- 2 In a viewport, drag out a rectangle and release the mouse button. This creates and selects a grid object, which appears in white wireframe, divided into four quadrants with coordinate axes at the center.

While the newly created grid object is still selected, you can change its settings on the Parameters rollout.

You can also create a grid object during object creation. Turn on AutoGrid, then press Alt during object creation. A grid is created at the same time as the object and remains displayed and active. See [AutoGrid](#) on page 2513 for more information.

#### **To activate a grid object:**

A grid object requires activation before use. Standard selection doesn't activate it unless you turn on the option to do so (see [User Grids](#) on page 2595 ).

Only one grid can be active for construction at a time, whether it's the home grid or a grid object. Activating a user grid "deactivates" the home grid.

Activating a grid object enables options to reactivate the home grid on the Views menu > Grids submenu and the Quad menu.

If you have more than one grid object in your scene, you have to activate each one separately. Select the grid object you want to make active and follow the same procedure. Activating another grid object deactivates the current one.

- 1 Select a grid object.
- 2 Do one of the following:
  - From the Views menu, choose Grids > Activate Grid Object.
  - Right-click the selected grid object and choose Activate Grid from the quad menu.

The grid object changes to show its internal grid structure. Except for its main axes, the home grid disappears in all viewports.

#### **To reactivate the home grid, do one of the following:**

- 1 From the Views menu, choose Grids > Activate Home Grid.
- 2 Right-click the selected grid object and choose Activate Home Grid from the quad menu.

This deactivates the grid object and returns the home grid in all views.

If you delete an activated grid object, the home grid also reactivates.

You can assign a keyboard shortcut to Activate Home Grid in the [Keyboard panel](#) on page 7489 of the Customize User Interface dialog. This is useful if you need to move back and forth between different grids.

### **To use a grid object as construction plane:**

When activated, a grid object replaces the home grid as the frame of reference for creating objects.

An activated grid object creates a true plane in 3D space. No matter how small an activated grid object appears on screen, its XY plane is effectively infinite, just as if it were the XY plane of the home grid.

- 1 Activate the grid object.
- 2 Create any category of object.  
3ds Max creates the object directly on the plane of the grid object, with the object's Z axis perpendicular to the plane.
- 3 Use File menu > Merge to import an object.  
3ds Max creates the object directly on the plane of the grid object, with the object's Z axis perpendicular to the plane.

See [Align](#) on page 938 for details on aligning objects and grids.

Like other objects in the software, you can move and rotate grid objects freely using standard transformation methods. These transforms, along with alignment, are essential in positioning a construction plane in 3D space.

### **To nudge a grid object up or down:**

- 1 Activate the grid object.
- 2 Press the + or – keys on the numeric keypad to move the grid object up or down.  
The Grid Nudge Distance is controlled in the [Viewports panel](#) on page 7545 of the Preferences dialog.



## Interface

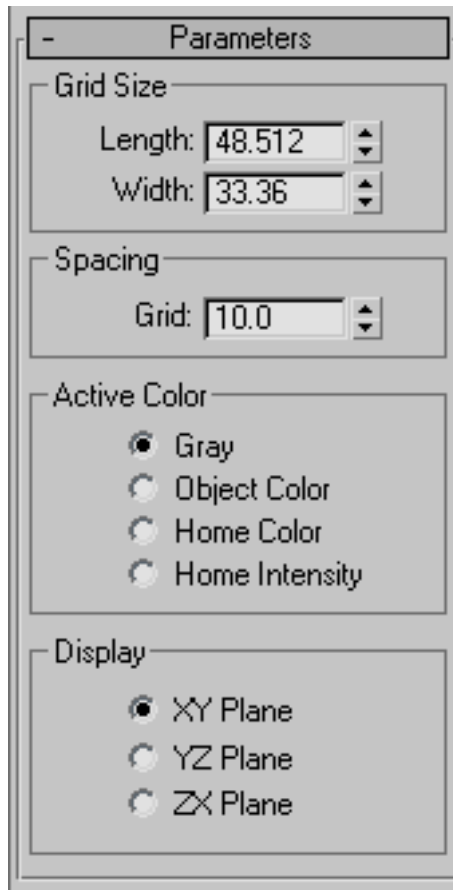

### Grid Size group

Sets the overall size of the grid object. This size determines the extents of a viewport set to the grid object. It doesn't affect the useful limits of the grid, which extend infinitely.

**Length/Width** Specifies the length and width of the grid.

### Grid Spacing group

**Grid** Specifies the size of the smallest square in the visible grid. This setting appears on the status line when the grid is activated.

---

**NOTE** You can set Grid Spacing when a grid is selected, but you won't see the grid spacing until the grid is activated.

---

### **Active Color group**

Determines the color used to draw the grid in viewports when it's not selected.

**Gray** The active grid object is two shades of gray.

**Object Color** The main grid lines use the assigned object color, while the secondary lines use a lighter intensity.

**Home Color** The grid object uses the home grid color assigned via the [Customize User Interface dialog](#) on page 7489 .

**Home Intensity** The grid object uses the grid intensity settings assigned to the home grid in the [Customize User Interface dialog](#) on page 7489 .

### **Display group**

**XY Plane, YZ Plane, ZX Plane** Determines which of the three planes of the grid object are displayed in the viewport.

## **Point Helper**

Create panel > Helpers > Standard > Object Type rollout > Point

Create menu > Helpers > Point

Point provides a specific location in 3D space that can be used as a reference or by other program functions.

### **Procedures**

**To create a point in space:**

- 1 Click Point and check the type of display from the Parameters rollout.
- 2 Adjust the size of the point object by using the Size spinner in the Parameters rollout. Default=20.0
- 3 Left-click and drag anywhere in your scene.

The point follows the cursor until you release the mouse button, indicating the current location of the point object.

- 4 Move the cursor to where you want the point object and release the mouse button.  
The point object appears using the display setting you chose.  
You can move and rotate the point as needed using standard transformation methods.

### Interface

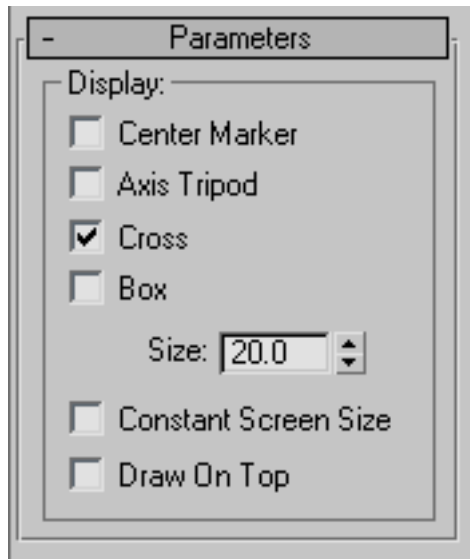

**Center Marker** Displays a small X marker at the center of the point object.

**Axis Tripod** Displays a tripod axis indicating the position and orientation of the point object. The axis remains visible when the point object is no longer selected.

**Cross** Displays an axis-aligned cross.

**Box** Displays a small axis-aligned box at the center of the point object.

**Size** Sets the size for the point object. Use this to minimize the point object, or increase its size to aid in locating it. Default=20.

**Constant Screen Size** Keeps the size of the point object constant, regardless of how much you zoom in or out.

**Draw On Top** Displays the point object on top of all other objects in the scene.

---

**NOTE** You can also choose to activate multiple display settings.

---

## Tape Helper

Create panel > Helpers > Standard > Object Type rollout > Tape

Create menu > Helpers > Tape Measure

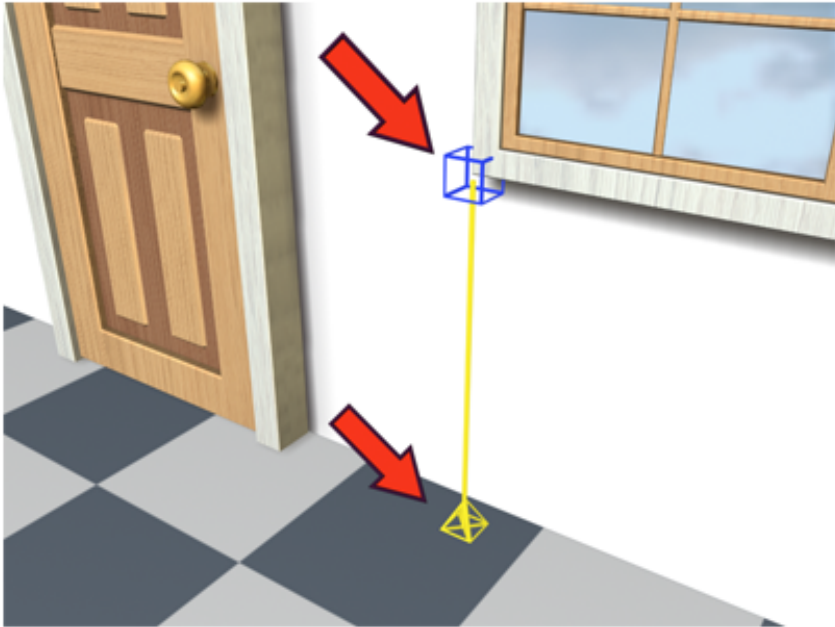

Using a tape helper to measure the distance from floor to window frame.

Tape provides an on-screen "tape measure" for determining and setting distances. The tape is composed of two named objects, in the same way targeted lights and cameras are. By default, these are named Tape## and Tape##.Target. The tape and target icons are connected by a line representing the current distance between them.

You can drag a length (the default), or enter a specific length by turning on Specify Length. You can snap or align either end of the tape or link to objects in your scene. Deleting either end deletes the tape.

---

**NOTE** When you add a Tape helper object, the software automatically assigns a [Look At controller](#) on page 3124 to it, with the tape's target object assigned as the Look At target. You can use the controller settings on the Motion panel to assign any other object in the scene as the Look At target.

---

## Selection

You can select a tape-measure object from either end, or from the middle. When you click the connecting line, both ends of the tape object become selected so you can move them as one. Note that the same is true of target cameras and lights.

---

**NOTE** Line selection is available only when clicking with the mouse. Region selection doesn't work for this.

---

**TIP** The Length readout of the tape object is displayed in the Modify panel only when you select the tape end of the object (as opposed to the target or link line). You can lock the Length display by activating the Pin Stack button while the tape end is selected, and then proceed to adjust any part of the tape object or any other object in your scene.

---

## See also:

- [Measure Distance Tool](#) on page 2529

## Procedures

### To measure a distance:

- 1 Click Tape and drag from one point to create the tape, and then drag to a second point and release the mouse button to create the target.

The distance between tape and target appears in the Length field. The number in the Length field is gray to indicate that this is a read-only measurement.

---

**NOTE** To snap the tape ends to object vertices, edges and so on, turn on [Snap](#) on page 2568 with the appropriate snap settings activated.

---

- 2 Move either end to a new location. The line between stretches to the new distance, shown in the Length field.

---

**NOTE** For accurate results when moving a tape endpoint with Snap, you must turn on Pivot in the Snap Settings panel as well as the types of sub-object you want to snap to; see [Snaps](#) on page 2578 . This is because the endpoints are actually pivots.

---

**To set a distance:**

- Turn on Specify Length in the Parameters rollout, enter a length, and then create the tape.  
The connector line is the length you specified, although you can still set the target to any offset by dragging. You can reorient this line as required.

---

**NOTE** Clearing Specify Length will adjust the connector line length to meet the target and the new length appears in the Length field.

---

**Interface**

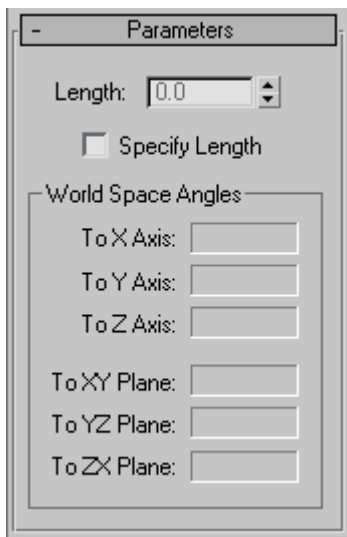

**Parameters rollout**

**Length** Specifies the length of the tape object. You must select the Specify Length check box to enable this option.

**Specify Length** Activates the Length parameter setting. Otherwise the tape object's length will be specified by clicking and dragging in the viewport.

### **World Space Angles group**

**To X/Y/Z Axis** Displays the angle of the tape object relative to each axis in world space.

**To XY/YZ/ZX Plane** Displays the angle of the tape object relative to each of these home planes.

## **Protractor Helper**

Create panel > Helpers > Standard > Object Type rollout > Protractor

Create menu > Helpers > Protractor

Protractor measures the angle between a point and any two objects in your scene.

The names of the two objects appear above their respective buttons, and the angle formed at the protractor object between the pivot points of the two objects is displayed in the Angle field. Lines are drawn between the protractor and the two selected objects.

---

**NOTE** The line to the first selected object uses the Target Line color, and the line for the second selected object uses the color of the protractor. The Target Line color is set with Customize User Interface dialog > [Colors panel](#) on page 7505 > Elements drop-down list > Gizmos group. The Protractor color is set by choosing the Tape Object in Customize User Interface dialog > [Colors panel](#) on page 7505 > Elements drop-down list > Objects group.

---

You can reselect the protractor at any time, enter the [Modify panel](#) on page 7425 , and pick new objects to measure. You can move either of the two objects or the protractor itself to change the angle.

---

**NOTE**  If you need to watch the Angle readout while moving either of the objects, first select the protractor, then click the Pin Stack button on the Modify panel. You can now select and move the other objects while the stack remains pinned to display the protractor angle.

---

## Procedures

### To use the protractor:

- 1 After selecting Protractor in the Create panel > Helpers section, click in the viewport to place and create the protractor icon. You can also drag to move it before releasing the mouse button.
- 2 Click the Pick Object 1 button, and then select one of the objects in the scene.  
The name of the selected object appears above the button.
- 3 Click Pick Object 2, and then select a second object in the scene.  
The Angle parameter shows the angle formed by lines from the protractor object to the two picked objects.

## Interface

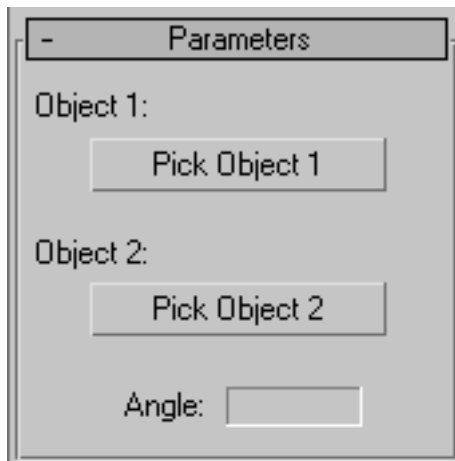

### Parameters rollout

**Pick Object 1** Click this and select the first of the two objects whose angle you want to measure.

**Pick Object 2** Click this and select the second of the two objects whose angle you want to measure.

**Angle** Displays the angle formed by the lines from the protractor to the two objects.



# Compass Helper

Create panel > Helpers > Standard > Object Type rollout > Compass

Create menu > Helpers > Compass

Compass displays as a non-rendering compass rose, with indicators for North, South, East, and West. A compass is part of a [Daylight or Sunlight system](#) on page 5024 ; you create a compass automatically when you create sunlight. In a Sunlight system, the orientation of the compass indicates the orientation of the scene, relative to the path of the sun (the ecliptic).

Use the Compass helper object if you want to create an orientation symbol in your scene, but don't need to create a sunlight system.

## Procedures

To create a compass object:

- 1 Choose Compass in the Create panel > Helpers section.
- 2 Click and drag to define the radius of the compass.
- 3 Select and rotate the compass object to orient it.

## Interface

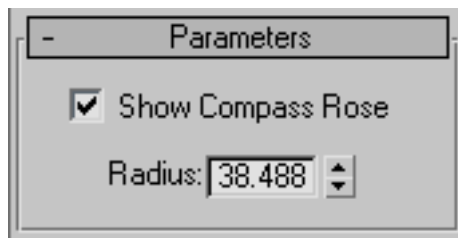

### Parameters rollout

**Show Compass Rose** Displays the non-rendering compass rose in the viewport.

**Radius** Specifies the radius of the compass object.

# Manipulator Helper Objects

Create panel > Helpers > Manipulators > Object Type rollout

Create menu > Helpers > Manipulators

Manipulator helpers are objects you can create to manipulate other objects. They let you add customized controls to your scene that provide visual feedback in viewports. To control other objects, manipulators use the [parameter wiring feature](#) on page 3247 .

Manipulators can be especially useful when you create a scene that will be used by more than one animator.

There are three kinds of manipulator helpers:

[Cone Angle Manipulator](#) on page 2552

[Plane Angle Manipulator](#) on page 2556

[Slider Manipulator](#) on page 2559

**See also:**

- [Wire Parameters](#) on page 3247
- [Parameter Wiring Dialog](#) on page 3249
- [Select And Manipulate](#) on page 2529

## Cone Angle Manipulator

Create panel > Helpers > Manipulators > Object Type rollout > Cone Angle button

Create menu > Helpers > Manipulators > Cone Angle

The Cone Angle manipulator is a cone whose base you can adjust. By wiring its Angle value to a parameter of another object, you can create a custom control, with visual feedback, within a scene.

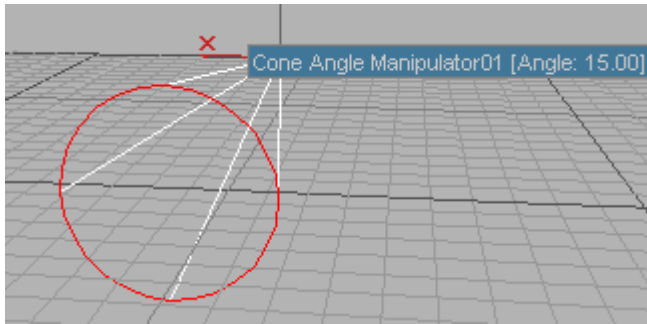



### Cone angle manipulator

Cone angle manipulators are used by a spotlight's Hotspot and Falloff controls.

### Procedures

To create a cone angle manipulator:

- 1   In the Create panel, go to Helpers and choose Manipulators from the drop-down list.
- 2 Click to turn on Cone Angle.
- 3 Drag in a viewport, and then release the mouse.  
The cone angle manipulator is created along the negative Z axis of the viewport in which you drag. In other words, its initial position points away from you.

To change the angle of a cone angle manipulator:

- 1  Turn on Select And Manipulate.

---

**TIP**  If you are still in the Create panel, turn on Select Object before using the manipulator. Otherwise, it is too easy to create a new one.

---

- 2 In a viewport, move the mouse over the manipulator.



The manipulator turns red when the mouse is over it and it is available to be manipulated. Also, a tooltip appears, showing the name of the manipulator and its current value.

- 3 Drag the base of the cone angle manipulator's cone.

The Angle value changes as you drag the manipulator. This value can range between 0.0 and 180.0.

#### To select a cone angle manipulator:

- 1  Turn on Select Object.

  You can also use Select And Move, Select And Rotate, and the scale options on a cone angle manipulator.

- 2  Turn off Select And Manipulate.

If you don't turn off Select And Manipulate, you adjust the manipulator's Angle value without affecting its properties.

- 3 Adjust the properties of the selected manipulator.

#### To connect a cone angle manipulator so it controls another object:

- 1  Select the cone angle manipulator.

---

**NOTE**  Select And Manipulate must be *off* before you can select the manipulator.

---

- 2 Choose Animation > Wire Parameters > Wire Parameters.

You can also right-click the manipulator and choose Wire Parameters from the Transform (lower-right) quadrant of the quad menu.

A pop-up menu appears over the manipulator.

- 3 In the pop-up menu, choose Object (Cone Angle Manipulator) > Angle.
- 4 Click the object you want to manipulate.

A pop-up menu appears over the object.

- 5 In the pop-up menu, choose Object, then the name of the parameter you want to manipulate.

The [Parameter Wiring dialog](#) on page 3249 appears.

- 6 On the Parameter Wiring dialog, click the “control direction” arrow between the two upper lists that goes from the manipulator to the object (or both directions), and then click Connect.

- 7 Close the Parameter Wiring dialog.

Now when you turn on Select And Manipulate and use the manipulator, the object updates under the manipulator's control.

### Interface

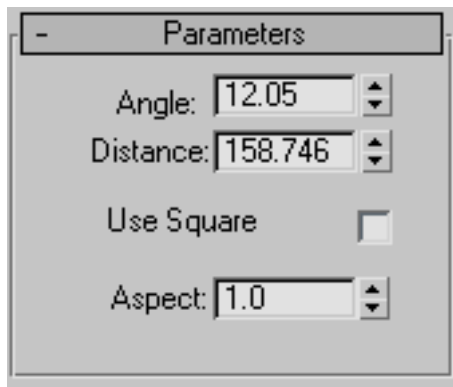

**Angle** The initial angle of the manipulator.

**Distance** The length of the manipulator, in 3ds Max units. Default=the distance of mouse drag when the manipulator was created.

**Use Square** When on, the base of the cone is square or rectangular, rather than circular. Default=off.

**Aspect** When Use Square is on, adjusts the aspect ratio of the rectangular cone base. Default=1.0.

# Plane Angle Manipulator

Create panel > Helpers > Manipulators > Object Type rollout > Plane Angle button

Create menu > Helpers > Manipulators > Plane Angle

The Plane Angle manipulator looks like a lever or joystick. By wiring its Angle value to a parameter of another object, you can create a custom control, with visual feedback, within a scene.

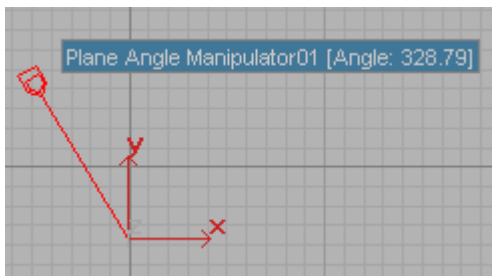
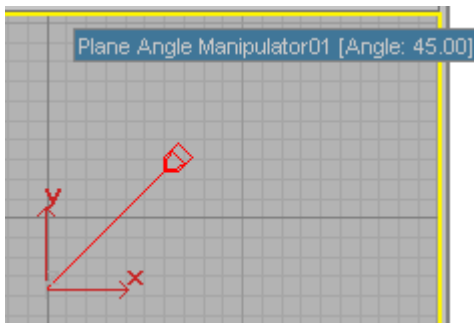

Plane angle manipulator at different angles

## Procedures

### To create a plane angle manipulator:

-  In the Create panel, go to Helpers and choose Manipulators from the drop-down list.
- Click to turn on Plane Angle.
- Drag in a viewport, and then release the mouse.  
The plane angle manipulator is always created vertically, along the Y axis of the viewport in which you drag.

### To change the angle of a plane angle manipulator:

-  Turn on Select And Manipulate.

---



**TIP**  If you are still in the Create panel, turn on Select Object before using the manipulator. Otherwise, it is too easy to create a new one.

---

- In a viewport, move the mouse over the manipulator.  
The manipulator turns red when the mouse is over it and it is available to be manipulated. Also, a tooltip appears, showing the name of the manipulator and its current value.
- Drag the handle of the plane angle manipulator.  
The Angle value changes as you drag the manipulator. This value can range between -100000.0 and 100000.0.

### To select a plane angle manipulator:

-  Turn on Select Object.

  You can also use Select And Move, Select And Rotate, and the scale options on a plane angle manipulator.

-  Turn off Select And Manipulate.  
If you don't turn off Select And Manipulate, you adjust the manipulator's Angle value without affecting its properties.
- Adjust the properties of the selected manipulator.

**To connect a plane angle manipulator so it controls another object:**

-  Select the plane angle manipulator.

---

**NOTE**  Select And Manipulate must be *off* before you can select the manipulator.

---

- Choose Animation > Wire Parameters > Wire Parameters.  
You can also right-click the manipulator and choose Wire Parameters from the Transform (lower-right) quadrant of the quad menu.  
A pop-up menu appears over the manipulator.
- In the pop-up menu, choose Object (Plane Angle Manipulator) > Angle.
- Click the object you want to manipulate.  
A pop-up menu appears over the object.
- In the pop-up menu, choose Object, then the name of the parameter you want to manipulate.  
The [Parameter Wiring dialog](#) on page 3249 appears.
- On the Parameter Wiring dialog, click the “control direction” arrow between the two upper lists that goes from the manipulator to the object (or both directions), and then click Connect.
- Close the Parameter Wiring dialog.  
Now when you turn on Select And Manipulate and use the manipulator, the object updates under the manipulator's control.



## Interface

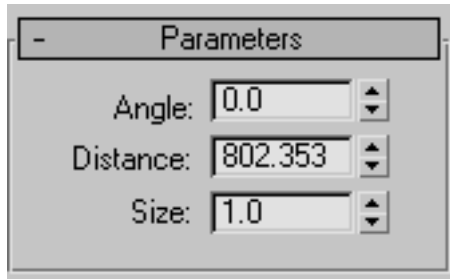

**Angle** The angle of the manipulator, from 0.0 to 360.0 (both values are perpendicular in the Y axis of the viewport where you created the manipulator, unless you have rotated the manipulator object). Default=0.0.

**Distance** The length of the manipulator, in 3ds Max units. Default=the distance of mouse drag when the manipulator was created.

**Size** The size of the manipulator's handle, in 3ds Max units. Default=1.0.

## Slider Manipulator

Create panel > Helpers > Manipulators > Object Type rollout > Slider button

Create menu > Helpers > Manipulators > Slider

The Slider manipulator is a graphic control that appears in the active viewport. By wiring its Value to a parameter of another object, you can create a custom control, with visual feedback, within a scene.

---

**NOTE** Because the slider manipulator is a custom control, its Value has no inherent unit. It takes on the unit of the parameter to which it is wired. When the minimum is 0.0 and the maximum is 100.0, the slider Value can represent a percentage.

---



Slider manipulator

## Using a Slider Manipulator

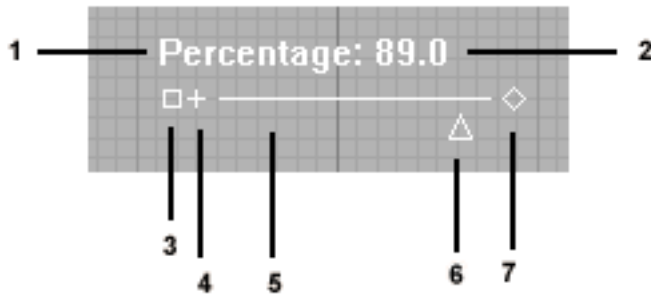

Slider manipulator components:

1. Label
2. Value
3. Move
4. Show/hide
5. Slider bar
6. Adjust value
7. Change width

The slider appears in the same location in whichever viewport is active.

You can adjust the slider's value by dragging the triangle below the slider bar. The triangle turns red when you move the mouse over it. It represents the slider's value, and the value changes as the triangle is dragged. You can also make the following changes without going into the Modify panel:

- Dragging the small square at the left moves the slider.
- Dragging the diamond at the right changes the width of the slider.
- Clicking the plus sign (next to the move icon at the left) hides all of the slider except for the label and the move icon.

Like the Value triangle, these components also turn red when you move the mouse over them.

## Procedures

### To create a slider manipulator:

- 1  In the Create panel, go to Helpers and choose Manipulators from the drop-down list.
- 2 Click to turn on Slider.
- 3 Click a viewport.  
The slider manipulator is created with its default width of 100 units. It will appear at the same viewport location in whichever viewport is active.

### To change the value of a slider manipulator:

- 1  Turn on Select And Manipulate.  
The slider turns green.

---

**TIP**  If you are still in the Create panel, turn on Select Object before using the manipulator. Otherwise, it is too easy to create a new one.

---

- 2 In a viewport, move the mouse over the triangle below the slider bar.  
The triangle turns red when the mouse is over it and it is available to be dragged.
- 3 Drag the value triangle of the slider manipulator.  
The slider's value display changes as you drag the triangle.

### To move a slider manipulator:

- 1  Turn on Select And Manipulate.
- 2 In the active viewport, move the mouse over the move icon, which is the small square at the left of the slider, below the sliders label (if there is one) and value display.  
The square turns red when the mouse is over it and it is able to be dragged.
- 3 Drag the box to move the slider.

Unlike angle manipulators, transforms have no effect on sliders.

**To connect a slider manipulator so it controls another object:**

- 1  Select the slider.

---

**NOTE**  Select And Manipulate must be *off* before you can select the slider.

---

- 2 Choose Animation > Wire Parameters > Wire Parameters.  
You can also right-click the manipulator and choose Wire Parameters from the Transform (lower-right) quadrant of the quad menu.  
A pop-up menu appears over the manipulator.
- 3 In the pop-up menu, choose Object > Value.
- 4 Drag to the object you want to manipulate, and click it.  
A pop-up menu appears over the object.
- 5 In the pop-up menu, choose Object, then the name of the parameter you want to manipulate.  
The [Parameter Wiring dialog](#) on page 3249 appears.
- 6 In the Parameter Wiring dialog, make sure the direction goes from the slider to the object (or both directions), and then click Connect.
- 7 Close the Parameter Wiring dialog.  
Now when you turn on Select And Manipulate and use the slider, the object updates under the slider's control.

## Interface

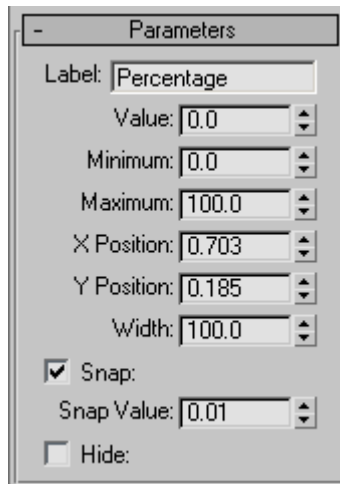

**Label** The slider name that appears in viewports. Default=none.

**Value** The value of the slider, based on the position of the slidable triangle. Default=0.0.

**Minimum** The minimum possible value of the slider. Default=0.0.

**Maximum** The maximum possible value of the slider. Default=100.0.

When the minimum is 0.0 and the maximum is 100.0, the slider Value can represent a percentage.

**X Position** The slider's X location in the active viewport. Default=Viewport X location you clicked when you created the slider.

**Y Position** The slider's Y location in the active viewport. Default=Viewport Y location you clicked when you created the slider.

**Width** The slider's width, in 3ds Max units. Default=100.0.

**Snap** When on, the slider "snaps" to incremental values determined by the Snap Value setting. Default=on.

**Snap Value** The increment used by the slider when Snap is on. Default=0.01.

**Hide** When on, hides all of the slider except for the label and the move and show/hide components. Default=off.

# Grid Commands

Views menu > Grids

The Grids submenu provides functions to manipulate the [home grid](#) on page 7808 and [grid objects](#) on page 7805 .

The Snaps system uses grids both as visual references and as physical snap references. In addition, grids serve as construction planes, since the objects you create are built on the active grid in the active viewport.

As a default, the software uses a construction grid called the home grid. The home grid is the basic reference system, and is defined by three fixed planes on the world coordinate axes. It provides ready-to-use construction planes, intersecting at right angles through the origin. When the home grid is displayed, each [orthographic viewport](#) on page 7877 is coplanar (parallel) with one of the grid faces.

A custom grid, or grid object, is a helper object that you can use in place of the home grid. While the home grid is three intersecting planes whose orientation is fixed in world space, a grid object is a free-floating, 2D grid that you can position and rotate anywhere, letting you construct objects at any angle in world space. You can also automatically create grids on the surface of objects by using [AutoGrid](#) on page 2513 .

The Grids submenu contains the following commands:

[Show Home Grid](#) on page 2564

[Activate Home Grid](#) on page 2565

[Activate Grid Object](#) on page 2566

[Align Grid to View](#) on page 2566

## Show Home Grid

Views menu > Grid > Show Home Grid

Right-click a viewport label. > Show Grid

Keyboard > G

Show Home Grid toggles the display of the [home grid](#) on page 7808 in the active viewport.

Grids are used both as visual references and as physical snap references by the Snap system. In addition, grids are construction planes, since the objects you create are built on the active grid in the active viewport.

As a default, there is a home construction grid called home grid. The home grid is the basic reference system, and is defined by three fixed planes on the world coordinate axes. It provides ready-to-use construction planes, intersecting at right angles through the origin. When the home grid is displayed, each [orthographic viewport](#) on page 7877 is coplanar (parallel) with one of the grid faces.

## Procedures

To toggle the display of the home grid, do one of the following:

- 1 Choose Views menu > Grids, and click Show Home Grid.
- 2 Right-click a viewport label and click Show Grid on the viewport right-click menu.
- 3 Press G on the keyboard.

# Activate Home Grid

Activate a grid other than the Home grid. > Views menu > Grids > Activate Home Grid

This command activates the [home grid](#) on page 7808 as the construction grid, and deactivates the active [grid object](#) on page 7805 .

## Procedures

To return to the home grid, do one of the following:

- 1 Choose Views menu > Grids > Activate Home Grid.
- 2 Right-click the selected grid object, and choose Activate Home Grid from the quad menu.

This deactivates the grid object and activates the home grid in all views.

# Activate Grid Object

Select a grid object. > Views menu > Grids > Activate Grid Object

This command activates the selected [grid object](#) on page 7805 as the construction grid and deactivates the [home grid](#) on page 7808. This menu item is available only when a grid object is selected.

## Procedures

To activate a grid object:

- 1 Select a grid object.
- 2 Do one of the following:
  - Choose Views menu > Grids > Activate Grid Object.
  - Right-click the selected grid object and choose Activate Grid from the quad menu.  
The grid object changes to show its internal grid structure. Except for its main axes, the home grid disappears in all viewports.
- 3 Right-click the selected grid object and choose Activate Grid from the quad menu.  
The grid object changes to show its internal grid structure. Except for its main axes, the home grid disappears in all viewports.

# Align Grid to View

Activate a grid object. > Views menu > Grids > Align Grid to View

This command aligns a [grid object](#) on page 7805 with the current view. The grid object is aligned so that it's coplanar with the view and oriented with the top of the grid at the top of the view.

## Procedures

To align a grid object with a viewport:

- 1 Activate a grid object.
- 2 Click or right-click in a viewport.



- 3 Right-click to open the quad menu.
- 4 In the Tools 1 quadrant, choose Align Grid to View.  
The grid object rotates to align itself with the selected view. The grid object is now planar, or parallel, with the viewport.
- 5 Choose Views menu > Grids > Align Grid to View.  
The grid object rotates to align itself with the selected view. The grid object is now planar, or parallel, with the viewport.

## Snap Commands

main toolbar > Snap buttons

Snaps help you precisely control the dimensions and placement of objects when you create them or transform them. There is also a Spinner snap for controlling the entry of values.

 You can use objects within an XRef scene as snap references.

The snap commands listed below and described in this section are found on the main toolbar (except for Ortho and Polar; see their topics for details) .



[2D Snap](#), [2.5D Snap](#), [3D Snap](#) on page 2568



[Angle Snap Toggle](#) on page 2570



[Percent Snap Toggle](#) on page 2571



[Spinner Snap Toggle](#) on page 2572



[Ortho Snapping Mode](#) on page 2573



[Polar Snapping Mode](#) on page 2575

## 2D Snap, 2.5D Snap, 3D Snap

Main toolbar > 2D Snap, 2.5D Snap, or 3D Snap on the Snaps Toggle flyout

Keyboard > S

The buttons on the Snaps Toggle [flyout](#) on page 7789 provide control over the range of 3D space where snaps are active. A wide variety of snap types is available from the [Snaps dialog](#) on page 2578, which you can use to activate different snap types as you work.



2D, 2.5D, 3D Snaps flyout

### Object Snapping

Object snapping lets you snap to specific portions of existing geometry during creation and transforms of objects or sub-objects. You can also snap to the grid, and you can snap to tangents, midpoints, pivot points, face centers and other options.

The mode you choose maintains its state when you switch levels.

### Transforming Around Snap Points

When snapping is on and [Auto Key](#) on page 7344 is off, rotations and scales occur about the snap point. For example, if you're using Vertex snapping and you're rotating a box, you can rotate it about any of its corner vertices. See [To use snaps to move an absolute distance](#): on page ? below.

When Auto Key is on and either Select And Rotate or Select And Scale is active, the Snaps Toggle button is disabled, and rotation and scaling take place about the pivot point of the object.

## Procedures

### To turn snap off during a transform:

- Press S to toggle snapping off when it gets in the way. Press S again to turn it back on.

### To use snaps to move a relative distance:

- 1 Turn on Snaps with the S key, or by clicking the Snaps Toggle button.



- 2 Lock your selection set with the spacebar, or by clicking Lock Selection on the status bar.
- 3 Wherever you click in the viewport, the snap will stay relative to the distance of your cursor to the object.

### To use snaps to move an absolute distance:

- 1 Turn on Snaps Toggle.
- 2 Click the selection. Snap uses the point you click for the snap source.
- 3 Move to whatever target snap you desire. The object will snap to an absolute distance.

### To rotate a box around a vertex using snaps:

- 1 Make sure the Auto Key button is off.
- 2 Select the box.



- 3 On the Main toolbar, click Select And Rotate.
- 4 Turn Snaps on by pressing S on the keyboard.
- 5 On the Customize menu, choose Grid And Snap Settings. Turn on Vertex and turn off Grid Points.



- 6 Lock your selection set by clicking Lock Selection on the status bar.
- 7 On the toolbar, choose Use Transform Coordinate Center (hold the mouse down on Use Pivot Point Center to expose the flyout).

- 8 Move your cursor over any vertex in the box. The blue snap cursor will appear, and then you can rotate the box around that vertex.

## Interface

There are three snap modes:



**2D Snap** The cursor snaps only to the active construction grid, including any geometry on the plane of that grid. The Z axis, or vertical dimension, is ignored.



**2.5D Snap** The cursor snaps only to the vertices or edges of the projection of an object onto the active grid.

Suppose you create a [grid object](#) on page 7805 and make it active. You then position the grid object so you can see through the grid to a cube further off in 3D space. Now with 2.5D set, you can snap a line from vertex to vertex on the distant cube, but the line is drawn on the active grid. The effect is like holding up a sheet of glass and drawing the outline of a distant object on it.



**3D Snap** This is the default tool. The cursor snaps directly to any geometry in 3D space. 3D snapping lets you create and move geometry in all dimensions, ignoring the construction plane.

Right-click this button to display the [Grid and Snap Settings dialog](#) on page 2578, which lets you change snap categories and set other options.

## Angle Snap Toggle



Main toolbar > Angle Snap Toggle

Keyboard > A

Angle Snap Toggle determines the incremental rotation for a number of features, including the standard Rotate transform. As you rotate an object (or group of objects), the object moves around a given axis in the increment you set.

Angle Snap Toggle also affects Pan/Orbit camera controls, [FOV](#) on page 7776 and Roll camera settings, and [Hotspot/Falloff](#) on page 7811 spotlight angles.

## Procedures

**To turn angle snap on:**

- Click Angle Snap Toggle on the Main toolbar. When turned on, angle snap affects all rotational transforms.

**To rotate an object an even number of degrees:**

- Turn on Angle Snap Toggle and rotate the object. The rotations take place in 5-degree increments as a default.

**To rotate an object a precise degree of rotation, do one of the following:**

- 1 Click Select And Rotate, then right-click it to display the [Transform Type-In dialog](#) on page 874 . Enter the exact rotation you want.
- 2 Choose Select And Rotate from the quad menu, then right-click it to use the [Transform Type-In dialog](#) on page 874 . Enter the exact rotation you want.
- 3 Right-click Angle Snap Toggle and click the Options tab on the dialog that is displayed. Set the Angle value in the General group to the precise degree of rotation you need, then rotate the object. Rotation snaps to the angle increment you specified.

## Interface

The angle increment is set on the Options panel of the [Grid and Snap Settings dialog](#) on page 2577 . Right-click the Angle Snap Toggle button to display the Options panel of the Grid and Snap Settings dialog. The default is 5 degrees.

## Percent Snap Toggle



Main toolbar > Percent Snap Toggle

Keyboard > Ctrl+Shift+P

Percent Snap Toggle increments scaling of objects by the specified percentage.

## Interface

The snap percent increment is set in the Grid And Snap Settings dialog. The default is 10 percent. Right-click the Percent Snap Toggle button to display the [Grid and Snap Settings dialog](#) on page 2577 .

This is a general-purpose snap system that applies to any operation involving a percentage, such as scaling or squashing.

## Spinner Snap Toggle



Main toolbar > Spinner Snap Toggle

Spinner Snap Toggle sets the single-click increment or the decrement value for all of the spinners in 3ds Max.

### Procedures

To set and toggle spinner snap:

- 1 Do one of the following:
  - Choose Customize menu > Preferences.
  - Right-click the Spinner Snap Toggle button on the main toolbar. Either method opens the Preference Settings dialog > General panel. The two controls for spinner snap are in the Spinners group on this panel.
- 2 Set a value in the Snap field.
- 3 Turn on Use Snap.  
When you exit the dialog, the Spinner Snap Toggle button is turned on.
- 4 As you work, use the Spinner Snap Toggle button to toggle the alternate setting.

### Interface

The amounts for Spinner Snap are controlled by settings on the [General panel](#) on page 7536 of the Preferences dialog. Default=1.0.

# Ortho Snapping Mode

When drawing a [Line spline](#) on page 551 or [Wall object](#) on page 456 , Ortho Snapping Mode constrains line creation to the horizontal or vertical directions relative to the active grid. That is, with Ortho on, you can draw only lines that are parallel to lines of the active grid. Ortho is particularly useful for drawing plans where all lines must be at 90 degrees to each other, such as a house plan. To constrain line-drawing to other angle increments, use [Polar Snapping Mode](#) on page 2575 instead.

---

**IMPORTANT** By default, Ortho Snapping Mode is not directly accessible in the 3ds Max user interface. To add it as a button on the Snaps toolbar, follow [this procedure](#) on page ? .

---

The following provisions apply to using Ortho:

- Use of Ortho is mutually exclusive of use of the [Polar Snapping Mode toggle](#) on page 2575 ; only one can be active at a time.
- Ortho Snapping applies primarily to the creation of line splines and wall objects. It can be used while creating other objects, but results are likely to be unsatisfactory.

Ortho mode displays a compass which gives a readout of the current angle of the input relative to the positive direction of the local X axis.

---

**NOTE** If you hold down the Alt key in Ortho mode, the next point becomes doubly constrained by both the previous point and the first point of the current object. This allows you to close splines precisely. In this mode, two compasses are displayed; one each at the first *and* previous points.

---

## Procedures

### To add Ortho Snapping Mode to the Snaps toolbar:

- 1 Open the Snaps toolbar, if necessary. To do so, right-click an empty part of the main toolbar, such as the area directly below one of the drop-down lists, and choose Snaps.
- 2 Drag the right end of the toolbar to the right to make room for a new button.
- 3 Choose Customize menu > Customize User Interface.

This opens the Customize User Interface dialog.

- 4 On the dialog, click the Toolbars tab.
- 5 Scroll down the Action list on the dialog to the Ortho Snapping Mode item. You can jump to the O section by clicking any item in the list and then pressing O on the keyboard.
- 6 Drag the Ortho Snapping Mode item from the list to the empty section of the Snaps toolbar. This adds the button to the toolbar.
- 7 Close the Customize User Interface dialog.  
3ds Max automatically saves the toolbar in its revised state and makes the new button a permanent part of the user interface.

**To use Ortho:**

- 1 Turn on the Ortho Snapping Mode button.  
The button appears depressed.
- 2 Begin to draw a Line spline.  
An orange compass appears where you place the first point, along with a red number indicating the angle of the current line segment with the positive direction of the local X axis.
- 3 Move the mouse cursor around in the viewport.  
The line jumps to 90-degree angle increments on the local X axis, while the compass reading updates to show the current angle.
- 4 Click to place the next vertex.
- 5 Repeat steps 3 and 4 until you're ready to complete the shape.
- 6 Do either of the following:
  - To finish the shape at the most recent vertex without closing it, right-click anywhere.
  - To finish the shape by closing it, position the mouse cursor close to the first point and then click. A small dialog opens asking if you want to close the spline; click Yes.



# Polar Snapping Mode

When drawing a [Line spline](#) on page 551 or [Wall object](#) on page 456, Polar Snapping Mode constrains line creation to angle increments determined by the Angle Snap setting relative to the active grid. To change the Angle Snap setting, right-click the Angle Snap Toggle button on the main toolbar and in the Options panel > General group, edit the Angle setting.

---

**IMPORTANT** By default, Polar Snapping mode is not directly accessible in the 3ds Max user interface. To add it as a button on the Snaps toolbar, follow [this procedure](#) on page ? .

---

Polar is particularly useful for drawing plans where angles between all lines must conform to specific angle increments, such as 45 degrees. If all lines must be at 90-degree angles to each other, use the [Ortho Snapping Mode toggle](#) on page 2573 instead.

The following provisions apply to using Polar:

- Use of Polar is mutually exclusive of use of the Ortho toggle; only one can be active at a time.
- Polar applies primarily to the creation of line splines and wall objects. It can be used while creating other objects, but results are likely to be unsatisfactory.

Polar mode displays a compass that provides a readout of the current angle of the input relative to the positive direction of the local X axis.

---

**NOTE** If you hold down Alt in Polar mode, the next point becomes doubly constrained by both the previous point and the first point of the current object. This allows you to close splines precisely. In this mode, two compasses are displayed; one each at the first *and* previous points.

---

## Procedures

### To add Polar Snapping Mode to the Snaps toolbar:

- 1 Open the Snaps toolbar, if necessary. To do so, right-click an empty part of the main toolbar, such as the area directly below one of the drop-down lists, and choose Snaps.
- 2 Drag the right end of the toolbar to the right to make room for a new button.

- 3 Choose Customize menu > Customize User Interface.  
This opens the Customize User Interface dialog.
- 4 On the dialog, click the Toolbars tab.
- 5 Scroll down the Actions list on the dialog to the Polar Snapping Mode item. You can jump to the P section by clicking any item in the list and then pressing P on the keyboard.
- 6 Drag the Polar Snapping Mode item from the list to the empty section of the Snaps toolbar. This adds the button to the toolbar.
- 7 Close the Customize User Interface dialog.  
3ds Max automatically saves the toolbar in its revised state and makes the new button a permanent part of the user interface.

**To use Polar:**

- 1 Turn on the Polar Snapping Mode button.  
The button appears depressed.
- 2 Begin to draw a line spline.  
An orange compass appears where you place the first point, along with a red number indicating the angle of the current line segment with the positive direction of the local X axis.
- 3 Move the mouse cursor around in the viewport.  
The line jumps to specific angle increments from the X-axis, while the compass reading updates to show the current angle. You set the angle increment in the Grid And Snap Settings dialog > [Options panel](#) on page 2587 > General group, which you can access by right-clicking the Angle Snap Toggle button on the main toolbar.
- 4 Click to place the next vertex.
- 5 Repeat steps 3 and 4 until you're ready to complete the shape.

- 6 Do any of the following:
  - To finish the shape at the most recent vertex without closing it, right-click anywhere.
  - To finish the shape by closing it, position the mouse cursor close to the first point and then click. A small dialog opens asking if you want to close the spline; click Yes.
  - To finish the shape by closing it while constraining the line to the polar snap, first position the mouse cursor close to the first point, press and hold Alt to constrain the mouse by both the previous point and the first point, and then click. This vertex is automatically placed at the current angle increment from the first point, so that you need only click the first point to close the shape.

## Grid and Snap Settings

Customize menu > Grid and Snap Settings

Right-click any snap button

This command displays the Grid and Snap Settings dialog. This modeless dialog establishes settings and options for snaps, the [home grid](#) on page 7808, and user-defined grids.

Controls on the Grid And Snap Settings dialog determine which snap settings are used when you activate snaps by clicking 3D Snap Toggle. Adjusting any of these snap settings does not automatically turn on snaps.



You can use objects within an XRef scene as snap references.

The Grid And Snap Settings dialog contains tabs for:

[Snap Settings](#) on page 2578

[Snap Options](#) on page 2587

[Home Grid Settings](#) on page 2592

[User Grids Settings](#) on page 2595

## Procedures

To change grid and snap settings:

- 1 Choose Customize menu > Grid And Snap Settings and click the appropriate tab.
- 2 Choose the type of snap you want (Standard or NURBS).
- 3 Select the snap settings.

## Snap Settings

Customize menu > Grid And Snap Settings > Grid And Snap Settings dialog > Snaps tab

Main toolbar > Right-click a snap button

Keyboard > Hold Shift+right-click > Snaps quadrant

Keyboard > S (toggles snaps on and off)

Snapping gives you additional control when creating, moving, rotating, and scaling objects by causing the cursor to “jump” to specific portions of existing geometry and other scene elements during creation and transformation of objects or sub-objects. The controls in this dialog set the snap strength and other characteristics such as the snap target.

---

**NOTE** Snapping functionality includes several features that enhance ease of use. For details, see [the General Group section of the Snap Options topic](#) on page 2590

---

You can specify the portion of the geometry where you will snap. For example, when Vertex is the active snap type, creating and transforming objects snaps to the vertices of existing geometry. You can specify any combination of active snap types to provide multiple snapping points. For example, if Vertex and Midpoint are active, snapping occurs at both vertices and edge midpoints.

The default snap type is Grid Points .

---

**NOTE** Snapping is not on by default. You can toggle snapping by pressing the S key at any time, even in the middle of a transform. In this way you can combine snapping with free positioning.

---



- 3 In the Snaps tab, select one or more of the types of snaps you want active.
- 4 Create an object or transform an object.  
Snap markers appear when the mouse cursor is over existing geometry or on a grid, depending on the active snap types. Each snap type has a different display; clicking when the snap-specific display is visible snaps to that spot.

**To display the Snaps shortcut menu:**

- Hold Shift and right-click anywhere in any viewport. The quad menu that opens gives you access to various snap settings including Snaps Use Axis Constraints and Snap To Frozen Objects.

**To use both constraint and snaps, do one of the following:**

- 1 In the Grid and Snap Settings dialog > Options tab > Translation group, turn on Use Axis Constraints.
- 2 Hold Shift and right-click in the viewport, and then choose Options > Transform Constraints from the Snap quadrant.

**Example: To use 3D snaps and rotation transformations together:**

- 1 Create a box.
- 2 Select the box and choose Lock Selection.
- 3 Turn on 3D Snaps and click Rotate on the toolbar.



- 4 From the Use Center flyout on the main toolbar, choose [Use Transform Coordinate Center](#) on page 908 .
- 5 Activate the Perspective viewport and move the cursor over the grid. A blue icon displays when the cursor passes over a grid point.
- 6 When the blue icon displays, click and drag to rotate the box around the selected grid point.  
You can rotate around anything you can snap to.

**To turn snaps on and off during an operation:**

- Use the S keyboard shortcut to turn snap on and off.

---

**TIP** You can select something with snap off, and then turn snap on to snap it to a snap target. Alternately you might want to snap to something, then position it freely wherever you want.

---

## **Interface**

Use these check boxes on the Snaps tab to turn on any combination of snap settings.

After setting snaps, close the dialog using the Close button in the dialog's upper-right corner. Do not click the Clear All button, or you'll turn off all the snaps.

**Override** This label changes to display the temporary snap type used by the Override system. For more information, see [Snap Override](#) on page 2585 .

**Clear All** Turns off all of the Snaps check boxes.

---

**NOTE** The layout of the Grid And Snap Settings dialog is generated at runtime. Because of this, it might appear slightly different than the illustrations shown here.

---

## Standard snaps

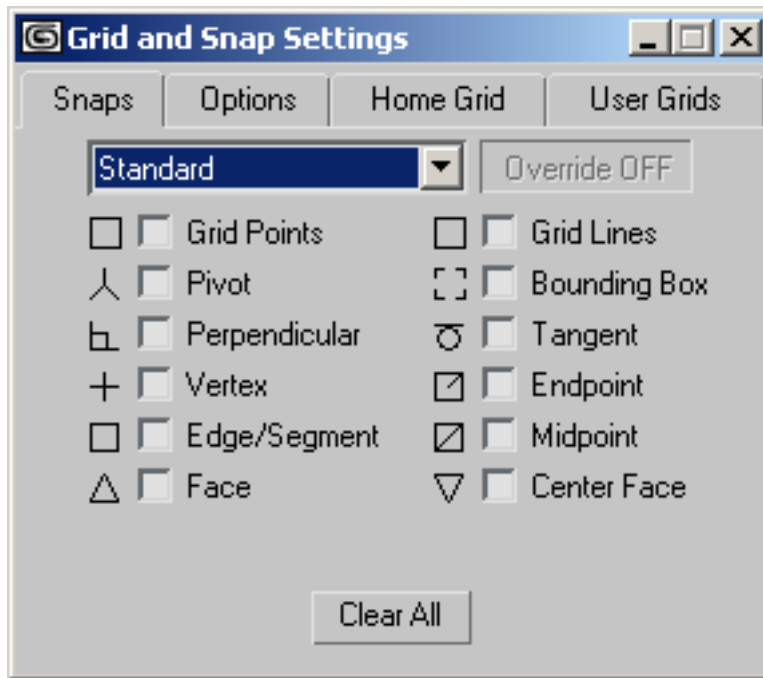

These are the standard snap types used for grids, mesh, and shape objects. Non-grid snap types, when active, take priority over Grid Points and Grid Lines snaps: if the mouse is equally near a grid point and some other snap type, it will choose the other snap type.

**NOTE** The button images shown below are from the [Snaps toolbar](#) on page 2579

.



**Grid Points** Snaps to grid intersections. This snap type is on by default. Keyboard shortcut=Alt+F5.

**Grid Lines** Snaps to any point on a grid line.



**Pivot** Snaps to pivot points of objects. Keyboard shortcut=Alt+F6.



**Bounding Box** Snaps to one of the eight corners of an object's bounding box.

**Perpendicular** Snaps to the perpendicular point on a spline, relative to the previous point.

**Tangent** Snaps to a tangent point on a spline, relative to the previous point.



**Vertex** Snaps to vertices of mesh objects or objects that can be converted to editable meshes. Snaps to segments on splines. Keyboard shortcut=Alt+F7.

**Endpoint** Snaps to the end points of edges on meshes or spline vertices. Keyboard shortcut=Alt+F8



**Edge/Segment** Snaps anywhere along edges (visible or invisible) or spline segments. Keyboard shortcut=Alt+F10.



**Midpoint** Snaps to the middle of edges on meshes and spline segments. Keyboard shortcut=Alt+F9.



**Face** Snaps anywhere on the surface of a face. Back faces are culled, so they have no effect. Keyboard shortcut=Alt+F11.

**Center Face** Snaps to the center of triangular faces.

## NURBS Snaps

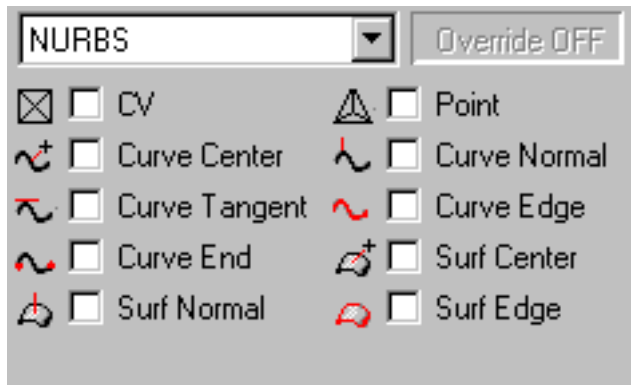

These options snap to objects or sub-objects in a [NURBS model](#) on page 7865 .

The NURBS snaps settings are aids for creating and transforming objects, and are not constraints. The software does not maintain the relationship between the NURBS object and other objects you create or transform.

**CV** Snaps to a [CV sub-object](#) on page 7750 in a [NURBS curve](#) on page 7864 or [NURBS surface](#) on page 7865 .

**Point** Snaps to a [point sub-object](#) on page 7897 in a NURBS model.

**Curve Center** Snaps to the center of a NURBS curve.

The center of a NURBS curve is calculated parametrically, and might not be the same as the curve's apparent visual center.

**Curve Normal** Snaps to a point normal to a NURBS curve.

This snap operates only while you are creating a new object that requires two or more clicks to create.

**Curve Tangent** Snaps to a point tangent to a NURBS curve.

This snap operates only while you are creating a new object that requires two or more clicks to create.

**Curve Edge** Snaps to the edge of a NURBS curve (the current object moves or is created to lie along the curve).

**Curve End** Snaps to the end of a NURBS curve.

**Surf Center** Snaps to the center of a NURBS surface.

The center of a NURBS curve is calculated parametrically, and might not be the same as the curve's apparent visual center.

**Surf Normal** Snaps to a point on a NURBS surface normal to previous point.

This snap operates only while you are creating a new object.

**Surf Edge** Snaps to the edge of a NURBS surface.

## Snap Override

Any viewport > Hold Shift and right-click. > Standard > Choose snaps type.

Customize menu > Grid and Snap Settings > Snaps tab

Snap Override lets you supersede all the currently selected snap types and temporarily use only one, or none, of the snap types currently selected on the Grid and Snap Settings dialog. For example, you might be creating a spline while snapping to grid points, but then need to snap one of its vertices to the midpoint of an object.

---

**TIP** You can choose the override by cycling through active snap types via a keyboard shortcut instead of using the quad menu. Press Alt+S repeatedly to choose the override snap type. If the Grid and Snap dialog is displayed, the "Override OFF" label changes to display the selected snap type.

---

### Procedures

#### To use Snap Override (keyboard shortcut method):

- 1 Activate all the snap types you want to use or override with.
- 2 Make sure the Grid And Snap Settings dialog is open to the Snaps panel, so you can easily track the override type. Alternatively, if you're using only snap types available on the [Snaps toolbar](#) on page 2579 , you can keep the toolbar open instead.
- 3 While creating or moving an object with Snap on, press Alt+S repeatedly. The Grid And Snap Settings dialog > "Override OFF" label changes to display the first available override snap type, chosen from the active snap types. If the Snaps toolbar is open, and the override snap type is available on the toolbar, the override snap type is visible there as well.
- 4 Press Alt+S repeatedly.

The software cycles through all the active snap types for the override type.

The benefit of this method is that it's fast and easy; you don't have to use the quad menu. But if you want to override with a snap type that isn't currently active, it's necessary to use the standard override method, which is described in the next procedure.

#### **To use Snap Override (standard method):**

- 1 While creating or moving an object with Snap on, hold down Shift and right-click in a viewport.
- 2 Select one of the snap types from the sub-menus in the Snap Override quadrant to make it the *only* active snap type.

If the Grid And Snap Settings dialog is open to the Snaps panel, the "Override OFF" label changes to display the active snap override type. When you complete the mouse action, "Override OFF" is again displayed in the dialog, and the previously active snap types are active again.

#### **To use Snap Override during a drag operation:**

- 1 Left-click, press Shift, and then right-click to display the menu.
- 2 Release the left mouse button, and then left-click to select the snap you want.
- 3 Release the Shift key, right-click, and continue the drag operation (the geometry remains locked to the mouse).
- 4 Left-click to complete the operation.

### **Interface**

In addition to the available snap types, the snap quad menu contains these items:

**Snap Options quadrant** Lets you set the following options:

- **Grid and Snap Settings:** Toggles display of the Grid And Snap Settings dialog.
- **Snaps To Frozen Objects:** Turn this on to enable snapping to frozen objects. Default=off.

- **Snaps Use Axis Constraints:** Turn this on to use the current transform constraints. For example, if you're moving a vertex with Restrict To XY Plane on and want to snap the vertex to a point removed on the Z axis, turn this off, if necessary. Default=off.

**Snap Override quadrant** Lets you set the following options:

**NURBS/Standard** Let you choose a snap type for one-time use. This applies to the next snap only.

**None** Turns off all snap types for the next mouse action. (This item is unavailable if the Snap Toggle is off.)

**[last]** Displays the last snap override type you chose from the NURBS or Standard submenu, letting you easily reuse that type.

**Snap Toggles quadrant** Lets you set six of the most common snap types on an ongoing basis. These remain in effect until you turn them off; it's the same as setting them on the Grid And Snap Settings dialog.

## Snap Options

Customize menu > Grid and Snap Settings > Grid and Snap Settings dialog > Options panel

Main toolbar > Right-click 3D Snap Toggle > Grid and Snap Settings dialog > Options panel

The Options panel of the Grid And Snap Settings dialog lets you set options related to snapping.

### Procedures

#### To set snap options:

- 1 Choose Customize menu > Grid And Snap Settings.
- 2 Click the Options tab.
- 3 Set the options as desired.

#### Example: To use Snap Preview:

The Snap Preview Radius setting lets you preview a snap before it actually happens. The Snap Radius setting determines when actual snapping occurs, providing the same functionality as Snap Strength in previous versions.

This procedure also demonstrates how to cycle through available snap/preview points with the keyboard shortcut.

- 1 Reset the software, and then maximize the Perspective viewport.  
To maximize the Perspective viewport, make sure it's active (yellow border), and then press Alt+W.
- 2 Zoom in a bit so the grid squares are relatively large.  
Snap and Snap Preview measure in pixels, so if the grid points are relatively far apart, it's easy to see the difference between Snap Preview and Snap.



- 3 On the main toolbar, click the Snaps Toggle button to turn on snapping, and then right-click the button to open the Grid And Snap Settings dialog to the Snaps panel.  
The default Snaps setting is Grid Points only; if this is not the case, make it so. A grid point is the intersection of two grid lines.
- 4 On the dialog, click the Options tab.  
In the General group, Snap Preview Radius is set to 30 pixels and Snap Radius is set to 20 pixels. You can leave this dialog open while you use snaps.



- 5 On the Create panel, click Shapes, and then click Object Type rollout > Line.  
You're now in line-creation mode.
- 6 Click anywhere in the viewport to start creating a line-type spline object.
- 7 Move the cursor around the viewport.  
As you do so, a rubber-band line connects the mouse cursor to the start point.
- 8 Position the mouse cursor near a grid point, but not too close, so that the snap cursor (cyan box + crosshairs) appears at the grid point, but the line endpoint remains attached to the mouse cursor.  
This shows the snap preview; you'll see its purpose in the next step.
- 9 Click the left mouse button.

The second line vertex is created not where you clicked but at the grid point indicated by the snap preview. Snap preview lets you see where a snap will occur before it actually happens.

- 10 Move the cursor toward another grid point.

At the Snap Preview Radius distance (30 pixels), the snap cursor appears at the grid point.

- 11 Continue moving the cursor toward the grid point.

After you move it 10 pixels closer (the difference between Snap Preview Radius and Snap Radius), the line endpoint jumps from the mouse cursor to the grid point. This is the legacy snap functionality.

- 12 Click to accept the snap.

- 13 Complete the line, and then zoom out so the grid points are closer together. Start another line, and then position the mouse cursor in the center of a grid square, so the preview snap point appears at one of the grid points.

- 14 On the keyboard, press and hold Alt+Shift and then press S repeatedly to cycle through the remaining nearby grid points. If nothing happens, try zooming out more or increasing the Snap Preview Radius value.

By default, the software uses the closest snap point as the preview location. This keyboard shortcut lets you choose other qualifying snap points.

## Interface

---

**NOTE** The layout of the Grid And Snap Settings dialog is generated at runtime. Because of this, it might appear slightly different than the illustration shown here.

---

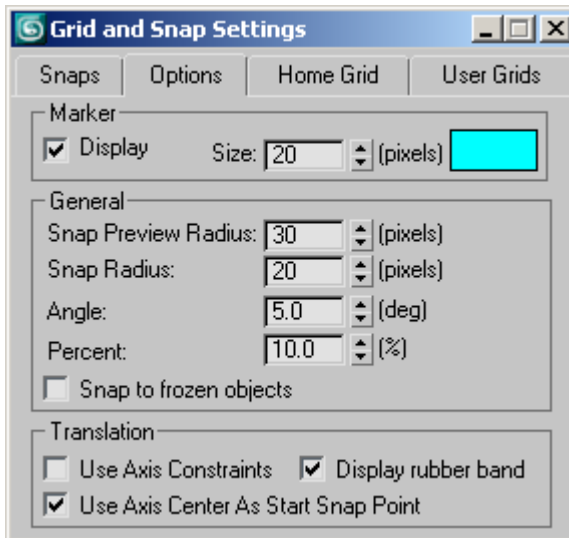

### Marker group

Provides settings that affect the visual display of the snap points.

**Display** Toggles the display of the snap guides. When off, the snaps still function, but there's no display.

**Size** Sets the size, in pixels, of the snap "hit" point. This is the small icon that indicates either the source or target snap point.

**Color** Click the color swatch to display the Color Selector, where you can set the color of the snap display.

### General group

Snap functionality includes several features that enhance ease of use. When using Snap, if the cursor comes within distance of a potential snap point that's less than the *Snap Preview Radius* distance but greater than the *Snap Radius* distance, the snap cursor jumps to that point as a preview of where the snap will occur, but no actual snapping occurs.

To use the preview point as the snap point, click or release the mouse button, depending on the context. If, instead, you then continue to move the cursor toward the potential snap point so that it comes within a distance equal to or less than the Snap Radius value, the snap takes place.



---

**TIP** For best results, keep the Snap Preview Radius value 10 pixels or more higher than the Snap Radius value. This lets you preview any snap before it actually occurs.

---

**Snap Preview Radius** When the cursor is a distance from a potential snap-to point between the Snap Preview Radius value and the Snap Radius value, the snap marker jumps to the closest potential snap-to point, but no snap occurs. Default=30.

When a snap-to preview point is highlighted, release or click the mouse button (depending on the context) to snap the current selection to that location. Alternatively, before using the displayed snap point, you can cycle through any other available preview and snap points by pressing and holding Alt+Shift and then press S repeatedly.

---

**NOTE** The Snap Preview Radius value should generally be set higher than the Snap Radius value, so that previewing occurs before snapping. If you attempt to set the Snap Preview Radius value lower than the Snap Radius value, the software lowers the latter so that the two are equal. This effectively turns off previewing, so that only snapping is in effect.

---

**Snap Radius** Sets the size of the area around the cursor, in pixels, within which snapping occurs automatically. Default=20.

---

**NOTE** The Snap Radius value should generally be set lower than the Snap Preview Radius value, so that previewing occurs before snapping. If you attempt to set the Snap Radius value higher than the Snap Preview Radius value, the software raises the latter so that the two are equal. This effectively turns off previewing, so that only snapping is in effect.

---

**Angle** Sets the increment at which objects are rotated about a given axis (degrees).

**Percent** Sets the percentage increment for scale transforms.



**Snap to Frozen Objects** When on, snapping to frozen objects is enabled. Default=off. This option is also available from the Snaps shortcut menu, accessed when you hold Shift and right-click in any viewport, as well as from the [Snaps toolbar](#) on page 2579 . Keyboard shortcut=Alt+F2.

## Translation group



**Use Axis Constraints** Constrains the selected object to move only along the axes specified on the [Axis Constraints toolbar](#) on page 7288 . When turned off (the default), the constraints are ignored, and snapped objects can be translated in any dimension (assuming 3D snapping is used). This is also available from the Snaps shortcut menu, accessed when you hold Shift and right-click in any viewport, as well as from the [Snaps toolbar](#) on page 2579 . Keyboard shortcut=Alt+F3 or Alt+D.

**Display rubber band** When on and you move an selection, a rubber-band line appears between the original location and the mouse position. Use this visual aid for greater accuracy when fine-tuning Default=on.

**Use Axis Center As Start Snap Point** Sets the center of the transform axis of the current selection set to be the initial snap point if there's no other start snap point detected by the snap system. This option works both at the object and sub-object levels.

This lets you, for example, snap the geometric center of a multi-object selection to a grid point.

## Home Grid Settings

Customize menu > Grid And Snap Settings > Home Grid panel

Main toolbar > Right-click 3D snap toggle. > Grid And Snap Settings > Home Grid panel

The Home Grid panel of the Grid And Snap Settings dialog sets the spacing and other characteristics of the [home grid](#) on page 7808 . Choosing useful home grid settings can simplify the construction process. The home grid provides a visual reference to use when creating objects in a scene.

In the software, grids have these primary uses:

- An aid in visualizing space, scale, and distance.
- Construction planes where you create and align objects in your scene.
- A reference system for using grid snaps.

## **Procedures**

### **To set grid spacing for unit measure:**

- 1 From the menu bar, choose Customize menu > Grid And Snap Settings.
- 2 Click the Home Grid tab.
- 3 Adjust the value for Grid Spacing, which is in current units.  
For example, if you have units set to centimeters, you might make one grid space equal to 1.000 (one unit, or one centimeter in this case).

### **To set major grid divisions for multiple units:**

- 1 From the menu bar, choose Customize menu > Grid And Snap Settings.
- 2 Click the Home Grid tab.
- 3 Adjust the Major Lines Every Nth Grid Line value, which is the number of grid squares between major lines. The minimum is 2.  
For example, if you use a grid spacing of one centimeter, you might use a value of 10 so the major grid divisions represent one decimeter.  
In perspective viewports, you can set a fixed size for the displayed home grid. If Inhibit Perspective View Grid Resize is turned off however, the grid size adjusts as you zoom in or out.

### **To set view update options:**

- 1 From the menu bar, choose Customize menu > Grid And Snap Settings.
- 2 Click the Home Grid tab.
- 3 Under Dynamic Update, choose either Active Viewport (the default) or All Viewports.

### **To allow subdivision below grid spacing:**

- 1 From the menu bar, choose Customize menu > Grid And Snap Settings.
- 2 Click the Home Grid tab.
- 3 Turn off Inhibit Grid Subdivision Below Grid Spacing.  
When you turn off this box, you can zoom indefinitely "deep" into any plane of the home grid. Each grid square subdivides into the same number of smaller grid spaces.

## Interface

**NOTE** The layout of the Grid And Snap Settings dialog is generated at runtime. Because of this, it might appear slightly different than the illustration shown here.

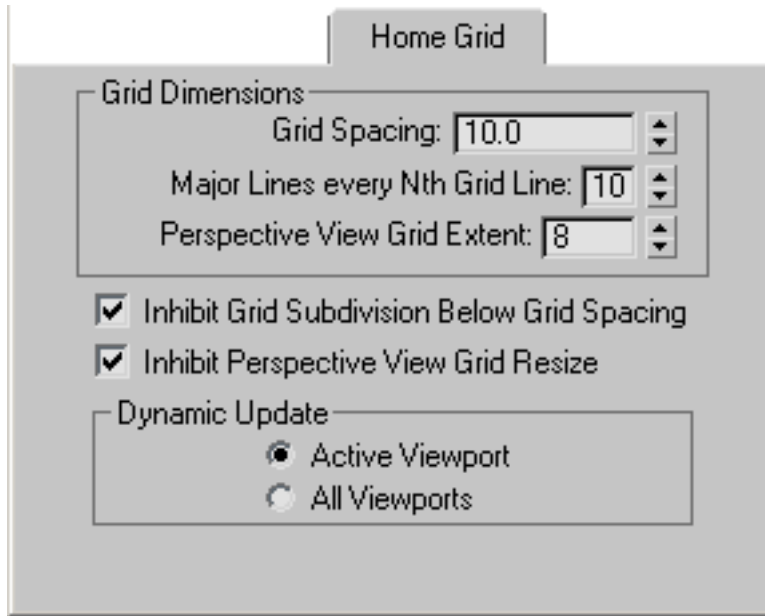

### Grid Dimensions group

**Grid spacing** Grid spacing is the size of the grid's smallest square. Use this spinner to adjust the spacing (which is in current units), or enter the value directly.

For example, if you have units set to centimeters, you might make one grid space equal to 1.000 (one unit, or one centimeter in this case).

**Major Lines every Nth Grid Line** The home grid displays heavier or "major" lines to mark groups of grid squares. Use spinner to adjust the value, which is the number of grid squares between major lines, or you can enter the value directly, the minimum is 2.

For example, if you use a grid spacing of one centimeter, you might use a value of 10 so the major grid divisions represent one decimeter.

**Perspective View Grid Extent** Sets the size of the home grid in the Perspective viewport.

This value is specified in terms of the Grid Spacing value, and represents the length of half the grid along an axis. This means that if Grid Spacing=10.0 and Perspective View Grid Extent=7, you will have a grid that is 140 x 140 units in size.

**Inhibit Grid Subdivision Below Grid Spacing** Causes 3ds Max to treat the grid as a fixed set of lines when you zoom in on the home grid. In effect, the grid stops at the grid space setting. If you keep zooming, the fixed grid is lost from view. Zooming out is not affected. When you zoom out, the home grid expands indefinitely to maintain the major grid divisions. Default=on.

When this is turned off, you can zoom indefinitely into any plane of the home grid. Each grid square subdivides into the same number of smaller grid spaces.

For a grid spacing of one centimeter and a major division of 10, the next level down subdivides into millimeter spaces, and so on.

**Inhibit Perspective View Grid Resize** Causes 3ds Max to treat the grid in the Perspective viewport as a fixed set of lines when you zoom in *or* out. In effect, the grid maintains one size, no matter how much you zoom. Default=on.

When this is turned off, the grid in the Perspective viewport will subdivide to adjust its size when you zoom in or out.

### **Dynamic Update group**

**Dynamic Update** By default, only the active viewport updates as you change values for Grid Spacing and Major Lines every Nth. The other viewports update after you have completed changing the values. Choose All Viewports to have all viewports update as you change the values.

## **User Grids Settings**

Customize menu > Grid And Snap Settings > Grid And Snap Settings dialog > User Grids tab

The User Grids panel controls automatic activation of [grid objects](#) on page 2538 and settings for [AutoGrid](#) on page 2513 .

### **Interface**

---

**NOTE** The layout of the Grid And Snap Settings dialog is generated at runtime. Because of this, it might appear slightly different than the illustration shown here.

---

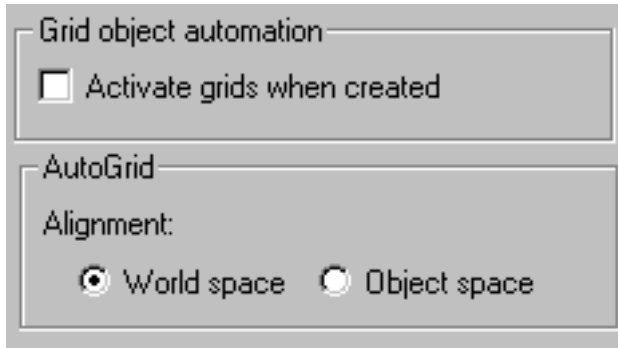

### Grid object automation group

Determines if the software automatically makes grids active upon creation.

**Activate grids when creating** Turn on to automatically activate the grid you created.

---

**TIP** If not turned on, you can activate the grid by selecting the grid, then right-clicking and choosing Activate Grid.

---

### AutoGrid group

AutoGrid allows you to automatically create grids on the surface of objects. The task of creating objects that are aligned to other object surfaces has been simplified. Turn on AutoGrid in the Object Type rollout of a command panel. When you turn on AutoGrid, the software uses the setting in the User Grids dialog for world or object space.

**World space** Aligns grids to world space.

**Object space** Aligns grids to object space.

## Drawing Aid Utilities

The utilities listed here are additional aids to drawing and precision. The Measure utility returns the measurements of a selected shape or 3D object. The Rescale World Units utility rescales either a selection or an entire scene.

Use the [Utilities panel](#) on page 7463 to open a drawing aid utility and make it active.

[Measure Utility](#) on page 2597

[Rescale World Units Utility](#) on page 2599

## Measure Utility

Utilities panel > Utilities rollout > Measure button

The Measure utility provides measurements of a selected object or shape.

**See also:**

- [Measure Distance Tool](#) on page 2529

### Procedures

**To measure an object:**

- 1 On the Utilities panel, click the Measure button.
- 2 Select the object you want to measure.

If both an object and a shape are in the selection, information is displayed for both types. If several objects are in a selection, the sum of their measurements is displayed.

## Interface

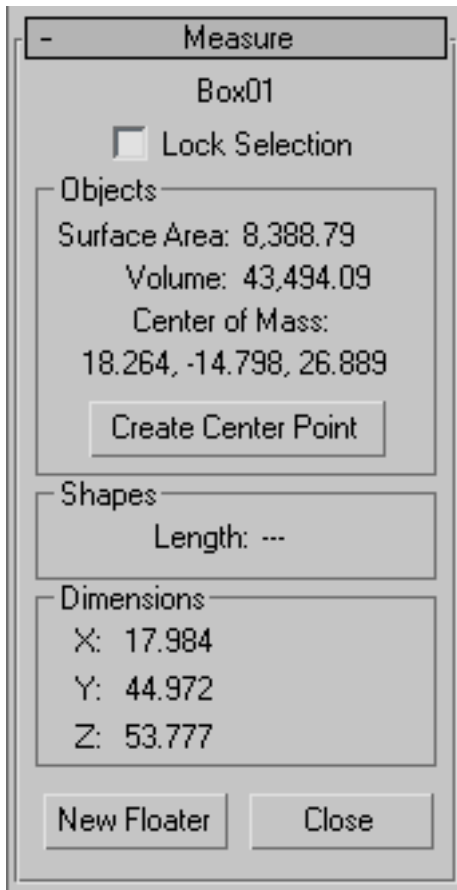

**Text display** Displays the name of the object in the current selection. If more than one object is in the selection, Multiple Objects Selected is displayed.

**Lock Selected** Prevents the displayed data from changing when you change selection. For example, you might need to select and manipulate another object that affects the currently selected object.

### Objects group

Displays information about renderable mesh objects.

**Surface Area** Displays the total surface area of all objects in the selection, in units squared.



**Volume** Displays the total volume of all objects in the selection, in units cubed. Note that objects with "holes" caused by missing faces can result in inaccurate volume values. When an object has one or more holes, an asterisk appears beside the Volume number.

**Center Of Mass** Displays the world coordinates of the location of the center of mass for the object or the center of mass of the selected objects.

**Create Center Point** Creates a point helper object at the center of mass.

### **Shapes group**

Displays information about shape objects.

**Length** Displays the sum of the length of all splines in all selected shapes.

### **Dimensions group**

Displays the dimensions of the object, as they appear in world space. For example, if it were a box with the created dimensions of 15 x 10 x 25, and that box were scaled 200 percent, then this group would report dimensions of 30 x 20 x 50.

### **Button set**

**New Floater** Launches a modeless Measure dialog that displays the same information found under the Objects, Shapes, and Dimensions groups on the Utilities panel. In addition, you can expand the dialog horizontally, in case the values are too long to be viewed in the default dialog size.

---

**TIP** While the Measure floater is displayed, you can view the length of a spline while you're creating it.

---

**Close** Closes the utility.

## **Rescale World Units Utility**

Utilities panel > Utilities rollout > More button > Utilities dialog > Rescale World Units

This utility rescales the world units of either the entire scene or selected objects in the scene. The Rescale World Units dialog controls scale factor and whether it is applied to the entire scene or the current selection.

## Procedures

### To rescale an object:

- 1 Select an object in the viewport.
- 2 On the Utilities panel, click the More button, and on the Utilities dialog, choose Rescale World Units from the list.
- 3 On the Utilities panel, click the Rescale World Units button.
- 4 On the Rescale World Units rollout, click the Rescale button.
- 5 Set the Scale Factor to the desired scale. For example, setting the scale to a value of 2.0 doubles the size of the object that it's applied to.
- 6 In the Affect group, choose the Selection option.
- 7 Click OK to apply the scale.

## Interface

### Rescale World Units rollout

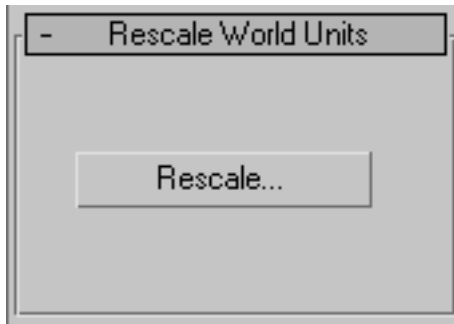

**Rescale** After selecting the objects you want to rescale, click this to display the Rescale World Units dialog.

## Rescale World Units dialog

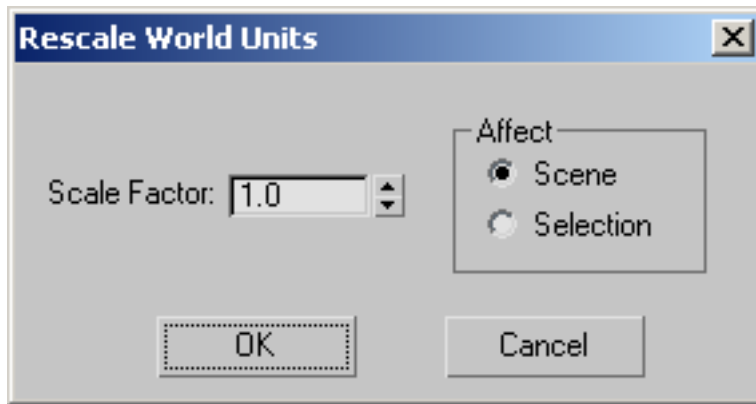

**Scale Factor** Specifies the scaling factor.

### Affect

- **Scene** Applies the scale to the entire scene.
- **Selection** Applies the scale only to the current selection.

**OK** Applies the scale.

**Cancel** Cancels the operation.



# Space Warps and Particle Systems

# 12

Space warps and particle systems are additional modeling tools. Space warps are “force fields” that deform other objects, creating the effect of ripples, waves, blowing wind, and so on. Particle systems generate particle sub-objects for the purpose of simulating snow, rain, dust, and so on. (You use particle systems primarily in animations.)

**See also:**

- [Space Warp Objects](#) on page 2603
- [Particle Flow](#) on page 2713
- [Non-Event-Driven Particle Systems](#) on page 2923

## Space Warp Objects

Create panel > Space Warps

Space warps are nonrenderable objects that affect the appearance of other objects. Space warps create force fields that deform other objects, creating the effect of ripples, waves, blowing wind, and so on.

Space warps behave somewhat like modifiers, except that space warps influence world space, rather than object space, as geometric modifiers do.

When you create a space warp object, viewports show a wireframe representation of it. You can transform the space warp as you do other 3ds Max objects. The position, rotation, and scale of the space warp affect its operation.

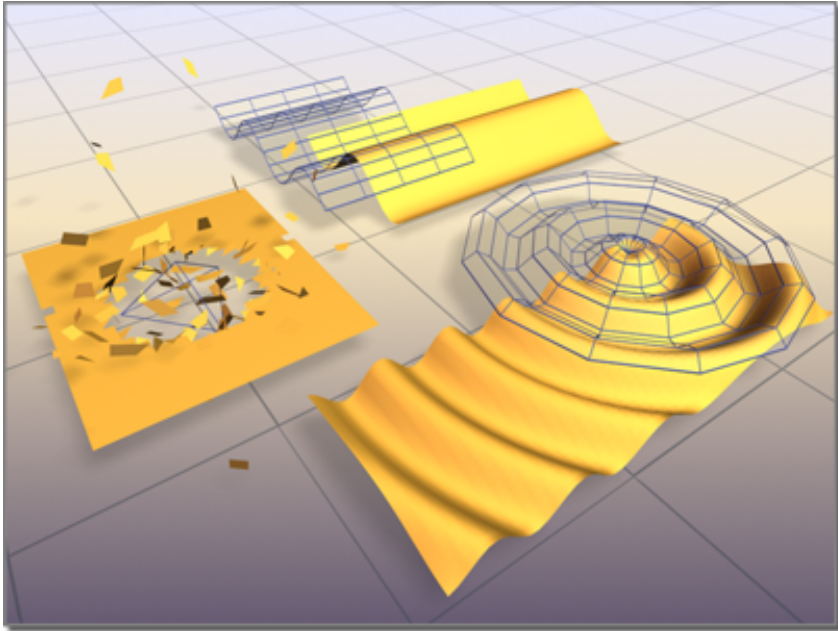

#### Surfaces deformed by space warps

**Left: Bomb**

**Right: Ripple**

**Rear: Wave**

A space warp affects objects only when the objects are [bound to it](#) on page 2609 . The warp binding appears at the top of the object's modifier stack. A space warp is always applied after any transforms or modifiers.

When you bind multiple objects to a space warp, the space warp's parameters affect all the objects equally. However, each object's distance from the space warp or spatial orientation to the warp can change the warp's effect. Because of this spatial effect, simply moving an object through warped space can change the warp's effect.

You can also use multiple space warps on one or more objects. Multiple space warps appear in an object's stack in the order you apply them.

---

**NOTE** You can take advantage of the AutoGrid feature to orient and position new space warps with respect to existing objects. See [AutoGrid](#) on page 2513 for details.

---

## Space Warps and Supported Objects

Some types of space warps are designed to work on deformable objects, such as geometric primitives, meshes, patches, and splines. Other types of warps work on particle systems such as Spray and Snow.

Five space warps (Gravity, PBomb, Wind, Motor, and Push) can work on particle systems and also serve special purposes in a dynamics simulation. In the latter case, you do not bind the warps to objects, but rather assign them as effects in the simulation.

On the Create panel, each space warp has a rollout labeled Supports Objects Of Type. This rollout lists the kind of objects you can bind to the warp.

## Basics of Using Space Warps

Follow these general steps to use space warps:

- 1 Create the space warp.
- 2 Bind objects to the space warp.



Click Bind To Space Warp on the main toolbar (available from the Select And Link flyout), and then drag between the space warp and the object.

The space warp has no visible effect on your scene until you bind an object, system, or selection set to it.

- 3 Adjust the space warp's parameters.
- 4 Transform the space warp with Move, Rotate, or Scale. The transforms often directly affect the bound object.

You can animate space warp parameters and transforms. You can also animate space warp effects by animating transforms of an object bound to the warp.

## Particle Leakage and Deflector Space Warps

A deflector is a space warp that acts as a barrier to particles in particle systems. Occasionally stray particles can leak through a deflector under the following circumstances:

- When a particle happens to hit the deflector too near the end or beginning of a time interval, and numerical error in the solution doesn't report a hit

- When a particle hits too near the edge of a face referenced by a UDeflector, and neither face finds it
- When a particle is moving quickly and first appears too close to the deflector, so the very first update cycle within the particle system takes it past the deflector without the deflector ever seeing it

Often this isn't a problem because the particles bounce off solid objects, so you don't see the errant particles. When it does cause problems, you can use a planar deflector instead of a UDeflector, a collection of planars to approximate the mesh, or a simple mesh to replace the planar. The solutions vary, so where one has a glitch the other might work just fine.

If particles are moving fast and the deflector is in a particular position (for example, it might be too close to the emitter) many particles can leak through defectors. Sometimes you can fix this leakage by changing the particle system's Subframe Sampling setting or the particle speed. Other times you must reposition the deflector farther away from the emitter.

In addition, particles imbued with [bubble motion](#) on page 2991 can leak through defectors, particularly when set to high amplitudes. To avoid this, use alternative methods of implementing bubble-like motion, such as varying speed (see [Particle Generation Rollout](#) on page 2973 ), setting a higher angle for the stream spread with spray systems (see [Spray Particle System](#) on page 2938 , [Super Spray Particle System](#) on page 2947 ), or using larger particles with an animated texture map.

## Space Warp Categories

There are four categories of space warps, available via the list on the Create panel's Space Warps category.

### Forces

These space warps are used to affect particle systems and dynamics systems. All of them can be used with particles, and some can be used with dynamics. The Supports Objects of Type rollout indicates which systems each space warp supports.



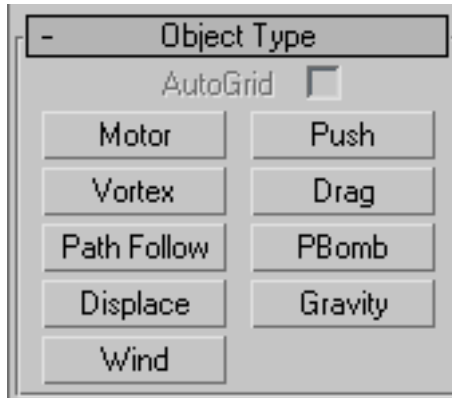

[Motor Space Warp](#) on page 2614

[Push Space Warp](#) on page 2609

[Vortex Space Warp](#) on page 2619

[Drag Space Warp](#) on page 2624

[Path Follow Space Warp](#) on page 2635

[PBomb Space Warp](#) on page 2629

[Displace Space Warp](#) on page 2645

[Gravity Space Warp](#) on page 2639

[Wind Space Warp](#) on page 2642

## **Deflectors**

These space warps are used to deflect particles or to affect dynamics systems. All of them can be used with particles and with dynamics. The Supports Objects of Type rollout indicates which systems each space warp supports.

[PDynaFlect Space Warp](#) on page 2656

[POmniFlect Space Warp](#) on page 2650

[SDynaFlect Space Warp](#) on page 2663

[SOmniFlect Space Warp](#) on page 2661

[UDynaFlect Space Warp](#) on page 2666

[UOmniFlect Space Warp](#) on page 2664

[SDeflector Space Warp](#) on page 2669

[UDeflector Space Warp](#) on page 2672

[Deflector Space Warp](#) on page 2675

### **Geometric/Deformable**

These space warps are used to deform geometry.

[FFD\(Box\) Space Warp](#) on page 2678

[FFD\(Cyl\) Space Warp](#) on page 2685

[Wave Space Warp](#) on page 2695

[Ripple Space Warp](#) on page 2699

[Displace Space Warp](#) on page 2645

[Conform Space Warp](#) on page 2703

[Bomb Space Warp](#) on page 2707

### **Modifier-Based**

These are space-warp versions of object modifiers (see [Modify Panel](#) on page 7425 ). Read more about these in [Modifier-Based Space Warps](#) on page 2711 .

[Bend Modifier](#) on page 1139

[Noise Modifier](#) on page 1501

[Skew Modifier](#) on page 1596

[Taper Modifier](#) on page 1739

[Twist Modifier](#) on page 1765

[Stretch Modifier](#) on page 1681

### **Procedures**

**To create a space warp:**

-  1 On the Create panel, click Space Warps.  
The Space Warps panel is displayed.
- 2 Choose a category of space warp from the list.
- 3 On the Object Type rollout, click a space warp button.

---

**TIP** You can take advantage of the AutoGrid feature to orient and position new space warps with respect to existing objects. For details, see [AutoGrid](#) on page 2513 .

---

- 4 Drag in a viewport to create the space warp.  
See the topics for the various space warps for further details.

## Bind to Space Warp

Main toolbar > Bind to Space Warp

Use the Bind to Space Warp button to attach the current selection to a [space warp](#) on page 7934 or vice versa.

### Procedures

**To bind the current selection to a space warp:**

- 1 Select an object



- 2 Click Bind to Space Warp.

- 3 Drag a line from the selected object to the space warp object. You can also press H to select the space warp by name.

The space warp object flashes for a moment to show that the bind was successful.

## Forces

### Push Space Warp

Create panel > Space Warps > Forces > Object Type rollout > Push

Create menu > Space Warps > Forces > Push

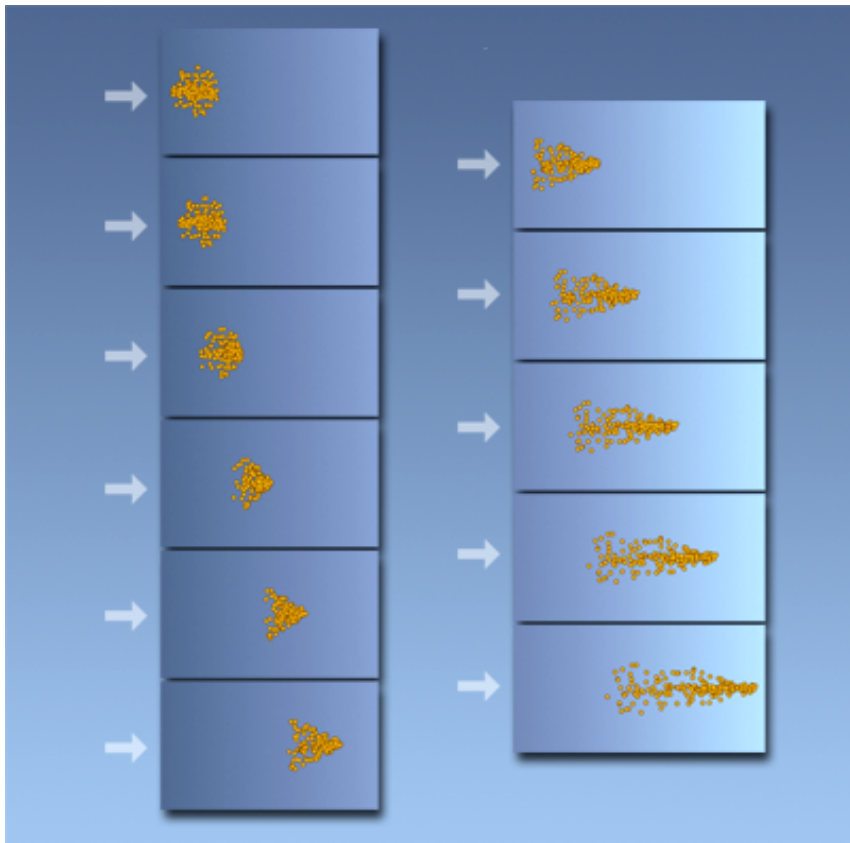

### Push disperses a cloud of particles

The Push space warp applies a force to either [particle systems](#) on page 2713 or [dynamics systems](#) on page 3775 . The effect is slightly different, depending on the system.

- **Particles:** Applies a uniform, unidirectional force in a positive or negative direction. A positive force moves in the direction of the pad on the hydraulic jack. The breadth of the force is infinite, perpendicular to the direction; you can limit it using the Range option.
- **Dynamics:** Provides a point force (also called a point load) away from the pad of the hydraulic jack icon. A negative force pulls in the opposite direction. In dynamics, applying a force is the same as pushing something with your finger.

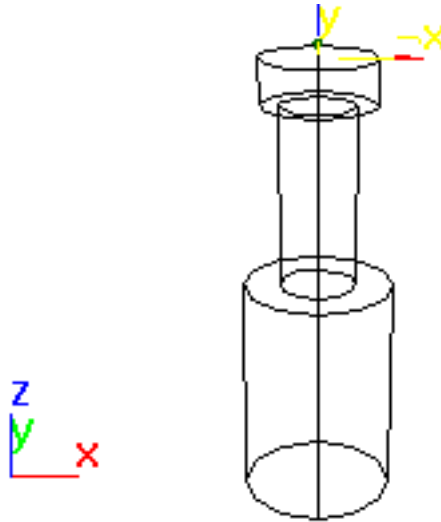

Push viewport icon

## Procedures

To create a Push space warp:

-  1 On the Create panel, click Space Warps. Choose Forces from the list, and then on the Object Type rollout, click Push.
- 2 Drag in a viewport to define the size.  
The Push warp appears as a hydraulic jack icon.

## Interface

**Parameters**

Timing

On Time: 0

Off Time: 30

Strength Control

Basic Force: 1.0

Newtons  Pounds

Feedback On

Reversible

Target Speed: 100.0

Gain: 50.0 %

Periodic Variation

Enable

Period 1: 0

Amplitude 1: 100.0 %

Phase 1: 0.0 deg

Period 2: 0

Amplitude 2: 100.0 %

Phase 2: 0.0 deg

Particle Effect Range

Enable

Range: 1000.0

Display Icon

Icon Size: 106.388

## Timing group

**On Time/Off Time** The numbers of the frames in which the space warp begins and ends its effect. Because Push moves the particles to which it's applied over time, no keyframes are created.

## Strength Control group

**Basic Force** The amount of force exerted by the space warp.

**Newtons/Pounds** This option specifies the units of force used by the Basic Force spinner.

A pound is about 4.5 Newtons, and one newton is one kilogram-per-second-squared. When Push is applied to particle systems, these values have only subjective meaning because they depend on the built-in weighting factors and time scaling used by the particle system. However, when used in a dynamics system, the value listed is precisely the value used.

**Feedback On** When on, the force varies depending on the speed of the affected particles relative to the specified Target Speed. When off, the force remains constant, regardless of the speed of the affected particles.

**Reversible** When on, if the particle's speed exceeds the Target Speed setting, the force is reversed. Available only if you turn on Feedback On.

**Target Speed** Specifies the maximum speed in units per frame before the Feedback takes effect. Available only if you turn on Feedback On.

**Gain** Specifies how quickly the force adjusts to approaching the target speed. If set to 100 percent, the correction is immediate. If set lower, a slower and "looser" response occurs. Available only if you turn on Feedback On.

---

**NOTE** Setting Gain above 100 percent can result in over-correction, but is sometimes necessary to overcome damping from other system settings, such as IK damping.

---

## Periodic Variation group

These settings introduce variations into the force by affecting the Basic Force value randomly. You can set two waveforms to produce a noise effect.

**Enable** Turns on the variations.

**Period 1** The time over which the noise variation makes a full cycle. For example, a setting of 20 means one cycle per 20 frames.

**Amplitude 1** The strength of the variation (in percent). This option uses the same types of units as the Basic Force spinner.

**Phase 1** Offsets the variation pattern.

**Period 2** Provides an additional variation pattern (a second wave) to increase the noise.

**Amplitude 2** The strength of the variation of the second wave (in percent). This option uses the same types of units as the Basic Force spinner.

**Phase 2** Offsets the variation pattern of the second wave.

### **Particle Effect Range group**

Lets you restrict the Push effect's range to a specific volume. This affects particle systems only; it has no effect on dynamics.

**Enable** When on, limits the range of the effect to a sphere, displayed as a tri-hooped sphere. The effect falls off increasingly as the particles near the boundary of the sphere.

**Range** Specifies the radius of the range of the effect, in units.

### **Display Icon group**

**Icon Size** Sets the size of the Push icon. This is for display purposes only, and does not alter the Push effect.

## **Motor Space Warp**

Create panel > Space Warps > Forces > Object Type rollout > Motor

Create menu > Space Warps > Forces > Motor



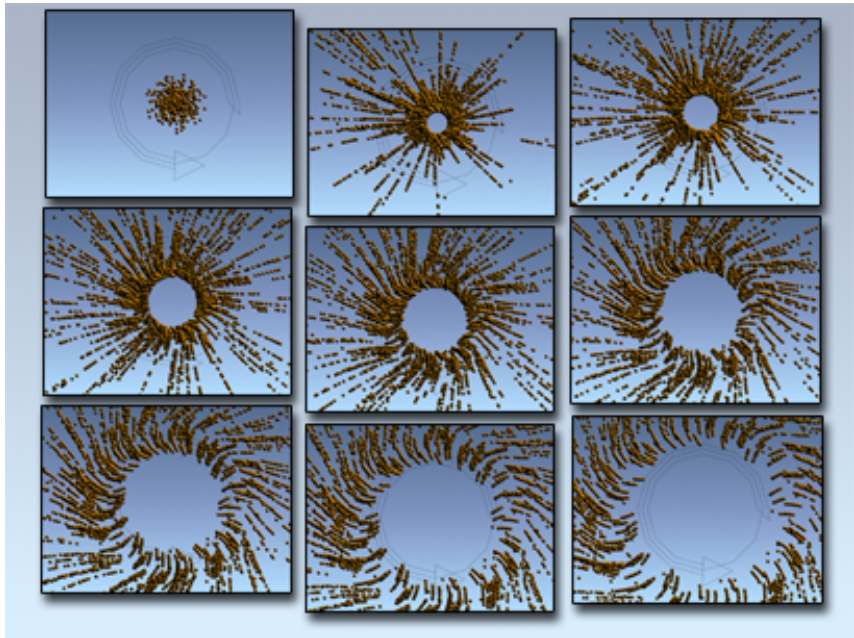

#### Motor disperses a cloud of particles

The Motor space warp works like [Push](#) on page 2609 , but applies rotational torque to the affected particles or objects rather than a directional force. Both the position and orientation of the Motor icon affect particles, which swirl around the Motor icon. When used in dynamics, the position of the icon relative to the affected object has no effect, but the orientation of the icon does.

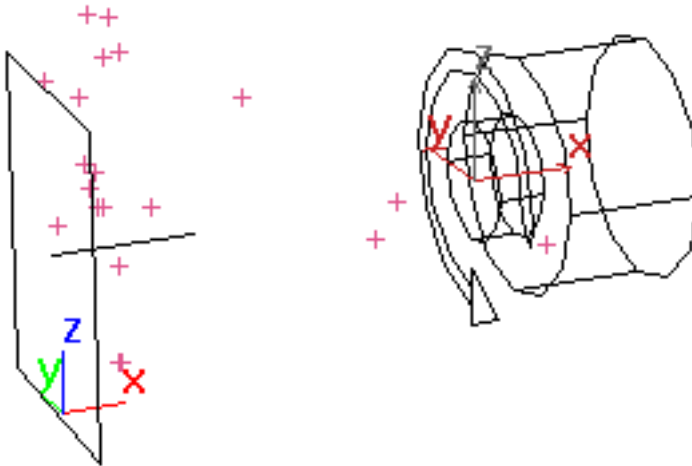

Motor viewport icon (with particle system on the left)

## Procedures

To create a motor space warp:

-  On the Create panel, click Space Warps > Forces > Motor. Choose Forces from the list, then on the Object Type rollout, click Motor.
- Click and drag in a viewport to define the size.  
The Motor warp appears as a box-shaped icon with an arrow indicating the direction of the torque.

## Interface

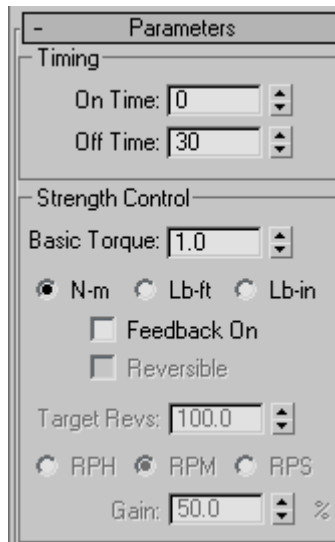

### Timing group

**On Time/Off Time** The numbers of the frames in which the space warp begins and ends its effect. Because Motor moves the objects to which it's applied over time, no keyframes are created.

### Strength Control group

**Basic Torque** The amount of force exerted by the space warp.

**N-m/Lb-ft/Lb-in** Specify the unit of measure for the Basic Torque setting, using common world measurements of torque. N-m stands for Newton meters, Lb-ft stands for pound-force feet, and Lb-in stands for pound-force inches.

**Feedback On** When on, the force varies depending on the speed of the affected objects relative to the specified Target Speed. When off, the force remains constant, regardless of the speed of the affected objects.

**Reversible** When on, if the object's speed exceeds the Target Speed setting, the force is reversed. Available only if you turn on Feedback On.

**Target Revs** Specifies the maximum revolutions before the feedback takes effect. Speed is specified in units traveled per frame. Available only if you turn on Feedback On.

**RPH/RPM/RPS** Specifies the units of measure for Target Revs in revolutions per hour, minute, or second. Available only if you turn on Feedback On.

**Gain** Specifies how quickly the force adjusts to approaching the target speed. If set to 100%, the correction is immediate. If set lower, a slower and "looser" response occurs. Available only if you turn on Feedback On.

---

**NOTE** Setting Gain above 100% can result in over-correction, but is sometimes necessary to overcome damping from other system settings, such as IK damping.

---

### Periodic Variation group

The image shows a software control panel with three sections:

- Periodic Variation:** Contains an  **Enable** checkbox. Below it are two sets of controls: **Period 1:** a text box with '0' and a spinner; **Amplitude 1:** a text box with '100.0' and a spinner, followed by a '%' symbol; **Phase 1:** a text box with '0.0' and a spinner, followed by a 'deg' symbol. The second set is identical: **Period 2:** '0', **Amplitude 2:** '100.0' %, and **Phase 2:** '0.0' deg.
- Particle Effect Range:** Contains an  **Enable** checkbox and a **Range:** text box with '1000.0' and a spinner.
- Display Icon:** Contains an **Icon Size:** text box with '46.157' and a spinner.

These settings introduce variations into the force by affecting the Basic Torque value randomly. You can set two waveforms to produce a noise effect.

**Enable** Turn on to enable the variations.

**Period 1** The time over which the noise variation makes a full cycle. For example, a setting of 20 means one cycle per 20 frames.

**Amplitude 1** The strength of the variation (in percent). This option uses the same types of units as the Basic Torque spinner.

**Phase 1** Offsets the variation pattern.

**Period 2** The next two spinners provide an additional variation pattern to increase the noise.

**Amplitude 2** The strength of the variation of the second wave in (percent). This option uses the same types of units as the Basic Torque spinner.

**Phase 2** Offsets the variation pattern of the second wave.

### **Particle Effect Range group**

Lets you restrict the Motor effect's range to a specific spherical volume. This affects particles systems only; it has no effect on dynamics.

**Enable** When on, limits the range of the effect to a sphere, displayed as a tri-hooped sphere. The effect falls off increasingly as the particles near the boundary of the sphere.

**Range** Specifies the radius of the range of the effect, in units.

### **Display Icon group**

**Icon Size** Sets the size of the Motor icon. This is for display purposes only, and does not alter the Motor effect.

## **Vortex Space Warp**

Create panel > Space Warps > Forces > Object Type rollout > Vortex

Create menu > Space Warps > Forces > Vortex

The Vortex space warp applies a force to [particle systems](#) on page 2713, spinning them through a whirling vortex, and then moving them down a long, thin spout or *vortex well*. Vortex is useful for creating black holes, whirlpools, tornadoes, and other funnel-like objects.

The space warp settings let you control the vortex shape, the well characteristics, and rate and range of particle capture. The shape of the vortex is also affected by particle system settings, such as speed.

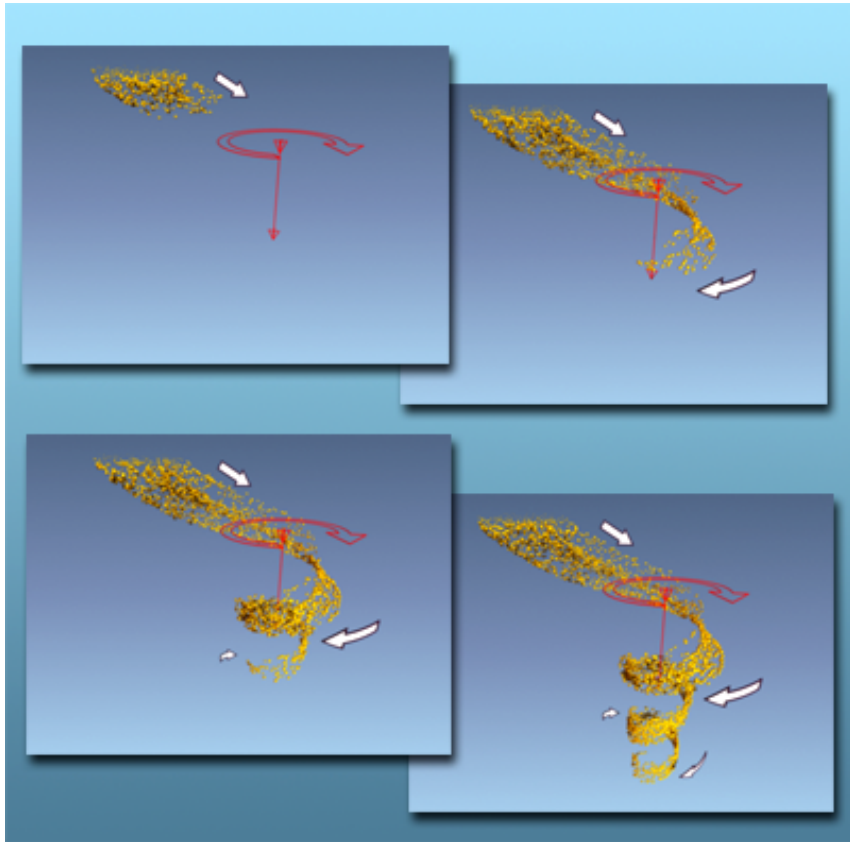

Particle stream caught in a vortex

## Procedures

To create a Vortex space warp:

- 1  On the Create panel, click Space Warps. Choose Forces from the list, and then click Vortex.
- 2 Determine which world axis you want the vortex to spiral around, and then drag in the appropriate viewport to create the space warp. For example, if you want the vortex to spin around the vertical world axis, create the space warp in the Top viewport. You can rotate the warp later to change the vortex direction, and animate the warp orientation.

The Vortex warp appears as a curved-arrow icon in the plane you drag in, with a second, perpendicular arrow indicating the axis of rotation as well as the direction of the well. This second axis is called the *drop axis*.

---

**NOTE** The position of the space warp plays an important role in the results. The vertical position affects the shape of the vortex, and the horizontal position determines its location. If you want the particles to spiral around the particle emitter, place both at the same location.

---

## Interface

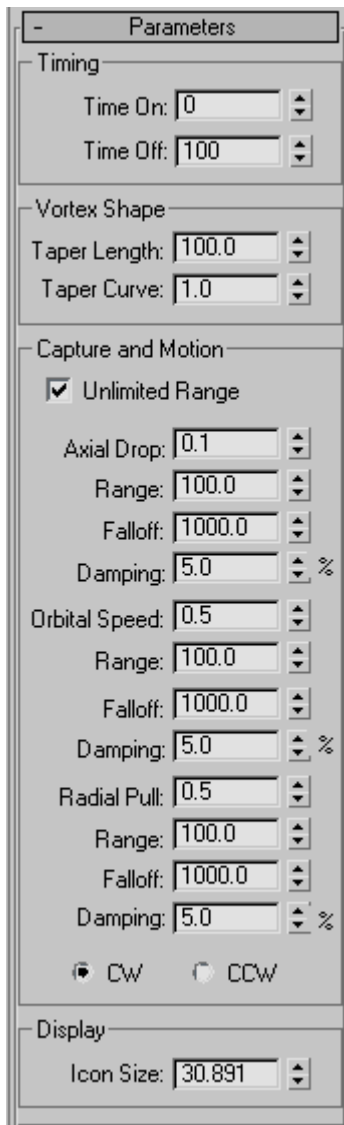

### Timing group

**Time On/Time Off** The frame numbers at which the space warp becomes active and becomes inactive.



## **Vortex Shape group**

**Taper Length** Controls the length of the vortex, as well as its shape. Lower settings give you a "tighter" vortex, while higher settings give you a "looser" vortex. Default=100.0.

**Taper Curve** Controls the shape of the vortex. Low values create a vortex with a wide, flared mouth, while high values create a vortex with nearly vertical sides. Default=1.0. Range=1.0 to 4.0.

## **Capture and Motion group**

This group contains basic settings for Axial Drop, Orbital Speed, and Radial Pull, with Range, Falloff, and Damping modifiers for each.

**Unlimited Range** When on, Vortex exerts full damping strength over an unlimited range. When off, the Range and Falloff settings take effect.

**Axial Drop** Specifies how quickly particles move in the direction of the drop axis.

**Range** The distance from the center of the Vortex icon, in system units, at which Axial Damping has its full effect. Takes effect only when Unlimited Range is turned off.

**Falloff** Specifies the distance beyond the Axial Range within which Axial Damping is applied. Axial Damping is strongest at the Range distance, decreases linearly out to the limit of the Axial Falloff, and has no effect beyond that. Takes effect only when Unlimited Range is turned off.

**Damping** Controls the degree to which particle motion parallel to the drop axis is restrained per frame. Default=5.0. Range=0 to 100.

For subtle effects, use values of less than 10%. For more overt effects, try using higher values that increase to 100% over the course of a few frames.

**Orbital Speed** Specifies how quickly the particles rotate.

**Range** The distance from the center of the Vortex icon, in system units, at which Orbital Damping has its full effect. Takes effect only when Unlimited Range is turned off.

**Falloff** Specifies the distance beyond the Orbital Range within which Orbital Damping is applied. Orbital Damping is strongest at the Range distance, decreases linearly out to the limit of the Orbital Falloff, and has no effect beyond that. Takes effect only when Unlimited Range is turned off.

**Damping** Controls the degree to which orbital particle motion is restrained per frame. Smaller values produce a wide spiral, while larger values produce a thin spiral. Default=5.0. Range=0 to 100.

**Radial Pull** Specifies the distance from the drop axis at which the particles rotate.

**Range** The distance from the center of the Vortex icon, in system units, at which Radial Damping has its full effect. Takes effect only when Unlimited Range is turned off.

**Falloff** Specifies the distance beyond the Radial Range within which Radial Damping is applied. Radial Damping is strongest at the Range distance, decreases linearly out to the limit of the Radial Falloff, and has no effect beyond that. Takes effect only when Unlimited Range is turned off.

**Damping** Controls the degree to which Radial Pull is restrained per frame. Default=5.0. Range=0 to 100.

**CW/CCW** Determines whether particles rotate clockwise or counterclockwise.

### **Display group**

**Icon Size** Specifies the size of the icon.

## **Drag Space Warp**

Create panel > Space Warps > Forces > Object Type rollout > Drag

Create menu > Space Warps > Forces > Drag

The Drag space warp is a particle motion damper that reduces particle velocity by a specified amount within a specified range. The damping can be applied linearly, spherically, or cylindrically. Drag is useful for simulating wind resistance, transfers into dense media (like water), impacts with force fields, and other, similar situations.

With each damping type, you can control the damping effect along several vectors. The damping is also affected by particle system settings, such as speed.

---

**NOTE** To create a uniform drag effect, the default value for all directional parameters is 5.0%.

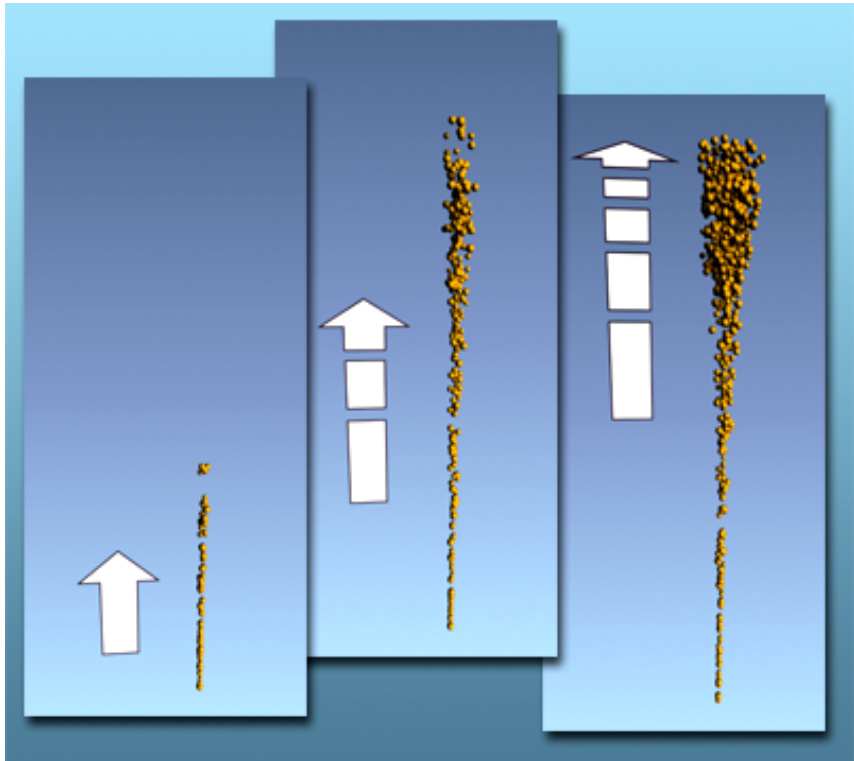

---



Drag slows down a stream of particles.

## Procedures

To create a Drag space warp:

-   On the Create panel, click Space Warps. Choose Forces from the list, and then click Drag.
- Drag in a viewport to create the space warp.  
The space warp appears initially as a box within a box, indicating that it's using the default Linear Damping mode.
- To apply the damping spherically or cylindrically, choose Spherical Damping or Cylindrical Damping in the command panel.

---

**NOTE** The position and orientation of the space warp plays an important role for all three damping types.

---

- 4 Change the settings for the current damping type as necessary.

## Interface

**Parameters**

**Timing**

Time On:

Time Off:

**Damping Characteristics**

Unlimited Range

Linear Damping

X Axis:  %

Range:

Falloff:

Y Axis:  %

Range:

Falloff:

Z Axis:  %

Range:

Falloff:

Spherical Damping

Radial:  %

Range:

Falloff:

Tangential:  %

Range:

Falloff:

Cylindrical Damping

Radial:  %

Range:

Falloff:

Tangential:  %

Range:

Falloff:

Axial:  %

Range:

Falloff:

**Display**

Icon Size:

## Timing group

**Time On/Time Off** The frame numbers at which the space warp becomes active and becomes inactive.

## Damping Characteristics group

This group lets you choose Linear Damping, Spherical Damping, or Cylindrical Damping, plus a set of parameters for each.

**Unlimited Range** When on, Drag exerts full damping strength over an unlimited range. When off, the Range and Falloff settings for the current damping type take effect.

- **Linear Damping** Motion for each particle is separated into vectors for the space warp's local X, Y, and Z axes. The area over which damping is exerted for each vector is an infinite plane whose thickness is determined by the corresponding Range setting.

**X Axis/Y Axis/Z Axis** Specifies the percentage of particle motion along the local Drag space warp axis that's affected by the damping.

**Range** Sets the thickness of the "range plane," or the infinite plane perpendicular to the specified axis. Takes effect only when Unlimited Range is turned off.

**Falloff** Specifies the distance beyond the X, Y, or Z Range within which Linear Damping is applied. Damping is strongest at the Range distance, decreases linearly out to the limit of the Falloff, and has no effect beyond that. While Falloff takes effect only beyond the Range, it is measured from the center of the icon, and always has a minimum value equal to the Range value. Takes effect only when Unlimited Range is turned off.

- **Spherical Damping** When Drag operates in Spherical Damping mode, its icon is a sphere within a sphere. Particle motion is broken up into radial and tangential vectors. Damping is applied for each vector within a spherical volume whose radius is set by the Range setting, when Unlimited Range is off.

**Radial/Tangential** Radial specifies the percentage of particle motion toward or away from the center of the Drag icon that's affected by the damping. Tangential specifies the percentage of particle motion across the body of the Drag icon that's affected by the damping.

**Range** Specifies the distance from the center of the Drag icon, in system units, within which damping is in full effect. Takes effect only when Unlimited Range is turned off.

**Falloff** Specifies the distance beyond the Radial/Tangential Range within which Linear Damping is applied. Damping is strongest at the Range distance, decreases linearly out to the limit of the Falloff, and has no effect beyond that. While Falloff takes effect only beyond the Range, it is measured from the center of the icon, and always has a minimum value equal to the Range value. Takes effect only when Unlimited Range is turned off.

- **Cylindrical Damping** When Drag operates in Spherical Cylindrical mode, its icon is a cylinder within a cylinder. Particle motion is broken up into radial, tangential, and axial vectors. Damping is applied within a spherical volume for the radial and tangential vectors and on a planar basis for the axial vector.

**Radial/Tangential/Axial** Damping controls the percentage of particle motion toward or away from the center of the circular portion of the icon (Radial), across the radial vector (Tangential), or along the length of the icon's long axis (Axial) that's affected by the damping, on a per-frame basis.

**Range** Specifies the distance from the center of the Drag icon, in system units, within which Radial and Axial damping are in full effect. Range also specifies the thickness of the infinite plane that governs the range of Axial damping. Takes effect only when Unlimited Range is turned off.

**Falloff** Specifies the distance beyond the Radial/Tangential/Axial Range within which Linear Damping is applied. Damping is strongest at the Range distance, decreases linearly out to the limit of the Falloff, and has no effect beyond that. While Falloff takes effect only beyond the Range, it is measured from the center of the icon, and always has a minimum value equal to the Range value. Takes effect only when Unlimited Range is turned off.

## Display group

**Icon Size** Specifies the size of the icon.

## PBomb Space Warp

Create panel > Space Warps > Forces > Object Type rollout > PBomb

Create menu > Space Warps > Forces > PBomb

The PBomb space warp creates an impulse wave to blow up a particle system, as distinguished from the [Bomb space warp](#) on page 2707, which blows up geometry. The PBomb is particularly well suited to the Particle Array (PArray)

system with Particle Types set to Object Fragments. This space warp also applies an impulse as a dynamics effect.

The general usage is as follows:

- Create a particle system (recommended: a [PArray system](#) on page 2964 set to Object Fragments).



- Create a PBomb and use [Bind to Space Warp](#) on page 2609 to bind it to a non-event-driven particle system. Be sure to bind the PBomb to the particle system and not to the distribution object. Or, if using Particle Flow, use a [Force operator](#) on page 2867 to apply the space warp to the particle system.
- Adjust the parameters of both the PBomb and the particle system.

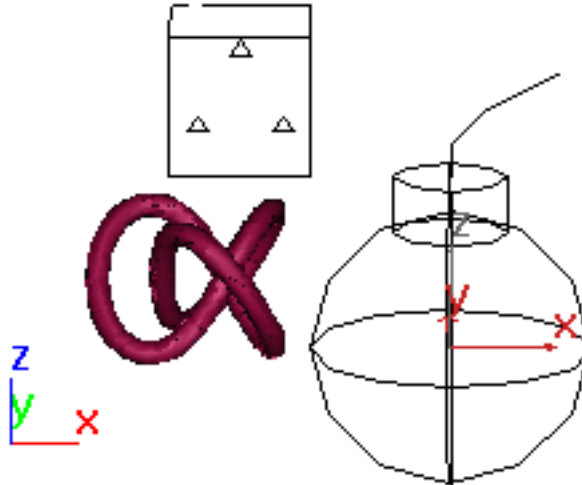

Right: PBomb viewport icon

Above: PArray particle system

Below: Torus knot used as the PArray's distribution object





Effect of blowing up the torus knot

## Procedures

### Example: To use PBomb with PArray:

You can use the Particle Bomb bound to a Particle Array to blow an object into fragments. The following steps demonstrate the basic setup.

Begin by binding a particle array to an object, and setting parameters.

- 1 Create the object you want to blow up.
- 2 Create a PArray and use Pick Object to assign the object to blow up as the PArray object-based emitter.
- 3 In the Basic Parameters rollout > Viewport Display group, choose Mesh to display the fragments as mesh objects in the viewports.
- 4 On the Particle Generation rollout of PArray, set Speed and Divergence to 0.0. This prevents PArray from moving the particles, letting PBomb do the work.
- 5 On the Particle Generation rollout, set Life to the length of the active time segment, so that the fragments appear during the entire animation.

- 6 In the Particle Type rollout > Particle Types group, choose Object Fragments. In the Object Fragment Controls group, choose Number of Chunks, and set the Minimum to about 50, depending on your distribution object and the effect you want.

Now create a particle bomb, and bind it to the particle array.

- 1 In the Space Warps panel > Particles & Dynamics category, click the PBomb button and drag in a viewport to create the PBomb icon.
- 2 Use Bind to Space Warp to bind the PArray icon to the PBomb icon. (Don't bind the distribution object by mistake.)
- 3 Select the PBomb icon and move to the Modify panel.
- 4 In the Explosion Parameters group, set Blast Symmetry to Spherical, Start Time to 10, Duration to 1, and Strength to 1.0. Choose Linear, if it's not already chosen.
- 5 Drag the time slider between frames 9 and 20 to see the effect.
- 6 Go to frame 12 and try out various settings. Notice that increasing Strength expands the explosion effect at the current frame. If you decrease Range enough, the bomb no longer affects all or part of the object (depending on the placement of the PBomb icon). Test the three Blast Symmetry settings by placing the bomb in the center of the object and then seeing the different blast patterns.

Once you get an explosive effect you like, you can return to the PArray settings, add spin or thickness to the fragments, and so on.

## Interface

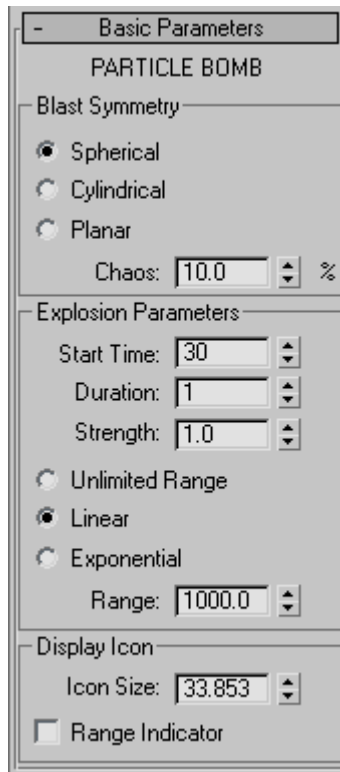

### Blast Symmetry group

These options specify the shape, or pattern of the blast effect.

**Spherical** The blast force radiates outward from the PBomb icon in all directions. The icon looks like a spherical anarchist's bomb.

**Cylindrical** The blast force radiates outward from and normal to the central axis, or core of the cylindrical icon. The icon looks like a stick of dynamite with a fuse.

**Planar** The blast force radiates both up and down, perpendicular to the plane of the planar icon. The icon looks like a plane with arrows pointing up and down along the direction of the blast force.

**Chaos** The blast forces vary for each particle or each frame, an effect similar to Brownian motion, with a rate of change in the direction of force equal to

the rendering interval rate. Note: This setting is effective only when the Duration spinner is set to 0.

### **Explosion Parameters group**

**Start Time** The frame number at which the impulse forces are first applied to the particles.

**Duration** The number of frames, beyond the first, over which the forces are applied. This value should typically be a small number, such as between 0 and 3.

**Strength** The change in velocity along the blast vector, in units per frame. Increasing Strength increases the speed with which the particles are blown away from the bomb icon.

**Unlimited Range** The effects of the bomb icon reach all bound particles throughout the scene. This option ignores the Range setting (which specifies the distance of the PBomb effect).

**Linear** The impulse forces decay linearly between the full Strength setting to a value of 0 at the specified Range setting.

**Exponential** The impulse forces decay exponentially between the full Strength setting to a value of 0 at the specified Range setting.

**Range** The maximum distance, in units, over which the PBomb icon affects the bound particle system. If the Range is large enough to reach only a portion of the particle system, only that part of the system is affected.

If you turn on Range Indicator (see following), the extent of the range is indicated by a tri-hooped sphere. If you choose Unlimited Range, this parameter has no effect.

### **Display Icon group**

These options affect the visual display of the PBomb icon.

**Icon Size** Alters the overall size of the PBomb icon.

**Range Indicator** Displays a wireframe sphere that indicates the volume of the particle bomb's influence. If you choose Unlimited Range, turning this on has no effect.

## Path Follow Space Warp

Create panel > Space Warps > Forces > Object Type rollout > Path Follow

Create menu > Space Warps > Forces > Path Follow

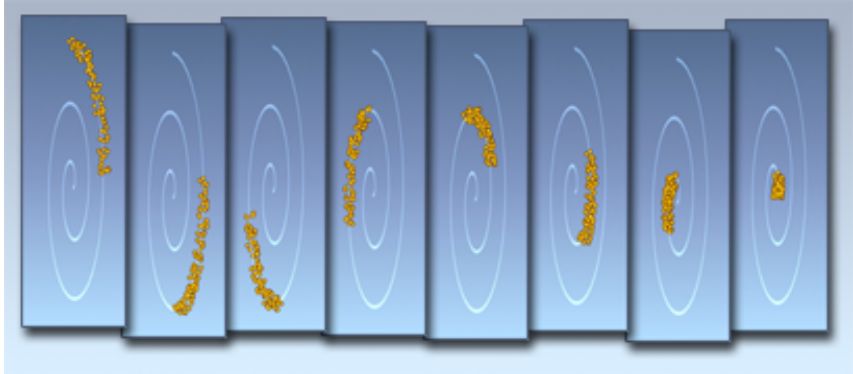



Particles following a spiral path

The Path Follow space warp forces particles to follow a spline path.

### Procedures

To create a Path Follow space warp:

-   On the Create panel, click Space Warps. Choose Forces from the list, then on the Object Type rollout, click Path Follow.
- Click and drag in a viewport to define the size.  
The Path Follow warp appears as a box-shaped icon containing curved lines that indicate hypothetical paths.

To set up and use Path Follow:

- Create a shape consisting of a single spline. (You can use shapes with multiple splines, but the software uses only one spline for the path.)
- Create a particle system and set its parameters to emit particles over a range of frames.

- 3 On the Create panel, click Path Follow, and drag in a viewport to create the Path Follow icon (a cube with wavy lines). The display and position of this icon don't affect the particles.
- 4 On the Basic Parameters rollout, click Pick Shape Object and select the spline you created earlier.



- 5 Bind the Path Follow icon to the particle system.
- 6 Adjust the Path Follow parameters to create the particle movement you want.

---

**NOTE** You can further animate the particle effect by animating the spline vertices.

---

**TIP** To adjust the position of the path or particle system while maintaining access to the Path Follow parameters, turn on Modifier Stack rollout > Pin Stack while the Path Follow space warp is selected.

---

If the particles don't follow the emitter after it's moved, then change any PathFollow parameter, and the motion will be corrected.

## Interface

- Basic Parameters

PARTICLE PATH FOLLOW

Current Path

Object: <None>

Pick Shape Object

Unlimited Range

Range: 100.0

Motion Timing:

Start Frame: 0

Travel Time: 30

Variation: 0.0 %

Last Frame: 100

Particle Motion

Along Offset Splines

Along Parallel Splines

Constant Speed

Stream Taper: 0.0 %

Variation: 0.0 %

Converge

Diverge

Both

Stream Swirl: 0.0

Variation: 0.0 %

Clockwise

Counterclockwise

Bidirectional

Uniqueness

Seed: 12345

Display Icon

Icon Size: 36.216

## Current Path group

Lets you choose the path for the particles, and specify the range of influence of the Space Warp.

**Object** Displays the name of the currently assigned path.

**Pick Shape Object** Click this, and then click a shape in the scene to select it as a path. You can use any shape object as a path; if you select a multiple-spline shape, only one the lowest-number spline is used. You can also use NURBS curves as paths.

**Unlimited Range** When off, the range of influence of the space warp is limited to the value set in the Distance spinner. When on, the space warp influences all bound particles in the scene, regardless of their distance from the path object.

**Range** Specifies the range of influence when Unlimited Range is off. This is the distance between the path object and the particle system. The position of the Path Follow space warp's icon is ignored.

## Motion Timing group

These controls affect how long particles are influenced by Path Follow.

**Start Frame** The frame at which Path Follow begins to influence the particles.

**Travel Time** The time each particle takes to traverse the path.

**Variation** The amount by which each particle's travel time can vary.

**Last Frame** The frame at which Path Follow releases the particles and no longer influences them.

## Particle Motion group

The controls in this area determine the motion of particles.

**Along Offset Splines** The distance between the particle system and the path alter the effect of the particle motion. If the first vertex of the spline is at the birthplace of the particle, the particle follows the spline path. If you move the path away from the particle system, the particles are affected by the offset.

**Along Parallel Splines** Particles follow a copy of the selected path, parallel to the particle system. In this mode, the position of the path relative to the particle system does not matter. The orientation of the path, however, affects the particle stream.

**Constant Speed** When on, all particles travel at the same speed.



**Stream Taper** Causes particles to converge or diverge toward the path over time, or to simultaneously converge and diverge. You specify the effect by choosing Converge, Diverge, or Both (see following). This provides a tapering effect over the length of the path.

**Variation** The amount by which Stream Taper can vary for each particle.

**Converge** When Stream Taper is greater than 0, the particles move in toward the path as they follow the path. The effect is that the stream tapers from larger to smaller over time.

**Diverge** Provides the opposite effect of Converge. The particles diverge from the path over time.

**Both** Splits the particle stream, causing some particles to converge and others to diverge.

**Stream Swirl** Specifies the number of turns by which particles spiral about the path. In conjunction with Stream Taper, alters the diameter of the spiral. Stream Swirl is generally more effective when you choose Along Offset Splines.

**Variation** The amount by which each particle can vary from the Spiral value.

**Clockwise** Particles spiral in a clockwise direction.

**Counterclockwise** Particles spiral in a counterclockwise direction.

**Bidirectional** The stream is split so that particles spiral in both directions.

### **Uniqueness group**

Provides a seed number for unique generation of the particle pattern.

**Seed** Specifies the seed number for the current Path Follow.

### **Display Icon group**

Affects the display of the Path Follow icon.

**Icon Size** Specifies the size of the Path Follow icon. Does not alter the Path Follow effect.

## **Gravity Space Warp**

Create panel > Space Warps > Forces > Object Type rollout > Gravity

Create menu > Space Warps > Forces > Gravity

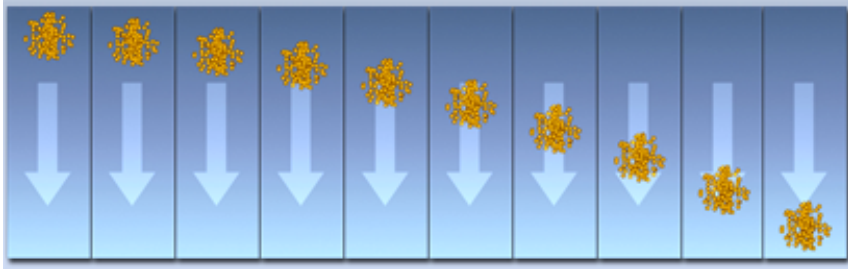

**Particles falling because of gravity**

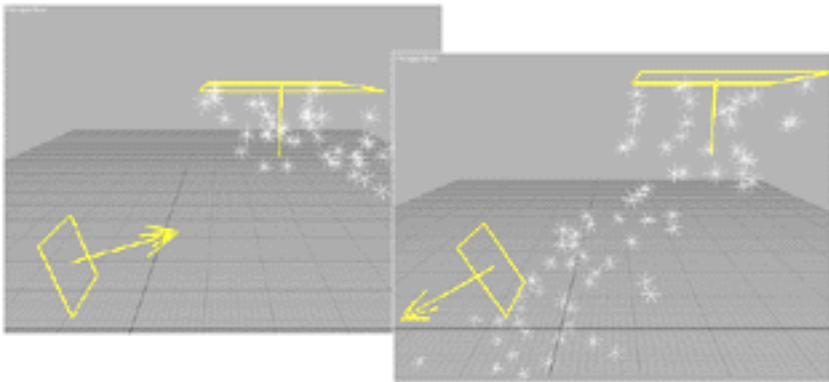

The Gravity space warp simulates the effect of natural gravity on particles generated by a particle system. Gravity is directional. Particles moving in the direction of the gravity arrow accelerate. Particles moving against the arrow decelerate. In the case of spherical gravity, motion is toward the icon. Gravity can also be used as an effect in dynamics simulations. See [Dynamics Utility](#) on page 3775 .



**Gravity effect on snow**

### **Procedures**

**To create gravity:**

- 1   On the Create panel, click Space Warps. Choose Forces from the list, then on the Object Type rollout, click Gravity.
- 2 Drag in a viewport.

The Gravity icon appears. For planar gravity (the default), the icon is a wireframe square with a direction arrow on one side. For spherical gravity, the icon is a wireframe sphere.

The initial direction of planar gravity is along the negative Z axis of the construction grid that is active in the viewport where you drag. You can rotate the gravity object to change the direction.

## Interface

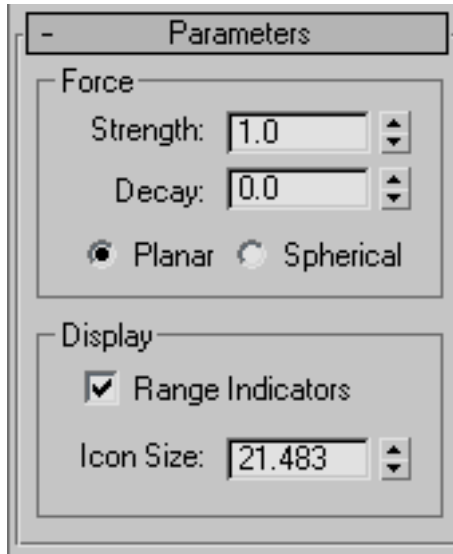

### Force group

**Strength** Increasing Strength increases the effect of gravity; that is, how objects move in relation to the Gravity icon's direction arrow. Strength less than 0.0 creates negative gravity, which repels particles moving in the same direction and attracts particles moving in the opposite direction. When Strength is set to 0.0, the Gravity space warp has no effect.

**Decay** When Decay is set to 0.0, the Gravity space warp has the same strength throughout world space. Increasing the Decay value causes gravity strength to diminish as distance increases from the position of the gravity warp object. Default=0.0.

**Planar** Gravity effect is perpendicular to the plane of the Gravity warp object throughout the scene.

**Spherical** Gravity effect is spherical, centered on the Gravity warp object. This choice is effective for creating water fountain or planetary effects.

### Display group

**Range Indicators** When on, and when the Decay value is greater than 0.0, icons in the viewports indicate the range at which the force of gravity is half the maximum value. For the Planar option, the indicators are two planes; for use the Spherical option, the indicator is a double-hooped sphere.

**Icon Size** Size of the Gravity warp object icon, in active units. You set the initial size when you drag to create the Gravity object. This value does not change the gravity effect.

## Wind Space Warp

Create panel > Space Warps > Forces > Object Type rollout > Wind

Create menu > Space Warps > Forces > Wind

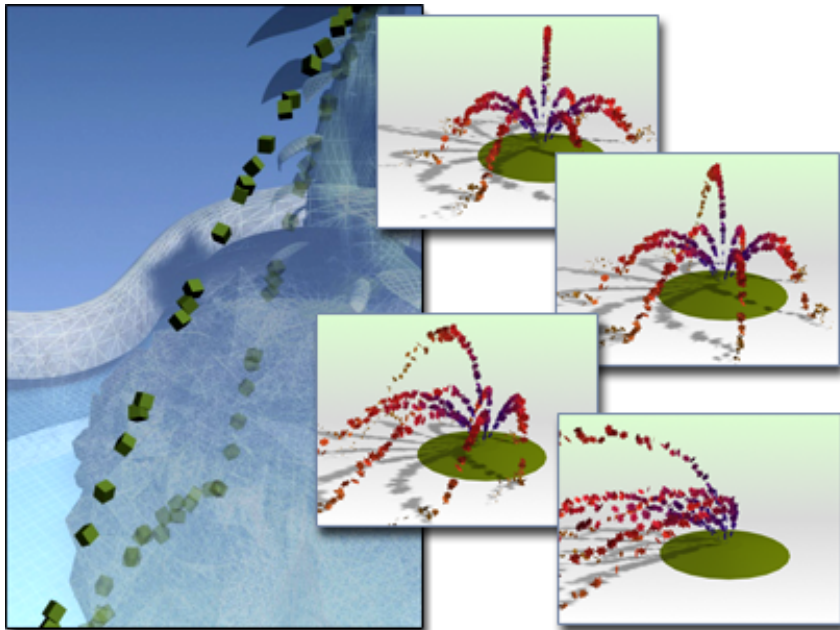

Wind changing the direction of the spray of a fountain

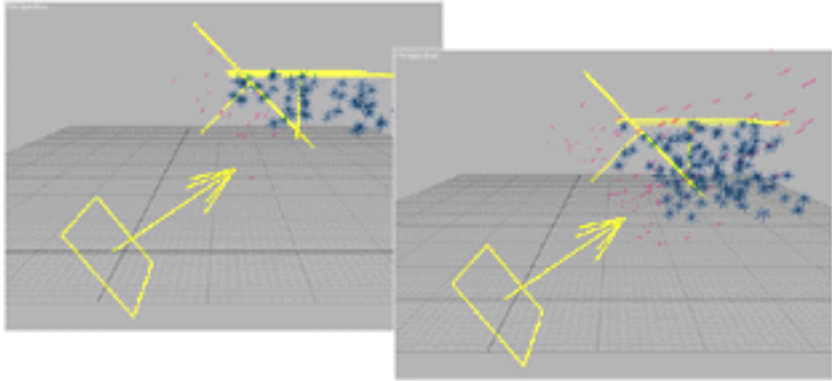

The Wind space warp simulates the effect of wind blowing particles generated by a particle system. Wind is directional. Particles moving in the direction of the wind arrow accelerate. Particles moving against the arrow decelerate. In the case of spherical wind, motion is toward or away from the icon. Wind is similar in effect to the Gravity space warp, but has added parameters for turbulence and other features characteristic of wind in the natural world. Wind can also be used as an effect in dynamics simulations. See [Dynamics Utility](#) on page 3775 .



Wind effect on snow and spray

## Procedures

### To create wind:

- 1   On the Create panel, click Space Warps. Choose Forces from the list, then on the Object Type rollout, click Wind.

- 2 Drag in a viewport.

The wind icon appears. For planar wind (the default), the icon is a wireframe square with a direction arrow coming out of one side. For spherical wind, the icon is a wireframe sphere.

The initial direction of planar wind is along the negative Z axis of the construction grid that is active in the viewport where you drag. You can rotate the wind object to change the direction.

## Interface

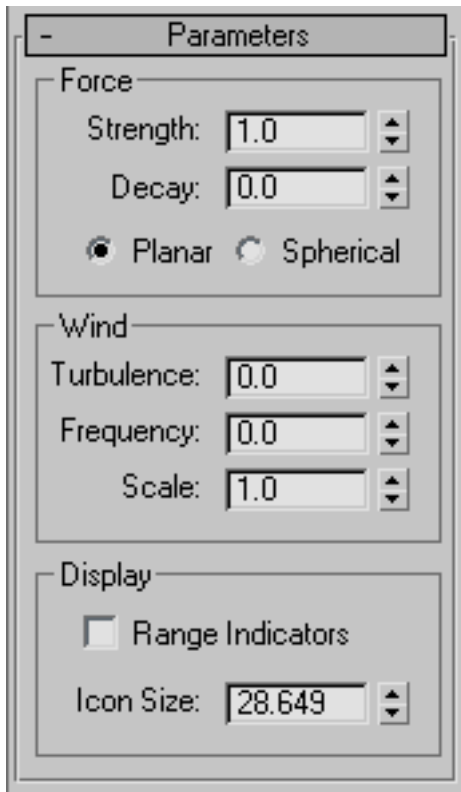

### Force group

These settings are comparable to the Gravity parameters.

**Strength** Increasing Strength increases the wind effect. Strength less than 0.0 creates a suction. It repels particles moving in the same direction and attracts particles moving in the opposite direction. When Strength is 0.0, the Wind warp has no effect.

**Decay** When Decay is set to 0.0, the Wind warp has the same strength throughout world space. Increasing the Decay value causes wind strength to diminish as distance increases from the position of the Wind warp object. Default=0.0.

**Planar** Wind effect is perpendicular to the plane of the Wind warp object, throughout the scene.

**Spherical** Wind effect is spherical, centered on the Wind warp object.

### **Wind group**

These settings are specific to the Wind space warp.

**Turbulence** Causes particles to change course randomly as the wind blows them. The greater the value, the greater the turbulence effect.

**Frequency** When set greater than 0.0, causes turbulence to vary periodically over time. This subtle effect is probably not visible unless your bound particle system generates a large number of particles.

**Scale** Scales the turbulence effect. When Scale is small, turbulence is smoother and more regular. As Scale increases, turbulence grows more irregular and wild.

### **Display group**

**Range Indicators** When the Decay value is greater than zero, icons appear in the viewports that represent the range at which the force of wind is half the maximum value. When you use the Planar option, the indicators are two planes; when you use the Spherical option, the indicator is a double-hooped sphere.

**Icon Size** Size of the Wind warp object icon, in active units. You set the initial Icon Size value when you drag to create the wind object. This value does not change the wind effect.

## **Displace Space Warp**

Create panel > Space Warps > Geometric/Deformable > Object Type rollout > Displace

Create menu > Space Warps > Geometric/Deformable > Displace

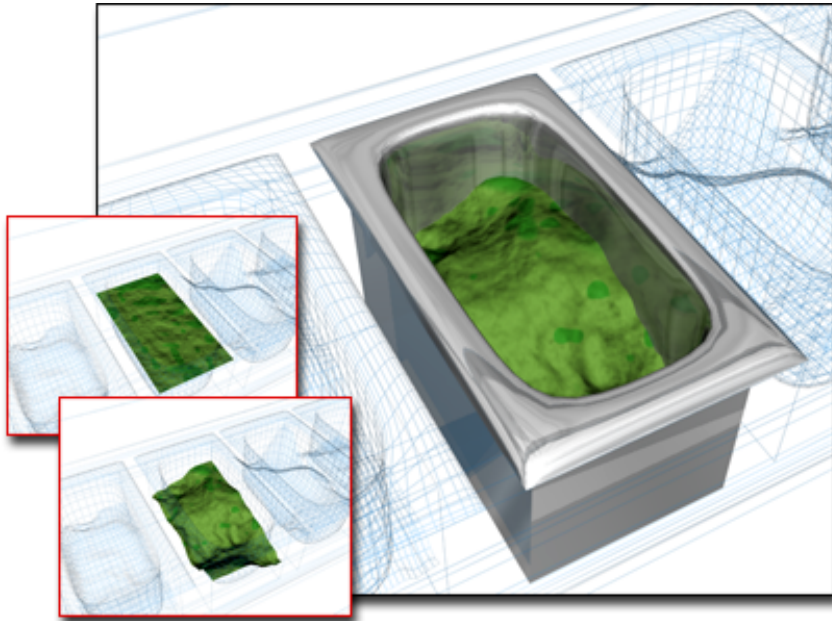

#### **Displace used to change the surface in the container**

The Displace space warp acts as a force field to push and reshape an object's geometry. Displace affects both geometry (deformable objects) and particle systems. There are two basic ways to use the Displace space warp:

- Apply the gray scale of a bitmap to generate the displacement amount. Black areas of the 2D image are not displaced. Whiter areas push outward, causing a 3D displacement of geometry.
- Apply displacement directly by setting displacement Strength and Decay values.

The Displace space warp works similarly to the Displace modifier, except that, like all space warps, it affects world space rather than object space. Use the Displace modifier when you need to create detailed displacement of a small number of objects. Use the Displace space warp to displace particle systems, a large number of geometric objects at once, or an object relative to its position in world space.

For geometry, the detail of the displacement depends on the number of vertices. Use the Tessellate modifier to tessellate faces you want to show in greater detail.



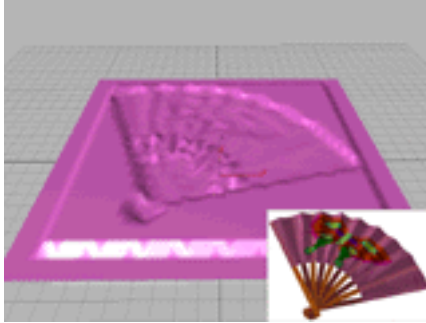



Displace space warp on a patch and the bitmap it uses

## Procedures

To create a Displace space warp:

-   On the Create panel, click Space Warps. Choose Geometric/Deformable from the list, and then on the Object Type rollout, click Displace.
- Drag in a viewport to create the Displace warp object, which appears as a wireframe. Its shape depends on the active mapping parameter settings. Regardless of the mapping, a single drag creates the space warp.
- Bind the space warp to an appropriate object.

To assign a bitmap to a displace space warp:

- Select the Displace warp object.
- In the Parameters rollout > Displacement group, click the Bitmap button (labeled "None" by default). Use the selection dialog to choose a bitmap.
- Set the Strength value. Vary the strength of the field to see how the bitmap displaces the object's geometry.

## Interface

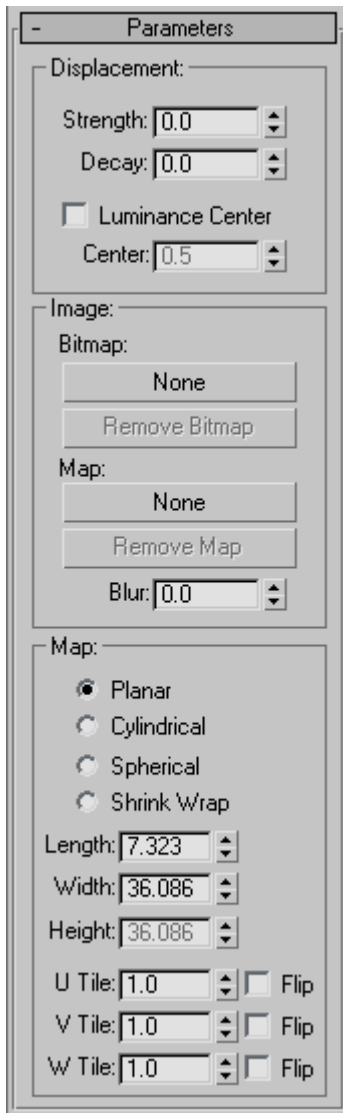

### Displacement group

These are the basic controls for Displace space warps.

**Strength** When set to 0.0, the Displace warp has no effect. Values greater than 0.0 displace object geometry or particles away from the position of the Displace space warp object. Values less than 0.0 displace geometry toward the warp. Default=0.0

**Decay** By default, the Displace warp has the same strength throughout world space. Increasing Decay causes displacement strength to diminish as distance increases from the position of the Displace warp object. Default=0.0

**Luminance Center** By default, the Displace space warp centers the luminance by using medium (50%) gray as the zero displacement value. Gray values greater than 128 displace in the outward direction (away from the Displace warp object) and gray values less than 128 displace in the inward direction (toward the Displace warp object). You can adjust the default using the Center spinner. With a Planar projection, the displaced geometry is repositioned above or below the Planar gizmo. Default=0.5. Range=0 to 1.0.

### **Image group**

These options let you choose a bitmap and map to use for displacement.

**Bitmap** (Labeled "None" by default.) Click to assign a bitmap or map from a selection dialog. After you choose a bitmap or map, this button displays the bitmap's name.

**Remove Bitmap** Click to remove the bitmap or map assignment.

**Blur** Increase this value to blur or soften the effect of the bitmapped displacement.

### **Map group**

This area contains mapping parameters for a bitmapped Displace warp. The mapping options are comparable to those options used with mapped materials. The four mapping modes control how the Displace warp object projects its displacement. The warp object's orientation controls where in the scene the displacement effect will appear on bound objects.

**Planar** Projects the map from a single plane.

**Cylindrical** Projects the map as if it were wrapped around the cylinder.

**Spherical** Projects the map from a sphere, with singularities at the top and bottom of the sphere, where the bitmap edges meet at the sphere's poles.

**Shrink Wrap** Truncates the corners of the map and joins them all at a single pole, creating one singularity.

**Length, Width, Height** Specify the dimensions of the bounding box of the space warp gizmo. Height has no effect on planar mapping.

**U/V/W Tile** The number of times the bitmap repeats along the specified dimension. The default value of 1.0 maps the bitmap once; a value of 2.0 maps the bitmap twice, and so on. Fractional values map a fractional portion of the bitmap in addition to copies of the whole map. For example, a value of 2.5 maps the bitmap two and one-half times.

**Flip** Reverses the orientation of the map along the corresponding U, V, or W axis.

## Deflectors

### POmniFlect Space Warp

Create panel > Space Warps > Deflectors > Object Type rollout > POmniFlect

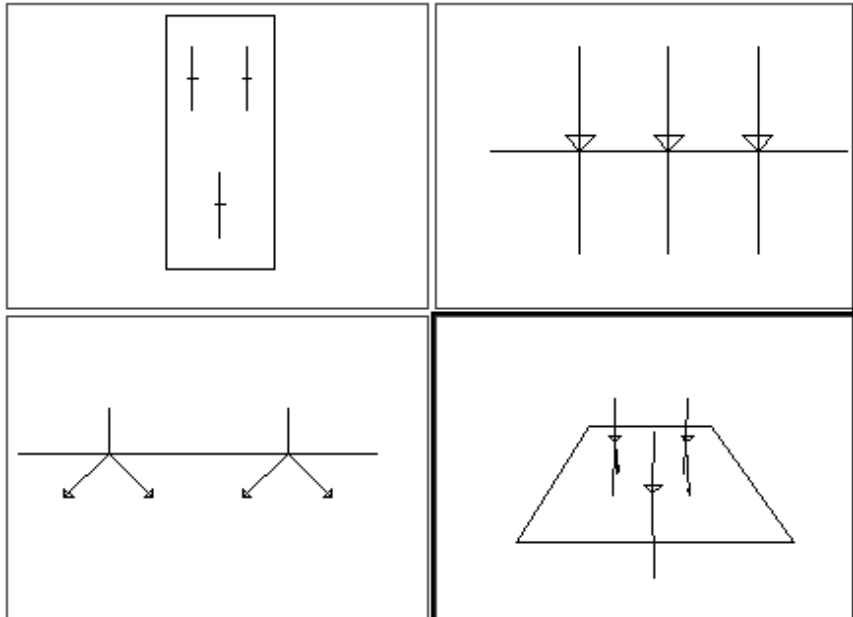

POmniFlect is a planar version of the omniflector type of space warp. It provides enhanced functionality over that found in the original Deflector space warp, including refraction and spawning capabilities.



POMniFlect viewport icon

## Procedures

To create a POMniFlect space warp:

- 1   On the Create panel, click Space Warps. Choose Deflectors from the list, then on the Object Type rollout, click POMniFlect.
- 2 Drag in a viewport to create the planar icon.

---

**NOTE** Because particles bounce off the icon, the size of the icon affects particle deflection.

---

- 3 Apply the deflector to the particle system using the appropriate method:
  - If using [Particle Flow](#) on page 2713 , specify the deflector in the [Collision test](#) on page 2881 or [Collision Spawn test](#) on page 2885 parameters.
  -  If using a [non-event-driven particle system](#) on page 2923 , [bind](#) on page 2609 the particle system to the deflector icon.
- 4 Position the POMniFlect icon to interrupt the particle stream.
- 5 Adjust the POMniFlect parameters as necessary.

## Interface

**Parameters**

**Timing**

Time On: 0

Time Off: 100

**Reflection**

Reflects: 100.0 %

Bounce: 1.0

Variation: 0.0 %

Chaos: 0.0 %

**Refraction**

Refracts: 100.0 %

Pass Vel: 1.0

Variation: 0.0 %

Distortion: 50.0 %

Variation: 0.0 %

Diffusion: 0.0 %

Variation: 0.0 %

**Common**

Inherit Vel: 1.0

Friction: 0.0 %

**Spawn Effects Only**

Spawns: 100.0 %

Pass Vel: 1.0

Variation: 0.0 %

**Display Icon**

Width: 0.0

Height: 0.0

## Timing group

The two spinners specify the start frame and end frame of the deflection effect.

**Time On/Off** Time On specifies the frame at which the deflection begins, and Time Off specifies the frame at which the deflection ends.

## Reflection group

These options affect the *reflection* of particles from the space warp. The POmniFlect can reflect or refract particles, or perform a combination of the two.

**Reflects** Specifies the percentage of particles to be reflected by the POmniFlect. See also Refracts, later in this topic, for methods of combining the two effects.

**Bounce** This is a multiplier that specifies how much of the initial speed of the particle is maintained after collision with the POmniFlect. Using the default setting of 1.0 causes the particle to rebound with the same speed as it collides. A real-world effect would usually be less than 1.0. For a “flubber” effect, set greater than 1.0.

**Variation** Specifies the variation of Bounce applied to the range of particles. For example, a Variation of 50% applied to a Bounce setting of 1.0 would result in randomly applied Bounce values ranging from 0.5 to 1.5.

**Chaos** Applies a random variation to the bounce angle. When set to 0.0 (no chaos), all particles bounce off the POmniFlect surface perfectly (like banking pool balls). A non-zero setting causes the deflected particles to scatter.

## Refraction group

These settings are similar to those in the Reflection group, but these affect the *refraction* of particles as they pass through the POmniFlect, causing the direction of the particles to change.

**Refracts** Specifies the percentage of particles *not already reflected* that will be refracted by the POmniFlect.

---

**NOTE** The Refracts value affects only those particles not already reflected because the reflected particles are processed before the refracted particles. Thus, if you set Reflects to 50% and Refracts to 50%, you would not get a 50/50 split of particles. Rather, half the particles would be reflected, and then *half the remainder* (25% of the total) would be refracted. The remaining particles either pass through without being refracted or are passed on to Spawn Effects.

---



To get a 50/50 split of reflection and refraction, set Reflects to 50% and Refracts to 100%.

**Pass Vel** Specifies how much of a particle's initial speed is maintained after passing through the POMniFlect. The default setting of 1 retains the initial speed is retained, so there's no change. A setting of 0.5 reduces the speed by half.

**Variation** Specifies the variation of Pass Velocity applied to the range of particles.

**Distortion** Controls the angle of refraction. A value of 0 means there's no refraction. A value of 100% sets the angle of the particles to be parallel with the POMniFlect surface. A value of -100% sets the angle perpendicular to the surface. The Distortion effect is reversed when particles strike the POMniFlect from the back side.

---

**NOTE** Distortion and Refraction do not work properly when particles strike the POMniFlect surface at exactly 90 degrees. In this case, any positive Distortion settings cause a scattering of particles, while negative values have no effect.

---

**Variation** Specifies a range of variation of the Distortion effect.

**Diffusion** Applies a diffusion effect to the refraction by randomly modifying each particle's Distortion angle by the Diffusion angle. This effectively scatters the particles into a hollow cone.

**Variation** Specifies a range of variation of the Diffusion value.

### **Common group**

**Friction** The amount by which particles are slowed as they move along the deflector surface. A value of 0% means they're not slowed at all. A value of 50% means they're slowed to half their original speed. A value of 100% means they stop moving when they strike the surface. Default=0%. Range=0% to 100%.

---

**TIP** To have particles slide along a deflector surface, set Bounce to 0. Also, unless influenced by a force such as Wind or Gravity, particles meant to slide should strike the surface at an angle other than 90 degrees.

---

**Inherit Vel** (Velocity Inheritance) Determines how much of a moving POMniFlect's speed is applied to reflected or refracted particles.

For example, if Inherit Vel is 1.0, particles with no motion that are hit by a moving PomniFlect inherit the speed of the POMniFlect at the point of collision.

## Spawn Effects Only group

These settings affect only particles set to Spawn On Collision that do not either reflect or refract from the omniflector. See [Particle Spawn Rollout](#) on page 2992 . The Spawns percentage spinner works like the Reflects and Refracts percentage spinners, but is the third in line to be processed. Thus, if either Reflects or Refracts are set to 100%, no particles are affected by these settings. Note also that reflective or refractive particles spawn upon collision, regardless of the settings in this group.

**Spawns** Specifies the percentage of particles that can use spawn effects.

**Pass Vel** Specifies how much of the particle's initial speed is maintained after passing through the POmniFlect.

**Variation** Specifies the variation of the Pass Velocity setting applied to the range of particles.

## Display Icon group

**Width/Height** Specify the width and height of the POmniFlect icon. This is for display purposes only and does not influence the deflector effect.

## PDynaFlect Space Warp

Create panel > Space Warps > Deflectors > Object Type rollout > PDynaFlect

PDynaFlect (planar dynamics deflector) is a planar version of the dynaflector, a special class of space warp that lets particles affect objects in a dynamics situation. For example, if you want a stream of particles to strike an object and knock it over, like the stream from a firehose striking a stack of boxes, use a dynaflector.

---

**NOTE** You use dynaflectors in the same way as omniflectors; that is, you can use them as deflectors alone, with no dynamics simulation. Because they take physics into account, dynaflectors are slower than omniflectors. Therefore, it is recommended that you use dynaflectors only when a dynamics simulation is involved.

---

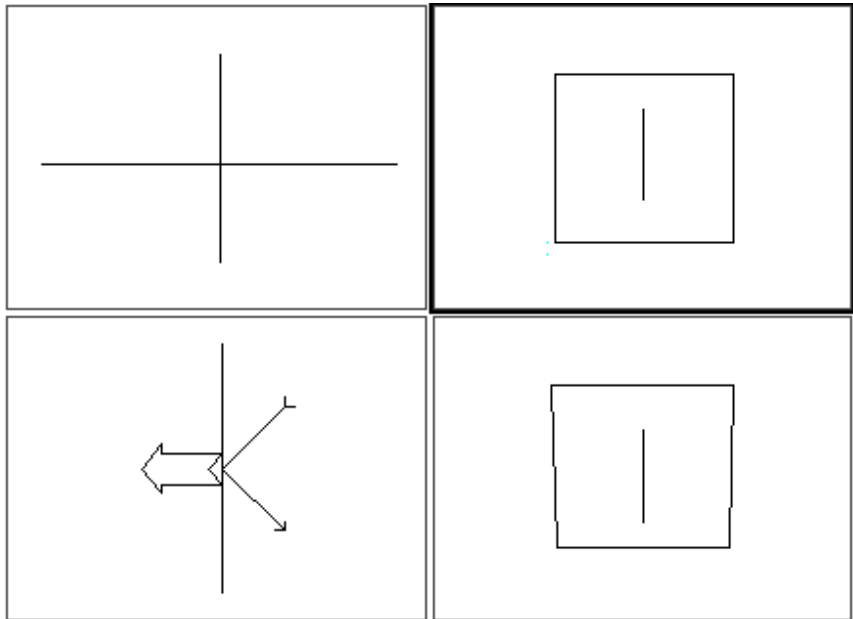



**PDynalect viewport icon**

## **Procedures**

Many dynaflector parameters are the same as those for omniflectors. However, the procedure of associating the dynaflector with both the particle system and the object to be affected is more complex than the simple binding used by omniflector.

### **To create a particle/dynamics system:**

- 1 Create or load a scene containing a [non-event-driven particle system](#) on page 2923 and an object to be affected by the particles (hereafter called "the object"). Position and orient the two as desired so that the particles strike the object.
  - The icon for the particle system must be visible in at least one non-disabled viewport.
  - On the Basic Parameters rollout of the particle system, set Percentage of Particles to 100%. Otherwise, only those particles displayed in the viewport will be calculated.

2   On the Create panel, click Space Warps. Choose Deflectors from the drop-down list, and then click one of the dynaflector buttons (PDynaFlect, SDynaFlect, or UDynaFlect). Drag in a viewport to create the deflector.

3 Do either of the following:

- If using a PDynaFlect or SDynaFlect, position the space warp icon where the particles strike (or will strike) the object. Resize and orient it as needed.



Also, link the PDynaFlect or SDynaFlect as a child of the object. This step isn't absolutely necessary, but allows the deflector to follow the object as it moves.

- If using a UDynaFlect, go to the Modify panel > Parameters rollout, click the Pick Object button, and then select the object. The position of the space warp icon doesn't matter, and it's not necessary to link the two.

4  Bind the particle system to the dynaflector using the toolbar [Bind to Space Warp button](#) on page 2609 .

5  Go to the Utilities panel and open the Dynamics utility.

6 On the Dynamics rollout, click New to create a new simulation.

7 Click Edit Object List, and add the object to the dynamics simulation.

8 Click Edit Object. On the Edit Object dialog, click Assign Object Effects and assign the dynaflector to the object.

9 On the Dynamics rollout, turn on the Update Display w/Solve check box above the Solve button.

10 Solve the simulation.

## Interface

The image shows a software interface titled "Parameters" with a minus sign in the top-left corner. It is divided into four sections, each with a minus sign in the top-left corner:

- Timing:** Contains two spinners. "Time On:" is set to 0, and "Time Off:" is set to 100.
- Particle Bounce:** Contains five spinners, each followed by a percent sign (%). "Reflects:" is 100.0, "Bounce:" is 1.0, "Variation:" is 0.0, "Chaos:" is 0.0, and "Friction:" is 0.0. "Inherit Vel:" is 1.0.
- Physical Properties:** Contains a spinner for "Mass:" set to 1.0. Below it is the text "Units of Mass" and three radio buttons: "gram" (selected), "Kg", and "Lbm".
- Display Icon:** Contains two spinners. "Width:" is 0.0 and "Height:" is 0.0.

### Timing group

The two spinners specify the start frame and end frame of the deflection effect.

**Time On/Off** Time On specifies the frame at which the deflection begins, and Time Off specifies the frame at which the deflection ends.

### **Particle Bounce group**

These settings affect the reflection of particles from the space warp.

**Reflects** Specifies the percentage of particles to be reflected by the PDynaFlect.

This affects both the particles and the dynamics reaction of the object struck by the particles. The more particles that strike the affected object, the more force applied to that object. If set to 0.0, the particles have no effect on the object.

**Bounce** This is a multiplier that specifies how much of the initial speed of the particle is maintained after collision with the PDynaFlect.

Using the default setting of 1.0 causes the particle to rebound with the same speed as it collides. A real-world effect would usually be less than 1.0. For a "flubber" effect, set greater than 1.0.

**Variation** Specifies the variation of Bounce applied to the range of particles.

For example, a Variation setting of 50% applied to a Bounce setting of 1.0 would result in randomly applied Bounce values ranging from 0.5 to 1.5.

**Chaos** Applies a random variation to the bounce angle.

When you set Chaos to 0.0 (no chaos), all particles bounce off the PDynaFlect surface perfectly (like banking pool balls). A non-zero setting causes the deflected particles to scatter.

**Friction** The amount by which particles are slowed as they move along the deflector surface. A value of 0% means they're not slowed at all. A value of 50% means they're slowed to half their original speed. A value of 100% means they stop moving when they strike the surface. Default=0%. Range=0% to 100%.

---

**TIP** To have particles slide along a deflector surface, set Bounce to 0. Also, unless influenced by a force such as Wind or Gravity, particles meant to slide should strike the surface at an angle other than 90 degrees.

---

**Inherit Vel** (Velocity Inheritance) Determines how much of a moving PDynaFlect's speed is applied to reflected or refracted particles.

For example, if Inherit Vel is 1.0, particles with no motion that are hit by a moving PDynaFlect inherit the speed of the PDynaFlect at the point of collision.

## Physical Properties group

These options let you set the mass of each particle.

**Mass** Specifies the mass based on the chosen unit.

**gram** One gram equals 1/1000 kg or 22/1000 Lbm at a gravity of 1.0.

**Kg** One kg (kilogram) equals 1000 grams or 2.2 Lbm at a gravity of 1.0.

**Lbm** One Lbm (pounds-mass) equals 5/11 kg or 454 5/11 grams at a gravity of 1.0. (Pounds-mass, the amount of mass in one pound of weight, is dependent on gravity. For pounds-mass values at a gravity other than 1.0, multiply the pounds-mass value by the gravity factor.)

## Display Icon group

**Width/Height** Specify the width and height of the PDynaFlect icon. This is for display purposes only and does not influence the deflector effect.

## SOMniFlect Space Warp

Create panel > Space Warps > Deflectors > Object Type rollout > SOMniFlect

SOMniFlect is the spherical version of the omniflector type of space warp. It provides more options than the original SDeflector. Most settings are the same as those in [POmniFlect](#) on page 2650 . The difference is that this space warp provides a spherical deflection surface rather than the planar surface. The only settings that are different are in the Display Icon area, in which you set the Radius, instead of the Width and Height.

---

**NOTE** Opposite sides of the deflectors reverse the distortion effect. Thus, a refracted particle passing through the SOMniFlect hits its outside surface first, and then its inside surface. A positive Distortion value warps the particles toward the perpendicular; then, as the particles pass through the inside surface, the same positive Distortion value warps them toward the parallel.

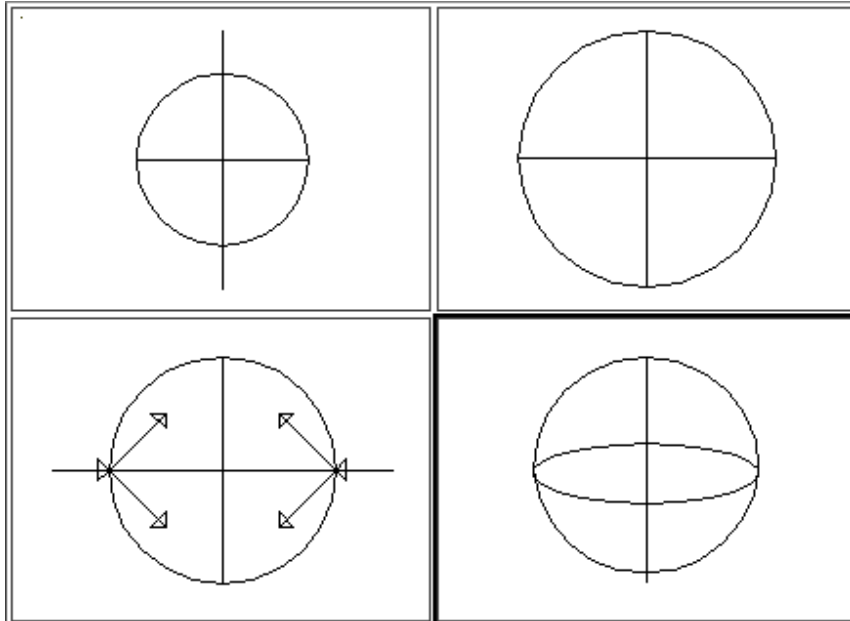



SOMniFlect viewport icon

---

## Procedures

To create an SOMniFlect space warp:

-   On the Create panel, click Space Warps. Choose Deflectors from the list, then on the Object Type rollout, click SOMniFlect.
- Drag in a viewport to create the spherical icon.

---

**NOTE** Because particles bounce off the icon, the size of the icon affects particle deflection.

---



- 3 Apply the deflector to the particle system using the appropriate method:
  - If using [Particle Flow](#) on page 2713 , specify the deflector in the [Collision test](#) on page 2881 or [Collision Spawn test](#) on page 2885 parameters.
  -  If using a [non-event-driven particle system](#) on page 2923 , [bind](#) on page 2609 the particle system to the deflector icon.
- 4 Position the SOMniFlect icon to interrupt the particle stream.
- 5 Adjust the SOMniFlect parameters as necessary.

## SDynaFlect Space Warp

Create panel > Space Warps > Deflectors > Object Type rollout > SDynaFlect

The SDynaFlect space warp is a spherical dynamics deflector. It's like the [PDynaFlect](#) on page 2656 warp, except that it's spherical, and its Display Icon spinner specifies the icon's Radius value.

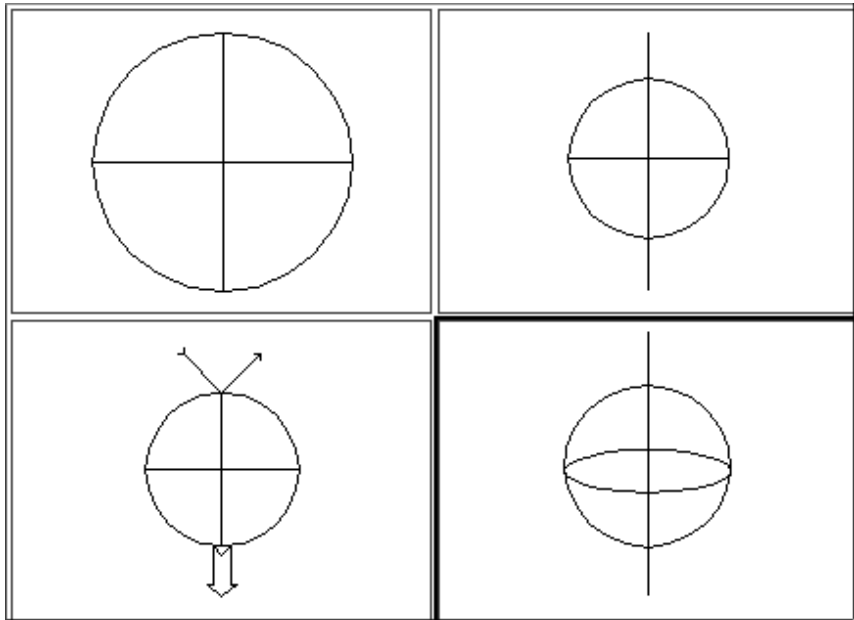

SDynaFlect viewport icon

## UOmniFlect Space Warp

Create panel > Space Warps > Deflectors > Object Type rollout > UOmniFlect

UOmniFlect, the universal omniflector, provides more options than the original UDeflector. This space warp lets you use any other geometric object as a particle deflector. The deflections are face accurate, so the geometry can be static, animated, or even morphing or otherwise deforming over time.

---

**NOTE** Some particle “leakage” can occur with this deflector, particularly when you use many particles and a complex deflector object. To avoid this, perform a test render to check for leaking particles, and then add POmniFlects to catch the strays.

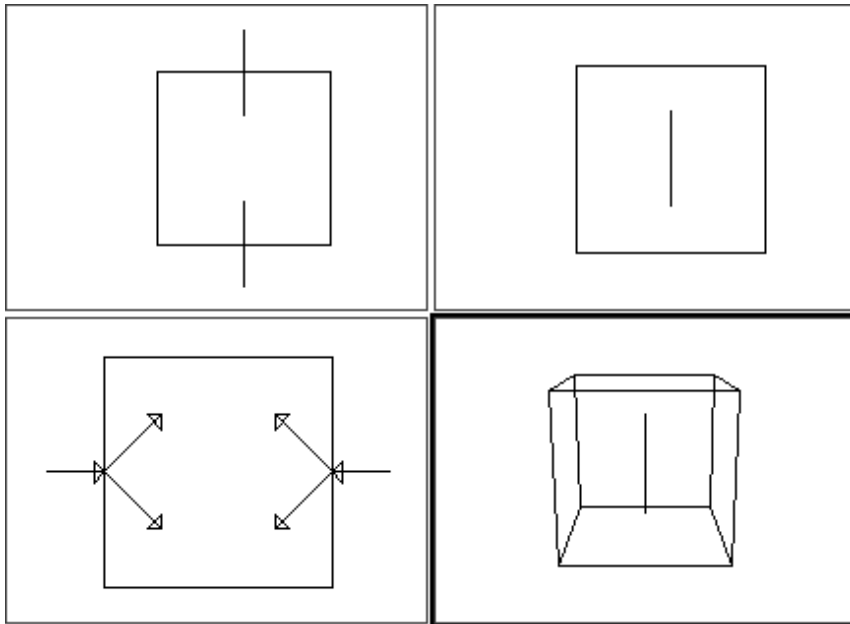

UOmniFlect viewport icon

## Procedures

### To use the UOmniFlect space warp:

To use a universal omniflector, you need a minimum of three objects in the scene:

- 1 The particle system
- 2 The UOmniFlect space warp
- 3 The object used as the deflector
- 4 Add or select an object used as the deflector.
- 5 Create a particle system whose particles intersect the deflector object.



- 6 On the Create panel, click Space Warps. Choose Deflectors from the list, and then click UOmniFlect.
- 7 Click and drag in a viewport to place the space warp icon.

---

**NOTE** The size and position of the UOmniFlect icon do not alter the effect.

---

- 8 Apply the deflector to the particle system using the appropriate method:
  - If using [Particle Flow](#) on page 2713 , specify the deflector in the [Collision test](#) on page 2881 or [Collision Spawn test](#) on page 2885 parameters.



- If using a [non-event-driven particle system](#) on page 2923 , [bind](#) on page 2609 the particle system to the deflector icon.



- 9 On the Modify panel > Parameters rollout > Object-Based OmniFlector group, click Pick Object, and then select the object to use as a deflector.
- 10 Adjust the particle system and UOmniFlect parameters as necessary.

## Interface

### Parameters rollout

The settings for the UOmniFlect are the same as those for [POmniFlect](#) on page 2650 , with the following additions:

#### Object-Based OmniFlector group

Lets you choose the object to use as a deflector.

**Item** Displays the name of the selected object.

**Pick Object** Click this, and then select any renderable object to use as a deflector.

#### Display Icon group

**Icon Size** Specifies the size of one side of the square UOmniFlect icon.

## UDynaFlect Space Warp

Create panel > Space Warps > Deflectors > Object Type rollout > UDynaFlect

The UDynaFlect space warp is a universal dynamics deflector that lets you use the surface of any object as both the particles deflector and the surface that reacts dynamically to the particle impact.

The procedures and options for using UDynaFlect are the same as for [PDynaFlect](#) on page 2656 , with the following changes and additions.

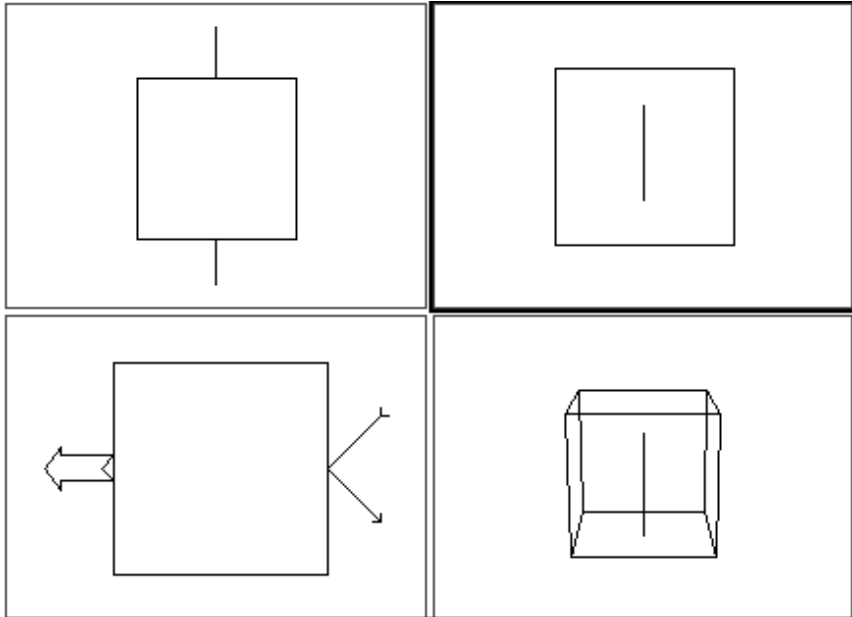

**UDynaFlect viewport icon**

---

**NOTE** When you use UDynaFlect, you must indicate the object to be affected with the Pick Object button. Linking is not necessary.

---

## Interface

The image shows a software interface titled "Parameters" for "Object-Based DynaFlector". It contains several sections with adjustable parameters:

- Object-Based DynaFlector**
  - Item: <None>
  - Pick Object button
- Timing**
  - Time On: 0
  - Time Off: 10000
- Particle Bounce**
  - Reflects: 100.0 %
  - Bounce: 1.0
  - Variation: 0.0 %
  - Chaos: 0.0 %
  - Friction: 0.0 %
  - Inherit Vel: 1.0
- Physical Properties**
  - Mass: 1.0
  - Units of Mass:  gram  Kg  Lbm
- Display Icon**
  - Icon Size: 8.088

## Object-Based DynaFlector group

Lets you choose the object to use as a deflector.

**Item** Displays the name of the selected object.

**Pick Object** Click this, and then select any renderable object to use as a deflector.

## Display Icon group

**Icon Size** Specifies the size of the UDynaFlect icon.

## SDeflector Space Warp

Create panel > Space Warps > Deflectors > Object Type rollout > SDeflector

Create menu > Space Warps > Deflectors > SDeflector

The SDeflector space warp serves as a spherical deflector of particles.

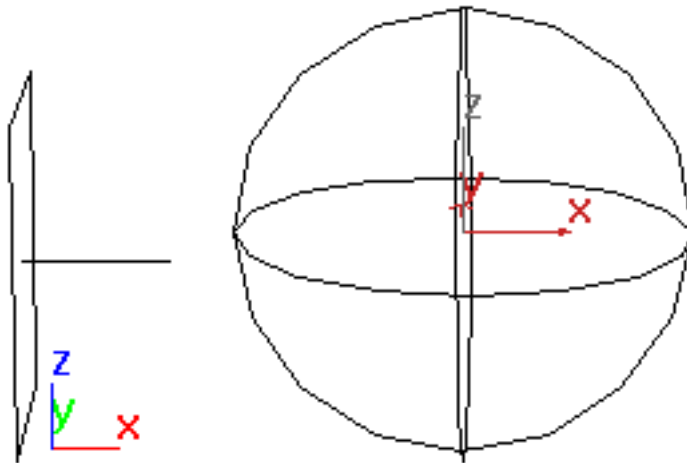

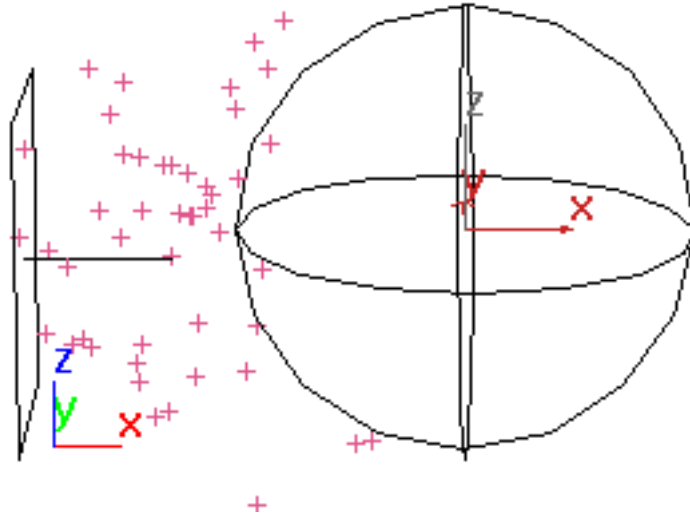

SDeflector viewport icon (with particle system on the left)



SDeflector repelling particles

## Procedures

To create an SDeflector:

- 1   On the Create panel, click Space Warps. Choose Deflectors from the list, then on the Object Type rollout, click SDeflector.
- 2 Drag in a viewport to create the spherical icon.

---

**NOTE** Because particles bounce off the perimeter of the spherical icon, the size of the icon affects particle deflection.

---

- 3 Apply the deflector to the particle system using the appropriate method:
  - If using [Particle Flow](#) on page 2713 , specify the deflector in the [Collision test](#) on page 2881 or [Collision Spawn test](#) on page 2885 parameters.
  -  If using a [non-event-driven particle system](#) on page 2923 , [bind](#) on page 2609 the particle system to the deflector icon.
- 4 Position the SDeflector icon to interrupt the particle stream.



5 Adjust the SDeflector parameters as necessary.

### Interface

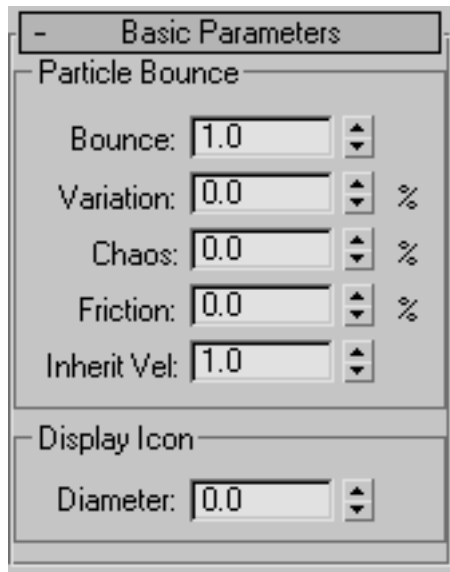

### Particle Bounce group

These settings determine how the deflector affects the bound particles.

**Bounce** Determines the speed with which particles bounce off the deflector. At 1.0, the particles bounce at the same speed as they approach. At 0, they don't deflect at all.

**Variation** The amount by which each particle can vary from the Bounce setting.

**Chaos** The amount of variation from the perfect angle of reflection (found when Chaos is set to 0.0). 100% induces a variation in reflection angle of up to 90 degrees

**Friction** The amount by which particles are slowed as they move along the deflector surface. A value of 0% means they're not slowed at all. A value of 50% means they're slowed to half their original speed. A value of 100% means they stop moving when they strike the surface. Default=0%. Range=0% to 100%.

---

**TIP** To have particles slide along a deflector surface, set Bounce to 0. Also, unless influenced by a force such as Wind or Gravity, particles meant to slide should strike the surface at an angle other than 90 degrees.

---

**Inherit Vel** (Velocity Inheritance) When the value is greater than 0, the motion of the deflector affects particles as well as the other settings. For example, to animate the SDeflector passing through a passive array of particles, turn up this value to affect the particles.

### **Display Icon group**

This option affects the display of the icon.

**Diameter** Specifies the diameter of the SDeflector icon. This setting also alters the effect of the deflection, because particles bounce off the perimeter of the icon. The scale of the icon also affects the particles.

## **UDeflector Space Warp**

Create panel > Space Warps > Deflectors > Object Type rollout > UDeflector

Create menu > Space Warps > Deflectors > UDeflector

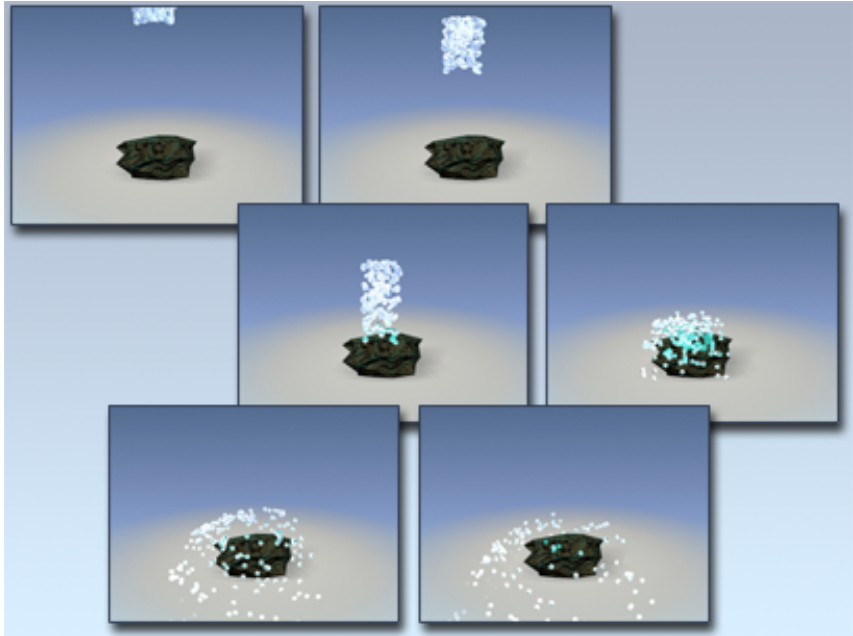



Particles scatter when they strike a UDeflector object

The UDeflector is a universal deflector that lets you use any object as a particle deflector.

### Procedures

To create a UDeflector:

- 1   On the Create panel, click Space Warps. Choose Deflectors from the list, then on the Object Type rollout, click UDeflector.
- 2 In a viewport, drag out a rectangle to add a UDeflector warp to the scene.
- 3 On the command panel, click the Pick Object button and select an object to be a particle deflector.

- 4 Apply the deflector to the particle system using the appropriate method:
  - If using [Particle Flow](#) on page 2713 , specify the deflector in the [Collision test](#) on page 2881 or [Collision Spawn test](#) on page 2885 parameters.
  -  If using a [non-event-driven particle system](#) on page 2923 , [bind](#) on page 2609 the particle system to the deflector icon.
- 5 Position the UDeflector icon to interrupt the particle stream.
- 6 Adjust the UDeflector parameters as necessary.

### Interface

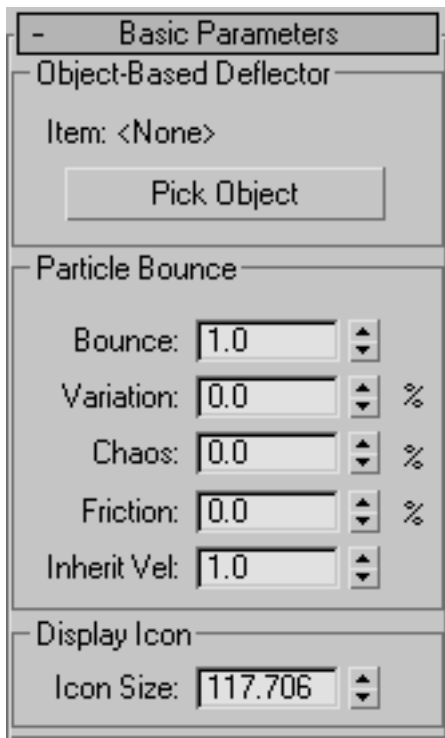

#### Object-Based Deflector group

Specifies the object to use as a deflector.

**Item** Displays the name of the selected object.

**Pick Object** Click this, and then click any renderable mesh object to be used as a deflector.

### **Particle Bounce group**

**Bounce** Determines the speed with which particles bounce off the deflector. At 1.0, the particles bounce at the same speed as they approach. At 0, they don't deflect at all.

**Variation** The amount by which each particle can vary from the Bounce setting.

**Chaos** The amount of variation from the perfect angle of reflection (found when Chaos is set to 0.0). 100% induces a variation in reflection angle of up to 90 degrees.

**Friction** The amount by which particles are slowed as they move along the deflector surface. A value of 0% means they're not slowed at all. A value of 50% means they're slowed to half their original speed. A value of 100% means they stop moving when they strike the surface. Default=0%. Range=0% to 100%.

---

**TIP** To have particles slide along a deflector surface, set Bounce to 0. Also, unless influenced by a force such as Wind or Gravity, particles meant to slide should strike the surface at an angle other than 90 degrees.

---

**Inherit Vel** (Velocity Inheritance) When greater than 0, the motion of the deflector affects particles as well as the other settings. For example, to animate the SDeflector passing through a passive array of particles, turn up this value to affect the particles.

### **Display Icon group**

**Icon Size** This spinner displays and lets you change the size of the icon.

## **Deflector Space Warp**

Create panel > Space Warps > Deflectors > Object Type rollout > Deflector

Create menu > Space Warps > Deflectors > Deflector

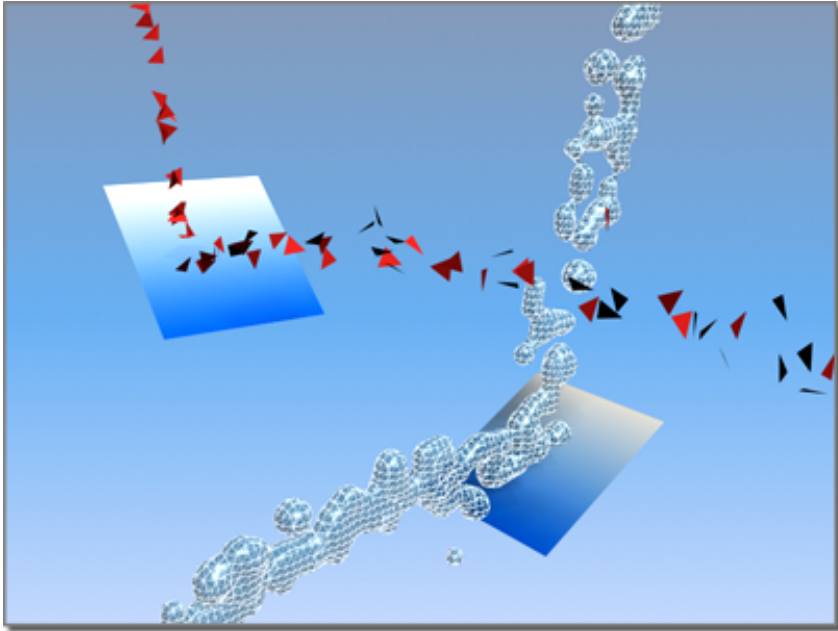

**Two streams of particles striking two deflectors**



The Deflector space warp acts as a planar shield to repel the particles generated by a particle system. For example, you can use Deflector to simulate pavement being struck by rain. You can combine a Deflector space warp with a Gravity space warp to produce waterfall and fountain effects.

**See also:**

- [SDeflector Space Warp](#) on page 2669
- [UDeflector Space Warp](#) on page 2672

**Procedures**

**To create a deflector:**

- 1   On the Create panel, click Space Warps. Choose Deflectors from the list, then on the Object Type rollout, click Deflector.
- 2 Drag in a viewport to define the deflection area.

The deflector appears as a wireframe rectangle.

3 Apply the deflector to the particle system using the appropriate method:

- If using [Particle Flow](#) on page 2713 , specify the deflector in the [Collision test](#) on page 2881 or [Collision Spawn test](#) on page 2885 parameters.



- If using a [non-event-driven particle system](#) on page 2923 , [bind](#) on page 2609 the particle system to the deflector icon.

### Interface

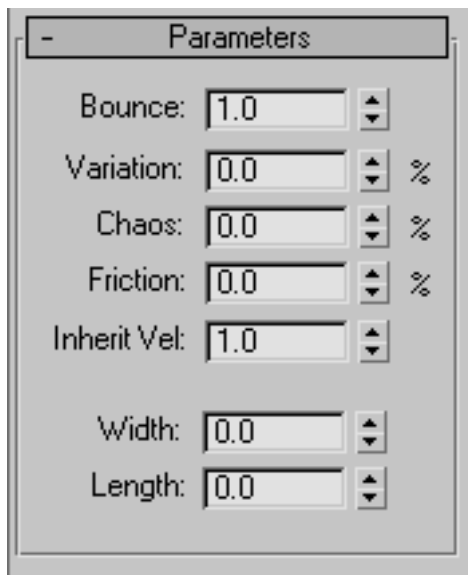

The deflector's effect is controlled mainly by its size and orientation in the scene, relative to the particle system that is bound to it. You can also adjust how strongly the deflector deflects particles.

**Bounce** Controls the speed at which particles bounce off the deflector. At a setting of 1.0, particles bounce off the deflector at the same speed they struck it. At 0.0, particles do not bounce at all. At values between 0.0 and 1.0, particles bounce off the deflector at a speed reduced from their initial speed. At values greater than 1.0, particles bounce off the deflector at a speed greater than their initial speed. Default=1.0.

**Variation** The amount by which each particle can vary from the Bounce setting.

**Chaos** The amount of variation from the perfect angle of reflection (found when Chaos is set to 0.0). 100% induces a variation in reflection angle of up to 90 degrees

**Friction** The amount by which particles are slowed as they move along the deflector surface. A value of 0% means they're not slowed at all. A value of 50% means they're slowed to half their original speed. A value of 100% means they stop moving when they strike the surface. Default=0%. Range=0% to 100%.

---

**TIP** To have particles slide along a deflector surface, set Bounce to 0. Also, unless influenced by a force such as Wind or Gravity, particles meant to slide should strike the surface at an angle other than 90 degrees.

---

**Inherit Vel** (Velocity Inheritance) When the value is greater than 0, the motion of the deflector affects particles as well as the other settings. For example, if you want an animated SDeflector passing through an array of particles to affect the particles, turn up this value.

**Width** Sets the deflector's width.

**Length** Sets the deflector's length.

## Geometric/Deformable

### FFD(Box) Space Warp

Create panel > Space Warps > Geometric/Deformable > Object Type rollout > FFD(Box)

Create menu > Space Warps > Geometric/Deformable > FFD(Box)

Free-form deformations (FFDs) provide a method of deforming an object by adjusting the control points of a lattice. The offset position of the control points to the original lattice source volume causes the distortion of the affected object.

The FFD(Box) space warp is a box-shaped lattice FFD object similar to the original FFD modifiers. This FFD is available as both an object modifier and a space warp. For information on the object-modifier version, see [FFD \(Box/Cylinder\) Modifiers](#) on page 1389 .



You create FFD space warps as separate objects similarly to the way you create standard primitives: by dragging the mouse in the viewport. The result is a lattice of control points. The source lattice of an FFD modifier is fitted to the geometry it's assigned to in the stack. This might be a whole object or a sub-object selection of faces or vertices.

Because FFD space warps are separate objects, they carry their own adjustable dimension parameters among the creation parameters.

You can apply object modifiers to space warp objects. For example, you can use the Linked XForm modifier with a space-warp FFD.

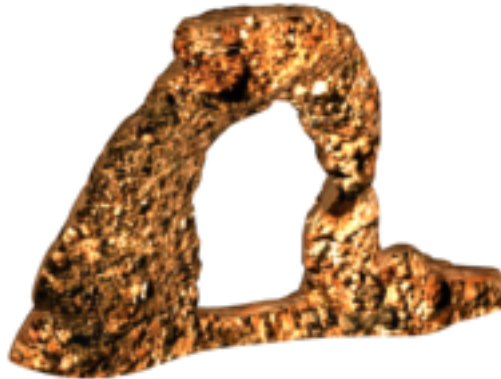

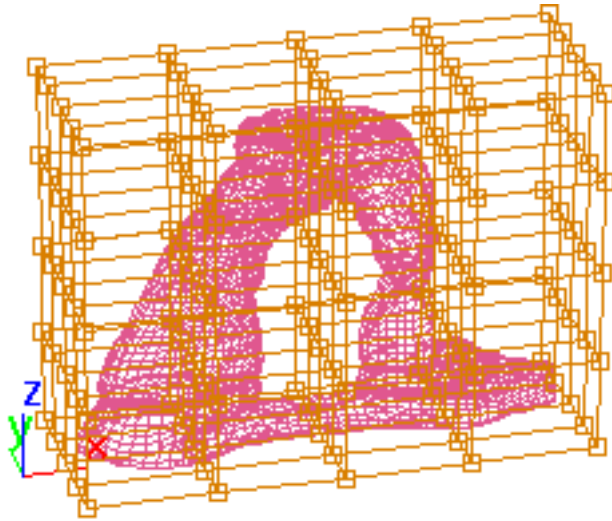

Object and object surrounded by an FFD lattice

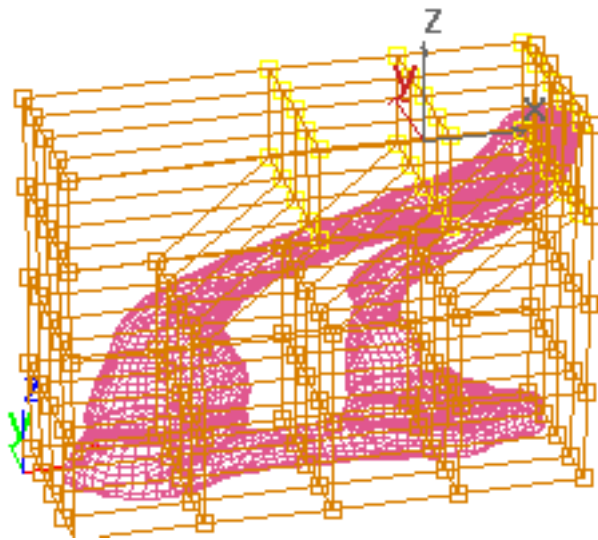

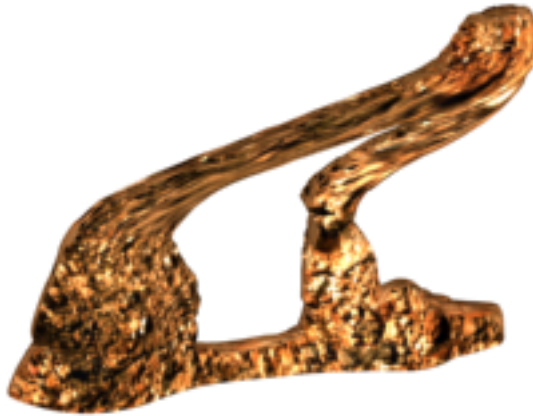





Moving control points in the lattice deforms the object.

## Procedures

To use the FFD(box) space warp:

-   On the Create panel, click Space Warps. Choose Geometric/Deformable from the list, then on the Object Type rollout, click FFD(Box).
- 2 Drag in a viewport to create the base. Release the mouse button, and then move the mouse to define the height of the FFD lattice. Click to finish the lattice.
-  3 Bind the lattice to the object you want to deform.
- 4 Determine the relative placement of the lattice to the object.  
If the lattice is to be outside of the object, turn on All Vertices. To affect only those vertices inside the lattice, choose Only In Volume, and position the lattice accordingly.

- 5  In the modifier stack display, choose Control Points as the sub-object level for FFD(box).
- 6 Adjust the control points.

---

**NOTE** The distortion effect of an FFD modifier is based on the positional offset of the control points from their original positions in the source volume. If you don't move control points, there is no effect on the target object. Keep this in mind when using space-warp version of the FFD.

---

If you're using the Deform group > All Vertices option, once you've distorted the object you can set the Falloff value to adjust how much the lattice affects the object, based on distance. This is particularly useful if the lattice is animated to approach or move away from the target object. When Falloff is set to 0, all the vertices are affected, regardless of distance.

---

**NOTE** When you're at the base-parameters level of an FFD modifier in the Stack, the Show End Result button is turned off and spring-loaded, as it is in an Edit Mesh modifier.

---

## Interface

- FFD Parameters

Dimensions:

Length:

Width:

Height:

4x4x4

Display:

Lattice

Source Volume

Deform:

Only In Volume

All Vertices

Falloff:

Tension:

Continuity:

Selection:

This rollout lets you set the size and resolution of the lattice, and how it displays and deforms.

### **Dimensions group**

These options let you adjust the unit dimensions of the source volume, and specify the number of control points in the lattice. Note that the point dimensions are displayed beside the modifier name in the Stack list.

**Length, Width, Height** These three spinners display and let you adjust the length, width, and height of the lattice. To create the space warp, you drag the mouse in the same way that you would to create a standard Box primitive. Note that these spinners don't exist in the object-modifier version of the FFD.

**Label** Displays the current number of controls points in the lattice (for example: 4x4x4).

**Set Number of Points** Displays a dialog containing three spinners labeled Length, Width, and Height, plus OK/Cancel buttons. Specify the number of control points you want in the lattice, and then click OK to make the change.

---

**NOTE** Make changes to the dimensions before you adjust the positions of the lattice control points. When you change the number of control points with this dialog, any adjustments you've already made to the control points are lost; however, you can undo this use of the dialog.

---

### **Display group**

These options affect the display of the FFD in the viewports.

**Lattice** When turned on, lines are drawn connecting the control points to make a grid. Although viewports can become cluttered when these extra lines are drawn, they help to visualize the lattice.

**Source Volume** When on, the control points and lattice are displayed in their unmodified state. This display is helpful when you're adjusting the source volume to affect specific vertices that lie within or without it. See the All Vertices and Only in Volume options, later in this topic.

### **Deform group**

These options provide controls that specify which vertices are affected by the FFD.

**Only In Volume** Only vertices that lie inside the source volume are deformed. Vertices outside the source volume are not affected.

**All Vertices** All vertices are deformed regardless of whether they lie inside or outside the source volume, depending on the value in the Falloff spinner. The deformation outside the volume is a continuous extrapolation of the deformation inside the volume. The deformation can be extreme for points far away from the source lattice.

**Falloff** This spinner, enabled only when you choose All Vertices, determines the distance from the lattice that the FFD effect will decrease to zero. When this spinner is set to 0, it's effectively turned off, and there is no falloff; that is, all vertices are affected regardless of their distance from the lattice. The units of the Falloff parameter are specified relative to the size of the lattice: A falloff of 1 means that the effect will go to 0 for points that are a lattice width/length/height away from the lattice (depending on which side they are on).

**Tension/Continuity** Lets you adjust the tension and continuity of the deformation splines. Although you can't see the splines in an FFD, the lattice and control points represent the structure that controls the splines. As you adjust the control points, you alter the splines (which move through each point). The splines, in turn, deform the geometry of the object. By altering the tension and continuity of the splines, you alter their effect on the object.

### **Selection group**

These options provide additional methods of selecting the control points. You can toggle the state of any combination of the three buttons to select in one, two, or three dimensions at once.

**All X, All Y, All Z** When one of these buttons is on and you select a control point, all control points along the local dimension specified by the button are selected as well. By turning on two buttons, you can select all control points in two dimensions.

**About** Displays a dialog with copyright and licensing information.

## **FFD(Cyl) Space Warp**

Create panel > Space Warps > Geometric/Deformable > Object Type rollout > FFD(Cyl)

Create menu > Space Warps > Geometric/Deformable > FFD(Cyl)

Free-form deformations (FFDs) provide a method of deforming an object by adjusting the control points of a lattice. The offset position of the control

points to the original lattice source volume causes the distortion of the affected object.

The FFD(Cyl) space warp uses a cylindrical array of control points in its lattice. This FFD is available as both an object modifier and a space warp. For information on the object modifier version, see [FFD \(Box/Cylinder\) Modifiers](#) on page 1389 .

You create FFD space warps as separate objects similarly to the way you create standard primitives: by dragging the mouse in the viewport. The result is a lattice of control points. The source lattice of an FFD modifier is fitted to the geometry it's assigned to in the stack. This might be a whole object or a sub-object selection of faces or vertices.

Because FFD space warps are separate objects, they carry their own adjustable dimension parameters among the creation parameters.

You can apply object modifiers to space warp objects. For example, you can use the Linked XForm modifier with a space-warp FFD.

## Procedures

**Example: Create an animated tablecloth:**

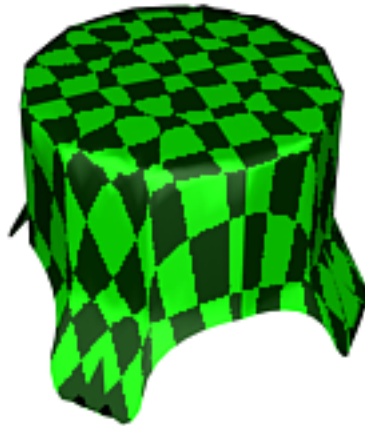

Finished tablecloth using FFD (Cyl) space warp



This example shows how to use the FFD(Cyl) space warp to create a tablecloth that flies in and drapes itself over a table.

Begin by creating the table and tablecloth.

- 1 Create a table from two cylinders. Make the table top with a radius of **30** units, and a height of **2** units. Make the "table stand" cylinder with a radius of **3** and a height of **60**.
- 2 Make a tablecloth from a box **100** units square and **0.5** units in height. Increase Length and Width Segments to **30**, and keep Height Segments at **1**.
- 3 Position the tablecloth so it's level with or slightly above the table top, and a little less than **100** units to the left of the table edge, as seen from the Top view.
- 4 Apply a nice wood grain to the table, and a checker to the tablecloth. (Set the checker tiling to about 15x15, and choose any color for the checkers.)

Now, set up a cylindrical FFD space warp that will form the drape of the tablecloth over the table.

- 1 From the Create panel > Space Warps > Geometric/Deformable, choose FFD(Cyl).
- 2 In the Top viewport, create a cylindrical FFD space warp, centered on the table top, with a radius of **45** and a height of **5**.
- 3 Click the Set Number of Points button and, in the Set FFD Dimensions dialog, set Side points to **12**, Radial points to **5**, and Height points to **2**.
- 4 Move the entire FFD lattice up until it's just over the surface of the table, as seen from the Front viewport.

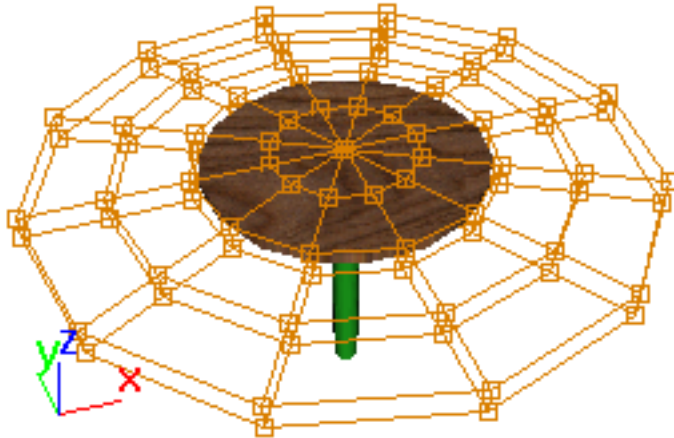

Next, adjust the control points of the lattice to drape over the table.

- 1 Zoom Extents All Selected.
- 2 On the Modify panel, in the stack display (below "Modifier List"), click the FFD(cyl) item so it turns yellow. This means you've enabled direct access to the FFD space warps control point sub-objects.
- 3 In the FFD Parameters rollout > Selection group, turn on All X. This lets you select control points around the perimeter of the FFD cylinder.
- 4 In the Top viewport, use the [Select and Move tool](#) on page 888 and region-select the two visible control points of the two outer rings of control points at the nine-o'clock position. (This is easier shown than described. You can actually region-select any number of vertices in the two outer concentric rings of vertices. Because All X is on, all control points for the two rings will be selected.)



- 5 On the status bar, click the Selection Lock Toggle button to lock the selection. In the Front viewport, drag the selected points halfway down the height of the table.
- 6 Unlock the selection, and then region-select any control point in the outer ring to select all points in the outer ring.

- 7 Lock the selection and, in the Front viewport, drag the outer ring of points down to the floor.

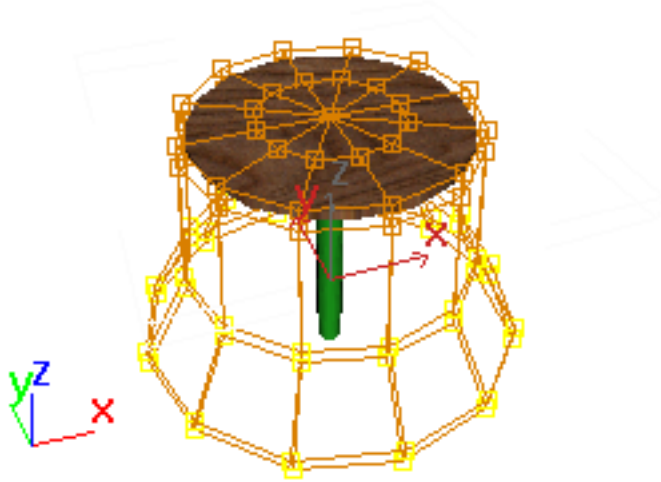

You now have a truncated cone shape over the table.

- 8 Unlock the selection. In the Top viewport, again select all the control points in the two outer rings.
- 9 Scale the selected control points in, until the radius of the inner ring of points is slightly larger than the table top.
- 10 Select only the outer ring of points, and scale them so their radius is slightly larger than the inner ring.  
If necessary, move the points, as seen from the Front viewport, down to touch the floor again.

You now have a lattice of control points draped over the table.

In this next series of steps, you'll bind the tablecloth to the FFD lattice, and then animate it to move over the table.

- 1 In the stack display, click the FFD(cyl) entry again to exit the sub-object level. It turns gray.



- 2 In the main toolbar, click the Bind to Space Warp button, and drag between the FFD and the tablecloth.

3 Select the FFD lattice.

4 Choose Deform group > All Vertices.

The tablecloth is immediately deformed because all vertices are now affected, including those outside the lattice volume, and Falloff is set to 0. A falloff value of 0 means that the distance of the vertices from the lattice doesn't matter. Any number greater than 0, however, limits the effect.

5 Set the Falloff spinner to **0.4**.

No longer influenced by the FFD space warp, the tablecloth returns to its square shape.

6 Turn on Auto Key, and go to frame 100.

7 In the Top viewport, select the tablecloth, and move it until it's centered over the table.

8 As the tablecloth nears the table, it droops down to the floor, sweeps up and over the table, and finally drapes itself over the table.

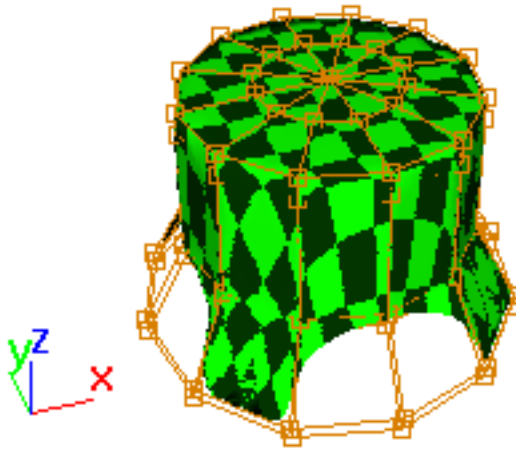

9 As you move the time slider back and forth and examine the animation, you might find that the bottom of the tablecloth is deformed to the point where it's hanging below the floor. To fix this, turn off Auto Key, go to frame 100, select the lower ring of control points, and move them up

until the tablecloth is at the height you want it. You can also adjust the position of the other control points to create drapes, and so on.

- 10** On the Display command panel > Hide by Category rollout, turn on Space Warps to hide the FFD space warp.
- 11** Set up appropriate lights and a camera, and play your animation.

## Interface

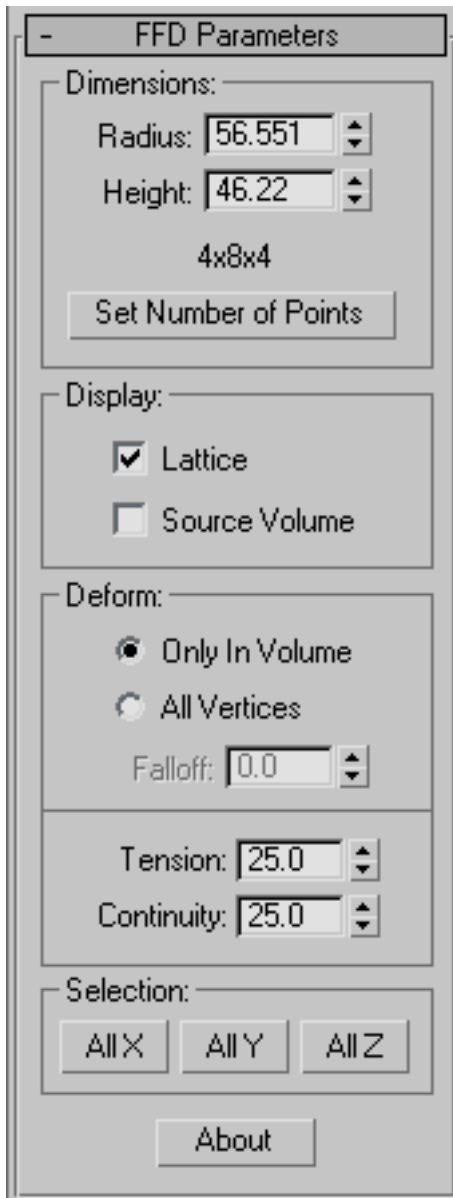

This rollout lets you set the size and resolution of the lattice, and how it displays and deforms.

### **Dimensions group**

These options let you adjust the unit dimensions of the source volume, and specify the number of control points in the lattice. Note that the point dimensions are displayed beside the modifier name in the Stack list.

**Radius, Height** These two spinners display and let you adjust the length, width, and height of the lattice. To create the space warp, drag the mouse in the same way that you would to create a standard Cylinder primitive. Note that these spinners don't exist in the object-modifier version of the FFD.

**Label** Displays the current number of controls points in the lattice (for example: 4x8x4).

**Set Number of Points** Displays a dialog containing three spinners labeled Side, Radial, and Height, plus OK/Cancel buttons. Specify the number of control points you want in the lattice, and then click OK to make the change.

**Side** The number of control points around the perimeter of the lattice.

**Radial** The number of control points, radially, from the center to the outer perimeter of the lattice.

**Height** The number of control points along the height of the lattice.

---

**NOTE** Make changes to the dimensions before you adjust the positions of the lattice control points. When you change the number of control points with this dialog, any adjustments you've already made to the control points are lost; however, you can undo this use of the dialog.

---

### **Display group**

These options affect the display of the FFD in viewports.

**Lattice** When on, lines are drawn connecting the control points to make a grid. Although viewports can become cluttered when these extra lines are drawn, they help to visualize the lattice.

**Source Volume** When on, the control points and lattice are displayed in their unmodified state. This display is helpful when you're adjusting the source volume to affect specific vertices that lie within or without it. See the All Vertices and Only in Volume options, later in this topic.

## Deform group

These options provide controls that specify which vertices are affected by the FFD.

**Only In Volume** When on, only vertices that lie inside the source volume are deformed. Vertices outside the source volume are not affected. This is the default choice.

**All Vertices** When on, all vertices are deformed regardless of whether they lie inside or outside the source volume, depending on the value in the Falloff spinner. The deformation outside the volume is a continuous extrapolation of the deformation inside the volume. Note that the deformation can be extreme for points far away from the source lattice.

**Falloff** This spinner, enabled only when you choose All Vertices, determines the distance from the lattice that the FFD effect will decrease to zero. When this spinner is set to 0, it's effectively turned off, and there is no falloff; that is, all vertices are affected regardless of their distance from the lattice. The units of the Falloff parameter are specified relative to the size of the lattice: A falloff of 1 means that the effect will go to 0 for points that are a lattice width/length/height away from the lattice (depending on which side they are on).

**Tension/Continuity** Lets you adjust the tension and continuity of the deformation splines. Although you can't see the splines in an FFD, the lattice and control points represent the structure that controls the splines. As you adjust the control points, you alter the splines (which move through each point). The splines, in turn, deform the geometry of the object. By altering the tension and continuity of the splines, you alter their effect on the object.

## Selection group

These options provide additional methods of selecting control points. You can toggle any combination of the three buttons to select in one, two, or three dimensions at once.

**All X, All Y, All Z** When one of these buttons is on and you select a control point, all control points along the local dimension specified by the button are selected as well. By turning on two buttons, you can select all control points in two dimensions.

**About** Displays a dialog with copyright and licensing information.



## Wave Space Warp

Create panel > Space Warps > Geometric/Deformable > Object Type rollout > Wave

Create menu > Space Warps > Geometric/Deformable > Wave

The Wave space warp creates a linear wave through world space. It affects geometry and behaves the same as the [Wave modifier](#) on page 1918 . Use the Wave space warp when you want the wave to affect a large number of objects, or to affect an object relative to its position in world space.

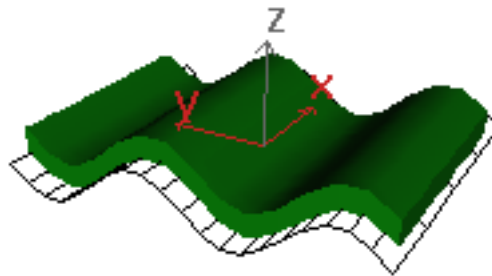
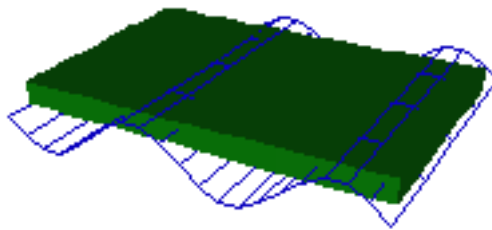





**Using a wave to deform a box**

**See also:**

- [Ripple Space Warp](#) on page 2699

### **Procedures**

**To create a Wave space warp:**

- 1   On the Create panel, click Space Warps. Choose Geometric/Deformable from the list, then on the Object Type rollout, click Wave.
- 2 Drag in a viewport to define the initial size of the wave object icon. The icon is displayed as a flat mesh wireframe.
- 3 Release the mouse button to set the icon size; then move the mouse to define the initial amplitude of the wave.
- 4 Click to set the wave amplitude.

## Interface

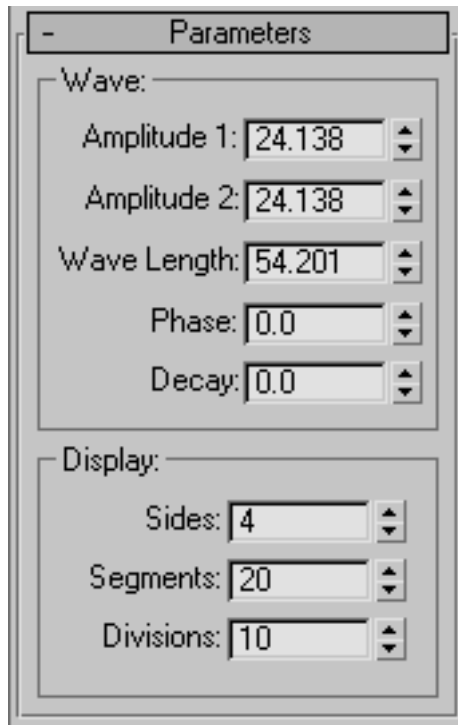

The initial amplitude sets both Amplitude 1 and Amplitude 2. Set these parameters to unequal values to create a cross wave.

### Wave group

These options control the wave effect.

**Amplitude 1** Sets wave amplitude along the wave warp object's local X axis.

**Amplitude 2** Sets wave amplitude along the wave warp object's local Y axis.

Amplitude is expressed in units. The wave is a sine wave along its Y axis and parabolic along its X axis. Another way to think of the difference between the amplitudes is that Amplitude 1 is at the center of the wave gizmo and Amplitude 2 is at the edge of the gizmo.

**Wave Length** Sets the length of each wave along the wave's local Y axis, in active units.

**Phase** Offsets the phase of the wave from its origin at the wave object's center. Whole values have no effect; only fractional values do. Animating this parameter makes the wave appear to travel through space.

**Decay** When set to 0.0, the wave has the same amplitude or amplitudes throughout world space. Increasing the Decay value causes amplitude to diminish as distance increases from the position of the wave warp object. Default=0.0.

### **Display group**

These options control the geometry of the Wave warp gizmo. In some cases, such as when the two Amplitude values differ, they change the effect of the wave.

**Sides** Sets the number of side segments along the wave object's local X dimension.

**Segments** Sets the number of segments along the wave object's local Y dimension.

**Divisions** Adjusts the size of the wave icon without altering the wave effect as scaling would.

### **Flexibility parameter (Modify panel)**

The Wave space warp also has a Flexibility parameter that you can adjust individually in each bound object's stack, at the Wave Binding level. The parameter belongs to each binding; it doesn't appear with the Wave warp parameters.



**Flexibility** Makes the bound object more or less responsive to the wave by multiplying the amplitude by this value.

## Ripple Space Warp

Create panel > Space Warps > Geometric/Deformable > Object Type rollout > Ripple

Create menu > Space Warps > Geometric/Deformable > Ripple

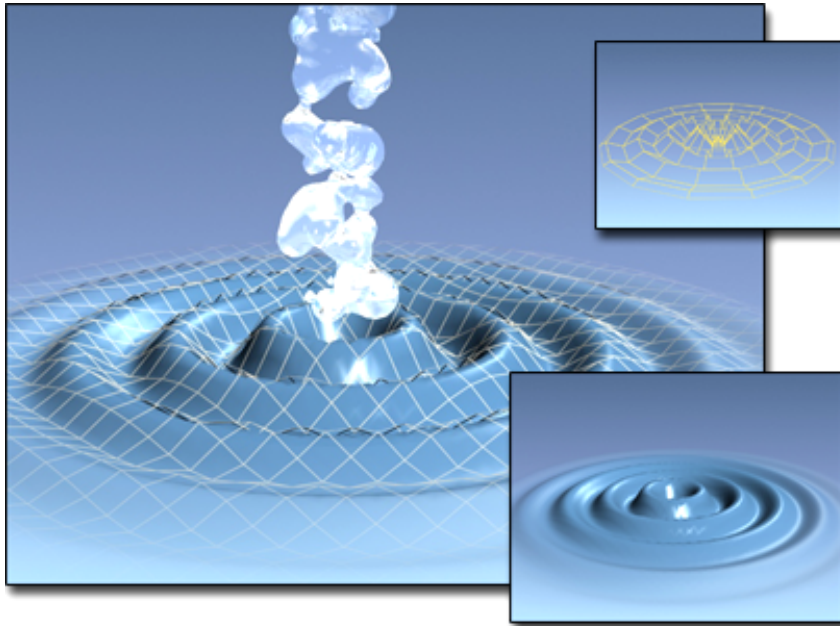

### Using a ripple to deform a surface



The Ripple space warp creates a concentric ripple through world space. It affects geometry and behaves the same as the [Ripple modifier](#) on page 1583 . Use the Ripple space warp when you want the ripple to affect a large number of objects, or to affect an object relative to its position in world space.

### See also:

- [Wave Space Warp](#) on page 2695

### Procedures

#### To create a Ripple space warp:

- 1   On the Create panel, click Space Warps. Choose Geometric/Deformable from the list, then on the Object Type rollout, click Ripple.
- 2 Drag in a viewport to define the initial size of the ripple object icon. The icon is displayed as a wireframe spider web.

- 3 Release the mouse button to set the icon size, and then move the mouse to define the initial amplitude of the ripple wave.
- 4 Click to set the wave amplitude.

### Interface

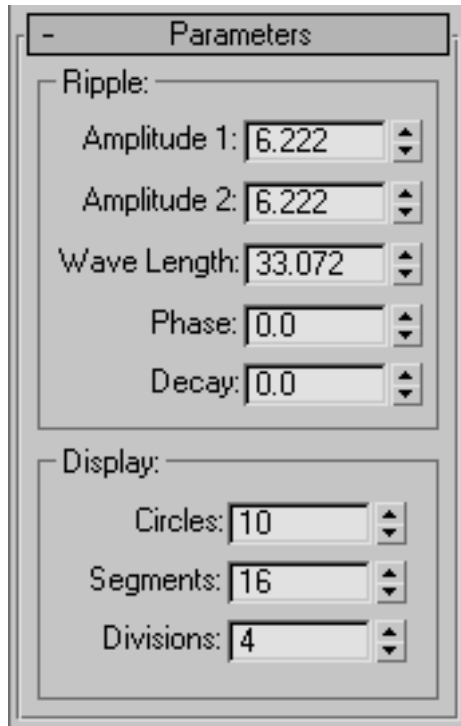

The amplitude value set by dragging applies equally in all directions. The ripple's Amplitude 1 and Amplitude 2 parameters are initially equal. Set these parameters to unequal values to create a ripple whose amplitude varies relative to the local X and Y axes of the space warp.

### Ripple group

**Amplitude 1** Sets ripple amplitude along the ripple warp object's local X axis. Amplitude is expressed in active units.

**Amplitude 2** Sets ripple amplitude along the ripple warp object's local Y axis. Amplitude is expressed in active units.

**Wave Length** Sets the length of each wave, in active units.

**Phase** Offsets the phase of the wave from its origin at the ripple object's center. Whole values have no effect; only fractional values do. Animating this parameter makes the ripple appear to travel through space.

**Decay** When set to 0.0, the ripple has the same amplitude or amplitudes throughout world space. Increasing the Decay value causes amplitude to diminish as distance increases from the position of the ripple warp object. Default=0.0.

### **Display group**

The options control display of the Ripple warp object's icon. They don't change the effect of the ripple.

**Circles** Sets the number of circles in the ripple icon.

**Segments** Sets the number of segments (pie slices) in the ripple icon.

**Divisions** Adjusts the size of the ripple icon without altering the ripple effect as scaling would.

### **Flexibility parameter (Modify panel)**

The Ripple space warp also has a Flexibility parameter that you can adjust individually in each bound object's stack, at the Ripple Binding level. The parameter belongs to each binding; it doesn't appear with the Ripple warp parameters.





**Flexibility** Makes the bound object more or less responsive to the wave by multiplying the amplitude by this value.

## Conform Space Warp

Create panel > Space Warps > Geometric/Deformable > Object Type rollout > Conform

Create menu > Space Warps > Geometric/Deformable > Conform

The Conform space warp modifies its bound object by pushing its vertices in the direction indicated by the space warp icon, until they hit a specified target object, or until the vertices move a specified distance from their original position.

After creating a Conform space warp, you specify a target object in the Conform parameters, and then bind the Conform to the object you want to deform. You rotate the Conform icon to specify the travel direction (toward the target object). The vertices of the deformed object move until they hit the target object.

There is also a [Conform compound object](#) on page 660 that provides additional methods of conforming one object to another.

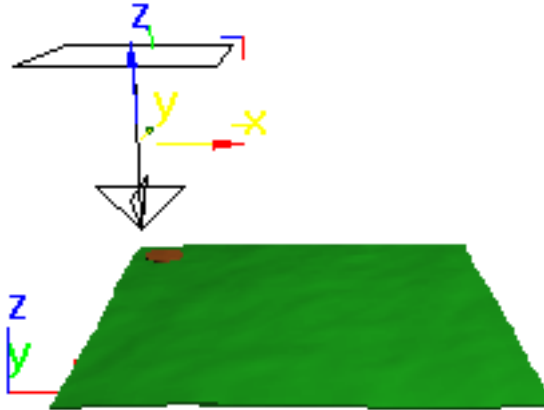

**Conform viewport icon (a surface is below it)**

## Procedures

### Example: Using the Conform space warp:

Begin by making two objects.

- 1 Create a terrain by making a wide, flat box with plenty of Length and Width segments (or a quad patch). Apply a Noise modifier and adjust its parameters to result in a bumpy terrain (not mountainous, but low and irregular).
- 2 Create a short, wide cylinder whose radius is about one-eighth the area of the box (like a coin). You'll animate the cylinder to float diagonally over the surface of the terrain.
- 3 Set Cap Segments in the cylinder to **4**, and position the cylinder to float over the terrain.
- 4 Set the object color of the cylinder to contrast with the color of the terrain.
- 5 Move the cylinder inside one corner of the terrain as seen from the Top viewport. Turn on Animate, move to frame 100, and move the cylinder to the opposite corner of the terrain.

The coin/disk moves from one corner of the terrain to the other.

The terrain will become the target object, and the cylinder the deformed object. The next step is to create the Conform space warp and bind it to the cylinder.

- 1 On the Create panel, choose Space Warps, and then, from the drop-down list, choose Geometric/Deformable. Click the Conform button.
- 2 In the Top viewport, in the center of the terrain, drag outward to create the Conform space warp.
- 3 Click the Pick Object button, and then click the terrain box.
- 4 In the Front viewport, drag the space warp up until it's above the cylinder. As seen in the Front viewport, the terrain is at the bottom, the cylinder is between the terrain and the space warp, and the space warp is at the top.
- 5 Bind the space warp to the cylinder.  
The cylinder becomes a disk that seems to be painted on the surface of the terrain.
- 6 Drag the time slider to see the cylinder/disk move across the box, following the terrain.

Because the vertices are pushed almost to the level of the terrain, the faces of the two object might intersect. In the following steps, you'll fix this by adjusting the standoff distance between the target surface and the pushed vertices. Then you'll go on to affect only selected vertices in the cylinder.

- 1 Select the Conform space warp, and open the Modify panel.
- 2 Set Standoff Distance to **3**.  
You can now clearly see the surface of the disk above the terrain.
- 3 Set the Standoff Distance to **20**.  
The disk floats 20 units above the terrain. Next, change the affected vertices.
- 4 Select the disk/cylinder.
- 5 In the modifier stack display, click the Cylinder item so it's highlighted in gray.
- 6 Apply a Mesh Select modifier.

- 7 At the Vertex sub-object level, in the Front viewport, region-select the bottom cap vertices of the cylinder.
- 8 Remain at the sub-object level, and in the stack display click the Conform Binding item.
- 9 In the viewport, select the Conform icon.
- 10 In the Modify panel, turn on Use Selected Vertices.

Now that only the bottom cap vertices are selected, the rest of the cylinder is restored. If you adjust the viewing angle and play the animation, you'll see that the bottom face of the cylinder follows the terrain, while the rest of the cylinder retains its shape.

### Interface

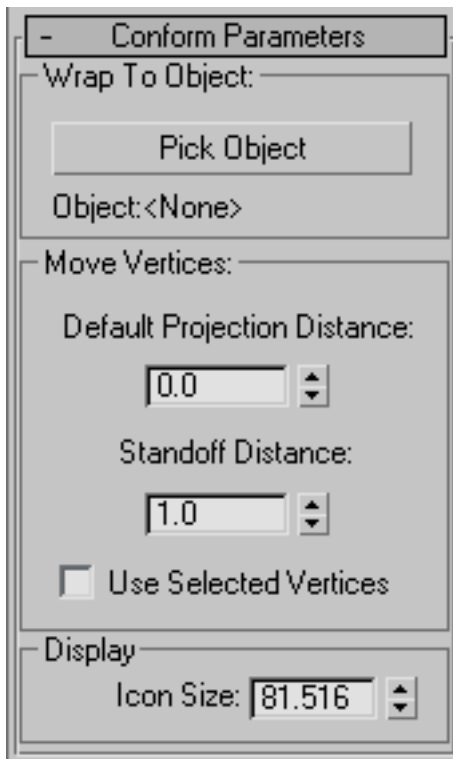

## Wrap To Object group

These options provide controls to select the target object.

**Pick Object** Click this, and then select an object in the scene. The object you select becomes the barrier against which the bound object's vertices will be pushed.

**Object** Displays the name of the picked object.

## Move Vertices group

These options affect how the vertices are moved.

**Default Projection Distance** The distance a vertex in the bound object moves from its original location if it does not intersect the target object.

**Standoff Distance** The distance maintained between the vertex and the surface of the target object. For example, if set to 5, the vertices can be pushed no closer than 5 units from the surface of the target object.

**Use Selected Vertices** When on, only the sub-object selection of vertices on the Stack are pushed. When off, all vertices in the object are pushed regardless of the Stack selection.

## Display group

**Icon Size** Specifies the size of the icon.

## Bomb Space Warp

Create panel > Space Warps > Geometric/Deformable > Object Type rollout > Bomb

Create menu > Space Warps > Geometric/Deformable > Bomb

The Bomb space warp explodes objects into their individual faces.

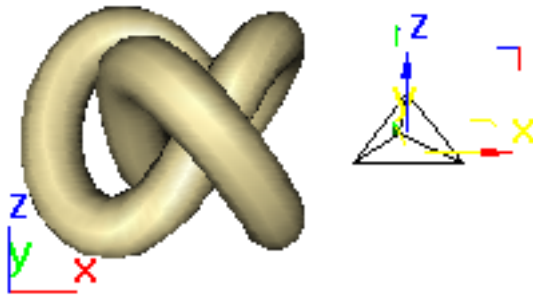

Right: Bomb viewport icon

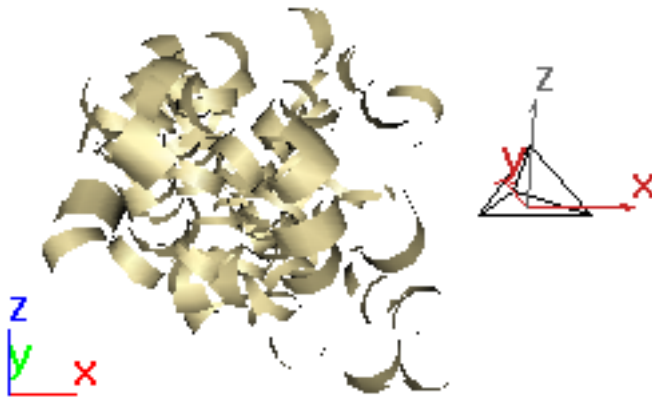

Left: Torus knot



Effect of exploding the torus knot

## Procedures

To create a Bomb space warp:

- 1   On the Create panel, click Space Warps. Choose Geometric/Deformable from the list, and then on the Object Type rollout, click Bomb.
- 2 Create mesh objects to be exploded.



- 3 On the toolbar, click the Bind to Space Warp button.
- 4 Drag the mouse between each object and the Bomb space warp.
- 5 Adjust Bomb parameters to achieve different effects.

### Interface

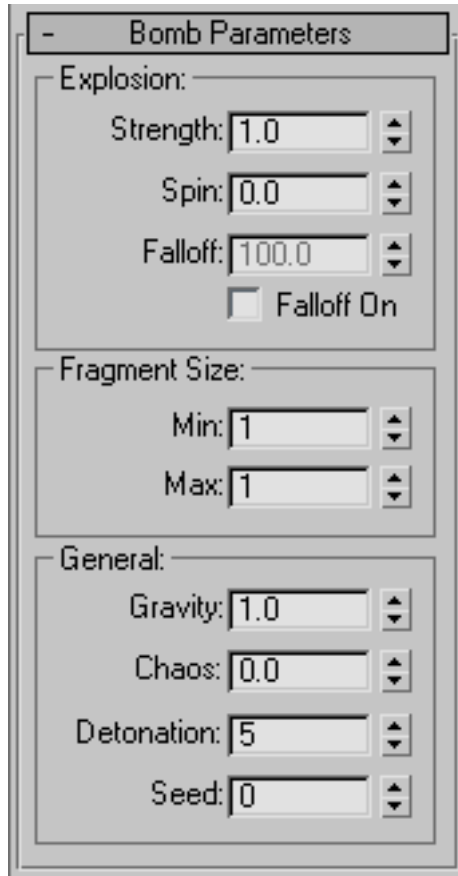

### Explosion group

**Strength** Sets the power of the bomb. Larger values make the particles fly farther. The closer an object is to the bomb, the greater the effect of the bomb.

**Spin** The rate at which fragments rotate, in revolutions per second. This is also affected by the Chaos parameter (which causes different fragments to rotate at different speeds), and by the Falloff parameter (which causes the force of the explosion to be weaker the farther the fragment is from the bomb).

**Falloff** The distance from the bomb, in world units, of the effect of the bomb. Fragments past this distance are not affected by the Strength and Spin settings, but are affected by the Gravity setting.

For example, this is useful for blowing up the base of a building, and having the top of the building topple. To see the effect, place a bomb at the base of a tall cylinder with many height segments, and adjust Falloff to be less than the height of the cylinder.

**Falloff On** Turn on to use the Falloff setting. The falloff range appears as a yellow, tri-hooped sphere.

### **Fragment Size group**

These two parameters define the number of faces per fragment. Any given fragment will have a number of faces, randomly determined, between the Min and Max values.

**Min** Specifies the minimum number of faces per fragment to be randomly generated by the "explosion."

**Max** Specifies the maximum number of faces per fragment to be randomly generated by the "explosion."

### **General group**

**Gravity** Specifies the acceleration due to gravity. Note that gravity is always in the direction of the world Z axis. You can have negative gravity.

**Chaos** Adds random variation to the explosion to make it less uniform. A setting of 0.0 is totally uniform; 1.0 is a realistic setting. A value greater than 1.0 makes the explosion extra chaotic. Range=0.0 to 10.0.

**Detonation** Specifies the frame at which the bomb goes off. Bound objects are unaffected before this time.

**Seed** Change to alter randomly generated numbers in the bomb. You can achieve a different bomb effect by changing Seed while maintaining the other settings.

Although you can animate strength and gravity, the equations used for projectile motion assume they are constant. Therefore, the motion will not



be physically correct, but it might look interesting. Also, if the bomb object is in motion during the blast, the result is not physically correct.

## Modifier-Based Space Warps

Create panel > Space Warps > Modifier-Based

Create menu > Space Warps > Modifier-Based



Modifier-based space warps duplicate the effects of standard object modifiers. Like other space warps, they must be bound to objects, and they work in world space. They are useful when you want to apply effects such as Twist or Bend to a widely scattered group of objects.

### Creating Modifier-Based Space Warps

You create modifier-based space warps the same way that you create other space warps. Modifier-based space warps are listed on the Create panel as a separate category under Space Warps.

All the modifier-based space warps use a box-shaped (nonrenderable) object. When you create one, you use the mouse in the viewport as you do when creating a Box primitive.

Unlike their modifier versions, these space warps do not have sub-object levels.

## Interface

### Gizmo Parameters rollout



### Gizmo Size group

**Length/Width/Height** Let you adjust the warp object's dimensions.

### Deformation group

**Decay** When is set to 0, there is no decay, and the space warp affects its bound object regardless of its distance from the object. When you increase the decay, the effect on the bound object falls off exponentially. See the topics on the individual modifiers for more information.

### Parameter rollout

The parameters for a modifier-based space warp are identical to those of the modifier on which the space warp is based:

[Bend Modifier](#) on page 1139

[Taper Modifier](#) on page 1739

[Noise Modifier](#) on page 1501

[Twist Modifier](#) on page 1765

[Skew Modifier](#) on page 1596

[Stretch Modifier](#) on page 1681

# Introduction to Particle Systems

Particle systems are useful for a variety of animation tasks. Primarily, they're employed when animating a large number of small objects using procedural methods; for instance, creating a snowstorm, a stream of water, or an explosion. 3ds Max provides two different types of particle systems: event-driven and non-event-driven. The event-driven particle system, also known as [Particle Flow](#) on page 2713 , tests particle properties, and, based on the test results, sends them to different events. Each event assigns various attributes and behaviors to the particles while they're in the event. In the [non-event-driven systems](#) on page 2923 , particles typically exhibit similar properties throughout the animation.

---

**IMPORTANT** Particle systems can involve a great many entities, each of which is potentially subject to any number of complex calculations. For this reason, when using them for advanced simulations, you should have a very fast computer and as much memory as possible. Also, a powerful graphics card helps speed the display of particle geometry in the viewports. Even so, it's still easy to overburden the system; if you encounter loss of responsiveness, wait for the particle system to finish its calculations, and then reduce the number of particles in the system, implement a cache, or use other methods to optimize performance.

---

## Which Particle System to Use?

Having access to a wealth of particle systems in 3ds Max leads to the need to decide which system to use for a particular application. In general, for a simple animation, such as falling snow or a water fountain, setup is faster and easier with a non-event-driven particle system. With more complex animations, such as an explosion that generates different types of particles over time (for example: fragments, fire, and smoke), use Particle Flow for greatest flexibility and control.

## Particle Flow

Particle Flow is a versatile, powerful particle system for 3ds Max. It employs an event-driven model, using a special dialog called [Particle View](#) on page 2730 . In Particle View, you combine individual [operators](#) on page 7873 that describe particle properties such as shape, speed, direction, and rotation over a period of time into groups called [events](#) on page 7770 . Each operator provides a set of parameters, many of which you can animate to change particle

behavior during the event. As the event transpires, Particle Flow continually evaluates each operator in the list and updates the particle system accordingly.

To achieve more substantial changes in particle properties and behavior, you can create a [flow](#) on page 7787 . The flow sends particles from event to event using [tests](#) on page 7948 , which let you [wire](#) on page 7971 events together in series. A test can check, for example, whether a particle has passed a certain age, how fast it's moving, or whether it has collided with a deflector. Particles that pass the test move on to the next event, while those that don't meet the test criteria remain in the current event, possibly to undergo other tests.

---

**NOTE** Operators and tests are known collectively as [actions](#) on page 7701 .

---

Following are the principal sections in the Particle Flow documentation:

[Using Particle Flow](#) on page 2714

[Particle Flow User Interface](#) on page 2730

[Actions](#) on page 2758

The  
*ms-its:3dsmax\_t.chm::/WSf742dab04106313315bef0fb112a19e466a-7ffb.htmParticle Flow Tutorials* .

**See also:**

■ [Non-Event-Driven Particle Systems](#) on page 2923

## How Particle Flow Works

[Particle View](#) on page 2730 is the primary interface for building and modifying Particle Flow systems. The first event in the system is always a *global event*, whose contents affect all particles in the system. It has the same name as the Particle Flow source icon. By default, the global event contains a single Render operator that specifies rendering properties for all particles in the system. You can add other operators here to have them act globally, such as Material, Display, and Speed. When you use an operator globally, be sure not to use the same operator locally (that is, in any other events in the system) to avoid potential conflicts.

The global event also serves as the Particle View representation of the particle system. You can create a new system by duplicating this event, or by adding an Empty Flow or Standard Flow. Conversely, if you clone the Particle Flow

icon in a viewport, or add a new PF Source, the new system appears in Particle View as well.

The second event is called the *birth event*, because it must contain a Birth operator. The Birth operator should exist at the top of the birth event, and in no other place. The default birth event also contains a number of operators that act locally to specify properties of particles while in that event. The default particle system provides a basic global event and birth event that serve as a useful starting point for creating your own system. If you like, you can instead start with an empty system that lets you build a particle system from scratch.

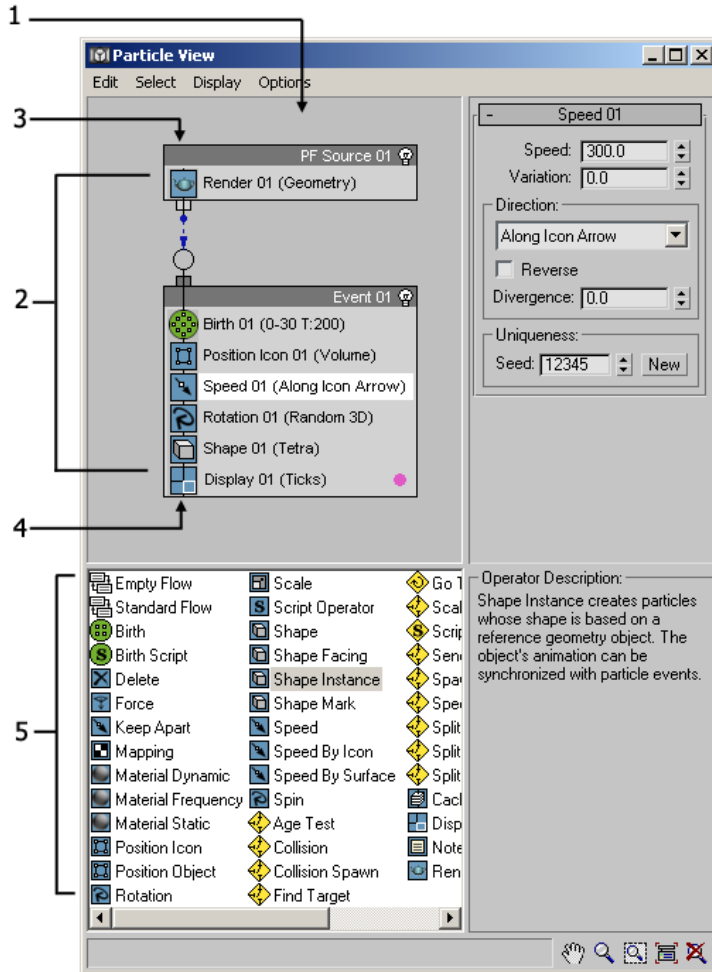

1. Event display
2. Particle diagram
3. Global event
4. Birth event
5. Depot

To add an action to the *particle diagram*, you drag it to the *event display* from the *depot* (the area at the bottom of the Particle View dialog). If you drag an

action to an event, you can add it to the event or replace an existing action, depending on where you drop it. If you drop it in an empty area, it creates a new event. Then, to customize the action, you click its event entry, and then edit its settings in the parameters panel at the side of Particle View.

To add complexity to the particle system, you can add a test to an event, and then wire the test to another event. You can adjust the test parameters to affect particle behavior, as well as determine whether specific conditions exist. When particles meet these conditions, they become eligible for redirection to the next event.

Particle Flow provides a number of tools for determining where in the system particles currently reside, including the ability to change particle color and shape on an event-by-event basis. You can also easily enable and disable actions and events, and determine the number of particles in each event. To speed up checking particle activity at different times during the animation, you can cache particle motion in memory. Using these tools, plus the ability to create custom actions with scripting, you can create particle systems of a level of sophistication previously unachievable.

## The Life of a Particle

Another way of looking at Particle Flow is from the perspective of an individual particle. Each particle first comes into existence, or is *born*, via the [Birth operator](#) on page 2764 , which lets you specify when to start and stop creating particles, and how many to create.

The particles first appear at an object called an emitter. By default, the emitter is the Particle Flow source icon using the [Position Icon operator](#) on page 2770 , but you can alternatively use the [Position Object operator](#) on page 2773 to specify that particles should be born on the surface of or within any mesh object in the scene.

After being born, particles can remain stationary at the emission point, or start moving in two different ways. First, they can move, physically, within the scene at a speed and in a direction specified by various actions. These are typically Speed operators, but other actions can also affect particle motion, including [Spin](#) on page 2783 and [Find Target](#) on page 2891 . In addition, you can use the [Force operator](#) on page 2867 to affect their motion with outside forces.



1. Particle immediately after creation, with no speed.
2. The Speed operator sets the particle in motion.
3. The particle continues moving until acted upon by another action.

The second way that particles move is logically, from event to event through the particle diagram, as constructed in [Particle View](#) on page 2730 . Each event can contain any number of operators that can affect, in addition to motion, a particle's surface appearance, its shape and size, and others.

The particles start out in the birth event, which typically is the first event after the global event. During a particle's residence in an event, Particle Flow evaluates each of the event's actions from top to bottom, once per integration step, and makes any applicable changes to the particle. If the event contains a test, Particle Flow determines whether the particle tests True for the test's parameters, such as whether it has collided with an object in the scene. If it does, and if the test is wired to another event, Particle Flow sends the particle to the next event. If it doesn't, the particle remains in the current event, and may be further acted upon by its operators and tests. Thus, each particle exists in only one event at a time.

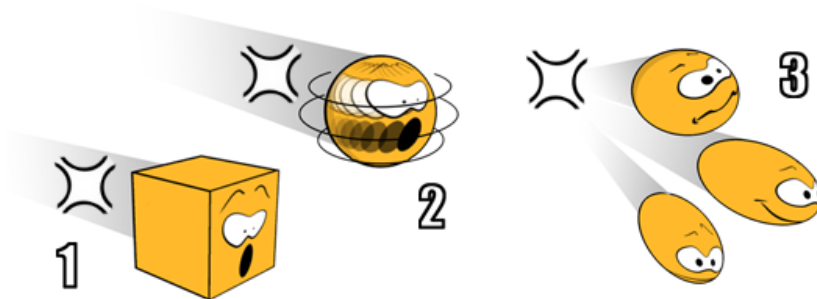

An action in an event can change the particle shape (1), or the particle spin (2), or spawn new particles (3).



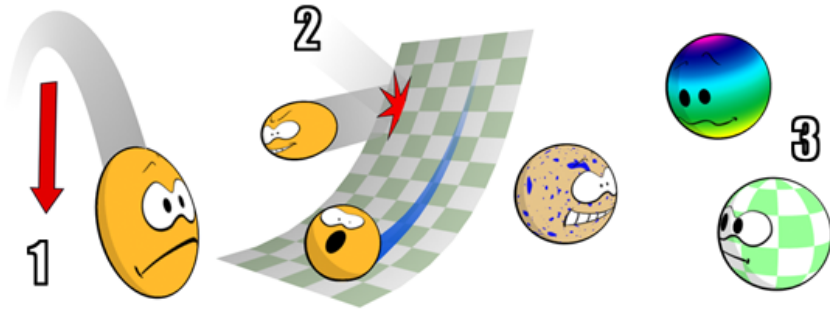

Actions can also apply forces to particles (1), specify collision effects (2), and alter surface properties (3).

In this way, the particle continues to travel through the system. Due to the flexible nature of schematic construction in Particle Flow, a particle may be redirected to the same event several times. But at some point, you might want the particle's life to end. For this purpose, you'd use the [Delete operator](#) on page 2768 or the [Collision Spawn test](#) on page 2885 or [Spawn test](#) on page 2912. Otherwise, the particle lives throughout the entire animation.

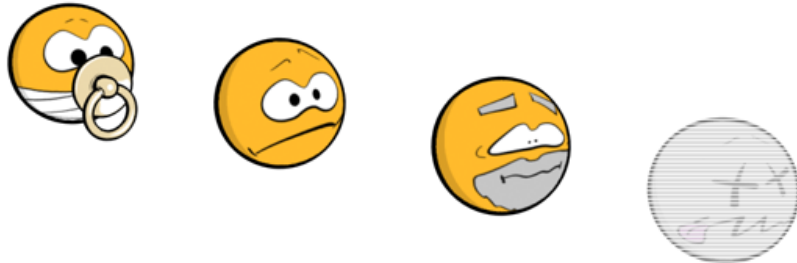

Particle age can be used to kill a particle.

As a particle moves through the system, it's accompanied by a number of channels. For example, each particle has a speed channel that defines how fast it moves, and a material ID channel that lets Particle Flow know which sub-material to apply to it. However, the material itself is not defined by a channel, but by a Material operator that acts locally or globally. Properties that are defined by channels persist, unless altered by an action. For example, the [Material Dynamic operator](#) on page 2846 can change a particle's material ID. In effect, by setting up a particle diagram and modifying how particles look and act during the animation, you're deciding how channel values change based on events and animation keyframes.

## Particle Flow FAQ

This topic offers answers to a number of questions users commonly ask when first learning to use Particle Flow. The first section contains links to all the questions, and the subsequent sections contain the questions and answers organized by category.

### Question List

[How does Particle Flow handle time?](#) on page 2721

[When I go to a different frame, the software sometimes seems to freeze for a while. What's going on?](#) on page 2722

[Is there a way to pre-calculate portions of a particle simulation, as in "baking" the animation?](#) on page 2722

[What else can I do to optimize performance?](#) on page 2723

[How do I use Particle Flow to make an object explode?](#) on page 2723

[How can I control the accuracy of the Particle Flow simulation?](#) on page 2723

[Can I use MAXScript to affect particles?](#) on page 2723

[Can I use more than one object as instanced geometry?](#) on page 2724

[How can I exclude particles from certain light sources?](#) on page 2724

[How do I open Particle View without clicking Particle View button on the command panel?](#) on page 2724

[Do I need multiple Particle Views to manage more than one particle system?](#) on page 2724

[Can I selectively disable or "turn off" portions of a particle system?](#) on page 2724

[I sometimes see events named "Action Recovery" in Particle View. Where did they come from?](#) on page 2725

[How do I animate action parameters?](#) on page 2725

[How can I synchronize an animated bitmap texture to particle age?](#) on page 2725

[Do I still need to bind my Particle Flow particles to space warps?](#) on page 2725

[How do I make particles follow a path?](#) on page 2725

[Can I use Snapshot or dynamics with Particle Flow?](#) on page 2726

[How do I use motion blur with Particle Flow?](#) on page 2726

[How do I use the Particle Age and Particle MBlur maps with Particle Flow?](#) on page 2726

[I'm trying to apply Particle Flow to an animation created with a dynamics system. Why am I getting strange results such as unexpected spawning of particles?](#) on page 2727

[How can I make all particles appear in the first frame while giving them different ages?](#) on page 2727

[How can I specify the time frame in which animated parameters are applied to particles?](#) on page 2727

[How can I apply bubble motion to particles?](#) on page 2727

[How can I branch an event to several other events?](#) on page 2728

[Does it matter which order I put actions in an event?](#) on page 2728

[How can I tell which particles are in a certain event?](#) on page 2729

[Why do my particles lose their material when they move to another event?](#) on page 2729

[Can I have an event receive input from multiple events?](#) on page 2729

[I changed an operator setting, but it doesn't seem to have any effect on the particle system.](#) on page 2729

[Can an event be isolated in Particle View and not connected to anything?](#) on page 2730

## **General**

### **How does Particle Flow handle time?**

Parameters that measure time in Particle Flow, such as [Birth](#) on page 2764 > Emit Start/Stop and [Age Test](#) on page 2879 > Test Value, are specified in frames. However, Particle Flow is always aware of the current system frame rate (fps), and if you change this rate, it adjusts all time-related parameters to keep the same timing. For instance, if you set Test Value to 60 when you're using the NTSC frame rate (30 fps), and then switch to PAL (25 fps), Particle Flow automatically changes the value to 50, so the age that's tested for is still two seconds.

On the other hand, rate parameters, such as Speed, are measured in units per second, so they don't change when you go to a different frame rate.

## **When I go to a different frame, the software sometimes seems to freeze for a while. What's going on?**

Most of the animation in Particle Flow is history dependent; that is, to be able to draw the particles in a particular frame, the program needs to know what happened in all previous frames. Normally, when you change a parameter value, the program needs to recalculate all frames between the start and the current frames. Or, if you go to a different frame, Particle Flow must recalculate one or more animation frames. If you go forward, it must calculate the frames between the current frame and the one you go to. So, for example, if you just go to the next frame, relatively little calculation is needed. But if you go backward, even only by one frame, it must calculate all frames from the start of the animation to the frame you go to.

If a lot of calculation is needed, there is a delay. Meanwhile, the software displays a message like “PF Source 01 Update xx% (Press Esc to cancel)” in the status bar, so you can get an idea of how the recalculation is progressing. If, when you see this message, you press the Esc key, Particle Flow displays an alert with the message “Click OK to turn off PF Source 01.” If you click OK, the recalculation stops, giving you the opportunity to optimize the animation. For example, you could reduce the number of particles for testing purposes. You must turn the source back on to continue. If you click Cancel, the calculation continues.

---

**TIP** An easy way to speed up recalculation and rendering of particles is by adjusting the total number of particles. To do this, select the Particle Flow source icon, and then go to the Modify panel > Emission rollout > Quantity Multiplier group. Here you can increase or decrease by percentage the total number of particles, separately for viewport display and rendering.

---

**TIP** To speed up animation playback when you're not adjusting parameters, use the Cache operator (see the following item).

---

## **Is there a way to pre-calculate portions of a particle simulation, as in "baking" the animation?**

Yes. Particle Flow's [Cache operator](#) on page 2856 lets you store all or part of a particle animation in memory, and then play back the animation from memory rather than having to recalculate particle motion. This makes it much faster to jump between different parts of the animation. You can even save the cached animation to disk as part of the scene file.

## What else can I do to optimize performance?

Particle Flow can place heavy processing and resource demands on your computer. For optimal performance, the most important thing you can do is to use the fastest available CPU. Also, when using particle systems with many particles, install as much memory as possible in your computer, especially if you're using caching.

Other ways to improve performance include reducing the percentage of viewport particles with the Quantity Multiplier setting, and temporarily disabling flows and actions that you're not currently working with. When making parameter changes, return to the first frame and play forward, or set Particle View > Options menu > Update Type to "Forward". That way, if you change a setting, the particle system is not forced to recalculate its state from the very beginning. The change will affect only animation from the current frame forward. On the other hand, the result could be misleading, because you won't be able to see the difference right away.

Also, be cautious when using spawning; it can quickly create very large numbers of particles, especially when you use the By Travel Distance option in the [Spawn test](#) on page 2912 .

## How do I use Particle Flow to make an object explode?

Particle Flow doesn't have a fragmentation operator, but by utilizing PArray in a Birth Script operator, you can implement fragmentation in Particle Flow. You can find an example scene, with a commented script operator, in the file *scriptfragmentationwithcache.max*, on the install disc in the directory *Samples\Scenes\Version6Features\Scenes\Particle Flow\Fragments*.

## How can I control the accuracy of the Particle Flow simulation?

On the command panel > [System Management rollout](#) on page 2754 of the PF Source icon, you can adjust the integration step independently for viewport playback and rendering. The smaller the integration step, the more times Particle Flow calculates particle motion per frame, resulting in greater accuracy at the cost of calculation time.

## Can I use MAXScript to affect particles?

Yes. Particle Flow includes a [Script operator](#) on page 2874 and [test](#) on page 2911 , as well as a [Birth Script operator](#) on page 2767 , that let you fully customize the particle system. Each scriptable action includes a sample script, which also lists all relevant scriptable functions. You can also control parameters of the

[Force operator](#) on page 2867 and [Keep Apart operator](#) on page 2815 with script wiring, described in the respective topics.

In addition, you can execute a script at each integration step, and another just before each frame is viewed or rendered; see [Script rollout](#) on page 2756 .

### **Can I use more than one object as instanced geometry?**

Yes. With the [Shape Instance operator](#) on page 2825 , you can use groups, hierarchies, and objects consisting of multiple elements, with each members of the combined object constituting a separate particle. These objects can be emitted in a specific order, or in a random order. For example, you can use a text object, with the letters emitted in the order in which they appear in the text.

### **How can I exclude particles from certain light sources?**

To prevent particles from being affected by a light source, use the light's Exclude function, found on the General Parameters rollout (Modify panel), to specify any events containing particles to be excluded. Specifying the PF Source XX object (default name) has no effect; you must specify all objects listed as PF Source XX->Event XX.

## **Particle View**

### **How do I open Particle View without clicking Particle View button on the command panel?**



Press the 6 key. It might be necessary to first turn on the Keyboard Shortcut Override Toggle.

### **Do I need multiple Particle Views to manage more than one particle system?**

No: All particle systems appear in Particle View. You can scroll and zoom the event display to see the different systems.

### **Can I selectively disable or "turn off" portions of a particle system?**

Yes. Particle View gives you a number of different ways of doing this. You can click an action's icon or an event's light-bulb icon to turn it off, or use the right-click menu, or use Edit menu's Turn On and Turn Off commands. Also,

if you press Esc while Particle Flow is calculating, the software gives you the opportunity of turning off the entire particle system, thus immediately returning control of the software to you. You can then analyze the system to determine the area of slowdown, optimize or simplify the particle flow, and then recalculate the animation.

### **I sometimes see events named “Action Recovery” in Particle View. Where did they come from?**

When you merge a scene containing Particle Flow data, you can import entire events and isolated actions. If you merge an action without its events, the software places it in an event named “Action Recovery.”

## **Animation**

### **How do I animate action parameters?**

Use the same [Auto Key](#) on page 3007 method as with animating any other parameter in 3ds Max.

---

**NOTE** Avoid animating Particle Flow parameters with Set Key mode or with Shift+right-click. Also, to see animation keys for actions in the track bar, make sure the Particle Flow source icon is selected.

---

### **How can I synchronize an animated bitmap texture to particle age?**

Use the [Material Dynamic operator](#) on page 2846 in conjunction with the [Bitmap 2D map](#) on page 5633. You'll find a procedure that describes the method in detail [here](#) on page ? .

### **Do I still need to bind my Particle Flow particles to space warps?**

No; you use the [Collision test](#) on page 2881 , [Collision Spawn test](#) on page 2885 , or [Force operator](#) on page 2867 to affect particle motion with 3ds Max space warps. The ability to do this on a global and local (per-event) basis gives you much greater control over how space warps affect the particles than with previous systems.

### **How do I make particles follow a path?**

You can use the [Speed By Icon operator](#) on page 2796 or the [Find Target test](#) on page 2891 , assigning the icon or target to a spline path. You'll find illustrative procedures in both topics.

## Can I use Snapshot or dynamics with Particle Flow?

No. The Snapshot tool is not currently compatible with Particle Flow, nor is **reactor** or the legacy dynamics system.

## How do I use motion blur with Particle Flow?

You can apply motion blur on a per-event basis by editing the event's [object properties](#) on page 245 with the right-click menu in Particle View, or on a global basis by editing the global event's object properties. In the Particle View dialog, highlight the event to edit and then right-click and choose Properties. On the Object Properties dialog, edit the Motion Blur group settings.

Alternatively, you can apply motion blur to an entire Particle Flow system without the need to set properties by using the [multi-pass motion blur effect](#) on page 5147 with a camera.

---

**NOTE** You can also use Object Properties to set other properties for events and the particle system, as with any object in 3ds Max. Do this *only within Particle View*, not using the source icon in the viewports (right-click menu > Properties or Edit menu > Object Properties).

---

**NOTE** When using Object Motion Blur, if an event contains a Material Dynamic operator that uses a material with a Particle Age, Particle MBlur, or Bitmap map, the event should not also contain a Delete operator, or a Spawn or Collision Spawn test. Also, the event should not contain any tests that are wired to another event. The only exception to this is the Age Test operator when set to Absolute Time without any variation; that is, all particles leave the event at the same time. This applies to the use of Object Motion Blur only; there are no restrictions with Image Motion Blur.

---

## How do I use the Particle Age and Particle MBlur maps with Particle Flow?

To use the Particle Age map with Particle Flow, you must use the Delete operator to give the particles a finite life span. For further information, see [Delete Operator](#) on page 2768.

Also note the following:

- Particle Age, Particle MBlur and a Bitmap map containing an animated bitmap can be used only with [Material Dynamic operator](#) on page 2846, with Same As Particle ID turned on. You'll find procedures for using Bitmap and Particle Age at this topic.



- The particle material cannot be a submaterial; it must be the main material.
- In the non-event-driven particle systems in 3ds Max, Particle MBlur is used with a control named Direction Of Travel\MBlur and an accompanying Stretch parameter. In Particle Flow, you can replicate the stretching effect by using a Scale operator, turning off Scale Factor > Constrain Properties, and scaling the particle along one axis.

### **I'm trying to apply Particle Flow to an animation created with a dynamics system. Why am I getting strange results such as unexpected spawning of particles?**

The dynamics system probably generates rotation keys using the Euler XYZ controller. To avoid interpolation discontinuities, change the rotation controller for such objects to TCB Rotation.

### **How can I make all particles appear in the first frame while giving them different ages?**

Use a negative frame range in the [Birth operator](#) on page 2764 . For example, to get a particle-age spread of 30 frames, set Emit Start to **-29** and Emit Stop to **0**.

### **How can I specify the time frame in which animated parameters are applied to particles?**

You can animate many of the Particle Flow parameter values with keyframing. In most actions, you can choose the time frame by which to apply this animation to the particles from a drop-down list labeled Sync By. You can apply this animation to particles in the time frame of the entire animation, or at a specific time of each particle's life (particle age), or based on the length of time the particle has been in the current event. See the individual operator and test topics for details.

### **How can I apply bubble motion to particles?**

Although Particle Flow doesn't have the [bubble motion option](#) on page 2991 found in PArray, you can simulate the effect by following this procedure:

- 1 Add an object to serve as particle geometry and a [dummy helper object](#) on page 2531 .
- 2 Position the dummy away from the center of the particle geometry object and [link](#) on page 3267 your particle geometry to the dummy so that the

dummy is the parent object (that is, drag from the geometry object to the dummy). The distance between the [pivots](#) on page 3398 of the two objects determines the radius of the bubble motion.

- 3 In Particle View, add a [Shape Instance operator](#) on page 2825 and a [Spin operator](#) on page 2783 to the event in which the bubble motion is to occur.
- 4 Click the Shape Instance operator and specify the dummy object as the particle geometry object.
- 5 Click the Spin operator and set appropriate values for Spin Rate and Variation. For Spin Axis, keep the default setting of Random 3D.

The result is particle motion in which the particles bob about while moving along their paths, similar to bubble motion.

## Events

### How can I branch an event to several other events?

Particle Flow includes several Split tests, which let you send some particles to another event based on quantity, selection, or source. You can use any number of these in a single event to send parts of the particle stream to different events, and then use a [Send Out test](#) on page 2912 to redirect the remaining particles to another event. Keep in mind that any tests subsequent to the first can work only with particles remaining in the event, not necessarily all particles that begin in the event.

### Does it matter which order I put actions in an event?

It depends. If an event contains two or more operators of the same type, such as Shape, the last one overrides the rest. If an event contains two or more tests, they are evaluated and particles redirected in the order in which the tests appear.

However, if two actions in an event control the same properties, the interaction is more complex. An action that works on a continuous basis will typically prevail over one that affects particles only when they first enter the event. For example, both the [Find Target test](#) on page 2891 and [Speed operator](#) on page 2791 can control particle speed and direction, but the test works continuously, while the operator takes effect only once. If an event contains both, particle speed and direction will be primarily controlled by the test, in general, even if the operator comes after the test. However, the operator's settings will still have some influence over particle behavior, particularly if its Speed value is

significantly higher than that of the test. For a list of actions' effective time frames, see [Action Time Frames](#) on page 2759 .

Also, if you're testing for a specific condition that can be affected by other actions in an event, be sure to place the test *after* the actions. For example, in an event with a [Force operator](#) on page 2867 and a [Collision test](#) on page 2881 , place the Collision test after the Force operator. This avoids the possibility of the force pushing particles past the deflector before the software can test for the collision, which would allow the particles to penetrate the deflector. In general, place tests at the end of the event.

### **How can I tell which particles are in a certain event?**

One way is to set the Type option for the [Display operator](#) on page 2864 in each event to a different choice. For example, the first event could use Ticks, the second Circles, and the third Lines. This way the particles change appearance in the viewports as they move from event to event. You can also use the Display operator to change particle colors, to further distinguish them.

Another way is to select all particles in a certain event. Select the Particle Flow source icon, and then go to the Modify panel > Selection rollout and click the Event icon. You can then click an event in the Select By Event list to highlight all of its particles in the viewports.

### **Why do my particles lose their material when they move to another event?**

A material is a static property of an event. It does not travel along with the particles from event to event. A particle's material ID does, but its material does not. If you want particles always to use the same material, define the material in the [global event](#) on page 7801 with a [Material operator](#) on page 2839 or a [Shape Instance operator](#) on page 2825 . Otherwise, you need to define it in each local event.

### **Can I have an event receive input from multiple events?**

Particle Flow lets you wire any number of tests to a single event.

### **I changed an operator setting, but it doesn't seem to have any effect on the particle system.**

A similar operator in the global event might be overriding your local operator. By default, Particle Flow evaluates local operators first, and then global operators. If a global operator affects the same property, such as speed, as a

local one, the particle system will use the value set by the global operator. You can set local operators to override global ones by choosing Particle View > Options menu > Action Order > Globals First.

### **Can an event be isolated in Particle View and not connected to anything?**

Yes, but it won't affect the particle system at all.

## **Particle Flow User Interface**

### **Particle View**

Select a Particle Flow source icon > Modify panel > Setup rollout > Click Particle View (or press 6).

Create panel > Geometry > Particle Systems > Object Type rollout > Click PF Source. > Setup rollout > Click Particle View (or press 6).

Particle View provides the main user interface for creating and modifying particle systems in Particle Flow. The main window, known as the *event display*, contains the *particle diagram*, which describes the particle system. A particle system consists of one or more *events* wired together, each of which contains a list of one or more [operators on page 2761](#) and [tests on page 2877](#). Operators and tests are known collectively as *actions*.

The first event is called the *global event*, because any operators it contains can affect the entire particle system. The global event always has the same name as the Particle Flow icon; by default, this is PF Source ## (starting with 01 and counting upward). Following this is the *birth event*, which must contain a [Birth operator on page 2764](#) if the system is to generate particles. By default, the birth event contains this operator as well as several others that define the system's initial properties. You can add any number of subsequent events to a particle system; collectively, the birth event and additional events are called *local events*. They're called this because a local event's actions typically affect only particles currently in the event.

You use tests to determine when particles are eligible to leave the current event and enter a different one. To indicate where they should go next, you *wire* the test to another event. This wiring defines the schematic, or flow, of the particle system.

By default, the name of each operator and test in an event is followed by its most important setting or settings in parentheses. Above the event display is a menu bar, and below is the *depot*, containing all actions available for use in the particle system, as well as a selection of default particle systems.

**TIP** The easiest way to open Particle View is by pressing the 6 key. It's not necessary to first select a Particle Flow icon.

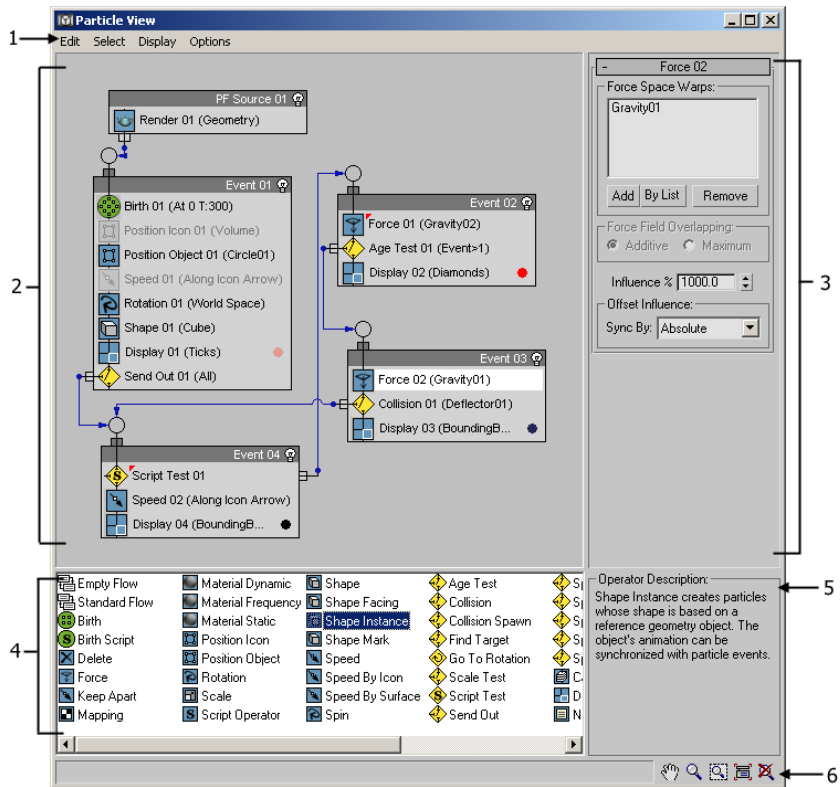

1. Menu bar
2. Event display
3. Parameters panel
4. Depot
5. Description panel
6. Display tools

Particle View comprises the following elements:

- The [menu bar on page 2732](#) provides functions for editing, selection, adjusting the view, and analyzing the particle system.
- The [event display on page 2741](#) contains the particle diagram, and provides functions for modifying the particle system.
- The [parameters panel](#) contains rollouts for viewing and editing parameters of any selected actions. Basic functionality is identical to that of rollouts on the 3ds Max command panels, including usage of the right-click menu. To toggle display of the parameters panel, choose Display menu > Parameters.
- The [depot](#) contains all Particle Flow actions, as well as several default particle systems. To see an item's description, click its entry in the depot. To use an item, drag it into the [event display on page 2741](#). The contents of the depot fall into three categories: [operators on page 2761](#), [tests on page 2877](#), and [flows on page 2875](#). To toggle display of the depot, choose Display menu > Depot.
- The [Description panel](#) displays a brief description of the highlighted depot item. To toggle display of the description panel, choose Display menu > Description.
- The icon-based [display tools](#) in the bottom-right corner of the Particle View dialog let you pan and zoom the event display window. For descriptions, see [Display menu on page 2738](#).

## Particle View Menu Bar

Select a Particle Flow source icon. > Modify panel > Setup rollout > Click Particle View (or press 6).

Create panel > Geometry > Particle Systems > Object Type rollout > Click PF Source. > Setup rollout > Click Particle View (or press 6).

The menu bar provides access to a number of important Particle View functions.

## Procedures

### To render only particles in specific events:

- 1 In Particle View, highlight the events containing the particles you want to render.
- 2 Choose Select menu > Assign Selection To Viewport.
- 3 Render using one of the [Render Type](#) on page 5900 > Selected options.

### To bring a Particle Flow setup into a different scene:

- 1 In Particle View, highlight the events containing the particles you want to merge with a different scene. For example, to designate only a particular flow, you might highlight its global event, and then choose Select menu > Select Downstreams.
- 2 Choose Select menu > Save Selected, and use the file dialog to specify a file to save.

---

**NOTE** Any scene objects on which Particle Flow depends are also saved. For instance, if a [Shape Instance operator](#) on page 2825 in one of the highlighted events refers to a certain object, that object is saved along with the designated events.

---

- 3 Open or create the scene with which the saved Particle Flow setup will be combined, and then use [Merge](#) on page 6854 to merge the file from step 2.

## Interface

### Edit menu

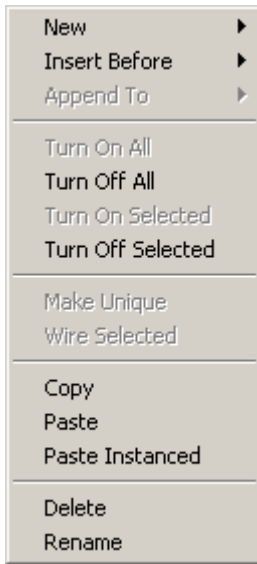

Each of the first three commands on this menu presents a submenu containing all actions. Choose the command, and then choose an action from the submenu.

---

**NOTE** The Undo and Redo commands are available from the main 3ds Max Edit menu, and their default keyboard shortcuts are the same: Ctrl+Z and Ctrl+Y, respectively.

---

**New** Adds a new event containing the chosen action to the event display.

**Insert Before** Inserts the chosen item above each highlighted action. Available only when one or more actions are highlighted.

**Append To** Inserts the chosen item at the end of each highlighted event. Available only when one or more events are highlighted.

**Turn On All** Turns on all actions and events.

**Turn Off All** Turns off all actions and events.

**Turn On Selected** Turns on any highlighted, turned-off actions or events. Available only when one or more highlighted items are turned off.



**Turn Off Selected** Turns off any highlighted, turned-on actions or events. Available only when one or more highlighted items are turned on.

**Make Unique** Converts an instanced action to a copy that's unique to its event. Available only when one or more instanced actions are highlighted.

**Wire Selected** Wires one or more highlighted tests to a highlighted event, or one or more highlighted global events to a highlighted birth event. Available only when one or more tests and a single event are highlighted, or when one or more global events and a single birth event are highlighted.

**Copy** Copies any highlighted events, actions, and wires to the paste buffer. Keyboard equivalent: Ctrl+C.

**Paste** Pastes the contents of the paste buffer to the event display. Keyboard equivalent: Ctrl+V.

The result of copying and then pasting multiple items depends on what you copied:

- If you copied multiple actions, pasting adds them all to a single new event, even if they originally came from different events.
- Copying multiple events or wires pastes them exactly as copied.
- If you copied a combination of actions and events, pasting creates a new event for each group of actions from a single event. For example, if you highlight event A, some actions from event B, and some actions from event C, copying and then pasting would add three events: a copy of event A, a second event with the actions from event B, and a third event with the actions from event C.

**Paste Instanced** Pastes the contents of the paste buffer to the event display, making instances of any pasted actions and their originals.

For the results of pasting multiple copied items, see Paste, above.

**Delete** Deletes any highlighted items. Keyboard equivalent: Delete.

Deleting an event also deletes all of its actions.

**Rename** Lets you enter a new name for any single highlighted item in the event display. Available only when one action or test is highlighted

## Select menu



By default, the Select tool is active when Particle View is open, as indicated by the arrow-shaped mouse cursor. You can use this tool to highlight, move, and copy events, actions, tools, and wires. You can also use the commands on this menu to highlight all elements, no elements, or elements by category.

---

**NOTE** When you render using any of the Selected options, the software renders only events that are selected in the viewports. You can use the last three commands on this menu to manage and coordinate selection of events and flows between Particle View and the viewports. This also applies to use of the Views menu > Shade Selected command.

---

**Select Tool** Activates the Select tool. Choose this to return to the Select tool after using interactive tools for panning and zooming the event display. Alternatively, simply right-click anywhere in the event display to activate the Select tool.

**Select All** Highlights all items in the event display.

**Select None** Deselects all items in the event display. Alternatively, click an empty area in the event display.

**Select Actions** Highlights all operators and tests in the event display.

**Select Operators** Highlights all operators in the event display.

**Select Tests** Highlights all tests in the event display.

**Select Events** Highlights all events in the event display.

**Select Wires** Highlights all wires in the event display.

**Select Downstreams** Highlights all events after currently highlighted events. Available only when one or more events are highlighted.

**Save Selected** Saves only highlighted elements in the event display to a *.max* file. You can then open this file, or combine it with an existing scene with File menu > Merge.

---

**NOTE** The Particle View > Save Selected command saves all items selected in Particle View *and* in the scene. So if a PF Source icon is selected in the scene, then this command will save its global event as well as any birth events associated with it. If you want to save only parts of a Particle Flow setup, first unselect everything in the scene.

---

Also, if an action references an object (for example, a [Shape Instance operator](#) on page 2825 uses a geometry object), and the action or its parent event is highlighted when you use Save Selected, then the reference object is saved as well.

**Get Selection From Viewport** Highlights global events whose source icons are selected in the viewports.

**Assign Selection To Viewport** Transfers an event selection to the viewports. Use this to render only particles in specific events. First, in Particle View, highlight the events to render. Next, choose this command, and finally, render using one of the [Render Type](#) on page 5900 > Selected options.

**Sync Source/Events Selection In Viewport** Selects all events of any source icons selected in the viewports. You can then propagate this selection to Particle View with the Get Selection From Viewport command.

Use this function to render a specific particle flow using one of the Render > Selected options.

## Display menu



The first five commands on this menu are also available as icons, in the Display tools section on the right side of the bottom border of the Particle View dialog. Each command's Display tools icon is shown below.



**Pan Tool** Drag in the event display to move the view. The mouse cursor changes to a hand icon. You can also pan the view by dragging with the middle mouse button or wheel button held down.

To exit this mode, right-click in the event view or choose the command again.



**Zoom Tool** Drag in the event display to zoom the view. The mouse cursor changes to a magnifying-glass icon. Drag upward to zoom in, or downward to zoom out.

To exit this mode, right-click in the event view or choose the command again.



**Zoom Region Tool** Drag in the event display to define a zoom rectangle. The mouse cursor changes to the image of a magnifying glass inside a zoom region. When you release the mouse button, the display zooms to show only the area defined by the region.

To exit this mode, right-click in the event view or choose the command again.



**Zoom Extents** Sets the zoom to show the entire particle diagram in the event display.



**No Zoom** Sets the zoom to the default level. This is the level displayed when you first open Particle View in a given session.

**Parameters** Toggles display of the parameters panel, on the right side of the Particle View dialog. Default=on.

**Depot** Toggles display of the depot, below the Particle View dialog. Default=on.

**Description** Toggles the Description panel, to the right of the depot. Default=on.

The Description panel displays a brief description of any action highlighted in the depot.

### Options menu

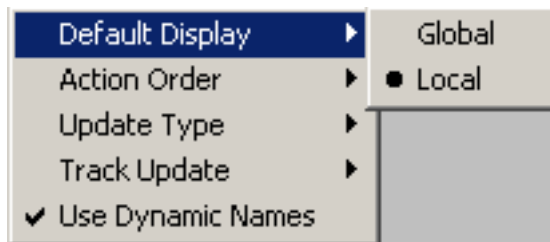

This menu contains a number of options useful in analyzing and debugging particle systems.

**Default Display** Determines whether the Display operator is applied locally or globally to new particle systems and events. Default=Local.

- **Global** When you create a new particle system, Particle Flow adds a single Display operator to the global event. It does not add a Display operator to each new event.
- **Local** Particle Flow adds a Display operator to each new event. This lets you easily distinguish particles in different events in the viewports.

**Action Order** For predictable results, don't use similar actions in the global and local events. However, if comparable actions do exist in both the global event and other events, Particle Flow applies them to the system in the order specified here. Typically, the effect that's applied *last* is the one that's visible in the particle system. Default=Locals First.

For example, consider a situation in which the global event contains a Shape operator set to Cube, and the other events in the same system contain Shape operators set to Tetra or Sphere. By default, Particle Flow applies the global Shape operator last at each integration step, overwriting any local shapes, so all particles would be cubes. But if you set Action Order to Globals First, the local shapes are applied last, and particles appear as tetrahedrons or spheres, depending on which event they're in.

- **Globals First** At each integration step, Particle Flow first applies actions in the global event, and then actions in the other (local) events. Typically, the result is that actions in the local events override comparable actions in the global event.
- **Locals First** At each integration step, Particle Flow first applies actions in the local events, and then actions in the global event. Typically, the result is that actions in the global event override comparable actions in the local events.

**Update Type** This setting determines how Particle Flow updates the system when you change a parameter during playback. Because the state of the particle system at any given frame can depend on events in previous frames, using the Complete option can provide a more accurate depiction of the result of the change, at a cost in speed; it takes more time to recalculate the entire system starting at the first frame. Default=Complete.

- **Complete** When you change a setting during playback, Particle Flow updates the entire system, starting at the first frame.
- **Forward** When you change a setting during playback, Particle Flow updates the system starting at the current frame.

**Track Update** Provides options for visualizing the particle system status in Particle View.

- **Particle Count** Adds a tab above each event that shows the number of particles in the event. The global event's count shows the total number of particles in the particle system. Use this, in addition to the ability to display particles differently in each event, to trace particle progress through the system.
- **Update Progress** Highlights each action in color whenever Particle Flow evaluates it. The highlighting is very fast, but this option can add significant computational overhead to the particle system, with the result that

real-time playback might skip a greater number of frames. To see all frames, turn off Time Configuration > Real Time.

**Use Dynamic Names** When on, action names in events are followed by their most important setting or settings, in parentheses. When off, only the names appear. Default=on.

## Particle View Event Display

Select a Particle Flow source icon. > Modify panel > Setup rollout > Click Particle View (or press 6).

Create panel > Geometry > Particle Systems > Object Type rollout > Click PF Source. > Setup rollout > Click Particle View (or press 6).

The [event display](#) on page 7772 in Particle View contains the particle diagram, and provides a complete range of intuitive functions for editing the particle system.

---

**NOTE** A number of these functions are also available from the [event display right-click menu](#) on page 2745 , as well as the [menu bar](#) on page 2732 .

---

### Editing the Particle Diagram and Particle System

Interactive functionality in event display includes the following:

#### General

- To add an action to the particle system, drag it from the depot to the event display. If you drop it in an empty area of the event display, it creates a new event. If you drag it to an existing event, the result depends on whether a red line or a blue line appears when you drop it. If a red line, the new action replaces the underlying action. If a blue line, the action is inserted in the list.
- To edit an action's parameters, click its name in an event. The parameters appear on the right side of Particle View. If not, it means the parameters panel is hidden; to display it, choose Display menu > Parameters.



- To wire a test to an event, drag from its *test output*, the blue dot that by default sticks out to the left of the test, to the event's *event*

*input*, which sticks out from the top, or vice-versa. Similarly, you can wire a global event to a birth event by dragging between the *source output* on the bottom of the global event and the event input. The mouse cursor changes to the first depicted image when you can begin this operation, and to the second image when you can complete it.

- To pan or zoom the event display, use the controls available from the [Display menu](#) on page 2738, the [right-click menu](#) on page 2745, or as icons at the bottom-right of the dialog.

## Modifying Actions and Events in the Event Display

- To change the color used by a Display operator, click its color swatch to the right of its name.



- To toggle an operator (that is, turn it off and on), click its icon in the event. The mouse cursor changes to the depicted image when this action is possible.



A turned-off operator does not affect the particle system, and appears as gray in the event list; however, its parameters are still available for editing.

Toggleing an instanced operator doesn't affect its other instances.

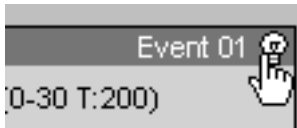

- To toggle an event (that is, turn it off and on), click the light-bulb icon next to its name in the title bar. Turning off an event is equivalent to turning off all of its operators and tests, although you cannot turn the operators and tests back on individually. The event's items do not affect the particle system, and appear as gray in the event list. All particles entering a turned-off event are immediately passed on to the next event, if any.

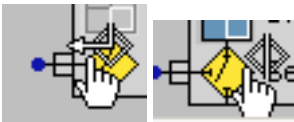

- To make a test result always True or False, click its icon's left or right side, respectively. The mouse cursor changes to the



first image at the left (with the left-pointing arrow) when you can click for always True, and to the second image at the left (without the left-pointing arrow) when you can click for always False.



The test icon changes to a green or red light bulb to indicate current functionality: green for always True, and red for always False.



To return to the original functionality, click the icon again. The mouse cursor changes to the depicted image when this action is possible.

## Selecting, Moving, and Copying

- To copy an action or event, first press and hold the Shift key and position the mouse cursor over the item to copy. When the plus sign (+) appears next to the mouse cursor arrow, drag the item to a new location. When you release the mouse button, the Clone Options dialog appears; choose Copy or Instance and click OK. In the Clone Options dialog, the Event And Particle System group is unavailable, as a reminder that you cannot instance these elements. Reference is not an option when cloning Particle System elements. Cloning an event or particle system simply creates a new event or particle system containing clones of the original's actions. Any instanced actions have identical properties. Changing one instance's values changes them all. On the other hand, copied actions can have different values.

To clone multiple items, highlight them all before Shift+dragging. If you attempt to clone a combination of actions and events, or actions from different events, the result depends on where you start dragging from. If you drag a highlighted action, you'll clone only actions from that event. If you drag an event, only highlighted events are cloned.

---

**NOTE** When you highlight an instanced action, Particle View indicates all of its other instances by changing their background color to a lighter shade of gray.

---

- To move an event, drag its title bar, or the icon of any of its actions. If you drag the event to an edge of the display, and scrolling is possible, the display window will automatically scroll in that direction.
- To resize an event, drag its right edge.

- To highlight multiple items, drag a rectangle around them, or Ctrl+click them individually.
- To delete an event, action, or wire, highlight it and then press Delete. Be sure the Particle Dialog is active, or you might inadvertently delete a selection in the scene instead.
- To move an action, drag its *name* (not its icon) to the new location. If you drag the event to an edge of the display, and scrolling is possible, the display window will automatically scroll in that direction. If you drag an action to an event, you can insert the action or replace an existing action, depending on where you position the mouse cursor before releasing the button. A blue line (before releasing) indicates that it will be inserted at that location, and a red line indicates that it will replace the underlying action. If you drag the action to an empty space in the event display, it will form a new event, and, by default, the system will add a new Display operator.

---

**NOTE** Particle Flow doesn't let you perform illegal operations. For instance, a Birth operator must always be the first item in a [birth event](#) on page 7728 ; the system doesn't let you position it elsewhere. You can place a Birth operator in an isolated event, but you can't then wire that event into a particle system, except in parallel with another birth event. For more information, see the [Birth operator topic](#) on page 2764 .

---



- To move a test output or switch it to the opposite side of the event, drag from just inside the test output to the desired new location. The mouse cursor changes to the depicted image when this operation is possible.

### Getting Information

- To see a renamed action's original type, position the mouse cursor over its event list entry until the tooltip appears.
- To see a brief description of an action, click it in the depot. The description appears on the Description panel, to the right of the depot.

## Event Display Right-Click Menu

Select a Particle Flow source icon. > Modify panel > Setup rollout > Click Particle View (or press 6). > Right-click in event display.

Create panel > Geometry > Particle Systems > Object Type rollout > Click PF Source. > Setup rollout > Click Particle View (or press 6). > Right-click in event display.

The event display right-click menu provides handy access to a number of contextual commands. The contents of the menu, as well as the results of its commands, depend in some cases on where you click, in other cases on what's highlighted, and in still other cases, on both.

In the following descriptions, “item” means an action or event, or, in some cases, a wire.

### Interface

**Insert** Displays a submenu of all actions, and when you choose a new action, inserts it where you originally right-clicked. Available only when you right-click over an event or action.

If you right-click over an action, and then insert an action, the inserted action replaces the old one. If you right-click above or below an action (no tooltip appears), the new action is added to the event at that location. If you right-click over an event, the action is inserted at the first available position.

**Append** Displays a submenu of all actions, and when you choose a new action, inserts it at the end of the event. Available only when you right-click over an event or action.

**Turn On** Turns on the event or action under the mouse cursor. Available only when the item under the mouse cursor is turned on.

To affect an event, the mouse cursor must be over its title bar.

Turning on a highlighted item affects all highlighted items.

**Turn Off** Turns off the event or action under the mouse cursor. Available only when the item under the mouse cursor is turned off.

To affect an event, the mouse cursor must be over its title bar.

Turning off a highlighted item affects all highlighted items.

**Make Unique** Converts an instanced action to a copy that's unique to its event. Available only when the mouse cursor is over an instanced action.

If you right-click over a highlighted, instanced action, Make Unique affects all such actions.

**Wire** Wires one or more highlighted tests to a highlighted event, or one or more highlighted global events to a highlighted birth event. Available only when one or more tests and a single event are highlighted, or when one or more global events and a single birth event are highlighted, and when you right-click over an eligible, highlighted item.

**Copy** Copies any highlighted events, actions, and wires to the paste buffer. Available only when the mouse cursor is over an highlighted action, but affects all highlighted items.

**Paste** Pastes the contents of the paste buffer to the event display at the mouse cursor.

If the cursor is over a list, and you copied actions, the actions are added to the event. If the cursor is over an empty area of the event display, the software creates a new event containing the pasted actions. A copied event can be pasted only in an empty area of the event display.

The result of copying and then pasting multiple items depend on what you copied and the position of the mouse cursor:

- If you copied multiple actions, pasting adds them all to the event under the mouse cursor, or, if the cursor is over an empty area, to a new event, even if they originally came from different events.
- Copying multiple events and/or wires pastes them exactly as copied, but in this case Paste is available only when the mouse cursor is over an empty area.
- If you copied a combination of actions and events, you can paste them only when the mouse cursor is over an empty area. Pasting creates a new event for each group of actions from a single event. For example, if you highlight event A, some actions from event B, and some actions from event C, copying and then pasting would add three events: a copy of event A, a second event with the actions from event B, and a third event with the actions from event C.

**Paste Instanced** Pastes the contents of the paste buffer to the event display, making instances of any pasted actions and their originals.

For the results of pasting multiple copied items, and the limitations based on mouse position, see Paste, above.

**New** Add a new item to the event display from the submenu. The submenu contents are identical to that of the depot. Available only when the mouse cursor is over an empty area.

**Delete** Deletes the item under the mouse cursor. Available only when the mouse cursor is over an item.

If the mouse cursor is over a highlighted item, choosing Delete deletes all highlighted items.

**Rename** Lets you rename the item under the mouse cursor. Enter a new name from the keyboard.

**Properties** Opens the Object Properties dialog for the event under the mouse cursor. Available only when the mouse cursor is over the title bar of a highlighted event.

Particle Flow lets you set object properties on a per-event basis. This lets you set attributes such as Hide, Renderable, and Motion Blur separately for each event. Alternatively, you can set properties for the entire particle system from the global event.

For more information, see [Object Properties](#) on page 245 .

---

**NOTE** Set properties for events and the particle system *only within Particle View* , not via the source icon in the viewports (using the right-click menu > Properties or Edit menu > Object Properties).

---

**Use Script Wiring** Lets you use a script to specify certain parameters in the [Force operator](#) on page 2867 and [Keep Apart operator](#) on page 2815 . This command appears only when you right-click either of the specified, highlighted operators in an event.

**Comments** Lets you add comments to each action and event, and view existing comments. Available only when the mouse cursor is over an action or the title bar of an event.

Choosing Comments opens a window for entering text from the keyboard. Begin typing, and click OK to finish. A commented event or action has a red triangle near its name to indicate the presence of the comment. You can click this triangle to open the comment.

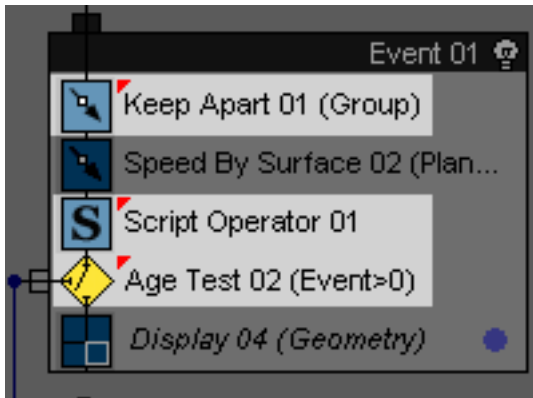

Commented actions; click the triangle to view a comment.

---

**NOTE** A comment is specific to the action or event to which it's applied. If you copy a commented event or action, the comment is not included in the copy, because it's probably not applicable to the copy.

---

**Pan** Switches to the Pan tool. Drag in the event display to change the view; right-click to exit. Available only when you click over an empty area of the event display.

**Zoom** Switches to the Zoom tool. Drag upward in the event display to zoom in, and downward to zoom out; right-click to exit. Available only when you click over an empty area of the event display.

**Zoom Region** Switches to the Zoom Region tool. Drag a rectangle in the event display to specify the area to zoom into; right-click to exit. Available only when you click over an empty area of the event display.

## Particle Flow Source

Add a Particle Flow system to the scene. > Create panel

Select a PF Source icon. > Modify panel

[Particle View](#) on page 2730 > Click a global event (title bar). > Parameters panel

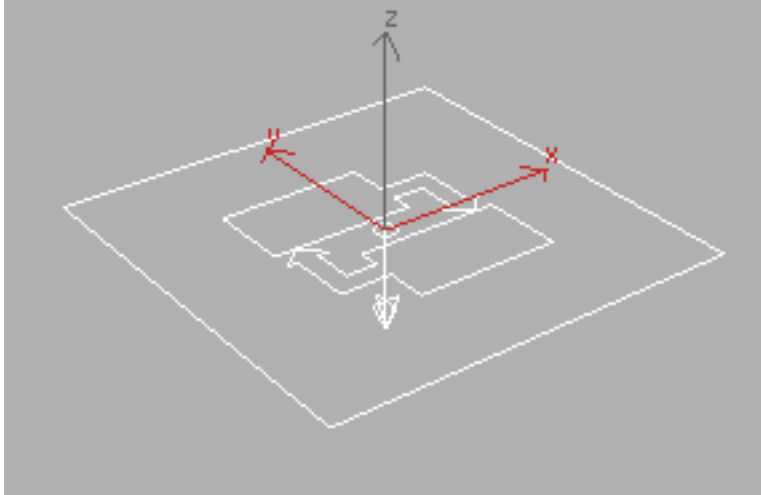

The Particle Flow source is the viewport icon for each [flow](#) on page 7787 , and also serves as the default emitter. By default, it appears as a rectangle with a central logo (see above illustration), but you can change its shape and appearance using the controls described below.

When you select a source icon in the viewport, the Particle Flow emitter-level rollouts appear on the Modify panel. Alternatively, click the title bar of a global event in Particle View to highlight it, and to access the emitter-level rollouts from the parameters panel on the right side of the Particle View dialog. Use these controls for setting global attributes, such as icon properties and the maximum amount of particles in the flow.

The particle source icon is roughly equivalent to the corresponding [global event](#) on page 7801 in Particle View. They have the same name, but selecting one does not select the other. If you delete a particle source icon from the scene, the software converts the global event to an isolated local event in Particle View, retaining its operators with their settings intact. Any other events in the system remain in Particle View, along with their wiring. However, if you delete a global event, the software also removes any local events used exclusively by that system, as well as the corresponding particle source icon. To retain the local events, first delete the wire from the global event, and then delete the global event.

If you clone a particle source in a viewport with Shift+transform or Edit menu > Clone, an equal number of copies of the global event appear in Particle View, each wired to the original [birth event](#) on page 7728 . The Clone Options dialog offers only the Copy option. However, if you clone a global event in Particle View, the Clone Options dialog also lets you create instances of the cloned

operators and tests. It's not possible to create instances of global and local events, so these options are unavailable in the Clone Options dialog, as a reminder. Also, global events cloned in Particle View are not automatically wired to the original birth event.

## Interface

### Modifier stack

In the modifier stack, expanding the hierarchy of a Particle Flow source object provides access to two sub-object levels: Particle and Event. For further information, see [Selection rollout](#) on page 2753 .

### Setup rollout

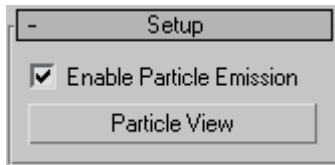

Use these controls to turn the particle system on and off, and to open Particle View.

---

**NOTE** This rollout appears only on the Create and Modify panels, not on the Particle View dialog > parameters panel.

---

**Enable Particle Emission** Turns the particle system on and off. Default=on.

You can also turn off all particle flows in Particle View with Edit menu > Turn Off All, or a specific particle flow by right-clicking its global event's title bar and choosing Turn Off.

**Particle View** Click to open the [Particle View dialog](#) on page 2730 .



## Emission rollout

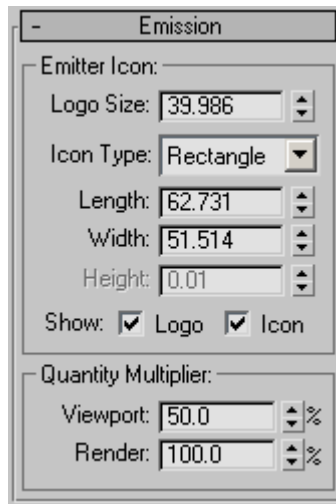

Sets the physical characteristics of the emitter (particle source) icon, and the percentage of particles produced in the viewports and when rendering.

### Emitter Icon group

**Logo Size** Sets the size of the Particle Flow logo, which appears at the center of the source icon, as well as the arrow that indicates the default direction of particle motion.

By default, the logo size is proportional to that of the source icon; with this control, you can make it larger or smaller.

This setting affects only the viewport display of the logo; changing it has no effect on the particle system.

**Icon Type** Choose the basic geometry of the source icon: Rectangle, Box, Circle, or Sphere. Default=Rectangle.

This choice matters only if you use the source icon as the particle emitter. The available size settings depend on which icon type you choose, and, again, are important only if you use the source icon as an emitter.

The default icon type is Rectangle. If you add a particle system, and then change the icon type to Box, the icon continues to resemble a rectangle. To make it look like a box, increase the Height setting.

**Length/Diameter** Sets the length of the Rectangle and Box icon types, and the diameter of the Circle and Sphere icon types.

**Width** Sets the width of the Rectangle and Box icon types. Unavailable with the Circle and Sphere icon types.

**Height** Sets the height of the Box icon type. Available only with the Box icon type.

**Show Logo/Icon** Turns display of the logo (with arrow) and icon on and off, respectively.

These settings affect only the viewport display of these items; they have no effect on the particle system.

### Quantity Multiplier group

These settings determine the percentage of the total number of particles in each [flow](#) on page 7787 that are actually produced in the viewports and at render time. They don't affect the percentage of particles that are visible; those are determined by the [Display operator](#) on page 2864 and [Render operator](#) on page 2872. You can use them to quickly decrease or increase the number of particles consistently throughout all events in the particle system. The maximum setting, 10,000%, lets you multiply the number of particles generated by the flow by 100.

The total number of particles is determined by the combined effects of the following operators and tests: [Birth](#) on page 2764, [Birth Script](#) on page 2767, [Delete](#) on page 2768, [Collision Spawn](#) on page 2885, and [Spawn](#) on page 2912. Scripted operators and tests can also affect this number.

**Viewport** Sets the percentage of the total number of particles in the system produced in the viewports. Default=50.0. Range=0.0 to 10000.0.

**Render** Sets the percentage of the total number of particles in the system produced at render time. Default=100.0. Range=0.0 to 10000.0.

## Selection rollout



Use these controls for selecting particles on a per-particle or event basis. Selection of particles at the Event level is for debugging and tracking purposes. Particles selected at the *Particle level* can be acted upon by the [Delete operator](#) on page 2768 and the [Split Selected test](#) on page 2921 . You cannot directly manipulate selected particles with standard 3ds Max tools such as Move and Rotate.

---

**NOTE** This rollout appears only on the Modify panel, not on the Create panel or Particle View dialog > parameters panel.

---



**Particle** Lets you select particles by clicking them or dragging a region.



**Event** Lets you select particles by event. At this level, you can select all particles in one or more events by highlighting the event(s) in the [Select By Event list](#) on page 2754 , or in the viewports with standard selection methods. To convert a selection from the Event level to the Particle level for use with the Delete operator or Split Selected test, use [Get From Event Level](#) on page 2754 .

Selected particles appear in the viewports in red (if not geometry), in the form designated by the [Display operator > Selected setting](#) on page 2867 .

### Select by Particle ID group

Each particle has a unique ID number, starting with 1 for the first particle and counting up. Use these controls to select and deselect particles by their ID numbers. Available only at the Particle selection level.

---

**TIP** You can display particle IDs in the viewports by turning on Display operator > Show Particle IDs.

---

**ID** Use this to set the ID number of the particle you want to select. You can set only one number at a time.

**Add** After setting the ID number of a particle to select, click Add to add it to the selection. By default, selecting a particle doesn't deselect any others.

**Remove** After setting the ID number of a particle to deselect, click Remove to remove it from the selection.

**Clear Selection** When on, clicking Add to select a particle deselects all other particles.

**Get From Event Level** Click to convert an Event-level selection to the Particle level. Available only at the Particle level.

**Select By Event** This list shows all events in Particle Flow, and highlights selected events. To select all of an event's particles, click its list entry, or use standard viewport-selection methods.

**# Particles Selected** Shows the number of selected particles.

### System Management rollout

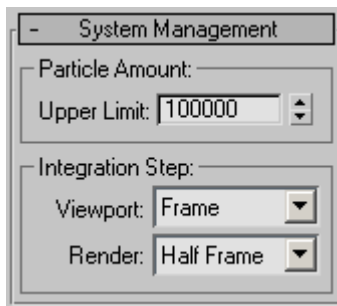

Use these settings to limit the number of particles in the system, and to specify the frequency of updating the system.

### **Particle Amount group**

**Upper Limit** The maximum number of particles the system may have. Default=100000. Range=1 to 10000000.

---

**TIP** You can have more than 10,000,000 particles in a single system by using multiple particle sources and wiring them to the same birth event. Note, however, that Particle Flow is limited to sending a maximum of 5,000,000 particles per event to the renderer.

---

### **Integration Step group**

At each integration step, Particle Flow updates the particle system, applying each active action to particles in its event. A smaller integration step can improve accuracy, at the cost of calculation time. These settings let you apply different integration steps to the particle animation in the viewports and at render time.

In most cases, the default Integration Step settings work fine. One instance in which increasing the integration-step frequency might help is when fast-moving particles that should collide with a deflector penetrate it instead.

**Viewport** Set the integration step for animation playback in the viewports. Default=Frame (once per animation frame). Range=1/8 Frame to Frame.

**Render** Set the integration step at render time. Default=Half Frame (twice per animation frame). Range=1 Tick to Frame.

There are 4,800 ticks in a second; thus, at the NTSC video rate of 30 frames per second, there are 160 ticks per frame.

## Script rollout

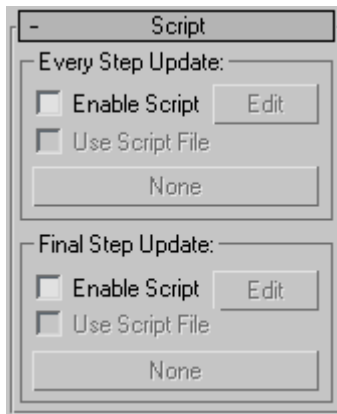

This rollout lets you apply a script to the particle system at each integration step, as well as after the last integration step of each frame you view. Use an Every Step Update script to set up history-dependent properties, and a Final Step Update script to set up history-independent properties.

### Every Step Update group

The Every Step Update script is evaluated at the end of each integration step, after all actions in the particle system are evaluated, and all particles are finally in their respective events. When, for example, you are setting up Material ID according to a particle index, it is important to be sure that particles are not about to jump to another event.

When you set up history-dependent properties, such as speed, it is important to do that at every integration step, because otherwise the final position would be quite different.

**Enable Script** Turn on to cause a script in memory to be executed at each integration step. You can modify this script by clicking the Edit button, or load and use a script file with the remaining controls in this group.

The default script modifies particle speed and direction, causing particles to follow a wavy path.

**Edit** Click this button to open a text-editor window with the current script.

When Use Script File is off, this is the default Every Step Update script (*3dsmax\scripts\particleflow\example-everystepupdate.ms*). When Use Script File is on, this is the loaded script, if you've loaded one. If you haven't, clicking Edit displays the Open dialog.

**Use Script File** When on, you can load a script file by clicking the button below.

**[button]** Click this button to display an Open dialog that lets you specify a script file to load from disk. After you load a script, the name of script file appears on the button.

### **Final Step Update group**

The Final Step Update script is executed after the last integration step has been completed for each frame that you view (or render). For example, if you play the animation in the viewport with Real Time turned off, Particle Flow runs this script at each frame, immediately before the particle system is rendered to the viewport. However, if you simply jump to a different frame, the script is run once only, so if the script assumes a certain history, you might get unexpected results.

For this reason, it's best to use the Final Step Update script to modify history-independent properties. For example, if no operators in the system depend on the material indices, you could use it to modify the material index. In this case there's no need to set those indices in every intermediate integration step. Also, you can set up a position channel in the Final Step Update script if you know the analytical expression for the position.

**Enable Script** Turn on to cause a script in memory to be executed after the final integration step. You can modify this script by clicking the Edit button, or load and use a script file with the remaining controls in this group.

The default script modifies particle speed and direction, causing particles to follow a bulb-shaped path.

**Edit** Click this button to open a text-editor window with the current script.

When Use Script File is off, this is the default Final Step Update script (*3dsmax\scripts\particleflow\example-finalstepupdate.ms*). When Use Script File is on, this is the loaded script, if you've loaded one. If you haven't, clicking Edit displays the Open dialog.

**Use Script File** When on, you can load a script file by clicking the button below.

**[button]** Click this button to display an Open dialog that lets you specify a script file to load from disk. After you load a script, the name of script file appears on the button.

# Particle Flow Keyboard Shortcuts

To use Particle Flow keyboard shortcuts, the Keyboard Shortcut Override Toggle on the main toolbar must be turned on.

To view and customize these shortcuts, open the Customize User Interface dialog from the Customize menu, and then, from the Group drop-down menu, choose Particle Flow.

Particle Flow Function	Keyboard Shortcut	Description
Copy Selected In Particle View*	Ctrl+C	
Particle Emission Toggle	;	Toggles active status of all particle systems.
Particle View Toggle	6	Toggles Particle View dialog.
Paste In Particle View*	Ctrl+V	
Select All In Particle View*	Ctrl+A	Selects all events, actions, and wires.
Selected Particle Emission Toggle	Shift+;	Toggles active status only of particle systems whose icons are selected in the viewports.

\* These functions are specific to Particle View. It is recommended that you use Customize User Interface to change their keyboard shortcuts only, and not assign them to toolbars, quads, or menus.

## Actions

The Particle Flow components for creating particle systems are known collectively as *actions*. These are subdivided into three main categories:

- [Operators](#) on page 2761
- [Flows](#) on page 2875



- [Tests](#) on page 2877

## Action Time Frames

Most actions in Particle Flow operate on particles in either of two time frames: once, when the particle first enters the event, or on a continuous basis, potentially changing particle behavior at each integration step. Some actions can work only in one time frame, while others can work on an instantaneous or continuous basis, depending on their settings. The tables below list each action with its time frame.

### Operators

Operator	Time Frame
Birth	n/a
Birth Script	n/a
Delete	n/a
Force	Continuous
Keep Apart	Continuous
Mapping	Continuous
Material Dynamic	Continuous
Material Frequency	Once
Material Static	Once
Position Icon	Once, except continuous with Lock On Emitter

<b>Operator</b>	<b>Time Frame</b>
Position Object	Once, except continuous with Lock On Emitter
Rotation	Once, except continuous with Speed Space Follow
Scale	Once, except continuous with Absolute and Relative options
Script Operator	Depends on script
Shape	Once
Shape Facing	Continuous
Shape Instance	Once, except continuous with Animated Shape
Shape Mark	Once, except continuous with Align To Surface Animation
Speed	Once
Speed By Icon	Continuous
Speed By Surface	Depends on setting
Spin	Once, except continuous with Speed Space Follow
n/a=not applicable	

### **Tests**

Most tests in Particle Flow function only as tests. At each integration step, they check each particle for the specified conditions, and then return the test

result: True or False. So, as tests, they work on a continuous basis. For example, Age Test checks each particle's age at every integration step, because particles might not reach the specified age until remaining in the event for a while, and also because another action in the event might change or reset particle age.

The principal exceptions to this are the Split tests, which test each particle only when it first enters the event. That is, a Split test splits the particle stream only once for each particle that enters the event. Any particles that remain in the event are not subject again to being split off from the stream by the same test. Also, the Send Out test performs no test, but simply moves particles along to the next event.

Some tests also function as operators, in that they directly affect particle behavior. These are the ones listed here, and the specified time frame is related to the operator functionality, not the test.

Test	Time Frame
Collision Spawn	Continuous
Find Target	Continuous
Go To Rotation	Continuous
Script Test	Depends on script
Spawn	Continuous, except once with Once

## Operators

The operator is the basic element of the particle system; you combine operators into events to specify the particles' characteristics over a given period of time. Operators let you describe particle speed and direction, shape, appearance, and more.

The operators reside in two groups in the Particle View depot, and within each group appear in alphabetical order. Each operator's icon has a blue background, except for the Birth operators, which have a green background. The first group contains operators that directly affect particle behavior, such as transformation.

The second group, found at the end of the depot listing, contains four operators that serve more of a utility function: Cache, for optimizing particle-system playback; Display, for determining how particles appear in the viewports; Notes, for adding comments; and Render, for specifying render-time characteristics.

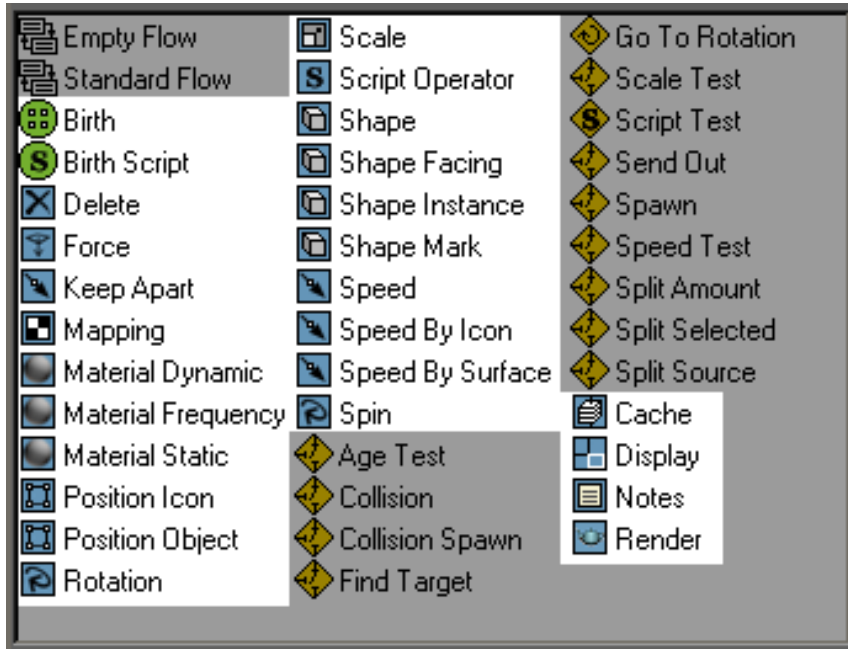

The Particle Flow operators in the Particle View depot

The primary operators in Particle Flow are:

[Birth Operator](#) on page 2764

[Birth Script Operator](#) on page 2767

[Delete Operator](#) on page 2768

[Force Operator](#) on page 2867

[Keep Apart Operator](#) on page 2815

[Mapping Operator](#) on page 2853

[Material Dynamic Operator](#) on page 2846

[Material Frequency Operator](#) on page 2844

[Material Static Operator](#) on page 2841  
[Position Icon Operator](#) on page 2770  
[Position Object Operator](#) on page 2773  
[Rotation Operator](#) on page 2781  
[Scale Operator](#) on page 2785  
[Spin Operator](#) on page 2783  
[Select and Uniform Scale](#) on page 892  
[Script Operator](#) on page 2874  
[Shape Operator](#) on page 2821  
[Shape Facing Operator](#) on page 2822  
[Shape Instance Operator](#) on page 2825  
[Shape Mark Operator](#) on page 2832  
[Speed Operator](#) on page 2791  
[Speed By Icon Operator](#) on page 2796  
[Speed By Surface Operator](#) on page 2806

The utility operators are:

[Cache Operator](#) on page 2856  
[Display Operator](#) on page 2864  
[Notes Operator](#) on page 2871  
[Render Operator](#) on page 2872

**See also:**

- [Flows](#) on page 2875
- [Tests](#) on page 2877

# Birth and Death

## Birth Operator

[Particle View](#) on page 2730 > Click Birth in an event or add a Birth operator to the particle system and then select it.

The Birth operator enables creation of particles within the Particle Flow system using a set of simple parameters. In general, use Birth as the first operator in any event connected directly to a [global event](#) on page 7801 ; this is called the [birth event](#) on page 7728 .

You can specify a total number of particles, or a rate of particles born per second. You can also tell the system when to begin emitting particles, and when to stop.

---

**NOTE** The Birth operator must always come at the beginning of a particle stream; the system doesn't let you position it elsewhere. You can place a Birth operator in an isolated event, but you can't then wire that event in series with a stream that already uses a Birth operator. However, you can wire multiple Birth operators, each in its own event, into a particle stream with an existing Birth operator, *in parallel* . The following procedure illustrates this. If you need to create particles midstream, use the [Spawn Test](#) on page 2912 or [Collision Spawn Test](#) on page 2885 test.

---

**See also:**

- [Birth Script Operator](#) on page 2767

### Procedures

#### To use the Birth operator:

This procedure demonstrates the impossibility of using multiple Birth operators in series, and shows how to use multiple Birth operators in parallel.

- 1 Start or reset the software, and add a new PF Source object to the scene.
- 2 Press 6 to open Particle View.  
The default particle system contains a Birth operator as the first action in the birth event.
- 3 Try to drag the Birth operator elsewhere in Event 01.

You can't. As you drag over the different actions in Event 01, a red line appears at the top of the event, showing that the Birth operator will be placed here, no matter where you release the mouse button.

- 4 Try to drag a new Birth operator from the depot to Event 01.  
As in the previous step, the only place you can drop the Birth operator is at the top of the event, replacing the existing Birth operator.
- 5 From the depot, drag the Birth operator to an empty area in the event display.  
Particle Flow creates a new birth event, Event 02, containing the Birth operator and a Display operator.
- 6 Wire the output of the global event, PF Source 01, to the event input of Event 02.  
Each birth event must be associated with a global event to be able to generate particles.
- 7 From the depot, add a Send Out test at the end of both Event 01 and Event 02.
- 8 Try to wire the test output of Event 02 to the event input of Event 01.  
Particle Flow doesn't let you, because this would result in two Birth operators in series.
- 9 Try to wire the test output of Event 01 to the event input of Event 02.  
Again, Particle Flow doesn't let you, because this would result in two Birth operators in series.
- 10 Drag a Speed operator to an empty area of the event display.  
Particle Flow creates a new event, Event 03.
- 11 Wire the test output of Event 01 to the event input of Event 03.
- 12 Wire the test output of Event 02 to the event input of Event 03.  
There's no problem wiring the two birth events to a single, third event. The birth events exist in the particle stream in parallel, each generating particles independently and then feeding its particle stream into a common event, where the two streams are combined.  
  
If the second birth event had its own global event, you could, at any point further downstream, separate the streams back out according to their origin using the [Split Source test](#) on page 2922 . To do this, delete the wire from PF Source 01 to Event 02, add an [Empty Flow](#) on page 2875 to the system, and then wire it to Event 02.

## Interface

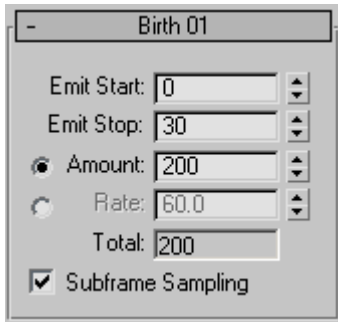

The user interface appears in the parameters panel, on the right side of the Particle View dialog.

**Emit Start** The frame number at which the operator begins emitting particles.

**Emit Stop** The frame number at which the operator stops emitting particles.

---

**NOTE** The Emit Start and Emit Stop values are tied to the system frame rate. If you change the frame rate, Particle Flow automatically adjusts the Emit values accordingly. For example, if you set Emit Start to 120 and Emit Stop to 300 using the default NTSC frame rate (30 fps), and then switch to PAL (25 fps) using the Time Configuration dialog, you've reduced the frame rate to 5/6 of the original value. Thus, Particle Flow automatically uses the same ratio to adjust the Emit settings, resulting in an Emit Start value of 100 and an Emit Stop value of 250. This allows the particle system to retain the timing you specify, no matter which frame rate you use.

---

**NOTE** With Subframe Sampling off, such adjustments are rounded off to the nearest integer frame number. With Subframe Sampling on, fractional frame values that result from such adjustments will be used, but not displayed.

---

**Amount** To specify the total number of particles emitted by the operator, choose Amount, and then set the quantity of particles.

Using the Amount option, the first particle is always emitted at the Emit Start frame, and the last particle is always emitted at the Emit Stop frame. Particles emitted between these endpoints appear at equal intervals within the emission period. For example, if you set Amount to 3, the second particle is emitted halfway through the emission period.



To determine the number of particles emitted per frame when using Amount, divide the Amount value by the number of emission frames (Emit Stop-Emit Start+1).

**Rate** To specify the number of particles emitted *per second*, choose Rate, and then set the value. The operator emits this number of particles per second starting at the Emit Start frame and ending at the Emit Stop frame.

If you specify a birth rate value that isn't an integer multiple of the system frames-per-second value (set in the Time Configuration dialog), Particle Flow uses interpolation to determine when to emit particles. For example, if you use the system default rate of 30 frames per second, and set the birth rate to 4, the system would emit each particle at intervals of seven or eight frames if Subframe Sampling is off, or at intervals of 7.5 frames if Subframe Sampling is on.

**Total** The calculated total number of particles emitted by the operator.

**Subframe Sampling** Turning this on helps avoid particle "puffing" by emitting particles at a much higher subframe resolution (that is, throughout each frame), rather than using the relatively coarse frame resolution. Default=on.

"Puffing" is the effect of emitting separate "puffs" or clusters of particles, rather than a continuous stream. This effect is especially noticeable when the emitter is animated.

Turn off Subframe Sampling to cause particles to be emitted exactly at frame times. This makes it easier to sort particles by their age later.

---

**TIP** If, when using the [Collision](#) on page 2881 or [Collision Spawn test](#) on page 2885, you experience an irregular particle stream, try turning off Subframe Sampling.

---

## Birth Script Operator

[Particle View](#) on page 2730 > Click Birth Script in an event or add a Birth Script operator to the particle system and then select it.

The Birth Script operator enables creation of particles within the Particle Flow system using a MAXScript script. The script can use any program functionality available to MAXScript.

The default script (`3dsmax\scripts\particleflow\example-script\birth.ms`) emits particles for 100 frames in a wavy, circular path. To see this, turn off or delete any Speed and Position operators in the event.

**See also:**

- [Birth Operator](#) on page 2764

## Interface



The user interface appears in the parameters panel, on the right side of the Particle View dialog.

**Edit Script** Click this button to open the current script in a MAXScript Editor window.

For detailed information about the MAXScript utility, open the MAXScript Reference, available from Help menu > MAXScript Reference.

**Emit Start** The frame number at which the operator begins emitting particles.

### Uniqueness group

The Uniqueness setting provides a randomization seed that the script can use or ignore.

**Seed** Specifies a randomization value.

**New** Calculates a new seed using a randomization formula.

## Delete Operator

[Particle View](#) on page 2730 > Click Delete in an event or add a Delete operator to the particle system and then select it.

Use the Delete operator to remove particles from the particle system. By default, particles live “forever,” that is, for the duration of the animation. The Delete operator lets you give them a finite life span. This is useful for eliminating particles once they’ve served their purpose in the animation.

The Delete operator is also necessary when using the Particle Age map, which, when incorporated into the Material Dynamic operator, applies different materials to particles depending on their age. Because the map works on the basis of a percentage of the particle's life span, you need to use a Delete operator to define the particles' maximum age. For an example of usage, see [Material Dynamic operator](#) on page 2846 .

## Interface

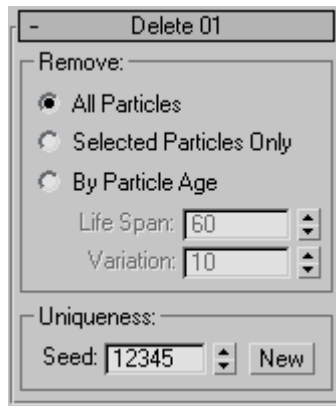

The user interface appears in the Parameters panel, on the right side of the Particle View dialog.

## Remove group

Choose whether to delete all particles, selected particles, or particles past a specific age.

The Uniqueness setting enables randomization of maximum particle age using the By Particle Age > Variation setting.

**All Particles** Deletes all particles in the event immediately.

**Selected Particles Only** Deletes particles selected at the Particle sub-object level in the event immediately. See [Selection rollout](#) on page 2753 .

**By Particle Age** Deletes particles in the event after they've existed for a specific length of time, with an optional random variation. Choosing this makes the Life Span and Variation settings available.

**Life Span** The number of frames of life allowed to the particles. After this period, they're deleted. Default=60.

**Variation** The maximum amount by which Life Span may vary. To get each particle's actual life span, this value is multiplied by a random number between -1.0 and 1.0, and then added to Life Span. Default=10.

### **Uniqueness group**

The Uniqueness setting enables randomization of maximum particle age using the By Particle Age > Variation setting.

**Seed** Specifies a randomization value.

**New** Calculates a new seed using a randomization formula.

## **Transforms**

### **Position Icon Operator**

[Particle View](#) on page 2730 > Click Position in an event or add a Position operator to the particle system and then select it.

By default, particles are born, or *emitted*, from the Particle Flow icon. This topic uses the term *emitter* to refer to this icon. Use the Position Icon operator to control the initial placement of particles on the emitter. You can set the emitter to emit particles from its surface, volume, edges, vertices, or center. And, if you animate the emitter, you can cause its motion to be imparted to the particles it emits.

Alternatively, you can use [Position Object](#) on page 2773 to emit particles from any other object.

## Interface

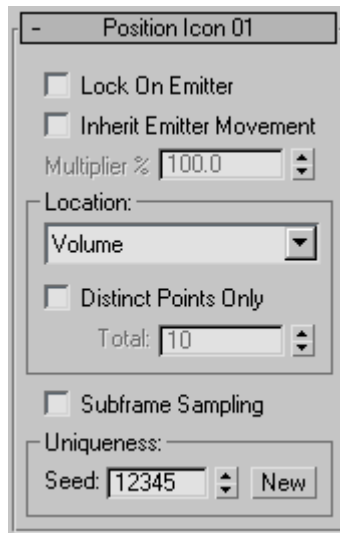

The user interface appears in the parameters panel, on the right side of the Particle View dialog.

**Lock On Emitter** When on, causes all particles to remain at their initial positions on the emitter. In effect, they're “glued” to the emitter. When off, each particle's birth position is determined by the emitter's current location. Default=off.

**Inherit Emitter Movement** When on, the software sets each particle's rate and direction of motion to that of the emitter at the time of birth. When off, the emitter movement doesn't affect that of the particles. Available only when Lock On Emitter is off. Default=off.

---

**NOTE** If a Speed operator exists later in the event, it overrides any motion imparted by Inherit Emitter Movement.

---

**Multiplier** Determines, as a percentage, the extent to which particles inherit the emitter's motion. Available only when Inherit Emitter Movement is on. Default=100.

To have the particles move half as fast as the emitter, set Multiplier to 50. To have them move the same speed, use the default setting of 100. To make the particles move twice as fast as the emitter, set Multiplier to 200.

## Location group

The Location drop-down list lets you specify where on the emitter the particles appear. You can create a variety of emission behaviors by varying the [icon type](#) on page 2751, Location setting, and direction of emission. Default=Volume.

- **Pivot** Emits particles from the center of the icon.
- **Vertices** For the Box and Rectangle icon types, emits particles from the corners of the icon. For the Sphere icon type, emits particles from the six intersections of the three circles that define the sphere. For the Circle icon type, emits particles from the center.
- **Edges** Emits particles from random points along the edges of the icon.
- **Surface** Emits particles from random points on the surface of the icon.
- **Volume** Emits particles from random points within the volume of the icon.

**Distinct Points Only** Limits emission to a specific number of points (see Total, below) on the specified Location type.

Emission points are still randomized; change the Uniqueness setting to alter these.

**Total** Sets the number of emission points. Available only when Distinct Points Only is on. Default=10.

**Subframe Sampling** When on, the operator acquires animation of the emitter icon on a tick basis (every 1/4800th of a second) rather than a frame basis. This provides greater precision in allowing the particle positions to follow animation of the emitter icon. Default=off.

## Uniqueness group

The Uniqueness setting lets you alter the randomization of emission points.

**Seed** Specifies a randomization value.

**New** Calculates a new seed using a randomization formula.

## Position Object Operator

[Particle View](#) on page 2730 > Click Position Object in an event or add a Position Object operator to the particle system and then select it.

By default, particles are born, or *emitted*, from the Particle Flow icon. The Position Object operator lets you emit particles from any other object or objects in the scene instead. This topic uses the term *emitter* to refer to an object or objects used to emit particles with this operator. For example, use it to create a meteor's fiery trail.

Use the Position Object settings to control the initial placement of particles on the emitter. You can set the emitter to emit particles from its surface, volume, edges, vertices, or pivot, or from a sub-object selection. You can also control particle emission with a material applied to the object.

Alternatively, you can use the [Position Icon operator](#) on page 2770 to emit particles from the Particle Flow icon.

---

**NOTE** Typically, you would use Position Object in a birth event, so the particles appear initially at the emitter object(s). If you use it in a non-birth event, the particles jump to the designated emitter(s) upon entering the event. This could be useful for a teleportation effect.

---

**TIP** The default speed operator, [Speed](#) on page 2791, typically uses the Particle Flow icon to control the direction of the particle flow, so if the emitter object(s) and the icon aren't coincident and aligned, you might get unexpected results. For better control over the direction of particle movement when using Position Object, use the [Speed By Surface operator](#) on page 2806 instead and designate as Surface Geometry the same object(s) as with Position Object.

---

### Procedures

#### To use Position Object:

- 1 Create a Particle Flow system and one or more mesh objects to use as emitters. Animate the emitter objects and set particle system parameters as necessary.
- 2 In Particle View, add a Position Object operator to the birth event, replacing the Position Icon operator if one exists. Click the operator to display its parameters.

- 3 In the Emitter Objects group, click Add, and then select an object to serve as the emitter. Alternatively, click By List and then use the Select Emitter Objects dialog to designate one or more objects as emitters.
- 4 Use the Location drop-down list to choose where the particles should appear on the emitter: surface, vertices, and so forth.
- 5 Set other options as necessary. For example, if you want the particles to use the same motion as the emitter at the time of emission, turn on Inherit Emitter Movement. Or if you're using an emitter object whose shape is animated, turn on Animated Shape.



## Interface

- Position Object 01

Lock On Emitter

Inherit Emitter Movement

Multiplier %:

Variation %:

Emitter Objects:

Teapot01

Add By List Remove

Animated Shape

Subframe Sampling

Location:

Surface

Surface Offset

Min:

Max:

Density By Material

Grayscale

Use Sub-Material

Mtl ID:

Separation

Distance:

Distinct Points Only

Total:

If Location Is Invalid:

Delete Particles

Uniqueness:

Seed:  New

Attempts Max:

The user interface appears in the parameters panel, on the right side of the Particle View dialog.

**Lock On Emitter** When on, causes all particles to remain at their initial positions on the emitter. In effect, they're “glued” to the emitter. When off, each particle's birth position is determined by the emitter's current location. Default=off.

**Inherit Emitter Movement** When on, the software sets each particle's speed and direction of motion to those of the emitter at the time of birth. When off, the emitter movement doesn't affect that of the particles. Available only when Lock On Emitter is off. Default=off.

---

**NOTE** If a Speed operator exists later in the event, it overrides any motion imparted by Inherit Emitter Movement.

---

**Multiplier** Determines, as a percentage, the extent to which particles inherit the emitter's motion. Available only when Inherit Emitter Movement is on. Default=100.

To have the particles move half as fast as the emitter, set Multiplier to 50. To have them move the same speed, use the default setting of 100. To make the particles move twice as fast as the emitter, set Multiplier to 200.

**Variation** Determines, as a percentage, the extent to which inherited emitter motion can vary per particle. To determine the final multiplier for each particle, the Variation value is multiplied by a random number between -1.0 and 1.0, and then added to the Multiplier value. Default=0.

### **Emitter Objects group**

Use these controls to assign objects to be used as particle emitters. The list in this group shows the objects, or reference geometry, that the operator uses as emitters.

If you don't assign any objects, Particle Flow uses the world origin (0,0,0) as the emitter source.

With more than one emitter object, the division of particles among the objects depends on which option you choose for Location. If you set Location to Pivot, then each object has one emission point and each object emits the same number of particles (total number of particles/number of objects). But if you set Location to any other option, each object emits a number of particles proportionate to the number of available emission points per object. For instance, if you set Location to Volume, then a larger object will emit more

particles than a smaller one. Similarly, with Location set to Vertices, an object with 100 vertices will emit twice as many particles as an object with 50.

If you delete from the scene an object designated as an emitter, its entry in the list is replaced with “<deleted>”.

Use the Add and Remove buttons to edit this list.

**Add** Adds an object to the list. Click Add, and then click an object in the viewport.

**By List** Adds multiple objects to the list. Click By List to open the Select Emitter Objects dialog. This works just like [Select From Scene](#) on page 168 : Highlight the objects to use as emitters, and then click the Select button.

**Remove** Removes an object from the list. Highlight the object in the list, and then click Remove.

**Animated Shape** Turn on to allow particles to emit from the surface of an object whose form is animated by morphing or with modifiers.

**Subframe Sampling** When on, the operator acquires animation of the emitter shape on a tick basis (every 1/4800th of a second) rather than a frame basis. This provides greater precision in allowing the particle positions to follow animation of the emitter object's form.

### Location group

The Location drop-down list lets you specify where on each emitter the particles appear. This choice applies to all emitter objects. Default=Surface.

The Selected Vertices/Edges/Faces options in this list let you emit particles from a specific part of the emitter object by using an existing sub-object selection. To create this selection, first convert the object to an editable mesh or poly, or apply a Mesh Select or Poly Select modifier (or equivalent), select the sub-objects that are to emit particles, and then choose the corresponding Location option. If the software doesn't find a sub-object selection, it uses all sub-objects of the indicated type.

**Pivot** Emits particles from the *original position* of the emitter object's pivot. Moving the pivot does not affect this option.

**Vertices** Emits particles from randomly selected vertices of the emitter objects.

**Edges** Emits particles from random points along the edge sub-objects of the emitter objects.

**Surface** Emits particles from random points on the surface of the icon.

**Volume** Emits particles from random points within the volume of the icon.

**Selected Vertices** Emits particles from the current vertex sub-object selection.

**Selected Edges** Emits particles from the current edge sub-object selection.

**Selected Faces** Emits particles from the current face or polygon sub-object selection.

You can modify the Location choice with any combination of the following:

**Surface Offset** Lets you specify a range of distances from the object surface for particle placement.

Surface Offset is unavailable when Location is set to Pivot or Volume. Use the Min and Max parameters to set the range.

---

**NOTE** Negative values offset the particles below the surface.

---

**Min/Max** When Surface Offset is on, these let you specify the range of offset distances from the object surface. The Min value cannot exceed the Max value, and vice-versa. If you try to raise Min above Max, or lower Max below Min, both values change equally.

**Density by Material** Varies emission over the emitter surface based on properties of the material applied to the emitter. For example, if the object is assigned a black-and-white checkered diffuse map and you choose the Grayscale option, particles are emitted only from the white checks.

---

**IMPORTANT** For material-influenced emission to appear properly in the viewports, two conditions are required:

- At least one viewport must be set to a shaded display mode.
- The material or map must have Show Map In Viewport turned on in the Material Editor.

---

The options are as follows:

- **Grayscale** The software internally converts the material-based coloring (diffuse) to grayscale, and then emits more particles in lighter areas and fewer in darker areas.

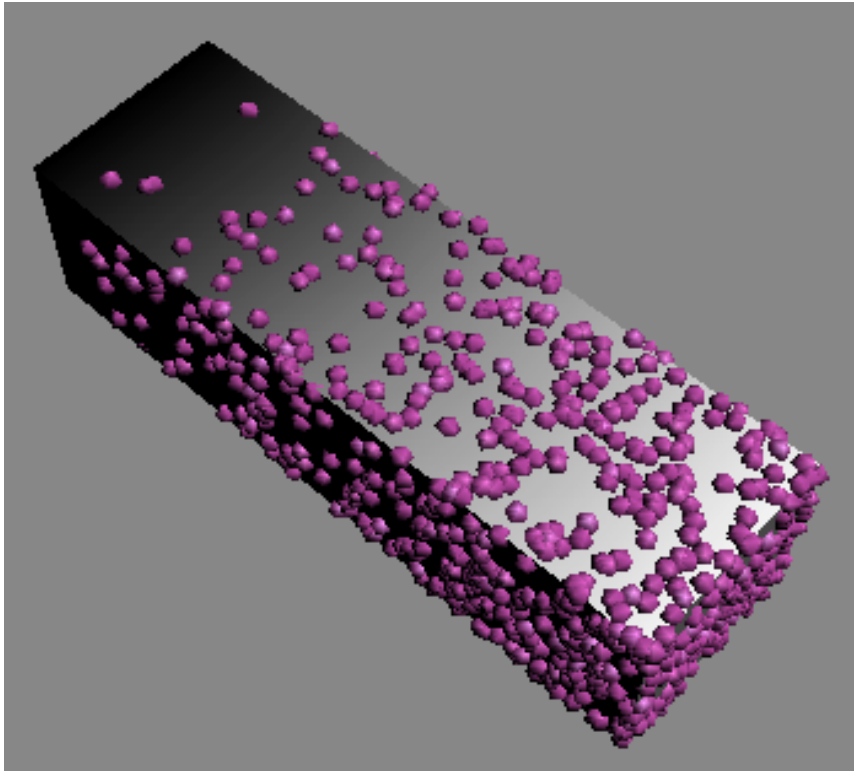

The box emitter is mapped with a gradient. With Position Object set to Density By Material > Grayscale, the particles appear with greater frequency in the lighter areas of the box.

- **Opacity** Particles are more likely to appear on opaque areas than on transparent areas.
- **Grayscale & Opacity** Combines the two: More particles appear on light, opaque areas than on dark, transparent areas.
- **Red/Green/Blue** Considers only the specified color channel. The higher its value at any given pixel, the more likely particles are to appear there.

**Use Sub-Material** When on, uses a sub-material from the Multi/Sub-Object material assigned to the emitter to define density values.

This option allows usage of “invisible” materials for particle placement. If the emitter uses a Multi/Sub-Object material but its geometry doesn't use the ID

that corresponds to one of the sub-materials, the sub-material doesn't appear. However, the operator can use it to calculate the density of particle placement. The software assumes the material to be applied to the entire object surface.

**Mtl ID** Specifies the material ID of the sub-material to be used for particle emission.

**Separation** When on, the software attempts to keep the particles apart by the amount specified in Distance. The likelihood of successfully separating particles depends on the number of particles, the specified distance, and the Attempts Max value.

**Distance** Specifies the distance, in system units, by which the software should try to keep the particles separate. Default=1.0.

**Distinct Points Only** Limits emission to a specific number of points (see Total, below) on the specified Location type.

Emission points are still randomized; change the Uniqueness setting to alter these.

**Total** Sets the number of emission points. Available only when Distinct Points Only is on. Default=10.

### **If Location Is Invalid group**

**Delete Particles** When on, if the software cannot place a particle according to the current option, it deletes the particle. When off, particle placement is undefined; that is, it depends on other variables. Default=off.

If the number of particles is more important than the position on the object, leave this off. However, if exact placement is of higher priority than the number of particles, turn Delete Particles on.

### **Uniqueness group**

The Uniqueness setting enables randomization of placement on the emitters.

**Seed** Specifies a randomization value.

**New** Calculates a new seed using a randomization formula.

**Attempts Max** When using the Separation option, this specifies the maximum number of times Particle Flow will try to set particle positions that maintain the requested distance. If unsuccessful within this number of attempts, particles might be closer together than the requested distance. Also affects placement with Density By Material using either of the Grayscale options.

# Rotation Operator

[Particle View](#) on page 2730 > Click a Rotation operator in an event or add a Rotation operator to the particle system and then select it.

The Rotation operator lets you set and animate particle orientation during an event, with optional random variation. You can apply orientation in any of five different matrices: two random and three explicit. For some options you can set a degree of random variation or divergence from the specified orientation.

To cause particles to spin, use the [Spin operator](#) on page 2783 .

## Interface

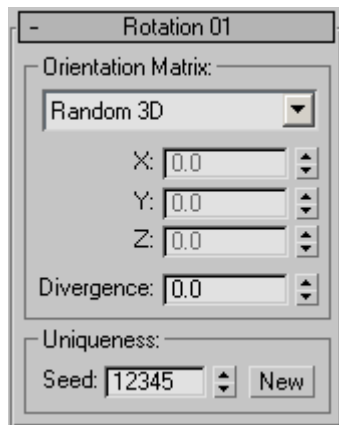

The user interface appears in the parameters panel, on the right side of the Particle View dialog.

## Orientation Matrix group

The Orientation Matrix setting includes options that give particles random orientations, or let you specify orientation in any of three different ways. Default=Random 3D.

**Random 3D** Gives each particle an arbitrary, random 3D orientation.

**Random Horizontal** Gives each particle an arbitrary, random 3D orientation about the Z axis only. Rotation about the X and Y axes doesn't change (unless Divergence is used), so the particles remain vertical.

**World Space** Orientation is specified in the world coordinate space.

Use the X/Y/Z settings to specify the orientation for all particles.

**Speed Space** The coordinate space for particle orientation is determined by the particles' direction upon entering the event.

By default, using the [Speed operator](#) on page 2791 > Along Icon Arrow option, particles are aimed straight down when born.

Use the X/Y/Z settings to specify the orientation for all particles.

**Speed Space Follow** The coordinate space for particle orientation is determined continually while the particles are in the event. Thus, by default, particles constantly reorient themselves to “aim” in the direction they're traveling.

For example, if you add a [Find Target test](#) on page 2891 to the end of the default Event 01, move the target sideways, and set Rotation to Speed Space Follow, the particles start out pointing straight down, as oriented by the Speed operator, and then gradually reorient themselves to point in the direction they're traveling: toward the target.

Use the X/Y/Z settings to specify the orientation for all particles. The Divergence setting is unavailable when using Speed Space Follow.

**X/Y/Z** Set the basic orientation about the particles' local axes. Unavailable with the Random 3D and Random Horizontal options.

**Divergence** Defines the range of variation (in degrees) for particle orientation. The actual deviation is calculated at random within this range. Unavailable with the Random 3D or Speed Space Follow option. Default=0.0.

**Restrict Diverg[ence] To Axis** When on, lets you use the Divergence Axis controls to set the axis to which divergence will be applied. When off, the software uses a random axis for each particle. Unavailable with the Random 3D or Speed Space Follow option. Default=off.

**Divergence Axis** Use the X/Y/Z settings to set the axis to which divergence will be applied. Default=1,0,0. Range=-1.0 to 1.0.

To specify one of the world axes, set the corresponding parameter to any non-zero value, and the others to 0. A negative value flips the axis. The numeric values come into play when you want to use an axis that's not aligned with the X, Y, or Z axis. In that case, you specify multiple non-zero values whose effect is relative to one another. For example, if you want the axis to be oriented halfway between the positive X and Y axes, you would set X and Y to the same positive amount. The actual value doesn't matter. Similarly, to set the axis to 30 degrees (1/3 of the angle) from the X axis to the Y axis, you'd



set the Y value to twice that of the X value. For example, X=0.2 and Y=0.4, or X=0.5 and Y=1.0.

### Uniqueness group

The Uniqueness setting affects the randomization of orientation with the Random 3D and Random Horizontal options, and also Divergence.

**Seed** Specifies a randomization value.

**New** Calculates a new seed using a randomization formula.

## Spin Operator

[Particle View](#) on page 2730 > Click a Spin operator in an event or add a Spin operator to the particle system and then select it.

The Spin operator gives an angular velocity to particles in an event, with optional random variation. Spin is applied once per event per particle, except when using the Speed Space Follow option; however, the settings can be animated.

To simply specify particle orientation, use the [Rotation operator](#) on page 2781.

### Interface

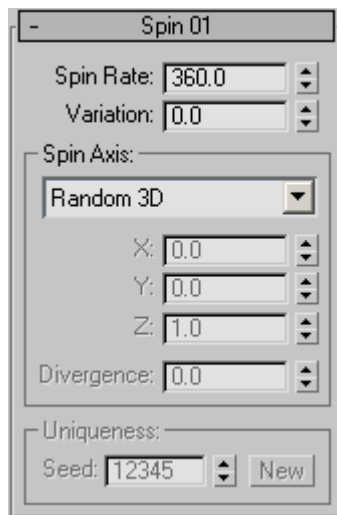

The user interface appears in the parameters panel, on the right side of the Particle View dialog.

**Spin Rate** The rate of revolution in degrees per second.

**Variation** The maximum amount, in degrees per second, by which the spin rate can vary. The actual variation is calculated once, at random, for each particle.

### **Spin Axis group**

The Spin Axis setting includes options that let you apply the spin on a random or specific axis, with optional random variation of the spin axis.  
Default=Random 3D.

**Random 3D** Spins each particle about an arbitrary, random 3D axis.

**World Space** The spin axis is specified in the world coordinate space.

Use the X/Y/Z settings to specify the spin axis.

**Particle Space** The spin axis is specified in the local coordinate space of each particle.

Use the X/Y/Z settings to specify the spin axis.

**Speed Space** The coordinate space for particle orientation is determined by the particles' direction upon entering the event.

The X axis is aligned with the particle direction, while the Z axis is perpendicular to the X axis and is pointed upward with respect to world space as much as possible.

Use the X/Y/Z settings to specify the orientation for all particles.

**Speed Space Follow** The coordinate space for particle orientation is determined by the particles' direction throughout the event. Use this option to allow particles that change direction during the event to keep the spin axis aligned with their direction.

The X axis is aligned with the particle direction, while the Z axis is perpendicular to the X axis and is pointed upward with respect to world space as much as possible.

Use the X/Y/Z settings to specify the orientation for all particles.

**X/Y/Z** Use these to set the spin axis. Unavailable for the Random 3D option.  
Default=0,0,1. Range=-1.0 to 1.0.

To specify a single axis, set the corresponding parameter to any non-zero value, and the others to 0. A negative value flips the axis, and reverses the

direction of rotation. The numeric values come into play when you give more than one axis a non-zero value, in which case their effect is relative to one another. For example, if you want the spin axis to be oriented halfway between the positive X and Y axes, you would set X and Y to the same positive amount. The actual value doesn't matter. Similarly, to set the spin axis to 30 degrees (1/3 of the angle) from the X axis to the Y axis, you'd set the Y value to twice that of the X value. For example, X=0.2 and Y=0.4, or X=0.5 and Y=1.0.

**Divergence** Defines the range of variation (in degrees) for spin-axis orientation. The actual deviation is calculated at random within this range. Unavailable for the Random 3D option. Default=0. Range=0 to 180.

### **Uniqueness group**

The Uniqueness setting affects the randomization of spin rate variation, spin axis with the Random 3D option, and Divergence with the other options.

**Seed** Specifies a randomization value.

**New** Calculates a new seed using a randomization formula.

## **Scale Operator**

[Particle View](#) on page 2730 > Click a Scale operator in an event or add a Scale operator to the particle system and then select it.

The Scale operator lets you set and animate particle size during an event, with optional random variation. Options for how scaling and animation are applied give this operator a great deal of flexibility.

### **Procedures**

#### **Example: To animate particle scale:**

This procedure gives an overview of animating particles to grow for 30 frames, remain at full size for the next 30 frames, and then shrink for 30 frames. It also gives an option for having the particles pulsate in size during the middle period. To follow this procedure, you should be familiar with the basic usage of Particle Flow and Track View.

- 1 Set up a default Particle Flow system. Set the Shape operator to Sphere, and set the Display operator to Geometry.
- 2 Add a Send Out test to Event 01.

- 3 Add a new Scale operator to the event display, creating a new event. Set the new event's Display operator to Geometry, and make sure it's a different color than the one in Event 01.
- 4 Wire the Send Out test in Event 01 to Event 02.
- 5 In the Event 02 > Scale operator, set Type to Absolute, and animate the Scale Factor values from **10** to **100** over frames 0 to 30. In the Animation Offset Keying group, set Sync By to Event Duration.
- 6 Add an Age Test to Event 02. Set it to Event Age, set Test Value to **30**, and Variation to **0**.  
In this event, particles grow from 10 percent of their original size to full size over the first 30 frames of their existence, which is the same as their duration in the event. At that point, they'll be eligible to move to the next event.
- 7 Use a new Scale operator to create a new event, Event 03. Set the new event's Display operator to Geometry, and make sure it's a different color than the others.
- 8 Wire the Age Test in Event 02 to Event 03.
- 9 In the Event 03 > Scale operator, Set Type to Absolute, and in the Animation Offset Keying group, set Sync By to Event Duration.
- 10 Copy and paste the Age Test as an instance from Event 02 to Event 03. Particles in Event 03 remain at full scale for 30 frames, and then move on to the next event.
- 11 Use a new Scale operator to create a new event: Event 04. Set the new event's Display operator to Geometry, and make sure it's a different color than the others.
- 12 Wire the Age Test in Event 03 to Event 04.
- 13 In the Event 04 > Scale operator, set Type to Absolute, and animate the Scale Factor values from **100** to **10** over frames 0 to 30. In the Animation Offset Keying group, set Sync By to Event Duration.
- 14 Copy and paste the Age Test as an instance from Event 03 to Event 04. In this event, particles shrink from full size to 10 percent of their original size over 30 frames.
- 15 Play the animation.  
Next, you'll use a Noise controller to cause the particles in Event 03 to pulsate in size.

- 16** Add a second Scale operator to Event 03, below the existing Scale operator. Set it to Relative Successive, and set Sync By to Event Duration.  
The name of this operator should be Scale 04.
- 17** In Particle view, right-click the Scale Factor X % parameter field on the Scale 04 rollout, and choose Show In Track View.  
The Curve Editor opens with the X Scale Factor parameter highlighted.
- 18** Right-click the X Scale Factor item and choose Assign Controller from the menu.
- 19** In the Assign Float Controller dialog, double-click Noise Float.  
The Noise Controller dialog opens.
- 20** Set Strength to **200**, and to the right of Strength, turn on the >0 check box.
- 21** Copy this controller, and then paste it as instances to Y Scale Factor and Z Scale Factor.  
Although the Scale operator defaults to constraining all scale factors to the same value, thus scaling particles uniformly, changing controllers in Track View works on a per-parameter basis.
- 22** Play the animation.  
This time, the particles grow in size for 30 frames, then pulsate in size for the next 30 frames, and then shrink from the size at the end of Event 03 to 10 percent of that over the next 30 frames.

## Interface

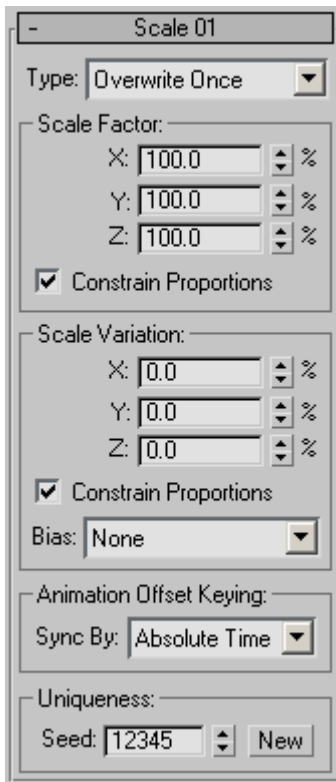

The user interface appears in the parameters panel, on the right side of the Particle View dialog.

## Type

The scaling Type setting includes options that let you scale particles once in an event or repeatedly, and apply scaling as an absolute or relative factor. Default=Overwrite Once.

**Overwrite Once** Sets the scale *one time only* as an absolute percentage value, disregarding any previous scaling.

To produce a range of different birth sizes, and specify the scaling explicitly, use Overwrite Once with animated scale factors.

**Inherit Once** Sets the scale *one time only* as a percentage of existing scaling. The existing scaling should be specified with a previous Scale operator, the

Scale setting in the [Shape operator](#) on page 2821 , or a [Shape Instance operator](#) on page 2825 .

For instance, if you previously used Scale with Overwrite Once to scale particles' birth size within a range, and then want to scale them to half their previous size, use Inherit Once and set Scale Factor to 50%.

**Absolute** Sets the scale *continuously*, while the particle is in the event, as an absolute percentage value, disregarding any previous scaling.

Use Absolute if you want to animate the particles' scale explicitly.

**Relative First** Sets the scale *continuously*, while the particle is in the event, as a percentage of existing scaling. The existing scaling should be specified with a previous Scale operator, or a Shape Instance.

Use Relative First when you want to scale the particles relative to the scaling at which they enter the event, and optionally animate the scaling, or before a Relative Successive operator.

**Relative Successive** Scales the particles *continuously*, relative to scaling set earlier in the same event.

---

**NOTE** Always precede Relative Successive *in the same event* with an operator that modifies the scale channel all the time, such as a Scale operator set to Absolute or Relative First, or a Shape Instance operator with the Scale check box turned on (it's on by default).

---

### Scale Factor group

The operator performs scaling on each particle's local axes. It can scale particles on a single axis or on any combination of axes.

**X/Y/Z** Sets the scaling as a percentage of the particle's current size. To scale uniformly, turn on Constrain Proportions, and then change any axis setting. Range=0 to 10000000. Default=100.

**Constrain Proportions** When on, retains the current ratio of scale factor settings, so that changing any axis setting changes all of them. Default=on.

### Scale Variation group

**X/Y/Z** Sets the scaling variation as a percentage of the particle's previous size. To scale uniformly, turn on Constrain Proportions, and then change any axis setting. Range=0 to 100. Default=0.

**Constrain Proportions** When on, retains the current ratio of scale variation settings, so that changing any axis setting changes all of them. Default=on.

**Bias** Lets you choose how to distribute the scaling variation within the specified range or ranges. Default=None.

- **None** No bias; scaling variation is distributed equally through the range.
- **Centered** Scaling variation is concentrated near the middle of the range; that is, at 0.0%.  
With this choice, scaling will occur more frequently with low percentage values than with ones near the values you set. In other words, most scaling variants will be close to the specified scaling value.
- **Towards Minimum** Scaling variation is concentrated near the lower end of the range (base-variation); that is, most scaling variants will be smaller than the scaling value.
- **Towards Maximum** Scaling variation is concentrated near the upper end of the range (base+variation); that is, most scaling variants will be larger than the scaling value.

### **Animation Offset Keying group**

If you animate the Scale Factor or the Scale Variation settings or both, the software can begin applying this animation to all particles as of the start frame of the animation or the first frame of the current event, or to each particle based on its age. For instance, if you set Sync By to Particle Age, and set Scale Factor keys at frames 0 and 30, then the software will animate the scaling factor for each particle between its birth and its 30th frame of existence, if the particle is in the scaling event or a prior event. Following this example, any particle that has already reached its 30th frame of existence before reaching the event will enter the event fully scaled. That is, the software will apply the Scale Factor value that you set at frame 30 to each particle aged 30 or above at the moment it enters the scaling event. However, any particle that leaves the scaling event before reaching age 30 will stop scaling as of its exit frame. In other words, with respect to particles in other events, animation of action parameters is retroactive, but not post-active.

Alternatively, if you set Sync By to Absolute Time, the scaling is animated from frame 0 to frame 30 of the animation, regardless of particle age, and even if no particles are in the event at that time. Or, if you set Sync By to Event Duration, the scaling animation is applied to each particle as of the time that it enters the event.



---

**NOTE** With the Overwrite Once and Inherit Once scaling types, scaling always occurs with respect to the entire animation; that is, in Absolute Time mode. Thus, when either of those scaling types is in effect, the Sync By setting is unavailable. Also, if you animate Scale Factor or Scale Variation when using Overwrite Once or Inherit Once, it doesn't cause scaling animation in the particles, but rather applies one-time scaling to particles born during that period. For instance, if you animate Scale Factor on all three axes from 100% to 200% over frames 0 to 30, particles born at frame 0 are normal size, particles born at frame 15 are one-and-one-half times normal size, and particles born at frame 30 (and thereafter) are twice normal size.

---

**Sync By** Choose the time frame for applying animated parameters:

- **Absolute Time** Any keys set for parameters are applied at the actual frames for which they're set.
- **Particle Age** Any keys set for parameters are applied at the corresponding frames of each particle's existence.
- **Event Duration** Any keys set for parameters are applied to each particle starting when it first enters the event.

### **Uniqueness group**

The Uniqueness setting affects the randomization of scale variation.

**Seed** Specifies a randomization value.

**New** Calculates a new seed using a randomization formula.

## **Speed**

### **Speed Operator**

[Particle View](#) on page 2730 > Click Speed in an event or add a Speed operator to the particle system and then select it.

This is the default Speed operator, which appears in the first event when you create a new Particle Flow icon. It provides basic controls over particle speed and direction.

Directional controls provided by the Speed operator are based on the position and orientation of the Particle Flow icon. For best results when using other

objects as emitters, use the [Speed By Surface Operator](#) on page 2806 operator instead.

**See also:**

- [Speed By Icon Operator](#) on page 2796
- [Keep Apart Operator](#) on page 2815

## Procedures

**Example: To change particles' speed:**

The Speed operator works on an instantaneous basis: It sets each particle's speed once only, when it enters the event. Even if you animate the Speed value, each particle moves at a constant rate of speed, defined by the value at the time it enters the event. This procedure demonstrates a trick you can use to change particle speed with an animated Speed value, thanks to Particle Flow's looping ability.

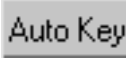
- 1 Create a default particle system, and position it at the top of the Perspective viewport.
- 2 Play the animation.  
The particles fall downward at the default rate: 300 units per second.
- 3 Add a Send Out test at the bottom of Event 01.
- 4 Add a Speed operator to an empty area of the event display.  
This creates a new event.
- 5  Turn on Auto Key, and move the time slider to frame 30.
- 6 In Particle View, click the new Speed 02 operator, and then in the Particle View parameters panel, set Speed to **0**.  
This animates the Speed value from 300 at frame 0 to 0 at frame 30.
- 7  Turn off Auto Key.
- 8 Wire the Send Out test in Event 01 to Event 02.
- 9 Play the animation.  
The particles born later move slower, but all still move at a constant rate of speed.

- 10 Add a Send Out test at the end of Event 02.
- 11 Create a new event using an Age Test. Click the Age Test to display its parameters, and then set the following:
  - Event Age
  - Test Value=1
  - Variation=0
- 12 Wire the Send Out test in Event 02 to Event 03.
- 13 Wire the Age Test in Event 03 to Event 02.
- 14 Play the animation.

All the particles slow down simultaneously and eventually come to a stop.

Here's how it works: As each particle enters Event 02, its speed is set to the current Speed value in the Speed operator. Particle Flow then sends the particle immediately to Event 03, where it sits for one frame. Event 03 then returns the particle to Event 02, whose Speed value is now lower. Particle Flow perceives the returned particle as newly entering the event, so it changes its speed to the current Speed value. Thus, the particles continually return to Event 02 one frame later than before, and are assigned a progressively lower speed.

If you wanted the particles to do something else after they stop, you could add a Speed Test to Event 02, above the Send Out test, set Test True If Particle Value to Is Less Than Test Value, and set Test Value to a very low value, such as 0.01. Then wire the Speed Test to a different event.

## Interface

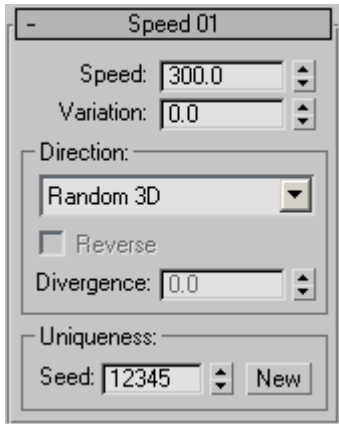

The user interface appears in the parameters panel, on the right side of the Particle View dialog.

**Speed** The particle speed in system units per second. Default=300.

A positive Speed value moves the particles in the direction determined by the Direction setting; a negative Speed value moves the particles in the opposite direction.

---

**NOTE** Speed sets each particle's speed once only: when the particle enters the event (or is born, in the case of a birth event). If you animate the Speed value, particle speed does not vary: rather, each particle is given a constant speed equal to the current Speed value when it enters the event.

---

**Variation** The amount by which particle speed can vary, in system units per second. Default=0.0.

To obtain each particle's speed, the system multiplies the Variation value by a random number between -1.0 and 1.0, and then adds the result to the Speed value. For example, if Speed=300 and Variation=100, then each particle's speed would be between 200 and 400.

### Direction group

The Direction drop-down list lets you specify which way the particles go after they're born. Default=Along Icon Arrow. In most cases, the actual direction also depends on the icon orientation. The primary exception is when Position > Location is set to Pivot.

Particle movement is always in a straight line unless influenced by other factors.

**Along Icon Arrow** Particles move parallel to the icon arrow. Rotate the icon to change the direction.

**Icon Center Out** Each particle moves along an imaginary line drawn between the particle's location and the icon center.

With the flat icon types (Rectangle and Circle), this results in all the particles moving in one plane, unless you increase Divergence above 0.0. With icons that have height (Box and Sphere), the particles move outward in three dimensions.

Particles at the center, as is the case when the Position operator's Location parameter is set to Pivot, arbitrarily move along the world X axis.

**Icon Arrow Out** Each particle moves along an imaginary line drawn between the particle's location and the icon arrow. The line is perpendicular to the icon arrow, which is considered an infinite line for this purpose.

With the flat icon types (Rectangle and Circle), this results in all the particles moving in one plane, unless you increase Divergence above 0.0. With icons that have height (Box and Sphere), the particles move outward in a cylindrical formation.

**Random 3D** Particles move in all directions. This option is affected by the Uniqueness setting.

**Random Horizontal** Each particle moves in a random horizontal direction; that is, parallel to the world XY plane. This option is affected by the Uniqueness setting.

**Inherit Previous** Uses the current direction of motion.

If you choose Inherit Previous but no direction was previously specified, the speed and direction are undefined; the particles don't move.

**Reverse** When on, the direction is reversed. Default=off.

Using Reverse is the equivalent of multiplying the Speed value by -1. This option is unavailable if Random 3D or Random Horizontal is chosen.

**Divergence** When on, spreads out the particle stream. Use the numeric setting to define the extent of the divergence, in degrees. Range=0 to 180. Default=0. The value can be animated.

This option is unavailable if Random 3D is chosen.

---

**TIP** For a fountain-like spray, set Position > Location to Pivot, set Direction to Along Icon Arrow, set Divergence to the desired angle, and rotate the icon so its arrow points upward.

---

### Uniqueness group

The Uniqueness setting enables randomization of speed variation, and randomization of direction with the Random 3D and Random Horizontal options.

**Seed** Specifies a randomization value.

**New** Calculates a new seed using a randomization formula.

## Speed By Icon Operator

[Particle View](#) on page 2730 > Click Speed By Icon in an event or add a Speed By Icon operator to the particle system and then select it.

Click a Speed By Icon operator icon in the viewport > Modify panel

Create panel > Helpers > Particle Flow > SpeedByIcon

The Speed By Icon operator lets you use a special, non-rendering icon to control particle speed and direction.

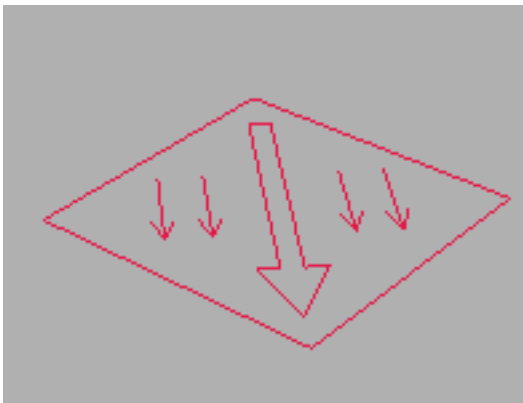

**Speed By Icon operator icon**

When you add a Speed By Icon operator to the particle system in [Particle View](#) on page 2730, the Speed By Icon *operator icon* appears in the scene at the world origin (0,0,0). When animated, the operator icon's motion is

imparted to the particles. If you delete the icon, the software also deletes the operator.

---

**NOTE** If you add Speed By Icon from the Create panel, Particle Flow creates a separate event for the operator in the particle diagram.

---

**WARNING** If you delete a Speed By Icon operator icon in the viewport, you also delete the corresponding operator in the Particle Flow system.

---

**See also:**

- [Speed Operator](#) on page 2791
- [Speed By Surface Operator](#) on page 2806
- [Keep Apart Operator](#) on page 2815

## Procedures

**To use the Speed By Icon operator:**

- 1 Add a Speed By Icon operator to an event. Be sure to add it *after* any existing Speed operators in the event. Alternatively, delete or turn off any existing Speed operators.  
The Speed By Icon operator icon appears at the world origin (0,0,0).
- 2 Animate the icon as you would any object. You can do this manually, or with a controller such as Path Constraint. See the following procedure for an example of this.  
The particles' motion is now under the influence of the animated icon.
- 3 Set the Speed By Icon parameters. With the icon selected, you can do this in the Modify panel.  
In general, the default Icon Animation > Sync By setting, Event Duration, works best. It causes the icon animation to be applied to the particles within the time frame of the event containing the Speed By Icon operator.

**Example: To send particles along a path:**

- 1 Reset the software, and then add a Particle Flow system in the Perspective viewport.

2 On the Create panel, choose Shapes > Splines > Helix, and then, in the Perspective viewport, at the center of the grid, create a helix shape. Then, on the Parameters rollout, set the following:

- Radius 1=100
- Radius 2=20
- Height=20
- Turns=3
- Bias=0

This will serve as the particle path.

3 Move and rotate the Particle Flow source icon so that it's at the start of the helical path, and aimed along the path, as shown. Get the base of the arrow as close as possible to the start of the path.

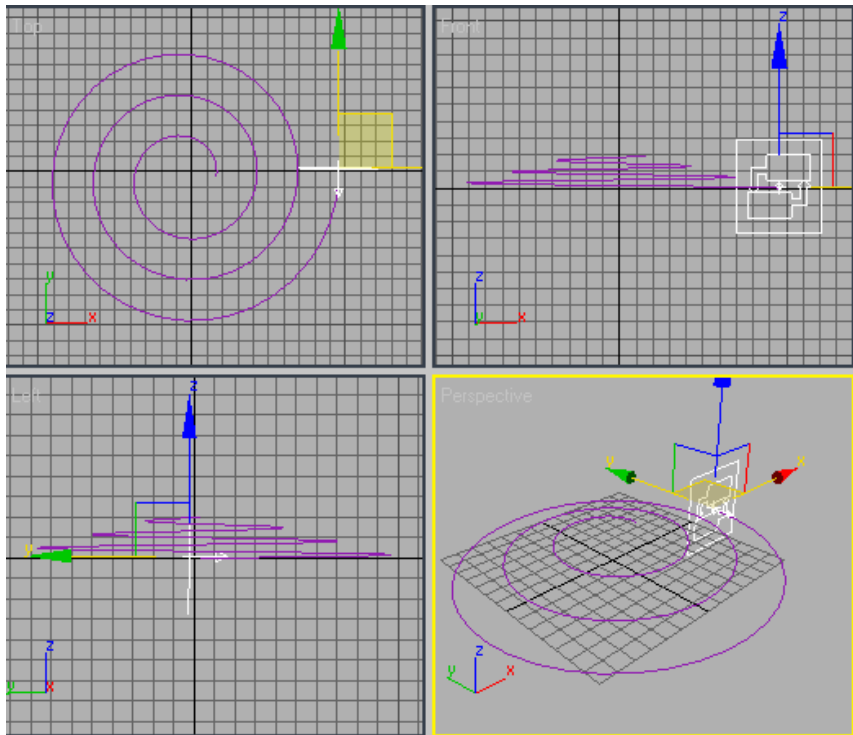

4 Open Particle View (press 6).



- 5 In Event 01, click the Position Icon operator and set Location to Pivot. This causes the particles to be emitted in a thin stream.
- 6 Insert a Speed By Icon operator at the end of Event 01. The operator icon appears at the world origin.
- 7 Select the operator icon, and then, from the Animation menu, choose Position Controllers > [Path Constraint](#) on page 3222 . When you move the mouse cursor into the viewport, a rubber-band line joins the cursor to the icon.
- 8 Select the Helix object. The command panel switches to the Motion tab, and the controls indicate that the software has applied a Position List controller to the icon, with the listed controllers being a Position XYZ and a Path Constraint. You can delete the former if you like, but it doesn't make any difference for the purposes of this procedure.
- 9 Close Particle View, and then drag the time slider back and forth between its extents a few times.

---

**TIP** The best way to view the results is from the Top viewport.

---

The particles follow the path fairly closely, but diverge noticeably at the end of the path, where the turns are tightest. Correcting divergence in tight turns typically requires an increase in the acceleration limit.

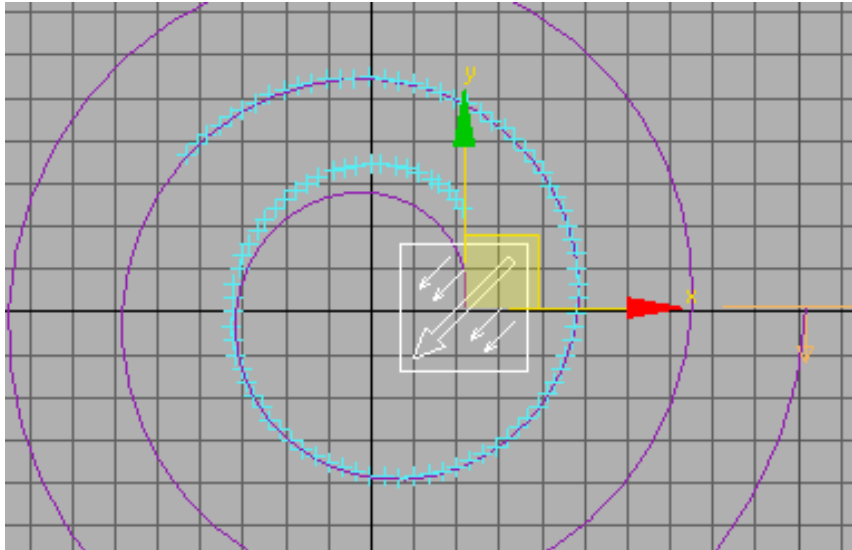

**The particle stream diverges from the path at its endpoint.**

- 10** Stop at frame 100.  
This will let you see the results of changing the Speed By Icon parameters as you make the changes.
- 11** Open the Modify panel, and, if necessary, select the Speed By Icon operator icon.  
The operator parameters appear on the Modify panel. This is the case with any action that uses a unique icon, and lets you adjust the parameters without using Particle View.
- 12** On the Parameters rollout, use the Accel Limit spinner to slowly increase the value as you observe the changes to the particle path.  
As you approach a value of 150, the end of the particle path comes closer and closer to the Helix. You shouldn't see much change above 150.

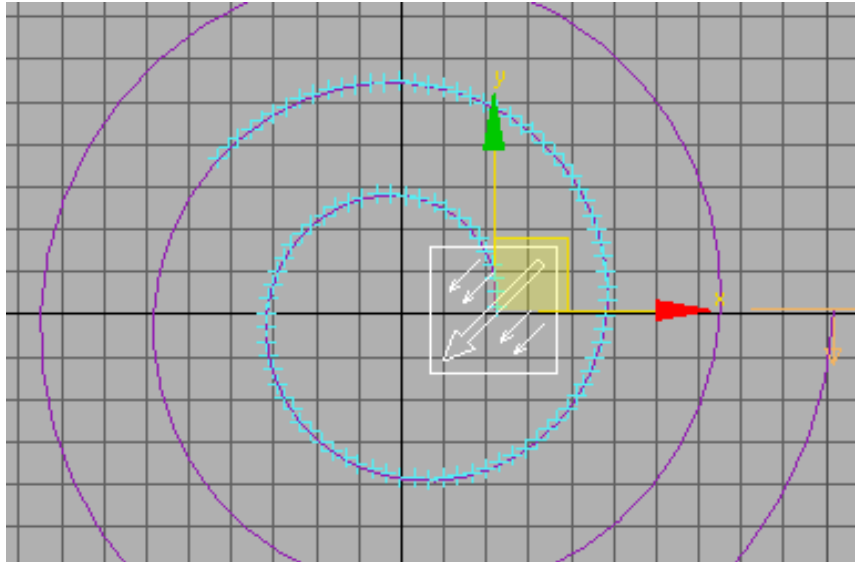

The endpoints now coincide.

- 13 Drag the time slider again.

The particle path remains similar to that of the Helix for the entire duration of the animation. With other setups, you might need to use different values for Influence %, and for paths with tight twists and turns, you might need to increase Accel Limit as well.

You might be wondering why you didn't simply replace the default Speed operator with the Speed By Icon operator. To see why not, try this:

- 14 Go to frame 100, open Particle View, and click the Speed 01 operator's icon to turn it off. Play the animation.

The entire particle path is offset from the Helix, so it's difficult to tell how closely it follows the latter's curves.

- 15 Try adjusting the Speed By Icon's Accel Limit and Influence % setting to get the particles to follow the helical path more closely.

It's not easy. You get more reliable results using the Speed operator to set the initial speed, and then Speed By Icon to set the particle path.

### To use the Use Icon Orientation option:

The Use Icon Orientation option applies arc-like motion to the particles based on rotation animation of the icon. To best understand how it works, it's necessary to isolate its influence by eliminating any potentially conflicting factors.

- 1 Reset the software, and then add a Particle Flow system in the Perspective viewport. Set its position to the world origin: (0,0,0).
- 2 Open Particle View and click the Birth operator. Set Emit Stop=0. This causes all particles to appear at frame 0.
- 3 Click the Speed operator and press the Delete key to delete it.
- 4 Drag a Speed By Icon operator from the Depot to the end of Event 01. The Speed By Icon operator icon appears at the world origin.

- 5  Select the Speed By Icon operator icon, and then right-click the icon and choose Rotate from the menu. Go to frame 20, turn on Auto Key, and rotate the icon 180 degrees about the X axis.

- 6  Turn off Auto Key.

- 7 Drag the time slider.  
The particles aren't affected by the icon animation.

Because the Speed By Icon operator icon is selected, the operator's parameters appear on the Modify panel.

- 8 On the Modify panel, turn on Use Icon Orientation. Drag the time slider again.

This time, the particles move in unison with the icon rotation, as if they were glued to an infinite plane coincident with the icon.

- 9 Go to frame 10, select the Particle Flow source icon (not the Speed By Icon operator icon), and then right-click the icon and choose Move from the menu. Move the icon straight up, on the Z axis, about 100 units.

As you drag upward, the particles move away from the icon.

- 10 Drag the time slider again. This time the particles move in an arc around the icon.

- 11 Try moving and rotating the two icons, playing the animation each time you make a change. Also set Emit Stop back to 30.

As you can see, the possibilities with just this simple setup are myriad. In combination with the many other variables and options in Particle Flow, they're endless.

## Interface

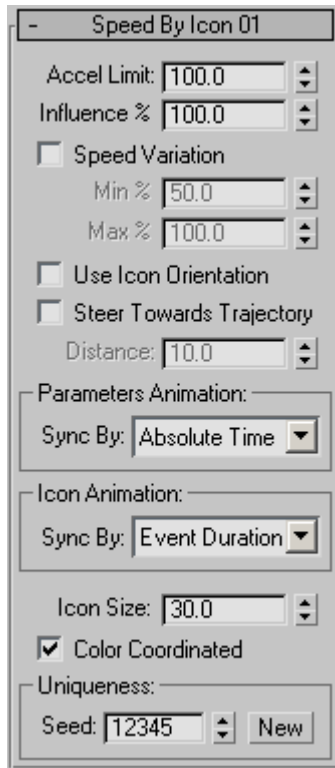

The user interface appears in the parameters panel, on the right side of the Particle View dialog. When the icon is selected, the parameters also appear on the Modify panel.

**Accel(eration) Limit** The maximum amount, in system units per second per second, by which the particles' speed can change in order to match the speed of the operator icon. Default=100.0.

If the operator icon changes speed or direction rapidly, increase this value to let the particles follow it more closely.

---

**TIP** Use a lower Accel Limit value for smooth motion, and a higher value when greater accuracy is needed, such as when the particles should hit a small target. You can animate this setting (use Sync By > Event Duration) to specify different appropriate values, depending on the required results.

---

**Influence %** Determines the mix of the previous speed with the speed of the operator icon. Default=100.0. Range=0.0 to 100.0.

At the default value of 100, the speed is controlled only by that of the icon. At 0, the icon speed doesn't affect particle speed at all. At in-between values, the mix proportion is determined by the Influence % value.

**Speed Variation** Enables random variation of the particles' speed, so they don't all move at exactly the same rate as the icon. Turn this on, and then set the minimum and maximum percentages of variation. Default=off.

Using Speed Variation can help keep the particles from bunching up as they travel along the animation path. Note, however, that each individual particle's speed doesn't vary; it travels at a constant speed.

**Min %/Max %** Set the minimum and maximum percentages, respectively, of particle speed variation. Default=50.0 (Min %), 100.0 (Max %).

For example, if you set Min % to 50 and Max % to 200, the particles will vary in speed between half and two times the speed of the icon.

**Use Icon Orientation** Applies animation of the icon's orientation to the particles.

By default, Speed By Icon controls particle motion only by animation of the icon's position. If you turn on Use Icon Orientation, the software also applies rotation of the icon to the particle motion. In essence, this motion is circular, and its extent depends on the distance between each particle and the icon. Default=off.

The best way to understand how this works is by using it. To try out Use Icon Orientation, see [this procedure](#) on page ? .

**Steer Towards Trajectory** Particles farther away than the Distance value from the icon are moved directly toward the icon. Default=off.

**Distance** Sets the distance between the particles and the operator icon beyond which Steer Towards Trajectory takes effect. Default=10.0.

### **Parameters Animation group**

If you animate the operator settings, the software can begin applying this animation to all particles as of the start frame of the animation or the first

frame of the current event, or to each particle based on its age. For instance, if you set Sync By to Particle Age, and set Speed Variation keys at frames 0 and 30, then the software will animate the speed variation for each particle born while the event is active between its birth and its 30th frame of existence. Alternatively, if you set Sync By to Absolute Time, the speed variation is animated from frame 0 to frame 30 of the animation, even if no particles are in the event at that time. Or, if you set Sync By to Event Duration, the speed variation animation is applied to each particle as of the time that it enters the event. For further information, see [Animation Offset Keying group](#) on page 2790 .

**Sync By** Choose the time frame for applying animated parameters:

- **Absolute Time** Any keys set for parameters are applied at the actual frames for which they're set.
- **Particle Age** Any keys set for parameters are applied at the corresponding frames of each particle's existence.
- **Event Duration** Any keys set for parameters are applied to each particle relative to the frame at which it first enters the event.

### **Icon Animation group**

The software can begin applying animation of the Speed By Icon operator icon to all particles as of the start frame of the animation or the first frame of the current event, or to each particle based on its age. For an explanation, see [Animation Offset Keying group](#) on page 2790 .

**Sync By** Choose the time frame for applying animation of the icon to the particles:

- **Absolute Time** Any keys set for icon motion are applied at the actual frames for which they're set.
- **Particle Age** Any keys set for icon motion are applied at the corresponding frames of each particle's existence.
- **Event Duration** Any keys set for icon motion are applied to each particle relative to the frame at which it first enters the event.

**Icon Size** Sets the size of the operator icon. This setting is for visibility only; it doesn't affect particle behavior.

## Uniqueness group

The Uniqueness setting enables randomization of the speed variation range.

**Seed** Specifies a randomization value.

**New** Calculates a new seed using a randomization formula.

## Speed By Surface Operator

[Particle View](#) on page 2730 > Click Speed By Surface in an event or add a Speed By Surface operator to the particle system and then select it.

The Speed By Surface operator lets you control particle speed and direction with any object or objects in the scene. This is in contrast to the default [Speed operator](#) on page 2791, which uses the Particle Flow icon to control particle speed and direction. Speed By Surface also provides options for controlling speed by materials in the scene, and continuous speed control.

Typically, you use Speed By Surface to assign speed and direction characteristics based on the objects used as emitters with the [Position Object operator](#) on page 2773. That is, you assign the same objects as emitters with Position Object and as Surface Geometry objects with Speed By Surface.

---

**TIP** For greater control over particle motion on the surface, apply a [Speed operator](#) on page 2791 before the Speed By Surface operator in the same event. Use the Speed operator to specify particle direction on the surface, and the Speed By Surface operator to adjust the vertical component of the speed vector to follow the contour of the surface.

---

**See also:**

- [Speed By Icon Operator](#) on page 2796
- [Keep Apart Operator](#) on page 2815



## Procedures

### Example: To use Speed By Surface:

The Speed By Surface operator offers a wealth of possibilities for usage. This procedure will lead you through several examples, but you're encouraged to explore the operator further on your own to learn more about it.

- 1 Start or reset the software, and add a Particle Flow system. Position the source icon at the world origin ( $X/Y/Z=0$ ), and set the icon's Length and Width values both to **30**.
- 2 Add a Cylinder primitive to the scene. Position it above the source icon:  $X/Y=0$  and  $Z=30$ . Set Radius=**20** and Height=**40**.
- 3 Play the animation, and then stop.  
The particles move downward, using the default starting setup.
- 4 Open Particle View and add a Speed By Surface operator to the end of Event 01. Click the operator in the event to display its parameters panel in Particle View.
- 5 In the Surface Geometry group, click Add, and then select the cylinder.
- 6 Play the animation again, and then stop.  
The particles still move downward.
- 7 Go to frame 15, so you can see the particles, and then slowly move the cylinder downward along the Z axis, while watching the particles in the Perspective and Front viewports. Stop when the emitter is above the cylinder.  
As the bottom of the cylinder passes below the emitter, more and more particles start moving on the XY plane rather than perpendicular to it. That's because they eventually become closer to one of the vertical sides of the cylinder, rather than the bottom, at which point they move perpendicular to the vertical sides. When the top becomes the closest side, the particles again move vertically, but upward instead of downward.
- 8 Move the cylinder back up until the emitter is at its vertical center. Then, on the Modify panel, click the lower part of the Sides spinner to decrease the number of sides, one at a time.  
Each time you click, the particle streams traveling outward change, to move perpendicular to the vertical sides as they change position. You might also try rotating the cylinder, and note that the particle streams also rotate, like the spokes of a wheel.

- 9 In the Speed By Surface parameters, change Direction to Out Of Surface, and then move the cylinder up and down.

The overall behavior doesn't change much. Out Of Surface becomes more useful when you use the Control Speed Continuously option, as you'll observe shortly.

- 10 In the Speed By Surface parameters, change Direction to Parallel To Surface, and then move the cylinder up and down.

Now the particle behavior is effectively opposite of that with the other two options. When the particles are closer to the top or bottom, they move along the XY plane, and when they're closer to the vertical sides, they move downward. If you want them to move upward instead, set Speed to a negative value.

Next, you'll discover how the Control Speed Continuously option alters particle behavior.

- 11 In the Speed By Surface parameters, choose Control Speed Continuously, and then drag the time slider.

The particles spread out from the emitter, and then start orbiting the cylinder in a roughly cylindrical overall formation. The software continually checks to see which side of the cylinder a particle is closest to, and, if necessary, changes its direction to make it travel parallel to that side. You can affect the size of the particles' orbits by changing their speed.

Lastly, you'll see how to contain particle motion within the cylinder.

- 12 Make the cylinder considerably larger: Radius=**60** and Height=**90**. Activate the Perspective viewport, if necessary, and then press F3 to set it to Wireframe view.

- 13 In Particle View, click the Speed 01 operator and set Direction to Random 3D.

- 14 Click the Speed By Surface operator. Set Speed to 300 if necessary. In the Direction group, choose Out Of Surface, and then drag the time slider.

After exiting the emitter, the particles always move away from the nearest surface, with the result that they end up milling about in the center of the cylinder.

- 15 Gradually increase the Speed value, up to **1,000** or so.

The particles start to spread out vertically, and eventually start moving so fast that they escape the cylinder. You can make them stay inside the

cylinder by letting them accelerate more quickly, so they can turn before moving past the nearest surface.

- 16** Increase the Accel Limit setting until the particles no longer exit the cylinder.
- 17** Try giving the particles more room to move about in by increasing the size of the emitter. Also try changing other settings throughout the particle system to see their effects. The possibilities don't end here, and the more you experiment, the more you'll learn about how this powerful operator works.

## Interface

- Speed By Surface 01

Control Speed Continuous ▾

Speed: 865.83 ▾  
Variation: 0.0 ▾

Surface Geometry:

Cylinder01

Add By List Remove

Animated Shape  
 Subframe Sampling  
 Speed By Material

Grayscale Multiplier ▾

Use Sub-Material  
Mat ID: 1 ▾

Direction:

Out Of Surface ▾

Divergence: 0.0 ▾

Continuous Speed Control:

Accel Limit: 221.76 ▾  
 Unlimited Range  
Range: 10.0 ▾  
Falloff Zone: 10.0 ▾

Animation Offset Keying:

Sync By: Absolute Time ▾

Uniqueness:

Seed: 12345 ▾ New

The user interface appears in the parameters panel, on the right side of the Particle View dialog.

The first setting lets you choose whether the operator controls speed once or continuously.

**Set Speed Once** The operator sets the speed for each particle once: when the particle enters the event.

**Control Speed Continuously** The operator sets particle speed throughout the event. When you choose this option, the [Continuous Speed Control group](#) on page 2814 becomes available.

**Speed** The particle speed in system units per second. Default=300.

With the Control Speed Continuously option, you can turn off Speed. This causes Particle Flow to use the current particle speed.

Using a negative Speed value causes particles to move in the opposite direction of that effected by a positive speed.

**Variation** The amount by which particle speed can vary, in system units per second. Default=0.0.

To obtain each particle's speed, the system multiplies the Variation value by a random number between -1.0 and 1.0, and then adds the result to the Speed value. For example, if Speed=300 and Variation=100, then each particle's speed would be between 200 and 400.

## Surface Geometry group

Use these controls to assign objects to affect particle speed and direction. The list in this group shows the objects, or reference geometry, that the operator uses to control speed and direction.

If you don't assign any objects, the current particle speed and direction are not affected.

You can assign multiple Surface Geometry objects, but if they're not all emitters as well, the results can be difficult to interpret. In general, assign the same objects as Surface Geometry that your system uses as emitters.

---

**TIP** For optimal performance, when moving particles with respect to high-polygon objects, create a low-poly proxy version to use as surface geometry, link it as a child of the high-poly object if necessary, and then hide the low-poly proxy.

---

Use the Add and Remove buttons to edit this list.

**Add** Adds an object to the list. Click Add, and then click an object in the viewport.

**By List** Adds multiple objects to the list. Click By List to open the Select Surface Objects dialog. This works just like [Select From Scene](#) on page 168 : Highlight the objects to use to control speed and direction, and then click the Select button.

**Remove** Removes an object from the list. Highlight the object in the list, and then click Remove.

**Animated Shape** Turn on to allow particles to follow the surface of an object whose form is animated by morphing or with modifiers.

**Subframe Sampling** When on, the operator acquires animation of the Surface Geometry shape on a tick basis (every 1/4,800th of a second) rather than a frame basis. This provides greater precision in allowing the particle positions to follow animation of the Surface Geometry object's form.

**Speed by Material** Varies particles' existing speed and direction based on properties of the material applied to each Surface Geometry object. For example, if an object is assigned a black-and-white checkered diffuse map and you choose the Grayscale Multiplier option, particles near the white-checked areas move faster than those from the black-checked areas.

---

**NOTE** For material-influenced speed to appear properly in the viewports, two conditions are required: at least one viewport must be set to a shaded display mode, and the material or map must have Show Map In Viewport turned on in the Material Editor.

---

The options are as follows:

- **Grayscale Multiplier** Lets material luminance control speed, with darker areas producing slower particles and lighter areas producing faster ones. The software multiplies the luminance of the material near each particle, converted to a percentage, by the particle's current speed. A luminance of 0 converts to 0%, of 128 converts to 50%, and of 255 converts to 100%. For example, if the speed of a particle traveling at 50 units per second is influenced by a pixel whose luminance is 90, the resulting speed is  $90/255*50$ , or about 17.6 units per second.
- **Signed Grayscale** Works like Grayscale Multiplier, but the multiplier can be negative as well, causing reversal of motion. Signed Grayscale uses a material luminance value of 128 as the midpoint, and assigns it a multiplier of 0%. Luminance values from 0 to 127 result in multipliers of -100% to

about -1%, respectively, and values of 129 to 255 result in multipliers of about 1% to 100%, respectively.

- **RGB as World XYZ Mult.** Works like Grayscale Multiplier, but uses the intensity of the material's red, green, and blue channels to affect particle speed on the world X, Y, and Z axes, respectively. So, for example, if the material pixel is pure red, that is, its RGB value is (255,0,0), then the particle will retain its current speed on the world X axis, but its speed on the Y and Z axes will be reduced to 0. Similarly, a medium-yellow pixel (128,128,0) will cause speed on the world X and Y axes to be reduced by half, and will cut speed on the Z axis to 0.
- **RGB as Local XYZ Mult.** Works like RGB as World XYZ Mult., but uses the object's local coordinates rather than world coordinates.

**Use Sub-Material** When on, uses a sub-material from the Multi/Sub-Object material assigned to the Surface Geometry object to define speed.

This option allows usage of “invisible” materials for controlling particle speed. If the emitter uses a Multi/Sub-Object material but its geometry doesn't use the ID that corresponds one of the sub-materials, the sub-material doesn't appear. However, the operator can use it to calculate the density of particle placement. The software assumes the material to be applied to the entire object surface.

**Mtl ID** Specifies the material ID of the sub-material to be used for particle speed control.

### **Direction group**

The Direction drop-down list lets you specify which way the particles go after they're born. Default=Surface Normals. In most cases, the actual direction also depends on the icon orientation. The primary exception is when Position > Location is set to Pivot.

Particle movement is always in a straight line unless influenced by other factors.

**Surface Normals** Each particle moves along a line perpendicular to the nearest face. The direction the surface faces doesn't matter.

**Out Of Surface** Particles move away from the closest face.

---

**TIP** You can use this option to confine particles to the interior of an object. Position the emitter inside the object, designate the object as the Surface Geometry, choose Control Speed Continuously, and choose Out Of Surface. Each time a particle comes close to a surface, it turns to travel directly away from the surface. Control the particles' travel range with the Speed setting, but keep in mind that particles moving very fast might “escape” their container. If this happens, increase the Accel Limit setting; this lets the particles turn more quickly.

---

**Parallel To Surface** Each particle travels parallel to the nearest face.

To make particles orbit an object, use this with Control Speed Continuously, and set appropriate Continuous Speed Control values (see the following section).

**Divergence** When on, spreads out the particle stream. Use the numeric setting to define the extent of the divergence. Range=0 to 180. Default=0. The value can be animated.

This option is unavailable if Control Speed Continuously is chosen.

---

**TIP** For a fountain-like spray, set Position > Location to Pivot, set Direction to Along Icon Arrow, set Divergence to the desired angle, and rotate the icon so its arrow points upward.

---

### **Continuous Speed Control group**

When you choose the Control Speed Continuously option, these controls become available. Basically, these controls let the particles move about within the region of the Surface Geometry object rather than in a straight line away from the emitter.

**Accel Limit** Sets the maximum acceleration. The higher this value, the more quickly particles can turn and change speed.

---

**TIP** Use a lower Accel Limit value for smooth motion, and a higher value when greater accuracy is needed, such as when the particles should hit a small target. You can animate this setting (use Sync By > Event Duration) to specify different appropriate values, depending on the required results.

---

**Unlimited Range** When on, the surface controls speed and direction of particles at any distance. When off, particles must be within a specified range. Default=on.



**Range** The maximum distance, in system units, between the particles and controlling surface. The Surface Geometry will not control particles beyond this distance.

**Falloff Zone** The distance, in system units, beyond the Range value within which the Surface Geometry exerts partial control over particles. The degree of control diminishes from 100% at the Range distance to 0% at the Range+Falloff Zone distance.

### **Animation Offset Keying group**

Choose the time frame for applying animated parameters. For an explanation, see [Animation Offset Keying group](#) on page 2790 .

**Absolute Time** Any keys set for parameters are applied at the actual frames for which they're set.

**Particle Age** Any keys set for parameters are applied at the corresponding frames of each particle's existence.

**Event Duration** Any keys set for parameters are applied to each particle starting when it first enters the event.

### **Uniqueness group**

The Uniqueness setting enables randomization of speed variation, and randomization of direction with the Random 3D and Random Horizontal options.

**Seed** Specifies a randomization value.

**New** Calculates a new seed using a randomization formula.

## **Keep Apart Operator**

[Particle View](#) on page 2730 > Click Keep Apart in an event or add a Keep Apart operator to the particle system and then select it.

The Keep Apart operator, a member of the Speed operator family, lets you apply forces to particles to cause them to separate, in order to prevent or minimize collisions among particles. Alternatively, you can use a negative force to keep particles from separating too much. The operator works by controlling particle speed and acceleration.

---

**NOTE** Keep Apart doesn't use particle geometry; rather, it creates a spherical force field centered on the pivot of each particle. You can adjust the size of the force field by changing the particle size.

---

**TIP** In certain cases, the default settings might not be sufficient to keep particles from interpenetrating. For increased separation, use higher values for Force and Accel Limit, choose Relative To Particle Size, and increase the Core % value.

---

**See also:**

- [Speed Operator](#) on page 2791
- [Speed By Surface Operator](#) on page 2806
- [Speed By Icon Operator](#) on page 2796

### **Script Wiring rollout**

This rollout appears in the parameters panel below the main operator rollout after you highlight the operator, right-click it, and then choose Use Script Wiring. Thereafter, a check mark appears next to the Use Script Wiring in the right-click menu, and the rollout appears whenever you highlight the operator. To turn off script wiring, choose Use Script Wiring again from the right-click menu.

Script wiring lets you use a script to control the Force and Range parameters, which you normally specify in the operator's parameters. Place a [Script operator](#) on page 2874 before the Keep Apart operator in the event, and then use it to define values in the particleFloat and particleVector channels. For an example of a script that sets particleFloat values, see [particleFloat Sample Script](#) on page 2868 .

On the Script Wiring rollout, choose either of the following:

**Use Script Float As** Choose either of the following:

- **Not Used** Particle Flow uses the [Force setting](#) on page 2819 specified in the Parameters rollout.
- **Influence** Particle Flow applies the script particleFloat value to the Force value.

**Use Script Vector As** Choose one of the following. Choosing Absolute Size Range or Relative Size Range makes the Range settings on the Parameters rollout unavailable.

- **Not Used** Particle Flow uses the [Range](#) on page 2819 settings specified in the Parameters rollout.
- **Absolute Size Range** Particle Flow applies the script particleVector values to the Absolute Size Range values. The X component of the vector value is used for the core radius, and the Y component for the falloff radius.
- **Relative Size Range** Particle Flow applies the script particleVector values to the Relative Size Range values. The X component of the vector value is used for the core percent, and the Y component for the falloff percent.

## Interface

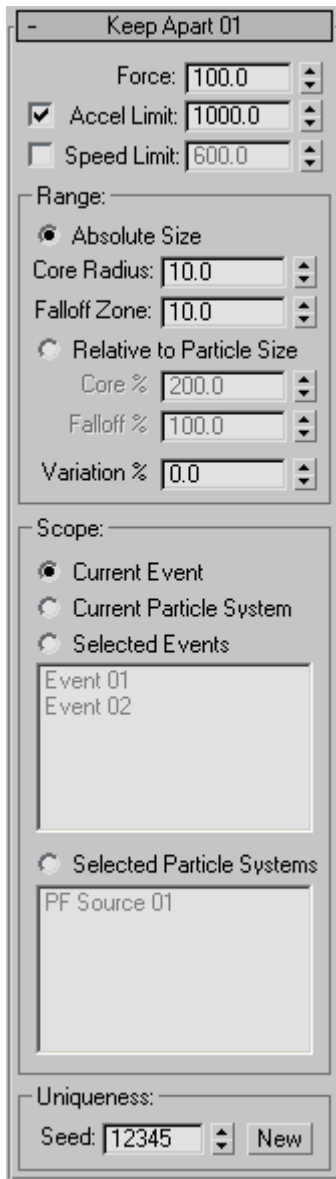

The user interface appears in the parameters panel, on the right side of the Particle View dialog.

**Force** The amount of force applied to the particles. Use positive values to separate particles, or negative values to move them closer together. Default=100.0

**Accel(eration) Limit** When on, lets you set a maximum acceleration value that can be applied to particles' motion. When off, the software uses any necessary acceleration. Default=on, 1000.0.

---

**TIP** Use a lower Accel Limit value for smooth motion, and a higher value when greater accuracy is needed, such as when the particles should hit a small target. You can animate this setting (use Sync By > Event Duration) to specify different appropriate values, depending on the required results.

---

**Speed Limit** When on, lets you set a maximum speed value that can be applied to particles' motion. When off, the software uses any necessary speed. Default=off, 600.0.

### **Range group**

You can set a volume and falloff within which the force takes effect, either as absolute distances or relative to particle size. Default=Absolute Size.

**Absolute Size** Choose this to set the core radius and falloff zone as absolute distances, in system units.

**Core Radius** The distance from each particle's pivot point, in system units, within which the force is applied at full strength. Default=10.0

**Falloff Zone** The distance beyond the core radius, in system units, over which the force diminishes from full strength to 0. Default=10.0

**Relative to Particle Size** Choose this to set the core radius and falloff zone as percentages, relative to the radius of each particle. The particle radius is determined by measuring the distance from the pivot point to the farthest corner of its bounding box.

**Core %** The distance from each particle, as a percentage of the particle radius, within which the force is applied at full strength. Default=200.0

**Falloff %** The distance beyond the core radius, as a percentage of the radius, over which the force diminishes from full strength to 0. Default=100.0

**Variation %** The amount by which range values can vary randomly, as a percentage of the specified values. The software uses the same random variation value for both Core and Falloff values, whether absolute or relative. Default=0.0

For example, if you choose Absolute Size, set Core Radius to 40 and Falloff Zone to 20, and set Variation % to 50, then each particle's actual core radius

will be a random number in the range 20 to 60, and the falloff zone a random number in the range 10 to 30. For each particle, the software uses the same Variation % value, so if Core Radius is determined to be 20, then Falloff Zone would be 10.

### **Scope group**

By default, the Keep Apart force keeps particles only in the current event (that is, the event that contains the Keep Apart operator) apart from each other when used locally, or particles in each event in the current [flow](#) on page 7787 apart when used globally. These settings let you alternatively keep particles away from particles in other events or flows without affecting the behavior of latter. Default=Current Event.

**Current Event** Keeps particles in the current event only away from each other.

When used globally, keeps particles in each event in the current flow apart from each other, but not apart from particles in other events in the flow.

**Current Particle System** Keeps particles in the current event away from each other, and away from all other particles in the current [flow](#) on page 7787 . The particles not in the current event are not influenced by the Keep Apart operator.

When used globally, keeps apart and influences all particles in the current flow.

**Selected Events** Keeps particles in the current event away from all particles in the events highlighted in the list below this choice. Particles not in the current event are not influenced by the Keep Apart operator.

When used globally, keeps all particles in the current flow apart from all particles in the events highlighted in the list below this choice, but influences only particles in the current flow.

After choosing this option, click items in the list to highlight them.

**Selected Particle Systems** Keeps particles in the current event away from all particles in the [flows](#) on page 7787 highlighted in the list below this choice. The particles not in the current event are not influenced by the Keep Apart operator.

When used globally, keeps all particles in the current flow apart from all particles in the flows highlighted in the list below this choice, but influences only particles in the current flow.

After choosing this option, click items in the list to highlight them.

## Uniqueness group

The Uniqueness setting enables randomization of the [Range](#) on page 2819 > Variation % calculations.

**Seed** Specifies a randomization value.

**New** Calculates a new seed using a randomization formula.

## Shape

### Shape Operator

[Particle View](#) on page 2730 > Click Shape in an event or add a Shape operator to the particle system and then select it.

Shape is the default operator for defining the geometry used in the particle system. You can use it to specify particles in the shape of pyramids, cubes, spheres, or vertices, as well as particle size.

---

**NOTE** All primitive particles created with Shape have pivot points in their geometric centers.

---

#### See also:

- [Shape Instance Operator](#) on page 2825
- [Shape Facing Operator](#) on page 2822
- [Shape Mark Operator](#) on page 2832

#### Interface

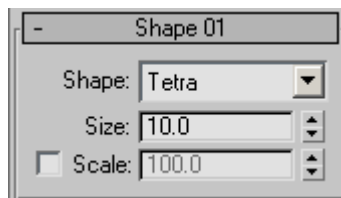

**Shape** Sets the shape of the particles to Vertex or one of three geometric primitives. Default=Pyramid.

- **Vertex** Use this option to create non-rendering particles whose sole attribute is their location. This can be useful when using script operators.
- **Tetra** These tetrahedron-shaped particles have a four triangular sides. Having only four polygons, the tetra is the simplest of the rendering particle shapes.
- **Cube** These box-shaped particles have six square sides, all the same size.
- **Sphere** Creates spherical particles. The sphere has the most polygons of the rendering particle shapes, and its orientation isn't obvious.

**Size** Sets the overall size of the particles in system units. Default=10.0

Setting Size=0 makes the particles invisible.

**Scale** Turn on to set the size of the particles as a percentage of the Size value. Use the numeric field to set the Scale percentage value. Default=100.

Scale is animatable, while Size is not. Also, turning on Scale creates the scale data that any Scale operators further on in the flow can work with.

## Shape Facing Operator

[Particle View](#) on page 2730 > Click Shape Facing in an event or add a Shape Facing operator to the particle system and then select it.

The Shape Facing operator creates each particle as a rectangle that always faces a particular object, camera, or direction. For effects like smoke, fire, water, bubbles, or snowflakes, use Shape Facing with a material containing appropriate opacity and diffuse maps.

By default, the particles' top and bottom sides are parallel to the horizontal plane. The Orientation setting lets you change this default alignment.

---

**NOTE** For the Shape Facing operator to be able to calculate the particle orientation, it must know the current particle position. For this reason, always place the Shape Facing operator *below* a Position operator in an event.

---

**See also:**

- [Shape Operator](#) on page 2821



- [Shape Instance Operator](#) on page 2825
- [Shape Mark Operator](#) on page 2832

## Interface

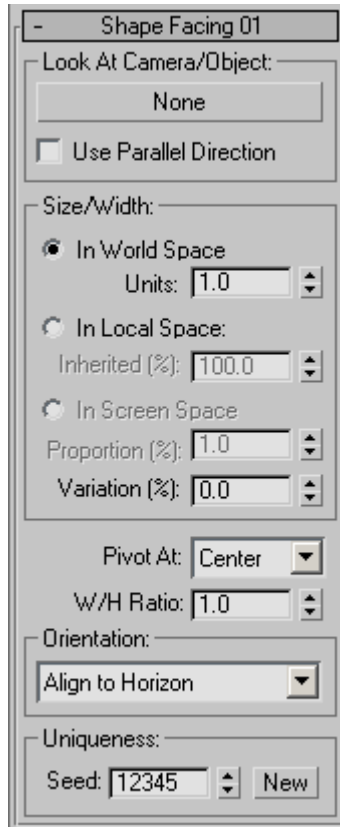

### Look At Camera/Object group

Use this control for defining the camera or object toward which the particle will face. This object is known as the *Look At object*. For the technically minded, the facing is maintained by keeping each particle's local Z axis pointed at the Look At object, or when Use Parallel Direction is on, aligned with the vector between the Particle Source icon and the Look At object.

**Name** After picking a Look At object, its name appears here.

**Pick Camera or Object** Click this button, and then select a camera or object in the scene to use as the Look At object. The mouse cursor changes to a cross shape when positioned over a valid object.

**Use Parallel Direction** When off, all particles continuously rotate to stay facing toward the Look At object. Each particle's orientation varies because its location differs from those of the others. When on, all particles face in the same direction, defined by an imaginary line between the Particle Source gizmo center and the Look At object. Default=off.

### **Size/Width group**

Use these settings to specify the coordinate system for setting the size, as well as the size parameters. The numeric settings in this group are not animatable.

**In World Space** Sets the absolute size in system units, using the World coordinate system.

**Units** With the In World Space option, sets the particle size in system units. Range=0 to 1000000000. Default=1.

**In Local Space** Sets particle size relative to the existing size, in local space. The software uses the dimensions of the existing shape to determine the size of the “facing rectangle.”

**Inherited %** Sets the facing particles' size as a percentage of the existing size. Range=0 to 100. Default=100.

**In Screen Space** Sets the facing particles' size as a percentage of the screen width. The actual size of each particle changes as necessary throughout the animation, depending its distance from the camera, to maintain a constant size from the camera's point of view.

This option is available only when the Look At object is a camera, and Use Parallel Direction is off.

**Proportion %** Sets the particle size as a percentage of the screen width. Default=1.

**Variation %** Sets the percentage by which particle size can vary. Default=0.

**Pivot At** Specifies the part of the particle around which rotation is performed when maintaining the facing direction. The choices, available from the drop-down list, are Top, Center, and Bottom. Default=Center.

With Top and Bottom, the center of the corresponding side is used as the particle center for rotation.

This option is useful, for example, when particles are lying on a surface, and each particle is an explosion. In this situation, you'd probably want the entire particle rectangle to appear above the surface, so you'd set Pivot At to Bottom.

**W/H Ratio** Defines the aspect (width-to-height) ratio of the shape rectangle.

Adjust this ratio to that of the particle-map imagery. For the commonly used TV aspect ratio of 4:3, set W/H Ratio=1.33. The parameter is not animatable. Range=0.001 to 1000. Default=1 (square particles).

This value is not animatable.

## **Orientation**

Use this drop-down list to choose how particles rotate on the axes not specified by the Look At direction. Default=Align to Horizon.

**Align to Horizon** Keeps the top edge aligned with the horizon (the world XY plane).

**Align to Speed Follow** Uses the right side of each particle as the leading edge, so the top and bottom edges are aligned with the direction of particle motion.

**Random** Orients the top edge at random.

**Allow Spinning** To spin the particles, choose this option, and in the same event use a [Spin operator](#) on page 2783 . In the latter, set Rotation Axis to Particle Space and use the default axis values: X=0, Y=0 , Z=1.

## **Uniqueness group**

The Uniqueness setting enables changing the randomization of the size/width variation.

**Seed** Specifies a randomization value.

**New** Calculates a new seed using a randomization formula.

## **Shape Instance Operator**

[Particle View](#) on page 2730 > Click Shape Instance in an event or add a Shape Instance operator to the particle system and then select it.

Shape Instance lets you use any [reference object](#) on page 7910 in the scene as particles. You can effectively define only one reference object per event, but the object can comprise any number of sub-objects, each of which Particle Flow can treat as a separate particle. Also, using tests, you can divide the

particle stream into multiple branches and define a different particle shape for each.

As the name of the operator indicates, reference geometry is instanced into the particle system. Thus, any physical changes you make to the original geometry are reflected instantly in the particle system. If you hide the original geometry, the particles still appear. However, if you delete the original geometry, the particles are deleted as well.

### Using Transform-Animated Reference Objects

You can create animated particle shapes by animating the reference object with modifiers, and then turning on [Animated Shape](#) on page 2831 . However, Shape Instance ignores any rotational and positional transformations applied directly to the reference object; it uses only the pure scale component. For example, if you scale an object non-uniformly using the View reference coordinate system, the result might skew the object's shape. Because the skewing is the by-product of a rotational transform, it wouldn't be reflected in the particles' shape. However, modifiers and comparable functions that contain transformations applied to the reference object are reflected in the instanced particles. For example, if you want particles to use rotational transforms applied to the reference object, use the Reset XForm function on the reference object. Reset XForm is available from the Utilities panel.

---

**TIP** Particle Flow *can* , however, use rotational and positional animation applied to descendant objects in a hierarchy, when you use the entire hierarchy as a single particle. To do this, create a hierarchy, animate the descendant objects, and then designate the parent as the reference object. Do not turn on Separate Particles For > Object And Children. You'll find a procedure illustrating this, below.

---

When using an animated reference object, it is recommended that you hide the reference object after instancing it in the particle system.

**See also:**

- [Shape Operator](#) on page 2821
- [Shape Facing Operator](#) on page 2822
- [Shape Mark Operator](#) on page 2832

## Procedures

**Example: To use the reference object's rotational and positional animation in the particle system:**

- 1 Create an object you want to use as the particle shape, such as a teapot, and a Dummy helper object.
- 2 Animate the teapot using the Move and Rotate tools.



- 3 Use the Align tool to center the teapot to the dummy.

This step isn't necessary, but it can help to obtain more consistent results.



- 4 Link the teapot as a child of the dummy (drag from the teapot to the dummy).

You can use any object as the parent, but using a dummy, which doesn't render, lets you animate all instanced particles visible in the final animation.

- 5 Create a default Particle Flow system.
- 6 In Particle View, delete the Rotation operator.
- 7 Replace the Shape operator with a Shape Instance operator.
- 8 In the Shape operator parameters, designate the dummy as the Particle Geometry Object.
- 9 Turn on Animated Shape.
- 10 For sequential animation, which can be more interesting visually, in Animation Offset Keying, set Sync By to Particle Age or Event Duration.

## Interface

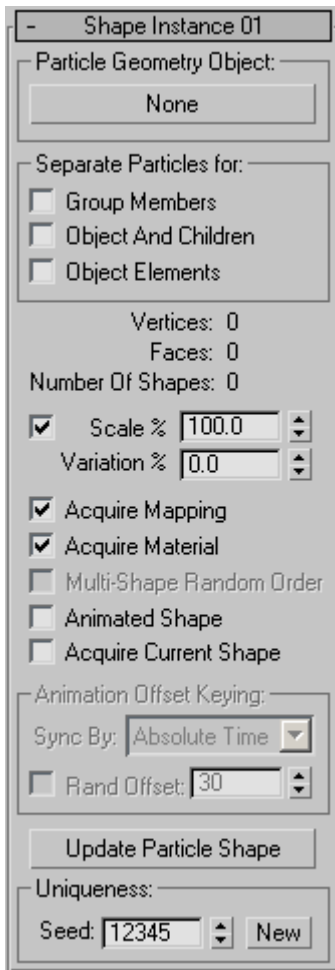

### Particle Geometry group

Use this control for defining the object to be used as the particle geometry. This object is known as the *reference object*.

**[button]** Click this button, and then select a geometry object in the scene to be used as the particle shape. The mouse cursor changes to a cross shape when positioned over an object that's valid for use as a reference object. Valid

objects include *multi-shape* objects such as groups and hierarchies; see [Separate Particles For group](#) on page 2829 .

After picking a reference object, its name appears on the button.

You can use almost any geometry object as a reference object. By default, the operator automatically converts closed splines to rendering geometry by “filling in” the area defined by the shape outline. To use the shape outline instead, select the original shape and, on the Modify panel > Rendering rollout, turn on Display Render Mesh. You needn't turn on Renderable, but changes to all other Rendering rollout settings, such Thickness and Sides, are reflected in the rendered particles.

Particle Flow does not automatically “fill in” open shapes such as Line (non-closed) and Arc. To render these shapes when using them as particles, turn on Modify panel > Rendering rollout > Display Render Mesh.

If a Shape Instance operator is in effect for which the geometry object is not defined, and the viewport display type is set to Geometry, then the particles appear in the viewports as X characters.

---

**NOTE** If a multi-shape object used as a reference object comprises objects both with and without materials applied, and Acquire Material is on, Particle Flow will apply the first available material to any objects without materials applied.

---

---

**NOTE** You can use a NURBS surface as a reference object, but not a NURBS curve. To use a NURBS curve as particle geometry, first convert it to a surface using a method such as the Cap function.

---

---

**TIP** For best results, when using an animated reference object, it's highly recommended that you hide the original object before rendering, or use Object Properties to turn off its Renderable check box.

---

---

**NOTE** If using a group as a reference object, make sure the group is closed before selecting it. Selecting an open group will add only the group member you click, not the entire group.

---

## Separate Particles For group

3ds Max provides a number of methods for combining disparate objects into single entities, including grouping, building hierarchies with linking, and attaching. By default, when using such a *multi-shape* object as particle geometry, each particle comprises all member objects. Alternatively, you can instruct Particle Flow to treat each member object as a separate particle with these options. When on, the software uses each member object as a single particle,

in left-to-right order according to its X-axis position, by default. So, for example, if you create text in the Front viewport, assign it as reference geometry, and turn on Object Elements, the letters come out in the proper order.

You can vary the order randomly by turning on [Multi-Shape Random Order](#) on page 2831 .

You can turn on any combination of Separate Particles items. All are off by default.

**Group Members** When on, group members are treated as separate particles.

**Object and Children** When on, linked objects are treated as separate particles.

**Object Elements** When on, element sub-objects of a single mesh object are treated as separate particles.

**Vertices/Faces** Show the number of vertices and triangles per particle. If the reference geometry is multi-shape and the appropriate check boxes in the Separate Particles are on, then these displays show an average vertex/face count.

**Number of Shapes** Shows number of different particle shapes. This number is always 1 unless the reference geometry is multi-shape and the appropriate check boxes in the Separate Particles For group are on, in which case this displays the number of resulting different shapes.

**Scale (%)** Specifies a uniform scaling factor for all particles. Range=0 to 100000. Default=on, 100.

The center of scaling for multi-shape object members treated individually depends on how the objects are combined. For grouped and linked objects, the scaling is done about the objects' pivot points. For object elements, the scaling center is the geometric center of each object; that is, the averaged location of all the vertices.

This value cannot be animated. To animate particle size, use the [Scale operator](#) on page 892 .

**Variation (%)** Specifies a randomized percentage of scaling variation. Use the Uniqueness setting to change the randomization. Range=0 to 100. Default=0.

This value cannot be animated. To animate scaling variation, use the [Scale operator](#) on page 2785 operator.

**Acquire Mapping** When on, all mapping data from the reference object is transferred to particles. Default=on.



**Acquire Material** When on, material data from the reference object is transferred to particles. Default=on.

If the reference object is a group, with different materials applied to the group members, the software creates a new Multi/Sub-Object material containing all of the materials and uses it as the particle material.

---

**TIP** Because materials are “sticky” in Particle Flow, if you turn off Acquire Material after specifying a reference object with an attached material, the material remains applied to the particles. To avoid applying the instanced shape's material to the particles, turn off Acquire Material before specifying the reference object.

---

**Multi-Shape Random Order** When on, assigns shapes to particles in random order. When off, Particle Flow emits each shape in the multi-shape object as a single particle, in the order of the shape's X coordinate. In other words, the shape with the lowest X-axis coordinate is emitted first, then the one with the next highest, and so on. The option is available only if at least one of Separate Particles For group check boxes is on. Default=off.

For example, if you want the particles to spell out a word or phrase, use extruded text created in the Front viewport as the reference object, turn on Separate Particles For > Group Elements, but leave Multi-Shape Random Order off.

**Animated Shape** When on, particles use any animation in the reference object, including cyclic animation applied with the Parameter Curve Out-of-Range Types controls. When off, the particles are not animated.

With this option, you can use the Animation Offset Keying controls to specify how to synchronize the reference-object animation with the particles. See the next section.

---

**NOTE** A particle that uses this option is animated only while in the event containing the Shape Instance operator. If it moves to another event that doesn't contain a shape operator, it keeps the same shape, but the animation stops. The easiest way to keep the animation going from event to event is to place the Shape Instance operator in the [global event](#) on page 7801 . Otherwise, you need to place the operator in each event in which the particle should be animated.

---

**Acquire Current Shape** When on, Particle Flow acquires the particle shape from the reference object as each particle enters the event. Thus, if the reference object is animated, particles that enter at different times get different shapes. However, these shapes are not animated. When the option is off, the shape is acquired from frame 0. Default=off.

This option is available only when Animated Shape is off.

## Animation Offset Keying group

These controls are available only when Animated Shape is on.

**Sync By** Lets you choose how to synchronize reference-object animation with the particles.

- **Absolute Time** All particles have the same shape at any given moment.
- **Particle Age** Animation of the reference object is synchronized with particle age: Frame 0 of the reference-object animation corresponds to the frame of each particle's birth.
- **Event Duration** Frame 0 of the reference-object animation corresponds to the moment the particle enters the event.

**Rand Offset** When on, randomly varies the start of each particle's animation. Use the numeric setting to specify the number of frames by which the animation start can vary.

**Update Particle Shape** Refreshes instanced particle shapes from the reference object. Use this after changing an object in a hierarchical reference object.

In most cases, Particle Flow automatically updates instanced particles when changes are made to the reference object. However, in some cases, when you change an object deep in a hierarchy, the particle instances might not be updated. In such a case, click Update Particle Shape to refresh the instances.

## Uniqueness group

The Uniqueness setting enables changing the randomization of the scale variation, animation offset, and the multi-shape random order.

**Seed** Specifies a randomization value.

**New** Calculates a new seed using a randomization formula.

## Shape Mark Operator

[Particle View](#) on page 2730 > Click Shape Mark in an event or add a Shape Mark operator to the particle system and then select it.

Use the Shape Mark operator to replace each particle with either a rectangle or a box cut out from the particle geometry with an image mapped onto it.

The image can be animated and the animation can be synchronized with particle events.

A typical application of Shape Mark would be to leave marks after particles impact objects in the scene. For example, when a torpedo hits a boat and explodes, you could use Shape Mark to leave scorch marks on the boat surface.

---

**TIP** By default, the mark left by Shape Mark is always rectangular, no matter what shape the particles are. To leave a differently shaped mark, choose the Shape group > Rectangle option, and use a [material](#) on page 2839 in the same event with transparent areas to define the mark's outline. For example, apply a Mask map to the material's Opacity channel, and to the map's Mask channel, apply a bitmap containing an alpha channel. On the Bitmap Parameters rollout, set Mono Channel Output to Alpha.

---

**NOTE** With its default settings, the Shape Mark operator can generate coplanar faces, which the mental ray renderer cannot render well. If you want to use mental ray rendering with Shape Mark, adjust the operator's settings as follows:

---

- In the Shape group, choose Box Intersection.
- Set Surface Offset to **0.01**.
- Set Offset Variation to **0.005**.
- Set Vertex Jitter to **0.002**.

With these settings, faces are no longer coplanar, and the mental ray renderer gives better results.

**See also:**

- [Shape Operator](#) on page 2821
- [Shape Instance Operator](#) on page 2825
- [Shape Facing Operator](#) on page 2822

## Procedures

**Example: To use Shape Mark:**

- 1 Determine which object is to receive the marks; this will be the *contact object*. Apply a deflector to this object.

- 2 Set up your particle system with an event that causes particles to collide with the contact object deflector.
- 3 At the end of this event, add a [Collision test](#) on page 2881 .
- 4 In the Collision test, designate the deflector from step 1.
- 5 Create a new event with the Shape Mark operator, and wire the Collision test to this event.
- 6 In the Shape Mark operator > Contact Object group, designate the object from step 1. Change the other Shape Mark settings as necessary.  
Now, when the particles strike the contact object, they disappear, leaving marks on the object.  
If you want the particles to bounce after leaving marks, rather than disappearing, use a [Collision Spawn test](#) on page 2885 instead, and turn off its Delete Parent check box. The spawned particles become the marks, and the original particles remain in the first event.
- 7 Optionally, add a Material operator to define the surface characteristics of the marks.

## Interface

- Shape Mark 01

Contact Object:  
None

Align To Surface Animation

Orientation:  
Align To: Speed

Divergence: 0.0

Size:

In World Space  
Width: 1.0  
Length: 1.0

In Local Space:  
Inherited %: 100.0  
Variation %: 0.0

Impact Angle Distortion  
Distor. Max %: 1000.0

Shape:

Rectangle  
 Box Intersection  
Box Height: 10.0

Allow Multiple Elements  
 Continuous Update

Generate Mapping Coords.

Pivot Offset %: 0.0  
Surface Offset: 0.001  
Offset Variation: 0.0  
Vertex Jitter: 0.0

Uniqueness:  
Seed: 12345 New

## Contact Object group

Use this control for defining the object on which marks are to be left.

**[button]** Click this button, and then select an object in the scene to use as the contact object. The mouse cursor changes to a cross shape when positioned over a valid object.

After picking a contact object, its name appears on the button.

**Align to Surface Animation** When on, Shape Mark takes into account surface changes due to vertex animation of the contact object. If [Shape](#) on page 2837 is set to Rectangle, then the mark changes its orientation and position to appear be stuck to the surface of the contact object. If Shape is set to Box Intersection, then the mark changes shape along with that of the contact object. When off, only transformation of the contact object is taken into consideration. Default=off.

Turn this on only if there is significant vertex animation at the contact point, such as with an animated water surface.

---

**WARNING** This option requires significant CPU and memory resources.

---

## Orientation group

**Align To** Depending on the setting for [Shape](#) on page 2837, Shape Mark creates either a rectangle or a box cutout on the contact geometry. The Orientation setting specifies how the shape is oriented. In the mark's local coordinate system, the X axis is Length, the Y axis is Width, and with the box cutout, Z is height. The Z axis is perpendicular to the surface of the object at the contact point.

The alignment choices are as follows:

- **Speed** The Length direction is parallel to the projection of the particles' speed vector onto the contact plane.
- **Particle X/Y/Z** The Length direction is parallel to the projection of the particle's local coordinate axis X, Y, or Z, respectively, as the particle moves toward the contact object.
- **Random** Uses a random Length direction in the contact plane.

**Divergence** Applies a range of random variation, in degrees, to the orientation of the Length direction. Unavailable when using the Random option.

## Size group

Use these settings to specify the coordinate system for setting the size of the mark, as well as the size parameters. The numeric settings in this group are not animatable.

**In World Space** Sets the absolute size of the mark in system units, using the World coordinate system.

**Width/Length** With the In World Space option, sets the particle dimensions in system units. Range=0 to 1000000000. Default=1.0.

**In Local Space** Sets the mark size relative to the existing particle size, in local space. The software uses the dimensions of the existing shape to determine the size of the “facing rectangle.”

**Inherited %** Sets the percentage of the mark size, relative to the existing particle size. Range=0 to 100. Default=100.0.

**Variation %** Sets the percentage by which particle size can vary. Default=0.0.

**Impact Angle Distortion** When on, increases the Length value of the mark according to the particle's angle of approach. This effectively stretches the mark shape if particle approaches the contact geometry at a low angle. Available only when Align To is set to Speed. Default=off.

For example, if a drop of paint hits a surface perpendicularly, it creates a circular mark, but if it hits the surface at a lower angle, the resulting shape is an ellipse.

**Distor(tion) Max %** Sets the maximum percentage by which the software may stretch the mark. Available only when Impact Angle Distortion is on. Default=1000.

With very low angles of approach, the stretching factor can become very high. For example, value 500% means that the stretching factor cannot exceed 5.

## Shape group

These settings let you specify the mark-making object as a rectangle or a box. Default=Rectangle.

**Rectangle** The mark shape is a two-faced rectangle.

When using a material with Shape Mark, always choose this option.

**Box Intersection** With this option, the software creates a box for each particle that leaves a mark, and derives the mark shape from a Boolean intersection between the contact object and the box.

**Box Height** Sets the height of the box used with the Box Intersection method. Available only with Box Intersection. Default=10.0.

**Allow Multiple Elements** When on, particles can leave marks on all parts of contact objects that contain multiple elements. When off, a particle marks only the first element it collides with. Available only with Box Intersection. Default=off.

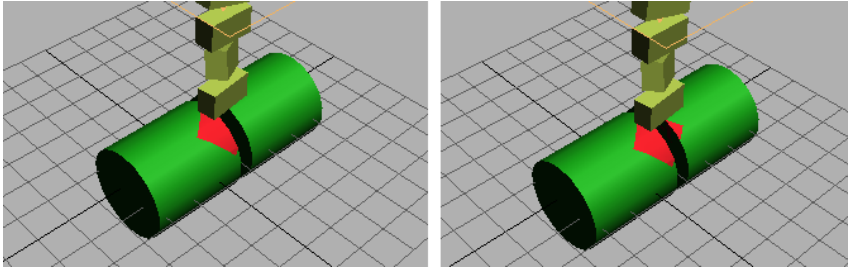

Particles falling onto a two-element cylinder

Left: Allow Multiple Elements is off; Right: Allow Multiple Elements is on.

**Continuous Update** When on, the shape of the mark is recalculated at each frame, according to the current positions of the particle and the contact surface. This option can consume a great deal of CPU time. Available only with Box Intersection.

**Generate Mapping Coords.** Allows correct application of the shape mark when using a mapped material. Default=on.

If you're not using a mapped material, you can save memory by turning this off.

**Pivot Offset %** Shifts the position of the shape mark along its length dimension with respect to the pivot of the impacting particle. Default=0.0. Range=-50.0 to 50.0.

By default, the center of the mark's length dimension coincides with the point where the particle's pivot strikes the contact object. This setting lets you offset the mark's position to anywhere along its length.

---

**NOTE** The width dimension and the Box Intersection's height dimension are always centered at the intersection of the particle pivot and the contact object's surface.

---

**Surface Offset** Specifies the distance of the shape mark above the contact object's surface. Default=0.001.



The mark is slightly elevated above the contact geometry to achieve the visual effect of the mark spot overlapping the contact geometry. This parameter is not animatable.

**Offset Variation** Specifies the maximum extent of a random variation in the actual surface offset among particles. Default=0.0.

Adjusting this value can help to alleviate rendering artifacts with overlapping marks.

**Vertex Jitter** Specifies the maximum extent of a random variation in the positions of vertices of marks created using the Box Intersection method. Available only with the Box Intersection method. Default=0.0.

Adjusting this value can help to alleviate rendering artifacts with overlapping marks.

### **Uniqueness group**

The Uniqueness setting enables changing the randomization of the size/width variation.

**Seed** Specifies a randomization value.

**New** Calculates a new seed using a randomization formula.

## **Materials and Mapping in Particle View**

Particle Flow provides three operators for applying materials to particles. To give the same appearance to all particles throughout an event, use [Material Static Operator](#) on page 2841 . If you're using a compound material such as [Multi/Sub-Object](#) on page 5558 , you can assign different sub-materials to different particles with the [Material Frequency operator](#) on page 2844 . And to assign materials that change in appearance over time, use the [Material Dynamic operator](#) on page 2846 .

Related to this is the [Mapping operator](#) on page 2853 , which lets you give the same mapping coordinates to the entire surface of each particle in an event, thus using a single pixel from a material to color the particles. By animating the mapping coordinates, you can cause the particles to change color over time. This is particularly effective with a gradient material.

The [Bitmap map](#) on page 5633 , used in conjunction with Material Dynamic, lets you assign different frames from an image sequence to particles based on the particle age, among other effects.

Following are some items to keep in mind when using materials with Particle Flow:

- A material is a static property of an event. It does not travel along with the particles from one event to the next. A particle's material ID does, but its material does not. If you want particles always to use the same material, define the material in the [global event](#) on page 7801 with a Material operator or a [Shape Instance operator](#) on page 2825 . Otherwise, you need to define it in each local event.
- The primitive particle shapes available with the [Shape operator](#) on page 2821 do not have mapping coordinates. The [Mapping operator](#) on page 2853 applies the same mapping coordinates to each particle's entire surface, so it's not suitable in this situation. If you want to apply image-based materials to particles, use [Shape Instance](#) on page 2825 instead.
- If you use a Material operator with [Shape Instance](#) on page 2825 , be sure to apply mapping coordinates to the [reference object\(s\)](#) on page 7910 . You can do this by making sure the object's Generate Mapping Coords option is on (if available), or applying a [UVW Map modifier](#) on page 1849 or [Unwrap UVW modifier](#) on page 1769 . If you don't apply mapping coordinates, the system generates a Missing Map Coordinates warning when you render the scene.
- If you use an object with a material already applied as a [reference object](#) on page 7910 for instanced particles, you don't need a Material operator in the same event. However, the material appears only in the event containing the [Shape Instance operator](#) on page 2825 ; it does not persist from event to event.
- If you use the [Cache operator](#) on page 2856 with Update set to Always, toggling the Material Editor > Show Map In Viewport switch causes Particle Flow to recalculate the cache.
- You can drag a material from the Material Editor to a Particle Flow source icon, but the material will not have any effect on the system. You must use a Material operator or Shape Instance to apply materials to particles in Particle Flow.
- Once you've assigned a material to a Material operator, the material shows up in the Material Editor as “hot”; that is, triangles appear in the corners of its sample slot. However, because of the nature of the Particle Flow data structure, the Material Editor functions Select By Material and Get Material > Browse From Selected do not work correctly with Particle Flow systems. You can, however, use Get Material > Browse From Scene.

# Material Static Operator

[Particle View](#) on page 2730 > Click Material Static in an event or add a Material Static operator to the particle system and then select it.

The Material Static operator lets you give particles material IDs that remain constant throughout the event. It also lets you assign a material to each particle based on its material ID. The operator can assign the same material ID to all particles, or different IDs to successive particles on a cyclical or random basis. The most common usage of this latter capability is with a Multi/Sub-Object material, for applying a different material to each particle.

### See also:

- [Materials and Mapping in Particle View](#) on page 2839
- [Material Frequency Operator](#) on page 2844
- [Material Dynamic Operator](#) on page 2846

### Interface

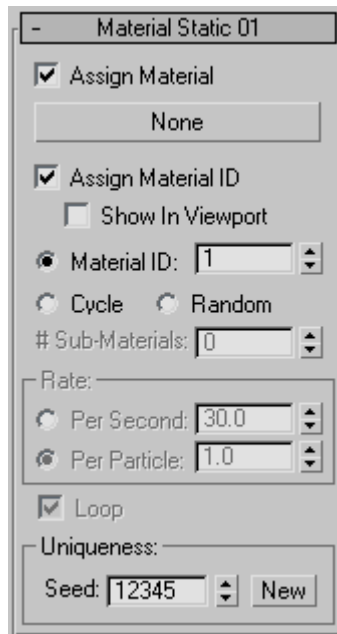

The user interface appears in the parameters panel, on the right side of the Particle View dialog.

**Assign Material** When on, the operator assigns a material to the particles. Default=on.

**[button]** Use this button to assign a material to the operator. Click the button and then use the Material/Map Browser to choose the material. Alternatively, drag the material from a Material Editor sample slot to the button. After you assign a material to the operator, its name appears on the button.

**Assign Material ID** When on, the operator defines a material ID number for each particle. Default=off.

**Show In Viewport** When on, the material is shown applied to the particles in the viewports.

### Assignment Method

The Material Static operator gives you a choice of three different methods for assigning Material IDs to particles:

**Material ID** Assigns the same material ID to all particles. Use the numeric field to set the ID value.

**Cycle** Assigns each particle a material ID in the range 1 to N, where N=# Sub-Materials, in increasing sequential order. The first ID assigned is 1, then 2, then ..., then N, then 1 again, and so on.

**Random** Assigns each particle a random material ID in the range 1 to N, where N=# Sub-Materials.

**# Sub-Materials** The highest ID number assigned to particles using the Cycle or Random option.

In general, set this to the same number of sub-materials in the Multi/Sub-Object material. If you set it to a smaller number, the operator will use only that many sub-materials, starting with the first and counting upward.

---

**NOTE** The software automatically sets this value to the number of sub-materials in the material, *once only*, the first time you apply the material to the operator. Any subsequent changes in the material itself, or applying a different material to the operator, will not change or update the setting.

---

### Rate group

These settings let you choose the basis on which the operator changes material ID assignments, and specify the rate of change.

**Per Second** Sets the number of times per second that the assigned material ID is incremented. If this value is the same as the rate at which particles enter the event, then one ID is assigned per particle. If it's lower, then multiple particles are given the same ID, or if it's higher, then the software increments the assigned ID faster than 1 per particle.

For instance, if particles enter the event at intervals of 1/60 of a second, and Per Second=30, then each pair of particles will be assigned the same ID. Or if particles enter the event at intervals of 1/15 of a second, and Per Second=30, then the ID is incremented (or changed randomly) twice per particle.

**Per Particle** Sets the number of particles that must appear before material ID assignment changes. For example, If you set Per Particle=3, the material ID changes every three particles.

If you set Per Particle to a number less than 1.0, the software then moves through the sub-material list more rapidly than one (or more) particle per ID. That is, the software divides this value into 1.0, and adds the result to the current material ID to obtain the next one. For example, with eight sub-materials, if you set Per Particle=0.33, and use the Cycle option, the following series of IDs will result: 1, 4, 7, 2, 5, 8, 3, 6, 1, ... In general, this option is useful only with the Cycle option.

**Loop** When on, and the last ID has been assigned, the software loops back around to the first ID and continues the cycle. When off, the software assigns the last cycle ID to all subsequent particles. Available only with the Cycle assignment method. Default=on.

For example, say you want the first eight particles that enter the event to use different materials, and all subsequent particles to use a ninth material. To do so, you would create a nine-sub-material Multi/Sub-Object material and assign it to the Material Static operator. Turn on Assign Material ID, choose the Cycle assignment method, and set # Sub-Materials=9. For Rate, use the default settings of Per Particle and 1.0. Lastly, turn off Loop.

### **Uniqueness group**

The Uniqueness setting varies the sequence of assigned IDs with the Random option.

**Seed** Specifies a randomization value.

**New** Calculates a new seed using a randomization formula.

## Material Frequency Operator

[Particle View](#) on page 2730 > Click Material Frequency in an event or add a Material Frequency operator to the particle system and then select it.

The Material Frequency operator lets you assign a material to an event, and specify the relative frequency with which each sub-material appears on the particles. Typically, the material is a Multi/Sub-Object or other compound material, and you specify the frequency by setting a percentage for each of up to 10 different sub-materials (or material ID). The software assigns IDs to particles in a random sequence, based on these percentages. You can also use other materials that use sub-materials, such as Double Sided and Top/Bottom.

### See also:

- [Materials and Mapping in Particle View](#) on page 2839
- [Material Static Operator](#) on page 2841
- [Material Dynamic Operator](#) on page 2846

## Interface

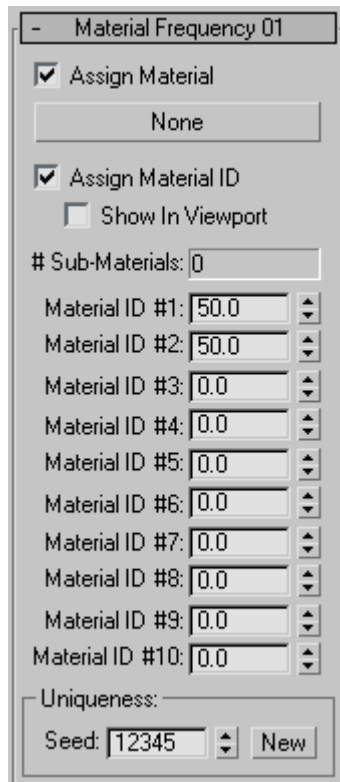

The user interface appears in the parameters panel, on the right side of the Particle View dialog.

**Assign Material** When on, the operator assigns a material to the particles. Default=on.

**[button]** Use this button to assign a material to the operator. Click the button and then use the Material/Map Browser to choose the material. Alternatively, drag the material from a Material Editor sample slot to the button. After you assign a material to the operator, its name appears on the button.

**Assign Material ID** When on, the operator defines a material ID number for each particle, and enables the remaining parameters. Default=on.

In general, this should remain on. Particle Flow uses the material ID with compound materials to know which sub-material to assign to a particle.

**Show In Viewport** When on, the material is shown applied to the particles in the viewpoints.

**# Sub-Materials** Displays the number of sub-materials in the assigned material.

**Material ID #1–10** Specifies the relative likelihood of particles to be assigned the corresponding material ID. Assign values for all IDs, or sub-materials, in the material that you want to have applied to the particles. So, for example, with a Multi/Sub-Object material containing five sub-materials, you'd set values for Material IDs #1-5.

This value is not absolute, but relative to the other settings. To follow the previous example, if you wanted all five materials to appear with equal frequency, you'd set the same non-zero value for Material IDs #1-5; the actual value wouldn't matter. On the other hand, if you wanted the materials to appear with decreasing frequency, you'd set the lower Material ID settings to relatively higher values; say 100, 80, 50, 33, and 10. In this case, each particle would twice as likely to be assigned material ID 1 as it would material ID 3, and one-tenth as likely to be assigned ID 5 as it would ID 1.

The actual sequence of material ID assignments is random, and can be varied by changing the Uniqueness Seed setting.

### **Uniqueness group**

The Uniqueness setting varies the random sequence of assigned IDs.

**Seed** Specifies a randomization value.

**New** Calculates a new seed using a randomization formula.

## **Material Dynamic Operator**

[Particle View](#) on page 2730 > Click Material Dynamic in an event or add a Material Dynamic operator to the particle system and then select it.

The Material Dynamic operator lets you give particles material IDs that can vary during the event. It also lets you assign a different material to each particle based on its material ID. When used with an [animated texture](#) on page 7711, this lets you assign a different frame or map to each particle based on its total age or the amount of time it has spent in the current event. In this context, one example of an animated texture is a material that uses a multi-frame bitmap, such as an AVI file, as the Diffuse [Bitmap map](#) on page 5633. Other examples of animated textures are materials that use the [Particle Age map](#) on



page 5727 or the [Particle MBlur map](#) on page 5729 . Alternatively, you can use different sub-materials from a compound material such as Multi/Sub-Object.

---

**NOTE** When using Object Motion Blur, if an event contains a Material Dynamic operator that uses a material with a Particle Age/MBlur/Bitmap map, the event should not also contain a Delete operator, or a Spawn or Collision Spawn test. Also, the event should not contain any tests that are wired to another event. The only exception to this is the Age Test operator when set to Absolute Time without any variation; that is, all particles leave the event at the same time. This applies to the use of Object Motion Blur only; there are no restrictions with Image Motion Blur.

---

**See also:**

- [Materials and Mapping in Particle View](#) on page 2839
- [Material Static Operator](#) on page 2841
- [Material Frequency Operator](#) on page 2844

**Procedures**

**Example: To assign animation frames to particles based on age:**

- 1 Prepare a file to be used as the animated bitmap. This can be a multiple-frame format such as AVI, or an image file list (IFL file) that points to a sequence of still images. With the latter, you can use images in a format such as Targa that contain predefined alpha channels to specify particle opacity selectively.



- 2 Open the Material Editor, and assign a Bitmap map as the Diffuse map.
- 3 Use the Select Bitmap Image File dialog to assign the file from step 1 as the bitmap. This dialog appears automatically when you first assign a Bitmap map; alternatively, click the Bitmap button on the map's Bitmap Parameters rollout.
- 4 On the map's Time rollout, turn on Sync Frames To Particle Age.
- 5 If you want to use the image background or alpha channel to define transparency, on the Maps rollout, copy this map to the Opacity slot, and set the parameters accordingly.

- 6  At the material level, turn on Show Map In Viewport.
- 7 Add a camera to the scene and set it up as desired. Activate the Perspective viewport and press the C key to set the viewport to show the camera view.
- 8 Create a default Particle Flow system.
- 9 Open Particle View.
- 10 Replace the Shape operator with a Shape Facing operator.  
Using this operator makes it easier to see the animation.
- 11 Click the Shape Facing operator, and in its rollout, click the Look At Camera/Object button, and then select the camera.
- 12 In the Size/Width group, increase In World Space > Units to about 15.
- 13 Add a Material Dynamic operator to Event 01, and assign it the material from the beginning of this procedure.
- 14 Turn on Show In Viewport.
- 15 In the Animated Texture group, make sure Same As Particle ID is chosen, and turn on Reset Particle Age.  
Always choose Same As Particle ID with an animated texture, and one of the Sub-Material Rotoscoping options when using a compound material.  
Turning on Reset Particle Age causes the software to set particles to age 0 as they enter the event. In this example, the particles are born in the event, so technically it's not necessary to turn on Reset Particle Age. However, it's a good habit to get into to ensure that the animation always plays from the first frame.
- 16 Play the animation.  
In the viewport, the bitmap animation advances as the particles move, but all the particles show the same frame, regardless of age. This is anomalous behavior related to the limitations of viewport interactivity. The particles render correctly, however.
- 17 Render the animation.  
As each particle is born, it begins displaying the animation from the first frame. At each frame, each particle's age is incremented, and it displays the next frame from the applied map.

### Example: To use the Particle Age map:

The [Particle Age map](#) on page 5727 applies up to three different colors or maps to particles throughout their life span, gradually changing from one to the next as the particles age. This effect can be used, for example for sparks flying from a fire: At first they're yellow; then, as they cool down, they turn red, and finally they become gray ashes. In order for Particle Age to know how far a particle has progressed through its life span, the particle has to be given a finite life. You do this using the [Delete operator](#) on page 2768 .

- 1 Start or reset the program, and add a Particle Flow system.
- 2 Open Particle View and the Material Editor. Position them side by side.
- 3 In Particle View, add a Material Dynamic operator and a Delete operator to Event 01.  
For Particle Age to work, the Delete operator must be in the same event as the Material Dynamic operator. Alternatively, you can add the Delete operator to the [global event](#) on page 7801 so that it affects every event.
- 4 Click the Delete operator, and in the parameters panel, choose By Particle Age, and set Life Span=**100** and Variation=**0**.  
This gives each particle a life span of 3 1/3 seconds.
- 5 Click the Material Dynamic operator.
- 6 In the Material Editor, assign a Particle Age map as the Diffuse map. On the Particle Age Parameters rollout, set three different colors, such as red, green, and blue. Also change the Age percentage values as necessary. For example, if you want each particle to show the second color a third of the way through its life instead of halfway, change Age #2 to **33**.
- 7 Drag the active material from its sample slot to the material button on the Material Dynamic parameters rollout in Particle View. When the Instance (Copy) dialog appears, click OK to accept the default choice: Instance.
- 8 In the Material Dynamic parameters, make sure Assign Material ID is on. If it isn't, the particles all change color at the same time.  
There's no need to turn on Show In Viewport; the Particle Age map doesn't appear in the viewports.
- 9 Render the animation, or a few representative frames.  
As each particle falls, it gradually changes color, with the oldest particles changing first.

---

**TIP** You needn't actually delete the particles to use this method. There are several ways to avoid this. You could set Life Span to a higher number than the length of the animation, and then, in the Particle Age map parameters, lower the Age #2 and Age #3 settings. Or, if you're using a local Delete operator, you could use an [Age test](#) on page 2879 to move the particles into another event just before they're scheduled to be deleted. In that case, to avoid an abrupt color change, you might want to add to subsequent events a [Material Static operator](#) on page 2841 with a material that uses the same final color or map as the Particle Age map.

---

## Interface

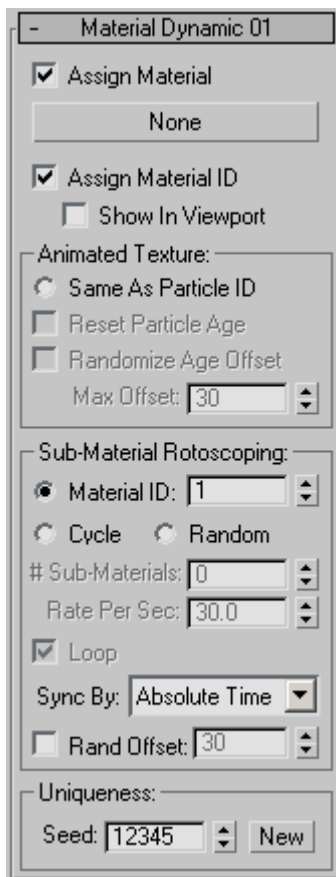

The user interface appears in the parameters panel, on the right side of the Particle View dialog.

**Assign Material** When on, the operator assigns the specified material (see next parameter) to the particles. Default=on.

**[button]** Use this button to assign a material to the operator. Click the button and then use the Material/Map Browser to choose the material. Alternatively, drag the material from a Material Editor sample slot to the button.

After you assign a material to the operator, its name appears on the button.

**Assign Material ID** When on, the operator defines a material ID number for each particle. Default=on.

In general, this should remain on. Particle Flow uses the material ID with the Particle Age map to find the particle's other properties, including its life span and current age. And it uses the material ID with compound materials to know which sub-material to assign to a particle.

**Show In Viewport** When on, the material is shown applied to the particles in the viewports when the particles are displayed as geometry.

## **Assignment Method**

The Material Dynamic operator lets you assign Material IDs to particles in several different ways, depending on whether you're using an animated texture or a compound material. Default=Same As Particle ID.

## **Animated Texture group**

**Same As Particle ID** Assigns the same material ID to a particle as its particle ID. Choose this when using a material containing an animated texture, such as a Bitmap, Particle Age, or Particle MBlur map.

---

**NOTE** Particle Flow assigns Particle IDs consecutively to particles at birth, starting with 0. Although the highest possible Particle ID is over 2,000,000,000, the highest possible *material ID* is 65535. Thereafter, the numbering sequence starts again at 0. Thus, when using a Particle Age map in a material assigned to the Material Dynamic operator, for best results, use a total of 65,536 particles or fewer.

---

**Reset Particle Age** When on, sets each particle's age to 0 when it enters the event.

When using an animated material with a Bitmap map, turn this on to ensure that the animation always plays from the first frame.

**Randomize Age Offset** When on, the software varies the difference between the particle age and the starting material ID at random. The maximum difference is determined by the Max Offset parameter.

**Max Offset** The maximum number of frames by which the software can randomly vary particle age.

### **Sub-Material Rotoscoping group**

These settings let you choose the basis on which the operator changes material ID assignments when using a compound material such as Multi/Sub-Object, and specify the rate of change.

**Material ID** Assigns the same material ID to all particles. Use the numeric field to set the ID value.

**Cycle** Assigns each particle a material ID in the range 1 to N, where N=# Sub-Materials, in increasing sequential order. The first ID assigned is 1, then 2, continuing to increment each by 1 until N; then 1 again, and so on.

**Random** Assigns each particle a random material ID in the range 1 to N, where N=# Sub-Materials.

**# Sub-Materials** The highest ID number assigned to particles using the Cycle or Random option.

In general, set this to the same number of sub-materials in the Multi/Sub-Object material. If you set it to a smaller number, the operator will use only that many sub-materials, starting with the first and counting upward.

---

**NOTE** The software automatically sets this value to the number of sub-materials in the material, *once only*, the first time you apply the material to the operator. Any subsequent changes in the material itself, or applying a different material to the operator, will not change or update the setting.

---

**Rate Per Sec(ond)** Sets the number of times per second that the assigned material ID is incremented. If this value is the same as the rate at which particles enter the event, then one ID is assigned per particle. If it's lower, then multiple particles are given the same ID, or if it's higher, then the software increments the assigned ID faster than 1 per particle.

For instance, if particles enter the event at intervals of 1/60 of a second, and Per Second=30, then each pair of particles will be assigned the same ID. Or if particles enter the event at intervals of 1/15 of a second, and Per Second=30, then the ID is incremented (or changed randomly) twice per particle.

**Loop** When on, and the last ID has been assigned, the software loops back around to the first ID and continues the cycle. When off, the software assigns the last cycle ID to all subsequent particles. Available only with the Cycle assignment method. Default=off.

For example, say you want the first eight particles that enter the event to use different materials, and all subsequent particles to use a ninth material. To do so, you would create a nine-sub-material Multi/Sub-Object material and assign it to the Material Dynamic operator. Choose the Cycle assignment method, and set # Sub-Materials=9. Set the Rate Per Sec value to the rate at which particles enter the event. Lastly, turn off Loop.

**Sync By** Choose the time frame for applying animated parameters. Available only with the Material ID and Cycle options.

- **Absolute Time** Any keys set for parameters are applied at the actual frames for which they're set.
- **Particle Age** Any keys set for parameters are applied at the corresponding frames of each particle's existence.
- **Event Duration** Any keys set for parameters are applied to each particle starting when it first enters the event.

**Rand Offset** When on, the software varies the difference between the particle age and the assigned material ID at random. The maximum difference is determined by the numeric parameter. Available only with the Material ID and Cycle options.

### **Uniqueness group**

The Uniqueness setting varies the sequence of assigned IDs with the Random option, and the offset with the Randomize Age Offset option.

**Seed** Specifies a randomization value.

**New** Calculates a new seed using a randomization formula.

## **Mapping Operator**

[Particle View](#) on page 2730 > Click Mapping in an event or add a Mapping operator to the particle system and then select it.

The Mapping operator lets you assign a constant UVW mapping to the entire surface of the particles. It works in conjunction with a map specified in a

material operator in the current event. By animating the mapping coordinates, you can vary the location on the material map from which the particle color is taken, thus changing the particle color in a predictable way over time.

The Mapping operator was designed primarily to be used with gradient maps, although you can use it with any map you like. The procedure below describes a recommended method for using the Mapping operator.

**See also:**

- [Material Static Operator](#) on page 2841
- [Material Frequency Operator](#) on page 2844
- [Material Dynamic Operator](#) on page 2846

**Procedures**

**Example: To animate particle coloring using the Mapping operator:**



- 1 Open the Material Editor, and create a material that uses Gradient Ramp as the Diffuse map.
- 2 On the map's Gradient Ramp Parameters rollout, make sure Gradient Type is set to Linear.
- 3 Create a colorful gradient. The Mapping operator uses the colors in left-to-right order as the U value increases from 0.0 to 1.0.
- 4 Add a Particle Flow Source object to the scene.
- 5 Open Particle View.
- 6 In Event 01, click the Speed operator and set Speed to **100**.
- 7 In Event 01, click Display and set Type to Geometry.
- 8 Add a Material Static operator to Event 01, and then click the operator in the event.
- 9 Drag the material you created from its Material Editor sample slot to the button (labeled "None") on the Material Static parameters rollout in Particle View.
- 10 Add a Mapping operator to Event 01, and then click the operator in the event.



11 On the Mapping rollout in Particle View, turn on Show Map In Viewport.

12 **Auto Key** Go to frame 100 and turn on Auto Key.

13 On the Mapping rollout in Particle View, set Map Values > U=1.0.

14 For Sync By, choose Particle Age.

15 **Auto Key**  Turn off Auto Key, and click Play Animation.

As each particle is born and falls, its U mapping coordinate gradually changes from 0.0 to 1.0, while its color changes to match the corresponding position across the Gradient Ramp map.

To vary the effect, try changing the Gradient Type setting, and animate the V and W values as well. Or, for more sophisticated effects, assign animation controllers such as Noise Float to the Mapping coordinate values, or wire them to other changing parameters in the scene (Animation menu > Wire Parameters > Parameter Wire Dialog).

---

**TIP** In the Material Editor, it's easier to see the result of the Gradient Type choice if you set Sample Type to Cube.

---

## Interface

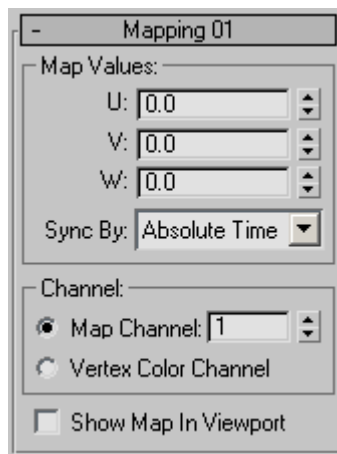

The user interface appears in the parameters panel, on the right side of the Particle View dialog.

## Map Values group

**U/V/W** Set the coordinates on the map from which the particle color is taken. One pixel from this location is used to color the entire particle.

In general, U and V represent the horizontal and vertical dimensions, respectively, beginning at the upper-left corner of the map, and W is useful only with three-dimensional maps, in which context it specifies depth.

**Sync By** Choose the time frame for applying animated parameters. For further information, see [Animation Offset Keying group](#) on page 2790 .

- **Absolute Time** Any keys set for parameters are applied at the actual frames for which they're set.
- **Particle Age** Any keys set for parameters are applied at the corresponding frames of each particle's existence.
- **Event Duration** Any keys set for parameters are applied to each particle starting when it first enters the event.

## Channel group

The Channel setting determines whether the mapping is applied to a map channel or to a vertex color channel.

**Map Channel** The mapping is applied to the specified map channel.

**Vertex Color Channel** The mapping is applied to the particles' vertex color channel.

**Show Map In Viewport** The map coloring is visible in the viewports.

## Additional Operators

### Cache Operator

[Particle View](#) on page 2730 > Click Cache in an event or add a Cache operator to the particle system and then select it.

The Cache operator records and stores particle states to memory. When it's in effect, the first time you play or go to a frame, the particle motion up to and including the frame is calculated and recorded in the cache. Thereafter,

playing the frame or any previous frames uses the data in the cache, rather than recalculating the particle action. This is particularly useful with large or complex particle systems, where playback, and particularly backtracking, are slow because of the large amount of processing required. With caching on, the particle system needs to be calculated only once for each frame, and thereafter playback and moving among frames is significantly faster.

To cache an entire flow, add a Cache operator to the global event. To cache an individual local event, add a Cache operator to it.

To determine how best to implement caching in your particle system, turn on Particle View > Track Update > Update Progress, and then play the animation or go to a frame relatively distant from the current frame. Observe the particle diagram, and watch for events with actions that highlight longer than a fraction of a second, or events with more activity than the rest. Any such events could benefit from caching.

---

**NOTE** Use no more than one Cache operator per event, unless you're using two: one set up for viewports, and the other for rendering. Similarly, don't use global and local Cache operators in the same flow, unless one is set up for viewports, and the other for rendering.

---

**TIP** When using real-time playback, if playback isn't fast enough, you can use the Cache operator to speed it up. For best results, set the Viewport integration step to the same value as the real-time playback speed, and set cache sampling to Integration Step. For example, if the real-time playback speed is set to 1/4x, then the Viewport Integration Step for viewport should be also set to 1/4 Frame, and the Cache operator Sampling parameter should be set to Integration step. Thus, because real-time playback is showing four times as many frames per second, and the Cache operator has stored four times as many frames per second, the two are synchronized. If the real-time playback speed is set to 2x or 4x, set the Viewport Integration Step to Frame.

---

## Procedures

### Example: To use the Cache operator:

- 1 Start or reset the software, and then add a Particle Flow system.
- 2 Open Particle View.
- 3 In Particle View, go to Options menu > Track Update and turn on Update Progress.

This lets you monitor calculation of the particle system by highlighting actions in Particle View as the system executes them.

- 4 In Particle View, Add a [Keep Apart operator](#) on page 2815 to Event 01. Keep Apart is a fairly calculation-intensive operator.
- 5 Go to frame 100 by clicking the right end of the time slider track.  
There is a delay as the system calculates all particle motion between frames 0 and 100. This is necessary because Particle Flow is a history-dependent system. At the same time, the actions in the system highlight briefly in Particle View as they're executed at each frame.
- 6 Go to frame 50 by clicking the center of the time slider track.  
There is a another delay as the system calculates all particle motion between frames 0 and 50.
- 7 In Particle View, drag a Cache operator from the depot to Event 01. Insert it anywhere in the event.  
When you release the mouse button, there is a delay as the Cache operator automatically caches particle motion from the start of the animation to the current frame. Meanwhile, each action highlights briefly at each frame.
- 8 Go to frame 20 or so.  
The only operators that highlight are Cache (very fast) and Display; there is no delay for calculation. All frames between 0 and 50 have been cached.
- 9 Go to frame 100.  
The delay this time is a result of caching particle motion for frames 50 to 100.
- 10 Jump to different frames, and drag the time slider.  
All particle motion is now cached, so no delays occur. But if you change a setting's value, the Cache operator automatically recalculates and stores the particle motion.
- 11 Go to frame 100, and then, in Particle View, click the Keep Apart operator and use the keyboard to change the Falloff Zone value to **8.0**.  
By default, the Cache operator automatically updates the cache when you change any parameters it stores. Thus, when you change the Falloff Zone value at frame 100, it recalculates and recaches the entire animation. Next, you'll briefly explore how manual caching works.
- 12 Click the Cache operator and set Update to Manually.  
The Cache operator no longer updates the stored data automatically when you change a parameter.

- 13 Click the Keep Apart operator, change the Falloff Zone value to **9.0**, and then drag the time slider.

There is no delay, because the animation is still playing back from the cached data. However, the cached data is now invalid, because you changed a parameter in the particle system.

- 14 Click the Cache operator, and in the Manual Update group, click Update.

The software closes Particle View, updates the cache for the active segment, and then reopens Particle View. The cached data is now accurate.

Other manual update options let you update the cache for the entire animation or a custom frame range.

As you can see, the Cache operator is quite powerful. When present and active, by default it overrides recalculation of the particle system, except when you change any action parameters, whereupon it automatically updates the cached data. Used appropriately, it can save a good deal of time in setting up and testing particle systems.

## Interface

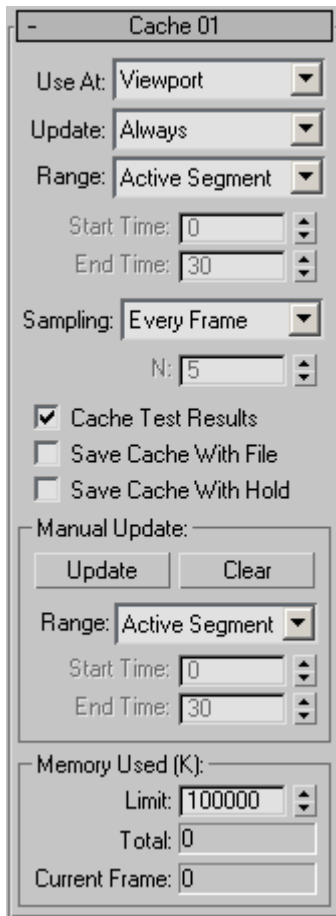

The user interface appears in the parameters panel, on the right side of the Particle View dialog.

**Use At** Caches particle motion when playing back in the viewports, or at render time, or both. Default=Viewport.

---

**IMPORTANT** Choose the Viewport/Render option only when using the same number of particles in the viewports and for rendering (see [Quantity Multiplier group](#) on page 2752 ). Otherwise, unpredictable results can occur.

---

**Update** If you change a parameter in the particle system, the cached data might become invalid. This setting determines whether Particle Flow should update the cache automatically, or let you do it manually. Default=Always.

- **Always** Changing any parameter under the Cache operator's purview causes it automatically to update stored data from the start of the current range (see next parameter) to the current frame.
- **Manually** Updating occurs only when you click the Update button, or clear the cache and then move to a different frame.

**Range** Sets the frame range within which the Cache operator operates. Default=Active Segment.

- **Complete** The software caches the entire animation.
- **Active Segment** The software caches only frames in the active segment, as defined by the Start Time and End Time settings on the Time Configuration dialog. This is the frame range shown on the track bar. You can also change the active segment by holding down Alt and Ctrl and dragging the track bar with the left, middle, or right mouse button.
- **Custom** The software caches only frames in the custom range, as defined by the Cache operator's Start Time and End Time settings (see following).

---

**NOTE** If you cache only part of the animation, Particle Flow calculates particle behavior in subsequent, non-cached frames using the cached data. For example, if you cache frames 0 to 50, and then jump to frame 60, Particle flow will calculate frame 51 based on the cached data, and frames 52 to 60 based on each previous frame.

---

**Start/End Time** The first and last frames of the range considered for caching when Range=Custom (see above). Default=0, 30.

---

**NOTE** The frame range time frame is in absolute time; that is, in terms of the entire animation. If you use a Cache operator locally, and specify a frame range during which no particles are present in the event, Particle Flow won't use the cache.

---

**Sampling** Determines how often the Cache operator samples and caches the animation. Default=Every Frame.

- **Every Frame** The software caches animation data once per frame.

- **Integration Step** The software caches animation data at each integration step, using the Integration Step setting as specified in the Use At setting (see above). If Use At is set to Viewport/Render, it uses lower of the two Integration Step values. For example, if Viewport is set to Half Frame, and Render to 1/8 Frame, the sampling rate would be eight per frame.
- **Every Nth Frame** The software caches animation data at frame intervals specified by the N value, below.

**N** Determines the frame interval for caching when Sampling (above) is set to Every Nth Frame. Default=5.

For example, with N set to the default value of 5, the cache stores animation data for every fifth frame.

**Cache Test Results** When caching particle data, this caches the results of test actions as well. Default=on.

This is important if Cache is used as a local operator, and the next event doesn't have a Cache operator. For the next event to work properly, it should receive particles from the current event. Those particles result from the activity of a test action. The Cache operator can record the test activity to play it back later.

If the Cache operator is used as a global operator, there is no need to cache the test results. This is because the system has cache data for every event, and is able to jump to an arbitrary frame without the need for test results.

**Save Cache with File** When on, the software Includes the cached data with scenes that you save to disk. This can significantly increase the size of saved files, but saves the time of recalculating the particle motion upon reloading the file. Default=off.

Normally, the cache data is saved only in disk files that you create with the Save or Save As commands. You can also instruct the software to include cached data with other types of files using the two following options.

**Save Cache with Hold** Saves cached data in the Hold file, created with Edit menu > Hold. Default=off.

### **Manual Update group**

These controls let you update or clear the cache manually within a frame range, or clear the entire cache.



**Update** Calculates particle motion within the current range (defined below) and stores it in the cache, replacing any existing cached data. Available only when Range is set to Active Segment or Custom.

During the update, the software temporarily closes Particle View and displays a Cache Update Progress bar, while moving the time slider through the cached range. At the same time, by default, the animation plays in the viewports. To prevent this, and speed calculation, turn off Update Viewports.

If the cache runs out of memory during a manual update, Particle Flow halts the update operation and displays an alert. Click OK to continue, and then, if possible, increase the Limit value before updating the cache again.

**Clear** Deletes any cached data.

After you clear the cache buffer, if you go to a different frame or change any action parameters, the software automatically caches particle motion even if Update is set to Manually.

**Range** Sets the frame range within which the Cache operator recalculates data when you click Update. Default=Active Segment.

- **Complete** The software *clears* the cache for entire animation. Choosing Complete makes the Update button unavailable; this option is for clearing the cache only.

To update the entire animation, set the active segment or the custom range to encompass all frames, and then use the corresponding choice and click Update.

- **Active Segment** The software updates the cache only for frames in the active segment, as defined by the Start Time and End Time settings on the Time Configuration dialog. This is the frame range shown on the track bar. You can also change the active segment by holding down Alt+Ctrl and dragging the track bar with the left, middle, or right mouse button.

- **Custom** The software updates the cache only for only frames in the custom range, as defined by the Start Time and End Time settings (see following).

**Start/End Time** The first and last frames of the range that's updated when Range=Custom (see above). Defaults=0, 30.

**Update Viewports** When on, the animation plays in the viewports during manual updating of the cache. Turn this off to disable playing the animation in the viewports during manual caching; this can speed up the caching process, especially with large or complex particle systems. Default=on.

## Memory Used (K) group

The Cache operator stores data in system memory; you can specify an upper limit for the amount of memory it uses. If the Limit setting and the amount of cached data exceeds the available free memory, the computer system might use virtual (hard disk-based) memory instead, which slows down the caching. If Particle Flow fills the cache, any remaining frames are calculated on the fly.

This group also lets you monitor the amount of memory used for caching data.

**Limit** The maximum amount of system memory used to cache particle data, in kilobytes. Default=100,000, or 97.6 MB.

**Total** The amount of memory currently used by the cached data, in kilobytes. Read-only.

---

**NOTE** Even animation frames with no particles will probably consume a certain amount of cache memory. The reason for this is that the cache also stores states for randomly calculated values such as Variation, to ensure that particle activity is consistent across a rendering network, and with machines that might not have regular access to all frames.

---

**Current Frame** The amount of memory used by the data cached for the current frame, in kilobytes. Read-only.

## Display Operator

[Particle View](#) on page 2730 > Click Display in an event or add a Display operator to the particle system and then select it.

The Display operator lets you specify how particles appear in the viewports. The default display mode is Ticks, which is the simplest, and thus the fastest to display. It's useful for animations that use a large number of particles. At the opposite end of the complexity spectrum is the Geometry option, which lets the software depict particles as their actual shapes. In addition, the Display operator provides a variety of simple shapes that provide fast feedback in testing animation, as well as the ability to easily distinguish among particles in different events. It also lets you set the percentage of visible particles.

By default, Particle Flow automatically inserts a new Display operator in each local event you add to the system. Alternatively, you can choose Particle View > Options menu > Default Display > Global. With this option, the software

automatically inserts a Display operator in new global events, but does not add one to new local events.

Particles in any local event that doesn't contain a Display operator don't appear in the viewports, unless an associated global event contains a Display operator (that is, a global Display operator). If a particle is affected by multiple Display operators (for example, both global and local operators) simultaneously, the software generates all viewport particle representations at the same time.

**See also:**

- [Render Operator](#) on page 2872

**Interface**

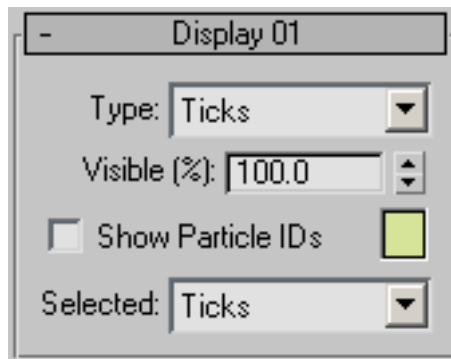

The user interface appears in the parameters panel, on the right side of the Particle View dialog.

**Type** Choose how particles appear in the viewports. The two-dimensional particle markers depict position only. Geometry shows how particles will actually render, in three dimensions; Lines shows speed and direction of motion; and Bounding Boxes reflects scale and orientation.

In the following list, each choice's description is preceded by the number of dimensions used by each particle representation:

- **None** Particles do not appear in the viewports.
- **Dots** (0D) Each particle appears as a single pixel.
- **Ticks** (2D) Each particle appears as a + sign.
- **Circles** (2D) Each particle appears as a small circle.

- **Lines** (1D) Each particle appears as a line, one pixel thick. The line's length indicates particle speed, and its orientation reflects the direction of motion. Use this option for fast, accurate feedback when experimenting with the Speed operators.

---

**TIP** When using the Lines display type with the OpenGL display driver, slow-moving particles might not appear properly in the viewports. In such cases, to see all particles, add a second Display operator in the same event and set its Type to Dots.

---

- **Bounding Boxes** (3D) Each particle appears as a bounding box. Use this option for a good representation of the final animation, at a slight cost in computational speed.
- **Geometry** (3D) Each particle appears as its actual geometry. Use this option for the best representation of the final animation, at the greatest cost in computational speed.
- **Diamonds** (2D) Each particle appears as a diamond.
- **Boxes** (2D) Each particle appears as a small square.
- **Asterisks** (2D) Each particle appears as an asterisk (\*).
- **Triangles** (2D) Each particle appears as a small triangle.

**Visible %** Specifies the percentage of particles visible in the viewports. This option lets you speed up viewport redrawing by reducing the number of visible particles.

**Show Particle IDs** When on, each particle's unique index number is visible in the viewports. Particles are numbered in the order of their birth, starting with 1 for the first particle born.

**[color swatch]** Shows the color for particles displayed using options other than Geometry, as well as for the particle IDs. The software chooses a different color at random for each Display operator added to the system. In addition to the Type options, using different colors helps to distinguish among particles in different events.

To change the color, click the color swatch and use the Color Selector dialog to choose a new color.

If a system has a global Display operator, and you select its Source icon in a viewport, then you can change the color of the global Display operator from the color swatch on the Modify panel. However, changing the global Display

operator's color in Particle View does not change the color of the swatch on the Modify panel.

---

**NOTE** When a Particle Flow source icon is selected, all of its non-selected particles, other than those shown as geometry, are colored white in the viewports. To see all assigned particle colors, deselect the particle system.

---

**Selected** Choose how [selected particles](#) on page 2753 appear in the viewports. The choices are the same as for Type, above.

## Force Operator

[Particle View](#) on page 2730 > Click a Force operator in an event or add a Force operator to the particle system and then select it.

The Force operator lets you influence particle motion with one or more space warps from the Forces category. Use this operator along with different forces to simulate the effects of wind, gravity, and so on. The following force space warps work with the Force operator:

- [Displace](#) on page 2645
- [Drag](#) on page 2624
- [Gravity](#) on page 2639
- [Motor](#) on page 2614
- [PBomb](#) on page 2629
- [Push](#) on page 2609
- [Vortex](#) on page 2619
- [Wind](#) on page 2642

---

**NOTE** By default, the influence of these space warps on Particle Flow particles is equivalent to their influence on the 3ds Max 2 particle systems: PArray, Super Spray, Blizzard, and PCloud. To obtain an influence on Particle Flow particles equivalent to that of the 3ds Max 1 particle systems Snow and Spray, set [Influence](#) on page 2870 to **100.0**.

---

**TIP** To make the particles follow a path, use the [Speed By Icon operator](#) on page 2796 and use Path Constraint to assign its icon to the path. For a procedure, see [Example: To send particles along a path:](#) on page 2797 .

---

To employ deflectors for particle dynamics, with or without the Force operator, use the [Collision test](#) on page 2881 and [Collision Spawn test](#) on page 2885 .

### **Script Wiring rollout**

This rollout appears in the parameters panel below the main operator rollout after you highlight the operator, right-click it, and then choose Use Script Wiring. Thereafter, a check mark appears next to the Use Script Wiring in the right-click menu, and the rollout appears whenever you highlight the operator. To turn off script wiring, choose Use Script Wiring again from the right-click menu.

Script wiring lets you use a script to control parameters that you normally specify in the operator's parameters. Place a [Script operator](#) on page 2874 before the Force operator in the event, and then use it to define values in the particleFloat channel. You'll find an example script below.

**Use Script Float As** Choose either of the following:

- **Not Used** Particle Flow uses the [Influence setting](#) on page 2870 specified in the Parameters rollout.
- **Influence** Particle Flow applies the script to the Influence setting.

### **particleFloat Sample Script**

---

**NOTE** See this topic in the online *User Reference* for the particleFloat sample MAXScript code.

---

### **Procedures**

**To affect particle motion with force space warps:**

- 1 Add one or more force space warps to the scene, and set them up as necessary.
- 2 In Particle View, add a Force operator to any events in which particles are to be affected by the forces. To affect particles in all events, add the Force operator to the PF Source instead.
- 3 Highlight the Force operator, and then use the Add or By List button to apply the force space warps to the operator.

## Interface

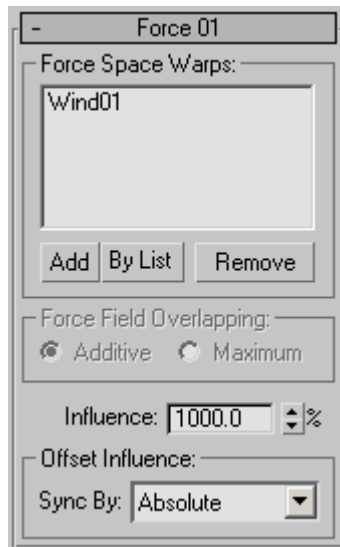

The user interface appears in the parameters panel, on the right side of the Particle View dialog.

### Force Space Warps group

This group displays the forces currently in effect, and let you add and remove forces.

**[List]** Shows the forces that apply to this operator. If more than three forces apply, a scroll bar appears at the right side of the list.

If you delete a listed space warp from the scene, its name is replaced in the list by the entry “<deleted>”.

---

**NOTE** Particle Flow applies the forces to particle motion in the order in which the space warps appear in the list; the effect is cumulative in top-to-bottom order. First, the topmost space warp is applied to particle motion, then the second space warp is applied to the result of the first space warp, and so on. Changing the order can alter the final result.

---

**Add** Click this button, and then select a force space warp in the scene to add it to the end of the list.

**By List** Click this button, and then use the Select Force Space Warps dialog to add one or more space warps to the list. The space warps must already exist in the scene.

The software adds space warps to the list in same order in which they appear in the dialog. To effect a different order, use the Add button to add them one at a time.

**Remove** Highlight a space warp in the list, and then click this button to remove it from the list. Any removed space warps remain in the scene.

**Force Field Overlapping** Determines how multiple forces that occupy the same volume of space affect the particles. With Additive, the forces are combined according to their relative strengths. With Maximum, only the force with the greatest strength affects the particles.

For example, you might apply Wind and Gravity space warps to particles, and set their Strength parameters to 1.5 and 1.0, respectively. If you choose Additive, the Wind space warp will have approximately 50 percent more influence over the particles than the Gravity space warp. But if you choose Maximum, only the Wind space warp will affect the particles.

**Influence** Specifies the strength with which the force or forces are applied to the particles as a percentage. Default=1000.0.

A negative Influence value reverses the force effects.

---

**NOTE** By default, the influence of the Force space warps on Particle Flow particles is equivalent to their influence on the 3ds Max 2 particle systems PArray, Super Spray, Blizzard, and PCloud. To obtain an influence on Particle Flow particles equivalent to that of the 3ds Max 1 particle systems Snow and Spray, set Influence=100.0 .

---

### **Offset Influence group**

Choose the time frame for applying animated parameters. For an explanation, see [Animation Offset Keying group](#) on page 2790 .

**Sync By** Choose the time frame for applying animated parameters:

- **Absolute Time** Any keys set for parameters are applied at the actual frames for which they're set.
- **Particle Age** Any keys set for parameters are applied at the corresponding frames of each particle's existence.
- **Event Duration** Any keys set for parameters are applied to each particle starting when it first enters the event.



## Notes Operator

[Particle View](#) on page 2730 > Click Notes in an event or add a Notes operator to the particle system and then select it.

The Notes operator lets you add a textual comment to any event. It doesn't have any direct effect on the particle system, but it helps you keep track of the overall function of each event.

---

**NOTE** You can also add a comment directly to an event or action by right-clicking it and choosing Comments.

---

### Interface



The user interface appears in the parameters panel, on the right side of the Particle View dialog.

The interface is a simple text box. Click in the box and enter your text.

# Render Operator

[Particle View](#) on page 2730 > Click a Render operator in an event or add a Render operator to the particle system and then select it.

The Render operator provides controls related to rendering particles. You can specify the form that rendered particles are to take, and how to convert the particles to individual mesh objects for rendering purposes.

## Interface

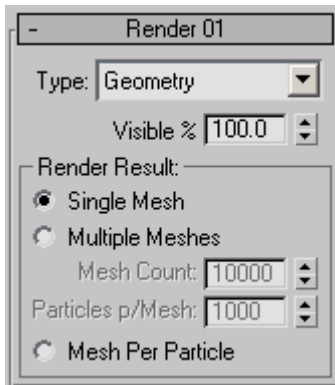

The user interface appears in the parameters panel, on the right side of the Particle View dialog.

**Type** Lets you render particles as bounding boxes or geometry, or disable the particle system at render time, or enable the particle system but prevent it from sending renderable particles to the 3ds Max renderer.  
Default=Geometry.

- **None** The particle system (or event, if used locally) is considered non-renderable, and therefore is never evaluated during render.
- **BoundingBox** Particles render as boxes whose sizes represent the particle geometry extents.  
Use this option with complex particle systems to speed up test renders.
- **Geometry** Particles render with their actual geometry.  
Use this option with simpler particle systems, and for the final render.
- **Phantom** Use this option when you want Particle Flow to function normally, calculating the animation at each frame, but not to render geometry directly. An example would be when you're using a [Final Step](#)

[Update script](#) on page 2757 to pass data from the particle system to other objects in the scene.

**Visible %** The percentage of particles that render. Range=0 to 100.  
Default=100.

Lower this value for faster rendering of complex particle systems.

You can also reduce the number of particles in the system at render time with the [Quantity Multiplier > Render setting](#) on page 2752 .

### **Render Result group**

These settings determine how the system converts particles to mesh format for rendering. By default, the software renders all particles as a single mesh per event, which provides for the most efficient operation under most conditions. However, in some situations each particle should be converted to an individual mesh object by turning on Mesh Per Particle. For example, with particles each of whose face count exceeds 10,000, it's most efficient to render a mesh per particle. Alternatively, you can opt to combine particles into multiple meshes by specifying a face count and number of particles per mesh.

Certain renderers might require a non-default setting for Render Result. Consult the renderer documentation for further information.

---

**NOTE** The number of particles Particle Flow can handle per frame is limited only by system resources, but each single mesh is allowed a maximum of 5,000,000 faces or vertices. If the total number of faces or vertices in a mesh exceeds 5,000,000, Particle Flow ignores particles beyond this limit.

---

**Single Mesh** Sends the renderer one mesh object comprising all particles in the system.

**Multiple Meshes** Sends the renderer the specified number of mesh objects, each containing the specified number of particles. If the result of dividing the total number of particles by the Particles p/Mesh value is less than the specified Mesh Count value, some of the meshes might contain few or no faces.

This is a compromise method of operation, and can be used with renderers that cannot handle all particles in a single mesh, but can deal with groups of particles of a certain size.

**Mesh Count** The maximum number of mesh objects that Particle Flow will send to the renderer.

**Particles p/Mesh** The number of particles that each mesh object will comprise.

**Mesh Per Particle** Sends the renderer a separate mesh for each particle.

This is the least efficient method of operation, but might be required by certain renderers.

---

**NOTE** With the default scanline and mental ray renderers, this method does not support rendering of particles born after the start of the rendered frame sequence. In general, use Mesh Per Particle only with renderers that require it.

---

## Script Operator

[Particle View](#) on page 2730 > Click Script Operator in an event or add a Script Operator to the particle system and then select it.

The Script operator enables control of particles within the Particle Flow system using a MAXScript script. The script can use any program functionality available to MAXScript.

When you add a new Script operator, it contains a default script that slows particles, and then, when they are slow enough, splits off the first 50 particles into a stream traveling in a negative direction on the world X axis, and the remainder traveling in the opposite direction.

---

**TIP** You can use MAXScript to align particle scale with the underlying bitmap, thus providing a “scale bitmap” function. This requires a sandwich with three operators: two Script operators, and a Speed By Surface operator in between. The first Script operator reads the current speed vector into the MXVector channel, thus caching the current speed. The Speed By Surface operator changes the speed according to the underlying bitmap. And the second Script operator reads the speed channel into a temporary variable, restores the speed from the MXVector channel (the cached value), and uses the temporary variable to define the scale. This way, the original speed is restored, and the scale value is defined by the bitmap.

---

### Interface

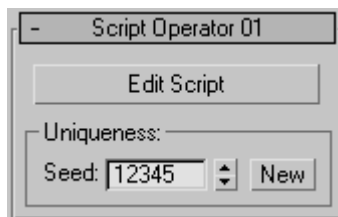

The user interface appears in the parameters panel, on the right side of the Particle View dialog.

**Edit Script** Click this button to open the current script in a MAXScript Editor window.

For detailed information about the MAXScript utility, open the MAXScript Reference, available from Help menu > MAXScript Reference.

### **Uniqueness group**

The Uniqueness setting provides a randomization seed that the script can use or ignore.

**Seed** Specifies a randomization value.

**New** Calculates a new seed using a randomization formula.

## **Flows**

The flows category contains two operators for creating initial particle system setups. These are:

[Empty Flow](#) on page 2875

[Standard Flow](#) on page 2876

**See also:**

■ [Operators](#) on page 2761

■ [Tests](#) on page 2877

## **Empty Flow**

[Particle View](#) on page 2730 > depot

Empty Flow provides a starting point for a particle system consisting of a single global event containing a Render operator. This lets you build a system completely from scratch, without having first to delete the default operators provided by the Standard Flow system.

To use Empty Flow, drag it from the depot to the event display. In Particle View, this creates a global event containing a single Render operator. If the

Global default display option is active in the Particle View > Options menu, the global event will also contain a Display operator. Adding an Empty Flow also creates a Particle Flow Source icon in the viewports, at the world origin (0,0,0).

---

**NOTE** If an orthogonal viewport is active when you add an Empty Flow to the system, the software orients the new source icon parallel to the plane of the active viewport, with the default emission direction pointing forward. For example, if the Front viewport is active, the icon is oriented parallel to the XZ plane in the world coordinate system, with the default emission direction along the positive Y axis. If a Camera or Perspective viewport is active, Particle Flow uses the default orientation: parallel to the XY plane, pointing in the negative Z direction.

---

**See also:**

- [Standard Flow](#) on page 2876

## Standard Flow

[Particle View](#) on page 2730 > depot

Standard Flow provides a starting point for a particle system consisting of a global event containing a Render operator, wired to a birth event containing a Birth, a Position, a Speed, a Rotation, a Shape, and a Display operator, with all parameters set to default values. This is the same system that the software creates automatically when you add a Particle Flow icon to the viewport.

To use Standard Flow, drag it from the depot to the event display. In Particle View, this creates the particle system described above. If the Global default display option is active in the Particle View > Options menu, the global event will also contain a Display operator. Adding a Standard Flow also creates a Particle Flow Source icon in the viewports, at the world origin (0,0,0).

---

**NOTE** If an orthogonal viewport is active when you add a Standard Flow to the system, the software orients the new source icon parallel to the plane of the active viewport, with the default emission direction pointing forward. For example, if the Front viewport is active, the icon is oriented parallel to the XZ plane in the world coordinate system, with the default emission direction along the positive Y axis. If a Camera or Perspective viewport is active, Particle Flow uses the default orientation: parallel to the XY plane, pointing in the negative Z direction.

---

**See also:**

- [Empty Flow](#) on page 2875

## Tests

The basic function of a test in Particle Flow is to determine whether particles satisfy one or more conditions, and if so, make them available for sending to another event. When a particle passes a test, it is said to “test True.” To send eligible particles to another event, you must *wire* the test to that event. Particles that don't pass the test (“test False”) remain in the event and are repeatedly subjected to its operators and tests. Or, if the test isn't wired to another event, all particles remain in the event. You can use several tests in an event; the first test checks all particles in the event, and each test after the first checks only particles that remain in the event.

One test, Spawn, doesn't actually perform a test, but simply creates new particles from existing ones, and sets the new particles' test result to True so they're automatically eligible for redirection to another event. And the Send Out test simply sends all particles to the next event by default.

Some tests can also serve as operators, in that they contain parameters that modify particle behavior. If you don't wire a test to another event, it functions only as an operator; the test aspect doesn't affect particle flow.

---

**TIP** Always place a test at the end of its event, unless you have specific reasons for placing it elsewhere. That way, all preceding actions can take effect during each integration step before the test is evaluated.

---

All the tests are grouped together in the Particle View depot, and are listed in alphabetical order. All test icons are the same: a yellow diamond containing a simplified diagram of an electrical switch.

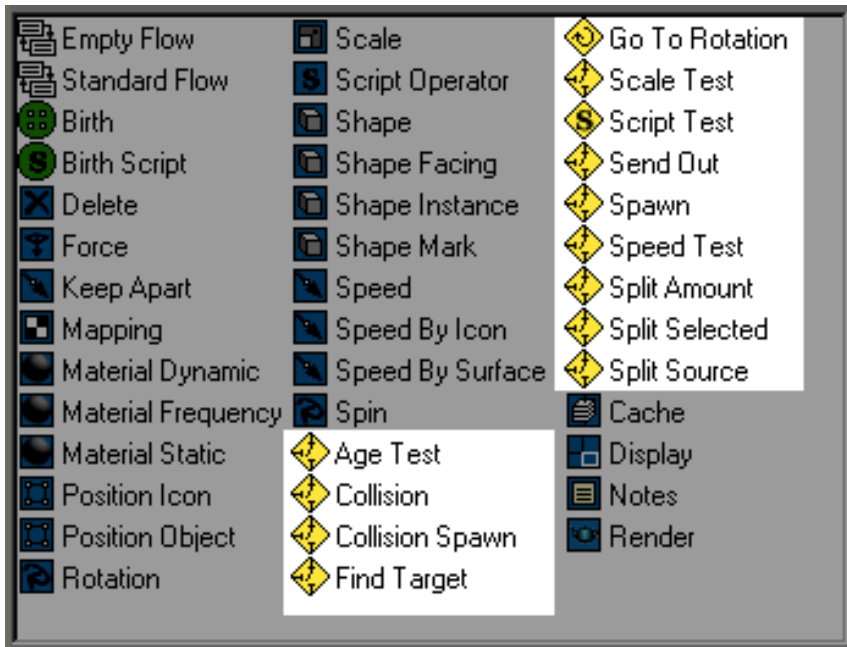

**The Particle Flow tests in the Particle View depot**

The tests are:

[Age Test](#) on page 2879

[Collision Test](#) on page 2881

[Collision Spawn Test](#) on page 2885

[Find Target Test](#) on page 2891

[Go To Rotation Test](#) on page 2902

[Scale Test](#) on page 2908

[Script Test](#) on page 2911

[Send Out Test](#) on page 2912

[Spawn Test](#) on page 2912

[Speed Test](#) on page 2917

[Split Amount Test](#) on page 2920

[Split Selected Test](#) on page 2921



[Split Source Test](#) on page 2922

See also:

- [Operators](#) on page 2761
- [Flows](#) on page 2875

## Age Test

[Particle View](#) on page 2730 > Click Age Test in an event or add Age Test to the particle system and then select it.

Age Test lets the particle system check whether a specific amount of time has passed since the start of the animation, or how long a particle has existed, or how long a particle has been in the current event, and branch accordingly.

### Interface

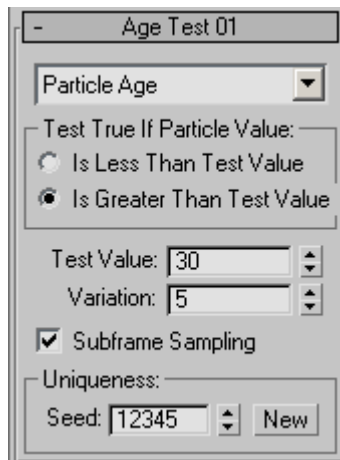

The user interface appears in the parameters panel, on the right side of the Particle View dialog.

The first interface element is a drop-down list that lets you choose the type of age to test. Default=Particle Age.

- **Absolute Age** Tests the current frame number in the animation.

- **Particle Age** Tests the current age of each particle in frames. This is the default test type.
- **Event Age** Tests the current duration of the current event in frames.

**Test True if Particle Value** Lets you specify whether the test passes particles on to the next event if the age test succeeds or fails. Default=Is Greater Than Test Value

By default, Age Test returns True if the value tested for exceeds the Test Value quantity, but you can alternatively choose Is Less Than Test Value. For example, if you use the Absolute Age test type and set Test Value=60 and Variation=0, and choose Is Less Than Test Value, then particles will move to the next event only until frame 60. After frame 60, any remaining particles stay in the current event unless another test returns True.

**Test Value** The specific frame number, particle age (in frames), or event duration (in frames) to test for. Default=30.

This value cannot be animated.

**Variation** The number of frames by which the value tested for can vary randomly. Default=5.

This value cannot be animated.

To obtain the actual test value for each particle, the system multiplies the Variation value by a random number between -1.0 and 1.0, and then adds the result to the Test Value setting. For example, if Test Value=300 and Variation=10, then tested value for each particle would be between 290 and 310.

**Subframe Sampling** Turning this on helps avoid particle "puffing" when passing particles to the next event by testing the time at a much higher subframe resolution (that is, throughout each frame), rather than using the relatively coarse frame resolution. Default=on.

"Puffing" is the effect of creating separate "puffs" or clusters of particles, rather than a continuous stream.

Turn off Subframe Sampling to cause the test to be executed exactly at frame times.

### **Uniqueness group**

The Uniqueness setting enables randomization of the test value variation.

**Seed** Specifies a randomization value.

**New** Calculates a new seed using a randomization formula.

## Collision Test

[Particle View](#) on page 2730 > Click Collision in an event or add Collision to the particle system and then select it.

Collision tests for particles that collide with one or more specified Deflector space warps. It can also test whether a particle has slowed down or sped up after one or more collisions, has collided more than once, and even whether it will collide with a deflector in a specified number of frames.

The Collision test supports all deflector space warps except the DynaFlect deflectors:

- [POmniFlect](#) on page 2650
- [SOmniFlect](#) on page 2661
- [UOmniFlect](#) on page 2664
- [SDeflector](#) on page 2669
- [UDeflector](#) on page 2672
- [Deflector](#) on page 2675

---

**TIP** When testing for collisions with multiple deflectors, for best results, place all the deflectors in a single Collision test. This tests for collisions with all the deflectors simultaneously, and helps avoid possible missed collisions.

---

**See also:**

- [Collision Spawn Test](#) on page 2885

### Procedures

**Example: To test for particles slowing down after one or more collisions:**

In the real world, particles bouncing repeatedly against a surface lose kinetic energy at each collision, and slow down gradually. Rather than testing for a specific number of bounces, you can use the Is Slow After Collision(s) to test whether particle speed has sunk below a specific level.

- 1 Start or reset 3ds Max. Set the animation length to **500** frames.

- 2 Add a Gravity space warp and a Deflector space warp. Decrease the deflector's Bounce setting below 1.0, and increase the Variation and Chaos values above 0.0. Set the deflector's Width and Length to **500**.
- 3 Create a default Particle Flow system. Position the emitter directly above the deflector.
- 4 Add a [Force operator](#) on page 2867 to the end of Event 01 and add the Gravity space warp to the Force operator.
- 5 Create a new event with a [Display operator](#) on page 2864, and change the display type to a different choice than is used in Event 01.
- 6 Add a Collision test to Event 01, below the Force operator, and wire it to the new event.
- 7 In the Collision test settings, add the deflector. Choose Is Slow After Collision(s), and set Speed Min=**100** (assuming you're using the default initial speed of 300).
- 8 Play the animation. You might need to adjust one or more settings before seeing the expected behavior.

After several bounces, the particles change in appearance and move steadily away from the deflector, indicating that they've entered the second event. Of course, you can set any behavior you like in this event.

In the next step, you'll see what happens when actions in an event are not in the right order.

- 9 In Event 01, move the Collision test above the Force operator, and then play the animation.

Quite a few particles leak through the deflector. This happens because the software first tests the particles for a collision, and then applies the Gravity force. The particles that are approaching the deflector and are very close to it are being tested for a collision, which tests False because they haven't actually struck the deflector yet. The software then applies the gravity, which pushes them past the deflector, making them no longer eligible for testing for collision. Generally speaking, it is best to keep Force operators above Collision tests in each event to ensure that particles don't leak through the deflector.

## Interface

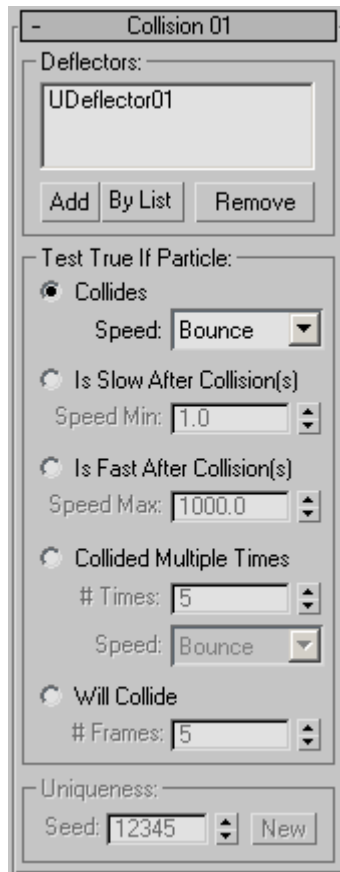

The user interface appears in the parameters panel, on the right side of the Particle View dialog.

### Deflectors group

This group displays the deflectors currently in effect, and let you add and remove deflectors.

**[list]** Shows the deflectors that apply to this operator. If more than three deflectors apply, a scroll bar appears at the right side of the list.

If you delete a listed space warp from the scene, its name is replaced in the list by the entry "<deleted>".

**Add** Click this button, and then select a Deflector space warp in the scene to add it to the list.

**By List** Click this button, and then use the Select Deflectors dialog to add one or more space warps to the list. The space warps must already exist in the scene.

**Remove** Highlight a deflector in the list, and then click this button to remove it from the list. Any removed space warps remain in the scene.

### **Test True If Particle group**

Choose the condition under which the test will pass particles on to the next event, and then adjust the associated setting or settings. Default=Collides.

**Collides** Choose this option, and then set Speed according to how particle speed should be affected by the collision.

**Speed** Choose one of the following. Default=Bounce.

- **Bounce** The speed and direction after collision is determined by the deflector properties.
- **Continue** Particle speed and direction are unaffected by the collision.
- **Stop** Particle speed is set to 0 after the collision.
- **Random** Particles bounce off the deflector in random directions.

**Is Slow After Collision(s)** The test succeeds if, after collision, particle speed is less than the Speed Min value.

With this choice, particle behavior with respect to the deflector(s) is the same as with the Collides > Bounce option.

**Speed Min** Particles traveling at less than this speed, in system units per second, test True and become eligible for moving to the next event. Default=1.0.

**Is Fast After Collision(s)** The test succeeds if, after collision, particle speed is greater than the Speed Max value.

With this choice, particle behavior with respect to the deflector(s) is the same as with the Collides > Bounce option.

**Speed Max** Particles traveling faster than this speed, in system units per second, test True and become eligible for moving to the next event. Default=1000.0.

**Collided Multiple Times** The test becomes True after a particle collides a specific number of times. The particle is moved to the point of the last collision and then redirected to the next event.

**# Times** The number of times a particle must collide in order to test True.

**Speed** Determines speed and direction after the specified number of collisions. See above for explanations of the choices.

**Will Collide** The software extrapolates particle motion in a linear fashion, based on the current direction and speed, and the test becomes True if the results suggest that the particle will collide with the deflector during a specified time interval. The particle is redirected to the next event without updating its speed or position.

**# Frames** The number of frames ahead during which the software looks for an impending collision.

### **Uniqueness group**

The Uniqueness setting enables randomization of the Random options in the Speed drop-down lists.

**Seed** Specifies a randomization value.

**New** Calculates a new seed using a randomization formula.

## **Collision Spawn Test**

[Particle View](#) on page 2730 > Click Collision Spawn in an event or add Collision Spawn to the particle system and then select it.

Collision Spawn creates new particles from existing ones that collide with one or more Deflector space warps. You can specify different post-collision behavior for the colliding particles and their offspring. Each spawned particle is born at the same location as its parent, and has the same orientation and shape. Collision Spawn can give the spawned particles a different speed and scaling factor. If you wire the Collision Spawn test to another event, spawned particles are sent to that event, where you can specify different properties for the new particles.

Examples of Collision Spawn usage include marks or explosions resulting from collisions between particles and objects. To achieve these effects, you can use Collision Spawn in conjunction with the [Shape Mark](#) on page 2832 and [Shape Facing](#) on page 2822 operators.

The Collision Spawn test supports all deflector space warps except the DynaFlect deflectors:

- [POmniFlect](#) on page 2650
- [SOmniFlect](#) on page 2661
- [UOmniFlect](#) on page 2664
- [SDeflector](#) on page 2669
- [UDeflector](#) on page 2672
- [Deflector](#) on page 2675

---

**TIP** When testing for collisions with multiple deflectors, for best results, place all the deflectors in a single Collision Spawn test. This tests for collisions with all the deflectors simultaneously, and helps avoid possible missed collisions.

---

**See also:**

- [Collision Test](#) on page 2881
- [Spawn Test](#) on page 2912



## Interface

- Collision Spawn 01

Test True for:

- Parent Particles
- Spawn Particles

Deflectors:

UDeflector01

Add By List Remove

Spawn Rate and Amount:

- Spawn On First Collision
  - Delete Parent
- Spawn On Each Collision
  - Until #: 3

Spawnable: 100.0 %

Offspring #: 1

Variation: 0.0 %

Sync By: Absolute Time

Restart Particle Age

Speed:

Parent: Bounce

Offspring: Bounce

- In Units: 100.0
- Inherited: 100.0 %

Variation: 0.0 %

Divergence: 12.0

Size:

Scale Factor: 100.0 %

Variation: 0.0 %

Uniqueness:

Seed: 12345 New

The user interface appears in the parameters panel, on the right side of the Particle View dialog.

In the context of Collision Spawn, a *parent* is the original particle from which new particles are spawned.

### **Test True for group**

These check boxes let you specify which particles, if any, should become eligible for redirection to the next event upon satisfaction of the test conditions.

---

**NOTE** After a particle tests True, the Collision Spawn test no longer tests the particle for collision. If you simply want particles to spawn every time they collide, turn either or both of these off and use a different test for redirection.

---

**Parent Particles** When on, parent particles qualify for redirection when the test conditions are met. Default=on.

When using the [Spawn On First Collision option](#) on page 2889 , Parent Particles is available only when Delete Parent is off.

This option is also available when using the [Spawn On Each Collision option](#) on page 2889 . In this case, parent particles test True only after colliding the number of times specified by the Until # value.

**Spawn Particles** When on, spawned particles qualify for redirection when the test conditions are met. Default=on.

### **Deflectors group**

This group displays the deflectors currently in effect, and let you add and remove deflectors.

**[list]** Shows the deflectors that apply to this operator. If more than three deflectors apply, a scroll bar appears at the right side of the list.

If you delete a listed space warp from the scene, its name is replaced in the list by the entry "<deleted>".

**Add** Click this button, and then select a Deflector space warp in the scene to add it to the list.

**By List** Click this button, and then use the Select Deflectors dialog to add one or more space warps to the list. The space warps must already exist in the scene.

**Remove** Highlight a deflector in the list, and then click this button to remove it from the list. Any removed space warps remain in the scene.

### **Spawn Rate And Amount group**

Use these settings to specify when particles are to spawn and other values related to how many particles are spawned.

**Spawn On First Collision** Particles spawn only the first time they collide with a deflector.

**Delete Parent** When on, deletes each original particle from which a new one is spawned. Available only with the Spawn On First Collision option.

**Spawn On Each Collision** Particles spawn on each of multiple collisions, up to a limit specified with the Until # parameter.

**Until #** The maximum number of collisions by the parent particles that produce spawned particles. Available only with the Spawn On Each Collision option. Default=3.

When Test True For > Parent Particles is on, parent particles test True only after colliding the number of times specified by the Until # value.

**Spawnable** The percentage of particles in the current event that will spawn new particles. This is determined once for each particle, when it enters the event. However, the parameter is animatable. Default=100.0.

For values other than 100.0, Spawnable uses a randomized selection process, which is affected by the Uniqueness Seed value. For example, with five parent particles, Offspring #=1, and Spawnable=80.0, you might get any number of spawned particles between two and five for each collision. The average per spawning would be four, however.

**Offspring #** The number of new particles the system creates from each parent particle for each spawning event. Default=1.

**Variation** The amount by which the Offspring # value can vary randomly. Default=0.0.

To obtain the actual test value for each particle, the system multiplies the Variation value by a random number between -1.0 and 1.0, and then applies the result as a percentage of the Offspring # setting. For example, if Offspring #=20 and Variation=10, then the actual number of offspring for each particle would be between 18 and 22.

**Sync By** Choose the time frame to use when animating Offspring # and Variation:

- **Absolute Time** Any keys set for parameters are applied at the actual frames for which they're set.
- **Particle Age** Any keys set for parameters are applied at the corresponding frames of each particle's existence.
- **Event Duration** Any keys set for parameters are applied to each particle starting when it first enters the event.
- **Restart Particle Age** When on, sets the age of each newly spawned particle at 0. When off, each spawned particle inherits its parent's age. Default=on.

### Speed group

Lets you specify the behavior of spawned particles, as well as their speed in absolute terms or relative to the parents' speed, with optional random variation. The direction of a spawned particle is always in relation to that of its parent, but you can set a Divergence so they eventually spread out. Default=Inherited.

**Parent** Specify the parent's behavior. Available only when Delete Parent is off.

- **Bounce** The speed and direction after collision is determined by the deflector properties.
- **Continue** Particle speed and direction are unaffected by the collision.

**Offspring** Specify the behavior of the newly spawned particles.

- **Bounce** The speed and direction of offspring after collision is determined by the deflector properties.
- **Continue** Speed and direction of offspring are unaffected by the collision.

**In Units** Choose this to specify the speed of spawned particles in system units per second. Default=100.0.

A positive value inherits the parent's direction; a negative value reverses it.

**Inherited** Choose this to specify each spawned particle's speed as a percentage of its parent's speed. Default=100.0

A positive value inherits the parent's direction; a negative value reverses it.

**Variation** The amount by which a spawned particle's speed can vary randomly. Default=0.0.

To obtain the actual speed for each spawned particle, the system multiplies the Variation value by a random number between -1.0 and 1.0, and then adds the result to the particle's speed as specified or inherited. For example, if a particle's speed is 100 units/second and Variation=20, then the tested value for each particle would be between 80 and 120 units/second.

**Divergence** When on, spreads out the stream of spawned particles. Use the numeric setting to define the extent of the divergence in degrees. Range=0 to 180. Default=0.

### **Size group**

**Scale Factor** The amount of uniform scaling to apply to each spawned particle, as a percentage of its parent's size. Default=100.0.

**Variation** The amount by which a spawned particle's scale can vary randomly. Default=0.0.

To obtain the actual scaling for each spawned particle, the system multiplies the Variation value by a random number between -1.0 and 1.0, and then adds the result to the Scale Factor value. For example, if Scale Factor=100 and Variation=20, then each spawned particle would be between 80 and 120 percent of its parent's size.

### **Uniqueness group**

The Uniqueness setting enables randomization of the Spawnable result, when less than 100.0, as well as of the Variation values.

**Seed** Specifies a randomization value.

**New** Calculates a new seed using a randomization formula.

## **Find Target Test**

[Particle View](#) on page 2730 > Click Find Target in an event or add Find Target to the particle system and then select it.

Select a Find Target icon in the viewport. > Modify panel > Parameters rollout  
Create panel > Helpers > Particle Flow > Find Target

By default, Find Target sends particles to a specified target or targets. Upon reaching a target, the particles become eligible for redirection to another event. You can specify that the particles should use a particular speed or time frame in moving toward the target. You can also specify where on the target the particles should go.

Alternatively, you can use Find Target as a simple proximity test: If a particle comes within a certain distance of its target, it becomes eligible for redirection to the next event.

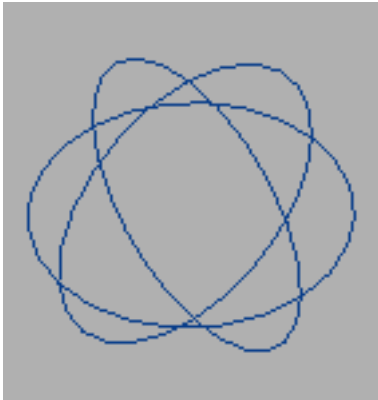

**Find Target icon**

When you add a Find Target test to the particle system in [Particle View](#) on page 2730, a spherical Find Target icon appears in the scene at the world origin (0,0,0). You can use this icon as a target, or you can use one or more mesh objects in the scene as targets. To display the Find Target parameters on the Modify panel, select the icon. If you delete the icon, the software also deletes the test.

---

**NOTE** If you add Find Target from the Create panel, Particle Flow creates a separate event for the test in the particle diagram.

---

**TIP** In a particle loop, all particles end up at their respective starting positions, enabling seamless repetition of the resulting animation. You can make particle loops with Particle Flow using a Script operator and a Find Target operator. At the start of the loop, the Script operator should read all particle positions and write them into the MXS Vector channel. Then, at the end of the loop, set the Find Target operator to Control by Time, set Timing to Absolute Time, set Time to the end of the loop, and in the Target group, set Point to By Script Vector. Particle Flow will direct particles to the previously cached position at the specified frame.

---

## Script Operator Example

---

**NOTE** See this topic in the online *User Reference* to view the script operator sample MAXScript code.

---

## Interface

- Find Target 01

Control By Speed ▾

Test True If Distance To:

Target Point ▾

Is Less Than: 1.0 ▾

Control By Speed:

Use Cruise Speed

Speed: 300.0 ▾

Variation: 0.0 ▾

Accel Limit: 1000.0 ▾

Ease In % 0.0 ▾

Sync By: Absolute Time ▾

Target:

Icon  Mesh Objects

Sphere02  
Sphere01

Add By List Remove

Sync By: Absolute Time ▾

Animated Shape

Follow Target Animation

Point: Random ▾

Object: Random ▾

Lock On Target Object

Docking Direction:

Type: None Specified ▾

Distance: 10.0 ▾

Icon Size: 30.0 ▾

Color Coordinated

Uniqueness:

Seed: 12345 ▾ New



The user interface appears in the parameters panel, on the right side of the Particle View dialog.

**Control By ...** The drop-down list at the top of the parameters panel lets you choose whether to send particles to a target by specifying the speed and acceleration, or by specifying the amount of time they should take. Alternatively, by choosing No Control, you can test particles' distance from a target.

- **Control By Speed** Specify speed and acceleration settings for the particles to follow while traveling to the target. Use the Control By Speed group to set the parameters.
- **Control By Time** Specify time-based settings for the particles to follow while traveling to the target. Use the Control By Time group to set the parameters.
- **No Control** With this option, Find Target functions only as a proximity test. When a particle comes within the specified distance of the target, the particles become eligible for redirection to the next event.

---

**NOTE** When you choose No Control, the Find Target test does not affect particle speed or direction.

---

### **Test True If Distance To group**

These settings let you choose which distance the Find Target test measures and specify the measured distance. You can choose Target Pivot or Target Point, and specify a distance with the Is Less Than setting.

**Target Pivot** Measures the distance between the particle and the target pivot.

If the particles are directed to the outside of the target and the Is Less Than value is small, this condition might never be satisfied.

**Target Point** Measures the distance between the particle and the [target point](#) on page 2899 .

**Is Less Than** When particles are closer than this distance from target pivot or point, they test True and become eligible for redirection to the next event. Measured in scene units.

---

**NOTE** If you set Is Less Than to 0, the particles might never test True. This might be desirable for an animation of, for example, bees buzzing around a flower but not landing on it. In this case, you might want to use a low value for Accel Limit so the bees don't circle too close to the flower.

---

## Control By Speed group

Use these settings to specify speed and acceleration parameters when using Control By Speed or Speed Then Time. This group is available only when using Control By Speed.

**Use Cruise Speed** When on, the software gives you explicit control over particle speed and speed variation. When off, the software calculates particle speed automatically using the Accel Limit value. Default=on.

**Speed** Particle speed in scene units per second. Default=300.0.

**Variation** The amount by which the actual Speed value can vary randomly. Default=0.0.

To obtain the actual speed for each particle, the system multiplies the Variation value by a random number between -1.0 and 1.0, and then applies the result as a percentage of the Speed setting. For example, if Speed=200 and Variation=10, then the actual speed for each particle would vary randomly between 190 and 210.

**Accel Limit** Sets the acceleration limit. This value impacts the inertia and speed of the particles. Default=1000.0.

The default acceleration limit value is based on the default Speed value of 300.0. If you change the Speed value, it is recommended that you also change the Accel Limit value proportionately.

---

**TIP** Use a lower Accel Limit value for smooth motion, and a higher value when greater accuracy is needed, such as when the particles should hit a small target. You can animate this setting (use Sync By > Event Duration) to specify different appropriate values, depending on the required results.

---

**Ease In %** Controls the rate by which particles slow down when it approaches the target point.

The software calculates the final speed with this formula:  $(100\% - \text{Ease In}) * \text{Speed}$ . Therefore, if the Ease In value is 100%, a particle should approach the target with a speed of 0, and if Ease In is 0%, the particle doesn't slow down at all when approaching the target. At intermediate values, the speed is calculated according to the distance to the target point, as linear interpolation between the initial (cruise) speed, and the final speed. When a particle enters the event, the distance to the target point is calculated and later used for the interpolation. Default=0.0.

**Sync By** Choose the time frame to use when animating Speed, Variation, and Accel Limit:

- **Absolute Time** Any keys set for parameters are applied at the actual frames for which they're set.
- **Particle Age** Any keys set for parameters are applied at the corresponding frames of each particle's existence.
- **Event Duration** Any keys set for parameters are applied to each particle starting when it first enters the event.

### Control By Time group

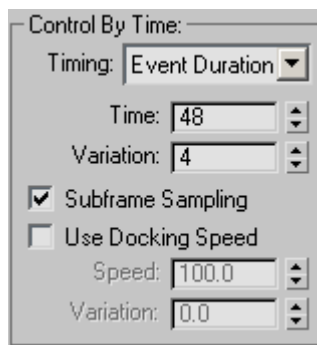

Lets you specify the amount of time particles should take to reach the target.

This group is unavailable when using Control By Speed.

**Timing** Determines how the software applies the specified timing, defined by the Time and Variation values. The possible options are:

- **Absolute Time** Time refers to the overall time of the system. Each particle will reach its target at the frame number specified by Time.
- **Particle Age** Time refers to the time elapsed since the birth of the particle. Each particle will reach its target when its age reaches the value specified by Time.
- **Event Duration** Time refers to the time elapsed since the particle entered the current event. Each particle will reach its target when it has been in the current for the number of frames specified by Time.

**Time** The number of frames particles should take to reach the target.  
Default=60.

**Variation** The number of frames by which Time can vary randomly. Default=5.

To obtain the actual time to the target for each spawned particle, the system multiplies the Variation value by a random number between -1.0 and 1.0, and then adds the result to the Time value. For example, if Time=60 and Variation=20, then the time to target for each particle would be between 40 and 80 frames.

**Subframe Sampling** Turning this on helps avoid particle "puffing" by timing particles at a much higher subframe resolution (that is, throughout each frame), rather than using the relatively coarse frame resolution. Default=on.

"Puffing" is the effect of clustering particles, rather than producing a continuous stream. This effect is especially noticeable when the emitter is animated.

**Use Docking Speed** Lets you specify particles' speed when they reach the target.

A particle might be required to reach the target from a specific direction at a specific speed. When Use Docking Speed is off, the software calculates a path for particles to reach the target in the shortest distance with the least acceleration along the path. When Use Docking Speed is on, the software calculates particles' final speed when they reach the target using the Speed and Variation parameters. Therefore if you want a "smooth landing," set Speed to 0.0. Default=off.

**Speed** The speed of particles when they reach the target in scene units per second. Default=100.0.

**Variation** The amount by which the actual Speed value can vary randomly. Default=0.0.

## **Target group**

By default, Find Target uses its own target icon, but you can use these controls to designate other scene objects as targets instead.

**Icon** Use the Find Target icon as the target.

Each Find Target test has its own target icon. Even if you don't use it as a target, it still influences particle behavior if you set the docking type to Parallel, Spherical, or Cylindrical.

**Mesh Objects** Use one or more scene mesh objects as targets. Choose this to make the list and list-management buttons available.

If you designate more than one target, the target used by each particle is determined by the choice in the [Object drop-down list](#) on page 2900 in this group.

**[list]** Shows the mesh objects used as targets. If more than three target objects apply, a scroll bar appears at the right side of the list.

**Add** Click this button, and then select a mesh object in the scene to add it to the list as a target.

**By List** Click this button, and then use the Select Target Objects dialog to add one or more mesh objects to the list. The objects must already exist in the scene, and the dialog shows only eligible objects.

**Remove** To remove a target object from the list, first highlight it and then click this button. Any removed objects remain in the scene.

**Sync By** Choose the time frame to use when sending particles toward animated objects when using Animated Shape or Follow Target Animation:

- **Absolute Time** Animation derived from the target is applied to particles immediately.
- **Particle Age** Animation derived from the target is applied to particles at the corresponding frames of each particle's existence.
- **Event Duration** Animation derived from the target is applied to particles is applied to each particle starting when it first enters the event.

**Animated Shape** Turn on to allow particles to target the surface of an object whose form is animated by scaling, by morphing, or with modifiers. This requires more computation, because the destination must be updated at every integration step.

**Follow Target Animation** Turn on to allow particles to follow a moving target; that is, a target whose location is animated. This requires more computation, because the destination must be updated at every integration step.

**Point** Lets you specify where on its target a particle should land.

- **Random** Each particle targets a random point on the target.
- **Closest Surface** Each particle targets the nearest point of the target's surface.

- **By Script Vector** The target point or points are defined using a Script operator that defines values in the particleVector channel. The Script operator can be anywhere upstream of the Find Target test.

---

**NOTE** When using By Script Vector to target absolute positions, such as vertex locations, be sure to set Target to Icon. If you set it to Mesh, the positions specified by the script will be relative to the position of the mesh object. This latter option is useful for placing scripted targets on the surface of a moving object.

---

**Object** With multiple mesh targets, lets you specify how the software should choose among them. Available only when targeting more than one object.

- **Random** For each particle, the software chooses a target object at random.
- **Closest Pivot** For each particle, the software chooses as its target the object whose pivot is nearest to the particle.
- **Closest Surface** For each particle, the software chooses as its target the object whose surface is nearest to the particle.
- **Least Deviation** For each particle, the software chooses as its target the object that requires the least change in its current direction (or resteeering) to reach.
- **By Script Integer** For each particle, the choice of a targeted object is defined by a script operator that sets an index. This index corresponds to a target-object entry position in the target list. See [Script Operator Example](#) on page 2893 .

**Lock On Target Object** When on, the software calculates each particle's target object once: when the particle enters the event. Thereafter, the particle is “locked on” to its target object. When off, the software can continually recalculate the target object for each particle. Available only when multiple target objects are designated.

For example, if you set particles to target the closest surface, due to the target animation and particle movement, the definition of the closest surface is constantly changing. Thus the particle may change the target object due to the circumstances.

---

**NOTE** Each time Find Target sets a target object, it “locks on” to a specific point on that object. This point can change only if the target object changes. Thus, with a single target object, the target point always remains constant *relative to the target object*. That is, if the target object or its surface is animated, and Follow Target Animation or Animated Shape is on, the absolute coordinates of the target point may change.

---

**NOTE** When Lock On Target Object is off, more calculation is required because the system might have to recalculate each particle's optimal target point in each frame.

---

## Docking Direction group

**Docking type** Lets you specify from which direction particles should approach targets.

- **None Specified** No docking constraints. Particles reach their targets in the most efficient way, based on their assigned parameters and their current attributes.
- **Along Icon Arrow** The final direction is the same as the Find Target icon arrow.

---

**NOTE** When using this option, arrows appear on the Find Target icon to indicate the direction particles will use for docking. You can change the docking direction by reorienting the icon. This applies even when using mesh objects as targets.

---

- **Icon Spherical** The final direction points toward the center of the operator icon.

---

**NOTE** When using this option, arrows appear on the Find Target icon to indicate the directions particles will use for docking. You can change the docking directions by reorienting the icon. This applies even when using mesh objects as targets.

---

- **Icon Cylindrical** The final direction points toward the icon arrow as a line, thus forming a cylindrical field with the arrow as the cylinder's main axis.

---

**NOTE** When using this option, arrows appear on the Find Target icon to indicate the directions particles will use for docking. You can change the docking directions by reorienting the icon. This applies even when using mesh objects as targets.

---

- **Surface Normals** Each particle reaches its target point from a direction perpendicular to the surface at that point.

---

**NOTE** When using this option, arrows appear on the Find Target icon to indicate that particles will use surface normals for docking; the actual directions they will use depends on the target surface. This applies even when using mesh objects as targets.

---

**Distance** The distance from the target at which particles begin docking behavior. This includes the docking direction, and, when using Control By Time, the docking speed.

**Icon Size** Set the size of the Find Target icon. This affects particle behavior when using the icon as the target.

**Color Coordinated** When on, the Find Target icon uses the color of the event containing the test as defined by its local Display operator, if one exists. This applies even if the Display operator is turned off. When off, the Find Target icon uses the default Test Gizmos color as defined in Customize User Interface > Colors > Particle Flow. Default=on.

Turn on Color Coordinated to make it easier to spot the Find Target icon, because the particles in the event use the same color as the icon.

### **Uniqueness group**

The Uniqueness setting enables randomization of the Random options and the Variation options.

**Seed** Specifies a randomization value.

**New** Calculates a new seed using a randomization formula.

## **Go To Rotation Test**

[Particle View](#) on page 2730 > Click Go To Rotation in an event or add Go To Rotation to the particle system and then select it.



The Go To Rotation test enables a smooth transition in the rotational component of a particle, so that the particle can gradually rotate to a specific orientation over a specific period. An example of its usage would be with falling leaves, which spin chaotically as they fall, but land on a flat side rather than an edge. The test aspect lets you direct the particle to a new event when the transition period ends.

To set a target orientation, place the Go To Rotation test *before* an orientation-type operator ( [Rotation](#) on page 2781 or a [Script operator](#) on page 2874 if it defines the rotation channel) in the same event. In this situation, the Go To Rotation test can grab the particle rotational component before the orientation-type operator overwrites it. The Go To Rotation operator modifies the particle orientation and spinning in the post-evaluation cycle. For an example, see the procedure below.

---

**WARNING** The Go To Rotation test is not compatible with the Spin, Shape Facing, and Shape Mark operators. Do not use any of these operators in the same event with a Go To Rotation test.

---

**NOTE** You can define the transition period only in terms of time. You cannot set the test to come to a specific rotation by the time of another test, such as a collision test. Also, limited control is provided over the axis of spinning when a particle comes to the final rotation.

---

## Procedures

### Example: To make falling particles land smoothly, face up:

This procedure assumes a basic knowledge of Particle Flow usage.

- 1 In the Perspective viewport, add a Particle Flow system and raise its icon about 80 units on the Z axis.
- 2 In Event 01, make the following changes:
  - Birth > Amount=**50**
  - Speed=**100**
  - Shape=Cube (or use Shape Instance with a custom object, such as a coin-shaped cylinder)
  - Display > Type=Geometry

This reduces the number of particles and slows them down, making it easier to see what's going on.

- 3** Add a [Spin operator](#) on page 2783 to Event 01, and set both Spin Rate and Variation to **150**.  
This gives the particles random spinning behavior as they fall.
- 4** Add an Age test to the end of Event 01, and set Test Value=15.  
This allows each particle to fall and tumble for 15 frames before Go To Rotation takes effect.
- 5** From the Depot, drag a Go To Rotation test to an empty area in Event Display. Set Duration=**15** and keep all other default settings.
- 6** Insert a Rotation operator immediately *after* the Go To Rotation test. Choose Random Horizontal as the orientation matrix. Keep the other default settings.  
The Go To Rotation test will use this as the final orientation for the particles.
- 7** Use a Speed event to create a third event. Set Speed=**0.0**.  
This stops the particles at the end of the animation.
- 8** In both new events, set Display > Type=Geometry.
- 9** Wire the Age Test in Event 01 to Event 02, and then wire the Go To Rotation test in Event 02 to Event 03.
- 10** Play the animation.  
The particles tumble chaotically as they fall for about 30 frames, and then come to a smooth stop, facing up.

## Interface

The image shows a software interface for configuring a 'Go To Rotation 01' event. The panel is organized into several sections:

- Test True When:** A checkbox labeled 'Transition Period Ends' is checked.
- Transition By:** A dropdown menu is set to 'Event Duration'. Below it are two numeric input fields: 'Duration' with the value '30' and 'Variation' with the value '0'.
- Target Rotation:** Two radio buttons are present: 'Constant' (selected) and 'Changing'.
- Target Rotation Spin:** A checkbox labeled 'Match Initial Spin' is checked. Below it are three numeric input fields: 'Spin Rate' with '0.0', 'Variation' with '0.0', and 'Ease In %' with '0.0'.
- Transition End:** A checkbox labeled 'Stop Spinning' is checked.
- Uniqueness:** A 'Seed' input field contains '12345' and a 'New' button is located to its right.

The user interface appears in the parameters panel, on the right side of the Particle View dialog.

### Test True When group

**Transition Period Ends** When on, the particles test True at the end of the specified transition period, and become eligible for redirection to the next event. When off, particles will not go to the next event, even if wired. Turn off to disable the test aspect of Go To Rotation. Default=on.

### Transition By group

Determines how the software applies the specified timing, defined by the Time and Variation values. Default=Event Duration.

The possible options are:

- **Absolute Time** Time refers to the overall time of the system. Each particle will reach its target orientation at the frame number specified by Time.
- **Particle Age** Time refers to the time elapsed since the birth of the particle. Each particle will reach its target orientation when its age reaches the value specified by Time.
- **Event Duration** Time refers to the time elapsed since the particle entered the current event. Each particle will reach its target orientation when it has been in the current for the number of frames specified by Time.

**Duration** The number of frames particles should take to reach the target orientation. Default=30.

**Variation** The number of frames by which Duration can vary randomly. Default=0.

To obtain the actual time to the target orientation for each particle, the system multiplies the Variation value by a random number between -1.0 and 1.0, and then adds the result to the Duration value. For example, if Duration=60 and Variation=20, then the time to target orientation for each particle would be between 40 and 80 frames.

### **Target Rotation group**

When you use an orientation-type operator with Go To Rotation, this setting lets you determine whether the test sets the target orientation on a one-time or ongoing basis. Default=Constant.

**Constant** Defines that the orientation-type operator sets a constant orientation for a particle.

For example, when using a Rotation operator set to an orientation matrix other than Speed Space Follow, the Go To Rotation operator would acquire the target orientation only once, and then use it as its goal.

**Changing** Defines that the orientation-type operator sets a changing rotation for a particle. At each frame the desirable final rotation may be different.

For example, if you use the test with a Rotation operator set to Speed Space Follow, the test will adjust the particle rotation constantly to aim at the changing final rotation.

## Target Rotation Spin group

Defines the angular velocity for each particle when it reaches the target orientation.

**Match Initial Spin** Sets the angular velocity at the end of the transition period to the same as the angular velocity when particle enters the event.

---

**NOTE** The axis of rotation might still be different, because it is calculated on the fly to let the particle come to the target orientation.

---

**Spin Rate** Defines each particle's angular velocity, in degrees per second, when it reaches the target orientation. Available only when Match Initial Spin is off. Default=0.0.

For a smooth transition to the target orientation, set to **0.0**.

**Variation** Defines a random variation in the Spin Rate value when a particle reaches the target orientation. Default=0.0.

To obtain the final angular velocity for each particle, the system multiplies the Variation value by a random number between -1.0 and 1.0, and then adds the result to the Spin Rate value. For example, if Spin Rate=6.0 and Variation=1.0, then the final angular velocity for each particle would be between 5.0 and 7.0 degrees per second.

**Ease In %** Defines a curve in achieving the final spin rate. Default=0.0

When set to 0.0, the test produces a linear interpolation between the initial and final spin rate, and when set to 100.0, the final spin rate is achieved earlier. For the smoothest approach to the target orientation, set Spin Rate and Variation to 0.0, and Ease In to 100.0.

## Transition End group

**Stop Spinning** When on, halts particle rotation when it reaches the target orientation. Default=on.

Even with Spin Rate spinner set to 0.0, we recommend that you keep this check box on to avoid slow spinning at the end, due to computational averaging and marginal errors.

## Uniqueness group

The Uniqueness setting enables randomization of the Variation options.

**Seed** Specifies a randomization value.

**New** Calculates a new seed using a randomization formula.

## Scale Test

[Particle View](#) on page 2730 > Click Scale Test in an event or add Scale Test to the particle system and then select it.

Scale Test lets the particle system check particle scaling, or particle size before or after scaling, and branch accordingly. The test provides a variety of axis options for measuring scale or size.

You can use this test to cause a change in behavior based on size. For example, a bubble could grow to a certain size, and then pop. Or an object could shrink in size until it falls under the influence of a force, like wind.

### Interface

The screenshot shows the configuration window for a 'Scale Test 01'. The interface includes several sections with dropdown menus, radio buttons, and input fields with spinners.

- Type:** Scale
- Axis:** Average
- Test True If Particle Value:**
  - Is Less Than Test Value
  - Is Greater Than Test Value
- Size:**
  - Test Value: 10.0
  - Variation: 0.0
- Scale:**
  - Test Value %: 100.0
  - Variation %: 0.0
- Test Value Offset Keying:**
  - Sync By: Absolute Time
- Uniqueness:**
  - Seed: 12345
  - Buttons: New

The user interface appears in the parameters panel, on the right side of the Particle View dialog.

**Type** Choose the type of measurement to test. You can test actual scaling, or the size before or after scaling. Default=Scale.

For example, if the X-axis size of a particle's bounding box starts out at 10 system units, and you then use the Scale operator to scale it by 150% on the X axis, the pre-scale size is 10, and the post-scale size is 15. And, of course, the scale is 150.

---

**NOTE** The software measures particle size based on each particle's bounding-box dimensions in the particle's local coordinate space. With the low-polygon Shape options Tetra and Sphere, the result of this measurement might not be the same as the Shape operator's Size value.

---

- **PreScale Size** Tests the size before scaling.
- **PostScale Size** Tests the size after scaling.
- **Scale** Tests the scaling percentage.

**Axis** Choose the axis to measure. Default=Average.

- **Average** Obtains an average measurement by adding the sizes on all three axes and then dividing by three.
- **Minimum** Uses the smallest dimension.
- **Median** Uses the middle dimension in order of size. For example, if the particle dimensions are X=5, Y=6, Z=12, then the number compared to Test Value would be 6.
- **Maximum** Uses the largest dimension.
- **X/Y/Z** Uses the specified dimension.

**Test True if Particle Value** Lets you specify whether the test passes particles on to the next event if the speed test succeeds or fails. Available for all tests except True When Accelerates/Decelerates. Default=Is Greater Than Test Value.

By default, Scale Test returns True if the value tested for exceeds the Test Value quantity, but you can alternatively choose Is Less Than Test Value. For example, if you set Type to Scale and set Test Value=150 and Variation=0, and choose Is Less Than Test Value, a particle will move to the next event only when its scaling factor is less than 150%.

## Size group

These settings are available when Type is set to PreScale Size or PostScale Size.

**Test Value** The specific size to test for. Default=10.0.

**Variation** The amount by which the value tested for can vary randomly. Default=0.0.

To obtain the actual test value for each particle, the system multiplies the Variation value by a random number between -1.0 and 1.0, and then adds the result to the Test Value setting. For example, if Test Value=10 and Variation=5, then the tested value for each particle would be between 5 and 15.

## Scale group

These settings are available when Type is set to Scale.

**Test Value** The specific scaling factor to test for. Default=100%.

**Variation** The amount by which the value tested for can vary randomly. Default=0.0%.

To obtain the actual test value for each particle, the system multiplies the Variation value by a random number between -1.0 and 1.0, and then adds the result to the Test Value setting. For example, if Test Value=100% and Variation=10%, then the tested value for each particle would be between 90% and 110%.

## Test Value Offset Keying group

**Sync By** Choose the time frame to use when animating Test Value and Variation:

- **Absolute Time** Any keys set for parameters are applied at the actual frames for which they're set.
- **Particle Age** Any keys set for parameters are applied at the corresponding frames of each particle's existence.
- **Event Duration** Any keys set for parameters are applied to each particle starting when it first enters the event.

## Uniqueness group

The Uniqueness setting enables randomization of the test value variation. Available only when either Variation value exceeds 0.0.



**Seed** Specifies a randomization value.

**New** Calculates a new seed using a randomization formula.

## Script Test

[Particle View](#) on page 2730 > Click Script Test in an event or add a Script Test operator to the particle system and then select it.

Script Test lets you test particle conditions using a MAXScript script. The script can use any program functionality available to MAXScript.

The default test script tests for the presence of all particles within a spherical volume of radius 20.

### Interface

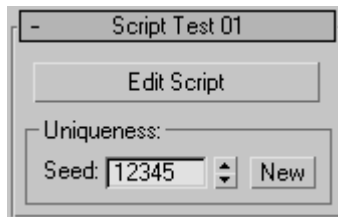

The user interface appears in the parameters panel, on the right side of the Particle View dialog.

**Edit Script** Click this button to open the current script in a MAXScript Editor window.

For detailed information about the MAXScript utility, open the MAXScript Reference, available from Help menu > MAXScript Reference.

### Uniqueness group

The Uniqueness setting provides a randomization seed that the script can use or ignore.

**Seed** Specifies a randomization value.

**New** Calculates a new seed using a randomization formula.

## Send Out Test

[Particle View](#) on page 2730 > Click Send Out in an event or add Send Out to the particle system and then select it.

The Send Out test simply sends all particles to the next event, or, conversely, keeps all particles in the current event. Use Send Out when you simply want to send particles to another event without any conditions.

---

**TIP** You can temporarily convert any test to Send Out. To specify that a test should send all particles out without any conditions, click the left side of its icon in Particle view; the icon changes to a green light bulb to indicate that all particles automatically test True. Or, if you click the right side of the icon, it changes to a red light bulb, indicating that all particles test False and thus will stay in the current event. To revert to the test's original function, click its icon again.

---

### Interface

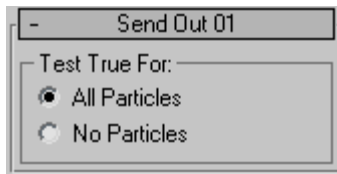

The user interface appears in the parameters panel, on the right side of the Particle View dialog.

**Test True For** Lets you specify whether the test passes all particles on to the next event or keeps them in the current event. Default=All Particles.

- **All Particles** All particles are passed on to the next event.
- **No Particles** All particles are retained in the current event.

## Spawn Test

[Particle View](#) on page 2730 > Click Spawn in an event or add Spawn to the particle system and then select it.

Spawn creates new particles from existing ones. Each spawned particle is born at the same location as its parent, and has the same orientation and shape. Spawn can give the spawned particles a different speed and scaling factor. If

you wire the Spawn test to another event, spawned particles are sent to that event, where you can specify different properties for the new particles.

Spawn is a test only in that it sends the spawned particles to another event (if wired); it doesn't actually test any properties. All particles that encounter Spawn are immediately affected by it. Thus, if you want particles to spawn based on the results of a test, use a different test that branches to an event containing the Spawn. In such a case, you might want to then send the spawned particles to yet another event, or the particles will continually respawn. Alternatively, to spawn particles after a collision, use [Collision Spawn Test](#) on page 2885 .

**See also:**

- [Collision Spawn Test](#) on page 2885

## Interface

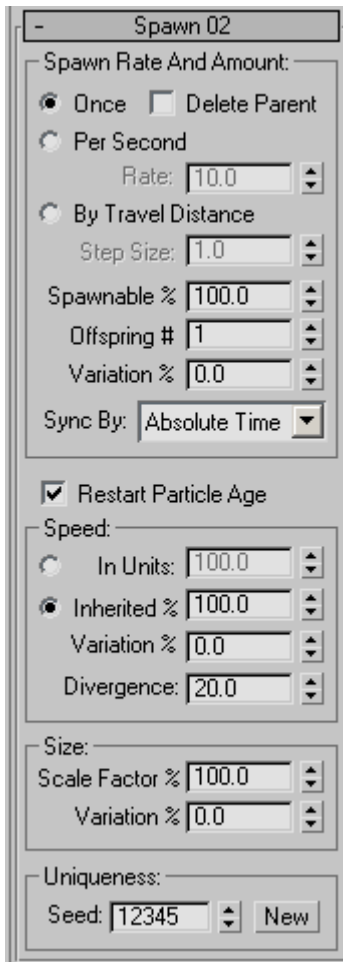

The user interface appears in the parameters panel, on the right side of the Particle View dialog.

In the context of Spawn, a *parent* is the original particle from which new particles are spawned.

### Spawn Rate And Amount group

Use these settings to specify how often particles are to spawn, the measurement system to use, and other values related to how many particles are spawned.

**Once** Particles spawn one time only. For each existing particle, one new one is born.

**Delete Parent** When on, deletes each original particle from which a new one is spawned. Available only with the Once option.

**Per Second** Lets you specify a number of particles to spawn every second. For example, if you use the default Rate setting of 10.0, at 30 fps a new particle is born every three frames.

**Rate** The number of particles to spawn per second. Available only with the Per Second option.

**By Travel Distance** Lets you spawn new particles at regular intervals over the path of a moving parent particle.

**Step Size** The system spawns a new particle every time the parent moves this distance, in system units.

**Spawnable** The percentage of particles in the current event that will spawn new particles. This is determined once for each particle, when it enters the event. However, the parameter is animatable. Default=100.0.

For values other than 100.0, Spawnable uses a randomized selection process, which is affected by the Uniqueness Seed value. For example, with five parent particles, Offspring #=1, and Spawnable=80.0, you might get any number of spawned particles between two and five. The average per spawning would be four, however.

**Offspring #** The number of new particles the system creates from each parent particle for each spawning event. Default=1.

**Variation** The amount by which the Offspring # value can vary randomly. Default=0.0.

To obtain the actual test value for each particle, the system multiplies the Variation value by a random number between -1.0 and 1.0, and then applies the result as a percentage of the Offspring # setting. For example, if Offspring #=20 and Variation=10, then the actual number of offspring for each particle would be between 18 and 22.

**Sync By** Choose the time frame to use when animating Rate, Step Size, Offspring #, and Variation:

- **Absolute Time** Any keys set for parameters are applied at the actual frames for which they're set.
- **Particle Age** Any keys set for parameters are applied at the corresponding frames of each particle's existence.

- **Event Duration** Any keys set for parameters are applied to each particle starting when it first enters the event.

**Restart Particle Age** When on, sets the age of each newly spawned particle at 0. When off, each spawned particle inherits its parent's age. Default=on.

### Speed group

Lets you specify the speed of spawned particles in absolute terms or relative to the parents' speed, with optional random variation. The direction of a spawned particle is always in relation to that of its parent, but you can set a Divergence so they eventually spread out. Default=Inherited.

**In Units** Choose this to specify the speed of spawned particles in system units per second. Default=100.0.

A positive value inherits the parent's direction; a negative value reverses it.

**Inherited** Choose this to specify each spawned particle's speed as a percentage of its parent's speed. Default=100.0

A positive value inherits the parent's direction; a negative value reverses it.

**Variation** The amount by which a spawned particle's speed can vary randomly. Default=0.0.

To obtain the actual speed for each spawned particle, the system multiplies the Variation value by a random number between -1.0 and 1.0, and then adds the result to the particle's speed as specified or inherited. For example, if a particle's speed is 100 units/second and Variation=20, then the tested value for each particle would be between 80 and 120 units/second.

**Divergence** When on, spreads out the stream of spawned particles. Use the numeric setting to define the extent of the divergence in degrees. Range=0 to 180. Default=0.

### Size group

**Scale Factor** The amount of uniform scaling to apply to each spawned particle, as a percentage of its parent's size. Default=100.0.

**Variation** The amount by which a spawned particle's scale can vary randomly. Default=0.0.

To obtain the actual scaling for each spawned particle, the system multiplies the Variation value by a random number between -1.0 and 1.0, and then adds the result to the Scale Factor value. For example, if Scale Factor=100 and

Variation=20, then each spawned particle would be between 80 and 120 percent of its parent's size.

### Uniqueness group

The Uniqueness setting enables randomization of the Spawnable result, when less than 100.0, as well as of the Variation values.

**Seed** Specifies a randomization value.

**New** Calculates a new seed using a randomization formula.

## Speed Test

[Particle View](#) on page 2730 > Click Speed Test in an event or add Speed Test to the particle system and then select it.

Speed Test lets the particle system check particle speed, acceleration, or the rate of circular travel, and branch accordingly. The test provides a number of variants that let you test speed or acceleration on specific axes, or simply whether the particle is accelerating or decelerating.

### Interface

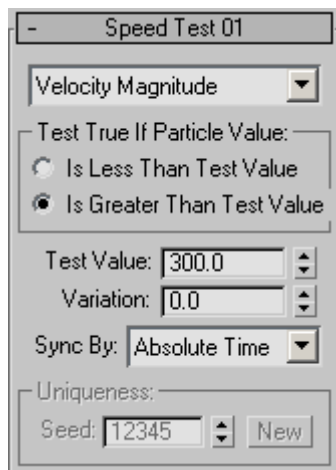

The user interface appears in the parameters panel, on the right side of the Particle View dialog.

The first interface element is a drop-down list that lets you choose the type of measurement to test:

- **Velocity Magnitude** Tests the particle velocity, in system units per second, without consideration of direction. This is the default test type.
- **Velocity X/Y/Z** Tests the particle velocity on the specified axis, in system units per second, using the world coordinate system.  
An example of this option would be with fireworks: As the particles move upward, their velocity on the world Z axis is positive. When they reach the top of their trajectory and begin to move downward, their velocity on the world Z axis slows to 0, and then becomes negative. If you choose Velocity Z and Is Less Than Test Value, and set Test Value to 0.0, you can send particles to another event at the moment they begin to move downward.
- **Acceleration Magnitude** Tests the particle acceleration (change in velocity), in system units per second per second, without respect to direction.
- **Acceleration X/Y/Z** Tests the particle acceleration (change in velocity) on the specified axis, in system units per second per second, using the world coordinate system.
- **Steering Rate** Tests the circular component of particle travel in degrees per second, without consideration of rotation or spinning.  
For example, if a particle travels along a parabolic path, its motion has both linear and circular components. The circular component is greatest at the top of the parabola. If a particle travels in a full circle in one second, the rate is 360; if it travels in a half circle, the rate is 180.  
Potential usage: When a particle is forced to turn too sharply, it might explode or change its type of movement. For example, missiles chase a jet fighter, which maneuvers to elude the missiles. The missiles are forced to change their course rapidly, but the missile construction cannot stand the fast change in steering, so the missiles blow up or disintegrate.

---

**TIP** You can test steering rate by setting the particle speed with [Speed By Icon](#) on page 2796 , and linking the Speed By Icon operator icon to a circular path.

---

- **True When Accelerates** Returns a True value when the particle velocity is increasing in value.
- **True When Decelerates** Returns a True value when the particle velocity is decreasing in value.



**Test True if Particle Value** Lets you specify whether the test passes particles on to the next event if the speed test succeeds or fails. Available for all tests except True When Accelerates/Decelerates. Default=Is Greater Than Test Value.

By default, Speed Test returns True if the value tested for exceeds the Test Value quantity, but you can choose Is Less Than Test Value as well. For example, if you use the Velocity Magnitude test type and set Test Value=200 and Variation=0, and choose Is Less Than Test Value, then particles will move to the next event only when they travel faster than 200 units per second. Any particles traveling 200 units per second or slower stay in the current event unless they later exceed that speed or another test returns True.

**Test Value** The specific speed or acceleration to test for. The unit of measurement depends on the type of test; see above. Default=300.0.

**Variation** The amount by which value tested for can vary randomly. Default=0.0.

To obtain the actual test value for each particle, the system multiplies the Variation value by a random number between -1.0 and 1.0, and then adds the result to the Test Value setting. For example, if Test Value=300 and Variation=10, then tested value for each particle would be between 290 and 310.

**Sync By** Choose the time frame to use when animating Test Value and Variation. For further information, see [Animation Offset Keying group](#) on page 2790 .

- **Absolute Time** Any keys set for parameters are applied at the actual frames for which they're set.
- **Particle Age** Any keys set for parameters are applied at the corresponding frames of each particle's existence.
- **Event Duration** Any keys set for parameters are applied to each particle starting when it first enters the event.

### **Uniqueness group**

The Uniqueness setting enables randomization of the test value variation.

**Seed** Specifies a randomization value.

**New** Calculates a new seed using a randomization formula.

## Split Amount Test

[Particle View](#) on page 2730 > Click Split Amount in an event or add Split Amount to the particle system and then select it.

The Split Amount test lets you send a specific number of particles to the next event, keeping all remaining particles in the current event. You can split the particle stream by a specific number or percentage, or by every Nth particle. With a specific number of particles, the splitting takes place once per event, but you can animate the percentage and “every Nth” values to vary the amount of split-off particles over time.

### Interface

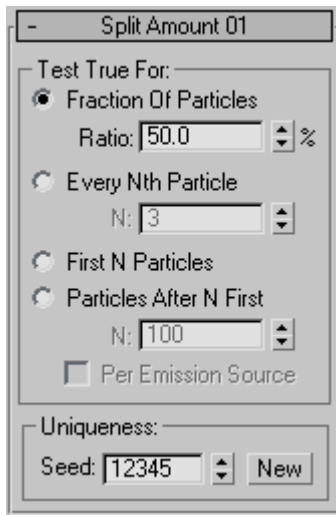

The user interface appears in the parameters panel, on the right side of the Particle View dialog.

### Test True For group

Lets you choose how to split the particle stream. Default=Fraction Of Particles, 50%.

**Fraction Of Particles** Split the particle stream on a percentage basis, specified with the Ratio value. With Ratio greater than 0.0, whether a particular particle is split off depends on a randomization factor; change this with the Uniqueness Seed value.

**Ratio** Specify the percentage of particles that will test True. Animatable. Default=50.0.

Available only with the Fraction Of Particles option.

**Every Nth Particle** Splits off a regular sample of particles.

**N** Specify how often to split off a particle. Animatable. Default=3.

For example, enter 8 to split off every eighth particle.

Available only with the Every Nth Particle option.

**First N Particles** Splits off the number of particles specified as the N value (below), starting with the first particle to enter the event, and retains the rest.

**Particles After N First** Splits off all particles starting with the first one after N particles, as specified with the N parameter (below). All particles starting with the first to enter the event up to N are retained in the event.

**N** Specify the number of particles to split off, with First N Particles, or to retain in the event, with Particles After N First.

Available only with the First N Particles or the Particles After N First option.

**Per Emission Source** When on, the software applies the N value for the options First N Particles and Particles After N First separately for each emission source.

Use this option with multiple Particle Flow sources converging into a single Split Amount test.

### **Uniqueness group**

The Uniqueness setting enables randomization of particle retention with the Fraction Of Particles option.

**Seed** Specifies a randomization value.

**New** Calculates a new seed using a randomization formula.

## **Split Selected Test**

[Particle View](#) on page 2730 > Click Split Selected in an event or add Split Selected to the particle system and then select it.

The Split Selected test lets you split the particle stream based on particles' selection status. For information about selecting particles, see [Selection rollout](#) on page 2753 .

---

**NOTE** This test considers only particles selected at the Particle sub-object level. To use all particles in an event at a specific frame, go to that frame, go to the Event sub-object level, and highlight the event. Then go to the Particle sub-object level, and on the Selection rollout, click Get From Event Level.

---

## Interface

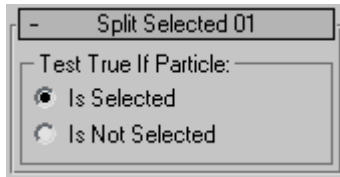

The user interface appears in the parameters panel, on the right side of the Particle View dialog.

## Test True If Particle group

Lets you choose how to split the particle stream. Default=Is Selected.

**Is Selected** All selected particles are eligible for redirection to another event.

**Is Not Selected** All non-selected particles are eligible for redirection to another event.

## Split Source Test

[Particle View](#) on page 2730 > Click Split Source in an event or add Split Source to the particle system and then select it.

The Split Source test lets you split the particle stream based on particles' origin. You can specify that particles from one or more specific Particle Flow sources should or should not be eligible for redirection to the next event.

## Interface

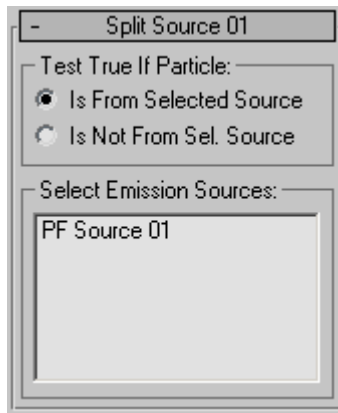

The user interface appears in the parameters panel, on the right side of the Particle View dialog.

### Test True If Particle group

Lets you choose how to split the particle stream. Default=Is From Selected Source.

**Is From Selected Source** All particles from sources highlighted in the Selected Emission Sources list are eligible for redirection to another event.

**Is Not From Sel(ected) Source** All particles from sources *not* highlighted in the Selected Emission Sources list are eligible for redirection to another event.

**Selected Emission Sources** Lists all emission sources in the system. Highlight the sources to be considered by the test.

## Non-Event-Driven Particle Systems

Create panel > Geometry > Particle Systems

Create menu > Particles

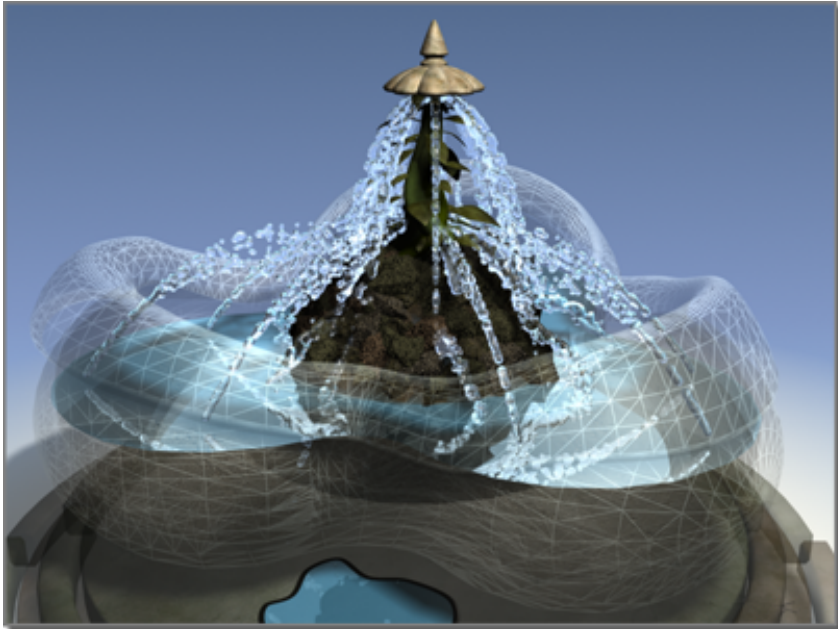

**Fountain spray created as a particle system**

Non-event-driven particle systems provide relatively simple, straightforward methods for generating particle sub-objects over time for the purpose of simulating snow, rain, dust, and so on. You use particle systems primarily in animations.

3ds Max provides six built-in, non-event-driven particle systems:

[Spray Particle System](#) on page 2938

[Snow Particle System](#) on page 2942

[Super Spray Particle System](#) on page 2947

[Blizzard Particle System](#) on page 2951

[PArray Particle System](#) on page 2964

[PCloud Particle System](#) on page 2956

---

**NOTE** You can take advantage of the AutoGrid feature to orient and position new particle systems with respect to existing objects. For details, see [AutoGrid](#) on page 2513 .

---

## See also:

- [Particle System Usage](#) on page 2926
- [Creating a Particle Emitter](#) on page 2928
- [Particle Flow](#) on page 2713

## Interface



### Snowstorm created as a particle system

This topic describes only the general properties of particle systems. Other plug-in particle systems might be available in your configuration.

The built-in particle systems share these controls:

**Emitter** Specifies where in the scene the particles are generated. The emitter is the particle system's main sub-object. It doesn't render. Particles appear on the surface of the emitter and fall (or drift, drop, flurry, spray) from the emitter in a particular direction.

**Timing** The timing parameters control the dynamics of particles in the system. They specify how quickly particles appear, how quickly they disappear, whether the emission rate is constant, and so on.

**Particle-specific parameters** These parameters are specific to the kind of particle system. Examples are particle size and speed.

**Rendering properties** These parameters are also specific to the kind of particle system. There are options for displaying particles in viewports and rendering them in scenes and animations. Particles do not necessarily appear the same in renderings as they do in viewports.

You can modify and animate particle system parameters. You can also affect particle system behavior with [space warps](#) on page 2603 . In addition, you can deform particle systems with the [Mesher compound object](#) on page 767 .

---

**NOTE** Particles can participate in dynamics simulations.

---

## Particle System Usage

You create particle systems when you want to model an object or effect that can best be described as a large collection of similar objects behaving in a similar fashion. Obvious examples of such effects include rain and snow, but other equally valid examples include water, smoke, ants, and even crowds of people.

On the Create panel, click Spray, Snow, Super Spray, Blizzard, PArray, or PCloud to create a particle system. Spray and Snow exist primarily for compatibility with earlier releases of 3ds Max, and are superseded by Super Spray and Blizzard.

To create a particle system, first choose Create menu > Particles > Spray or Snow.

These are the basic steps for creating a particle system:

- 1 Create a particle emitter. All particle systems require an emitter. Some particle systems use the particle system icon as the emitter while others use an object you select from the scene as the emitter.
- 2 Determine the number of particles. You set parameters such as birth rate and life span to control how many particles can exist at any given time.
- 3 Set particle shape and size. You can select from many standard particle types (including metaballs) or you can select an object to be emitted as a particle.
- 4 Set initial particle motion. You can set the speed, direction, rotation, and randomness of particles as they leave the emitter. Particles can also be affected by animation of the emitter.
- 5 Modify particle motion. You can further modify the motion of particles after they leave the emitter by binding the particle system to a space warp in the Forces group, such as Path Follow, or make them bounce off a deflector in the Deflectors space warp group, such as UDeflector.



---

**IMPORTANT** When you use forces and deflectors together, always bind the forces before the deflectors.

---

**TIP** If the particles don't follow the emitter after it's moved, then change any [Path Follow parameter](#) on page 2635 . The motion will be applied to the particles.

---

## Rain and Snow

Create rain and snow using [Super Spray](#) on page 2947 and [Blizzard](#) on page 2951 . These particle systems are optimized for droplet (Super Spray) and tumbling flake (Blizzard) effects. Add space warps such as [Wind](#) on page 2642 to create spring rains or winter storms.

## Bubbles

Create bubbles by using the Bubble Motion options of [Super Spray](#) on page 2947 . If you require good rendering speed, consider using constant or tetra particles. If you require bubble detail, consider using opacity-mapped facing particles, instanced spheres, or metaparticles.

## Flowing Water

You generate flowing liquid effects by setting [Super Spray](#) on page 2947 to generate closely packed metaparticles. The metaparticles blob together forming a stream. Add a [Path Follow](#) on page 2635 space warp to send the stream down a trough.

## Explosions

[Particle Array \(PArray\)](#) on page 2964 uses another object as its particle emitter. You can set the particle type to use fragments of the emitter object to simulate the object exploding.

## Volume Effects

[Particle Cloud \(PCloud\)](#) on page 2956 constrains its particles within a specified volume. You can use Particle Cloud to generate bubbles in a glass of soda, or bees buzzing inside a jar.

## Crowds

[Super Spray](#) on page 2947 , [Blizzard](#) on page 2951 , [Particle Array](#) on page 2964 , and [Particle Cloud](#) on page 2956 can use instanced geometry as their particle type. You can create a stream of ants, a flock of birds, or a cloud of dandelion seeds using instanced geometry particles.

## Creating a Particle Emitter

After you choose a particle system type to add, you create the particle system icon in the scene. The icon serves different purposes depending on the type of particle system.

**As an emitter:** The icon defines the starting location and direction of the particles. Spray, Snow, Super Spray, Blizzard, and Particle Cloud use the icon as the particle emitter.

**As a placeholder:** The icon serves only to hold the parameters for the particle system. The particles are emitted from another selected object. Particle Array and Particle Cloud use the icon as a placeholder.

You can choose whether Particle Cloud uses its icon or another selected object as the emitter.

### Procedures

#### To create emitter icons:

- Drag in a viewport to set the size and orientation of the particle emitter icon for Spray, Snow, Super Spray, Blizzard, and Particle Cloud. Spray, Snow, Blizzard, and Particle Cloud use the icon size as the area of particle emission. Super Spray emits particles from its center regardless of its icon size.

All particle systems align the particle direction with the Z axis of the creation grid.

#### To create placeholder icons:

- 1 Drag in a viewport to set the size of the placeholder icon for Particle Array and Particle Cloud. The size and location of the particle system icon has no effect on the particles.

- 2 After placing the particle system icon, click Pick Object on the Basic Parameters rollout to select the object to use as the particle emitter.

## Using Materials with Particle Array

The material that appears on the particles comes from one of three places:

- The particle system itself
- The material assigned to the distribution object (PArray only)
- The material assigned to the instanced objects

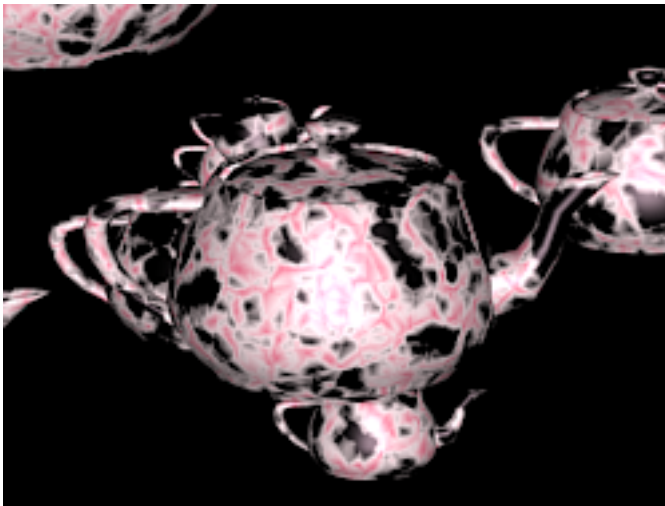
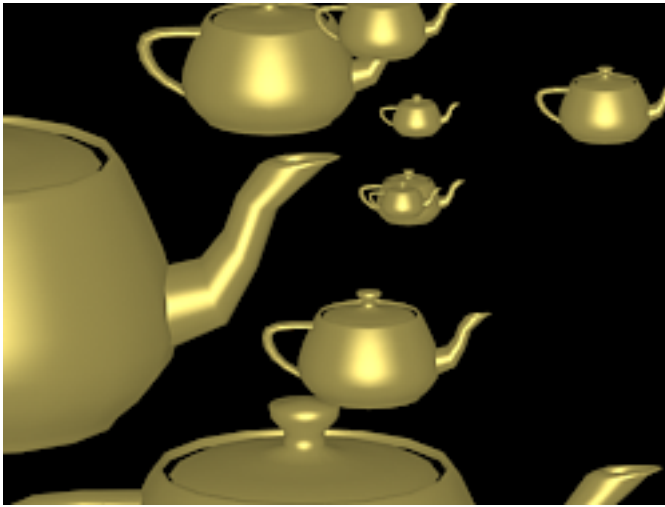

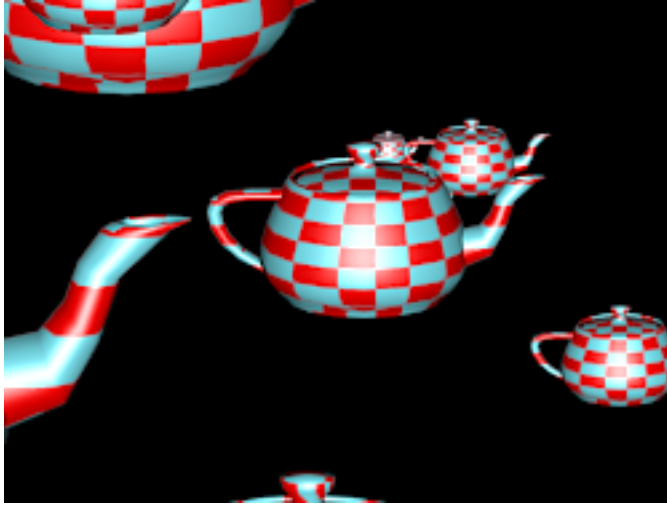

**Particles with various materials assigned to them**

You make this choice in the Material Mapping and Source group near the bottom of the Particle Type rollout. Choose Icon to use the material assigned to the particle system, choose Picked Emitter to use the material assigned to the distribution object, or choose Instanced Geometry to use the material assigned to the instanced objects. Note that this third option is available only when Instanced Geometry is the current particle type (selected in the Particle Types group at the top of the Particle Type rollout).

---

**NOTE** SuperSpray and Blizzard don't have distribution objects. PCloud has a distribution object but you can't get the material from it. In these cases, a radio button lets you use the material from the instanced geometry. Only PArray lets you get the material from the distribution object.

---

**IMPORTANT** A particle-system object, like any other object, can carry only a single material at any time. Thus, if you choose either Picked Emitter or Instanced Geometry, an instance of the chosen material is actually copied to the particle system, overwriting the material assigned to the emitter. If you want to restore the emitter material, choose Icon, and then reassign the material from the Material Editor or the Browser.

---

No matter what choice you make, if the material used is not mapped, then all particles take on the surface properties of the material, regardless of which object is used as the source of the material.

## Achieving Particle Motion Blur

Particle motion blur is actually the result of varying the opacity and the length of particles based on their speed. To accomplish this requires coordination between material assignment and the settings in the particle systems. Follow these instructions:

- Use the [Particle MBlur map](#) on page 5729 in the material that you assigned to the particles. For best results, assign it as an opacity map.
- Make sure that the particle system, PArray, PCloud, and Super Spray, or Spray, supports the Particle MBlur map.
- Choose Rotation and Collision rollout > Spin Axis Controls group > Direction of Travel/Mblur option.
- In this same group, set the Stretch spinner greater than 0 to stretch the particles as a percent of their length based on the particle Speed setting.
- Use the correct type of particle. MBlur works on all particle types except Constant and Facing.

---

**NOTE** Instanced objects with multi/sub-object materials cannot be image motion blurred.

---

## Using Mapped Materials with Particle Systems

Mapped materials affect particles differently, depending on the source of the material.



#### Particles with a diffuse-mapped material

When you choose Icon, the mapping coordinates of the material are applied across the V (vertical) axis, from  $V=0$  (the bottom edge of the map) to  $V=1$  (the top edge of the map). The bottom edge of the map is applied at the birth of the particle, and the top edge at either the death of the particle (if Time is on) or the distance of the particle at its death (if Distance is on).

The Time spinner specifies the number of frames from birth that it takes to complete one mapping of a particle. Thus, if set to 15, the particle uses the bottom edge of the map at its birth, and moves through to the top edge of the map at frame 15.

The Distance spinner specifies the distance, in units, from birth that it takes to complete one mapping of a particle. Thus, if set to 50, as the particle moves along the normal vector, it displays the bottom edge of the map at birth, and the top edge at 50 units along the normal vector.

The one exception to this is when you use the Tetra particle type. In this case, each particle is always constantly mapped with  $V=0$  at the head and  $V=1$  at the tail.

When you choose Picked Emitter, the particles take on the color of the object at the point at which they're created. If the mapped surface is yellow where the particle emerges, then the particle is yellow.

Again, Tetra particles are an exception and the distribution-object material is mapped from head to tail.

Fragment particles use the same technique, with additional options when the Thickness setting is greater than 0.

When Thickness is 0, all faces in the fragment are mapped the same as the portion of the object surface from which they're derived.

When Thickness is greater than 0, the outer faces of the fragment copy the surface of the distribution object, and are assigned the material ID specified in the Outside ID spinner in the Particle Type rollout > Fragment Materials group. The thickness edges use the Edge ID number, and the inner faces use Backside ID. Thus, by assigning a multi/sub-object material to the object-based emitter, you can specify a different material for the outer fragment surfaces, the edges, and the inner surfaces. Note that the Outside ID spinner defaults to a value of 0, which means "use whatever material is currently assigned." Change this to a specific sub-material number to assign a sub-material to the outside edges of the fragments.

## Using Multi/Sub-Object Materials with Particle Systems

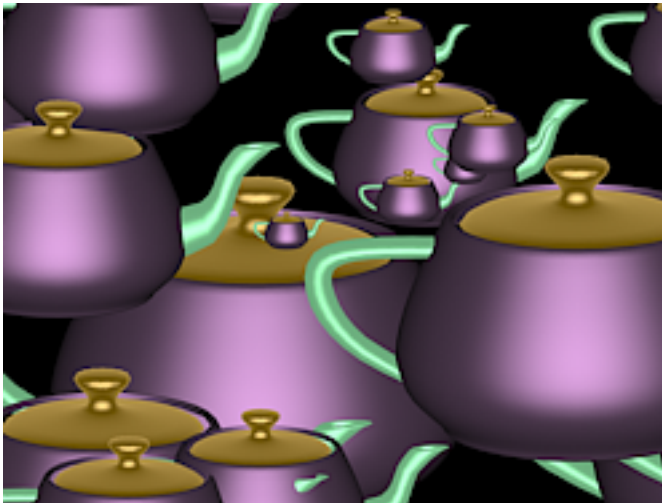

Particles with a Multi/Sub-Object material



If the assigned material is a Multi/Sub-Object material, particles are affected in the following ways, depending on the source of the material:

- **Icon:** In most cases, each particle, at its birth, is assigned a different sub-material, cycling through each available sub-material. For example, if there are only three sub-materials, the first particle receives sub-material #1, the second #2, the third #3, the fourth #1, and so on. The exceptions to this are as follows:
- MetaParticles use only the first sub-material.
- Object fragments are born at once, so all of them use only the first sub-material.
- **Picked Emitter:** When used with object fragments as particles, each particle uses the three ID numbers in the Fragment Materials group. If this source is used with the other particle types, the particles are assigned sub-materials in the same way as when Icon is chosen.
- **Instanced Geometry:** When used with Instanced Geometry particles, each particle is assigned a sub-material in exactly the same way as the source object, so each particle looks just like the source object. When used with other particle types, the particles are assigned sub-materials in the same way as when Icon is chosen.

---

**NOTE** Instanced objects with Multi/Sub-Object materials cannot be image motion blurred.

---

## Using Spawned Particles

The examples in this topic start you out with a very simple spawning using the Super Spray particle system.

### Example: Setting up the particle system:

- 1 In the Perspective viewport, create a pyramid that's **5** units in all dimensions.
- 2 Create a cylinder with a radius and height of **3**, and **6** sides.
- 3 In the center of the Perspective viewport, create a Super Spray emitter.
- 4 Set Speed in the Particle Motion group (Particle Generation rollout) to **3.0**.

- 5 On the Particle Type rollout, choose Instanced Geometry, then in the Instancing Parameters group click Pick Object, and select the pyramid.
- 6 In the Viewport Display group of the Basic Parameters rollout, choose Mesh and set the Percentage of Particles to **100**.
- 7 On the Particle Generation rollout, choose Use Rate, and set the spinner to **1**.
- 8 Set Emit Start and Emit Stop to **0**, set Display Until to **100**, set Life to **10**, and leave Variation at **0**.
- 9 Under Particle Size, set Grow For and Fade For to **0**.
- 10 Drag the time slider between frames 0 and 15.  
A single pyramid particle emerges from the emitter, moves up, and then dies and disappears at frame 10.

**Example: Adding spawning effects:**

- 1 On the Particle Spawn rollout, choose Spawn on Death.
- 2 Leave Spawns spinner at 1, and set the Multiplier to **2**.
- 3 Set the Direction Chaos spinner to **50**.
- 4 Drag the time slider slowly over frames 8 to 25 (approximately).  
At frame 10, two pyramids appear at the death of the original particle (because of the Multiplier setting), and move off in different directions (because of the Direction Chaos setting). All particles die after frame 20 because only one generation of spawned particles is specified.
- 5 Set Spawns to **4**, and the Multiplier to **4**.
- 6 Drag the time slider over frames 8 to 50.  
With each spawned generation the particles increase exponentially.

**Example: To mutate the objects:**

- 1 In the Object Mutation Queue group, click Pick Object, and then select the cylinder.  
The name of the cylinder appears in the list window.
- 2 Click Pick Object and select the pyramid. Then click Pick Object again, and select the cylinder. Your list now reads: Cylinder01, Pyramid01, Cylinder01.

3 Drag the time slider over frames 0 to 50.

The pyramid appears over frames 0 to 10, then changes to four cylinders at frame 11, then 16 pyramids at the next spawning, and so on.

## Using Interparticle Collision

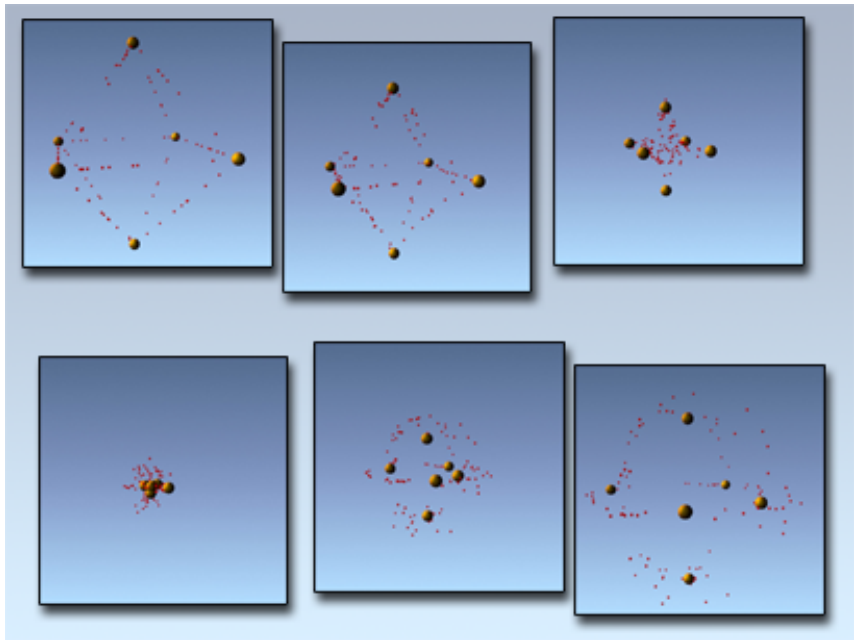

Particles colliding and then rebounding

You can set up particles to detect collisions with each other. This can be useful when the particles are meant to model solid objects such as marbles.

### Procedures

**Example: To create particles that collide with each other:**

- 1 Create a Super Spray particle emitter, and place a [Deflector space warp](#) on page 2675 a short distance from it with the surface of the deflector perpendicular to the stream of the particles. Bind the deflector to the Super Spray.

- 2 Set the Super Spray values as follows:
  - Off Axis: **1**, Spread: **1**, Off Plane: **180**, Spread: **180**
  - Mesh: **chosen**, Percent of Particles: **100**
  - Particle Quantity: Use Rate **chosen** and set to: **1**
  - Speed: **3**, Variation: **100%**
  - Emit Start: **0**, Emit Stop: **5**, Display Until: **100**, Life: **100**
  - Size: **4.0**, Grow For: **0**, Fade For: **0**
  - Particle Type: **Sphere**
- 3 Drag the time slider so you can see the particle spheres bounce off the deflector. Note that the rebounding particles move through each other.
- 4 On the Rotation & Collision rollout, turn on Enable in the Interparticle Collisions group. View the animation again. This time, the particles bounce off each other.

---

**TIP** InterParticle Collisions, Deflector Binding, and Bubble Noise do not get along well together. Particles may leak through the deflector when these three are used together. Instead of bubble motion use animated mapping. Use facing particles with an animated map of a bubble, where the bubble is smaller than the map size. The bubble is animated moving around the map. This simulates bubble motion at the map level.

---

## Spray Particle System

Create panel > Geometry button > Choose Particle Systems from the drop-down list. > Object Type rollout > Spray

Create menu > Particles > Spray

Spray simulates water drops such as rain, a fountain, the spray from a garden hose, and so on.

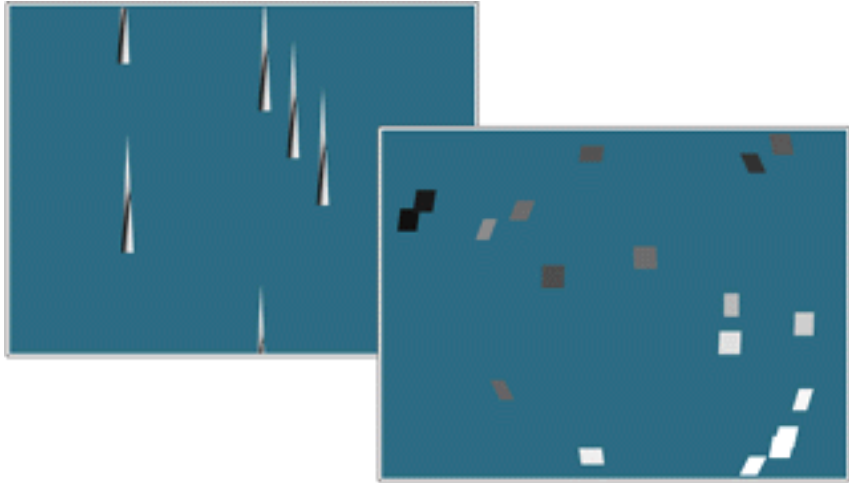

### Kinds of Spray

---

**NOTE** [SuperSpray](#) on page 2947 is a more powerful and advanced version of Spray. It provides all the functionality of Spray, plus additional features.

---

**TIP** To animate particles following a path through space, use the [Path Follow space warp](#) on page 2635 .

---

### Procedures

To create spray:

- 1  On the Create panel, make sure the Geometry button is active and Particle Systems is chosen in the object category list, then click Spray.
- 2 Drag in a viewport to create the Spray emitter; see [Creating a Particle Emitter](#) on page 2928 .

The emitter's direction vector points in the negative Z direction of the active construction plane. For example, if you create the emitter in the Top viewport, the particles will move downward in the Front and Left viewports.

## Interface

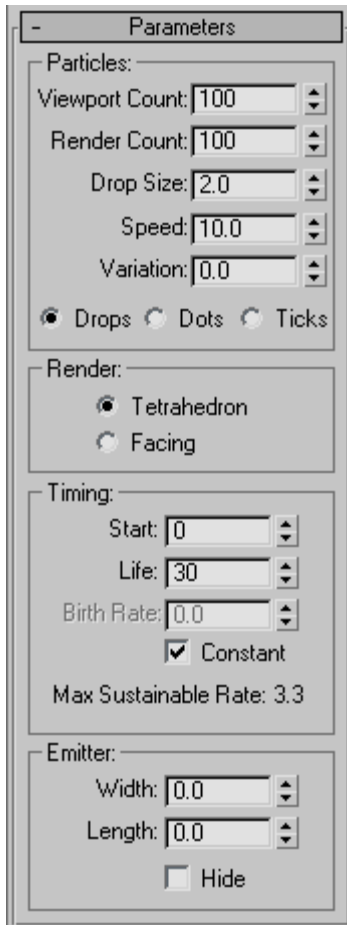

### Particles group

**Viewport Count** Maximum number of particles displayed in viewports at any given frame.

---

**TIP** Setting the viewport count less than the render count can improve viewport performance.

---

**Render Count** Maximum number of particles that can appear in a single frame when you render it. Works in combination with the particle system's timing parameters.

- When the number of particles reaches the Render Count value, particle creation is suspended until some particles die.
- When enough particles die, particle creation resumes until Render Count is reached again.

**Drop Size** Size of a particle in the active units.

**Speed** Initial velocity of each particle as it leaves the emitter. Particles travel at this speed unless they are affected by a particle system space warp.

**Variation** Varies the initial speed and direction of particles. The greater the Variation, the stronger and broader the spray.

**Drops, Dots, or Ticks** Choose how particles are displayed in viewports. The display setting does not affect how particles are rendered. Drops are streaks that appear like raindrops, dots are points, ticks are small plus signs.

### Render group

**Tetrahedron** Particles are rendered as long tetrahedrons, with the length you specify in the Drop Size parameter. Tetrahedron is the default setting for rendering. It provides a basic simulation of water drops.

**Facing** Particles are rendered as square faces whose width and height equals the Drop Size. Facing particles always face the camera (or the user's perspective). They are provided especially for use with material maps. Use with an appropriate opacity map for bubbles or snowflakes.

---

**NOTE** Facing works correctly only in a perspective or camera view.

---

### Timing group

Timing parameters control the "birth and death" rates of emitted particles.

At the bottom of the Timing group is a line that displays the maximum sustainable rate. This value is based on the Render Count and the lifetime of each particle. To be precise:

maximum sustainable rate=Render Count/Life

Because the number of particles in a frame never exceeds Render Count, if the Birth Rate exceeds the maximum rate, the system will run out of particles,

pause until some die off, and then start again, generating particles in bursts or spurts.

**Start** Number of the first frame where particles appear.

**Life** The lifetime of each particle, in number of frames.

**Birth Rate** The number of new particles born per frame.

If this is less than or equal to the maximum sustainable rate, the particle system generates an even flow of particles. If it is greater than the maximum rate, the particle system generates particles in bursts.

You can animate the Birth Rate parameter.

**Constant** When on, Birth Rate is unavailable and the birth rate used equals the maximum sustainable rate. When off, Birth Rate is available. Default=on.

Turning Constant off does not mean that the birth rate varies automatically; the birth rate remains constant unless you animate the Birth Rate parameter.

### **Emitter group**

The emitter specifies the area where particles appear in the scene. It has a geometry you can display in viewports, but it isn't renderable.

The emitter is displayed as a rectangle with a vector pointing out of one side. The vector shows the direction in which the system emits particles.

**Width and Length** You implicitly set the initial value of these parameters when you drag in a viewport to create the emitter. You can adjust the values in the rollout.

The space occupied by the particle system at any given time is the result of a combination of its initial parameters (such as size of the emitter, and speed and variation of emission) and any space warps that have been applied.

**Hide** Turn on to hide the emitter in viewports. When Hide is off, the emitter is displayed in viewports. The emitter is never rendered. Default=off.

## **Snow Particle System**

Create panel > Geometry button > Choose Particle Systems from the drop-down list. > Object Type rollout > Snow

Create menu > Particles > Snow



Snow simulates falling snow or confetti. The snow system is similar to Spray, but it has additional parameters to generate tumbling snowflakes, and its rendering options are different.

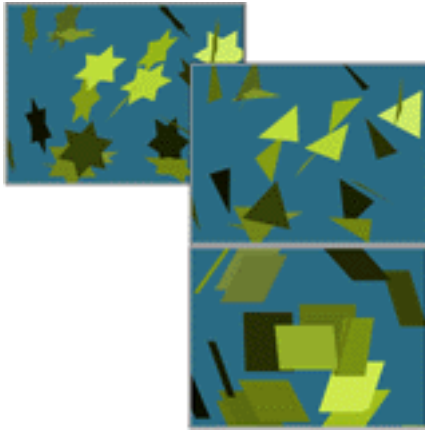

#### Kinds of Snow

---

**NOTE** [Blizzard](#) on page 2951 is a more powerful and advanced version of Snow. It provides all the functionality of Snow, plus additional features.



---

**TIP** To animate particles following a path through space, use the [Path Follow space warp](#) on page 2635 .

---

#### Procedures

To create snow:

-   In the Create panel, make sure the Geometry button is active and Particle Systems is selected from the object category drop-down list, then click Snow.
- 2 Drag in a viewport to create the Snow emitter; see [Creating a Particle Emitter](#) on page 2928 .  
The emitter's direction vector points in the negative Z direction of the active construction plane.

## Interface

## Particles group

**Viewport Count** Maximum number of particles displayed in viewports at any given frame.

---

**TIP** Setting the viewport count less than the render count can improve viewport performance.

---

**Render Count** Maximum number of particles that can appear in a single frame when you render it. Works in combination with the particle system's timing parameters.

- When the number of particles reaches the Render Count value, particle creation is suspended until some particles die.
- When enough particles die, particle creation resumes until Render Count is reached again.

**Flake Size** Size of a particle in the active units.

**Speed** Initial velocity of each particle as it leaves the emitter. Particles travel at this speed unless they are affected by a particle system space warp.

**Variation** Varies the initial speed and direction of particles. The greater the Variation, the broader the area of snowfall.

**Tumble** Amount of random rotation for snowflake particles. This parameter can range from 0 to 1. At 0, flakes do not rotate; at 1, they rotate the most. The axis of rotation is generated randomly for each particle.

**Tumble Rate** Speed at which snowflakes rotate. The greater the Tumble Rate, the faster the rotation.

**Flakes, Dots, or Ticks** Select how particles are displayed in viewports. The display setting does not affect how particles are rendered. Flakes are star-shaped snowflakes, dots are points, ticks are small plus signs.

## Render group

**Six Point** Each particle is rendered as a six-pointed star. Each side of the star is a face to which you can assign a material. This is the default setting for rendering.

**Triangle** Each particle is rendered as a triangle. Only one side of the triangle is a face to which you can assign a material.

**Facing** Particles are rendered as square faces whose width and height equals the Drop Size. Facing particles always face the camera (or the user's perspective). They are provided especially for use with material maps. Use with an appropriate opacity map for bubbles or snowflakes.

---

**NOTE** Facing works correctly only in a perspective or camera view.

---

### **Timing group**

Timing parameters control the "birth and death" rates of emitted particles.

At the bottom of the Timing group is a line that displays the maximum sustainable rate. This value is based on the Render Count and the lifetime of each particle. To be precise:

maximum sustainable rate=Render Count/Life

Because the number of particles in a frame never exceeds Render Count, if the Birth Rate exceeds the maximum rate, the system will run out of particles, pause until some die off, and then start again, generating bursts or spurts of particles.

**Start** Number of the first frame where particles appear.

**Life** The lifetime of a particle, in number of frames.

**Birth Rate** The number of new particles born per frame.

If this is less than or equal to the maximum sustainable rate, the particle system generates an even flow of particles. If it is greater than the maximum rate, the particle system generates particles in bursts.

You can animate the Birth Rate parameter.

**Constant** When on, Birth Rate is unavailable and the birth rate used equals the maximum sustainable rate. When off, Birth Rate is available. Default=on.

Turning Constant off does not mean that the birth rate varies automatically; the birth rate remains constant unless you animate the Birth Rate parameter.

### **Emitter Group**

The emitter specifies the area where particles appear in the scene. It has a geometry you can display in viewports, but it isn't renderable.

The emitter is displayed as a rectangle with a vector pointing out of one side. The vector shows the direction in which the system emits particles.

You set emitter parameters in the Emitter group of the particle system's Parameters rollout.

**Width and Length** You implicitly set the initial value of these parameters when you drag in a viewport to create the emitter. You can adjust the values in the rollout.

The space occupied by the particle system at any given time is the result of a combination of its initial parameters (size of the emitter, and speed and variation of emission) and any space warps that have been applied.

**Hide** Turn on to hide the emitter in viewports. When off, the emitter is displayed in viewports. The emitter is never rendered. Default=off.

## Super Spray Particle System

Create panel > Geometry button > Choose Particle Systems from the drop-down list. > Object Type rollout > Super Spray

Create menu > Particles > Super Spray

Super Spray emits a controlled spray of particles. This particle system is like the simple Spray particle system with the added power provided by all the newer particle systems.

---

**TIP** To animate particles following a path through space, use the [Path Follow space warp](#) on page 2635 .

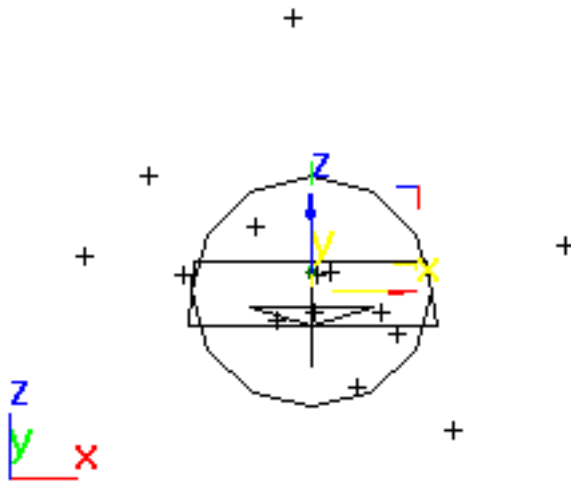

Super Spray viewport icon (emitter)

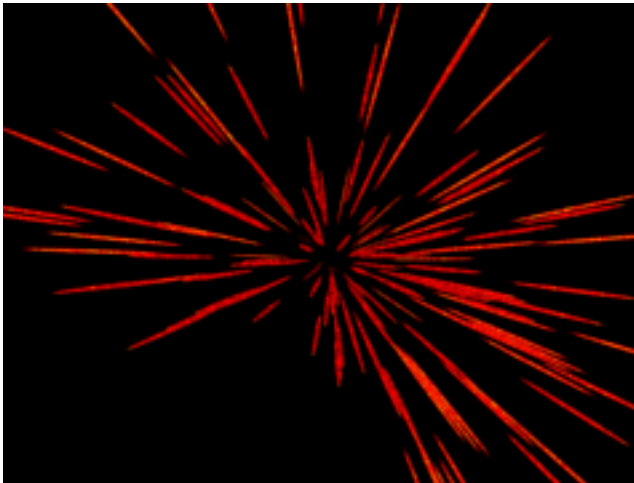

Particles emerging from a super spray system

---

## Procedures

To create a super spray particle system:

-  1 On the Create panel, make sure the Geometry button is active and Particle Systems is chosen in the object category list, then click Super Spray.
- 2 Drag in any viewport to create the Super Spray emitter icon; see [Creating a Particle Emitter](#) on page 2928 .  
The icon appears as an intersecting plane and circle with an arrow. The initial direction of the spray (based on the orientation of the emitter icon and indicated by the icon arrow) depends on the viewport in which you create the icon. Generally, the particles spray toward you when created in an orthographic viewport, or spray upward when created in a Perspective viewport.
- 3 Adjust the various parameters to alter the spray effect.

## Interface

---

**NOTE** This section describes the Particle Formation group in the Basic Parameters rollout, and the Particle Motion group in the Particle Generation rollout. These are the only controls unique to Super Spray. The other Super Spray rollouts and their contents are identical with those in Particle Array, except that Object Fragments and associated settings are not available on the Particle Type rollout. See [PArray Particle System](#) on page 2964 for details or choose from the following list for rollout information.

---

[Particle Generation Rollout](#) on page 2973

[Particle Type Rollout](#) on page 2977

[Rotation and Collision Rollout](#) on page 2987

[Object Motion Inheritance Rollout](#) on page 2990

[Bubble Motion Rollout](#) on page 2991

[Particle Spawn Rollout](#) on page 2992

[Load/Save Presets Rollout](#) on page 2999

**Basic Parameters rollout > Particle Formation group**

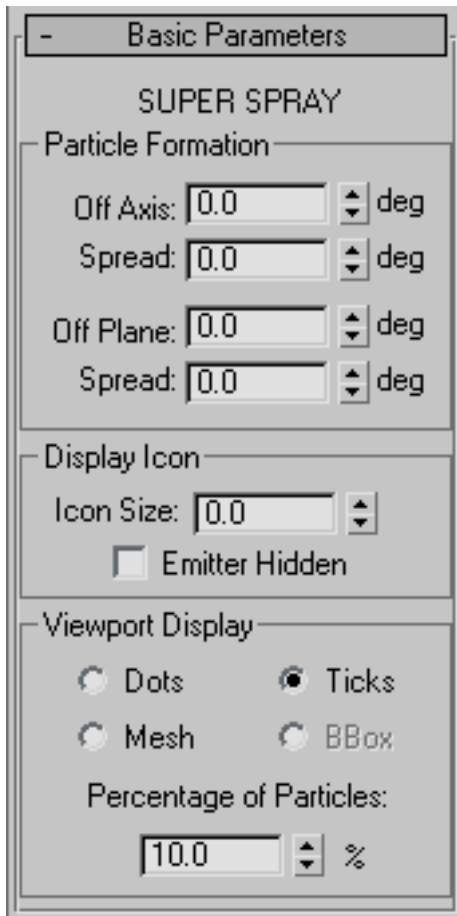

These items control the direction and spread of particles.

**Off Axis** Affects the angle of the particle stream off the Z axis (along the plane of the X axis).

**Spread** Affects the spread of the particles away from the emission vector (along the plane of the X axis).

**Off Plane** Affects the angle of emission about the Z axis. This has no effect if Off Axis is set to 0.

**Spread** Affects the spread of the particles about the Off Plane axis. This has no effect if Off Axis is set to 0.



## **Particle Generation rollout > Particle Motion group**

**Speed** The speed of the particle at birth, in units per frame.

**Variation** Applies a percentage of variation to the speed of emission for each particle.

## **Blizzard Particle System**

Create panel > Geometry button > Choose Particle Systems from the drop-down list. > Object Type rollout > Blizzard

Create menu > Particles > Blizzard

This is an advanced version of the original Snow particle system.

---

**TIP** To animate particles following a path through space, use the [Path Follow space warp](#) on page 2635 .

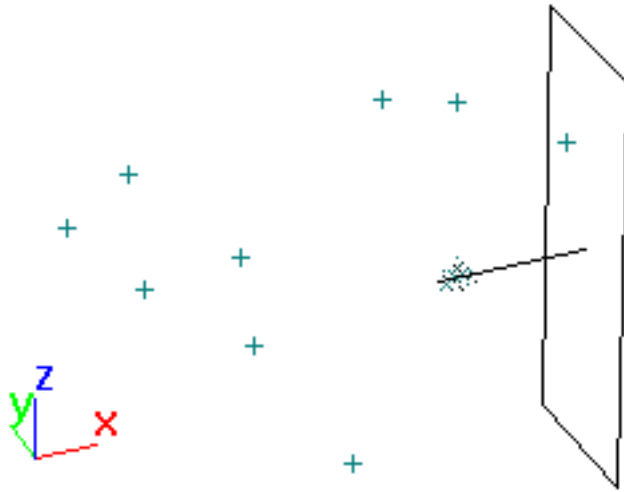

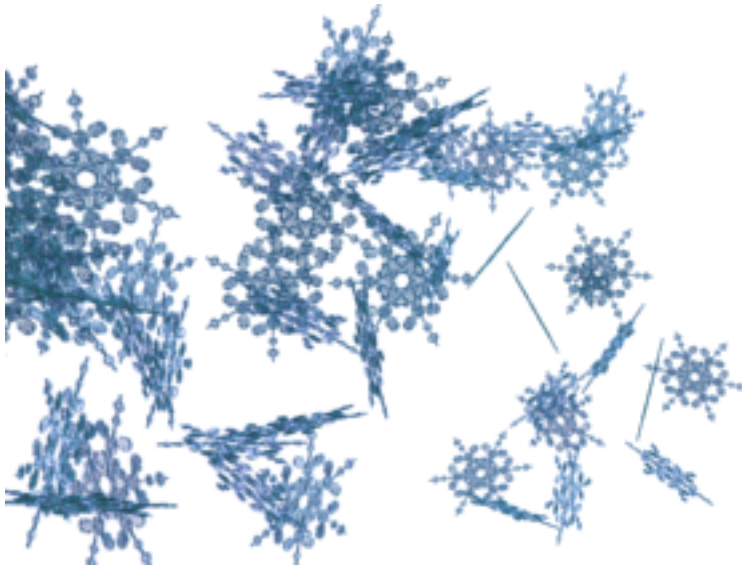

Blizzard viewport icon (emitter)



Snowflake particles in a blizzard

## Procedures

To create a blizzard particle system:

-   On the Create panel, make sure the Geometry button is active and Particle Systems is chosen in the object category list, then click Blizzard.
- Drag in a viewport to create the Blizzard emitter; see [Creating a Particle Emitter](#) on page 2928 .  
The icon appears as a plane with a perpendicular line pointing in the direction of emission.
- Adjust the various parameters on the command panel.

## Interface

This section describes the Display Icon group in the Basic Parameters rollout, the Particle Motion group in the Particle Generation rollout, and the Material Mapping and Source group in the Particle Type rollout. These are the only controls unique to Blizzard. The other Blizzard rollouts and their contents are identical with those in Particle Array, except that Object Fragments and associated settings are not available on the Particle Type rollout. See [PArray](#) on page 2964 for details or choose from the following list for rollout information.

[Particle Generation Rollout](#) on page 2973

[Particle Type Rollout](#) on page 2977

[Rotation and Collision Rollout](#) on page 2987

[Object Motion Inheritance Rollout](#) on page 2990

[Particle Spawn Rollout](#) on page 2992

[Load/Save Presets Rollout](#) on page 2999

## Basic Parameters rollout > Display Icon group

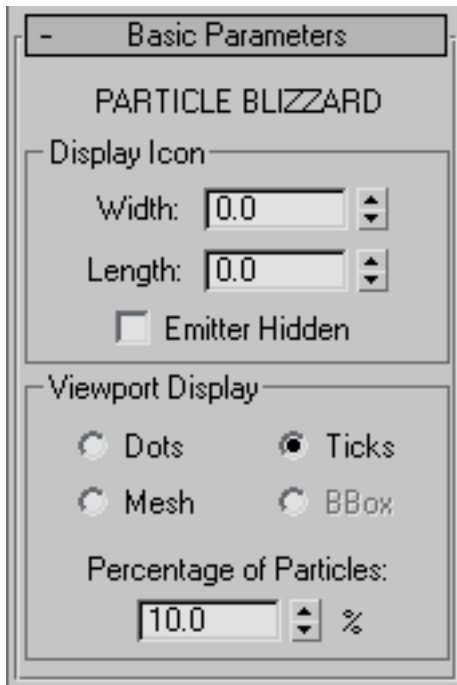

The emitter specifies the location where particles are generated in the scene. It has a geometry you can display in viewports, but it isn't renderable.

The emitter is displayed as a rectangle with a vector pointing out of one side. The vector shows the direction in which the system emits particles.

You set emitter parameters on the particle system's Basic Parameters rollout, in the Display Icon group.

**Width and Length** You implicitly set the initial value of these parameters when you drag in a viewport to create the emitter. You can adjust the values on the rollout.

The space occupied by the particle system at any given time is the result of a combination of its initial parameters (such as size of the emitter, and speed and variation of emission) and any space warps that have been applied.

**Emitter Hidden** Hides the emitter in viewports. When off, the emitter is displayed in viewports. The emitter is never rendered. Default=off.

## Particle Generation rollout > Particle Motion group

Specifies the number, size, and motion of particles.

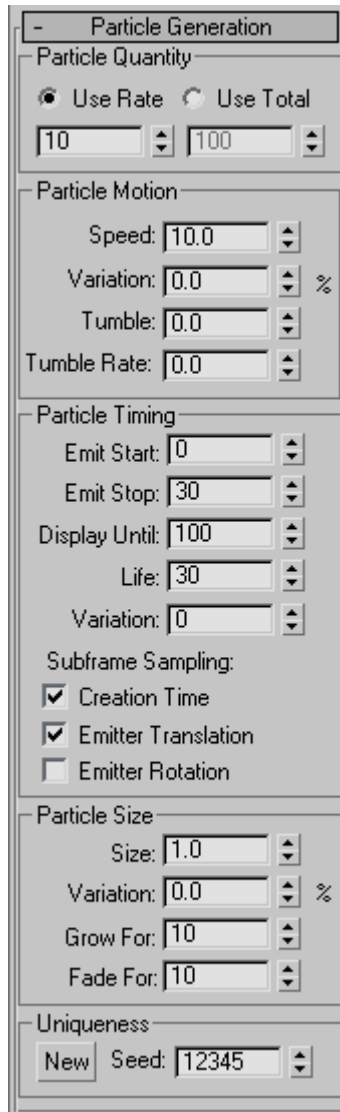

The image shows a software interface for particle generation settings. It is organized into several sections, each with a title bar and a minus sign icon. The sections are:

- Particle Quantity:** Contains two radio buttons, "Use Rate" (selected) and "Use Total". Below them are two numeric input fields with up/down arrows, containing the values "10" and "100".
- Particle Motion:** Contains four numeric input fields with up/down arrows: "Speed" (10.0), "Variation" (0.0) with a percentage symbol to its right, "Tumble" (0.0), and "Tumble Rate" (0.0).
- Particle Timing:** Contains five numeric input fields with up/down arrows: "Emit Start" (0), "Emit Stop" (30), "Display Until" (100), "Life" (30), and "Variation" (0). Below these are three checkboxes under the heading "Subframe Sampling": "Creation Time" (checked), "Emitter Translation" (checked), and "Emitter Rotation" (unchecked).
- Particle Size:** Contains four numeric input fields with up/down arrows: "Size" (1.0), "Variation" (0.0) with a percentage symbol to its right, "Grow For" (10), and "Fade For" (10).
- Uniqueness:** Contains a "New" button and a "Seed" input field with a numeric value of "12345" and up/down arrows.

**Speed** The speed of the particle at birth, in units per frame.

**Variation** Applies a percentage of variation to the speed of emission for each particle.

**Tumble** Amount of random rotation of the particles.

**Tumble Rate** Speed at which the particles rotate.

### Particle Type rollout > Mat'l Mapping and Source group

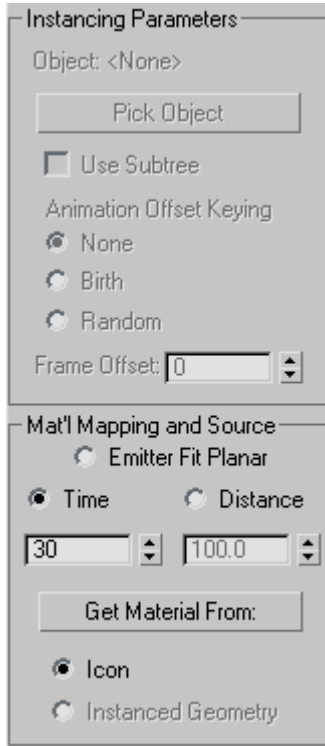

**Emitter Fit Planar** Maps particles at birth, based on their point of emission from the rectangular Blizzard emitter icon. The UV range of the mapped material runs from 0 to 1 over the width and length of the emitter.

## PCloud Particle System

Create panel > Geometry button > Choose Particle Systems from the drop-down list. > Object Type rollout > PCloud

Create menu > Particles > PCloud

Use the PCloud (or Particle Cloud) particle system when you want a "cloud" of particles that fill a specific volume. PCloud can provide a flock of birds, a starfield, or a troupe of soldiers marching over terrain. You can confine the particles using basic supplied volumes of a box, sphere, or cylinder, or you can use any renderable object in the scene as a volume as long as that object has depth. Two-dimensional objects do not work with PCloud.

---

**TIP** There is no automatic way to hide the object chosen as the object-based emitter. Hide it by using Hide Selected on the Display panel, or by applying a Hide key in Track View.

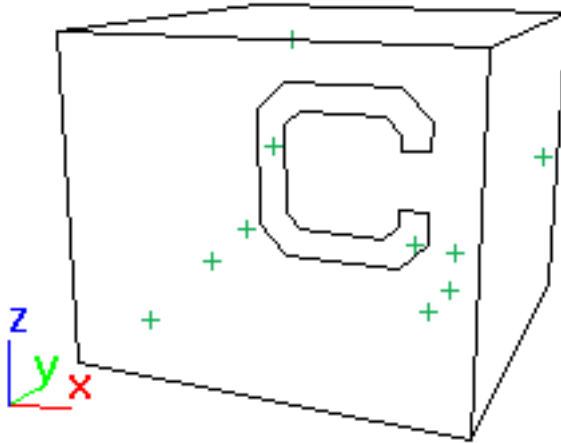

PCloud viewport icon (default emitter)

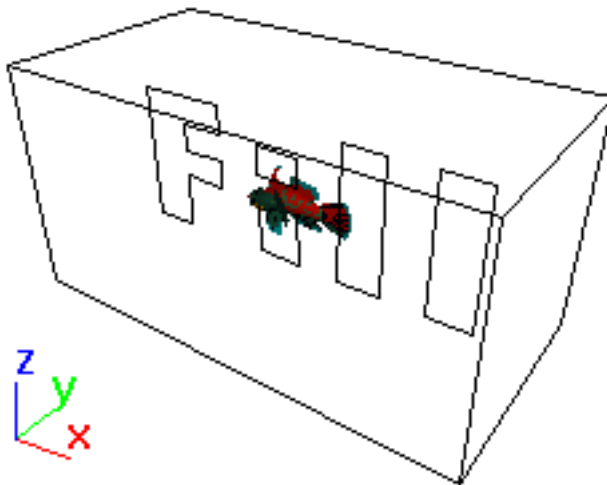

PCloud viewport icon (object-based emitter)



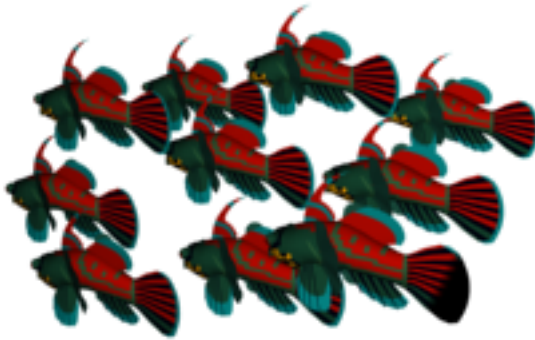



PCloud used to form a school of fish (each fish is a particle)

---

## Procedures

To create a particle cloud:

-   On the Create panel, make sure the Geometry button is active and Particle Systems is chosen in the object category list, then click PCloud.
- Drag in a viewport to create the PCloud emitter; see [Creating a Particle Emitter](#) on page 2928 .  
Adding a PCloud emitter works the same way as creating a box primitive: First drag out the length and width, then release the mouse button and move the mouse vertically to set the height, and then click to finish.  
The emitter appears with a letter "C" representing the particle cloud.
- Adjust the various parameters on the command panel.

## Interface

This section describes the Object-Based Emitter, Particle Formation, and Display Icon groups in the Basic Parameters rollout, and the Particle Motion group in the Particle Generation rollout. These are the only controls unique to PCloud.

The other PCloud rollouts and their contents are identical with those in Particle Array, except that Object Fragments and associated settings are not available on the Particle Type rollout. See [PArray](#) on page 2964 for details or choose from the following list for rollout information.

[Particle Generation Rollout](#) on page 2973

[Particle Type Rollout](#) on page 2977

[Rotation and Collision Rollout](#) on page 2987

[Object Motion Inheritance Rollout](#) on page 2990

[Bubble Motion Rollout](#) on page 2991

[Particle Spawn Rollout](#) on page 2992

[Load/Save Presets Rollout](#) on page 2999

## Basic Parameters rollout

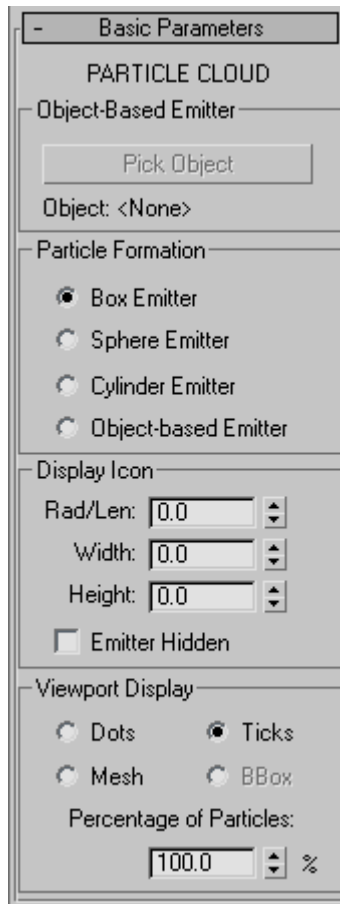

### Object-Based Emitter group

This button lets you select a renderable mesh object to use as a particle emitter. This object is used only when the Object-Based Emitter option is chosen in the Particle Formation group.

**Pick Object** Click this, and then select a renderable mesh object to be used as a custom emitter.

**Object** Displays the name of the picked object.

## Particle Formation group

These options let you specify the shape of the emitter.

**Box Emitter** Chooses a box-shaped emitter.

**Sphere Emitter** Chooses a sphere-shaped emitter.

**Cylinder Emitter** Chooses a cylindrical emitter.

**Object-Based Emitter** Chooses the object selected in the Object-Based Emitter group.

---

**NOTE** With regard to animation of the object-based emitter, the particles will properly fill a deformed object at frame 0, but they can't stay with the emitter while it's moving. If the emitter moves in a straight line, this can give the appearance of the cloud moving with the emitter.

---

## Display Icon group

These options let you adjust the dimensions of the emitter icon when a custom object is not used as an emitter. When a custom object is used you can still resize the "Fill" icon using these options.

**Rad/Len** Adjusts the radius of a spherical or cylindrical icon, and the length of a box icon.

**Width** Sets the width of a box emitter.

**Height** Sets the height of a box or cylindrical emitter.

**Emitter Hidden** Hides the emitter.

## Particle Generation rollout > Particle Motion group

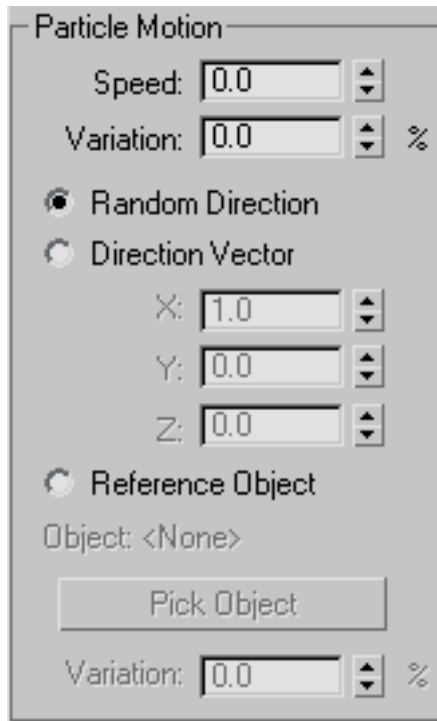

**Speed** The speed of the particle at birth along the normal, in units per frame.

---

**NOTE** For the correct volume effect, Speed should be set to 0.

---

**Variation** Applies a percentage of variation to the speed of emission for each particle.

**Random Direction** One of three options that affect the direction of the particles. This option emits particles in random directions.

**Direction Vector** Specifies the direction of the particles by a vector defined by the three X, Y, and Z spinners.

**X/Y/Z** Displays the particle direction vectors.

**Reference Object** Emits particles in the direction of the local Z axis of a specified object.

**Object** Displays the name of the picked object.

**Pick Object** Click this, and then select an object in the scene to use as a reference object. This button is available only when you choose Reference Object.

**Variation** Applies a percentage of variation to the direction when you choose either the Direction Vector or Reference Object option. This spinner is unavailable and has no effect when you choose Random Direction.

## PArray Particle System

Create panel > Geometry button > Choose Particle Systems from the drop-down list. > Object Type rollout > PArray

Create menu > Particles > PArray

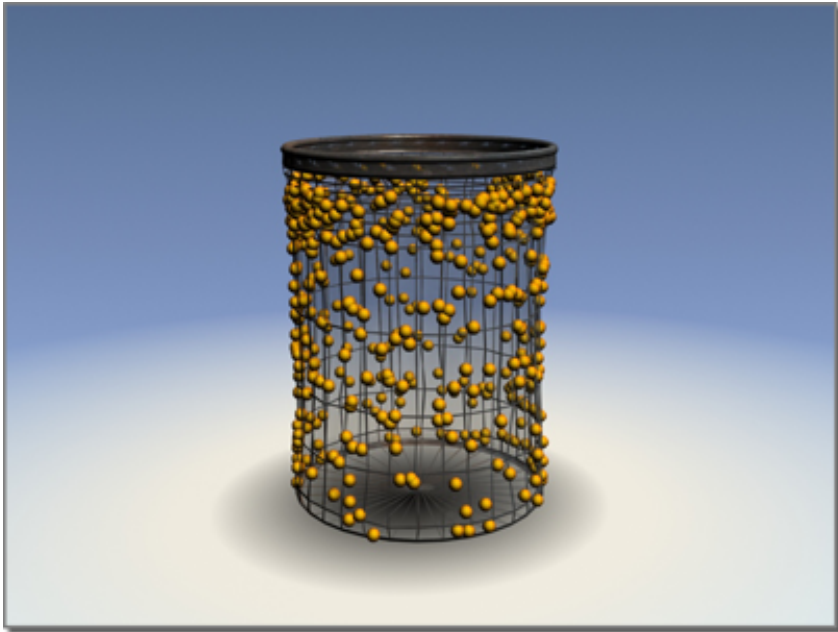

**Basket used as a distribution object for random particles over its surface**

The PArray (Particle Array) particle system provides two types of particle effects:

- You can use it to emit particles using a selected geometric object as the emitter template (or pattern) for the emission. This object is referred to here as the distribution object.

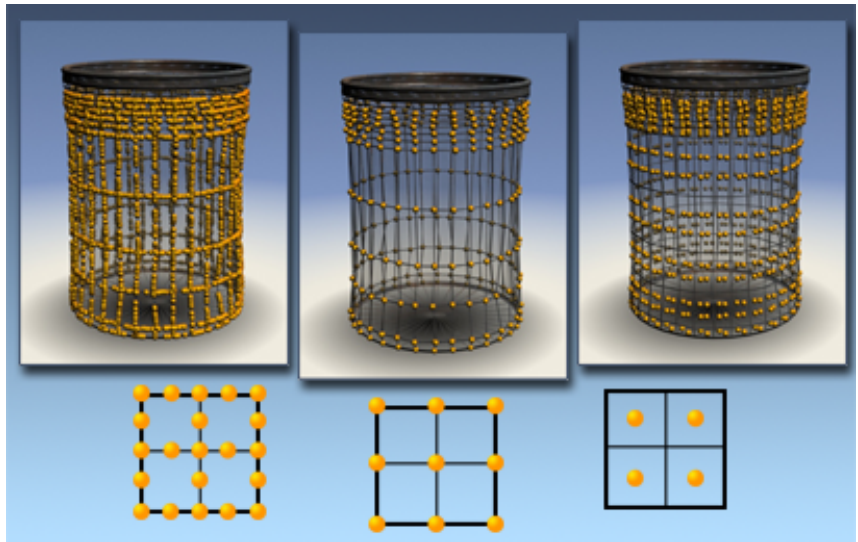

How particles can be distributed on an object:

Left: Edges

Center: Vertices

Right: Faces

- You can use it to create sophisticated object explosions.

---

**TIP** A good way to create explosions is to set the particle type to Object Fragments and then apply a [PBomb space warp](#) on page 2629 .

---

**See also:**

- [Particle System Usage](#) on page 2926
- [Using Materials with Particle Array](#) on page 2929
- [Achieving Particle Motion Blur](#) on page 2932
- [Using Mapped Materials with Particle Systems](#) on page 2932
- [Using Multi/Sub-Object Materials with Particle Systems](#) on page 2934

- [Using Spawned Particles](#) on page 2935
- [Using Interparticle Collision](#) on page 2937

## Procedures

### To set up a particle array:

- 1 Create an object that will become the distribution object, providing the emitter pattern (or exploded object) for the particle array.



- 2 On the Create panel, make sure the Geometry button is active and Particle Systems is chosen in the object category list, then click PArray.
- 3 Drag anywhere in a viewport to create the particle-system object; see [Creating a Particle Emitter](#) on page 2928 .
- 4 On the Basic Parameters rollout, click Pick Object, and then click the object to use as the distribution object.
- 5 Adjust the various options in the Particle Array rollouts to achieve the effect you want.

The distribution object can be any object containing renderable faces.

The particle-system object does not appear in the rendered scene. Its placement, orientation or size in the scene has no influence on the particle effect. To access the Particle Array parameters after creation, open the Modify panel and select the particle-system object (or click any visible particles in the viewport). To transform or otherwise modify the distribution object, select the distribution object itself.

Also, you can share a single distribution object among more than one particle-system object. The distribution object merely provides the template for the particles, which are actually generated by the particle system.

### Example: To assign three different mapped materials to fragments:

- 1 Apply mapping coordinates to the distribution object, either by turning on Generate Mapping Coords, if necessary, or by applying a [UVW Map modifier](#) on page 1849 .
- 2 Assign a [Multi/Sub-Object material](#) on page 5558 to the distribution object.



- 3 Set up the first three sub-materials to be mapped materials.
- 4 Select the PArray icon.
- 5 On the Particle Type rollout in the Mat'l Mapping And Source group, choose Picked Emitter.
- 6 In the Particle Type rollout > Particle Types group, turn on Object Fragments.
- 7 Make sure the three spinners in the Fragment Materials group are set to 1, 2, and 3, respectively (or match the numbers with the sub-materials you've assigned in your multi/sub-object material).

---

**TIP** Using a complex distribution object for object-fragment particles can really slow down viewport interaction. You can use a simple stand-in object as the distribution object, and then later use the File/Replace command to replace the distribution object with a more complex object of the same name.

---

## Interface

[Basic Parameters Rollout \(PArray\)](#) on page 2967

[Particle Generation Rollout](#) on page 2973

[Particle Type Rollout](#) on page 2977

[Rotation and Collision Rollout](#) on page 2987

[Object Motion Inheritance Rollout](#) on page 2990

[Bubble Motion Rollout](#) on page 2991

[Particle Spawn Rollout](#) on page 2992

[Load/Save Presets Rollout](#) on page 2999

## Basic Parameters Rollout (PArray)

Create panel > Geometry button > Choose Particle Systems from the drop-down list. > Object Type rollout > Parray > Basic Parameters rollout

The items on the Basic Parameters rollout let you create and adjust the size of the particle system, and pick the distribution object. In addition, they let you specify the initial distribution of the particles in relation to the geometry of the distribution object, and the initial velocity of the particles from the

distribution object. From here, you can also specify how the particles appear in the viewport.

## Interface

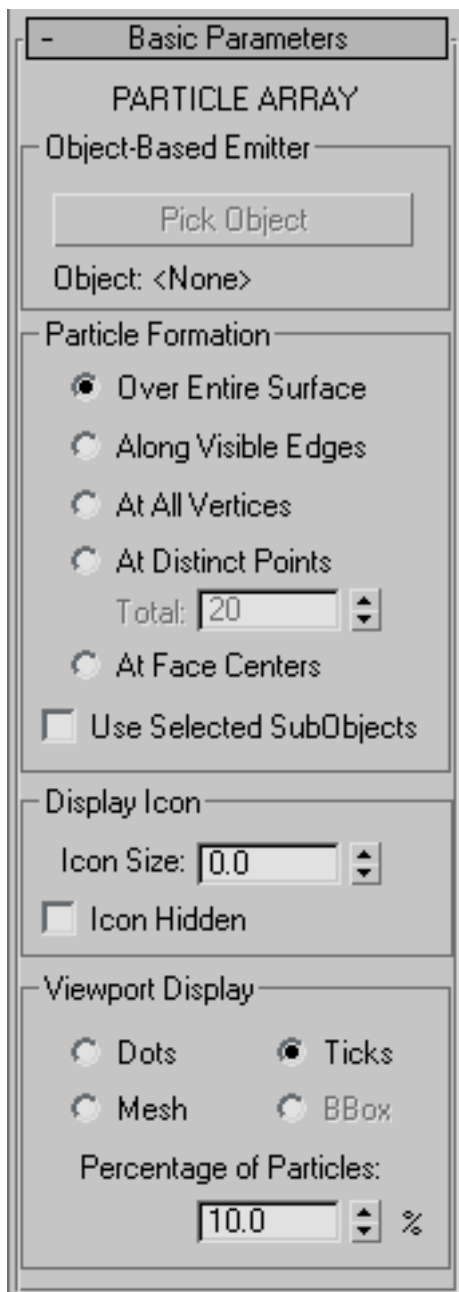

## Object-Based Emitter group

**Pick Object** After you create the particle-system object, the Pick Object button becomes available. Click this button, and then click to select an object in your scene. The selected object becomes the object-based emitter, and is used either as the source geometry over which particles form, or the source geometry used to create particles that appear to be fragments of the object.

**Object text field** Displays the name of the picked object.

## Particle Formation group

These options determine how standard particles are initially distributed over the surface of the object-based emitter. These controls are available only when the picked object is used as a distribution grid for standard particles, MetaParticles, or instanced geometry; see [Particle Type rollout](#) on page 2977. When Object Fragments is chosen in the Particle Type rollout, these controls are unavailable.

**Over Entire Surface** Emits particles randomly over the entire surface of the object-based emitter. This is the default choice.

**Along Visible Edges** Emits particles randomly from the visible edges of the object.

**At All Vertices** Emits particles from the vertices of the object.

**At Distinct Points** Places a specified number of emitter points randomly over the surface of the object.

**Total** Specifies the number of emitter points used when At Distinct Points is chosen.

**At Face Centers** Emits particles from the center of each triangular face.

**Use Selected SubObjects** With mesh-based emitters, and to a limited extent with patch-based emitters, limits the source of the particle stream to the sub-object selection passed up the modifier stack in the object-based emitter. For example, if your emitter object is a cylinder converted to an editable mesh, and the top cap of that cylinder is selected at the Face or Polygon sub-object level, if Use Selected SubObjects is on *and* Particle Formation group > At Face Centers is on, the particles will stream only from the top cap of the cylinder. Default=off.

The type of particle formation you specify determines the type of sub-object geometry used, as follows:

- **Over Entire Surface** Faces

■ **Along Visible Edges** Edges

■ **At All Vertices** Vertices

■ **At Distinct Points** Faces

■ **At Face Centers** Faces

If you've converted your object to an editable mesh, and selected different sub-object sections of it with vertex, edge, and face selection, as you switch particle formation options, you'll see the particles emit from different areas of the object.

---

**NOTE** Use Selected SubObjects is applicable to patch object emitters only at the patch and element sub-object levels, and is not applicable NURBS objects used as emitters.

---

**TIP** You can best see the emission patterns by first setting Speed on the Particle Generation rollout > Particle Motion group to 0. Move to a frame in which the particles appear, and then choose the various particle formation options.

---

### **Display Icon group**

Adjusts the display of the particle-system icon in the viewports. (The particle-system icon is usually called the "emitter." In this case, however, it doesn't actually emit particles, so we're avoiding the term.)

**Icon Size** Sets the overall size of the icon, in units.

**Icon Hidden** When on, the PArray icon is hidden in the viewports. Note that the icon does not render, in any case. Default=off.

### **Viewport Display group**

Specifies how the particles are displayed in the viewports.

**Dots** Displays the particles as dots.

**Ticks** Displays the particles as crosses.

**Mesh** Displays the particles as mesh objects. This results in slower viewport redraws.

**BBox** For instanced geometry only, this displays each instanced particle, whether a single object, a hierarchy, or a group, as a bounding box.

**Percentage of Particles** This spinner specifies the number particles displayed in the viewports as a percentage of the number of rendered particles. Default=10 percent.

Set the display percentage to 100 percent if you want to see the same number of particles as will be rendered in your scene. However, this can considerably slow viewport display.

## Particle Generation Rollout

Create panel > Geometry button > Choose Particle Systems from the drop-down list. > Object Type rollout > SuperSpray/Blizzard/Parray/PCloud > Particle Generation rollout

Select a SuperSpray/Blizzard/Parray/PCloud emitter. > Modify panel > Particle Generation rollout

Items on this rollout control when and how quickly particles form, how particles move, and the size of the particles over time.

## Interface



## Particle Quantity group

In this group, you can choose one of two methods by which the number of particles is determined over time. These settings are unavailable if you set Particle Type (in the [Particle Type rollout](#) on page 2977 ) to Object Fragments.

**Use Rate** Specifies a fixed number of particles emitted per frame. Use the spinner to set the number of particles formed per frame.

**Use Total** Specifies a total number of particles formed over the life of the system. Use the spinner to set the number of particles formed per frame.

The life of the system, in frames, is specified by the Life spinner in the Particle Timing group, described later in this topic.

---

**TIP** Generally, Use Rate is best for a continuous flow of particles, like a trail of pixie dust, while Use Total is better for bursts of particles over a short period of time.

---

## Particle Motion group

These spinners control the initial particle velocity, which is directed along the surface, edge, or vertex normals (interpolated for each emitter point).

**Speed** The velocity of the particle at birth, along the normal, in units traveled per frame.

**Variation** Applies a percentage of variation to the speed of emission for each particle.

**Divergence** Applies an angular degree of variation by which each particle's velocity can vary from the emitter normal.

---

**NOTE** The initial direction for a fragment cluster is the normal of the cluster's seed face. Clusters are created by choosing a single face (the seed face), and then creating a cluster outward from that face, depending on the method chosen in the Object Fragment Controls group on the Particle Type rollout.

---

## Particle Timing group

These options specify when particle emission starts and stops, and the lifespan of the individual particles.

**Emit Start** Sets the frame at which particles begin to exist in the scene.

**Emit Stop** Sets the last frame at which particles are emitted. This setting has no effect if you choose the Object Fragments particle type.

**Display Until** Specifies the frame at which all particles will disappear, regardless of other settings.

**Life** Sets the lifespan in number of frames of each particle from the frame of creation.

**Variation** Specifies the number of frames by which the life of each particle can vary from the norm.

**Subframe Sampling** Turning on any of the three check boxes below helps avoid particle "puffing" by sampling particles at a much higher subframe resolution, instead of the relatively coarse frame resolution. Depending on your needs, you can do this over time, over motion, or over rotation. "Puffing" is the effect of emitting separate "puffs" or clusters of particles, rather than a continuous stream. This effect is especially noticeable when the emitter is animated.

- **Creation Time** Enables the addition of a time offset to the equations of motion that prevents puffing in time. This setting has no effect with the Object Fragments particle type. Default=on.
- **Emitter Translation** If the object-based emitter is moving in space, particles are created at integral times at positions along the geometry's path between renderable positions. This prevents puffing in space. This setting has no effect if Object Fragment particle type is on. Default=on.
- **Emitter Rotation** If the emitter is rotating, turn this on to avoid puffing and produce smooth spiral effects. Default=off.

---

**IMPORTANT** Each additional subframe sampling check box that you turn on progressively increases the necessary computation. In addition, the methods are listed in order of least amount of computation to most. Thus, Emitter Rotation is more costly than Emitter Translation, which is more costly than Creation Time.

---

## Particle Size group

These spinners specify the size of the particles.

**Size** This animatable parameter specifies the target size for all particles in the system, depending on the type of particle:

- **Standard Particles** The major dimension of the particle.
- **Constant** The dimension, in rendered pixels, of a Constant type of particle.

- **Object Fragments** No effect.

**Variation** The percentage by which the size of each particle may vary from the norm. This is applied to the Size value. Use this parameter to get a realistic mix of large and small particles.

**Grow For** The number of frames over which the particle grows from being very small to the Size value. The result is subject to the Size/Variation value, since Grow For is applied after Variation. Use this parameter to simulate natural effects such as bubbles growing as they reach the surface.

**Fade For** The number of frames over which the particle will shrink to 1/10th its Size setting prior to its death. This is also applied after Variation. Use this parameter to simulate natural effects such as sparks fading to ash.

### **Uniqueness group**

By changing the Seed value in this spinner, you achieve different results using otherwise identical particle settings.

**New** Randomly generates a new seed value.

**Seed** Sets a specific seed value.

## **Particle Type Rollout**

Create panel > Geometry button > Choose Particle Systems from the drop-down list. > Object Type rollout > SuperSpray/Blizzard/Parray/PCLoud > Particle Type rollout

Select a SuperSpray/Blizzard/Parray/PCLoud emitter. > Modify panel > Particle Type rollout

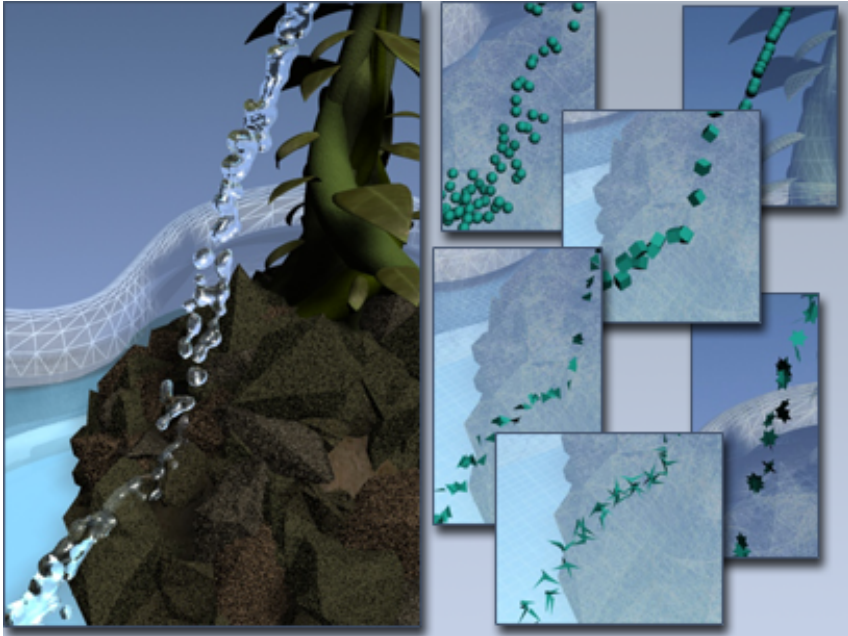

**Left: A stream from a fountain**

**Right: The same stream with various types of particles**

The controls on this rollout let you specify the type of particle used and the type of mapping performed on the particles.

## Interface

- Particle Type

Particle Types

- Standard Particles
- MetaParticles
- Instanced Geometry

Standard Particles

- Triangle  Cube
- Special  Facing
- Constant  Tetra
- SixPoint  Sphere

MetaParticle Parameter

Tension:

Variation:  %

Evaluation Coarseness:

Render:

Viewport:

Automatic Coarseness

One Connected Blob

Instancing Parameters:

Object: <None>

Use Subtree Also

Animation Offset Keying

- None
- Birth
- Random

Frame Offset:

## Particle Types group

These options specify one of four categories of particle type. Depending on which option you choose, different controls become available in the lower portion of the Particle Type rollout.

**Standard Particles** Uses one of several standard particle types, such as triangle, cube, tetra, and so on.

**MetaParticles** Uses Metaball particles. These are particle systems in which the individual particles blend together in blobs or streams.

**Object Fragments** Creates particles out of fragments of an object.

Object Fragments is available only with Particle Array. Choose it when you want to fracture the particle emitter object and use the pieces as particles. This option is useful for animating explosions and shattering collisions.

The fragments are created at the Emit Start frame. The Use Rate, Use Total, Emit Stop, and Particle Size parameters are unavailable.

**Instanced Geometry** Generates particles that are instances of either an object, a linked hierarchy of objects, or a group. The object is selected in the Instancing Parameters group on the Particle Type rollout.

Choose Instanced Geometry when you want particles to be identical instances of another object in your scene. Instanced geometry particles are extremely effective for creating crowds, flocks, or flows of very detailed objects. Here are a few examples:

- Instance a red blood cell and use Super Spray to animate blood flowing in an artery.
- Instance a bird and use Particle Cloud to animate a flock of birds flying.
- Instance a rock and use Particle Cloud to animate an asteroid field.

---

**NOTE** Only one type of particle can be used for the particle system. However, you can have more than one particle array bound to a single object, and each particle array can emit a different type of particle.

---

**TIP** Image motion blur, described in [Object Properties](#) on page 245 > Motion Blur group, is known not to work properly with instanced particles. Use object motion blur with instanced particles, or use image motion blur with standard particles.

---

## Standard Particles group

When you choose Standard Particles in the Particle Types group, the options in this group become available. Choose one of the following options to specify the particle type:

**Triangle** Renders each particle as a triangle. Use Triangle particles with noise opacity for steam or smoke.

**Cube** Renders each particle as a cube.

**Special** Each particle consists of three intersecting 2D squares. These are effective when you use a face-map material, described in [Shader Basic Parameters Rollout](#) on page 5301 , optionally along with an opacity map, to create the effect of a three-dimensional particle.

**Facing** Renders each particle as a square that always faces the view. Use with an appropriate opacity map for bubbles or snowflakes.

**Constant** Provides a particle that remains the same size, in pixels, specified in the Size spinner. This size never changes, regardless of its distance from the camera.

---

**IMPORTANT** You must render either a camera or a perspective view for Constant particles to render correctly.

---

**Tetra** Renders each particle as a mapped tetrahedron. Use Tetra particles for raindrops or sparks.

The default alignment of the tetra particles depends on the particle system type and emitter setup. To specify an alignment, use controls in the [Rotation and Collision rollout](#) on page 2987 .

**SixPoint** Renders each particle as a six-pointed, two-dimensional star.

**Sphere** Renders each particle as a sphere.

## MetaParticle Parameters group

When you choose the MetaParticles option in the Particle Types group, the options in this group become available, and metaballs are used as particles. Metaparticles take extra time to render but are very effective for spraying and flowing liquid effects.

**Tension** Determines the tightness of the particles, with regard to their tendency to blend with other particles. The higher the Tension, the harder the blobs, and the harder it is for them to merge.

**Variation** Specifies the percent of variation of the Tension effect.

**Evaluation Coarseness** Specifies how accurately the metaparticle solution is calculated. The higher the coarseness values, the less calculation. However, if the coarseness is too high, there may be little or no metaparticle effect at all. Conversely, if the coarseness is set too low, the time for calculation can become extremely long.

**Render** Sets the coarseness for metaparticles in the rendered scene. This option is unavailable when Automatic Coarseness is on.

**Viewport** Sets the coarseness for the viewport display. This option is unavailable when Automatic Coarseness is on.

**Automatic Coarseness** A general rule is to set the Coarseness value between 1/4 and 1/2 the size of the particles. When this item is on, the rendering coarseness is automatically set, based on the size of the particles, and the viewport coarseness is set to about twice that of the rendering coarseness.

**One Connected Blob** When off (the default), all particles are calculated; when on, a shortcut algorithm is used that calculates and displays only those particles that are adjoining or contiguous to each other.

---

**NOTE** One Connected Blob mode speeds particle calculations, but you should use it only when your metaparticles form one connected blob, as the label indicates. That is, all particles' blobs must be touching. For example, if you were to use One Connected Blob on a stream of particles containing a mass of 10 contiguous particles followed by a space, then 12 contiguous particles followed by another space, and finally 20 contiguous particles, one of the particles will be chosen, and only the mass connected to that particle will be displayed and rendered.

---

**TIP** When in doubt, leave this option off. If you think all your particles are contiguous and want to save time, turn on One Connected Blob, and then display various frames to see if everything appears.

---

### **Object Fragment Controls group**

With a particle array, when you choose the Object Fragments particle type, the items in this group become available, and the object-based emitter is exploded into fragments, rather than being used to distribute particles.

---

**NOTE** To see the fragments in the viewports, choose Mesh in the Viewport Display group near the bottom of the [Basic Parameters rollout](#) on page 2967 .

---

The items in this group include a Thickness spinner, along with three option buttons that determine how the fragments are formed.



---

**TIP** There is no automatic way to hide the distribution object that explodes into fragments. To create the illusion that an object is exploding, you must either set the original object to be invisible at the start of the explosion, as described in [Add Visibility Track](#) on page 3533 , or move or scale the original object so it doesn't remain in view.

---

**Thickness** Sets the thickness of the fragments. At 0, the fragments are single-sided with no thickness. When greater than 0, the fragments are extruded, at fragmentation time, by the amount specified. The outer and inner surfaces of the fragment use identical smoothing, which is picked up from the object-based emitter. The edges of the fragments are not smoothed.

The three options that follow specify how the object fragments.

**All Faces** Each face of the object becomes a particle. This results in triangular particles.

**Number of Chunks** The object breaks into irregular fragments. The Minimum spinner, below, specifies the minimum number of fragments that will appear. The method of calculating the chunks may result in more fragments than specified.

**Minimum** Determines a number of "seed" faces in the geometry. Each seed face collects connecting faces surrounding it until all available faces are exhausted. Any leftover faces become unique particles, thus increasing the minimum number of fragments.

**Smoothing Angle** The fragments are broken based on the angles between face normals, as specified in the Angle spinner. Generally, the higher the Angle value, the fewer the number of fragments.

**Angle** Sets the amount of smoothing angle.

### Instancing Parameters group

Instancing Parameters

Object: <None>

Pick Object

Use Subtree Also

Animation Offset Keying

None

Birth

Random

Frame Offset:

Mat'l Mapping and Source

Time  Distance

Get Material From:

Icon

Picked Emitter

Instanced Geometry

Fragment Materials

Outside ID

Edge ID

Backside ID

These options are used when you specify Instanced Geometry in the Particle Types group. They let you generate each particle as an instance of either an object, a linked hierarchy of objects, or a group.

---

**NOTE** Instanced objects can be animated, providing the animation incorporates one or more of the following types:

- Animation of object geometry parameters, such as a sphere's Radius setting.
- Animation of object-space modifiers, such as the Angle setting of a [Bend modifier](#) on page 1139 .
- Transform animation of a hierarchical object's children. Transform animation of the top-level parent and non-hierarchical objects is not supported. For example, if you use the toolbar [Select and Rotate function](#) on page 889 to animate a box rotating, and then use the box as instanced geometry with a particle system, the system will not use instanced box's keyframed animation.

---

**Object** Displays the name of the picked object.

**Pick Object** Click this, and then select an object in the viewport to be used as a particle. If you select an object that's part of a hierarchy and Use Subtree Also is on, then the picked object and its children become a particle.

If you pick a group, all objects in the group are used as a particle.

**Use Subtree Also** Turn this on when you want to include the linked children of the picked object in the particle. If the picked object is a group, all children of the group are included. Note that you can turn this on or off at any time to alter the particles.

**Animation Offset Keying** Because the instanced objects can be animated, the options here let you specify the timing of the animations for the particles.

**None** Each particle duplicates the timing of the original object. As a result, the animation of all particles will be identically timed.

**Birth** The firstborn particle is an instance of the current animation of the source object at the moment of that particle's birth. Each subsequent particle then uses the same start time for the animation. For example, if the animation of the source object is a bend from 0 to 180 degrees, and the first particle is born at frame 30, when the object is at 45 degrees, then that particle, and all subsequent particles will be born starting at a bend of 45 degrees.

**Random** This option is the same as None when Frame Offset is set to 0. Otherwise, each particle is born using the same animation as the source object

at the time of birth, but with a random offset of frames, based on the value in the Frame Offset spinner.

**Frame Offset** Specifies an offset value from the current timing of the source object.

### **Mat'l Mapping and Source group**

Specifies how a mapped material affects the particles, and lets you specify the source of the material assigned to the particles. A detailed description of how materials affect particles is in the topic [Using Mapped Materials with Particle Systems](#) on page 2932 .

**Time** Specifies the number of frames from the birth of the particle that it takes to complete one mapping of the particle.

**Distance** Specifies the distance, in units, from the birth of the particle that it takes to complete one mapping of the particle.

---

**NOTE** Tetra particles are an exception. They always have their own local mapping from head to tail, as described in the following section.

---

**Get Material From** Updates the material carried by the particle system, using the source specified by the option buttons below this button.

---

**IMPORTANT** Remember to click Get Material From whenever you choose a different source option button, or whenever you assign a new material to the specified source. Only a single material (or multi/sub-object material) is carried by the particle-system object at any time. Thus, when you change sources, you actually overwrite the currently assigned material with an instance of the source material.

---

**Icon** The particles use the material currently assigned to the particle system icon.

---

**NOTE** The Time and Distance options are available only when you choose this option.

---

**Picked Emitter** The particles use the material assigned to the distribution object.

**Instanced Geometry** The particles use the material assigned to the instanced geometry. This option is available only when you choose Instanced Geometry in the Particle Types group.

---

**IMPORTANT** When you turn on either Picked Emitter or Instanced Geometry, an instance of the material from the chosen source is copied to the emitter icon, overwriting the material originally assigned to the icon. Thus, if you've assigned a material to the particle emitter, and then switch to Picked Emitter, the material originally assigned to the icon is replaced by an instance of the material carried by the picked object. If you then return to the Icon option, the particle system does not revert to the material that was assigned the icon, but retains the material taken from the picked object.

---

## Fragment Materials group

These spinners let you assign different material ID numbers to outside surfaces, the edges and the back sides of fragment particles. You can then assign different materials to the front, edge and back of the fragments by using a multi/sub-object material.

**Outside ID** Specifies which face ID number is assigned to the outside faces of the fragments. This spinner defaults to 0, which is not a valid ID number, forcing the outside of the particle fragments to use whatever material is currently assigned to the associated faces. Thus, if your distribution object already has several submaterials assigned to its outer faces, these materials are retained by using ID 0. If you want a single, specific submaterial, you can assign it by changing the Outside ID number.

**Edge ID** Specifies which submaterial ID number is assigned to the edges of the fragments.

**Backside ID** Specifies which submaterial ID number is assigned to the back sides of the fragments.

## Rotation and Collision Rollout

Create panel > Geometry button > Choose Particle Systems from the drop-down list. > Object Type rollout > SuperSpray/Blizzard/Parray/PCLoud > Rotation and Collision rollout

Select a SuperSpray/Blizzard/Parray/PCLoud emitter. > Modify panel > Rotation and Collision rollout

Particles often move at high rates of speed. In such cases, you might want to add motion blur to the particles to enhance their motion. Also, real-world particles typically rotate as they move, and collide with each other.

The options on this rollout affect the rotation of the particles, provide motion blur effects, and control inter-particle collisions.

## Interface



### Spin Speed Controls group

**Spin Time** The number of frames for one rotation of a particle. If set to 0, no rotation takes place.

**Variation** The percent of variation of the Spin Time.

**Phase** Sets the initial particle rotation, in degrees. This has no meaning for fragments, which always begin with zero rotation.

**Variation** The percent of variation of the Phase.

### **Spin Axis Controls group**

These options determine the spin axis for the particles, and provide a partial method of applying motion blur to the particles.

**Random** The spin axis for each of the particles is random.

**Direction of Travel/Mblur** (Not available with the Blizzard particle system.) Rotates the particles about a vector formed by the direction in which they're moving. This option also lets you apply a form of motion blur to the particles by using the Stretch spinner. For further information, see [Achieving Particle Motion Blur](#) on page 2932 .

**Stretch** When greater than 0, the particles stretch along the travel axis, depending on their speed. Specifically, the Stretch value specifies the percent of their length per each unit of the Speed setting (in the Particle Motion group). Thus, if you set Stretch to 2 while Speed is set at 10, the particles are stretched 20 percent longer than their original size along the axis of their travel. This spinner is available only when you choose Direction of Travel/Mblur.

---

**NOTE** For best results when using Stretch, you should also assign the Particle MBlur map as an opacity map of the material assigned to the particle system.

---

**User Defined** Uses a vector defined in the three X, Y, and Z axis spinners.

**X/Y/Z Axis** Specifies the spin vector of the X, Y, or Z axis, respectively. These spinners are available only when User Defined is chosen.

**Variation** The amount, in degrees, by which the spin axis of each particle may vary from the specified X Axis, Y Axis, and Z Axis settings. This spinner is available only when you choose User Defined.

### **Interparticle Collisions group**

These options enable collisions between particles, and control how the collisions occur. Note that this involves intensive calculation, particularly when large numbers of particles are involved.

**Enable** Enables inter-particle collisions in the calculation of the particle movements.

**Calc Intervals Per Frame** The number of intervals per rendering interval, during which an inter-particle collision test is conducted. The higher the value, the more accurate the simulation, but the slower the simulation will run.

**Bounce** The degree to which speed is recovered after a collision.

**Variation** The percentage of random variation of the Bounce value, applied to the particles.

## Object Motion Inheritance Rollout

Create panel > Geometry button > Choose Particle Systems from the drop-down list. > Object Type rollout > SuperSpray/Blizzard/Parray/PCloud > Object Motion Inheritance rollout

Select a SuperSpray/Blizzard/Parray/PCloud emitter. > Modify panel > Object Motion Inheritance rollout

Each particle's position and direction of movement are determined by the position and orientation of the emitter at the time the particle is created. If the emitter is moving through the scene, particles are scattered along the emitter's path.

Use these options to affect the motion of the particles by the motion of the emitter.

### Procedures

**Example: To observe object motion inheritance:**

- 1 Create a Super Spray particle system.
- 2 Animate the emitter moving sideways (perpendicular to the direction of the particle stream) between frames 1 and 15.
- 3 Play the animation while observing it from the Top viewport.  
The emitter stops at frame 15, while the particles it has emitted up to that point continue moving along the diagonal between the emitter's path and that of the particles. The remaining particles move straight out from the emitter.
- 4 On the Object Motion Inheritance rollout, set Influence to 50.
- 5 Play the animation again.



This time, only some of the particles inherit the emitter's motion, while the rest move straight out from the emitter. Note that the latter form a diagonal stream because each particle emerges at a subsequent point on the emitter path.

## Interface

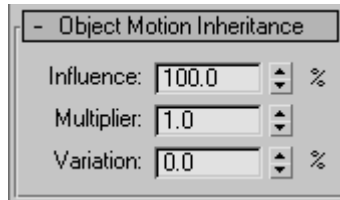

**Influence** The percent of particles that inherit the motion of the object-based emitter at the moment of particle formation. For example, when this is set at 100 (the default), all particles travel along with a moving object; when it's set at 0, none of the particles are affected by the translation of the object and fall behind its movement.

**Multiplier** Modifies the amount by which the emitter motion affects the particle motion. This can be a positive or negative number.

**Variation** Provides a percentage of variation of the Multiplier value.

## Bubble Motion Rollout

Create panel > Geometry button > Choose Particle Systems from the drop-down list. > Object Type rollout > SuperSpray/Parray/PCloud > Bubble Motion rollout

Select a SuperSpray/Parray/PCloud emitter. > Modify panel > Bubble Motion rollout

Bubble motion provides the wobbling effect you see in bubbles rising underwater. Typically, it's used when the particles are set to rise in thin streams. Bubble motion is similar to a waveform, and the Bubble Motion parameters let you adjust the amplitude, period, and phase of the bubble "wave."

---

**NOTE** The bubble motion is not affected by space warps, so you can use a space warp to control the direction of the particle flow without altering the local, wobbling bubble effect.

---

---

**TIP** InterParticle Collisions, Deflector Binding, and Bubble Noise do not get along well together. Particles may leak through the deflector when these three are used together. Instead of bubble motion, use animated mapping. Use facing particles with an animated map of a bubble, where the bubble is smaller than the map size. The bubble is animated moving around the map. This simulates bubble motion at the map level.

---

## Interface

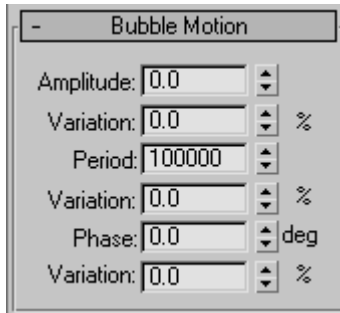

**Amplitude** The distance the particle moves off its usual velocity vector as it travels.

**Variation** The percent of Amplitude variation applied to each particle.

**Period** The cycle time for one complete oscillation of a particle through the bubble "wave." A recommended value might be 20 to 30 intervals.

---

**NOTE** Bubble motion is measured in time, not in rate, so a very large Period value means the motion takes a long time to complete. Thus, there is no motion, effectively. Period is therefore set to a very large default value so that the default motion of this type is none.

---

**Variation** The percent of Period variation for each particle.

**Phase** The initial displacement of the bubble pattern along the vector.

**Variation** The percent of Phase variation for each particle.

## Particle Spawn Rollout

Create panel > Geometry button > Choose Particle Systems from the drop-down list. > Object Type rollout > SuperSpray/Blizzard/Parray/PCloud > Particle Spawn rollout

Select a SuperSpray/Blizzard/Parray/PCloud emitter. > Modify panel > Particle Spawn rollout

The options on the Particle Spawn rollout let you specify what happens to particles when they die, or when they collide with a particle deflector. Using the options on this rollout, you can have particles generate additional generations of particles upon collision or death.

## Interface

The image shows a software interface for configuring particle spawning. It is organized into four main sections, each with a title bar and a collapse icon:

- Particle Spawning Effects:** Contains radio buttons for "None" (selected), "Die After Collision", "Spawn on Collision", "Spawn on Death", and "Spawn Trails". Below these are input fields for "Persist:" (0), "Variation:" (0.0 %), "Spawns:" (1), "Affects:" (100 %), "Multiplier:" (1), and another "Variation:" (0.0 %).
- Direction Chaos:** Contains an input field for "Chaos:" (0.0 %).
- Speed Chaos:** Contains an input field for "Factor:" (0.0 %), radio buttons for "Slow" (selected), "Fast", and "Both", and checkboxes for "Inherit Parent Velocity" and "Use Fixed Value".
- Scale Chaos:** Contains an input field for "Factor:" (0.0 %), radio buttons for "Down" (selected), "Up", and "Both", and a checkbox for "Use Fixed Value".

### Particle Spawning Effects group

Choose one of these options to determine what happens to the particles at either collision or death.

**None** Uses none of the spawning controls, and the particles act as they normally would. That is, upon collision, they either bounce or stick, depending on Particle Bounce settings in the deflector, and on death they disappear.

**Die After Collision** Particles disappear when they strike a deflector to which they're bound, such as the SDeflector.

**Persist** The life, in frames, that the particle will persist after the collision. Setting this to 0 (the default) causes particles to vanish immediately after the collision.

**Variation** Varies the Persist value of each particle, when Persist is greater than 0. This lets you "feather" the dying off of particle density.

**Spawn on Collision** Spawn effects take place upon collision with a bound deflector.

**Spawn on Death** Spawn effects take place at the end of each particle's life.

**Spawn Trails** Particles are spawned from existing particles at each frame of that particle's life. The Multiplier spinner specifies the number of particles that are spawned from each particle. The base direction of the spawned particles is opposite that of the parent's velocity. The Scale, Direction, and Speed Chaos factors are applied to that base direction.

---

**NOTE** If the Multiplier is greater than 1, at least one of the three Chaos factors must be greater than 0 in order to see the additional spawned particles. Otherwise, the multiples will occupy the same space.

---

**WARNING** This option can produce *many* particles. For best results, begin by setting Particle Quantity on the Particle Generation rollout to Use Rate and to 1.

---

**Spawns** The number of spawns beyond the original particle generation. For example, if this is set to 1, and you're spawning at death, one spawning will occur beyond the original lifespan of each particle.

**Affects** Specifies the percentage of particles that will spawn. Reducing this reduces the number of particles that produce spawned particles.

**Multiplier** Multiplies the number of particles spawned at each spawning event.

**Variation** Specifies a percentage range by which the Multiplier value will vary, frame by frame.

## **Direction Chaos group**

**Chaos** Specifies the amount by which the direction of the spawned particle can vary from the direction of the parent particle. A setting of 0 means no variance. A setting of 100 causes the spawned particle to travel in any random direction. A setting of 50 causes the spawned particle to deviate from its parent's path by up to 90 degrees.

## **Speed Chaos group**

These options let you vary the spawned particles' speed randomly in relation to their parents' speed.

**Factor** This is the range of a percentage of change in the speed of the spawned particle relative to its parent. A value of 0 means no change.

**Slow** Applies the speed factor randomly to slow the speed of the spawned particles.

**Fast** Randomly speeds up particles based on the speed factor.

**Both** Some particles speed up, while others slow down, based on the speed factor.

**Inherit Parent Velocity** Spawned particles inherit the speed of their parents, in addition to the effect of the speed factor.

**Use Fixed Value** Uses the Factor value as a set value, rather than as a range applied randomly to each particle.

## Scale Chaos group

The image shows three stacked control panels. The top panel, titled 'Scale Chaos', contains a 'Factor' input field with the value '0.0' and a percentage symbol, three radio buttons for 'Down' (selected), 'Up', and 'Both', and a 'Use Fixed Value' checkbox. The middle panel, titled 'Lifespan Value Queue', has 'Add', 'Delete', and 'Replace' buttons on the left and an empty list box on the right, with a 'Lifespan' input field below. The bottom panel, titled 'Object Mutation Queue', has an empty list box and 'Pick', 'Delete', and 'Replace' buttons.

These options apply random scaling to the particles.

**Factor** Determines a random percentage range of scaling of the spawned particles relative to their parents, and dependent on the options below.

**Down** Randomly scales down spawned particles to be smaller than their parents, based on the Factor value.

**Up** Randomly scales up spawned particles to be larger than their parents.

**Both** Scales spawned particles both larger and smaller than their parents.

**Use Fixed Value** Uses the Factor value as a fixed value, rather than a range of values.

## Lifespan Value Queue group

These options let you specify a list of alternative lifespan values for each spawned generation of particles. The spawned particles use these lifespans

rather than the lifespan specified for the original particles in the Life spinner on the [Particle Generation rollout](#) on page 2973 .

**List window** Displays a list of lifespan values. The first value on the list is used for the first generation of spawned particles, the next value is used for the next generation, and so on. If there are fewer values on the list than there are spawnings, then the last value is used repeatedly for all remaining spawnings.

**Add** Adds the value in the Lifespan spinner to the list window.

**Delete** Deletes the currently highlighted value in the list window.

**Replace** Lets you replace a value in the queue with a value in the Lifespan spinner. To use, first place a new value in the Lifespan spinner, then select the value in the queue you want to replace, and click the Replace button.

**Lifespan** Use this to set a value, and then click the Add button to add the value to the list window.

### **Object Mutation Queue group**

The options in this group let you switch between instanced-object particles with each spawning (as set with the Spawns spinner). These options are available only if Instanced Geometry is the current particle type.

**List window** Displays a list of objects to be instanced as particles. The first object on the list is used for the first spawning, the second for the second spawning, and so on. If there are fewer objects on the list than there are spawnings, then the last object on the list is used for all remaining spawnings.

**Pick** Click this, and then select an object in the viewport to add to the list. Note that the type of object you use is based on the settings in the Instancing Parameters group of the Particle Type rollout. For example, if you've turned on Subtree in that group, you can pick object hierarchies. Likewise, if you've picked a group, you can use groups as your spawned particles.

**Delete** Deletes the currently highlighted object in the list window.

**Replace** Replaces an object in the queue with a different object. Select an object in the queue to enable the Replace button. Click Replace, and then pick an object in the scene to replace the highlighted item in the queue.



## Load/Save Presets Rollout

Create panel > Geometry button > Choose Particle Systems from the drop-down list. > Object Type rollout > SuperSpray/Blizzard/Parray/Pcloud > Load/Save Presets rollout

Select a SuperSpray/Blizzard/Parray/Pcloud emitter. > Modify panel > Load/Save Presets rollout

These options let you store preset values that can be used in other, related particle systems. For example, after setting parameters for a PArray and saving it under a specific name, you can then select another PArray system, and load the preset values into the new system.

### Interface



**Preset Name** An editable field in which you can define a name for your settings. Click the Save button to save the preset name.

**Saved Presets** Contains all the saved preset names. A number of presets are included with 3ds Max; to see what they do, create a particle system, load a preset, and play back the animation. Some of the presets, such as Particle Array's Shimmer Trail, are most effective with moving particle systems.

**Load** Loads the preset currently highlighted in the Saved Presets list. Alternatively, double-click the preset name in the list to load it.

**Save** Saves the current name in the Preset Name field and places it in the Saved Presets window.

**Delete** Deletes the selected items in the Save Presets window.

---

**NOTE** Animated parameter values subsequent to frame 0 are not stored.

---