

Autodesk® 3ds Max®

2009

Help: Volume 3



Autodesk®

© 2008 Autodesk, Inc. All rights reserved. Except as otherwise permitted by Autodesk, Inc., this publication, or parts thereof, may not be reproduced in any form, by any method, for any purpose.

Certain materials included in this publication are reprinted with the permission of the copyright holder.

Portions Copyright © 2005 Microsoft Corporation. All rights reserved.

Portions Copyright Max HTR created 2003-2005 by Motion Analysis.

REALVIZ Copyright © 2006 REALVIZ S.A. All rights reserved.

Portions of this software JSR-184 Exporter Copyright © 2004 Digital Element, Inc.

JPEG software is copyright © 1991-1998, Thomas G. Lane. All Rights Reserved. This software is based in part on the work of the Independent JPEG Group.

Portions Copyright © 2005 Blur Studio, Inc.

Portions Copyright © 1999-2005 Joseph Alter, Inc. Credit to Joe Alter, Gonzalo Rueda, and Dean Edmonds.

Certain patents licensed from Viewpoint Corporation.

This product includes Radiance software (<http://radsite.lbl.gov/radiance>) developed by the Lawrence Berkeley National Laboratory (<http://www.lbl.gov>). Copyright © 1990-2005. The Regents of the University of California through Lawrence Berkeley National Laboratory. All rights reserved.

Portions Copyright © 1990-2007 Info-ZIP. All rights reserved.

For the purposes of this copyright and license, "Info-ZIP" is defined as the following set of individuals: Mark Adler, John Bush, Karl Davis, Harald Denker, Jean-Michel Dubois, Jean-loup Gailly, Hunter Goatley, Ed Gordon, Ian Gorman, Chris Herborth, Dirk Haase, Greg Hartwig, Robert Heath, Jonathan Hudson, Paul Kienitz, David Kirschbaum, Johnny Lee, Onno van der Linden, Igor Mandrichenko, Steve P. Miller, Sergio Monesi, Keith Owens, George Petrov, Greg Roelofs, Kai Uwe Rommel, Steve Salisbury, Dave Smith, Steven M. Schweda, Christian Spieler, Cosmin Truta, Antoine Verheijen, Paul von Behren, Rich Wales, Mike White. This software is provided "as is," without warranty of any kind, express or implied. In no event shall Info-ZIP or its contributors be held liable for any direct, indirect, incidental, special or consequential damages arising out of the use of or inability to use this software. Permission is granted to anyone to use this software for any purpose, including commercial applications, and to alter it and redistribute it freely, subject to the above disclaimer and the following restrictions: 1) Redistributions of source code (in whole or in part) must retain the above copyright notice, definition, disclaimer, and this list of conditions. 2) Redistributions in binary form (compiled executables and libraries) must reproduce the above copyright notice, definition, disclaimer, and this list of conditions in documentation and/or other materials provided with the distribution. The sole exception to this condition is redistribution of a standard UnZipSFX binary (including SFXWiz) as part of a self-extracting archive; that is permitted without inclusion of this license, as long as the normal SFX banner has not been removed from the binary or disabled. 3) Altered versions—including, but not limited to, ports to new operating systems, existing ports with new graphical interfaces, versions with modified or added functionality, and dynamic, shared, or static library versions not from Info-ZIP—must be plainly marked as such and must not be misrepresented as being the original source or, if binaries, compiled from the original source. Such altered versions also must not be misrepresented as being Info-ZIP releases—including, but not limited to, labeling of the altered versions with the names "Info-ZIP" (or any variation thereof, including, but not limited to, different capitalizations), "Pocket UnZip," "WiZ" or "MacZip" without the explicit permission of Info-ZIP. Such altered versions are further prohibited from misrepresentative use of the Zip-Bugs or Info-ZIP e-mail addresses or the Info-ZIP URL(s), such as to imply Info-ZIP will provide support for the altered versions. 4) Info-ZIP retains the right to use the names "Info-ZIP," "Zip," "UnZip," "UnZipSFX," "WiZ," "Pocket UnZip," "Pocket Zip," and "MacZip" for its own source and binary releases.

Portions relating to OpenEXR Bitmap I/O Plugin © 2003-2005 SplutterFish, LLC.

Portions relating to OpenEXR © 2003 Industrial Light and Magic a division of Lucas Digital Ltd. LLC.

Portions relating to Zlib © 1995-2004 Jean-loup Gailly and Mark Alder

Portions Copyright © 2000-2005 Size8 Software, Inc.

Portions Copyright © 1988-1997 Sam Leffler.

Portions Copyright © 1991-1997 Silicon Graphics, Inc. Permissions to use, copy, modify, distribute, and sell this software and its documentation for any purpose is hereby granted without fee, provided that (i) the above copyright notices and this permission notice appear in all copies of the software and related documentation, and (ii) the names of Sam Leffler and Silicon Graphics may not be used in any advertising or publicity relating to the software without the specific, prior written permission of Sam Leffler and Silicon Graphics.

Portions Copyright © 2006 IntegrityWare, Inc.

Portions © Copyright 1999-2005 Havok.com Inc. (or its licensors). All Rights Reserved. See <http://www.havok.com> for details.

Portions Copyright © MAX2Obj and Obj2Max created 1996-2001 by Harald A. Blab.

Portions developed by Digimation, Inc. for the exclusive use of Autodesk, Inc.

Portions Copyright 1998-2003 by Neil Hodgson. All Rights Reserved. Permission to use, copy, modify, and distribute this software and its documentation for any purpose and without fee is hereby granted, provided that the above copyright notice appear in all copies and that both that copyright notice and this permission notice appear in supporting documentation.

Portions of this software, Point Cache 2 are copyright © 2005-2006 Blizzard Entertainment, Inc.

Portions Copyright © 2003 ATI Technologies, Inc. All Rights Reserved. Permission to use, copy, modify, and distribute this software and its documentation for any purpose and without fee is hereby granted, provided that the above copyright notice appear in all copies and derivative works and that both the copyright notice and this permission notice appear in support documentation, and that the name of ATI Technologies, Inc. not be used in advertising or publicity pertaining to distribution of the software without specific, written prior permission.

Portions Copyright © 1994 F. Kenton Musgrave.

Portions of this software are Copyright © 1991-1994 by Arthur D. Applegate. All Rights Reserved. No part of this source code may be copied, modified or reproduced in any form without retaining the above copyright notice. This source code, or source code derived from it, may not be redistributed without express written permission of the author.

Portions Copyright © 1995, 1996 Guy Eric Schalnat, Group 42, Inc.

Portions Copyright © 1996, 1997 Andreas Dilger.

Portions Copyright © 1989, 1991, 1993 Aladdin Enterprises. All rights reserved.

Portions Copyright © 1999, 2000 NVIDIA Corporation. This file is provided without support, instructions or implied warranty of any kind. NVIDIA makes no guarantee of its fitness for a particular purpose and is not liable under any circumstances for any damages or loss whatsoever arising from the use or inability to use this file or items derived from it.

Portions Copyright © 2006 NVIDIA Corporation.

Portions Copyright 1990-1991 by Thomas Knoll. Copyright 1992-1995 by Adobe Systems, Inc.

Portions Copyright 1993-1996, Adobe Systems, Incorporated. All rights reserved worldwide.

This software contains source code provided by mental images GmbH.

Portions Copyright Guruware OBJio © 2007 <http://www.guruware.at>

Portions Copyright Orbaz Technologies © 2007

Portions Copyright Mathew Kaustinen © 2007

Trademarks

The following are registered trademarks or trademarks of Autodesk, Inc., in the USA and other countries: 3DEC (design/logo), 3December, 3December.com, 3ds Max, ActiveShapes, Actrix, ADI, Alias, Alias (swirl design/logo), AliasStudio, AliasWavefront (design/logo), ATC, AUGI, AutoCAD, AutoCAD Learning Assistance, AutoCAD LT, AutoCAD Simulator, AutoCAD SQL Extension, AutoCAD SQL Interface, Autodesk, Autodesk Envision, Autodesk Insight, Autodesk Intent, Autodesk Inventor, Autodesk Map, Autodesk MapGuide, Autodesk Streamline, AutoLISP, AutoSnap, AutoSketch, AutoTrack, Backdraft, Built with ObjectARX (logo), Burn, Buzzsaw, CAICE, Can You Imagine, Character Studio, Cinestream, Civil 3D, Cleaner, Cleaner Central, ClearScale, Colour Warper, Combustion, Communication Specification, Constructware, Content Explorer, Create>what's>Next> (design/logo), Dancing Baby (image), DesignCenter, Design Doctor, Designer's Toolkit, DesignKids, DesignProf, DesignServer, DesignStudio, DesignStudio (design/logo), Design Your World, Design Your World (design/logo), DWF, DWG, DWG (logo), DWG TrueConvert, DWG TrueView, DXF, EditDV, Education by Design, Exposure, Extending the Design Team, FBX, Filmbox, FMDesktop, Freewheel, GDX Driver, Gmax, Heads-up Design, Heidi, HOOPS, HumanIK, i-drop, iMOUT, Incinerator, IntroDV, Inventor, Inventor LT, Kaydara, Kaydara (design/logo), LocationLogic, Lustre, Maya, Mechanical Desktop, MotionBuilder, Mudbox, NavisWorks, ObjectARX, ObjectDBX, Open Reality, Opticore, Opticore Opus, PolarSnap, PortfolioWall, Powered with Autodesk Technology, Productstream, ProjectPoint, ProMaterials, Reactor, RealDWG, Real-time Roto, Recognize, Render Queue, Reveal, Revit, Showcase, ShowMotion, SketchBook, SteeringWheels, StudioTools, Topobase, Toxik, ViewCube, Visual, Visual Bridge, Visual Construction, Visual Drainage, Visual Hydro, Visual Landscape, Visual Roads, Visual Survey, Visual Syllabus, Visual Toolbox, Visual Tugboat, Visual LISP, Voice Reality, Volo, Wiretap, and WiretapCentral.

The following are registered trademarks or trademarks of Autodesk Canada Co. in the USA and/or Canada and other countries: Backburner, Discreet, Fire, Flame, Flint, Frost, Inferno, Multi-Master Editing, River, Smoke, Sparks, Stone, and Wire.

All other brand names, product names or trademarks belong to their respective holders.

Disclaimer

THIS PUBLICATION AND THE INFORMATION CONTAINED HEREIN IS MADE AVAILABLE BY AUTODESK, INC. "AS IS." AUTODESK, INC. DISCLAIMS ALL WARRANTIES, EITHER EXPRESS OR IMPLIED, INCLUDING BUT NOT LIMITED TO ANY IMPLIED WARRANTIES OF MERCHANTABILITY OR FITNESS FOR A PARTICULAR PURPOSE REGARDING THESE MATERIALS.

Material Editor, Materials, and Maps

19

Materials describe how an object reflects or transmits light. Within a material, maps can simulate textures, applied designs, reflections, refractions, and other effects. (Maps can also serve as environments and projections from lights.) The Material Editor is the dialog you use to create, alter, and apply the materials in your scene.



Image by Michael McCarthy

See also:

- [Designing Materials](#) on page 5260
- [Types of Materials](#) on page 5379
- [Material Editor](#) on page 5284
- [Types of Maps](#) on page 5767

Designing Materials



Materials make objects look more convincing.

These topics give you an overview of using the Material Editor to design [materials](#) on page 8041. The [Material Editor](#) on page 5284 gives you a wide variety of options for designing material, as well as myriad controls. If you're new to the Material Editor, read this topic for a general idea about working with materials, and what the most important options are.

For more details, follow the links in the workflow outline.

Workflow Outline

In general, when you create a new material and apply it to an object, you follow these steps:

- 1 Make a [sample slot](#) on page 5262 active, and enter a name for the material you are about to design.
- 2 Choose the [material type](#) on page 5264.

TIP 3ds Max provides two renderers: the [default scanline renderer](#) on page 6141 and the [mental ray renderer](#) on page 6230, each with distinctive capabilities. You choose a renderer for each scene based on its features. It is a good idea to design materials with a particular renderer in mind. The [mental ray Connection rollout](#) on page 5385 lets you add features unique to the mental ray renderer to basic 3ds Max materials.

When rendering with mental ray, it's highly recommended that you use the [Arch & Design material](#) on page 5544 whenever possible. This material is optimized for use with mental ray and offers a number of distinct advantages over other materials available with 3ds Max.

- 3 For a Standard or Raytrace material, choose the [shading type](#) on page 5265.
- 4 Enter settings for the various material [components](#) on page 5267: diffuse color, glossiness, opacity, and so on.

NOTE [Lights and Shading](#) on page 5268 describes how lights affect the appearance of a material. [Choosing Colors for Realism](#) on page 5270 gives guidelines on getting good results from unmapped materials.

- 5 Assign [maps](#) on page 5274 to the components you want to map, and adjust their parameters.
- 6 [Apply](#) on page 5278 the material to the object.
- 7 If necessary, adjust the [UV mapping coordinates](#) on page 5279 in order to orient maps with objects correctly.
- 8 [Save](#) on page 5280 the material.

Sample Slots and Material Name

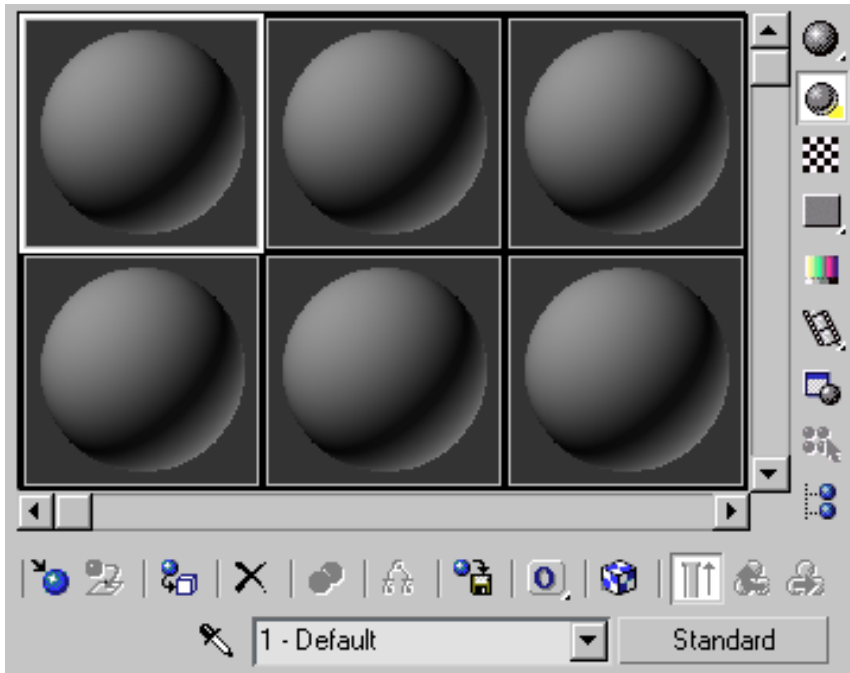

The [sample slots](#) on page 5304 display previews of materials. They are the most prominent feature of the Material Editor interface. Below and to the right of the sample slots are various [tool buttons](#) on page 5317 for the Material Editor. Below the tool buttons is a name field that shows the name of the material.

TIP Always give a material a unique, intelligible name as soon as you begin to work on it.

By default, six sample slots are visible at once. The Material Editor actually holds 24 materials at one time. You can use the scroll bars to move among the sample slots, or you can change the number of sample slots visible at once to 15 or 24 slots. Seeing more slots at once can be helpful if you are working with a complex scene.

IMPORTANT While the Material Editor can edit no more than 24 materials at a time, a scene can contain an unlimited number of materials. When you are through editing one material, and have applied it to objects in the scene, you can use that sample slot to [get](#) on page 5341 a different material from the scene (or create a new one) and then edit it.

To increase the number of sample slots visible at once, right-click a slot and then choose 5 X 3 Sample Windows or 6 X 4 Sample Windows from the pop-up menu.

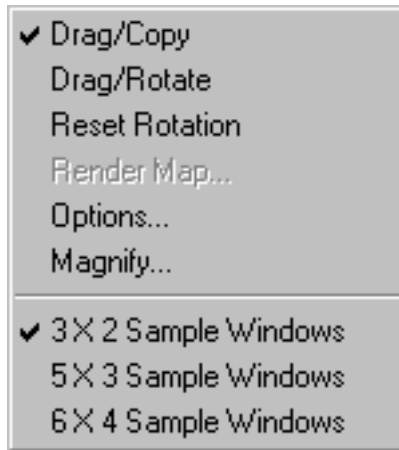

NOTE The right-click menu also has an [Options choice](#) on page 5335. This displays a dialog with various options for sample display. Exploring these options can help you learn to preview materials effectively. However, keep in mind that these settings affect the sample display *only*. They change nothing in the 3ds Max scene.

When more sample slots are visible, the images are smaller, but you can display a larger, floating, and resizable material sample by double-clicking the slot you want to see better.

Click a sample slot to make it active. Now you can design a new material from scratch, or you can load a previously stored material by clicking [Get Material](#) on page 5341, which displays the Material/Map Browser. The Browser is a dialog that lets you choose materials and maps from a material library, from the scene, and so on.

You can also copy a material from one sample slot to another. Drag the slot with the material to another slot. To avoid confusion, rename the copy in the new sample slot before you begin to make changes to it.

Material Type

Every material has a type. The default is [Standard](#) on page 5395, which is the material type you will probably use most often. In general, other material types are for special purposes. The other material types are:

- [Advanced Lighting Override](#) on page 5734
Used to fine-tune the effects of a material on [Advanced Lighting](#) on page 6153, including [light tracing](#) on page 6154 and [radiosity solutions](#) on page 6168. Radiosity Override is not required for calculating advanced lighting, but it can enhance the result.
- [Blend](#) on page 5708
Mixes two other materials together. Can use a mask or a simple amount control.
- [Composite](#) on page 5711
Mixes up to 10 materials.
- [Double-Sided](#) on page 5713
Contains two materials, one for the front and one for the back faces of an object.
- [Ink 'n Paint](#) on page 5742
Creates cartoon effects with flat shading and “inked” borders.
- [Lightscape](#) on page 5741
Supports [import](#) on page 7253 and [export](#) on page 7251 of data from the Lightscape product.
- [Matte/Shadow](#) on page 5699
Displays the environment but receives shadows. This is a special-purpose material. The effect is similar to using a matte in filmmaking.
- [Morpher](#) on page 5716
Lets you morph between materials using the [Morpher modifier](#) on page 1545.
- [Multi/Sub-Object](#) on page 5720
Lets you apply multiple sub-materials to a single object's sub-objects.
- [Raytrace](#) on page 5490
Supports the same kind of diffuse mapping as Standard material, but also provides fully raytraced reflections and refractions, along with other effects such as fluorescence.

- [Shell](#) on page 5732
Contains a material that has been [rendered to a texture](#) on page 6371, as well as the original material upon which the texture is based.
- [Shellac](#) on page 5727
Mixes two materials by applying a "shellac" material to another.
- [Standard](#) on page 5395
Uses surface shaders to simulate materials. In general, the standard material is probably the best choice for a simple material if you choose to use standard light objects. If you use photometric lights, use the default Architectural material.
- [Top/Bottom](#) on page 5729
Contains two materials, one for faces that point upward, the other for faces that point downward.

Standard materials let you set values for components such as color, glossiness, and opacity. They also let you apply maps to the components, which can produce an enormous variety of effects. Some other material types have these features as well. Some materials, such as Multi/Sub-Object or Double Sided, have controls only for combining other materials.

mental ray Materials

A group of materials is provided for use with the [mental ray renderer](#) on page 6230. See [mental ray Materials](#) on page 5543.

Shading Type

The Standard and Raytrace materials let you specify a shading type. Shading types are handled by a "shader," which describes how the surface responds to light.

WARNING When you change the shading type of a material, you lose the settings (including map assignments) for any parameters that the new shader does not support. If you want to experiment with different shaders for a material with the same general parameters, copy the material to a different [sample slot](#) on page 5304 before you change its shading type. That way, you can still use the original material if the new shader doesn't give you the effect you want.

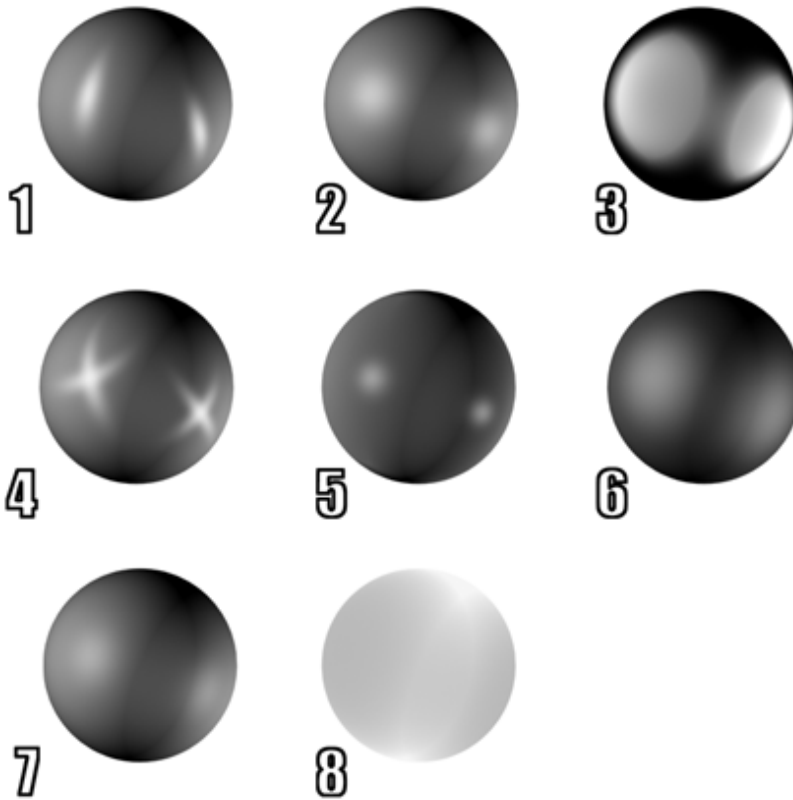

Samples of different shading for a standard material

1. Anisotropic
2. Blinn
3. Metal
4. Multi-layer
5. Oren-Nayar-Blinn
6. Phong
7. Strauss
8. Translucent

Several different shaders are available. Some of these are not available for the Raytrace material, as indicated below. Blinn is the most general-purpose of

these shaders. The others have special purposes, especially regarding how the material creates highlights.

- [Anisotropic](#) on page 5424
Creates surfaces with noncircular, "anisotropic" highlights; good for modeling hair, glass, or metal.
- [Blinn](#) on page 5426
Creates smooth surfaces with some shininess; a general-purpose shader.
- [Metal](#) on page 5427
Creates a lustrous metallic effect.
- [Multi-Layer](#) on page 5428
Creates more complex highlights than Anisotropic by layering two anisotropic highlights.
Not available for Raytrace material.
- [Oren-Nayar-Blinn](#) on page 5429
Creates good matte surfaces such as fabric or terra-cotta; similar to Blinn.
- [Phong](#) on page 5426
Creates smooth surfaces with some shininess; similar to Blinn, but doesn't handle highlights (especially glancing highlights) as well.
- [Strauss](#) on page 5431
Creates both nonmetallic and metallic surfaces; has a simple set of controls.
Not available for Raytrace material.
- [Translucent](#) on page 5434
Translucent shading is similar to Blinn shading, but it also lets you specify translucency, where light is scattered as it passes through the material.
You can use translucency to simulate frosted and etched glass.
Not available for the Raytrace material.

Material Components

A material's components describe its visual and optical properties. The components in the [Architectural material](#) on page 5526 are based on physical qualities; for example, diffuse color, shininess, transparency, and so on. The components in a [Standard material](#) on page 5395 include color components, highlight controls, self-illumination, and opacity. Like the Standard material, the [Raytrace material](#) on page 5490 uses a nonphysical model to describe surfaces.

Standard and Raytrace material components vary depending on which [shader](#) on page 5265 you use.

You can assign maps to most components, including color components such as Diffuse, and value components such as Transparency or Opacity. Maps can increase the complexity and realism of the material's appearance.

Lights and Shading

Materials work in combination with [lights](#) on page 4970. The intensity of light that falls on a surface determines the intensity of color to display. Three factors contribute to the intensity of light where it falls on an object:

- **Light intensity:** A light's original intensity at its point of origin.
- **Angle of incidence:** The more a surface inclines away from the light source, the less light it receives and the darker it appears. The angle between a ray of light and the [face normal](#) on page 8059 of a surface is the angle of incidence for that face.

When the angle of incidence is 0 degrees (that is, the light strikes the face perpendicularly), the face is illuminated at full intensity unless the light is attenuated. Full intensity is the light's Multiplier value times the value of the face's surface color. The Multiplier value is 1.0 by default; the surface value is the Value component of the surface color's [HSV description](#) on page 8105. As the angle of incidence increases, the intensity of the face illumination decreases.

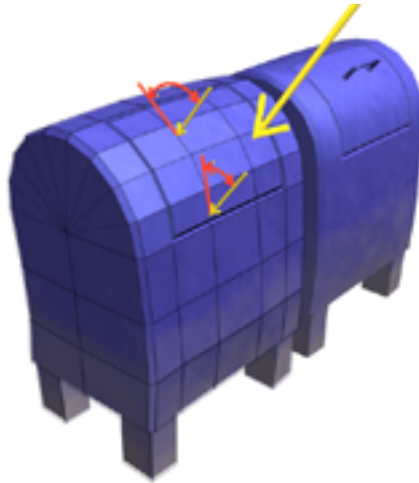

Angle of incidence affects intensity.

- **Distance:** Light diminishes over distance. This effect is known as [attenuation](#) on page 7915. By default, attenuation is turned off, but you can turn it on and specify the distance over which it operates.

Lights and the Component Colors of a Standard Material

As the names of a standard material's [color components](#) on page 5267 imply, the kind of light that strikes a surface with a material determines how the surface appears when it is shaded.

- **Ambient color** appears where the surface is lit by ambient light alone (where the surface is in shadow).
- **Diffuse color** appears where light falls directly on the surface. It is called "diffuse" because light striking it is reflected in various directions. Highlights, on the other hand, are reflections of light sources.
- **Specular highlights** appear where the viewing angle is equal to the angle of incidence. Glancing highlights appear where the angle of incidence is high, relative to the observer or camera (that is, the light ray is nearly parallel to the surface). Shiny surfaces usually have specular highlights. Glancing highlights are characteristic of metallic surfaces. Some surfaces are completely reflective, or nearly so. These reflect their environment as well as the light sources that illuminate them. To model

such surfaces, you need to use [reflection mapping](#) on page 5964 or ray tracing (see [Raytrace Material](#) on page 5490).

The three color components blend at the edges of their regions. Between ambient and diffuse, the blending is calculated by the shader. Between diffuse and specular, you set the amount of blending by using the standard material's highlight controls.

Choosing Colors for Realism

Materials add greater realism to a scene only if you choose their colors and other properties to appear like real-world objects. This topic presents some general guidelines for choosing standard material colors. When possible, you should also observe colors in the objects you are modeling, especially under different lighting conditions.

For objects on which you want the viewer to focus attention, an unmapped standard material doesn't often provide the level of realistic detail you probably want. However, for distant and peripherally visible objects, as well as some kinds of real-world materials, such as molded plastic, an unmapped standard material can work well. Keeping the number of maps to a minimum can help keep down the file size.

Indoor and Outdoor Lighting

Whether a scene is indoors or outdoors affects your choice of material colors, just as it affects the way you set up [lights](#) on page 4970. Full sunlight is bright and unidirectional. Most indoor lighting is less intense and more even (that is, multidirectional) than daylight. However, some special indoor lighting (and nighttime outdoor lighting), as for the stage, also features intense, directional light.

Direct sunlight has a yellow tint. Materials for objects to appear in daylight should have a specular color of a pale, unsaturated yellow (for example, RGB values of 240, 240, 188). The ambient color should be the complement of the specular: a deep, dark purple with a hint of the diffuse color.

Materials for objects to appear under normal interior lighting should have a specular color that is close to white. (Our perception compensates for the yellow or green tint that is often present in artificial light.) The ambient color can often have the same hue as the diffuse color, but with a darker value.

Materials for objects to appear under spotlights should follow the general guidelines for daylight materials. The specular color should match the spotlight's color, and the ambient color should be a very dark value of the spotlight color's complementary hue, mixed with a bit of the material's diffuse color.

If you want to render an object under changing lighting conditions, you can choose colors that are a compromise between the optimal colors for each kind of lighting, or you can [animate](#) on page 5361 the material so that its colors change to suit the changing light.

Representing Natural Materials



Outdoor scene with natural materials

Most natural materials have a matte surface with little or no specular color. For natural materials such as these, use the following guidelines:

- **Ambient color:** The ambient color depends on whether the scene is indoors or outdoors, as previously described.
- **Diffuse color:** Choose a color found in nature. It is best to use the observed color of the object itself, or a similar object.

- **Specular color:** Make the specular color the same hue as the diffuse, but with a higher value and a lower saturation.
- **Glossiness:** Set the Glossiness to a low value.
Some foliage, bird feathers, fish scales, and so on, are shiny. For materials such as these, set the Glossiness to higher values. You might also want to change the specular color so it's closer to the lighting color than the surface's diffuse color.

Water is reflective, and is best modeled by a color component in combination with a [reflection map](#) on page 5964 or a [water map](#) on page 5907.

While metal is a natural material, its special visual characteristics are most apparent when it has been polished. Standard material represents this by using a special shading type, described later in this topic.

Representing Manufactured Materials



Indoor scene with manufactured materials

Manufactured materials often have a synthetic color rather than an "earth tone." Also, many manufactured materials, such as plastics and porcelain glazes, are very shiny. For manufactured materials, use the following guidelines:

- **Ambient color:** The ambient color depends on whether the scene is indoors or outdoors, as previously described.
- **Diffuse color:** Although the diffuse color doesn't have to be an "earth tone," as with natural materials you should use the observed color of the object or a similar object.
- **Specular color:** Make the specular color close to white, or to the color of the light source. White is especially characteristic of plastic materials.
- **Glossiness:** Set the glossiness to a high value.

Representing Metallic Objects



Metallic cup and ice cream scoop

Polished metal has a characteristic "glancing" highlight that appears where the light is at a high angle of incidence. To generate this effect, Metal shading uses the Cook/Torrance illumination model.

For metallic materials, you can use the Metal shading type. This disables the specular color and highlight controls. The Metal shader calculates its own specular color, which can vary between the diffuse color and the color of the light.

In the diffuse region of a metal material, the ambient component is greater than it is for other kinds of materials.

The Anisotropic, Multi-Layer, and Strauss shaders give you further options for modeling polished metal.

If the metallic object is the focus of the scene, you can improve realism by using a [Blend material](#) on page 5708 to combine metallic shading with a [reflection map](#) on page 5964.



TIP When you preview metallic surfaces, it is useful to turn on a backlight. This displays the metal's glancing highlight. The Backlight button is to the right of the sample slots.

Using Maps to Enhance a Material

Maps provide images, patterns, color adjustments, and other effects you can apply to the visual/optical components of a material. Without maps, material design in 3ds Max is limited. Maps give the Material Editor its full flexibility, and can give you dramatic results.



Spheres with various maps applied to them (as well as a reflection map applied to the surface beneath them)

The simplest use of a map is to assign a pattern to a material's Diffuse color. [Diffuse mapping](#) on page 5460 is also known as "texture mapping." It applies an image or pattern to geometry the material is applied to.

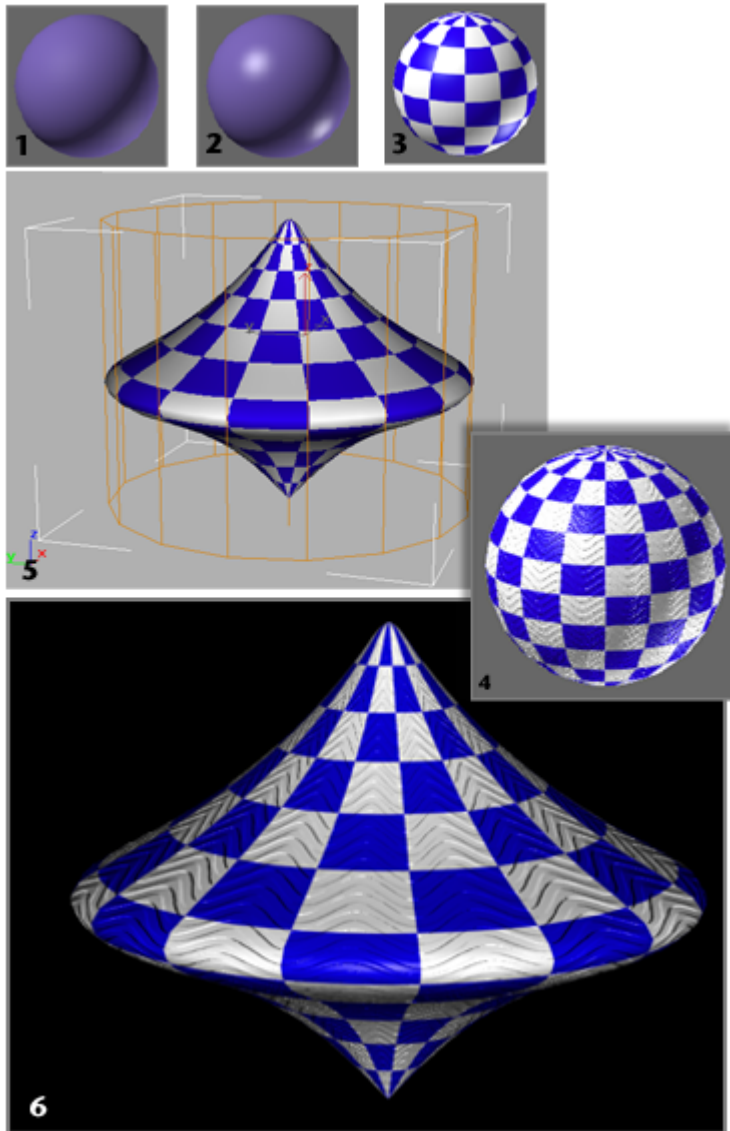

Example of designing a mapped material:

1. Choose a sample slot.
2. Increase the highlight.
3. Apply a checker map to the material's diffuse component.
4. Apply a bump map to give the material ridges.

5. The checker map displays in viewports, but the bump map does not, by default.
6. Rendering the material shows the full effect of mapping.

WARNING When you change the [shading type](#) on page 5265 of a standard material, you lose the settings (including map assignments) for any parameters that the new shader does not support. If you want to experiment with different shaders for a material with the same general parameters, copy the material to a different [sample slot](#) on page 5304 before you change its shading type. That way, you can still use the original material if the new shader doesn't give you the effect you want.

Map Terminology

The term "material map" is sometimes used to describe a map assigned in the material editor. A material map applies a color or pattern to a surface. This is different from maps used for displacement mapping with the [Displace modifier](#) on page 1344, environment mapping for backgrounds, or projection mapping from lights.

The term "texture map" is sometimes used as well. It is interchangeable with "diffuse map"; that is, with a map that applies colors to geometry, as opposed to a map that create reflections, bumps, and so on.

In the [Material/Map Browser](#) on page 5290, maps are categorized according to how the map software functions. The categories are:

- **2D maps**
A [bitmap](#) on page 5795 is the prototypical 2D map. 2D maps apply pictures and patterns to the surface of objects.
- **3D maps**
3D maps are generated procedurally. 3D maps apply patterns throughout an object's geometry.
- **Compositors**
Compositors combine other maps.
- **Color Modifiers**
Color modifiers are usually composited with another map to adjust its color. The Vertex Color map is a special case that displays the colors you assign to vertices in a mesh.
- **Other**
"Other" maps include maps that simulate reflection or refraction.

The names of individual map types describe the pattern or effect they create, such as Checker map, Bitmap, Gradient, Flat Reflection, and so on.

NOTE In some cases the user interface also uses "map" to describe not the map type, but the visual component being mapped. For example, a "diffuse map" means a map of any type applied to a material's diffuse component. This is an ambiguity in the use of "map" that can be a bit confusing when you first encounter it.

Assigning Maps

For a [standard material](#) on page 5395, you assign maps using the Maps rollout. Click the Map button in line with the name of the visual component you want to map. The [Material/Map Browser](#) on page 5290 is displayed. Select the map type (for example, Bitmap) from the list of maps, and then click OK. Double-clicking the map's name in the Browser also assigns the map type.

The Browse From group box in the Browser creates new maps by default. You can also use it to obtain maps from a library (see Saving A Material), from the current scene, from objects selected in the scene, or from elsewhere in the material editor.

In the Browser, you can turn on icons of differing sizes to preview maps before you assign them.

A Standard material's Basic Parameters rollout has shortcut buttons for assigning a map to *some* of the material's visual components. These small buttons are equivalent to the buttons in the Maps rollout. Assigning a map to a button in one rollout changes the corresponding button in the other.

Each type of map has its own set of parameters and controls. If the map is a Checker map, for example, you can choose the colors of the checkers, and whether a checker color has a map of its own. You can change tiling values to affect the scale of the checkers, adjust noise parameters to make the checkers irregular, and so on.

NOTE To save loading time, if a map with the same name is in two different locations (in two different paths), it is loaded only once. This poses a problem only if your scene includes two maps that have different content but the same name. In this case, only the first map encountered will appear in the scene.

Navigating the Material/Map Tree

When you build a material of any complexity, you are building a material/map tree. The root of the tree is the material itself. The branches are the maps you

have assigned to the material's components. Some maps can themselves contain maps, as in a map applied to one color of a [Checker material](#) on page 5808, so the tree can be more than two levels deep, and can actually be as deep as you need it to be.



The [Material/Map Navigator](#) on page 5357 is a dialog that displays the tree for the current material. It is useful for finding a map and displaying its parameters. Click the map to display its rollouts in the Material Editor. To copy a map to a different component of the same material, you can also drag the map's name from the Navigator to a map button in the Material Editor.



The Go Forward To Sibling and Go To Parent buttons also navigate the map tree. Go Forward To Sibling moves laterally in the map tree, while Go To Parent moves up the tree. (To move down the tree, click a map button that has a map assigned to it.) Another way to move between parents and children in the tree is to drop down the [material name field](#) on page 5360 and click the name of a map or material.

Applying a Material to an Object

There are two ways to apply a material to an object:

- If the sample slot is active and the object is already selected, click [Assign Material To Selection](#) on page 5344.
- Drag from the sample slot to the object.
As you drag, a tooltip appears over each object beneath the mouse, showing the object's name. You can apply the material whether the object is selected or not. Release the mouse to apply the material.

Applying a material overrides any previous material assignment the object might have had. Once the material is applied, while the sample slot is active, the material is "hot" and changes you make to it affect the object automatically. See [Sample Slots](#) on page 5304 for more about hot and cold materials.

The [Undo command](#) on page 262 works for material assignment.

You can apply only one material to an object. To overcome this restriction, use a [Multi/Sub-Object material](#) on page 5720. This is a container for various sub-materials that correspond to specified sub-objects such as different faces in a mesh, NURBS surfaces in a NURBS model, and so on.

You can apply the same material to multiple objects in the scene.

See also:

- [Dragging and Dropping Maps and Materials](#) on page 5310
- [Drag and Drop Sub-Object Material Assignment](#) on page 5312

Mapping Coordinates

An object assigned a 2D mapped material (or a material that contains 2D maps) must have mapping coordinates. These coordinates specify how the map is projected onto the material, and whether it is projected as a "decal," or is tiled or mirrored. Mapping coordinates are also known as UV or [UVW coordinates](#) on page 8161. These letters refer to coordinates in the object's own space, as opposed to the XYZ coordinates that describe the scene as a whole.

Most renderable objects have a Generate Mapping Coordinates parameter. This is on by default, but if it's off and the object contains a mapped material, when you try to render, you get a warning.

Some objects, such as editable meshes, don't have automatic mapping coordinates. For these types of objects, you can assign coordinates by applying a [UVW Map Modifier](#) on page 1931.

If the material appears the way you want it with the default mapping, you don't need to adjust the mapping. If you need to adjust it, use the map's Coordinates rollout. There are two typical sets of coordinates parameters: one for 2D maps such as [Bitmaps](#) on page 5795, and another for 3D maps such as [Noise](#) on page 5886. See [Coordinates Rollout \(2D\)](#) on page 5782 and [Coordinates Rollout \(3D\)](#) on page 5861.

NOTE The [UVW Remove utility](#) on page 5284 provides a way to remove mapping coordinates or an entire material from selected objects.

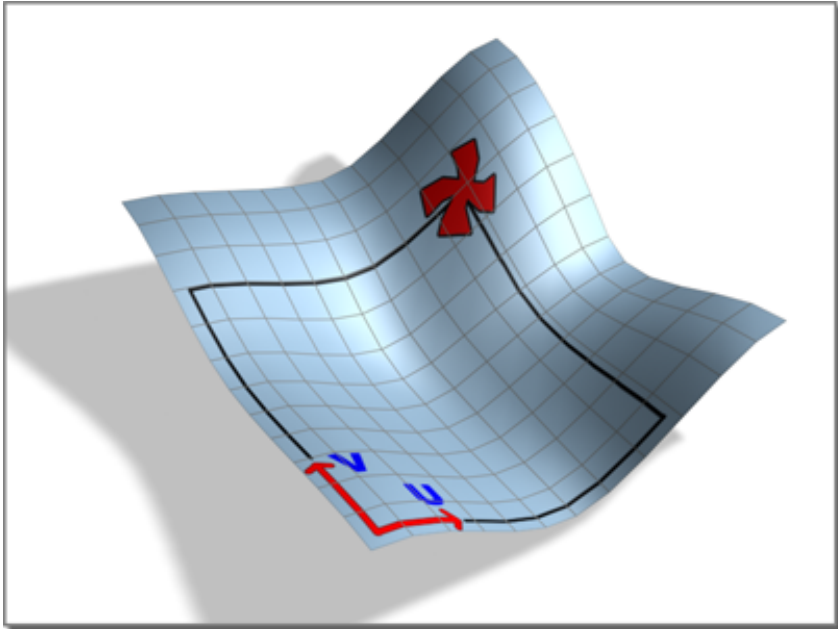

Mapping coordinates shown as U and V axes local to a surface.

Saving a Material



While a material is in the Material Editor or applied to an object, it is part of the scene, and is saved with the scene. However, for complicated scenes it is inconvenient to have all materials active in the Material Editor. You can also save a material by putting it into a material library. Some libraries are provided in the `\materiallibraries` subdirectory. The file `3dsmax.mat` is the default library. You can add your material to this library, or create your own libraries.

Procedures

To save a material in a library:

This stores a material in the current material library. To use a different library, first open it using the [Material/Map Browser](#) on page 5290.

- 1 In the Material Editor, click the sample sphere for the material to save.

- 2  On the Material Editor toolbar, click [Put to Library](#) on page 5348. This opens the [Put to Library dialog](#) on page 5372. Change the material name or leave it as is, and then click OK.
- 3  Choose Rendering > Material/Map Browser, or, on the Material Editor toolbar, click [Get Material](#) on page 5341. The [Material/Map Browser](#) on page 5290 opens.
- 4 In the Browser > Browse From group, choose Mtl Library, if necessary. The stored material appears in the list.
- 5 In the Browser > File group, click Save to save the library with the current name (if any) or Save As to save it as a different file.

TIP You can use the Merge function in the File group to add materials from the current library to another library.

Material XML Exporter Utility

Utilities panel > Utilities rollout > More button > Utilities dialog > Material XML Export

You can export materials you create in 3ds Max to XML files, which can then be shared with other 3ds Max users or used in AutoCAD Architecture (formerly Autodesk Architectural Desktop) to modify material definitions.

NOTE You can add an exported XML material to your 3ds Max scene by dragging and dropping from a Web site or Windows Explorer onto an object in your scene, or by importing it directly onto objects.

Interface

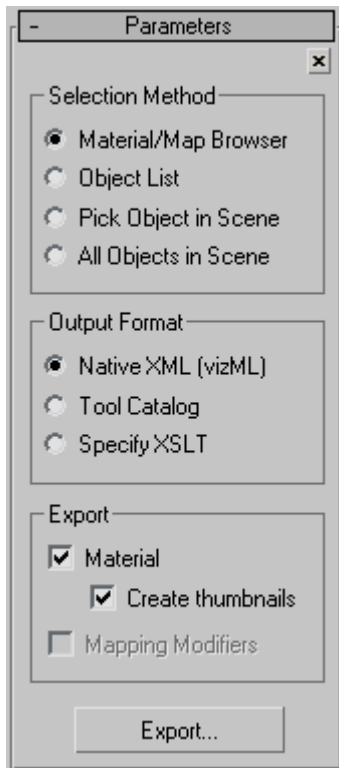

Selection Method group

The Selection Method group lets you set the method for selecting the materials you wish to export.

Material/Map Browser Lets you select a material to export from the [Material/Map browser](#) on page 5290.

Object List Lets you specify objects using the Select Object For Material Modifier Export dialog, which works like the [Select From Scene dialog](#) on page 228. All materials assigned to the selected objects are exported.

Pick Object in Scene Lets you select an object from your scene. Any materials assigned to the selected object are exported.

All Objects in Scene Exports all of the assigned materials in your scene.

Output Format group

The Output Format group defines the format of the XML Material output.

Native XML (vizML) Materials are exported as raw XML.

TIP Use this format for sharing XML material files within 3ds Max.

Tool Catalog Materials are exported to the ATC (Autodesk Tool Catalog) format.

This file type is suitable for display in the AutoCAD Content Browser and the Autodesk VIZ Content Browser.

NOTE This file type cannot be imported to 3ds Max unless you also have Autodesk VIZ Render installed on the same system.

Specify XSLT This option lets you apply your own XSL transform to the XML output.

Export group

The Export group lets you define the parts of the material assignments to export.

Material Exports the material definitions.

Create Thumbnails Exports thumbnails for each material.

NOTE Thumbnail images are referenced by the ATC and displayed in the AutoCAD Content Browser and Autodesk VIZ Content Browser.

Mapping Modifiers Exports the mapping modifiers applied to specific objects.

Export This button begins the XML export process, using the defined selection method, output format, and export parameters.

Upon clicking Export, you are prompted to set the path or URL to store in the XML file as the path to any referenced bitmap files. The default is an empty string, which means no path will be prepended to the bitmap filenames when written to XML. When the material is later imported, it will be assumed that the referenced bitmap file can be found in the bitmap search path.

If you have elected to export thumbnails or to apply your own XSL transform, you are then prompted to set a path to store the thumbnail files and to locate your XSLT file, respectively.

UVW Remove Utility

Utilities panel > Utilities rollout > More button > Utilities dialog > UVW Remove

The UVW Remove utility removes mapping coordinates or materials from the currently selected objects.

Interface

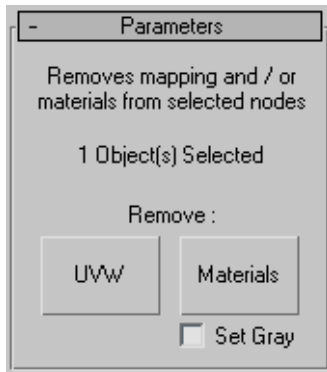

UVW Click to remove UVW mapping from this object.

NOTE The utility can remove UVW mapping only from collapsed editable mesh objects; that is, editable meshes with no modifiers.

Materials Click to remove material assignment from the selected objects.

Set Gray If this is on when you click the Materials button, the object color is set to a neutral gray. Default=off.

Material Editor

Main toolbar > Material Editor

Rendering menu > Material Editor

Keyboard > M

The Material Editor provides functions to create and edit [materials](#) on page 8041 and [maps](#) on page 8036.

Materials create greater realism in a scene. A material describes how an object reflects or transmits light. Material properties work hand-in-hand with light properties; shading or rendering combine the two, simulating how the object would look in a real-world setting.

You apply materials to individual objects or selection sets; a single scene can contain many different materials.

NOTE Creating a new material clears the Undo/Redo lists.

Procedures

To view the Material Editor:

-  Click the Material Editor button on the main toolbar, or press M. The Material Editor dialog has [sample slots](#) on page 5304 for viewing previews of materials. When you first view the Material Editor, the material previews have a uniform default color.

To give a material a different name:

- Edit the name field that appears below the Material Editor toolbar. The name of the active material appears in the title bar of the Material Editor dialog. The name of the material is not a file name: it can contain spaces, numbers, and special characters. The name field displays only 16 characters, but a material name can be longer than that.

To make a copy of a preview material:

-  On the Material Editor toolbar, click [Make Material Copy](#) on page 5346.

To get a material from a scene:

If a material that you want to change has been saved in the scene, but not in the Material Editor, you can load the material by getting it from the scene.

- 1 Click a sample slot to make it active.
Be careful not to click the sample slot of a material you want to use later.

- 2  On the Material Editor toolbar, click [Get Material](#) on page 5341. A modeless [Material/Map Browser](#) on page 5290 is displayed.
- 3 In the Browse From group box at the upper left, make sure that either Selected or Scene is chosen.
The Selected option lists only materials in the current selection. If no objects are selected, the list of materials is blank.
The Scene option lists all the materials currently in the scene.
- 4 In the list of materials, double-click the name of the material you want. You can also drag the material name to the sample slot.
The material you chose replaces the previous material in the active sample slot.

WARNING When you get a material from a scene, it is initially a [hot material](#) on page 8006.

To apply a material to objects in a scene:

- Drag the sample slot that contains the material you want to apply to an object in the scene.
If the object isn't selected, or if it's the only object selected in the scene, the material is applied immediately. If the object is one of several selected objects in the scene, the software prompts you to choose whether to apply the material to the single object only or to the whole selection (the latter is the default choice).



You can also apply materials to a selection by clicking [Assign Material To Selection](#) on page 5344 on the Material Editor toolbar.

NOTE When you apply a material to an object or selection, that material becomes a [hot material](#) on page 8006 (its sample slot is displayed with white corner brackets). When you change the properties of a hot material, the scene immediately updates to reflect those changes. *Every* object with that material changes its appearance, not just the objects in the current selection.

To remove a material from an object:

- 1  On the Material Editor toolbar, click Get Material.

The Material/Map Browser appears.

- 2 Drag the entry NONE from the top of the list in the Browser to the object.
The object now has no material applied to it.



To make a material no longer hot so it doesn't change the current scene, click [Make Material Copy](#) on page 5346.

To put a material back into a scene:



- On the Material Editor toolbar, click [Put Material To Scene](#) on page 5343.

The material in the active sample slot is now a [hot material](#) on page 8006.

The Put Material button is available only when (1) the material in the active sample slot has the same name as a material in a scene, and (2) the material in the active sample slot is not hot. In other words, this command is meant to fit into the following overall sequence of handling materials:

- You create a hot material either by applying it to objects in the scene or by getting it from the scene.
- You make a copy of the material.
- You make changes to the copy of the material.
- You update the scene by putting the changed material back into the scene.

These steps are not as immediate as changing a material while it is hot, but they help you avoid changing the scene's materials unintentionally or in unexpected ways.

When a material in the Material Editor is applied to objects in the scene, you can select the objects from the Material Editor.

To select objects that have the same material applied:

When a material in the Material Editor is applied to objects in the scene, you can select the objects from the Material Editor.

- 1 Click a sample slot that contains a material in the scene.

White corner brackets indicate materials that are in the scene.



- 2 Click [Select By Material](#) on page 5340.

This button is unavailable unless the active sample slot contains a material in the scene.

The [Select Objects dialog](#) on page 228 opens. The names of objects with the active material applied are highlighted when the dialog appears.

- 3 Click Select to select objects that have the active material applied to them. You can also change the selection by choosing other objects. If you change the selection, you can then apply the active material to newly selected objects by clicking [Assign Material To Selection](#) on page 5344.

To get a material from a library:



- 1 On the Material Editor toolbar, click [Get Material](#) on page 5341.

A modeless [Material/Map Browser](#) on page 5290 is displayed.

- 2 In the Browse From group box at the upper left, choose Material Library if necessary.

If you have opened a library, the list of materials shows the contents of the library.

If you haven't opened a library, click Open in the File group on the Browser. This opens the Open Material Library file dialog; use it to open a material library. After you open the library, its contents appear in the list of materials.

- 3 In the list of materials, double-click the name of the material you want. You can also drag the name of the material to the sample slot.

The material you chose replaces the previous material in the active sample slot.

To save a material in a library:

- 1 Click the sample slot that has the material you want to save.



- 2 On the Material Editor toolbar, click [Put To Library](#) on page 5348.

- 3 A [Put To Library dialog](#) on page 5372 appears.

- 4 Change the material name or leave it as is, and then click OK.

The material is saved in the currently open library. If no library is open, a new library is created. You can save the new library as a file using the [Material/Map Browser](#) on page 5290 file controls.

Interface

The Material Library interface consists of a menu bar at the top, sample slots (the spheres) below the menu bar, and toolbars along the bottom and side of the sample slots. For links to topics describing these interface elements as well as overviews of materials and maps, see the end of this section.

The Material Library interface also includes a number of rollouts whose contents depend on the active material (click a material's sample slot to make it active). Each rollout contains standard controls such as drop-down lists, check boxes, numeric fields with spinners, and color swatches.

In many cases, associated with a control (typically to its right) is a *map shortcut button*: a small, square, blank button, which you can click to apply a map to the control. If you have assigned a map to a control, the button displays the letter M. An uppercase M means that the corresponding map is assigned and active. A lowercase m means that the map is assigned but inactive (turned off). You turn maps on and off with the check boxes on the [Maps rollout](#) on page 5414 (see [this procedure](#) on page ? and the one following it). You can also right-click the map shortcut button to access functions such as copy and paste (see [Copying and Pasting: Right-Click Menu for Materials, Maps, Bitmaps, and Colors](#) on page 5301).

For choosing materials, see [Material/Map Browser](#) on page 5290. For applying materials using drag and drop techniques, see [Dragging and Dropping Maps and Materials](#) on page 5310.

For an overview of how to use the Material Editor, see [Designing Materials](#) on page 5260.

For the user interface elements in Material Editor and the different materials and map types, see the following topics:

[Material Editor Menu Bar](#) on page 5321

[Sample Slots](#) on page 5304

[Material Editor Tools](#) on page 5317

[Types of Materials](#) on page 5379

[Types of Maps](#) on page 5767

For information about how to animate materials, see [Animating Materials](#) on page 5361.

Material/Map Browser

Main toolbar > Material Editor > Get Material > Material/Map Browser

Rendering menu > Material/Map Browser

Material Editor > Click Material Type button or Map Type button. > Material/Map Browser

[Procedures](#) on page 5293 [Interface](#) on page 5295

The Material/Map Browser lets you choose a [material](#) on page 8041, [map](#) on page 8036, or [mental ray shader](#) on page 5974.

When you click [Get Material](#) on page 5341, the Browser that is displayed is modeless (you can leave it displayed while you do other work). However, when you display the Browser by clicking the [Type](#) on page 5361 button, a map assignment button in the [Environment dialog](#) on page 6689, or from a projector light (see [Advanced Effects Rollout](#) on page 5108), it appears as a modal dialog with OK and Cancel buttons.

You can leave the modeless Browser displayed, and drag materials from its listings to material or map sample slots and buttons in the user interface. When the Browser displays a Material Library, you can also add materials to the library by dragging them from the Material Editor [sample slots](#) on page 5304.

When you double-click a material, map, or shader in the Browser, it places that material, map, or shader in the Material Editor's active sample slot. It automatically chooses between an instance or a copy, as follows:

- Browsing New Materials: Creates a new material.
- Browsing a Library: Makes a copy.
- Browsing the Material Editor, Scene, or Selected: Depends on the status of the map or material.

When you browse the Material Editor, the Scene, or Selected objects, the choice between making a copy or an instance depends on the status of the material, as follows:

- If the material or map is already in the active slot, the Browser does nothing.
- If the material or map is in some other sample slot, the Browser puts a copy in the active slot.
- In all other cases, the Browser makes an instance of the material or map.

Browsing mental ray Materials and Maps

When you use the [mental ray renderer](#) on page 6230, you might want to use the materials and shaders that provide effects for this renderer only. (The default scanline renderer renders these materials and shaders only as black or white, or it simply ignores their effects.) The Material/Map Browser lists mental ray maps and materials only if you assign the mental ray renderer as the currently active renderer.

Once you have enabled the renderer, when you use the Browser, it shows mental ray materials and shaders. Materials are displayed with a yellow sphere, rather than blue for standard materials, and shaders are displayed with a yellow parallelogram, rather than green as for standard maps.

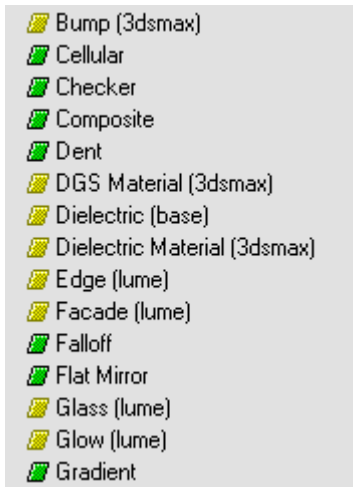

mental ray maps in the browser's list are shown with yellow icons.

When you use the [mental ray Connection rollout](#) on page 5385, or other shader buttons specific to mental ray materials and shaders, the shaders that appear in the Browser's list are restricted to those that the mental ray renderer allows for that particular shader component. By default, only shaders that ship with 3ds Max are listed. If you have acquired other shader libraries, you might see the names of shaders that are not mentioned in this reference.

NOTE You can see the listing of materials, maps, or shaders that are incompatible with the current renderer, if you turn on the Incompatible toggle in the Show group, as described under “Interface,” below.

See also:

- [Material/Map Navigator](#) on page 5357

Procedures

To navigate materials with the Browser:

TIP Use the Browser primarily in Root Only mode, to see only the top levels of the materials. This provides a simpler view of your materials, and speeds redraws when you're using any of the icon display modes. (You can also create thumbnails to speed up redraws, as described below.)

- 1 In the Material Editor, choose any sample slot you want that contains a complex, multilevel material.
- 2 In the Browser > Browse From group, choose Active Slot mode to display all levels of the active sample slot.
- 3 Click any of the items in the Browser's material/map list to move to that level of the current material.
- 4 When you want to switch to a different material, select its sample slot in the Material Editor, and its hierarchy will appear in the Browser.
- 5 Again, click the items in the Browser to change levels.

To delete an assigned map:

- 1 While viewing the map parameters, click the Map Type button.
- 2 In the Material/Map Browser, choose NONE as the new map type.

TIP You can also remove a material or map by dragging the NONE item from the Browser over to the object or map button.

To merge material libraries:

- 1 In the Browse From group, choose Mtl Library, and then click the Merge button.
- 2 In the [Merge Material Library dialog](#) on page 5371, select a material library other than the current library, or select a 3ds Max or **VIZ Render (DRF** on page 7167) scene.

A [Merge dialog](#) on page 5370 is displayed, listing all materials in the specified library, or all materials assigned to the 3ds Max or **VIZ Render** file. Below the list are All and None buttons to help in the selection.

- 3 Select the materials in the list that you want to merge, and then click OK.
The selected materials are merged into the current material library.
- 4 Save the library to save your changes.

To save the sample spheres as thumbnail images:

- 1 Open the Browser. In the Browse From group, choose Mtl Library.



- 2 Choose View Small Icons.

- 3 Display all of the icons in the library by either scrolling through all of them, or by enlarging the Browser so that all of the icons have been displayed at least once.

The action of displaying the icons automatically creates thumbnails in memory.

IMPORTANT If you want to include thumbnails of the sub-materials and maps, be sure to turn off Root Only.

- 4 Save the library.

When you save the library, you save the thumbnail images of the samples as they appeared in the Browser at that time. If you change any of the materials or maps later, you must re-save the library in order to update the thumbnails. If you do not re-save the library after altering or adding a materials, the icon of the material will still appear correctly, but it will be re-rendered when it first appears in the Browser, while all the other icons will appear immediately.

Interface

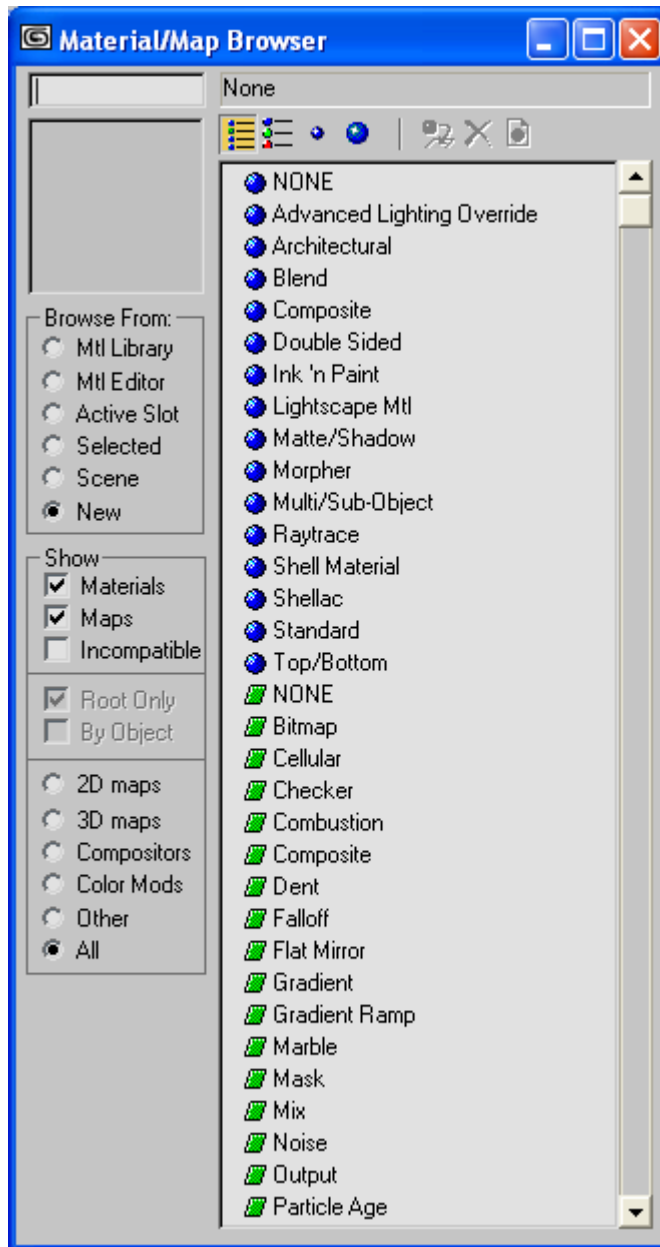

The Material/Map Browser contains the following controls:

Material/Map list The main part of the Material/Map Browser dialog is a scrollable list of materials and maps. The list indicates a material with a blue sphere, and indicates a map with a green parallelogram. When you list both materials and maps, the materials are listed first.

NOTE Icons of materials and maps for which [Show Standard/Hardware Map in Viewport](#) on page 5350 is on are red.

Also, the names of [instanced](#) on page 8014 materials and maps appear in boldface. Both of these effects are shown in the following illustration:

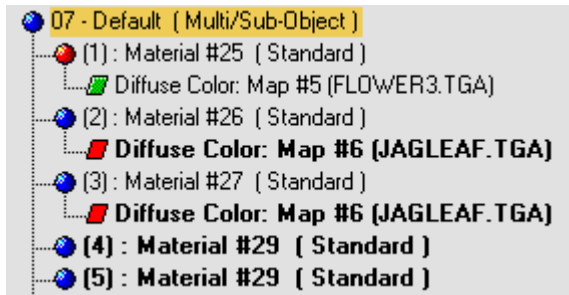

Text entry As you enter a material name in this field, the first matching text item is selected in the list. Press Enter to select the next matching name, and so on.

For example, if you enter **ch** when the list includes the material names Cherry Red, Chrome Blue, and Chrome Zinc, Cherry Red is selected first. Press Enter, and the Chrome Blue is selected. Press Enter again, and Chrome Zinc is selected. The search is not case-sensitive.

Sample slot Below the text-entry field is a single sample slot. This displays a sample of the current selection. You can drag the sample to any other sample slot or material button. The sample slot display is interruptible, so you can quickly click from one list item to the next without waiting. In addition, if you complete the display of one sample, then move on to another sample, when you return to the first sample, it displays instantly.

Tool buttons

The first part of this row of buttons controls how you view the list. The second part is for managing material libraries.

To speed up the display of the sample spheres in the Browser, the smaller of the sample spheres (those displayed when you choose View Small Icons or View List + Icons) can be saved as thumbnail images in the material library file. (See the Procedures for this topic, above.)

Keep in mind that the saved thumbnails increase the size of the material library file.



View List Displays the materials and maps in list format. Blue spheres are materials. Green parallelograms are maps. The green parallelograms turn red if Show Map in Viewport is on for a material.



View List + Icons Displays the materials and maps in a list with small icons.



View Small Icons Displays the materials and maps as small icons. As you move the mouse over the icons, tooltip labels pop up, showing you the name of the material or map.



View Large Icons Displays the materials and maps as large icons.

The large icons are labeled with the name of the material or map and are displayed using progressive refinement—samples are rendered quickly, with large pixels, then rendered a second time in greater detail.



Update Scene Materials from Library Updates materials in the scene with the materials of the same name stored in the library.

When you click Update Scene Materials from Library, the [Update Scene Materials dialog](#) on page 5377 is displayed. This dialog lists materials in the library that have the same name as materials in the scene. In the list, select the materials you want to update in the scene, and then click OK.

If no materials exist in the scene that match the names in the library, an alert informs you of this.

This button is available only when the Browser is viewing a library.



Delete from Library Removes the selected material or map from the library display. The library on disk is not affected until you save it. Use Open to reload the original library from disk. This button is only active when you select a named material that exists in the current library.

This button is available only when the Browser is viewing a library.



Clear Material Library Removes all materials from the library display. The library on disk is not affected until you save it. Use Open to reload the original library from disk.

This button is available only when the Browser is viewing a library.

Browse From group

The controls in this group choose the source of the materials displayed in the material/map list.

Material Library Displays the contents of a material library file from disk. When you set this option, the buttons under File become active (see below). You can also load a library from a MAX file. When browsing from the Material Library in the Material/Map Browser, choose Open, and then choose 3ds Max (*.max) from Files of type. Select and load a .max file. All materials assigned in that scene are listed in the Browser. To convert the collection of materials to a library file, click Save, and save it as a MAT (.mat) file.

Material Editor Displays the contents of the sample slots.

Active Slot Displays the contents of the currently active sample slot.

This option is unavailable in the modal version of the Browser.

When you choose this mode, all check boxes in the Show group box are made available. The entire material and map tree of the active material is displayed, regardless of the state of these check boxes in other Browse From modes.

You can also use Active Slot mode to navigate the hierarchy of the active material. When Active Slot is chosen, clicking an item in the material/map list moves Material Editor controls to that level of the material.

Selected Displays the material applied to the selected objects.

Scene Displays all materials applied to objects in the scene.

All maps assigned to the scene, including Environment Background or spotlight projector maps, are displayed in the Browser list.

New Displays the set of material/map types for you to create a new material.

Show group

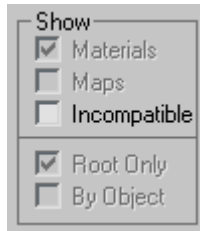

These options filter what is displayed in the list. Either Materials or Maps is always on, and both can be on at the same time. The first two options can be unavailable, depending on the active Browse From and View settings.

Materials Turns display of materials and sub-materials on or off.

This is always unavailable in the modal version of the Browser.

Maps Turns display of maps on or off.

This is always unavailable in the modal version of the Browser.

Incompatible When on, displays materials or maps and shaders that are incompatible with the currently active renderer. The incompatible materials are displayed in gray. You can still assign incompatible materials, maps, or shaders to buttons where they would be legal, but if you use the current renderer, the results might not be correct. Default=off.

Root/Object group

Root Only When on, the material/map list displays only the root of the material hierarchy. When off, the list displays the full hierarchy.

The default state of Root Only depends on how you display the Browser. Generally, when you display the modeless Browser, you're selecting materials rather than maps (to begin with), so Root Only is on. However, when you display the modal Browser (by clicking a map button anywhere in the user interface), Root Only is off so you can see all the maps.

By Object This is available only when you're browsing from either Scene or Selected. When on, the list displays materials by their object assignment in the scene. At the left are the names of the objects arranged alphabetically, with a yellow cube icons as in [Track View](#) on page 3503. Applied materials are shown as children of the objects. When off, the list displays only material names.

File group

This button group is displayed when you've chosen Material Library, Material Editor, Selected, or Scene in the Browse From group. All four buttons are displayed only when browsing from the Material Library; otherwise, only the Save As button appears.

Open Opens a material library.

Merge Merges materials from another material library or scene. When you click Merge, the [Merge Material Library dialog](#) on page 5371 is displayed. This file dialog lets you choose a material library or a scene. When you choose a library or scene to merge, the [Merge dialog](#) on page 5370 is displayed. This lets you select which materials to merge. If there are duplicate names among the materials you're merging, the [Duplicate Name dialog](#) on page 5368 is displayed so you can resolve the name conflicts.

Save Saves the open material library.

Save As Saves the open material library under another name.

Display group

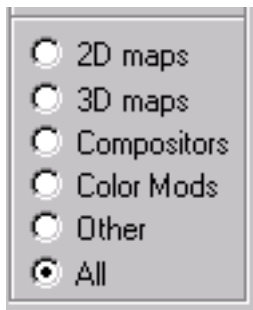

This group of radio buttons is displayed only when you've chosen New under Browse From. It controls what types of maps the Browser displays in the material/map list. (The Browser displays materials regardless of this setting.)

2D Maps Lists only 2D map types.

3D Maps Lists only 3D ([procedural](#)) on page 8097 map types.

Compositors Lists only compositor map types.

Color Mods Lists only color modifier map types.

Other Lists reflection and refraction map types.

All (The default.) Lists all map types.

Copying and Pasting: Right-Click Menu for Materials, Maps, Bitmaps, and Colors

Material Editor > Right-click a Type button, sub-materials button, map button, bitmap button, or color swatch.

Elsewhere in the user interface > Right-click a map button or color swatch.

A set of right-click pop-up menus in the Material Editor (and elsewhere in the program's user interface) lets you copy and paste, and otherwise manage materials, maps, bitmaps, and colors.

You see these menus only if copy and paste actions are appropriate. For example, if you copy a material and then right-click a map button, nothing happens.

Material Right-Click Menu

When you right-click a button that represents a material, this menu appears. This includes the [Type button](#) on page 5361 for a material, and sub-material buttons such as you find in the [Multi/Sub-Object material](#) on page 5720, the [Blend material](#) on page 5708, and others.

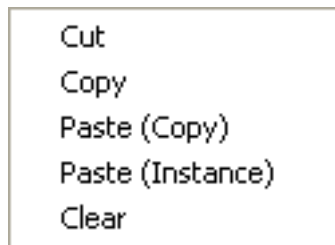

Cut Makes a copy of the material. If you right-click a sub-material button, this also removes the material from that sub-material component. If you right-click the Type button, Cut is equivalent to Copy.

Copy Makes a copy of the material.

Paste (Copy) Pastes a copy from the copy buffer.

This item doesn't appear if you haven't yet copied a material.

Paste (Instance) Pastes an instance from the copy buffer.

This item doesn't appear if you haven't yet copied a material.

Clear If you right-click a sub-material button, Clear removes the material from that sub-material component without making a copy of it. If you right-click the Type button, Clear has no effect.

Map Right-Click Menu

When you right-click the button for a map component (a “map slot”), the menu you see depends on whether a map has been assigned yet.

When a Map Has Been Assigned

The following menu appears if a map has been assigned:

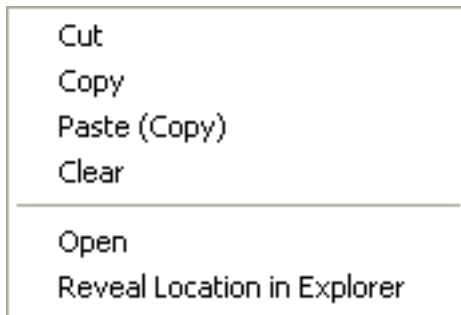

Cut Removes the assigned map, and puts a copy of it in the copy buffer.

Copy Copies the map without removing it.

Paste (Copy) Pastes a copy from the copy buffer.

This item doesn't appear if you haven't yet copied a map.

Clear Removes the assigned map without copying it.

Open For [bitmaps](#) on page 5795, launches whichever application is associated with the currently assigned 2D map.

This item does not appear for other map types such as procedural maps.

Reveal Location in Explorer Launches a copy of Windows Explorer to display the folder where the map is saved.

When No Map Has Been Assigned

If no map has been assigned, all you can do is paste another:

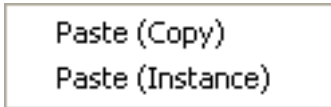

Paste (Copy) Pastes a copy from the copy buffer.

Paste (Instance) Pastes an instance from the copy buffer.

When No Map Has Been Either Assigned or Copied

If no map has been assigned and you haven't copied a map yet, then no right-click menu appears at all.

Bitmap Right-Click Menu

This menu appears when you click a button that specifies an external [bitmap](#) on page 7926. See [Bitmap 2D Map](#) on page 5795.

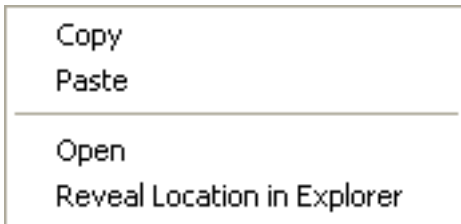

Copy Copies the bitmap.

Paste Pastes the bitmap from the copy buffer.

Open Launches whichever application is associated with the bitmap.

Reveal Location in Explorer Launches a copy of Windows Explorer to display the folder where the bitmap is saved.

Color Swatch Right-Click Menu

This menu appears when you right-click a color swatch.

NOTE This menu does not apply to the VertexPaint modifier's [Color Palette](#) on page 1984, which has its own right-click menu.



Copy Copies the color.

Pastes Pastes a color from the copy buffer.

Sample Slots

Material Editor > Sample slots display

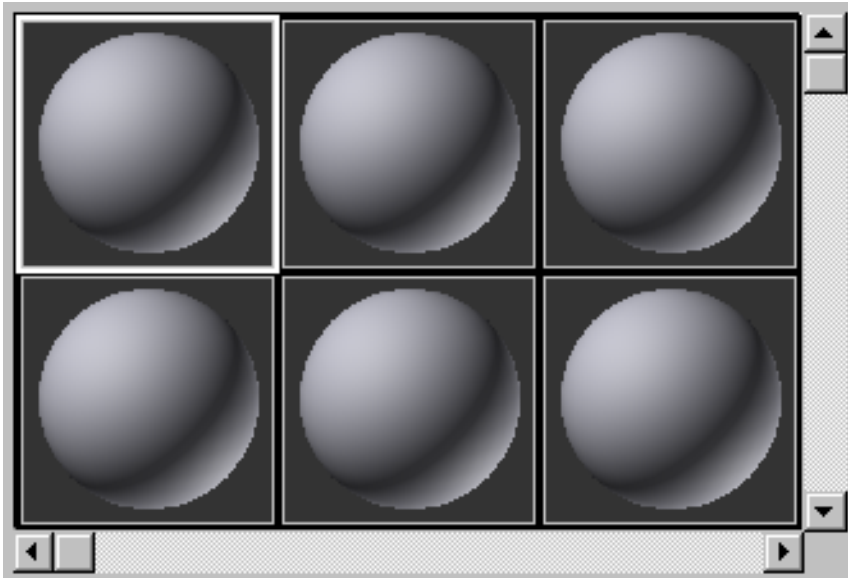

The sample slots let you maintain and preview [materials](#) on page 8041 and [maps](#) on page 8036. Each slot previews a single material or map. You can change the material by using the Material Editor controls, and you can apply the material to objects in the scene. The easiest way to do this is to drag the material from the sample slot to objects in viewports. See [Dragging and Dropping Maps and Materials](#) on page 5310.

IMPORTANT While the Material Editor can edit no more than 24 materials at a time, a scene can contain an unlimited number of materials. When you are through editing one material, and have applied it to objects in the scene, you can use that sample slot to [get](#) on page 5341 a different material from the scene (or create a new one) and then edit it.

You can display a sample slot in a window of its own. This magnifies the sample slot, which can make it easier to preview the material. You can resize

the magnified window to make it even larger. To magnify a sample slot, double-click it, or right-click and choose Magnify from the pop-up menu. See [Sample Slot Right-Click Menu](#) on page 5308.

The Material Editor has 24 sample slots. You can view them all at once, six at a time (the default), or 15 at a time. When you view fewer than 24 slots at once, scroll bars let you move among them. See [Material Editor Options](#) on page 5335 and [Sample Slot Right-Click Menu](#) on page 5308.

A material in a slot is shown on a sample object. By default, the object is a sphere. Use the [Sample Type flyout](#) on page 5328 to change the sample object.

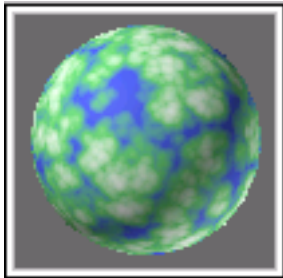

Sample slot showing a material

By default, a standalone map in a slot fills the whole slot. This is when the slot shows *only* a standalone map at the top of a tree; when the map is assigned to a material, the slot shows it as part of the material, mapped to the sample object. See [Get Material](#) on page 5341 and [Material Editor Options](#) on page 5335.



Sample slot showing a map

The Material Editor renders only the active sample sphere for the current frame.

Hot and Cool Materials

A sample slot is "hot" on page 8006 when the material in the slot is assigned to one or more surfaces in the scene. When you use the Material Editor to adjust a hot sample slot, the material in the scene changes at the same time.

The corners of a sample slot indicate whether the material is a hot material:

- No triangle: The material is not used in the scene.
- Outlined white triangle: The material is hot. In other words, it's instanced in the scene. Changes you make to the material in the sample slot will change the material displayed in the scene.
- Solid white triangle: The material is not only hot, but is applied to the currently selected object.



Left: "Hot" material applied to currently selected object.

Middle: "Hot" material assigned to scene but not to currently selected object.

Right: "Cool" material: active but not assigned to scene.

A material is "cool" on page 7943 if it is not applied to any object in the scene.

To make a hot sample slot cool, click [Make Material Copy](#) on page 5346. This copies the material in the sample slot on top of itself so that it's no longer used in the scene.

You can have the same material (with the same name) in more than one sample slot, but only one slot containing that material can be hot. You can have more than one hot sample slot, as long as each has a different material.

If you drag to copy a material from a hot slot to another slot, the destination slot is cool, and the original slot remains hot.

See also:

- [Sample Slot Right-Click Menu](#) on page 5308
- [Dragging and Dropping Maps and Materials](#) on page 5310
- [Creating a Custom Sample Object](#) on page 5314

Procedures

To use a sample slot:

- Click the sample slot to make it active.
The active sample slot is displayed with a white border around it.
The sample slot shows a sample object shaded with a material. (By default, the sample object is a sphere.) The sample object is lit by a light source above it and slightly toward the viewer. For the sphere, the highlight is in the upper-left quadrant. The diffuse color shows most clearly above and to the left of the highlight, shading toward the ambient color at the sphere's lower right.

To change the preview shape:

- 1 Make sure the sample slot of the material you want to view is active.
- 2 Use the [Sample Type flyout](#) on page 5328 to choose the shape you want to view. The flyout gives you three options: sphere (the default), cylinder, or box.
The new shape is displayed in the sample slot, with the material mapped to it.

To render the current mapping level:

- 1 Move to the level of the map hierarchy that you want to render.
- 2 Right-click in the sample slot, and choose Render Map from the pop-up menu.
The [Render Map dialog](#) on page 5373 is displayed.
- 3 Choose Single or the range of frames you want to render.
- 4 In the Dimensions group box, specify the pixel resolution of the map.

- 5 Click the Files button, and specify a path and file name for the file. Make sure Save To File is on unless you want to see the image only in a [Rendered Frame Window](#) on page 6073.
- 6 Click Render.
A Rendered Frame Window appears displaying the map. If Save To File is on, the image is also saved to disk.

Sample Slot Right-Click Menu

Material Editor > Right-click active sample slot.

When you right-click the active sample slot, a pop-up menu is displayed. For other sample slots, click or right-click once to select them, then right-click to use the pop-up menu.

The pop-up menu is available in magnified sample slot windows. See the "Magnify" option, below.

Interface

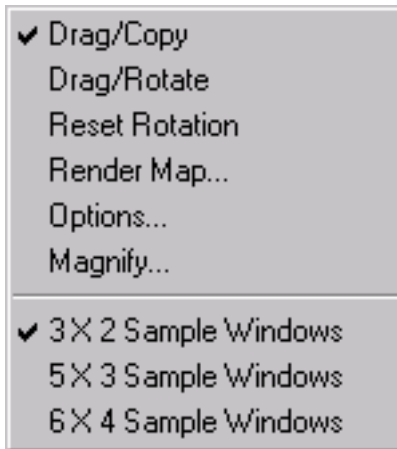

The pop-up menu has these options:

Drag/Copy Sets dragging a sample slot to copy mode. When on, dragging a sample slot copies the material from one sample slot to another, or from the sample slot to an object in the scene or a material button.

Drag/Rotate Sets dragging a sample slot to rotate mode. When on, dragging in the sample slot rotates the sample object. This helps you preview the material. Drag over the object to rotate it about its X or Y axis; drag in the corners of the sample slot to rotate the object about its Z axis. In addition, if you press Shift before dragging in the center, the rotation is constrained to the vertical or horizontal axis, depending on your initial drag direction.

If you have a three-button mouse and are using Windows NT, the middle mouse button rotates the sample object while Drag/Copy mode is active.

Reset Rotation Resets the sample object to its default orientation.

Render Map Renders the current map, creating a bitmap or an AVI file (if the map is animated). Only the current map level renders. That is, the rendering shows the image displayed when Show End Result is turned off.

If you're at a material level instead of a map level, this menu item is disabled.

Options Displays the [Material Editor Options dialog](#) on page 5335. This is an alternative to clicking the Options button.

Magnify Generates a magnified view of the current sample slot. The magnified sample is displayed in its own, floating (modeless) window. You can display up to 24 magnified windows, but you can't display the same sample slot in more than one magnified window at a time. You can resize magnify windows. Clicking a magnify window activates the sample slot, and vice versa.

Shortcut Double-click a sample slot to display the magnified window.

The magnify window's title bar displays the contents of the editable [material name field](#) on page 5360. It varies depending on which level of the material is active.

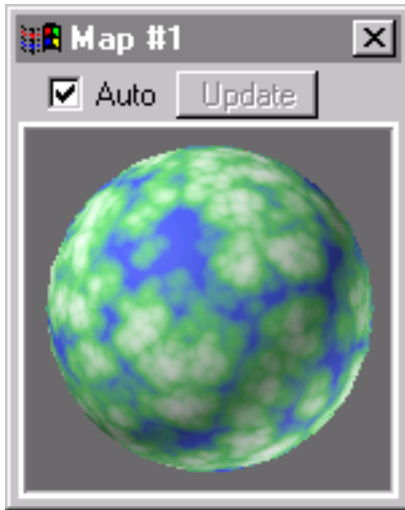

Auto Turn off to prevent the magnified window from updating automatically. This can save rendering time, especially when you have resized the magnified window to make it larger. Default=on.

Update Click to update the magnified window. This button is unavailable unless Auto is turned off.

Dragging a different sample slot to the magnify window changes the contents of the magnify window.

Sample Windows options

The Material Editor always has 24 sample slots available. You can choose to display fewer sample slots at a larger size. When you do, scroll bars let you move around among the sample slots.

3 X 2 Sample Windows Displays a 3 x 2 array of sample slots. (The default: 6 windows.)

5 X 3 Sample Windows Displays a 5 X 3 array of sample slots. (15 windows.)

6 X 4 Sample Windows Displays a 6 X 4 array of sample slots. (24 windows.)

Dragging and Dropping Maps and Materials

You can move materials from sample slots to objects using a drag-and-drop operation. You can also drag to and from map and material buttons. See the

following lists to determine where in the interface you can drag from and drag to.

When dragging materials, use the [Undo command](#) on page 262 to cancel material assignments.

Where You Can Drag From

- [Sample Slots](#) on page 5304
The content you drag from a sample slot is always at the top level of the sample slot, regardless of which level is currently displayed. If the sample slot contains a material, you can't drag from the sample slot to a map button, even if you're at the map level of the material.
- Material preview and map preview
- The Material Editor [Type button](#) on page 5361
- [Material/Map Browser](#) on page 5290 lists (text or icon lists)
You can't drag from the modal version of the Browser (when OK and Cancel buttons are present).
- The sample slot in the Browser
- Material map buttons (see below)
- A projector light map button (see [Advanced Effects Rollout](#) on page 5108)
- The [Environment Background](#) on page 6689 map button
- [Fog](#) on page 6707 Color and Opacity map buttons
- [Displace modifier](#) on page 1344 map buttons

Material Map Buttons

The material map buttons you can drag from include:

- The buttons in the [Maps rollout](#) on page 5414
- The small shortcut map buttons on the [Basic Parameters rollouts](#) on page 5406.
- Any map buttons at any level.
- Sub-material buttons, such as those found in the [Multi/Sub-Object material](#) on page 5720.

Where You Can Drag To

- All of the items in the previous list.
- Objects in viewports.
Drag from a material button, sample slot, or Browser listing into the viewport and over an object. When you release the mouse, the material is applied.
If you drag a material over two or more selected objects, an alert message asks if you want to apply the material to the object or to the selection. Choose the option you want, and click OK.
- The Material Editor [Type button](#) on page 5361.
You can drag to the Type button only from the Browser. If the Type button shows a standalone map, you can drag only a map to it. If it shows a material type, you can drag only a material to it.
- All of the items in the previous list, except that you can drag to the Browser only when it displays a material library.
When the Browser is set to browse from a Material Library, dragging materials and maps into the Browser adds them to the library.
- Any palette in the Content Browser. You can drag individual materials, selections of materials, or entire panels or palettes into the Content Browser.
- A Face, Polygon, Patch, or Element sub-object selection of an editable surfacemesh object (mesh, patch, or poly).
- A Face, Polygon, Patch, or Element sub-object selection created by the [Edit Mesh modifier](#) on page 1353 or [Edit Patch](#) on page 1360; or by one of these selection modifiers: [Mesh Select](#) on page 1527, [Patch Select](#) on page 1592, or [Poly Select](#) on page 1613.

See also:

- [Applying a Material to an Object](#) on page 5278
- [Drag and Drop Sub-Object Material Assignment](#) on page 5312

Drag and Drop Sub-Object Material Assignment

You can apply a material to a selection of renderable sub-objects, such as faces in a mesh. In the Material Editor, you can use [Assign Material to Selection](#) on

page 5344. You can also drag the material from the Material Editor or the [Material/Map Browser](#) on page 5290 to the selected faces. This can create a new [Multi/Sub-Object material](#) on page 5720 on the fly.

You can disable drag-and-drop of materials to sub-objects. To do so, go to the [General tab](#) on page 7744 of the [Preferences dialog](#) on page 7743, and in the Sub-Materials group, turn off Assign Automatically. This check box is on by default.

How the Multi/Sub-Object Material Is Created

The Multi/Sub-Object material is created in one of three ways, depending on what material is already applied to the selected sub-objects:

■ No material applied

If the selected faces have no material applied, a new Multi/Sub-Object material is created. The dragged material becomes a sub-material in the new material. If material IDs already exist, they are preserved.

■ Existing material applied (other than Multi/Sub-Object material)

A new Multi/Sub-Object material is created and applied to the selected faces. The existing material is moved into the Multi/Sub-Object material and becomes the first sub-material. Unselected faces get material ID #1, the selected faces get material ID #2, and the dragged material becomes part of the Multi/Sub-Object material. Existing material IDs are not preserved.

■ Multi/sub-object material applied

If the existing Multi/Sub-Object material is already applied more than once in the scene, the material is copied and the new copy is applied to the selected faces.

If the Multi/Sub-Object material is only applied once in the scene, then the existing material is used. The dragged material is added to the existing Multi/Sub-Object material.

If the dragged material already is a part of the Multi/Sub-Object material, then the selected faces receive the corresponding material ID number. If the selected faces all have the same material ID number, and no unselected faces are already using this number, then this number is used and the new material replaces the old sub-material at this ID. Otherwise, a new material ID number is assigned to the faces, and used for the dragged material. In this case, any existing material IDs are preserved.

Procedures

To drag materials onto sub-object selections:

- 1 In the Modify panel > Modifier Stack rollout, choose Face as the sub-object level.
- 2 Select faces of an editable mesh object.
- 3 Drag a material from a Material Editor sample slot to the selected faces.
- 4 In the Modifier Stack rollout, click to turn off Sub-Object and return to the object level.
- 5  On the Material Editor, click Pick Material From Object, then use the eyedropper to get the material from the sphere.
The new Multi/Sub-Object material appears in the active sample slot.

Creating a Custom Sample Object

Material Editor > Right-click the active sample slot. > Right-click menu > Options > Material Editor Options dialog

Material Editor > Material Editor Options > Material Editor Options dialog

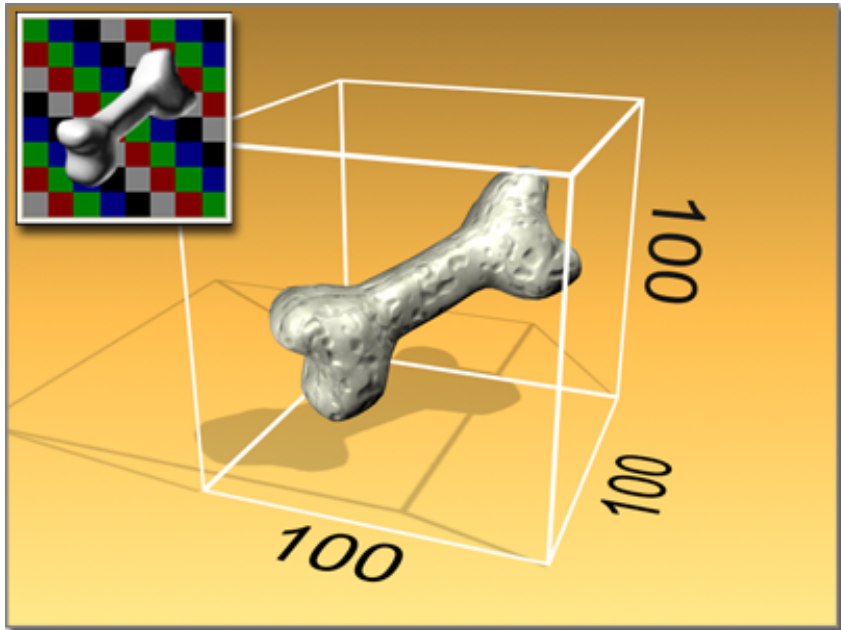

Custom sample object fits within a 100-unit cube

By default, the sample object in a sample slot is a sphere. You can use the [Sample Type flyout](#) on page 5328 to change this to a cube or a cylinder. You can also create a custom sample object by creating a 3ds Max scene that shows the object.

Overview of Using a Custom Sample Object

See Procedures for more details.

The scene you create should contain a single object that fits into an imaginary cube that is 100 units on each side. The object must be at the root level of the scene: it can't be linked to other objects. If more than one object is in the scene, only the first object listed in the Track View hierarchy is used as the sample object.

If the object is of a type that doesn't have a Generate Mapping Coords check box, apply a [UVW Map modifier](#) on page 1931 to it.

After you have saved the single-object scene as a MAX file, use the Custom Sample Object group in the [Material Editor Options dialog](#) on page 5335 to specify the file. When you specify the file, a new button is displayed at the

right of the Sample Type flyout. This button, which shows an object with a question mark, displays the sample object file you chose.

If the sample object scene contains only the object, sample slots display it with default lighting. If the scene also contains a camera and lights, you can use the camera to specify the view, and the lights to light the object as you choose. Turn on Load Camera and/or Lights in the Custom Sample Object group.

Procedures

To set up a custom sample object:

- 1** Create a scene with a single object, such as a pyramid.
The object should fit into an imaginary cube that is 100 units on each side. Also, the object must be at the root level of the scene: it can't be linked to other objects.
If more than one object is in the scene, the Material Editor uses the first object listed in the Track View hierarchy.
- 2** If the object does not have built-in mapping coordinates (via a Generate Mapping Coords check box), then assign a [UVW Map modifier](#) on page 1931 to it to provide mapping coordinates.
If the object has a Generate Mapping Coords check box, it's on by default, and the Material Editor uses those coordinates. If you want to use coordinates other than those built into the object, assign a UVW Map modifier and set up your own coordinates.
- 3** Save the scene as a MAX file.
- 4** In the Material Editor Options dialog, click the File Name button in the Custom Sample Object group box, and choose the file that contains your object.
- 5** Activate the sample slot in which you want to see the custom object, then choose the button at the far right of the Sample Type flyout.
Your custom object is displayed in the sample slot.
If the size of your object is not quite right for the sample slot, adjust its size and save the scene again. To update the sample slot so it uses the newly saved MAX file, open the Material Editor Options dialog, and then click OK.

To use a camera and lights with the custom sample object:

- 1 Create a camera in the scene that contains your sample object, and then adjust the camera to show the object as you want it seen in sample slots.

TIP Viewports have a different aspect ratio than sample slots, so using [Zoom Extents](#) on page 7594 on the sample object usually results in the object appearing *smaller* in a sample slot. Perform Zoom Extents on the object, and then before you save the file, zoom in a little farther so the object more than fills the viewport. The sample slot projection is based on the width of the sample object's geometry, not on the image in the viewport.

If more than one camera is in the scene, the Material Editor uses the first camera listed in the Track View hierarchy.

- 2 If you want to use your own lighting rather than the default sample-slot lighting, set up as many lights as you need. If you want to use the sample-slot lighting, do not add any lights to the scene.
- 3 Save the MAX file.
- 4 In the Material Editor Options dialog, specify the file as the Custom Sample Object file.
- 5 Turn on Load Camera and/or Lights.

Sample Slots set to use the custom object now display the object as seen through the camera. If lights are in the scene, those lights are used in the sample slot instead of the default lights.

Material Editor Tools

Main toolbar > Material Editor

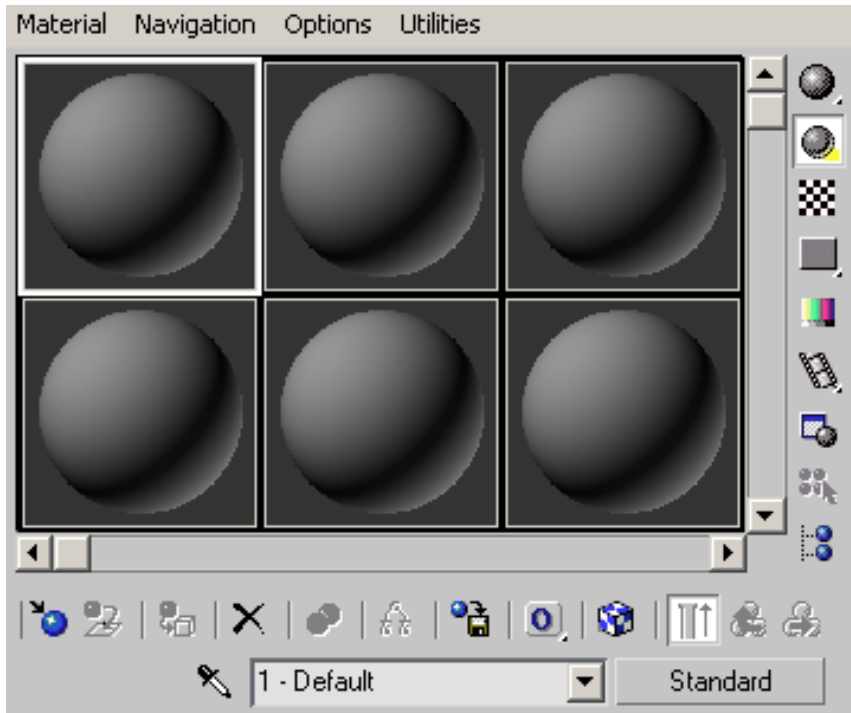

Material Editor tools below and to the right of the sample slots

Above the Material Editor [sample slots](#) on page 5304 is the menu bar. Below and to the right of the sample slots are buttons and other controls that you use to manage and change maps and materials.

[Material Editor Menu Bar](#) on page 5321

[Reflectance and Transmittance Display](#) on page 5324

NOTE These fields are not displayed unless you change a toggle in Preferences > Advanced Lighting.

Buttons below the sample slots (the "toolbar")



[Get Material](#) on page 5341



[Put Material to Scene](#) on page 5343



[Assign Material to Selection](#) on page 5344



[Reset Map/Mtl to Default Settings](#) on page 5345



[Make Material Copy](#) on page 5346



[Make Unique](#) on page 5346



[Put to Library](#) on page 5348



[Material ID Channel](#) on page 5348



[Show Map in Viewport](#) on page 5350



[Show End Result](#) on page 5356



[Go to Parent](#) on page 5356



[Go Forward to Sibling](#) on page 5357

Buttons to the right of the sample slots



[Sample Type](#) on page 5328



[Backlight](#) on page 5329



[Background](#) on page 5329



[Sample UV Tiling](#) on page 5330



[Video Color Check](#) on page 5332



[Make Preview, Play Preview, Save Preview](#) on page 5333



[Material Editor Options](#) on page 5335



[Select By Material](#) on page 5340



[Material/Map Navigator](#) on page 5357

Controls below the toolbar



[Pick Material from Object](#) on page 5360

[Material name field](#) on page 5360

[Material Type button](#) on page 5361

Procedures

To use the Material Editor Options dialog:

- 1  Click [Options](#) on page 5335 to the right of the sample slots.
- 2 Set the options as you want, and then click OK.

To change the preview shape:

- 1 Activate the sample slot of the material you want to view.
- 2 Use the [Sample Type flyout](#) on page 5328 to choose the shape you want to view.

The new shape is displayed in the sample slot, with the material mapped to it.

The flyout gives you three options: sphere (the default), cylinder, or box. An additional custom object option is available if you define a custom object as described in [Creating a Custom Sample Object](#) on page 5314.

Material Editor Menu Bar

Material Editor > Menu bar

The Material Editor menu bar appears at the top of the Material Editor window. It provides another way to invoke the various Material Editor tools.

Material Menu

The Material menu provides the most commonly used Material Editor tools.

- [Get Material](#) on page 5341
- [Pick from Object](#) on page 5360
- [Select By Material](#) on page 5340
- **Highlight Assets in ATS Dialog** If the active material uses maps that are [tracked assets](#) on page 7099 (typically bitmap textures), opens the Asset Tracking dialog with the assets highlighted.
- [Assign to Selection](#) on page 5344
- [Put to Scene](#) on page 5343
- [Put to Library](#) on page 5348
- **Change Material/Map Type** Equivalent to clicking the [Material Type Button](#) on page 5361.
- [Make Material Copy](#) on page 5346
- **Launch Magnify Window** Equivalent to double-clicking the active [sample slot](#) on page 5304, or choosing Magnify on its [right-click menu](#) on page 5308.
- **Save as .FX File** See [DirectX Manager Rollout](#) on page 5393.
- [Make Preview](#) on page 5333
- [View Preview](#) on page 5333
- [Save Preview](#) on page 5333
- [Show End Result](#) on page 5356
- [Show Materials in Viewport As](#) on page 173

- **Reset Sample Slot Rotation** Returns the active sample slot's object to its default orientation; equivalent to choosing Reset Rotation on the [sample slot right-click menu](#) on page 5308.
- **Update Active Material** If [Material Editor Options dialog](#) on page 5335 > Update Active Only is on, choosing this updates the active material in its sample slot.

Navigation Menu

The Navigation menu provides tools that navigate a material's hierarchy.

- [Go to Parent](#) on page 5356
- [Go Forward to Sibling](#) on page 5357
- **Go Backward to Sibling** Like Go Forward To Sibling, but navigates to the preceding sibling map in the tree instead of the succeeding one.

Options Menu

The Options menu provides some additional tools and display choices.

- [Propagate Materials to Instances](#) on page 5328
- **Manual Update Toggle** Equivalent to the Manual Update toggle in the [Material Editor Options dialog](#) on page 5335.
- **Copy/Rotate Drag Mode Toggle** Equivalent to choosing either Drag/Copy or Drag/Rotate on the [sample slot right-click menu](#) on page 5308.
- [Background](#) on page 5329
- **Custom Background Toggle** If you have used the [Material Editor Options dialog](#) on page 5335 to assign a custom background, this toggles its display.
- [Backlight](#) on page 5329
- **Cycle 3X2, 5X3, 6X4 Sample Slots** Cycles through the equivalent choices on the [sample slot right-click menu](#) on page 5308.
- **Options** Opens the [Material Editor Options dialog](#) on page 5335.

Utilities Menu

The Utilities menu provides map rendering and selecting objects by material.

- **Render Map** Equivalent to choosing Render Map on the [sample slot right-click menu](#) on page 5308.
- [Select Objects by Material](#) on page 5340
- [Clean MultiMaterial](#) on page 6052
- [Instance Duplicate Map](#) on page 6058
- **Reset Material Editor Slots** Replaces all materials in the Material Editor with the default material type. This action is not undoable, but you can restore the previous state of the Material Editor with the Restore Material Editor Slots command (see below).
- **Condense Material Editor Slots** Sets all unused materials in the Material Editor to the default type, retaining only materials in the scene and moving those materials to the first slots in the editor. This action is not undoable, but you can restore the previous state of the Material Editor with the Restore Material Editor Slots command (see below).
- **Restore Material Editor Slots** When you use either of the two previous commands, 3ds Max saves the current state of the Material Editor in a buffer; using this command restores the state of the editor using the buffer contents.

TIP The buffer that holds the material definitions survives the File menu > Reset command. Thus, if you use either the Reset Material Editor Slots or the Condense Material Editor Slots function, and then reset 3ds Max, you can then use Restore Material Editor Slots to bring all materials back into the Material Editor. This makes it easy to use the same materials in different projects.

For best results, follow this procedure:

- 1 Save your scene.
- 2 Use the Reset Material Editor Slots or Condense Material Editor Slots function.
- 3 Reset 3ds Max. When prompted to save the scene, click No. Otherwise, you might lose material definitions in the Material Editor that were saved with the scene.
- 4 Open the Material Editor and choose Utilities menu > Restore Material Editor Slots.

The Material Editor status before step 2 is restored.

Reflectance and Transmittance Display

Material Editor > Reflectance and Transmittance fields (below the sample slots)

These fields show the reflectance and transmittance of the active material. Both the average value and the maximum value are shown.

NOTE These fields appear only when you turn on Material Editor > Display Reflectance & Transmittance Information on the [Radiosity panel](#) on page 7786 of the Preferences dialog.

Reflectance	Transmittance
Avg: 67% Max: 67%	Avg: 0% Max: 0%

These fields can change according to the current [Show End Result setting](#) on page 5356. When Show End Result is off, the reflectance and transmittance show the properties of the current element in the material hierarchy, not the properties of the material overall.

The reflectance and transmittance values of a material are particularly important when you are preparing a [radiosity solution](#) on page 6168 to obtain a physically accurate lighting simulation. If a material's reflectance or transmittance values are not what your scene needs, you need to adjust these values.

Materials and Radiosity

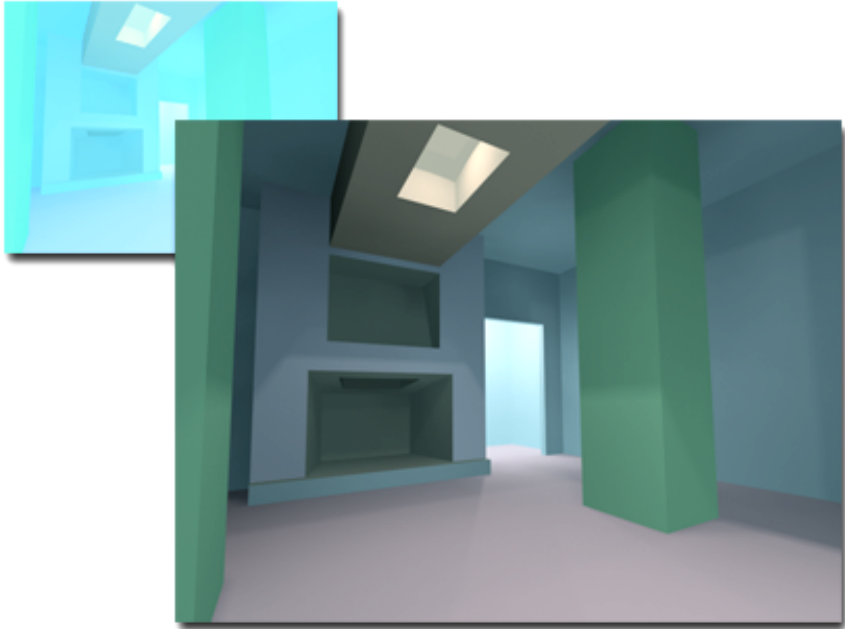

Upper left: Washed-out walls due to high reflectance.

Right: Better radiosity achieved by reducing the HSV Value (V) of materials in the scene.

To get good radiosity results, keep these points in mind as you design materials:

- Before you generate a radiosity solution, check the reflectance value of all materials in the scene, to make sure it is not too high. The reflectance of a material determines how much of the light energy it receives is subsequently used in the radiosity calculation. Keep this value within the range of the physical materials you are simulating. (See the table in the description of “Reflectance,” below.)
- Don’t be concerned if a material preview seems too dark. For example, a white wall with the maximum recommended reflectance of 80% appears gray. The color balance will be adjusted correctly by the [exposure control](#) on page 6732 in the final rendering.
- Bitmaps used as diffuse textures have already been illuminated by the scanner, digital camera, or paint program in which you created them. To bring them into the proper reflectance range, you might have to dim them

by reducing the RGB Level value in the bitmap's [Output rollout](#) on page 5774.



Left: Wood grain bitmap as originally photographed has too high a reflectance.

Right: Reducing the RGB Level value reduces the map's reflectance.

Interface

Reflectance Reflectance is the percentage of diffuse light energy that is reflected from a material. When you increase a material's HSV value (V), the material reflects more diffuse light. Decreasing a material's Opacity also decreases its reflectance.

Typically, the reflectance of a material should never be greater than 85%. This is an unusually high value that will lead to poor-quality renderings. In the real world, even the whitest wall reflects no more than 80% of the light it receives.

One source of high reflectance can be a map assigned to the material's diffuse component. For example, a white tile bitmap might create high reflectance. In this case, you can reduce reflectance by reducing the RGB Level in the bitmap's [Output rollout](#).

An alternate way to reduce a bitmapped material's reflectance is to set the diffuse color of the material to black, and then reduce the diffuse map's Amount (in the parent material's [Maps rollout](#) on page 5414). You can use this method to reduce the reflectance of [3D procedural maps](#) on page 5860 as well.

Here are some typical reflectance ranges for common materials:

Material	Minimum	Maximum
Ceramic	20%	70%
Fabric	20%	70%
Masonry	20%	50%
Metal	30%	90%
Paint	30%	80%
Paper	30%	70%
Plastic	20%	80%
Stone	20%	70%
Wood	20%	50%

Transmittance Transmittance is the amount of light energy transmitted through a material. A completely opaque material has 0% transmittance.

When the material is transparent (like clear glass), the energy transmitted is specular, and light passes directly through the material (subject to refraction). The value of specular transmittance is an interaction between the material's [Opacity value](#) on page 5442 and its [filter color](#) on page 7976. When the filter color is pure white, specular transmittance is the inverse of Opacity.

When the material is translucent (like frosted glass), the energy transmitted is diffuse, and scattered in all directions. The value of diffuse transmittance is based on the HSV value (V) of the [translucent color](#) on page 5447. Diffuse transmittance happens only for materials that use the [Translucent shader](#) on page 5434, or [Raytrace materials](#) on page 5490, that specify translucency.





Usually, when a material has high transmittance, it has low reflectance, and the other way around.

Sample Type

Material Editor > Sample Type



The Sample Type flyout lets you choose which geometry to display in the active [sample slot](#) on page 5304. This flyout has three buttons:

-  **Sphere (the default)** Displays the material on a sphere.
-  **Cylinder** Displays the material on a cylinder.
-  **Cube** Displays the material on a cube.
-  **Custom** Displays the material on a custom object. This button appears only if you have used the [Material Editor Options dialog](#) on page 5335 to specify a custom object for sample slots.

See also:

- [Creating a Custom Sample Object](#) on page 5314

Propagate Materials to Instances

Material Editor > Options menu > Propagate Materials to Instances

When Propagate Materials To Instances is on, any material assignment you make will be propagated to all [instances](#) on page 8014 of the object in your scene, including imported AutoCAD blocks and ADT style-based objects; these object types are common in [DRF files](#) on page 7167. Assignments are also propagated to instances of Revit objects and of other instances that you've made in the current scene.

When Propagate Materials To Instances is off, materials are assigned in traditional 3ds Max fashion; each object has a unique material assignment.

Backlight

Material Editor > Backlight

Material Editor menu > Options menu > Backlight

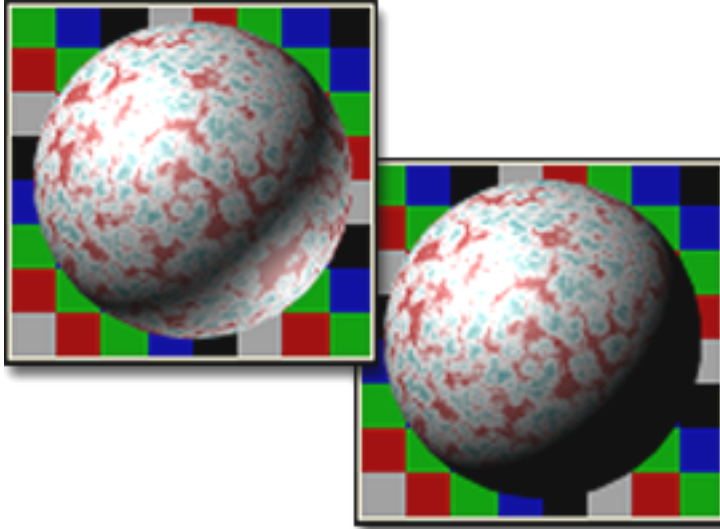

Left: Backlight on

Right: Backlight off

Turning on Backlight adds a backlight to the active sample slot. This button is on by default.

The effect is most easily seen with the sample spheres, where the backlight highlights the lower-right edge of the sphere.

Backlight is especially useful whenever you're creating [metal](#) on page 5427 and [Strauss](#) on page 5431 materials. Backlight lets you see and adjust the specular highlight created by glancing light, which is much brighter on metals.

Sample Slot Background

Material Editor > Background

Material Editor menu > Options menu > Background

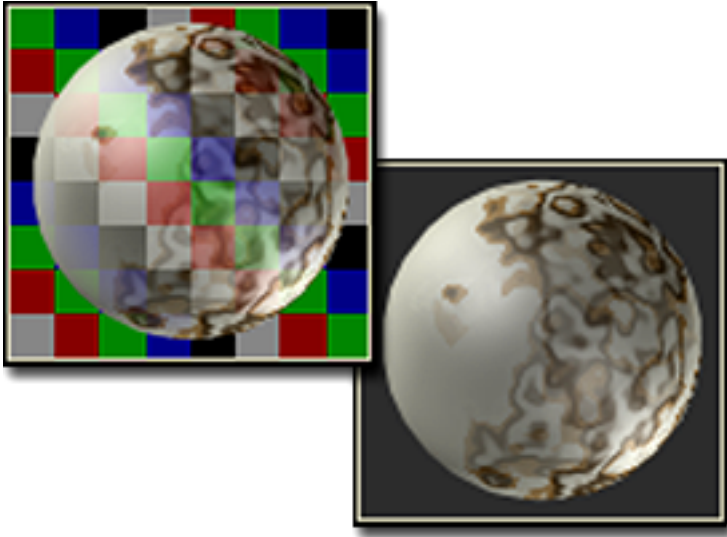

Left: Background on

Right: Background off

Turning on Background adds a multicolored checkered background to the active sample slot. The pattern background is helpful when you want to see effects of opacity and transparency.

The [Material Editor Options dialog](#) on page 5335 also lets you assign a bitmap to use as a custom background.

Sample UV Tiling

Material Editor > Sample UV Tiling







1x1, 2x2, and 3x3 sample tiling



The buttons on the Sample UV Tiling flyout adjust the repetition of the [map](#) on page 8036 pattern on the sample object in the active sample slot.

The tiling pattern you set with this option affects *only* the sample slot. It has no effect on the tiling on the geometry in the scene, which you control with parameters in the map's own coordinates rollout.

-  **1 x 1 (the default)** Tile once in the U dimension and once in V. This is equivalent to no tiling at all.
-  **2 x 2** Tile twice in U and twice in V.
-  **3 x 3** Tile three times in U and three times in V.
-  **4 x 4** Tile four times in U and four times in V.

The buttons specify the number of times the pattern repeats over the surface of the sample object. Because maps are mapped spherically around the sample sphere, the [tiling](#) on page 8148 repetition covers the entire surface of the sphere. The sample cylinder maps cylindrically. The sample cube uses box mapping: the tiling appears on each side of the cube. Custom sample objects use the

default mapping coordinates for that kind of object, unless the object has a [UVW Map modifier](#) on page 1931 applied to it, in which case the modifier controls the mapping.

This flyout is unavailable when the sample slot displays a standalone (top-level) map.

See also:

- [Creating a Custom Sample Object](#) on page 5314

Video Color Check

Material Editor > Video Color Check

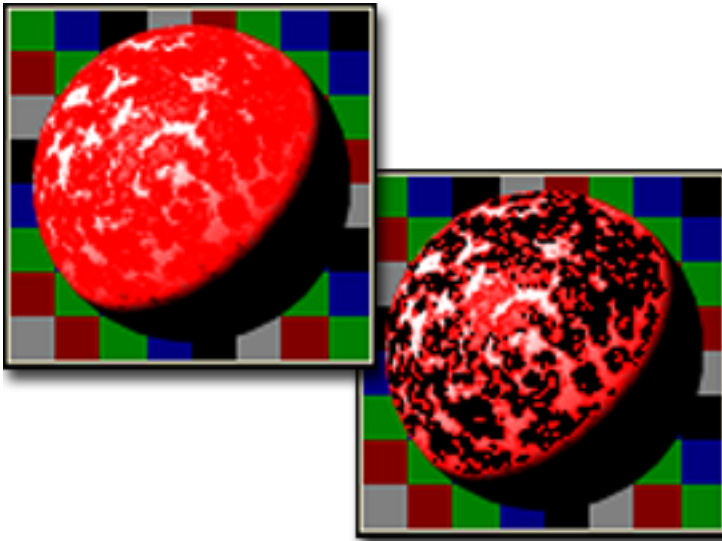

Left: Material with oversaturated colors

Right: Video color check shows black areas that are beyond the video threshold

Video Color Check checks the material on the sample object for colors that are beyond the safe [NTSC](#) on page 8059 or [PAL](#) on page 8078 threshold.

Such colors tend to blur or fuzz when transferred from computer to video. Pixels containing these "illegal" or "hot" colors are flagged on the sample object.

You can have 3ds Max correct illegal colors automatically when you render, depending on the settings in the [Rendering tab](#) on page 7768 of the [Customize/Preferences dialog](#) on page 7743.

Use this option as a guide only. The colors in a rendered scene depend not only on the material color but also on the intensity and color of the lighting. A material that shows as safe in the sample slot might become illegal if rendered under several bright lights. A safe practice for video is to use colors whose saturation is less than 80 to 85 percent.

Procedures

To check for illegal video colors:

-  On the Material Editor, turn on [Video Color Check](#) on page 5332. The active sample slot now renders "illegal" pixels as black. Illegal pixels have a color that is beyond the safe video threshold.
If Video Color Check detects illegal colors, try reducing the saturation of the material colors in question.
- You can also check for legal video colors when you render a scene.

To change the video system:

[NTSC](#) on page 8059 is the default video system to check. You can change the video checking to [PAL](#) on page 8078.

- In the Tools menu > Options > Options dialog > [Rendering panel](#) on page 7768 > Video Color Check group, change the setting to PAL. The sample slot does not automatically update when you change the video system preference. Turn video checking off and back on to see the change.

NOTE The Rendering panel also shows options for choosing alternate ways to display illegal pixels. These apply to renderings only, not to the sample slots in the Material Editor.

Make Preview, Play Preview, Save Preview



Material Editor > Make/Play/Save Preview flyout

Material Editor menu > Material menu > Make Preview, View Preview, or Save Preview

You can use animated maps to add movement to a scene. For example, to simulate a sky view, you could map an animation of moving clouds to a clerestory window. The Make Preview options let you experiment with the effect in the Material Editor before you apply it to your scene.

The buttons on the Make Preview, Play Preview, Save Preview flyout let you preview the effect of an animated map on the object in a sample slot (see [Sample Type](#) on page 5328 for alternatives to the default sphere.) You can use an [AVI file](#) on page 7326, or [IFL file](#) on page 7339 as a source for the animation. The finished preview is saved as a new AVI file and automatically played back. You can also view the preview in a sample slot by dragging the time slider.

This flyout has three options:

-  **Make Preview** Displays a [Create Material Preview dialog](#) on page 5366 to create an AVI file of the animated material. When the preview is complete, it is saved as `_medit.avi` in the `\previews` subdirectory. The file is then opened in the Windows Media Player and played back. Without this option, the only other way to preview a complex animated material in real time is to use the [renderer](#) on page 6121 to render an animated sequence and save it to an AVI file, a digital disk recorder, or a video tape recorder.
-  **Play Preview** Uses the Windows Media Player to play the current `_medit.avi` preview file in the `\previews` subdirectory.
-  **Save Preview** Saves the `_medit.avi` preview to an AVI file of a different name in the `\previews` subdirectory.

Procedures

To create a preview of an animated material:

- 1 Choose Make Preview from the flyout.
- 2 In the Create Material Preview dialog, set the preview conditions you want, and then click OK.

The preview is created, and then plays.

To play back a preview of an animated material:

- Choose Play Preview from the flyout.
The Material Editor starts the Windows Media Player. The Player then loads the current *_medit.avi* preview file in the *\previews* subdirectory and plays it in a separate window.

To view an animated material in a sample slot:

- Drag the time slider through the range of frames.
By default, all sample slots with animated maps update at the same time. To change this, see [Material Editor Options Dialog](#) on page 5335.

To save a preview under a different name:

- 1 Choose Save Preview from the flyout.
The Material Editor displays a File Save dialog.
- 2 Enter a new name for the preview, and then click OK to save the file in the *\previews* subdirectory.

To play a renamed preview:

- 1 Choose Tools menu > Display Image.
- 2 In the View File dialog, change to the *\previews* subdirectory.
- 3 Select the renamed preview file and click Open.
The preview is played in a separate window.

Material Editor Options

Material Editor > Material Editor Options

Material Editor menu > Options menu > Options

This button displays the Material Editor Options dialog to let help you control how materials and maps are displayed in the [sample slots](#) on page 5304.

These settings are “sticky”; they survive a reset, and even quitting and restarting 3ds Max.

NOTE The controls to assign a renderer for the sample slots are on the [Assign Renderer rollout](#) on page 6135.

Interface

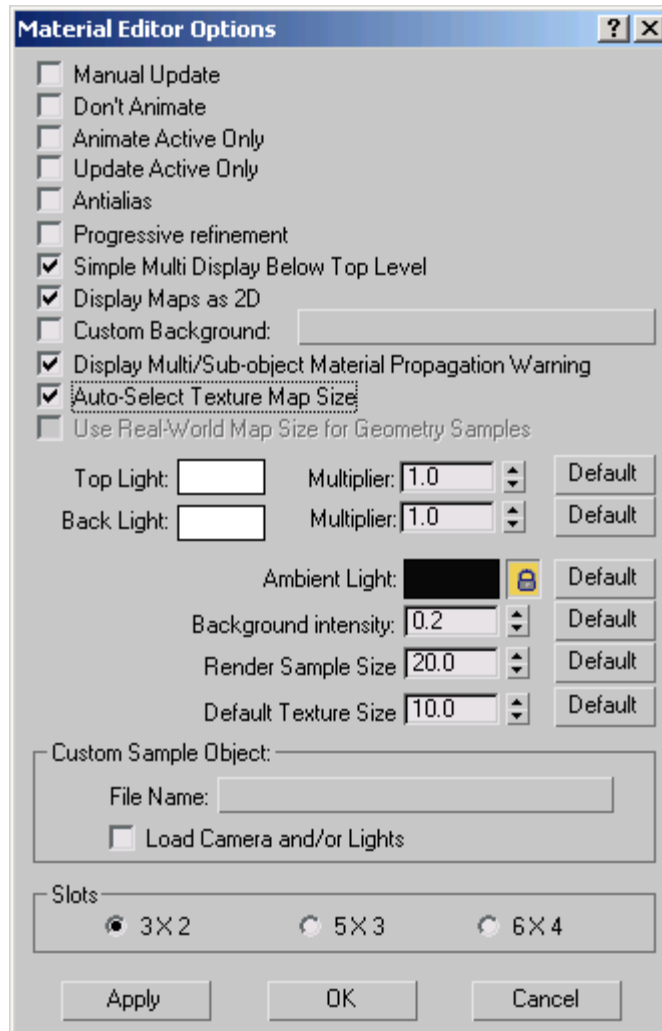

Manual Update When on, the sample slots don't update their contents until you click them. This option affects only the updating of the sample slots; it doesn't affect the icon displays in the Browser. Default=off.

Don't Animate When on, animated maps are not updated in the sample slots while you play an animation or drag the time slider. However, the animation is updated to the current frame when you stop the animation or release the time slider. An animated map can use an [AVI file](#) on page 7326 or [IFL file](#) on page 7339 as a source. Default=off.

Animate Active Only When on, only the active sample slot is animated when you play an animation or drag the time slider. This option is good for situations where you have multiple animated materials in the Material Editor, but you only need to see one at a time. This check box is unavailable when Don't Animate is on. Default=off.

Update Active Only When on, sample slots do not load or generate maps until you make one sample slot active. This can save time while you use the Material Editor, especially when your scene uses a lot of materials with maps. Default=off.

Antialias Turns on [antialiasing](#) on page 7904 in the sample slots. Default=off. If the mental ray renderer is used to render sample slots, this setting is disregarded. The mental ray renderer's sampling values control antialiasing.

Progressive Refinement Turns on progressive refinement in the sample slots. When on, samples are rendered quickly, with large pixels, then rendered a second time in greater detail. Default=off.

Simple Multi Display Below Top Level When on, the sample sphere for a Multi/Sub-Object material displays the multiple patches only at the top level of the material. The sub-materials are displayed over the entire sphere. When you use nested Multi/Sub-Object materials, the multiple patches again appear at the top level of the nested material, but the sample sphere is again whole when displaying any of the sub-materials. Default=on.

Display Maps as 2D When on, sample slots display maps, including standalone maps, in 2D. The map fills the entire slot. When off, maps are displayed on the sample object, as materials are. Default=on.

Custom Background Lets you specify a custom background for the sample slots, instead of the default checkers background. Click the file-assignment button to display a file dialog from which you can select the custom background. This can be any bitmap format supported by 3ds Max. Turn on Custom Background to use the new background instead of the checkered

background. The custom background is stored in the [3dsmax.ini](#) on page 83 file, so it is available from session to session. Default=off.

Display Multi/Sub-Object Material Propagation Warning Toggles display of warning dialog when you apply a [Multi/Sub-Object material](#) on page 5720 to an instanced ADT style-based object.

Auto-Select Texture Map Size When on, and you have a material that uses a texture map set to Use Real-World Scale, ensures that the map will be displayed correctly on the sample sphere. Turn off to be able to enable Use Real-World Map Size For Geometry Samples (see following).

NOTE If a material uses several texture maps at different levels, and only one is set to Use Real-World Scale, the sample sphere will render with real-world size coordinates.

Use Real-World Map Size For Geometry Samples This is a global setting that allows you to manually choose which style of texture coordinates are used. When on, real-world coordinates are used for the sample slot display. Otherwise, the old style of 3ds Max mapping coordinates is active. When off, you must turn on Use Real-World Scale on the map's Coordinates rollout to see the sample sphere as you'd expect. Available only when Auto-Select Texture Map Size (above) is off. Default=off.

Top Light color/Back Light color Specify the two lights used in the sample slots. Click the color swatch to alter the color of either light. Adjust the Multiplier spinners to multiply the values (intensity) of the lights.

Use the Default buttons to return to the initial settings.

Ambient Light Shows the color of [ambient light](#) on page 7906 used in the sample slots. Click the color swatch to change the color. When the lock button is on, changing the Ambient Light color here or on the [Environment panel](#) on page 6689 changes both; when off, changing one setting does not affect the other.

Use the Default button to return to the initial setting.

Background Intensity Sets the background intensity in the sample slots. The range is from 0 (black) to 1 (white). Default=0.2.

Use the Default button to return to the initial setting.

Render Sample Size Sets the scale of the sample sphere to any size, making it consistent with the object or objects in the scene that have the texture on them. This setting affects how 2D and 3D maps are displayed providing that the sample spheres are set to display real-world scale.

NOTE The size is scaled to use the current units.

This is a global option that affects all the sample slots. Default=100.0 (Imperial units) and 2.54m (Metric units).

Use the Default button to return to the initial setting.

Default Texture Size Controls the initial size (both height and width) of a newly created real-world texture. You see the result of changing this option only when you create a new texture in a material; the change appears in the [Coordinates rollout](#) on page 5782. Default=48.0 (Imperial units) and 1.219m (Metric units).

NOTE This setting applies to real-world textures only. For the default size to be applied to newly created textures, the Preferences dialog > General panel > Use Real-World Texture Coordinates check box must be on.

Use the Default button to return to the initial setting.

DirectX Shader group

These options affect the viewport behavior of the [DirectX 9 Shader material](#) on page 5758.

Force Software Rendering When on, forces DirectX 9 Shader materials to use the selected software render style for viewports. When off, the FX file specified in the DirectX 9 Shader is used unless the material's local Force Software Rendering toggle is on. Default=off.

Shade Selected When Force Software Rendering is on, selected objects, and only selected objects, are shaded by the DirectX 9 Shader material. This toggle is unavailable unless Force Software Rendering is on. Default=off.

Custom Sample Object group

Controls in this group let you specify a [custom sample object](#) on page 5314 to use in the [sample slots](#) on page 5304.

File Name Selects the MAX scene file.

The scene should contain a single unlinked object that fits in an imaginary cube 100 units on a side. The object must be either a primitive with a Generate Mapping Coords. check box, or have a [UVW Map modifier](#) on page 1931 applied to it. The scene can contain a camera and lights.

Load Camera and/or Lights Turn on to have sample slots use the camera and lights in the scene, instead of the default sample slot lighting.

Slots group

These options let you choose how many sample slots to display at a time.

The Material Editor always has 24 sample slots available. You can choose to display fewer sample slots at a larger size. When you do, scroll bars let you move around among the sample slots.

3 X 2 Specifies a 3 x 2 array of sample slots. (The default: 6 windows.)

5 X 3 Specifies a 5 X 3 array of sample slots. (15 windows.)

6 X 4 Specifies a 6 X 4 array of sample slots. (24 windows.)

Apply Applies the current settings, except for changes to the Slots group, without leaving the Material Editor Options dialog. This is useful when you adjust lighting values for the sample slots.

OK Closes the dialog and applies any changes you made.

Cancel Closes the dialog and cancels any changes you made, including changes you applied with the Apply button.

Select By Material

Material Editor vertical toolbar > Select By Material button

Material Editor > Material menu > Select by Material

Material Editor > Utilities menu > Select Objects by Material

Select By Material allows you to select objects based on the active material in the Material Editor. This command is unavailable unless the active sample slot contains a material used in the scene.

Choosing this command opens the Select Objects dialog, which works like [Select From Scene](#) on page 228. All objects that have the selected material applied to them are highlighted in the list.

NOTE Hidden objects don't appear in this list, even if the material is applied to them. However, in the [Material/Map Browser](#) on page 5290, you can choose Browse From: Scene, turn on By Object, and then browse from the scene. This lists all objects in the scene, hidden and unhidden, along with their assigned materials.

Procedures

To select objects that have the same material applied:

- 1 Click a sample slot that contains a material in the scene.
White corner brackets indicate materials that are in the scene.

- 2  Click [Select By Material](#) on page 5340 in the Material Editor.
This button is unavailable unless the active sample slot contains a material in the scene.

The [Select Objects dialog](#) on page 228 opens. The names of objects with the active material applied are highlighted.

- 3 Click Select to select objects with the active material applied.
You can also change the selection by choosing other objects. If you change the selection, you must then click [Assign Material To Selection](#) on page 5344 to apply the active material to newly selected objects.

Get Material

Material Editor > Get Material

Material Editor menu > Material menu > Get Material

Get Material displays the [Material/Map Browser](#) on page 5290 to allow you to choose a [material](#) on page 8041 or [map](#) on page 8036.

Procedures

To get a material from a scene:

- 1 Click a sample slot to make it active.
Be careful not to click the sample slot of a material you want to use later.

- 2  On the Material Editor toolbar, click [Get Material](#) on page 5341.
A modeless [Material/Map Browser](#) on page 5290 is displayed.

- 3 In the Browse From group box at the upper left, make sure that either Selected or Scene is chosen.

The Selected option lists only materials in the current selection. If no objects are selected, the list of materials is blank.

The Scene option lists all the materials currently in the scene.

- 4 In the list of materials, double-click the name of the material you want to get.

You can also drag the material name to the sample slot.

The material you chose replaces the previous material in the active sample slot.

WARNING When you get a material from a scene, initially it is a [hot](#) on page 8006 material.

To get a material from a library:



- 1 On the Material Editor toolbar, click [Get Material](#) on page 5341. A modeless [Material/Map Browser](#) on page 5290 is displayed.
- 2 In the Browse From group box at the upper left, make sure that Material Library is chosen.
If you have opened a library, the list of materials shows the contents of the library.
If you haven't opened a library, click Open in the file area of the Browser. A file dialog is displayed. Choose a library. After you open the library, the list of materials updates to show the library contents.

NOTE Open also lets you get materials from a 3ds Max scene (a *.max* file).

- 3 In the list of materials, double-click the name of the material you want to get.
You can also drag the name of the material to the sample slot.
The material you chose replaces the previous material in the active sample slot.

To create a standalone map tree:

- 1 Activate a sample slot.



- 2 On the Material Editor toolbar, click Get Material.

- 3 In the [Material/Map Browser](#) on page 5290, make sure Browse From is set to New.
- 4 In the Show group box, turn off Materials so only maps are displayed in the list.
- 5 Double-click the name of the map type (not a material type) you want to use, or drag the map to a sample slot.
The sample slot now contains a standalone map not associated with material parameters.
- 6 Use the Material Editor to modify the map as you would any other map.
By default, the sample slots distinguish maps from materials by displaying maps as 2D surfaces without lighting or shading.

To remove a material from an object:

- 1  On the Material Editor toolbar, click Get Material.
The Material/Map Browser appears.
- 2 Drag the entry NONE from the top of the list in the Browser to the object.
The object now has no material applied to it.

Put Material to Scene

Material Editor > Put Material to Scene

Material Editor menu > Material menu > Put to Scene

Put Material To Scene updates a material in the scene after you edit the material. Put Material To Scene is available only when:

- The material in the active sample slot has the same name as a material in a scene.
- The material in the active sample slot is not hot.

In other words, this command is intended to fit into the overall sequence of handling materials:

- You create a hot material either by applying it to objects in the scene or by getting it from the scene.
- You make a copy of the material.
- You make changes to the copy of the material.
- You update the scene by putting the changed material back into the scene.

Notes

- If you apply a mapped material to a parametric object whose Generate Mapping Coords option is off, the software automatically turns on mapping coordinates at render time. In addition, if you apply a mapped material with Show Map in Viewport active to an object, that object's Generate Mapping Coords option is turned on if necessary.
- The Show Map In Viewport flag is now saved with individual materials, so you can drag mapped materials from the modeless Browser onto objects in your scene, and the mapping appears in the viewports.

Procedures

To put a material back into a scene:

-  On the Material Editor toolbar, click Put Material To Scene. The material in the active sample slot is now a [hot material](#) on page 8006.

Assign Material to Selection

Material Editor > Assign Material to Selection

Material Editor menu > Material menu > Assign to Selection

Assign Material to Selection applies the material in the active sample slot to the currently selected object or objects in the scene. At the same time, the sample slot becomes [hot](#) on page 8006.

If you apply a mapped material to a parametric object whose Generate Mapping Coords option is off, the software automatically turns on mapping coordinates at render time. In addition, if you apply a mapped material with [Show Map In Viewport](#) on page 5350 active to a parametric object, that object's Generate Mapping Coords option is turned on if necessary.

The Show Map In Viewport flag is saved with individual materials, so when you drag mapped materials from the modeless [Browser](#) on page 5290 onto objects in your scene, the mapping appears in the viewports.

The Undo command works for material assignment.

Procedures

To apply a material to objects in a scene:

- 1 Select the sample slot that contains the material you want to apply.
- 2 Select the objects you want to apply the material to.
- 3 Do either of the following:
 - Drag from the sample slot to the objects. If more than one object is selected, you are asked whether you want to apply to the single object or to the whole selection.
 -  Click [Assign Material To Selection](#) on page 5344 on the Material Editor toolbar.

WARNING When you apply a material to an object or selection, that material becomes a [hot material](#) on page 8006. When you change the material's properties, the scene immediately updates to reflect those changes. *Any* object with that material will change its appearance, not just the objects in the current selection. When a material is hot, its sample slot is displayed with white corner brackets.



To make a material no longer hot so it doesn't change the current scene, click [Make Material Copy](#) on page 5346.

Reset Map/Mtl to Default Settings

Material Editor > Reset Map/Mtl to Default Settings

Reset Map/Mtl to Default Settings resets the values for the map or material in the active sample slot.

The material colors are removed and set to shades of gray. Glossiness, opacity, and so on are reset to their default values. Maps assigned to the material are removed.

If you are at a map level, this button resets the map to default values.

Reset changes the [name](#) on page 5360 *only* when this field names a material used in the scene.

Make Material Copy

Material Editor > Make Material Copy

Material Editor menu > Material menu > Make Material Copy

Make Material Copy "cools" on page 7943 the current [hot](#) on page 8006 sample slot by copying the material to itself.

The sample slot is no longer hot, but the material retains its properties and name. You can adjust the material without affecting it in the scene. Once you've got what you want, you can click [Put Material to Scene](#) on page 5343 to update the material in the scene and change the sample slot to hot again.

Make Unique (Material Editor)

Material Editor > Make Unique

Make Unique makes a map [instance](#) on page 8014 into a unique copy. It also makes an instanced sub-material into a unique, standalone sub-material. It gives the sub-material a new material name. A sub-material is a material within a [Multi/Sub-Object material](#) on page 5720.







Using Make Unique prevents changes to the top-level material instance from affecting the sub-material instance within the Multi/Sub-Object material.

You can also use Make Unique at the map level, when a map is instanced to different components of the same material.

NOTE If you drag an instanced map to a Material Editor sample slot, the Make Unique button will not be available, because it is not clear from the context what it would be unique relative to. Instead, you need to bring one of the parent maps or materials into the Material Editor, browse down into the map, and then make the map unique relative to that parent.

Procedures

Example: Create an instanced sub-material:

-  1 Create a box and a sphere.
-  2 Open the Material Editor.
- 3 Choose a sample slot, click the Material Type button, choose Multi/Sub-Object in the Material/Map Browser, and then click OK.
-   4 Select the box, and then apply the new Multi/Sub-Object material to it.
- 5 Drag one of the Sub-Material buttons from the Material Editor to the sphere.
-  6 Choose a different sample slot, and use the Pick Material From Object button to get the sub-material applied to the sphere.
At this point, the material applied to the sphere and the sub-material are instances of each other.
- 7 Go to the parameters for the instanced sub-material by clicking its Sub-Material button.
-  8 The Make Unique button is now available. Click it to make the sub-material unique again, and assign it a new material name.
Make Unique is not available for the top-level instance of the sub-material.

Put to Library

Material Editor > Put to Library

Material Editor menu > Material menu > Put to Library

Put to Library adds the selected material to the current library.

A [Put to Library dialog](#) on page 5372 is displayed, which lets you enter a name for the material that's different from the one you used in the Material Editor.

The material becomes visible in the material library display in the [Material/Map Browser](#) on page 5290. The material is saved to the library file on disk. (You can also save a library by using the Save button in the Material/Map Browser.)

Procedures

To save a material in a library:

- 1 Click to select the sample slot that has the material you want to save.

- 2  On the Material Editor toolbar, click [Put To Library](#) on page 5348.

- 3 A [Put To Library dialog](#) on page 5372 is displayed.

- 4 Either change the material name or leave it as is, and then click OK.

The material is saved in the currently open library. If no library is open, a new library is created. You can save the new library as a file using the [Material/Map Browser](#) on page 5290 file controls.

Material ID Channel

Material Editor > Material ID Channel

The buttons on the Material ID Channel flyout tag a material as a target for a [Video Post](#) on page 6773 effect or a [rendering effect](#) on page 6583, or for storing with a rendered image saved in [RLA](#) on page 7364 or [RPF](#) on page 7366 file format (so that the channel value can be used in a post-processing application). The material ID value is the counterpart of a [G-buffer value](#) on page 7991 for objects.



Zero (0), the default, indicates that no material ID channel is assigned.

A value from 1 to 15 means to apply a Video Post or rendering effect that uses this channel ID to this material.

For example, you might want a material to glow wherever it appears in the scene. The material is in the Material Editor and the glow comes from a rendering effect. First, you add a [Glow rendering effect](#) on page 6599 and set it up so that it operates on ID 1. Use Material ID Channel to give the material an ID number of 1, then apply the material to objects in the scene in the usual way.

To save the channel data with the rendering, use the RLA or RPF format.

WARNING The [mental ray renderer](#) on page 6230 does not recognize Z-depth with G-buffers. G-buffer data is saved on a single layer. Also, the mental ray renderer does not support the following effects:

- [Glow lens effect](#) on page 6599 (rendering effect)
- [Ring lens effect](#) on page 6606 (rendering effect)
- [Lens effects Focus filter](#) on page 6871 (Video Post)

Procedures

To assign a material ID channel to a material:

-  Choose a channel number from the [Material ID Channel flyout](#) on page 5350.

NOTE Giving a material a nonzero ID channel number tells the renderer to generate a material ID channel containing that value. This information is stored in images only if you save the rendered scene in RLA or RPF format. However, the ID channel data is available to rendering effects at render time.

Material ID Channel Flyout

Material Editor > Tool buttons > Material ID Channel flyout



The [Material ID Channel](#) on page 5348 flyout in the [Material Editor](#) on page 5284 lets you assign a material ID to the material. The ID value can associate a [Video Post effect](#) on page 6773 or [rendering effect](#) on page 6583 to objects assigned this material. The channel ID can also be saved if you render to a file in the [RLA](#) on page 7364 or [RPF](#) on page 7366 format. Saving the material ID in an image file lets you use the channel in post-processing applications, such as Autodesk Combustion.

Zero (0), the default, indicates that no material ID channel is assigned.

A value from 1 to 15 says that an effect that uses this material ID will be applied to this material.

Show Standard/Hardware Map in Viewport



Material Editor > Show Standard/Hardware Map in Viewport

Material Editor menu > Material menu > [Show Materials in Viewport As](#) on page 173





Left: Map shown on sample cube

Right: Map shown in a viewport

This control lets you switch between using software and hardware (DirectX 9.0c and above) for the viewport display, and also toggles the display of mapped materials on the surfaces of objects in shaded viewports with the [interactive renderer](#) on page 8164. The control is actually a [flyout](#) on page 7985 with four possible states:

- 

Show Standard Map in Viewport [off]: Uses the legacy software display and disables viewport display of all maps for the active material.
- 

Show Standard Map in Viewport [on]: Uses the legacy software display and enables viewport display of all maps for the active material.
- 

Show Hardware Map in Viewport [off]: Uses the hardware display and disables viewport display of all maps for the active material.
- 

Show Hardware Map in Viewport [on]: Uses the hardware display and enables viewport display of all maps for the active material.

Comparison of Standard and Hardware Displays

The ability to render materials in the viewports using a hardware-based display mode lets you view and adjust certain parameters interactively without having to generate a final render, saving time when editing materials. The hardware display does not fully support all material parameters, however. When considering which display mode to use for a material, take these points into consideration:

Software Display	Hardware Display
Supports all materials	Supports only Standard and Arch & Design materials
Supports Diffuse maps only	Supports Diffuse, Specular, and Bump maps, as well as Anisotropy and BRDF settings
No reflection	Reflects the sky shader on page 5181
Calculates specularity on per-face basis	Calculates specularity on per-pixel basis
Faster, no special hardware requirements	Slower but more accurate, requires a DirectX9.0c-compliant video card
Renders faceted display modes correctly	Renders faceted display modes as smoothed

The following image, taken from the 3ds Max viewport, shows two spheres to which are applied two copies of an Arch & Design material with identical settings, including texture-mapped diffuse color and bump mapping, a high reflectivity level, and a Checker map applied to the Anisotropy channel. The scene also includes a Daylight system with mr Sun and Sky, with the Environment Map set to mr Physical Sky. The only difference is that the material on the left-hand sphere is set to Show Standard Map in Viewport, while the material on the right-hand sphere is set to Show Hardware Map in Viewport. The latter shows the bump mapping, reflection of the sky, and the checkered anisotropy in the specular highlight. The spheres render identically, and look similar to the right-hand sphere.

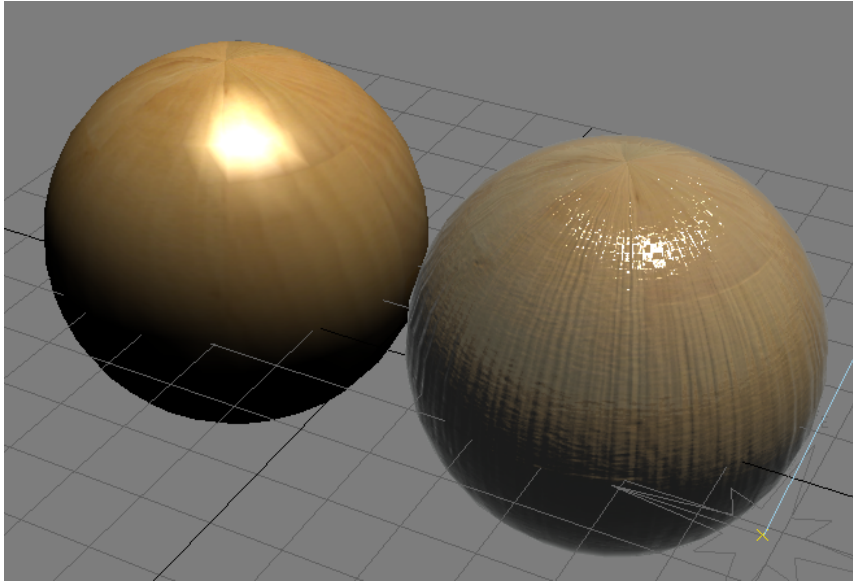

Usage Notes

Please observe the following important aspects of using these controls:

- The hardware display applies only to the [Standard](#) on page 5395 and [Arch & Design](#) on page 5544 materials; when it's active, 3ds Max still uses the software display to render all other materials.
- Choosing the alternate flyout button does not toggle its state. For example, if Show Standard Map in Viewport is off for the active material, choosing Show Hardware Map in Viewport simply switches the material to hardware display mode; it does not turn on the maps. You must toggle the control explicitly.
- This control is also available at the map level, where it functions only as a toggle for the option set at the material level, and applies only to the active map. So, for example, with the hardware display you could enable viewport display of the bump map while disabling display the diffuse map, although both would appear in the final rendered image. Changing the setting at the material level overrides any map-level settings.

NOTE If the toggle is unavailable at a map level, it means viewport display of the map is unsupported. One possible reason is that the map is nested too deep in the material tree.

- Hardware viewport rendering requires a DirectX9.0c-compliant video card. Also, hardware viewport rendering is supported only by the [Direct3D display driver](#) on page 7802.
- These options do not apply to [XRef materials](#) on page 5765, including materials from [XRef objects](#) on page 6936 and [XRef scenes](#) on page 6959
- Displaying mapped materials in a viewport can slow performance. If you don't need to view the map, turn off its viewport display.
- You can toggle Show Standard/Hardware Map In Viewport for *all* materials by choosing Views menu > [Show Materials in Viewport As](#) on page 173.
- The state of this button is saved with the material in the library. When you apply a mapped material while Show Map In Viewport is active, the object's Generate Mapping Coords. check box is turned on. This means that you can drag mapped materials from the Material Library in the Browser over objects in your scene, and have the mapped material appear in the viewports.
- In the [Material/Map Browser](#) on page 5290 and [Material/Map Navigator](#) on page 5357, icons of materials and maps for which Show Map in Viewport is on are red, as shown in the following example:

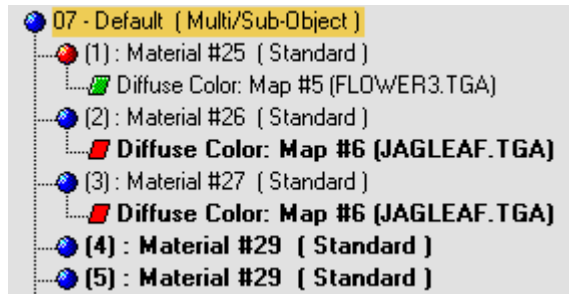

Requirements

For mapped materials to display in the viewport, the following conditions must be met:

- [Mapping coordinates](#) on page 8034 must be applied to the object. This is already the case with most primitive objects, which by default have Generate Mapping Coords on at creation. If an object doesn't have mapping coordinates, you can turn this on, or apply a mapped material to the object

(if it has a Generate Mapping Coords check box), or apply a [UVW Map modifier](#) on page 1931 or an [Unwrap UVW modifier](#) on page 1841.

- A mapped material must be applied to the object.
- Show Map In Viewport must be on, either at the level of the material that contains the [map](#) on page 8036, or at the top level of the material.

NOTE With the [software display driver](#) on page 7794, viewports don't accurately display a map with transparency that has UV tiling or mirroring. Also, this driver cannot display a map on a faceted material.

3D Maps in Viewports

Show Map In Viewport works for 3D procedural maps as well as 2D maps.

3D map display in viewports is not necessarily accurate. To improve the 3D preview, you can use the [Material Editor Options dialog](#) on page 5335 to set the 3D Map Sample Scale to equal a main dimension of the object you are applying the map to. For example, if you want to use the planet map on a sphere with a radius of 20, change the map scale from 100 (the default) to 20.

Particle Age and Particle MBlur maps do not preview in viewports.

Multiple Maps in Viewports

Viewports can display multiple maps. For multiple map display, the display driver must be [OpenGL](#) on page 7796 or [Direct3D](#) on page 7802. The [software display driver](#) on page 7794 does not support multiple map display.

The [composite map](#) on page 5918 and [mix map](#) on page 5926 support multiple map display.

In addition, turning on Show Map In Viewport at the top level of a [standard material](#) on page 5395 lets you view maps on both the diffuse and opacity components (though not on other mapped components).

Procedures

To view maps interactively:

- 1 Select an object.
- 2 In the object's creation parameters, make sure that Generate Mapping Coords. is on. (If this option isn't enabled, the object can't be mapped.)

If the object type does not have a mapping coordinates check box, apply a [UVW Map](#) on page 1931 modifier.

- 3 In the Material Editor, apply the mapped material to the object.

- 4  Turn on Show Standard Map In Viewport, or with the Standard or Arch & Design material, alternatively turn on Show Hardware Map in Viewport.

The map appears on objects assigned the material in all shaded viewports. Now when you adjust a map, the viewports update to display the adjustments.

To turn off interactive texture display:

-  Turn off Show Map In Viewport.
The object is shaded but the map no longer appears.

Show End Result

Material Editor > Show End Result

Material Editor menu > Material menu > Show End Result

Show End Result lets you look at the material at the level you're on instead of looking at the end result of all the other [maps](#) on page 8036 and settings.

When this button is off, the sample slot shows only the current level of the material. This tool is useful when you are working with [compound materials](#) on page 7938. It would be difficult to see exactly what effect you're creating on a particular level if you didn't have the ability to turn off the display of the other levels.

Go to Parent

Material Editor > Go to Parent

Material Editor menu > Navigation menu > Go to Parent

Go To Parent moves up one level in the current material.

This button is available only when you are not at the top level of a [compound material](#) on page 7938. You can tell you're at the top level when this button is unavailable and the name in the edit field matches the name in the Material Editor title bar.

A typical situation is one in which you have a material with a Diffuse map. The Material level is the parent and the Diffuse map is the child. The Go To Parent button becomes available at the level of the Diffuse map.

TIP You can also navigate through the levels of a material with the [Material/Map Navigator](#) on page 5357.

Go Forward to Sibling

Material Editor > Go Forward to Sibling

Material Editor menu > Navigation menu > Go Forward to Sibling

Go Forward To Sibling moves to the next map or material at the same level in the current material.

This button is available only when you are not at the top level of a [compound material](#) on page 7938, and there is more than one map or material at the current level.

A typical situation is one in which you have a material with a Diffuse map, a Bump map, and a Glossiness map. The Material level is the parent and the Diffuse map, Bump map, and Glossiness map are its children. Go Forward To Sibling becomes available at the level of the children and allows you to go from one to another.

You can also navigate through the levels of a material with the [Material/Map Navigator](#) on page 5357.

Material/Map Navigator

Material Editor > Material/Map Navigator

The Material/Map Navigator is a modeless dialog that provides quick navigation through the hierarchy of [maps](#) on page 8036 in a [material](#) on page 8041, or of sub-materials in a [compound material](#) on page 7938.

The Navigator displays the material and maps in the currently active sample slot. You can navigate the hierarchy of the current material by clicking the material or map listed in the Navigator. Conversely, as you navigate the material in the Material Editor, the current level is highlighted in the Navigator. The selected material or map becomes active in the sample slot, while the rollouts for the selected material or map are displayed below.

You can also drag from the Navigator to any valid sample slot or button in the user interface.

Use the view buttons at the top to change the display. The list displayed in the Navigator is similar to the one displayed in the Track View hierarchy.

See also:

- [Material/Map Browser](#) on page 5290

Interface

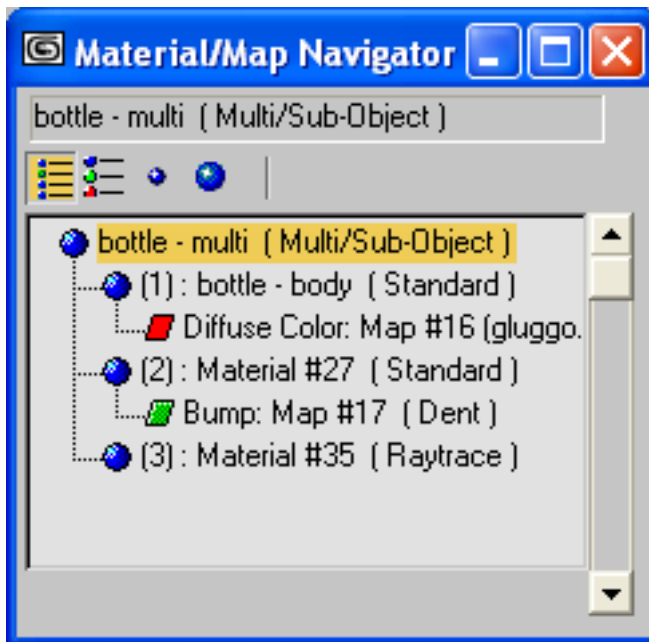

NOTE Icons of materials and maps for which [Show Standard/Hardware Map in Viewport](#) on page 5350 is on are red.

Also, the names of **instanced** on page 8014 materials and maps appear in boldface.

Both of these effects are shown in the following illustration:

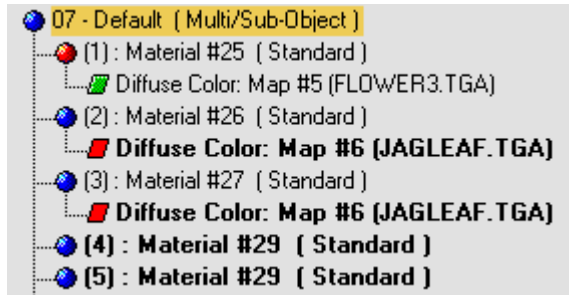

The view buttons are as follows:



View List Displays the materials and maps in list format. Blue spheres are materials. Green parallelograms are maps. The green parallelograms turn red if Show Map in Viewport is on for a material.



View List + Icons Displays the materials and maps as small icons in a list.



View Small Icons Displays the materials and maps as small icons. As you move the mouse over the icons, tooltip labels show you the name of the material or map.



View Large Icons Displays the materials and maps as large icons. As you move the mouse over the icons, tooltip labels show you the name of the material or map.

The large icons are labeled with the name of the material or map and are displayed using progressive refinement. That is, samples are rendered quickly, with large pixels, then rendered a second time in greater detail.

Pick Material From Object (Eyedropper)

Material Editor > Pick Material From Object

Material Editor menu > Material menu > Pick from Object

Pick Material From Object lets you select a material from an object in the scene. Click the eyedropper button, and then move the eyedropper cursor over the objects in the scene. When the eyedropper cursor is over an object containing a material, it fills with "ink" and a tooltip with the name of the object pops up. Click the object. The material is placed in the active sample slot.

If the material is already in the active sample slot, the eyedropper has no effect.

If the eyedropper cursor is over an [editable mesh](#) on page 2075 with faces selected at the sub-object level, and the mesh has a [Multi/Sub-Object material](#) on page 5720 applied to it, then the eyedropper picks up the sub-material. However, if the selected faces have more than one sub-material assigned to them, then the eyedropper picks up the entire Multi/Sub-Object material.

Name Field (Materials and Maps)

Material Editor > Material Name field

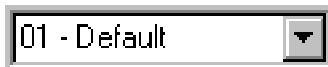

The Name field displays the name of the material or map. Default material names are "01 – Default," and so on, the number changing to reflect the material's sample slot. Maps are named "Map #1," and so on.

You can edit this field to change the name of the material in the active sample slot. You can also edit the names of maps and sub-materials assigned at lower levels of the map or material hierarchy.

The name of the material is not a file name: it can contain spaces, numbers, and special characters. It can be of any length.

This field also functions as a drop-down list. At the top level, it shows only the material or map name. At lower levels of the hierarchy, drop the list down to see the names of ancestors to the map or material. The top level is at the top of the list, the current level is at the bottom, and intermediate levels appear between them.

Procedures

To give a material a different name:

- Edit the name field that appears below the Material Editor toolbar. The name of the active material appears in the title bar of the Material Editor dialog.

Type Button (Materials and Maps)

Material Editor > Type button

Material Editor menu > Material menu > Change Material/Map Type

Click the Type button to display the [Material/Map Browser](#) on page 5290 and choose which material type or map type to use.

When changing a material's type, the original material type is replaced unless you choose a [compound material](#) on page 7938, in which case a [Replace Material dialog](#) on page 5376 is displayed. The Replace Material dialog lets you choose between discarding the original material or using it as a sub-material within the new material.

For a standalone map (a map at the top level), clicking the Type button lets you change the map type instead of the material type. However, you can't use this button to make a map standalone. To make a standalone map, you have to click [Get Material](#) on page 5341 and choose a map from the Browser it displays.

When you change the type of a standalone map, a [Replace Map dialog](#) on page 5376 is displayed. The Replace Map dialog lets you choose between discarding the original map or using it as a sub-map within the new map.

Animating Materials

This topic provides some suggestions about how to animate materials.

Animating Basic Materials

In general, you animate a basic material by changing its parameters in different keyframes while Auto Key is active. 3ds Max interpolates values between keyframes, as it does when you animate transforms and modifiers.

Be aware that the tracks for a material assigned to an object are distinct from the material tracks that belong to the Material Editor: animating a material in the Material Editor affects the scene only if the material is [hot](#) on page 8006.

Animating Mapped Materials

As with basic materials, you can create animation keys for map parameters.

The noise parameters and the [Noise map](#) on page 5886 itself provide the Phase parameter specifically for animating the noise function.

You can also produce an animated material by applying an animated bitmap as a map. This automated bitmap can be an [AVI](#) on page 7326 or [MOV](#) on page 7348 file, or an image sequence in the form of an [IFL](#) on page 7339 file.

Changing One Material into Another

Probably the easiest way to animate the change of one material into another is to create a [Blend material](#) on page 5708, make the two other materials its sub-materials, and then animate its Mix Amount parameter.

Preview and Playback

When you animate a material, or use an animated bitmap in a material, you can create and view a preview of this material before you decide to use it in a fully rendered animation.

See also:

- [Creating and Playing Animated Material Previews](#) on page 5362
- [Synchronizing an Animated Bitmap with the Scene](#) on page 5363

Creating and Playing Animated Material Previews

You can create a preview movie of an animated material. Use [Make Preview](#) on page 5333 in the Material Editor. Clicking this button displays the [Create Material Preview dialog](#) on page 5366, which like the Renderer has controls for which frames to render, playback speed, and output size.

The preview movie is saved in the `\previews` subdirectory in a file called `_medit.avi`. Each time you create a new preview, the Material Editor overwrites this file. To keep a preview movie on hand, save it under a different name by using the Save Preview button on the same flyout as Make Preview.

Procedures

To create a preview of an animated material:

- 1 Choose Make Preview from the flyout.
- 2 In the Create Material Preview dialog, set the preview conditions you want, and then click OK.
The Material Editor creates the preview.

To play back a preview of an animated material:

- 1 Choose Play Preview from the flyout.
The Material Editor starts the Windows Media Player with the active preview movie loaded.
- 2 Click Play to view the preview movie.

To save a preview movie under a different name:

- 1 Choose Save Preview from the flyout.
The Material Editor displays a file save dialog.
- 2 Enter a new name for the preview, and then click OK.

Synchronizing an Animated Bitmap with the Scene

Material editor > Bitmap map > Time rollout

[Bitmaps](#) on page 5795 have a Time rollout with controls that let you synchronize an animated bitmap with scene animation.

Interface

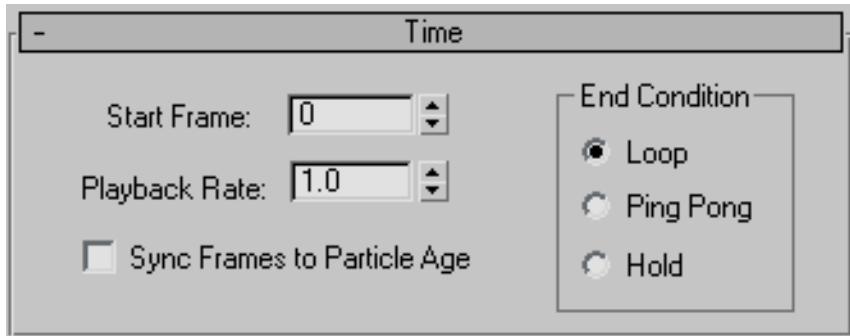

Start Frame The frame number of the 3ds Max scene at which the bitmap animation begins to play.

Playback Rate Sets the bitmap's playback rate. This value is a multiplier: 1.0 is one bitmap frame per scene frame, 2.0 is twice as fast, 3.33 is 1/3 as fast, and so on. Default=1.0.

Sync Frames to Particle Age When on, the software synchronizes the frames of a bitmap sequence to the age of particles to which the map is applied. With this effect, each particle displays the sequence from the start when it is born, rather than being assigned whichever frame is current. Default=off.

When using Particle Flow, assign the material containing the Bitmap map to a Material Dynamic operator. For more details and a procedure, see [Material Dynamic Operator](#) on page 2925.

NOTE This functionality is not supported by the mental ray renderer.

End Condition group

Determines what happens after the last frame of the bitmap animation if the animation is shorter than the scene.

Loop Causes the animation to repeat over and over again from the beginning.

Ping-Pong Causes the animation to be played forward and then backward repeatedly, making every animated sequence "loop smoothly."

Hold Freezes on the last frame of the bitmap animation.

Material Editor Subdialogs

Copy (Instance) Map Dialog

Material Editor > Drag one map button to another.

The Copy (Instance) Map dialog is displayed when you copy a map by dragging and dropping a map button. It gives you the choice of copying the map, making the newly assigned map an instance of the one you dragged, or swapping maps.

You can drag map buttons in the Maps rollout, in the Basic Parameters rollout, or from one rollout to the other.

TIP When you use the same map for multiple parameters, such as both self-illumination and opacity, it is usually easier to work with an instance rather than a copy.

Interface

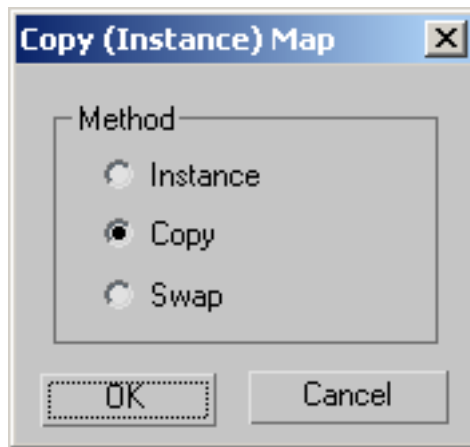

Instance Makes an instance of the map you dragged. The newly assigned map is not independent. Adjusting the parameters of one map or the other changes both of them.

Copy Copies the map you dragged. The newly assigned map is a copy whose parameters you can adjust independently.

Swap Swaps the maps. This option isn't displayed when you drag from one rollout to another.

Copy or Swap Colors Dialog

Material Editor > Basic Parameters rollout or Extended Parameters rollout or both > Drag one color swatch to another.

The Copy or Swap Colors dialog is displayed when you copy a color by dragging and dropping a color swatch. It gives you the choice of copying the color or swapping the colors, trading one for the other.

Interface

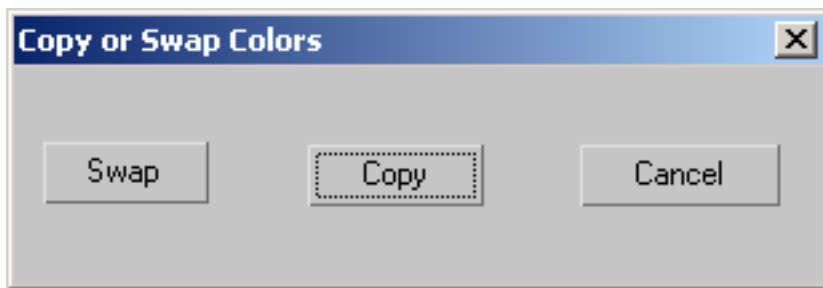

Swap Swaps the colors.

Copy Copies the color you dragged.

Create Material Preview Dialog

Material Editor > Make/Play/Save Preview flyout > Make Preview

The Create Material Preview dialog is displayed when you click [Make Preview](#) on page 5333 to preview an animated material. By default, the preview is saved in the `\previews` subdirectory with the name `_medit.avi`. You can use Save Preview to give the preview a different name so it won't be overwritten the next time you use Make Preview.

Interface

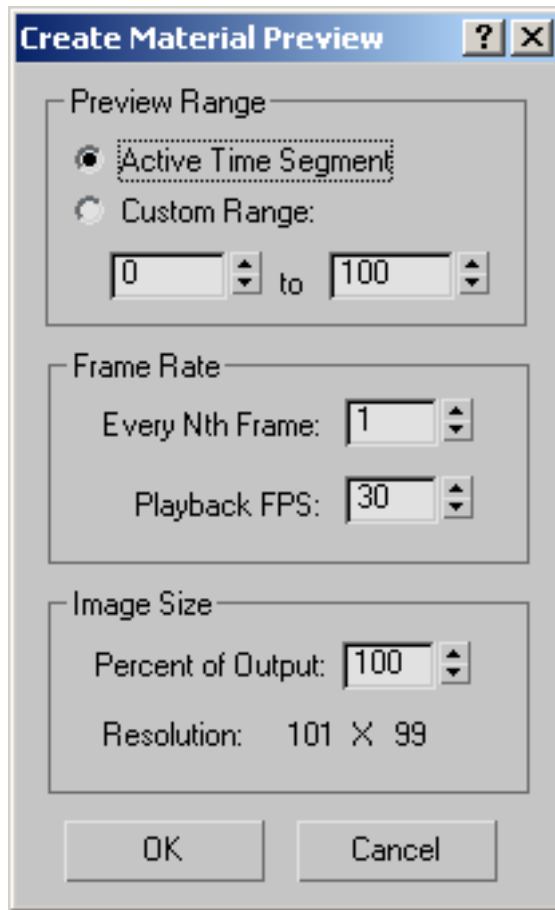

Preview Range group

Active Time Segment Renders the [active time segment](#) on page 7898.

Custom Range Renders a custom range from the start to the end frame you specify in the spinners below.

Frame Rate group

These controls specify the playback rate.

Every Nth Frame Renders a regular sampling of the animation. For example, a value of 8 includes only every eighth frame in the preview. Default=1 (every frame).

Playback FPS Specifies the playback rate in frames per second. Default=30 (full speed).

Image Size group

Percent of Output Specifies the resolution of the preview. This value is a percentage; 100 percent has a resolution of 101 x 99 pixels (the size of a sample slot in the 3 x 2 array). Default=100.

Duplicate Name Dialog (Material Library)

Material Editor > Get Material or Type button > Browse From group > Select Mtl Library. > File group > Open material library. > File group > Merge > Merge Material Library dialog > Open another material library or a 3ds Max scene. > Merge dialog > Select materials to merge > OK

File > XRef Objects > XRef Objects dialog > Create XRef Record from File > Choose a file. > Select objects to XRef. > Duplicate Name dialog

The Duplicate Name dialog is displayed if, after you click OK in the [Merge dialog](#) on page 5370, one or more materials to merge have the same name as materials in the open library.

If this dialog appears while you are using [XRef Objects](#) on page 6936, in the XRef Objects dialog you can see the updated material name in the “Scene Name” column, while the original name in the source scene appears in the “Source Name” column.

Interface

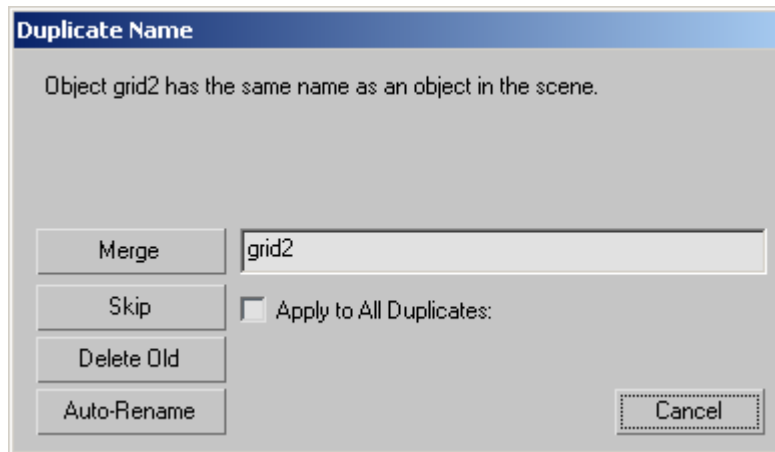

Material name At the right, the dialog displays a duplicate material name. You can edit the name to make it unique before you merge it with the open (current) library by clicking the Merge button.

Apply to All Duplicates If you turn this on before you use the buttons, all subsequent incoming materials with duplicate names are treated the same way as the current one, and no further alert messages are displayed.

Use this option when you know that you've got several duplicate materials, and don't need constant reminders.

This check box is unavailable if you edit the material name.

Merge Merges the material with the open, current library. This button is unavailable unless you edit the duplicate name to be a different, unique name.

Skip Skips this material and doesn't merge it with the open, current library.

Delete Old Deletes the "old" material in the open, current library and replaces it with the material to merge.

Auto-Rename Click to have 3ds Max automatically rename the material by appending a sequence number to the duplicate material name.

Cancel Cancels further merging of materials with duplicate names. If you have already merged some materials, they appear in the open, current library.

Merge Dialog (Material Library)

Material Editor > Get Material or Type button > Browse From group > Select Mtl Library. > File group > Open material library. > File group > Merge > Merge Material Library dialog > Open another material library or a 3ds Max scene.

The Merge dialog displays a list of materials to merge with the open library. The materials are from a different material library or from a 3ds Max or **VIZ Render** ([DRF](#) on page 7167) scene.

Procedures

To merge all materials:

- Click All.

To select a single material to merge:

- Click the material's name.

To select materials to merge one by one:

- 1 Click a material's name.
- 2 Hold down Ctrl, and click other material names.

To select a group of contiguous materials to merge:

- 1 Click a material's name.
- 2 Hold down Shift, and click another material's name.

The dialog selects the two materials you clicked, and all materials whose names lie between the two.

Interface

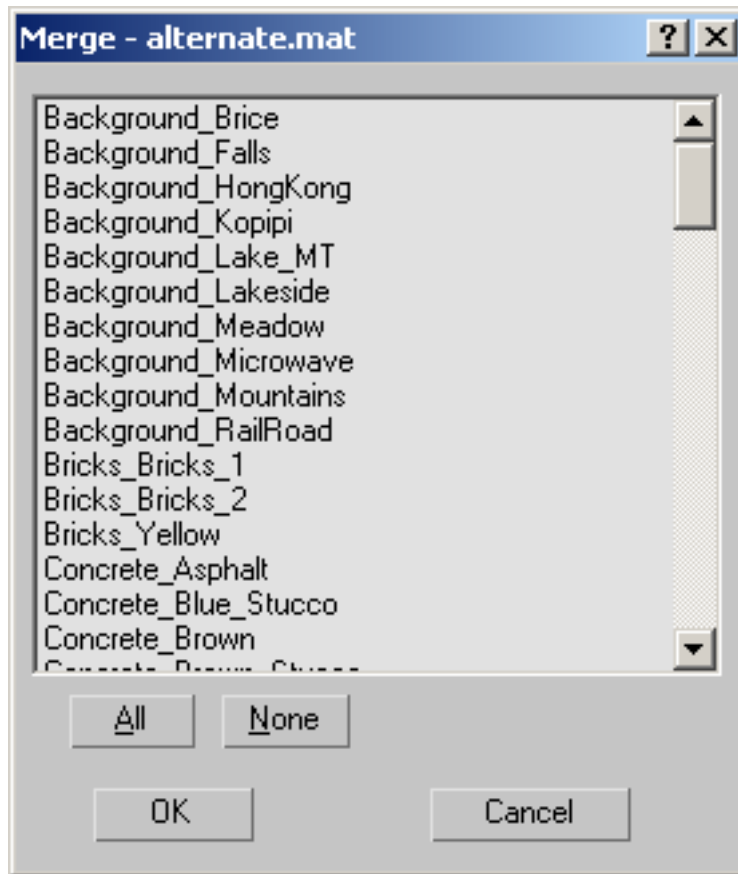

Material list Shows the names of all materials in the library or scene.

All Selects all materials in the list.

None Deselects all materials in the list.

Merge Material Library Dialog

Material Editor > Get Material or Type button > Material/Map Browser > Browse From group > Select Mtl Library. > File group > Open material library. > File group > Merge

The Merge Material Library dialog lets you merge materials in the open material library with materials in another material library or another 3ds Max or **VIZ Render** (DRF on page 7167) scene.

Interface

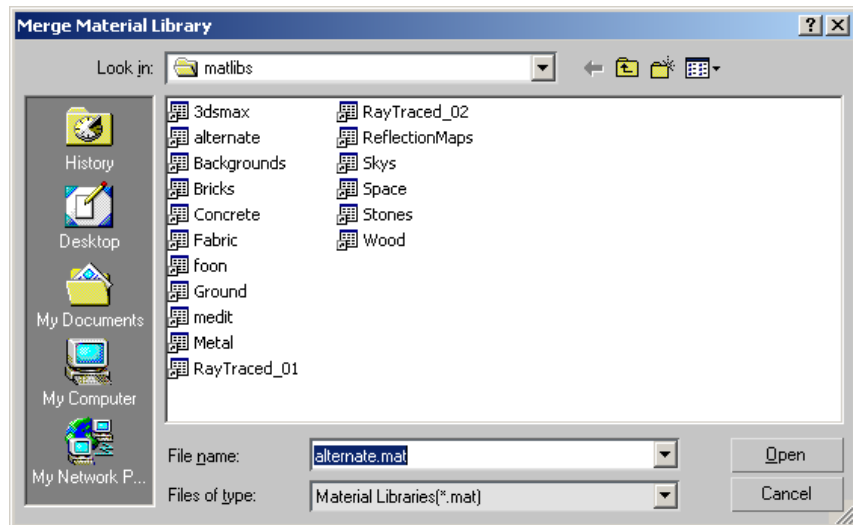

This is a standard Windows file dialog. It lets you select either material library (MAT) files, 3ds Max (MAX), or **VIZ Render** (DRF on page 7167) scene files.

When you click OK, a further [Merge dialog](#) on page 5370 is displayed. This lets you select by name the materials you want to merge with the open library.

Put to Library Dialog

Material Editor > Put To Library

The Put To Library dialog is displayed when you want to save the material in an active [sample slot](#) on page 5304 into a material library file. It lets you change the material's name before you save it.

Interface

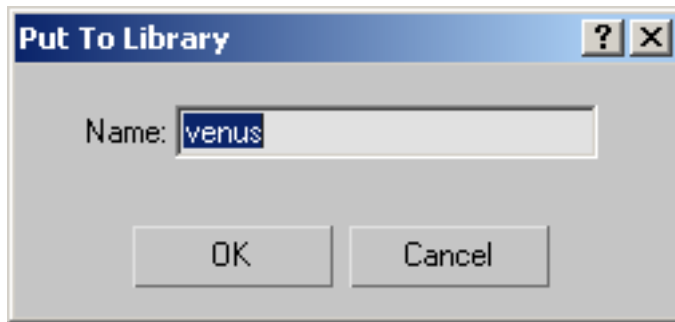

Name Shows the name of the material to save. You can edit this name to save it under a different name.

Render Map Dialog

Material Editor > Right-click a sample slot. > Render Map > Render Map dialog

The Render Map dialog is displayed when you use Render Map on the [Sample Slots Right-Click Menu](#) on page 5308 to render the map displayed in a sample slot

Interface

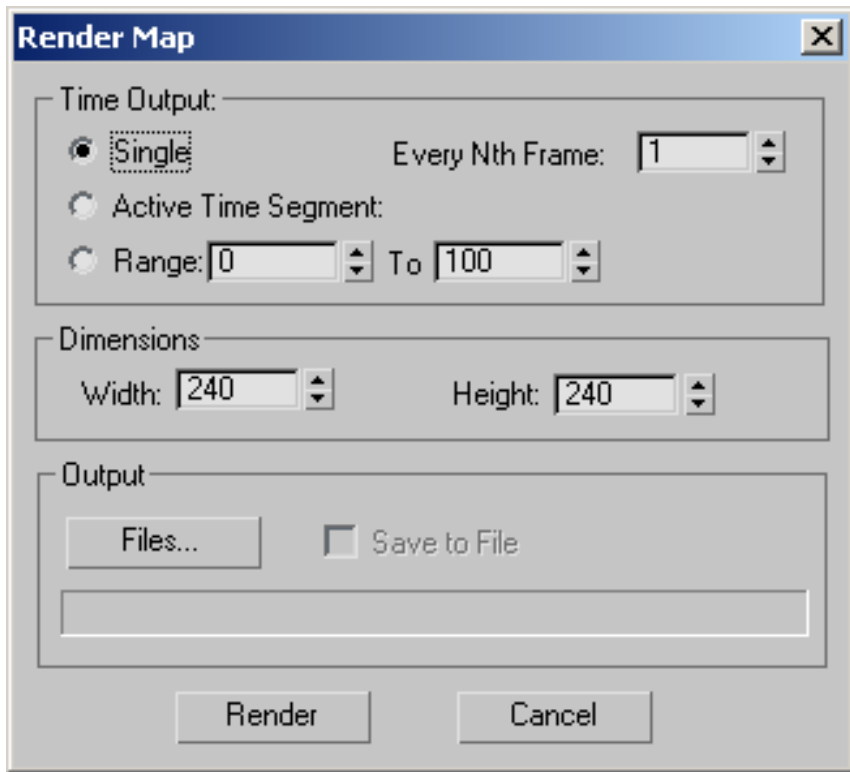

Time Output group

These controls specify how many frames to render.

Single Renders a single frame.

Every Nth Frame Renders a regular sampling of the animation. For example, a value of 8 includes only every eighth frame in the preview. Default=1 (every frame).

Active Time Segment Renders the [active time segment](#) on page 7898.

Range Renders a custom range from the start to the end frame you specify in the spinners below.

Dimensions group

These controls specify the size of the rendered frames, in pixels.

Width Specifies the frame width, in pixels.

Height Specifies the frame height, in pixels.

Output group

These controls let you save the rendered map to a file.

Files Click to display a file dialog that lets you specify where to save the rendered map.

When you click Save in the file dialog, you might see an additional dialog that gives you options specific to the file type you chose. These are the file formats available for a rendered map:

[AVI](#) on page 7326

[BMP](#) on page 7328

[Kodak Cineon](#) on page 7328

[Encapsulated Postscript](#) on page 7332

[JPEG](#) on page 7347

[PNG](#) on page 7360

[MOV \(QuickTime\)](#) on page 7348

[SGI](#) on page 7369

[RLA](#) on page 7364

[RPF](#) on page 7366

[Targa](#) on page 7370

[TIFF](#) on page 7372

Save to File When on, the rendered map is saved to a file. When off, the map is rendered only to a [Rendered Frame Window](#) on page 6073. This check box is unavailable unless you use Files to specify a file name, when it defaults to on.

File name field Displays the name of the file you chose.

Render Renders the map to a feature-reduced version of the [Rendered Frame Window](#) on page 6073, and to a file if you chose one.

Replace Map Dialog

Material Editor > Go to a map level or a standalone map. > Type button > Material/Map Browser > Choose a compound map.

The Replace Map dialog is displayed when you change a map type to any type of map that can have sub-maps. It gives you the choice of replacing the original ("old") map completely, or using the original map as a sub-map of the new map.

Interface

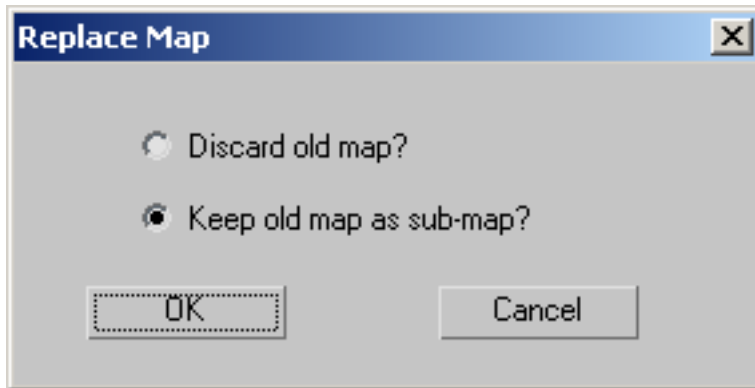

Discard old map Discards the old map.

Keep old map as sub-map Retains the old map as a sub-map.

Replace Material Dialog

Material Editor > Type button > Material/Map Browser > Choose a compound material.

The Replace Material dialog is displayed when you change a material type to one of the [compound material types](#) on page 5706. It gives you the choice of replacing the original ("old") material completely, or using the original material as a sub-material of the new material.

Interface

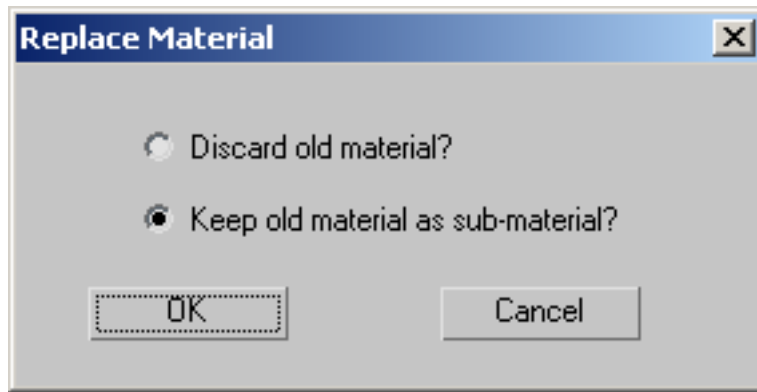

Discard old material Discards the old material.

Keep old material as sub-material Retains the old material as a sub-material.

Update Scene Materials Dialog

Material Editor > Get Material > Material/Map Browser > Update Scene Materials from Library > Update Scene Materials dialog

The Update Scene Materials dialog lets you use a library to update materials in the scene. It appears only when you click Update Scene Materials From Library in the [Material/Map Browser](#) on page 5290, and the scene contains materials that have the same name as materials in the library.

Procedures

To update a material in the scene and replace it with a material from the library:

- In the Update Scene Materials dialog, select the name of the material, and then click OK.

To leave a material in the scene unchanged, do one of the following:

- 1 In the Update Scene Materials dialog, make sure the name of the material is *not* selected, and then click OK.

2 Click Cancel.

Interface



Material name list Shows the materials that have the same name in the library and in the scene.

All Selects all material names in the list.

None Deselects all material names in the list.

Types of Materials

Rendering menu > Material Editor > Type button > Material/Map Browser > In Show group, turn off Maps. > Material types are listed.

Materials create greater realism in a scene. A material describes how an object reflects or transmits light. You assign materials to individual objects or selection sets; a single scene can contain many different materials.

Different materials have different uses.

- [Standard material](#) on page 5395 is the default material. This is a versatile surface model with a large number of options.
- [Raytrace material](#) on page 5490 can create fully raytraced reflections and refractions. It also supports fog, color density, translucency, fluorescence, and other special effects.
- [mental ray materials](#) on page 5543 are provided for use with the [mental ray renderer](#) on page 6230. Of particular importance in this category is the [Arch & Design material](#) on page 5544.
- [Architectural material](#) on page 5526 provides a physically accurate material. It is especially intended for use with the default scanline renderer and [radiosity](#) on page 6168.
- [Matte/Shadow material](#) on page 5699 is specifically for making an object into a [matte object](#) on page 8042 that reveals the current [environment map](#) on page 7964. A matte object is effectively invisible in the scene, but it can receive shadows cast onto it from other objects.
- [Shell material](#) on page 5732 is for storing and viewing [rendered textures](#) on page 6371.
- [Advanced Lighting Override material](#) on page 5734 is used to fine-tune the effects of a material on [radiosity solutions](#) on page 6168 or the [Light Tracer](#) on page 6154. This material is not required for calculating advanced lighting, but it can help improve the result.

NOTE The Architectural material has its own controls for adjusting advanced lighting.

- [Lightscape material](#) on page 5741 helps support import and export of data from the Lightscape product.
- [Ink 'n Paint material](#) on page 5742 gives a cartoon appearance to objects.

- The [DirectX 9 Shader material](#) on page 5758 enables you to shade objects in viewports using DirectX 9 (DX9) shaders. To use this material, you must have a display driver that supports DirectX 9, and you must be using the Direct3D display driver.
- The [XRef material](#) on page 5765 lets you externally reference a material in a different scene file.

Other material types fall into the category of [Compound materials](#) on page 5706.

Compound Materials

Compound materials combine other materials in some way.

- [Blend](#) on page 5708 material mixes two materials on a single side of a surface.
- [Composite](#) on page 5711 material mixes up to 10 materials, using additive colors, subtractive colors, or opacity mixing.
- [Double-Sided](#) on page 5713 material lets you assign different materials to the front and back faces of an object.
- [Morpher](#) on page 5716 material uses the [Morpher modifier](#) on page 1545 to manage multiple materials over time.
- [Multi/Sub-Object](#) on page 5720 material uses the sub-object level to assign multiple materials to a single object, based on material ID values.
- [Shellac](#) on page 5727 material superimposes one material on another using additive composition.
- [Top/Bottom](#) on page 5729 material lets you assign different materials to the top and bottom of faces of an object.

Procedures

To get a material:

- 1  Click Get Material on the Material Editor toolbar. The [Material/Map Browser](#) on page 5290 is displayed.
- 2 Double-click a material type (not a map type) in the list, or drag the material to a sample slot.

The Material Editor replaces the original material.

To change a material type:

- 1 At the level of a material, click the Type button below the Material Editor toolbar.

A modal [Material/Map Browser](#) on page 5290 is displayed. If you were at a material when you clicked Type, the Browser lists only materials (if you were at a map, it lists only maps).

- 2 Choose a material from the list, and then click OK.

If you choose a compound material, a [Replace Material](#) on page 5376 dialog is displayed. This dialog lets you choose whether to keep or discard the original material.

The Material Editor now displays controls for the new material.

SuperSampling Rollout

Material Editor > Architectural material > SuperSampling rollout

Material Editor > Raytrace material > SuperSampling rollout

Material Editor > Standard material > SuperSampling rollout

The SuperSampling rollout is used by Architectural, Raytrace, and Standard. It lets you choose a [supersampling method](#) on page 8141. Supersampling performs an additional [antialiasing](#) on page 7904 pass on the material. This requires more time but can improve image quality. Supersampling is especially helpful when you need to render very smooth specular highlights, subtle bump mapping, or high resolutions.

In 3ds Max the default is to apply a single supersampling method to all materials in the scene. This feature gives you more control over your scenes, especially larger models that make use of many materials, by letting you control the supersampling at a global level from the Rendering dialog. You can override this locally by turning off Use Global Settings. It also gives you file compatibility and workflow replication with DRF files imported from VIZ Render.

NOTE SuperSampling settings are ignored by the [mental ray Renderer](#) on page 6230, which has its own sampling method.

Use supersampling when you notice artifacts in your final renderings. For example, a thin bump map might produce scintillating, jagged bumps that supersampling can correct. Supersampling requires considerably more time to render, although it does not necessarily require any additional RAM.

NOTE Supersampling is *not* processed when you turn off Antialiasing in the production [renderer](#) on page 6121. You can also globally disable supersampling for all materials using the parameters for the [default scanline renderer](#) on page 6141. Globally disabling supersampling can speed up test renderings.

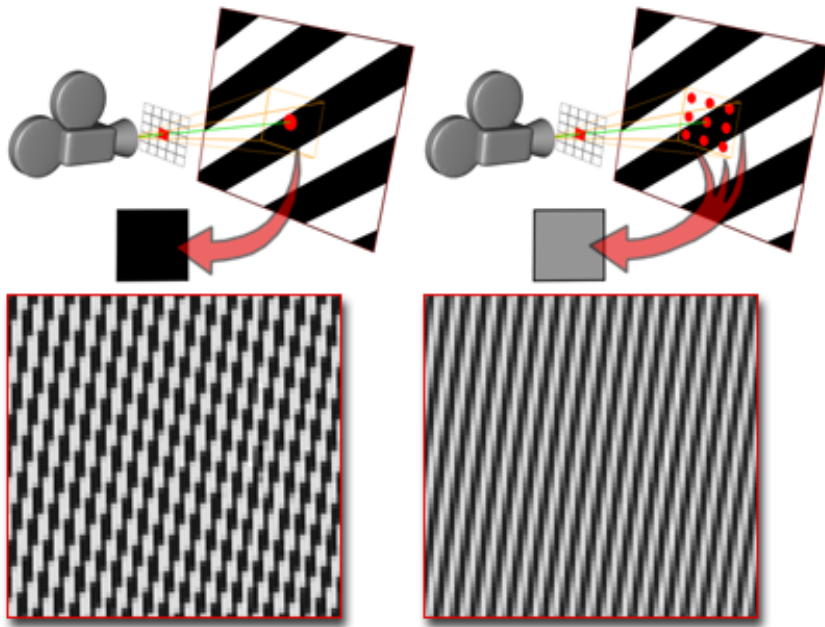

Supersampling uses smaller sampling points, and returns averaged values to increase the antialiasing effect.

Supersampling and Antialiasing

Supersampling is one of several antialiasing techniques. Textures, shadows, highlights, and raytraced reflections and refractions all have their own preliminary antialiasing strategies. Supersampling is an additional step that provides a "best guess" color for each rendered pixel. The supersampler's output is then passed on to the renderer, which performs a final antialiasing pass.

A single rendered pixel represents an area of the scene's geometry. The pixel can stand in for multiple colors, especially when it appears at the edge of an object or a region of color. This is where aliasing effects occur.

When supersampling is turned off, 3ds Max simply looks at the center of the geometry covered by the pixel, and uses that for the pixel color.

When you turn on supersampling, a supersampler performs an additional antialiasing pass on the material. You can choose one of four supersamplers. As the name implies, a supersampler takes additional samples of geometry color in or near each pixel, in order to obtain a more accurate pixel color that is less prone to aliasing error.

These are the supersampling methods:

Name	Description
Adaptive Halton	Spaces samples along both X and Y axes according to a scattered, "quasi random" pattern. Depending on Quality, the number of samples can range from 4 to 40. This method is adaptive, as described below.
Adaptive Uniform	Spaces samples regularly, from a minimum quality of 4 samples to a maximum of 36. The pattern is not square, but skewed slightly to improve accuracy in the vertical and horizontal axes. This method is adaptive, as described below.
Hammersley	Spaces samples regularly along the X axis, but along the Y axis it spaces them according to a scattered, "quasi random" pattern. Depending on Quality, the number of samples can range from 4 to 40. This method is not adaptive.
MAX 2.5 Star	The sample at the center of the pixel is averaged with four samples surrounding it. The pattern is like the

Name	Description
	fives on dice. This is the super-sampling method that was available in 3ds Max 2.5.

Regular sampling, as performed by the Adaptive Uniform and MAX 2.5 Star methods, is more prone to aliasing than the irregular patterns performed by the Adaptive Halton and Hammersley methods.

You can set a variable Quality value for the Adaptive Halton, Adaptive Uniform, and Hammersley methods. Quality can range from 0.0 to 1.0. A quality of 0.0 is minimal, with about four samples per pixel. A quality of 1.0 is the highest possible, with between 36 and 40 samples per pixel. High-quality supersampling is very time consuming.

Another setting for the Adaptive Halton and Adaptive Uniform supersamplers is the Adaptive toggle, which works in conjunction with the Threshold spinner. When Adaptive is on, these methods take fewer samples unless a change in color is greater than the Threshold value. In that case, they take the full number of samples specified by the Quality. To reduce the amount of time the supersampler spends, leave the Adaptive check box on.

Interface

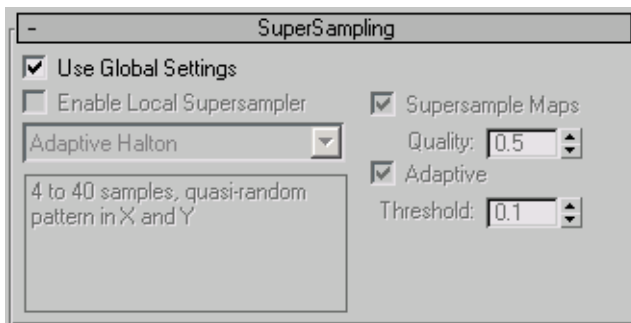

Use Global Settings When on, the material uses the supersampling options set in the [Default Scanline Renderer rollout](#) on page 6141. Default=on.

Enable Local Supersampling When on, applies supersampling to the material. Default=off

Sampler drop-down list Lets you choose which supersampling method to apply. The list is not active unless Use Global Settings is turned off. Default=Max 2.5 Star.

Supersample Maps When on, the maps applied to the material are supersampled as well. When off, the supersampler uses pixel averages for maps. This switch is active only when Use Global Settings is turned off. Default=on.

Quality Adjusts the quality of supersampling by controlling the number of samples used for each pixel. At the minimum value, 0.0, four samples are taken per pixel. At the maximum value, 1.0, about 40 samples are taken per pixel (the value varies depending on which shader is active). Range=0.0 to 1.0. Default=0.5.

This spinner is unavailable for the Max 2.5 Star method.

Adaptive Visible only for the Adaptive Halton and Adaptive Uniform methods. When on, these methods take fewer samples than the Quality specifies unless samples show a change in color greater than the Threshold value. In that case, they take all the samples specified by the Quality. Turning on Adaptive On can reduce the amount of time required to supersample. Default=on.

Threshold Controls the Adaptive methods. Visible only for the Adaptive Halton and Adaptive Uniform methods. A change in color greater than the Threshold value causes the adaptive methods to take the full number of samples specified by the Quality. If the color does not change as much, the adaptive method takes fewer samples and does not require as much processing time. Can range from 0.0 to 1.0. Setting Threshold to 0.0 has the same effect as turning off Adaptive On. Default=0.1.

mental ray Connection Rollout

Material Editor > Click a sample slot that contains a material other than a Multi/Sub-Object or a mental ray material. > mental ray Connection rollout

The mental ray Connection rollout is available for all types of materials except the Multi/Sub-Object material and the mental ray materials themselves (for which it would be redundant). With this rollout you can add mental ray shading to conventional 3ds Max materials. These effects are visible only when you use the [mental ray renderer](#) on page 6230.

IMPORTANT The mental ray Connection rollout does not appear unless you have enabled the mental ray extensions by using the [mental ray Preferences panel](#) on page 7787. In addition, you can't assign shaders to the options in this rollout unless the mental ray renderer is the currently active renderer.

Interface

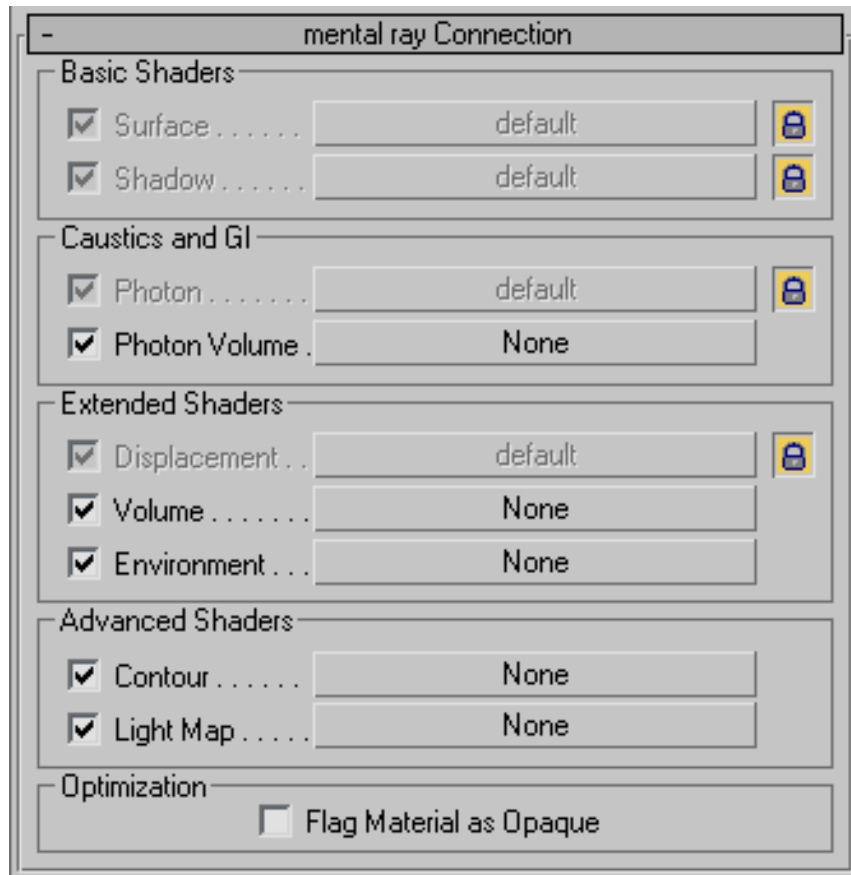

For each kind of shader on this rollout, there is a toggle and a button.

- The toggle controls whether the assigned shader is active or not. If no shader is assigned, the toggle has no effect.

- The button lets you assign a shader to the component type. Clicking it displays the [Material/Map Browser](#) on page 5290: assigning a shader is just like assigning a map to a component of a standard material. While a shader is assigned, its name appears on the button.



- In addition to the toggle and button, some of the shader types have a lock button to the right. When button is on, the component is inherited from the base material, and you can't assign a shader. For example, by default the Surface component is locked, and the surface is shaded using the settings of the 3ds Max material (basic parameters, maps, and so on). Turn off this button to replace the base material's settings with a mental ray shader.

NOTE Using a shader for the Surface component can result in a material whose appearance in mental ray renderings is completely different from the appearance it has in the sample slot, viewports, and scanline renderings.

Basic Shaders group

Surface Shades the surface of objects that have this material. Default=locked to parent material.

In addition to any of the usual 3ds Max materials, the surface component can be assigned the following mental ray materials or shaders:

Shader	Library
Bump on page 5986	3ds Max
DGS Material on page 5615	3ds Max
<i>Dielectric</i>	base
Dielectric Material on page 5992	3ds Max
<i>Edge</i>	lume
<i>Facade</i>	lume

Shader	Library
<i>Glass</i>	lume
<i>Glow</i>	lume
<i>Landscape</i>	lume
Material to Shader on page 6001	3ds Max
<i>Metal</i>	lume
<i>Ocean</i>	lume
<i>Opacity</i>	base
<i>Reflect</i>	base
<i>Refract</i>	base
Shader List on page 6003	3ds Max
<i>Stain</i>	lume
<i>Translucency</i>	lume
<i>Transmat</i>	physics
<i>Transparency</i>	base
<i>Two Sided</i>	base
UV Generator on page 6005	3ds Max

Shader	Library
<i>Water Surface</i>	lume
<i>Wet-Dry Mixer</i>	lume
XYZ Generator on page 6013	3ds Max

NOTE Unlike a standard 3ds Max material, if you assign the Surface component a bitmap with tiling turned off, the original surface color does not “show through.” In renderings, you see only the untiled map, and none of the rest of the object.

Shadow Assigns a shadow shader. Default=locked to parent material.

The shadow component can be assigned the following shaders:

Shader	Library
<i>Edge Shadow</i>	lume
<i>Facade</i>	lume
<i>Glass</i>	lume
<i>Glow</i>	lume
Material to Shader on page 6001	3ds Max
<i>Metal</i>	lume
Shader List on page 6003	3ds Max
<i>Shadow Transparency</i>	base
<i>Translucency</i>	lume
<i>Transmat</i>	physics

Shader	Library
<i>Water Surface Shadow</i>	lume

Caustics and GI group

Photon Assigns a photon shader. Photon shaders affect how object surfaces respond to photons; that is, they control how the surfaces behave when generating caustics and global illumination. Default=locked to parent material. The photon component can be assigned the following shaders:

Shader	Library
DGS Material on page 5615	3ds Max
Dielectric Material Photon on page 5992	3ds Max
<i>Edge</i>	lume
<i>Glow</i>	lume
Material to Shader on page 6001	3ds Max
<i>Metal</i>	lume
<i>Photon Basic</i>	base
<i>Translucency</i>	lume
<i>Transmat</i>	physics

Photon Volume Assigns a photon volume shader. Photon volume shaders affect how an object's volume responds to photons; that is, they control how the volume behaves when generating caustics and global illumination.

The photon volume component can be assigned the following shaders:

Shader	Library
Material to Shader on page 6001	3ds Max
<i>Parti Volume Photon</i>	physics
Shader List on page 6003	3ds Max

Extended Shaders group

Displacement Assigns a [displacement shader](#) on page 6268. Default=locked to parent material.

The displacement component can be assigned the following shaders:

Shader	Library
3D Displacement on page 5983	3ds Max
Material to Shader on page 6001	3ds Max
<i>Ocean</i>	lume

Volume Assigns a [volume shader](#) on page 6265.

The volume component can be assigned the following shaders:

Shader	Library
<i>Beam</i>	lume
Material to Shader on page 6001	3ds Max
<i>Mist</i>	lume
<i>Parti Volume Photon</i>	physics
Shader List on page 6003	3ds Max

Shader	Library
<i>Submerge</i>	lume

Environment Assigns an environment shader. The environment shader provides an environment local to the material. It is visible if the material is reflective or transparent.

The environment component can be assigned the following shaders:

Shader	Library
Environment on page 5995	3ds Max
Material to Shader on page 6001	3ds Max
Shader List on page 6003	3ds Max

Advanced Shaders group

Contour Assigns a [contour shader](#) on page 6269.

The contour component can be assigned the following shaders:

Shader	Library
<i>Combi</i>	contour
<i>Curvature</i>	contour
<i>Depth Fade</i>	contour
<i>Factor Color</i>	contour
<i>Layer Thinner</i>	contour
<i>Simple</i>	contour
<i>Width From Color</i>	contour

Shader	Library
<i>Width From Light</i>	contour
<i>Width From Light Dir</i>	contour

Light Map Assigns a light map shader.

WARNING No light map shaders are provided with 3ds Max. This option is for users who have access to light map shaders via other shader libraries or custom shader code.

Optimization group

Flag Material as Opaque When on, indicates that the material is fully opaque. This tells the mental ray renderer that it doesn't need to process transparency for this material, or to use the shadow shader. This can improve rendering time. Default=off.

DirectX Manager Rollout

Material Editor > DirectX Manager rollout

Lets you select a DirectX viewport shader for viewing Direct3D hardware shaders. DirectX shaders require the [Direct3D graphics driver](#) on page 7802, which uses DirectX. With DirectX shading, materials in a viewport more accurately represent how the material will appear in another application, or on other hardware such as a game engine.

DirectX viewport shaders are especially useful for previewing [texture-baked materials](#) on page 6371.

3ds Max provides two DirectX shaders:

- [LightMap shader](#) on page 5760
- [Metal Bump shader](#) on page 5761

NOTE This rollout does not appear for Multi/Sub-Object and Shell materials, which are simply containers of other materials.

See also:

- [DirectX 9 Shader Material](#) on page 5758

Interface

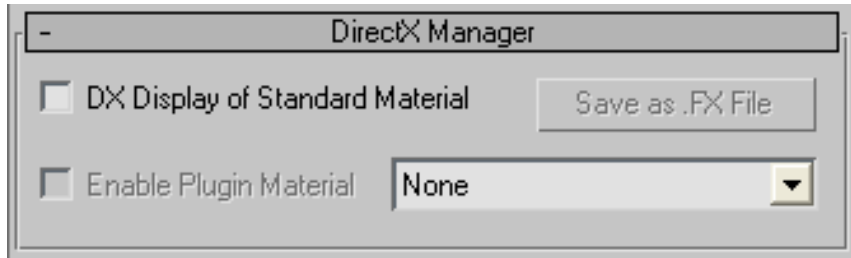

DX Display of Standard Material When on, displays the active material as a DX shader. You can save the material as an FX file by clicking Save As .FX File.

For full support of this feature, DX9 must be active.

WARNING Not all standard 3ds Max features can be represented by DX shaders, and you it is possible to create a standard material that is more complex than a DX video card can display. DX shaders do support the most commonly used material components: diffuse color (or texture), specular highlights, opacity, bump mapping, and reflections.

Save as .FX File Click to display a Save Effect File dialog that lets you save the active material as an [FX file](#) on page 7990.

Enable Plugin Material Turn on to use the chosen DirectX shader in shaded viewports. Default=off.

When not enabled, viewports continue to use the default [viewport \(interactive\) renderer](#) on page 8164 (or the [ActiveShade renderer](#) on page 6102, if that has been chosen).

This toggle is unavailable if no shader plug-in has been chosen from the drop-down list, and when DX Display Of Standard Material is on.

Plug-in drop-down list Use the drop-down list to choose a DirectX viewport shader.

The list is unavailable when DX Display Of Standard Material is on.

Standard Material

Material Editor > Type button > Material/Map Browser > Standard

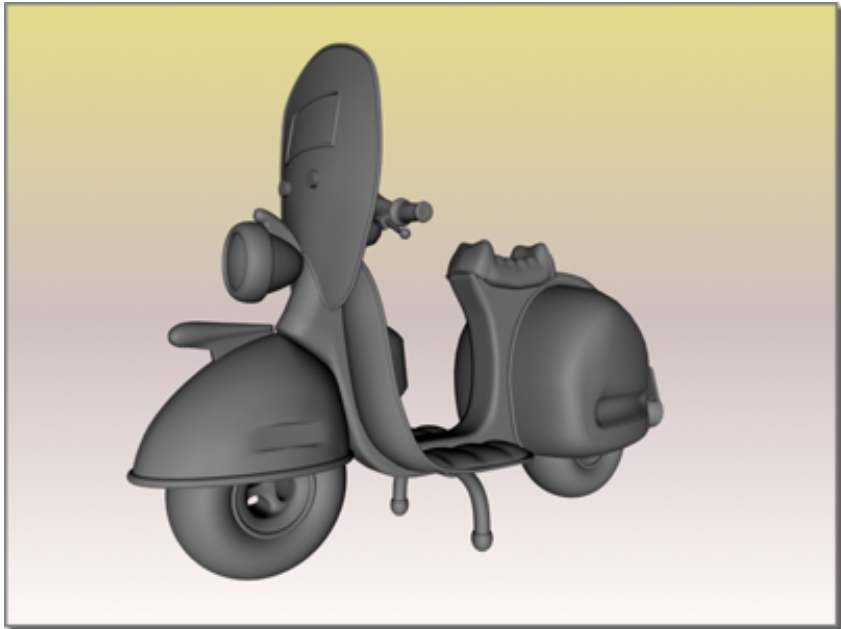

Scooter rendered with the default standard material

The Standard material type provides a fairly straightforward way to model surfaces. In the real world, the appearance of a surface depends on how it reflects light. In 3ds Max, a standard material simulates a surface's reflective properties. If you don't use [maps](#) on page 8036, a standard material gives an object a single, uniform color.

Standard material is the default material in the Material Editor sample slots.

This topic introduces the controls for Standard material, exclusive of mapping.

TIP The Standard material supports hardware-based viewport display for improved feedback while editing its parameters. For more information, see [Show Standard/Hardware Map in Viewport](#) on page 5350.

Standard Color Components

A surface of a "single" color usually reflects many colors. Standard materials typically use a four-color model to simulate this. (This can vary, depending on which [shader](#) on page 5397 you use.)

- [Ambient color](#) on page 7906 is the color of the object in shadow.
- [Diffuse](#) on page 7955 is the color of the object in direct, "good" lighting.
- [Specular](#) on page 8133 is the color of shiny highlights.

NOTE Some shaders generate the specular color procedurally, rather than letting you choose it.

- [Filter](#) on page 7976 is the color transmitted by light shining through the object.
The Filter color component isn't visible unless the material's Opacity is less than 100 percent.

NOTE The [Raytrace material](#) on page 5490 uses a different, six-color model to simulate surfaces. Several components are similar to those in the Standard Material, but they behave differently in Raytrace.

When we describe an object's color in conversation, usually we mean its diffuse color. The choice of an ambient color depends on the kind of lighting. For moderate indoor lighting, it can be a darker shade of the diffuse color, but for bright indoor lighting and for daylight, it should be the complement of the primary (key) light source. The specular color should be either the same color as the key light source, or a high-value, low-saturation version of the diffuse color.

For more tips on choosing color components, see [Choosing Colors for Realism](#) on page 5270.

WARNING When you change the shading type of a material, you lose the settings (including map assignments) for any parameters that the new shader does not support. If you want to experiment with different shaders for a material with the same general parameters, copy the material to a different [sample slot](#) on page 5304 before you change its shading type. That way, you can still use the original material if the new shader doesn't give you the effect you want.

Other Standard Material Components

A standard material's specular color appears in highlights. You can control the size and shape of the highlight. A polished surface has a small and strong highlight. A matte surface has a large, weak highlight, or no highlight at all.

Standard materials also have controls for making the object appear transparent, and for making it self-illuminating so that it appears to glow.

Along with the material's color components, *components* also refers to the parameters that control highlights, transparency, self-illumination, and so on.

See also:

- [Material Components](#) on page 5267
- [Choosing Colors for Realism](#) on page 5270

Interface

The interface for a standard material is organized into several rollouts:

[Shader Basic Parameters Rollout](#) on page 5397

[Basic Parameters Rollout \(Standard Material\)](#) on page 5406

[Extended Parameters Rollout \(Standard Material\)](#) on page 5408

[SuperSampling Rollout](#) on page 5381

[Maps Rollout \(Standard Material\)](#) on page 5414

[Dynamics Properties Rollout](#) on page 5423

[DirectX Manager Rollout](#) on page 5393

Shader Basic Parameters Rollout

Material Editor > Standard material > Shader Basic Parameters rollout > Choose shader from drop-down list.

The Shader Basic Parameters rollout lets you choose the type of shader to use with a [Standard](#) on page 5395 material. Some additional controls affect how the material appears.

Procedures

To set a material's shading type:

- 1 On the Shader Basic Parameters rollout, open the shader drop-down list.
- 2 Click the name of the shader type to use for the active material.

To use Wire mode:

- On the Shader Basic Parameters rollout, turn on Wire.
The material is now shaded as a wireframe mesh. The wire portions of the geometry do not change; color components, shininess, and so on, remain the same.

For a wireframe material, turn on the 2-Sided option as well.

You have two choices for how wireframe materials are rendered. The controls for tuning wireframe shading are on the [Extended Parameters](#) on page 5408 rollout.

If you choose Pixels, the thickness of the wires maintains the same apparent thickness regardless of the scale of the geometry or how near or far the object is positioned. In other words, pixel wires have a constant display size as if the wires were traced over an image. If you choose Units, the wires behave as if they were modeled in the geometry. They appear thinner at a distance and thicker at close range. Scaling a wireframe object does scale wire width.

Interface

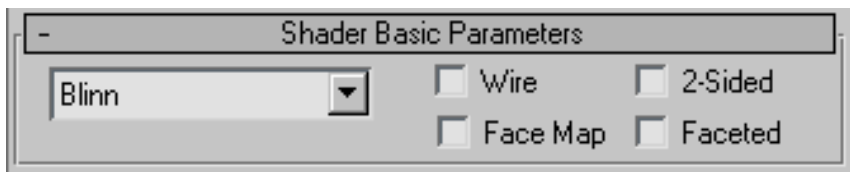

[shader drop-down list] Chooses a shader. The material's Basic Parameters rollout can change to show the controls for the shader you choose. Default shader=Blinn

There are seven different shaders. Some are named for what they do; others are named for their creators. These are the basic material shaders:

- [Anisotropic](#) on page 5424: For surfaces with elliptical, "anisotropic" highlights. These highlights are good for modeling hair, glass, or brushed metal.

- [Blinn](#) on page 5426: For rounder, softer highlights than Phong shading
- [Metal](#) on page 5427: For metallic surfaces
- [Multi-Layer](#) on page 5428: For surfaces with more complex highlights than Anisotropic
- [Oren-Nayar-Blinn](#) on page 5429: For matte surfaces such as fabric or terra-cotta
- [Phong](#) on page 5430: For surfaces with strong, circular highlights
- [Strauss](#) on page 5431: For metallic and nonmetallic surfaces. The Strauss shader has a simpler interface than other shaders.
- [Translucent](#) on page 5434: Similar to Blinn shading, the Translucent shader also lets you specify translucency, where light is scattered as it passes through the material.

For more information about the shaders, including illustrations, see [Understanding Shaders](#) on page 5399.

Wire Renders the material in [wireframe mode](#) on page 8172. You can set the size of the wire in [Extended Parameters](#) on page 5408.

2-Sided Makes the material [2-sided](#) on page 7893. Applies the material to both sides of selected faces.

Face Map Applies the material to the faces of the geometry. If the material is a mapped material, it requires no [mapping coordinates](#) on page 8034. The map is automatically applied to each facet of the object.

Faceted Renders each face of a surface as if it were flat.

Understanding Shaders

For standard materials, a shader is an algorithm that tells 3ds Max how to calculate surface rendering. Each shader has a unique set of characteristics in order to serve a particular purpose. Some are named for what they do well, such as the Metal shader. Others are named for the person who developed them, such as the Blinn and Strauss shaders. The default shader in 3ds Max is the Blinn shader.

NOTE In addition to the shaders listed below, 3ds Max supports plug-in shader types.

The following list describes the shaders supplied with the software:

- **Anisotropic:** Used for brushed metal or hair. Creates a highlight that is stretched and angled, rather than the standard circular highlight.



- **Blinn:** Has the same features as the Phong shader, but its mathematics are more accurate. This is the default shader for Standard materials.



- **Metal:** Used for making metals.



- **MultiLayer:** Two anisotropic shaders in one. Used to make two different highlights with independent controls. Simulates materials such as a metal that is covered with a shiny coat of wax.



- **Oren-Nayar-Blinn:** An adaptation of the Blinn shader. It gives objects a porous, non-plastic appearance, and is suitable for surfaces like skin.



- **Phong:** A classic shading method that was the first to enable specular highlights. Suitable for plastic surfaces.



- **Strauss:** Suitable for metals. Allows you to control the degree of metallic characteristics of the material.

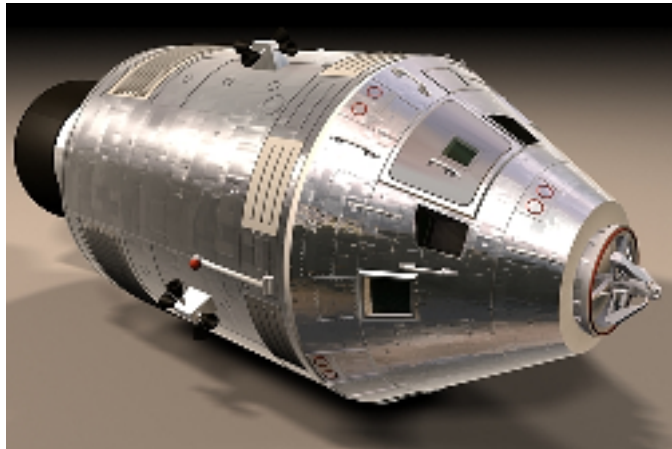

- **Translucent Shader:** Translucent shading is similar to Blinn shading, but it also lets you specify translucency. A translucent object allows light to pass through, and also scatters light within the object. You can use translucency to simulate frosted and etched glass.

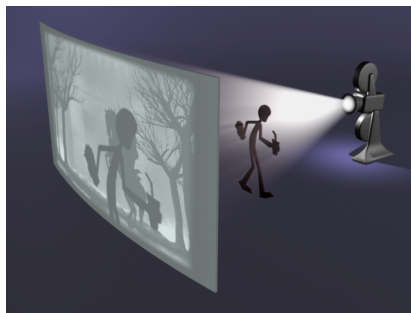

Comparing Shader Parameters

A shader is an algorithm that tells the program how to calculate surface rendering. Each shader has a unique set of characteristics in order to serve a particular purpose.

Compare the parameters of different shader types:

- 1 Open the Material Editor and click an available sample slot.
- 2 In the list on the Shader Basic Parameters rollout, change Blinn to Anisotropic.

The Blinn Basic Parameters rollout changes to the Anisotropic Basic Parameters rollout. Observe the differences in the available basic parameters.





- 3 Select each shader type from the list and compare its parameters with the others. Some parameters are shared in common, but each shader has its own unique combination of settings.

For more information on shader types, see [Shader Basic Parameters Rollout](#) on page 5397.

Basic Parameters Rollout (Standard Material)

Material Editor > Standard material > Basic Parameters rollout for the shader you've chosen

The Basic Parameters rollouts for Standard materials contain controls that let you set the color of your material, the shininess, the transparency, and so on, and specify [maps](#) on page 8036 to use for the various components of the material.

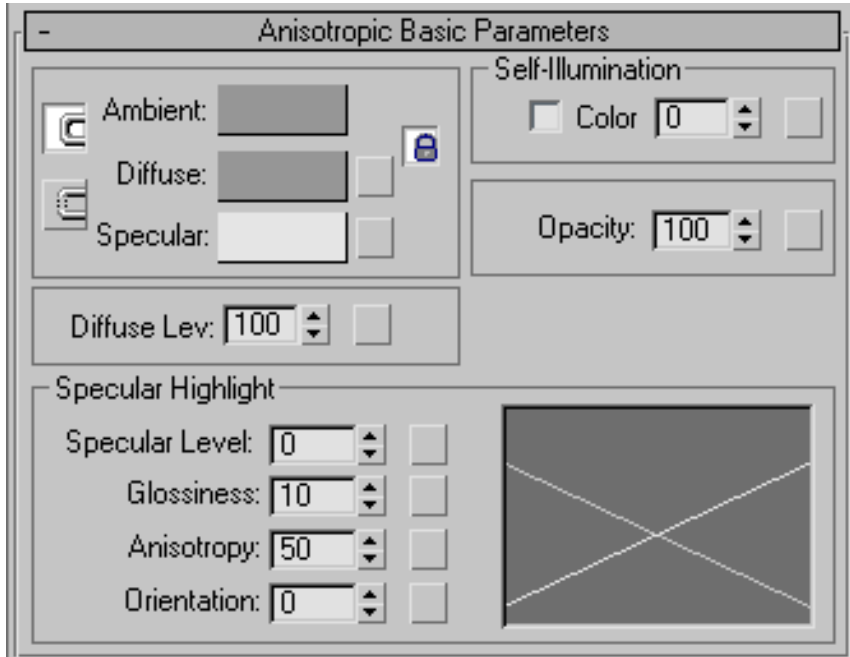

Example: The Basic Parameters rollout for the Anisotropic shader.

Basic Parameters rollouts vary depending on which shader is chosen.

The Basic Parameters rollout changes depending on which kind of shader you choose in the [Shader Basic Parameters](#) on page 5397.

NOTE The Strauss shader's Basic Parameters rollout is simpler than those for other shaders. See [Strauss Shader](#) on page 5431 for a description.

Component Controls

The first part of the Basic Parameters rollout contains controls for overall material components. They are described in the following topics:

- [Color Controls](#) on page 5436 let you choose the material's color components, or replace them with maps.
- [Self-Illumination](#) on page 5440 makes a material appear lit from within. Self-illumination is not available for the [Strauss shader](#) on page 5431.
- [Opacity](#) on page 5442 controls how opaque or transparent a material is.
- [Diffuse Level](#) on page 5444 controls the brightness of the diffuse color component. Diffuse Level is available only for the [Anisotropic](#) on page 5424, [Multi-Layer](#) on page 5428, and [Oren-Nayar-Blinn](#) on page 5429 shaders.
- [Roughness](#) on page 5446 controls how quickly the diffuse component blends into the ambient component. Roughness is available only for the [Multi-Layer](#) on page 5428 and [Oren-Nayar-Blinn](#) on page 5429 shaders.

Highlight Controls

The second part of the Basic Parameters rollout contains controls for specular highlights, which in some ways are the greatest difference between the various shaders. See these topics for a description:

- [Anisotropic Highlights](#) on page 5424
- [Blinn, Oren-Nayar-Blinn, and Phong Highlights](#) on page 5451
- [Metal Highlights](#) on page 5452
- [Multi-Layer Highlights](#) on page 5454

For information on highlights with the Strauss shader, see [Strauss Shader](#) on page 5431.

Translucency Controls

For the [Translucent shader](#) on page 5434, an additional group on the Basic Parameters rollout contains controls for [translucency](#) on page 5447.

Extended Parameters Rollout (Standard Material)

Material Editor > Standard material > Extended Parameters rollout

The Extended Parameters rollout is the same for all shading types of Standard material. It has controls related to transparency and reflection, as well as options for Wire mode.

This topic contains tables of the Index of Refraction for some common physical materials. These can be used to create Standard materials with realistic transparency.

Additive Opacity and the Alpha Channel

By default, additive opacity does not generate an alpha value. In other words, the alpha value is zero, indicating no transparency. This gives correct results with backgrounds in renderings, but if you want to composite objects with additive opacity using [video post](#) on page 6773 or a different compositing program, you might want to have additive opacity render with transparency. To do so, add the following line to the [Renderer] section of the *3dsmax.ini* file, and then restart 3ds Max:

```
AlphaOutOnAdditive=1
```

To revert to the default method of rendering additive opacity, in the *3dsmax.ini* file, change the value of AlphaOutOnAdditive back to 0 (zero), and then restart 3ds Max.

Interface

Advanced Transparency group

These controls affect the [opacity falloff](#) on page 8068 of a transparent material.

NOTE For the [Translucent shader](#) on page 5434, these controls do not appear. They are replaced by the [Translucency controls](#) on page 5447 on the Basic Parameters rollout.

Falloff Chooses whether falloff is in or out, and how great it is.

- **In** Increases transparency toward the inside of the object, as in a glass bottle.
- **Out** Increases transparency toward the outside of the object, as in a cloud of smoke.

Amt (Amount) Specifies the amount of transparency at the outside or inside extreme.

Type These controls choose how transparency is applied.

- **Filter** on page 7976 computes a filter color that it multiplies by the color behind the transparent surface. Click the color swatch to change the filter color. Click the button to assign a map to the filter color component. The filter, or transmissive color, is the color transmitted through transparent or semi-transparent materials such as glass. You can use the filter color with volumetric lighting to create effects such as colored light through a stained-glass window. [Ray-traced shadows](#) on page 8103 cast by transparent objects are tinted with the filter color.

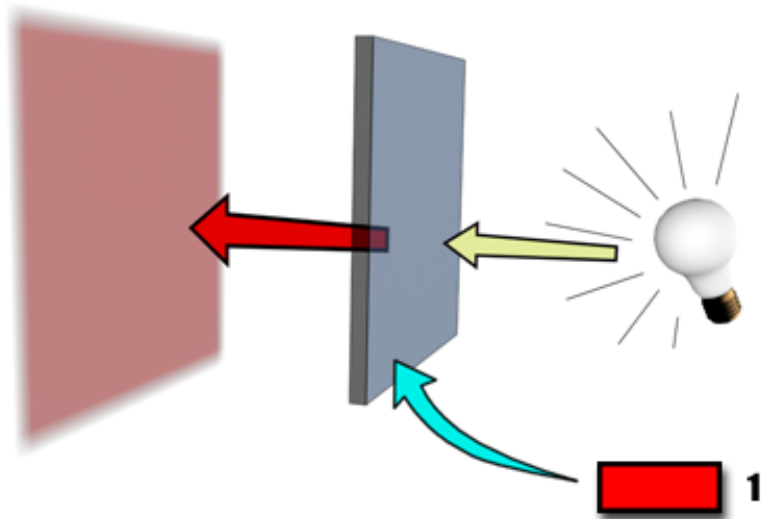

A shadow's color is changed with a red filter color.

- **Subtractive** on page 8140 subtracts from the color behind the transparent surface.
- **Additive** on page 7901 adds to the color behind the transparent surface.

Index of Refraction Sets the index of refraction (IOR) used by refraction maps and raytracing. The IOR controls how severely the material refracts transmitted

light. Left at 1.0, the IOR of air, the object behind the transparent object does not distort. At 1.5 the object behind distorts greatly, like a glass marble. At an IOR slightly less than 1.0, the object reflects along its edges, like a bubble seen from under water. Default=1.0.

Common IORs (assuming the camera is in air or a vacuum) are:

Material	IOR Value
Vacuum	1.0 (exactly)
Air	1.0003
Water	1.333
Glass	1.5 (clear glass) to 1.7
Diamond	2.417

In the physical world, the IOR results from the relative speeds of light through the transparent material and the medium the eye or the camera is in. Typically this is related to the object's density; the higher the IOR, the denser the object. You can also use a map to control the index of refraction. IOR maps always interpolate between 1.0 (the IOR of air) and the setting in the IOR parameter. For example, if the IOR is set to 3.55 and you use a black-and-white Noise map to control IOR, the IORs rendered on the object will be set to values between 1.0 and 3.55; the object will appear denser than air. If, on the other hand, your IOR is set to 0.5, then the same map values will render between 0.5 and 1.0, as if the camera were under water and the object was less dense than the water.

Here are some more IOR values for various materials:

Material	IOR Value
Carbon Dioxide, Liquid	1.200
Ice	1.309
Acetone	1.360

Material	IOR Value
Ethyl Alcohol	1.360
Sugar Solution 30%	1.380
Alcohol	1.329
Flourite	1.434
Quartz, Fused	1.460
Calspar2	1.486
Sugar Solution 80%	1.490
Glass, Zinc Crown	1.517
Glass, Crown	1.520
Sodium Chloride	1.530
Sodium Chloride (Salt) 1	1.544
Polystyrene	1.550
Quartz 2	1.553
Emerald	1.570
Glass, Light Flint	1.575
Lapis Lazuli	1.610
Topaz	1.610

Material	IOR Value
Carbon Bisulfide	1.630
Quartz 1	1.644
Sodium Chloride (Salt) 2	1.644
Glass, Heavy Flint	1.650
Methylene Iodide	1.740
Ruby	1.770
Sapphire	1.770
Glass, Heaviest Flint	1.890
Crystal	2.000
Chromium Oxide	2.705
Copper Oxide	2.705
Amorphous Selenium	2.920
Iodine Crystal	3.340

Wire group

Size Sets the size of the wire in [wireframe mode](#) on page 8172. You can set either pixels or current units.

In Chooses how to measure wire.

- **Pixels** (The default.) Measures wire in pixels. With pixels, wires maintain the same apparent thickness regardless of the scale of the geometry or how near or far the object is positioned.

- **Units** Measures wire in 3ds Max units. With units, the wires appear thinner at a distance and thicker at close range, as if they were modeled in the geometry.

Reflection Dimming group

These controls dim reflection maps that are in shadow.

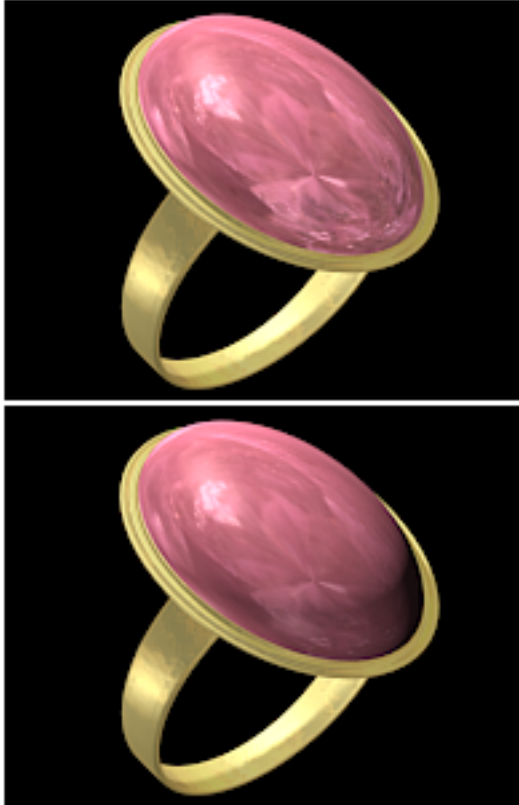

Reflection dimming

Above: None

Below: 0.0 (100% dimming)

Apply Turn on to use reflection dimming. When off, the reflection-mapped material is not affected by the presence or absence of direct light. Default=off.

Dim Level The amount of dimming that takes place in shadow. At 0.0, the reflection map is completely dark in shadow. At 0.5, the reflection map is half dimmed. At 1.0, the reflection map is not dimmed and the material appears as if Apply were turned off. Default=0.0.

Refl. Level Affects the intensity of the reflection that is *not* in shadow. The Reflection Level value multiplies the illumination level of the lit area of the reflection, to compensate for dimming. In most cases, the default value of 3.0 keeps the reflection in the lit area at about the same level it would appear if reflection dimming were not on.

Maps Rollout (Standard Material)

Material Editor > Standard material > Maps rollout

A material's Maps rollout lets you access and assign [maps](#) on page 8036 to various components of the material.

You can choose from a large variety of map types. To find descriptions of these types, and how to set their parameters, see [Map Types](#) on page 5767.

Assigning the Same Map to Different Parameters

Applying the same map to different parameters is useful in some cases. For example, using a pattern to map both self-illumination and opacity can make the pattern appear to glow and hover in space.

Blending Map Amounts for Opacity and Other Material Components

When you map a scalar component (such as Specular Level, Glossiness, Self-Illumination, and Opacity), the component's value in the [Basic Parameters](#) on page 5406 rollout is blended with its associated map Amount in the Maps rollout.

For example, when the Opacity spinner is set to 0, the map Amount spinner completely controls Opacity. That is, reducing the Amount value increases the transparency of the entire surface. On the other hand, when Opacity is 100, reducing the map's Amount value increases the opacity of the entire surface. You can adjust a Checker Opacity map so that the opaque areas remain opaque, while the transparent areas become semi-transparent.

Other scalar components behave in the same way. Setting the map's Amount to 100 applies all of the map. Setting the Amount to 0 is the equivalent of

turning the map off. Intermediate Amount values are blended with the value of the scalar component.

When you load old 3ds Max files or bring earlier materials from the Browser into the Materials Editor, the spinner values for Opacity, Specular Level, Glossiness, and Self-Illumination are altered, where necessary, to maintain the equivalent material effect.

Ambient and Diffuse Map Lock



In the Maps rollout, the lock button to the right of the Diffuse Color map button locks ambient mapping to diffuse mapping. It is on by default. Usually it makes sense to use the same map for the ambient and diffuse components. To use different maps for ambient and diffuse, turn off the lock button. The map button for Ambient Color becomes available.

Procedures

To assign a map:

- 1 In the Maps rollout, click a map button.
A modal [Material/Map Browser](#) on page 5290 is displayed.
- 2 Use the Browse From buttons to choose where you want to look.
If you choose Material Library and the dialog's display area is blank, you need to open a library file. Click the Open button and then choose the library to browse.
- 3 Use the display buttons to choose how you view maps.



- View List shows each map by name.



- View List + Icons shows a small preview and each map's name.



- View Small Icons shows a small preview for each map.



- View Large Icons shows a large preview for each map, along with the map's name.

TIP You can resize the Browser dialog to increase the size of the display area. This is especially useful when you view large icons.

- 4 Double-click the map you want.

To use the same map for different parameters:

- 1 In the Maps rollout, use a map button to assign a map.
The Material Editor is now at the map level, and displays controls for the map parameters.



- 2 Click Go To Parent to return to the material level, and then open the Maps rollout.

- 3 Drag the assigned map button to another map button.
The [Copy \(Instance\) Map dialog](#) on page 5365 is displayed.

- 4 Choose Copy or Instance, and then click OK.
If you choose Swap, the Material Editor swaps the two button assignments.

To view the parent material's parameters:



- If you are currently at the map level in the Material Editor, click Go To Parent.
The parameters for the map's parent material are displayed. Also, the Show End Result and Go To Parent buttons become unavailable.

To view a map's parameters:

- If you are currently at the material level in the Material Editor, click the button that corresponds to the map.
The parameters for the map are displayed. Also, the [Show End Result](#) on page 5356 and [Go To Parent](#) on page 5356 buttons become available.
In the Basic Parameters rollout, if a map has been assigned to a color component or parameter, the corresponding button displays a letter M.
In the Maps rollout, if a map has been assigned, the corresponding button displays the map name.

To view a map's location:



- Click Material/Map Navigator to view the Navigator.
The [Material/Map Navigator](#) on page 5357 displays the hierarchy of the current material, which contains the map.

To go to a map using the Navigator:

- In the [Material/Map Navigator](#) on page 5357, click the name of the map, or the green or red parallelogram to the left of the map's name.
The Navigator goes to the level of the map, and the Material Editor displays the controls for the map you clicked.
As the Navigator's map tree shows, maps for basic material components and parameters are one level below the material itself.

To preview a map in a sample slot:

- 1 Go to the level of the map, as described in previous procedures.
The Material Editor displays the map's parameters.



- 2 Turn off [Show End Result](#) on page 5356.
The sample slot shows the map instead of the material. If the map contains sub-maps, these are also visible.
By default, the sample slot displays a map with no three-dimensional shading. You can change this in the [Material Editor Options dialog](#) on page 5335.

To view the map interactively:

- 1 Select an object.
- 2 In the object's creation parameters, make sure that Generate Mapping Coords is on.
If the object type does not have a Generate Mapping Coordinates toggle, you need to assign mapping coordinates by applying a [UVW Map modifier](#) on page 1931.
- 3 In the Material Editor, assign the mapped material to the object.
- 4 If you are at the material level (the top level), click the appropriate map button to go to the map level.

- 5  Turn on [Show Map In Viewport](#) on page 5350.

The map appears on objects assigned the material in all shaded viewports. Now when you adjust the map, the viewports update to display the adjustments.

Turning on Show Map In Viewport for one map automatically turns this button off for all other maps the material has.

Viewports can display 2D maps such as Checker and Bitmap.

Viewports can also display most kinds of 3D maps. The exceptions are Particle Age and Particle MBlur. Also, the appearance of the Falloff map in viewports give only a vague indication of how it will appear when rendered.

Show Map In Viewport is unavailable if the active map type cannot display in viewports.

Displaying mapped materials in a viewport can slow performance. If you don't need to view the texture, turn off its viewport display.

To turn off interactive texture display:

- 1 Go to the map level.

If you are at the material level, click the appropriate map button to go to the map level.

- 2  Turn off [Show Map in Viewport](#) on page 5350.

The object is shaded but the map no longer appears.

To turn a map off:

- On the Maps rollout, turn off the map's check box. The check box is to the left of the map's name.

When a map is off, a lowercase m appears on the corresponding map button.



To turn a map on:

- In the Maps rollout, turn on the map's check box. The check box is to the left of the map's name. When a map is on, an uppercase M appears on the corresponding map button.

To change a map's strength:

- In the Maps rollout, adjust the map's Amount spinner. The material's sample slot reflects the change.

NOTE Adjusting a map's output (in the map's Output rollout) can also change the map's strength.

To move directly to an ancestor:

- 1 Below the Material Editor toolbar, click the arrow to the right of the map's [name field](#) on page 5360. A drop-down list of ancestors is displayed.
- 2 Click a name in the Ancestor list. With this list, you can skip intermediate levels in the tree.



The Ancestor drop-down list shows only part of the tree. It does not show side branches and siblings. To view these, use the [Material/Map Navigator](#) on page 5357 or the [Go Forward To Sibling](#) on page 5357 and [Go To Parent](#) on page 5356 buttons on the Material Editor toolbar.

To change a map type:

- 1 At the level of a map, click the button labeled Type below the Material Editor toolbar.

A modal [Material/Map Browser](#) on page 5290 is displayed. If you were at a map, it lists only maps (if you were at a material when you clicked Type, the Browser lists only materials).

- 2 Choose a map type from the list, and then click OK.

If you change a map type and the new map type can have component maps, a Replace Map dialog is displayed. This dialog gives you a choice between discarding the original map or using it as a component map.

If the new map type does not have components, it simply replaces the original map type.

To create a standalone map tree:

- 1 Activate a sample slot.



- 2 Click [Get Material](#) on page 5341.

- 3 In the [Material/Map Browser](#) on page 5290, make sure Browse From is set to New.

- 4 Double-click the name of the map type (not a material type) you want to use, or drag the map to a sample slot.

The sample slot now contains a standalone map not associated with material parameters.

- 5 Use the Material Editor to modify the map as you would any other map.

By default, the sample slot displays a map with no three-dimensional shading. You can change this in the [Material Editor Options dialog](#) on page 5335.

Interface

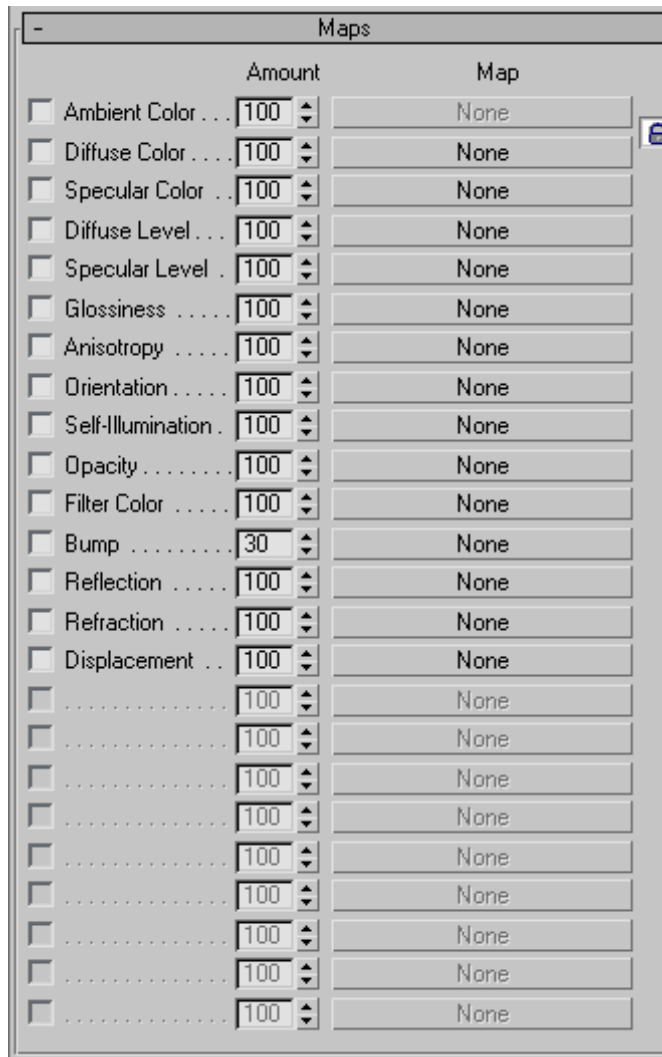

The Maps rollout contains a wide button for each map type. Click this button to select a bitmap file stored on disk or to select a [procedural map type](#) on page 8097. After you select a map, its name and type appears on the button. Use the check box to the left of the button to turn the effect of the map off and on. When the check box is off, the map is not computed and has no effect in the render.

The Amount spinner determines the amount that the map affects the material expressed as a percentage of full intensity. For example, a diffuse map at 100% is completely opaque and covers the base material. At 50%, it is semi-transparent and the base material (the diffuse, ambient, and other colors of the material without mapping) shows through.

[Ambient Color Mapping](#) on page 5458

[Diffuse Color Mapping](#) on page 5460

[Diffuse Level Mapping](#) on page 5462

[Diffuse Roughness Mapping](#) on page 5464

[Specular Color Mapping](#) on page 5465

[Glossiness Mapping](#) on page 5467

[Glossiness and Specular Level Settings](#) on page 7999

[Self-Illumination Mapping](#) on page 5469

[Opacity Mapping](#) on page 5470

[Filter Color Mapping](#) on page 5471

[Anisotropy Mapping](#) on page 5473

[Orientation Mapping](#) on page 5474

[Metalness Mapping](#) on page 5476

[Bump Mapping](#) on page 5478

[Reflection Mapping](#) on page 5480

[Refraction Mapping](#) on page 5483

[Displacement Mapping](#) on page 5487

The Maps rollout can have unused, disabled control rows at the bottom. This is because the number of components that can be mapped varies depending on the current [shader](#) on page 5397. The last four rows are always Bump, Reflection, Refraction, and Displacement, in that order.

NOTE The sub-material and sub-map buttons for most materials and maps have check boxes beside each button. These turn that branch of the material or map off or on. For example, in the Top/Bottom material, the Top Material and Bottom Material buttons each have check boxes. Similarly, the Checker map has two map buttons, one for each color. Each button has check box beside it that lets you turn off that color's map.

Dynamics Properties Rollout

Material Editor > Standard material > Dynamics Properties rollout

The Dynamics Properties rollout lets you specify surface properties that affect the animation of an object upon collision with another object. If there are no collisions in your simulation, these settings have no effect. The dynamics properties are used by the [Dynamics utility](#) on page 3852.

Since the Dynamics Properties rollout is available at the top level of any material (including submaterials), you can specify different surface dynamic properties for each face in an object. There are also controls in the Dynamics utility that let you adjust the surface properties at the object level, but only the Materials Editor lets you alter the surface properties at the sub-object level, through use of a [Multi/Sub-Object material](#) on page 5720.

As a default, the values in the Dynamics Properties rollout provide a surface that's similar to Teflon-coated hardened steel.

Interface

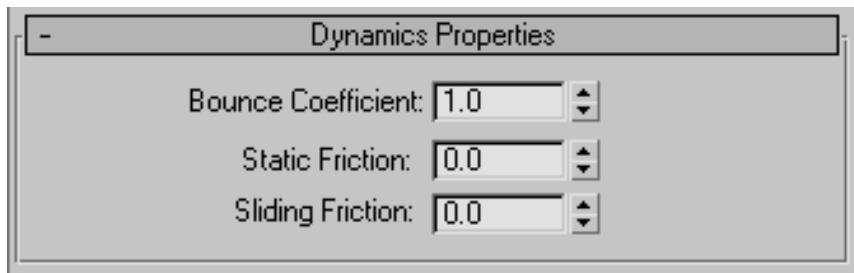

Bounce Coefficient Sets how far an object bounces after hitting a surface. The higher the value, the greater the bounce. A value of 1 represents a "perfectly elastic collision," or a bounce in which no kinetic energy is lost. Default=1.0.

If you've seen the desktop toy with four ball bearings swinging back and forth on strings and hitting one another, you've seen an example that comes very close to a bounce coefficient of 1. Generally, hardened steel or a super ball have a bounce near 1, while lead has a bounce near 0.

Static Friction Sets how difficult it is for the object to start moving along a surface. The higher this value, the more difficult. Default=0.0.

If something weighs ten pounds and sits on Teflon (a static friction of near 0), it takes almost no force to make it move sideways. On the other hand, if it sits on sandpaper, then the static friction might be very high, on the order

of 0.5 to 0.8. A static friction near 1 is very difficult to create in the real world without adhesives or friction material.

Sliding Friction Sets how difficult it is for the object to keep moving over a surface. The higher this value, the more difficult for the object to keep moving. Default=0.0.

Once two objects begin to slide over one another, static friction disappears and sliding friction takes over. Generally, sliding friction is lower than static friction due to surface tension effects. For example, once steel starts sliding over brass (a value of static friction that might run from 0.05 to 0.2), the sliding friction drops to a significantly lower value, on the order of .01 to 0.1. For some materials, such as specific friction materials like brake linings, sliding friction is just as high as static friction because it is used in conjunction with a nearly frictionless material such as hardened polished steel.

Basic Material Shaders

Anisotropic Shader

Material Editor > Standard material > Shader Basic Parameters rollout > Anisotropic shader > Anisotropic Basic Parameters rollout

The Anisotropic shader creates surfaces with elliptical, "anisotropic" highlights. These highlights are good for modeling hair, glass, or brushed metal. The basic parameters are similar to those for [Blinn or Phong shading](#) on page 5426, except for the Specular Highlight parameters, and Diffuse Level controls such as those for [Oren-Nayar-Blinn shading](#) on page 5429.

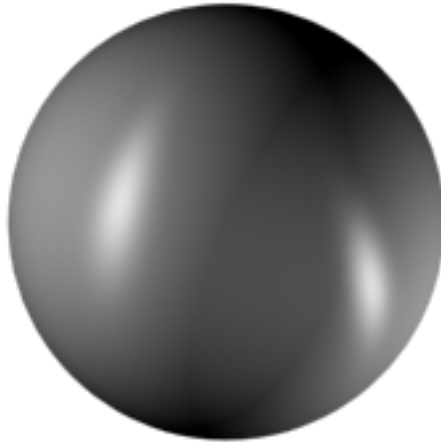

Anisotropic highlights are elliptical, with differing U and V dimensions.

Anisotropy measures the difference between sizes of the highlight as seen from two perpendicular directions. When anisotropy is 0, there is no difference at all. The highlight is circular, as in Blinn or Phong shading. When anisotropy is 100, the difference is at its maximum. In one direction the highlight is very sharp; in the other direction it is controlled solely by Glossiness.

For more complex highlights, see the [Multi-Layer shader](#) on page 5428.

See also:

- [Shader Basic Parameters Rollout](#) on page 5397
- [Basic Parameters Rollout \(Standard Material\)](#) on page 5406
- [Anisotropic Highlights](#) on page 5449

Blinn Shader

Material Editor > Standard material > Shader Basic Parameters rollout > Blinn shader > Blinn Basic Parameters rollout

Blinn shading is a subtle variation on Phong shading. The most noticeable difference is that highlights appear rounder. In general, you don't need to use the Soften parameter (described in [Blinn, Oren-Nayar-Blinn, and Phong Highlights](#) on page 5451) as often as you do with Phong shading.

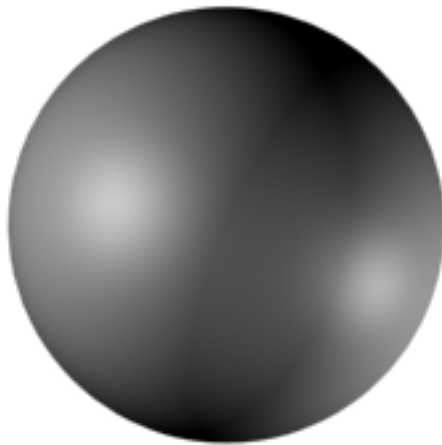

Blinn shading tends to have soft, round highlights.

With Blinn shading, you can obtain highlights produced by light glancing off the surface at low angles. These highlights are lost when you increase the value of Soften using Phong shading.

The Blinn and Phong shaders have the same [basic parameters](#) on page 5406.

See also:

- [Shader Basic Parameters Rollout](#) on page 5397
- [Basic Parameters Rollout \(Standard Material\)](#) on page 5406

- [Blinn, Oren-Nayar-Blinn, and Phong Highlights](#) on page 5451

Metal Shader

Material Editor > Standard material > Shader Basic Parameters rollout > Metal shader > Metal Basic Parameters rollout

Metal shading provides realistic-looking metallic surfaces and a variety of organic-looking materials.

Metal shading has a distinct curve for specular highlights. Metal surfaces also have glancing highlights. Metal materials calculate their own specular color, which can vary between the material's diffuse color and the color of the light. You can't set a metal material's specular color.



Metal shading has distinctive highlights.

Because there's no separate specular highlight, the two specular highlight spinners behave differently than the spinners for [Blinn and Phong shading](#) on page 5426. The Specular Level spinner still controls intensity, but the Glossiness spinner affects both the intensity and size of the specular areas.

TIP When you create a metal material, make sure the [backlight](#) on page 5329 is on in the sample slot.

See also:

- [Shader Basic Parameters Rollout](#) on page 5397
- [Basic Parameters Rollout \(Standard Material\)](#) on page 5406
- [Metal Highlights](#) on page 5452

Multi-Layer Shader

Material Editor > Standard material > Shader Basic Parameters rollout > Multi-Layer shader > Multi-Layer Basic Parameters rollout



Upper left: No highlights

Upper right: Single highlight

Lower middle: Multiple highlights from the multi-layer shader

The Multi-Layer shader is similar to the [Anisotropic shader](#) on page 5424, but it has a set of two specular highlight controls. The highlights are layered, letting you create complex highlights that are good for highly polished surfaces, special effects, and so on.

Highlights in the Multi-Layer shader can be anisotropic. Anisotropy measures the difference between sizes of the highlight as seen from two perpendicular directions. When anisotropy is 0, there is no difference at all. The highlight is circular, as in Blinn or Phong shading. When anisotropy is 100, the difference is at its maximum. In one direction the highlight is very sharp; in the other direction it is controlled solely by Glossiness.

See also:

- [Shader Basic Parameters Rollout](#) on page 5397
- [Basic Parameters Rollout \(Standard Material\)](#) on page 5406
- [Multi-Layer Highlights](#) on page 5454

Oren-Nayar-Blinn Shader

Material Editor > Standard material > Shader Basic Parameters rollout > Blinn shader > Oren-Nayar-Blinn shader > Oren-Nayar-Blinn Basic Parameters rollout

The Oren-Nayar-Blinn shader is a variant of the [Blinn shader](#) on page 5426. It contains additional "advanced diffuse" controls, Diffuse Level and Roughness, that you can use to give the material a matte effect. This shader is good for matte surfaces such as fabric, terra-cotta, and so on.

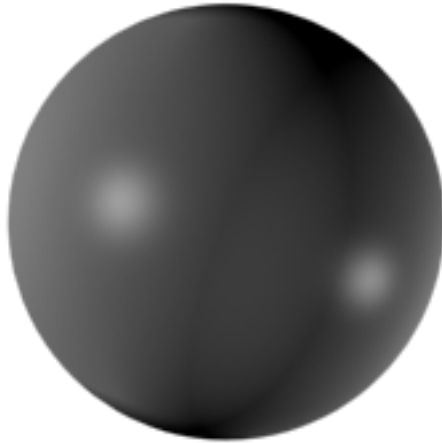

Oren-Nayar-Blinn shading typically has a matte appearance.

See also:

- [Shader Basic Parameters Rollout](#) on page 5397
- [Basic Parameters Rollout \(Standard Material\)](#) on page 5406
- [Blinn, Oren-Nayar-Blinn, and Phong Highlights](#) on page 5451

Phong Shader

Material Editor > Standard material > Shader Basic Parameters rollout > Phong shader > Phong Basic Parameters rollout

Phong shading smooths the edges between faces and renders highlights realistically for shiny, regular surfaces. This shader interpolates intensities across a face based on the averaged face normals of adjacent faces. It calculates the normal for every pixel of the face.

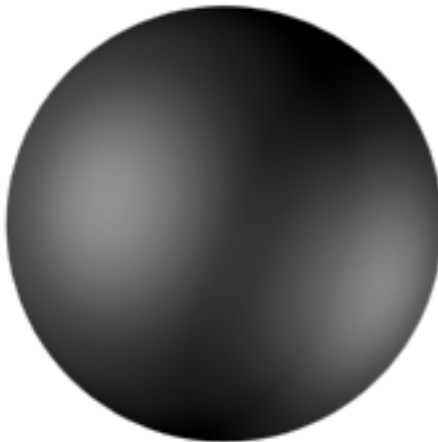

Phong-shaded highlights are typically less regular than Blinn highlights.

Phong shading can accurately render bump, opacity, shininess, specular, and reflection maps.

The Blinn and Phong shaders have the same [basic parameters](#) on page 5406.

See also:

- [Shader Basic Parameters Rollout](#) on page 5397
- [Basic Parameters Rollout \(Standard Material\)](#) on page 5406
- [Blinn, Oren-Nayar-Blinn, and Phong Highlights](#) on page 5451

Strauss Shader

Material Editor > Standard material > Shader Basic Parameters rollout > Strauss shader > Strauss Basic Parameters rollout

The Strauss shader is for modeling metallic surfaces. It uses a simpler model and has a simpler interface than the [Metal shader](#) on page 5427.

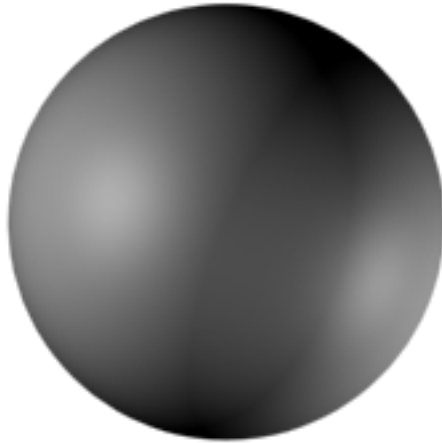

Sample of Strauss shading

NOTE The Strauss shader's Basic Parameters rollout differs a great deal from the Basic Parameters rollouts for other shaders, and is described in this topic.

See also:

- [Shader Basic Parameters Rollout](#) on page 5397

Procedures

To change the color of a Strauss material:

- 1 Click the Color swatch.
The [Color Selector](#) on page 391 is displayed.
Right-clicking the color swatch also displays the Color Selector.
- 2 In the Color Selector, change the values of the color.
As you change color values, the color also changes in the sample in the sample slot.

To reduce a material's opacity:

- Change Opacity to a value less than 100%.

The material becomes more transparent. A fully transparent object (0% Opacity) is nearly invisible except for the light it reflects: the specular highlights.

To preview transparency in the sample slots, view the sample object against a background. Click the checkered [Background](#) on page 5329 button to the right of the sample slots.

Transparent materials render more realistically when you turn on 2-Sided in the material's [Shader Basic Parameters](#) on page 5397.

To increase or decrease the size and intensity of highlights:

- Change the Glossiness value.

The width of the Highlight curve and the highlights in the preview change. At 0% glossiness, the curve is at its maximum width. At 100% glossiness, the curve is extremely narrow.

Increasing Glossiness also dims the diffuse color.

To make the material appear more metallic:

- 1 Increase the Glossiness value.

The metallic effect requires visible highlights.

- 2 Increase the value of Metalness.

Highlights become more focused, and the (diffuse) color component is dimmed.

Interface

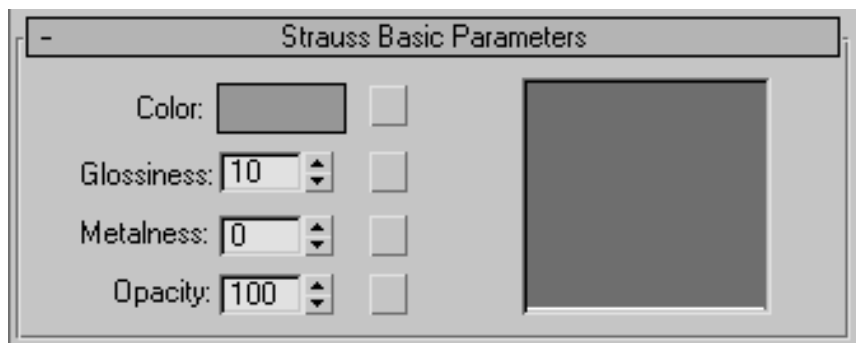

Color Controls the color of the material. This corresponds to the [diffuse color](#) on page 7955 you specify for other kinds of shaders. With the Strauss shader, you control only this color. The shader calculates the ambient and specular color components.

Click the map button to assign a map to the color component. See [Diffuse Mapping](#) on page 5460. This button is a shortcut: you can also assign color mapping in the [Maps](#) on page 5414 rollout.

Glossiness Affects the size and intensity of the specular highlight. As you increase the value, the highlight gets smaller and the material appears shinier. Default=25.

Glossiness also controls the strength of reflection maps assigned to a Strauss material.

Click the map button to assign a map to the glossiness component. See [Glossiness Mapping](#) on page 5467. This button is a shortcut: you can also assign glossiness mapping in the [Maps](#) on page 5414 rollout.

Metalness Changes the metallic appearance of a material. Increasing the Metalness value increases the metallic appearance, with glancing as well as primary highlights. Because a metallic appearance principally depends on highlights, the Metalness value has little effect unless you also increase the Glossiness value. Default=0.

TIP When you create a metal material, make sure the [backlight](#) on page 5329 is on in the sample slot.

Opacity Sets the opacity/transparency of the material as a percentage. The effect is best previewed against a [pattern background](#) on page 5329 in the sample slot. You can control [opacity falloff](#) on page 8068 in the Extended Parameters. Default=100.

Click the map button to assign a map to the opacity component. See [Opacity Mapping](#) on page 5470. This button is a shortcut: you can also assign opacity mapping in the [Maps rollout](#) on page 5414.

Highlight graph This curve shows the effect of adjusting the value of Glossiness. As you decrease Glossiness, the curve grows shorter; as you increase it, the curve grows taller.

Translucent Shader

Material Editor > Standard material > Shader Basic Parameters rollout > Translucent shader > Translucent Basic Parameters rollout



The bust on the right has been made translucent.

Translucent shading is similar to Blinn shading, but it also lets you specify translucency. A translucent object allows light to pass through, and also scatters light within the object. You can use translucency to simulate frosted and etched glass.

Translucency is inherently a two-sided effect: with the translucent shader, backface illumination appears on front faces. To generate translucency, both sides of the material receive diffuse light, though only one side is visible in renderings and shaded viewports unless you turn on 2-Sided (in the Shader Basic Parameters rollout).

If you use [radiosity](#) on page 6168, it will process light transmitted by translucency. The accuracy of this depends on the mesh: the more subdivided the faces are, the more accurate the solution will be (at a cost of processing time).

For specular highlights, you have a choice: to model materials like translucent plastic, you can choose to have highlights on both sides; to model materials like frosted glass, which is reflective on one side only, you can choose to have highlights on only one side. This is controlled by the Backside Specular toggle in the translucent highlight controls.

TIP To simulate frosted glass, a fine-grained bump map can also help.

The translucent effect appears only in renderings. It does not appear in shaded viewports.

NOTE The translucent shader does *not* simulate the scattering of light within the object. Because of this, it is better at simulating thin objects such as glass or paper, than at thick objects. For thicker objects, the light passing through might saturate excessively. To avoid this, try reducing the HSV Value of the material's Translucent Color.

Translucent materials also capture shadows cast on the backfaces of the material. However, because the translucent shader doesn't scatter light, for thicker objects the effect is not an accurate simulation of real-world translucency.

WARNING Do not use shadow maps with the translucent shader. Shadow maps result in artifacts at the edge of translucent objects.

See also:

- [Shader Basic Parameters Rollout](#) on page 5397
- [Basic Parameters Rollout \(Standard Material\)](#) on page 5406
- [Translucency Setting](#) on page 5447
- [Translucent Highlights](#) on page 5457

Basic Parameters for Standard Materials

Color Controls

Material Editor > Standard material > Anisotropic, Blinn, Metal, Multi-Layer, Oren-Nayar-Blinn, or Phong Basic Parameters rollout > First group in the rollout (unlabeled)

Color controls set the colors for different color components. You can set the color by clicking the color swatch to display the [Color Selector](#) on page 391.

NOTE The Metal shader does not have a Specular component, because it generates the specular color automatically. The Multi-Layer shader can have two different Specular color components, so for this material the Specular color swatches are found in the Specular Highlights group. The Strauss shader has only a single color component, which corresponds to Diffuse.

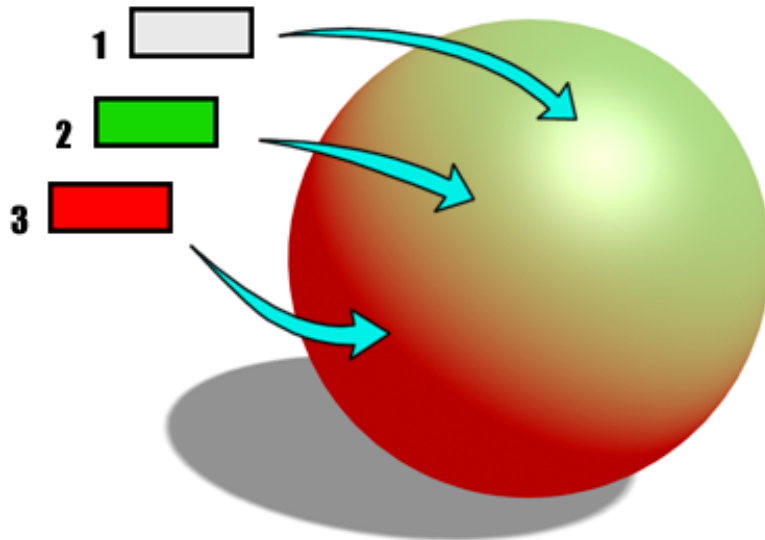

1. Specular color
2. Diffuse color
3. Ambient color

Copying and Locking Color Components

For convenience in changing color components, the Material Editor lets you copy one color component to another by dragging, and to lock two color components together with the lock buttons to the left of the Ambient and Diffuse, and Diffuse and Specular color swatches.

When you drag and drop a color swatch, the [Copy or Swap Colors dialog](#) on page 5366 asks if you want to copy the color or swap the two colors.

In general, materials with two identical color components do not look realistic, and except for materials that are close to solid black, you should avoid using

copied or locked color components in materials you use in a scene. Color copying and locking are best used as conveniences when you design a new basic material.

Shortcut Map Buttons

The small buttons to the right of the color swatches access the [Material/Map Browser](#) on page 5357, where you select a map for that component. These buttons are shortcuts: you can also use the corresponding buttons in the [Maps rollout](#) on page 5414. If you have assigned a map to one of these color components, the button displays the letter M. An uppercase M means that the corresponding map is assigned and active. A lowercase m means that the map is assigned and inactive (turned off).



The lock button to the right of the Diffuse map button locks Ambient mapping to Diffuse mapping. It is on by default. Usually it makes sense to use the same map for the ambient and diffuse components. To use different maps for ambient and diffuse, turn off the lock button. A map shortcut button for Ambient appears.

Procedures

To change a color component:

- 1 Click the color swatch next to the color component you want to change. The Material Editor displays a [Color Selector](#) on page 391. Right-clicking the color swatch also displays the Color Selector.
- 2 Use the Color Selector to change the values of the color component. As you change color values, the color component also changes in the sample slot.

To copy one color component to another:

- 1 Drag the color swatch of the color you want to copy to the color swatch of the other color component. A [Copy or Swap Colors dialog](#) on page 5366 is displayed.
- 2 Click Copy to replace the second color swatch with the color you dragged. Click Swap to swap the two color components.

To lock two color components:

- 1  Click the lock button between Ambient and Diffuse or between Diffuse and Specular.

The Material Editor displays an alert that asks whether you want to lock the two color components.

- 2 Click Yes.

The color above replaces the color below. In other words, Ambient replaces Diffuse and Diffuse replaces Specular.

If two colors are locked, and you lock the other two, all three component colors are replaced by the active color.

While two colors are locked, adjustments to one color component affect the other as well.

To unlock two color components:

-  Click the lock button to turn it off.

The two colors remain the same until you change one of them, or both.

Interface

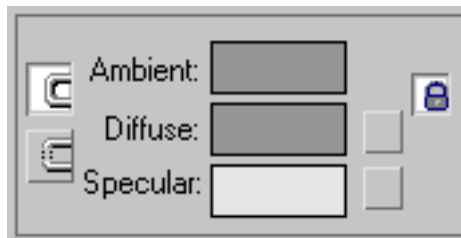

Ambient Controls the [ambient color](#) on page 7906. The ambient color is the color in shadow (indirect light).

Diffuse Controls the [diffuse color](#) on page 7955. The diffuse color is the color in direct light.

Specular Controls the [specular color](#) on page 8133. The specular color is the color of the highlight on a shiny object. You can control the size and shape of highlights in the Specular Highlights group, described below.

Self-Illumination Setting

Material Editor > Standard material > Anisotropic, Blinn, Metal, Multi-Layer, Oren-Nayar-Blinn, or Phong Basic Parameters rollout > Self-Illumination group

These controls make the material [self illuminated](#) on page 8122. Self-illumination creates the illusion of incandescence by replacing shadows on the surface with the diffuse color. As you increase self-illumination, the self-illumination color takes over from the ambient color. At a setting of 100, the material shows no shaded areas, although it can show specular highlights.

The self-illumination color appears in viewports. (In releases prior to 3ds Max 5,, viewports showed the self-illumination value but not the color.)

NOTE The [Strauss shader](#) on page 5431 does not have self-illumination.

There are two ways to specify self-illumination. You can turn on the check box and use a self-illumination color, or turn off the check box and use a monochrome spinner, which is comparable to using a gray scale self-illumination color.

Self-illuminated materials do not show shadows cast onto them, and they are unaffected by the lights in the scene. The brightness (Value in the [HSV color description](#) on page 8105) remains the same regardless of the scene's lighting.

To make a visible light source in a scene, you can combine a geometric object with a light object, and give the geometric object a self-illuminating surface. For example, you could create a lofted light bulb shape, assign it a self-illuminating white or yellowish material, and place an omni light in the same location.

To make a material both self-illuminating and transparent, use the Additive transparency type in combination with self-illumination. See [Extended Parameters](#) on page 5408.

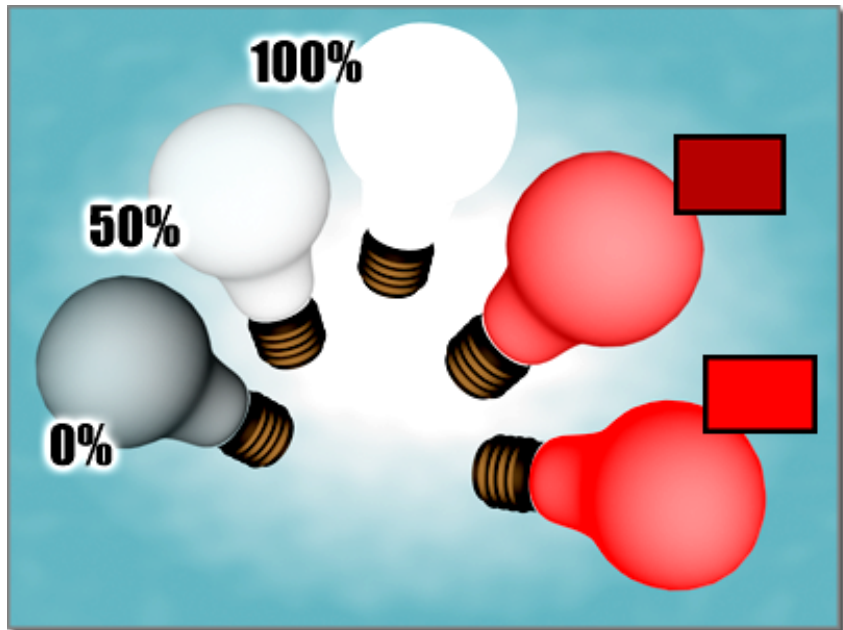

A self-illuminated object using a percentage value and a color

Procedures

To make a material self-illuminating:

- 1 Click the color swatch in the Self-Illumination group.
- 2 In the [Color Selector](#) on page 391, choose a color for self-illumination.
- 3 Use the color's Value parameter (in the HSV model) to increase or decrease the amount of [self-illumination](#) on page 8122.

You can also set self-illumination with a monochrome spinner. To do so, turn off the self-illumination check box and adjust the spinner.

The self-illumination color is mixed with the material's diffuse color. The closer to black the self-illumination color, the more diffuse color is used.

As self-illumination increases, the sample object appears flatter and more luminous.

Interface

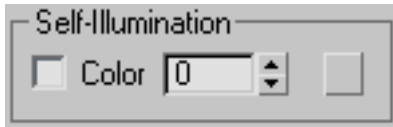

Color check box When on, the material uses a special self-illumination color. When off, the material uses the diffuse color for self-illumination, and displays a spinner to control the self-illumination amount. Default=off.

Color swatch When Color is on, the color swatch shows the self-illumination color. To change the color, click the swatch and then use the [Color Selector](#) on page 391. Adjusting the Value (in the color's [HSV description](#) on page 8105) adjusts the amount of self-illumination. The greater the Value, the more the self-illumination color dominates both the ambient and diffuse color components.

Mono spinner When Color is off, the diffuse component is used as the self-illumination color, and this spinner lets you adjust the amount of self-illumination. At 0, there is no self-illumination. At 100, the diffuse color takes over from the ambient color.

Click the map button to assign a map to the self-illumination component. See [Self-Illumination Mapping](#) on page 5469. This button is a shortcut: you can also assign self-illumination mapping in the [Maps rollout](#) on page 5414.

Opacity

Material Editor > Standard material > Anisotropic, Blinn, Metal, Multi-Layer, Oren-Nayar-Blinn, or Phong Basic Parameters rollout > Opacity group (unlabeled)

Opacity controls whether a material is opaque, transparent, or translucent. (A more physically accurate way to generate translucency is to use the [Translucent shader](#) on page 5434.)

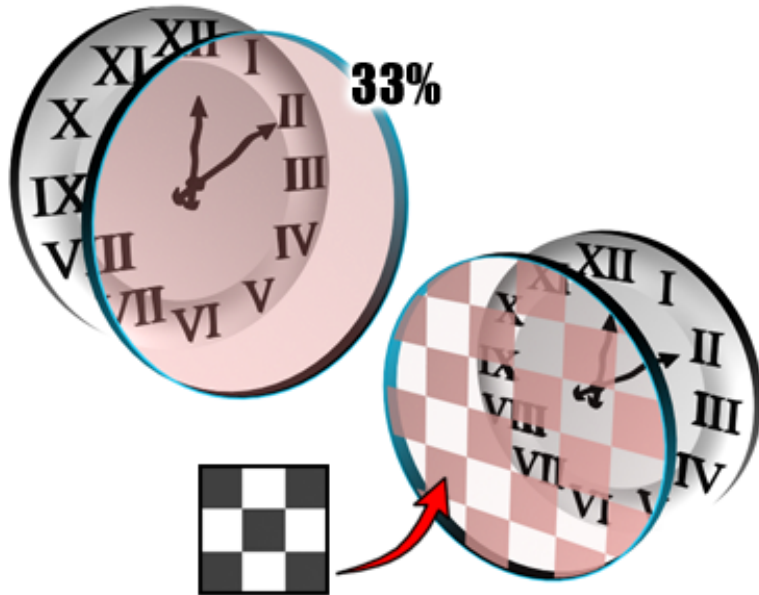

Controlling opacity using the Opacity setting (left) or an opacity map (right).

Procedures

To reduce a material's opacity:

- Change Opacity to a value less than 100%. The material becomes more transparent. A fully transparent object (0% Opacity) is nearly invisible except for the light it reflects (the specular highlights).

To preview transparency in the sample slots, view the sample object against a background. Click the checkered [Background button](#) on page 5329 to the right of the sample slots.

Transparent materials render more realistically when you turn on 2-Sided in the material's [Shader Basic Parameters](#) on page 5397.

Interface

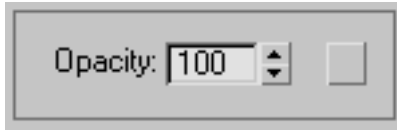

Opacity Sets the opacity/transparency of the material as a percentage. The effect is best previewed against a [pattern background](#) on page 5329 in the sample slot. You can control [opacity falloff](#) on page 8068 in the Extended Parameters. Click the map button to assign a map to the opacity component. See [Opacity Mapping](#) on page 5470. This button is a shortcut: you can also assign opacity mapping in the [Maps rollout](#) on page 5414.

Diffuse Level

Material Editor > Standard material > Anisotropic, Multi-Layer, or Oren-Nayar-Blinn Basic Parameters rollout > Diffuse Level group (unlabeled) or Advanced Diffuse group

Diffuse Level controls the brightness of the material's diffuse component.

NOTE The Blinn, Metal, Phong, and Strauss shaders do not have Diffuse Level control.

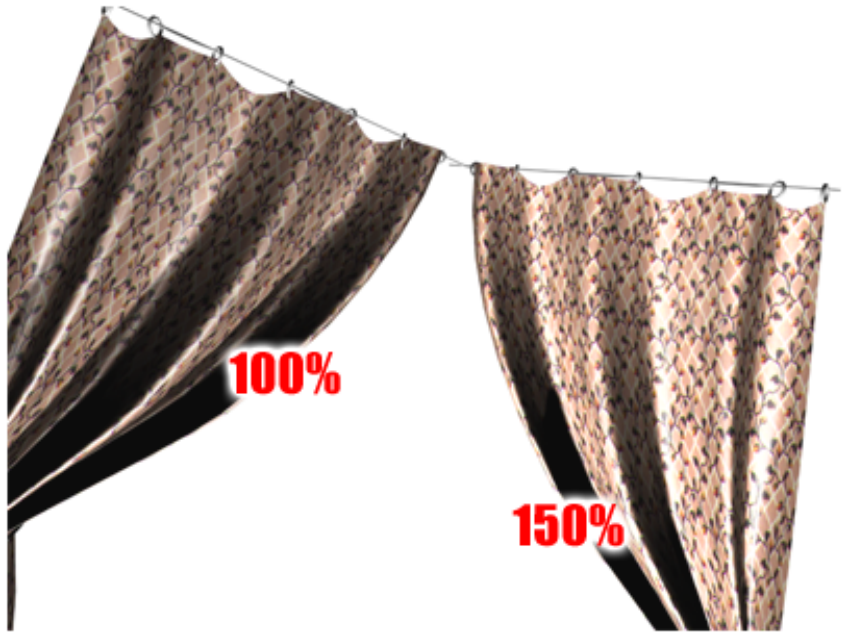

Adjusting diffuse level

Procedures

To adjust the diffuse level:

- Change the value of Diffuse Level.
The material grows lighter or darker. Lowering the Diffuse Level dims the material's diffuse color without affecting the specular highlight. Diffuse Level is intended primarily so you can create a [map](#) on page 5462 that makes portions of the material very dark.

Interface

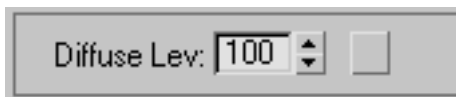

Diffuse Level Increasing this value increases diffuse brightness, and decreasing it reduces diffuse brightness without affecting the specular highlight. You can increase the diffuse level over and above the diffuse color's Value (in its [HSV description](#) on page 8105). This parameter can range from 0 to 400. Default=100. Click the map button to assign a map to the diffuse level parameter. See [Diffuse Level Mapping](#) on page 5462. This button is a shortcut: you can also assign diffuse level mapping in the [Maps rollout](#) on page 5414.

Roughness

Material Editor > Standard material > Multi-Layer or Oren-Nayar-Blinn Basic Parameters rollout > Advanced Diffuse group (unlabeled for Multi-Layer)

Roughness controls the rate at which the diffuse component blends into the ambient component.

NOTE The Roughness parameter is available only with the [Oren-Nayar-Blinn](#) on page 5429 and [Multi-Level](#) on page 5428 shaders, and with the [Arch & Design material \(mental ray\)](#) on page 5544.

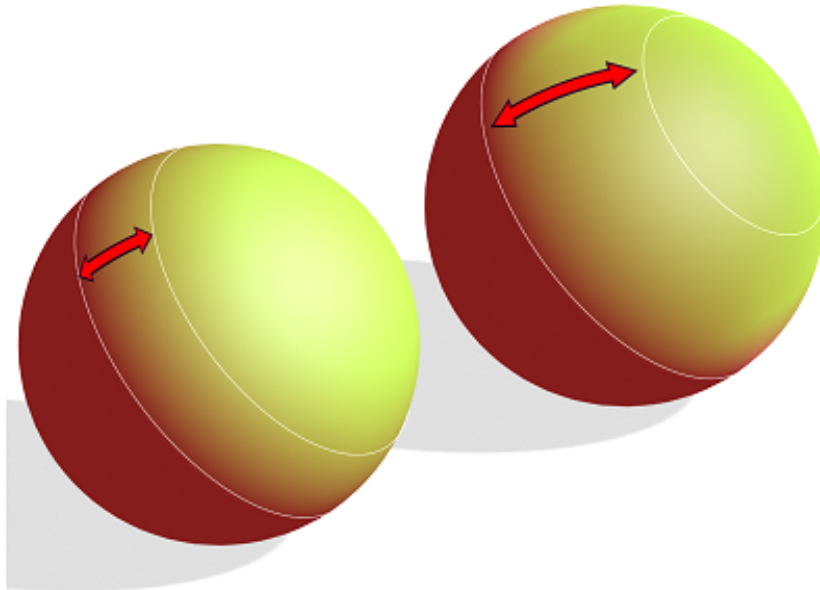

Increasing the blending area between ambient and diffuse with Roughness

Procedures

To adjust the roughness:

- Change the value of Roughness.
Increasing roughness makes the material have a flatter, more matte appearance.

Interface



Roughness As you increase this value, the matte appearance of the material increases. It also grows darker and appears more flat. At 0, the roughness is the same as it is with [Blinn shading](#) on page 5426. Range (Oren-Nayar-Blinn and Multi-Layer)=0 to 100. Range (Arch & Design material)=0.0 to 1.0. Default=0. Click the map button to assign a map to Roughness. This button is a shortcut: you can also assign Diffuse Roughness mapping on the [Maps rollout](#) on page 5414 (Oren-Nayar-Blinn and Multi-Layer) or [General Maps rollout](#) on page 5579 (Arch & Design material). See [Diffuse Roughness Mapping](#) on page 5464.

Translucency Setting

Material Editor > Standard material > Shader Basic Parameters rollout > Translucent shader > Translucent Basic Parameters rollout > Translucency group

The translucency controls are available for the [Translucent shader](#) on page 5434.

WARNING Do not use shadow maps with the translucent shader. Shadow maps result in artifacts at the edge of translucent objects.

Procedures

To make a material translucent:

- Increase the [HSV Value \(V\)](#) on page 8105 of the Translucent Color. As the Value increases, the material becomes more translucent. The Hue of the Translucent Color tints the light that is scattered within the material.

Translucent materials render more realistically when you turn on 2-Sided in the material's [Shader Basic Parameters](#) on page 5397. The translucent effect does not appear in shaded viewports.

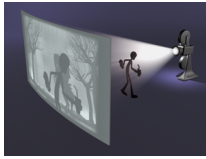

Example of translucency

Interface



Translucent Clr (Color) Specifies a translucency color. This is the color of light that is scattered within the material. It does not need to be the same as the filter color, which is light transmitted by the material. The two color values are multiplied. Click the color swatch to change the translucent color. Click the button to assign a map to the translucent color component.

Filter Color Specifies a [filter color](#) on page 7976 that is multiplied by the translucent color. Click the color swatch to change the filter color. Click the button to assign a map to the filter color component.

The filter, or transmissive color, is the color transmitted through transparent or semi-transparent materials such as glass. You can use the filter color with volumetric lighting to create effects such as colored light through a stained-glass window. [Ray-traced shadows](#) on page 8103 cast by transparent objects are tinted with the filter color.

Opacity Sets the [opacity/transparency](#) on page 5442 of the material as a percentage. The effect is best previewed against a [pattern background](#) on page 5329 in the sample slot.

Click the map button to assign a map to the opacity component. See [Opacity Mapping](#) on page 5470. This button is a shortcut: you can also assign opacity mapping in the [Maps rollout](#) on page 5414.

Specular Highlight Controls

Anisotropic Highlights

Material Editor > Standard material > Anisotropic Basic Parameters rollout > Specular Highlight group

Material Editor > Raytrace material > Raytrace Basic Parameters rollout > Shading: Anisotropic > Specular Highlight group

Anisotropic highlights are good for modeling hair, glass, or brushed metal.

NOTE For the [Raytrace material](#) on page 5490, the Specular Color component appears in the Specular Highlight group. Also, highlight controls that don't pertain to the current shader are labeled "N / A."

Procedures

To increase or decrease the size of a highlight:

- Change the Glossiness value.
The width of the Highlight curves and the highlights in the preview change. At 0% glossiness, the curves are at their maximum width. At 100% glossiness, both curves are extremely narrow.

To increase or decrease the strength of a highlight:

- Change the value of Specular Level.
The intensity of the Highlight curves and the highlights in the preview change. At 0% specular level, there is no highlight. At 100% specular level, the curves are at their maximum height with no overloading. At values greater than 100%, the curves are overloaded: they grow wider, and a wider area is at the maximum highlight intensity.

The shape of the Highlight curves affects the blending between the specular and diffuse color regions of the material. The steeper the curve, the less blending there is and the sharper the edge of the specular highlight.

To adjust the shape (anisotropy) of the highlight:

- Change the value of Anisotropy.
The width of the white highlight curve and the highlights in the preview change. At 0% anisotropy, both highlight curves are the same and the

highlight is circular, as in Blinn and Phong shading. At 100% anisotropy, the white highlight curve and the highlights are extremely narrow.

To adjust the orientation of the highlight:

- Change the value of Orientation.
Highlights in the preview show the change in orientation. The display of the highlight curve does not change.

Interface

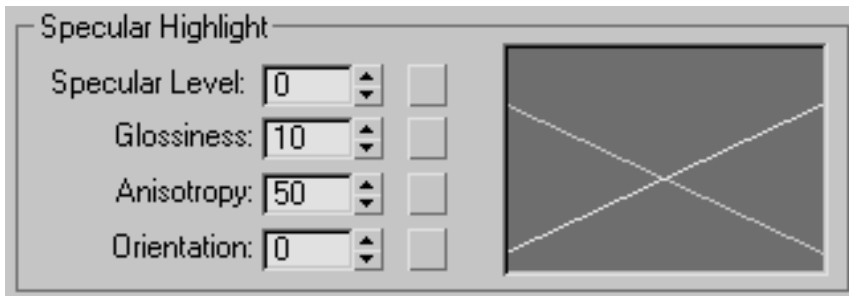

Specular Level Affects the intensity of the specular highlight. As you increase the value, the highlight grows brighter. Default=5.

Click the map button to assign a map to the specular level component. See [Specular Level Mapping](#) on page 5466. This button is a shortcut: you can also assign specular level mapping in the [Maps rollout](#) on page 5414.

Glossiness Affects the size of the specular highlight. As you increase the value, the highlight gets smaller and the material appears shinier. Default=25.

Click the map button to assign a map to the glossiness component. See [Glossiness Mapping](#) on page 5467. This button is a shortcut: you can also assign specular level mapping in the [Maps rollout](#) on page 5414.

Anisotropy Controls the anisotropy, or shape, of the highlight. At 0, the highlight is round. At 100, the highlight is extremely narrow. One axis of the Highlight graph changes to show changes in this parameter. Default=50.

Orientation Changes the orientation of the highlight. The sample slot shows changes in orientation. This is a value in degrees that can range from 0 to 9,999. Default=0.

Highlight graph These two intersecting curves show the effect of adjusting the values of Specular Level, Glossiness, and Anisotropy. As you decrease Glossiness, the curves grow wider; as you increase Specular Level, the curves

grow taller. As you adjust Anisotropy, the white curve changes to show how wide or narrow the highlight is.

Blinn, Oren-Nayar-Blinn, and Phong Highlights

Material Editor > Standard material > Blinn, Oren-Nayar-Blinn, or Phong Basic Parameters rollout > Specular Highlight group

Material Editor > Raytrace material > Raytrace Basic Parameters rollout > Shading: Blinn, Oren-Nayar-Blinn, or Phong > Specular Highlight group

The [Blinn](#) on page 5426, [Oren-Nayar-Blinn](#) on page 5429, and [Phong](#) on page 5430 shaders all have circular highlights and share the same highlight controls. Blinn and Oren-Nayar-Blinn highlights are somewhat softer and rounder than Phong highlights.

NOTE For the [Raytrace material](#) on page 5490, the Specular Color component appears in the Specular Highlight group. Also, highlight controls that don't pertain to the current shader are labeled "N/A."

Procedures

To increase or decrease the strength of a highlight:

- Change the value of Specular Level.

The intensity of the Highlight curve and the highlight in the preview change. At 0% specular level, there is no highlight. At 100% specular level, the curve is at its maximum height with no overloading. At values greater than 100%, the curve is overloaded: it grows wider, and a wider area is at the maximum highlight intensity.

The shape of the Highlight curve affects the blending between the specular and diffuse color regions of the material. The steeper the curve, the less blending there is and the sharper the edge of the specular highlight.

To increase or decrease the size of a highlight:

- Change the Glossiness value.

The width of the Highlight curve and the highlight in the preview change. At 0% glossiness, the curve is at its maximum width. At 100% glossiness, the curve is extremely narrow.

Interface

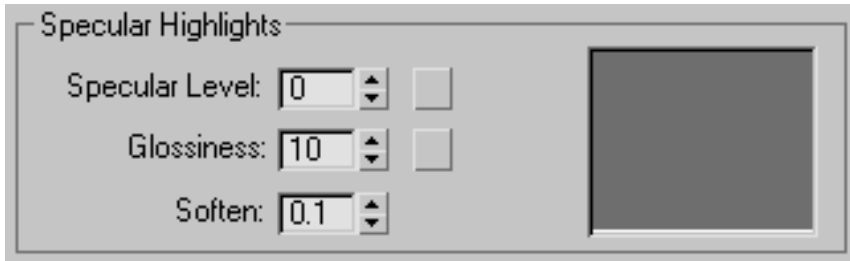

Specular Level Affects the intensity of the specular highlight. As you increase the value, the highlight grows brighter. Default=5.

Click the map button to assign a map to the specular level component. See [Specular Level Mapping](#) on page 5467. This button is a shortcut: you can also assign specular level mapping in the [Maps rollout](#) on page 5414.

Glossiness Affects the size of the specular highlight. As you increase the value, the highlight gets smaller and the material appears shinier. Default=25.

Click the map button to assign a map to the glossiness component. See [Glossiness Mapping](#) on page 5467. This button is a shortcut: you can also assign specular level mapping in the [Maps rollout](#) on page 5414.

Soften Softens the effect of specular highlights, especially those formed by glancing light. When Specular Level is high and Glossiness is low, you can get harsh backlights on surfaces. Increase the value of Soften to mitigate this effect. At 0, there is no softening. At 1.0, the maximum amount of softening is applied. Default=0.1.

NOTE The Soften control was a check box in releases prior to 3ds Max 2. When you load a material created in an earlier version of 3ds Max, if Soften was originally off, the new Soften value is 0.0. If Soften was originally on, the new Soften value is 0.6.

Highlight graph This curve shows the effect of adjusting the values of Specular Level and Glossiness. As you decrease Glossiness, the curve grows wider; as you increase Specular Level, the curve grows taller.

Metal Highlights

Material Editor > Standard material > Metal Basic Parameters rollout > Specular Highlight group

Material Editor > Raytrace material > Raytrace Basic Parameters rollout > Shading: Metal > Specular Highlight group

Metal-shaded materials generate their own specular color. Also, the highlight curve for the Metal shader differs in shape from the curve for [Blinn Oren-Nayar-Blinn, and Phong highlights](#) on page 5451.

NOTE For the [Raytrace material](#) on page 5490, the Specular Color component appears in the Specular Highlight group. Also, highlight controls that don't pertain to the current shader are labeled "N/A."

Procedures

To increase or decrease the size and intensity of a highlight:

- Change the Glossiness value.
The width of the Highlight curve and the highlights in the preview change. At 0% glossiness, the curve is at its maximum width. At 100% glossiness, the curve is extremely narrow.

To increase or decrease the strength of a highlight:

- Change the value of Specular Level.
The intensity of the Highlight curve and the highlight in the preview change. At 0% specular level, there is no highlight. At 100% specular level, the curve is at its maximum height with no overloading. At values greater than 100%, the curve is overloaded: it grows wider, and a wider area is at the maximum highlight intensity.

Increasing the Specular Level also dims the diffuse color.

The shape of the Highlight curve affects the blending between the specular and diffuse color regions of the material. The steeper the curve, the less blending there is and the sharper the edge of specular and glancing highlights.

Interface

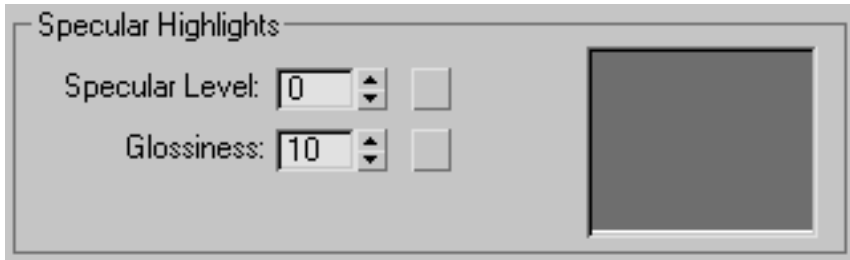

Specular Level Affects the intensity of the specular highlight. As you increase the value, the highlight grows brighter and the diffuse color grows dimmer. Default=5.

Click the map button to assign a map to the specular level component. See [Specular Level Mapping](#) on page 5466. This button is a shortcut: you can also assign specular level mapping in the [Maps](#) on page 5414 rollout.

Glossiness Affects the size of the specular highlight. As you increase the value, the highlight curve grows narrower and the highlight gets smaller. Default=25.

Click the map button to assign a map to the glossiness component. See [Glossiness Mapping](#) on page 5467. This button is a shortcut: you can also assign specular level mapping in the [Maps](#) on page 5414 rollout.

Highlight graph This curve shows the effect of adjusting the values of Specular Level and Glossiness. As you decrease Glossiness, the curve grows wider; as you increase Specular Level, the curve grows taller.

Multi-Layer Highlights

Material Editor > Standard material > Multi-Layer Basic Parameters rollout > First Specular Layer/Second Specular Layer groups

Multi-layer highlights consist of two layers, each of them anisotropic. The highlights are transparent to each other. Where they overlap, the Multi-Layer shader blends their colors.

Procedures

To increase or decrease the size of a highlight (specular) layer:

- Change the Glossiness value.

The width of the Highlight curves and the highlights in the preview change. At 0% glossiness, the curves are at their maximum width. At 100% glossiness, both curves are extremely narrow.

To increase or decrease the strength of a highlight (specular) layer:

- Change the value of Specular Level.

The intensity of the Highlight curves and the highlights in the preview change. At 0% specular level, there is no highlight. At 100% specular level, the curves are at their maximum height with no overloading. At values greater than 100%, the curves are overloaded: they grow wider, and a wider area is at the maximum highlight intensity.

The shape of the Highlight curves affects the blending between the specular and diffuse color regions of the material. The steeper the curve, the less blending there is and the sharper the edge of the specular highlight.

To adjust the shape (anisotropy) of a highlight (specular) layer:

- Change the value of Anisotropy.

The width of the white highlight curve and the highlights in the preview change. At 0% anisotropy, both highlight curves are the same and the highlight is circular, as in Blinn and Phong shading. At 100% anisotropy, the white highlight curve and the highlights are extremely narrow.

To adjust the orientation of a highlight (specular) layer:

- Change the value of Orientation.

Highlights in the preview show the change in orientation. The display of the highlight curve does not change.

Interface

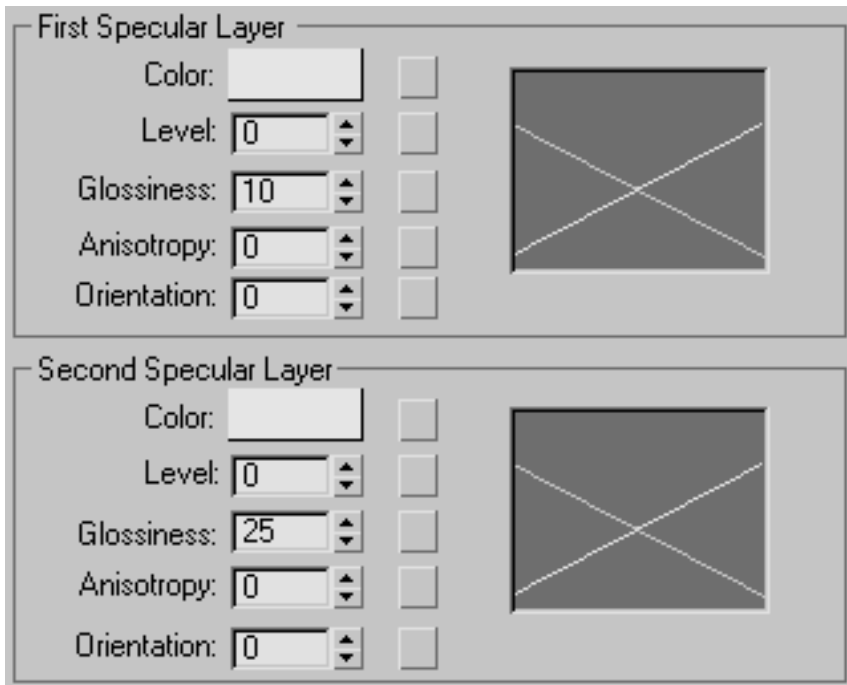

The First Specular Layer and Second Specular Layer groups have identical controls, which can have different settings.

Color Controls the [specular color](#) on page 8133 of this highlight. The specular color is the color of the highlight on a shiny surface.

Level Affects the intensity of this specular highlight. As you increase the value, the highlight grows brighter. Default: First layer=5, Second layer=0.

Click the map button to assign a map to the specular level component. See [Specular Level Mapping](#) on page 5466. This button is a shortcut: you can also assign specular level mapping in the [Maps rollout](#) on page 5414.

Glossiness Affects the size of this specular highlight. As you increase the value, the highlight gets smaller and the material appears shinier. Default=25.

Click the map button to assign a map to the glossiness component. See [Glossiness Mapping](#) on page 5467. This button is a shortcut: you can also assign specular level mapping in the [Maps rollout](#) on page 5414.

Anisotropy Controls the anisotropy, or shape, of this highlight. At 0, the highlight is round. At 100, the highlight is extremely narrow. One axis of the Highlight graph changes to show changes in this parameter. Default=0.

Orientation Changes the orientation of this highlight. The sample slot shows changes in orientation. This is a value in degrees that can range from 0 to 9,999. Default=0.

Highlight graph These two intersecting curves show the effect of adjusting the values of Level, Glossiness, and Anisotropy. As you decrease Glossiness, the curves grow wider; as you increase Specular Level, the curves grow taller. As you adjust Anisotropy, the white curve changes to show how wide or narrow the highlight is.

Translucent Highlights

Material Editor > Standard material > Translucent Basic Parameters rollout > Specular Highlight group

Like the Blinn shader, the Translucent shader has circular highlights.

Procedures

To increase or decrease the strength of a highlight:

- Change the value of Specular Level.
The intensity of the Highlight curve and the highlight in the preview change. At 0% specular level, there is no highlight. At values greater than 100%, the curve is overloaded: it grows wider, and a wider area is at the maximum highlight intensity. At 100% specular level, the curve is at its maximum height with no overloading.
The shape of the Highlight curve affects the blending between the specular and diffuse color regions of the material. The steeper the curve, the less blending there is and the sharper the edge of the specular highlight.

To increase or decrease the size of a highlight:

- Change the Glossiness value.
The width of the Highlight curve and the highlight in the preview change. At 0% glossiness, the curve is at its maximum width. At 100% glossiness, the curve is extremely narrow.

Interface

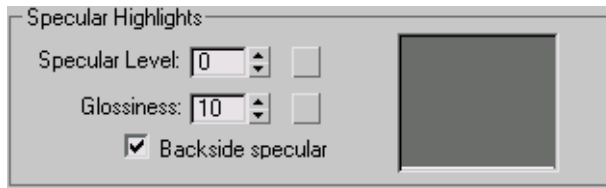

Specular Level Affects the intensity of the specular highlight. As you increase the value, the highlight grows brighter. Default=0.

Click the map button next to the spinner to assign a map to the specular level component. See [Specular Level Mapping](#) on page 5466. This button is a shortcut: you can also assign specular level mapping in the [Maps rollout](#) on page 5414.

Glossiness Affects the size of the specular highlight. As you increase the value, the highlight gets smaller and the material appears shinier. Default=10.

Click the map button next to the spinner to assign a map to the glossiness component. See [Glossiness Mapping](#) on page 5467. This button is a shortcut: you can also assign specular level mapping in the [Maps rollout](#) on page 5414.

Backside specular When on, both sides of the material receive a specular highlight. When off, only the front side of the material receives a highlight. Default=on.

Leave Backside Specular on to model materials like translucent plastic. Turn it off to model materials like frosted glass.

TIP When Backside Specular is turned off, the front side is always the one that receives a specular highlight. You can change this by reversing the normals of surfaces that have the translucent-shaded material.

Mapping Standard Material Components

Ambient Color Mapping

Material Editor > Standard material > Maps rollout > Ambient button

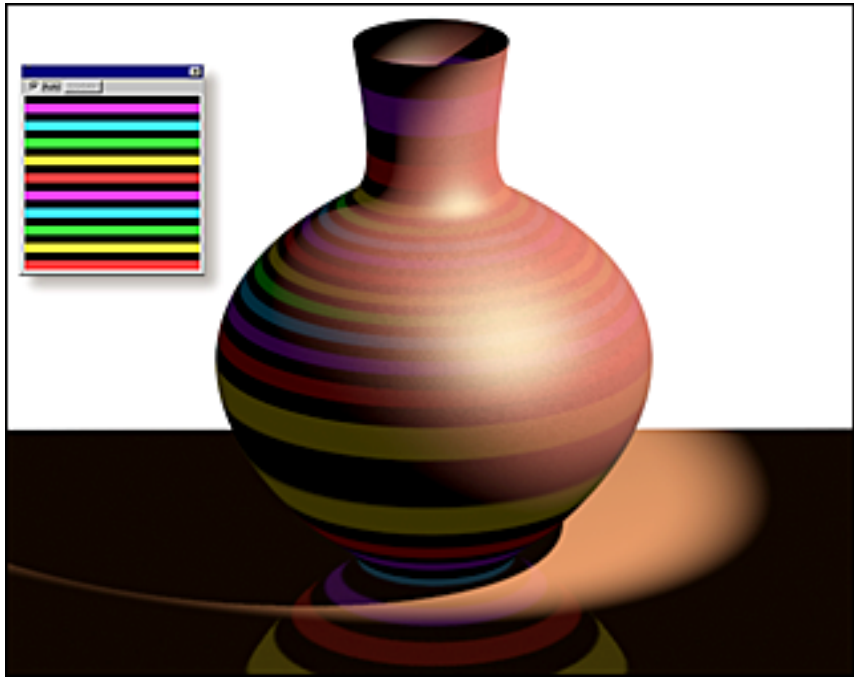

Mapping the ambient color

You can select a bitmap file or [procedural map](#) on page 8097 to map an image to the material's [ambient color](#) on page 7906. The image is painted on the shaded parts of the object.

By default, diffuse mapping maps the ambient component as well, so you seldom need to use a different map for diffuse and ambient components. If you do want to apply a separate ambient map, first click to turn off the lock button to the right of the long Map buttons in the [Maps rollout](#) on page 5414. This unlocks ambient and diffuse mapping. The Map button for ambient color becomes available. You can then click the ambient button to select a map.

NOTE Ambient color mapping is not visible in viewports or renderings unless the level of ambient light is greater than default value of black. Choose Rendering > Environment, then adjust the level of ambient light using the [Environment dialog](#) on page 6689.

Procedures

To map the ambient color:



- 1 Make sure the ambient and diffuse components have their maps unlocked. Click to turn off the lock button. The Map button for ambient color becomes available.
- 2 Click the Map button for Ambient color.
The [Material/Map Browser](#) on page 5357 is displayed.
- 3 Choose from the list of map types, and then click OK.
The Material Editor is now at the map level, and displays controls for the map parameters.
- 4 Use the map controls to set up the map.

Diffuse Color Mapping

Material Editor > Standard material > Maps rollout > Diffuse button (or Color button for the Strauss shader)

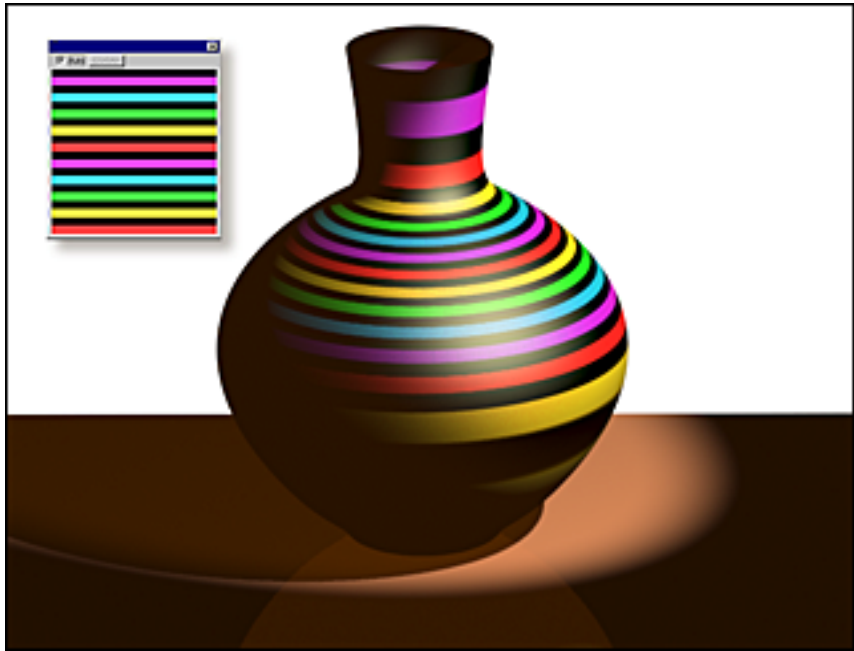

Applying a texture by mapping the diffuse color

You can select a bitmap file or [procedural map](#) on page 8097 to assign a pattern or texture to a material's [diffuse color](#) on page 7955. The colors of the map replace the material's diffuse color component. This is the most common kind of mapping.

Mapping the diffuse color is like painting an image on the surface of the object. For example, if you want a wall to be made out of brick, you can choose a map with an image of bricks, such as [Bricks](#) on page 5851.

By default, diffuse mapping applies the same map to the [ambient color](#) on page 7906 as well. You seldom need to use a different map for diffuse and ambient components.

It isn't strictly necessary to lock the ambient and diffuse maps. By turning the lock off and using a different map for each component, you can obtain interesting blend effects. But in general, the purpose of diffuse mapping is to simulate a single surface that is more complex than a basic material, and for this purpose the lock should be on.

Procedures

To map the diffuse color:

- 1 Make sure the ambient and diffuse components have their maps locked. This button is to the right of the map shortcut buttons for Ambient and Diffuse on the Basic Parameters rollout, and on the Maps rollout in a similar position. It is on by default. When it is on, the map button for the ambient color component is unavailable.
- 2 Click the Map button for Diffuse color.
The [Material/Map Browser](#) on page 5357 is displayed.
- 3 Choose from the list of map types, and then click OK.
The Material Editor is now at the map level, and displays controls for the map parameters.
- 4 Use the map controls to set up the map.

Diffuse Level Mapping

Material Editor > Standard material > Shader Basic Parameters rollout > Anisotropic, Oren-Nayar-Blinn, or Multi-Level shader > Maps rollout > Diffuse Level button

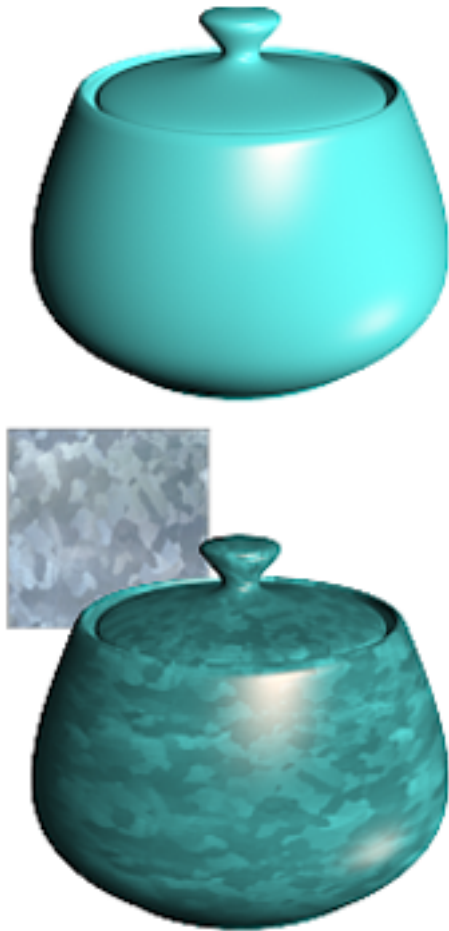

Mapping diffuse level

Top: No mapping

Bottom: Mapping diffuse level with a bitmap

You can select a bitmap file or [procedural map](#) on page 8097 to control the Diffuse Level parameter. White pixels in the map leave the diffuse level unchanged. Black pixels reduce the diffuse level to 0. Intermediate values adjust the diffuse level accordingly.

The diffuse level parameter is available with the [Anisotropic](#) on page 5424, [Oren-Nayar-Blinn](#) on page 5429, and [Multi-Level](#) on page 5428 shaders.

Reducing the Amount of the diffuse level map reduces the map's effect, and increases the effect of the Diffuse Level value on the Basic Parameters rollout. When the Amount is 0 percent, the map isn't used at all.

Procedures

To map the diffuse level value:

- 1 Click the Map button for Diffuse Level.
The [Material/Map Browser](#) on page 5357 is displayed.
- 2 Choose from the list of map types, and then click OK.
The Material Editor is now at the map level, and displays controls for the map parameters.
- 3 Use the map controls to set up the map.

Diffuse Roughness Mapping

Material Editor > Standard material > Shader Basic Parameters rollout > Oren-Nayar-Blinn or Multi-Level shader > Maps rollout > Diff. Roughness button

You can select a bitmap file or [procedural map](#) on page 8097 to control the Roughness parameter on the Basic Parameters rollout. White pixels in the map increase roughness. Black pixels reduce roughness to 0. Intermediate values adjust roughness accordingly.

NOTE The Roughness parameter is available only with the [Oren-Nayar-Blinn](#) on page 5429 and [Multi-Level](#) on page 5428 shaders, and with the [Arch & Design material \(mental ray\)](#) on page 5544.

Reducing the Amount of the Diffuse Roughness map reduces the map's effect, and increases the effect of the Roughness value on the Basic Parameters rollout. When the Amount is 0 percent, the map isn't used at all.

Procedures

To map the roughness value:

- 1 Click the Map button for Diffuse Roughness (Diff. Roughness).
The [Material/Map Browser](#) on page 5357 is displayed.

- 2 Choose from the list of map types, and then click OK.
The Material Editor is now at the map level, and displays controls for the map parameters.
- 3 Use the map controls to set up the map.

Specular Color Mapping

Material Editor > Standard material > Maps rollout > Specular button

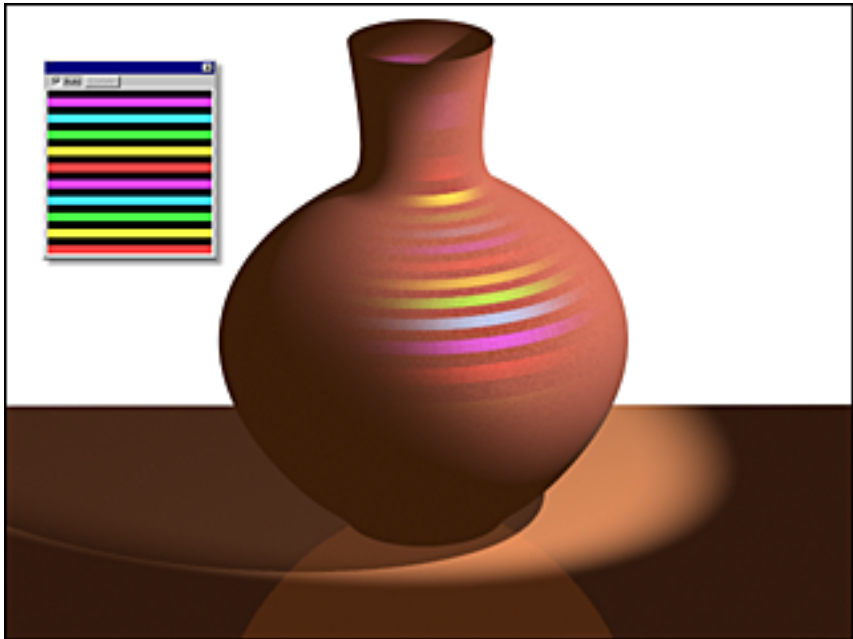

Mapping the specular highlight

You can select a bitmap file or [procedural map](#) on page 8097 to apply an image to the material's [specular color component](#) on page 8133. The map's image appears only in the specular highlight areas.

When the amount spinner is at 100, all specular color is provided by the map.

Specular mapping is used primarily for special effects such as placing an image in a reflection. The important thing to remember is that, unlike Specular Level or Glossiness mapping, which alter the *intensity and location* of specular highlights, specular mapping alters the *color* of specular highlights.

Procedures

To map the specular color:

- 1 Click the Map button for Specular color.
The [Material/Map Browser](#) on page 5357 is displayed.
- 2 Choose from the list of map types, and then click OK.
The Material Editor is now at the map level, and displays controls for the map parameters.
- 3 Use the map controls to set up the map.

Specular Level Mapping

Material Editor > Standard material > Maps rollout > Specular Level button



Mapping the specular level: the sea reflects more than the land.

You can select a bitmap file or [procedural map](#) on page 8097 to alter the intensity of specular highlights, based on the intensity of the bitmap. White pixels in

the map produce full specular highlights. Black pixels remove the specular highlights completely, and intermediate values reduce the specular highlights accordingly.

Mapping the specular level component is different from mapping specular color. Mapping the specular level alters the *intensity* of highlights, while specular mapping alters the *color* of highlights.

Specular level mapping usually works best when you assign the same map to both Specular Level and Glossiness. (In the [Maps](#) on page 5414 rollout, you can do this by dragging from one map button to another.)

Procedures

To map the specular level value:

- 1 Click the Map button for the Specular Level value.
The [Material/Map Browser](#) on page 5357 is displayed.
- 2 Choose from the list of map types, and then click OK.
The Material Editor is now at the map level, and displays controls for the map parameters.
- 3 Use the map controls to set up the map.

Glossiness Mapping

Material Editor > Standard material > Maps rollout > Glossiness button

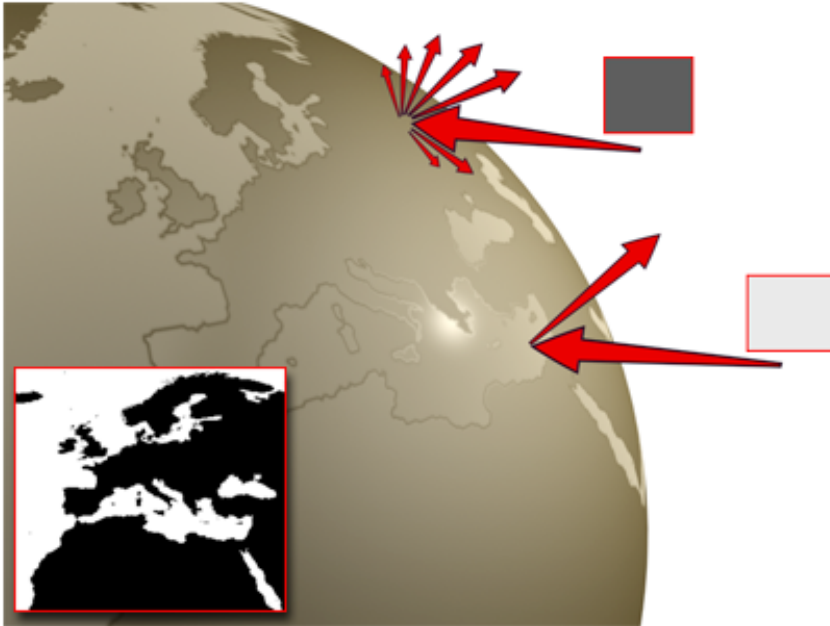

An object with glossiness mapping. The sea appears more reflective than the land.

You can select a bitmap file or [procedural map](#) on page 8097 that affects where specular highlights appear. A map assigned to glossiness determines which areas of the whole surface are more glossy and which areas are less glossy, depending on the intensity of colors in the map. Black pixels in the map produce full glossiness. White pixels remove glossiness completely, and intermediate values reduce the size of the highlight.

Mapping the glossiness component is different from mapping specular color. Mapping glossiness alters the *location* of highlights, while specular mapping alters the *color* of highlights.

Glossiness mapping usually works best when you assign the same map to both Glossiness and Specular Level. (In the Maps rollout, you can do this by dragging from one map button to the other.)

Procedures

To map the glossiness value:

- 1 Click the Map button for the Glossiness value.
The [Material/Map Browser](#) on page 5357 is displayed.

- 2 Choose from the list of map types, and then click OK.
The Material Editor is now at the map level, and displays controls for the map parameters.
- 3 Use the map controls to set up the map.

Self-Illumination Mapping

Material Editor > Standard material > Maps rollout > Self-Illumination button



Mapping self-illumination

You can select a bitmap file or [procedural map](#) on page 8097 to map the [self-illumination](#) on page 8122 value. This makes portions of an object appear to glow. White areas of the map render as fully self illuminating. Black areas render with no self-illumination. Gray areas render as partially self illuminating, depending on the grayscale value.

Self-illumination means that the glowing area is not affected by lights in the scene (its ambient color component goes away), and does not receive shadows.

Procedures

To map the self-illumination value:

- 1 Click the Map button for Self-Illumination.
The [Material/Map Browser](#) on page 5357 is displayed.
- 2 Choose from the list of map types, and then click OK.
The Material Editor is now at the map level, and displays controls for the map parameters.
- 3 Use the map controls to set up the map.

Opacity Mapping

Material Editor > Standard material > Maps rollout > Opacity button

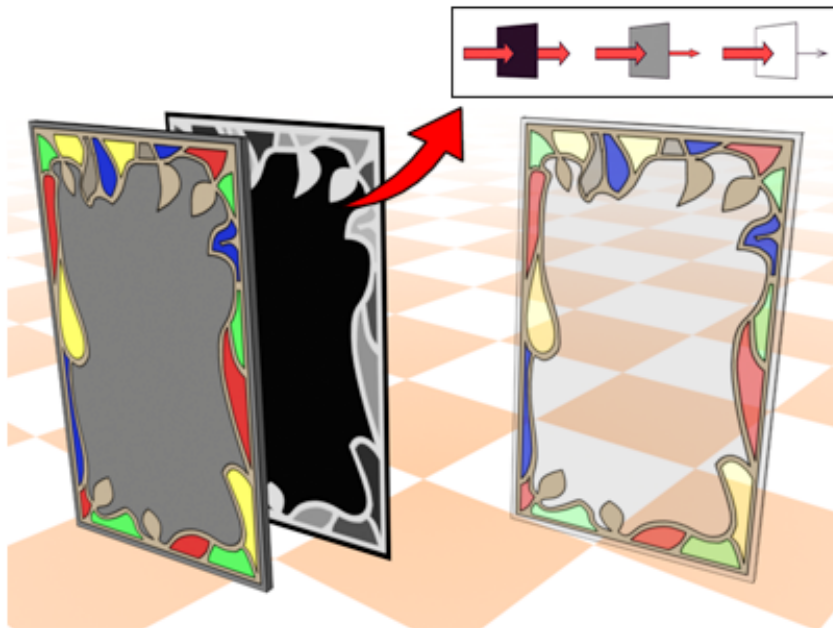

The gray levels of an opacity map determine the amount of opacity.

You can select a bitmap file or [procedural map](#) on page 8097 to make an object partially transparent. Lighter (higher-value) areas of the map render as opaque; darker areas render as transparent; and values in between are semi-transparent.

Setting the opacity map's Amount to 100 applies all of the map. Transparent areas are fully transparent. Setting the Amount to 0 is the equivalent of turning the map off. Intermediate Amount values are blended with the Opacity value on the Basic Parameters rollout. Transparent areas of the map become more opaque.

Specular highlights are applied to transparent areas of the opacity map, as well as to opaque areas, creating the effect of glass. If you want the transparent areas to look like holes, map the [specular level](#) on page 5467 as well.

Procedures

To map the opacity value:

- 1 Click the Map button for Opacity.
The [Material/Map Browser](#) on page 5357 is displayed.
- 2 Choose from the list of map types, and then click OK.
The Material Editor is now at the map level, and displays controls for the map parameters.
- 3 Use the map controls to set up the map.

Filter Color Mapping

Material Editor > Standard material > Maps rollout > Filter Color button

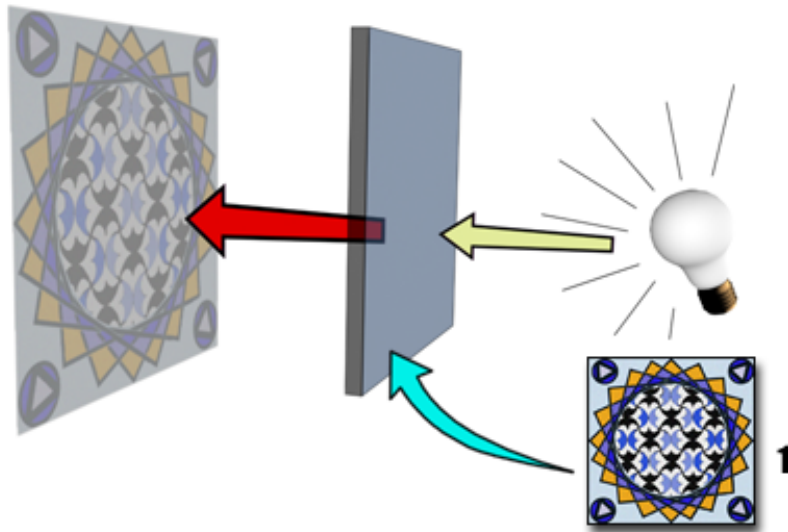

Mapping filter color

The filter, or transmissive color, is the color transmitted through transparent or semi-transparent materials such as glass.

You can select a bitmap file or [procedural map](#) on page 8097 to map the filter color component. This map applies a transparent-color effect based on the intensity of the map's pixels.

You can combine a mapped filter color with [volumetric lighting](#) on page 6721 to create effects such as colored light through a stained-glass window. [Ray-traced shadows](#) on page 8103 cast by transparent objects are tinted by the filter color.

Procedures

To map the filter color:

- 1 Click the Map button for Filter color.
The [Material/Map Browser](#) on page 5357 is displayed.
- 2 Choose from the list of map types, and then click OK.

The Material Editor is now at the map level, and displays controls for the map parameters.

- 3 Use the map controls to set up the map.

Anisotropy Mapping

Material Editor > Standard material > Shader Basic Parameters rollout > Anisotropic or Multi-Level shader > Maps rollout > Anisotropy button

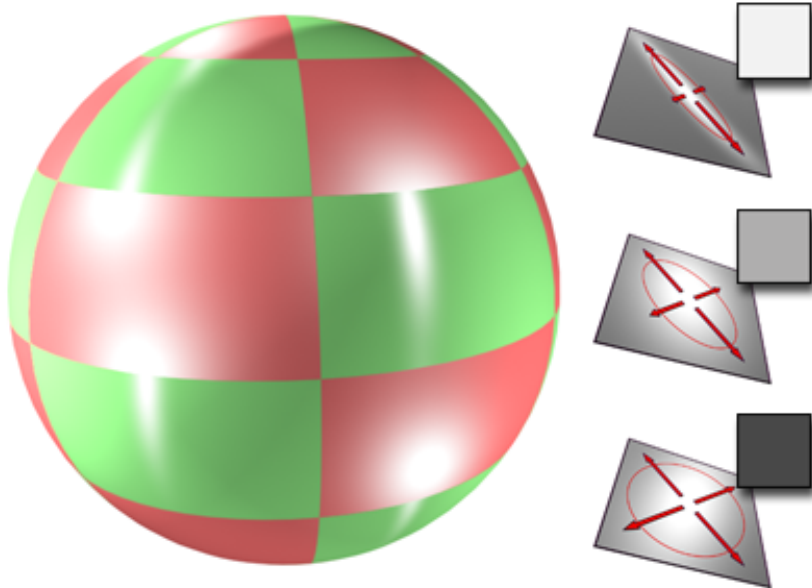

Mapping anisotropy. The stretch of the highlight depends on the level of gray in the map.

You can select a bitmap file or [procedural map](#) on page 8097 to control the Anisotropy parameter. The map controls the shape of the anisotropic highlight, roughly (but not necessarily) within the area specified by the glossiness parameter. Black and white values have little effect. Maps with a good deal of grayscale values, such as [Noise](#) on page 5886 or [Falloff](#) on page 5877, can be very effective.

The anisotropy parameter is available with the [Anisotropic](#) on page 5424 and [Multi-Level](#) on page 5428 shaders.

The effect of mapping anisotropy is not very apparent unless the specular level is fairly high and glossiness is fairly low.

Reducing the Amount of the anisotropy map reduces the map's effect, and increases the effect of the Anisotropy value on the Basic Parameters rollout. When the Amount is 0 percent, the map isn't used at all.

Procedures

To map the anisotropy value:

- 1 Click the Map button for Anisotropy.
The [Material/Map Browser](#) on page 5357 is displayed.
- 2 Choose from the list of map types, and then click OK.
The Material Editor is now at the map level, and displays controls for the map parameters.
- 3 Use the map controls to set up the map.

Orientation Mapping

Material Editor > Standard material > Shader Basic Parameters rollout > Anisotropic or Multi-Level shader > Maps rollout > Orientation button

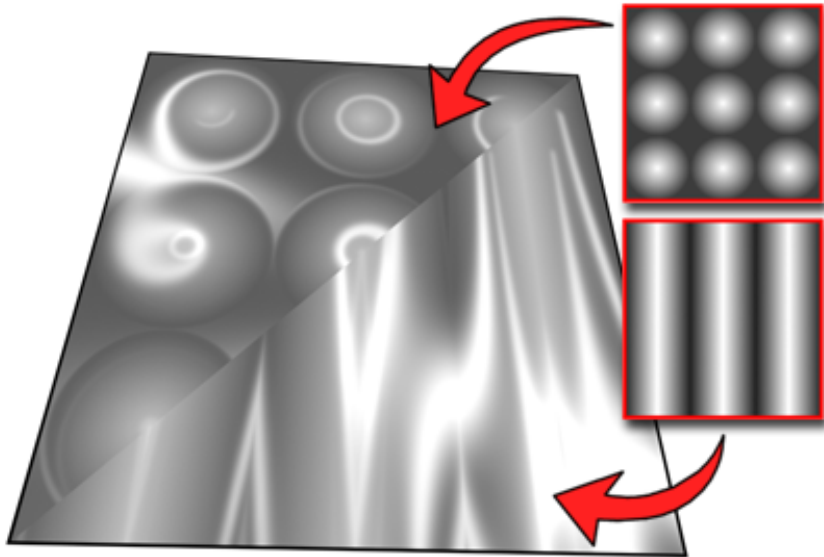

Mapping anisotropy orientation

You can select a bitmap file or [procedural map](#) on page 8097 to control the Orientation parameter. Orientation controls the position of the anisotropic highlight. Mapping orientation changes the highlight's position. Black and white values have little effect. Maps with a good deal of grayscale values, such as [Noise](#) on page 5886 or [Falloff](#) on page 5877, can be very effective. You can also get a good effect using the same map for orientation mapping and [bump mapping](#) on page 5478.

The orientation parameter is available with the [Anisotropic](#) on page 5424 and [Multi-Level](#) on page 5428 shaders.

Reducing the Amount of the orientation map reduces the map's effect, and increases the effect of the Orientation value on the Basic Parameters rollout. When the Amount is 0 percent, the map isn't used at all.

The effect of mapping orientation, like anisotropy, is not very apparent unless the specular level is fairly high and glossiness is fairly low.

TIP Using an instance of the same map to control both anisotropy and orientation can give you good control over anisotropic highlights.

Procedures

To map the orientation value:

- 1 Click the Map button for Orientation.
The [Material/Map Browser](#) on page 5357 is displayed.
- 2 Choose from the list of map types, and then click OK.
The Material Editor is now at the map level, and displays controls for the map parameters.
- 3 Use the map controls to set up the map.

Metalness Mapping

Material Editor > Standard material > Shader Basic Parameters rollout > Strauss shader > Maps rollout > Metalness button

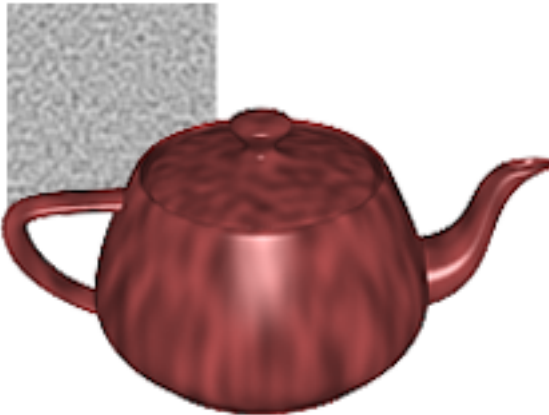

Mapping metalness

Top: No mapping

Bottom: Mapping metalness with noise map

You can select a bitmap file or [procedural map](#) on page 8097 to control the Metalness parameter. White pixels in the map increase metalness. Black pixels reduce metalness to 0. Intermediate values adjust metalness accordingly.

The metalness parameter is available with the [Strauss shader](#) on page 5431.

Reducing the Amount of the metalness map reduces the map's effect, and increases the effect of the Metalness value on the Basic Parameters rollout. When the Amount is 0 percent, the map isn't used at all.

Procedures

To map the metalness value:

- 1 Click the Map button for Metalness.
The [Material/Map Browser](#) on page 5357 is displayed.
- 2 Choose from the list of map types, and then click OK.
The Material Editor is now at the map level, and displays controls for the map parameters.
- 3 Use the map controls to set up the map.

Bump Mapping

Material Editor > Standard material > Maps rollout > Bump button



An object with two different bump maps.

You can select a bitmap file or [procedural map](#) on page 8097 to use for bump mapping. Bump mapping makes an object appear to have a bumpy or irregular

surface. When you render an object with a bump-mapped material, lighter (whiter) areas of the map appear to be raised, and darker (black) areas appear to be low.

NOTE The effect of a bump map is not previewed in viewports. You must render the scene to see the bump effect.

Bump mapping uses the intensity of the map to affect the surface of the material. In this case, the intensity affects the apparent bumpiness of the surface: white areas protrude, and black areas recede.

Use bump maps when you want to take the smoothness off a surface, or to create an embossed look. Keep in mind, however, that the depth effect of a bump map is limited. If you want extreme depth in a surface, you should use modeling techniques instead. For example, the [Displace modifier](#) on page 1344 pushes surfaces or faces in and out based on the intensity of a bitmap image. ([Displacement mapping](#) on page 5487 is another way to do emboss a surface.)

Grayscale images can make effective bump maps. Maps that shade between white and black generally work better than maps with hard edges between the white and black areas.

The bump map Amount adjusts the degree of bumpiness. Higher values render as higher relief; low values render as low relief.

The bumps are a simulation created by perturbing face normals before the object is rendered. Because of this, bumps don't appear on the silhouette of bump-mapped objects.

TIP If you render a bump-mapped material and notice aliasing in the highlights, try turning on [supersampling](#) on page 5381 and rendering again.

NOTE Most controls on the [Output rollout](#) on page 5774 don't affect bump mapping. Only the Invert toggle is considered; it reverses the direction of the bumps.

Procedures

To assign a bump map:

- 1 Click the Map button labeled Bump.
The [Material/Map Browser](#) on page 5290 is displayed.
- 2 Choose from the list of [map types](#) on page 5767, and then click OK.
The Material Editor is now at the map level, and displays controls for the map parameters.

(If you choose Bitmap as the map type, you first see a file dialog that lets you choose the image file.)

- 3 Use the map controls to set up the map.

TIP To avoid aliasing caused by a 2D bump map, go to the bump map's Coordinates rollout. Set Blur to be in the range 0.3 to 0.6, and increase Blur Offset to be greater than 0.0. The default Blur and Blur Offset values work well for mapping other material components, but for bump mapping, lower Blur and higher Blur Offset values give better results.

To remove a bump map from a material:

TIP You can disable the map without removing it. Simply turn off the toggle immediately to the left of the map button on the Special Effects rollout.

- 1 If the Material Editor is displaying the map controls, click the [Type button](#) on page 5361 to display the Material/Map Browser. If the map controls aren't visible, click the Bump map button to display them, and then click the Type button.
- 2 In the Browser, choose NONE as the map type, and then click OK.
The map is removed.

Reflection Mapping

Material Editor > Standard material > Maps rollout > Reflection button

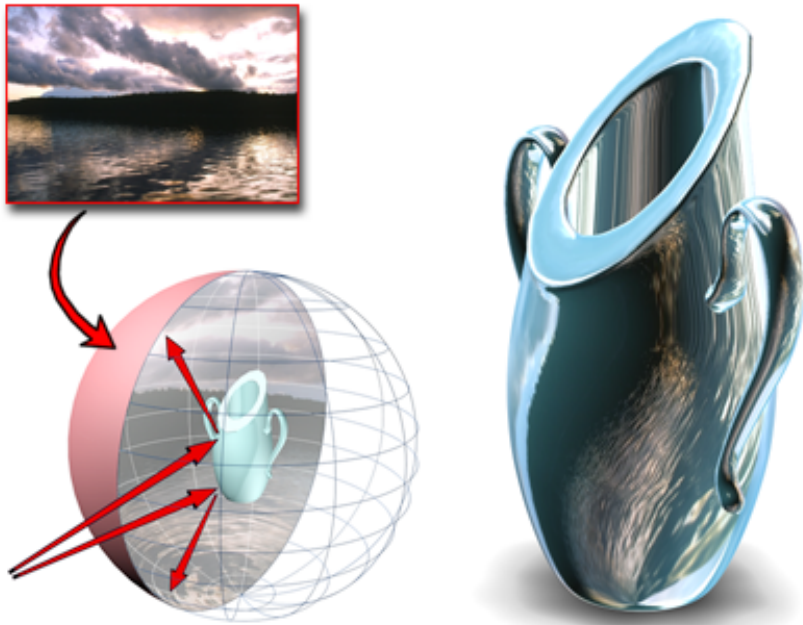

Reflection created by mapping

You can select a bitmap file or [procedural map](#) on page 8097 to use as a reflection map.

You can create three kinds of reflection: basic reflection maps, automatic reflection maps, and [flat-mirror](#) on page 7982 reflection maps.

- A basic reflection map creates the illusion of chrome, glass, or metal by applying a map to the geometry so that the image looks like a reflection on the surface.
- An automatic reflection map uses no mapping at all, but looks outward from the center of the object, and maps what it sees onto the surface. Another way to generate reflections automatically is to assign a [Raytrace map](#) on page 5952 to be the reflection map.
- A flat-mirror reflection map is applied to a series of coplanar faces and reflects objects facing it, exactly like a real mirror. Reflection maps don't need [mapping coordinates](#) on page 8034 because they're locked to the world, not to the geometry. The illusion of a reflection is created because the map doesn't move with the object, but with changes in the view, as do real reflections.

The most common use of reflection maps in a realistic scene is to add just a touch of reflection to an otherwise non-reflective surface. By default, reflection map strength is 100 percent, as it is for other maps. For many kinds of surfaces, however, reducing the strength gives the most realistic result. A polished table top, for example, primarily shows a wood grain; the reflections are secondary.

Reflection maps look more realistic if you increase the Glossiness and Specular Level values in the [Basic Parameters rollout](#) on page 5406. They are also affected by the [diffuse](#) on page 7955 and [ambient](#) on page 7906 color values. The darker the color, the stronger the mirror effect.

Even when the Amount spinner is at 100, the reflection map is tinted by the ambient, diffuse, and [specular](#) on page 8133 colors.

In metal materials, the Diffuse color tints the reflection map. Specifically, the color from the reflection map is multiplied by the diffuse color (including a diffuse map, if one exists). The value (in the [HSV](#) on page 8105 description) of the diffuse color controls the reflection map intensity. If the diffuse color value is 255, the reflection is at full intensity; if the value is 0, the map is not visible.

In non-metal materials, the Specular color multiplies only reflection maps. The value (in the [HSV](#) on page 8105 description) of the specular color affects the reflection intensity. If the specular color value is 255, the reflection is at full intensity; if the value is 0, the map is not visible.

Procedures

To create an automatic reflection:

- 1 In the Maps rollout, click the Map button labeled Reflection.
- 2 In the [Material/Map Browser](#) on page 5357, choose the Reflect/Refract map type, and then click OK.

Adjusting the map's Strength slider in the parent material's Maps rollout controls how reflective the material is. At 100 percent, the material is fully reflective.

To assign a bitmap as a reflection map:

- 1 In the Maps rollout, click the Map button labeled Reflection. In the [Material/Map Browser](#) on page 5357, double-click Bitmap.
- 2 In the Bitmap Parameters rollout, click the Bitmap button.
- 3 Use the file dialog to choose the bitmap file.

- 4 Reduce the Reflection map's Amount to get the effect you want.

Refractions are similar to reflections. Bitmaps simulate reflections, while Reflect/Refract maps generate them based on the scene's background and geometry.

Refraction Mapping

Material Editor > Standard material > Maps rollout > Refraction button

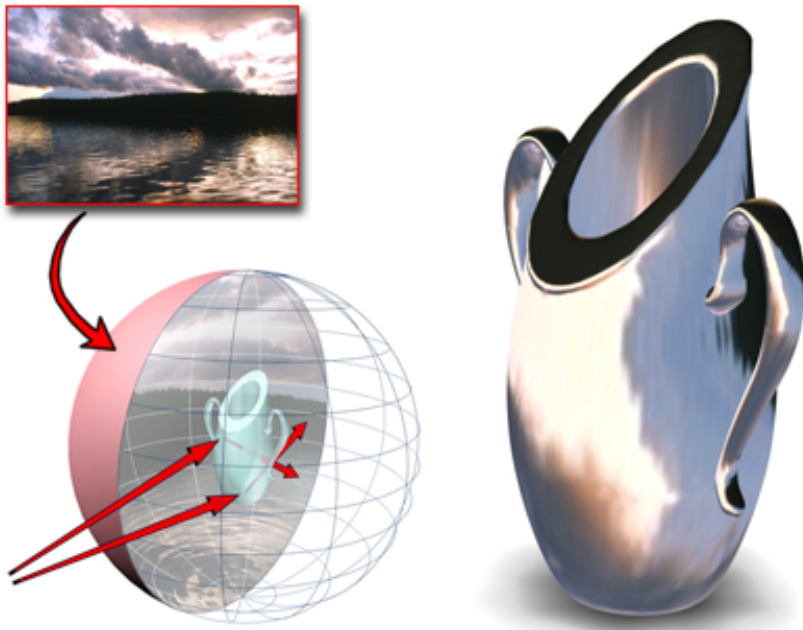

Refractions show the scene or background through a refractive object.

You can select a bitmap file or a [procedural map](#) on page 8097 such as [Reflect/Refract](#) on page 5964 to use for refraction mapping.

Refraction mapping is similar to reflection mapping. It maps the view onto the surface in such a way that the image looks like you're seeing it through the surface, rather than being reflected off it.

Like a reflection map, a refraction map's orientation is locked to the view rather than to the object. That is, as you move or rotate the object, the position of the refracted image remains fixed.

Setting the Index of Refraction

The physical properties of refractive objects often distort the image. A special parameter adjusts this distortion. It is in the parent material's [Extended Parameters rollout](#) on page 5408.

Index of Refraction The index of refraction (IOR) controls how severely the material refracts transmitted light. Left at 1.0, the IOR of air, the object behind the transparent object does not distort. At 1.5 the object behind distorts greatly (like a glass marble). At an IOR slightly less than 1.0, the object reflects along its edges (like a bubble seen from under water). Default=1.5 (the IOR of typical glass).

Common IORs (assuming the camera is in air or a vacuum) are:

Material	IOR Value
Vacuum	1.0 (exactly)
Air	1.0003
Water	1.333
Glass	1.5 to 1.7
Diamond	2.419

In the physical world, the IOR results from the relative speeds of light through the transparent material and the medium the eye or the camera is in. Typically this is related to the object's density. The higher the IOR, the denser the object.

You can also use a map to control the index of refraction. IOR maps always interpolate between 1.0 (the IOR of air) and the setting in the IOR parameter. For example, if you set the IOR to 3.55 and use a black-and-white Noise map to control IOR, the IORs rendered on the object will be set to values between 1.0 and 3.55; the object will appear denser than air. If, on the other hand, you set the IOR to 0.5, then the same map values will render between 0.5 and 1.0: as if the camera is under water and the object is less dense than the water.

Here are some more IOR values for various materials:

Material	IOR Value
Carbon Dioxide, Liquid	1.200

Material	IOR Value
Ice	1.309
Acetone	1.360
Ethyl Alcohol	1.360
Sugar Solution 30%	1.380
Alcohol	1.329
Flourite	1.434
Quartz, Fused	1.460
Calspar2	1.486
Sugar Solution 80%	1.490
Glass	1.500
Glass, Zinc Crown	1.517
Glass, Crown	1.520
Sodium Chloride	1.530
Sodium Chloride (Salt) 1	1.544
Polystyrene	1.550
Quartz 2	1.553
Emerald	1.570

Material	IOR Value
Glass, Light Flint	1.575
Lapis Lazuli	1.610
Topaz	1.610
Carbon Bisulfide	1.630
Quartz 1	1.644
Sodium Chloride (Salt) 2	1.644
Glass, Heavy Flint	1.650
Methylene Iodide	1.740
Ruby	1.770
Sapphire	1.770
Glass, Heaviest Flint	1.890
Crystal	2.000
Diamond	2.417
Chromium Oxide	2.705
Copper Oxide	2.705
Amorphous Selenium	2.920
Iodine Crystal	3.340

Tip: The [Reflect/Refract](#) on page 5964 map type used as a Refraction map doesn't effectively model a material surrounding an object, such as a pencil in a glass of water. For this effect, use either the [Thin Wall Refraction](#) on page 5971 or the [Raytrace map type](#) on page 5952.

Procedures

To create an automatic refraction:

- 1 In the Maps rollout, click the Map button labeled Refraction.
- 2 In the [Material/Map Browser](#) on page 5357, choose the [Reflect/Refract](#) on page 5964 map type, and then click OK.
At a Refraction Amount of 100 percent, the material is extremely refractive, regardless of the material's Opacity setting. At a Refraction Amount of 0 percent, the map is turned off. When the Amount is less than 100 percent, both the Reflect/Refract map and the Opacity setting control transparency.

To assign a bitmap as a refraction map:

- 1 In the Maps rollout, click the Refraction map button.
- 2 Use the [Material/Map Browser](#) on page 5357 to choose the Bitmap type.
- 3 Use the file dialog to choose the bitmap file.
For bitmapped refractions, you don't necessarily want to reduce the map strength.

Displacement Mapping

Material Editor > Standard material > Maps rollout > Displacement button

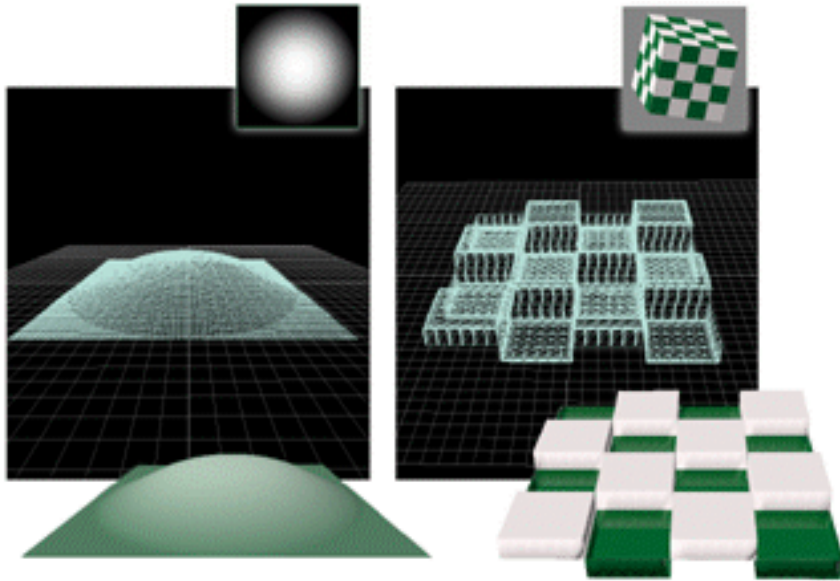

Using displacement mapping to alter a surface

A displacement map displaces the geometry of surfaces. The effect is similar to using the [Displace](#) on page 1344 modifier. Unlike [bump mapping](#) on page 5478, displacement mapping actually changes the geometry of the surface or patch tessellation. Displacement maps apply the gray scale of the map to generate the displacement. Lighter colors in the 2D image push outward more strongly than darker colors, resulting in a 3D displacement of the geometry.

WARNING A displacement map generates many triangular faces per surface, sometimes over 1M faces per surface. While displacement mapping can create good effects, there is a large cost in terms of time and memory.

The displacement Amount is measured as a percentage of the diagonal of the bounding box for the object that contains the patch or surface. This makes the displacement effect consistent for all surfaces in an object, and it also means that when you scale the object, the displacement is scaled with it.

You can apply a displacement map directly to the following kinds of objects:

- [Bezier patches](#) on page 2067
- [Editable meshes](#) on page 2075
- [Editable polymeshes](#) on page 2123

- [NURBS surfaces](#) on page 2237

For other kinds of geometry such as primitives, extended primitives, compound objects, and so on, you can't apply displacement mapping directly. To use displacement mapping with these kinds of objects, apply a [Disp Approx](#) on page 1340 (Displacement Approximation) modifier. This makes the object's surface displaceable. Disp Approx works with any kind of object that you can convert to an editable mesh.

Displacement mapping isn't visible in viewports unless you apply a modifier to make it so.

- For NURBS surfaces, you can make displacement mapping visible in viewports and editable as a mesh object by using the [Displace NURBS](#) on page 1117 world space modifier.
- For editable meshes and objects with Disp Approx applied to them, use the [Displace Mesh](#) on page 1115 modifier to obtain the same effect.

NOTE If you apply a [UVW Map](#) on page 1931 modifier to the surface, all maps obtain their coordinates from the modifier except for the displacement map, which *always* obtains its coordinates from the original surface or the Disp Approx modifier.

Under certain circumstances, such as when the underlying mesh is fairly simple, displacement mapping of an editable mesh can cause problems because of the way the underlying mesh is tessellated. (These problems don't occur when you apply displacement mapping to a NURBS surface.) When this happens, something does not work properly and you can see the underlying wireframe mesh in the surface itself. To correct this problem, use these techniques:



- Avoid applying displacement mapping to large areas of a single color. Map the diffuse color and use a small amount of variation, such as slight amount of noise, in the map you use for the diffuse color.
- Add a small amount of noise to the map you use for displacement. This can complicate the tessellation enough to ease the problem.
- Add detail to the mesh. The more initial faces, and the smoother the mesh curvature, the more even the displacement mapping will be.

Procedures

To apply a displacement map to a NURBS surface, editable mesh, or patch:

- 1 In a material's Maps rollout, click the map button for Displacement.
The [Material/Map Browser](#) on page 5357 is displayed.
- 2 Choose from the list of map types, and then click OK.
The Material Editor is now at the map level, and displays controls for the map parameters.
- 3 Use the map controls to set up the map.

To apply a displacement map to other kinds of objects:

- 1  Select the object. Go to the Modify panel and choose Disp Approx from the Modifiers drop-down list.
You can adjust the Disp Approx modifiers parameters, or you can leave them at their default settings.
- 2  Go to the Material Editor.
- 3 In a material's Maps rollout, click the map button for Displacement.
The [Material/Map Browser](#) on page 5357 is displayed.
- 4 Choose from the list of map types, and then click OK.
The Material Editor is now at the map level, and displays controls for the map parameters.
- 5 Use the map controls to set up the map.
For example, if you chose Bitmap as the map type, you now need to select the bitmap file to use.

Raytrace Material

Material Editor > Type button > Material/Map Browser > Raytrace

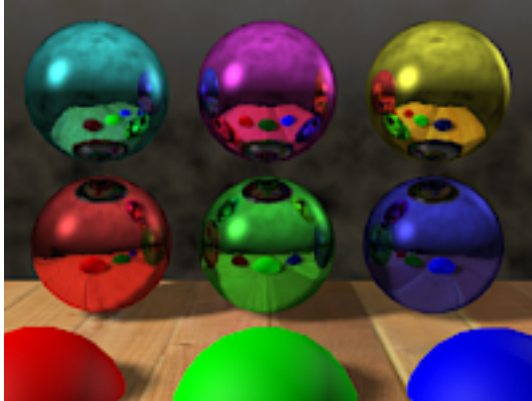

Balls using raytrace material to reflect each other

Raytrace material is an advanced surface shading material. It supports the same kinds of diffuse surface shading that a standard material does. It can also create fully raytraced reflections and refractions. It also supports fog, color density, [translucency](#) on page 8158, [fluorescence](#) on page 7984, and other special effects.

The reflections and refractions Raytrace material generates are more accurate than those produced by the [Reflect/Refract](#) on page 5964 map. Rendering raytraced objects can be slower than using Reflect/Refract. On the other hand, Raytrace is optimized for rendering 3ds Max scenes. You can further optimize it for your scene by excluding specific objects from raytracing.

NOTE If you want accurate, raytraced reflections or refractions in a standard material you can use the [Raytrace map](#) on page 5952, which uses the same raytracer. The Raytrace map and material share global parameter settings.

IMPORTANT Raytrace map and Raytrace material use a surface's normal to decide whether a ray is entering or exiting a surface. If you flip the normals of an object, you can get unexpected results. Making the material 2-Sided doesn't correct the problem as it often does with reflections and refractions in Standard materials.

In some cases, the colors in the Basic Parameters rollout of Raytrace material behave differently from colors in standard materials. Standard material has a diffuse shading model that does an excellent job of rendering solid, nonreflective objects such as plastic, ceramic, and so on. In effect, this model applies color to the object. The color components in Raytrace material, on the other hand, attempt to model their physical counterparts in nature.

In Raytrace material, the surface reflects its Diffuse color component without specular reflection, while the Reflect color component controls the amount of specular reflection. These two material components are layered together. The results you see depend on the layering effect. For example, if the material is not transparent and completely reflective, no diffuse color is visible. If the material is not transparent and completely nonreflective, only the diffuse color is visible.

The Dynamics Properties rollout for the Raytrace material contains the same controls as the dynamics properties for a [standard material](#) on page 5395.

Raytrace material has a large user interface with a lot of controls. In general, if you are using Raytrace to create reflections and refractions, the controls in the Basic Parameters rollout are the only ones you need to adjust. The Extended Parameters rollout for Raytrace has controls for special effects. The Raytracer Controls rollout affects the raytracer itself. Use the Raytracer Controls to turn the raytracer on or off, and to toggle other options. Use the [Raytracer Global Parameters rollout](#) on page 6221 (Rendering > Raytrace Globals) to set options globally (for all Raytrace materials and maps in the scene), including recursion depth.

Interface

Raytrace material has the following rollouts, which are described in these topics:

[Raytrace Basic Parameters Rollout](#) on page 5493

[Raytrace Extended Parameters Rollout](#) on page 5502

[Raytracer Controls Rollout](#) on page 5506

[SuperSampling Rollout](#) on page 5381

[Raytrace Maps Rollout](#) on page 5509

[Raytrace Dynamics Properties Rollout](#) on page 5516

The following are also part of the Raytrace material's interface:

[Raytracer Global Parameters rollout](#) on page 6221

[Raytracing Acceleration Parameters Dialog](#) on page 5518

[Raytrace Exclude/Include Dialog](#) on page 5519

[Raytrace Antialiaser Dialog: Fast Adaptive Antialiaser](#) on page 5522

[Raytrace Antialiaser Dialog: Multiresolution Adaptive Antialiaser](#) on page 5524

Raytrace Basic Parameters Rollout

Main toolbar > Material Editor > Type button > Material/Map Browser > Choose Raytrace. > Raytrace Basic Parameters rollout

The Raytrace Basic Parameters rollout for a [Raytrace material](#) on page 5490 controls the material's shading, color components, reflectivity or refractivity, and bumps.

Interface

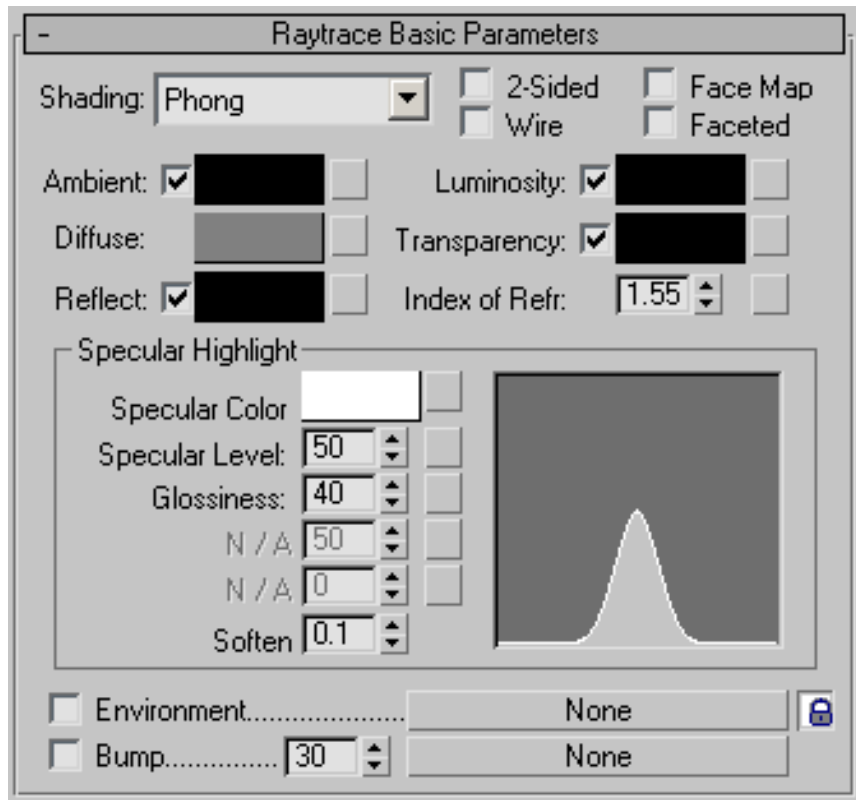

The basic parameters in this rollout are similar to the basic parameters for standard materials, but the color components of a Raytrace material behave differently.

As with standard materials, you can use a map for Raytrace color components and various other parameters. The small buttons to the right of the color

swatches and parameters take you to the [Material/Map Browser](#) on page 5290, where you select a map of corresponding type. These are shortcuts that also have corresponding buttons in the Maps rollout. If you have assigned a map to one of these colors, the button displays the letter M. An uppercase M means that the corresponding map is assigned and active. A lowercase m means that the map is assigned and inactive (turned off).

Shading drop-down list Chooses a shader. Depending on the shader you choose, the Specular Highlight can change to show the controls for that shader. The alternatives are:

- **Anisotropic:** on page 5449 For surfaces with elliptical, "anisotropic" highlights.
- **Blinn:** on page 5451 For rounder, softer highlights than Phong shading.
- **Metal:** on page 5452 For metallic highlights.
- **Oren-Nayar-Blinn:** on page 5451 For matte surfaces such as fabric or terra-cotta.
- **Phong:** on page 5451 For surfaces with strong, circular highlights. Phong is the default shading type.

2-Sided Same as for standard materials. When on, shades and raytraces both sides of faces. By default, objects are one-sided in order to speed up rendering. If you have a 2-sided, reflective and refractive object, and you use the [raytrace map](#) on page 5952 rather than the material, the raytracer runs until it hits the maximum recursion level. This can be time-consuming.

Wire Same as for standard materials. When on, renders the material in [wireframe mode](#) on page 8172. You can specify the wire size in the Extended Parameters rollout.

With pixels, wires maintains the same apparent thickness regardless of the scale of the geometry or how near or far the object is positioned. With units, the wires appear thinner at a distance and thicker at close range, as if they were modeled in the geometry.

Face Map Applies the material to the faces of the geometry. If the material is a mapped material, it requires no [mapping coordinates](#) on page 8034. The map is automatically applied to each facet of the object.

Faceted Renders each face of a surface as if it were flat.

NOTE Raytrace material has the same [SuperSampling](#) on page 5381 options as a Standard material.

Ambient This is *not* the same as the standard ambient color. For Raytrace material, this controls an ambient absorption factor: that is, how much the material absorbs ambient light. Setting Ambient to white is the same as locking the ambient and diffuse colors in a standard material. Default=black.

- **Ambient Color check box** When on, the material uses an ambient color. When off, the material uses a spinner to set a grayscale value only. Default=on.
- **Color swatch** When on, the color swatch shows the ambient color. To change the color, click the swatch and then use the [Color Selector](#) on page 391.
- **Mono spinner** When the check box is off, the ambient component is gray, and this spinner lets you adjust the gray value. Click the map button to assign a map to the ambient component. See [Ambient Mapping](#) on page 5458. This button is a shortcut: you can also assign ambient mapping on the [Raytrace Maps rollout](#) on page 5509.

Diffuse Sets the diffuse color. This is the same as the standard diffuse color. It is the color that the object reflects, *without* specular reflection. Reflection and transparency effects are layered on top of the diffuse result. When Reflect is 100% (pure white), the diffuse color isn't visible. (This differs from the standard material.) Default=50% gray.

Reflect Sets the specular reflection color. This is the color that the reflected environment (that is, the rest of the scene) is filtered through. The color's Value controls the amount of reflection. If your reflect color is saturated and the diffuse color is black, the effect is like colored chrome (for example, colored Christmas tree balls). Default=black (no reflection).

If raytracing is off (on the Raytracer Controls rollout), the object still reflects the environment, but ignores other objects in the scene. The environment can be the background color, the environment map, or the map in the Raytrace material's Environment component.

TIP If you turn off raytraced reflections, set the Reflect color to a color other than black, and use a Reflect/Refract map for the local environment (see the Environment parameter, below), you get the same effect as a reflection map in a standard material. This can improve rendering time.

NOTE Raytrace reflects and transmits the IDs in [material effects channel](#) on page 5348 ([G-buffer](#) on page 7991), so it can create glowing reflections, and so on.

- **Reflect Color check box** When on, the material uses a reflection color. When off, the material uses a spinner to set a grayscale value only. Default=on.
- **Color swatch** When the check box is on, the color swatch shows the reflection color. To change the color, click the swatch and then use the [Color Selector](#) on page 391.
- **Mono spinner** When the check box is off, the reflection color component is gray, and this spinner lets you adjust the gray value.
- **Fresnel** Clicking the check box a second time displays this option. When active, applies a Fresnel effect to the reflection. This can add a bit of refraction to the reflecting object, depending on the viewing angle of the object.

Click the map button to assign a map to the reflect component. This button is a shortcut: you can also assign reflect mapping in the [Raytrace Maps rollout](#) on page 5509.

Luminosity Similar to the Standard material's self-illumination component, except that it does not depend on the diffuse color. You can have a blue diffuse object with red luminosity. Default=black.

NOTE When Luminosity is off, the name of this control changes to Self-Illum (Self-Illumination).

- **Luminosity check box** When on, the material uses a luminosity color. When off, the material uses a spinner to set a grayscale value only for self-illumination. Default=on.
- **Color swatch** When the check box is on, the color swatch shows the luminosity color. To change the color, click the swatch and then use the [Color Selector](#) on page 391.
- **Mono spinner** When the check box is off, the luminosity color component is gray, and this spinner lets you adjust the gray value.

Click the map button to assign a map to the luminosity component. This button is a shortcut: you can also assign reflect mapping in the [Raytrace Maps rollout](#) on page 5509.

Transparency Similar to the standard material's filter color for transmitted light, combined with the standard material's opacity controls. This color filters scene elements that are behind the object with Raytrace material. Black is opaque, white is fully transparent, and any value in between filters objects behind the raytraced object. A fully saturated color in both the diffuse and transparency components gives the effect of tinted glass. If you want more of an opaque look, pick the color you want as a transparent color, copy it to the diffuse color, make the diffuse color fully saturated, and then adjust the transparency to get the effect you want. Default=black (no transparency). If raytracing is turned off (in the Raytracer Controls rollout), the object still refracts the environment mapping, but ignores other objects in the scene.

NOTE By separating the diffuse, reflect, and transparency components, Raytrace material gives you a great deal of control over how the object reacts to its environment. For example, an object might diffusely reflect red, specularly reflect green, and transmit blue. This is not a real-world effect, but it can be useful.

- **Transparency Color check box** When on, the material uses a transparency color. When off, the material uses a spinner to set a grayscale value only. Default=on.
- **Color swatch** When the check box is on, the color swatch shows the transparency color. To change the color, click the swatch and then use the [Color Selector](#) on page 391.
- **Mono spinner** When the check box is off, the transparency color component is gray, and this spinner lets you adjust the gray value.

Click the map button to assign a map to the transparency component. See [Filter Color Mapping](#) on page 5471. This button is a shortcut: you can also assign reflect mapping in the [Raytrace Maps rollout](#) on page 5509.

Index of Refr. (Refraction) The index of refraction (IOR) controls how severely the material refracts transmitted light. At 1.0, the IOR of air, the object behind the transparent object does not distort. At 1.5, the object behind distorts greatly, like a glass marble. At an IOR slightly less than 1.0, the object reflects along its edges, like a bubble seen from under water. Default=1.0.

Common IORs (assuming the camera is in air or a vacuum) are:

Material	IOR Value
Vacuum	1.0 (exactly)

Material	IOR Value
Air	1.0003
Water	1.333
Glass	1.5 to 1.7
Diamond	2.419

In the physical world, the IOR results from the relative speeds of light through the transparent material and the medium the eye or the camera is in. Typically this is related to the object's density, and the higher the IOR, the denser the object.

You can also use a map to control the IOR. IOR maps always interpolate between 1.0 (the IOR of air) and the setting in the IOR parameter. For example, if the IOR is set to 3.55 and you use a black-and-white Noise map to control IOR, the IORs rendered on the object will be set to values between 1.0 and 3.55. The object will appear denser than air. If, on the other hand, your IOR is set to 0.5, then the same map values will render between 0.5 and 1.0, as if the camera were under water and the object was less dense than the water.

Here are some more IOR values for various materials:

Material	IOR Value
Carbon Dioxide, Liquid	1.200
Ice	1.309
Acetone	1.360
Ethyl Alcohol	1.360
Sugar Solution 30%	1.380
Alcohol	1.329
Flourite	1.434

Material	IOR Value
Quartz, Fused	1.460
Calspar2	1.486
Sugar Solution 80%	1.490
Glass	1.500
Glass, Zinc Crown	1.517
Glass, Crown	1.520
Sodium Chloride	1.530
Sodium Chloride (Salt) 1	1.544
Polystyrene	1.550
Quartz 2	1.553
Emerald	1.570
Glass, Light Flint	1.575
Lapis Lazuli	1.610
Topaz	1.610
Carbon Bisulfide	1.630
Quartz 1	1.644
Sodium Chloride (Salt) 2	1.644

Material	IOR Value
Glass, Heavy Flint	1.650
Methylene Iodide	1.740
Ruby	1.770
Sapphire	1.770
Glass, Heaviest Flint	1.890
Crystal	2.000
Diamond	2.417
Chromium Oxide	2.705
Copper Oxide	2.705
Amorphous Selenium	2.920
Iodine Crystal	3.340

Specular Highlight group

The controls in this group affect the appearance of specular highlights. Specular highlights simulate the surface of the raytraced object reflecting the lights in the scene. Changing the color or intensity of lights in the scene can change the appearance of specular highlights.

As in standard materials, as you adjust the values in this group the highlight curve at the right changes to give you an idea of the effect. The material preview in the sample slot also updates.

Specular Color Sets the [specular color](#) on page 8133, assuming there are white lights in the scene.

Click the color swatch to display the [Color Selector](#) on page 391 and change the highlight color.

Click the map button to assign a map to the specular color. See [Specular Mapping](#) on page 5465. This button is a shortcut: you can also assign specular level mapping in the [Raytrace Maps rollout](#) on page 5509.

The remaining controls in the Specular Highlight group depend on the active shader, as shown next to “Shading:” at the top of this rollout. These highlight controls are the same as for the Standard material shaders.

These are the highlight controls available to Raytrace materials:

- [Anisotropic highlights](#) on page 5449
- [Blinn, Oren-Nayar-Blinn, and Phong highlights](#) on page 5451
- [Metal highlights](#) on page 5452

NOTE Highlight controls that don’t pertain to the current shader are labeled “N/A.”

Environment Specifies an environment map that overrides the global environment map. Both Reflect and Transparency use the scene-wide environment map unless you use this button to specify another map. With this control, you can use different environment maps on a per-object basis, or provide an environment to specified objects when the scene as a whole has none.

This map overrides the scene-wide environment for both reflection and refraction. To override for refraction alone, see the Transparency Environment control in the Extended Parameters rollout.

Use the check box to turn this map on or off.

TIP You can use any map as the Raytrace environment, including the [Reflect/Refract](#) on page 5964 map. Reflect/Refract map is often adequate for getting the required look, and it usually renders more quickly than raytracing the entire scene, especially if the Raytrace material is transparent. If you are using Raytrace material just to get the glass to look right on a car’s headlight or on a light bulb hanging in the middle of a room, turn off the raytracer and use an environment map instead.

Lock button Locks the Environment map to the Transparency Environment map (found on the [Extended Parameters rollout](#) on page 5502). When on, the Transparency Environment map controls are disabled, and a map applied to the Raytrace Environment applies to the Transparency Environment as well. When off, the Transparency Environment map controls are enabled, and the Transparency Environment can have a different map assigned to it. Default=on.

Changing this button’s setting here also changes it on the [Extended Parameters rollout](#) on page 5502 and the [Maps rollout](#) on page 5509.

Bump This is the same as [bump mapping](#) on page 5478 for Standard materials. Click the button to assign the map. Use the spinner to change the bump Amount. Use the check box to turn the map on or off.

Raytrace Extended Parameters Rollout

Material Editor > Type button > Material/Map Browser > Raytrace > Extended Parameters rollout

The Extended Parameters rollout for a [Raytrace material](#) on page 5490 controls the material's special effects, transparency properties, and advanced reflectivity.

Interface

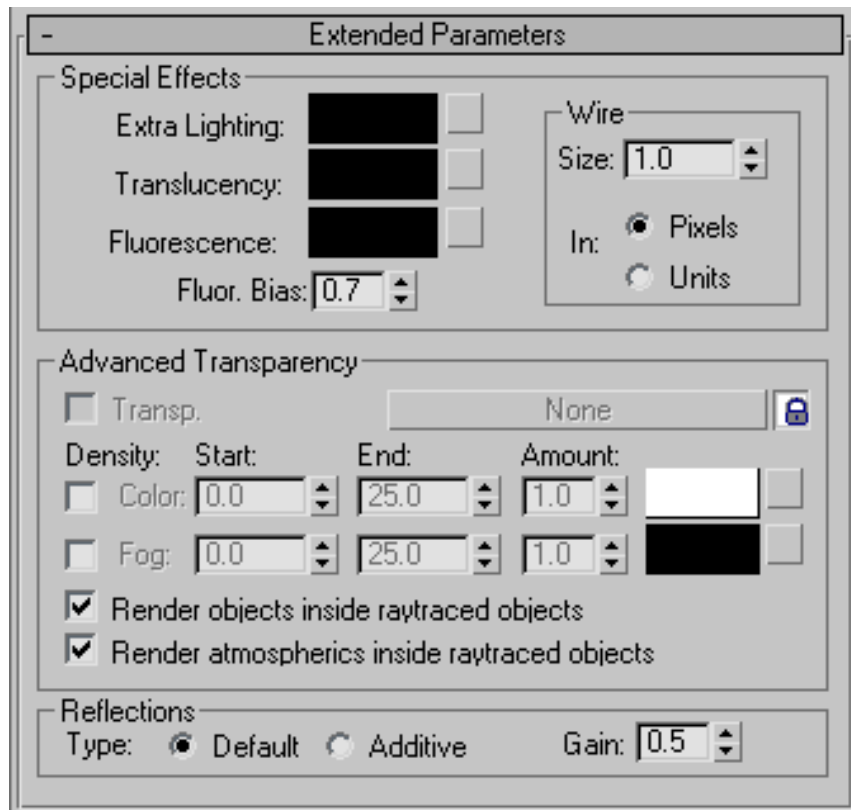

Except for the wireframe controls, the controls in the Extended Parameters rollout for Raytrace material are specific to the Raytrace material.

Special Effects group

The controls in this group are special effects. They are powerful, but you might need to experiment to use them effectively.

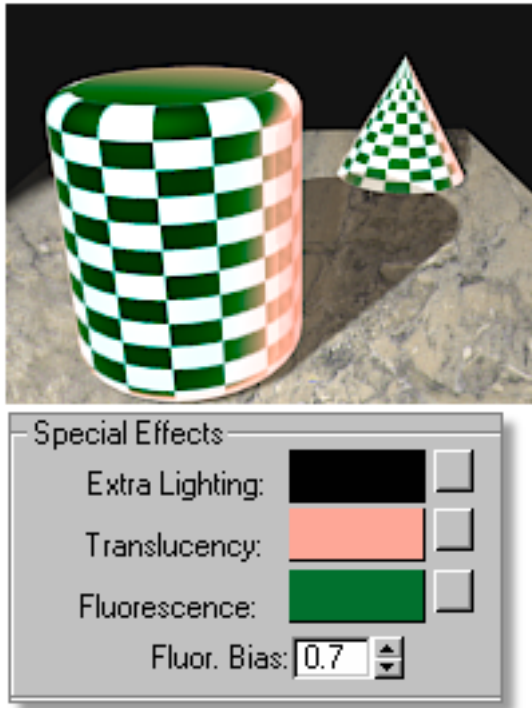

Object with raytrace material using translucency and fluorescence

Extra Lighting Adds light to the surface of objects with the Raytrace material. You can view this as an ambient lighting color that you can control on a per-material basis, but don't confuse it with the ambient absorption from the Basic Parameters rollout.

By mapping this parameter, you can simulate radiosity: the ambient light that results from reflected light in a scene. One effect of radiosity is color bleeding. For example, in strong light a white shirt next to an orange wall will show a reflected orange color.

Translucency Creates a [translucent effect](#) on page 8158. The Translucency color is a non-directional diffuse reflection. The diffuse color on an object depends upon the angle between the surface normal and the position of the light source. By ignoring the surface normal alignment, this color component simulates translucent materials.

For thin objects, the appearance can be like shining a light on the back of a piece of rice paper. You can cast shadows onto the back of the paper and see them projected through the paper; this works well with a projector light. On thicker objects, you can get some good wax-like effects.

Fluorescence and Fluor. Bias Creates an effect similar to black light on a black light poster. The light from a black light is largely ultraviolet, outside the visible spectrum. Under black light, [fluorescent](#) on page 7984 paints flare or glow. The fluorescence in Raytrace material takes whatever light it sees in the scene, applies the Bias to it, and then, regardless of the color of the lights in the scene, illuminates the fluorescent material as if it were lit by white light. At 0.5, The Bias makes Fluorescence behave just like diffuse coloring. Bias values higher than 0.5 increase the fluorescent effect, making the object brighter than other objects in the scene. Bias values lower than 0.5 make the object dimmer than other objects in the scene. You can get some chromatic shifting effects with this.

TIP Full saturation and value for the Fluorescence color help give the effect of commercial fluorescent paints.

TIP A slight amount of Fluorescence can add to the realism of skin and eyes.

Wire group

Size Sets the size of the wire in [wireframe mode](#) on page 8172. You can set either pixels (the default) or current units.

In Chooses how to measure wire. With pixels, wires maintain the same apparent thickness regardless of the scale of the geometry or how near or far the object is positioned. With units, the wires appear thinner at a distance and thicker at close range, as if they were modeled in the geometry.

Pixels (The default.) Measures wire in pixels.

Units Measures wire in 3ds Max units.

Advanced Transparency group

The controls in this group let you further tune transparency effects.

Transp. (Transparency Environment) Similar to the environment map in Basic Parameters, but overrides the scene's environment map for transparency (refraction) only. Transparent objects refract this map, while reflections still reflect the scene (or the Basic Parameters Environment map, if one is chosen). Click the button to choose the Transparency Environment map. Use the check box to toggle the effect of the map.

Lock button Locks the Transparency Environment map to the Environment map (found on the [Basic Parameters rollout](#) on page 5493). When on, the Transparency Environment map controls are disabled, and a map applied to the Raytrace Environment applies to the Transparency Environment as well. When off, the Transparency Environment map controls are enabled, and the Transparency Environment can have a different map assigned to it. Default=on. Changing this button's setting here also changes it on the [Basic Parameters rollout](#) on page 5493 and the [Maps rollout](#) on page 5509.

Density The density controls are for transparent materials. If the material is opaque (the default), they have no effect.

Color Sets a transmission color based on thickness. While filter (Transparency) color tints objects behind the transparent object, the density color gives the appearance of color *within* the object itself, like tinted glass.

To use, first make sure the object is transparent. Click the color swatch to display the Color Selector. Choose a color, and then turn on the check box.

The Amount controls the amount of density color. Reducing this value reduces the density color effect. Range=0 to 1.0. Default=1.0.

A thin piece of tinted glass is mainly clear, while a thick piece of the same glass has more color. The Start and End controls help you simulate this effect. They are expressed in world units. Start is the position in the object where the density color begins to appear. (Default=0.0.) End is the position in the object where the density color reaches its full Amount value. (Default=25.0) To have a lighter effect, increase the End value. To have a heavier effect, reduce the End value.

The object must be at least as thick as the Start value before the density color is visible.

You can map this color component.

Fog Density fog is also a thickness-based effect. It fills the object with a fog that is both opaque and self illuminated. The effect is like smoke trapped in a glass, or wax at the tip of a candle. Colored fog in tubular objects can resemble neon tubes.

To use, first make sure the object is transparent. Click the color swatch to display the Color Selector. Choose a color, and then turn on the check box.

The Amount controls the amount of density fog. Reducing this value reduces the density fog effect and makes the fog translucent. Range=0 to 1.0. Default=1.0.

The Start and End controls let you adjust the fog effect based on the object's dimensions. They are expressed in world units. Start is the position in the object where the density fog begins to appear. (Default=0.0.) End is the position in the object where the density fog reaches its full Amount value. (Default=25.0) To have a lighter effect, increase the End value. To have a heavier effect, reduce the End value.

You can map this color component.

Render objects inside raytraced objects Turns the rendering of objects inside raytraced objects on or off. Default=on.

Render atmospheric effects inside raytraced objects Turns the rendering of atmospheric effects inside raytraced objects on or off. Atmospheric effects include fire, fog, volume light, and so on. Default=on.

Reflections group

Controls in this group give you finer control over reflections.

Type When set to **Default**, reflections are layered with the Diffuse color. For example, if the material is not transparent and completely reflective, no diffuse color is visible. When set to **Additive**, reflections are added to the Diffuse color, as in [Standard materials](#) on page 5395. The diffuse component is always visible.

Gain Controls reflection brightness. The lower the gain value, the brighter the reflection. At a gain of 1.0, no reflection is visible. Default=0.5.

Raytracer Controls Rollout

Material Editor > Type button > Material/Map Browser > Raytrace material > Raytracer Controls rollout

The Raytracer Controls rollout for a [Raytrace material](#) on page 5490 controls affect the operation of the raytracer itself. It can help you improve rendering performance.

Interface

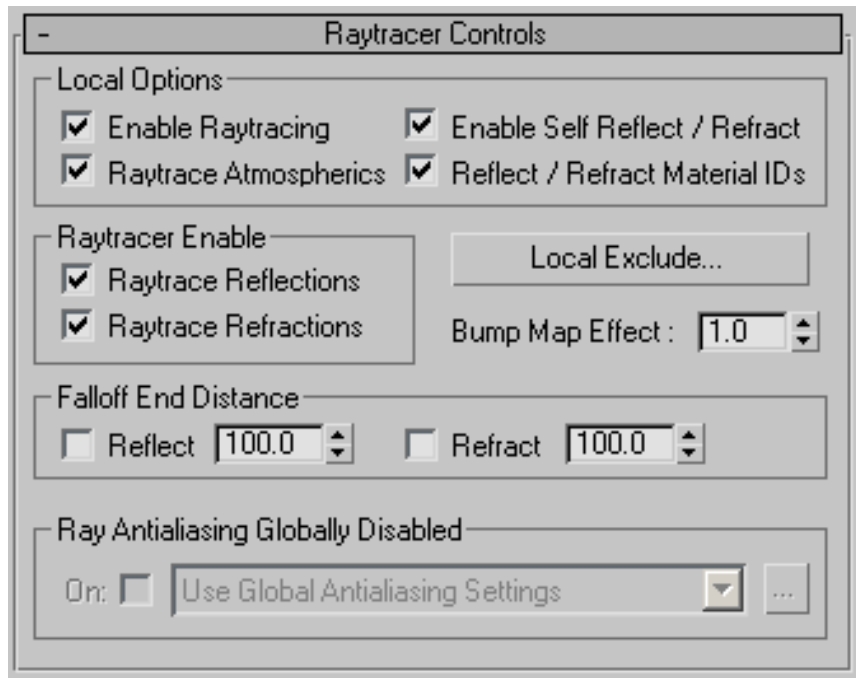

Local Options group

Enable Raytracing Turns the raytracer on or off. Default=on.

Even with raytracing off, Raytrace material and Raytrace map still reflect and refract the environment, including both the environment map for the scene, and the environment map assigned to the Raytrace material.

Raytrace Atmospheric Turns the raytracing of atmospheric effects on or off. Atmospheric effects include fire, fog, volume light, and so on. Default=on.

Enable Self Reflect/Refract Turns self reflection/refraction on or off. Default=on.

Can an object reflect itself? For example, a teapot's body reflects the teapot's handle, but a sphere will never reflect itself. If you don't need this effect, you can improve render time by turning off this toggle.

TIP If you have a transparent object such as glass, and Enable Self Reflect/Refract is on, you don't have to make the object [2-sided](#) on page 7893. The raytracer sees back faces when exiting refractive objects.

Reflect/Refract Material IDs When on, the material reflects effects assigned to material IDs in the renderer's [G-buffer](#) on page 7991 on or off. Default=on. By default, Raytrace material and Raytrace map reflect effects assigned to a material's ID, so that G-buffer effects are not lost. For example, if a raytraced object reflects a lamp made to glow with the Video Post Glow filter (Lens Effects Glow), the reflection glows as well.

Raytracer Enable group

These two check boxes turn raytracing of reflections or refractions on or off for this material. If you are using the Raytrace material to create only reflections or refractions, turn off the one you aren't using to improve rendering time.

Raytrace Reflections Turns raytracing of reflective objects on or off. Default=on.

Raytrace Refractions Turns raytracing of transparent objects on or off. Default=on.

Local Exclude Displays the local [Exclude/Include dialog](#) on page 5519. An object that is excluded locally is excluded from this material only.

TIP Using exclusion lists is one of the best and simplest ways to speed up the raytracer.

Bump Map Effect Adjusts the effect of bump maps on raytraced reflections and refractions. Default=1.0.

Falloff End Distance group

Reflect Dims reflections to black at this distance. Default=100.0.

Refract Dims refractions to black at this distance. Default=100.0.

NOTE The toggles for Reflect Falloff and Refract Falloff aren't animatable.

Raytraced Reflection and Refraction Antialiaser group

Controls in this group let you override the global antialiasing settings for raytraced maps and materials. They are unavailable if antialiasing is turned

off globally. To turn on antialiasing globally, choose Rendering > Raytrace Globals to display the [Raytracer Global Parameters rollout](#) on page 6221.

On When on, uses antialiasing. Default=unavailable unless global antialiasing is on; on if global antialiasing is turned on.

Drop-down list Chooses which antialiasing settings to use. There are three options:

- **Use Global Antialiasing Settings** (The default.) Uses the global antialiasing settings.
Click ... to open the [Raytracer Global Parameters rollout](#) on page 6221.
- **Fast Adaptive Antialiaser** Uses the Fast Adaptive antialiaser, regardless of the global setting.
Click ... to open the [Fast Adaptive Antialiaser dialog](#) on page 5522.
- **Multiresolution Adaptive Antialiaser** Uses the Multiresolution Adaptive antialiaser, regardless of the global setting.
Click ... to open the [Multiresolution Adaptive Antialiaser dialog](#) on page 5524.

When you change settings for an antialiaser locally, you don't affect the global settings for that antialiaser.

Raytrace Maps Rollout

Material Editor > Type button > Material/Map Browser > Raytrace material > Maps rollout

As with a standard material, the Maps rollout for a [Raytrace material](#) on page 5490 contains map buttons for the components of the Raytrace material that can be mapped.

You can choose from a large variety of map types. See [Map Types](#) on page 5767 to find descriptions of these types, and how to set their parameters.

Assigning the Same Map to Different Parameters

Applying the same map to different parameters is useful in some cases. For example, using a pattern as both a self-illumination map and an opacity map can make the pattern appear to glow and hover in space.

Blending Map Amounts for Opacity and Other Material Components

The Specular Level, Glossiness, Self-Illumination, and Opacity values in the four spinners in the Basic Parameters rollout are blended with their associated map Amount values in the Maps rollout.

When the Opacity spinner is set to 0, the map Amount spinner completely controls Opacity. That is, reducing the Amount value increases the transparency of the entire surface. On the other hand, when Opacity is 100, reducing the map Amount value increases the opacity of the areas where the Opacity map is less than 1. For example, you can now adjust a Checker Opacity map so that the solid areas remain solid, while the clear areas are semi-transparent.

The Specular Level, Glossiness, and Self-Illumination channels all behave in the same way. A setting of 100 applies all of the map; a setting of 0 is the equivalent of turning the map off.

When you load old 3ds Max files or bring earlier materials from the Browser into the Materials Editor, the spinner values for Opacity, Specular Level, Glossiness, and Self-illumination are altered, where necessary, to maintain the equivalent material effect.

Procedures

To assign a map:

- 1 Click a map button.
A modal [Material/Map Browser](#) on page 5290 is displayed.
- 2 Use the Browse From buttons to choose where you want to look.
If you choose Material Library and the dialog's display area is blank, you need to open a library file. Click the Open button and then choose the library to browse.
- 3 Use the display buttons to choose how you view maps.
 - View List shows each map by name.
 - View List + Icons shows a small preview and each map's name.
 - View Small Icons shows a small preview for each map.
 - View Large Icons shows a large preview for each map, along with the map's name.

TIP You can resize the Browser dialog to increase the size of the display area. This is especially useful when you view large icons.

- 4 Double-click the map you want.

To use the same map for different parameters:

- 1 In the Maps rollout, use a map button to assign a map.
The Material Editor is now at the map level, and displays controls for the map parameters.
- 2  Click Go To Parent to return to the material level, and then open the Maps rollout.
- 3 Drag the assigned map button to another map button.
The [Copy \(Instance\) Map dialog](#) on page 5365 is displayed.
- 4 Choose Copy or Instance, and then click OK.
If you choose Swap, the Material Editor swaps the two button assignments.

To view the parent material's parameters:

- 1  If you are currently at the map level in the Material Editor, click Go To Parent.
The parameters for the map's parent material are displayed. Also, the Show End Result and Go to Parent buttons become unavailable.

To view a map's parameters:

- 1 If you are currently at the material level in the Material Editor, click the button that corresponds to the map.
The parameters for the map are displayed. Also, the [Show End Result](#) on page 5356 and [Go to Parent](#) on page 5356 buttons become available.
In the Basic Parameters rollout, if a map has been assigned to a color component or parameter, the corresponding button displays a letter M.
In the Maps rollout, if a map has been assigned, the corresponding button displays the map name.

To view a map's location:

-  Click Material/Map Navigator to view the Navigator. The [Material/Map Navigator](#) on page 5357 displays the hierarchy of the current material, which contains the map.

To go to a map using the Navigator:

- In the [Material/Map Navigator](#) on page 5357, click the name of the map, or the green or red parallelogram to the left of the map's name. The Navigator goes to the level of the map, and the Material Editor displays the controls for the map you clicked. As the Navigator's map tree shows, maps for basic material components and parameters are one level below the material itself.

To preview a map in a sample slot:

- 1 Go to the level of the map, as described in previous procedures. The Material Editor displays the map's parameters.

- 2  Turn off [Show End Result](#) on page 5356. The sample slot shows the map instead of the material. If the map contains sub-maps, these are also visible. By default, the sample slot displays a map with no three-dimensional shading. You can change this in the [Material Editor Options dialog](#) on page 5335.

To view the map interactively:

- 1 Select an object.
- 2 In the object's creation parameters, make sure that Generate Mapping Coords is on. If the object type does not have a Generate Mapping Coordinates toggle, you need to assign mapping coordinates by applying a [UVW Map modifier](#) on page 1931.
- 3 In the Material Editor, assign the mapped material to the object.
- 4 If you are at the material level (the top level), click the appropriate map button to go to the map level.

- 5  Turn on [Show Map in Viewport](#) on page 5350.

The map appears on objects assigned the material in all shaded viewports. Now when you adjust the map, the viewports update to display the adjustments.

Turning on Show Map In Viewport for one map automatically turns this button off for all other maps the material has.

Viewports can display 2D maps such as Checker and Bitmap. They cannot display other kinds of maps such as 3D maps. Show Map in Viewport is unavailable if the active map type cannot display in viewports.

TIP Displaying mapped materials in a viewport can slow performance. If you don't need to view the texture, turn off its viewport display.

To turn off interactive texture display:

- 1 Go to the map level.
If you are at the material level, click the appropriate map button to go to the map level.

- 2  Turn off [Show Map in Viewport](#) on page 5350.
The object is shaded but the map no longer appears.

To turn a map off:

- Turn off the map's check box.
The check box is to the left of the map's name on the Maps rollout.

To turn a map on:

- Turn on the map's check box.
The check box is to the left of the map's name on the Maps rollout.

To change a map's strength:

- Adjust the map's Amount spinner in the Maps rollout.
The material's sample slot reflects the change.

NOTE Adjusting a map's output (in the map's Output rollout) can also change the map's strength.

To move directly to an ancestor:

- 1 Click the arrow to the right of the map's [name](#) on page 5360 field.
A drop-down list of ancestors is displayed.

- 2 Click a name in the Ancestor list.

With this list, you can skip intermediate levels in the tree.

The Ancestor drop-down list shows only part of the tree. It does not show side branches and siblings. To view these, use the [Material/Map Navigator](#) on page 5357.



You can also use the [Go Forward to Sibling](#) on page 5357 and [Go to Parent](#) on page 5356 buttons.

To change a map type:

- 1 At the level of a map, click the button labeled Type below the Material Editor toolbar.

A modal [Material/Map Browser](#) on page 5290 is displayed. If you were at a map, it lists only maps (if you were at a material when you clicked Type, the Browser lists only materials).

- 2 Choose a map type from the list, and then click OK.

If you change a map type and the new map type can have component maps, a Replace Map dialog is displayed. This dialog gives you a choice between discarding the original map or using it as a component map.

If the new map type does not have components, it simply replaces the original map type.

Interface

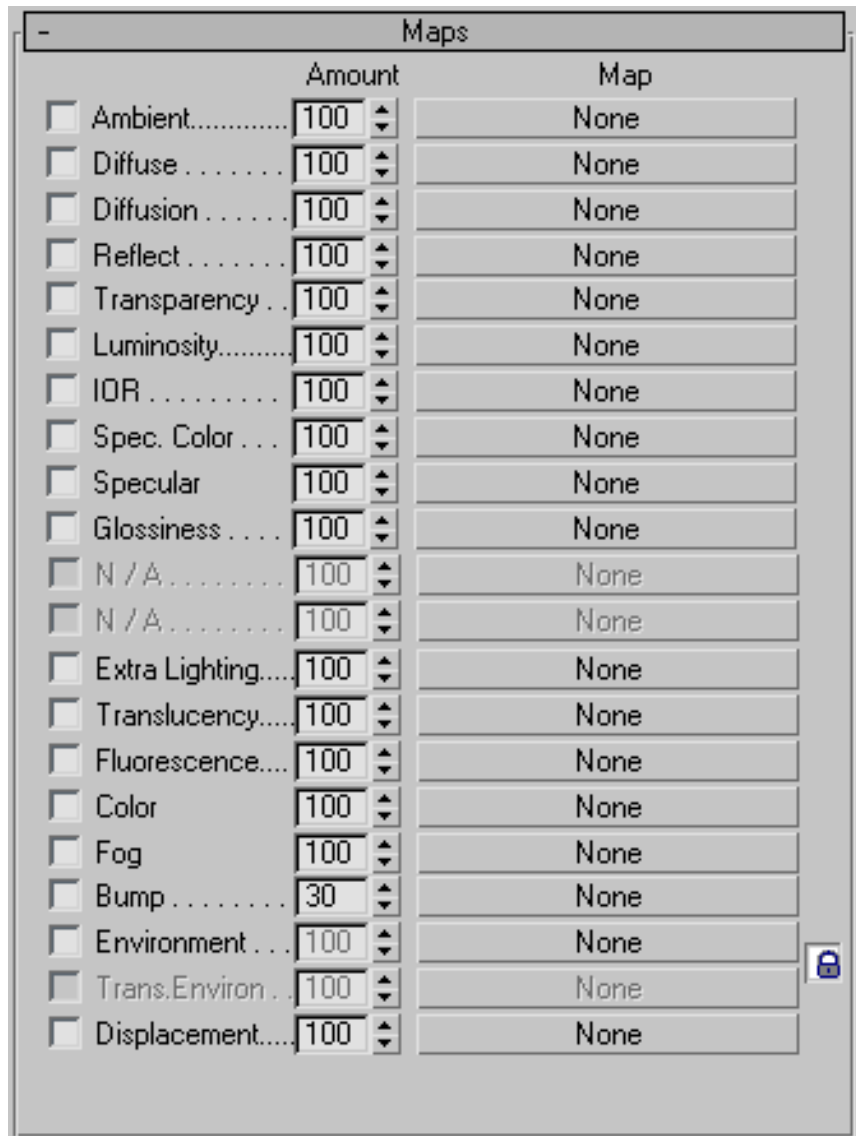

The Maps rollout for Raytrace contains a wide button for each map type. Click this button to select a bitmap file stored on disk or to select a [procedural-map type](#) on page 8097. After you select a map, its name and type appears on the button. Use the check box to the left of the button to turn the effect of the

map off and on. When the check box is off, the map is not computed and has no effect in the renderer.

The Amount spinner determines the amount that the map affects the material, expressed as a percentage of full intensity. For example, a diffuse map at 100% is completely opaque and covers the base material. At 50%, it is semi-transparent and the base material (the diffuse, ambient, and other colors of the material without mapping) shows through.

Lock button Locks the Environment map to the Transparency Environment map. When on, the Transparency Environment map controls are disabled, and a map applied to the Raytrace Environment applies to the Transparency Environment as well. When off, the Transparency Environment map controls are enabled, and the Transparency Environment can have a different map assigned to it. Default=on.

Changing this button's setting here also changes it on the [Basic Parameters rollout](#) on page 5493, and the [Extended Parameters rollout](#) on page 5502.

Diffusion Mapping

The Diffusion map component lets you apply an additional, second texture to modify the Diffuse component. Typically, you will want to reduce the Amount of this map to allow the main Diffuse map to show through.

For example, you might have a clean, bright image for a billboard. You use this image as the Diffuse map, and then use a second map as a Diffusion map to apply soot and city grime.

TIP Animating the Amount can change the appearance of the material over time, letting the Diffusion map either conceal or reveal the underlying Diffuse map.

NOTE Show Map In Viewport does not display the Diffusion map.

Raytrace Dynamics Properties Rollout

Material Editor > Type button > Material/Map Browser > Raytrace material > Dynamics Properties rollout

As with a standard material, the Dynamics Properties rollout for a [Raytrace material](#) on page 5490 lets you specify surface properties that affect the animation of an object upon collision with another object. If there are no collisions in your simulation, these settings have no effect.

Since the Dynamics Properties rollout is available at the top level of any material (including sub-materials), you can specify different surface dynamic properties for each face in an object. There are also controls in the Dynamics utility that let you adjust the surface properties at the object level, but only the Materials Editor lets you alter the surface properties at the sub-object level, through use of a [Multi/Sub-Object material](#) on page 5720.

As a default, the values in the Dynamics Properties rollout provide a surface that's similar to Teflon-coated hardened steel.

Interface

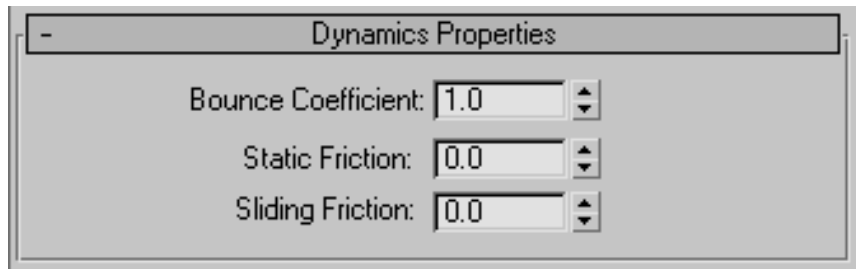

Bounce Coefficient Sets how far an object bounces after hitting a surface. The higher the value, the greater the bounce. A value of 1 represents a "perfectly elastic collision," or a bounce in which no kinetic energy is lost. Default=1.0. If you've seen the desktop toy with four ball bearings swinging back and forth on strings and hitting one another, you've seen an example that comes very close to a bounce coefficient of 1. Generally, hardened steel or a super ball have a bounce near 1, while lead has a bounce near 0.

Static Friction Sets how difficult it is for the object to start moving along a surface. The higher this value, the more difficult. Default=0.0.

If something weighs ten pounds and sits on Teflon (a static friction of near 0), it takes almost no force to make it move sideways. On the other hand, if it sits on sandpaper, then the static friction might be very high, on the order of 0.5 to 0.8. A static friction near 1 is very difficult to create in the real world without adhesives or friction material.

Sliding Friction Sets how difficult it is for the object to keep moving over a surface. The higher this value, the more difficult for the object to keep moving. Default=0.0.

Once two objects begin to slide over one another, static friction disappears and sliding friction takes over. Generally, sliding friction is lower than static friction due to surface tension effects. For example, once steel starts sliding

over brass (a value of static friction that might run from 0.05 to 0.2), the sliding friction drops to a significantly lower value, on the order of .01 to 0.1. For some materials, such as specific friction materials like brake linings, sliding friction is just as high as static friction because it is used in conjunction with a nearly frictionless material such as hardened polished steel.

Raytracing Acceleration Parameters Dialog

Rendering menu > Raytracer Settings > Render Setup dialog > Raytracer panel > Raytracer Global Parameters rollout > Global Raytrace Engine Options group > Acceleration Controls button

The controls in this dialog let you override the default acceleration values and specify your own requirements. Typically you don't need to use them, but if you are familiar with the requirements of your scene, they can help you optimize raytrace rendering for your specific needs and time constraints.

Raytracing subdivides the scene, organizing it into a tree for raytrace purposes. A node in this tree is known as a "voxel." Voxel trees are dynamic, and you can't explicitly specify the structure of the tree. (If you set Max. Divisions to 2, the tree is an octree, which is possibly a more familiar data structure.)

TIP If your scene is particularly unbalanced (for example, it has a giant planet object and a cluster of small spacecraft objects) keep the Balance setting low.

Interface

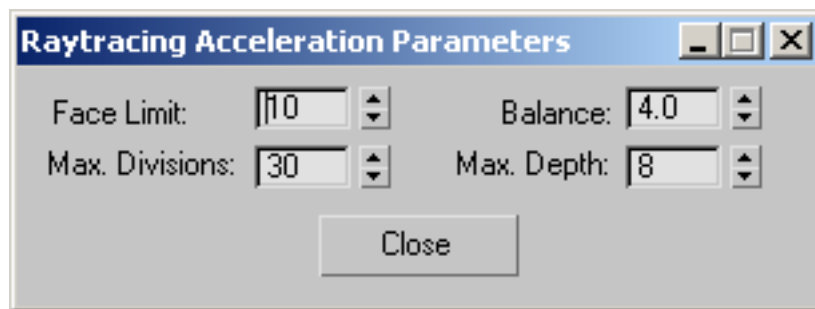

Face Limit Sets the maximum number of faces allowed in a lattice voxel before it is subdivided. Default=10.

Balance Determines the sensitivity of the subdivision algorithm. Increasing this value uses more memory but can increase performance. Default=4.0.

Max. Divisions Sets the initial lattice dimension. For example, 4 is a 4 x 4 x 4 lattice. Default=30.

Max. Depth Sets the maximum number of lattice subdivisions. Default=8.

Raytrace Exclude/Include Dialog

Rendering menu > Raytrace Global Include/Exclude

Material Editor > Raytrace material > Raytracer Controls rollout > Local Exclude button

Material Editor > Raytrace map > Raytracer Parameters rollout > Local Exclude button

Rendering menu/main toolbar > Raytracer Settings > Render Setup dialog > Raytracer panel > Raytracer Global Parameters rollout > Global Raytrace Engine Options group > Exclude button

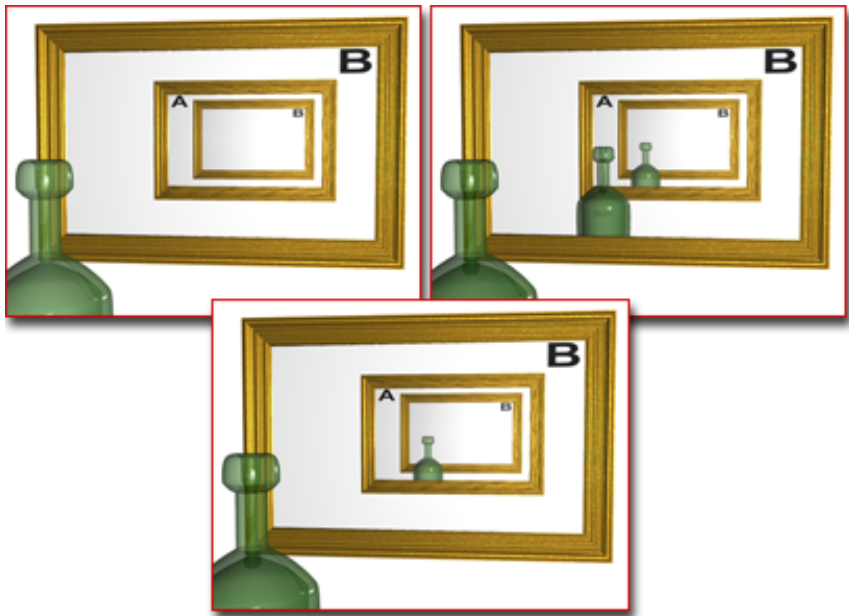

Upper left: Bottle excluded from both mirrors

Upper right: Bottle reflected by both mirrors

Lower middle: Bottle excluded from one mirror

These dialogs let you specify which objects the raytracer will and won't see. This is a good optimization when you are working with complex scenes and all you really need is for an object to reflect itself or some other, simpler elements in the scene.

The global dialog affects *all* Raytrace materials and Raytrace maps in your scene. The local dialog affects only the current material or map.

TIP Another good use for exclusion can be when you are working on a scene where the world-space scale of objects is not realistic. For example, consider an animation of a space dog-fight, with a planet and its moon in the background. You would use a planet that was actually much smaller, relative to the fighters, than an actual planet. (For example, the planet might be only five times bigger than the fighters, and the moon only half as big as the fighters.) If the fighters are reflective, the reflections of the planet and moon will be incorrect and will give away the fact that you are using miniatures. In this case, raytrace the reflective fighters, and laser blasts, and so on, but exclude the planet and moon props from the raytracer. Create an environment map that represents the planet and moon at their correct scale, and make that the Raytrace material's local environment. When you render, the scale of the planet and moon geometry appears to be correct, and the reflections on the fighters will behave as your eye expects.

Interface

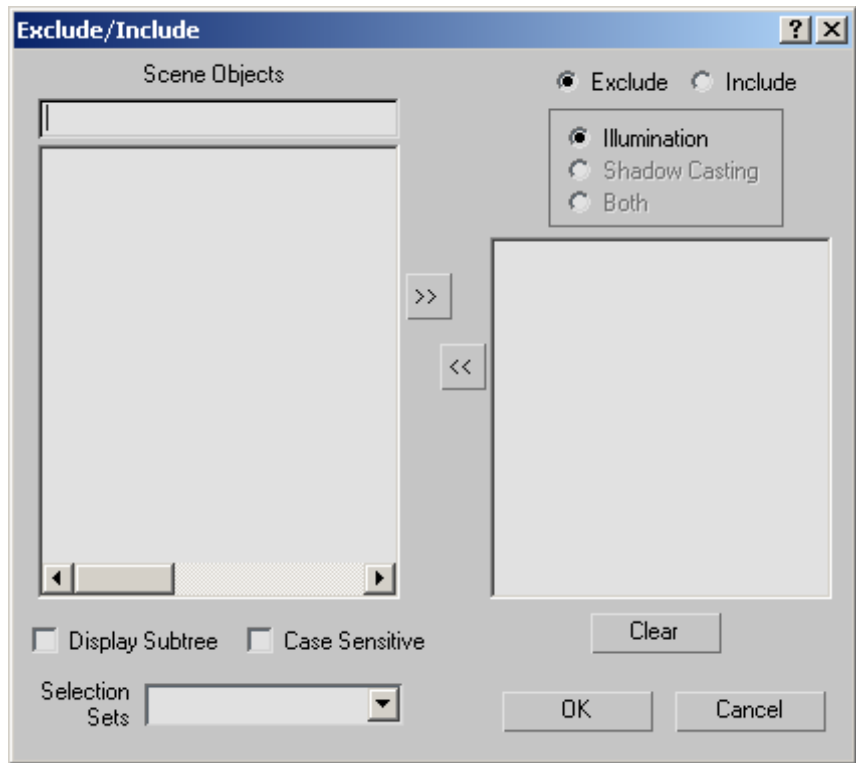

Both the Global and the Local Exclude/Include dialogs contain the following controls:

Exclude/Include Choose whether raytracing will exclude or include the objects named in the list on the right.

Illumination / Shadow Casting / Both For the raytracer, this is turned off (always set to Illumination).

Scene Objects Select objects from the Scene Objects list on the left, then use the arrow buttons to add them to the exclusion list on the right.

The Exclude/Include dialog treats a group as an object: you can exclude or include all objects in a group by selecting the group's name in the Scene Objects list. If a group is nested within another group, it isn't visible in the Scene Objects list.

Search Field The edit box above the Scene Objects list lets you search for object names by entering names that use wildcards.

Display Subtree When on, indents the list according to the object hierarchy.

Case Sensitive When on, uses case sensitivity when searching object names.

Selection Sets Displays a list of named selection sets. Choosing a selection set from this list selects those objects in the Scene Objects list.

Clear Clears all entries from the Exclude/Include list on the right.

OK Closes the dialog and retains the exclude or include operations you performed.

Cancel Closes the dialog and cancels the exclude or include operations you performed.

Raytrace Antialiaser Dialog: Fast Adaptive Antialiaser

Rendering menu > Raytracer Settings > RaytracerGlobal Parameters dialog > Global Ray Antialiaser group > Turn on global ray antialiasing. > Choose Fast Adaptive Antialiaser from the drop-down list. > ... button

Material Editor > Type button > Material/Map Browser > Raytrace material > Raytracer Controls rollout > Raytraced Reflection and Refraction Antialiaser group (enabled only if antialiasing is globally enabled) > Choose Fast Adaptive Antialiaser from the drop-down list. > ... button

Material Editor > Type button > Material/Map Browser > Raytrace map > Raytracer Parameters rollout > Raytraced Reflection and Refraction Antialiaser group (enabled only if antialiasing is globally enabled) > Choose Fast Adaptive Antialiaser from the drop-down list. > ... button

The Fast Adaptive Antialiaser dialog changes settings for the Raytrace material and maps Fast Adaptive antialiaser. You can use this dialog either globally, from the [Raytracer Global Parameters rollout](#) on page 6221, or locally, from the [Raytracer Controls rollout](#) on page 5506. When you locally change settings for an antialiaser, you don't affect the global settings for that antialiaser.

Interface

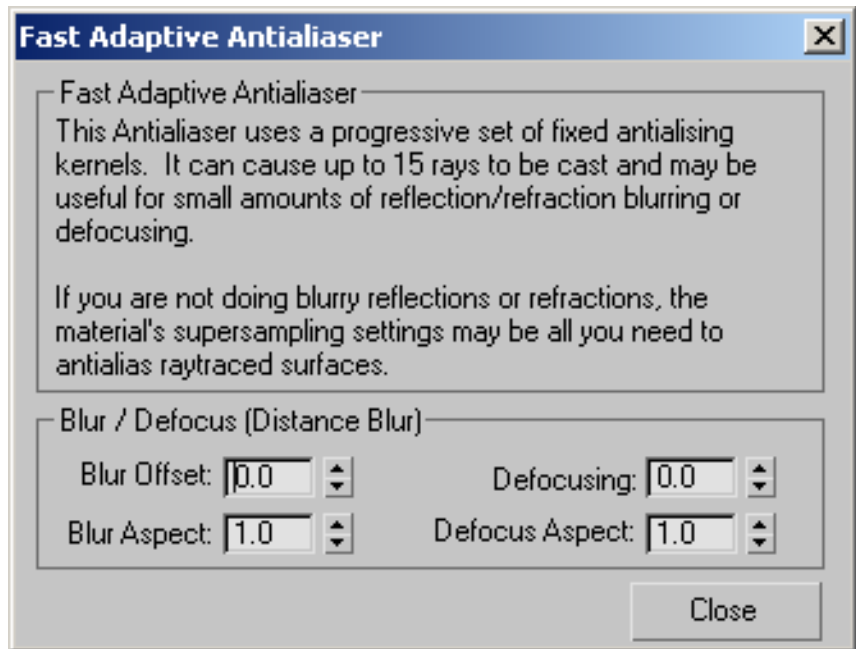

Blur / Defocus (Distance Blur) group

Blur Offset is similar to blur offset for Bitmaps, while defocus is based on distance.

Blur Offset Affects the sharpness or blurriness of the reflections or refractions without regard to distance. You can use Blur Offset to soften or defocus the details of a reflection or refraction. The value is specified in pixels. Default=0.0.

TIP The default Blur Offset setting usually produces good results. If you see aliasing in reflections or refractions, increase its value in increments of 0.5 until the aliasing goes away.

See [Blur/Blur Offset](#) on page 7928.

Blur Aspect This is an aspect ratio that changes the shape of the blur. Usually you will not need to change it. Default=1.0.

TIP If you see aliasing that occurs mostly along horizontal lines, try increasing Blur Aspect to 1.5. This changes the shape of the blurred effect. The reverse is also true. If aliasing occurs mostly along vertical lines, try decreasing Blur Aspect to 0.5.

Defocusing Defocusing is a blur based on distance. With Defocus, objects near the surface are not blurred, but objects farther away are blurred. The rays cast are spread as they leave the Raytrace material object's surface. Default=0.0.

TIP Increasing the value of Defocusing can give a good distance blurring effect. Small adjustments are usually adequate. Try starting with a value less than 0.1, and increase or decrease it as necessary. Also try adjusting Reflect Falloff in Raytrace material or Attenuation in Raytrace map to get the best distance blurring effect.

Defocus Aspect This is an aspect ratio that changes the shape of the defocusing. Usually you will not need to change it. Default=1.0.

Raytrace Antialiaser Dialog: Multiresolution Adaptive Antialiaser

Rendering menu > Raytracer Settings > Render Setup dialog > Raytracer panel > Raytracer Global Parameters rollout > Raytracer Global Parameters > Global Ray Antialiaser group > Turn on global antialiasing. > Choose Multiresolution Adaptive Antialiaser from the drop-down list. > ... button

Material Editor > Type button > Material/Map Browser > Raytrace material > Raytracer Controls rollout > Raytraced Reflection and Refraction Antialiaser group (enabled only if antialiasing is globally enabled) > Choose Multiresolution Adaptive Antialiaser from the drop-down list. > ... button

The Multiresolution Adaptive Antialiaser dialog changes settings for the Raytrace material and maps Multiresolution Adaptive antialiaser. You can use this dialog either globally, from the [Raytracer Global Parameters rollout](#) on page 6221, or locally, from the [Raytracer Controls rollout](#) on page 5506. When you locally change settings for an antialiaser, you don't affect the global settings for that antialiaser.

Interface

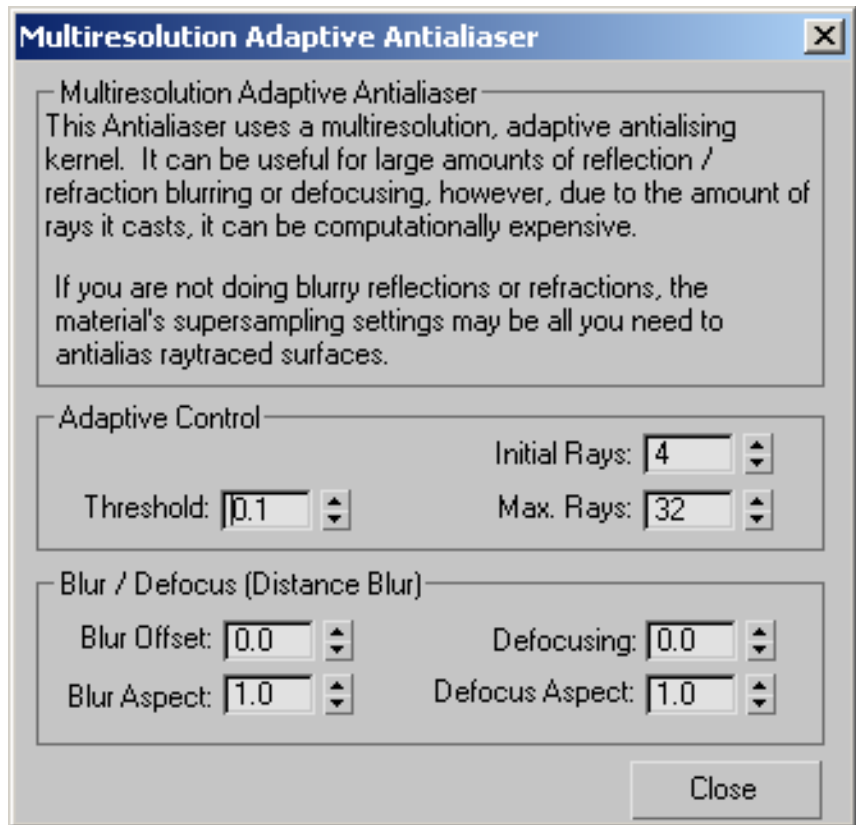

Adaptive Control group

Initial Rays Sets the initial number of rays cast per pixel. Default=4.

Threshold Determines the sensitivity of the adaptation algorithm. It can range from 0 to 1, where 0 always casts the maximum number of rays and 1 always casts only the minimum number of rays. Default=0.1.

Max. Rays (Maximum Rays) Sets the maximum number of rays the algorithm will cast. Default=32.

Blur / Defocus (Distance Blur) group

Blur Offset is similar to [blur offset](#) on page 7928 for bitmaps, while Defocusing is based on distance.

Blur Offset Affects the sharpness or blurriness of the reflections or refractions without regard to distance. You can use Blur Offset to soften or defocus the details of a reflection or refraction. The value is specified in pixels. Default=0.0.

TIP The default Blur Offset setting usually produces good results. If you see aliasing in reflections or refractions, increase its value in increments of 0.5 until the aliasing goes away.

Blur Aspect This is an aspect ratio that changes the shape of the blur. Usually you will not need to change it. Default=1.0.

TIP If you see aliasing that occurs mostly along horizontal lines, try increasing Blur Aspect to 1.5. This changes the shape of the blurred effect. The reverse is also true. If aliasing occurs mostly along vertical lines, try decreasing Blur Aspect to 0.5.

Defocusing Defocusing is a blur based on distance. With Defocus, objects near the surface are not blurred, but objects farther away are blurred. The rays cast are spread as they leave the Raytrace material object's surface. Default=0.0.

TIP Increasing the value of Defocusing can give a good distance blurring effect. Small adjustments are usually adequate. Try starting with a value less than 0.1, and increase or decrease it as necessary. Also try adjusting Reflect Falloff in Raytrace material or Attenuation in Raytrace map to get the best distance blurring effect.

Defocus Aspect This is an aspect ratio that changes the shape of the defocusing. Usually you will not need to change it. Default=1.0.

Architectural Material

The settings for an Architectural material are physical properties, so it provides the greatest possible realism when used with [photometric lights](#) on page 5005 and [radiosity](#) on page 6168. With this combination of features, you can create lighting studies with a high degree of accuracy.

It is *not recommended* that you use the Architectural material with standard 3ds Max lights in the scene, or with the Light Tracer. The point of this material is to provide accurate modeling. Use it with photometric lights and radiosity.

The mental ray renderer, on the other hand, can render the Architectural material, with some limitations described below.

TIP If you don't need the degree of realism that the Architectural material provides, you can use a [standard material](#) on page 5395 or other material type.

Material Templates

When you create a new material, you can choose from a variety of templates. A template is simply a set of preset material parameters, which approximates the kind of material you want to create, and gives you a starting point. See [Templates Rollout](#) on page 5528.

Rendering Architectural Materials with the mental ray Renderer

The [mental ray Renderer](#) on page 6230 can render Architectural materials. There are some limitations, as follows:

- Emit Energy (Based on Luminance): This setting is ignored. The Architectural material does not contribute to the scene's lighting.
- Sampling Parameters: These settings are ignored, as the mental ray renderer uses its own sampling.

TIP When rendering with mental ray, instead of the Architectural material, we *highly* recommend that you use the [Arch & Design material](#) on page 5544. This material was designed especially for mental ray and provides superior flexibility, rendering characteristics, and speed.

Interface

[Templates Rollout](#) on page 5528

[Physical Qualities Rollout](#) on page 5530

[Special Effects Rollout](#) on page 5534

[Advanced Lighting Override Rollout](#) on page 5536

[SuperSampling Rollout](#) on page 5381

[mental ray Connection Rollout](#) on page 5385

Templates Rollout

Material Editor > Architectural material > Templates rollout

The Templates rollout gives you a list of material types to choose from. A template is simply a set of preset parameters for the Physical Qualities rollout, which approximates the kind of material you want to create, and gives you a starting point. Once you choose a template, you can adjust its settings and add [maps](#) on page 5767 to enhance realism and improve the material's appearance.

The templates do not affect the Diffuse Color on the Physical Qualities rollout, only the numeric settings.

Interface

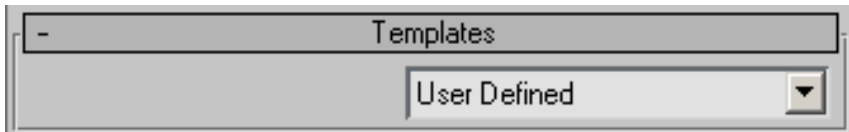

Template drop-down list Chooses the kind of material you are designing. Each template provides preset values for the various material parameters.

These are the material templates provided with 3ds Max. The purpose of most templates is clear, so the table doesn't comment on all of them.

Template	Comments
Ceramic Tile - Glazed	
Fabric	
Glass - Clear	
Glass - Translucent	
Ideal Diffuse	A neutral white material
Masonry	A good base for a diffuse map
Metal	Shiny and reflective

Template	Comments
Metal - Brushed	Less shiny
Metal - Flat	Even less shiny
Metal - Polished	Highly shiny
Mirror	Completely shiny
Paint Flat	Another neutral white material
Paint Gloss	Also white, but shiny
Paint Semi-Gloss	Also white, only slightly shiny
Paper	
Paper - Translucent	
Plastic	
Stone	A good base for a diffuse map
Stone Polished	Has a bit of shininess; also a good base for a diffuse map
User Defined	Neutral; a good base for a diffuse map
User-Defined Metal	Somewhat shiny; also a good base for a diffuse map
Water	Completely clear and shiny
Wood Unfinished	Neutral; a good base for a map

Wood Varnished

Physical Qualities Rollout

Material Editor > Architectural material > Physical Qualities rollout

When you create a new [Architectural material](#) on page 5526 or edit an existing one, the settings on the Physical Qualities rollout are the ones you are most likely to need to adjust.

Procedures

To match a material's luminance to a light:

WARNING Only photometric lights give correct luminance. Also, the mental ray renderer disregards the Emit Energy setting.

-  Click to turn on Set Luminance From Light (below the Luminance setting), then in a viewport, click the light. After you choose the light, the button turns off once more.

TIP If you are using a [radiosity solution](#) on page 6168, make sure to turn on Emit Energy (Based On Luminance) for any material whose luminance is greater than zero. This control is on the [Advanced Lighting Override rollout](#) on page 5536.

Interface

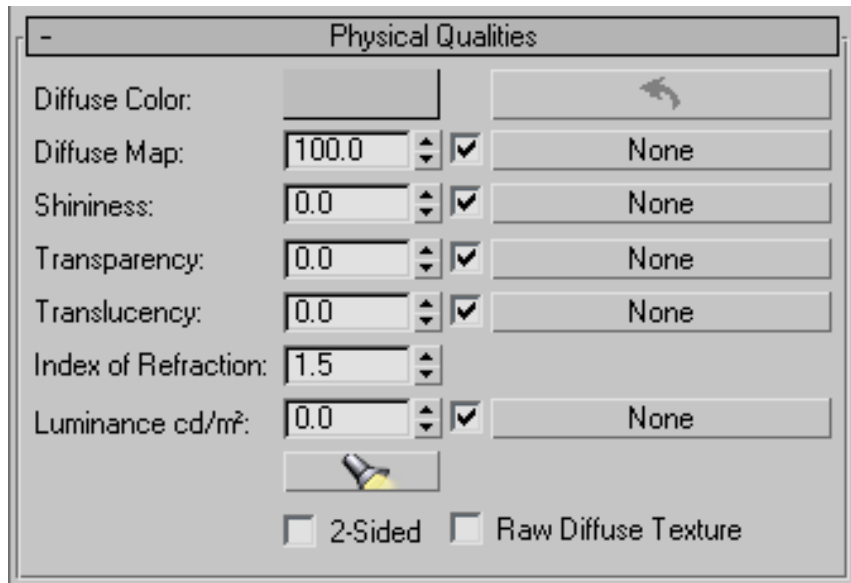

Diffuse Color Controls the [diffuse color](#) on page 7955. The diffuse color is the color this material has in direct light. Click the color swatch to display the [Color Selector](#) on page 391 and change the diffuse color.



Set color to texture average Click to change the diffuse color to an average of the colors in the current diffuse map. (If no map is assigned, this button has no effect.)

This button is useful when you are going to reduce the diffuse map's Amount. When the diffuse map pattern appears over an average of itself, for most kinds of materials the effect is more realistic than when the pattern appears over an unrelated color.

WARNING This button will change the diffuse color even if the diffuse map is turned off.

Diffuse Map These controls assign a map to the material's diffuse component. To assign a map, click the oblong button (labeled "None" by default). This displays the Material/Map Browser. In the Browser, choose the map type, and then click OK. If you choose Bitmap as the map type, an additional dialog prompts you to choose the particular bitmap file to use.

While a map is assigned to the material, its name appears as the map button's label.

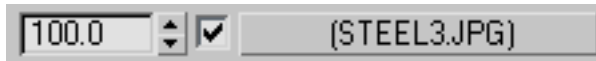

- **Amount spinner** The spinner at the left sets the amount of diffuse map to use. This value is a percentage: at 100.0, only the map is visible; at lower amounts, the diffuse color shows through; at 0.0, the map is not visible at all.
- **On/off** The check box between the spinner and the map button is an on/off switch. When on, the map appears in the material. When off, the map does not appear.

Shininess Sets the shininess of the material. This value is a percentage: at 100.0, the material is as shiny as possible; at lower values, it is less shiny; at 0.0, it is not shiny at all.

In general, the shinier a material is, the smaller its specular highlights appear. Specular highlights are reflections of the lights that illuminate the material. (The index of refraction can also affect the size of highlights.) Shininess also controls how much the material reflects other objects in the scene.

NOTE Shininess alone is not sufficient to produce specular reflections and highlights on a surface. You must also consider the Index Of Refraction (IOR), described below.

The amount spinner for a shininess map scales the map. If no map is assigned, the spinner value is used by itself.

Transparency Controls how transparent the material is. This value is a percentage: at 100.0, the material is completely transparent; at lower values, the material is partly opaque; and at 0.0, the material is completely opaque.

TIP The effect of transparency is best previewed against a pattern background. If the material preview doesn't show a pattern of colored checks, right-click the material preview or the map preview, and choose Background from the pop-up menu.

The amount spinner for a transparency map scales the map. If no map is assigned, the spinner value is used by itself.

Translucency Controls how translucent the material is. A translucent object transmits light, but also scatters it within the object. This value is a percentage:

at 0.0, the material is completely opaque; at 100.0, the material is as translucent as possible.

The amount spinner for a translucency map scales the map. If no map is assigned, the spinner value is used by itself.

Index of Refraction The index of refraction (IOR) controls how severely the material refracts transmitted light, and how reflective the material appears. At 1.0, the IOR of air, the object behind the transparent object does not distort. At 1.5, the object behind distorts greatly, like a glass marble. Range=1.0 to 2.5.

Common IORs (assuming the camera is in air or a vacuum) are:

Material	IOR Value
Vacuum	1.0 (exactly)
Air	1.0003
Water	1.333
Glass	1.5 to 1.7
Diamond	2.419

In the physical world, the IOR results from the relative speeds of light through the transparent material and the medium the eye or the camera is in. Typically this is related to the object's density: the higher the IOR, the denser the object. The IOR affects how shiny a material appears; or, in the case of transparent materials such as water or glass, the amount of distortion. For nontransparent materials, the higher the IOR, the more light is reflected from the material, and the shinier the material appears.

A refractive index of 1.0 means that all light is transmitted into the material. In this case, even if the material has a high Shininess value, the surface appears perfectly diffuse, and shows no specular highlights.

Luminance cd/m² When its luminance is greater than 0.0, the material appears to glow, and if you turn on Emit Energy (see below), it contributes energy to the [radiosity solution](#) on page 6168. Luminance is measured in candelas per meter squared.

The amount spinner for a luminance map scales the map. If no map is assigned, the spinner value is used by itself.



Set luminance from light Obtains the material's luminance from a light in the scene. Click to turn on this button, then click a light in a viewport. The material's luminance is set to match the luminance of the light, and the button is turned off once more.

2-Sided When on, makes the material [2-sided](#) on page 7893. Applies the material to both sides of selected faces.

Raw Diffuse Texture When on, excludes the material from lighting and exposure control. This makes the material render with a completely flat look, using the pure RGB values of the diffuse color or map. Default=off.

Special Effects Rollout

Material Editor > Architectural material > Special Effects rollout

When you create a new [Architectural material](#) on page 5526 or edit an existing one, the settings on the Special Effects rollout let you assign maps that create bumps or displacement, adjust light intensity, or control transparency.

Interface

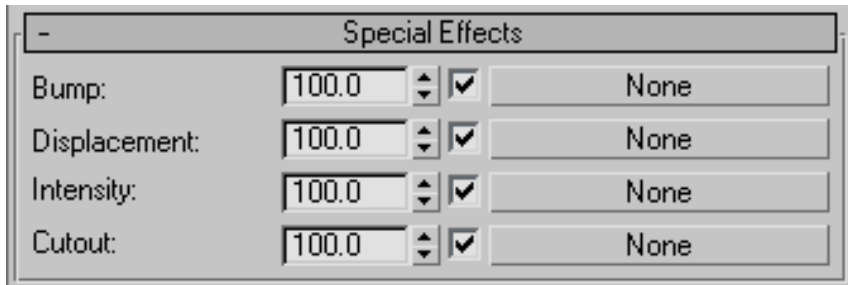

Bump controls These controls assign a [bump map](#) on page 5478 to the material. To assign a map, click the oblong button (labeled “None” by default). This displays the Material/Map Browser. In the Browser, choose the map type, and then click OK. If you choose Bitmap as the map type, an additional dialog prompts you to choose the particular bitmap file to use.

While a map is assigned to the material, its name appears as the map button's label.



- **Amount spinner** The spinner at the left sets the amount of bump mapping to use. At 1000.0, bump mapping has its greatest effect; at lower amounts, the bumps are less pronounced; at 0.0, the bumps are not visible at all. Negative values reverse the direction of the bump effect. Range: -1000.0 to 1000.0.
- **On/off** The check box between the spinner and the map button is an on/off switch. When on, the map is used in the material. When off, the map is not used.

Displacement controls These controls assign a [displacement map](#) on page 5487 to the material. To assign a map, click the oblong button (labeled “None” by default). This displays the Material/Map Browser. In the Browser, choose the map type, and then click OK. If you choose Bitmap as the map type, an additional dialog prompts you to choose the particular bitmap file to use. While a map is assigned to the material, its name appears as the map button’s label.



- **Amount spinner** The spinner at the left sets the amount of displacement mapping to use. At 1000.0, displacement mapping has its greatest effect; at lower amounts, the displacement is less pronounced; at 0.0, the displacement are not visible at all. Negative values reverse the direction of the displacement. Range: -1000.0 to 1000.0.
- **On/off** The check box between the spinner and the map button is an on/off switch. When on, the map is used in the material. When off, the map is not used.

Intensity controls These controls assign an intensity map to the material, modulating the material's brightness. The map is treated as a black-and-white scale of intensity values.

TIP Applying a low-frequency [Noise map](#) on page 5886 to the intensity can help reduce the “computer-generated” look of a texture, and add a natural feel to surfaces such as bricks and carpets lit by daylight.

To assign a map, click the oblong button (labeled “None” by default). This displays the Material/Map Browser. In the Browser, choose the map type, and

then click OK. If you choose Bitmap as the map type, an additional dialog prompts you to choose the particular bitmap file to use.

While a map is assigned to the material, its name appears as the map button's label.



- **Amount spinner** The spinner at the left sets the amount of intensity mapping to use. At 100.0, intensity mapping has its greatest effect; at lower amounts, the effect is less pronounced; at 0.0, the map has no effect; and at values less than 0.0, the material is dimmed. Range: -100.0 to 100.0.
- **On/off** The check box between the spinner and the map button is an on/off switch. When on, the map is used in the material. When off, the map is not used.

Cutout controls These controls assign a [cutout map](#) on page 5541 to the material. To assign a map, click the oblong button (labeled “None” by default). This displays the Material/Map Browser. In the Browser, choose the map type, and then click OK. If you choose Bitmap as the map type, an additional dialog prompts you to choose the particular bitmap file to use.

While a map is assigned to the material, its name appears as the map button's label.



- **Amount spinner** The spinner at the left sets the amount of cutout mapping to use. This value is a percentage: at 100.0, the map has its full effect; lower amounts have the effect of darkening the map, reducing its effect and increasing transparency. At 0.0, the map is completely black, making objects with this material completely transparent.
- **On/off** The check box between the spinner and the map button is an on/off switch. When on, the map is used in the material. When off, the map is not used.

Advanced Lighting Override Rollout

Material Editor > Architectural material > Advanced Lighting Override rollout

When you create a new [Architectural material](#) on page 5526 or edit an existing one, the settings on the Adjust Radiosity rollout let you adjust how the material behaves in a [radiosity solution](#) on page 6168.

Obtaining a Better Image

Materials with a bright diffuse color or high shininess can be highly reflective. This can lead to overexposed or washed-out radiosity solutions. In general, the best way to adjust this is to reduce the HSV Value (V) of a material's diffuse color; or, for a material with a diffuse map, reduce the map's RGB level. In some situations, the controls on this rollout can improve the appearance of the radiosity solution. Examples of situations where the material's radiosity settings can help include color bleeding and large dark areas:

- You might want to reduce Reflectance Scale or Color Bleed Scale when a large area of color (for example, a red carpet in a room with white walls) creates excessive color bleeding. This might be physically accurate, but the eye adjusts for such effects, and the radiosity result might look better with less reflectance or less color bleeding.

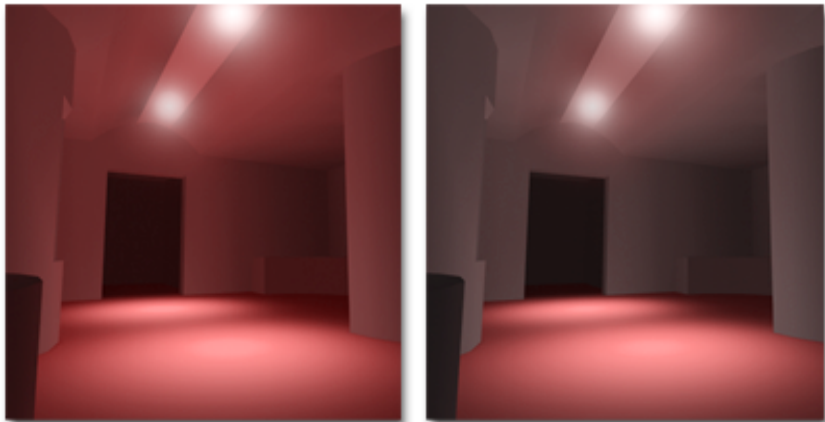

Left: Excessive bleeding of the floor color onto the walls and ceiling.

Right: Reducing the floor's Reflectance Scale causes less bleeding.

- You might want to increase Reflectance Scale when the scene includes a large dark area (for example, a black floor). This can lead to a very dark radiosity result. You can maintain the floor's color but increase reflectance, giving the solution the colors you want while increasing its brightness.

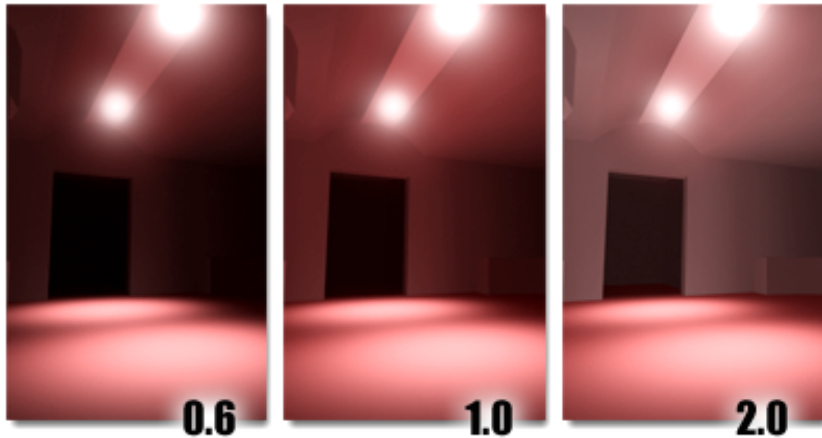

The room is lit only by spotlights pointed at the floor. Increasing reflectance of the floor brightens the entire room.

TIP Check the [reflectance and transmittance display](#) on page 5324 to get an idea of how the current material will affect the radiosity solution.

Interface

WARNING There is no problem with reducing the default scale, but increasing it for any of these parameters might cause colors to “burn out”: if the scale is too great, they render as pure white, appearing overexposed.

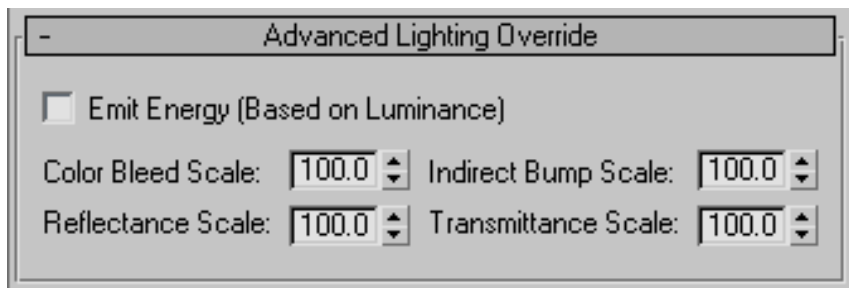

Emit Energy (Based on Luminance) When on, the material contributes energy to the radiosity solution, based on the material’s luminance value (see above).

NOTE The [mental ray renderer](#) on page 6230 does not use this setting. The Architectural material does not contribute to the scene's lighting.

Increasing the Luminance (above 0.0) makes an object appear to glow in ordinary renderings, but does not contribute energy to the radiosity solution. To have radiosity processing take a self-illuminating material into account, turn on Emit Energy (Based On Luminance).

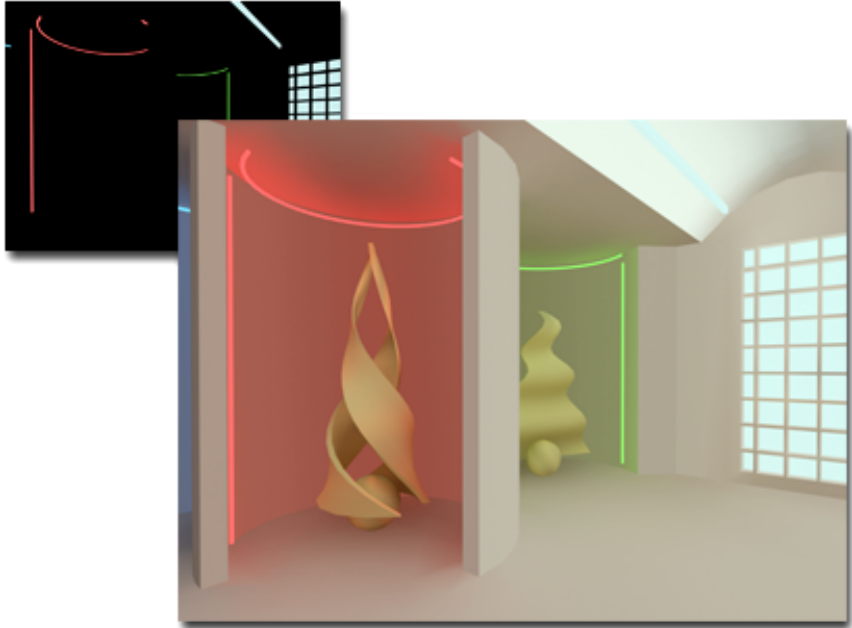

Upper left: By default, luminous neon lights do not influence the scene light.

Right: With Emit Energy on, the radiosity solution takes luminance into account.

TIP When you increase luminance to achieve a special effect in the rendering (for example, to make the globe surrounding a lamp appear to be glowing), probably you shouldn't turn on Emit Energy (in the example, both the globe and lamp would then add light to the scene). When you increase luminance because the object really glows (for example a neon light tube), then you should turn on Emit Energy, so that the object contributes light to the scene.

Color Bleed Scale Increases or decreases the saturation of reflected color. Range=0.0 to 100.0. Default=100.0.

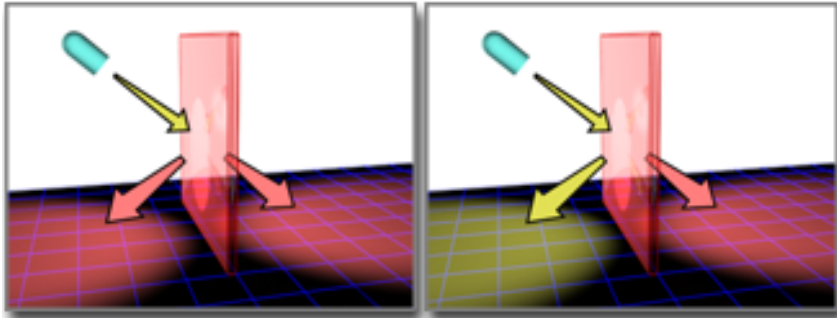

Color Bleed increases or decreases the saturation of reflected color.

Indirect Bump Scale Scales the effect of the base material's [bump mapping](#) on page 5478 in areas lit by indirect light. When this value is zero, no bump mapping is done for indirect light. Increasing Indirect Light Bump Scale increases the bump effect under indirect lighting. This value does not affect the Bump amount in areas where the base material is lit directly. Range=-999.0 to 999.0. Default=100.0.

TIP This parameter is useful because indirect bump mapping is simulated and not always accurate. Indirect Light Bump Scale lets you adjust the effect by hand.

Reflectance Scale Increases or decreases the amount of energy the material reflects. Range=0.0 to 100.0. Default=100.0.

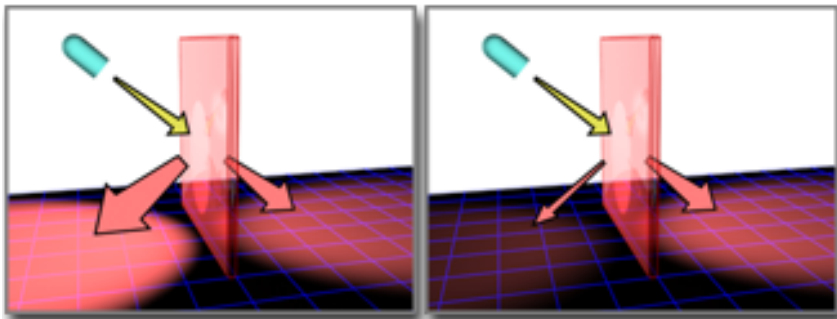

Reflectance Scale increases or decreases the energy of reflected rays.

TIP Don't use this control to increase self-illumination. Use the material's Luminance instead. The Luminance control is on the [Physical Qualities rollout](#) on page 5530.

Transmittance Scale Increases or decreases the amount of energy the material transmits. Range=0.1 to 5.0. Default=1.0.

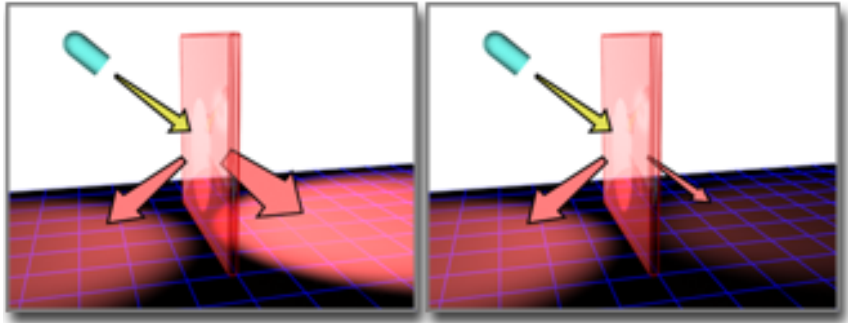

Transmittance Scale increases or decreases the energy of transmitted rays.

Cutout Mapping

Material Editor > Architectural material > Special Effects rollout > Cutout map button

Assigning a [bitmap](#) on page 5795 or [procedural map](#) on page 8097 to the Cutout component of an [Architectural material](#) on page 5526 makes the material partially transparent. Lighter (higher-value) areas of the map render as opaque; darker areas render as transparent; and values in between are semi-transparent.

Setting the cutout map's Amount to 100 applies all of the map. Transparent areas are fully transparent. Setting the Amount to 0 is the equivalent of turning the map off. Intermediate Amount values are blended with the Transparency value on the Physical Qualities rollout. Transparent areas of the map become more opaque.

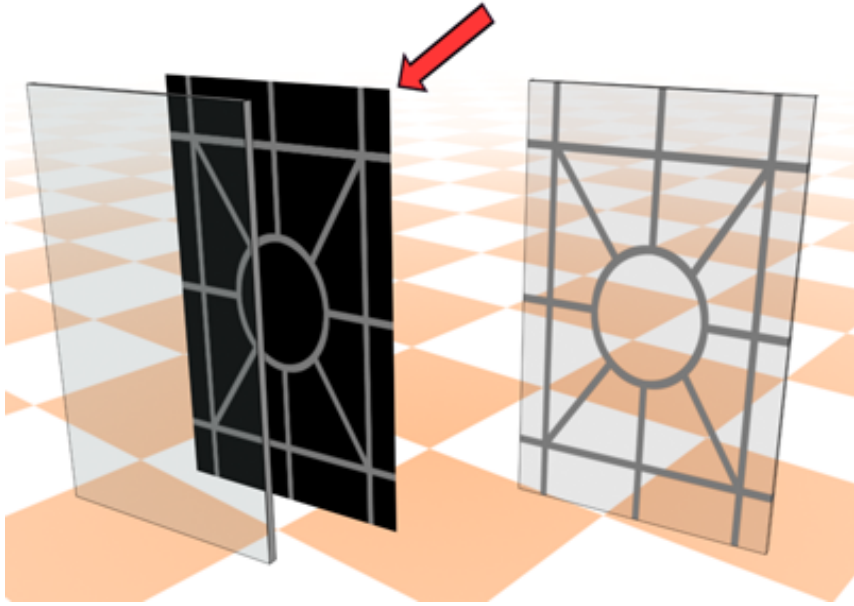

The gray levels of a cutout map determine the amount of transparency.

Procedures

To use a cutout map:

- 1 Click the Cutout map button.
The [Material/Map Browser](#) on page 5290 is displayed.
- 2 Choose from the list of [map types](#) on page 5767, and then click OK.
The Material is now at the map level, and displays map controls.
(If you choose Bitmap as the map type, you first see a file dialog that lets you choose the image file.)
- 3 Use the map controls to set up the map.

To remove a cutout map from a material:

TIP You can disable the map without removing it. Simply turn off the toggle immediately to the left of the map button on the Special Effects rollout.

- 1 If the Material Editor is displaying the map controls, click the [Type button](#) on page 5361 to display the Material/Map Browser. If the map controls aren't visible, click the Cutout map button to display them, and then click the Type button.
- 2 In the Browser, choose NONE as the map type, and then click OK.
The map is removed.

mental ray Materials

3ds Max comes with several materials created specifically for use with the [mental ray renderer](#) on page 6230. These materials are visible in the [Material/Map Browser](#) on page 5290 when mental ray is the active renderer.

- [Arch & Design](#) on page 5579
The Arch & Design material is a monolithic material shader designed to support most materials used in architectural and product-design renderings. For most applications this is the recommended material.
- [Car Paint](#) on page 5607
Car Paint, available as both a material and a shader, has components for a paint layer with embedded metal flakes, a clear-coat layer, and a Lambertian dirt layer.
- [DGS](#) on page 5615
DGS stands for Diffuse, Glossy, and Specular. This material behaves in a physically realistic way.
- [Glass](#) on page 5619
The Glass material simulates both the surface properties and the light-transmitting (photon) properties of glass.
- [Matte/Shadow/Reflection](#) on page 5622
The Matte/Shadow/Reflection (mi) material is used to create “matte objects”; that is, objects that represent real-world objects in a photograph used as the scene background. The material provides a wealth of options for marrying a photographic background with the 3D scene, including support for bump mapping, ambient occlusion, and indirect illumination.

- [mental ray](#) on page 5638
The mental ray material has components for the surface shader, and for the other nine optional shaders that make up a material in mental ray.
- [Subsurface Scattering Materials](#) on page 5693
The subsurface scattering materials, supported by a shader library from mental images, can model skin and similar organic materials.
-  [ProMaterials](#) on page 5647 model materials commonly used in construction, design, and the environment.
- [Utility mental ray Materials](#) on page 5695
The utility mental ray materials allow you to combine a material with multiple maps.

NOTE When you wire the parameters of an object with a mental ray material assigned, the names of material parameters might differ from those in the Material Editor interface. Also, parameters not supported by 3ds Max might appear as blanks in the wiring menu.

Arch & Design Material (mental ray)

Material Editor > Type button > Material/Map Browser > Arch & Design Material

Material Editor > any material > Click a Map button. > Material/Map Browser > Car Paint Shader

Note: The Arch & Design material appears in the Browser only if the mental ray renderer is the currently active renderer.

The mental ray Arch (architectural) & Design material improves the image quality of architectural renderings and improves workflow and performance in general and for glossy surfaces such as floors in particular. Special features include self-illumination, advanced options for reflectivity and transparency, ambient occlusion settings, and the ability to round off sharp corners and edges as a rendering effect.

TIP The Arch & Design material supports hardware-based viewport display for improved feedback while editing its parameters. For more information, see [Show Standard/Hardware Map in Viewport](#) on page 5350.

TIP The Arch & Design material interface has built-in descriptions of all of its important parameters. To view a tooltip describing a parameter of interest, position the mouse cursor over the control's spinner, color swatch, check box, etc.

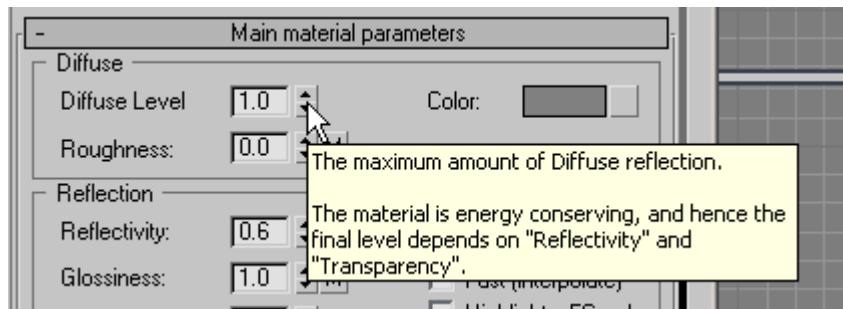

See also:

- [Arch & Design Material \(mental ray\): Overview](#) on page 5579
- [Arch & Design Material \(mental ray\): Tips and Tricks](#) on page 5593

Procedures

To create a physically correct, self-illuminated surface:

An example of this application is a realistic halogen pendant luminaire with a translucent shade, such as frosted glass.

- 1 Create your geometry and obtain or create a photometric file of the luminaire. Determine the lamp color and intensity, as measured or provided by the manufacturer; for example: 1,500 cd/m² and 3,700 degrees Kelvin. Enable [tone mapping](#) on page 6732 and [global illumination](#) on page 6261.
- 2 Create a photometric light (the halogen lamp) and set its color and intensity.
- 3 Turn off the light source's Affect Specular property.
- 4 Create and place the light-shade geometry and apply an Arch & Design material to it.
- 5 On the Self Illumination (Glow) rollout, set the same color and intensity you applied to the light source. Also turn off the Illuminates The Scene (When Using FG) check box in the Glow Options group.

6 Render the scene.

Interface

[Main material parameters rollout](#) on page 5547

[BRDF rollout](#) on page 5557

[Self Illumination \(Glow\) rollout](#) on page 5559

[Special Effects rollout](#) on page 5563

[Advanced Rendering Options rollout](#) on page 5568

[Fast Glossy Interpolation rollout](#) on page 5574

[Special Purpose Maps rollout](#) on page 5577

[General Maps rollout](#) on page 5579

Templates rollout

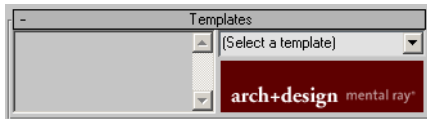

Provides access to Arch & Design material presets for quickly creating different types of materials such as wood, glass, and metal. You can also use these as starting points for generating customized materials. Choose a template from the drop-down list; a description of the material then appears in the left-hand pane.

NOTE The Arch & Design material works only with the mental ray renderer, so in order to see it represented accurately in the sample slots, you must first set mental ray to render in the Material Editor. For details, see [Assign Renderer Rollout](#) on page 6135.

Main material parameters rollout

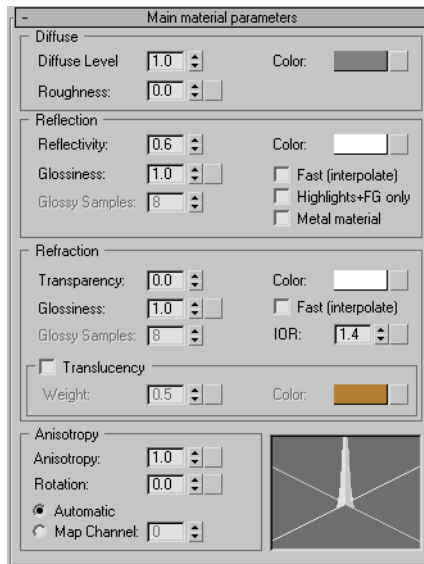

Diffuse group

Diffuse Level [Diffuse Level](#) on page 5444 controls the brightness of the diffuse color component. Range=0.0 to 1.0. Default=1.0.

NOTE Because the material is energy conserving, the actual diffuse level used depends on the reflectivity and transparency, as discussed in the introductory section, above.

Color Controls the [diffuse color](#) on page 7955. The diffuse color is the color in direct light. Default=50% gray.

Roughness [Roughness](#) on page 5446 controls how quickly the diffuse component blends into the ambient component. Range=0.0 to 1.0. Default=0.0.

The diffuse component uses the Oren-Nayar shading model. When the Roughness value is 0.0 this is identical to classical Lambertian shading, but with higher values the surface gets a more “powdery” look, as shown in the following illustration.

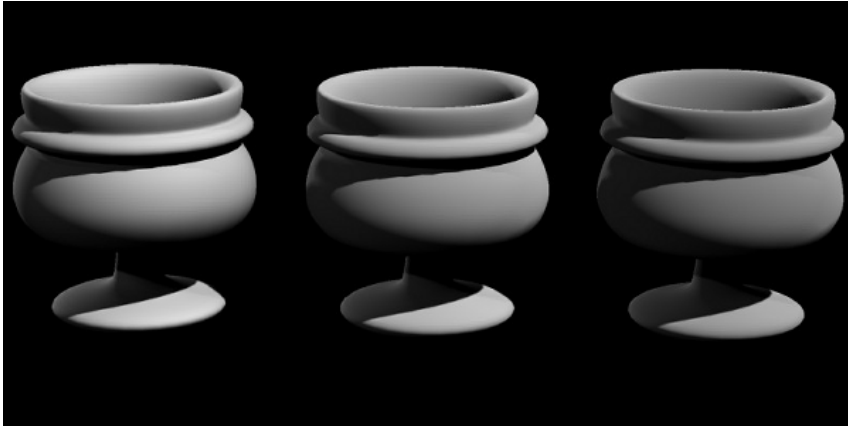

Left: Roughness=0.0; Center: 0.5; Right: 1.0

Reflection group

Reflectivity The overall level of reflectivity. Range=0.0 to 1.0. Default=0.6. The Reflectivity and Color values combine to define the level of reflections as well as the intensity of the traditional highlight, also known as the *specular highlight*.

This value is the maximum value; the actual value also depends on the angle of the surface and comes from the BRDF curve. This curve (see [BRDF rollout](#) on page 5557) lets you define 0-degree reflectivity for surfaces facing the view and 90-degree reflectivity for surfaces perpendicular to the view.



Left: No reflectivity, with a purely diffuse material

Center: Angle-dependent reflectivity, with 0-degree reflectivity of 0.1 and a 90-degree reflectivity of 1.0

Right: Constant reflectivity, with both 0-degree reflectivity and 90-degree reflectivity of 0.9

NOTE In the preceding illustration, the high reflectivity automatically “subtracts” from the white diffuse color. If this didn’t happen, the material would become unrealistically overbright, and would break the laws of physics.

Color The overall color of reflected light. Default=white.

Glossiness Defines the surface “glossiness,” ranging from 1.0 (a perfect mirror) to 0.0 (a diffusely reflective surface). Default=1.0.



Left: Glossiness=1.0; **Center,** 0.5; **Right,** 0.25

Glossy Samples Defines the maximum number of samples (rays) that mental ray shoots to create glossy reflections. Higher values cause slow rendering but create a smoother result. Lower values render faster but create a grainier result. Generally 32 is enough for most cases.

Available only when Glossiness does not equal 1.0. Because a Glossiness value of 1.0 creates a “perfect mirror,” it is meaningless to shoot multiple rays for this case, hence only one reflection ray is shot.

NOTE If you set Glossy Samples to 0, the reflections take the form of a “perfect mirror” and only one ray is shot, regardless of the actual value of Glossiness. You can use this to boost performance for surfaces with very weak reflections. The highlight still respects the Glossiness value.

Glossy reflections need to trace multiple rays to yield a smooth result, which can affect performance. For this reason, the material includes the following two special features designed to enhance performance:

Fast (interpolate) When on, a smoothing algorithm allows rays to be reused and smoothed. The result is faster and smoother glossy reflections at the expense of accuracy. Interpolation is explained in greater detail in the section on the [Fast Glossy Interpolation rollout](#) on page 5574.

NOTE This method works best on flat surfaces.

Highlights+FG only When on, mental ray traces no actual reflection rays. Instead, only the highlights are shown, as well as soft reflections emulated with the help of using Final Gathering.

The Highlights+FG Only mode takes no additional rendering time compared to a non-glossy (diffuse) surface, yet can yield surprisingly convincing results. While it might not be completely convincing for “hero” objects in a scene, it can work very well for less-essential scene elements. It tends to work best on materials with weak reflections or extremely glossy (blurred) reflections, as shown in the following illustration:

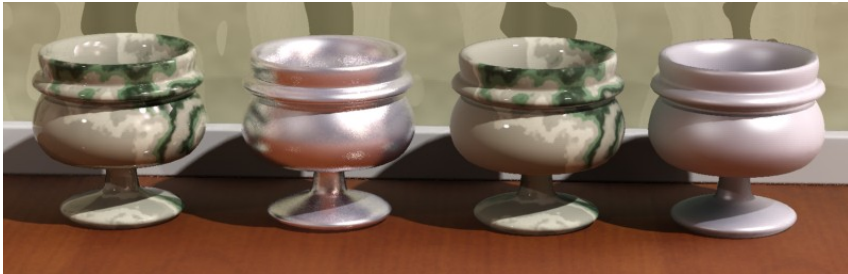

The two cups on the left use real reflections, while those on the right use Highlights+FG Only.

Metal material Metallic objects actually influence the color of their reflection, whereas other materials do not. For example, a gold bar will have gold colored reflections, but a red glass orb does not have red reflections. This is supported through the Metal Material option:

- When off, the Reflection Color parameter defines the color, and the Reflectivity parameter together with the BRDF settings defines the intensity and colors of reflections.

- When on, the Diffuse Color parameter defines the color of reflections, and Reflectivity parameter sets the “weight” between diffuse reflections and glossy (metallic) reflections.



Left: Non-metallic reflections (Metal Material is off). Reflections clearly contain the color of the objects they reflect and are not influenced by the color of the materials.

Center: Metallic reflections (Metal Material is on). Now the color of reflections are influenced by the color of the object.

Right: A variant of this with Reflectivity=0.5, creating a 50:50 mix between colored reflections and diffuse reflections

Refraction group

Transparency Defines the level of refraction. Range=0.0 to 1.0. Default=0.0.

Due to the material's energy-conserving nature, the value set in the Transparency parameter is the maximum value; the actual value depends on the reflectivity as well as the BRDF curve.

Color Defines the color of refraction. While this color can be used to create “colored glass,” a slightly more accurate method to do this is described in the [Colored Glass section](#) on page 5595 of the Tips & Tricks topic.

Glossiness Defines the sharpness of the refraction/transparency, ranging from 1.0 (completely clear transparency) to 0.0 (extremely diffuse or blurry transparency). Default=1.0.



Left: Refraction Glossiness=1.0; Center: 0.5; Right: 0.25

Glossy refraction needs to trace multiple rays to yield a smooth result, which can affect performance. For this reason, the material includes the following special feature designed to enhance performance:

Fast (interpolate) When on, a smoothing algorithm allows rays to be reused and smoothed. The result is faster and smoother glossy refraction at the expense of accuracy. Interpolation is explained in greater detail in the section on the [Fast Glossy Interpolation rollout](#) on page 5574.

NOTE This method works best on flat surfaces.

Glossy Samples Defines the maximum number of samples (rays) that mental ray shoots to create glossy refraction. Higher values cause slow rendering but create a smoother result. Lower values render faster but create a grainier result, like frosted glass. Generally 32 is enough for most cases.

Available only when Glossiness does not equal 1.0. Because a Glossiness value of 1.0 creates a perfectly clear (non-blurry) transparency, it is meaningless to shoot multiple rays for this case, hence only one refraction ray is shot.

NOTE If you set Glossy Samples to 0, the refraction takes the form of a “perfect lens” and only one ray is shot, regardless of the actual value of Glossiness. You can use this to boost performance for draft renderings.

IOR The Index of Refraction, which is a measurement of how much a ray of light bends when entering a material.

The direction in which light bends depends on whether it is entering or exiting the object. The Arch & Design material use the direction of the surface normal

as the primary cue for figuring out whether it is entering or exiting. It is therefore important to model transparent, refractive objects with the surface normals pointing in the proper direction.

The IOR can also be used to define the BRDF curve, which is what happens in the class of transparent materials known as “dielectric” materials, and is illustrated here:



Left: IOR=1.0; Center: 1.2; Right: 1.5

The leftmost cup looks completely unrealistic and is almost invisible. Because an IOR of 1.0, which equals that of air, is impossible in solid matter, we get no change in reflectivity across the material and hence perceive no edges or changes of any kind. On the other hand, the center and rightmost cups have realistic changes in reflectivity guided by the IOR.

Instead of basing the reflectivity on the IOR, you can instead use the BRDF mode to set it manually:



Different types of transparency

As in the previous illustration, the leftmost cup acquires its curve from the index of refraction. The center cup has a manually defined curve, which has been set to a 90 degree reflectivity of 1.0 and a 0 degree reflectivity of 0.2; this looks a bit more like metallized glass. The rightmost cup uses the same BRDF curve, but instead is set to [thin-walled transparency](#) on page 5571. Clearly, this method is better for making non-refractive objects than simply setting IOR to 1.0, as we tried above.

Translucency group

Translucency is handled as a special case of transparency; in order to use translucency there must first exist some level of transparency. The implementation of translucency in the Arch & Design material is a simplification concerned solely with the transport of light from the back of an object to its front faces and is not true SSS (subsurface scattering) effect. You can create an SSS-like effect by using glossy transparency coupled with translucency, but this is neither as fast nor as powerful as the dedicated [SSS shaders](#) on page 5693.

Translucency When on, the remaining Translucency become available and take effect when rendering.

Weight Determines how much of the existing transparency is used as translucency. For example, if Weight=0.0, all of the transparency is used as transparency. If Weight=0.3, 30 percent of the transparency is used as translucency.

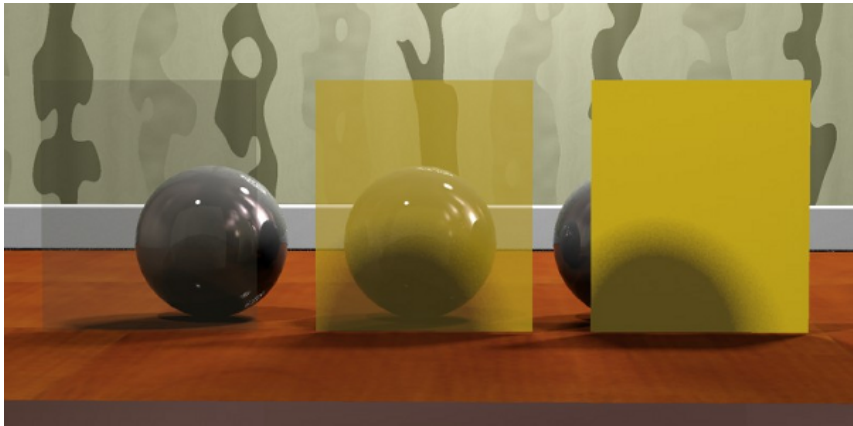

All: Transparency=0.75. Left: Weight=0.0; Center: Weight=0.5; Right: Weight=1.0

Translucency is intended for use primarily in [thin-walled mode](#) on page 5571, as in the example above) to model things like curtains, rice paper, and similar effects. In thin-walled mode it simply allows the shading of the reverse side of the object to bleed through. The shader also operates in [solid mode](#) on page 5571, but, as explained above, the SSS shaders are better suited for such purposes.

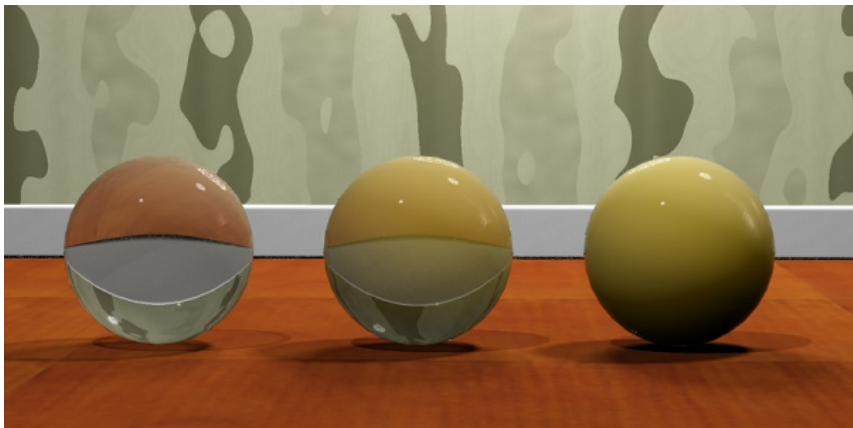

Solid translucency with: Left: Weight=0.0; Center: Weight=0.5; Right: Weight=1.0

Color The translucency color.

Anisotropy group

Anisotropy Controls the anisotropy, or shape, of the highlight. At 1.0, the highlight is round; that is, no anisotropy. At 0.01, the highlight is elongated. One axis of the highlight graph changes to show changes in this parameter. Default=1.0.



Left: Anisotropy=1.0; Center: Anisotropy=4.0; Right: Anisotropy=8.0

Rotation Changes the orientation of the highlight. The sample slot shows changes in orientation. This value can range from 0.0 to 1.0, with 1.0=360 degrees. So, for example, 0.25=90 degrees and 0.5=180 degrees. Default=0.0.



Left: Anisotropy Rotation=0.0; Center: Anisotropy Rotation=0.25; Right: Anisotropy Rotation=[texture map]

TIP When using texture-mapped Anisotropy Rotation, make sure the texture is not antialiased (filtered). You can achieve this by setting the map's Blur parameter to 0.0. Otherwise the antialiased pixels cause local vortices in the anisotropy that appear as seam artifacts.

Automatic/Map Channel Lets you optionally apply anisotropy to a specific map channel.

If the Map Channel setting is Automatic, the base rotation follows the object's local coordinate system. If it is any other value (in other words, a specific map channel), the space that defines the stretch directions of the highlights is derived from that channel's texture space.

WARNING Deriving the anisotropy from the texture space creates only one space per triangle and can cause visible seams between triangles.

Also see [Brushed Metal](#) on page 5605.

BRDF rollout

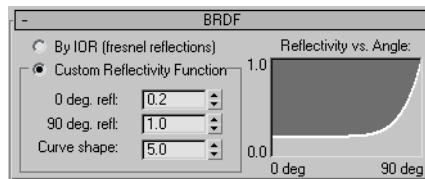

BRDF stands for *bidirectional reflectance distribution function*. As explained in the [introduction](#) on page 5586, this property lets the material's reflectivity be ultimately guided by the angle from which the object surface is viewed.

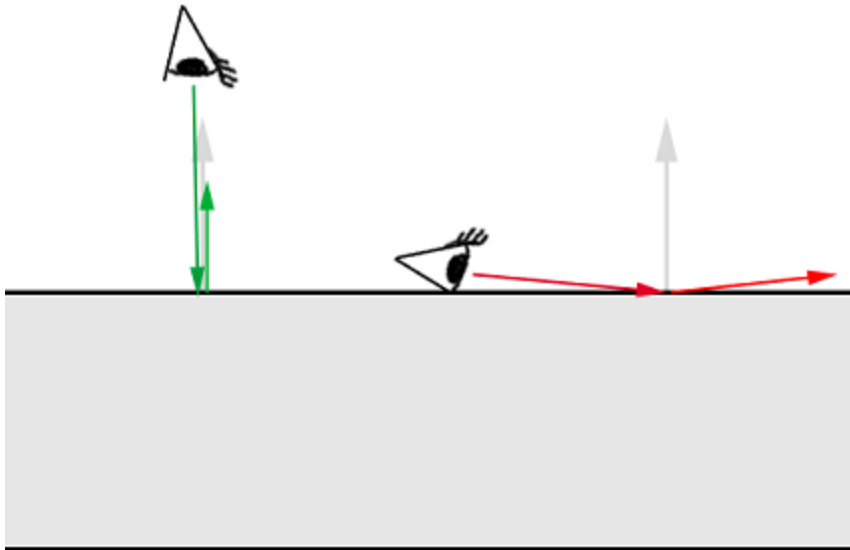

0 degree (green) and 90 degree (red) view angles

[BRDF method] Lets you choose how the BRDF curve is defined:

- **By IOR (fresnel reflections)** How the reflectivity depends on the angle is guided solely by the material's index of refraction. This is known as *Fresnel reflections* and follows the behavior of most dielectric materials such as water and glass.
- **Custom Reflectivity Function** When chosen, the following settings determine reflectivity based on angle of view.
 - **0 deg. refl.** Defines the reflectivity for surfaces directly facing the viewer (or incident ray).
 - **90 deg. refl.** Defines the reflectivity of surfaces perpendicular to the viewer.
 - **Curve shape** Defines the falloff of the BRDF curve.

This mode is used for most hybrid materials or for metals. Most materials exhibit strong reflections at grazing angles; hence the 90 degree reflectivity parameter can generally be kept at 1.0, using the Reflectivity parameter to guide the overall reflectivity instead. Metals tend to be fairly uniformly

reflective and the 0 degree reflectivity value is high (0.8–1.0), but many other layered materials, such as linoleum and lacquered wood have lower 0 degree reflectivity values, in the range 0.1–0.3). For further information, see [Quick Guide to Some Common Materials](#) on page 5593.

Reflectivity vs. Angle graph Depicts the combined Custom Reflectivity Function settings.

Self Illumination (Glow) rollout

These parameters let you specify luminous surfaces within the Arch & Design material, such as a translucent lamp shade. Such a surface does not actually cast light, but it can optionally act as a source of indirect light when [Final Gather](#) on page 6295 is in effect, and thus can have an impact on scene lighting in the rendered image.

The optimal settings for self-illuminated surfaces depend on the lighting conditions and desired effects. This table provides recommended initial settings for lights and the glow options under different circumstances:

	Light Object		Self-Illuminated Surface	
	<i>Affect Specular</i>	<i>Affect Diffuse</i>	<i>Visible in Reflections</i>	<i>Illuminates with FG</i>
Area Lights	Off	On	On	Off
Point Lights	On	On	Off	Off
Glowing Object	not applicable	not applicable	On	On

TIP The easiest way to toggle the Affect Specular and Affect Diffuse switches for a light source is to select it in the viewport, right-click it, and then use the Tools 1 quadrant settings. This applies to only one light source at a time.

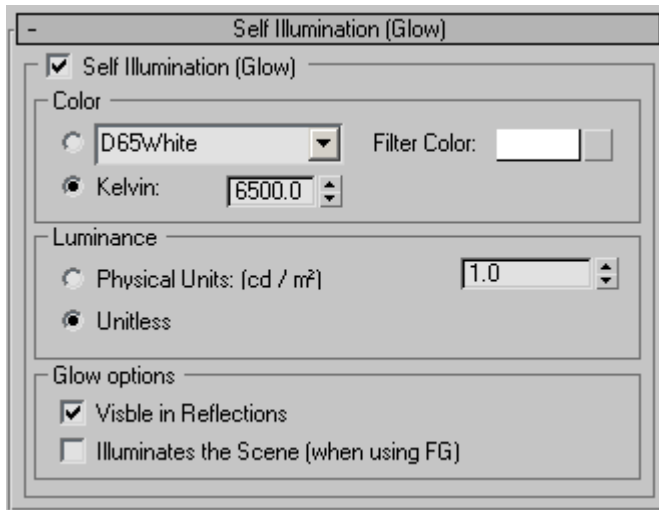

Self Illumination (Glow) When on, the material is set to be self-illuminating, and the remaining rollout settings become available. Default=off.

Color group

To set the illumination color, choose either option and adjust its parameter:

- **Light** Pick a common lamp specification to approximate the spectral character of the desired illumination.
- **Kelvin** Set the color of the self-illuminated surface by adjusting the color temperature spinner. The color temperature is displayed in degrees Kelvin.

Filter Use a color filter to simulate the effect of a color filter placed over the self-illuminated surface. For example, a red filter over a white luminance source casts red light. Set the filter color by clicking the color swatch to display the [Color Selector](#) on page 391. Default=white (RGB=255,255,255; HSV=0,0,255).

Luminance

To set the brightness of the illuminated surface, choose either option and then adjust the numeric setting.

- **Physical Units** Sets the brightness in candelas per square meter. This is a physical value that takes the physical scale into account.
- **Unitless** Uses an arbitrary numeric value to represent the brightness.

[numeric value spinner] When Physical Units is chosen, sets the brightness in cd/m². When Unitless is chosen, sets the brightness as an arbitrary value. The following table shows some representative real-world luminance values.

Object	Brightness in cd/m²
Cathode-ray tube (CRT) television screen	250
Liquid-crystal diode (LCD) television screen	140
Bright light-emitting diode (LED) panel on an electronic device such as a DVD player	100
Frosted lens in front of a desk lamp	10,000 (average)
Frosted lens in front of a residential recessed halogen lamp	10,000 (average)
Exterior of a ceramic lamp shade on a decorative fixture	1300
Interior of a ceramic lamp shade on a decorative fixture	2500
Frosted incandescent bulb inside a decorative fixture	210,000
Cloudy sky in the afternoon	8,000
White ceiling in a brightly daylit room on a cloudy day, oriented north	140
Reflection from a cloudy sky on a varnished wooden floor	875
Dark asphalt on a cloudy afternoon, outdoors	115

Glow Options

Visible in Reflections When on, the illumination produced by the settings on this rollout appears in reflections on other surfaces. When off, the object is still reflected, but the illumination is not.

Illuminates the Scene (when using FG) When on, and [Final Gather](#) on page 6295 is in effect, the self-illuminated surface acts as an indirect light source and contributes to the final gather lighting in the scene. When off, has no effect on final gather.

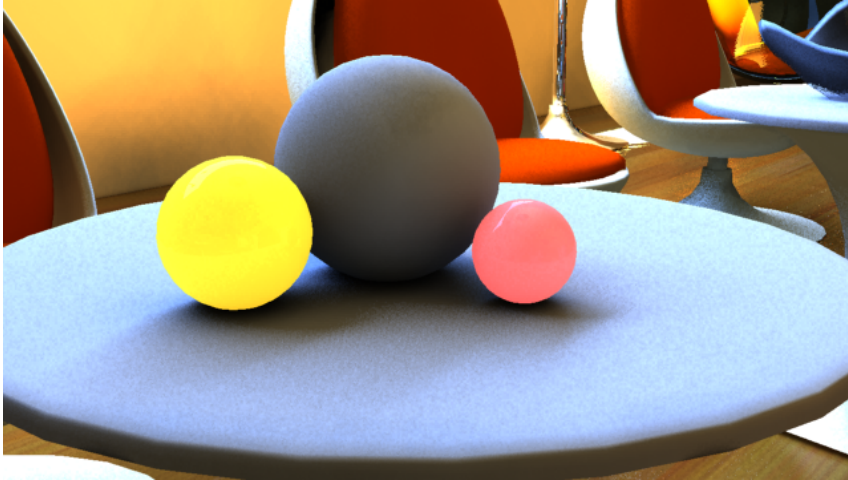

Self-illuminated spheres not illuminating the scene

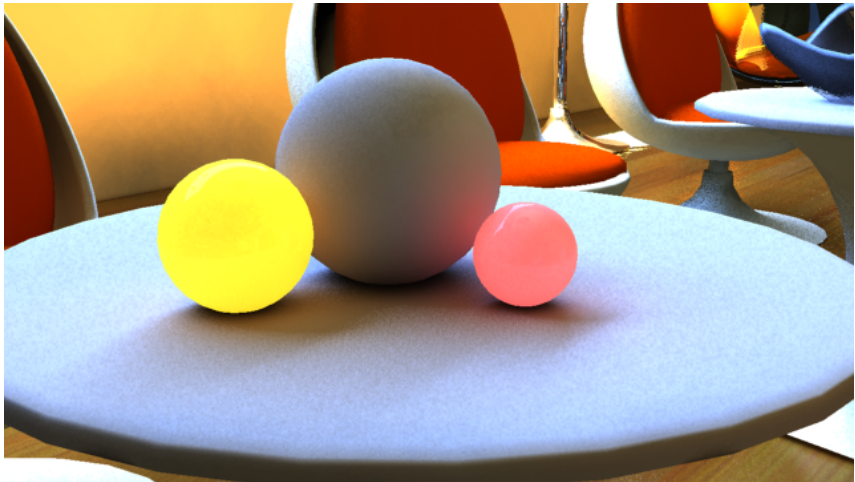

Self-illuminated spheres illuminating the scene

Special Effects rollout

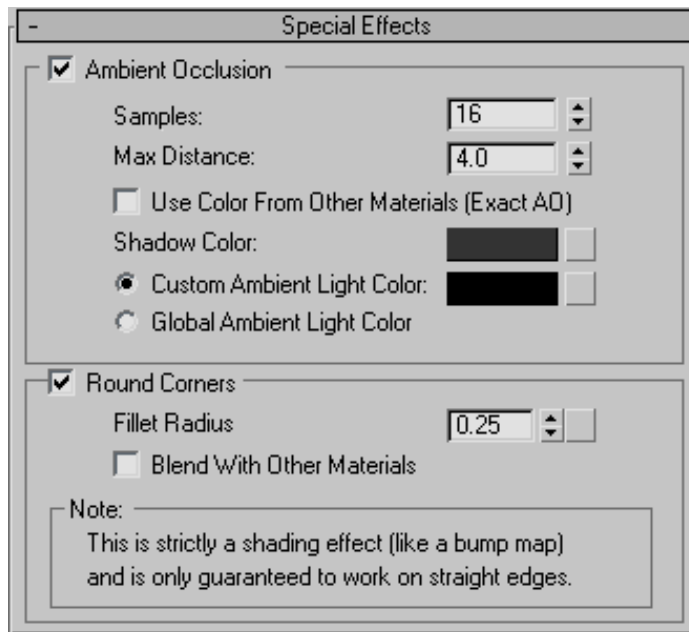

Provides settings for [ambient occlusion](#) on page 5589 (AO) and round corners/edges.

Ambient Occlusion group

Ambient occlusion helps emulate the look of global illumination by creating darker areas where light doesn't reach without actually generating shadows. With the Arch & Design material, you can specify ambient occlusion on a per-material basis.

The following illustration depicts a model helicopter that is lit almost exclusively by indirect light. Note how the helicopter does not feel “grounded” in the left-hand image and the shadows under the landing skids are too vague. The right-hand image uses AO to “punch out” the details and the contact shadows.



Left: Without AO; Right: With AO

Ambient Occlusion When on, enables ambient occlusion (AO) and makes the remaining group controls available.

Samples The number of samples (rays) shot for creating AO. Higher values yield smoother results but render more slowly, while lower values render faster but look grainier. Values in the range 16–64 cover most situations.

Max Distance Defines the radius within which mental ray looks for occluding objects. Smaller values restrict the AO effect to small crevices only but are much faster to render. Larger values cover larger areas but render more slowly.

The following illustrations show the raw AO contribution with two different distances:

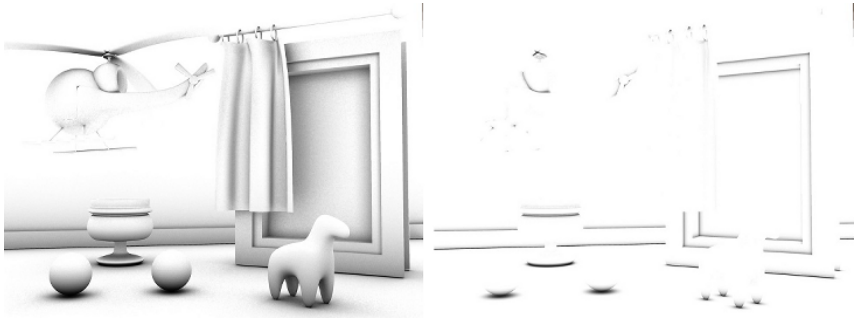

Left: Higher Max Distance value; Left: Lower Max Distance value

TIP To specify an infinite radius, set Distance to 0.0.

Use Color From Other Materials (Exact AO) When on, derives the AO coloring from surrounding materials, for more accurate overall results (also known as *color bleeding*). For example, a glowing material would return a brighter color than a dark material.

NOTE When this parameter is on, the function of the Shadow Color setting (see following) changes to let you specify the extent of color bleeding from nearby materials.

In the following pair of illustrations, the first image shows the problem with the traditional AO: It applies to all indirect illumination and always makes it darker. It is most noticeable on the glowing sphere, which has a dark spot under it, but can also be perceived on the floor in front of the cube which is suspiciously dark, even though the cube is strongly lit on the front, as well as between the legs of the horse and the underside of the red sphere.

In contrast, the second image has Use Color From Other Materials on for all materials, so the floor is lit correctly by the glowing ball, there is a hint of white bounce light on the floor from the cube, and light appears between the legs of the horse and on the underside of the red ball.



Use Color From Other Materials is off



Use Color From Other Materials is on

If you find that using AO creates a “dirty” look with excessive darkening in corners, or dark rims around self-illuminated objects, turn on Use Color From Other Materials for a more accurate result.

Shadow Color When Use Color From Other Materials (see preceding) is off, sets the darkness of the AO shadows. It is used as the multiplier value for completely occluded surfaces. In practice, a black color makes the AO effect very dark; a middle-gray color makes the effect less noticeable (brighter), and so on.

When Use Color From Other Materials is on, this setting determines the ratio between the standard AO functionality with Shadow Color set to black and the color bleeding from other materials. For example, at the default setting, RGB=0.2, 20 percent of the AO shadow color is derived from black and 80 percent is derived from the color of the nearby material. If you set Shadow Color to RGB=0.0 (black), then 100 percent of the shadow color comes from nearby materials. If you set Shadow Color to RGB=1.0 (white), then 100 percent of the shadow color comes from black; this is the same as turning off Use Color From Other Materials and setting Shadow Color to black.

Custom/Global Ambient Light Color You can specify a color for the ambient light used in AO, or use the global color specified on the [Environment panel](#) on page 6689 > Common Parameters rollout.

This parameter is used for doing more traditional AO; that is, supplying an imagined “ever-present ambient light” that is then attenuated by the AO effect to create shadows.

While traditional AO is generally used when rendering without other indirect light, you can also combine it with existing indirect light. Bear in mind that this “ever-present ambient light” is inherently non-physical, but can possibly help lighten some troublesome dark corners.

Round Corners group

This effect rounds off corners and straight edges as a rendering effect only; it has no effect on geometry.

The rounding effect happens to convex corners and surfaces that actually intersect. Concave corners that merely touch will not display the effect. To get the effect to work in concave corners the objects must be pushed into each other a little. The effect is intended for straight edges and is not guaranteed to work properly for highly curved, complex intersections.

Round Corners When on, rounds off corners and straight edges at render time.

Fillet Radius Specifies the radius of the filleted corners and/or edges.

Blend With Other Materials By default, the rounding effect happens only between surfaces of the same material, but if you turn this on the filleting is performed against any material.

In the following image, the molten chocolate is rounded off against the submerged objects even though they use different materials. In actuality, the molten chocolate is a completely flat plane.

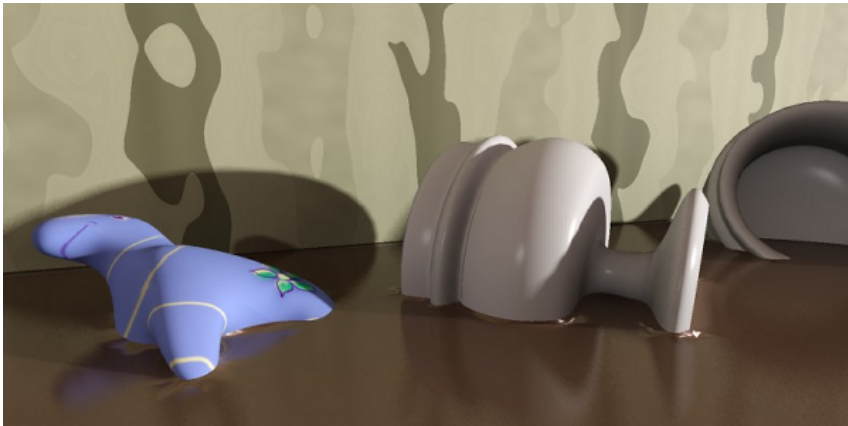

Objects in molten chocolate

Advanced Rendering Options rollout

These parameters define performance-boosting options.

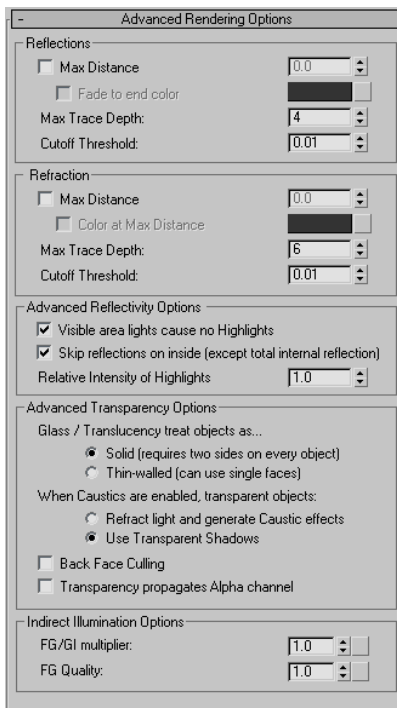

Reflections group

Max Distance Allows limiting reflections to a certain distance, which both speeds up rendering and avoids pulling distant objects into extremely glossy reflections.

Fade to end color When on, reflections fade to this color. When off, reflections fade to the environment color. The former tends to be more useful for indoor scenes; the latter, for outdoor scenes.

Available only when Max Distance is on.



Left: Full reflections (Max Distance=off); Center: 100mm; Right: 25mm

Max Trace Depth When this trace depth is reached, the material behaves as if the Highlights+FG Only switch is on; that is, it shows only highlights and “emulated” reflections created with the help of Final Gathering.

Cutoff Threshold The level at which reflections are rejected; that is, not traced. It’s a relative value: For example, the default setting of 0.01 means that rays that contribute less than 1 percent to the final pixel are ignored. A setting of 0.25 means that mental ray discards rays that contribute less than a quarter of the value of the final pixel.

Refraction group

The optimization settings for refraction (transparency) are nearly identical to those for reflections. The exception is that of Color At Max Distance, which behaves differently.

Max Distance Allows limiting refraction to a certain distance.

Color at Max Distance When on, the material simulates physically correct absorption. At the distance specified by Max Distance, the refracted image has the color given by Color At Max Distance, but the rays are not limited in reach. At twice the distance, the influence of Color At Max Distance is double, at half the distance half, etc.

When off, transparency rays simply fade to black. This is like smoked glass and other highly absorbent materials. Transparency just stops at the specified distance. This has the same performance advantage as using the Max Distance for reflections: Tracing shorter rays is much faster.

Available only when Max Distance is on.



Left: No limit (Max Distance=off); Center: Fade to black; Right: Fade to blue

Max Trace Depth When this trace depth is reached, the material refracts black.

Cutoff Threshold The level at which refraction is rejected; that is, not traced. It's a relative value: For example, the default setting of 0.01 means that rays that contribute less than 1 percent to the final pixel are ignored. A setting of 0.25 means that mental ray discards rays that contribute less than a quarter of the value of the final pixel.

Advanced Reflectivity Options group

Visible area lights cause no Highlights When on, mental ray area lights ([Omni](#) on page 5070 and [Spotlight](#) on page 5073) with the Show Icon In Renderer property on create no specular highlights. Default=on.

The Show Icon In Renderer check box is found on the light's Area Light Parameters rollout. When on, the light is visible and reflects in any glossy,

reflective objects. If both the reflection of the visible area light and the highlight is rendered, the light is added twice, causing an unrealistic brightening effect. When on, this switch causes visible area lights to lose their highlights and instead only appear as reflections. Note that this does not apply to the [Highlights+FG Only](#) on page 5550 mode, which doesn't actually reflect anything.

Skip reflections on inside (except total internal reflection) Most reflections *inside* transparent objects are very faint, except in the special case that occurs at certain angles known as *total internal reflection* (TIR). When on, this option saves rendering time by ignoring the weak reflections completely but retaining the TIRs. Default=on.

Relative Intensity of Highlights Defines the intensity of specular highlights vs. the intensity of true reflections. When the value is 1.0, the two intensities are equal. A lower value subdues the intensity of highlights compared to reflections, while a higher value intensifies the highlights.

Advanced Transparency Options group

The options give you control over some of the deepest details of the Arch & Design material.

Glass/Translucency treat objects as...

- **Solid** The object behaves as if it is made of a solid, transparent substance.
- **Thin-walled** The object behaves as if made of wafer-thin sheets of a transparent material.

For more information, see [Solid versus Thin-Walled](#) on page 5588.



Left: Solid; Right: Thin-walled

When Caustics are enabled, transparent objects: When not rendering caustics, the Arch & Design material uses a shadow shader to create transparent shadows. For objects such as window panes this is perfectly adequate, and actually creates a better result than using caustics, because the direct light is allowed to pass more or less undisturbed through the glass into a space such as a room.

Traditionally, enabling caustics in mental ray causes all materials to stop casting transparent shadows and instead start to generate refractive caustics. In most architectural scenes this is undesirable; you might want a glass decoration on a table to generate caustic effect, but still want the windows to the room to let in normal direct light. This switch makes this possible at the material level.

- **Refract light and generate Caustic effects** The material refracts light and generates caustics.
- **Use Transparent Shadows** No caustics are produced; the material and object simply transmit the light, with greater shadowing in thicker areas.

In the following illustration, the left side shows the result with Use Transparent Shadows chosen, and the right side shows the result with Refract Light And Generate Caustic Effects chosen. You can freely mix the two modes in the same rendering. Photons are automatically treated accordingly by the built-in photon shader, shooting straight through as direct light in the former case, and being refracted as caustics in the latter.



Left: Using transparent shadows; Right: Using refractive caustics.

Back Face Culling When on, enables a special mode that makes surfaces invisible to the camera when seen from the reverse side. You can use this to create “magic walls” in a room. If all walls are planes with the normals facing inwards, the Back Face Culling switch allows the room to be rendered from “outside.” The camera can see into the room, but the walls will still exist and cast shadows, bounce photons, etc. while being invisible when the camera goes outside.

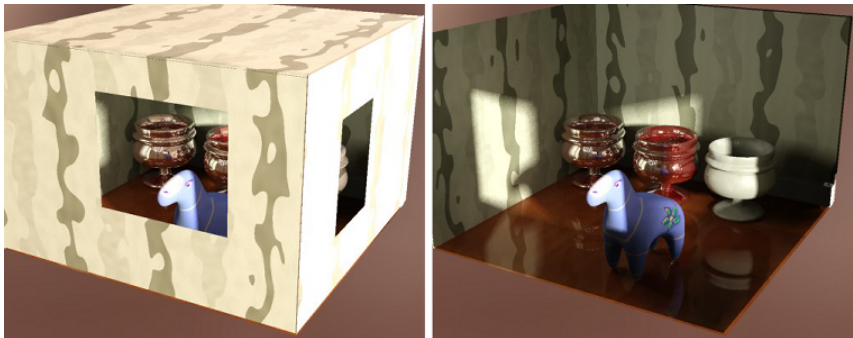

Left: Back Face Culling=off; Right: Back Face Culling=on

Transparency propagates Alpha channel Defines how transparent objects treats any alpha channel information in the background. When on, refraction and other transparency effects propagate the alpha of the background “through” the transparent object. When off, transparent objects have an opaque alpha.

Indirect Illumination Options

FG/GI multiplier Allows tweaking of how strongly the material responds to indirect light.

FG Quality A local multiplier for the number of final gather rays shot by the material.

Fast Glossy Interpolation rollout

Glossy reflections and refraction can be *interpolated*, which causes them to render faster and look smoother. Interpolation works by precalculating glossy reflection in a grid across the image. The number of samples (rays) taken at each point is governed by the [Reflection > Glossy Samples](#) on page 5549 or [Refraction > Glossy Samples](#) on page 5552 parameters, as in the non-interpolated case.

Note that interpolation can cause *artifacts*. Because it is done on a low-resolution grid, it can lose details. And because it blends neighbors of this low-resolution grid, it can cause oversmoothing. For this reason it is useful primarily with flat surfaces. Interpolation does not work well with wavy, highly detailed surfaces or surfaces that use bump maps.

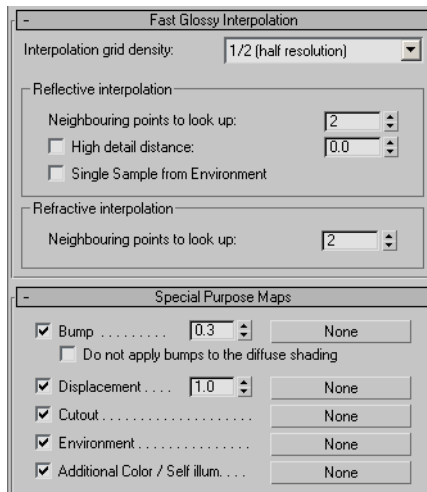

Interpolation grid density The resolution of the grid used for interpolating glossy reflections and refraction. Choose a setting from the drop-down list.

Within the grid, data is stored and shared across the points. Using a lower grid resolution is faster, but causes greater loss of detail information.

Reflective interpolation group

Neighboring points to look up Defines how many stored grid points (in an N by N group around the currently rendered point) is looked up to smooth out reflective glossiness. The default is 2, and higher values will “smear” the glossiness more, but are hence prone to more oversmoothing artifacts.

In the following illustration, the reflection of the left cup in the floor does not use interpolation, and some grain is evident (here intentionally exaggerated). The floor tiles under the other two cups use a half-resolution interpolation with point lookup set to 2 (center) and 4 (right), respectively.



Left: No interpolation; Center: Looking up two points; Right: Looking up four points.

The preceding image also illustrates one of the consequences of using interpolation: The foot of the left cup, which is near the floor, is reflected quite sharply, and only the parts of the cup far from the floor are blurry. However, the interpolated reflections of the right cups have a base level of blurriness, due to the smoothing of interpolation, which makes even the closest parts somewhat blurry. In most scenes with weak glossy reflections this discrepancy will never be noticed, but in other cases this can make things like legs of tables and chairs feel “unconnected” with a glossy floor, if the reflectivity is high. To resolve this, you can use the High Detail Distance setting (see following).

High detail distance Allows tracing of a second set of detail rays to create a “clearer” version of objects within the specified radius.

In the following illustration, all three floor tiles use interpolation but the two on the right use different distances for the detail distance.



Left: No detail distance; Center: 25mm detail distance; Right: 150mm detail distance

This also allows an interesting trick: Set Reflection > Glossy Samples to 0, which renders reflections as if they were mirror-perfect, but also use interpolation to introduce blur into this reflection, and perhaps use High Detail Distance to make nearby parts less blurry. This is a fast way to obtain a glossy reflection.

The floor tiles in the following illustration are rendered with mirror reflections, and the blurriness comes solely from the interpolation. This renders as fast as or faster than pure mirror reflections, yet gives a satisfying illusion of true glossy reflections, especially when utilizing the High Detail Distance option, as on the right.

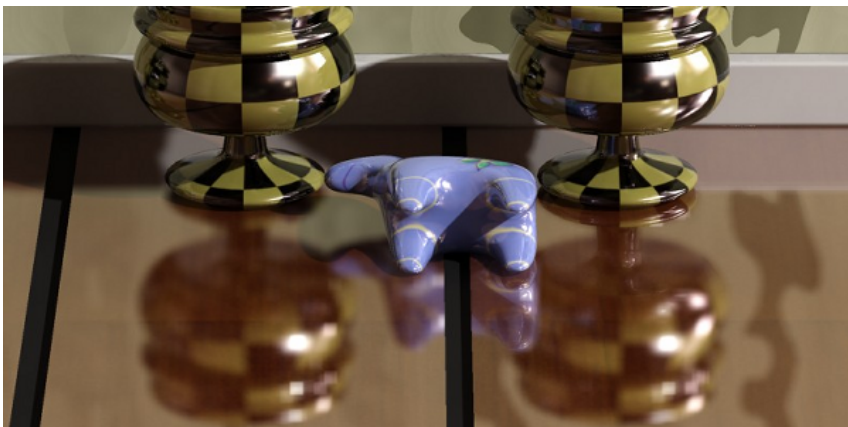

Left: No detail distance; Right: With detail distance

Single Sample from Environment Creating realistically blurry glossy reflections normally requires taking multiple samples from the environment, which can result in grainy, slow-rendering environment reflections. With this check box on, mental ray instead takes only *one* sample, thus preventing the grain. This also prevents blurring the environment, so it is best used together with a local, "pre-blurred" environment map. You can do the pre-blurring in an image-processing program or with the Material Editor > [Coordinates rollout](#) on page 5782 > Blur and Blur Offset settings.

Refractive interpolation group

Neighboring points to look up Defines how many stored grid points (in an N by N group around the currently rendered point) are looked up to smooth out refractive glossiness. The default is 2; higher values tend to "smear" the glossiness more, but are hence prone to more oversmoothing artifacts.

Special Purpose Maps rollout

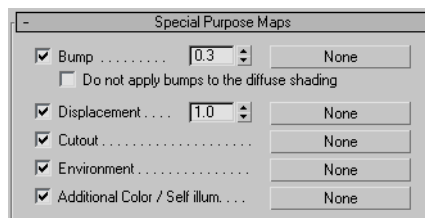

Lets you apply bump, displacement, and other maps. Each left-justified setting has a check box for enabling and disabling the map, and a button for defining the map.

Bump Lets you apply a bump map and multiplier.

Do not apply bumps to the diffuse shading When off, the bumps apply to all shading components: diffuse, highlights, reflections, refractions, etc. When on, bumps are applied to all components except the diffuse. This means bumps are seen in reflections, highlights, etc. but the diffuse shading shows no bumps. It is as if the material's diffuse surface is smooth, but is covered by a bumpy lacquer coating.



Left: Do Not Apply Bumps ...=off; Right: Do Not Apply Bumps ...=on

Displacement Lets you apply a displacement map and multiplier.

Cutout Lets you apply an opacity map to completely remove parts of objects. A classic example is to map an image of a tree to a flat plane and use opacity to cut away the parts of the tree that are not there.



Left: Mapped transparency; Right: Using Cutout

Environment Lets you apply an environment map and shader.

Additional Color/Self illum. Lets you apply any shader. The output of this shader is added on top of the shading done by the Arch & Design material

and can be used for self-illumination-type effects, as well as adding any additional shading you want.

General Maps rollout

This rollout enables application of maps or shaders to any of the Arch & Design material parameters. Of course, you can apply a shader to a parameter at its standard location in the user interface by clicking its Map button, so the principal value of this rollout is that it also lets you toggle a parameter's shader, using the check box, without removing the map.

Arch & Design Material (mental ray): Overview

This topic serves as an introduction to the Arch & Design material for mental ray. For a detailed reference to the material interface, see [Arch & Design Material \(mental ray\)](#) on page 5544. For a variety of suggestions for using the material to create specific effects, see [Arch & Design Material \(mental ray\): Tips and Tricks](#) on page 5593.



A range of material effects available with the Arch & Design material

What Is the Arch & Design Material?

The mental ray Arch & Design material is a monolithic material shader designed to support most materials used in architectural and product-design renderings. It supports most hard-surface materials such as metal, wood and glass. It is especially tuned for fast glossy reflections and refractions (replacing the [DGS material](#) on page 5615) and high-quality glass (replacing the [dielectric material](#) on page 5992).

The major features are:

- **Easy to use, yet flexible** - controls are arranged logically in a most-used-first fashion.

- **Templates** - allow fast access to settings combinations for common materials.
- **Physically accurate** - the material is energy conserving, making it impossible to create shaders that break the laws of physics.
- **Glossy performance** - advanced performance boosts including interpolation, emulated glossiness, and importance sampling.
- **Tweakable BRDF** (bidirectional reflectance distribution function) - the user can define how reflectivity depends on angle.
- **Transparency** - “Solid” or “thin” materials: transparent objects such as glass can be treated as either solid (refracting, built out of multiple faces) or thin (nonrefracting, can use single faces).
- **Round corners** - simulate fillets to allow sharp edges to still catch the light in a realistic fashion.
- **Indirect Illumination control** - set the final gather accuracy or indirect illumination level on a per-material basis.
- **Oren-Nayar diffuse** - allows “powdery” surfaces such as clay.
- **Built-in Ambient Occlusion** - for contact shadows and enhancing small details.
- **All-in-one shader** - photon and shadow shader built in.
- **Waxed floors, frosted glass and brushed metals** - all fast and easy to set up.

Physics and the Display

The Arch & Design material attempts to be physically accurate, hence its output has a high dynamic range. How visually pleasing the material looks depends on how colors inside the renderer are mapped to colors displayed on the screen.

When rendering with the Arch & Design material it is highly recommended that you operate through a tone mapper/exposure control such as the [mr Photographic Exposure Control](#) on page 6744 in conjunction with [gamma correction](#) on page 7758, or at the very least use gamma correction.

A Note on Gamma

Describing all the details of gamma correction is beyond the scope of this topic; this is just a brief overview.

The color space of a normal, off-the-shelf computer screen is not linear. The color with RGB value 200 200 200 is not twice as bright as a color with RGB value 100 100 100, as one might expect.

This is not a bug because, due to the fact that our eyes see light in a nonlinear way, the former color is actually perceived to be about twice as bright as the latter. This makes the color space of a normal computer screen roughly perceptually uniform. This is a good thing, and is actually the main reason 24-bit color (with only 8 bits or 256 discrete levels for each of the red, green and blue components) looks as good as it does to our eyes.

The problem is that physically correct computer graphics operates in a true linear color space where a value represents actual light energy. If one simply maps the range of colors output to the renderer naively to the 0–255 range of each RGB color component it is incorrect.

The solution is to introduce a mapping of some sort. One of these methods is called *gamma correction*.

Most computer screens have a gamma of about 2.2 (known as the sRGB color space), but 3ds Max defaults to a gamma of 1.8, which makes everything look too dark (especially midtones), and light does not “add up” correctly.

Using a gamma of 2.2 is the theoretically correct value, making the physically linear light inside the renderer appear in a correct linear manner on screen.

However, because the response of photographic film isn’t linear either, users find that this theoretically correct value looks too bright and washed out. A common compromise is to render to the default gamma of 1.8, making things look more photographic; that is, as if the image had been shot on photographic film and then developed. However, when exporting and importing images (for example, as texture maps) with external image-editing programs, for best results set all gamma values on Preferences > [Gamma and LUT Preferences](#) on page 7758 to 2.2.

Tone Mapping

Another method for mapping the physical energies inside the renderer to visually pleasing pixel values is known as *tone mapping*. You can accomplish this either by rendering to a floating-point file format and using external software, or with a plug-in that allows the renderer to do it on the fly. In 3ds

Max such plug-ins are known as exposure controls and are accessed from the Environment dialog.

Use Final Gathering and Global Illumination

The Arch & Design material is designed to be used in a realistic lighting environment; one that incorporates full direct and indirect illumination.

mental ray provides two basic methods for generating indirect light: Final Gathering and Global Illumination. For best results, be sure to use at least one of these methods.

At the very least, enable Final Gathering, or use Final Gathering combined with Global Illumination (photons) for quality results. Performance tips for using Final Gather and Global Illumination can be found [here](#) on page 5593.

If you use an environment for your reflections, make sure the same environment (or a blurred copy of it) is used to light the scene through Final Gathering. In 3ds Max this means you should include a [Skylight](#) on page 5065 in your scene set to Use Scene Environment, or use [Daylight system](#) on page 5139 with Skylight set to mr Sky.

Use Physically Correct Lights

Traditional computer-graphics light sources live in a cartoon universe where the intensity of the light doesn't change with the distance. The real world doesn't agree with that simplification. Light decays when leaving a light source due to the fact that light rays diverge from their source and the intensity of the light changes over distance. This decay of a point light source is $1/d^2$; in other words, light intensity is proportional to the inverse of the square of the distance to the source.

One of the reasons for this traditional oversimplification is the fact that in the early days of computer graphics, tone mapping was not used and problems of colors blowing out to white in the most undesirable ways was rampant. (Raw clipping in sRGB color space is displeasing to the eye, especially if one color channel clips earlier than the others. Tone mapping generally solves this by "soft clipping" in a more suitable color space than sRGB.)

However, as long as only Final Gathering (FG) is used as indirect illumination method, such traditional simplifications still work. Even light sources with no decay still create reasonable renderings. This is because FG is concerned only with the transport of light from one surface to the next, not with the transport of light from the light source to the surface.

It's when working with Global Illumination (GI) (that is, with photons) the troubles arise.

When GI is enabled, light sources shoot photons. For the Arch & Design material (or any other mental ray material) to be able to work properly, it is imperative that the energy of these photons to match the direct light cast by that same light. And since photons model light in a physical manner, decay is built in.

Hence, when using GI:

- Light sources must emit photons at the correct energy.
- The direct light must decay in a physically correct way to match the decay of the photons.

Therefore it is important to make sure the *light shader* and the *photon emission shader* of the lights work well together.

In 3ds Max this is most easily solved by using the [photometric lights](#) on page 5005. All of these lights are guaranteed to have their photon energy in sync with their direct light. It is built in and automatic and one does not need to worry about it.

Features

The Shading Model

From a usage perspective, the shading model consists of three components:

- **Diffuse** - diffuse channel /including Oren Nayar “roughness”).
- **Reflections** - glossy anisotropic reflections (and highlights).
- **Refraction** - glossy anisotropic transparency (and translucency).

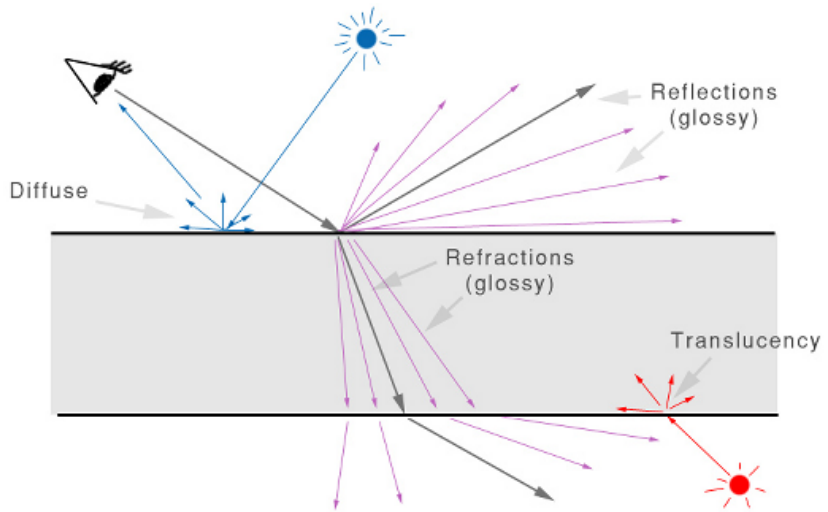

The Arch & Design material shading model

Direct and indirect light from the scene cause diffuse reflections as well as translucency effects. Direct light sources also create specular highlights.

Ray tracing is used to create reflective and refractive effects, and advanced importance-driven multi-sampling is used to create glossy reflections and refraction.

The rendering speed of the glossy reflections/refraction can further be enhanced by interpolation as well as “emulated” reflections with the help of Final Gathering.

Conservation of Energy

One of the most important features of the material is that it is automatically energy conserving. This means that it makes sure that diffuse + reflection + refraction ≤ 1 . In other words, no energy is magically created and the incoming light energy is properly distributed to the diffuse, reflection and refraction components in a way that maintains the first law of thermodynamics.

In practice, this means, for example, that when adding reflectivity, the energy must be taken from somewhere, and hence the diffuse level and the transparency will be automatically reduced accordingly. Similarly, adding transparency happens at the cost of the diffuse level.

The rules are as follows:

- Transparency takes energy from diffuse; that is, at 100% transparency, there is no diffuse at all.
- Reflectivity takes energy from both diffuse and transparency; that is, at 100% reflectivity there is neither diffuse nor transparency.
- Translucency is a type of transparency, and the Translucency Weight parameter defines the percentage of transparency vs. translucency.



From left to right: Reflectivity=0.0, 0.4, 0.8, and 1.0



From left to right: Transparency=0.0, 0.4, 0.8, and 1.0

Conservation of energy also means that the level of highlights is linked to the glossiness of a surface. A high Reflection Glossiness value causes a narrow, intense highlight, while a lower value causes a wider, less intense highlight. This is because the energy is now spread out and dissipated over a larger area.

BRDF: How Reflectivity Depends on Angle

In the real world, the reflectivity of a surface is often view-angle dependent. A fancy term for this is *bidirectional reflectance distribution function* (BRDF); that is, a way to define how much a material reflects when seen from various angles.



The reflectivity of the wood floor depends on the view angle.

Many materials exhibit this behavior. The most obvious examples are glass, water, and other dielectric materials with Fresnel effects (where the angular dependency is guided strictly by the index of refraction), but other layered materials such as lacquered wood and plastic display similar characteristics.

The Arch & Design material allows this effect to be defined by the index of refraction, and also allows an explicit setting for the two reflectivity values for:

- 0 degree faces (surfaces directly facing the camera)
- 90 degree faces (surfaces 90 degrees to the camera)

For more information, see [BRDF rollout](#) on page 5557.

Reflectivity Features

The final surface reflectivity is in reality caused by the sum of three components:

- The diffuse effect
- The actual reflections
- Specular highlights that simulate the reflection of light sources



Diffuse, reflections, and highlights

In the real world, highlights are just glossy reflections of the light sources. In computer graphics it's more efficient to treat these separately. However, to maintain physical accuracy the material automatically keeps highlight intensity, glossiness, anisotropy, etc. in sync with the intensity, glossiness and anisotropy of reflections. Thus, there are no separate controls for these as both are driven by the reflectivity settings.

Transparency Features

The material supports full glossy anisotropic transparency and includes a translucent component, described in detail [here](#) on page 5554.



Translucency

Solid versus Thin-Walled

The transparency/translucency property can treat objects as either *solid* or *thin-walled*.

If all objects were treated as solids at all times, every window pane in an architectural model would have to be modeled as *two* faces: an entry surface that refracts the light slightly in one direction, and immediately following it an exit surface, where light is refracted back into the original direction.

Not only does this entail additional modeling work, it is a waste of rendering power to simulate refraction that has very little net effect on the image. Hence the material allows modeling the entire window pane as a single flat plane, foregoing any actual refraction of light.



Solid vs. thin-walled transparency and translucency

In the preceding illustration the helicopter canopy, the window pane, the translucent curtain, and the right-hand sphere all use thin-walled transparency or translucency, whereas the glass goblet, the plastic horse, and the left-hand sphere all use solid transparency or translucency.

Cutout Opacity

Beyond the “physical” transparency, which models an actual property of the material, the material provides a completely separate, non-physical “cutout opacity” channel to allow “billboard” objects such as trees, or to cut out objects such as a chainlink fence with an opacity mask.

Special Effects

Built-in Ambient Occlusion

Ambient Occlusion (AO) is a method spearheaded by the film industry for emulating the look of true global illumination by using shaders that calculate the extent to which an area is occluded, or prevented from receiving incoming light.

Used alone, an AO shader, such as the separate mental ray Ambient/Reflective Occlusion shader, creates a grayscale output that is dark in areas light cannot reach and bright in areas where it can:

The following image illustrates the main results of AO: dark crevices and areas where light is blocked by other surfaces, and bright areas that are exposed to the environment.

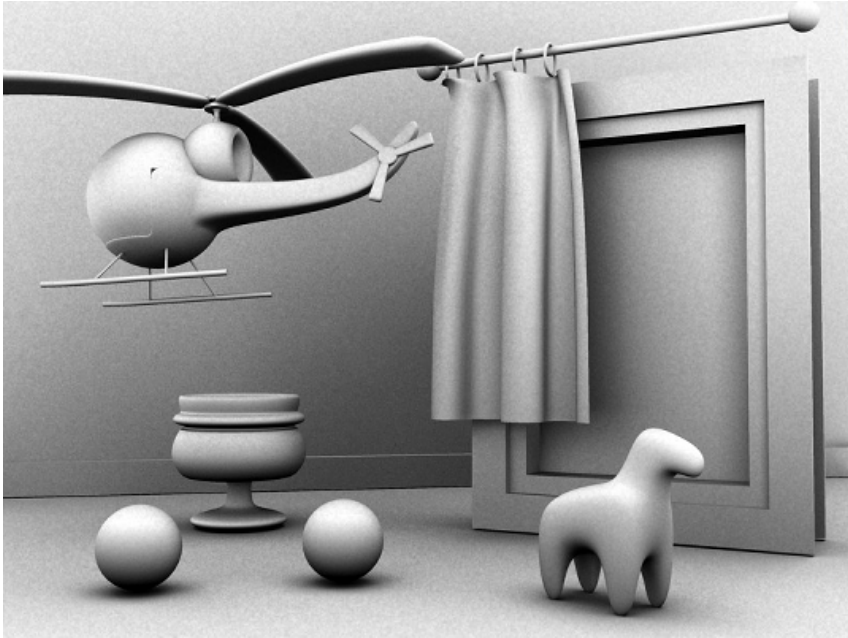

An example of AO applied to a scene

One important aspect of AO is that the user can how far it looks for occluding geometry.

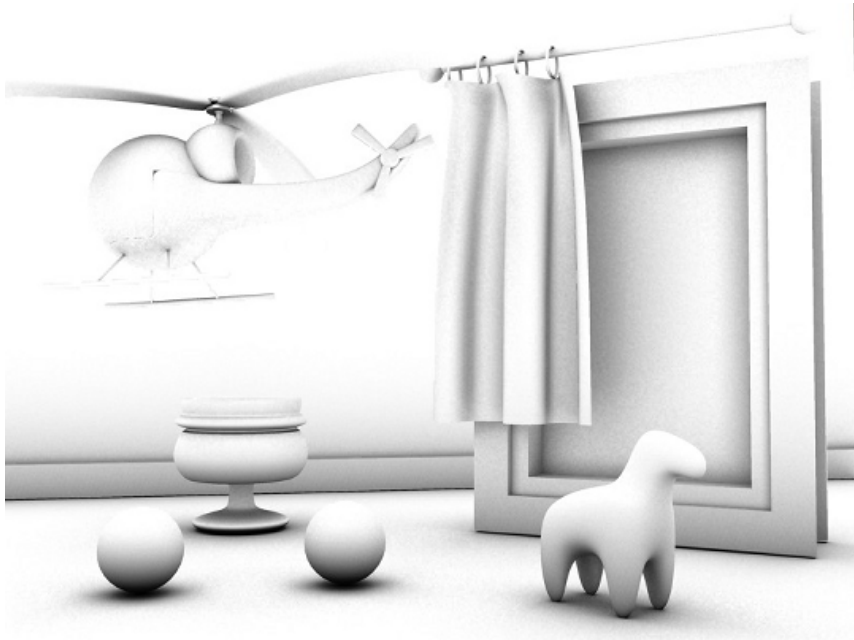

AO looked up within a shorter radius

Using a radius creates a localized AO effect: Only surfaces within the given radius are considered as occluders. This also speeds up rendering. The practical result is that the AO provides nice “contact shadow” effects and makes small crevices visible.

The Arch & Design material gives you two ways to utilize its built-in AO:

- Traditional AO for adding an omnipresent ambient light that is then attenuated by the AO to create details.
- Use AO for *detail enhancement* together with existing indirect lighting methods such as Final Gathering or photons.

The latter method is especially interesting when using a highly smoothed indirect illumination solution, such as a high photon radius or an extremely low final gather density, which could otherwise lose small details. By applying the AO with short rays these details can be brought back.

Round Corners

Computer-generated imagery tends to look unrealistic, partly because edges of objects are geometrically sharp, whereas most edges in the real world are slightly rounded, chamfered, worn, or filleted in some manner. This rounded edge tends to “catch the light” and create highlights that make edges more visually appealing.

The Arch & Design material can create the illusion of rounded edges at render time. This feature is intended primarily to speed up modeling, so that you need not explicitly fillet or chamfer edges of objects such as a tabletop.



Left: No round corners; Right: Round corners

The function is not a displacement; it is merely a shading effect, like bump mapping, and is best suited for straight edges and simple geometry, not advanced, highly curved geometry.

Performance Features

Finally, the Arch & Design material contains a large set of built-in functions for optimal performance, including but not limited to:

- Advanced importance sampling with ray rejection thresholds
- Adaptive glossy sample count
- Interpolated glossy reflection/refraction with detail enhancements
- Ultra-fast emulated glossy reflections (Highlights+FG Only mode)
- The option to ignore internal reflections for glass objects
- The choice between traditional transparent shadows, suitable for objects such as a window pane, and refractive caustics, suitable for solid glass objects, on a per-material basis.

Arch & Design Material (mental ray): Tips and Tricks

This topic contains information to help you more effectively use the [Arch & Design material](#) on page 5544 for mental ray.

See also:

- [Arch & Design Material \(mental ray\): Overview](#) on page 5579
- [Arch & Design Material \(mental ray\)](#) on page 5544

Final Gather Performance

The final gather algorithm in mental ray 3.5 is vastly improved from earlier versions, especially in its adaptiveness. This means you can often use much lower ray counts and much lower densities than in previous versions of mental ray.

In many cases, you can render still images with such extreme settings as 50 rays and a density of 0.1. If this causes “oversmoothing” artifacts, you can use the [built-in ambient occlusion](#) on page 5564 to solve those problems.

When using final gather together with GI (photons), make sure the photon solution is fairly smooth by first rendering with Final Gather disabled first. If the photon solution is noisy, increase the photon search radius until it “calms down,” and then enable Final Gather.

Quick Guide to Some Common Materials

Following are some quick rules of thumb for creating various materials. Each assumes the basic default settings as a starting point.

General Rules of Thumb for Glossy Wood, Flooring, and So On

These are the kind of “hybrid” materials you might require for architectural renderings; lacquered wood, linoleum, etc.

For these materials, set BRDF to Custom Reflectivity Function; that is, you'll define a custom BRDF curve. Start out with 0 degree reflectivity of 0.2, 90 degree reflectivity of 1.0, and apply a suitable texture map to the Diffuse Color. Set Reflectivity between 0.6 and 1.0.

How glossy is the material? Are reflections clear or blurry? Are they strong or weak?

- For clear, fairly strong reflections, keep Reflection Glossiness at 1.0.
- For slightly blurry but strong reflections, set a lower Reflection Glossiness value. If performance becomes an issue try turning on Fast (interpolate).
- For slightly blurry but also very weak reflections, you can “cheat” by applying a lower Reflection Glossiness value for broader highlights while setting Reflection Glossy Samples to 0. This shoots only one mirror ray for reflections, but if they are very weak, the viewer can often not really tell.
- For moderately blurry surfaces, set an even lower Reflection Glossiness value and maybe increase the Reflection Glossy Samples value. Again, for improved performance turn on Fast (interpolate).
- For extremely blurry surfaces or surfaces with very weak reflections, try turning on Highlights+FG Only.

A typical wooden floor could use Reflection Glossiness of 0.5, Reflection Glossy Samples of 16, Reflectivity of 0.75, a nice wood texture for Diffuse Color, perhaps a slight bump map. If bumpiness should appear only in the lacquer layer, turn on Special Purpose Maps rollout > Do Not Apply Bumps To The Diffuse Shading.

Linoleum flooring could use the same settings but with a different texture and bump map, and probably with slightly lower Reflectivity and Reflection Glossiness values.

Ceramics

Ceramic materials are glazed; that is, they're covered by a thin layer of transparent material. They follow rules similar to the general materials mentioned above, but set the [BRDF method](#) on page 5557 to By IOR (fresnel reflections) and set IOR to about 1.4 and Reflectivity to 1.0.

Set the Diffuse Color to a suitable texture or color, such as white for white bathroom tiles.

Stone Materials

A stone object usually has a fairly matte finish, or has reflections that are so blurry they are nearly diffuse. You can simulate the “powdery” character of stone with the Diffuse Roughness parameter; try 0.5 as a starting point. Porous stone such as brick would have a higher value.

Stone would have a very low Reflection Glossiness (lower than 0.25) and one can most likely use Highlights+FG Only to good effect for very good performance. Use a nice stone texture for Diffuse Color, some kind of bump map, and perhaps a map that varies the Reflection Glossiness value.

The Reflectivity would be around 0.5-0.6 with By IOR (fresnel reflections) off and 0 degree reflectivity at 0.2 and 90 degree reflectivity at 1.0

Glass

Glass is a dielectric, so By IOR (fresnel reflections) should definitely be on. The IOR of standard glass is 1.5. Set Diffuse Level to 0.0, Reflectivity to 1.0 and Transparency to 1.0. This is enough to create basic, completely clear refractive glass.

If this glass is for a window pane, turn Thin-walled on. If this is a solid glass block, turn Thin-walled off and consider if caustics are necessary or not, and set Refractive Caustics accordingly.

If the glass is frosted, set Refraction Glossiness to a suitable value. Tune the Refraction Samples for good quality or turn on Fast (interpolate) for performance.

Colored Glass

For clear glass, use the tips in the preceding section. Colored glass, however, is a different story.

Many shaders set the transparency at the surface of the glass. And indeed this is what happens if one simply sets a Refractive Color to some value, such as blue. For glass with Thin-walled turned on this works perfectly. But for solid glass objects this is not an accurate representation of reality.

The scene in following illustration contains two glass blocks of different sizes, a sphere with a spherical hole inside it, and a glass horse.

NOTE The spherical hole was created by inserting a second sphere with its normals flipped inside the outer sphere. Don't forget to flip the normals of such surfaces or they will not render correctly.

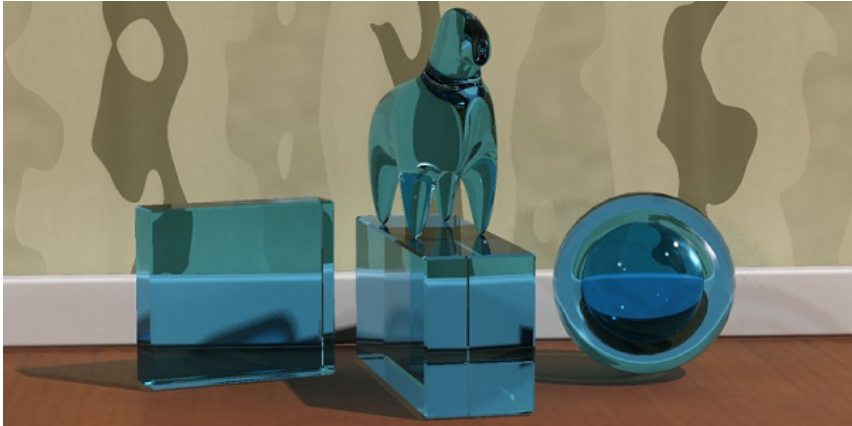

With a blue refraction color: Glass with color changes at the surface

The problems are evident:

- The two glass blocks are of different thicknesses, yet they are exactly the same level of blue.
- The inner sphere is darker than the outer one.

Why does this happen?

Consider a light ray that enters a glass object. If the color is located at the surface, the ray is colored somewhat as it enters the object, retains this color through the object, and receives a second coloration (attenuation) when it exits the object:

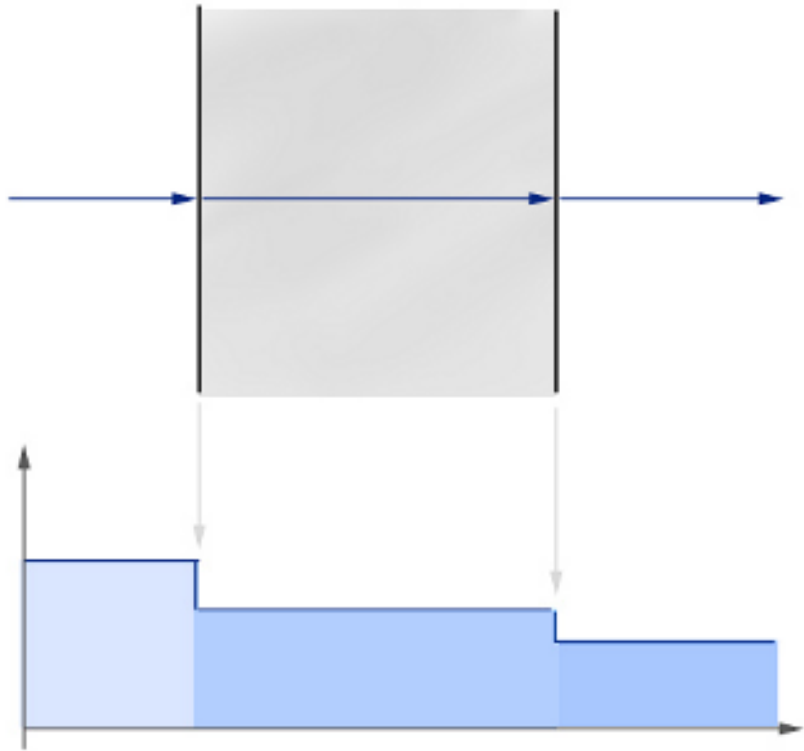

Diagram for glass with color changes at the surface

In the above illustration the ray enters from the left, and at the entry surface it drops in level and gets slightly darker (the graph illustrates the level schematically). It retains this color throughout its travel through the medium and then drops in level again at the exit surface.

For simple glass objects this is quite sufficient. For any glass using [Thin-walled](#) on page 557 it is by definition the correct thing to do, but for any complex solid it is not. It is especially wrong for negative spaces inside the glass (like the sphere in our example) because the light rays have to travel through four surfaces instead of two, getting two extra steps of attenuation at the surface.

In real colored glass, light travels through the medium and is attenuated as it goes. In the Arch & Design material this is accomplished by turning on

Advanced Rendering Options > Refraction > Max Distance, setting the Color At Max Distance, and setting the Refraction Color to white. This is the result:

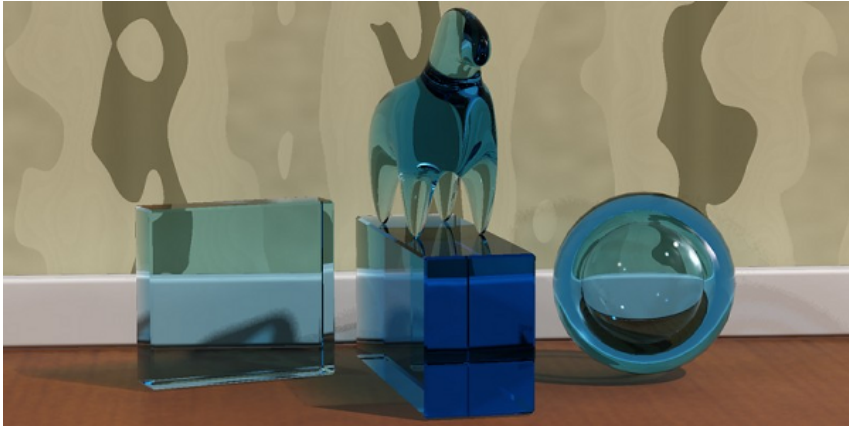

Glass with color changes within the medium

The result is clearly much more satisfactory: The thick glass block is a deeper blue than the thin one, and the hollow sphere now looks correct. In diagram form it looks as follows:

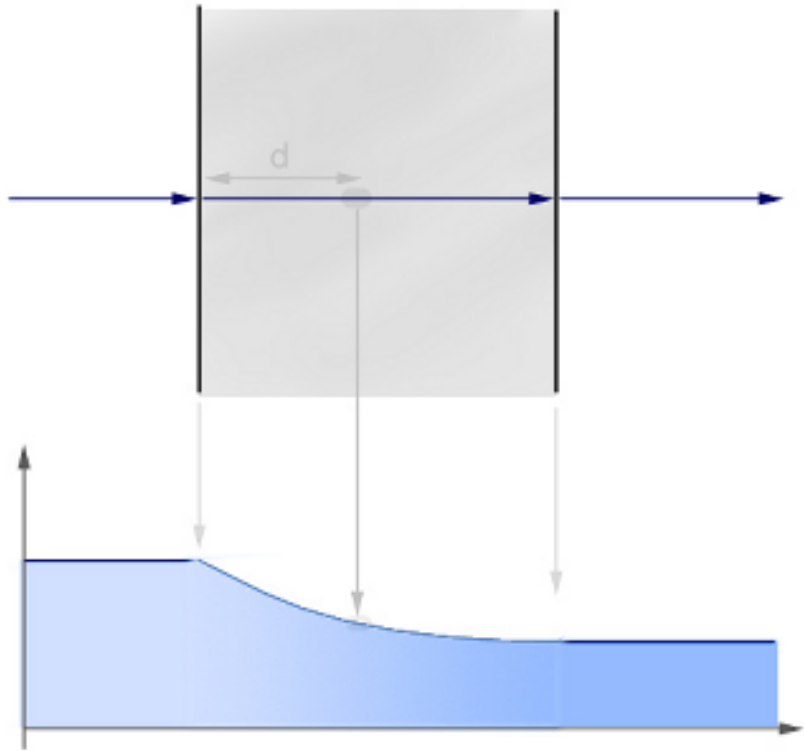

d=Max Distance where attenuation is Color at Max Distance

The ray enters the medium and is attenuated throughout its travel. The strength of the attenuation is such that precisely the Max Distance (d in the figure) the attenuation matches that of Color At Max Distance. In other words, at this depth the attenuation is the same as was received immediately at the surface with the previous scene. The falloff is exponential, so at double the Max Distance value the effect is that of Color At Max Distance squared, and so on.

There is one minor tradeoff:

To render the shadows of a material correctly using this method, you must either use caustics or make sure mental ray is rendering shadows in Segments mode (see [Shadows & Displacement Rollout \(mental ray Renderer\)](#) on page 6292).

Using caustics naturally gives the most correct-looking shadows (the above image was rendered without caustics), but requires that the scene has caustic photons enabled and contains a physical light source that shoots caustic photons.

On the other hand, the mental ray Segments shadows have a slightly lower performance than the more widely used Simple shadow mode. But if it is not used, the shadow intensity will not take the attenuation through the media into account properly. However, the image might still look pleasing.

Water and Liquids

Water, like glass, is a *dielectric* with an IOR of 1.33. Hence, the same principles as for glass (above) apply to bodies of water, which truly need to refract their environment. An example is water running from a tap. Colored liquids use the same principles as colored glass.



Water into wine

To create a liquid in a container, as in the preceding image, it is important to understand how the Arch & Design material handles refraction through multiple surfaces vs. the real-world behavior of light in such circumstances.

What is important for refraction is the transition from one medium to another with a different IOR. Such a transition is known as an *interface*.

For lemonade in a glass, imagine a ray of light travelling through the air (IOR=1.0). When it enters the glass, it is refracted by the IOR of the glass (1.5). The ray then leaves the glass and enters the liquid; that is, it passes through an interface from a medium of IOR 1.5 to another medium of IOR 1.33.

One way to model this in computer graphics is to make the glass one separate closed surface, with the normals pointing outward from the surface of the glass and an IOR of 1.5, and a second, closed surface for the liquid, with the normals pointing outward and an IOR of 1.33, leaving a small air gap between the container and the liquid.

This approach works, but can cause a problem: When light goes from a higher IOR to a lower there is a chance of an effect known as *total internal reflection* (TIR). This is the effect you see when diving into a swimming pool and then looking up: You can see the objects above the surface only in a small circle straight above. Anything below a certain angle shows only a reflection of the pool and things below the surface. The larger the difference in the IOR of the two media, the greater the chance of TIR.

So in our example, as the ray goes from glass (IOR=1.5) to air, there is a large chance of TIR. But in reality the ray would move from a medium of IOR=1.5 to one of IOR=1.33, which is a much smaller step with a much smaller chance of TIR. This looks different:



Left: Correct refraction; Right: the “air gap” method

The result on the left is the correct one, but how is it obtained?

The solution is to rethink the modeling, and not to think in terms of media, but in terms of interfaces. In our example, we have three different interfaces, where we can consider the IOR as the ratio between the IORs of the outside and inside media:

- air-glass interface ($\text{IOR}=1.5/1.0=1.5$)
- air-liquid interface ($\text{IOR}=1.33/1.0=1.33$)

- glass-liquid interface (IOR=1.33/1.5=0.8)

In the most common case of an interface with air, the IOR to use is the IOR of the media (because the IOR of air is 1.0), whereas in an interface between two different media, the situation is different.

To correctly model this scenario, then, we need three surfaces, each with a different Arch & Design material applied:

- the air-glass surface (blue), with normals pointing out of the glass, covering the area where air directly touches the glass, having an IOR of 1.5
- the air-liquid surface (green), with normals pointing out of the liquid, covering the area where air directly touches the liquid, having an IOR of 1.33
- the glass-liquid surface (red), with normals pointing out of the liquid, covering the area where the glass touches the liquid, having an IOR of 0.8

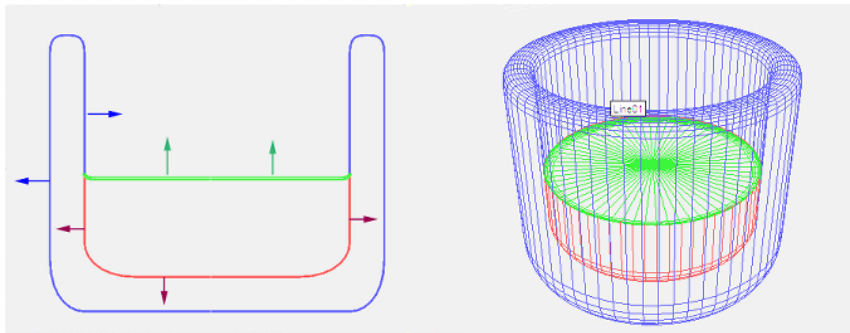

The three interfaces for a liquid in a glass

By setting suitable Max Distance and Color At Max Distance values for the two liquid materials (to get a colored liquid), we obtain the glass on the left in the preceding rendered image.

Ocean and Water Surfaces

A water surface is a slightly different matter than a visibly transparent liquid.

The ocean isn't blue; it is *reflective*. Not much of the light that penetrates the surface of the ocean gets anywhere of interest. A small amount of light is scattered back up again, doing a bit of literal subsurface scattering.

To make an ocean surface with the Arch & Design material, follow these steps:

- 1 Set Diffuse Level to 0.0, Reflectivity to 1.0, and Transparency to 0.0. That's right: No refraction is necessary.
- 2 Set IOR to 1.33 and turn on By IOR (fresnel reflections). Apply an interesting wobbly shader to Bump (Ocean (lume) works well here) and your ocean is basically done.

This ocean has reflections guided *only* by the IOR. But this might work fine; try it. Just make sure there is something there for it to reflect. Add a sky map, objects, or a just a blue gradient background. There must be something or it will be completely black.



The ocean isn't blue; the sky is.

For a more tropical look, try setting Diffuse Color to a slightly blue-green color, set the Diffuse Level to a fairly low number such as 0.1, and turn on Do Not Apply Bumps To The Diffuse Shading.

Now you have a base color in the water that emulates the small amount of scattering that occurs in the top level of the ocean.



Enjoy the tropics.

Metal

Metals are reflective, which means they need something to reflect. The best looking metals come from having a true HDRI environment, either from a spherically mapped HDRI photo, or something like the mental ray physical sky.

To create classic chrome, turn off By IOR (fresnel reflections), set Reflectivity to 1.0, 0 degree reflectivity to 0.9 and 90 degree reflectivity to 1.0. Set Diffuse Color to white, and turn on Metal Reflections.

This creates an almost completely reflective material. Tweak the Reflection Glossiness parameter for various levels of blurry reflections. Also consider using the [Round Corners effect](#) on page 5567, which tends to work very well with metallic objects.

Metals also influence the color of their reflections. Because you turned on Metal Reflections, this is already happening; try setting the Diffuse Color to a golden color to create gold.

Try various levels of Reflection Glossiness (with the help of Fast (interpolate) for performance, when necessary).

You can also change the Reflectivity value. This has a slightly different meaning when Metal Material is on; it blends between the reflections (colored by the Diffuse Color) and normal diffuse shading. This allows a blend between the glossy reflections and the diffuse shading, both driven by the same color. For

example, an aluminum material would need a bit of diffuse blended in, whereas chrome would not.



Gold, silver, and copper

Brushed Metal

Brushed metal is an interesting special case. In some cases, creating a brushed metal requires only turning down the Reflection Glossiness to a level where you obtain a very blurred reflection. This is sufficient when the brushing direction is random or the brushes are too small to be visible even as an aggregate effect.

For materials that have a clear brushing direction and/or where the actual brush strokes are visible, creating a convincing look is slightly more involved.

The tiny grooves in a brushed metal surface all work together to cause anisotropic reflections. This can be illustrated by the following schematic, which simulates the brush grooves by modeling many tiny adjacent cylinders, shaded with a simple Phong shader:

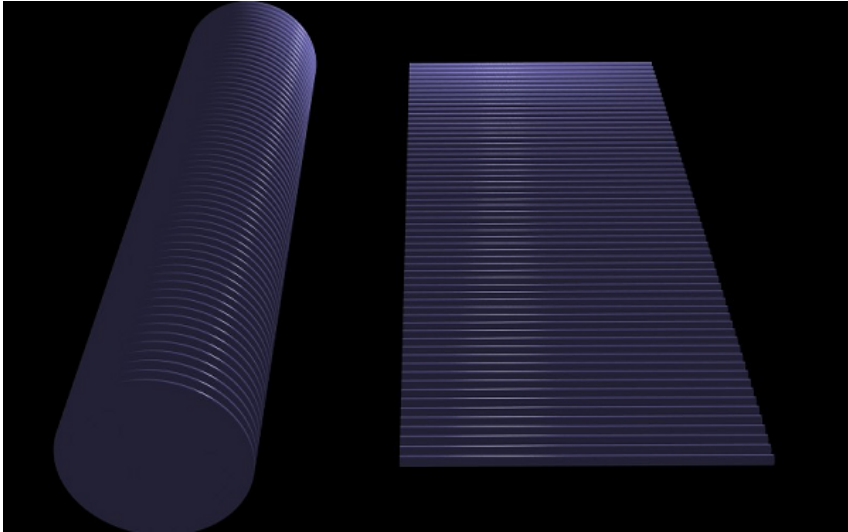

Many small adjacent cylinders

As you can see, the specular highlights in the cylinders work together to create an aggregate effect which is the anisotropic highlight.

Also note that the highlight isn't continuous; it is actually broken up into small, adjacent segments. So the primary visual cues that a material is brushed metal are:

- Anisotropic highlights that stretch out in a direction perpendicular to the brushing direction
- A discontinuous highlight with breaks in the brushing direction

Many attempts to simulate brushed metals have looked only at the first effect: the anisotropy. Another common mistake is to think that the highlight stretches in the brushing direction. Neither is true.

Hence, to portray brushed metals, it is necessary to simulate these two visual cues. The first is simple: Use Anisotropy and Anisotropy Rotation to make anisotropic highlights. The second can be done in several ways:

- with a bump map
- with a map that varies the Anisotropy or Reflection Glossiness values
- with a map that varies the Reflection Color

Each has advantages and disadvantages, but the one we suggest here is the last one. The reason for choosing this method is that it works well with interpolation.

- 1 Create a map for the brush streaks. The possible ways to do this include painting a map in a paint program, or using a Noise map that has been stretched heavily in one direction. The map should vary between middle-gray and white.
- 2 Apply this map to the Reflection Color in a scale suitable for the brushing.
- 3 Set Diffuse Color to white (or the color of the metal) but set Diffuse Level to 0.0 (or a small value).
- 4 Make sure Metal Material is on.
- 5 Set Reflection Glossiness to 0.75.
- 6 Set Anisotropy to 0.1 or a similar value. Use Anisotropy Rotation to align the highlight properly with the map. If necessary use Anisotropy Channel to base it on the same texture space as the map.



Brushed metal

Car Paint Material/Shader (mental ray)

Material Editor > Type button > Material/Map Browser > Car Paint Material

Material Editor > any material > Click a Map button. > Material/Map Browser > Car Paint Shader

Note: The Car Paint material and shader appear in the Browser only if the mental ray renderer is the currently active renderer.

Car Paint is available as both a mental ray material and shader; both have identical parameters, and support the following unique characteristics of real-world car paint:

- The lowest surface, applied directly to the car body, is a thin layer of pigment. The properties of this layer are such that the perceived color changes depending on the viewing angle as well as the incident angle of the incoming light.
- Tiny metal flakes are suspended within this layer. The flakes reflect light and can be seen glittering on a sunny day, due to individual flakes reflecting sunlight directly at the observer.
- On top of this is a clear-coat layer, which can be more or less reflective and more or less glossy, depending on the quality of the layer and any added wax coating. Most notably, this layer tends to exhibit a pronounced Fresnel effect, reflecting more light at glancing angles.
- An optional, topmost Lambertian dirt layer can help give an "unwashed" look.

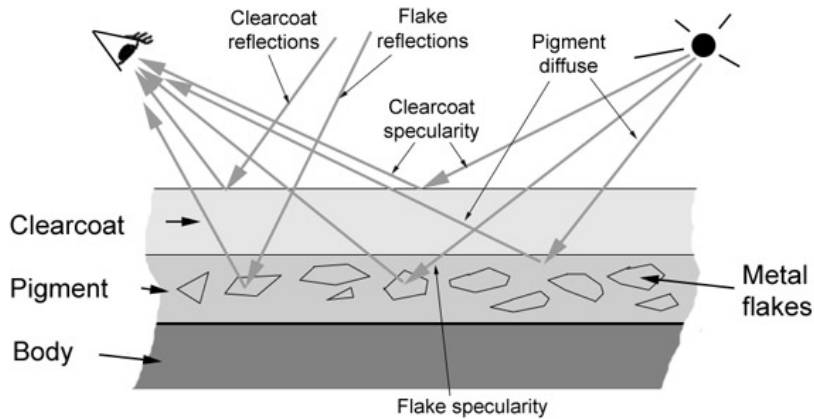

Interface

Diffuse coloring rollout

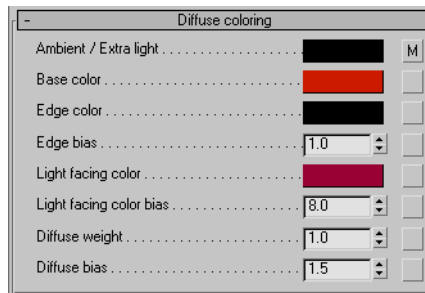

Ambient/Extra light The ambient light component.

NOTE This parameter is treated differently from the ambient/ambience parameter pair of many other base shaders in that it is influenced by the additional Diffuse Coloring parameters, and hence represents incoming light, rather than the object's "ambient color."

Base color The base diffuse color of the material.

Edge color The color seen at glancing angles (that is, edges), which tends to appear much darker. For deep metallic paints seen on sports cars it tends to be almost black.

Edge bias The falloff rate of the color towards the edge. Higher values make the edge region narrower; lower values make it wider. The useful range is 0.0 to approximately 10.0, where the value 0.0 turns the effect off.

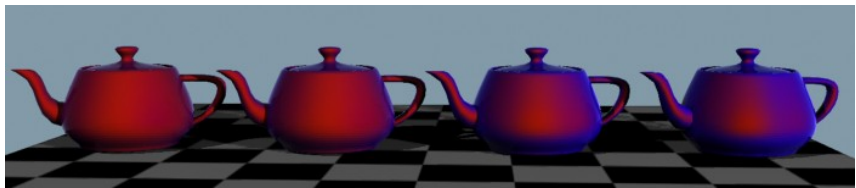

Color shift due to view angle, shifting between a red base color and a blue edge color (atypical colors chosen for demonstration purposes) with varying Edge Bias values

Light facing color The color of the area facing the light source.

Light facing color bias The falloff rate of the color towards the light. Higher values make the colored region facing the light smaller/narrower; lower values

make it larger/wider. The useful range is 0.0 to approximately 10.0, where the value 0.0 turns the effect off.

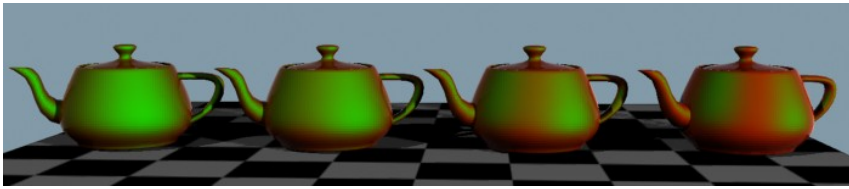

Color shift due to view angle, shifting between a red base color and a green light facing color (atypical colors chosen for demonstration purposes) with varying Light Facing Color Bias values

Diffuse weight Controls the overall level of the Diffuse Coloring parameters.

Diffuse bias Modifies the falloff of the diffuse shading. Higher values push the diffuse peak towards the light source, and lower values flatten the diffuse peak. The useful range is approximately 0.5 to 2.0, where 1.0 represents standard Lambertian shading.

Flakes rollout

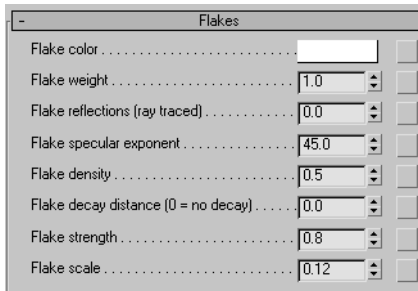

Flake color The color (reflectivity) of the flakes, which is generally white.

Flake weight A scalar multiplier for the flake color.

Flake reflections (ray traced) The amount of ray-traced reflection in the flakes, which allows glittery reflections of, for example, an HDRI environment. The value 0.0 turns the effect off.

This effect should generally be very subtle; a value of 0.1 is often enough. The final intensity of reflections also depends on the Flake Color and Flake Weight values.

Flake specular exponent The Phong specular exponent for the flakes.

Flake density The density of the flakes. The useful range is from 0.1 to approximately 10.0, where lower values indicate sparser flakes and higher values indicates denser flakes.

Flake decay distance The distance at which the influence of the flakes fades out. A value of 0.0 disables fading. Any positive value causes the Flake Weight value to be modulated so that it reaches zero at this distance.

Because flakes are relatively small, using can introduce rendering artifacts if their visual density becomes significantly smaller than a pixel. If the oversampling of the rendering is set high, small flakes can also potentially trigger massive oversampling and hence overlong rendering times needlessly, because the averaging caused by the oversampling will essentially cancel out the flake effect. If you experience these issues, use Flake Decay Distance to counteract them.

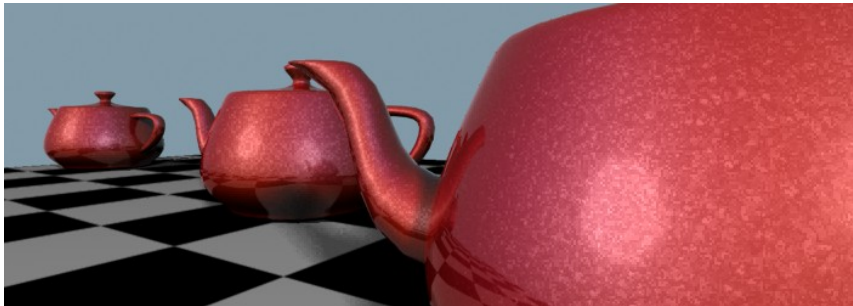

Flakes at different distances with no flake decay. The farthest flakes might cause flicker in animations, or trigger unnecessary oversampling and long render times (rendered here with low oversampling for illustrative purposes).

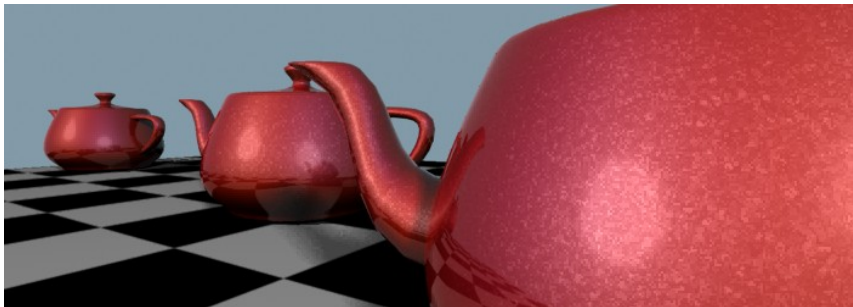

Using flake decay. The flake strength diminishes with distance. The same intentionally low oversampling as in the previous image has been used.

Flake strength The difference between the orientation of the flakes. The useful range is 0.0 to 1.0 where 0.0 means that all flakes are parallel to the surface, while higher values vary the orientation of flakes increasingly.

Flake scale The size of the flakes. The procedural texture is calculated in object space, and will hence follow the object. Thus, the scale is influenced by any scale transformation on the object.

Specular reflections rollout

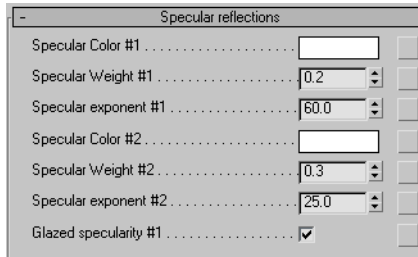

Specular Color #1 The color of the primary specular highlight.

Specular Weight #1 A scalar multiplier applied to Specular Color #1.

Specular exponent #1 The Phong exponent of Specular Color #1.

Specular Color #2 The color of the secondary specular highlight.

Specular Weight #2 A scalar multiplier applied to Specular Color #2.

Specular exponent #2 The Phong exponent of Specular Color #2.

Glazed specularity #1 Enables a special mode on the primary specular highlight called *glazing*. By applying a threshold to the specular highlight, it makes the surface appear more polished and shiny. For a new sports car with a lot of wax, turn this on. For a beat-up car in the junkyard, turn it off.



Left to right: Flake specularity only; standard specularity; "glazed" mode enabled; "glazed" mode specularity with flakes

Reflectivity rollout

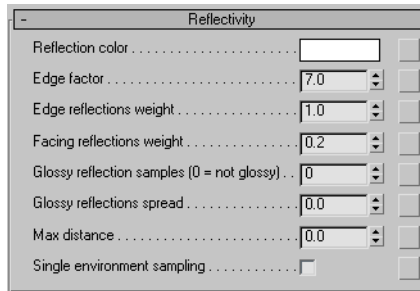

Reflection color The color of the reflections in the clear-coat layer. This is generally white.

Edge factor Clear coat tends to reflect more at glancing angles (edges). This parameter defines the "narrowness" of this edge.

Edge reflections weight The reflective strength at the edge (generally 1.0).

Facing reflections weight The reflective strength at facing angles (generally low: 0.1 - 0.3).

Glossy reflection samples Enables a glossy clear coat. This parameter sets the number of glossy reflection rays traced. A value of 0 disables glossiness.

Glossy reflections spread Sets the amount of glossiness. Cars are generally near-mirrors so this value should be kept small.

Max distance Limits the reach of reflective rays.

Single environment sampling Optimizes lookup of environment maps.

Dirty layer (Lambertian) rollout



Real cars are rarely clean. This shows the dirt layer (hand-painted dirt-placement map), including a bump map applied in the dirty regions.

A simple Lambertian dirt layer covers the underlying paint and clear-coat layers.

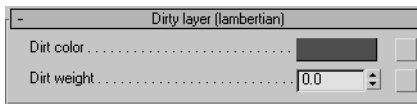

Dirt color The color of the dirt.

Dirt weight The amount of dirt in the layer. This is typically connected to a texture shader to obtain variations in the dirt across the surface. If the value is 0.0, no dirt is added.

Advanced options rollout

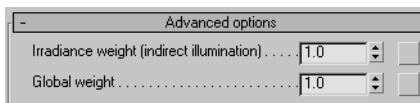

Irradiance weight (indirect illumination) The influence of indirect light (photons and final gathering) on the surface. It is internally divided by pi (3.14159); for example, a value of 1.0 means the standard 1.0/pi weight.

Global weight A global tuning parameter that affects the entire diffuse, flake, and specular subsystems. It does not affect reflections or dirt.

Shaders rollout

This rollout enables application of maps or shaders to any of the Car Paint parameters. Of course, you can apply a shader to a parameter by clicking its Map button, so the principal value of this rollout is that it also lets you toggle a parameter's shader, using the check box, without removing the map.

DGS Material (mental ray)

Material Editor > Type button > Material/Map Browser > DGS Material (physics_phen)

Note: The DGS material appears in the Browser only if the mental ray renderer is the currently active renderer.

DGS stands for Diffuse, Glossy, Specular. This material is a mental ray phenomenon (a scripted shader tree) that provides a physically accurate simulation of a surface. Using DGS materials with the mental ray renderer is comparable to using the [Architectural material](#) on page 5526 with the default scanline renderer.

The DGS material's basic components appear on the Parameters rollout. You can assign shaders to these components, creating a material of greater complexity. Buttons for assigning shaders are on both the Parameters rollout and the Shaders rollout.

Interface

Parameters rollout

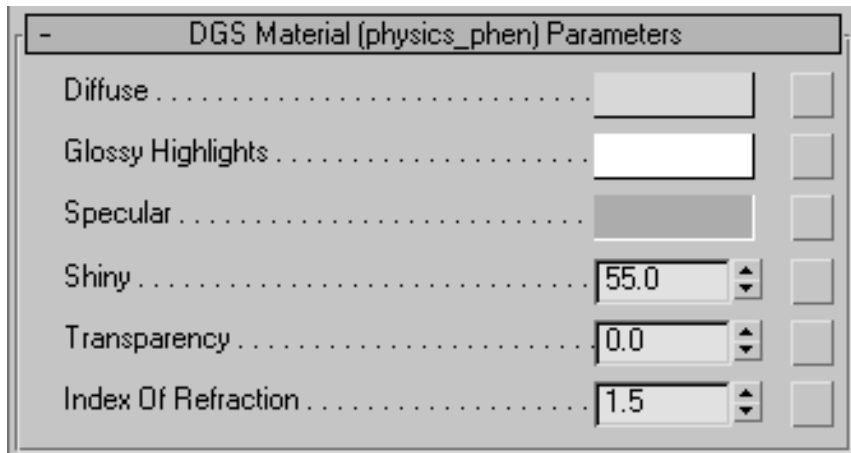

NOTE The button to the right of each control is a shortcut shader button. Clicking one of these buttons displays the [Material/Map Browser](#) on page 5290 so you can assign a shader to this component. When a map or a shader has been assigned to a component, this button displays the letter “M,” and the comparable button on the Shaders rollout displays the map or shader name.

Diffuse Click the color swatch to display a [Color Selector](#) on page 391 and change the material's diffuse color.

Glossy Highlights Click the color swatch to display a Color Selector and change the color of glossy highlights.

Specular Click the color swatch to display a Color Selector and change the color of mirror reflections. When the specular color is white, the material is 100 percent reflective, like a mirror. When the specular color is black, the material does not reflect any of its surroundings.

Shiny Sets the width of glossy highlights. The larger this value, the smaller the highlights. Default=30.0.

Transparency Specifies the transparency. The effective range of Transparency is from 0.0 to 1.0. At 0.0 the material is fully opaque. At 1.0 it is fully transparent. Default=0.0.

WARNING You can set the value of Transparency to be greater than 1.0, but this has no effect. An anomaly of the user interface for shaders in the mental ray and lume libraries is that spinner values are not “clamped” to lie within their effective ranges, as they are for controls in 3ds Max.

The value of Transparency also indirectly specifies the reflectivity of the material, which is calculated as 1.0 minus the Transparency value.

Index Of Refraction Specifies the IOR. In the physical world, the IOR results from the relative speeds of light through the transparent material and the medium the eye or the camera is in. Typically this is related to the object's density. The higher the IOR, the denser the object. Default=1.5.

See [Extended Parameters Rollout \(Standard Material\)](#) on page 5408 for a list of IOR values for commonly encountered materials.

NOTE When the IOR equals 1.0, there is no refraction, and calculating the transparency can take less time than when the material is refractive.

Shaders rollout

The controls on this rollout let you assign a map or shader to one of the basic parameters of the DGS material. This is comparable to mapping a component of a standard material; by adding shaders, you can create a shader tree that generates complex effects.

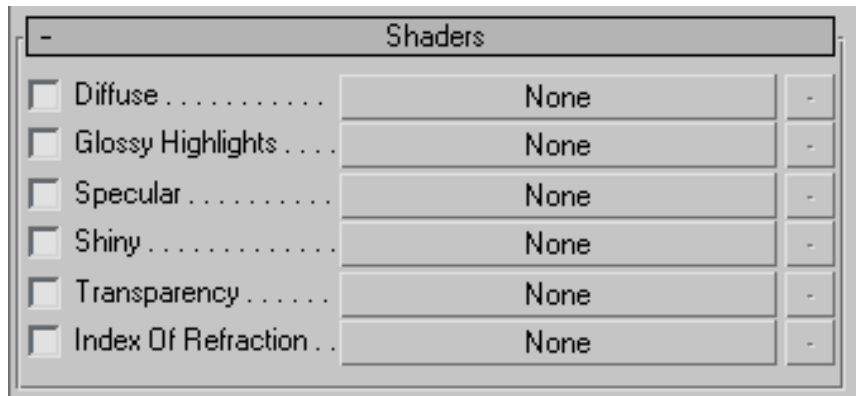

Click the button for a component to display the [Material/Map Browser](#) on page 5290 and assign the map or shader. Use the toggle at the left to turn the effect of the map off or on.



The button to the right of each main shader button is for shaders that can return multiple parameters. If a shader that returns multiple parameters is assigned to the component, the button's tooltip shows the parameter name. Clicking the button displays a [Connect Parameter To Shader dialog](#) on page 5981, which lets you change which parameter is being used.

IMPORTANT [UV Coordinates](#) on page 6013 and [XYZ Coordinates](#) on page 6017 are the only shaders with multiple return values provided with 3ds Max. You might encounter multiple return values in shaders provided with other shader libraries or custom shader code.

For all the DGS material components, the available mental ray shaders are the same:

Shader	Library
Bump on page 5986	3ds Max
DGS Material on page 5987	3ds Max
<i>Dielectric</i>	base
Dielectric Material on page 5992	3ds Max
<i>Edge</i>	lume
<i>Facade</i>	lume
<i>Glass</i>	lume
<i>Glow</i>	lume
<i>Landscape</i>	lume
Material to Shader on page 6001	3ds Max
<i>Metal</i>	lume

Shader	Library
<i>Ocean</i>	lume
<i>Opacity</i>	base
<i>Reflect</i>	base
<i>Refract</i>	base
Shader List on page 6003	3ds Max
<i>Stain</i>	lume
<i>Translucency</i>	lume
<i>Transmat</i>	physics
<i>Transparency</i>	base
<i>Two Sided</i>	base
UV Generator on page 6005	3ds Max
<i>Water Surface</i>	lume
<i>Wet-Dry Mixer</i>	lume
XYZ Generator on page 6013	3ds Max

Glass Material (mental ray)

Material Editor > Type button > Material/Map Browser > Glass (physics_phen)

Note: The Glass material appears in the Browser only if the mental ray renderer is the currently active renderer.

The Glass material simulates both the surface properties and the light-transmitting (photon) properties of glass. It is a mental ray phenomenon (a scripted shader tree) that is equivalent to a [mental ray material](#) on page 5638 with a [Dielectric Material shader](#) on page 5992 assigned to both its Surface and Photon components, with the parameter settings identical for both. A dielectric material, such as glass, is a material whose surface transmits most light that strikes it at angles close to perpendicular (90 degrees), but reflects most light that strikes at glancing angles (close to zero degrees).

NOTE This material does not use a shadow shader, so shadows will always be opaque unless you generate caustics.

Adjacent Refractive Materials

Two controls, Outside Light Persistence and Index Of Refraction (Out), are for situations where you are modeling two adjacent refractive materials. Consider a drink in a martini glass. The glass has an index of refraction (IOR) of 1.5, while the alcohol in the glass has an IOR of about 1.3. To create a physically accurate model of this situation, use *three* glass materials: one for the glass itself, one for the alcohol, and a third material for the surfaces where they touch each other. For this third material, set the “inside” IOR to 1.3, and the outside IOR to 1.5.

Interface

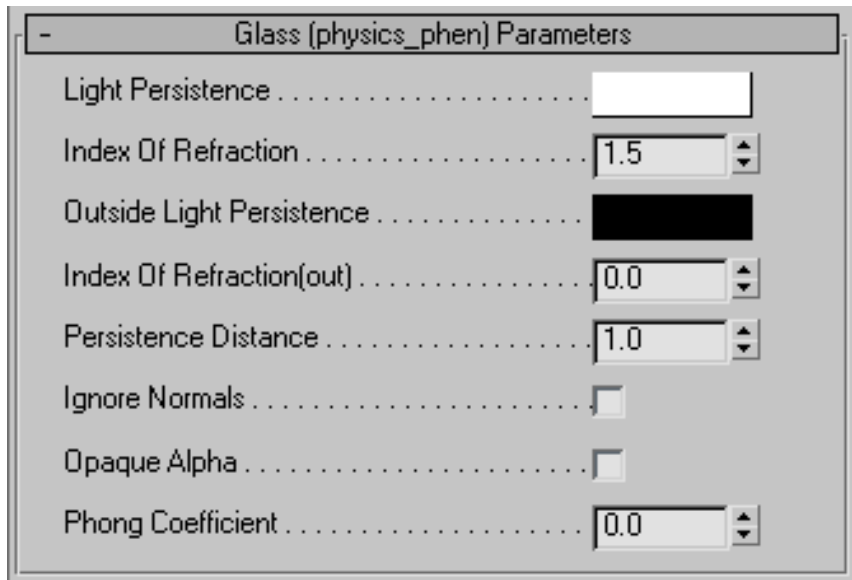

Light Persistence In conjunction with the Persistence Distance, controls the percentage of light that the volume transmits. For example, if the color is set to $R=G=B=0.5$ and the Persistence Distance is set to 2.0, then objects with a thickness of 2.0 units will appear 50 per cent transparent. Default=white ($R=G=B=1.0$).

Because transparency depends on the thickness of the object, objects with varying thickness show different transparency depending on the angle from which they are viewed.

Index Of Refraction Specifies the Index Of Refraction (IOR). In the physical world, the IOR results from the relative speeds of light through the transparent material and the medium the eye or the camera is in. Typically this is related to the object's density. The higher the IOR, the denser the object. Default=1.5.

See [Extended Parameters Rollout \(Standard Material\)](#) on page 5408 for a list of IOR values for commonly encountered materials.

Outside Light Persistence In conjunction with the Persistence Distance, controls the percentage of light transmitted on the other side of a surface. When set to the default of black, this control has no effect. See the section "Adjacent Refractive Materials," above. Default=black ($R=G=B=0.0$).

Index Of Refraction (out) Sets the IOR on the other side of a surface. When set to the default of zero, this control has no effect. See the section “Adjacent Refractive Materials,” above. Default=0.0.

Persistence Distance In conjunction with the Light Persistence color, controls the percentage of light that the volume transmits. It is the distance at which light transmission is reduced to the percentage specified by the Light Persistence RGB values. Default=1.0.

If you specify an Outside Light Persistence color, that setting also uses the Persistence Distance.

Ignore Normals When on, the renderer does not use normals to decide whether a light ray is entering or leaving the object. Normally, the material uses normals to decide whether a ray is entering or leaving an object. (It is entering if the normal points toward the ray, leaving if the normal points away from the ray.) This can present a problem for rendering objects whose normals are not unified. When Ignore Normals is on, the material determines whether a ray is entering or leaving the object by counting the number of times the ray has intersected the object. Default=off.

Opaque Alpha When on, refracted rays that touch the environment don't generate a transparent alpha value. (This is how 3ds Max usually treats the environment.) When off, refracted rays that touch the environment render a transparent alpha value, which can help if you plan to use the rendering as part of a composite. Default=off.

Phong Coefficient When greater than zero, generates Phong highlights on the material. The highlights appear in the sample slot. In general this value must be greater than 10 for highlights to be apparent. Default=0.0.



Matte/Shadow/Reflection (mi) Material

Material Editor > Type button > Material/Map Browser > Matte/Shadow/Reflection (mi)

Note: The Matte/Shadow/Reflection (mi) material appears in the Browser only if the mental ray renderer is the currently active renderer.

The Matte/Shadow/Reflection (mi) material, part of the [Production Shaders](#) on page 6017 library, is used to create “matte objects”; that is, objects that represent real-world objects in a photograph used as the scene background (also known as the *plate*). The material provides a wealth of options for

marrying a photographic background with the 3D scene, including support for bump mapping, ambient occlusion, and indirect illumination.

Applications include:

- Blocking another 3D object from the camera view, thus allowing the 3D object to appear to be behind the object in the photo.
- Allowing 3D objects to cast shadows and occlusion on and receive shadows from objects in the photo.
- Adding reflections of 3D objects to objects in the photo.
- Allowing the interplay of indirect light between 3D objects and objects in the photo.

In all these cases the material is applied to a matte object that represents an object in the background plate, and the 3D object uses a traditional material.

For additional information, see Help menu > Additional Help > mr Production Shader Library > Matte/Shadow Objects and CameraMaps, as well as the Tech Note (following).

Tech Note

The Matte/Shadow/Reflection shader works by doing a form of differential shading. In other words, it determines the amount of light a point would receive if it were not in shadow, compares it to the amount of light the point actually receives, and shades it by the relative difference.

This means that any point that is fully lit, unshadowed by any object, returns the same color it already had, completely disregarding the actual intensity of that light. If half of the incoming light is blocked, the point will be shaded at 50 percent intensity, regardless of the full-intensity amount in an absolute sense.

An important feature of the Matte/Shadow/Reflection material is that it is non-self-shadowing, non-self-occluding, non-self-reflecting, and does not cast indirect light onto itself. Because it is designed to act as a stand-in for objects present in a photographic plate, which already contains self-shadowing, self-reflection, and so on, the material automatically excludes these effects. However, it is still able to cast shadows on other objects, receive shadows from other objects, reflect other objects, and so on, without creating unwanted double shadows or double reflections for such effects already present in the plate.

Procedure

This multi-part procedure provides step-by-step instructions for a simple case of combining a 3D object with a photograph using the Matte/Shadow/Reflection material, the Environment/Background Camera Map shader, and the Environment Probe/Chrome Ball shader.

Prerequisites:

- A photo of a background



- A photo of a chrome ball, also known as a light probe, shot from the same camera angle and cropped so the edges touch the image.



Ideally, these should be HDR photos, but non-HDR images can also work well.

To use the production shaders to marry a 3D scene with a photographic background:

- 1 First set up the viewport:
 - 1 Make sure mental ray is the active renderer.
 - 2 Activate a Perspective viewport.
 - 3 Use [Viewport Background](#) on page 148 to set the background image (see the procedure introduction, above) .
 - 4 On the Viewport Background dialog, make sure both Display Background and Match Rendering Output are on.

- 5 Click OK to continue.
- 2 Open the Environment And Effects dialog to the Environment panel (press 8).
- 3 On the Common Parameters rollout, click the Environment Map button (reads "None").
- 4 From the list that opens, choose Environment/Background Switcher (mi)
- 5 Open the Material Editor.
- 6 Drag the Environment Map button from the Environment And Effects dialog to a sample slot in the Material Editor. Use the Instance option.
- 7 On the Material Editor > Environment/Background Switcher (mi) Parameters rollout, click the Background map button (all the way to the right of the parameter).
- 8 From the list that opens, choose Environment/Background Camera Map (mi).
- 9 On the Environment/Background Camera Map (mi) Parameters rollout, click the Browse button and again open the background image.



- 10 In the Material Editor, click the Go To Parent button to return to the Switcher map.
- 11 Click the map button to the right of Environment/Reflections.
- 12 From the list that appears, choose Environment Probe/Chrome Ball (mi).
- 13 On the Environment Probe/Chrome Ball (mi) Parameters rollout, click the Browse button and open the image containing the cropped photo of the chrome ball.

If the two photos have different exposures, use the Multiplier setting for either or both maps to match them.

Next you'll make a rudimentary model that represents objects already present in the background. At the very least you need a simple plane for the "ground" to place things on.

NOTE It is easier to see if you maximize the viewport and use wireframe display mode.

- 14 Align the viewport so it matches the angle of the photograph as closely as possible.
- 15 From the Create menu, choose Lights > Standard Lights > Skylight and then click in the Perspective viewport to add a Skylight to the scene.
- 16 On the Skylight Parameters rollout for the light, set Sky Color to Use Scene Environment.
This retrieves the appropriate ambient color from the chrome ball photo.
- 17 Create some geometry. For this example, add a plane to represent the ground.
- 18 Add a teapot on top of the plane. You'll use this temporarily to tune the shadows.
- 19 In the Material Editor, create an Arch & Design material, change the color to white, and apply it to the teapot.
- 20 Select the ground plane.
Next you'll set up the Matte/Shadow/Reflection material.
- 21 In the Material Editor, activate the existing Environment/Background Switcher map.
- 22 Right-click the Background map button and choose Copy.
- 23 Activate an unused sample sphere and create a new Matte/Shadow/Reflection material.
- 24 On the Matte/Shadow/Reflection Parameters rollout, right-click the Camera Mapped Background map button and choose Paste (Instance).
This places the same background map that is used in the environment switcher into the background map in the material as an instance.
This completes the basic setup. If you render now, you should see the teapot superimposed over the background image. The teapot should have a soft shadow underneath, which comes from the ambient occlusion.



Part 2: Marrying 3D with a photo:

Now you'll tune the lighting in the scene. Generally you need at least one key light to cast a directional shadow.

- 1** Add a light source such as mr Area Omni and place it in a location similar to where the main light seems to be coming from in the photo.
- 2** Tune the light so that the lighting direction and intensity on the teapot seems reasonable compared to the objects in the photo, and so the shadow directions seem to match. For now, ignore the shadow intensity; just consider the lighting on the teapot itself.



- 3 Now tune the overall intensity of the shadow with the Ambient/Shadow Intensity parameter to match existing shadows in the photo. If the shadow needs tinting, use the Ambient/Shadow Color setting. You might also need to modify the AO Max Distance value to make contact shadows more or less pronounced.
- 4 You can adjust the shadow softness with the mr Area Omni light's Radius setting, on the Area Light Parameters rollout.



The scene is now set up, although further tuning might be necessary.

- 5 Delete the teapot.
- 6 Add any objects you want to use to the scene.
- 7 Add any additional stand-in matte objects that you can use to occlude objects, receive and cast shadows, etc., to the scene, and apply the same Matte/Shadow/Reflection material to them.

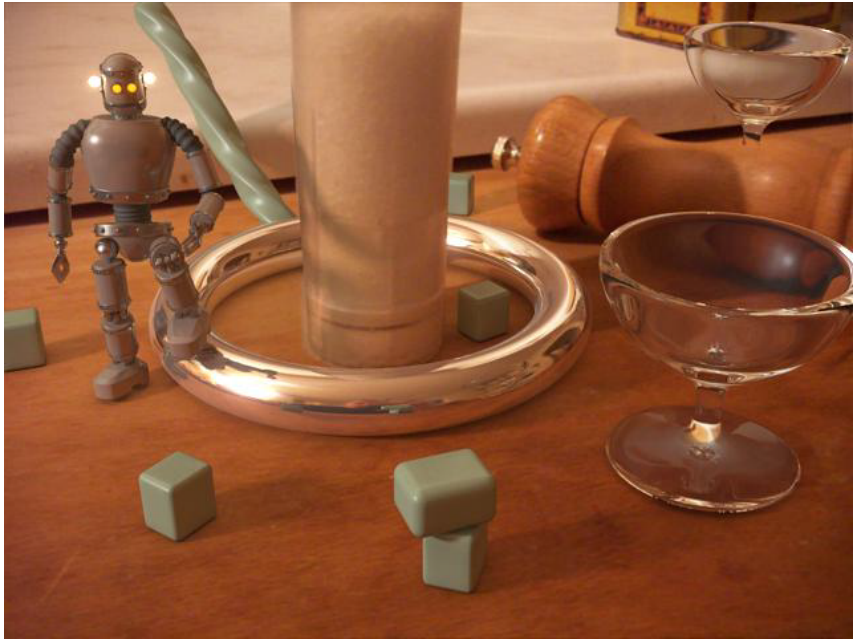

Part 3: Prepare for compositing:

So far the rendered 3D content has been added on top of the background directly in the render. Generally, you want to do this in an external compositing program, as follows:

- 1 Open the Material Editor.
- 2 Activate the Environment/Background Switcher shader (the one you instanced from the Environment panel).
- 3 Right-click the Background map button and choose Cut.
- 4 Click the color swatch next to Background and make sure the color is transparent black; in other words, Red, Green, Blue, and Alpha all equal 0.0. These are the default values, so no changes should be necessary. Close the Color Selector dialog.
- 5 Activate the Matte/Shadow/Reflection material and cut the Camera Mapped Background map.
- 6 To the Matte/Shadow/Reflection material > Camera Mapped Background map, apply a new Environment/Background Switcher shader.

- 7 Right click the Environment/Reflection map button (not the Background map button) and choose Paste (Instance) to apply the previously used map.
- 8 Click the Background color swatch and make sure the color is transparent black as well.

The scene now contains two Switcher nodes: one used in the environment (switching between transparent black and the chrome ball) and one in the material (switching between transparent black and the camera map).

If you render now, the resulting image still properly contains all the reflections, light, etc., from the background, but not the background itself. Shadows exist in the alpha channel, so the image is suitable for compositing directly on top of the background image.



A Note on Gamma

The preceding procedure did not mention gamma.

If you use a gamma-correct workflow, which yields a superior result, with literal mental ray textures (that is, you use the big Browse button to refer directly to a bitmap file, rather than inseriting a Bitmap map), you must set

the gamma of this bitmap explicitly in the appropriate Reverse Gamma Correction parameters.

NOTE Intentionally exaggerating the Reverse Gamma Correction setting on the chrome ball photo can turn a low-dynamic-range photo into a “faux” HDR image by artificially exaggerating its contrast.

Interface

Matte/Shadow/Reflection Parameters rollout

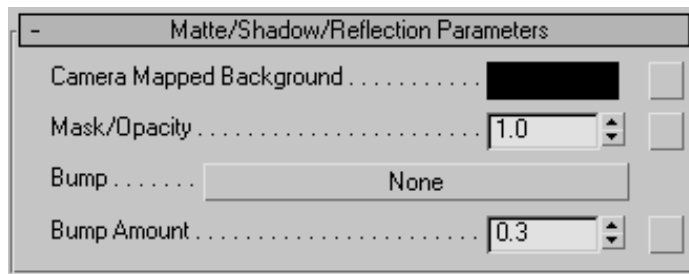

Camera Mapped Background Sets the color or map for the matte material. To use the scene background, click the map button, browse from the scene, and choose the background map.

NOTE Unlike the standard [Matte/Shadow material](#) on page 5699, this material does not automatically pick the background (that is, the scene environment) as its color; rather, it’s necessary to provide the background explicitly. There are several ways to do this:

- The most common method is to use a screen-projected map. However, using a Bitmap map with Screen environment mapping will not work correctly, because it does not handle reflections correctly. Instead, for this purpose, we recommend using the [Environment/Background Camera Map shader](#) on page 6020. This shader projects the texture back from the current rendering camera.
- Alternatively, you can apply the color in any applicable UV texture space, perhaps if you previously projected the texture into that texture space.
- A third option is to project the background at render time with the [Camera Map Per Pixel map](#) on page 6035.

Mask/Opacity The opacity of the material.

TIP One use case for the [Mask/Opacity setting](#) on page 5633 is to refine a rough stand-in object. For example, the plate might contain a person’s arm, and you want to put in a CG object that goes behind the person’s arm and/or has shadows thrown onto it by the person’s arm. You could create simple stand-in geometry (maybe even a cylinder) and then use a screen-projected opacity map that defines the exact edges of the arm. Also, if the arm in the plate is motion-blurred or out of focus, you can feather the opacity mask accordingly.

Bump Specifies a bump map for the material.

Bump Amount The multiplier for the bump map.

Shadows rollout

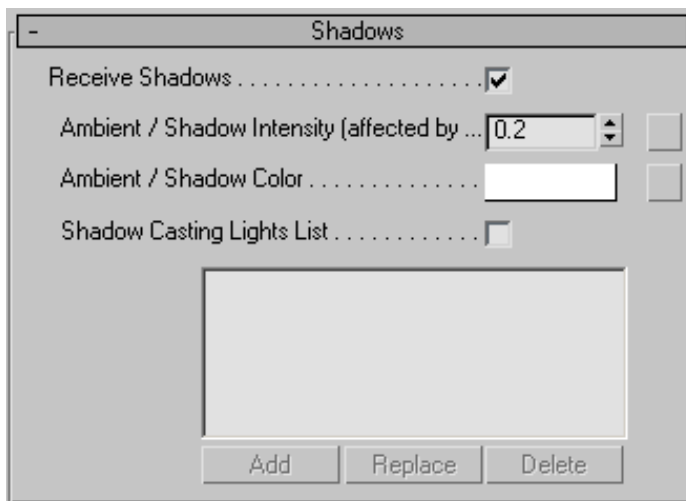

Receive Shadows When on, the surface can receive shadows. If Shadow Casting Lights List is off, all lights cast shadows on the surface.

Ambient/Shadow Intensity The amount of environmental light in the scene, which in a practical sense is how dark the shadows are. The Matte/Shadow/Reflection material does not use Skylights to generate shadows; any such shadows must come from the ambient occlusion feature. So when the shader is used together with a Skylight, this value should be similar to the level of light the Skylight provides.

The units value for this setting depends on the lighting unit. If you use the [mr Photographic Exposure Control](#) on page 6744, and set Physical Scale to Physical Units (cd/m²), this value will be in physical values, and might need to be in the hundreds (or thousands for an outdoor shot lit by [mental ray Sun](#)

and Sky on page 5161). However, if you don't use the exposure control, or set it Physical Scale to Unitless, this parameter is in a "traditional" unit space where 0 is black and 1 is white.

NOTE This "ambient" light is affected by ambient occlusion, so it is darkened by the occlusion at contact points and in areas hidden under objects.

Ambient/Shadow Color Setting a color or map here tints the shadows. For accurate shadow tint, use a neutral color.

Shadow Casting Lights List When on, you can use the Add/Replace/Delete buttons to edit the list, specifying lights that are to cast shadows on the surface. For the lights list to be in effect, Receive Shadows must also be on.

When off, and Receive Shadows is on, all lights in the scene cast shadows on the surface.

NOTE Shadow-casting lights act as representations of any real-world lights in the background plate, such as the sun or any artificial light sources. For further information, see [Direct Illumination rollout](#) on page 5637, following.

Ambient Occlusion rollout

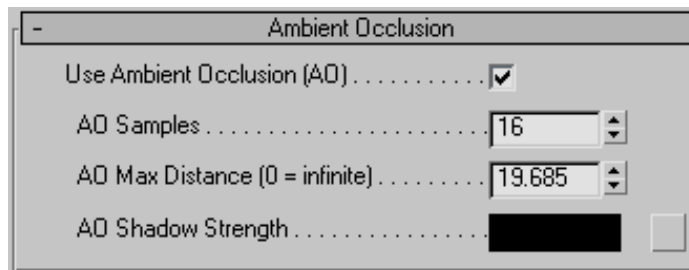

Use Ambient Occlusion (AO) When on, ambient occlusion affects the surface.

AO Samples The number of ambient-occlusion rays that are shot.

AO Max Distance The reach of ambient-occlusion rays. At 0, the ray distance is not limited. Using short rays increases performance but localizes the ambient-occlusion effect.

AO Shadow Strength The darkness of shadows the ambient occlusion causes. The default value is black, but you can cause a less-pronounced shading effect by using a lighter color.

Reflections rollout

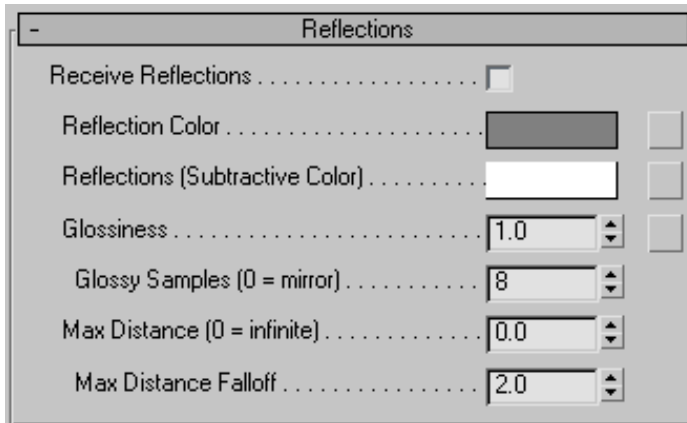

Receive Reflections When on, the surface reflects its surroundings.

Reflection Color Reflections are tinted this color. For accurate reflections, use a neutral color.

Reflections (Subtractive Color) The subtractive color for reflections. This amount is removed from the plate before reflections are added. If black, nothing is removed, and reflections are added purely additively on top of the plate. If 50% gray, the plate pixels are attenuated to 50% of their intensity, and the reflections are added on top of that, and so on.

Use this setting is used if the plate contains an area with many reflections that need to be removed before the new, synthetic reflection is added.

Glossiness The glossiness of reflections.

Glossy Samples The number of glossy-reflection samples.

Max Distance At values other than 0, limits the distance from which reflections are cast.

Max Distance Falloff The falloff curve for reflections at Max Distance. Lower values cause more rapid falloff.

Indirect Illumination rollout

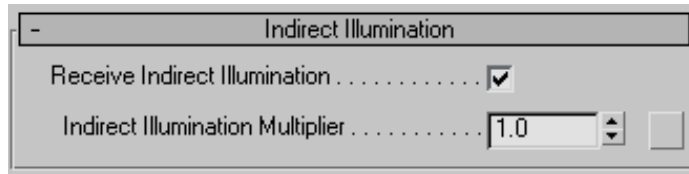

Receive Indirect Illumination When on, indirect light (final gather and global illumination) is gathered and scaled by the Indirect Illumination Multiplier value (see following).

Indirect Illumination Multiplier The multiplier for gathered indirect light.

Direct Illumination rollout

NOTE The lights specified on this rollout actually illuminate the background, unlike [shadow-casting lights](#) on page 5635. Thus, for the effect to be correct, make sure no light source exists in both lists.



Receive Direct Illumination When on, the surface renders where struck by direct illumination. If Illuminating Lights List is off, all lights in the scene illuminate the surface.

Illuminating Lights List When on, you can use the Add/Replace/Delete buttons to edit the list, specifying lights that are to illuminate the surface. For the lights list to be in effect, Receive Direct Illumination must also be on.

Maps Rollout

This rollout enables application of maps or shaders to the applicable material parameters. Of course, you can apply a shader to a parameter at its standard location in the user interface by clicking its map button (square button at the right side of the parameter), so the principal value of this rollout is that it also lets you toggle a parameter's shader, using the check box, without removing the map.

mental ray Material

Material Editor > Type button > Material/Map Browser > mental ray

Note: The mental ray material appears in the Browser only if the mental ray renderer is the currently active renderer.

The mental ray material lets you create a material exclusively for use by the [mental ray renderer](#) on page 6230. A mental ray material consists, at the top level, of from one to 10 kinds of shaders, or shading components.

IMPORTANT You must assign a shader to the material's Surface component. Otherwise, the mental ray material will not be visible when you render.

Interface

The interface to the mental ray material consists of two rollouts:

- [Material Shaders Rollout \(mental ray Material\)](#) on page 5638
- [Advanced Shaders Rollout \(mental ray Material\)](#) on page 5646

Material Shaders Rollout (mental ray Material)

Material Editor > Type button > Material/Map Browser > mental ray > Material Shaders rollout

Note: The mental ray material appears in the Browser only if mental ray is the active renderer.

The mental ray material lets you create a material exclusively for use by the [mental ray renderer](#) on page 6230. The Material Shaders rollout provides controls for the main kinds of component shaders you are likely to assign.

IMPORTANT You must assign a shader to the material's Surface component. Otherwise, the mental ray material will not be visible when you render.

See also:

- [Advanced Shaders Rollout \(mental ray Material\)](#) on page 5646

Interface

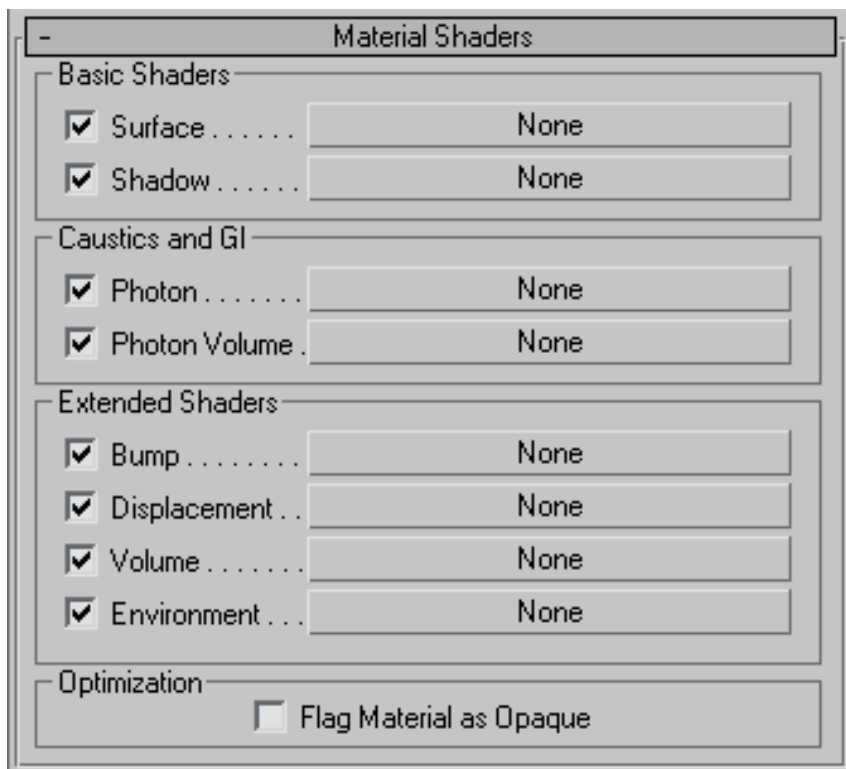

Each shader component has a toggle at the left of its name. When the toggle is on, the shader is used in rendering. When the toggle is off, the shader is not used, even if it has been assigned. Clicking the button to the right of the component name displays the [Material/Map Browser](#) on page 5290 so you can assign a particular shader to the component.

Basic Shaders group

Surface Shades the surface of objects that have this material.

In addition to any of the usual 3ds Max materials, the surface component can be assigned the following mental ray materials or shaders:

Shader	Library
<i>Ambient/Reflective Occlusion</i>	base1 (see note, below)
Bump on page 5986	3ds Max
Car Paint Shader (mi) on page 5607	3ds Max
DGS Material on page 5615	3ds Max
<i>Dielectric</i>	base
Dielectric Material on page 5992	3ds Max
<i>Edge</i>	lume
<i>Facade</i>	lume
<i>Glass</i>	lume
<i>Glow</i>	lume
<i>Landscape</i>	lume
Material to Shader on page 6001	3ds Max
<i>Metal</i>	lume

Shader	Library
mr Physical Sky on page 5181	3ds Max
<i>Ocean</i>	lume
<i>Opacity</i>	base
<i>Reflect</i>	base
<i>Refract</i>	base
Shader List on page 6003	3ds Max
<i>SSS Physical Material</i>	subsurface scattering
<i>Stain</i>	lume
<i>Texture Wave</i>	base
<i>Translucency</i>	lume
<i>Transmat</i>	physics
<i>Transparency</i>	base
<i>Two Sided</i>	base
UV Generator on page 6005	3ds Max
<i>Water Surface</i>	lume
<i>Wet-Dry Mixer</i>	lume

Shader	Library
--------	---------

[XYZ Generator](#) on page 6013 3ds Max

NOTE As of the current version of 3ds Max, the Ambient/Reflective Occlusion shader has been updated to support certain capabilities for texture baking (see [this note](#) on page 6381). If you load a file containing a material that uses the older version of the shader, that same version is still used in the scene, and the shader is renamed "Ambient/Reflective Occlusion (base) (old)". The old version of the shader continues to be used in the scene until you reapply it in the Material Editor.

NOTE Unlike a standard 3ds Max material, if you assign the Surface component a bitmap with tiling turned off, the original surface color does not "show through." In renderings, you see only the untiled map, and none of the rest of the object.

Shadow Assigns a shadow shader.

The shadow component can be assigned the following shaders:

Shader	Library
<i>Edge Shadow</i>	lume
<i>Facade</i>	lume
<i>Glass</i>	lume
<i>Glow</i>	lume
Material to Shader on page 6001	3ds Max
<i>Metal</i>	lume
Shader List on page 6003	3ds Max
<i>Shadow Transparency</i>	base
<i>Translucency</i>	lume

Shader	Library
<i>Transmat</i>	physics
<i>Water Surface Shadow</i>	lume

Caustics and GI group

Photon Assigns a photon shader. Photon shaders modify the appearance of caustics and global illumination. They modify light energy (luminous flux) rather than color (radiance).

The photon component can be assigned the following shaders:

Shader	Library
DGS Material on page 5615	3ds Max
Dielectric Material Photon on page 5992	3ds Max
<i>Edge</i>	lume
<i>Glow</i>	lume
Material to Shader on page 6001	3ds Max
<i>Metal</i>	lume
<i>Photon Basic</i>	base
<i>SSS Physical Material</i>	subsurface scattering
<i>Translucency</i>	lume
<i>Transmat</i>	physics

Photon Volume Assigns a photon volume shader. Like a photon shader, a photon volume shader modifies caustics and global illumination, but it affects

photons that pass through the inside of the object, rather than photons that collide with its surface.

The photon volume component can be assigned the following shaders:

Shader	Library
Material to Shader on page 6001	3ds Max
<i>Parti Volume Photon</i>	physics
Shader List on page 6003	3ds Max

Extended Shaders group

Bump Assigns a bump shader. Bump shading for mental ray materials is similar to [bump mapping](#) on page 5478 for standard materials.

The bump component can be assigned the following shaders:

Shader	Library
Bump on page 5986	3ds Max
<i>Ocean</i>	lume
Shader List on page 6003	3ds Max

Displacement Assigns a [displacement shader](#) on page 6268.

The displacement component can be assigned the following shaders:

Shader	Library
3D Displacement on page 5983	3ds Max
Material to Shader on page 6001	3ds Max
<i>Ocean</i>	lume

Volume Assigns a [volume shader](#) on page 6265.

The volume component can be assigned the following shaders:

Shader	Library
<i>Beam</i>	lume
Material to Shader on page 6001	3ds Max
<i>Mist</i>	lume
<i>Parti Volume Photon</i>	physics
Shader List on page 6003	3ds Max
<i>Submerge</i>	lume

Environment Assigns an environment shader. Like an environment you assign using the Render Setup dialog, the environment shader changes the scene background.

The environment component can be assigned the following shaders:

Shader	Library
Environment on page 5995	3ds Max
Material to Shader on page 6001	3ds Max
Shader List on page 6003	3ds Max

Optimization group

Flag Material as Opaque When on, indicates that the material is fully opaque. This tells the mental ray renderer that it doesn't need to process transparency for this material, or to use the shadow shader (if one has been assigned). This can improve rendering time. Default=off.

Advanced Shaders Rollout (mental ray Material)

Material Editor > Type button > Material/Map Browser > mental ray > Advanced Shaders rollout

Note: The mental ray material appears in the Browser only if the mental ray renderer is the currently active renderer.

The mental ray material lets you create a material exclusively for use by the [mental ray renderer](#) on page 6230. The Advanced Shaders rollout provides controls for two component shaders that aren't always used.

Interface

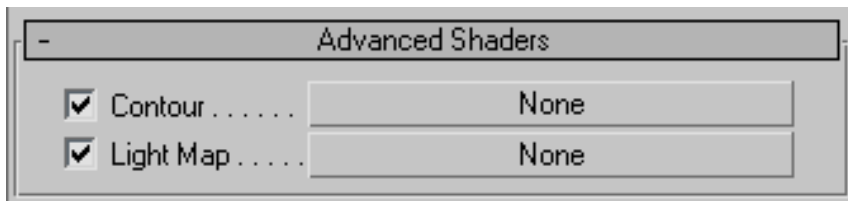

Each shader component has a toggle at the left of its name. When the toggle is on, the shader is used in rendering. When the toggle is off, the shader is not used, even if it has been assigned. Clicking the button to the right of the component name displays the [Material/Map Browser](#) on page 5290 so you can assign a particular shader to the component.

Contour Assigns a [contour shader](#) on page 6269 to the material.

The contour component can be assigned the following shaders:

Shader	Library
<i>Combi</i>	contour
<i>Curvature</i>	contour
<i>Depth Fade</i>	contour
<i>Factor Color</i>	contour
<i>Layer Thinner</i>	contour

Shader	Library
<i>Simple</i>	contour
<i>Width From Color</i>	contour
<i>Width From Light</i>	contour
<i>Width From Light Dir</i>	contour

NOTE Contours don't render unless you have also enabled them on the Render Setup dialog > Renderer panel > [Camera Effects rollout](#) on page 6283.

Light Map Assigns a light map shader to the material.

WARNING No light map shaders are provided with 3ds Max. This option is for users who have access to light map shaders via other shader libraries or custom shader code.



ProMaterials

ProMaterials™ are mental ray materials that model materials commonly used in construction, design, and the environment. They correspond to Autodesk Revit materials, so they provide a way to share surface and material information if you also use that application.

ProMaterials are based on the [Arch & Design material](#) on page 5544. Like that material, they work best when used with physically accurate (photometric) lights, and geometry that is modeled in real-world units. On the other hand, the interface of each ProMaterial is much simpler than the Arch & Design material interface, and lets you achieve realistic, physically correct results with comparatively little effort.

NOTE The ProMaterials library is a set of mental ray material libraries based on manufacturing-supplied data and professional images. This includes building and design materials such as professional wall paint with glossy or matte finishes, solid glass, and concrete. These materials provide a convenient way of creating realistic textures. There is actually one library (MAT) file that corresponds to each ProMaterial: when you use the Material/Map Browser to browse library files, you see library names such as *autodesk.max.promaterials.ceramic.mat*, *autodesk.max.promaterials.concrete.mat*, and so on.

Ceramic ProMaterial (mental ray)

Material Editor > Type button > Material/Map Browser > Choose ProMaterials: Ceramic, and then click OK.

Note: The Ceramic material appears in the Browser only if mental ray is the active renderer.

This material has the appearance of glazed ceramic, including porcelain.

Interface

Parameters rollout

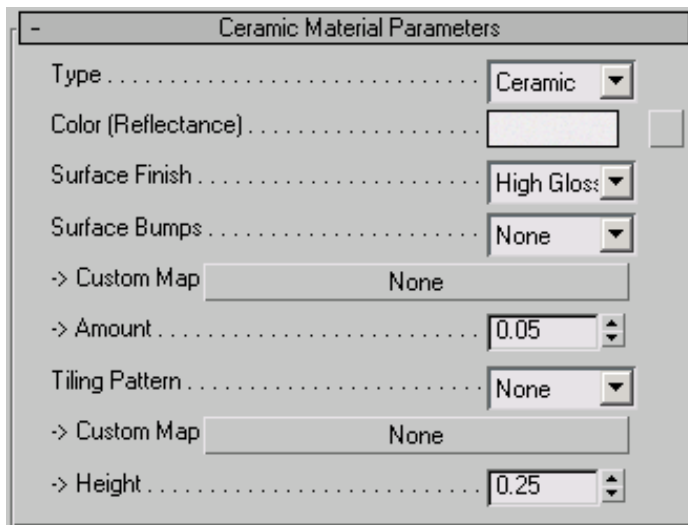

Type The type of ceramic material (Ceramic or Porcelain). Default=Ceramic.

Color (Reflectance) The color of the rendered appearance of the material.

- **Map button** Click to assign a map to this component.

TIP To specify a grout color, use an image file that shows both the tile color and the grout color.

Surface Finish The texture of the finished surface (High Gloss, Satin, or Matte). Default=High Gloss.

Surface Bumps Bump pattern to use on the finished surface (for example, to represent the surface roughness). Can be None, Wavy, or Custom. Default=None.

To define bumps using an image, select Custom and then assign a map.

- **Custom Map** Click to assign a bump map.
- **Amount** Adjusts the amount of mapping. Default=0.05.

Tiling Pattern An additional bump pattern, superimposed on the Finish Bumps pattern (for example, to define grout lines). To define bumps using an image, select Surface Bumps > Custom.

- **Custom Map** Click to assign a tiling pattern map.
- **Height** Adjusts the height of the tiling. Default=0.25.

Special Effects rollout

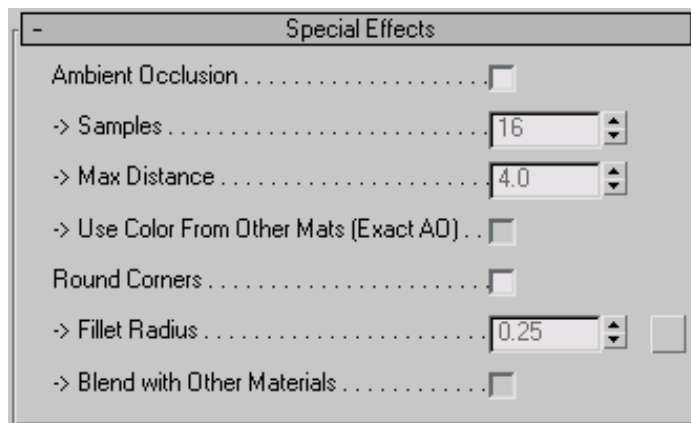

See [Ambient Occlusion Controls](#) on page 5685 and [Round Corners](#) on page 5690.

Performance Tuning Parameters rollout

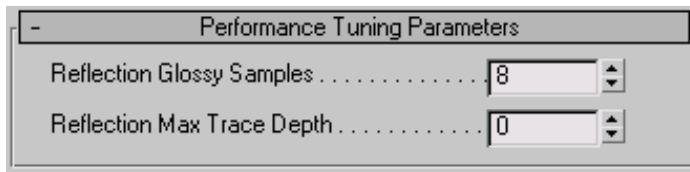

See [Performance Tuning Controls](#) on page 5692.

Maps rollout

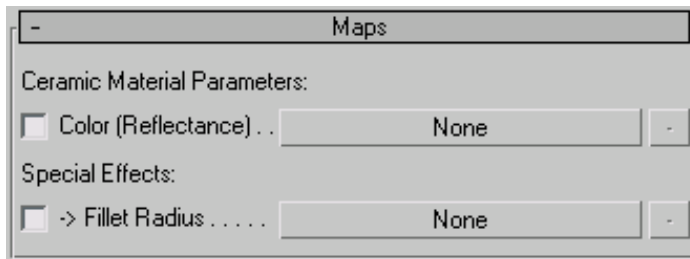

Ceramic Material Parameters > Color (Reflectance) Lets you assign a map to the Color component. The toggle at the left controls whether the map is active; when you assign a map, it turns on by default.

Special Effects > Fillet Radius See [Round Corners](#) on page 5690.



The button to the right of each main shader button is for shaders that can return multiple parameters. If a shader that returns multiple parameters is assigned to the component, the button's tooltip shows the parameter name. Clicking the button displays a [Connect Parameter To Shader dialog](#) on page 5981, which lets you change which parameter is being used.

IMPORTANT [UV Coordinates](#) on page 6013 and [XYZ Coordinates](#) on page 6017 are the only shaders with multiple return values provided with 3ds Max. You might encounter multiple return values in shaders provided with other shader libraries or custom shader code.



Concrete ProMaterial (mental ray)

Material Editor > Type button > Material/Map Browser > Choose ProMaterials: Concrete, and then click OK.

Note: The Concrete material appears in the Browser only if mental ray is the active renderer.

This material has the appearance of concrete.

Interface

Parameters rollout

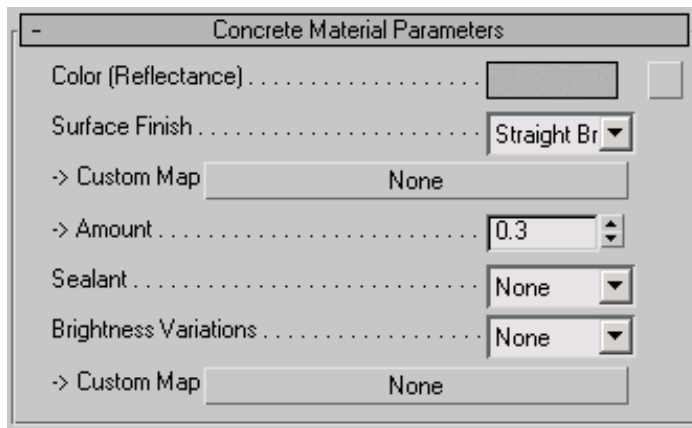

Color (Reflectance) The color of the rendered appearance of the material.

■ **Map button** Click to assign a map to this component.

Surface Finish Texture of the finished surface: Straight Broom, Curved Broom, Smooth, Polished, or Custom. Default = Straight Broom.

To define the finish using an image, select Surface Finish > Custom, and then assign a texture map.

■ **Custom Map** Click to assign a bump map.

■ **Amount** Adjusts the amount of bump mapping. Default=0.3.

Sealant The substance used to seal the surface: None, Epoxy, or Acrylic. Default=None.

Brightness Variations Simulates discoloration due to weather: None, Automatic, or Custom. Default=None.

To define a weathering pattern using an image, select Brightness Variations > Custom, and then assign a map.

- **Custom Map** Click to assign a brightness map.

Special Effects rollout

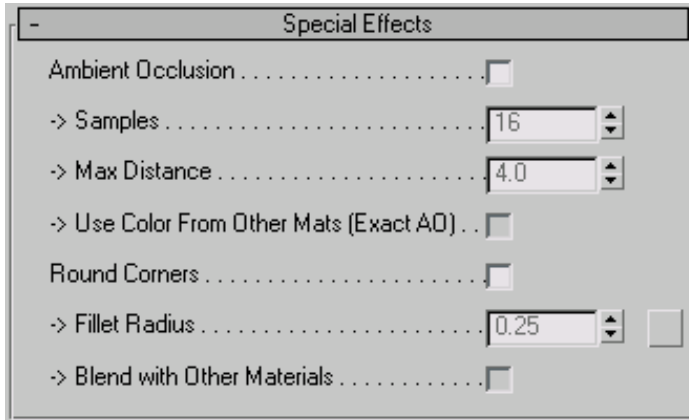

See [Ambient Occlusion Controls](#) on page 5685 and [Round Corners](#) on page 5690.

(Texture) Coordinates for Built-In Textures rollout

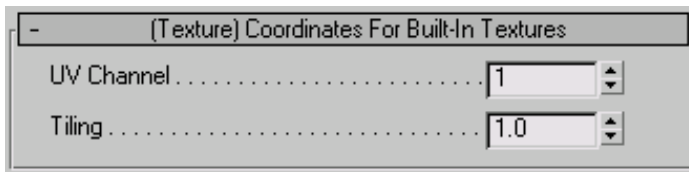

Specifies how to map the Surface Finish texture.

UV Channel Specifies the map channel ID to use. Default=1.

Tiling Scales the built-in texture to the geometry. The default value of 1.0 is a one-to-one mapping. Larger values tile the texture. Default=1.0.

Performance Tuning Parameters rollout

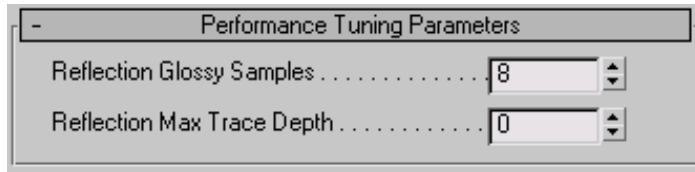

See [Performance Tuning Controls](#) on page 5692.

Maps rollout

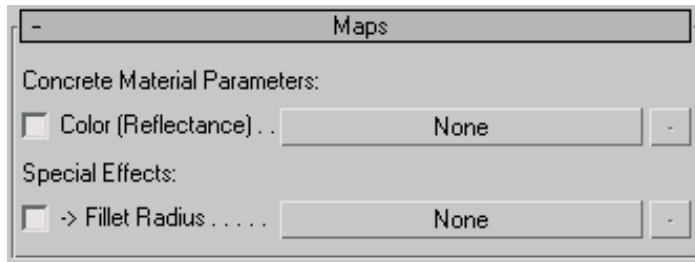

Concrete Material Parameters > Color (Reflectance) Lets you assign a map to the Color component. The toggle at the left controls whether the map is active; when you assign a map, it turns on by default.

Special Effects > Fillet Radius See [Round Corners](#) on page 5690.



The button to the right of each main shader button is for shaders that can return multiple parameters. If a shader that returns multiple parameters is assigned to the component, the button's tooltip shows the parameter name. Clicking the button displays a [Connect Parameter To Shader dialog](#) on page 5981, which lets you change which parameter is being used.

IMPORTANT [UV Coordinates](#) on page 6013 and [XYZ Coordinates](#) on page 6017 are the only shaders with multiple return values provided with 3ds Max. You might encounter multiple return values in shaders provided with other shader libraries or custom shader code.



Generic ProMaterial (mental ray)

Material Editor > Type button > Material/Map Browser > Choose ProMaterials: Generic, and then click OK.

Note: The Generic material appears in the Browser only if mental ray is the active renderer.

This material is a generic interface for creating a custom appearance.

Interface

Parameters rollout

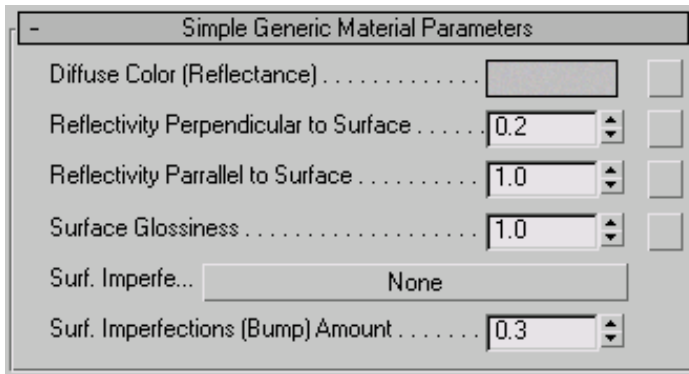

Diffuse Color (Reflectance) The color of the rendered appearance of the material.

■ **Map button** Click to assign a map to this component.

Reflectivity Perpendicular to Surface Measurement of how much the material reflects when the surface is directly facing the camera. Enter a value between 0 (no reflections) and 1 (maximum reflections). Default=0.2.

■ **Map button** Click to assign a map to this component.

Reflectivity Parallel to Surface Measurement of how much the material reflects when the surface is at an angle to the camera. Enter a value between 0 (no reflections) and 1 (maximum reflections). Default=1.0.

■ **Map button** Click to assign a map to this component.

Surface Glossiness Measurement of the glossy quality of the surface, which affects the size and intensity of highlights. Enter a value between 0 (dull) and 1.0 (a perfect mirror). Default=1.0.

■ **Map button** Click to assign a map to this component.

Surface Imperfections Click to assign a bump map to the surface.

Surface Imperfections (Bump) Amount Adjusts the amount of bump mapping. Default=0.3.

Transparency rollout

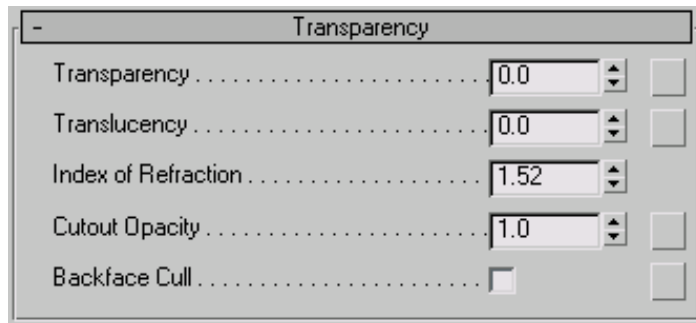

Transparency Measurement of how much light passes through the material. Enter a value between 0 (completely opaque) and 1 (completely transparent). When Transparency is 0, Translucency and Index Of Refraction are ignored. Default=0.0.

■ **Map button** Click to assign a map to this component.

Translucency Measurement of how much light is scattered by the material, so that objects behind the material cannot be seen clearly. Enter a value between 0 (not translucent) and 1 (completely translucent). Default=0.0.

■ **Map button** Click to assign a map to this component.

Index of Refraction Measurement of how much a ray of light bends when entering the material. Enter a value between 0 (no refraction) and 5 (the most refraction). Default=1.52 (a typical value for transparent glass).

Cutout Opacity Specifies shapes cut into the surface of the material. Click the map button to specify cut-outs using an image. The value is the amount

of transparency of the cutouts. Range: 0.0 to 1.0. Default=1.0 (completely transparent).

- **Map button** Click to assign a map to this component.

Backface Cull When on, faces whose normal points away from the camera are ignored when creating cutouts. Default=off.

- **Map button** Click to assign a map to this component.

Self Illumination rollout

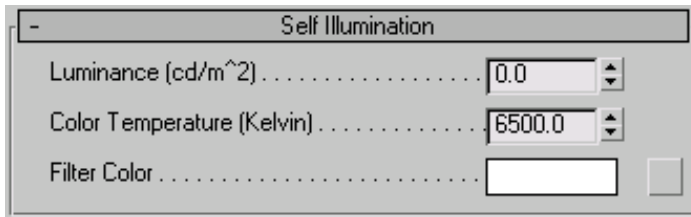

Luminance (cd/m²) Light emitted by the surface, measured in candelas per square meter. Default=0.0.

Color Temperature (Kelvin) The color of the self-illumination, described in terms of degrees Kelvin (K). This is useful for describing color values that are close to white. Default=6500.0 (close to overcast daylight).

Filter Color The color transmitted through the material if it is transparent or translucent.

- **Map button** Click to assign a map to this component.

Ambient Occlusion rollout

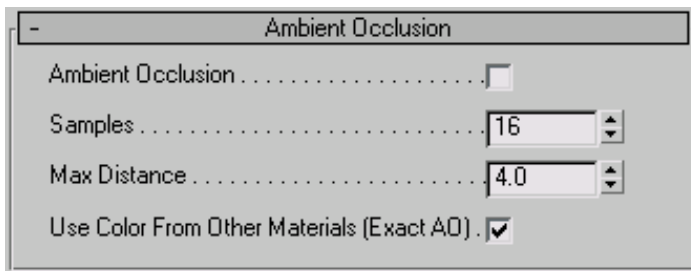

See [Ambient Occlusion Controls](#) on page 5685.

Round Corners rollout

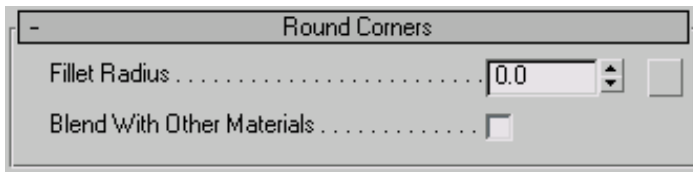

See [Round Corners](#) on page 5690.

Performance Tuning Parameters rollout

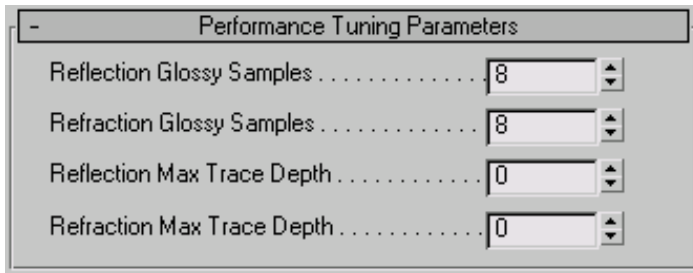

See [Performance Tuning Controls](#) on page 5692.

Maps rollout

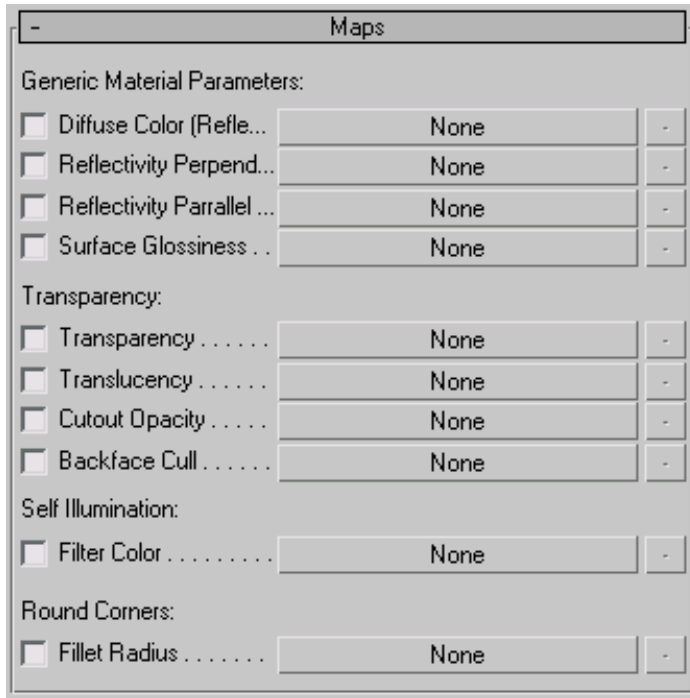

Simple Generic Material Parameters group

Diffuse Color (Reflectance) Lets you assign a map to the Color component. The toggle at the left controls whether the map is active; when you assign a map, it turns on by default.

Reflectivity Perpendicular Lets you assign a map to the Reflectivity Perpendicular To Surface component.

Reflectivity Parallel Lets you assign a map to the Reflectivity Parallel To Surface component.

Surface Glossiness Lets you assign a map to the Surface Glossiness component.

Transparency group

Transparency Lets you assign a map to the Transparency component.

Translucency Lets you assign a map to the Translucency component.

Cutout Opacity Lets you assign a map to the Cutout Opacity component

Backface Cull Lets you assign a map to the Backface Cull component.

Self Illumination group

Filter Color Lets you assign a map to the Filter Color component.

Round Corners group

Fillet Radius See [Round Corners](#) on page 5690.



The button to the right of each main shader button is for shaders that can return multiple parameters. If a shader that returns multiple parameters is assigned to the component, the button's tooltip shows the parameter name. Clicking the button displays a [Connect Parameter To Shader dialog](#) on page 5981, which lets you change which parameter is being used.

IMPORTANT [UV Coordinates](#) on page 6013 and [XYZ Coordinates](#) on page 6017 are the only shaders with multiple return values provided with 3ds Max. You might encounter multiple return values in shaders provided with other shader libraries or custom shader code.



Glazing ProMaterial (mental ray)

Material Editor > Type button > Material/Map Browser > Choose ProMaterials: Glazing, and then click OK.

Note: The Glazing material appears in the Browser only if mental ray is the active renderer.

This material has a glazed appearance. It is more general purpose than the Ceramic material.

Interface

Parameters rollout

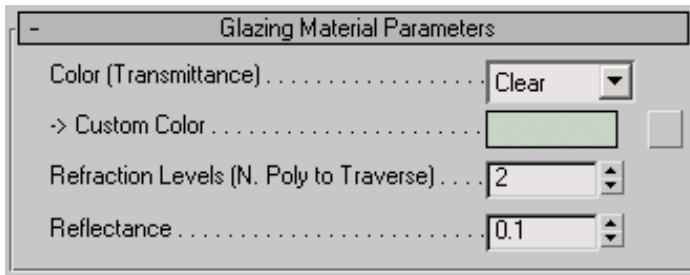

Color (Transmittance) The color of the glass. Can be Clear, Green, Gray, Blue, Blue-Green, or Custom Color. Default=Clear.

Custom Color When you set Color (Transmittance) to Custom Color, you can use this color swatch to assign a color other than one of the predefined choices.

■ **Map button** Click to assign a map to this component.

Refraction Levels (N. Poly to Traverse) The number of layers in the glazing. Range: 1 to 6. Default=2.

Reflectance The normalized percentage of light striking the glass that bounces off again (like a reflection) rather than being absorbed or passing through (transmittance). Enter a value between 0.001 and 1.0 (100 per cent). Default=0.1.

Performance Tuning Parameters rollout

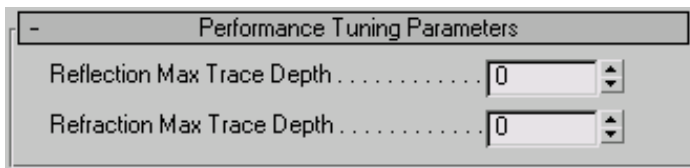

See [Performance Tuning Controls](#) on page 5692.

Maps rollout

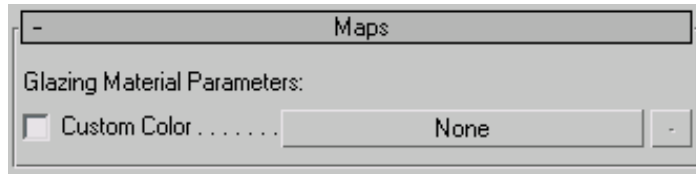

Glazing Material Parameters > Custom Color When you set Color (Transmittance) to Custom Color, you can assign a map to the color component. The toggle at the left controls whether the map is active; when you assign a map, it turns on by default.



The button to the right of each main shader button is for shaders that can return multiple parameters. If a shader that returns multiple parameters is assigned to the component, the button's tooltip shows the parameter name. Clicking the button displays a [Connect Parameter To Shader dialog](#) on page 5981, which lets you change which parameter is being used.

IMPORTANT [UV Coordinates](#) on page 6013 and [XYZ Coordinates](#) on page 6017 are the only shaders with multiple return values provided with 3ds Max. You might encounter multiple return values in shaders provided with other shader libraries or custom shader code.



Hardwood ProMaterial (mental ray)

Material Editor > Type button > Material/Map Browser > Choose ProMaterials: Hardwood, and then click OK.

Note: The Hardwood material appears in the Browser only if mental ray is the active renderer.

The Hardwood material has the appearance of wood.

NOTE In Revit, this material is simply called “Wood.”

Interface

Parameters rollout

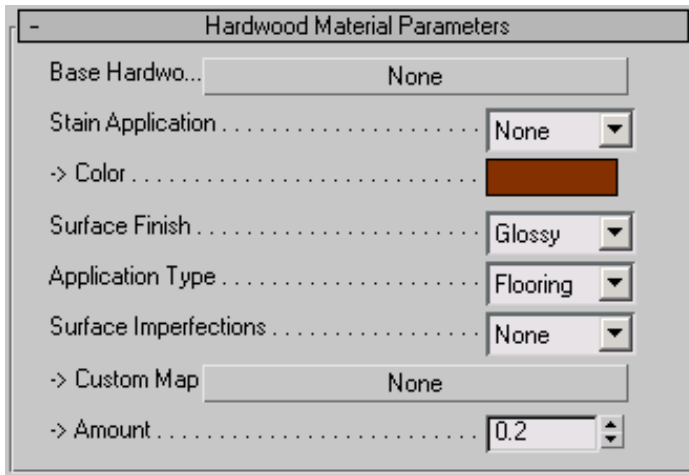

Base Hardwood Click to select an image used to represent the surface of the wood.

Stain Application Specifies whether the wood is stained: can be either None or Enabled. Default=None.

- **Color** Shows the color of the stain used when Stain Application = Enabled. Click the color swatch to change the stain color.

Surface Finish Texture of the finished surface. Can be Glossy, Semi-Glossy, Satin, or Unfinished. Default=Glossy.

Application Type The purpose of the wood (what it is used for): either Flooring or Furniture. Default=Flooring.

Surface Imperfections Bump pattern to use on the finished surface. Can be None, Automatic, or Custom. Default=None.

- **Custom Map** When Surface Imperfections = Custom, click to choose the bump map.
- **Amount** The amount of bump mapping. Default=0.2.

Special Effects rollout

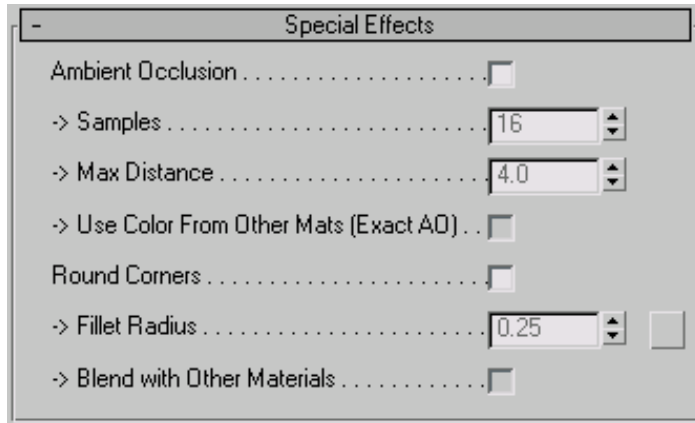

See [Ambient Occlusion Controls](#) on page 5685 and [Round Corners](#) on page 5690.

Performance Tuning Parameters rollout

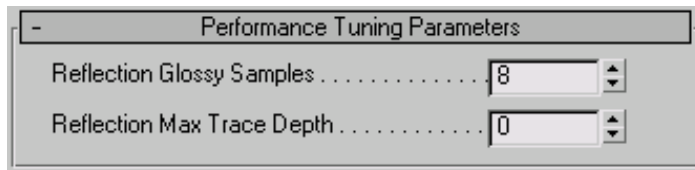

See [Performance Tuning Controls](#) on page 5692.

Maps rollout

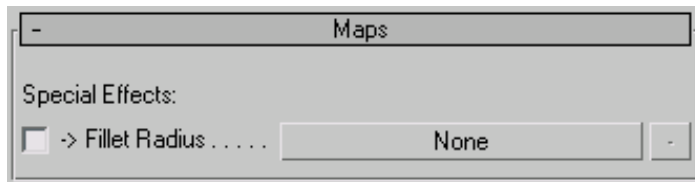

Special Effects > Fillet Radius See [Round Corners](#) on page 5690.



The button to the right of each main shader button is for shaders that can return multiple parameters. If a shader that returns multiple parameters is assigned to the component, the button's tooltip shows the parameter name.

Clicking the button displays a [Connect Parameter To Shader dialog](#) on page 5981, which lets you change which parameter is being used.

IMPORTANT [UV Coordinates](#) on page 6013 and [XYZ Coordinates](#) on page 6017 are the only shaders with multiple return values provided with 3ds Max. You might encounter multiple return values in shaders provided with other shader libraries or custom shader code.

Masonry/CMU ProMaterial (mental ray)

Material Editor > Type button > Material/Map Browser > Choose ProMaterials: Masonry/CMU, and then click OK.

Note: The Masonry/CMU material appears in the Browser only if mental ray is the active renderer.

This material has the appearance of concrete masonry units (CMUs) or masonry.

Interface

Parameters rollout

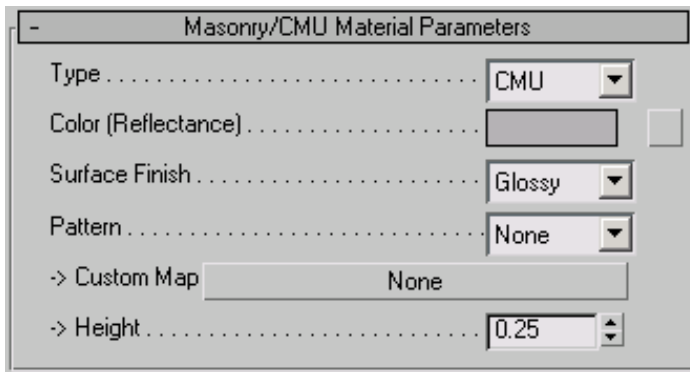

Type The type of masonry material: CMU or Masonry. Default=CMU.

Color (Reflectance) The color of the rendered appearance of the material.

■ **Map button** Click to assign a map to this component.

Surface Finish Texture of the finished surface. Can be Glossy, Matte, or Unfinished. Default=Glossy.

Pattern Bump pattern to use on the finished surface. Can be None or Custom. Default=None.

■ **Custom Map** When Pattern = Custom, click to choose the bump map.

■ **Height** The amount of bump mapping. Default=0.25.

Special Effects rollout

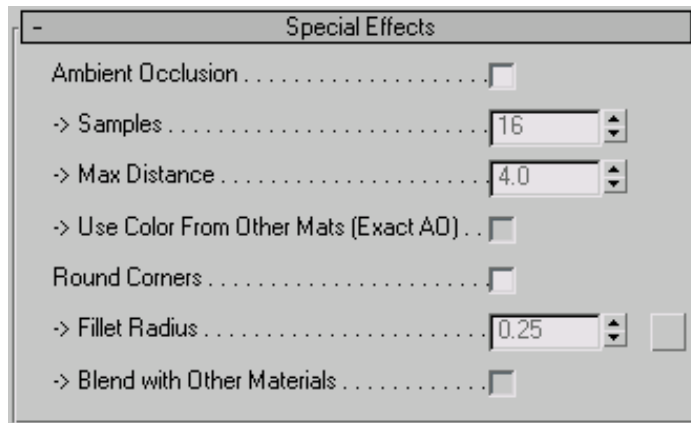

See [Ambient Occlusion Controls](#) on page 5685 and [Round Corners](#) on page 5690.

Performance Tuning Parameters rollout

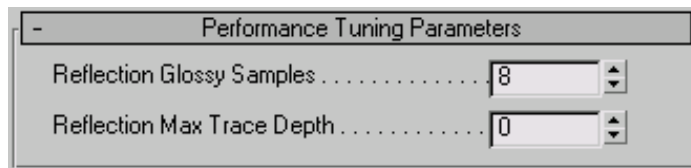

See [Performance Tuning Controls](#) on page 5692.

Maps rollout

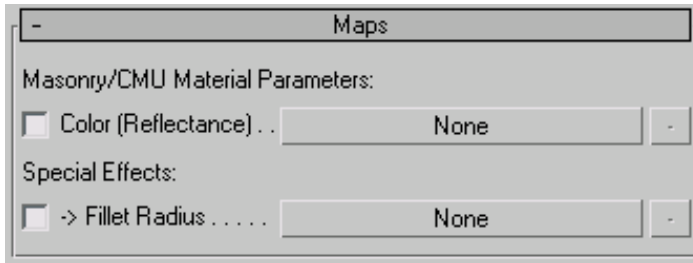

Masonry/CMU Material Parameters > Color (Reflectance) Lets you assign a map to the Color component. The toggle at the left controls whether the map is active; when you assign a map, it turns on by default.

Special Effects > Fillet Radius See [Round Corners](#) on page 5690.



The button to the right of each main shader button is for shaders that can return multiple parameters. If a shader that returns multiple parameters is assigned to the component, the button's tooltip shows the parameter name. Clicking the button displays a [Connect Parameter To Shader dialog](#) on page 5981, which lets you change which parameter is being used.

IMPORTANT [UV Coordinates](#) on page 6013 and [XYZ Coordinates](#) on page 6017 are the only shaders with multiple return values provided with 3ds Max. You might encounter multiple return values in shaders provided with other shader libraries or custom shader code.



Metal ProMaterial (mental ray)

Material Editor > Type button > Material/Map Browser > Choose ProMaterials: Metal, and then click OK.

Note: The Metal material appears in the Browser only if mental ray is the active renderer.

This material has the appearance of metal.

Interface

Parameters rollout

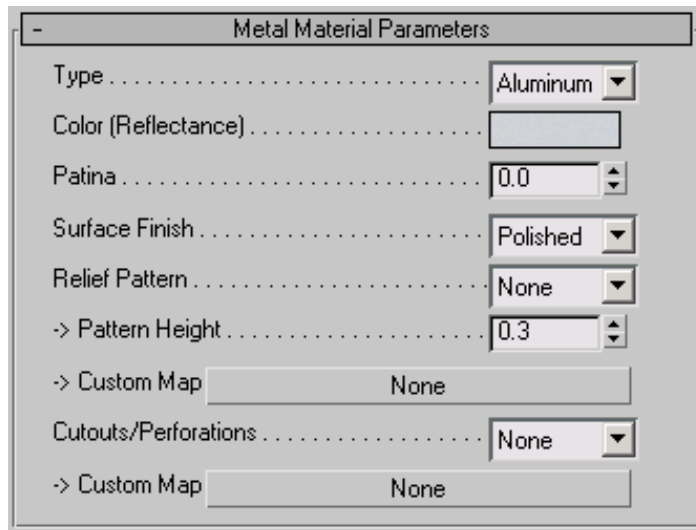

Type The type of metal: Aluminum, Anodized Aluminum, Chrome, Copper, Brass, Bronze, Stainless Steel, or Zinc. Default=Aluminum.

Color (Reflectance) The color of the metal when Type equals Anodized Aluminum.

Patina For Copper or Bronze, the degree of discoloration due to oxidation or the application of a chemical compound. Enter a value between 0.0 (none) and 1.0 (full). Default=0.0.

NOTE The Patina renders correctly only on curved surfaces.

Surface Finish Texture of the finished surface. Can be Polished, Semi-Polished, Satin, or Brushed. Default=Polished.

Relief Pattern Decorative design pressed onto the surface of the metal (in effect, a bump map). Select a pattern, or select Custom to define the relief pattern using an image. Can be None, Knurl, Diamond Plate, Checker Plate, or Custom. Default=None.

- **Pattern Height** Height of the relief pattern. Enter 0.0 to make the surface flat. Enter a value up to 2.0 to increase the depth of the relief pattern. Default=0.3.

- **Custom Map** When Relief Pattern = Custom, click to choose the bump map.

Cutouts/Perforations Shapes cut into the surface of the metal. Can be None, Round Holes, Square Holes, or Custom. Select a shape, or select Custom to define cut-outs using an image. Default=None.

- **Custom Map** When Cutouts/Perforations = Custom, click to choose the map that specifies holes in the metal.

Special Effects rollout

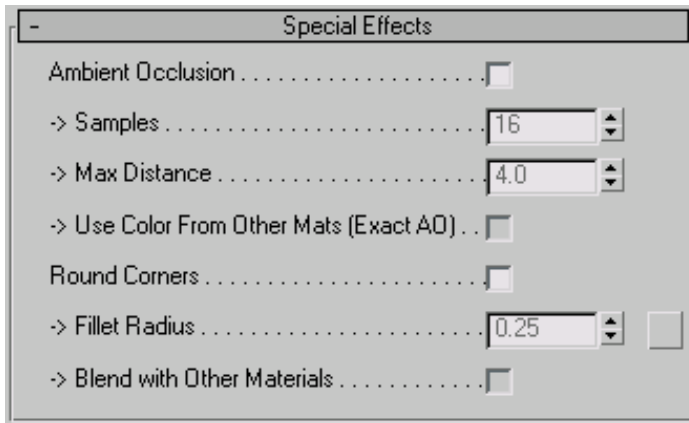

See [Ambient Occlusion Controls](#) on page 5685 and [Round Corners](#) on page 5690.

Performance Tuning Parameters rollout

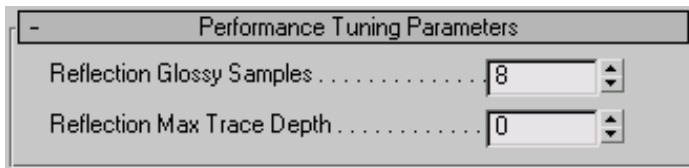

See [Performance Tuning Controls](#) on page 5692.

(Texture) Coordinates for Built-In Textures rollout

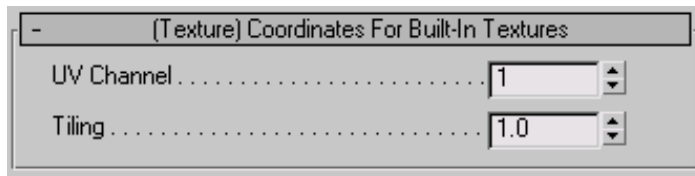

Specifies how to map the Surface Finish, Relief Pattern, and Cutout textures.

UV Channel Specifies the map channel ID to use. Default=1.

Tiling Scales the built-in textures to the geometry. The default value of 1.0 is a one-to-one mapping. Larger values tile the textures. Default=1.0.

Maps rollout

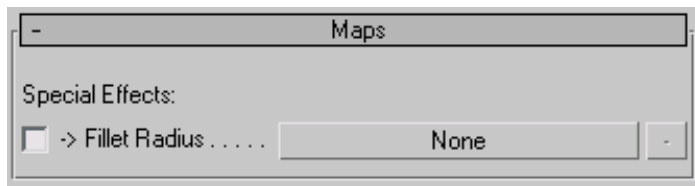

Round Corners > Fillet Radius See [Round Corners](#) on page 5690.



The button to the right of each main shader button is for shaders that can return multiple parameters. If a shader that returns multiple parameters is assigned to the component, the button's tooltip shows the parameter name. Clicking the button displays a [Connect Parameter To Shader dialog](#) on page 5981, which lets you change which parameter is being used.

IMPORTANT [UV Coordinates](#) on page 6013 and [XYZ Coordinates](#) on page 6017 are the only shaders with multiple return values provided with 3ds Max. You might encounter multiple return values in shaders provided with other shader libraries or custom shader code.



Metallic Paint ProMaterial (mental ray)

Material Editor > Type button > Material/Map Browser > Choose ProMaterials: Metallic Paint, and then click OK.

Note: The Metallic Paint material appears in the Browser only if mental ray is the active renderer.

This material has the appearance of metallic paint, as on an automobile.

Interface

Parameters rollout

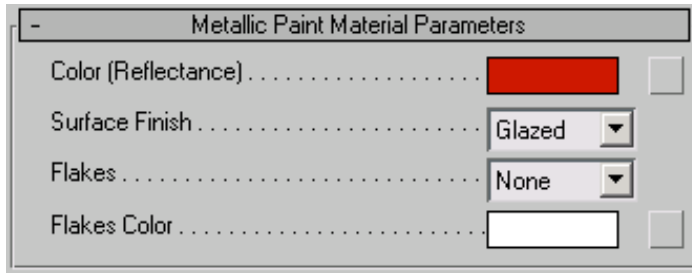

Color (Reflectance) Color of the metallic paint.

■ **Map button** Click to assign a map to this component.

Surface Finish Texture of the finished surface. Can be Glazed, Glossy, or Satin. Default=Glazed.

Flakes When set to Enable, adds flakes or flecks to the paint. Default=None.

Flakes Color Color of the flakes, when Flakes equals Enabled.

Special Effects rollout

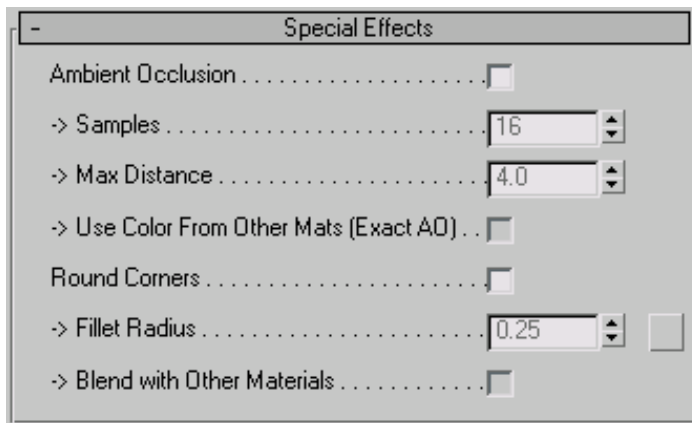

See [Ambient Occlusion Controls](#) on page 5685 and [Round Corners](#) on page 5690.

Performance Tuning Parameters rollout

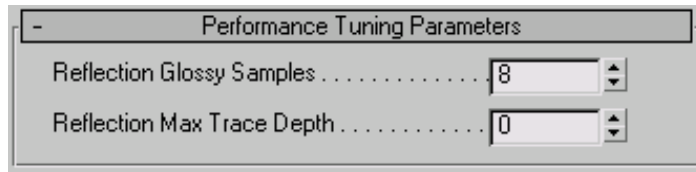

See [Performance Tuning Controls](#) on page 5692.

Maps rollout

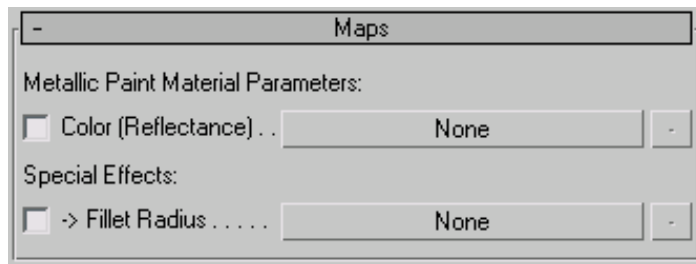

Metallic Paint Material Parameters > Color (Reflectance) Lets you assign a map to the Color component. The toggle at the left controls whether the map is active; when you assign a map, it turns on by default.

Round Corners > Fillet Radius See [Round Corners](#) on page 5690.



The button to the right of each main shader button is for shaders that can return multiple parameters. If a shader that returns multiple parameters is assigned to the component, the button's tooltip shows the parameter name. Clicking the button displays a [Connect Parameter To Shader dialog](#) on page 5981, which lets you change which parameter is being used.

IMPORTANT [UV Coordinates](#) on page 6013 and [XYZ Coordinates](#) on page 6017 are the only shaders with multiple return values provided with 3ds Max. You might encounter multiple return values in shaders provided with other shader libraries or custom shader code.



Mirror ProMaterial (mental ray)

Material Editor > Type button > Material/Map Browser > Choose ProMaterials: Mirror, and then click OK.

Note: The Mirror material appears in the Browser only if mental ray is the active renderer.

This material acts as a mirror.

Interface

Parameters rollout

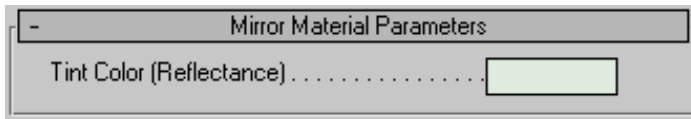

Tint Color (Reflectance) Color of the mirror surface.

Special Effects rollout

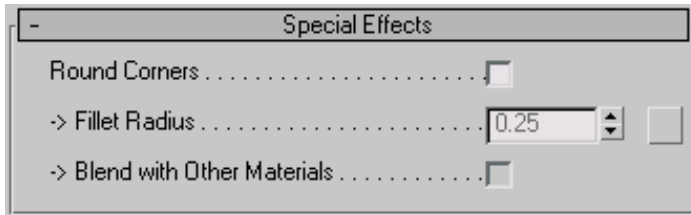

See [Round Corners](#) on page 5690.

Performance Tuning Parameters rollout

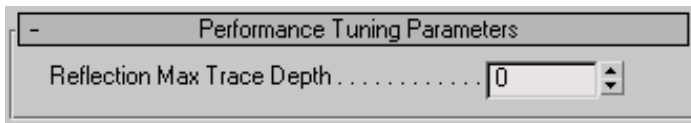

See [Performance Tuning Controls](#) on page 5692.

Maps rollout

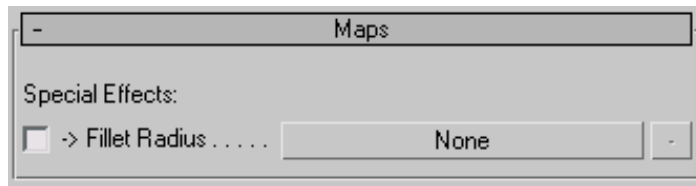

Special Effects > Fillet Radius See [Round Corners](#) on page 5690.



The button to the right of each main shader button is for shaders that can return multiple parameters. If a shader that returns multiple parameters is assigned to the component, the button's tooltip shows the parameter name. Clicking the button displays a [Connect Parameter To Shader dialog](#) on page 5981, which lets you change which parameter is being used.

IMPORTANT [UV Coordinates](#) on page 6013 and [XYZ Coordinates](#) on page 6017 are the only shaders with multiple return values provided with 3ds Max. You might encounter multiple return values in shaders provided with other shader libraries or custom shader code.



Plastic/Vinyl ProMaterial (mental ray)

Material Editor > Type button > Material/Map Browser > Choose ProMaterials: Plastic/Vinyl, and then click OK.

Note: The Plastic/Vinyl material appears in the Browser only if mental ray is the active renderer.

This material has a synthetic appearance, as of plastic or vinyl.

Interface

Parameters rollout

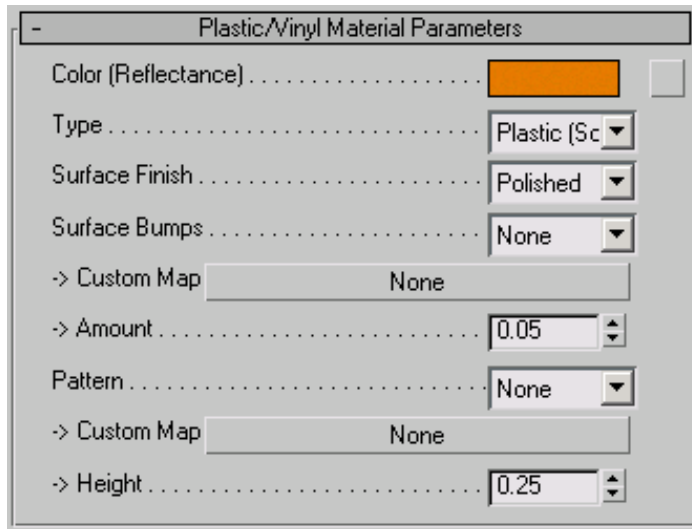

Color (Reflectance) The color of the rendered appearance of the material.

■ **Map button** Click to assign a map to this component.

Type The type of material. Can be Plastic (Solid), Plastic (Transparent), or Vinyl. Default=Plastic (Solid).

Surface Finish Texture of the finished surface. Can be Polished, Glossy, or Matte. Default=Polished.

Surface Bumps Bump pattern to use on the finished surface. Can be None or Custom. Default=None.

■ **Custom Map** When Surface Bumps = Custom, click to choose the bump map.

■ **Amount** The amount of bump mapping. Default=0.05.

Pattern An additional bump pattern, superimposed on the Finish Bumps pattern. Can be None or Custom. Default=None.

■ **Custom Map** When Pattern = Custom, click to choose the bump map.

■ **Height** The amount of bump mapping. Default=0.05.

Special Effects rollout

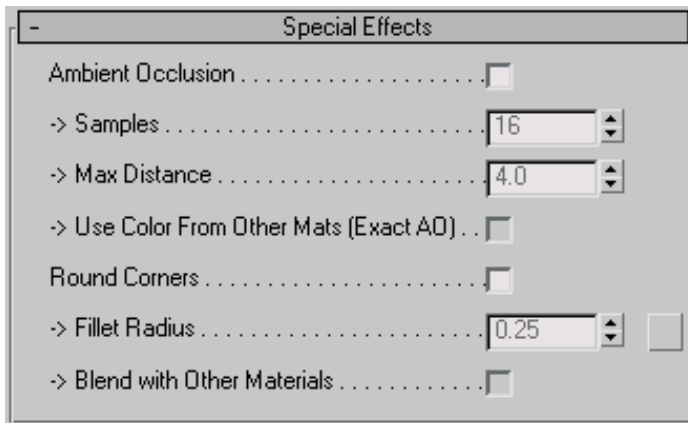

See [Ambient Occlusion Controls](#) on page 5685 and [Round Corners](#) on page 5690.

Performance Tuning Parameters rollout

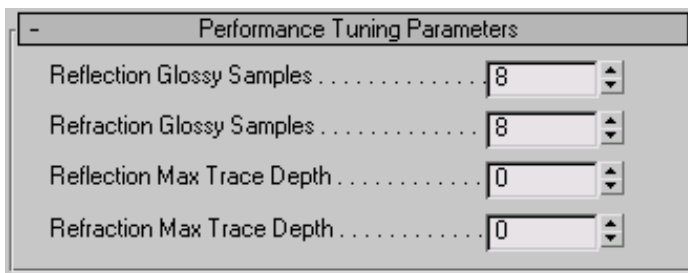

See [Performance Tuning Controls](#) on page 5692.

Maps rollout

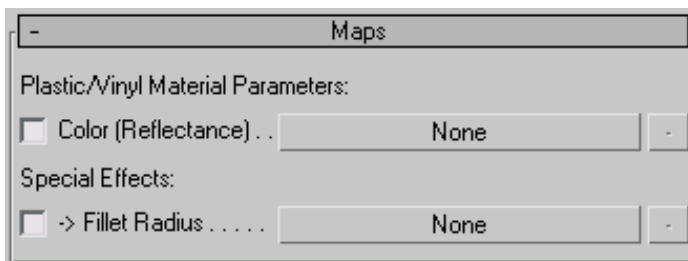

Plastic/Vinyl Material Parameters > Color (Reflectance) Lets you assign a map to the Color component. The toggle at the left controls whether the map is active; when you assign a map, it turns on by default.

Special Effects > Fillet Radius See [Round Corners](#) on page 5690.



The button to the right of each main shader button is for shaders that can return multiple parameters. If a shader that returns multiple parameters is assigned to the component, the button's tooltip shows the parameter name. Clicking the button displays a [Connect Parameter To Shader dialog](#) on page 5981, which lets you change which parameter is being used.

IMPORTANT [UV Coordinates](#) on page 6013 and [XYZ Coordinates](#) on page 6017 are the only shaders with multiple return values provided with 3ds Max. You might encounter multiple return values in shaders provided with other shader libraries or custom shader code.



Solid Glass ProMaterial (mental ray)

Material Editor > Type button > Material/Map Browser > Choose ProMaterials: Solid Glass, and then click OK.

Note: The Solid Glass material appears in the Browser only if mental ray is the active renderer.

This material has the appearance of glass.

Interface

Parameters rollout

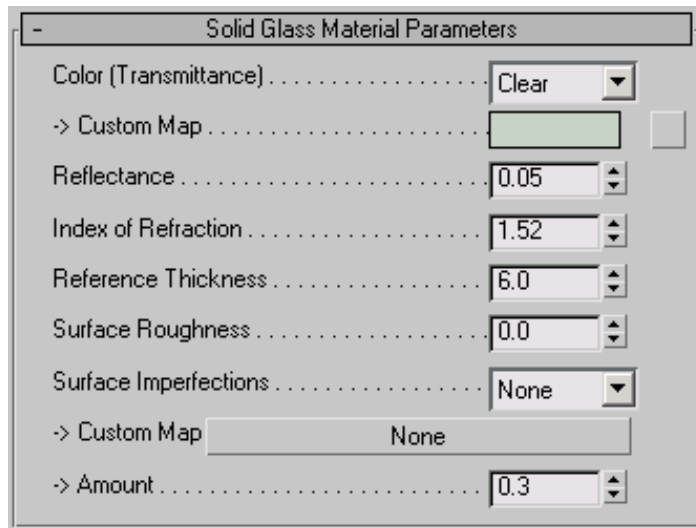

Color (Transmittance) The color of the glass. Can be Clear, Green, Gray, Blue, Blue-Green, Bronze, or Custom Color. Default=Clear.

- **Custom Map** When Color (Transmittance) equals Custom Color, you can either click the color swatch to assign the glass material a custom color, or click the map button to assign a map to this component.

Reflectance Sets the reflectivity of the glass. Default=0.05.

Index of Refraction Sets the Index Of Refraction (IOR). Default=1.52 (a typical value for glass).

Reference Thickness Sets the apparent thickness of the glass: this value is independent of the geometry to which the material is applied. Default=6.0.

Surface Roughness Sets the roughness of the glass surface. Default=0.0.

Surface Imperfections Sets a surface pattern for the glass. Can be None, Rippled, Wavy, or Custom. Default=None.

- **Custom Map** When Surface Imperfections = Custom, click to choose the bump map.

- **Amount** The amount of bump mapping. Default=0.3.

Special Effects rollout

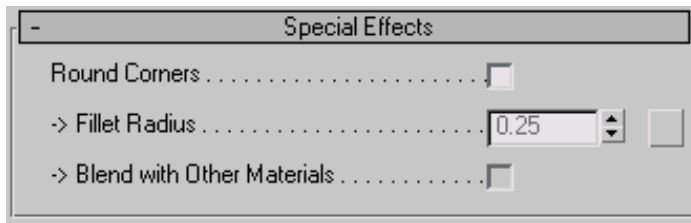

See [Round Corners](#) on page 5690.

Performance Tuning Parameters rollout

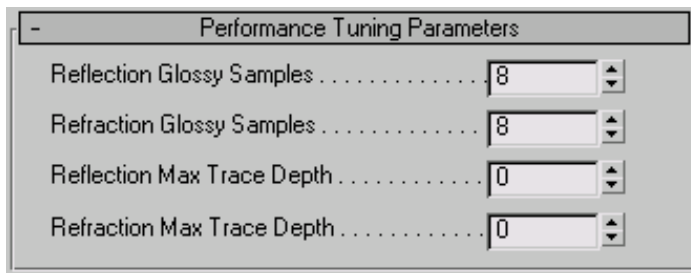

See [Performance Tuning Controls](#) on page 5692.

Maps rollout

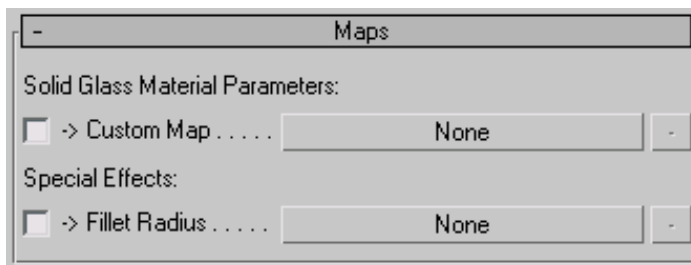

Solid Glass Material Parameters > Custom Map Lets you assign a map to the Color (Transmittance) component. The toggle at the left controls whether the map is active; when you assign a map, it turns on by default.

Special Effects > Fillet Radius See [Round Corners](#) on page 5690.



The button to the right of each main shader button is for shaders that can return multiple parameters. If a shader that returns multiple parameters is assigned to the component, the button's tooltip shows the parameter name. Clicking the button displays a [Connect Parameter To Shader dialog](#) on page 5981, which lets you change which parameter is being used.

IMPORTANT [UV Coordinates](#) on page 6013 and [XYZ Coordinates](#) on page 6017 are the only shaders with multiple return values provided with 3ds Max. You might encounter multiple return values in shaders provided with other shader libraries or custom shader code.



Stone ProMaterial (mental ray)

Material Editor > Type button > Material/Map Browser > Choose ProMaterials: Stone, and then click OK.

Note: The Stone material appears in the Browser only if mental ray is the active renderer.

This material has the appearance of stone.

Interface

Parameters rollout

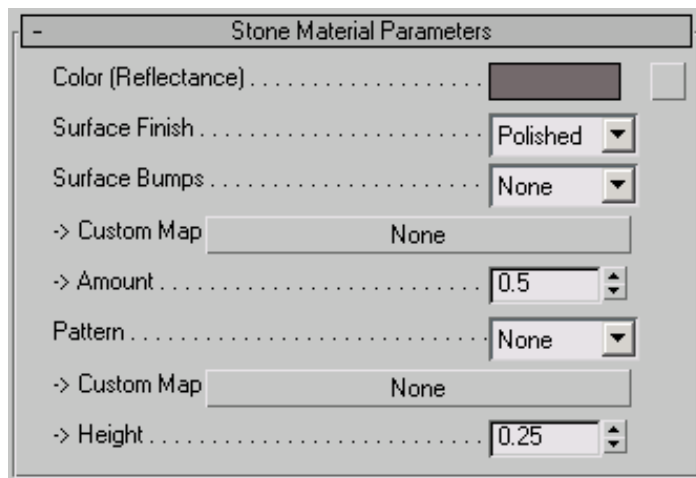

Color (Reflectance) The color of the material.

- **Map button** Click to assign a map to this component.

Surface Finish Texture of the finished surface. Can be Polished, Glossy, Matte, or Unfinished. Default=Polished.

Surface Bumps Bump pattern to use on the finished surface. Can be None, Polished Granite, Stone Wall, Glossy Marble, or Custom. Default=None.

- **Custom Map** When Surface Bumps = Custom, click to choose the bump map.

- **Amount** The amount of bump mapping. Default=0.5.

Pattern An additional bump pattern, superimposed on the Surface Bumps pattern. Can be None or Custom. Default=None.

- **Custom Map** When Pattern = Custom, click to choose the bump map.

- **Height** The amount of bump mapping. Default=0.25.

Special Effects rollout

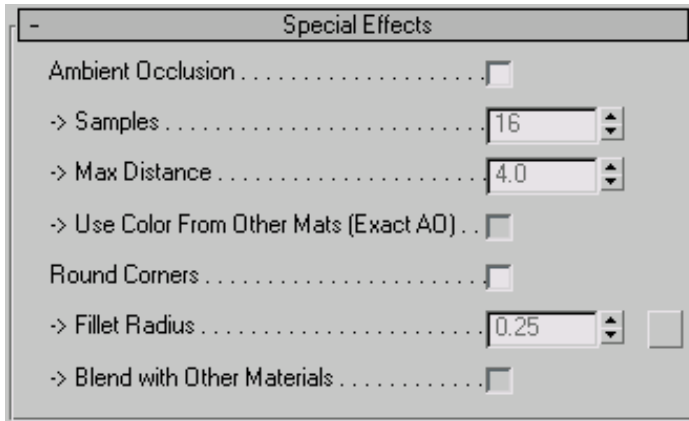

See [Ambient Occlusion Controls](#) on page 5685 and [Round Corners](#) on page 5690.

Performance Tuning Parameters rollout

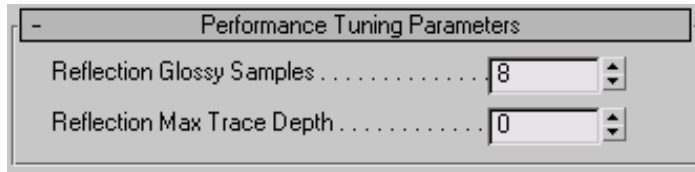

See [Performance Tuning Controls](#) on page 5692.

(Texture) Coordinates for Built-In Textures rollout

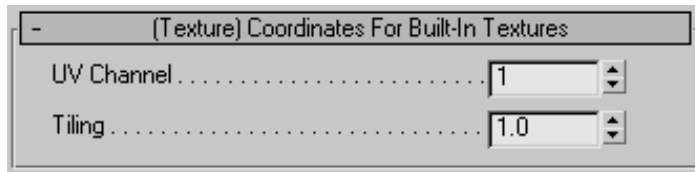

Specifies how to map the Surface Finish, Surface Bumps, and Pattern textures.

UV Channel Specifies the map channel ID to use. Default=1.

Tiling Scales the built-in textures to the geometry. The default value of 1.0 is a one-to-one mapping. Larger values tile the textures. Default=1.0.

Maps rollout

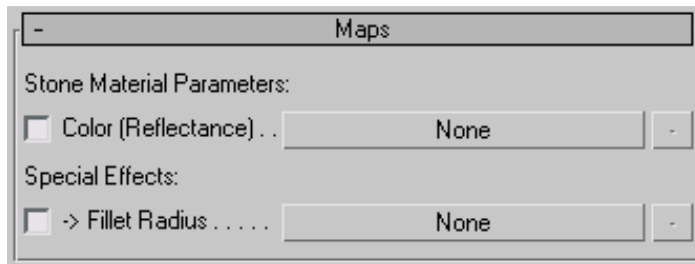

Stone Material Parameters > Color (Reflectance) Lets you assign a map to the Color component. The toggle at the left controls whether the map is active; when you assign a map, it turns on by default.

Special Effects > Fillet Radius See [Round Corners](#) on page 5690.



The button to the right of each main shader button is for shaders that can return multiple parameters. If a shader that returns multiple parameters is assigned to the component, the button's tooltip shows the parameter name. Clicking the button displays a [Connect Parameter To Shader dialog](#) on page 5981, which lets you change which parameter is being used.

IMPORTANT [UV Coordinates](#) on page 6013 and [XYZ Coordinates](#) on page 6017 are the only shaders with multiple return values provided with 3ds Max. You might encounter multiple return values in shaders provided with other shader libraries or custom shader code.



Wall Paint ProMaterial (mental ray)

Material Editor > Type button > Material/Map Browser > Choose ProMaterials: Wall Paint, and then click OK.

Note: The Wall Paint material appears in the Browser only if mental ray is the active renderer.

This material has the appearance of a painted surface.

NOTE In Revit, this material is simply called "Paint."

Interface

Parameters rollout

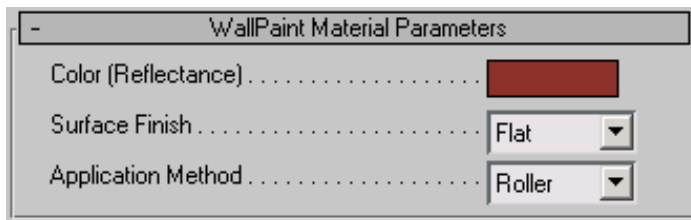

Color (Reflectance) Color of the paint.

Surface Finish Texture of the paint. Can be Gloss, Semi-Gloss, Pearl, Platinum, Eggshell, or Flat. Default=Flat.

Application Method The method used to apply the paint to the surface. Can be Roller, Brush, or Spray. Default=Roller.

Special Effects rollout

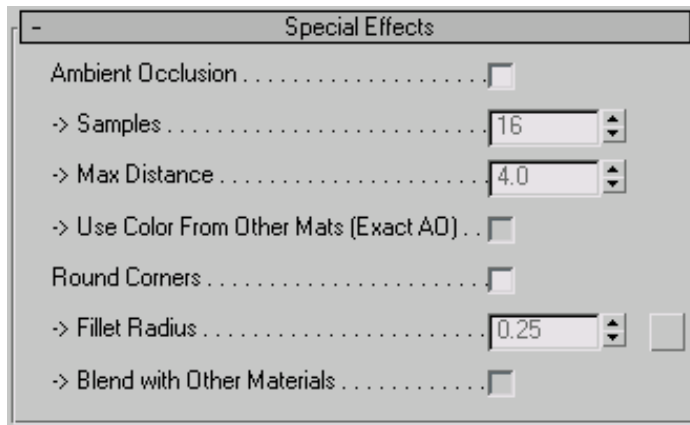

See [Ambient Occlusion Controls](#) on page 5685 and [Round Corners](#) on page 5690.

Performance Tuning Parameters rollout

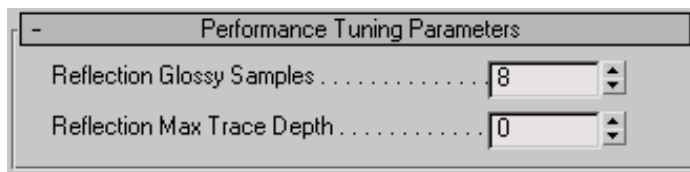

See [Performance Tuning Controls](#) on page 5692.

Maps rollout

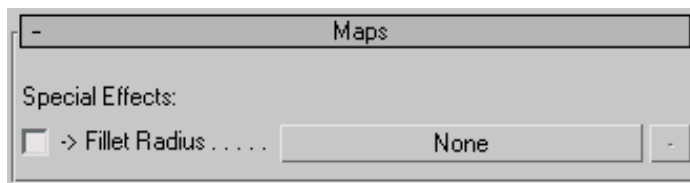

Special Effects > Fillet Radius See [Round Corners](#) on page 5690.



The button to the right of each main shader button is for shaders that can return multiple parameters. If a shader that returns multiple parameters is assigned to the component, the button's tooltip shows the parameter name.

Clicking the button displays a [Connect Parameter To Shader dialog](#) on page 5981, which lets you change which parameter is being used.

IMPORTANT [UV Coordinates](#) on page 6013 and [XYZ Coordinates](#) on page 6017 are the only shaders with multiple return values provided with 3ds Max. You might encounter multiple return values in shaders provided with other shader libraries or custom shader code.

Water ProMaterial (mental ray)

Material Editor > Type button > Material/Map Browser > Choose ProMaterials: Water, and then click OK.

Note: The Water material appears in the Browser only if mental ray is the active renderer.

This material has the appearance of water.

Interface

Parameters rollout

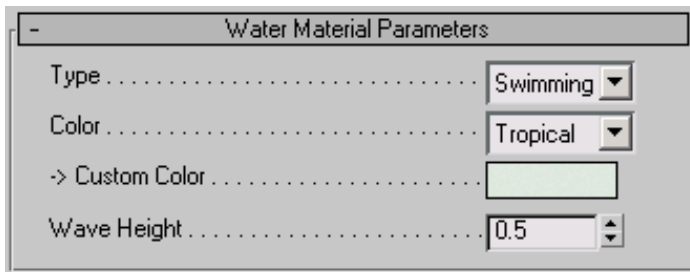

Type Type of water source. Can be Swimming Pool, Reflecting Pool, Stream/River, Pond/Lake, or Sea/Ocean. Default = Swimming Pool.

Color Color of the water (ignored when the Type equals Swimming Pool). Select a predefined water color, or select Custom to specify a color. Can be Tropical, Algae/Green, Murky/Brown, Reflecting Pool, Stream/River, Pond/Lake, Sea/Ocean, or Custom Color. Default=Tropical.

- **Custom Color** When Color equals Custom_Color, click to change the water color.

Wave Height Relative height of waves in the water. Enter a value between 0 (no waves) and 5 (big waves). Default=0.5.

Performance Tuning Parameters rollout

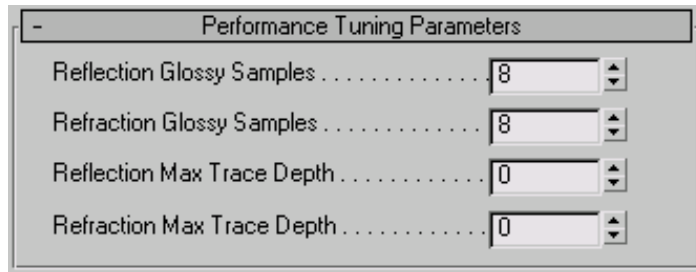

See [Performance Tuning Controls](#) on page 5692.



Common ProMaterials Controls

These topics describe controls that are common to all or most of the materials in the ProMaterials library.



Ambient Occlusion Controls

Material Editor > Type button > Material/Map Browser > Choose a ProMaterials material, and then click OK. > Special Effects rollout or Ambient Occlusion rollout > Ambient Occlusion controls

Note: ProMaterials (marked "adsk") appear in the Browser only if mental ray is the active renderer. Not all ProMaterials support ambient occlusion.

Ambient Occlusion (AO) is a method spearheaded by the film industry for emulating the look of true global illumination by using shaders that calculate the extent to which an area is occluded, or prevented from receiving incoming light.

Used alone, an AO shader, such as the separate mental ray Ambient/Reflective Occlusion shader, creates a grayscale output that is dark in areas light cannot reach and bright in areas where it can.

The following image illustrates the main results of AO: dark crevices and areas where light is blocked by other surfaces, and bright areas that are exposed to the environment.

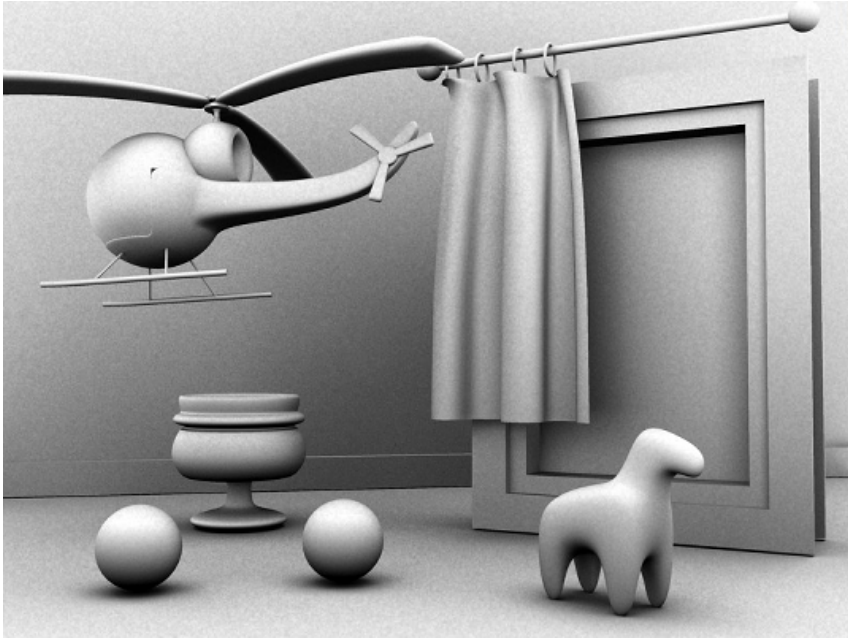

An example of AO applied to a scene

One important aspect of AO is that the user can see how far it looks for occluding geometry.

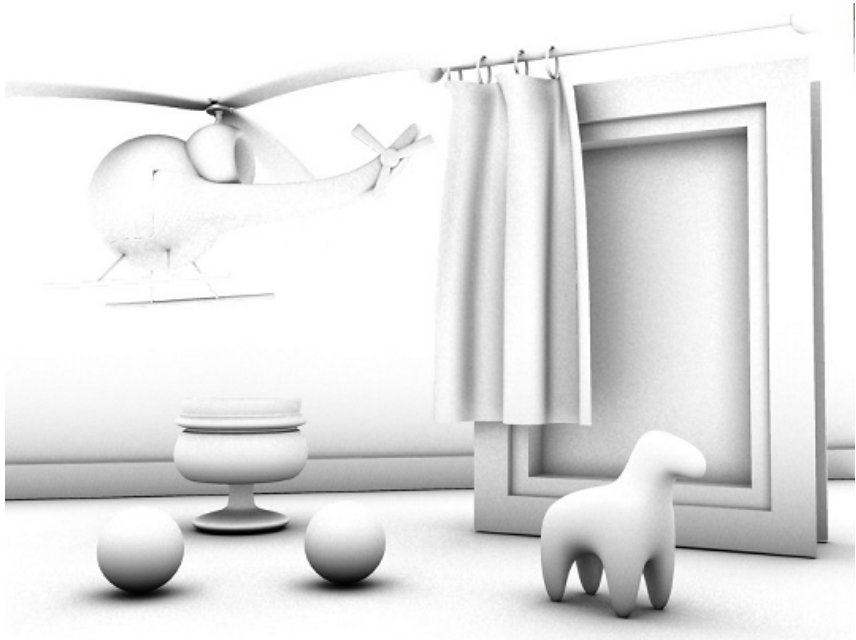

AO looked up within a shorter radius

Using a radius creates a localized AO effect: only surfaces within the given radius are considered as occluders. This also speeds up rendering. The practical result is that the AO provides nice “contact shadow” effects and makes small crevices visible.

Interface

Depending on the material, the ambient occlusion controls appear either on the Special Effects rollout or the Ambient Occlusion rollout. Not all ProMaterials support ambient occlusion.

The following illustration depicts a model helicopter that is lit almost exclusively by indirect light. Note how the helicopter does not feel “grounded” in the left-hand image and the shadows under the landing skids are too vague. The right-hand image uses AO to “punch out” the details and the contact shadows.



Left: Without AO

Right: With AO

There are four controls for ambient occlusion:

Ambient Occlusion When on, enables ambient occlusion (AO) and makes the remaining group controls available. Default=off.

Samples The number of samples (rays) shot for creating AO. Higher values yield smoother results but render more slowly, while lower values render faster but look grainier. Values in the range 16–64 cover most situations. Default=16.

Max Distance Defines the radius within which mental ray looks for occluding objects. Smaller values restrict the AO effect to small crevices only but are much faster to render. Larger values cover larger areas but render more slowly. Default=4.0.

The following illustrations show the raw AO contribution with two different distances:

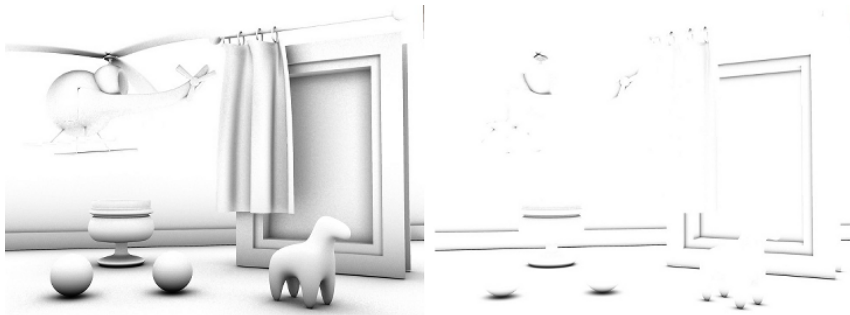

Left: Higher Max Distance value

Right: Lower Max Distance value

TIP To specify an infinite radius, set Distance to 0.0.

Use Color from Other Mats (Exact AO) When on, derives the AO coloring from surrounding materials, for more accurate overall results (also known as *color bleeding*). For example, a glowing material would return a brighter color than a dark material.

In the following pair of illustrations, the first image shows the problem with the traditional AO: it applies to all indirect illumination and always makes it darker. It is most noticeable on the glowing sphere, which has a dark spot under it, but can also be perceived on the floor in front of the cube which is suspiciously dark, even though the cube is strongly lit on the front, as well as between the legs of the horse and the underside of the red sphere.

In contrast, the second image has Use Color From Other Mats on for all materials, so the floor is lit correctly by the glowing ball, there is a hint of white bounce light on the floor from the cube, and light appears between the legs of the horse and on the underside of the red ball.



Use Color From Other Mats is off



Use Color From Other Mats is on

If you find that using AO creates a “dirty” look with excessive darkening in corners, or dark rims around self-illuminated objects, turn on Use Color From Other Mats for a more accurate result.



Round Corners

Material Editor > Type button > Material/Map Browser > Choose a ProMaterials material, and then click OK. > Special Effects rollout or Round Corners rollout > Round Corners controls

Note: ProMaterials (marked “adsk”) appear in the Browser only if mental ray is the active renderer. Not all ProMaterials support round corners.

Computer-generated imagery tends to look unrealistic, partly because edges of objects are geometrically sharp, whereas most edges in the real world are slightly rounded, chamfered, worn, or filleted in some manner. This rounded edge tends to “catch the light” and create highlights that make edges more visually appealing.

Many ProMaterials can create the illusion of rounded edges at render time. This feature is intended primarily to speed up modeling, so that you need not explicitly fillet or chamfer edges of an object such as a tabletop.



Left: No round corners

Right: Round corners

The function is not a displacement; it is merely a shading effect, such as bump mapping, and it is best suited for straight edges and simple geometry, not for advanced, highly curved geometry.

Interface

Depending on the material, the round corner controls appear either on the Special Effects rollout or the Round Corners rollout. Not all ProMaterials support round corners.

This effect rounds off corners and straight edges as a rendering effect only; it has no effect on geometry.

The rounding effect happens to convex corners and surfaces that actually intersect. Concave corners that merely touch will not display the effect. To get the effect to work in concave corners the objects must be pushed into each other a little. The effect is intended for straight edges and is not guaranteed to work properly for highly curved, complex intersections.

There are three controls for round corners:

Round Corners When on, rounds off corners and straight edges at render time. Default=off.

NOTE For some ProMaterials, there is no Round Corners toggle. In this case, the Fillet Radius defaults to 0.0. To enable rendering with round corners, increase the Fillet Radius value.

Fillet Radius Specifies the radius of the filleted corners and/or edges. Default=0.25.

You can apply a map to this parameter, to create variations in the amount of corner rounding.

Blend With Other Materials By default, the rounding effect happens only between surfaces of the same material, but if you turn this on the filleting is performed against any material. Default=off.

In the following image, the melted chocolate is rounded off against the submerged objects even though they use different materials. In actuality, the melted chocolate is a completely flat plane.

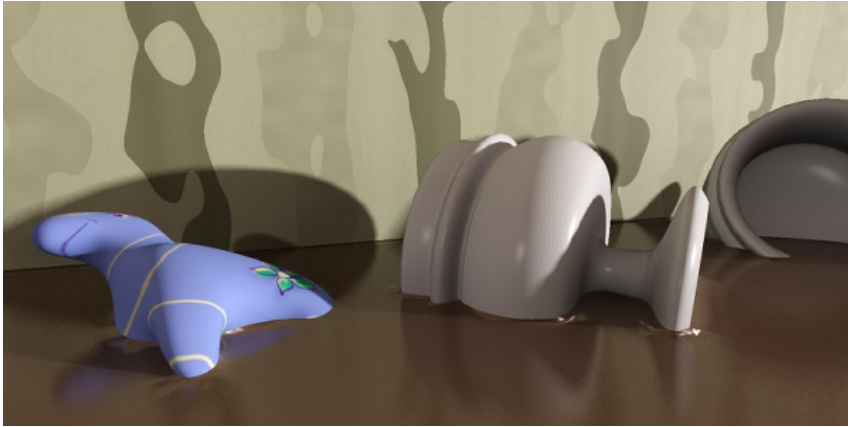

Objects in melted chocolate



Performance Tuning Controls

Material Editor > Type button > Material/Map Browser > Choose a ProMaterials material, and then click OK. > Performance Tuning Parameters rollout

Note: ProMaterials (marked “adsk”) appear in the Browser only if mental ray is the active renderer.

The performance tuning parameters let you tune performance by limiting the amount of calculation a ProMaterial has to perform. There are four parameters, but for each material, only the relevant settings appear in the interface.

Reflection Glossy Samples Defines the maximum number of samples (rays) that mental ray shoots to create glossy reflections. Higher values cause slow rendering but create a smoother result. Lower values render faster but create

a grainier result. Generally 32 is enough for most cases. Default=8 for most ProMaterials, 0 for Mirror.

NOTE When Reflection Glossy Samples equals 0, the reflections take the form of a “perfect mirror” and only one ray is shot, regardless of the actual value of Glossiness . You can use this to boost performance for surfaces with very weak reflections.

Refraction Glossy Samples Defines the maximum number of samples (rays) that mental ray shoots to create glossy refraction. Higher values cause slow rendering but create a smoother result. Lower values render faster but create a grainier result, like frosted glass. Generally 32 is enough for most cases. Default=8.

NOTE When Refraction Glossy Samples equals 0, the refraction takes the form of a “perfect lens” and only one ray is shot. You can use this to boost performance for draft renderings.

Reflection Max Trace Depth When this trace depth is reached, mental ray stops calculating reflections. Default=0.

Refraction Max Trace Depth When this trace depth is reached, mental ray stops calculating refractions. Default=0.

Subsurface Scattering (SSS) Materials

Material Editor > Type button > Material/Map Browser > Choose SSS Fast Material (mi), SSS Fast Skin Material (mi), SSS Fast Skin Material+Displace (mi), or SSS Physical Material (mi), and then click OK.

Note: The SSS materials appear in the Browser only if mental ray is the active renderer.

The subsurface scattering (SSS) materials are provided especially to model skin and other organic materials whose appearance depends on more than one layer of light scattering. 3ds Max provides four of these materials. Each material is a top-level wrapper (a “phenomenon”) for shaders whose controls are documented in the *Standard mental ray Shader Libraries* document. Click a link to see the mental images documentation for the shader.

TIP When you follow a link to the documentation for mental images library shaders, scroll up a bit in your browser. The links tend to go past the title of the section, and there might be introductory content above the link location. If the link goes to the beginning of a section, scroll down instead.

Material Name	mi Library Shader Name
SSS Fast Material (mi)	<i>misss_fast_simple_phen</i>
SSS Fast Skin Material (mi)	<i>misss_fast_skin_phen</i>
SSS Fast Skin Material+Displace (mi)	<i>misss_fast_skin_phen_d</i>
SSS Physical Material (mi)	<i>misss_physical</i>

Also see *Subsurface Scattering Shaders* and the topics that follow it for more general information. See *Physically Correct Subsurface Scattering* for background information and tips about the Physical material.

NOTE The SSS Physical Material can also be used as a shader for the Surface and Photon components of a [mental ray material](#) on page 5638.

For a downloadable tutorial offering a practical demonstration of using the SSS Fast Skin material, see <http://www.autodesk.com/3dsmax-mentalray-sssskin-tutorial>this Web page.

Light Controls for the SSS Physical Material

The SSS Physical material includes light controls that correspond to the *lights* array in the parameters for the *misss_physical* shader.

Lights When on, the material is illuminated only by those lights specified in the list. When Lights is turned off, all lights in the scene affect the material. Default=off.

The remaining light controls are available only when Lights is on.

- **List of lights** Displays the lights you have chosen to illuminate this material.
- **Add** Adds a light to the list. Click Add to turn it on, then click the light object in a viewport.

- **Replace** Replaces a light in the list. Highlight a light's name in the list, click Replace to turn it on, then click the replacement light object in a viewport.
- **Delete** Deletes a light from the list. Highlight a light's name in the list, then click Delete.



Utility mental ray Materials

The utility mental ray materials allow you to combine a material with multiple maps.



Utility Bump Combiner Material (mental ray)

Material Editor > Type button > Material/Map Browser > Utility Bump Combiner (adsk)

Note: The Bump Combiner material appears in the Browser only if the mental ray renderer is the currently active renderer.

The Bump Combiner lets you combine a material with up to three separate bump maps.

Interface

Parameters rollout

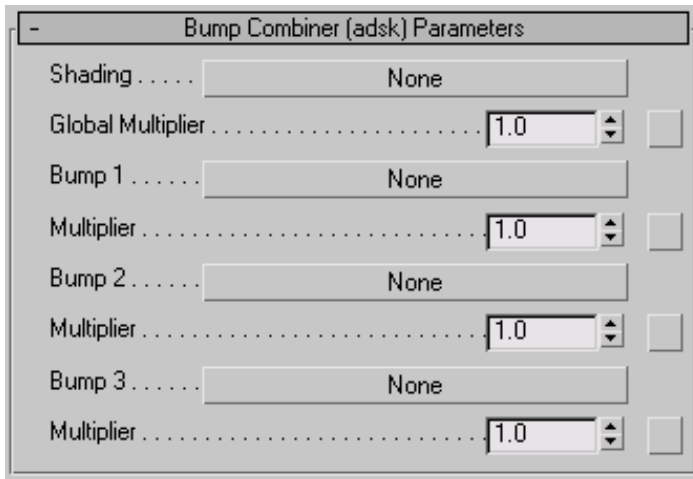

Shading Click the button to specify a base material. This can be any material that mental ray supports.

Global Multiplier Adjusts the strength of bump mapping for the material as a whole. This value overrides the individual bump map multiplier values. Can range from 0.0 to 20.0. Default=1.0.

Map button Click to apply a map to the Global Multiplier value.

Bump 1, Bump 2, and Bump 3 Click to add a bump map to the material.

Multiplier Adjusts the strength of the bump map. Can range from 0.0 to 20.0. Default=1.0.

Map button Click to apply a map to the Multiplier value.

Maps rollout

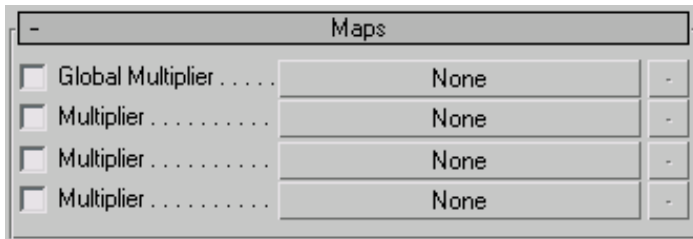

Global Multiplier Lets you assign a map to the Global Multiplier. The toggle at the left controls whether the map is active; when you assign a map, it turns on by default.

Multiplier 1, Multiplier 2, and Multiplier 3 Let you assign maps to the three bump map Multiplier values.



The button to the right of each main shader button is for shaders that can return multiple parameters. If a shader that returns multiple parameters is assigned to the component, the button's tooltip shows the parameter name. Clicking the button displays a [Connect Parameter To Shader dialog](#) on page 5981, which lets you change which parameter is being used.



Utility Displace Combiner Material (mental ray)

Material Editor > Type button > Material/Map Browser > Utility Displace Combiner (adsk)

Note: The Displace Combiner material appears in the Browser only if the mental ray renderer is the currently active renderer.

The Displace Combiner lets you combine a material with up to three separate displacement maps.

Interface

Parameters rollout

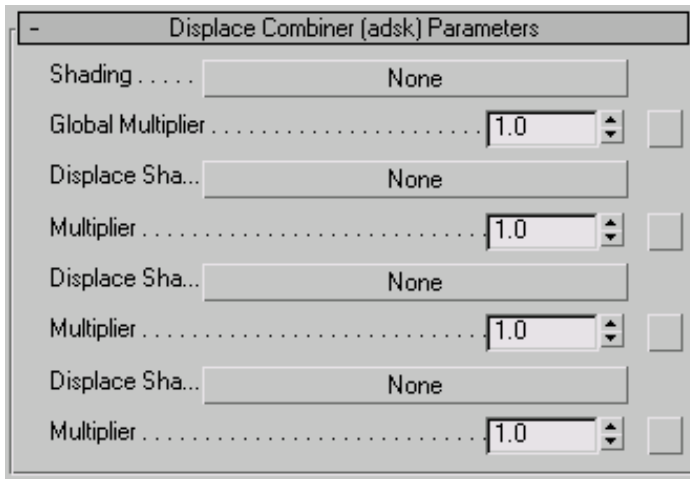

Shading Click the button to specify a base material. This can be any material that mental ray supports.

Global Multiplier Adjusts the strength of displacement mapping for the material as a whole. This value overrides the individual displacement shader multiplier values. Can range from 0.0 to 20.0. Default=1.0.

Map button Click to apply a map to the Global Multiplier value.

Displace Shader 1, Displace Shader 2, and Displace Shader 3 Click to add a displacement map to the material.

Multiplier Adjusts the strength of the displacement map. Can range from 0.0 to 20.0. Default=1.0.

Map button Click to apply a map to the Multiplier value.

Maps rollout

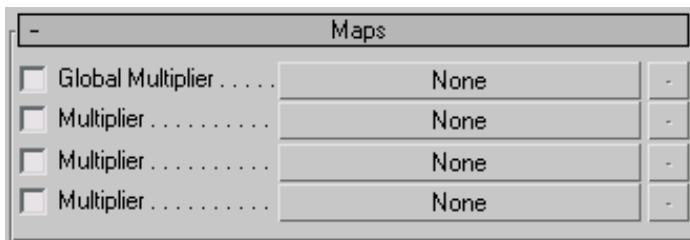

Global Multiplier Lets you assign a map to the Global Multiplier. The toggle at the left controls whether the map is active; when you assign a map, it turns on by default.

Multiplier 1, Multiplier 2, and Multiplier 3 Let you assign maps to the three displacement shader Multiplier values.



The button to the right of each main shader button is for shaders that can return multiple parameters. If a shader that returns multiple parameters is assigned to the component, the button's tooltip shows the parameter name. Clicking the button displays a [Connect Parameter To Shader dialog](#) on page 5981, which lets you change which parameter is being used.

Matte/Shadow Material

Material Editor > Type button > Material/Map Browser > Matte/Shadow

The Matte/Shadow material allows you to make whole objects (or any subsets of faces) into [matte objects](#) on page 8042 that reveal the current background color or [environment map](#) on page 7964.



Simply rendering the framed photo against a background shows the photo in front of the background.

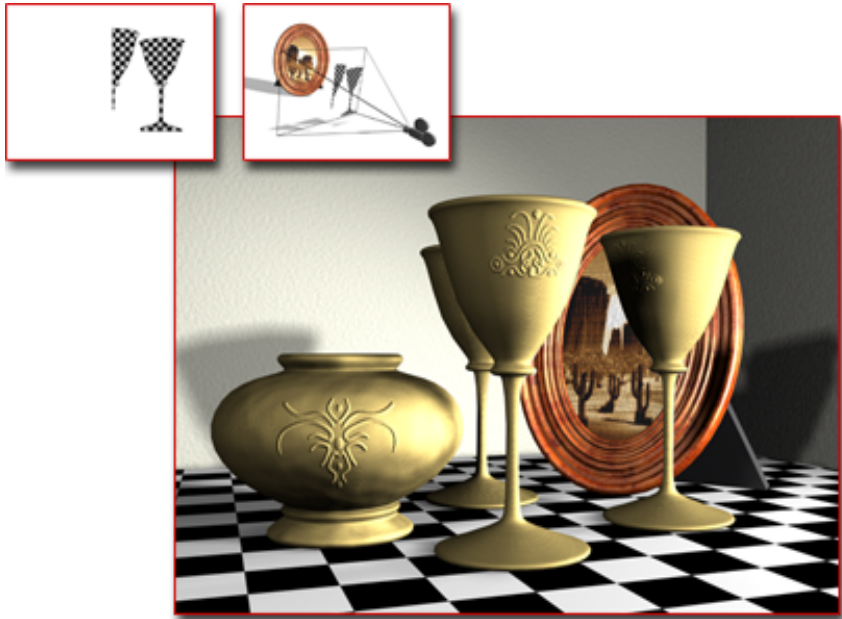

A matte object hides parts of the photo, revealing the background to make it appear the photo is behind the goblets.

It can also receive shadows cast on it from non-matte objects in the scene. Using this technique, you can cast shadows on backgrounds by building matte proxy objects and placing them in front of similarly shaped objects in the background.

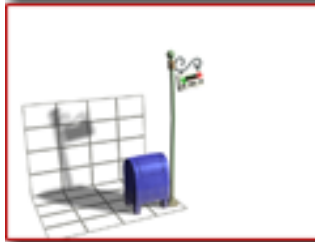
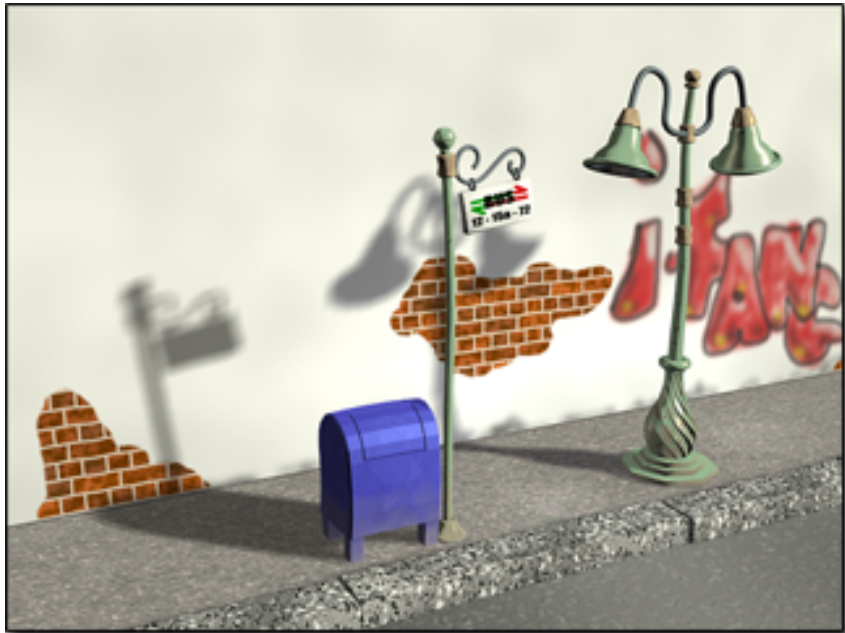

Creating a matte object for casting shadows against a background image

Matte/Shadow materials can also have reflections.

NOTE The Matte/Shadow effect is visible only when you render the scene. It isn't visible in viewports.

TIP When rendering with mental ray, for best results and greater flexibility use the [Matte/Shadow/Reflection \(mi\) material](#) on page 5622 instead of this one. Because of the availability of the mental ray-specific material, the Matte/Shadow material is designated [Incompatible](#) on page 5299 when mental ray is active.

Procedures

To render objects seamlessly against a background environment:

There are three ways you can render objects to blend seamlessly into a background environment:

- Assign a Matte/Shadow Material.
- Assign a 100% self-illuminated diffuse texture to an object using Camera Mapping.
- Assign a 100% self-illuminated diffuse texture using Environment/Screen projection.

Use the Plate Match/MAX R2.5 antialiasing whenever you are trying to match foreground objects with an unfiltered background, or trying to match the antialiasing qualities of the 3ds Max 2.5 renderer. See the description of Antialiasing Filter in the description of the [Default Scanline Renderer](#) on page 6141.

Example: To see the effect of Affect Alpha and Matte Reflection:

- 1 Create a scene with one or more objects on a box platform, and one or more shadow-casting spotlights.

TIP If you use only one spotlight, increase its Multiplier value.

- 2 Assign a Matte/Shadow material to the box, and render the scene with default Matte/Shadow parameters (Opaque Alpha is on, and Affect Alpha is off).



- 3 On the [Rendered Frame Window](#) on page 6073 that opens, turn on Display Alpha Channel.

The objects all appear as white silhouettes, including the platform.

- 4 On the Matte/Shadow Basic Parameters rollout, turn off Opaque Alpha, and turn on Receive Shadows and Affect Alpha.

- 5 Press F9 ([Render Last](#) on page 6117).

The silhouette of the box no longer appears, but the other objects and their shadows appear.

- 6 On the Matte/Shadow Basic Parameters rollout, click the Map button in the Reflection group, and use the [Material/Map Browser](#) on page 5290 to assign a [Flat Mirror](#) on page 5946 map to the box's material. On the Flat Mirror Parameters rollout, turn on Render group > Assign To Faces With ID and leave the value set to 1.
- 7 Press F9 ([Render Last](#) on page 6117).
- 8 On the Rendered Frame Window, turn off Display Alpha Channel.
The reflections of the objects appear on the box, even though the box itself is invisible.

Interface

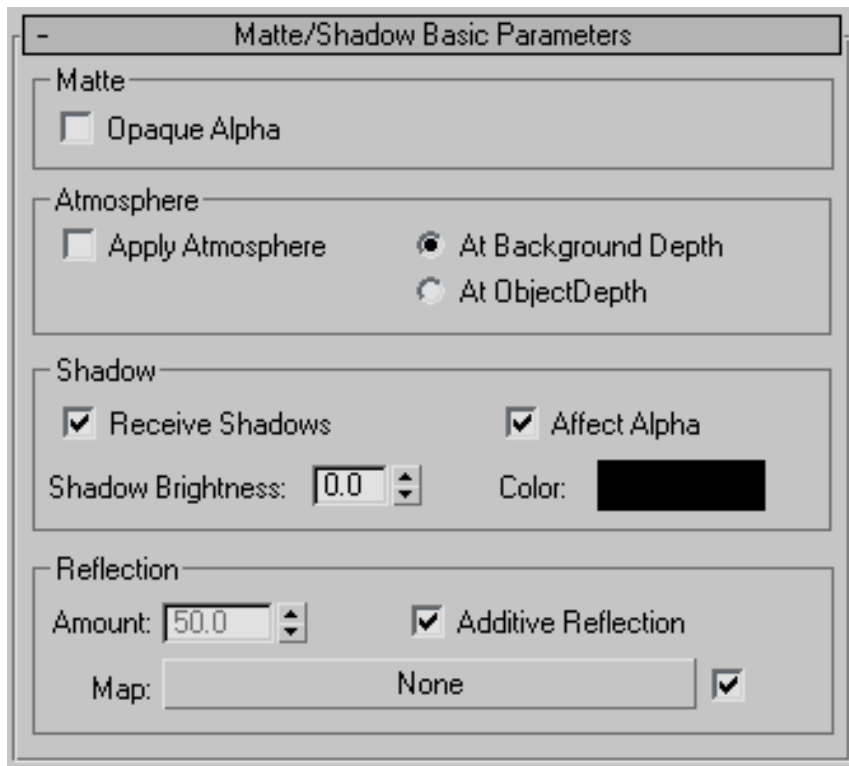

Matte group

Opaque Alpha Determines whether or not the matte material appears in the alpha channel. If you turn off Opaque Alpha, the matte object will not make an alpha channel, and the image can be used for compositing, just as if there are no matte objects in the scene. Default=off.

Atmosphere group

These options determine whether fog effects are applied to the matte surfaces, and how they are applied.

Apply Atmosphere Turns the fogging of matte objects on and off.

When applying fog, you can choose between two different methods. You can either apply fog as if the matte surface is at an infinite distance from the camera or you can apply it as if the matte surface is actually at that point on the object being shaded. In other words, you can apply the fog to the matte surface in either 2D or 3D. The following controls determine how this is applied:

At Background Depth This is the 2D method. The [scanline renderer](#) on page 8116 fogs the scene, and then renders its shadows. In this case, the shadows won't be lightened by the fog. If you want to lighten the shadows, you need to turn up the shadow brightness.

At Object Depth This is the 3D method. The renderer first renders the shadows, and then fogs the scene. Since this varies the amount of fog over the 3D matte surface, the generated matte/alpha channels don't blend perfectly into the background. Use At Object Depth when the matte object is meant to be a 3D object in the scene that the 2D background represents.

Shadow group

This group determines whether the matte surfaces receive shadows that are cast upon them, and how they receive them.

Receive Shadows Renders shadows on the matte surfaces. Default=on.

Affect Alpha When on, shadows cast on a matte material are applied to the alpha channel. This lets you render bitmaps with alpha channels that you can composite later. Default=on.

Affect Alpha is available only when Opaque Alpha (in the Matte group box) is turned off.

When Affect Alpha is on, the higher the Shadow Brightness value, the more transparent the shadow, allowing the background to show through more, and making the shadow appear brighter.

Shadow Brightness Sets shadow brightness. At 0.5, the shadows will not be attenuated on the matte surface; at 1.0, the shadows are brightened to the color of the matte surface; and at 0.0 they are darkened to completely obliterate the matte surface.

Color Displays a [Color Selector](#) on page 391 to let you choose the color of the shadow. Default=black.

Setting shadow color is especially useful when you're using a Matte/Shadow material to composite your shadows against a background image, such as video. It lets you tint your shadows to match pre-existing shadows in the image.

Reflection group

Controls in this group determine whether the matte surfaces can have reflections. You create matte reflections using a shadow map.

TIP Matte reflections don't successfully create an alpha channel unless you render them against a black background.

Amount Controls the amount of reflection to use. This is a percentage that can range from 0 to 100. This control is unavailable unless you have assigned a map. Default=50.

You can animate this parameter.

Map Displays the [Material/Map Browser](#) on page 5290 so you can assign a map to use for reflections. The reflection is independent of the environment unless you choose a [Reflect/Refract](#) on page 5946 or [Flat Mirror map](#) on page 5946.

Compound Materials

Compound materials combine two or more sub-materials. Compound materials are similar to [compositor maps](#) on page 5918, but they exist at the material level. Applying a compound material to an object creates a compound effect that often uses mapping. You load or create compound materials using the Material/Map Browser.

Using a filter control, you can choose whether the Browser lists maps or materials or both.

Different types of materials create different effects, behave in particular ways, or are provided as ways to combine multiple materials.

NOTE The sub-material buttons and sub-map buttons for most materials and maps have check boxes beside each button. These let you turn that branch of the material or map on or off. For example, in the Top/Bottom material, the Top Material and Bottom Material buttons each have check boxes. Similarly, the Checker map has two map buttons, one for each color. Each button has a check box beside it that lets you disable that color's map.

These are the different types of compound materials:

[Blend](#) on page 5708: Combines two materials by mixing their pixel colors, as Mix maps do.

[Composite](#) on page 5711: Mixes up to 10 materials, using additive colors, subtractive colors, or opacity mixing.

[Double-Sided](#) on page 5713: Stores two materials. One material is rendered on the object's outer faces (the usual side for one-sided materials, as determined by face normals), and the other is rendered on the object's inner faces.

[Morpher Material](#) on page 5716: Morpher materials use the [Morpher modifier](#) on page 1545 to manage multiple materials over time.

[Multi/Sub-Object](#) on page 5720: Lets you assign more than one material to the same object. Stores two or more sub-materials, which you assign at the sub-object level by using the [Mesh Select](#) on page 1527 modifier. You can also assign the sub-materials to whole objects by using the [Material modifier](#) on page 1517.

[Shellac](#) on page 5727: Superimposes one material on another.

[Top/Bottom](#) on page 5729: Stores two materials. One material is rendered on an object's top faces and the other is rendered on the object's bottom faces, depending on whether a face normal points up or down.

Procedures

To have the Browser list only materials:

- At the top of the Show group, leave Materials on and turn off Maps.

NOTE This option is available only at the material level in the Material Editor.

Blend Material

Material Editor > Type button > Material/Map Browser > Blend



Blend material combines bricks and stucco.

The Blend material lets you mix two materials on a single side of the surface. Blend has an animatable Mix Amount parameter that lets you draw material [morphing](#) on page 8049 function curves to control the way that the two materials are blended over time.

NOTE If even one sub-material has its shading set to Wire (see [Shader Basic Parameters Rollout](#) on page 5397), the *entire material* displays and renders as a wire material.

Procedures

To create a Blend material:

- 1 Activate a sample slot in the Material Editor.
- 2 Click the Type button.
- 3 In the [Material/Map Browser](#) on page 5290, choose Blend and then click OK.

A [Replace Map](#) on page 5376 dialog is displayed. This dialog asks whether you want to discard the original material in the slot, or retain it as a sub-material.

Blend materials have similar controls to Mix maps.

To specify a component material:

- In the Blend Basic Parameters rollout, click one of the two material buttons. The parameters for the sub-material are displayed. By default, a sub-material is a Standard material with Blinn shading.

To control the mix amount:

- In the Basic Parameters rollout, adjust the Mix Amount value. You can also control the mix amount by using a map.



Map used to reveal brick beneath stucco

To control the mix amount using a map:

- In the Basic Parameters rollout, click the map button next to Mask. The Browser is displayed so you can select a map type. The intensity of pixels in this mixing map controls the mix. When the intensity is close to zero, one of the component colors or maps is visible; when it is close to full intensity, the other component is visible.

TIP Using a Noise map for the mixing map can give good effects that have a natural appearance.

Mix Amount is unavailable while a map is assigned to this parameter. If Use Curve is turned off, the mixing map is used as is. If Use Curve is on, you can shift the effect of the mixing map's gradient ramp to reveal more of one material and less of the other.

Interface

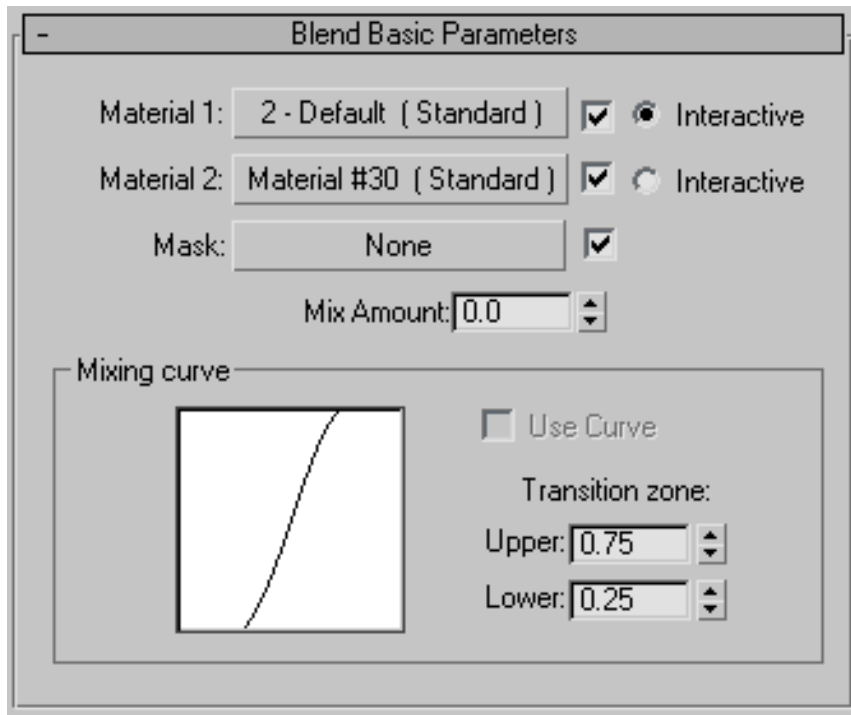

Material 1/Material 2 Set the two materials to be blended. Use the check boxes to turn the materials on and off.

Interactive Chooses which of the two materials is displayed on object surfaces in viewports by the interactive renderer.

If one material has [Show Map in Viewport](#) on page 5350 on, this takes precedence over the Interactive setting. Only one map at a time can be displayed in viewports.

Mask Sets a map to use as a mask. The degree of blending between the two materials depends on the intensity of the mask map. Lighter (whiter) areas of the mask show more of Material 1, while darker (black) areas of the mask show more of Material 2. Use the check box to turn the mask map on or off.

Mix Amount Determines the proportion of the blend (percentage). 0 means only Material 1 is visible on the surface; 100 means only Material 2 is visible. Unavailable if you have assigned a mask map and the mask's check box is on. You can animate this parameter. [Create Material Preview](#) on page 5333 is useful for testing the effect.

Mixing Curve group

The mixing curve affects how gradual or how sharp the transition between the two colors being blended will be. It affects the blend only when a mask map is assigned.

TIP For mottled effects, blend two standard materials using a noise map as a mask.

Use Curve Determines whether the Mixing Curve affects the mix. This control is available only when a mask is assigned and active.

Transition Zone These values adjust the level of the Upper and Lower limits. If the two values are the same, the two materials meet at a definite edge. Wider ranges give more gradual blending from one sub-material to the other. The mixing curve displays the effect of changing these values.

Composite Material

Material Editor > Type button > Material/Map Browser > Composite

Composite material [composites](#) on page 7937 up to 10 materials. The materials are superimposed from top to bottom, as listed in the rollout. Materials are combined using [additive opacity](#) on page 7901, [subtractive opacity](#) on page 8140, or mixed using an Amount value.

NOTE If even one sub-material has its shading set to Wire (see [Shader Basic Parameters Rollout](#) on page 5397), the *entire material* displays and renders as a wire material.

See also:

- [Composite Map](#) on page 5918

Interface

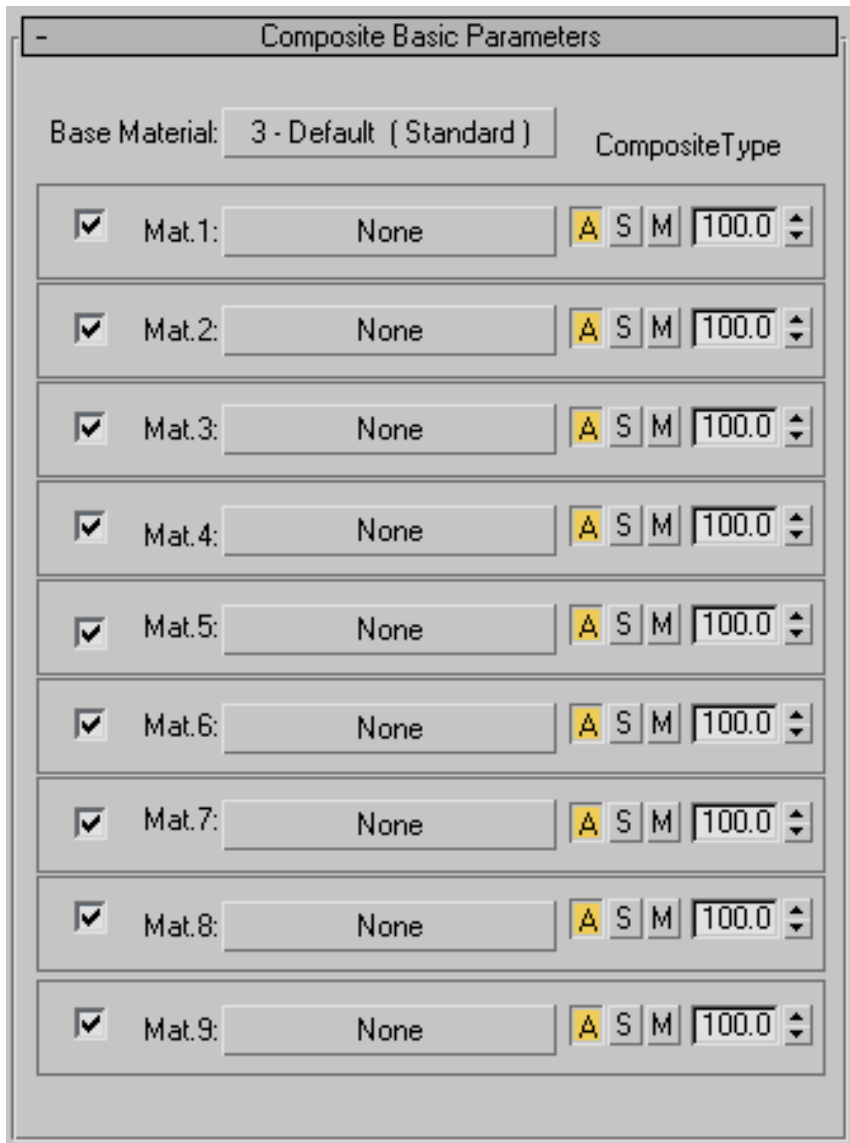

Base Material Displays the [Material/Map Browser](#) on page 5290, where you assign the base material. By default, the base material is a Standard material.

The other materials are composited by superimposing them on top of this material, in order from top to bottom.

Mat 1 through Mat 9 Each of these nine groups contains controls for a material to composite. By default, no materials are assigned.

Check box When on, uses the material in the composite. When off, doesn't use it. Default=on.

Button Displays the [Material/Map Browser](#) on page 5290, where you assign a material to composite.

ASM buttons These buttons control how the material is composited. Default=A.

- **A** This material uses [additive opacity](#) on page 7901. Colors in the material are summed based on their opacity.
- **S** This material uses [subtractive opacity](#) on page 8140. Colors in the material are subtracted based on their opacity.
- **M** This material mixes materials based on the Amount value (see following). Both color and opacity are blended as they are when you use a [Blend material](#) on page 5708 with no mask.

Amount Controls the amount of mixing. Default=100.0.

For additive (A) and subtractive (S) compositing, the Amount value can range from 0 to 200. When the Amount is 0.0, no compositing happens, and the material below is not visible. When the Amount is 100.0, the composite is complete. When the amount is greater than 100.0, compositing is "overloaded": transparent portions of the material become more opaque, until the material below is no longer visible.

For mix (M) compositing, the Amount can range from 0.0 to 100.0. When the Amount is 0.0, no compositing happens, and the material below is not visible. When the amount is 100.0, compositing is complete, and only the material below is visible.

Double-Sided Material

Material Editor > Type button > Material/Map Browser > Double-Sided

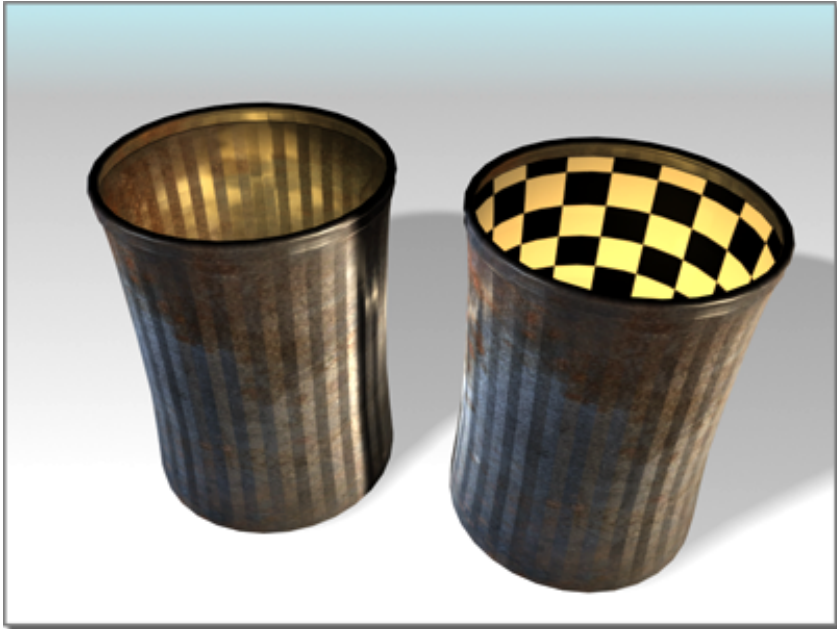

On the right, a double-sided material creates a pattern for the inside of the trash can.

The Double-Sided material lets you assign two different materials to the front and back faces of an object.

NOTE If even one sub-material has its shading set to Wire (see [Shader Basic Parameters Rollout](#) on page 5397), the *entire material* displays and renders as a wire material.

Procedures

To create a double-sided material:

- 1 Activate a sample slot in the Material Editor.
- 2 Click the Type button.
- 3 In the Material/Map Browser, choose Double-Sided and then click OK. A [Replace Map dialog](#) on page 5376 is displayed. This dialog asks whether you want to discard the original material in the slot, or retain it as a sub-material.

The Double-Sided material controls let you choose the two materials, and the translucency of the material overall.

To choose the outer material:

- Click the button labeled Facing Material.
The parameters for the sub-material are displayed. By default, a sub-material is a Standard material with Blinn shading.

To choose the inner material:

- 1 Go back to the parent material (parameters for the Double-Sided material).
- 2 On the Double-Sided Basic Parameters rollout, click the button labeled Back Material.
The parameters for the sub-material are displayed. By default, a sub-material is a Standard material with Blinn shading.

To make the material translucent:

- Set Translucency to a value greater than 0.
The Translucency control affects the blending of the two materials. When Translucency is 0, there is no blend. When Translucency is 100.0 percent, the outer material is visible on inner faces and the inner material is visible on outer faces. At intermediate values, the specified percentage of the inner material "bleeds through" and is visible on outer faces.

Interface

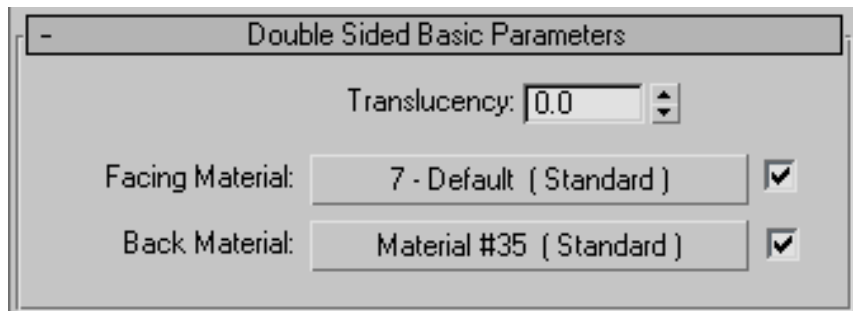

Translucency Sets the amount that one material shows through the other. This is a percentage that can range from 0.0 to 100.0. At 100 percent, the outer material is visible on inner faces and the inner material is visible on outer

faces. At intermediate values, the specified percentage of the inner material "bleeds through" and is visible on outer faces. Default=0.0.

You can animate this parameter.

Facing Material and Back Material Click to display the [Material/Map Browser](#) on page 5290 and choose a material for one side or the other.

Use the check boxes to turn the materials on or off.

Morpher Material

Material Editor > Type button (labeled Standard by default) > Material/Map Browser > Morpher material

[Procedures](#) on page 5717 [Interface](#) on page 5718

The Morpher material works hand-in-hand with the Morpher modifier. You can use it to make the cheeks of a character blush, or to wrinkle a character's forehead when the eyebrows are raised. With the Morpher modifier's channel spinners, you can blend materials the same way you morph the geometry.

The Morpher material has 100 material channels that map directly to the 100 channels in the Morpher modifier. After you apply the Morpher material to an object and bind it to the Morpher modifier, you use the channel spinners in the Morpher modifier to morph materials and geometry. Empty channels in the Morpher modifier, with no geometry morph data, can be used to morph materials only.

NOTE The [mental ray renderer](#) on page 6230 does not support the Morpher material.

NOTE If even one sub-material has its shading set to Wire (see [Shader Basic Parameters Rollout](#) on page 5397), the *entire material* displays and renders as a wire material.

See also:

- [Morpher Modifier](#) on page 1545

Applying the Morpher Material

An object must have at least one Morpher modifier in its modifier stack. You can assign the material to an object and bind it to the object's Morpher modifier in either of two ways.

- After the Morpher modifier is applied to an object, use the Assign New Material command in the Global Parameter rollout of the Morpher modifier. This is the simplest way, and applies the Morpher Material to the object and binds the material to the Morpher modifier at the same time.
- Open the Material Editor, select the Morpher material, and click Choose Morph Object in the Parameters rollout, then click the object in the viewports. After clicking the object, a dialog displays in the viewports, select the Morpher modifier from the dialog (an object may have multiple Morpher modifiers). This binds the Morpher material to the Morpher modifier.

NOTE You can bind a Morpher material to only one Morpher modifier.

Procedures

Example: To apply and use the Morpher material:



- 1 Create a sphere in the Perspective viewport.

- 2  On the Modify panel, right-click the sphere's entry in the modifier stack display, and choose Convert To: Editable Mesh.

- 3 From the Modifier List, choose Morpher.
This applies the Morpher modifier to the sphere.

- 4 On the Morpher modifier's Global Parameters rollout, click Assign New Material.



The Morpher material is now applied to the object and bound to the Morpher modifier.

- 5   Open the Material Editor, and click Pick Material from Object (the eyedropper), then click the sphere in the viewports.
The Material Editor displays the Morpher material parameters.

- 6 On the Morpher Material Parameters rollout, click the Mat 1 slot.

- 7 On the Material/Map Browser choose Standard.
- 8 On the Basic Parameters rollout, click the Diffuse color swatch.
- 9 On the Color Selector, choose a bright yellow, and close the color selector. Leave the Material Editor open.

- 10  Turn on the Auto Key button, then move the time slider to frame **50**.

- 11   Select the sphere, and then open the Modify panel.

- 12 On the Morpher modifier's Channel List rollout, set the channel 1 spinner to **100**.

In the Material Editor, the color of the sample sphere changes to yellow.

- 13 On the main toolbar, click Render.

The sphere is yellow. If you render an animation the sphere changes from a grey color to yellow.

Interface

The Morpher material interface is on a Parameters rollout in the Material Editor.

Modifier Connection group

Choose Morph Object Click this option, then select an object in the viewports that has a Morpher modifier applied to it. Clicking an object in the viewports displays the Choose Morpher modifier dialog. Choose a Morpher modifier, and click Bind.

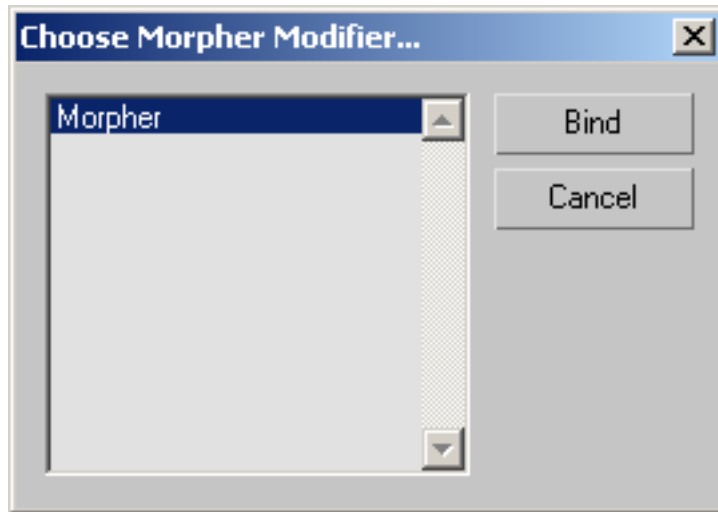

Name Field Displays the name of object to which the Morpher material is applied. If no object has been specified, the field displays "No Target".

Refresh Updates the channel data.

Marker List This list is identical to the marker list in the Morpher modifier. Markers you save in the Morpher modifier appear here.

Base Material group

Base material button Click to apply a base material to the object. The base material represents what the model looks like before any channel blending takes place.

Channel Material Setup group

Map # 100 material channels are available. The scroll bar allows you to scroll through all the channels. Double-click a channel to jump to the material parameters for that channel.

There is a one-to-one correspondence between the channels in the Morpher material and the Morpher modifier. A material in channel 1 of the Morpher material is controlled by the channel 1 spinner in the Morpher modifier.

Material on/off toggle Turns a channel on and off. Channels that are off do not affect the morph result.

Mixing Calculation Options group

The system can slow down if there are many active materials being blended. Options in this group allow you to control when the morph result will be computed.

Constantly Choose to compute the material morph result all the time.

When Rendering Choose to compute the material morph result at render time.

Never Calculate Choose to bypass material blending.

Multi/Sub-Object Material

Material Editor > Type button > Material/Map Browser > Multi/Sub-Object

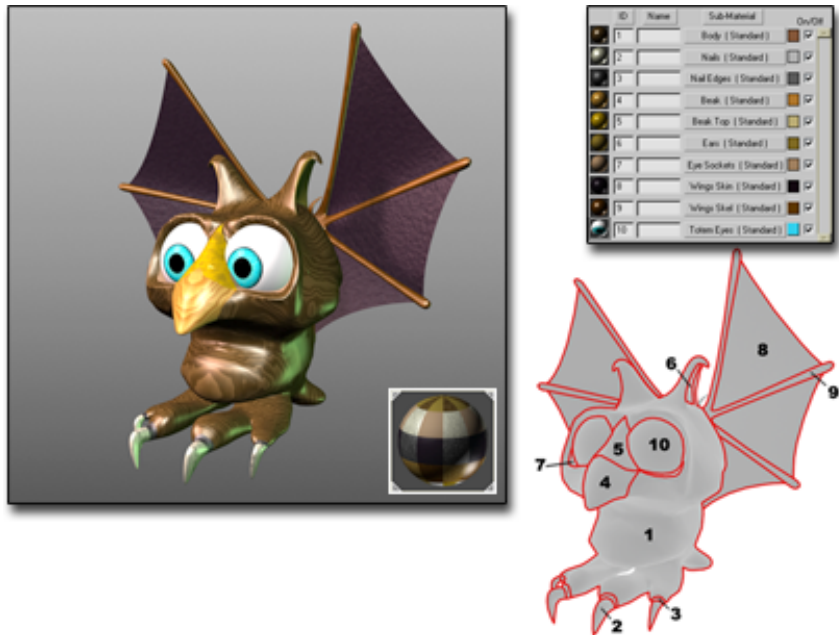

Figure mapped using a Multi/Sub-Object material

The Multi/Sub-Object material lets you assign different materials at the sub-object level of your geometry. You create a multi-material, assign it to an object, and then use the [Mesh Select modifier](#) on page 1527 to select faces and choose which of the sub-materials in the multi-material are assigned to the selected faces.

If the object is an [editable mesh](#) on page 2075, you can drag and drop materials to different selections of faces, building a Multi/Sub-Object material on the fly. See [Drag and Drop Sub-Object Material Assignment](#) on page 5312.

You can also create a new Multi/Sub-Object material by dragging to faces selected with the [Edit Mesh modifier](#) on page 1353.

Sub-material IDs do not depend on the order of the list, and you can enter new ID values.

The [Make Unique button](#) on page 5346 in the Material Editor lets you make an instanced sub-material into a unique copy.

At the Multi/Sub-Object material level, the sample slot's sample object shows a patchwork of the sub-materials. When you edit a sub-material, the sample

slot display depends on the setting of the Simple Multi Display Below Top Level toggle in the [Material Editor Options dialog](#) on page 5335.

Using Multi/Sub-Object Materials

Here are some usage tips with regards to mesh editing and managing sub-materials.

- When working at sub-object levels of Editable Meshes, Polys, Patches and Splines, or with objects that have Edit Mesh, Spline or Patch modifiers applied to them, you can browse by sub-material names if the object has a multi-sub-object material applied to it.
- Sub-materials that are not assigned to an object, or surface of an object, can be 'cleaned' from the Multi-Sub-Object material by using the [Clean MultiMaterial utility](#) on page 6052.
- Duplicate maps, assigned to materials, can be changed to instances by using the [Instance Duplicate Maps utility](#) on page 6058.

Procedures

To create a Multi/Sub-Object material:

- 1 Activate a sample slot in the Material Editor.
- 2 Click the Type button.
- 3 In the [Material/Map Browser](#) on page 5290, choose Multi/Sub-Object and then click OK.

A [Replace Map dialog](#) on page 5376 is displayed. This dialog asks whether you want to discard the original material in the slot, or retain it as a sub-material.

The controls for a Multi/Sub-Object material are essentially a list of the sub-materials it contains.

To assign a sub-material:

- On the Multi/Sub-Object Basic Parameters rollout, click a sub-material button.
The parameters for the sub-material appear. By default, a sub-material is a Standard material with Blinn shading.

To make one of the sub-materials a solid color:

- On the Multi/Sub-Object Basic Parameters rollout, click the color swatch next to the sub-material button.

In the [Color Selector](#) on page 391, choose a color.

The color swatches for sub-materials are shortcuts. They assign the color you choose to the sub-material's Diffuse component.

To assign one of the sub-materials to a sub-object selection:

- 1 Select the object, and assign a Multi/Sub-Object material to it.



- 2 On the [Modify panel](#) on page 7633, apply [Mesh Select](#) on page 1527 to the object.

- 3 Click Sub-Object and choose Face as the sub-object category.

- 4 Select the faces to which you will assign a sub-material.

- 5 Apply a [Material modifier](#) on page 1517, and set the material ID value to the number of the sub-material you want to assign.

The viewport updates to show the sub-material assigned to the selected faces.

The material ID values in the Multi/Sub-Object material and the material ID numbers in the Select Face rollout correspond. If you set the ID to a number that doesn't correspond to a material contained in the Multi/Sub-Object material, the faces render as black.

WARNING Some geometric primitives do not use 1 as the default material ID, and some, such as hedra or box, have multiple material IDs by default.

TIP You can also use the [Edit Mesh modifier](#) on page 1353 to assign a contained material to selected faces. Apply Edit Mesh to the object, go to the Face sub-object level, and select the faces to assign. Then on the Edit Surface rollout, set the material ID value to the ID of the sub-material. (You can [drag and drop](#) on page 5312 a Multi/Sub-Object material to an Edit Mesh modifier as you can to an editable mesh object.)

To add a new sub-material:

- Click Add.

A new sub-material is added to the end of the list. By default, the new sub-material's ID number is one greater than the highest material ID already in use.

To remove a sub-material:

- 1 Select the sub-material by clicking its small sample sphere in the Multi/Sub-Object Basic Parameters rollout.

The small sample sphere is surrounded by a black and white border to show the sub-material is selected.

If the list of sub-materials is longer than the rollout will hold, you can use the scroll bar at the right to display other parts of the list.

- 2 Click Delete.

The sub-material is removed.

Deleting a sub-material is an undoable operation.

Interface

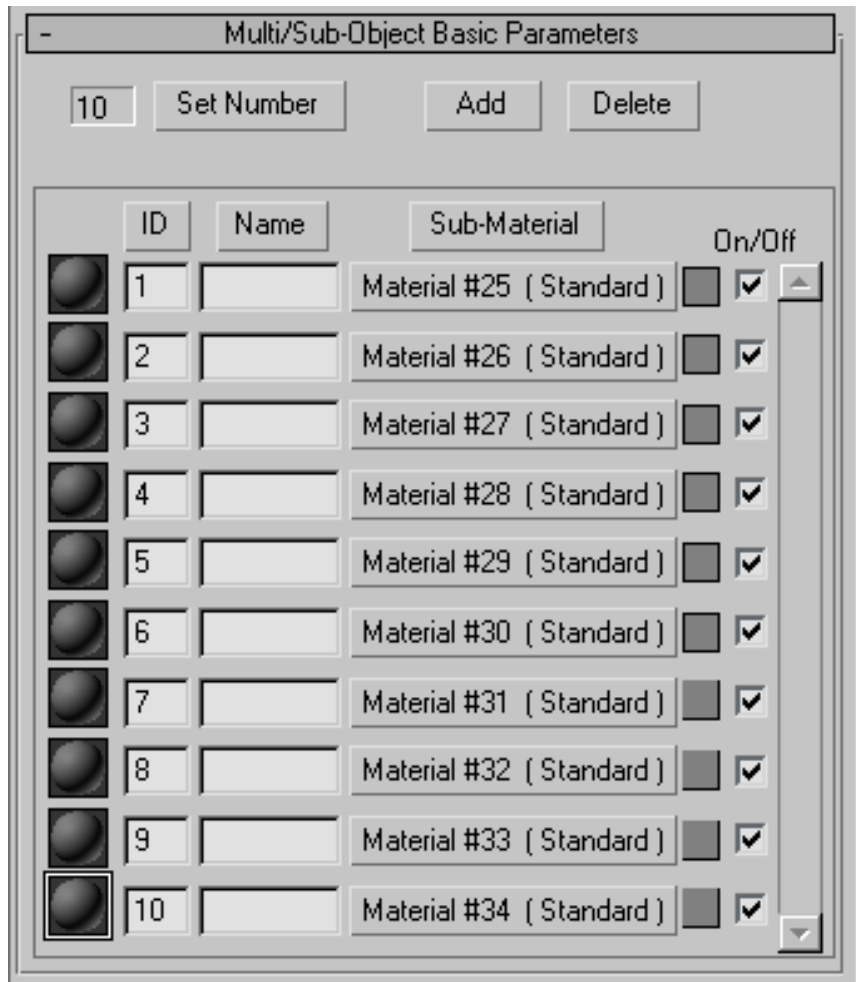

Number This field displays the number of sub-materials contained in the Multi/Sub-Object material.

Set Number Sets the number of sub-materials make up the material. At the Multi/Sub-Object material level, the sample slot's sample object shows a patchwork of the sub-materials. (When you edit a sub-material, the sample slot display depends on the setting of the Simple Multi Display Below Top Level toggle on the [Material Editor Options dialog](#) on page 5335.)

Reducing the number of sub-materials removes sub-materials from the end of the list. You can undo Set Number when you have used it to delete materials.

Add Click to add a new sub-material to the list. By default, the new sub-material's ID number is one greater than the highest material ID already in use.

Delete Click to delete the currently chosen sub-material from the list. You can undo deleting a sub-material.

Sort list controls

These buttons appear above three of the columns in the sub-materials list.

ID Click to sort the list so it begins with the sub-material that has the lowest material ID, and ends with the sub-material that has the highest material ID.

Name Click to sort the list by the names you have entered in the Name column.

Sub-Material Click to sort the list by the sub-material names that appear on the Sub-Material buttons.

List of sub-materials

Each sub-material has a single entry in this list. The rollout displays up to 10 sub-materials at a time. If the Multi/Sub-Object material contains more than 10 sub-materials, you can scroll the list using the scrollbar at the right.

Each sub-material in the list has the following controls:

Small sample sphere The small sample sphere is a "mini-preview" of the sub-material. Click it to select this sub-material. You must select a sub-material before you delete it.

ID Shows the ID number assigned to this sub-material. You can edit this field to change the ID number. If you assign two sub-materials the same ID, a warning message appears at the top of the rollout.

When the Multi/Sub-Object material is applied to an object, faces in the object assigned the same material ID number render with this sub-material.

You can click Sort by ID to sort the sub-material list by this value, from lowest to highest.

NOTE Sometimes the Sub-Material button shows a material number. This is *not* the sub-material ID.

Name Lets you enter a custom name for the material. A sub-material name appears in the [Name](#) on page 5360 field when you're at the level of the sub-material. It also appears in the Browser and the Navigator.

Sub-Material button Click the sub-material button to create or edit one of the sub-materials. Each of the sub-materials is a complete material in its own right, with as many [maps](#) on page 8036 and levels as you want.

By default, each sub-material is a [Standard material](#) on page 5395 with [Blinn shading](#) on page 5426.

Color swatch Click the color swatch to the right of the Sub-Material button to display the [Color Selector](#) on page 391 and choose a diffuse color for the sub-material.

On/Off toggle Turns the sub-material on or off. When a sub-material is off, it appears black in the sample slot and on objects in the scene. Default=on.

Shellac Material

Material Editor > Type button > Material/Map Browser > Shellac

Shellac material mixes two materials by superimposing one over the other. Colors in the superimposed material, called the "shellac" material, are added to colors in the base material. A Shellac Color Blend parameter controls the amount of color mixing.

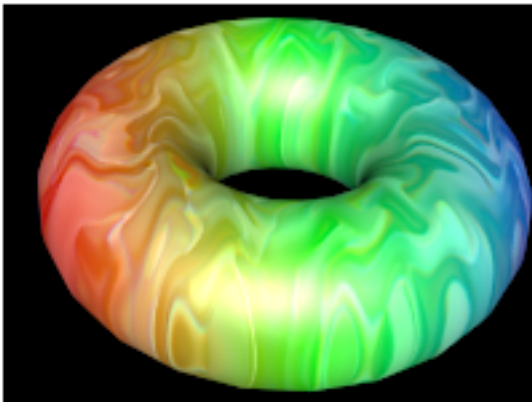
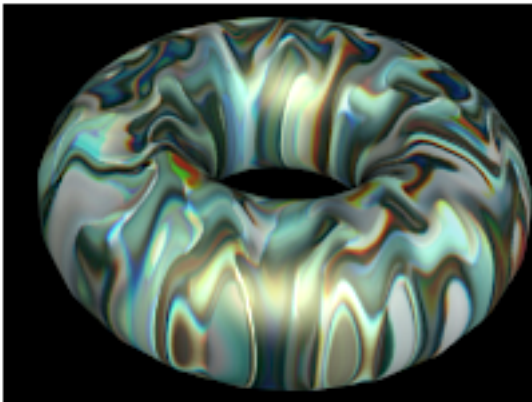
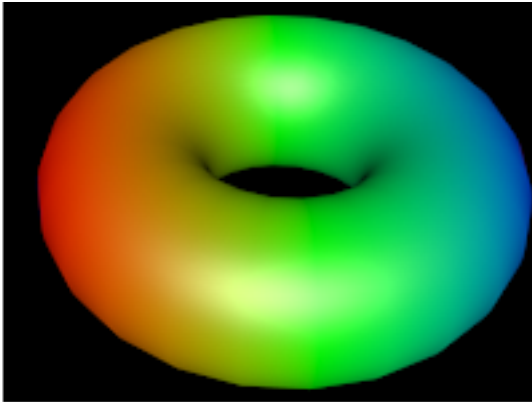

Top: Base material

Middle: Shellac material

Bottom: Materials combined with a shellac color blend value of 50%

NOTE If even one sub-material has its shading set to Wire (see [Shader Basic Parameters Rollout](#) on page 5397), the *entire material* displays and renders as a wire material.

Interface

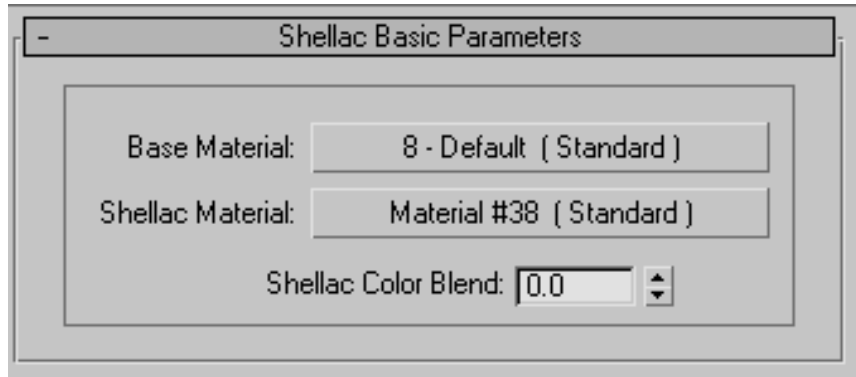

Base Material Goes to the level of the base sub-material. By default, the base material is a Standard material with Blinn shading.

Shellac Material Goes to the level of the shellac material. By default, the shellac material is a Standard material with Blinn shading.

Shellac Color Blend Controls the amount of color mixing. At 0.0, the shellac material has no effect. Increasing the Shellac Color Blend value increases the amount of shellac material color blended into the base material color. There is no upper limit on this parameter. Large values "overload" the shellac material colors. Default=0.0.

You can animate this parameter.

Top/Bottom Material

Material Editor > Type button > Material/Map Browser > Top/Bottom

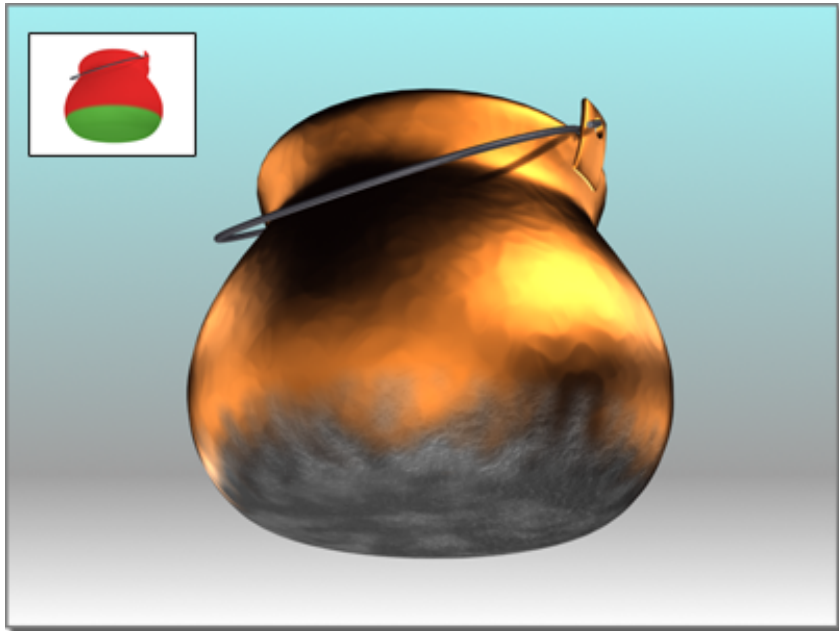

Top/bottom material gives the pot a charred bottom.

The Top/Bottom material lets you assign two different materials to the top and bottom portions of an object. You can blend the materials into one another.

The object's top faces are those whose normals point up. The bottom faces have normals that point down. You can choose whether "up" and "down" refer to the scene's world coordinates or to the object's local coordinates.

NOTE If even one sub-material has its shading set to Wire (see [Shader Basic Parameters Rollout](#) on page 5397), the *entire material* displays and renders as a wire material.

Procedures

To create a top/bottom material:

- 1 Activate a sample slot in the Material Editor.
- 2 Click the Type button.

- 3 In the [Material/Map Browser](#) on page 5290, choose Top/Bottom and then click OK.

A [Replace Map](#) on page 5376 dialog is displayed. This dialog asks whether you want to discard the original material in the slot, or retain it as a sub-material.

The Top/Bottom material controls let you choose the two materials, and also the transition between them.

To choose the top or bottom material:

- On the Top/Bottom Basic Parameters rollout, click the Top Material button or the Bottom Material button.
The parameters for the sub-material appear. By default, a sub-material is a Standard material with Blinn shading.

To swap the two component materials:

- In the Basic Parameters rollout, click Swap.
The remaining controls, described in the "Interface" section, affect the transition between top and bottom.

Interface

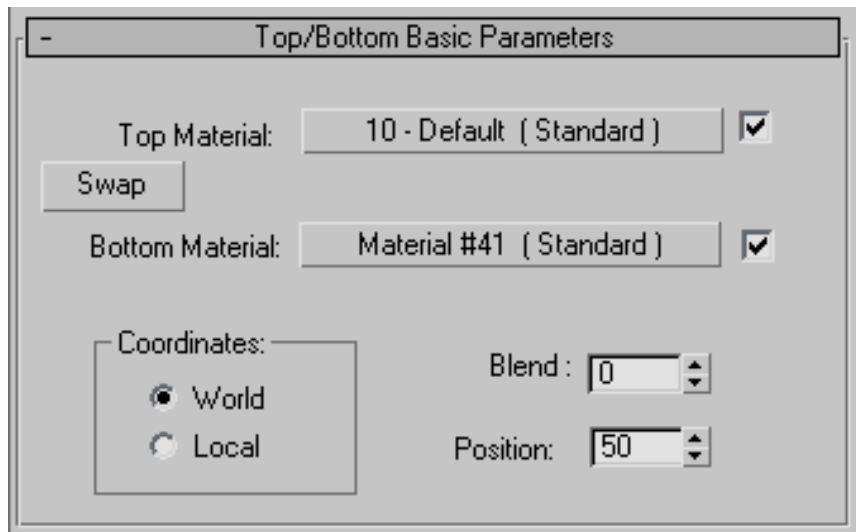

Top Material and Bottom Material Click to display the parameters for the top or bottom sub-material. By default, a sub-material is a Standard material with Blinn shading.

The check box to the right of each button lets you turn off that material, making it invisible in the scene and in the sample slot.

Swap Swaps the position of the top and bottom materials

Coordinates group

Controls in this group let you choose how the software determines the boundary between top and bottom.

World Faces point up or down according to the scene's world coordinates. When you rotate the object, the boundary between top and bottom faces remains in place.

Local Faces point up or down according to the object's local coordinates. When you rotate the object, the material rotates with it.

Blend Blends the edge between the top and bottom sub-materials. This is a percentage that can range from 0 to 100. At 0, there is a sharp line between the top and bottom sub-materials. At 100, the top and bottom sub-materials tint each other. Default=0.

You can animate this parameter.

Position Determines where the division between the two materials lies on an object. This is a percentage that can range from 0 to 100. 0 is at the bottom of the object, and displays only the top material. 100 is at the top of the object, and displays only the bottom material. Default=50.

You can animate this parameter.

Shell Material

Render to a texture. > Material Editor > Pick Material from Object > Click object with “baked” material.

The Shell material is for use with [texture baking](#) on page 6371. When you use Render To Texture to bake a texture, it creates a Shell material that contains two materials: the original material used in the rendering, and the baked material. The baked material is a bitmap that is saved to disk by Render To Texture. It is “baked,” or attached to an object in the scene.

The Shell material is a container for other materials, like Multi/Sub-Object. It also lets you control which material is used in which renderings.

NOTE The Material/Map Browser lists the Shell material when you assign a new material. You can apply two materials to a single object this way, but changing a material's type to Shell does not generate a baked texture that is saved to disk.

Procedures

To load a shell material into a sample slot:

1 Click an unused sample slot.

2  Click Pick Material From Object.

3 In a viewport, click an object that has a baked material.

The sample slot now contains the baked material, and the Shell Material Parameters rollout is displayed.

Interface

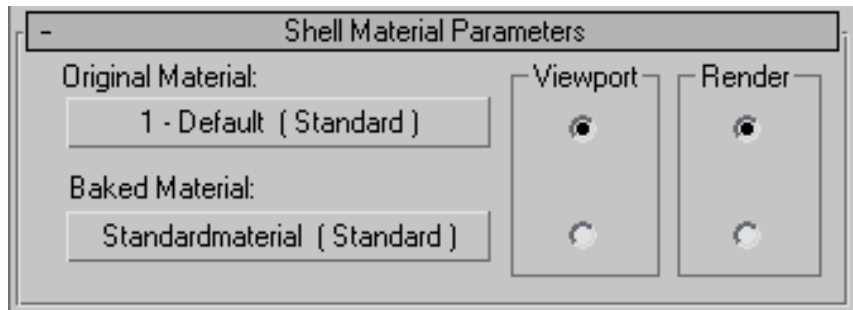

Original Material Displays the name of the original material. Click the button to view that material and adjust its settings.

Baked Material Displays the name of the baked material. Click the button to view that material and adjust its settings.

In addition to the color and mapping of the original material, the baked material can include shadows from lighting, and other information. Also, a baked material has a fixed resolution.

Viewport Use these buttons to choose which material appears in shaded viewports: the original material (upper button) or the baked material (lower button).

Render Use these buttons to choose which material appears in renderings: the original material (upper button) or the baked material (lower button).

Advanced Lighting Override Material

Material Editor > Type button > Material/Map Browser > Advanced Lighting Override

This material lets you directly control the radiosity properties of a material. Advanced Lighting Override is always a supplement to a *base material*, which can be any renderable material. The Advanced Lighting Override material has no effect on ordinary renderings. It affects the [radiosity solution](#) on page 6168 or [light tracing](#) on page 6154. Advanced Lighting Override has two main uses:

- Adjusting the material properties used in a radiosity solution or light tracing
- Creating special effects such as having self-illuminating objects contribute energy to the radiosity solution

As the rollout for the Advanced Lighting Override material states, you don't have to apply this material to obtain a radiosity solution, and most models will never require it.

IMPORTANT The [mental ray renderer](#) on page 6230 does not support the Advanced Lighting Override material.

Obtaining a Better Image

Materials that use default settings can be highly reflective. This can lead to overexposed or washed-out radiosity solutions. In general, the best way to adjust this is to reduce the HSV Value (V) of a material color; or, for a bitmapped material, reduce the RGB Level. In some situations, Radiosity Override can improve the appearance of the radiosity solution. Examples of situations where Radiosity Override can help include color bleeding and large dark areas:

- You might want to reduce Reflectance Scale or Color Bleed when a large area of color (for example, a red carpet in a room with white walls) creates excessive color bleeding. This might be physically accurate, but the eye

adjusts for such effects, and the radiosity result might look better with less reflectance or less color bleeding.

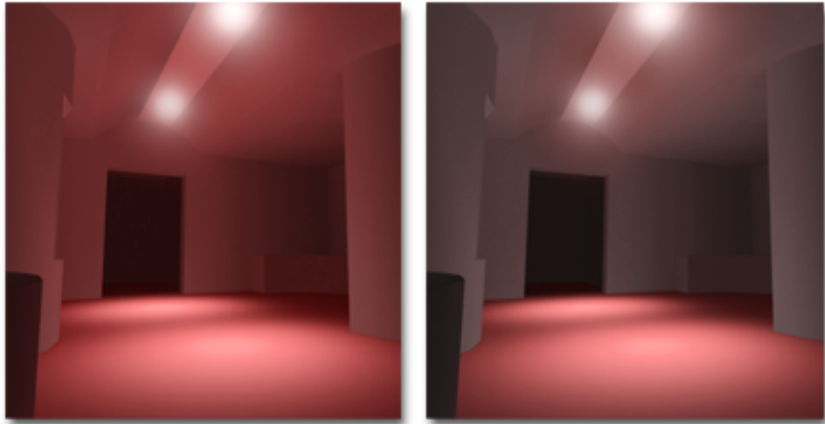

Left: Excessive bleeding of the floor color onto the walls and ceiling.

Right: Radiosity Override material reduces the floor's reflectance, causing less bleeding.

- You might want to increase Reflectance Scale when the scene includes a large dark area (for example, a black floor). This can lead to a very dark radiosity result. You can maintain the floor's color but increase reflectance, giving the solution the colors you want while increasing its brightness.

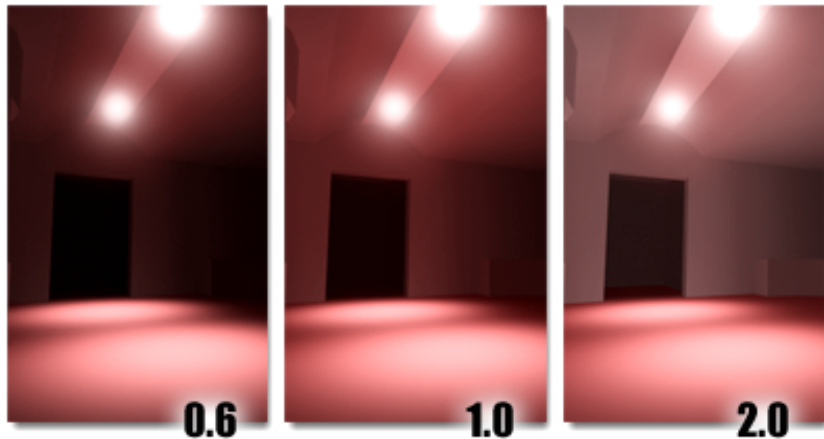

The room is lit only by spotlights pointed at the floor. Increasing reflectance of the floor brightens the entire room.

TIP Check the [reflectance and transmittance display](#) on page 5324 to get an idea of how the current material will affect the radiosity solution or light-traced rendering.

Creating Special Effects

[Self-illumination](#) on page 5440 makes an object appear to glow in ordinary renderings, but does not contribute energy to the radiosity solution. To have radiosity processing take a self-illuminating material into account, make this material the base material of Advanced Lighting Override, then increase the value of Luminance Scale.

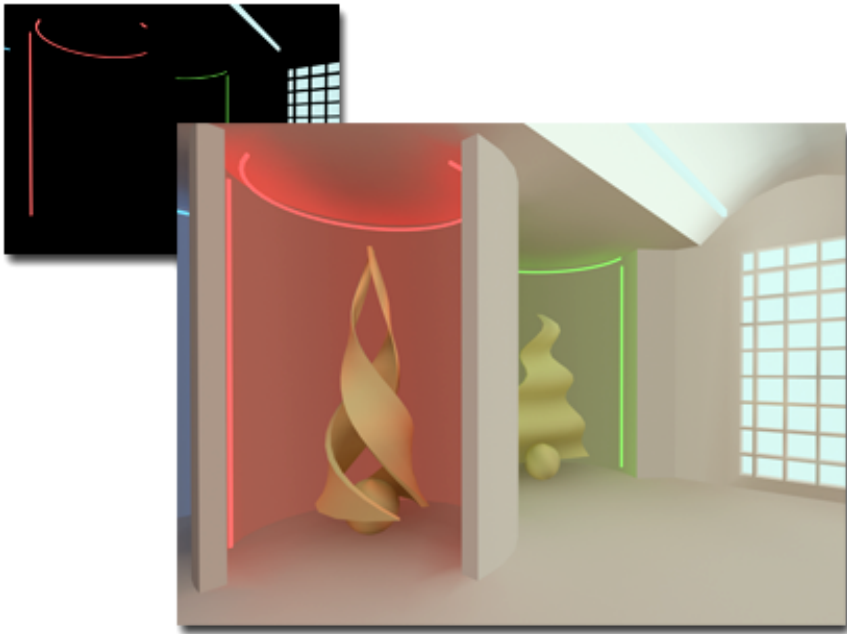

Upper left: By default, self-illuminated neon lights do not influence the scene light.

Right: Advanced Lighting Override material scales the neon lights' Luminance so the radiosity solution can take it into account.

Luminance scale takes [self-illumination mapping](#) on page 5469 into account. You can use this to model effects such as a computer monitor in a darkened room.

The Special Effects group of the Advanced Lighting Override material also has a control for adjusting the quality of [bump mapping](#) on page 5478 in areas of indirect lighting.

Procedures

To adjust a material's reflectance and transmittance:

- 1 Create a material for your scene.
- 2 Click the Type button and choose Advanced Lighting Override.
- 3 In the [Replace Material dialog](#) on page 5376, choose Keep Old Material As Sub-Material, and click OK.
- 4 Adjust the Reflectance Scale and Transmittance Scale parameters. As you do, watch the Reflectance and Transmittance display, and make sure the values are good for a radiosity solution. For example, 85 percent reflectance is about the highest that will work with radiosity. Most real-world materials have much lower reflectance.
See [Reflectance and Transmittance Display](#) on page 5324 for some reflectance properties of real-world materials.

To make a self-illuminating material emit radiosity energy:

- 1 Create a material that is self-illuminating.
- 2 Click the Type button and choose Advanced Lighting Override.
- 3 In the [Replace Material dialog](#) on page 5376, choose Keep Old Material As Sub-Material, and click OK.
- 4 Increase the value of Luminance Scale to have the material emit energy for radiosity processing.

Interface

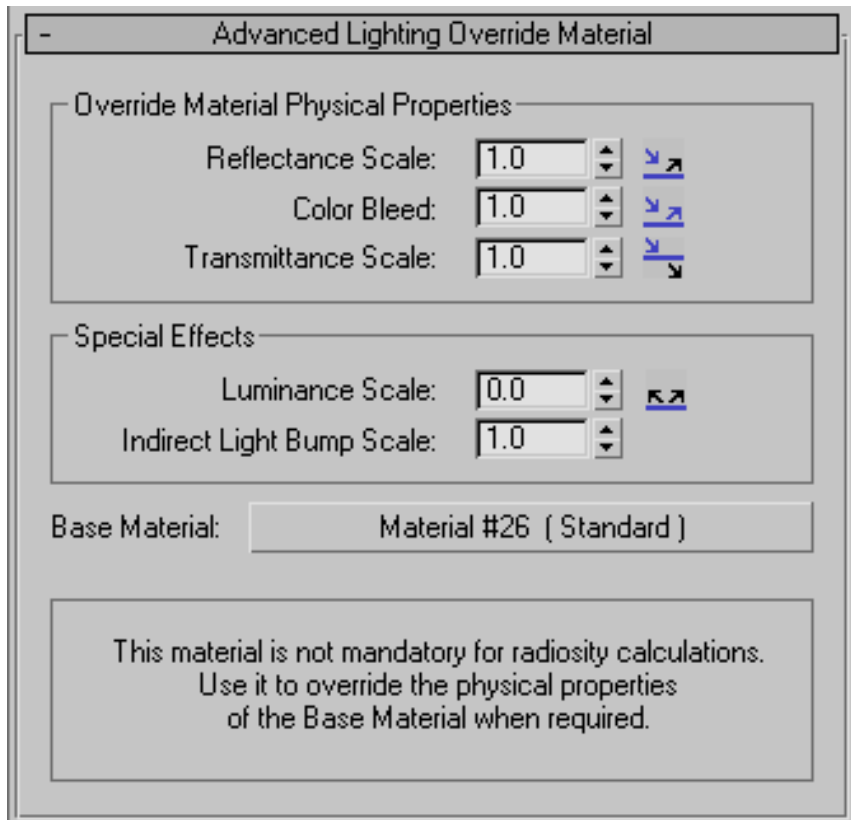

Override Material Physical Properties group

These parameters directly control the base material's advanced lighting properties.

WARNING There is no problem with reducing the default scale, but increasing it for any of these parameters might cause colors to "burn out": if the scale is too great, they render as pure white, appearing overexposed.

Reflectance Scale Increases or decreases the amount of energy the material reflects. Range=0.1 to 5.0. Default=1.0.

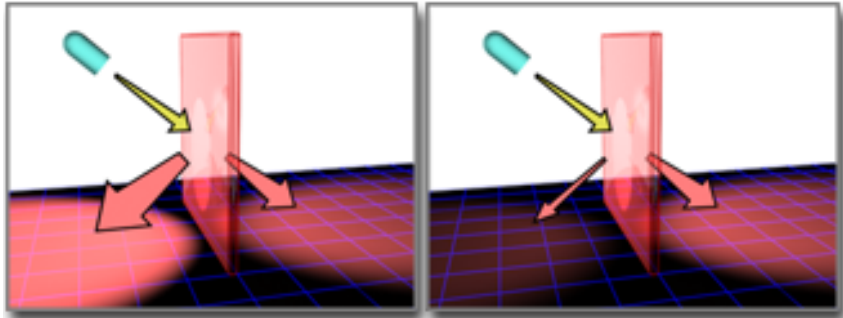

Reflectance Scale increases or decreases the energy of reflected rays.

TIP Don't use this control to increase self-illumination. Use the Luminance Scale instead. Luminance Scale is in the Special Effects group (below).

Color Bleed Increases or decreases the saturation of reflected color. Range=0.0 to 1.0. Default=1.0.

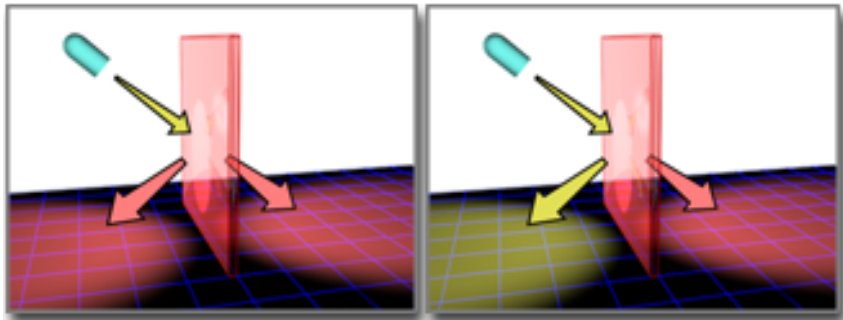

Color Bleed increases or decreases the saturation of reflected color.

Transmittance Scale Increases or decreases the amount of energy the material transmits. Range=0.1 to 5.0. Default=1.0.

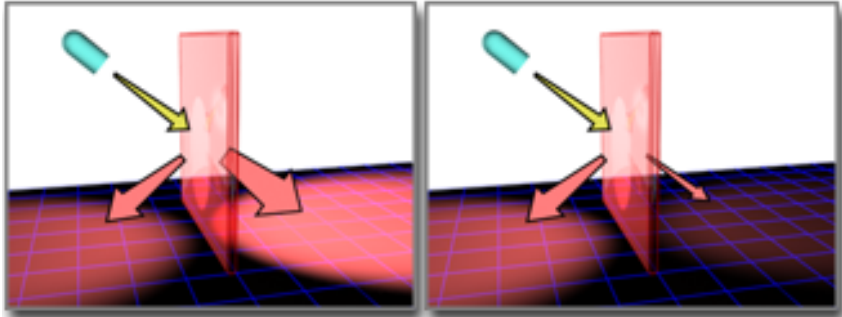

Transmittance Scale increases or decreases the energy of transmitted rays.

NOTE This parameter affects only radiosity. It has no effect on light tracing.

Special Effects group

These parameters relate to specific components in the base material.

Luminance Scale (cd/m^2) When greater than zero, scales the [self-illumination component](#) on page 5440 of the base material. Use this parameter to have self-illuminating objects contribute energy to the radiosity or light-traced solution. Cannot be less than zero. Default=0.0.

Typically, a value of 500 or more will give good results.

Indirect Light Bump Scale Scales the effect of the base material's [bump mapping](#) on page 5478 in areas lit by indirect light. When this value is zero, no bump mapping is done for indirect light. Increasing Indirect Light Bump Scale increases the bump effect under indirect lighting. This value does not affect the Bump amount in areas where the base material is lit directly. Cannot be less than zero. Default=1.0.

TIP This parameter is useful because indirect bump mapping is simulated and not always accurate. Indirect Light Bump Scale lets you adjust the effect by hand.

Base Material Click to go to the base material and adjust its components. You can also replace the base material with a different material type.



To return from the base material to the Advanced Lighting Override level, click Go To Parent.

Lightscape Material

Material Editor > Type button > Material/Map Browser > Lightscape Mtl

The Lightscape material lets you set radiosity behavior for 3ds Max materials you want to use in existing Lightscape radiosity meshes.

NOTE This material is for use with Lightscape. It is not meant for use with the advanced lighting solution in 3ds Max. For adjusting a material's radiosity properties in 3ds Max, use the [Advanced Lighting Override material](#) on page 5734.

IMPORTANT The [mental ray renderer](#) on page 6230 does not support the Lightscape material.

Interface

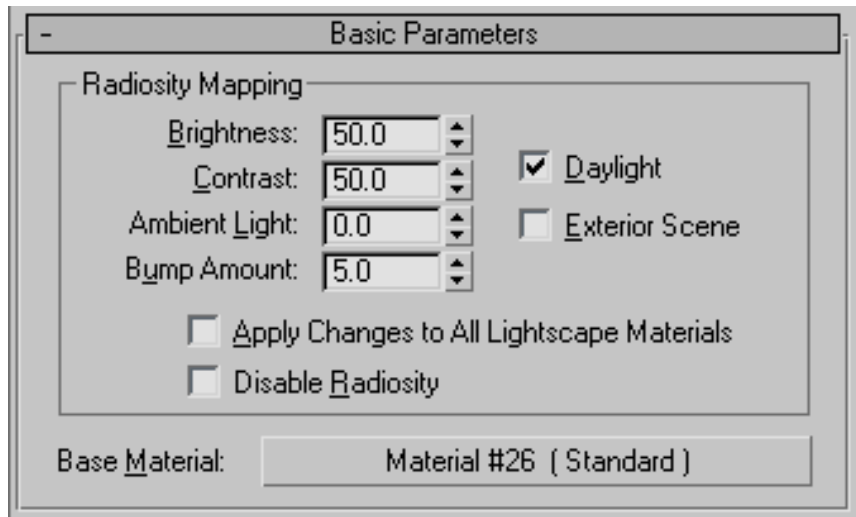

Radiosity Mapping group

Brightness Controls the brightness of the displayed image on your monitor. The setting of this control does not affect the actual lighting levels in the model. Note: The default value is exactly the same as the values set in the Import Lightscape Solution dialog.

Contrast Controls the contrast between light and dark regions in the model. Note: The default value is exactly the same as the values set in the Import Lightscape Solution dialog.

Ambient Light Controls the amount of 3ds Max ambient light that will be mixed in with the radiosity calculations. If the value is 0, none of the 3ds Max ambient light is used. If the value is 1, the 3ds Max ambient light value is added into the radiosity calculations. Default=0.0.

Bump Amount This value controls the strength of the bump map that is applied to the lighting from Lightscape, as opposed to lighting done by 3ds Max. It can be separately controlled from the bump amount in the 3ds Max material, so you can adjust the bumps in Lightscape lighting to match the bumps in 3ds Max lighting. Default=5.0.

Daylight Determines whether you want natural daylight to be used in the calculation. Note: The default value is exactly the same as the values set in the Import Lightscape Solution dialog.

Exterior Scene Used for exterior daylight simulations. Note: The default value is exactly the same as the values set in the Import Lightscape Solution dialog.

Apply Changes to All Lightscape Materials Determines whether or not the changes you make in this dialog are applied to every Lightscape Radiosity material. Default=off.

Disable Radiosity Determines whether or not the radiosity is calculated. This option provides a quick way to see the effect of the Lightscape-specific illumination. Default-off.

Base Material Displays the base 3ds Max material to which the radiosity illumination is applied. (The base material displays on the object while the Lightscape Radiosity material adds radiosity effects.) Use this button to change the base material on the object.

Ink 'n Paint Material

Material Editor > Type button > Material/Map Browser > Ink 'n Paint

The Ink 'n Paint material creates cartoon effects. Rather than the three-dimensional, realistic effect most other materials provide, Ink 'n Paint provides flat shading with “inked” borders.

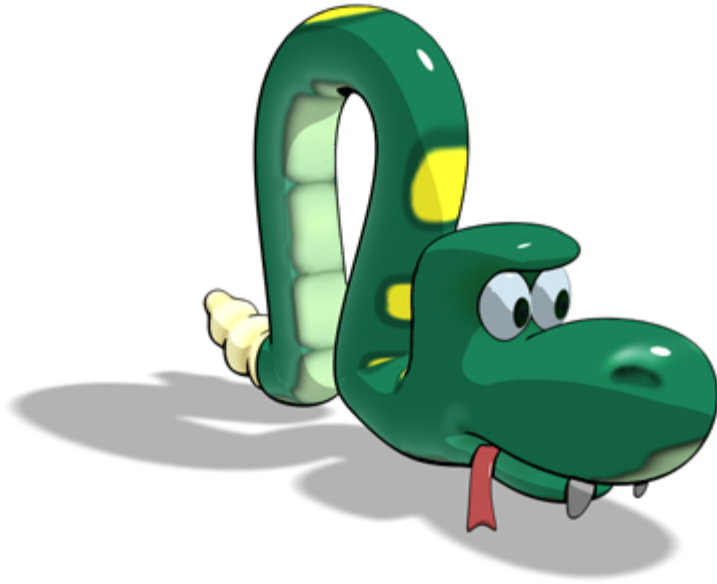

Snake rendered with ink 'n paint

Because Ink 'n Paint is a material, you can create a scene that combines 3D-shaded objects with flat-shaded cartoon objects.

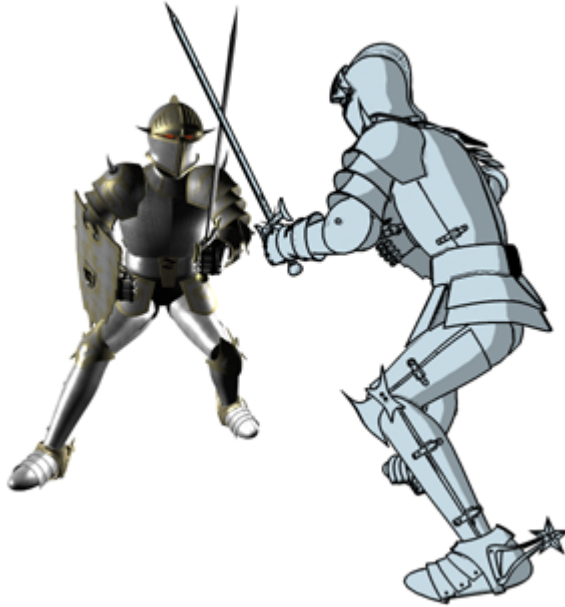

Rendering that combines realistic shading with cartoon shading

In the Ink 'n Paint material, ink and paint are two separate components, with customizable settings.

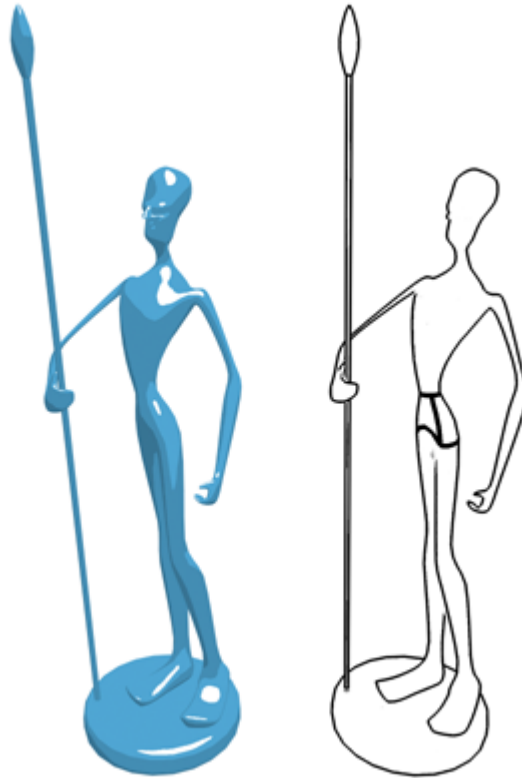

Left: The paint component only

Right: The ink component only

TIP Ink 'n Paint uses the [raytracer settings](#) on page 6221, so adjusting raytrace acceleration can have an effect on the speed of Ink 'n Paint. Also, while you work with Ink 'n Paint, disabling antialiasing can speed up the material, until you're ready to create final renderings. (Turning off Ink *really* speeds it up.)

NOTE Motion blur does not work with Ink 'n Paint. (Typically, hand-drawn cartoons are not motion blurred.)

NOTE Shadows don't appear on objects shaded with Ink 'n Paint unless the value of Paint Levels is 4 or greater.

WARNING Ink 'n paint will only give correct results when rendered from a camera or perspective view. It does not work in orthographic views.

Using Ink 'n Paint

You can use Ink 'n Paint on multiple objects, but in general, it tends to work best if you do the following:

- 1 Collect the objects for cartoon rendering into a single surface model such as an Editable Mesh.
- 2 Assign different [material ID values](#) on page 8038 to portions of the model you want to color differently.

Typically, you would do this at the Element sub-object level, although you can certainly apply different material IDs to faces and polygons as well.

- 3 Create a [Multi/Sub-Object material](#) on page 5720. In it, create a sub-material for each of the colors in the model. Make each sub-material an Ink 'n Paint material, then assign colors and maps using each sub-material's Paint controls.

If necessary, adjust the Ink controls as well.

TIP [ActiveShade](#) on page 6102 works with the Ink 'n Paint material, and can be a good way to preview the material's effect.

Troubleshooting

Here are some commonly encountered problems, and potential solutions:

- Internal ink lines are missing.
The Overlap bias is probably too high. Decrease it. If Underlap is turned on, this might also have too high a bias.
Another possible reason is that you have a self-intersecting object, or an object built by attaching smaller objects, thus creating intersecting faces. In this case, set up the objects to use the Mat ID or SmGroup ink components. If elements already have differing material IDs, try turning off Only Adjacent Faces.
- Ink looks sloppy on sloping parts of the object.
The Overlap or Underlap bias might be too low. Try increasing it.
- Ink looks sloppy between interpenetrating objects.
Find out which ink component is the sloppy one. Then adjust its bias control.
- Ink lines disappear or are too narrow when Variable Width is on.

Turn on Clamp. You can also try to see if reducing the lighting level helps. Or, you can try turning off Variable Width, then assigning a [Falloff map](#) on page 5877 to the Ink Width component.

TIP To isolate which ink component is causing a problem, you can try assigning each component a different, distinctive (and easy to read) color, then rendering the image.

WARNING Ink 'n paint will only give correct results when rendered from a camera or perspective view. It does not work in orthographic views.

Interface

Basic Material Extensions rollout

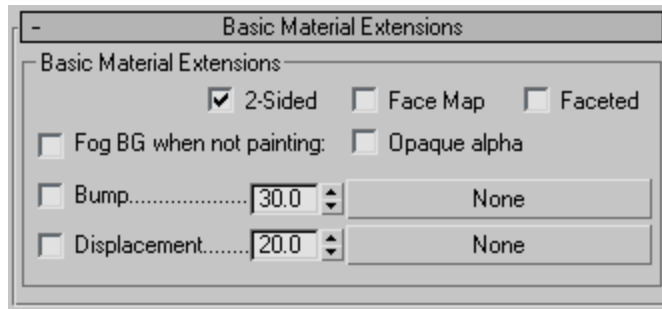

2-Sided Makes the material [2-sided](#) on page 7893. Applies the material to both sides of selected faces.

Face Map Applies the material to the faces of the geometry. If the material is a mapped material, it requires no [mapping coordinates](#) on page 8034. The map is automatically applied to each facet of the object.

Faceted Renders each face of a surface as if it were flat.

Fog BG when not painting When paint is turned off, the painted areas of the material color are the same as the background. This toggle, when on, lets the background in paint areas be affected by fog between the camera and the object. Default=off.

Opaque alpha When on, the alpha channel is opaque even if ink or paint is turned off. Default=off.

Bump Adds bump mapping to the material.

- **Toggle** When on, enables the bump map.
- **Spinner** Controls the bump map amount.
- **Map button** Click to assign a map to use for bump mapping.

Displacement Adds displacement mapping to the material.

- **Toggle** When on, enables the displacement map.
- **Spinner** Controls the displacement map amount.
- **Map button** Click to assign a map to use for displacement mapping.

Paint Controls rollout

Paint is the main color of the material.

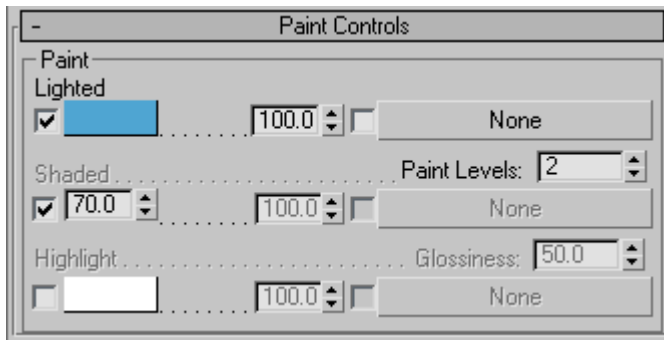

There are three main components of the “paint” of Ink 'n Paint. Each has several associated controls, most of which are documented toward the end of this section.

Lighted The fill color for the lighted side of objects. Default=light blue.

Turning off this component makes the object invisible, except for the ink. Default=on.

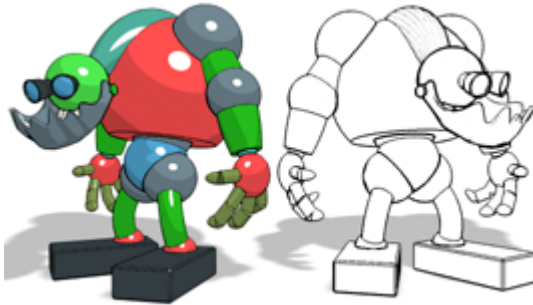

Left: A lighted character

Right: Lighted and Highlight both turned off to render only the ink

- **Paint Levels** The number of shades of color that are rendered, from light to dark. Lower values make objects look flatter. Range=1 to 255. Default=2.

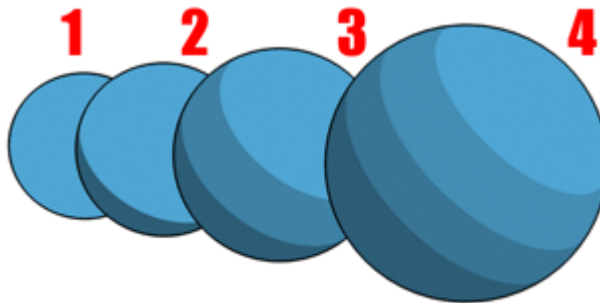

Increasing the value of Levels increases the number of shades of the basic color seen in the lighted area.

Shaded The value in the spinner at the left is the percent of the Lighted color that appears on the unlighted side of objects. Default=70.0.

Turning off this component displays a color swatch, which you can use to assign a distinct color to shaded areas. Default=on.

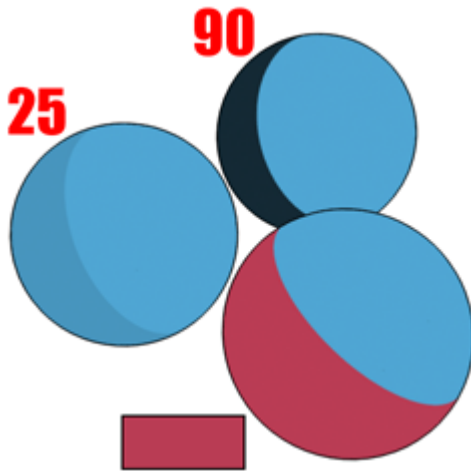

Increasing the value of Shaded increases the saturation of the shaded area. You can also use Shaded to assign a distinct color for shading.

Highlight The color of the specular highlight. Default=white.

When this component is off, there is no specular highlight. Default=off.

TIP A specular highlight can destroy the illusion of 2D. Use this component sparingly.

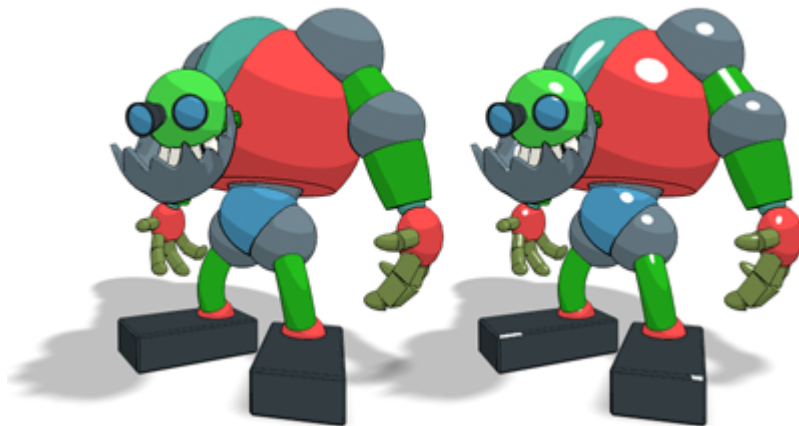

Left: No highlights

Right: Highlight on

- **Glossiness** The size of the specular highlight. The greater the Glossiness, the smaller the highlight. Default=50.0.

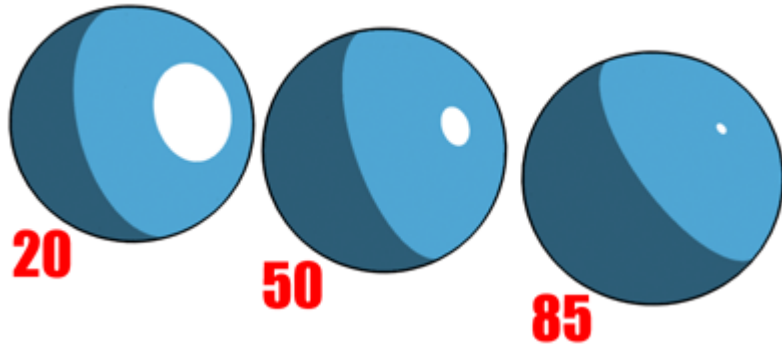

Increasing glossiness decreases the size of the highlight.

Color component controls:

These are the controls that are duplicated for each of the paint components. Each has an on/off toggle, a main control, and then on the right, a set of map controls.

- **Check box** The check box at the left of the rollout enables or disables that particular component. In the case of Shaded, it toggles between a percentage value (of the Lighted color) or a distinct Shaded color.
- **Color swatch or spinner** The main control for each component. Click a color swatch to display a [Color Selector](#) on page 391 and set the color of the component. In the case of Shaded, this control can also be a percentage spinner.



- **Map spinner** The spinner to the right of the main control is the percentage of the map to use. Default=100.0.

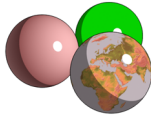

Mapping the Lighted component

Right rear: The original, unmapped material

Left: Lighted component with a falloff map applied

Right front: Lighted component with a bitmap applied

- **Map check box** The check box between the spinner and the button enables or disables the map. Default=off until a map is assigned, then on.
- **Map button** Click the button to assign a map to this component. While a map is assigned and enabled, at 100 percent it completely overrides the main color component. At lower percentages, the map is blended with the color.

Ink Controls rollout

Ink is the linework, the outlines, in the material.

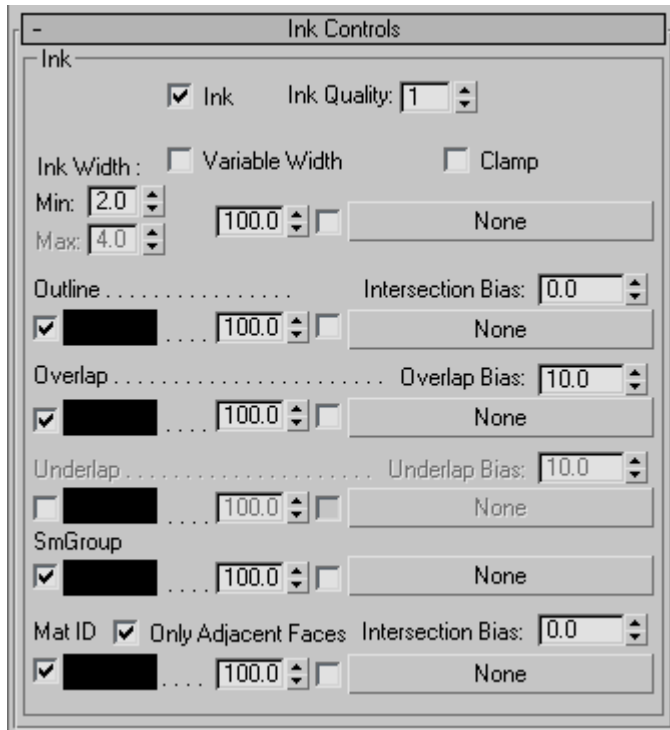

Except for Ink Width, each of the ink components has an on/off toggle and a color swatch. Click the color swatch to display a [Color Selector](#) on page 391 and change the ink component's color. Each ink component, Ink Width included, also has a set of map controls.

Ink When on, the rendering is “inked.” When off, no ink lines appear. Default=on.

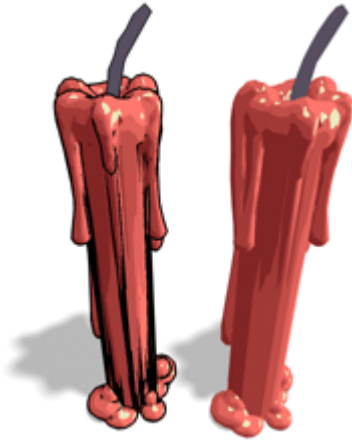

Left: Rendering with ink

Right: Ink turned off

Ink Quality Affects the shape of the brush and the number of samples it uses. When Quality equals 1, the brush is a “+” shape, and samples are taken over an area of 5 pixels. When Quality equals 2, the brush is octagonal and the samples are taken over an area of 9 to 15 pixels. When Quality equals 3, the brush is nearly circular, and samples are taken over an area of 30 pixels. Range=1 to 3. Default=1.

TIP For most models, increasing the Quality value introduces only a very subtle change, and can take considerably longer to render. Do so only when a sub-object's ink shows too many artifacts in the finished rendering, using the default Ink Quality. (Don't rely on the ActiveShade preview, which will tend to be aliased.)

Ink Width The width of the ink, in pixels. This is specified by the spinner labeled Min (minimum) unless Variable Width is on. When Variable Width is on, the Max (maximum) spinner is also enabled, and the ink width can vary between the minimum and maximum values. Default: Min=2.0, Max=4.0.



Left: One-pixel ink width

Middle: Five-pixel ink width

Right: Ink width varies from one to five pixels.

Variable Width When on, the ink's width can vary between the minimum and maximum Ink Width values. Ink with Variable Width looks a bit more streamlined than ink with a constant width. Default=off.

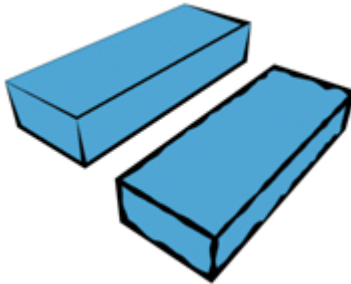

The thickness of ink can be mapped.

Left: Thickness mapped with a gradient map

Right: Thickness mapped with a noise map

Clamp When Variable Width is on, sometimes the scene lighting causes some ink lines to become so thin they nearly disappear. If this happens, turn on Clamp, which forces the ink width to always remain between the Min and Max values, regardless of the lighting. Default=off.

Outline The ink where the outer edges of the object appear against the background or in front of a different object. Default=on.

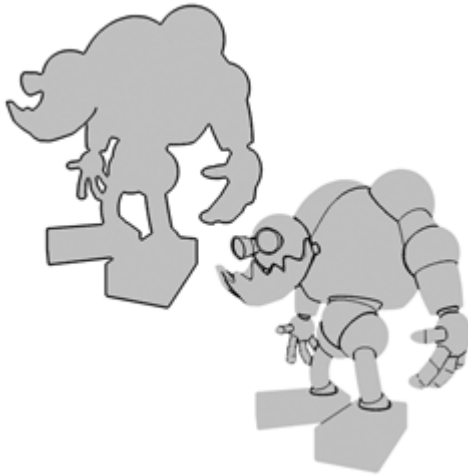

Left: Rendering the outline only

Right: Rendering only the overlap and underlap

- **Intersection Bias** Use this to adjust artifacts that might appear when two objects intersect each other. In effect, this moves the inked object closer to the rendering point of view, or farther away, so Ink 'n Paint can decide which object is in front. Positive values push the object away from the point of view, negative values pull it closer. Default=0.0.

Overlap The ink used when a portion of an object overlaps itself. Default=on.

- **Overlap Bias** Use this to adjust artifacts that might appear in ink that traces the overlap. It says how far the overlap has to be in front of the rear surface for Overlap ink to turn on. Positive values push the object away from the point of view, negative values pull it closer. Default=10.0.

Underlap Similar to Overlap, but applies ink to the farther surface rather than the nearer one. Default=off.

- **Underlap Bias** Use this to adjust artifacts that might appear in ink that traces the underlap. It says how far the underlap has to be behind the front surface for Underlap ink to turn on. Positive values push the object away from the point of view, negative values pull it closer. Default=0.0.

SmGroup The ink drawn between the boundaries of [smoothing groups](#) on page 8130. In other words, it inks the edges of the object that have not been smoothed. Default=on.

Mat ID The ink drawn between different [material ID values](#) on page 8038. Default=on.

TIP If two Ink 'n Paint materials overlap in the viewport, and both have Mat ID on, you will often get a doubly thick ink line where they overlap. To correct this, turn off the Mat ID component for one of these materials.

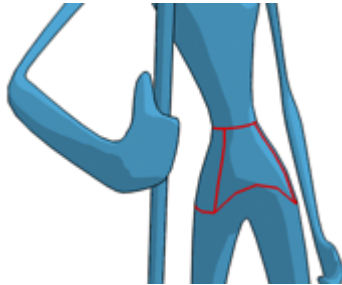

Inking the edges between sub-materials

- **Only Adjacent Faces** When on, inks the material ID edge between adjacent faces, but not between one object and another. When off, inks the material ID edge between two objects or other non-adjacent faces. Default=on.
- **Intersection Bias** When Only Adjacent Faces is turned off, use this to adjust any artifacts that appear at the boundary between two objects with different material IDs. Default=0.0.

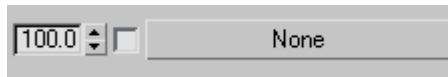

Map controls There are map controls for each of the ink components: Width, Outline, Overlap, Underlap, SmGroup, and Mat ID. These work the same as they do for the material's paint components, as described above.



Mapping the outline and overlap components to simulate the look of drawing on paper

DirectX 9 Shader Material

Material Editor > Type button > Material/Map Browser > DirectX 9 Shader

Note: Typically, this material is visible in the Browser only if DirectX 9 is available on your system, and you are using the Direct3D display driver with DirectX 9.0 chosen as the Direct3D version. If this material is not visible, you can see it (in gray) by turning on Incompatible in the Show group.

The DirectX 9 Shader material enables you to shade objects in viewports using DirectX 9 (DX9) shaders. With DirectX shading, materials in a viewport more accurately represent how the material will appear in another application, or on other hardware such as a game engine. You can use this material only

when you are using the [Direct3D Display driver](#) on page 7802 and DirectX 9.0 is chosen as the Direct3D version.

DX9 shaders are FX files. Several sample FX files are provided in the `\fx` folder in the 3ds Max program directory.

See also:

- [DirectX Shader group](#) on page 5339
- [FX File](#) on page 7990

Interface

DirectX 9 Shader rollout

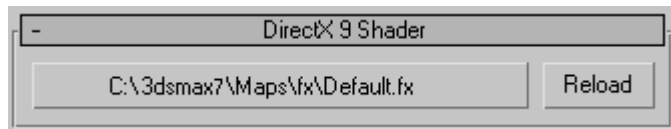

Shader button Click to display a file dialog that lets you select a DX9 FX effect (FX) file. By default, the *default.fx* file is chosen.

Reload Click to reload the active FX file. To update an FX file, you can edit it and then click Reload. You don't have to restart 3ds Max to see the effect of the changes to the shader.

Shader-specific rollouts

The rollouts that appear below the DirectX 9 Shader rollout and above the Software Rendering rollout are the interface to the shader you chose. These rollouts are specific to each shader.

Software Rendering rollout

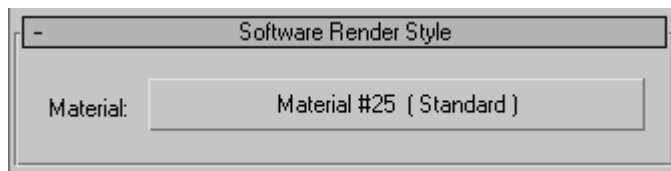

Specifies a material that controls software shading and rendering of objects to which the DirectX 9 Shader material is applied. Viewports use DX9 shading

unless the Software or OpenGL driver is active. Renderings *always* use software shading.

Usually you will want to choose a material that clearly identifies which objects in your scene have the DirectX 9 Shader material applied.

NOTE The DirectX 9 Shader material has no specific settings for software shading. Any type of 3ds Max material will do. Scenes from previous versions that used DX9-specific settings are assigned a Standard material with equivalent rendering properties.

NOTE If DirectX 9 is not available on your system, but you assign the DirectX 9 Shader material anyway (by using the Material/Map Browser's Incompatible option), this is the only rollout that appears in the Material Editor.

DirectX Viewport Shaders

LightMap Shader Rollout

Material Editor > Viewport Manager rollout > Choose LightMap from the drop-down list. > LightMap Shader rollout appears.

When you have chosen LightMap as the [DirectX viewport shader](#) on page 5393, this rollout appears. The LightMap shader can display both a base texture and a lighting map. Typically both these maps come from [rendering to textures \(texture baking\)](#) on page 6371. The base texture typically would be a completed map, a blend map, or a diffuse map. You can choose these map types, as well as lighting map, to render as [elements of a baked texture](#) on page 6376.

NOTE In order to use the LightMap shader, you must have 3ds Max configured to use the Direct3D graphics driver. To change the graphics driver configuration, refer to the [Viewport Preferences](#) on page 7753 topic.

Interface

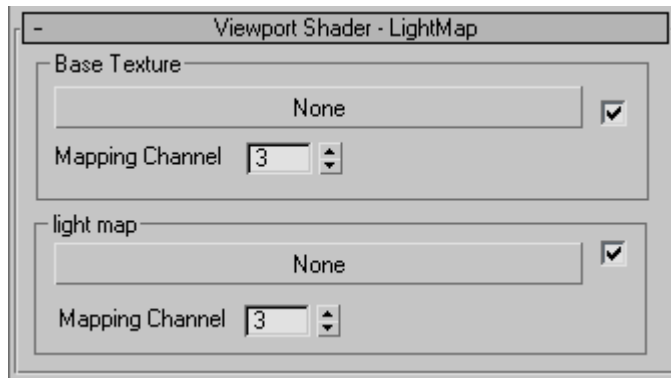

Base Texture group

Button Shows the name of the base texture. Click the button to display that material's parameters, and adjust them if necessary.

Toggle When on, shaded viewports display the base texture. When off, it is not displayed.

If both the Base Texture and Light Map toggles are off, the material appears black in viewports.

Mapping Channel Shows the [map channel](#) on page 8032 this texture uses.

Light Map group

Button Shows the name of the lighting map.

Toggle When on, shaded viewports display the lighting map. When off, it is not displayed.

If both the Base Texture and Light Map toggles are off, the material appears black in viewports.

Mapping Channel Shows the map channel this texture uses.

Metal Bump Shader Rollout

Material Editor > Viewport Manager rollout > Choose LightMap from the drop-down list. > Metal Bump Shader rollout appears.

When you have chosen Metal Bump as the [DirectX viewport shader](#) on page 5393, this rollout appears. The Metal Bump shader can display a variety of [texture-baked maps](#) on page 6371, including normal maps for an embossed effect. It is good for displaying shiny surfaces.

NOTE In order to use the Metal Bump shader, you must have 3ds Max configured to use the Direct3D graphics driver. To change the graphics driver configuration, refer to the [Viewport Preferences](#) on page 7753 topic.

The Metal Bump shader's results are always visible in viewports, regardless of the object type.

WARNING The Metal Bump shader lets you adjust settings to get various effects in shaded viewports. These settings will not necessarily apply when you display the texture-baked object on other Direct3D devices.

See also:

- [Baked Texture Elements](#) on page 6376

Interface

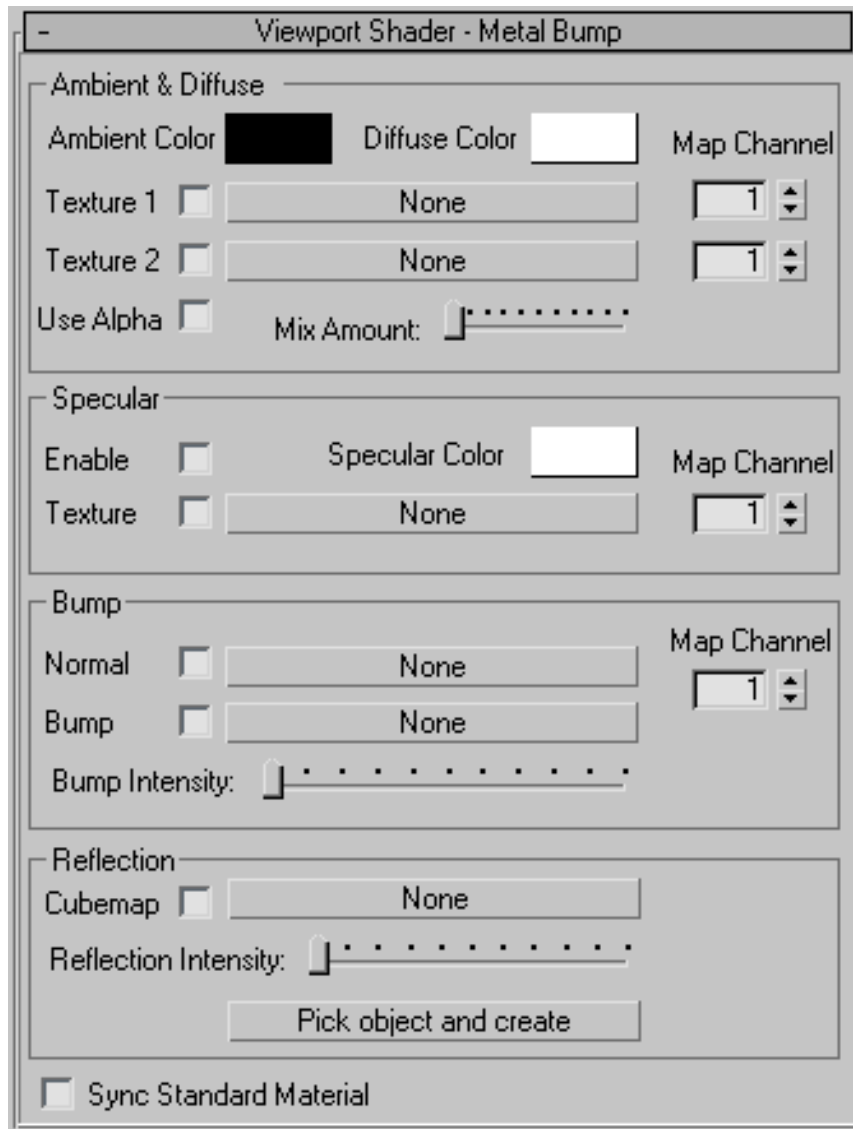

Ambient & Diffuse group

Ambient Color When not black, tints the object's ambient color. Click the color swatch to display a [Color Selector](#) on page 391 and choose the ambient color. Default=black.

Diffuse Color When not white, tints the diffuse color. Click the color swatch to display a Color Selector and choose the diffuse color. Default=white.

Texture 1 Displays a texture map for the diffuse color. Typically this would be a texture-baked diffuse map, completed map, or blend map.

See the section “Map Controls,” below, for a description of the individual controls.

Texture 2 Displays a second texture map for the diffuse color. Typically this would be a texture-baked lighting map or shadows map.

See the section “Map Controls,” below, for a description of the individual controls.

Use Alpha When on, displays the alpha channel. When off, does not. Default=off.

Mix Amount Adjusts the mixing of the two texture maps in shaded viewports.

Specular group

Enable When on, enables specular highlights for the object. Default=off.

Specular Color Specifies a specular color for the object. Click the color swatch to display a Color Selector and choose a color. Default=white.

Texture Displays a specular map for the object. Typically this would be a texture-baked specular map.

See the section “Map Controls,” below, for a description of the individual controls.

Bump group

Normal Displays a normal map for the object. Typically this would be a texture-baked normals map.

See the section “Map Controls,” below, for a description of the individual controls.

Bump Displays a bump map for the object. Typically this would be a bump map used for the original material.

See the section “Map Controls,” below, for a description of the individual controls.

Bump Intensity Adjusts the intensity of the bumps in shaded viewports.

Reflection group

Cubemap Displays a reflection map projected cubically (around the scene). Typically this would be an environment map.

Reflection Intensity Adjusts the intensity of reflections in shaded viewports.

Pick object and create Click to choose an object and have the program generate the reflections used in the viewport.

Sync Standard Material

When on, adjustments you make to the Metal Bump shader update settings in the active standard material, letting you save the changes you made. When off, the standard material is unchanged. Default=off.

Map Controls

In this rollout, all texture maps have the same general controls. The rollout appears only when you are using the DirectX viewport shader.

Toggle When on, the map is used in viewports. When off, it is not used. Default=on if a map is assigned, off otherwise.

Map button Click to choose the texture map to use for this component of the object.

Map Channel Specifies the [map channel](#) on page 8032 used by this map. This control is not present for the cubic reflection map.

XRef Material

Material Editor > Type button > Material/Map Browser > XRef Material

The XRef material lets you externally reference a material applied to an object in another scene file. As with [XRef objects](#) on page 6936, the material resides in a separate source file. You can set the material properties only in the source file. When you change them in the source file and then save it, the material's appearance can change in the master file that contains the XRef.

NOTE If an XRef object has a material applied to it in the original source file (and Merge Materials is turned off when you reference the source file), then that material is automatically externally referenced in the scene, and can be loaded in the Material Editor if you browse from the scene. When you explicitly use the Material Editor to create an XRef material, you don't have to have any XRef objects from that particular source file. However, the record's source file and material *do* appear in the [XRef Objects dialog](#) on page 6941.

The Show Map In Viewport button works for an XRef material only if the same button is turned on in the source file. Otherwise, it is disabled.

Interface

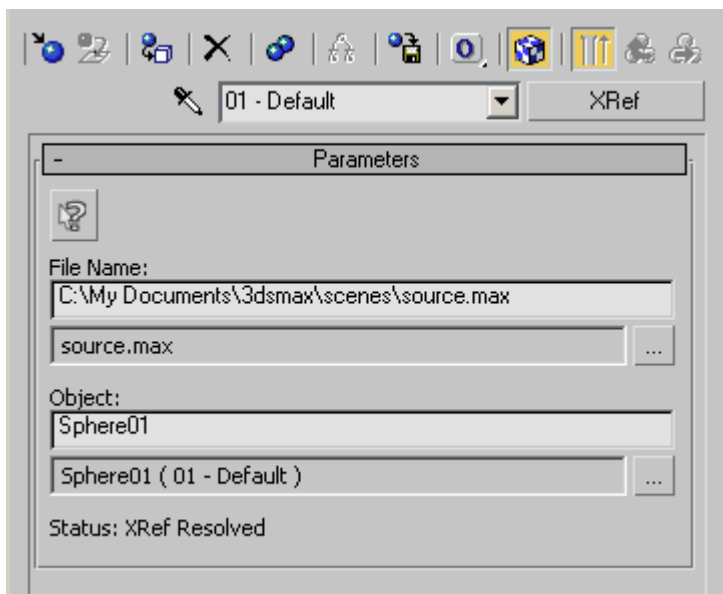

Highlight Corresponding XRef Record in the XRef Objects

Dialog Click to open the [XRef Objects dialog](#) on page 6941 that highlights the source file's current record with its object displayed in the XRef Entities list. If no file and object have yet been selected for the material, the XRef Objects dialog is displayed, and lets you browse for the file and material to use.

File name field Displays the path and file name of the scene file containing the source of the XRef material. You can edit this to point to a different path and file.

File name display Displays the file name only, without the path.



Path button Click to display the Open File dialog from which you can specify a different path and file name for the source file. After you choose the file, 3ds Max displays the [XRef Merge dialog](#) on page 6956 that lets you choose the object whose material you want to reference.

Object name field Displays the name of the source object pointed to in the source file.

Object name and material Displays the name of the source object followed by the material name in parentheses. For example, “Shaker (Chrome).”



Path button Click to display the [XRef Merge dialog](#) on page 6956 pointing to the scene in the XRef File Name field. Here, you can specify a different object whose material you want to reference.

Status line Displays the status of the material. For example, if the file and object are both found, this field says “Status: XRef Resolved.”

Types of Maps



The most common use for [maps](#) on page 8036 is to improve the appearance and realism of [Materials](#) on page 8041. You can also use maps to create [environments](#) on page 6689 or projections from lights (see [Advanced Effects Rollout](#) on page 5108).

Maps can simulate textures, applied designs, reflections, refractions, and other effects. Used with materials, maps add details without adding complexity to the geometry of an object. ([Displacement mapping](#) on page 5487 can add complexity.)

Accessing Map Types



You use the [Material/Map Browser](#) on page 5290 to load a map or create a map of a particular type. The Browser groups maps into categories according to their type. You can choose whether the Browser lists maps, materials, or both; you can choose which map types.

To list map types by category:

- 1  Open the Material Editor.
- 2  Click Get Material to display the Material/Map Browser.
- 3 On the left side of the Material/Map Browser, in the Show group, turn off Materials. Leave Maps turned on.
- 4 In the lower set of buttons, choose the category you want listed, or choose All to show all map types.
The list is displayed in the right panel of the Browser.

To open the Browser from the Material Editor:

As you work with materials, you can open the Material/Map Browser from the Material Editor.

- 1  Open the Material Editor.
- 2  On the Material Editor toolbar, click Get Material to display the Material/Map Browser.

Understanding Map Types

Different types of maps create different effects and behave in particular ways.

- [2D maps](#) on page 5782 are two-dimensional images that are typically mapped onto the surface of geometric objects, or used as environment maps to create a background for the scene. The simplest 2D maps are bitmaps; other kinds of 2D maps are generated procedurally.
- [3D maps](#) on page 5860 are patterns generated procedurally in three dimensions. For example, Marble has a grain that goes through the assigned geometry. If you cut away part of an object with Marble assigned as its texture, the interior matches the exterior.
- [Compositors](#) on page 5918 are for compositing other colors or maps.
- [Color Modifiers](#) on page 5933 alter the colors of pixels in a material.

- The "Other" category includes maps that create [reflections and refractions](#) on page 5946. It also includes [mental ray shaders](#) on page 5974, [Normal Bump maps](#) on page 6033, and [Camera Per-Pixel Projection maps](#) on page 6035.

Maps and mental ray Shaders

When the [mental ray renderer](#) on page 6230 is active, the Material/Map Browser also lists mental ray shaders. Shaders are similar to maps, but use yellow icons. You assign them the way you do maps. The mental ray shaders don't fit into the map categories described in the previous section, and aren't described in this topic. See [mental ray Shaders](#) on page 5974 for links to shader descriptions.

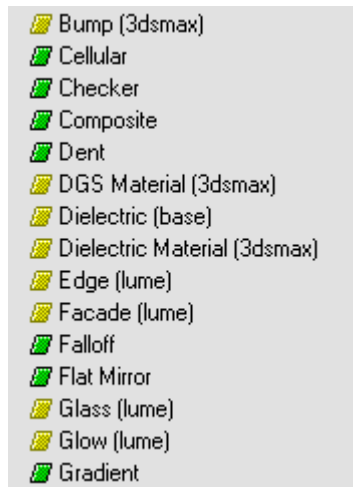

mental ray maps in the browser's list are shown with yellow icons.

TIP When the default scanline renderer is active, you can view mental ray shaders in the Browser list, and assign them, by turning on Incompatible in the Show group. Incompatible shaders in the list are displayed in gray.

Maps and Mapping Coordinates

Maps have a spatial orientation. When you apply a material with maps in it to an object, the object must have mapping coordinates. These are specified in terms of UVW axes local to the object.

Most objects have a Generate Mapping Coordinates toggle. You can turn this on to provide default mapping coordinates. If the object has this toggle, it is

also turned on automatically when you render the scene, or use [Show Map In Viewport](#) on page 5350.

Some objects, such as editable meshes, don't have automatic mapping coordinates. For these types of objects, you can assign coordinates by applying a [UVW Map modifier](#) on page 1931. If you assign a map that uses a mapping channel, but don't apply a UVW Map modifier to the object, the renderer displays a warning that lists objects that require mapping coordinates. You can also use UVW Map to change an object's default mapping.

See [Mapping Coordinates](#) on page 5279.

UVW Mapping Coordinate Channels

Each object can have from 1 to 99 UVW mapping coordinate channels. The default mapping (from the Generate Mapping Coordinates toggle) is always UVW 1. The UVW Map modifier can send coordinates to any of these channels.

Each map in a material can use any UVW channel (if present), or other type of mapping that depends on whether the map is 2D or 3D.

You can set the mapping channel used by [NURBS surface](#) on page 2275 sub-objects in their creation or modification parameters.

Mapping for 2D Maps

You can position a 2D map on the surface of an object by using a map channel, any assigned vertex color, or the local or world coordinate systems. You can also choose different environment mappings. See [Coordinates Rollout \(2D\)](#) on page 5782.

Mapping for 3D Maps

You can position a 3D map within the volume of an object by using a map channel, any assigned vertex color, or the local or world coordinate systems. See [Coordinates Rollout \(3D\)](#) on page 5861.

Noise for Maps

Random noise values increase the complexity of maps and can give them a more natural look. For 2D maps, see [Noise Rollout \(2D\)](#) on page 5793. For 3D maps, you can assign a separate Noise map. See [Noise Map](#) on page 5886.

Real-World Mapping

Real-world mapping is an alternative mapping paradigm in 3ds Max that is off by default. The idea behind real-world mapping is to simplify the correct scaling of texture-mapped materials applied to geometry in the scene. This feature lets you create a material and specify the actual width and height of a 2D texture map in the Material Editor. When you assign that material to an object in the scene, the texture map appears in the scene with correct scaling.

For real-world mapping to work, two requirements must be met. First, the correct style of UV texture coordinates must be assigned to the geometry. Essentially, the size of the UV space needs to correspond to the size of the geometry. To this end, a new option called Real-World Map Size has been added to many of the dialogs and rollouts that let you generate texture coordinates (see list at the end of this topic). Any dialog or rollout that lets you turn on Generate Mapping Coords also lets you enable Real-World Map Size. Also, you can toggle this option globally on the Preferences dialog > [General panel](#) on page 7744.

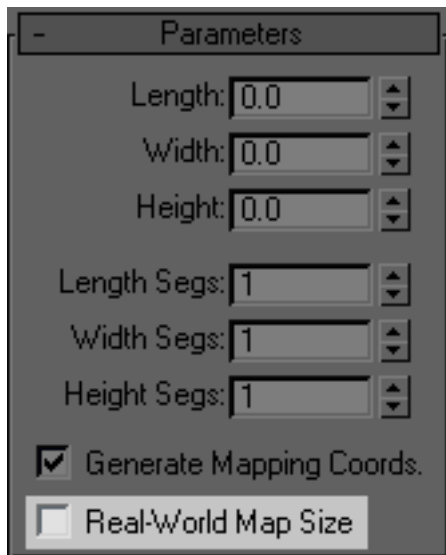

Most object parameters settings now include a Real-World Map Size toggle.

The second requirement is available in the Material Editor. All 2D texture maps, such as Bitmap, provide a Use Real-World Scale check box on the [Coordinates rollout](#) on page 5782. Like Real-World Map Size, this check box is off by default, but when on, the U/V parameter names change to Width/Height

and the Tiling label changes to Size. You can then specify the horizontal/vertical offsets and size of the texture map in current [system units](#) on page 7812.

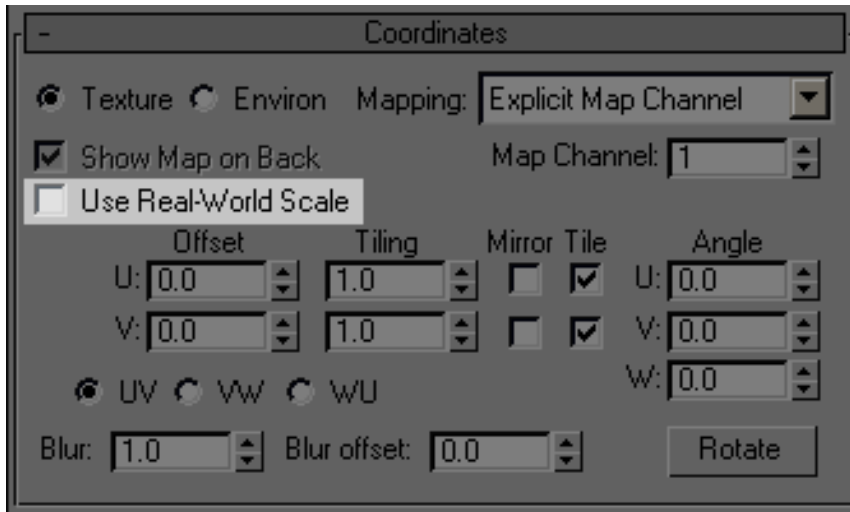

2D map coordinates settings now include a Use Real-World Scale toggle.

Following is a list of affected features (note links to topics with more extensive information):

- Bevel Modifier
- Bevel Profile Modifier
- Box Primitive
- Capsule Extended Primitive
- C-Ext Extended Primitive
- ChamferBox Extended Primitive Create panel > Geometry button
- ChamferCyl Extended Primitive
- Cone Primitive
- CV Curve
- Cylinder Primitive Create panel
- Doors

- Editable Spline
- Extrude Modifier
- Gengon Extended Primitive
- GeoSphere Primitive
- Importing AutoCAD Drawing
- Importing DXF Files
- Lathe Modifier
- L-Ext Extended Primitive
- L-Type Stair
- Loft > Surface Parameters Rollout
- Material Editor Coordinates Rollout
- [Material Editor Options](#) on page 5335
- OilTank Extended Primitive
- Plane Primitive
- Point Curve
- Pyramid Primitive
- Railing
- Renderable Spline Modifier
- Sphere Primitive
- Spindle Extended Primitive
- Spline Rendering File Link Settings
- Splines and Extended Splines
- Stairs
- Sweep Modifier
- Teapot Primitive
- Torus Primitive
- Tube Primitive

- [UVW Map Modifier](#) on page 1931
- Wall
- Windows

Output Rollout

Material Editor > Select sample slot. > Get Material > Material/Map Browser > Turn on 2D Maps and 3D Maps. > Choose a map type (Bitmap, Cellular, Falloff, Gradient, Gradient Ramp, Mix, Noise, or Output). > Double-click a map type to apply it to sample slot. > Output rollout (displayed near the bottom of the Material Editor)

After applying a map and setting its internal parameters, you can adjust its output parameters to determine the final appearance of the map.

NOTE Most controls on the Output rollout are for color output, and don't affect [bump mapping](#) on page 5478. Only the Invert toggle is considered; it reverses the direction of the bumps.

Interface

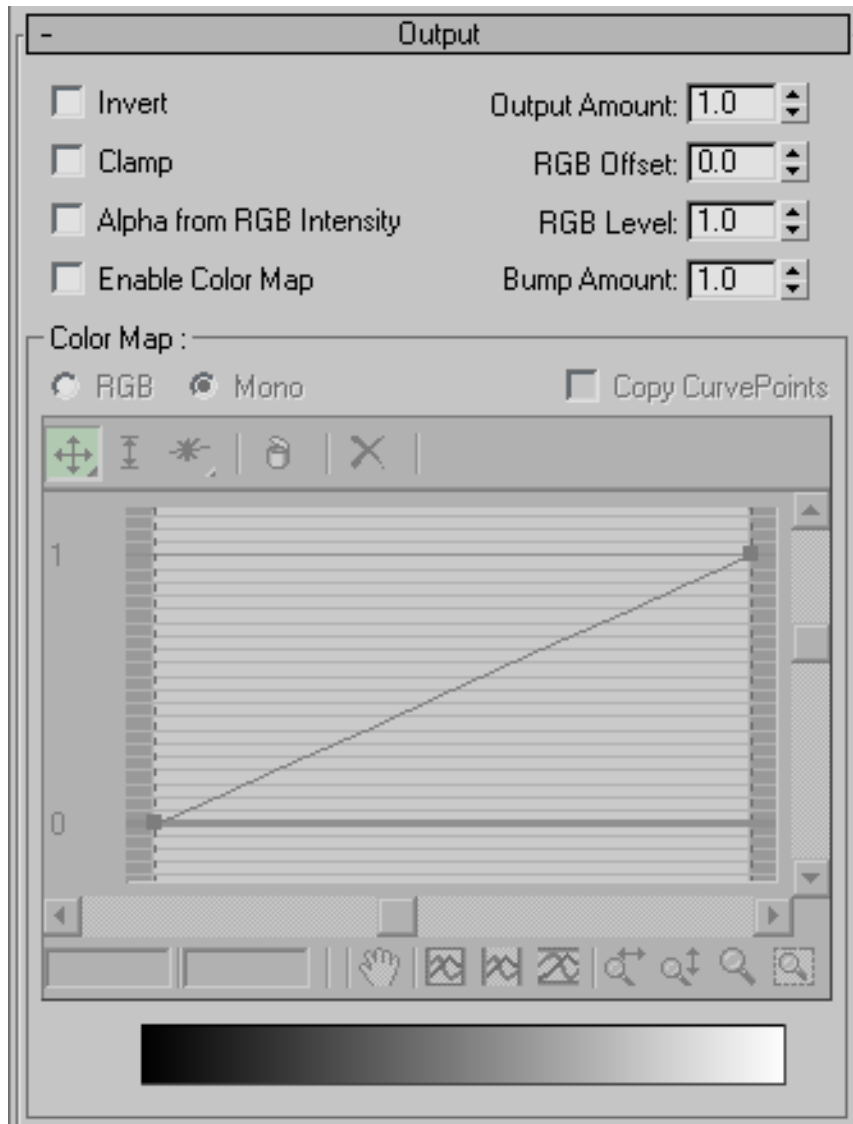

These controls appear on the Output rollout for a number of 2D and 3D maps:
Invert Reverses the hues of the map, like a negative color photo. Default=off.

Clamp When on, this parameter limits the values of the colors to no greater than 1.0. Turn this on when you're increasing the RGB Level, but don't want the map to appear self-illuminated. Default=off.

NOTE If you set the RGB Offset to a value greater than 1.0 while Clamp is on, all colors become white.

Alpha from RGB Intensity When on, an alpha channel is generated based on the intensity of the RGB channels in the map. Black becomes transparent and white becomes opaque. Intermediate values are translucent according to their intensity. Default=off.

Enable Color Map Turn on to use the Color Map. See “Color Map group.” Default=off.

Output Amount Controls the amount of the map being mixed into a composite material. Affects the saturation and alpha value of the map. Default=1.0.

RGB Offset Adds to the RGB values of the map colors by the amount set by the spinner, which affects the tonal value of the colors. Eventually the map becomes white and self-illuminated. Lowering the value decreases the tonal value toward black. Default=0.0.

RGB Level Multiplies the RGB values of the map colors by the amount set by the spinner, which affects the saturation of the color. Eventually the map becomes fully saturated and [self-illuminated](#) on page 8122. Lowering the value decreases the saturation and makes the map colors grayer. Default=1.0.

Bump Amount Adjusts the amount of bumpiness. This value has an effect only when the map is used as a bump map. Default=1.0.

For example, suppose you have a map instanced for both the Diffuse and the Bump components. If you want to adjust the amount of bumpiness without affecting the Diffuse colors, adjust this value, which changes the amount of bumpiness without affecting the map's use in other material components.

Color Map group

At the bottom of the Output rollout, the Color Map group is inactive until you turn on Enable Color Map.

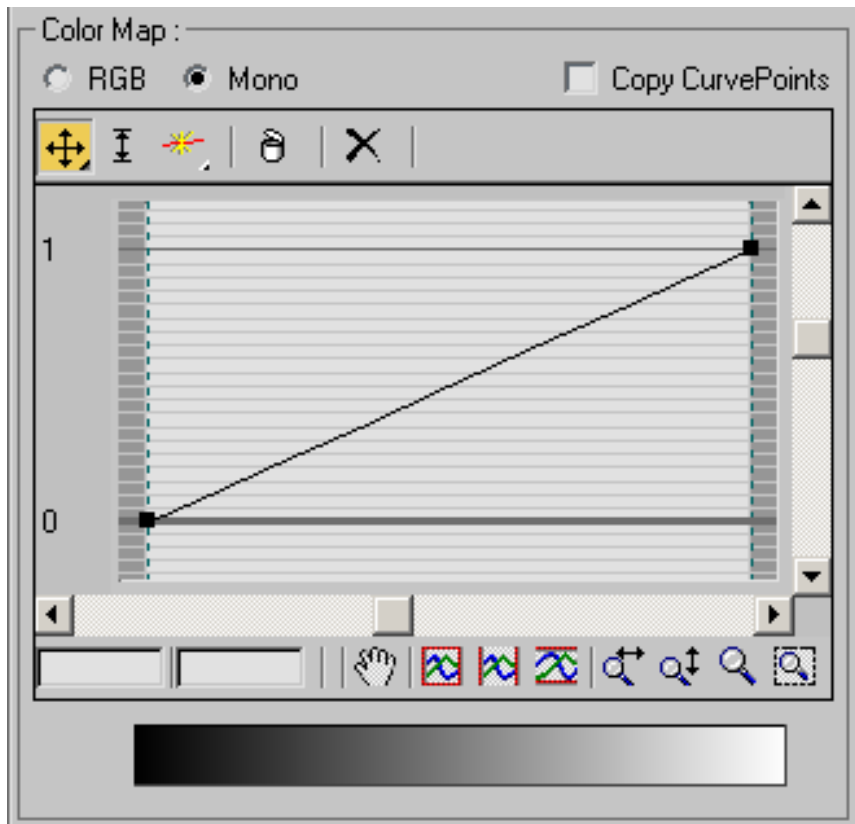

The Color Map graph lets you adjust the tonal range of an image. The point at 1,1 controls highlights, the point at 0.5,0.5 controls midtones, and the point at 0,0 controls shadows.

You adjust the shape of the graph by adding points to the line and moving or scaling them. You can add Corner, Bezier-Smooth, or Bezier-Corner points. When a move or scale option is active, points can be selected much like objects in a viewport, by clicking a point, dragging a region around one or more points, and holding down Ctrl to add or subtract from the selection.

When you select an individual point, its exact coordinates are displayed in the two fields below the graph at the lower left. You can enter values directly in these fields, but the values are automatically constrained as they are when you manually move or scale a point.

You can zoom into the graph to make detailed adjustments. As you zoom in, the graph updates to show decimal measurements along the left vertical axis.

You can pan anywhere on the graph with the horizontal and vertical scroll bars, use a button option, or the middle mouse button. Points can be deleted, and you can reset the graph to its default at any time.

RGB/Mono Specifies a map curve to either filter the RGB channels separately (RGB) or in combination (Mono).

Copy CurvePoints When turned on, points added to a Mono graph are copied when you switch to an RGB graph. If you start with an RGB graph, the points are copied to a Mono graph. You can animate the control points but not the Bezier handles.

IMPORTANT When Copy CurvePoints is on, animation created in Mono mode is carried over to RGB mode and you can switch channels. The reverse doesn't work.

The following controls affect the points on the graph:

Move flyout



Moves a selected point in any direction, limited by the unselected points on either side.



Constrains movement to the horizontal.



Constrains movement to the vertical.

On a Bezier smooth point, you can move the point or either handle.



Scale Point Changes the output amount of control points while maintaining their relative position. On a Bezier corner point, this control is effectively the same as a vertical move. On a Bezier smooth point, you can scale the point itself or either handle. As with the move controls, scale is limited by the unselected points on either side.

Add Point flyout



Adds a Bezier corner point anywhere on the graph line. The point makes a sharp angle when moved.



Adds a Bezier smooth point anywhere on the graph line. Handles attached to the point create smooth curves when moved.

When either Add Point button is active, you can use Ctrl+click to create the other type of point. This eliminates the need to switch between buttons.



Delete Point Removes selected points.



Reset Curves Returns graph to its default, a straight line between 0,0 and 1,1.

The following controls affect the view of the graph. The change in view does not affect the graph's results.



Pan Drags the graph in any direction within the viewing window.



Zoom Extents Shows the entire graph.



Zoom Horizontal Extents Shows the entire horizontal range of the graph. The scale of the curve will be distorted.



Zoom Vertical Extents Shows the entire vertical range of the graph. The scale of the curve will be distorted.



Zoom Horizontally Compresses or expands the graph in a horizontal direction.



Zoom Vertically Compresses or expands the view of the graph in a vertical direction.



Zoom Zooms in or out around the cursor.



Zoom Region Draws a rectangular region around any area of the graph, then zooms to that view.

Missing Map Coordinates Dialog

Material Editor > Assign a mapped material to an object that has no UVW Map modifier. > Map level > Coordinates rollout > Change Map Channel to a value other than 1. > Render

Menu bar > File menu > Open > One or more maps in MAX file can't be found.

The Missing Map Coordinates dialog is displayed when you attempt to render one or more objects with materials whose maps use a [map channel](#) on page 8032 other than channel 1. (Channel 1 is an exception because channel 1 mapping coordinates are automatically turned on when you assign a mapped material to an object.) Only maps with Show Map In Viewport toggled on are listed as missing.

To use other map channels, you must assign a [UVW Map modifier](#) on page 1931 to the object. In UVW Map, set Map Channel to match the value used in the material.

If the material has multiple maps that use multiple channels, you must assign a separate UVW Map modifier for each channel besides channel 1.

If the object is a [NURBS surface sub-object](#) on page 2423, you don't need to use UVW Map. Instead, set the map channel on the surface sub-object's [Material Properties rollout](#) on page 2364.

The Missing Map Coordinates dialog is also displayed when you open a MAX file that references bitmaps that can't be found in their original location, or are at a location not specified via the [Configure User Paths dialog](#) on page 7729. To open the MAX file, click the Browse button on the Missing Map Coordinates dialog. This opens the Configure User Paths dialog so you can assign one or more paths for the MAX file to access. These settings are then stored with the MAX file.

NOTE When you open a MAX file that references bitmaps that can't be found, you might also see a [Missing Map/Photometric Files dialog](#) on page 7130, which lets you browse for the missing files.

Interface

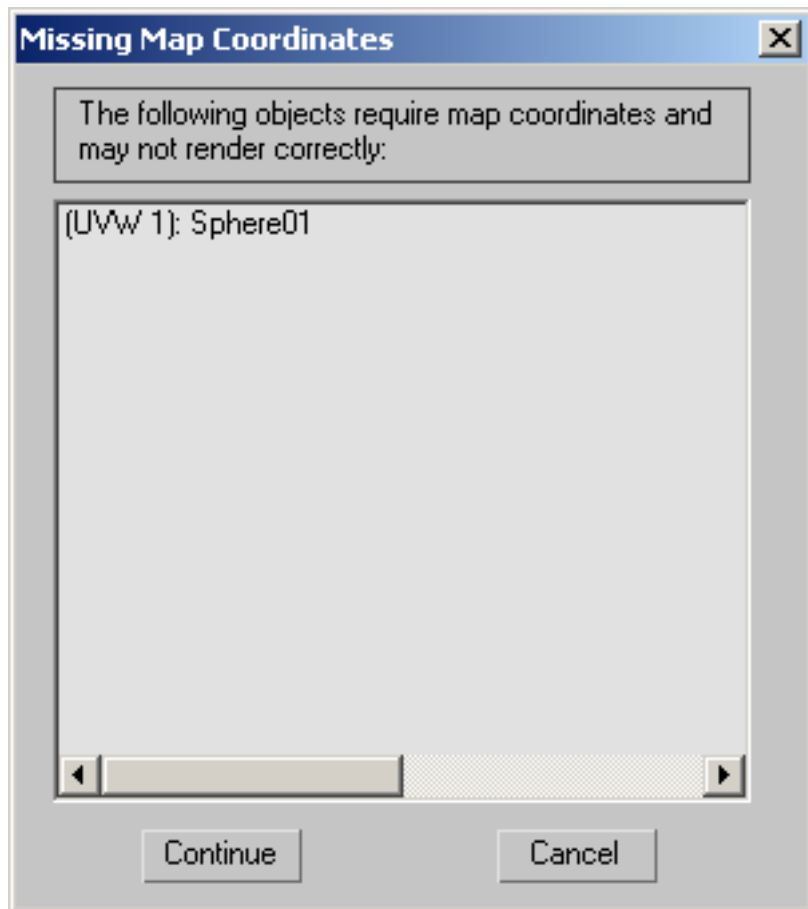

The list shows the map channel followed by the name of the object.

Continue Proceeds with the rendering. The objects listed will not show maps in the material assigned to them, and might not be visible at all.

Cancel Cancels rendering.

2D Maps

2D Maps are two-dimensional images that are typically mapped onto the surface of geometric objects, or used as environment maps to create a background for the scene. The simplest 2D maps are bitmaps; other kinds of 2D maps are generated procedurally.

Bitmap on page 5795: An image saved as an array of pixels in one of a number of still-image file formats, such as *.tga*, *.bmp*, and so on, or an animation file such as *.avi*, *.mov*, or *.iff*. (An animation is essentially a sequence of still images.) You can use any bitmap (or animation) file type that 3ds Max supports as a bitmap in a material.

Checker on page 5808: Combines two colors in a checker pattern. You can replace either color with a map.

Combustion on page 5811: Works in conjunction with the Autodesk Combustion product. You can paint directly on a bitmap or object and have the result update in the Material Editor and viewports. The map can include other Combustion effects. Painting and other effects can be animated.

Gradient on page 5835: Creates a linear or radial ramp of three colors.

Gradient Ramp on page 5840: Creates a great variety of ramps, using as many colors, maps, and blends as you choose.

Swirl on page 5848: Creates swirled (spiraling) patterns of two colors or maps.

Tiles on page 5851: Creates bricks or other tiled materials with colors or material mappings. Includes commonly defined architectural brick patterns, but you can also customize patterns.

Coordinates Rollout (2D)

Material Editor > Select sample slot. > Get Material > Material/Map Browser > Turn on 2D Maps. > Double-click a map type to apply it to sample slot. > Coordinates rollout is displayed on the Material Editor.

In the Coordinates rollout, by adjusting coordinate parameters, you can move a map relative to the surface of the object to which it is applied and achieve other effects.

Tiling

Often when you apply a bitmap, especially as a texture pattern, you want the pattern to repeat. This effect is known as *tiling*, as in a tiled floor or fountain. You control tiling directly from the Coordinates rollout for any 2D map.



Tiling a map

In default mapping, tiling is active, but because the map is scaled to fit the object, you don't see the effect of tiling unless you offset the UV coordinates or rotate the map. In this case, the portions of the surface from which the bitmap has moved away are filled by other portions of the map. Tiling wraps the object with the map image.

Mirroring

Mirroring a map is an effect related to tiling. It repeats the map and flips the repeated copy.

As with tiling, you can mirror in the U dimension, the V dimension, or both. The Tiling parameter for each dimension specifies how many copies of the map are shown. Each copy is flipped relative to its neighbors.



Mirroring a map

Tiling and Mirroring Combined

Because mirroring defaults to two reflected images of the map, the meaning of the Tiling value differs when Mirror is set.

In a single mapping dimension (U or V), a value of 1.0, the default, shows two copies of the bitmap; a value of 2.0 shows four copies; a value of 1.5 shows three copies; and so on. Mirroring in both dimensions multiplies the effect.

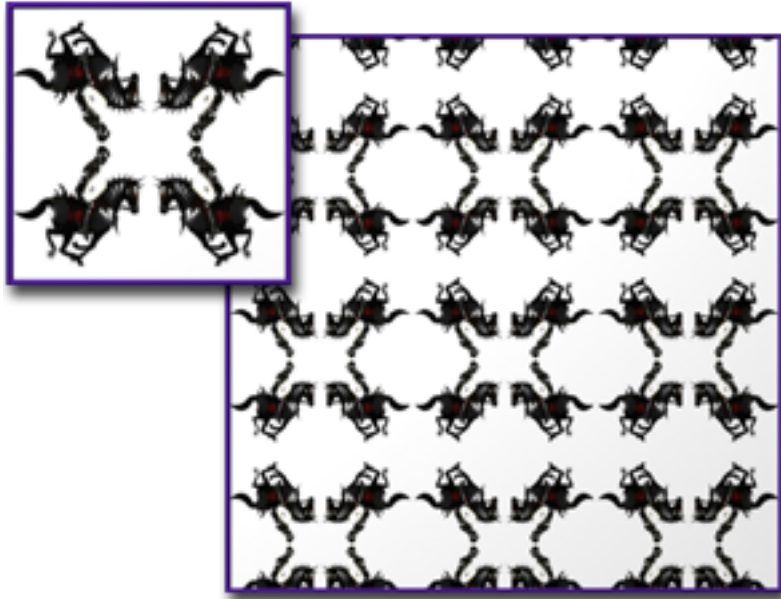

Mirroring and tiling a map

Decals

Decals are useful for mapping single designs, small elements such as stickers, or light switches.

A 2D map used as a decal appears only once and is not repeated as with tiling. Wherever the decal doesn't appear on the surface, the surface is rendered as a basic material, with the component colors specified at the material level. With map trees, a decal might appear on top of a different bitmap or other map type.



Decal mapping

Procedures

To set tiling:

- 1 In the Coordinates rollout, make sure Use Real-World Scale is turned off and Tile is turned on for the U or V coordinate, or for both.
- 2 In the Coordinates rollout, make sure Tile is turned on for the U or V coordinate, or for both.
- 3 Set the Tiling value for the corresponding coordinates.
In the Material Editor, the sample slot changes to show the tiling value you chose.

- The Tiling value is the number of times the bitmap repeats along the specified dimension. A value of 1.0, the default, maps the bitmap exactly once; a value of 2.0 maps the bitmap twice, and so on. Fractional values map a fractional portion of the bitmap in addition to copies of the whole map. For example, a value of 2.5 maps the bitmap two and a half times.
- Tiling values less than one increase the size of the map relative to the object. For example, a value of 0.5 maps half of the bitmap.
- Tiling is uniform if both the U and V dimensions are tiled by the same amount.

To preview the effect of tiling:



- In the Material Editor, use the Tiling flyout to choose a 1x, 2x, 3x, or 4x tiling preview.

The button you choose changes tiling in the active sample slot to 1.0, 2.0, 3.0, or 4.0 in both U and V.

The flyout setting has no effect on the material or its mapping. It does not change the Tiling value or the check box setting. It only helps you preview the effect of changing these settings.

To set mirroring:

- 1 On the Coordinates rollout, make sure Mirror is turned on for the U or V coordinate, or both.

Mirror and Tile are exclusive settings: if one is set when you choose the other, the original setting turns off.

- 2 Set the Mirror value for the corresponding coordinate or coordinates.

The material preview changes to show the Mirror value you chose.

To create a decal:

- 1 In the Material Editor, choose a bitmap as a diffuse map.
- 2 On the map's Coordinates rollout, turn off both Mirror and Tile for both the U and V coordinates. Change the mapping to Planar from Object XYZ.
- 3 Adjust the U and V Tiling parameters to scale the decal.
Changing the Tiling value changes the size of the mapped bitmap as it does when you tile the map, but with Mirror and Tile turned off, the bitmap appears only once.
- 4 Adjust the U and V Offset parameters to position the decal.

NOTE You can also use the Parameters rollout's Cropping and Placement controls to achieve a decal effect.

To offset the position of a map:

- 1 In the Coordinates rollout, make sure Use Real-World Scale is turned on.

- 2 On the Coordinates rollout, set the U and V values to be between 0.0 and 100, or between -100 and 0.0.
- 3 Set the Offset Width and Height values to be between 0.0 and 100, or between -100 and 0.0.

On the surface of the object, the map shifts in the directions you chose.

UV offsets are especially useful when you have turned tiling off and want the bitmap to appear in a single location.

To rotate the map:

- On the Coordinates rollout, set the Angle U, V, and W spinners. Positive angles rotate the map in the clockwise direction; negative angles rotate it counterclockwise.
The angle can be up to 360 degrees, which rotates the map completely and has no visible effect unless you are animating the map's rotation.
You can also click Rotate to use the Rotate Mapping Coordinates dialog, which lets you change the rotation by dragging the mouse.

To increase or decrease antialiasing:

- On the map's Coordinates rollout, increase or decrease the Blur value. For diffuse maps and other maps besides bump maps, the Blur value is most effective in the 0.5-20 range. Lower values decrease antialiasing; higher values increase it.
The Blur Offset parameter adjusts the image before antialiasing Blur is applied. If all you need is antialiasing, leave Blur Offset at its default of 0.0.

To make a map image fuzzier:

- On the map's Coordinate's rollout, increase the Blur Offset value. Blur Offset is a very strong parameter. The Blur Offset spinner has increments of 0.001. Values greater than 0.1 are likely to be too high.

To make a map image sharper:

- On the map's Coordinates rollout, decrease the Blur Offset value to a value below 0.0.
The negative Blur Offset value sharpens the image.

Interface

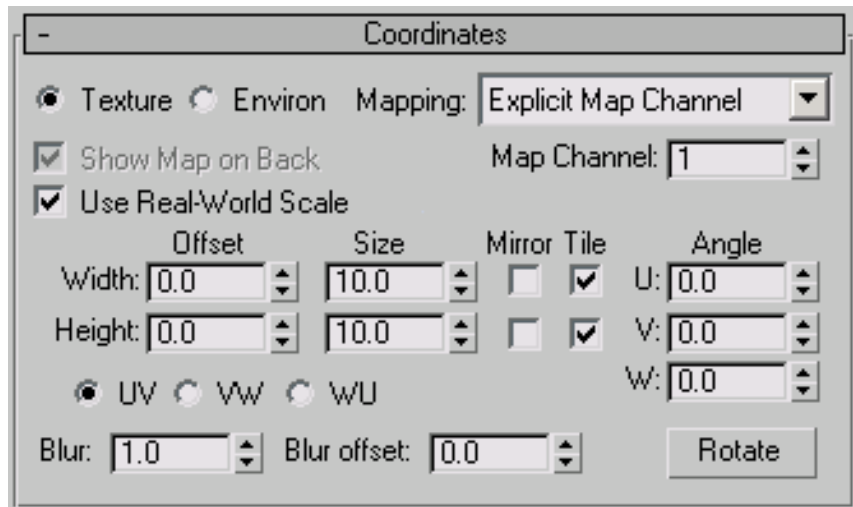

These controls appear on the Coordinates rollout for many 2D maps:

Texture Applies the map as a texture map to a surface. Select the type of coordinates from the Mapping list:

Environ Uses the map as an [environment map](#) on page 7964. Select the type of coordinates from the Mapping list:

Mapping list Options vary depending on choice of Texture or Environ mapping:

- **Explicit Map Channel** Uses any map channel. When selected, the Map Channel field becomes active, and you can choose any channel from 1 to 99.
- **Vertex Color Channel** Uses assigned vertex colors as a channel. See [Editable Mesh](#) on page 2075 for details on assigning vertex color. See also [Vertex Color Map](#) on page 5943 and [Assign Vertex Colors Utility](#) on page 6038.
- **Planar from Object XYZ** Uses planar mapping based on the object's local coordinates (disregarding the pivot point location). For rendering purposes, planar mapping doesn't project through to the back of the object unless you turn on Show Map On Back.
- **Planar from World XYZ** Uses planar mapping based on the scene's world coordinates (disregarding the object's bounding box). For rendering

purposes, planar mapping doesn't project through to the back of the object unless you turn on Show Map On Back.

- **Spherical Environment, Cylindrical Environment, Shrink-wrap Environment** Project the map into the scene as though it were mapped to an invisible object in the background. See [Environment Map](#) on page 7964.
- **Screen** Projects as a flat backdrop in the scene.

Show Map on Back When on, planar mapping (Planar from Object XYZ, or with the UVW Map modifier) projects through to render on the back of the object. When off, planar mapping doesn't render on the object's back. Default=on.

This toggle is available only when Tiling is off in both dimensions. Its effect is visible only when you render the scene.

NOTE In viewports, planar mapping always projects to the back of the object, whether Show Map On Back is turned on or not. To override this, turn off Tiling.

Use Real-World Scale When turned on, applies the map to objects using the real-world Width and Height values instead of UV values. Default=on.

When Real-World Scale is on, the texture placement is relative to the corner of the texture map so alignment with architectural objects like walls is more efficient. When off, the texture placement is relative to the center of the texture map.

Offset Changes the position of the map in [UV coordinates](#) on page 8161. The map moves in relation to its size. For example, if you want to shift the map its full width to the left, and half its width downward from its original position, you enter **-1** in the U Offset field and **0.5** in the V offset field.

UV/VW/WU Changes the [mapping coordinate](#) on page 8034 system used for the map. The default UV coordinates project the map onto the surface like a slide projector. The VW and WU coordinates rotate the map so that it is perpendicular to the surface.

Tiling Determines the number of times the map is [tiled](#) on page 8148 (repeated) along each axis.

Mirror Mirrors on page 8148 the map left-to-right (U axis) and/or top-to-bottom (V axis).

Tile Turns tiling on or off in the U or V axis.

When Use Real-World Scale is off

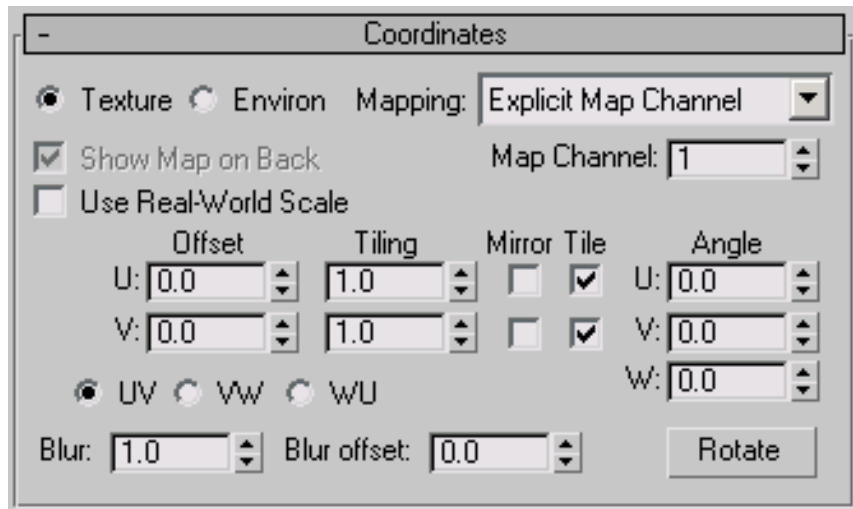

Offset (UV) Changes the position of the map in [UV coordinates](#) on page 8161. The map moves in relation to its size. For example, if you want to shift the map its full width to the left, and half its width downward from its original position, you enter **-1** in the U Offset field and **0.5** in the V offset field.

UV/VW/WU Changes the [mapping coordinate](#) on page 8034 system used for the map. The default UV coordinates project the map onto the surface like a slide projector. The VW and WU coordinates rotate the map so that it is perpendicular to the surface.

Tiling Determines the number of times the map is [tiled](#) on page 8148 (repeated) along each axis.

Mirror [Mirrors](#) on page 8148 the map left-to-right (U axis) and/or top-to-bottom (V axis).

Tile Turns tiling on or off in the U or V axis.

When Use Real-World Scale is on

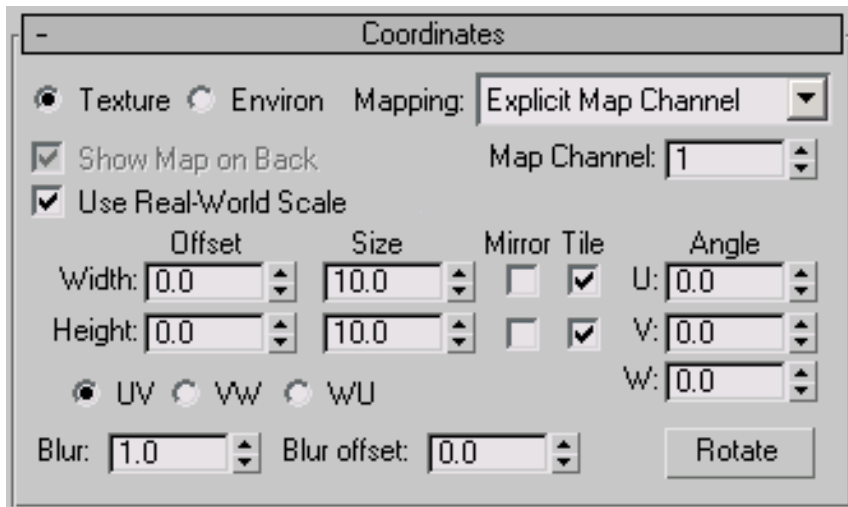

Offset (Width/Height) Move the map horizontally or vertically along the width or height of the object to which the material is applied. The offset distance is relative to the lower-left corner of the map.

UV/VW/WU Changes the [mapping coordinate](#) on page 8034 system used for the map. The default UV coordinates project the map onto the surface like a slide projector. The VW and WU coordinates rotate the map so that it is perpendicular to the surface.

Size Determines the real world width and height of the map.

For example, if you scan a piece of marble that is 12" x 8" and then assign this image as the Diffuse Map, you can type 12" (or 1') and 8" as the Width and Height. This ensures that the scale of the marble is correct in the rendered scene.

NOTE The default setting for the texture size can be set using the Default Texture Size option in the [Material Editor Options Dialog](#) on page 5335.

Mirror [Mirrors](#) on page 8148 the map horizontally and/or vertically.

Tile Turns horizontal and/or vertical tiling on or off.

NOTE If the Use Real-World Size switch is turned off in the Material Editor, the Real-World Map Size settings in modifiers like UVW Map or for primitives like Box will not work. Likewise, moving vertices at a sub-object level or scaling an object, in general, will not honor the Use Real-World Scale settings.

Angle U/V/W Rotates the map about the U, V, or W axis (in degrees).

Rotate Displays a schematic Rotate Mapping Coordinates dialog that lets you rotate the map by dragging on an arcball diagram (similar to the arcball used to rotate viewports, although dragging inside the circle rotates along all three axes, and dragging outside it rotates about the W axis only). The Angle UVW values change as you drag in the dialog.

Blur Affects the sharpness or blurriness of the map based on its distance from the view. The farther away the map is, the greater the blurring. The Blur value blurs maps in world space. Blur is primarily used to avoid [aliasing](#) on page 7904.

Blur Offset Affects the sharpness or blurriness of the map without regard to its distance from the view. Blur Offset blurs the image itself in object space. Use this option when you want to soften or defocus the details in a map to achieve the effect of a blurred image.

See [Blur/Blur Offset](#) on page 7928.

Noise Rollout (2D)

Material Editor > Select sample slot. > Get Material > Material/Map Browser > Turn on 2D Maps. > Select a map type. > Drag map from Browser thumbnail to sample slot. > Noise rollout is displayed in the Material Editor.

You can add a random noise to the appearance of your material. Noise perturbs the UV mapping of pixels by applying a fractal noise function.

Noise patterns can be very complex and are a versatile way to create apparently random patterns. They are also good for simulating surfaces found in nature, as is characteristic of fractal images.

Noise parameters interact closely with each other. Slight variations in each can create noticeably different effects.

NOTE Noise settings aren't displayed in viewports.

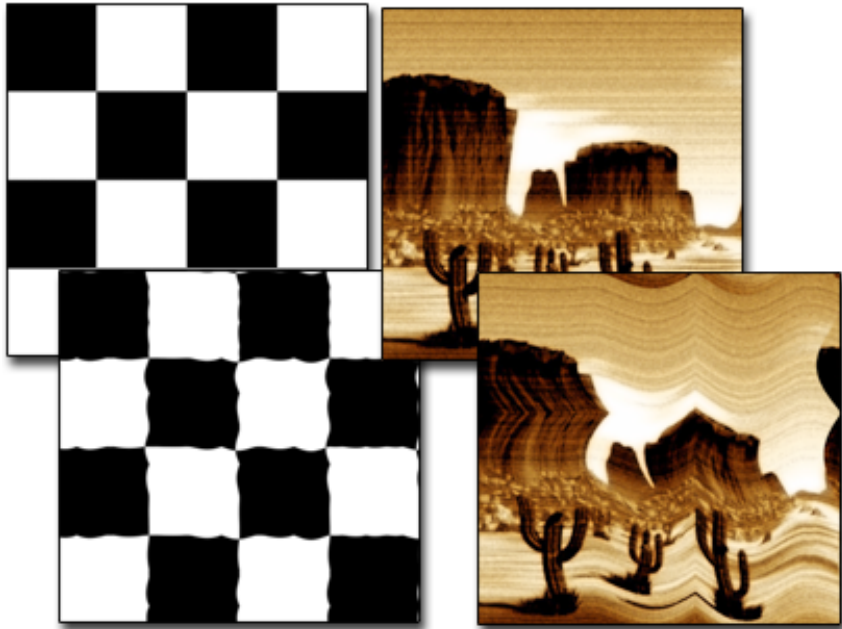

Above: A checker map and a bitmap

Below: The same maps with noise applied

Procedures

To add noise to a material:

- 1 In the Noise rollout, select On.
- 2 Adjust the three noise parameters to get an effect you like.

To remove noise from a material:

- In the Noise rollout, turn off On.
Noise is no longer applied to the map.

To animate the noise effect:

- 1 Turn on the Auto Key button.
- 2 Move to a non-zero frame.
- 3 In the Noise rollout, turn on Animate.

By default, animation keys are set at either end of the active frame range.

4 Change the Phase value at different keyframes.

Interface

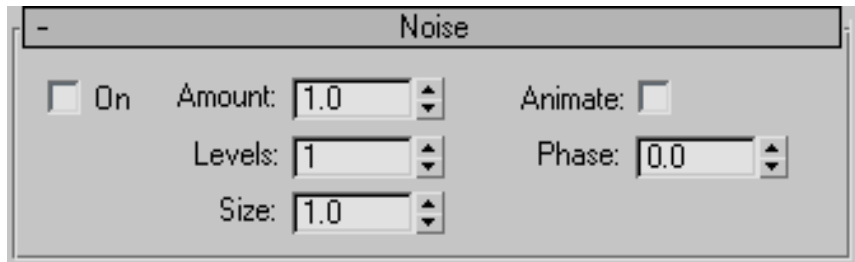

These controls appear on the Noise rollout for many 2D maps:

On Determines whether the Noise parameters affect the map.

Amount Sets the strength of the fractal function, expressed as a percentage. If the amount is 0 there is no noise. If the amount is 100 the map becomes pure noise. Default=1.0.

Levels Or iterations: the number of times the function is applied. The effect of the level is dependent on the Amount value. The stronger the amount, the greater the effect of increasing the Levels value. Range=1 to 10; Default=1.

Size Sets the scale of the noise function relative to geometry. At very small values, the noise effect becomes white noise. At large values, the scale can exceed the scale of the geometry, in which case it has little or no effect. Range=0.001 to 100; Default=1.0.

Animate Determines whether animation is on the noise effect. This parameter must be turned on if you intend to animate the noise.

Phase Controls the speed of the animation of the noise function.

Bitmap 2D Map

Material Editor > Maps rollout > Click a Map button. > Material/Map Browser > Bitmap



Bitmaps shown in Material Editor sample slots

A *bitmap* is an image produced by a fixed matrix of colored pixels, like a mosaic. Bitmaps are useful for creating many kinds of materials, from wood grains and wall surfaces to skin and feathers. You can also use an animation or video file instead of a bitmap to create an animated material.

When you assign the Bitmap map, the [Select Bitmap Image File dialog](#) on page 5804 opens automatically. Use this dialog to specify a file or sequence as the bitmap image.

The Bitmap map can synchronize the frames of a bitmap sequence to the age of particles to which the map is applied. With this effect, each particle displays the sequence from the start when it is born, rather than being assigned whichever frame is current. This is achieved by turning on the [Sync Frames To Particle Age check box](#) on page 5364. Also, when using Particle Flow, assign the material containing the Bitmap map to a Material Dynamic operator. For more details and a procedure, see [Material Dynamic Operator](#) on page 2925.

NOTE To save loading time, if a map with the same name is in two different locations (in two different paths), it is loaded only once. This poses a problem only if your scene includes two maps that have different content but the same name. In this case, only the first map encountered will appear in the scene.

Supported File Types

The Material Editor supports the following file formats:

[AVI files](#) on page 7326

[BMP files](#) on page 7328

[CIN files \(Kodak Cineon\)](#) on page 7328

[DDS files](#) on page 7330

[GIF files](#) on page 7334

[IFL files](#) on page 7339

[JPEG files](#) on page 7347

[MOV files \(QuickTime Movies\)](#) on page 7348

[MPEG files](#) on page 7348

[PNG files](#) on page 7360

[PSD files](#) on page 7361

[RGB files \(SGI format\)](#) on page 7369

[RLA files](#) on page 7364

[RPF files](#) on page 7366

[TGA files \(Targa\)](#) on page 7370

[TIFF files](#) on page 7372

[YUV files](#) on page 7374

NOTE If your scene includes animated bitmaps with materials, projector lights, or environments, the animation file is reloaded once per frame. If your scene uses multiple animations, or if the animations are large files, rendering will be slower.

See also:

- [Coordinates Rollout \(2D\)](#) on page 5782
- [Noise Rollout \(2D\)](#) on page 5793
- [Output Rollout](#) on page 5774

Procedures

To crop an image:

- 1 On the Bitmap Parameters rollout, click the Bitmap button and assign a bitmap.
- 2 In the Cropping/Placement group, turn on Apply to see the results of cropping in the sample slot (and in shaded viewports, if Show Map In Viewport is active).
- 3 Turn on Crop.
- 4 Click View Image to display the bitmap.
A frame window appears, displaying the image surrounded by a region outline (a dashed line at the outer edges of the image, with handles on the sides and corners).
- 5 Specify a cropping region by adjusting the spinners at the top of the window, or by dragging the region outline.

To place an image:

- 1 On the Bitmap Parameters rollout, click the Bitmap button and assign a bitmap.
- 2 In the Cropping/Placement group, turn on Apply to see the results of cropping in the sample slot (and in shaded viewports if Show Map In Viewport is active).
- 3 Turn on Place.
- 4 Click View Image.
A frame window appears, displaying the image surrounded by a region outline (a dashed line at the outer edges of the image, with handles on the sides and corners).
- 5 Move the image by adjusting the spinners at the top of the window, or by dragging the region outline.
The reduced image "decals" on the sample sphere. The diffuse color is visible around the image.

To use the alpha channel that is part of the bitmap:

- 1 On the Maps rollout, assign the map to the Opacity component.

(You can assign a copy or instance of this map to other components, such as Diffuse, as well.)

- 2 Click the map button for the Opacity component.
This lets you adjust the settings for the Opacity map.
- 3 In the Bitmap Parameters rollout > Alpha Source group, choose Image Alpha.
This option is not available if the bitmap does not have an alpha channel.
- 4 In the Bitmap Parameters rollout > Mono Channel Output group, choose Alpha.
This option is not available if the bitmap does not have an alpha channel.
The bitmapped material will now have the transparency specified by the alpha channel. This will appear in renderings. Transparency does not appear in viewports or ActiveShade renderings.

To create an alpha channel based on intensity:

- In Bitmap Parameters rollout > Alpha Source group, turn on RGB Intensity. The software creates an alpha channel. Full-intensity areas of the image are opaque, zero-intensity areas are transparent, and intermediate colors become partially transparent.

To use a completely opaque bitmap:

- In Bitmap Parameters rollout > Alpha Source group, turn on None (opaque). The software ignores the bitmap's alpha channel, if present, and does not create a new one.

Interface

Bitmap Parameters rollout

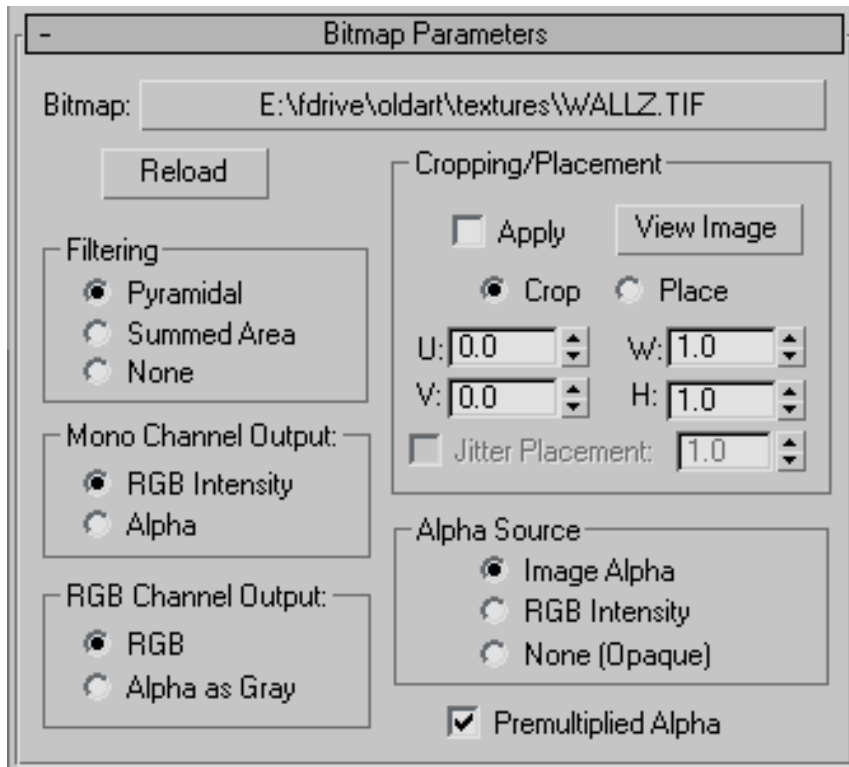

Bitmap Selects the bitmap using the standard file browser. After selection, the full path name appears on this button.

Reload Reloads the bitmap file using the same name and path. You don't need to use the file browser to reload the bitmap after you've updated it in your paint program.

Clicking reload for any instance of the map updates the map in all sample slots and in the scene.

Filtering group

[Filtering](#) on page 7977 options let you select the method of pixel averaging used in [antialiasing](#) on page 7904 the bitmap.

Pyramidal Requires less memory and is adequate for most purposes.

Summed Area Requires much more memory, but yields generally superior results.

None Turns off filtering.

Mono Channel Output group

Some parameters, such as opacity or specular level are a single value as opposed to a material's three-value color components. Controls in this group determine the source of the Output mono channel in terms of the input bitmap.

RGB Intensity Uses the intensity of the red, green, and blue channels for mapping. The color of the pixels is ignored and only the value or luminance of the pixels is used. The colors are computed as gray values in the range between 0 (black) and 255 (white).

Alpha Uses the intensity of the [alpha channel](#) on page 7905 for mapping.

RGB Channel Output group

The RGB Channel Output determines where the output RGB part comes from. The controls in this group affect only maps for material components that display color: Ambient, Diffuse, Specular, Filter Color, Reflection, and Refraction.

RGB Displays the full color values of the pixels. (Default)

Alpha as Gray Displays tones of gray based on the levels of the alpha channel.

Cropping/Placement group

The controls in this group let you crop the bitmap or reduce its size for custom placement. Cropping a bitmap means to reduce it to a smaller rectangular area than it originally had. Cropping doesn't change the scale of the bitmap.

Placing a bitmap lets you scale the map and place it anywhere within its tile. Placing can change the bitmap's scale, but shows the entire bitmap. The four values that specify the placement and size of the cropping or placement region are all animatable.

Cropping and placement settings affect the bitmap only as it's used for this map and any instances of the map. They have no effect on the bitmap file itself.

Apply Turn on to use the cropping or placements settings.

View Image Opens a window that shows the bitmap surrounded by a region outline with handles at its sides and corners. To change the size of the crop area, drag the handles. To move the region, position the mouse cursor inside it and drag.

To see the results of editing the region, turn on Apply (see preceding). This shows changes in the region as you make them.

The bitmap window has U/V and W/H (width/height) controls on its toolbar. Use these to adjust the location and size the image or crop area.

When Place is chosen, dragging the region area handles changes the scale of the bitmap (hold down Ctrl to preserve the bitmap's aspect ratio), and dragging the image changes its location within the tile area.

The UV/XY button at the right of the window toolbar lets you switch between using UV or XY coordinates in the toolbar spinners (Default=UV). .

Crop Makes cropping active.

Place Makes placement active.

U/V Adjusts the bitmap location.

W/H Adjusts the width and height of the bitmap or crop area.

Jitter Placement Specifies the amount of random offset. At 0, there is no random offset. Range = 0.0 to 1.0

When Place is turned on, the size and position specified by the spinners or editing window are ignored. The software then chooses a random size and tile position for the image.

Alpha Source group

Controls in this group determine the source of the Output alpha channel in terms of the input bitmap.

Image Alpha Uses the image's alpha channel (disabled if the image has no alpha channel).

RGB Intensity Converts the colors in the bitmap to grayscale tonal values and uses them for transparency. Black is transparent and white is opaque.

None (Opaque) Does not use transparency.

Premultiplied Alpha Determines how alpha is treated in the bitmap. When turned on, the default, [premultiplied alpha](#) on page 8096 is expected in the file. When turned off, the alpha is treated as non-premultiplied, and any RGB values are ignored.

TIP If you apply an alpha image as a Diffuse map, for example, and it doesn't decal correctly, the bitmap file probably contains non-premultiplied alpha; the RGB values are maintained separately from the alpha values. To correct this, turn off Premultiplied Alpha.

Time rollout

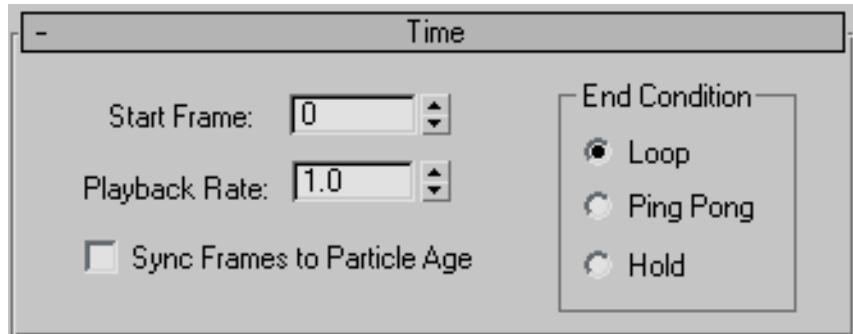

These controls let you change the start time and speed of animation ([AVI](#) on page 7326 or [MOV](#) on page 7348) files used as animated texture maps. They make it easier to use sequences of images as maps in scenes, because you can control the timing very precisely

Start Frame Specifies the frame where the playback of the animated map will begin.

Playback Rate Lets you speed up and slow down the rate that the animation is applied to the map (for example, 1.0 is normal speed, 2.0 is twice as fast, .333 is 1/3 as fast).

Sync Frames to Particle Age When on, the software synchronizes the frames of a bitmap sequence to the age of particles to which the map is applied. With this effect, each particle displays the sequence from the start when it is born, rather than being assigned whichever frame is current. Default=off.

When using Particle Flow, assign the material containing the Bitmap map to a Material Dynamic operator. For more details and a procedure, see [Material Dynamic Operator](#) on page 2925.

NOTE This functionality is not supported by the mental ray renderer.

End Condition group

Determines what happens after the last frame of the bitmap animation if the animation is shorter than the scene.

Loop Causes the animation to repeat over and over again from the beginning.

Ping-Pong Causes the animation to be played forward and then backward repeatedly, making every animated sequence "loop smoothly."

Hold Freezes on the last frame of the bitmap animation.

Select Bitmap Image File Dialog

Material Editor > Maps Rollout > Click any map selector button. > Material/Map Browser > Double-click Bitmap. > Select Bitmap Image.

Material Editor > Bitmap map > Bitmap Parameters rollout > Bitmap button

The Select Bitmap Image dialog allows you to choose a file or sequence of files for a map. If a sequence of files is selected by turning on Sequence, the [Image File List Control dialog](#) on page 7342 is opened when you click Setup or Open.

Procedures

To select a bitmap image for a map:

- 1 In the Material Editor, open the Maps rollout.
- 2 Click any button in the Map column.
This adds a map into the channel you've selected. For example, clicking in the Map column of the Diffuse channel creates a diffuse or texture map.
The Material Map Browser is displayed.
- 3 In the Material/Map Browser, double-click Bitmap.
The Select Bitmap Image dialog is displayed.
- 4 In the Select Bitmap Image dialog, navigate the Look In field to select the appropriate directory.

NOTE The Select Bitmap Image File dialog uses the last location where a bitmap was chosen, rather than the default bitmap path defined in Customize > Configure User Paths.

- 5 Highlight the file name in the file list window.
- 6 Click Open to close the dialog.

To select a set of still images as a bitmap sequence:

- 1 In the Material Editor, open the Maps rollout.
- 2 Click any button in the Map column.
This adds a map into the channel you've selected. For example, clicking in the Map column of the Diffuse channel creates a diffuse or texture map.
The Material Map Browser is displayed.
- 3 In the Material/Map Browser, double-click Bitmap.
The Select Bitmap Image dialog is displayed.
- 4 In the Select Bitmap Image dialog, navigate the Look in field to select the directory containing the sequence of files.
- 5 If necessary, change file type to match the file extension of the sequence, or choose All Formats.
- 6 Turn on Sequence, and choose the name of the first sequential file.
- 7 Click the Setup button.
The Image File List Control Dialog opens.
- 8 Click the Browse button and set the Target path to a writable directory on your hard disk. Do not set the path to a CD-ROM drive.
- 9 Choose the options you want and click OK.
The IFL file is written to the target directory.

Interface

TIP You can resize the dialog by dragging an edge or a corner.



History Displays a list of the most recent directories searched. Whenever an image is selected, the path used is added to the top of the history list as the most recently used path. The history information is saved in the *3dsmax.ini* on page 83 file.

Look In Opens a navigation window to browse other directories or drives.



Up One Level Moves you up a level in the directory structure.



Create New Folder Lets you create a new folder while in this dialog.



List Displays the contents of a directory without the details.



Details Displays the contents of a directory with all the details.

List Window When details are turned on, the contents of the directory are displayed with Name, Size, Type, Date Modified, and Attributes. You can sort based on each of these columns by clicking the column label.

File Name Displays the file name of the file selected in the list.

Files of Type Displays all the file types that can be displayed. This serves as a filter for the list.

Open Selects the highlighted file and closes the dialog.

Cancel Cancels the selection and closes the dialog.

Devices Lets you choose the hardware output device, for example, a digital video recorder. The device, its driver, and its 3ds Max plug-in must all be installed on your system to use the device.

Setup When Sequence is turned on, and there are sequential files in the directory displayed, this Setup displays an [Image File List Control dialog](#) on page 7342 to create an IFL file.

Info Displays expanded information about the file, such as frame rate, compression quality, file size, and resolution. The information here depends on the type of information that is saved with the file type.

View Displays the file at its actual resolution. If the file is a movie, the Media Player is opened so the file can be played.

Gamma Group

These controls are unavailable unless Enable Gamma Correction is turned on in the [Gamma panel](#) on page 7758 of the Preferences dialog.

Gamma Selects the type of gamma to be used for the selected file.

Use Image's Own Gamma Uses the gamma of the incoming bitmap.

Use System Default Gamma Ignores the image's own gamma and uses the system default gamma instead, as set in the Gamma panel of the Preferences dialog.

Override Defines a new gamma for the bitmap that is neither the image's own, nor the system default.

NOTE In general, it is less confusing to use the System Default Gamma for incoming bitmaps. But if you are using bitmaps created (or edited) by a variety of other programs, and need to adjust gamma differently for each program, then use Override.

Sequence Creates an "Image File List " using the given information. Note that each time an image is selected, an evaluation is done to see if an IFL sequence can be created. If the selected image does not yield a list, this option box is unavailable. In the past, it was necessary to enter a wild card in order to create a list. Now it is possible to use wild card to filter files in the file selector.

Preview Displays the image as a thumbnail in the image window.

Image Window Displays a thumbnail of the selected file.

Statistics Displays the resolution, color depth, file type, and number of frames of the selected file.

Location Displays the full path for the file. With this information at the bottom of the dialog, you always know exactly where you are.

Checker Map

Material Editor > Maps rollout > Click a Map button. > Material/Map Browser > Checker



Checker map used for the tablecloth and (in a composite) for the floor of the ice-cream shop

The Checker map applies a two-color checkerboard pattern to the material. The default checker map is a pattern of black and white squares. Checker maps are 2D procedural maps. The component checkers can be either colors or maps.

TIP Turning on Noise for a Checker map can be an effective way to create irregular patterns with a natural appearance.

See also:

- [Coordinates Rollout \(2D\)](#) on page 5782
- [Noise Rollout \(2D\)](#) on page 5793

Procedures

To create a Checker map:

- 1 Click a map button to assign a map.

- 2 Choose Checker in the Material/Map browser, and then click OK.

To change the color of one set of squares:

- 1 In the Checker Parameters rollout, click a color swatch to display the [Color Selector](#) on page 391.
- 2 Adjust the color.
- 3 Click Close.

To use a map for one set of squares:

- In the Checker Parameters rollout, click a map button to assign a map to a color.

To soften the edge between the two checker colors:

- In the Checker Parameters rollout, increase the value of Soften.
When Soften equals 0.0, there is a hard edge between the checker colors. Low positive values soften or blur the checker boundary. Larger Soften values can blur the entire material.

To swap the two checker components:

- In the Checker Parameters rollout, click Swap.

Interface

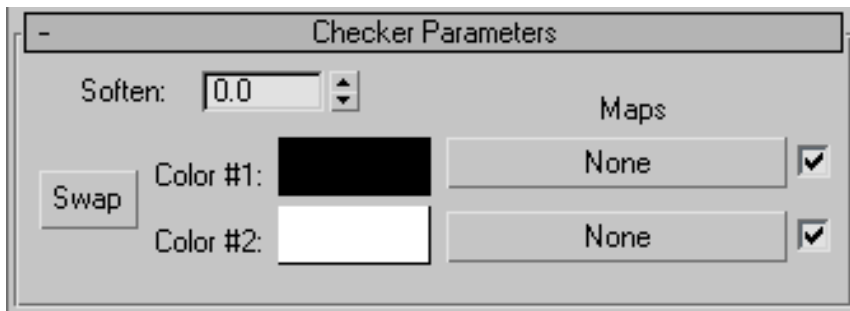

Soften Blurs the edges between the checkers. A little blurs a lot.

Swap Switches the position of the two checkers.

Color #1 Sets the color of one of the checkers. Click to display the [Color Selector](#) on page 391.

Color #2 Sets the color of one of the checkers. Click to display the [Color Selector](#) on page 391.

Maps Selects a map to use within the area of the checker color. For example, you could put an additional checkerboard within one of the checker colors. The check boxes enable or disable their associated map.

Combustion Map

Material Editor > Maps rollout > Click a Map button. > Material/Map Browser > Combustion

With the Combustion map, you can create maps interactively using the Autodesk Combustion software and 3ds Max at the same time. You use Combustion to paint on a bitmap, and the material updates automatically in the Material Editor and in shaded viewports.

IMPORTANT The Combustion map works only if Autodesk Combustion is installed on your system.

Only Combustion 2.1 and later formats are supported. Maps in the Combustion 1 format are not supported in 3ds Max.

IMPORTANT The [mental ray renderer](#) on page 6230 does not support the Combustion map.

See also:

- [CWS \(Combustion Workspace\) Files](#) on page 7329
- [Noise Rollout \(2D\)](#) on page 5793

About the 3ds Max and Combustion Integration

You can use Combustion as a material map in 3ds Max. With a Combustion map, you can create a material from a Paint or composite operator, and in turn apply that material to objects in a 3ds Max scene. The Combustion map can include Combustion effects, and it can be animated.

In addition, with Combustion you can import 3ds Max scenes that have been rendered to a [rich pixel file](#) on page 7366 ([RPF](#) on page 7366 or [RLA](#) on page 7364 file). The imported rich pixel rendering becomes an element of your composite. You can adjust its 3D position relative to video elements of the composite, and you can apply Combustion 3D Post effects to objects within it. See the *Combustion User's Guide* for more information.

NOTE Because 3ds Max runs only on Windows, you cannot use Combustion to create material maps on a Macintosh.

3ds Max Materials and the Combustion Map

In 3ds Max, a [material](#) on page 8041 is data that you assign to the surface or faces of an object so that it appears a certain way when rendered. Materials affect the color of objects, their shininess, their opacity, and so on.

The [Material Editor](#) on page 5284 is the portion of 3ds Max that creates and manages materials. In the Material Editor, you can assign maps to a material's color components and to its numeric components such as opacity. Maps add images, patterns, color adjustments, and other effects to the visual properties of the material.

In the 3ds Max Material Editor, you assign a map by clicking the map button for a component color or other component. This displays the Material/Map Browser, which lets you choose the map type.

3ds Max provides several types of [maps](#) on page 8036. The most basic is a 2D map, a two-dimensional image that is typically mapped onto the surface of geometric objects.

Other uses of 2D maps are as environments to create a background for the scene, as projections from lights, and as displacements to "emboss" geometry.

A Combustion map is a [2D map](#) on page 5782. It is a Combustion project used by the 3ds Max Material Editor, so like any Combustion project, it is vector-based, animatable, and fully editable. From within the Material Editor, you can have Combustion create a new project from scratch, or use an existing composite or Paint branch. You can synchronize the Combustion Timeline with the 3ds Max time slider so animated materials synchronize with your 3D scene.

With a Combustion map, you can paint in either program: that is, you can paint either in the Combustion viewport or on 3ds Max objects. Both programs update the paint display. You also have the option of using Combustion to paint on an "unwrapped" projection of 3ds Max object geometry.

In addition, with Combustion effects that require you to pick a point, such as Lens Flare or Ripple, you can use either program, Combustion or 3ds Max, to pick the point.

Tips for Working with a Combustion Map in 3ds Max

- If you have a dual-screen configuration, you can set it up so you can see both the 3ds Max and the Combustion windows at the same time. Otherwise, you need to use Alt+Tab to switch between the two windows.
- To work with Combustion, the 3ds Max object must have [mapping coordinates](#) on page 8034. Primitive objects have a Generate Mapping Coordinates toggle, which is automatically enabled when you assign a mapped material to the object. Some objects, such as editable meshes, do not have a Generate Mapping Coordinates toggle. For these kinds of objects, go to the Modify panel and apply a [UVW Map modifier](#) on page 1931.
- Sometimes it can be hard to see how the Combustion operator is oriented to the 3ds Max object's mapping coordinates. It can help to paint some temporary strokes in Combustion to see how they are aligned in 3ds Max viewports. Displaying the mapping coordinates in Combustion can help. See the procedure, "To display an unwrapped mesh." It can also help to paint directly on the object in a 3ds Max viewport. See the procedure, "To paint directly on the 3D object."

Procedures

To create a new Combustion map:

- 1 Open the Material Editor.
- 2 Drag an unused sample slot from the Material Editor to the object you want to paint.
- 3 In the Material Editor, click the map button for the Diffuse Color component. This button is on the material's Basic Parameters rollout.

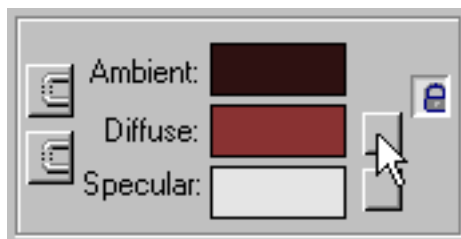

All standard materials have a Basic Parameters rollout, whose controls vary depending on the chosen shader. The Strauss shader has only one color component, labeled Color.

The Material/Map Browser appears.

- 4 In the Material/Map Browser, choose Combustion, and click OK.
A Combustion map is assigned to the Diffuse Color, and a black material map appears in the active sample slot.



- 5 Click to turn on Show Map In Viewport.
In the scene, the object turns black in shaded viewports.
- 6 In the Parameters rollout, click Edit.

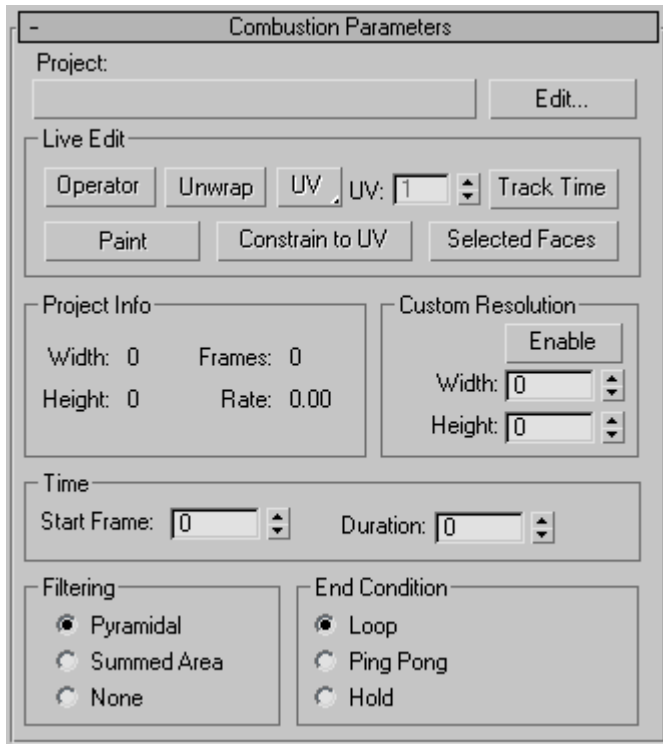

This launches Combustion, which displays the New Workspace dialog.

- 7 Set up the new project.

The composite or Paint branch that you create in Combustion appears on the object in 3ds Max viewports, as well as in the sample slot for the material with the Combustion map. The workspace name and path are assigned to the material, and appear on the Project button in the material's Combustion Parameters rollout.

For example, you can use the Paint operator in Combustion. When you release the mouse, the stroke appears on the 3ds Max object.

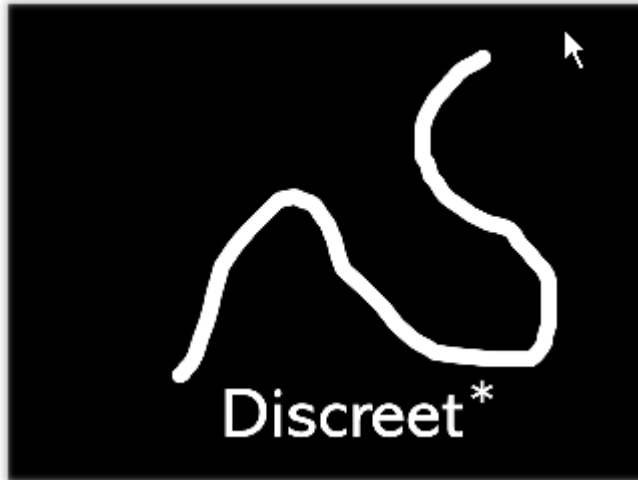

Paint operator in Combustion

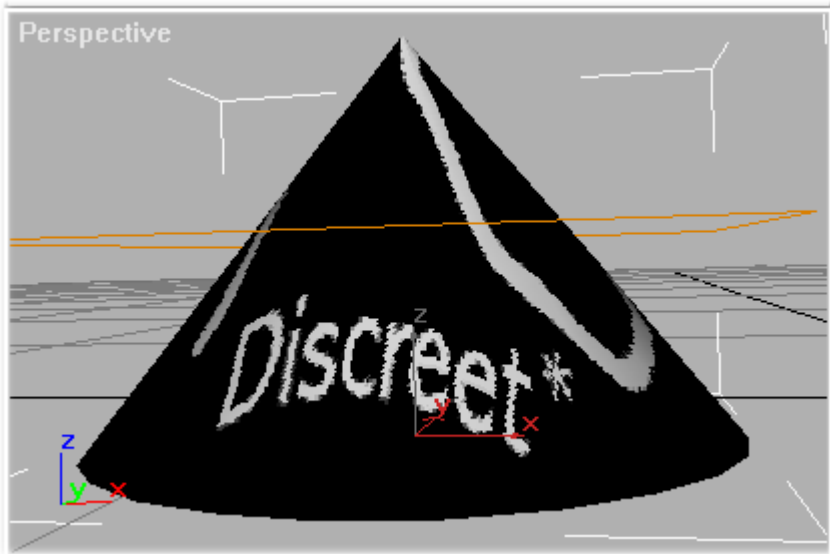

Painted object in 3ds Max

To display an unwrapped mesh:

In the 3ds Max Material Editor, you can use the Unwrap Mesh feature to display your 3D object as a 2D mesh in Combustion. You can adjust the color and size of the mesh.

The mesh display is only an overlay to help you orient paint strokes and other Combustion effects. It is displayed in Combustion but is not a part of the composite or the map.

- 1 Create a Combustion map.
- 2 In the 3ds Max Material Editor, enable Unwrap Selected in the Live Edit group.

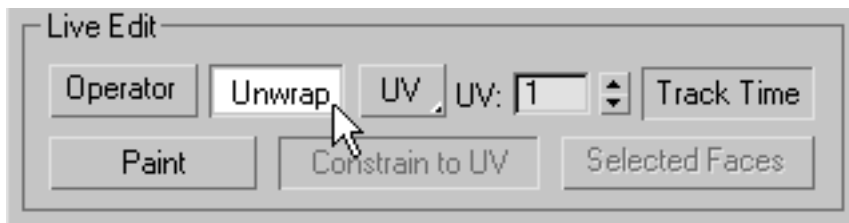

In Combustion, a mesh appears. This is an "unwrapped" projection of the 3D object.

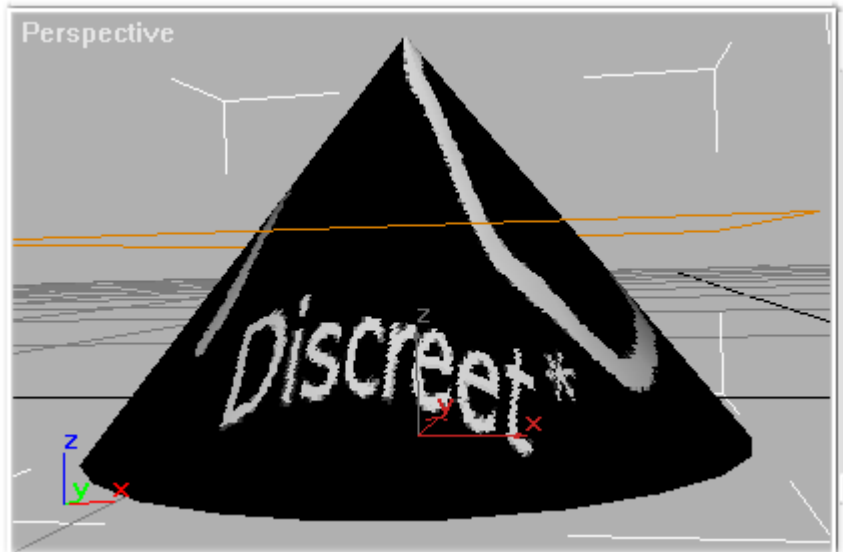

3D object in 3ds Max

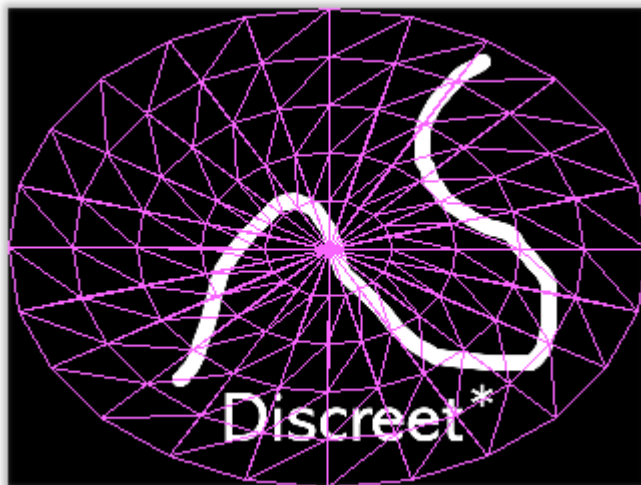

Corresponding mesh in Combustion

To set the mesh parameters:

- In Combustion, choose File > Preferences > Mesh.

Use	To
Anti-Alias Mesh	Remove jaggies from the mesh.
Display During Playback	Display the mesh when you play back the animation.
Color	Click the color box to set the color of the mesh using a color picker.

To paint directly on the 3D object:

- 1 Create a Combustion map.
- 2 In Combustion, select one of the following drawing tools:

-  Freehand

-  Straight Line

-  Rectangle

-  Ellipse

- 3 In the 3ds Max Material Editor, enable Paint in the Live Edit group of the Combustion Parameters rollout.

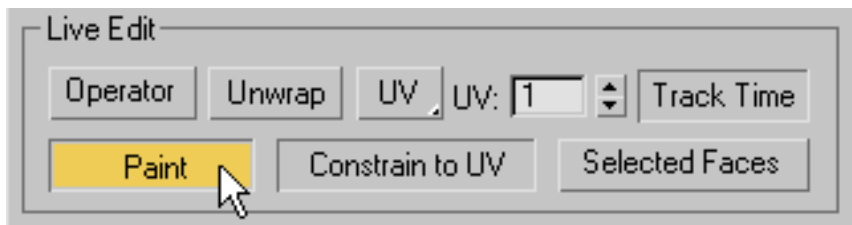

In the 3ds Max viewport, a pen cursor appears. Drag the cursor over the object to paint on it.

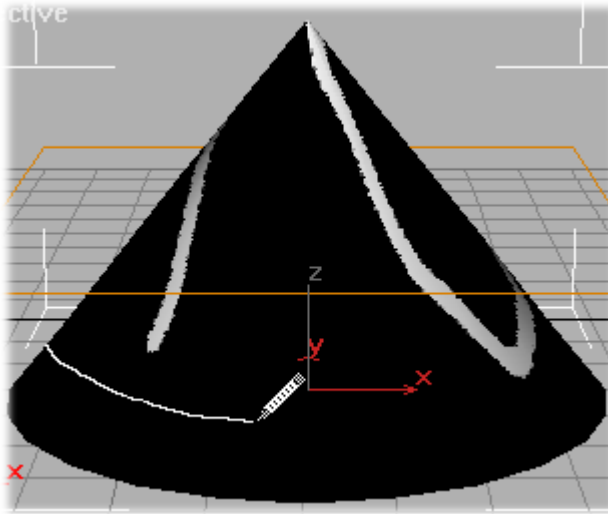

When you release the cursor, the Paint object also appears in Combustion.

To animate Combustion Paint strokes:

- 1 Create a Combustion map.
- 2 In Combustion, set the time scale to start at frame number 0. Choose File > Preferences. In the Preferences dialog select General, set Display Time As to Frames (From 0), and then click OK.
- 3 In the 3ds Max Material Editor, enable Track Time in the Live Edit group of the Combustion Parameters rollout.
Now the time slider in 3ds Max controls the Timeline indicator in Combustion.
- 4 In 3ds Max, move the time slider to a frame and create a Paint object.
The Paint object appears on that frame in both Combustion and 3ds Max.
- 5 Move to another frame and use Combustion to modify the Paint object.
Combustion uses interpolation to determine the appearance of the Paint object between keyframes. If you add a new Paint object, that object simply appears, starting on the frame where you created it.

- 6 Continue advancing in the clip, adding and modifying Paint strokes and effects to create your animated material. For more information on animating objects in Combustion, refer to the *Combustion User's Guide*. You can add Paint strokes in either program, but to modify them you must use Combustion.

NOTE Remember, Combustion tracks the time slider in 3ds Max, but 3ds Max does not track the Timeline indicator in Combustion. If the 3ds Max viewport does not appear to be updating as you paint in Combustion, you might be painting on a different frame than the one displayed in 3ds Max. To find your Paint objects, move to the correct frame in 3ds Max.

To use an existing Combustion workspace as a material map in 3ds Max:

- 1 Open the Material Editor and select an unused sample slot.
- 2 In the Material Editor, expand the Maps rollout, and click the Map button next to the Diffuse Color component.

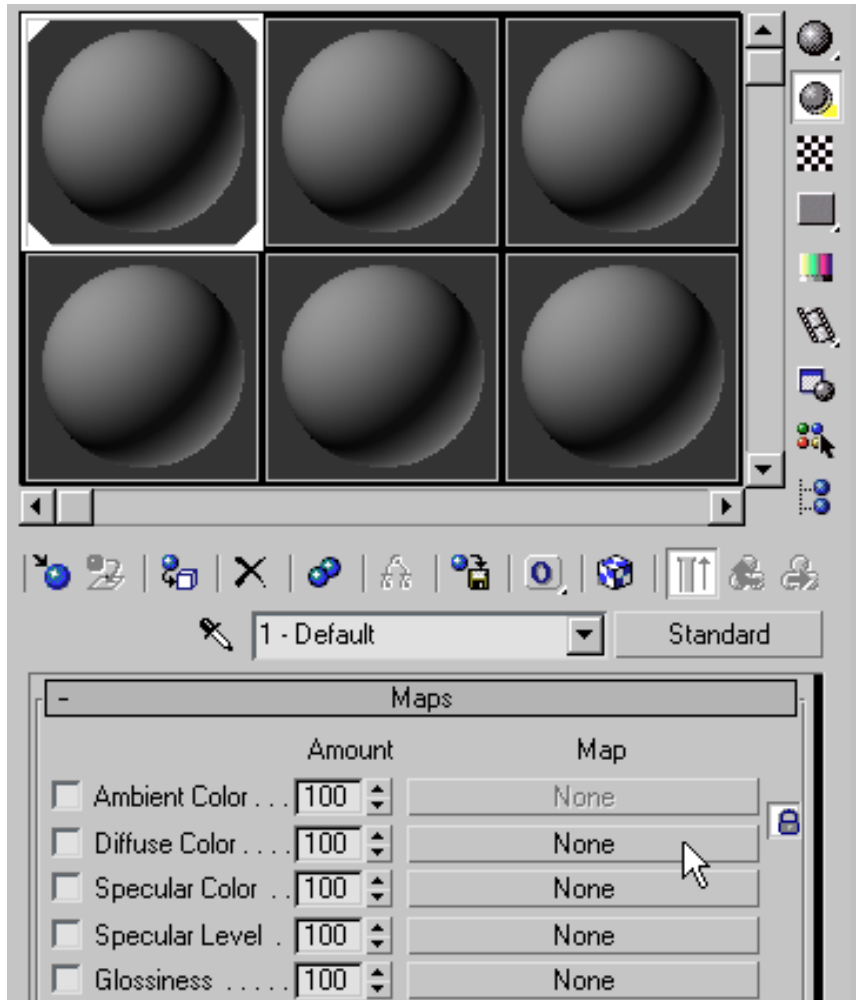

The Material/Map Browser appears.

- 3 In the Material/Map Browser, choose Combustion, and click OK.

A Combustion map is assigned to the Diffuse Color, and a black material map appears in the active sample slot.

- 4 In the Combustion Parameters rollout, click the Project bar.



The Open Project dialog appears.

- 5 Browse for the workspace file (.cws) that you want to use as a map, and click the Open button.

The Combustion workspace name and path appear in the Project button.

To apply the map to an object, drag the sample slot from the Material Editor to the object in a 3ds Max viewport.

To edit the map, click the Edit button in the Parameters rollout. In Combustion, the workspace corresponding to the selected map opens, and you can edit the image.

To paint geometry with a bitmapped material already assigned to it:

- 1 In 3ds Max, select the object that you want to paint.
- 2 In the Material Editor, select an unused sample slot.
- 3 Click the Pick Material From Object button, then click the object in the viewport to put the object's material in the selected sample slot.

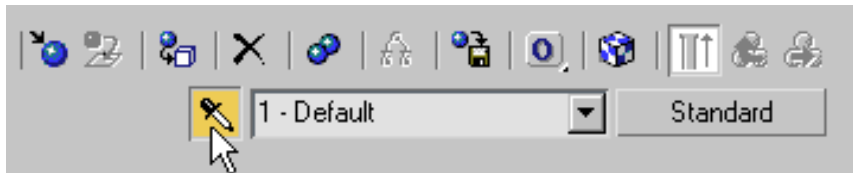

- 4 Open the Maps rollout and note the name of the bitmap file. Click Map to go to the bitmap level of the material.
- 5 Click the map's Type button.
The Material/Map Browser appears.
- 6 In the Material/Map Browser, choose Combustion to change the type from Bitmap to a Combustion map.
- 7 On the Paint Parameters rollout, click the blank Project button, and then choose the same bitmap.



- 8 Click Edit.

Combustion is launched and the Import Footage dialog appears. Import the same bitmap.

To paint on the bitmap, select Paint. You can also key or color correct the bitmap, or use it to build a composite. For more information, see the *Combustion User's Guide*.

- 9  In the 3ds Max Material Editor, click Show Map In Viewport. In the scene, the object is mapped in shaded viewports.

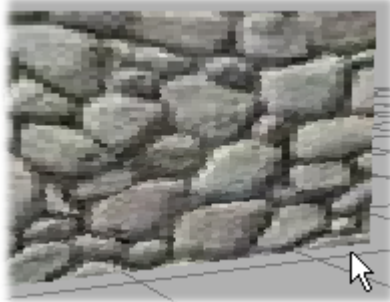

Object with original bitmap

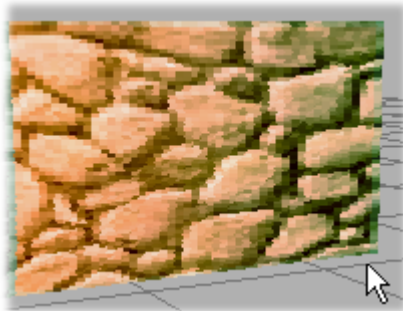

Object with painted bitmap

To paint selected faces:

Use a Multi/Sub-Object material to control the location of your painting. Any sub-material can have a Combustion map, so you can use Combustion to affect only the selected faces.

- 1 In 3ds Max, select the object you want to paint.
- 2 In the Modify panel, apply an Edit Mesh modifier to the object. (Choose Edit Mesh from the Modifier drop-down list.)

If you are working with an editable mesh object, or a patch or NURBS surface, skip step 2. For geometry primitives, an option is to convert the object to a mesh, patch, or NURBS surface before step 3. However, you then lose the ability to adjust object parameters (for example, the radius of a sphere, the height of a box).

- 3 Choose Face as the sub-object selection level. Select the faces on which you want to paint.

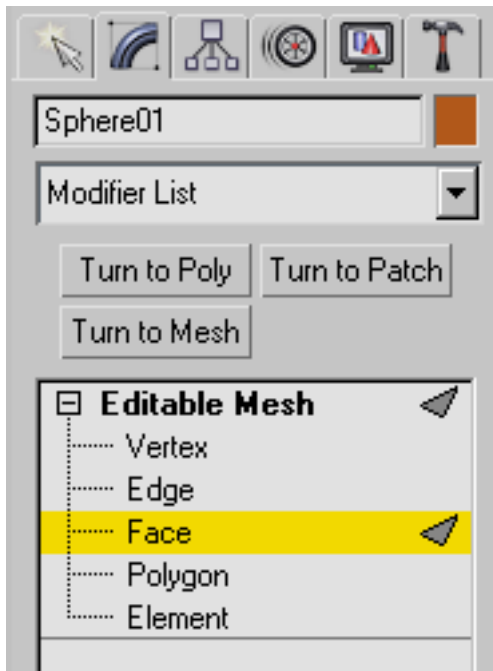

- 4 Drag a material from a sample slot in the Material Editor onto the selected faces.

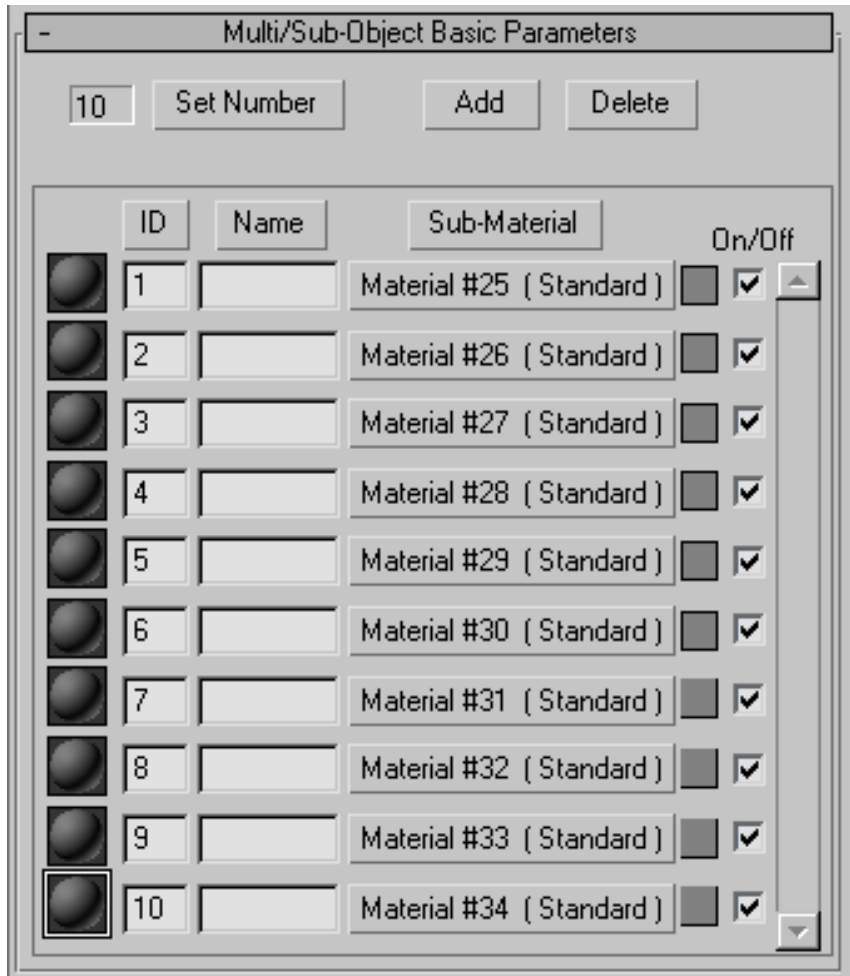

- 8 Assign a Combustion map to the Diffuse component of the sub-material applied to the selected faces.
- 9 Click Edit to launch Combustion.
- 10 Use the tools in Combustion to modify the material.

To modify a Combustion map:

- 1 In the Material Editor, select the material you want to modify.

Material maps created in Combustion are vector-based and fully modifiable.

- 2 In the Combustion Parameters rollout, click the Edit button.
The workspace corresponding to the Combustion map opens in Combustion. As you modify the workspace in Combustion the map is updated in 3ds Max.
- 3 In Combustion, save the workspace before you disable the Edit button in 3ds Max.

To create a displacement map:

In 3ds Max, the [Displace modifier](#) on page 1344 acts as a force field to push and reshape an object's geometry. You can apply its variable force directly from the modifier gizmo, from a bitmap image, or from a Combustion workspace.

The grayscale component of the image is used to generate the displacement. Lighter colors in the image push outward more strongly than darker colors, resulting in a 3D displacement of the geometry.

- 1 In 3ds Max, select the object to which you want to apply the displacement map.

In this example, the displacement is applied to a box primitive.

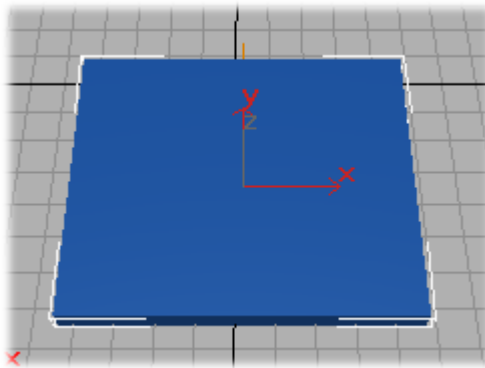

In the object's Parameters rollout, increase the number of Length and Width Segments. The closer the number of segments approaches the resolution of the displacement map, the more accurate is the result.

In the example, 150 by 150 gives good results.

- 2 Apply a Displace modifier: in the Modify panel, choose Displace from the Modifier drop-down list.

- 3 In the Parameters rollout, Image group, click the Map button.

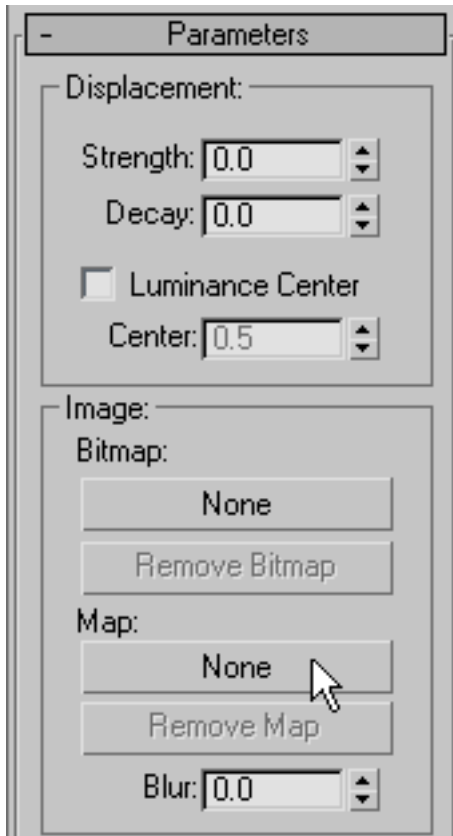

- 4 The Material/Map Browser appears. Select Combustion and click OK. The Map button now reads Map #1 (Combustion).
- 5 Open the Material Editor, and then click and drag the Map #1 (Combustion) button to an unused sample slot in the Material Editor. An Instance (Copy) Map dialog is displayed.

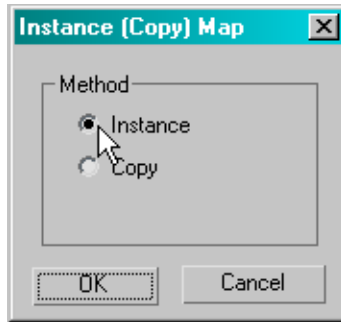

- 6 Select Instance and click OK.
- 7 In the Material Editor, Combustion Parameters rollout, click Edit.
This launches Combustion. In the New dialog, set the Type To Paint, and create a grayscale image to use as a displacement map. For more information, see the *Combustion User's Guide*.



- 8 In 3ds Max, increase the Displacement strength in the modifier Parameters rollout.
As you increase the strength, you can see the result of the displacement map on the selected object.

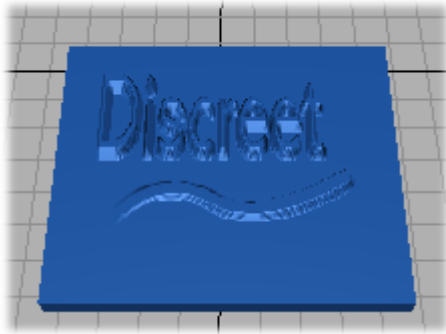

- 9 In Combustion, save your project, then in 3ds Max, disable Edit in the Combustion Parameters rollout to exit Edit mode.

Interface

2D Mapping Coordinates

Like any 2D map in 3ds Max, mapping coordinates control how a Combustion map is positioned on objects.

For geometric primitives, mapping coordinates are usually provided automatically. For some kinds of geometry, such as [meshes](#) on page 2075, [patches](#) on page 2067, and [NURBS surfaces](#) on page 2237, you must apply a [UVW Map modifier](#) on page 1931 to provide mapping coordinates.

Controls in a [2D map's Coordinates rollout](#) on page 5782 affect how the map is positioned.

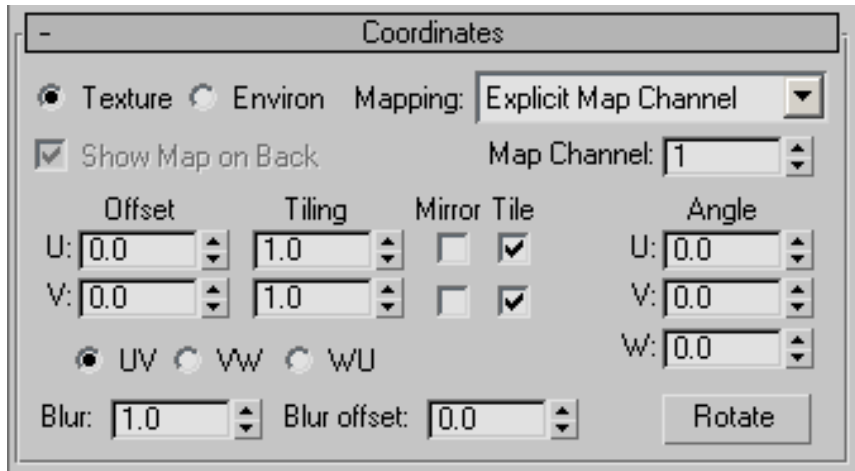

When you work with a Combustion map, these are the important points to remember:

- When you apply a Combustion map to an object, leave mapping set to the default values of Texture and Explicit Map Channel.
- When you use a Combustion map as an environment map, set mapping to Environ and then choose the mapping shape from the Mapping drop-down list.
- The offset, tiling, mirror, and angle controls are useful especially when the size of the projected Combustion map is smaller than the geometry.
- You can choose between UV, VW, and WU projections. (You can also do this from the Combustion Parameters rollout, as described below.) UV projects onto the surface of geometry like a slide projector. VW and WU project the map at right angles to the geometry. With a Combustion map, UV is almost always the most useful choice.

Combustion Parameters rollout

The Combustion Parameters rollout appears when you assign a Combustion map to a material.

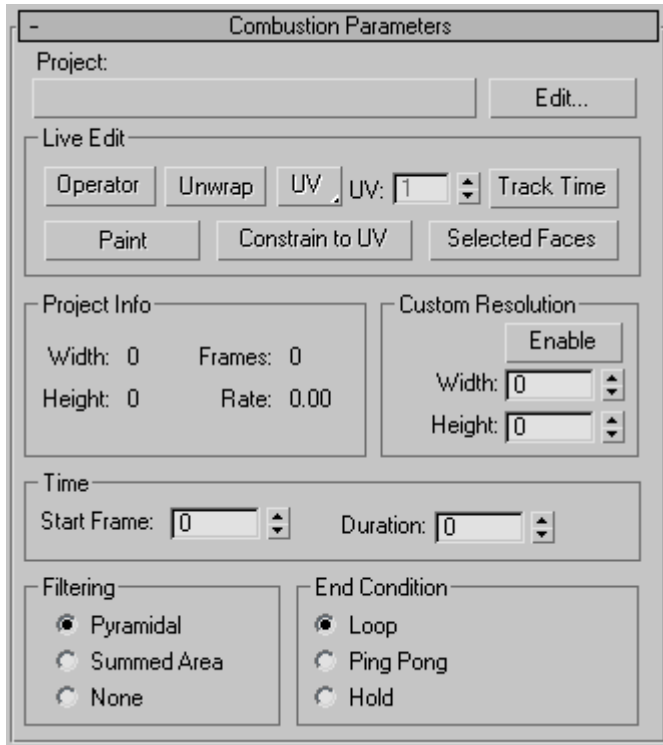

Project Loads the file to use in Combustion. You can load only file types supported by Autodesk Combustion, such as Combustion workspace files (*cws*), or footage and image file formats supported by Combustion (see the *Combustion User's Guide* for information on supported footage formats).

Edit Launches Combustion from the 3ds Max Material Editor. If a project is loaded, it is opened in Combustion. If no project is loaded, Combustion displays the New dialog. This dialog lets you specify a project type, name, video format, duration, and background color.

Live Edit group

These controls affect how you use Combustion with 3ds Max.

Operator Switches control to Combustion, where you can select an operator. The results of the operator appear as the image in the Combustion map. The operator does not have to be the last operator in the pipe.

While Combustion is active, you can also adjust the operator. The Combustion map updates to show the results.

Unwrap Selected Takes the current UVW mapping coordinates of the currently selected 3D object (or the current Face sub-object selection), and displays them in Combustion. This can help you coordinate the map and the mesh as you paint. The Unwrap display is only an overlay. It is displayed in Combustion but is not a part of the composite or the map.

UV List Changes the mapping coordinate system (the direction in which the map is projected) from UV to VW or UW. UV projects onto the surface of geometry like a slide projector. VW and WU project the map at right angles to the geometry. With a Combustion map, UV is almost always the most useful choice.

UV Specifies which mapping channel to unwrap and paint. Range=1 to 99.

Track Time Links the Timeline in Combustion to the time slider in 3ds Max. When Track Time is enabled, you can use the time slider in 3ds Max to navigate between frames in Combustion.

NOTE This control is not bidirectional; changing the frame in Combustion does *not* change the frame in 3ds Max.

Paint When enabled, displays a paint cursor in 3ds Max viewports. You can then paint directly on the 3D geometry. Dragging the cursor in the viewport over the geometry in 3ds Max creates paint strokes inside Combustion.

Constrain To UV When enabled, constrains paint strokes to remain within the edges of the UV mapping coordinates. When paint strokes are unconstrained on an object such as a box, they can jump to the other side of the map when you cross a map's edge. This can give erratic results. To prevent this, enable Constrain To UV.

In general, use the Constrain To UV option when you paint on boxes and other objects with planar maps. Disable this option when you want to paint on spherical maps or anywhere else the mapping has a singularity (where the edges of the map converge to a single point).

Selected Faces Constrains the Combustion image to only the faces selected. This gives additional control or masking based on faces rather than UV mapping.

Project Info group

These readouts display the format of the Combustion Paint or composite operator. They are active when a Combustion workspace is loaded or Edit mode is active.

Width Sets horizontal resolution of the frame in pixels.

Height Sets vertical resolution of the frame in pixels.

Frames Sets number of frames in the Combustion workspace.

Rate Sets playback speed in frames per second.

Custom Resolution group

With these controls, you can customize the resolution of the Combustion map.

Enable Enables the Width and Height controls.

Width and Height Width changes the horizontal resolution of the map. Height changes the vertical resolution of the map.

Time group

These controls relate frames in the Combustion workspace to frames in the Combustion map. See the controls under "End Condition Group" for how to handle the map when it contains fewer frames than the 3ds Max scene.

Start Frame Determines which frame of the Combustion sequence is used as the first frame of the Combustion map in 3ds Max.

Duration Sets how many frames of the Combustion file sequence are used by the Combustion map in 3ds Max.

Filtering group

These controls determine the method for calculating [antialiasing](#) on page 7904:

Pyramidal Sets the default antialiasing method. This method is faster than Summed Area filtering.

Summed Area Implements a better method of antialiasing. Summed Area filtering uses more memory than Pyramidal. If it has to use virtual memory, it can dramatically increase rendering time.

None Performs no antialiasing. This option takes the least time to render, but yields the lowest quality results.

End Condition group

These controls define what the 3ds Max renderer should do when the duration of the Combustion project (or the range of frames used in the Combustion map) is shorter than the rendering sequence in 3ds Max.

Loop Plays the Combustion project animation repeatedly until the rendering sequence ends.

Ping Pong Plays the animation forward, then backward, and repeatedly plays forward and backward until the rendering sequence is completed.

Hold Plays the animation once, then repeatedly displays the last frame of the project until the rendering sequence is completed.

Gradient Map

Material Editor > Maps rollout > Click a Map button. > Material/Map Browser > Gradient

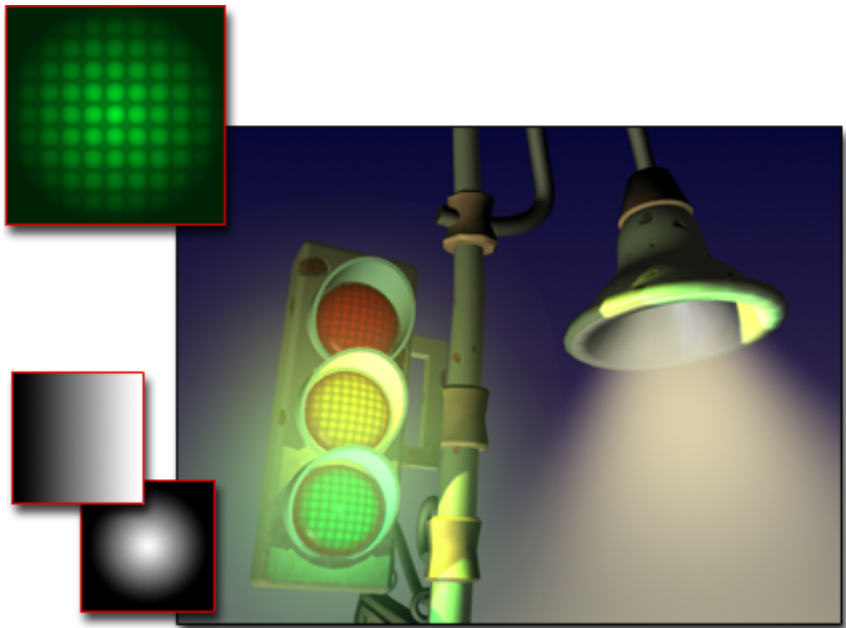

Gradient maps used for the stoplight lamps, and for the background of the scene

Gradients shade from one color to another. You specify two or three colors for the gradient; the software interpolates intermediate values. Gradient maps are 2D maps.

TIP You can swap colors by dragging one color swatch over another, then clicking Swap in the Copy or Swap Colors dialog. To reverse the overall direction of the gradient, swap the first and third colors.

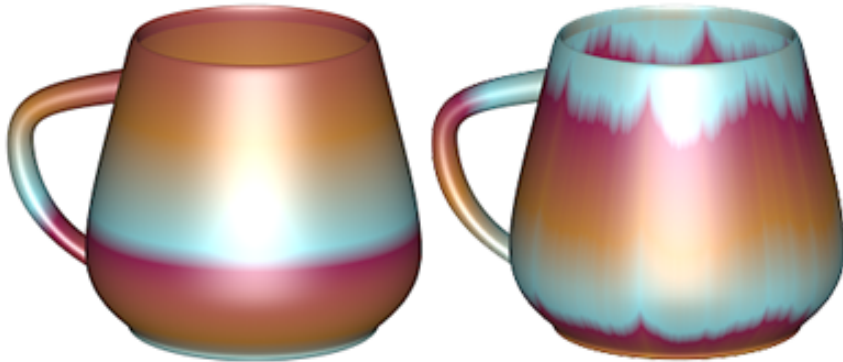

Gradient-mapped material tiled (left) and with noise (right)

See also:

- [Coordinates Rollout \(2D\)](#) on page 5782
- [Noise Rollout \(2D\)](#) on page 5793
- [Output Rollout](#) on page 5774

Procedures

To create a Gradient map:

- 1 Click a map button to assign a map.
- 2 Choose Gradient in the Material/Map Browser, and then click OK.

To change a gradient color:

- 1 In the Gradient Parameters rollout, click a color swatch to display the [Color Selector](#) on page 391.
- 2 Adjust the color.
- 3 Click one of the other color swatches.
- 4 Adjust the color.

To choose the kind of gradient:

- Choose either Linear or Radial.
A linear gradient shades from one color to another along a line. A radial gradient has one color on the inside and another on the outside, shading in a circular pattern.

To use a map for a color in the gradient:

- In the Gradient Parameters rollout, click a map button to assign a map to a color.

To adjust the position of the second color:

- Change the Color 2 Position value.
At the default value of 0.5, the second color is between the first and third colors. For a linear gradient, the second color's position ranges from the bottom at 0.0 to the top at 1.0. For a radial gradient, the second color's position ranges from the inside at 0.0 to the outside at 1.0.

Interface

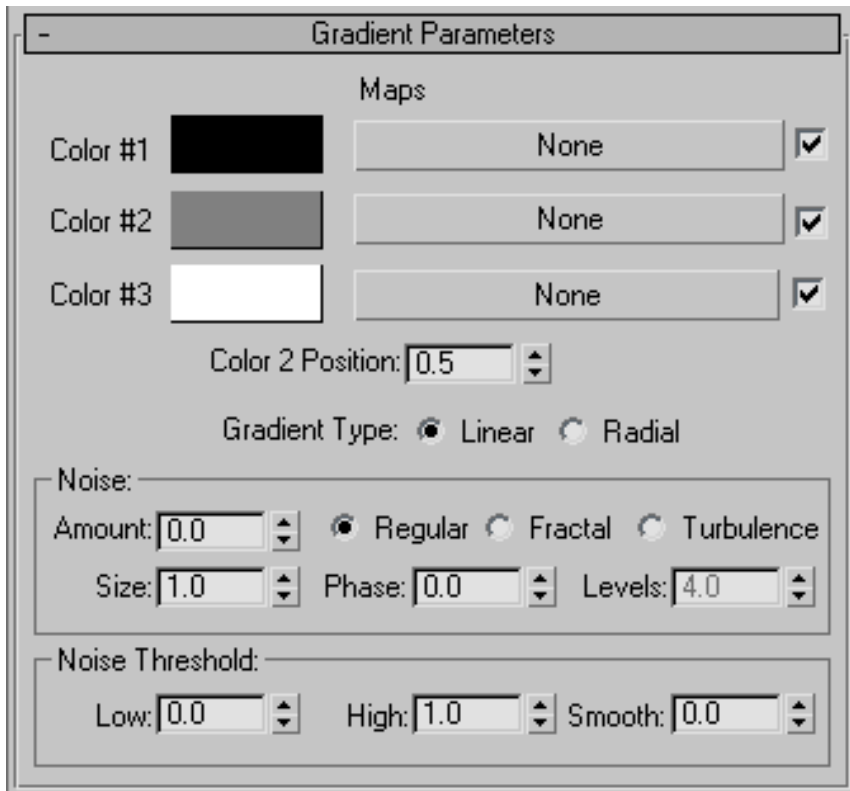

Color #1-3 Sets the three colors that the gradient interpolates between. Displays the [Color Selector](#) on page 391. You can drag and drop the colors from one swatch to another.

Maps Displays a [map](#) on page 8036 instead of the color. Maps are blended into the gradient in the same way that the gradient colors are blended. You can add nested procedural gradients in each window to make 5-, 7-, 9-color gradients, or more.

The check boxes enable or disable their associated maps.

Color 2 Position Controls the center point of the middle color. The position ranges from 0 to 1. When it is 0, color 2 replaces color 3. When it is 1, color 2 replaces color 1.

Gradient Type Linear interpolates the color based on the vertical position (V coordinate) while radial interpolates based on the distance from the center of

the map (center is: $U=0.5, V=0.5$). With both of these, you can rotate the gradient using the angle parameter under Coordinates, which is animatable.

Noise group

Amount When nonzero (ranges from 0 to 1), applies a noise effect. This perturbs the color interpolation parameter using a 3D noise function based on U , V , and Phase. For example, a given pixel is halfway between the first and second color (the interpolation parameter is 0.5). If noise is added, the interpolation parameter would be perturbed by some amount so that it may become less or more than 0.5.

Regular Generates plain noise. This is the same as Fractal noise with the Levels setting at 1. When the noise type is set to Regular, the Levels spinner becomes disabled (because Regular is not a fractal function).

Fractal Generates noise using a fractal algorithm. The Levels option sets the number of iterations for the fractal noise.

Turbulence Generates fractal noise with an absolute value function applied to it to make fault lines. The noise amount must be greater than 0 to see any effects of turbulence.

Size Scales the noise function. Smaller values give smaller chunks of noise.

Phase Controls the speed of the animation of the noise function. A 3D noise function is used for the noise. The first two parameters are U and V and the third is phase.

Levels Sets the number of fractal iterations or turbulence (as a continuous function).

Noise Threshold group

When the noise value is above the Low threshold and below the High threshold, the dynamic range is stretched to fill 0–1. This produces a smaller discontinuity at the threshold transition and thus causes less potential aliasing.

Low Sets the low threshold.

High Sets the high threshold.

Smooth Helps make a smoother transition from the threshold value to the noise value. When smooth is 0, no smoothing is applied. When it is 1, the maximum amount of smoothing is applied.

Gradient Ramp Map

Material Editor > Maps rollout > Click a Map button. > Material/Map Browser > Gradient Ramp

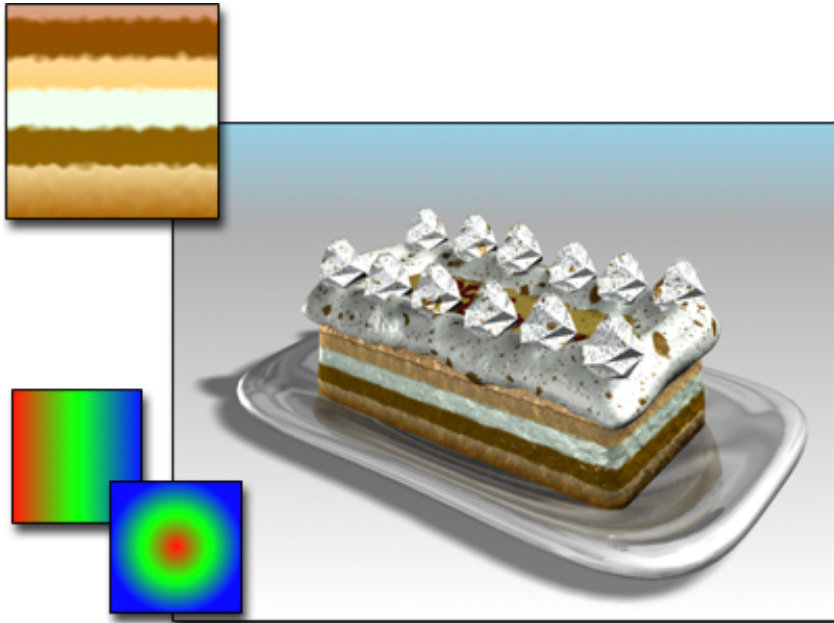

Gradient ramp used for the layers of the cake

Gradient Ramp is a 2D map similar to the Gradient map. It shades from one color to another. In this map, however, you can specify any number of colors or maps for the gradient. There are a variety of controls, making highly customized gradients possible. Almost any parameter of Gradient Ramp can be animated.

See also:

- [Coordinates Rollout \(2D\)](#) on page 5782
- [Noise Rollout \(2D\)](#) on page 5793
- [Output Rollout](#) on page 5774

Procedures

To create a material with a Gradient Ramp map:

- 1 Open the Material Editor, and choose an unused sample slot.
- 2 Close the Basic Parameters rollout, and open the Maps rollout.
- 3 Click the Map button for Diffuse to display the Material/Map Browser.
- 4 In the Browser list, click Gradient Ramp. The map appears in the upper-left of the Browser window. Click OK.
Gradient Ramp map is applied to the sample slot as the Browser closes.
- 5 In the Material Editor, under its toolbar, give the material a name to identify its use in your scene.

When you replace an existing map with a gradient ramp map, choosing to Keep Old Map as Submap in the Replace Map dialog, the old map becomes assigned to the first flag as a texture.

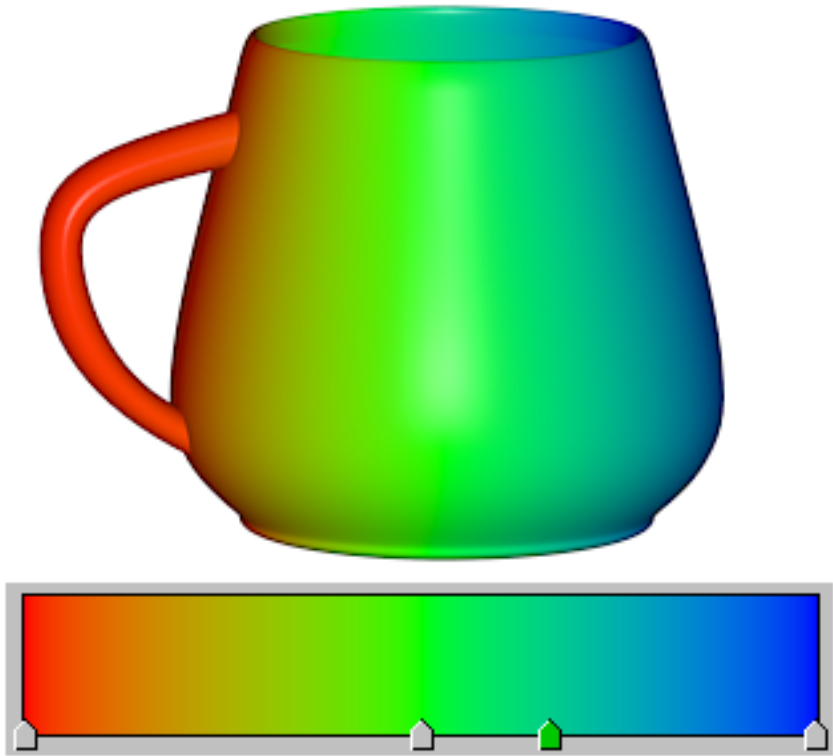

Gradient Ramp-mapped material with a colored gradient

Interface

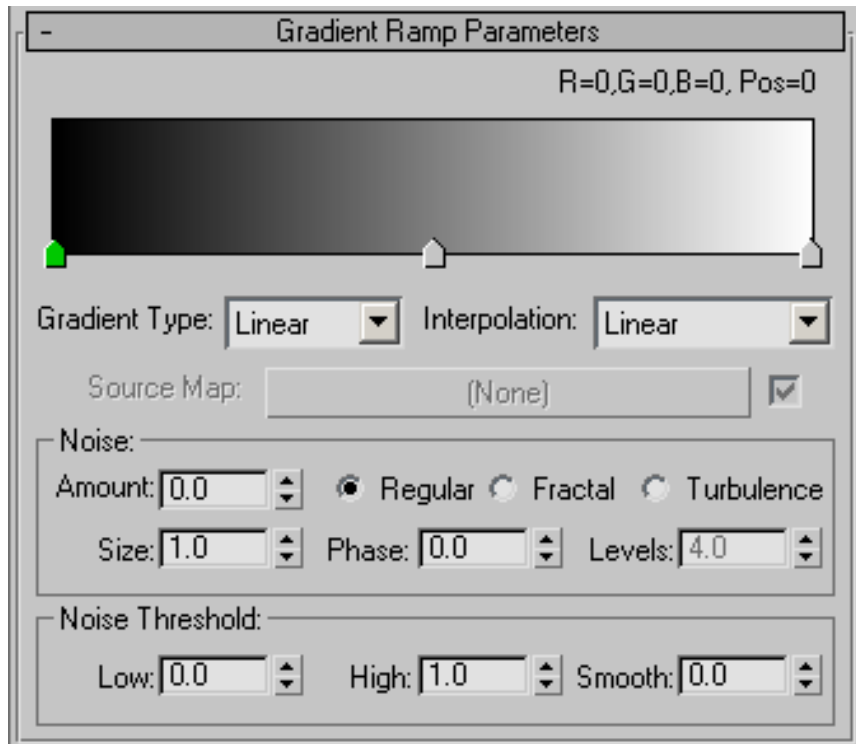

Gradient bar shows default gradient and interpolation types

Gradient bar Presents an editable representation of the gradient being created. The effect of the gradient moves from left (start point) to right (end point).

By default, three flags appear along the bottom edge of a red/green/blue gradient. Each flag controls a color (or map). The currently selected flag is green, and its RGB value and its position in the gradient (in the range 0 to 100) appear above the gradient bar. Each gradient can have any number of flags.

The gradient bar has the following features:

- Click anywhere along the bottom edge to create additional flags.
- Drag any flag to adjust the position of its color (or map) within the gradient. The start and end flags (Flag #1 at 0 and Flag #2 at 100) cannot be moved. However, other flags can occupy these positions and still be moved.

- More than one flag can occupy a given position. If two flags are at the same position, a slight edge appears between the colors. With three or more flags at the same position, the edge is a hard line.

Right-click options for gradient bar Right-click in the gradient bar to display a menu with these options:

Reset Returns gradient bar to defaults.

Load Gradient Loads an existing gradient (DGR) file into the gradient bar.

Save Gradient Loads your current gradient bar as a DGR file.

Copy, Paste Copies a gradient and pastes it into another Gradient Ramp map.

Load UV Map Selects a UV map.

Load Bitmap Selects a bitmap.

Flag Mode Toggles flag display.

Right-click options for flags Right-click any flag to display a menu with the following options:

Copy and Paste Lets you copy the current key and paste it to replace another key. The other key could be in another Gradient Ramp as well as the current one.

Edit Properties Choose this option to display the [Flag Properties dialog](#) on page 5846.

Delete Deletes the flag.

Gradient Type Chooses the type of gradient. The following Gradient types are available. These affect the entire gradient.

- **4 Corner** An asymmetrical linear transition of colors.
- **Box** A box.
- **Diagonal** A linear diagonal transition of colors.
- **Lighting** Based on the light intensity value. No light=far left; brightest light=far right.
- **Linear** A smooth, linear transition of colors.
- **Mapped** Lets you assign a map to use as the gradient. Enables the Source Map controls for specifying the map and turning it on and off.

- **Normal** Based on the angle between the vector from the camera to the object and the surface normal vector at the sample point. The leftmost flag of the gradient is 0 degrees; the rightmost flag is 90 degrees.
- **Pong** A diagonal sweep that repeats in the middle.
- **Radial** A radial transition of colors.
- **Spiral** A smooth, circular transition of colors.
- **Sweep** A linear sweep transition of colors.
- **Tartan** A plaid.

Interpolation Chooses the type of interpolation. The following Interpolation types are available. These affect the entire gradient.

NOTE Gradients are ordered from left to right. The “next” flag is to the right of the current flag; the “previous” flag is to the left.

Custom Sets an individual interpolation type for each flag. Right-click the flag to display the [Flag Properties dialog](#) on page 5846 and set the interpolation.

Ease In Weighted more toward the next flag than the current flag.

Ease In Out Weighted more toward the current flag than the next flag.

Ease Out Weighted more toward the previous flag than the next flag.

Linear Constant from one flag to the next. (Default.)

Solid No interpolation. Transitions are a sharp line.

Source Map Click to assign a map to a mapped gradient. The check box turns the map on or off.

The Source Map controls are available only when Mapped is the chosen gradient type.

Noise group

Amount When nonzero, a random noise effect is applied to the gradient, based on the interaction of the gradient ramp colors (and maps, if present). The higher this value, the greater the effect. Range=0 to 1.

Regular Generates plain noise. Basically the same as fractal noise with levels disabled (because Regular is not a fractal function).

Fractal Generates noise using a fractal algorithm. The Levels option sets the number of iterations for the fractal noise.

Turbulence Generates fractal noise with an absolute value function applied to it to make fault lines. Note that the noise amount must be greater than 0 to see any effects of turbulence.

Size Sets the scale of the noise function. Smaller values give smaller chunks of noise.

Phase Controls the speed of the animation of the noise function. A 3D noise function is used for the noise; the first two parameters are U and V and the third is phase.

Levels Sets the number of fractal iterations or turbulence (as a continuous function).

Noise Threshold group

When the noise value is above the Low threshold and below the High threshold, the dynamic range is stretched to fill 0 to 1. This causes a smaller discontinuity at the threshold transition and produces less potential aliasing.

High Sets the high threshold.

Low Sets the low threshold.

Smooth Helps make a smoother transition from the threshold value to the noise value. When Smooth is 0, no smoothing is applied. When Smooth is 1, the maximum amount of smoothing is applied.

Flag Properties Dialog

Material Editor > Maps rollout > Click a Map button. > Material/Map Browser > Gradient Ramp > Gradient Ramp Parameters rollout > Right-click a flag at the bottom of the gradient bar. > Edit Properties > Flag Properties dialog

By setting parameters on the Flag Properties dialog, you can customize the effect of each flag on the Gradient Ramp map. You have access to all flags from this dialog.

See also:

- [Gradient Ramp Map](#) on page 5840

Interface

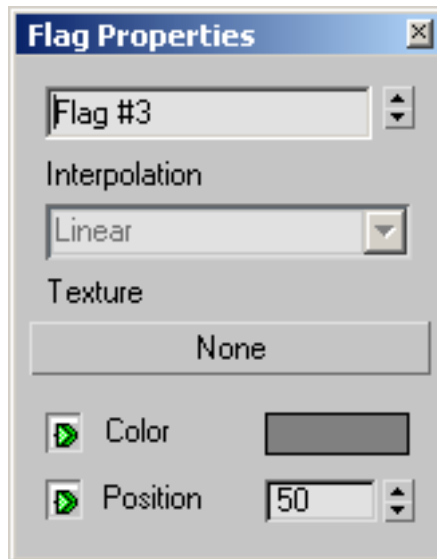

Name field Select any flag with the spinners. The selected flag turns green on the gradient bar. Use this field to rename a flag to represent its use in the gradient.

Interpolation Disabled unless the Interpolation type for the Gradient Ramp map is set to Custom. The available interpolation types for flags are similar to the corresponding ones in the Gradient Ramp map:

NOTE Gradients are ordered from left to right. The “next” flag is to the right of the current flag; the “previous” flag is to the left.

Ease In Weighted more toward the next flag than the current flag.

Ease In Out Weighted more toward the current flag than the next flag.

Ease Out Weighted more toward the previous flag than the next flag.

Linear Constant from one flag to the next. (Default.)

Solid No interpolation. Transitions are a sharp line.

Texture Assigns a map in place of a color. When unselected, the flag turns blue to indicate a map assignment.

Color Click the color swatch to change the color controlled by the selected flag.

Position Shows the current position of the selected flag. Use the spinners to reposition the flag, or enter a value directly. Position is not available for the start and end flags, because these flags can't be moved.



Animation keys Animation keys are created by default for Color and Position, and the keys are active, indicated by the green triangles next to the Color and Position labels. You can turn these keys off if you don't intend to animate the gradient.

Swirl Map

Material Editor > Maps rollout > Click a Map button. > Material/Map Browser > Swirl

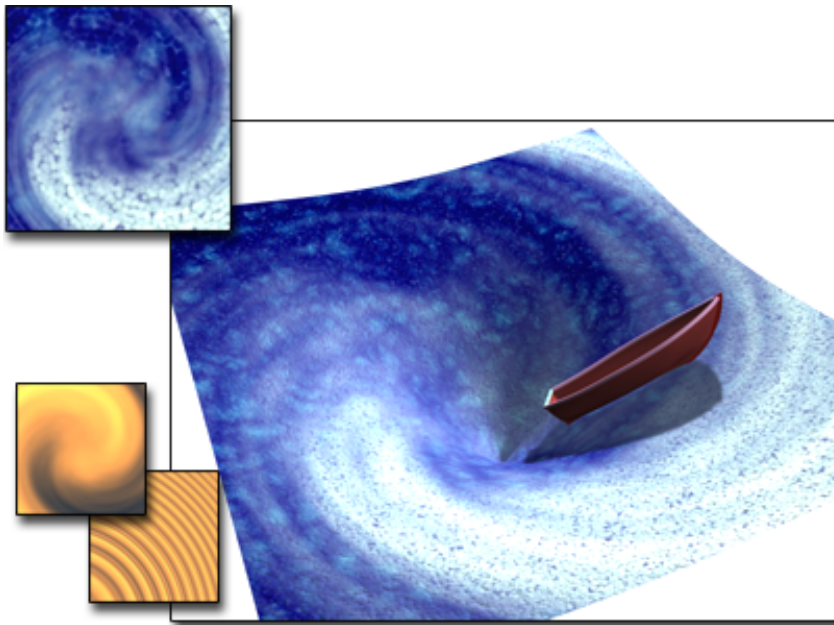

Swirl used to create the whirlpool

Swirl is a 2D procedural map that generates patterns similar to the swirls in two-flavor ice creams. Like other two-color maps, either color can be replaced with other maps, so it's possible to swirl marble with wood, for example.

See also:

- [Coordinates Rollout \(2D\)](#) on page 5782
- [Noise Rollout \(2D\)](#) on page 5793

Procedures

To create a Swirl-mapped material:

- 1 Open the Material Editor, and choose an unused sample slot.
- 2 Close the Basic Parameters rollout, and open the Maps rollout.
- 3 Turn on Diffuse Color. Click its Map button to display the Material/Map Browser.
- 4 In the Browser list, click Swirl. The map appears in the upper-left of the Browser window. Click OK.
Swirl map is applied to the sample slot as the Material/Map browser closes.
- 5 In the Material Editor, under its toolbar, give the material a name to identify its use in your scene.

Interface

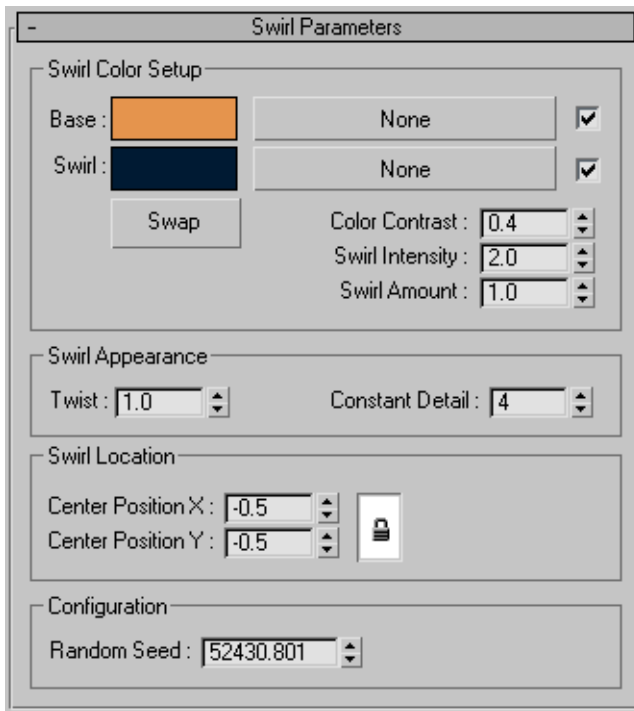

Swirl Color Setup group

Base The underlying layer for the swirl effect. Click the color swatch to change. Click None to assign a map in place of a color. The check box enables or disables the map.

Swirl Mixed with the Base color or map, produces the swirl effect. Click the color swatch to change this color. Click None to assign a map in place of a color.

Swap Reverses the color or map assignments for Base and Swirl.

Color Contrast Controls the contrast between Base and Swirl. At 0, the swirl is blurred. Higher values increase the contrast until all colors become black and white, even if Swirl Intensity and Swirl Amount are very high. Range=0 to 4.0; Default=0.4.

Swirl Intensity Controls the intensity of the swirl color. Higher values create a more vibrant mix of colors. At 0, the swirl effect disappears. Range=-10 to 10.0; Default=2.0.

Swirl Amount Controls the quantity of the Swirl color that gets mixed into the Base color. If set to 0, only the base color is used. Range=0 to 3.0; Default=1.0.

Swirl Appearance group

Twist Changes the number of spirals in the swirl effect. Higher values increase the number of spirals. Negative values change the direction of the twist. At 0, the colors are randomly distributed, not swirled. Range=-20.0 to 20.0; Default=1.0.

Constant Detail Changes the level of detail within a swirl. Lower values minimize the level of detail within the swirl. At 0, all detail is lost. Higher values increase detail until the swirl effect disappears. Values are in whole numbers. Range=0 to 10; Default=4.

Swirl Location group

Center Position X and Y Adjusts the location of the swirl's center on the object.

Lock X and Y values remain identical as you adjust them. By turning off Lock and adjusting either the X or Y position, you can “slide” the swirl effect across the object. Default=on.

Configuration group

Random Seed Sets a new starting point for the swirl effect. Changes the swirl pattern while maintaining other parameters. Range=0 to 65,535; No default.

Tiles Map

Material Editor > Maps rollout > Click a Map button. > Material/Map Browser > Tiles

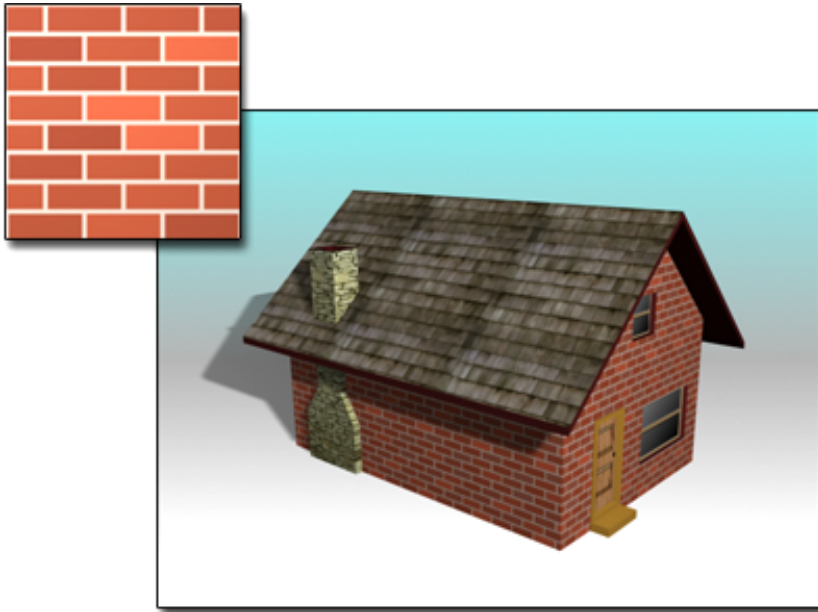

Tiles used for the walls of a house

Using the Tiles procedural map, you can create brick or stacked tiling of colors or material mappings. There are commonly defined architectural brick patterns available, or you can design custom patterns. With the Tiles map, you can:

- Assign many of the maps available through the Material Editor.
- Load textures and use colors in the pattern.
- Control the number of tiles in columns and rows.
- Control the size of the grout gap and its roughness.
- Apply random variance in the pattern.
- Control the stacking layout by shifting how the tiles line up.

See also:

- [Coordinates Rollout \(2D\)](#) on page 5782
- [Noise Rollout \(2D\)](#) on page 5793

Procedures

Example: To create a brick wall:

- 1 Create a wall using a Box primitive, or use an existing surface in one of your scenes.



- 2 Open the [Material Editor](#) on page 5284. Select an unused sample slot.
- 3 Click the Maps rollout to open it. Click the Map button for Diffuse to display the Material/Map Browser.
- 4 In the map list, select Tiles, then click OK.
The Tiles map is now assigned to the sample slot. On the Material Editor, you see new rollouts appear for this map.
- 5 On the Standard Controls rollout, use Preset Type to select the type of tiles for the wall. Stack Bond is the default.



- 6 On the Material Editor toolbar, click Assign Material To Selection to apply the tile map to the wall. Then click Show Map In Viewport to see the applied map.
- 7 Open the Advanced Controls rollout. Under Tiles Setup, adjust Horizontal and Vertical Count. The default is eight rows high, with three repeats of the pattern in each row. Visually scale the size of the tiles to your scene. Also adjust Texture as well as Color and Fade Variance to fine-tune the appearance of the tiles.
- 8 Under Grout Setup, adjust parameters for the texture of the grout, gap spacing between tiles, and roughness of the grout. You can also create missing bricks in the map by setting % Holes to a value above 0.
- 9 Under Miscellaneous, you can vary the color of the tiles by using the Random Seed option.

Example: To match the tiles on the top and side of a wall:

- 1 Select a wall mapped with tile.
- 2 On the Modify panel, choose Editable Mesh.
- 3 Turn on Sub-Object > Face.
- 4 Select the top face of the wall.

- 5 Open the Material Editor. Drag the wall's tile material to an unused sample slot to duplicate the material.
- 6 Under Tiles Setup, adjust the horizontal and vertical count of the new material to match the side of the wall.
- 7 Apply the new tile material to the selected faces on the top of the wall.
- 8 Under Stacking Layout, align the tiles by using the Line Shift option.

Interface

Standard Controls rollout

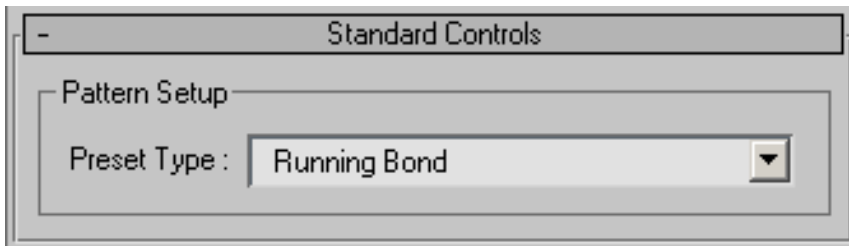

Preset Type Lists the commonly defined architectural tile bonds, or patterns, plus a custom pattern, which you design by selecting options under the Advanced Controls and Stacking Layout rollouts. The following illustrations show some of the different bonds:

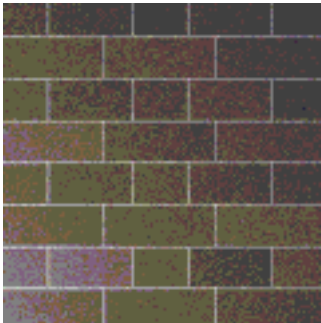

Common Flemish

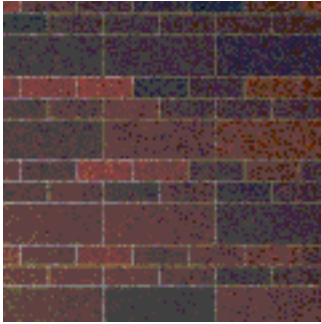

Fine Running

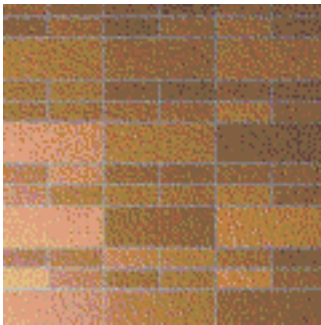

Fine Stack

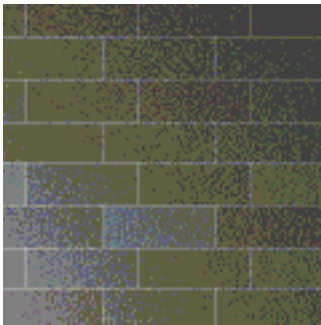

1/2 Running



Running

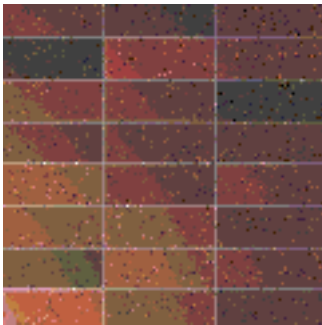

Stack

Advanced Controls rollout

- Advanced Controls

Show Texture Swatches

Tiles Setup

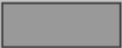
Texture:  None

Horiz. Count: Color Variance:

Vert. Count: Fade Variance:

Grout Setup

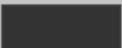
Texture:  None

Horizontal Gap:  % Holes:

Vertical Gap: Rough:

Miscellaneous

Random Seed: Swap Texture Entries

Stacking Layout

Line Shift: Random Shift:

Row and Column Editing

Row Modify Per Row:
Change:

Column Modify Per Column:
Change:

Show Texture Swatches Updates to show the texture assigned by a map for Tiles or Grout.

Tiles Setup group

Texture Controls the display of the current texture map for the tiles. When on, the texture is used as the tile pattern instead of the color swatch. When turned off, the color of the tiles is displayed; clicking the color swatch displays the [Color Selector](#) on page 391.

None Acts as a target where you drag and drop maps for the tiles. When you click this button with a map assigned, the software displays the rollout for the map. You return this button to None (removing the assigned map) by dragging and dropping a None map from the Map/Material Browser.

Horiz. Count Controls the number of tiles in a row.

Vert. Count Controls the number of tiles in a column.

Color Variance Controls the color variation among the tiles.

Fade Variance Controls the fading variation among the tiles.

Grout Setup group

Texture Controls the display of the current texture map for the grout. When on, the texture is used as the grout pattern instead of the color swatch. When off, the color of the grout is displayed, and clicking the color swatch displays the [Color Selector](#) on page 391.

None Acts as a target where you drag and drop maps for the grout. When you click this button with a map assigned, the software displays the rollout for the map. You return this button to None (removing the assigned map) by dragging and dropping a None map from the Map/Material Browser.

Horizontal Gap Controls the horizontal size of the grout between the tiles. This value is locked by default to the vertical gap, so that both values change as you edit one or the other. To unlock them, click the lock icon.



Vertical Gap Controls the vertical size of the grout between the tiles. This value is locked by default to the horizontal gap, so that both values change as you edit one or the other. To unlock them, click the lock icon.

% Holes Sets the percentage of holes in the tiled surface caused by missing tiles. The grout shows through the holes.

Rough Controls the roughness of the edges of the grout.

Miscellaneous group

Random Seed Randomly applies patterns of color variation to the tiles. Does not require any other setting to generate completely different patterns.

Swap Texture Entries Swaps the texture maps or colors between the tiles and the grout.

Stacking Layout group

NOTE This group of controls is active only when Custom Tiles is selected in Standard Controls rollout > Pattern Setup > Preset Type.

Line Shift Shifts every second row of tiles a distance of one unit.

Random Shift Randomly shifts all rows of tiles a distance of one unit.

Row and Column Editing group

NOTE This group of controls is enabled only when Custom Tiles is selected in Standard Controls rollout > Pattern Setup > Preset Type.

Row Modify When on, creates a custom pattern for rows, based on the values of Per Row and Change. Default=off.

- **Per Row** Specifies which rows to change. When Per Row equals 0, no rows change. When Per Row equals 1, every row changes. When Per Row is a value greater than 1, the change appears every *N* rows: a value of 2 changes every second row, a value of three changes every third row, and so on. Default=2.
- **Change** Changes the width of tiles in the affected rows. A value of 1.0 is the default tile width. Values greater than 1.0 increase the width of tiles, and values less than 1.0 decrease it. Range=0.0 to 5.0. Default=1.0. A value of 0.0 is a special case: When the Change value is 0.0, no tiles appears in that row, and the underlying material shows through.

Column Modify When on, creates a custom pattern for columns, based on the values of Per Column and Change. Default=off.

- **Per Column** Specifies which columns to change. When Per Column equals 0, no columns change. When Per Column equals 1, every column changes. When Per Column is a value greater than 1, the change appears every *N* columns: a value of 2 changes every second column, a value of three changes every third column and so on. Default=2.

- **Change** Changes the height of tiles in the affected columns. A value of 1.0 is the default tile height. Values greater than 1.0 increase the height of tiles, and values less than 1.0 decrease it. Range=0.0 to 5.0. Default=1.0. A value of 0.0 is a special case: When the Change value is 0.0, no tile appears in that column, and the underlying material shows through.

3D Maps

3D maps are patterns generated procedurally in three dimensions. For example, Marble has a grain that goes through the assigned geometry. If you cut away part of an object with marble assigned as its texture, the grain in the cutaway portion matches the grain on the object's exterior. The following 3D maps are available in 3ds Max:

Cellular on page 5862: Generates a cellular pattern that's useful for a variety of visual effects, including mosaic tiling, pebbled surfaces, and ocean surfaces.

Dent on page 5869: Generates three-dimensional bumps over a surface.

Falloff on page 5877: Generates a value from white to black based on the angular falloff of the face normals on the surface of the geometry. The Falloff map provides greater flexibility when creating opacity falloff effects. Other effects include Shadow/Light, Distance Blend, and Fresnel.

Marble on page 5883: Simulates the grain of marble with two explicit colors and a third intermediate color.

Noise on page 5886: Noise is a turbulence pattern in three dimensions. Like Checker in 2D, it is based on two colors, either of which can be mapped.

Particle Age on page 5889: Alters the color (or map) of a particle based on the particle's life.

Particle MBlur on page 5891: (MBlur is short for Motion Blur.) Alters the opacity of the leading and trailing ends of particles based on their rate of movement.

Perlin Marble on page 5893: An alternative, procedural marble map with a turbulence pattern.

Planet on page 5896: Simulates the contours of a planet as seen from space.

Smoke on page 5898: Generates fractal-based turbulence patterns to simulate the effects of smoke in a beam of light, or other cloudy, flowing mapping effects.

Speckle on page 5901: Generates a speckled surface for creating patterned surfaces that can simulate granite and similar materials.

[Splat](#) on page 5902: Generates a fractal pattern similar to splattered paint.

[Stucco](#) on page 5904: Generates a fractal pattern similar to stucco.

[Waves](#) on page 5907: Creates watery or wavy effects by generating a number of spherical wave centers and randomly distributing them.

[Wood](#) on page 5909: Creates a 3D wood grain pattern.

Coordinates Rollout (3D)

Material Editor > Select sample slot. > Get Material > Material/Map Browser > Turn on 3D Maps. > Double-click a map type to apply it to sample slot. > Coordinates rollout is displayed in Material Editor.

By adjusting coordinate parameters, you can move a map relative to the volume of the object to which it is applied.

Interface

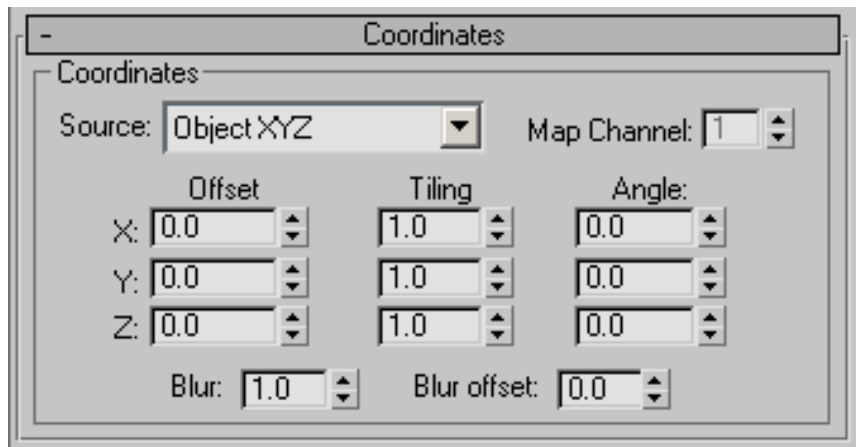

Source Chooses the coordinate system to use. There are four options:

- **Object XYZ** Uses the object's local coordinate system.
- **World XYZ** Uses the scene's world coordinate system.
- **Explicit Map Channel** Activates the Map Channel field. You can choose any channel from 1 to 99.

- **Vertex Color Channel** Assigns vertex colors as a channel. See [Editable Mesh](#) on page 2075 for details on assigning vertex color. See also [Vertex Color Map](#) on page 5943.

When one of the map channels is set, it locks the map into position on the vertices of the object so that the map "sticks" to the object as it deforms during animation.

When an object is deforming through its own local space (for example, when it is bending or twisting), the object appears to move through the map, because it passes through the XYZ coordinates of the 3D texture.

Map Channel Unavailable unless the source is Explicit Map Channel. When available, you can choose any channel from 1 to 99.

Offset Moves the map pattern along the specified axis.

Tiling Tiles on page 8148 the map pattern along the specified axis and makes the pattern narrower.

Angle Rotates the map pattern along the specified axis.

Blur Affects the sharpness or blurriness of the map based on its distance from the view. The farther away the map is, the greater the blurring. The Blur value blurs maps in world space. Blur is primarily used to avoid [aliasing](#) on page 7904.

Blur Offset Affects the sharpness or blurriness of the map without regard to its distance from the view. Blur Offset blurs the image itself in object space. Use when you want to soften or defocus the details in a map to achieve the effect of a blurred image.

Cellular Map

Material Editor > Maps rollout > Click a Map button. > Material/Map Browser > Cellular

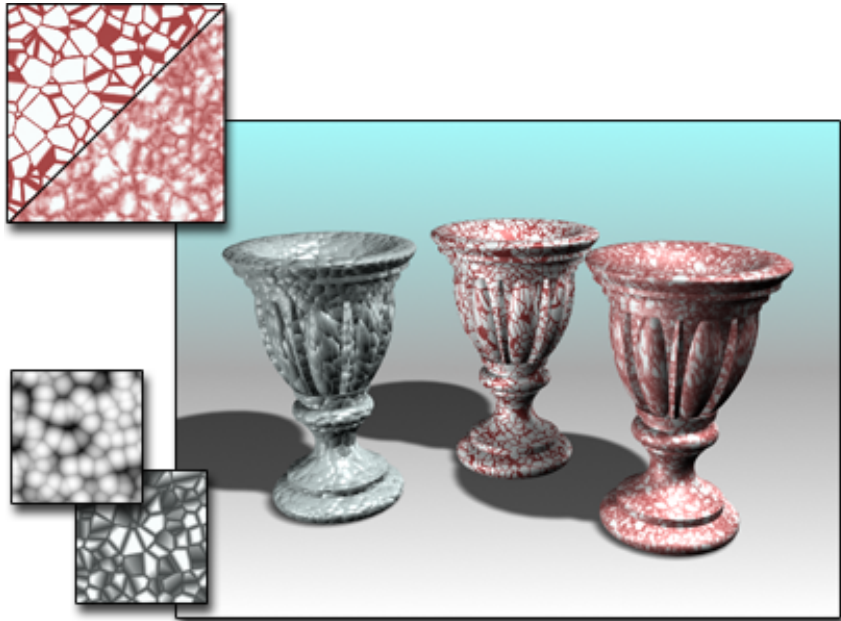

Cellular maps create the goblet textures.

The Cellular procedural map generates a pattern that's useful for a variety of visual effects, including mosaic tiling, pebbled surfaces, and even ocean surfaces.

TIP The Material Editor sample slot doesn't show the cellular effect very clearly. For a better visual aid to getting the effect you want, assign the map to geometry and render the scene.

See also:

- [Coordinates Rollout \(3D\)](#) on page 5861
- [Output Rollout](#) on page 5774

Procedures

Example: To create confetti:

- 1 Assign the Cellular map as a Diffuse map.
- 2 Set the parameters as follows:

Cell Color (use RGB values after clicking color swatch): **202, 75, 171**

Variation: **55**

Division Colors (use RGB values after clicking the color swatch):

■ First: **127, 150, 197**

■ Second: **0, 119, 163**

Cell Characteristics:

■ Circular

■ Size: **2.4**

■ Spread: **0.43**

■ Fractal: off

Thresholds:

■ Low: **0.19**

■ Mid: **0.65**

■ High: **0.86**

Example: To create alien skin:

1 Assign the Cellular map as a Diffuse map.

2 Set the parameters as follows:

Cell Color (use RGB values after clicking the color swatch): **52, 107, 58**

Variation: 0.0

Division Colors (use RGB values after clicking the color swatch):

■ First: **112, 119, 64**

■ Second: **143, 137, 112**

Cell Characteristics:

■ Circular

■ Size: **7.9**

■ Spread: **0.61**

■ Fractal: on

- Iterations: **2.0**

Thresholds:

- Low: **0.17**

- Mid: **0.64**

- High: **1.0**

- 3 Copy the Diffuse map to the Bump map.

If you increase the Bump amount, increase the Cellular bump map's Bump Smoothing value as well.

Example: To create a tile mosaic:

- 1 Assign the Cellular map as a Diffuse map.

- 2 Set the parameters as follows:

Cell Color (use RGB values after clicking the color swatch): **141, 120, 87**

Variation: **54**

Division Colors (use RGB values after clicking the color swatch):

- First: **128, 128, 128**

- Second: **221, 221, 221**

Cell Characteristics:

- Chips

- Size: **7.0**

- Spread: **0.35**

- Fractal: off

Thresholds:

- Low: **0.42**

- Mid: **0.76**

- High: **1.0**

- 3 Assign a Mix map as the Bump map.

- 4 Click Material/Map Navigator to display the Navigator. Copy the Cellular Diffuse map by dragging it from the Navigator to the Color #2 map window of the Mix map.
- 5 A dialog is displayed. You are asked if this should be an instance or a copy. Select Copy and click OK.
- 6 Assign a Noise map to the Color #1 map window of the Mix map.
- 7 Set the Noise parameters as follows:
Noise Type: Fractal
Levels: **6.0**
Size: **9.3**
- 8 In the Mix Parameters rollout of the Mix map, set the Mix Amount to **0.5**.
- 9 Go to top level of the material. In the Maps rollout, set Bump Amount to **82**.

Interface

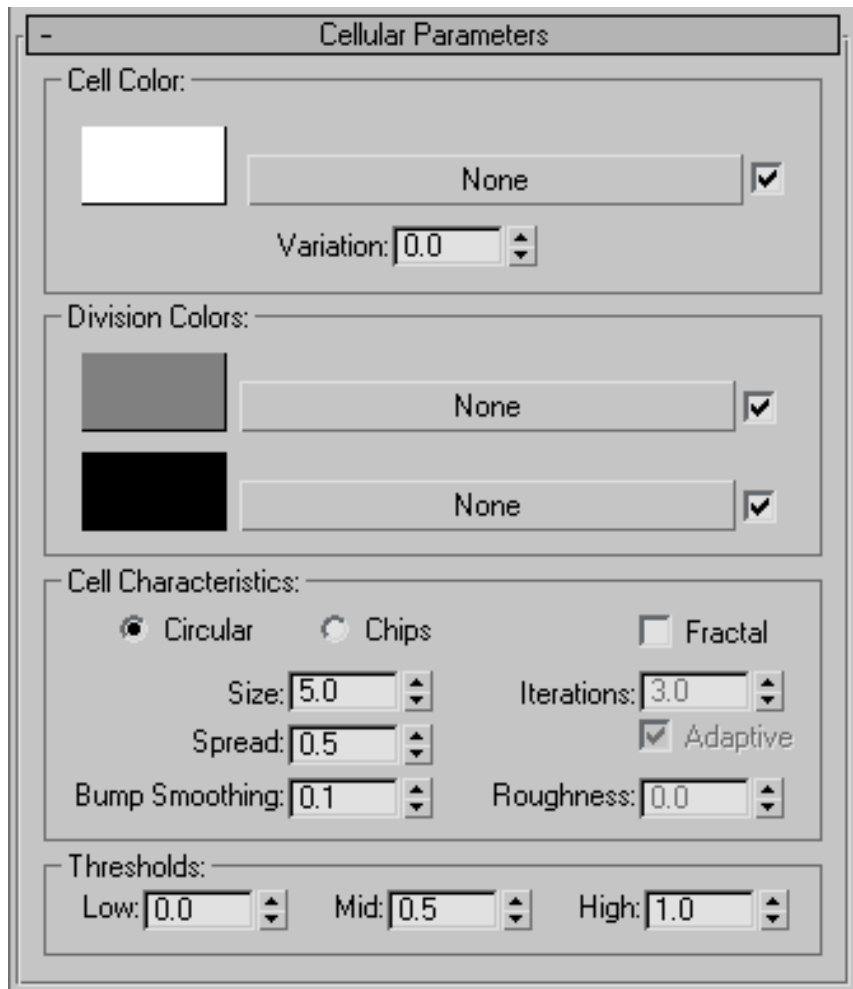

Cell Color group

These controls specify the color of the cells.

Color swatch Displays the [Color Selector](#) on page 391. Choose a color for the cells.

Map button Assigns a map to the cells, rather than a solid color.

Check box When on, enables the map. When off, disables the map (cell color reverts to the color swatch).

Variation Varies the color of the cells by randomly altering RGB values. The higher the variation, the greater the random effect. This percentage value can range from 0 to 100. At 0, the color swatch or the map completely determines the cell color. Default=0.

Division Colors group

These controls specify the color of the divisions between cells. Cell divisions are a ramp between two colors or two maps.

Color swatches Display the Color Selector for choosing a cell division color.

Map buttons Assigns a map to one of the cell division colors.

Check boxes When on, enables the associated map. When off, disables the associated map (the division color reverts to the color swatch).

Cell Characteristics group

These controls change the shape and size of the cells.

Circular/Chips Lets you choose how cell edges look. With Circular, the cells are circular. This gives a more organic, or bubbly look. With Chips, the cells have linear edges. This gives a more chipped or mosaic appearance. Default=Circular.

Size Alters the overall scale of the map. Adjust this value to fit the map to your geometry. Default=5.0.

Spread Alters the size of individual cells. Default=0.5.

Bump Smoothing When you use a cellular map as a [bump map](#) on page 5478, you might encounter aliasing or jaggedness at the boundaries of the cells. If this occurs, increase this value. Default=0.1.

Fractal Defines the cellular pattern as a fractal, thus enabling the three following additional parameters. Default=off.

Iterations Sets the number of times the fractal function is applied. Caution: Increasing this value increases rendering time. Default=3.0.

Adaptive When on, the number of fractal iterations is set adaptively. That is, the number of iterations increases the closer the geometry is to the scene's point of view, and decreases in the distance. This reduces aliasing and also saves time while rendering. Default=on.

Roughness When you use the Cellular map as a [bump map](#) on page 5478, this parameter controls how rough the bumps are. When Roughness is zero, each iteration is half the strength of the previous iteration, and half the size. As Roughness increases, each iteration is closer in strength and size to the previous iteration. When Roughness is at its maximum value of 1.0, each iteration is the same size and strength as the previous. In effect, this turns off the fractalization. Roughness has no effect unless Iterations is greater than 1.0. Default=0.0.

Thresholds group

These controls affect the relative size of cells and divisions. They are expressed as normalized percentages (0 to 1) of the sizes specified by the default algorithm.

Low Adjusts the size of the cells. Default=0.0.

Mid Adjusts the size of the first division color, relative to the second. Default=0.5.

High Adjusts the overall size of divisions. Default=1.0.

Dent Map

Material Editor > Maps rollout > Click a Map button. > Material/Map Browser
> Dent

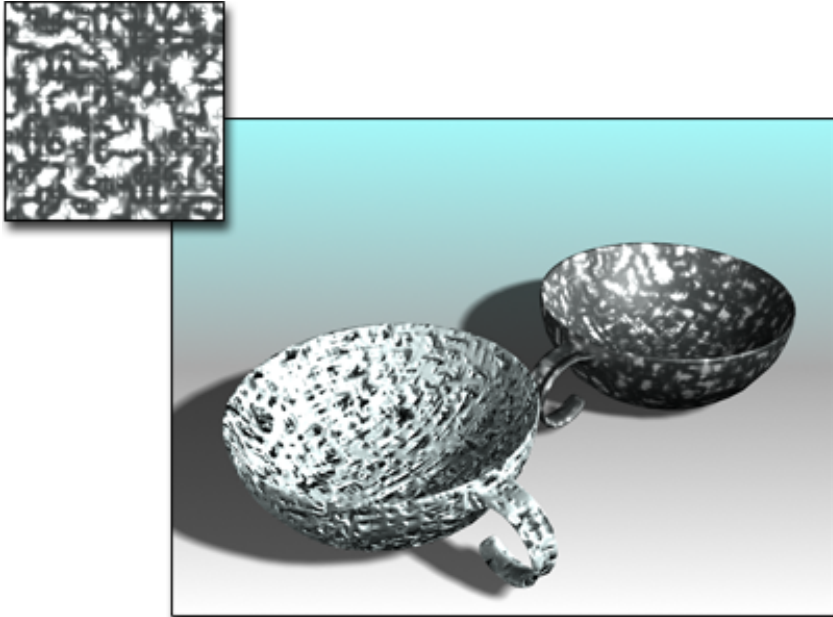

Dent map gives texture to the cup on the left; cup on the right has same pattern, but without dents.

Dent is a 3D procedural map. During scanline rendering, Dent creates a random pattern based on fractal noise. The effect of the pattern depends on the map type.

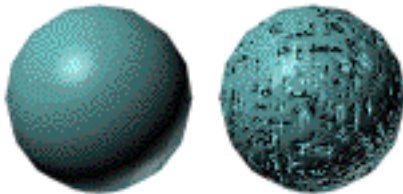

Effect of default parameters

Defaults: Iterations=2, Size=200, Strength=20

Dent was designed to be used primarily as a bump map, and its default parameters are optimized for this usage. As a bump map, Dent renders three-dimensional dents over the surface of an object. Editable parameters control the size, depth, and complexity of the denting effect.

Dent can also be used with other maps. With a diffuse color map, for example, the two colors assigned to Dent mix in random swirls over the surface of the object. Either of the colors can be replaced by other maps.



Dent bump maps

At left, default parameters produce fairly uniform dents over surface.

At right, increased Strength parameter creates a deeper and more irregular pitting effect.



Dent diffuse maps

At left, Dent as a two-color diffuse map.

At right, colors replaced with Dent and Marble maps.

See also:

- [Coordinates Rollout \(3D\)](#) on page 5861

Procedures

To make a Dent map:

- 1 In the Material Editor, click a sample slot to make it active.
- 2 Open the Maps rollout.
- 3 Click Bump or other map button to display the Material/Map Browser.
- 4 Double-click Dent in the list of map types.
The Material Editor displays the Coordinates and Dent Parameters rollouts.
- 5 Set parameters on the Dent Parameters rollout.

The active sample slot updates to show the Dent effect.

To replace a color:

- 1 Click a color swatch labeled Color #1 or Color #2.
- 2 In the standard [Color Selector](#) on page 391, choose a replacement color.
The color updates in the color box and sample slot.

To swap a color:

- Click Swap.
The position of the two colors is reversed in the color boxes and sample slot.

To replace a color with a map:

- 1 Click a Map bar marked None next to one of the color swatches.
The Material/Map Browser is displayed.
- 2 Select a map from the list.
The sample slot updates to show the map in place of the color.

Interface

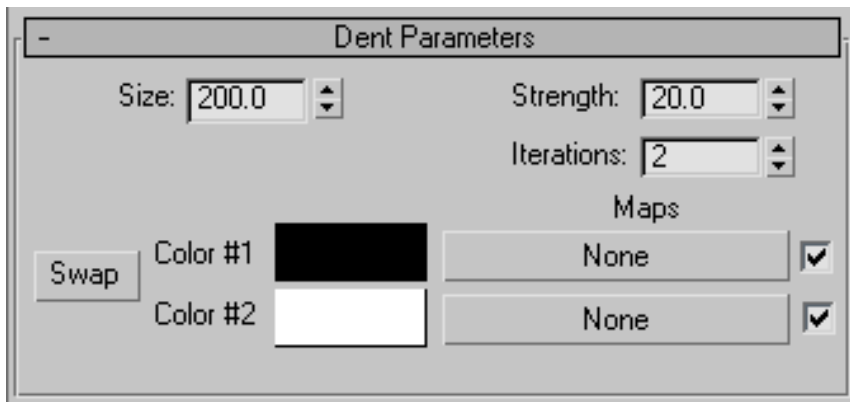

Size Sets the relative size of dents. As the size increases, the number of dents decreases when other settings are the same. Default=200.

Decreasing Size creates the appearance of tiny dents spaced fairly evenly. The effect can resemble a "sand-covered" surface.

Increasing Size creates the appearance of distinct grooves and gouges on a surface. The effect sometimes has a "hardened lava" look.

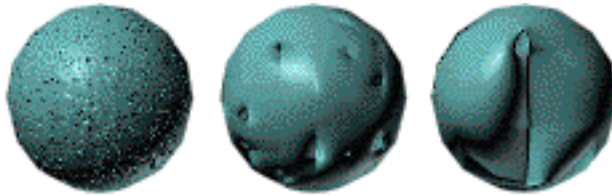

Size=10, 500, and 1000

Iterations=1, Strength=20 (default)



Size=10, 500, and 1000

Iterations=3, Strength=20 (default)

Each set of three spheres uses the same size range, but varies the number of iterations. Strength is held constant in both sets.

Strength Determines the relative coverage of the two colors. Higher values increase the coverage of Color #2, while lower values increase the coverage of Color #1. Default=20.

When using Dent as a bump map, increasing the Strength value typically makes the dents look deeper.

In the following illustrations, each set of three spheres uses the same Strength range, but varies the Size value between the two sets. The Iterations value is the same in both sets.

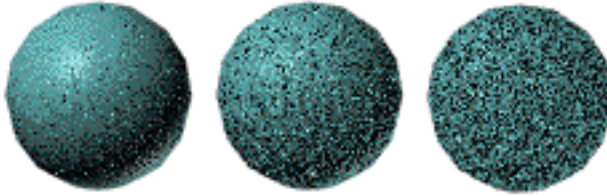

Size=10, Iterations=3

Strength=5, 20 (default), and 100

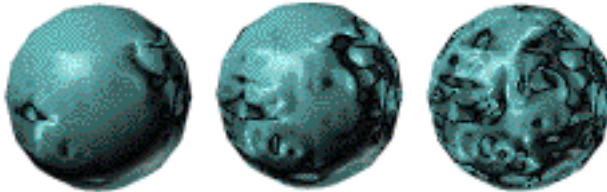

Size=1000, Iterations=3

Strength=5, 20 (default), and 100

Iterations Sets the number of calculations used to create the dents. Default=2. Dent is based on a fractal-noise equation. During rendering, a dented surface is calculated one or more times to produce the finished effect. Each calculation pass is an iteration.

As a surface is calculated, each iteration adds to the number of dents and the complexity and randomness of the final surface (dents become dented).

The Dent texture requires heavy calculation, especially at higher iterations. This can slow down rendering time considerably.



Iterations=1, 3, and 6

Size=500, Strength=20

The three spheres have uniform settings for size and strength. Only the number of iterations varies.

Swap Reverses the position of colors or maps.

Colors Allows choice of two colors where appropriate for a color component (such as Diffuse). Defaults=black for Color #1 and white for Color #2.

Dent can create patterns in an object's color as well as its surface. By using Dent as a diffuse color map, the entire surface is affected.

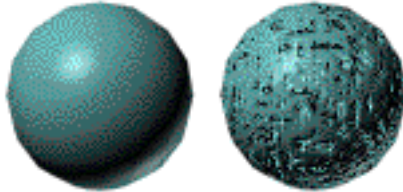

Size=500, Strength=60

Iterations=2

Two colors are mixed to produce a random pattern, governed by size, strength, and iteration settings. The default colors are black and white, but either can be replaced or swapped.

Left sphere: Sets the color to black and white.

Middle sphere: Replaces white with red.

Right sphere: Swap black and red.

By adjusting Strength, Size, and Iterations parameters, you vary the Dent patterns on a diffuse color map.

- Size sets the density of the dent pattern. At low settings, the pattern is dense. As Size increases with other settings held constant, the pattern becomes increasingly sparse.
- Strength sets the color strength in the dent pattern. At low settings, Color #1 (black) dominates the pattern. As Strength increases, Color #2 (white) replaces Color #1.
- Iterations sets the color iterations in the dent pattern. At low settings, Color #1 is dominant. As iterations increase, Color #2 gradually increases in the pattern.

Dent is applied as a diffuse map in the following examples. Colors are default black and white.



Size=100, 500, and 1000

Strength=20, Iterations=2

Color #1, #2=black, white (defaults)



Strength=20, 50, and 100

Size=500, Iterations=2



Iterations=2, 4, and 8

Size=500, Strength=20

Maps Replaces colors with maps in the dent pattern. The check boxes enable or disable their associated map.

You can assign maps to one or both of the Dent color slots. Any kind of map can be used, including Dent. The map overrides the assigned color, which has no effect.

In the three spheres below, the assigned colors are progressively replaced with maps. Parameters of the original Dent map are the same for all spheres.

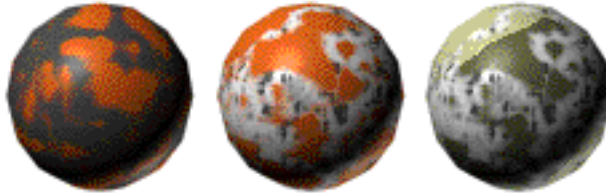

Size=500, Strength=60, Iterations=2

Left sphere: Applies Dent as a diffuse map. Color #1 is black; Color #2 is red.

Middle sphere: Replaces black with Dent map (all defaults).

Right sphere: Replaces red with Marble map (all defaults).

Falloff Map

Material Editor > Maps rollout > Click a Map button. > Material/Map Browser
> Falloff

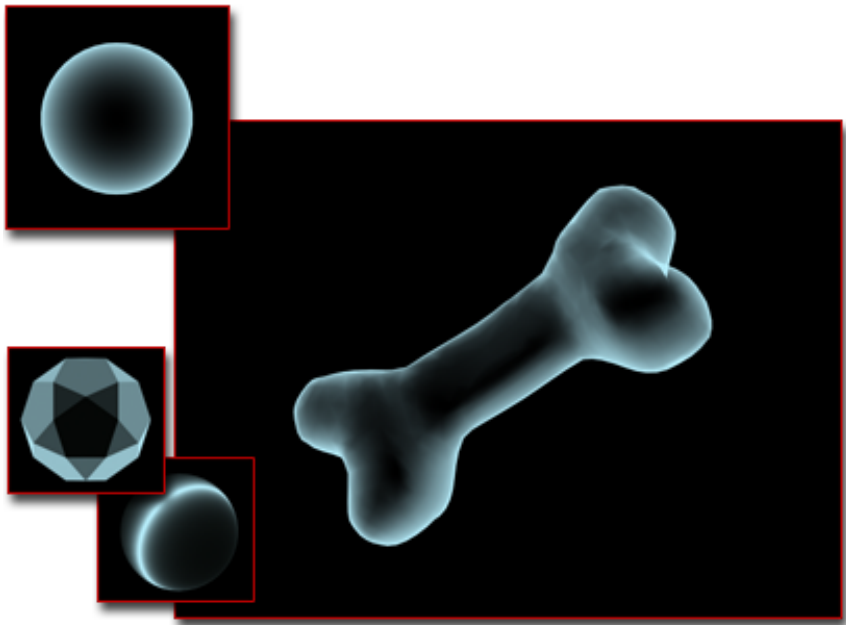

Falloff map creates the appearance of translucency.

The Falloff map generates a value from white to black, based on the angular falloff of the face normals on the surface of the geometry. The direction used to specify the angular falloff varies, depending on the methods you choose. However, with the default settings, the map generates white on faces whose normals point outward from the current view, and black on faces whose normals are parallel to the current view.

Falloff map provides a greater variety of opacity falloff effects than those in the Falloff settings in a standard material's [Extended Parameters rollout](#) on page 5408. You assign the Falloff map as an [opacity map](#) on page 5470. However, you can also use Falloff for special effects, such as an iridescent look.

NOTE When old files that use Falloff maps are brought into 3ds Max, the old Falloff interface is displayed, replacing the new Falloff interface.

See also:

- For functionality shared with other 3D maps, see [Output Rollout](#) on page 5774

Procedure

To control opacity using a Falloff map:

- 1 Assign the Falloff map as an opacity map.
- 2 Render to see the effect.
- 3 Adjust the falloff parameters to vary the effect.

Interface

Falloff Parameters rollout

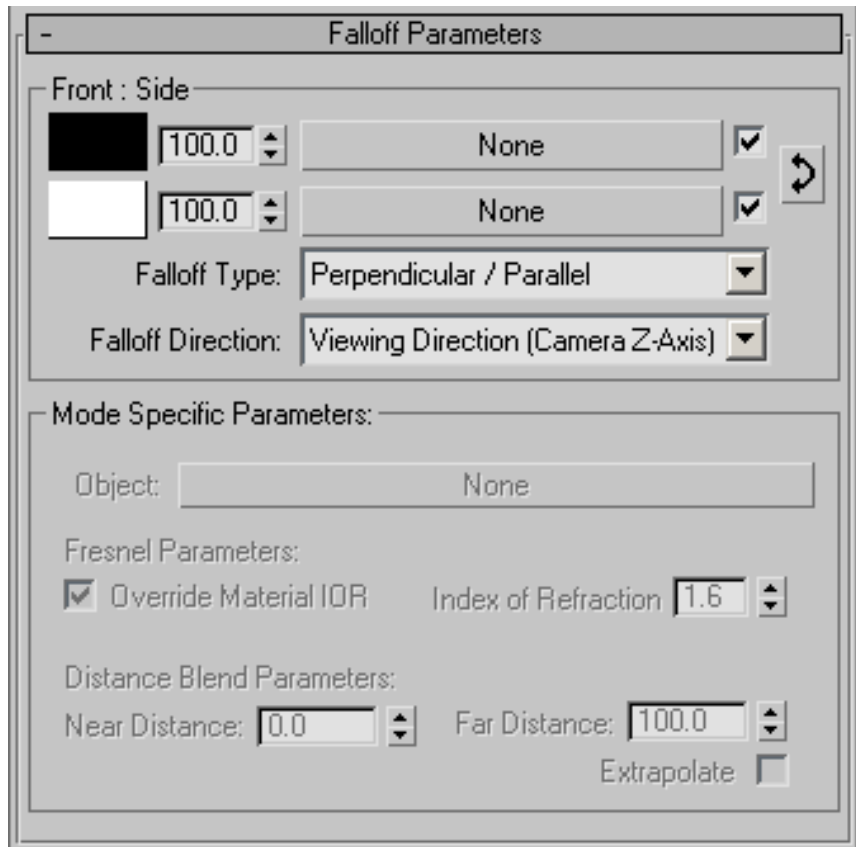

Front : Side By default, "Front : Side" is the name of the group at the top of this rollout. Front : Side indicates Perpendicular/Parallel falloff. This name changes depending on the falloff type selected. In all cases, the name on the left refers to the top set of controls, and the name on the right to the bottom set.

The controls are as follows:

- Click the color swatches to assign colors.
- Use the numeric fields and spinners to adjust the relative strength of the colors.

- Click the buttons marked None to assign maps.
- Turn on the check boxes to activate the maps; otherwise the colors are used. These are on by default.



- Click Swap Colors/Maps (the curved arrow) to exchange the assignments.

Falloff Type Chooses the kind of falloff. Five options are available:

- **Perpendicular/Parallel** Sets the angular falloff ranges between face normals that are perpendicular to the falloff direction and normals that are parallel to the falloff direction. The falloff range is based on a 90-degree change in face normal direction. (Default.)
- **Towards/Away** Sets the angular falloff ranges between face normals that face toward (parallel to) the falloff direction and normals that face away from the falloff direction. The falloff range is based on a 180-degree change in face normal direction.
- **Fresnel** Based on adjustments to the Index of Refraction (IOR). Results in dim reflections on surfaces facing the view, with much brighter reflections on angled faces, creating highlights like those on the sides of a glass.
- **Shadow/Light** Adjusts between two subtextures based on how much light is falling on the object.
- **Distance Blend** Adjusts between two subtextures based on Near Distance and Far Distance values. Uses include reducing aliasing on large terrain objects and controlling the shading in non-photorealistic environments.

Falloff Direction Chooses the direction of falloff. Five options are available:

- **Viewing Direction (Camera Z-Axis)** Sets the falloff direction relative to the camera (or screen). Changing object orientation doesn't affect the falloff map. (Default.)
- **Camera X/Y Axis** Similar to Camera Z-Axis. For example, using Camera X-Axis with the Toward/Away falloff type runs the gradient from left (Toward) to right (Away).
- **Object** Uses an object whose position determines the falloff direction. Click the wide button next to Object in the Mode Specific Parameters group, and then pick an object in the scene. The falloff direction is the direction from the point being shaded toward the object's center. Points

on the side toward the object center get the Towards value, and those away from the object get the Away value.

- **Local X/Y/Z Axis** Sets the falloff direction to one of the object's local axes. Changing the orientation of the object changes the falloff direction.
- **World X/Y/Z Axis** Sets the falloff direction to one of the world coordinate system axes. Changing object orientation doesn't affect the falloff map.

When no object is chosen, the falloff direction uses the local X, Y, or Z axis of the object being shaded.

Mode Specific Parameters group

The first parameter applies and is available only when you set [Falloff Direction](#) on page 5880 to Object:

Object Picks object from scene and puts its name on the button.

The following are parameters for the Fresnel falloff type:

Override Material IOR Allows change to the Index of Refraction set by the material.

Index of Refraction Sets a new Index of Refraction. This option is unavailable unless Override Material IOR is turned on.

The following are parameters for the Distance Blend falloff type:

Near Distance Sets the distance at which the blend effect begins.

Far Distance Sets the distance at which the blend effect ends.

Extrapolate When on, the effect continues beyond the Near and Far distances.

Mix Curve rollout

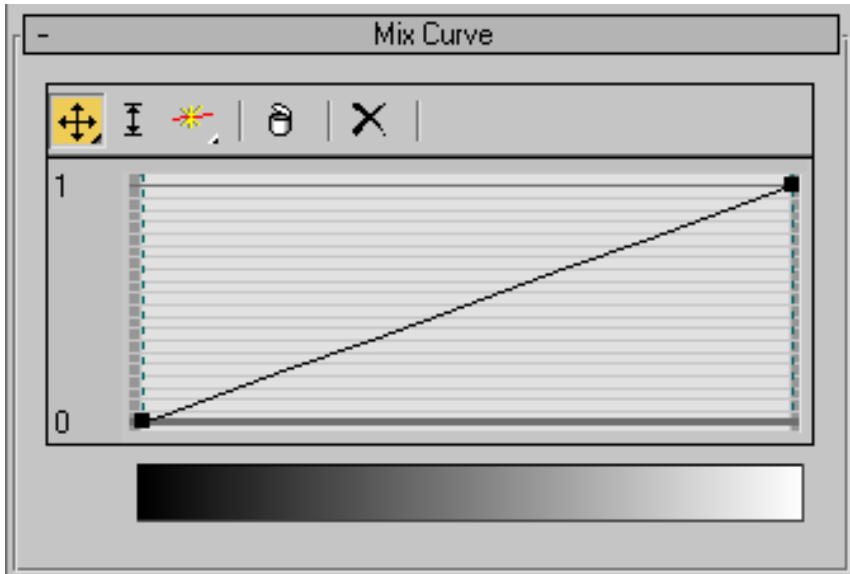

Using the graph on the Mix Curve rollout, you can precisely control the gradient produced by any falloff type. You see the resulting gradient in the bar below the graph.

Move flyout



Moves a selected point in any direction, limited by the unselected points on either side.



Constrains movement to the horizontal.



Constrains movement to the vertical.



Scale Point Scales the selected point within the range of its gradient. On a Bezier corner point, this control is effectively the same as a vertical move. On a Bezier smooth point, you can scale the point itself or either handle. As with the move controls, scale is limited by the unselected points on either side.

Add Point flyout



Adds a Bezier corner point anywhere on the graph line. The point makes a sharp angle when moved.



Adds a Bezier smooth point anywhere on the graph line. Handles attached to the point create smooth curves when moved. On a Bezier smooth point, you can move the point or either handle.



Delete Point Removes selected points.



Reset Curves Returns graph to its default, a straight line between 0 and 1.

Marble Map

Material Editor > Maps rollout > Click a Map button. > Material/Map Browser > Marble

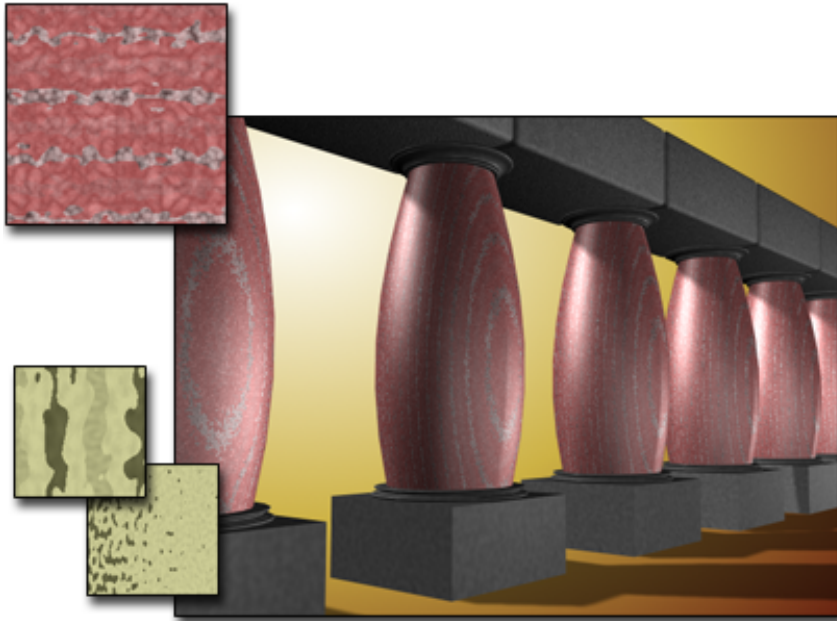

Marble map used for the balusters

The Marble map produces a marbled surface with colored veins against a colored background. A third color is automatically generated.

NOTE Another way to create marble is to use the [Perlin Marble Map](#) on page 5893.

See also:

- For functionality shared with other 3D maps, see [Coordinates Rollout \(3D\)](#) on page 5861.

Procedures

To create a Marble map:

- 1 Click a map button to assign a map.
- 2 Choose Marble in the Material/Map Browser, and then click OK.

To adjust the size of Marble veins:

- In the Marble Parameters rollout, change the Size value to change the overall scale of the vein pattern, and change Vein Width to change the width of veins relative to the overall scale.
The larger the Size value, the wider the veins. The larger the Vein Width value, the more veins appear relative to the overall pattern.

To change vein color:

- 1 In the Marble Parameters rollout, click a color swatch to display the [Color Selector](#) on page 391.
- 2 Adjust the color.
- 3 Click Close to dismiss the dialog.

To use a map for a vein:

- In the Marble Parameters rollout, click a map button to assign a map to a color.

To swap the two vein colors:

- In the Marble Parameters rollout, click Swap.

To adjust mapping coordinates:

- In the Coordinates rollout, adjust Offset, Tiling, or Angle.

Interface

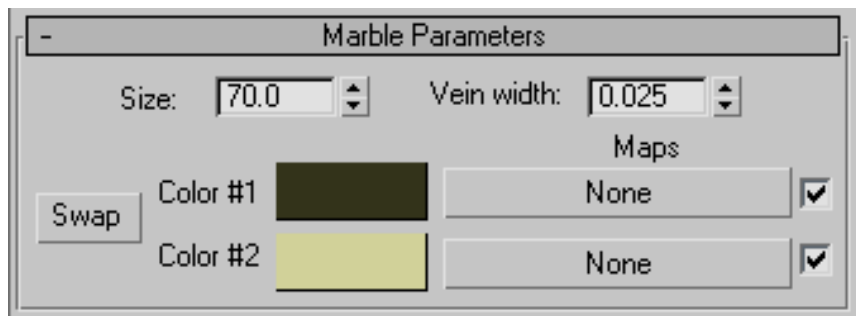

Size Sets the spacing between the veins.

Vein Width Sets the width of the veins.

Swap Switches the position of the two colors or maps.

Color # 1 and Color # 2 Displays the [Color Selector](#) on page 391. Select one color for the veins (color 1) and another for the background (color 2). A third color is generated from the two colors you select.

Maps Selects the bitmaps or [procedural maps](#) on page 8097 to appear in the veins or in the background color.

Turn on the check boxes to make the maps active.

Noise Map

Material Editor > Maps rollout > Click a Map button. > Material/Map Browser > Noise

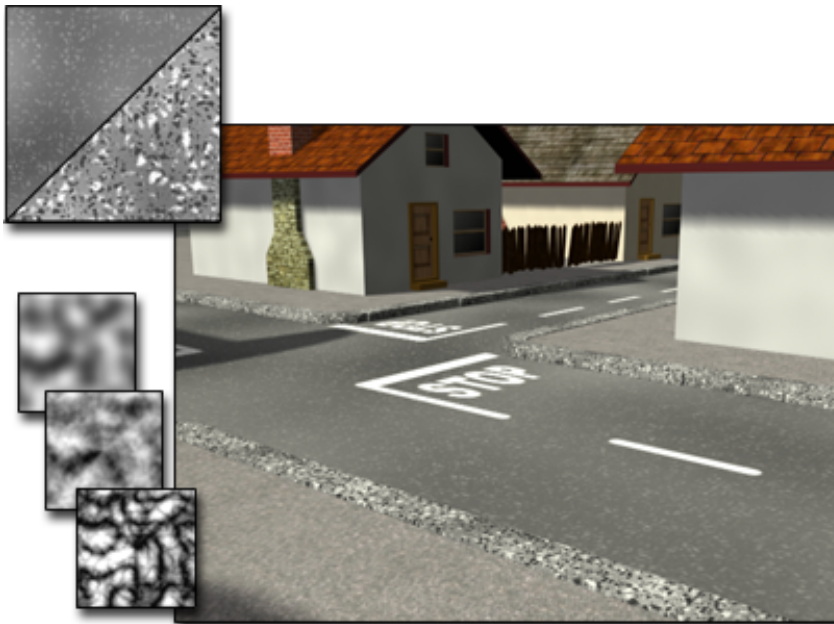

Noise map used for the edges of the street

The Noise map creates random perturbation of a surface based on the interaction of two colors or materials.

See also:

- [Coordinates Rollout \(3D\)](#) on page 5861
- [Output Rollout](#) on page 5774

Procedures

To change a component color:

- 1 In the Noise Parameters rollout, click a color swatch to display the [Color Selector](#) on page 391.
- 2 Adjust the color.
- 3 Click OK to dismiss the dialog.

To use a map for a component:

- In the Noise Parameters rollout, click a map button to assign a map to a color.

To swap the two component colors:

- In the Noise Parameters rollout, click Swap.

To adjust mapping coordinates:

- In the Coordinates rollout, adjust Offset, Tiling, or Angle.

Interface

NOTE For the Noise map, the tiling and mirroring controls are disabled in the Texture Tiling And Output rollout.

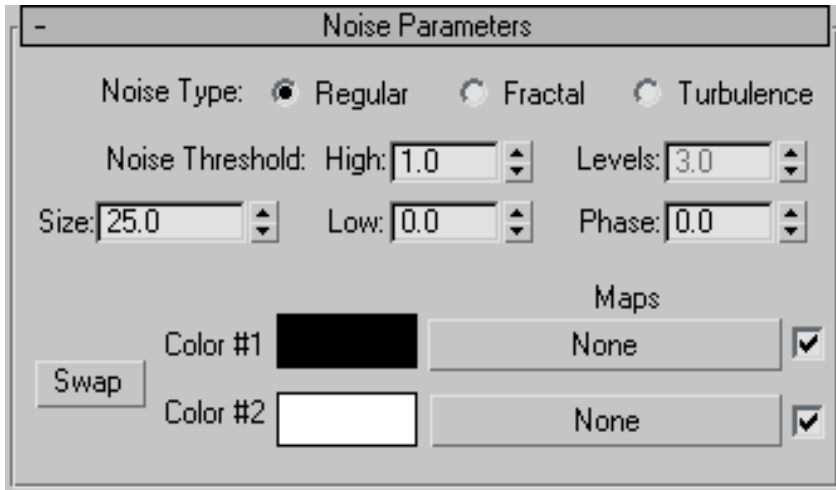

Noise Type

- **Regular** (The default.) Generates plain noise. Basically the same as fractal noise with the Levels setting at 1. When the noise type is set to Regular, the Levels spinner is inactive (because Regular is not a fractal function).
- **Fractal** Generates noise using a fractal algorithm. The Levels option sets the number of iterations for the fractal noise.
- **Turbulence** Generates fractal noise with an absolute value function applied to it to make fault lines.

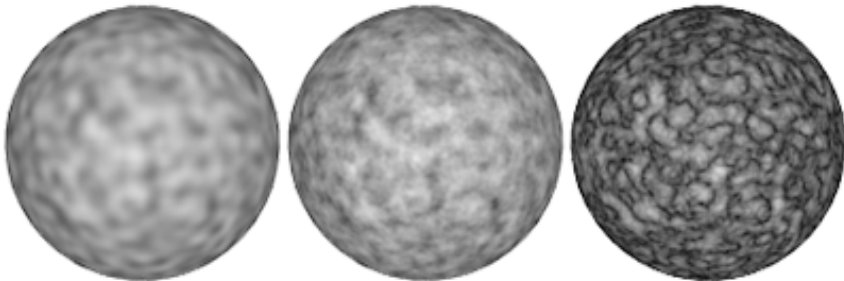

Regular, Fractal, Turbulence

Size Sets the scale of the noise function, in 3ds Max units. Default=25.0.

Noise Threshold When the noise value is above the Low threshold and below the High threshold, the dynamic range is stretched to fill 0 to 1. This creates

a smaller discontinuity (technically, 1st order instead of 0 order) at the threshold transition and produces less potential [aliasing](#) on page 7904.

■ **High** Sets the high threshold. Default=1.0.

■ **Low** Sets the low threshold. Default=0.0.

Levels Determines how much fractal energy is used for the Fractal and Turbulence noise functions. You can set the exact amount of turbulence you want, and also animate the number of fractal levels. Default=3.0.

Phase Controls the speed of the animation of the noise function. Use this option to animate the noise function. Default=0.0.

Swap Switches the position of the two colors or maps.

Color # 1 and Color # 2 Display the [Color Selector](#) on page 391 so you can choose one or the other of the two principal noise colors. Intermediate color values are generated from the two colors you select.

Maps Select the bitmaps or procedural maps to appear in one or the other noise color.

Turn on the check boxes to make the maps active.

Particle Age Map

Material Editor > Maps rollout > Click a Map button. > Material/Map Browser > Particle Age

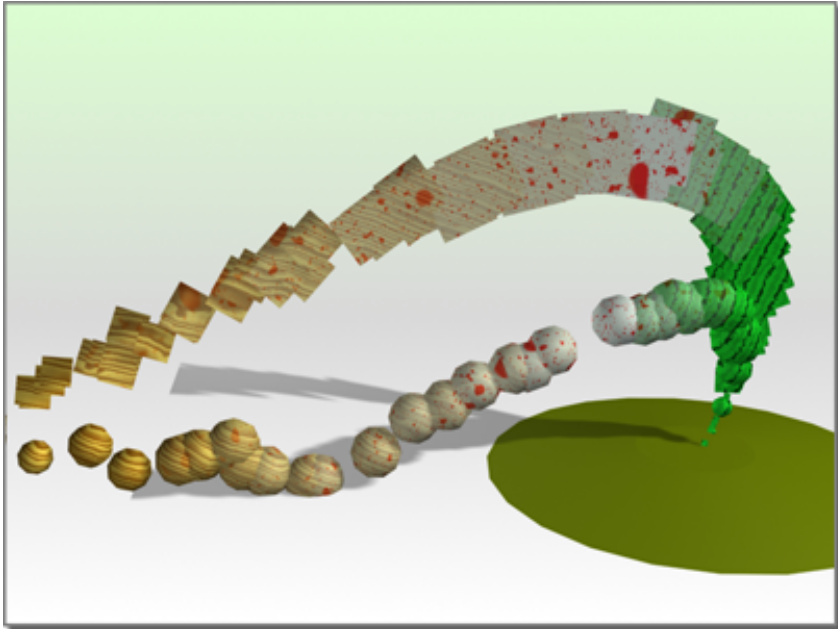

Particle age changes the appearance of particles over time.

The Particle Age map is for use with [particle systems](#) on page 8083. Typically you assign the Particle Age map as a [Diffuse map](#) on page 5460, or in Particle Flow with the [Material Dynamic operator](#) on page 2925. It alters the color (or map) of a particle based on the particle's life. The particles in a system begin as one color. At a specified age, they begin changing (by interpolation) to a second color, and then they change again to a third color before they die out.

TIP This map works well with the [Particle MBlur map](#) on page 5891. For example, you could assign Particle Age as a [diffuse map](#) on page 5460 and Particle MBlur as an [Opacity map](#) on page 5470. Another way to use Particle Age is in the mask channel of a [Blend](#) on page 5708 material. In this case, you could set up two of the colors to white, and one to black, which would make the particles change materials over their age. In addition, you could set up one of the two materials with an [effects channel](#) on page 7991 and use a [Glow](#) on page 6857 filter on it through Video Post.

See also:

- For functionality shared with other 3D maps, see [Output Rollout](#) on page 5774.

Interface

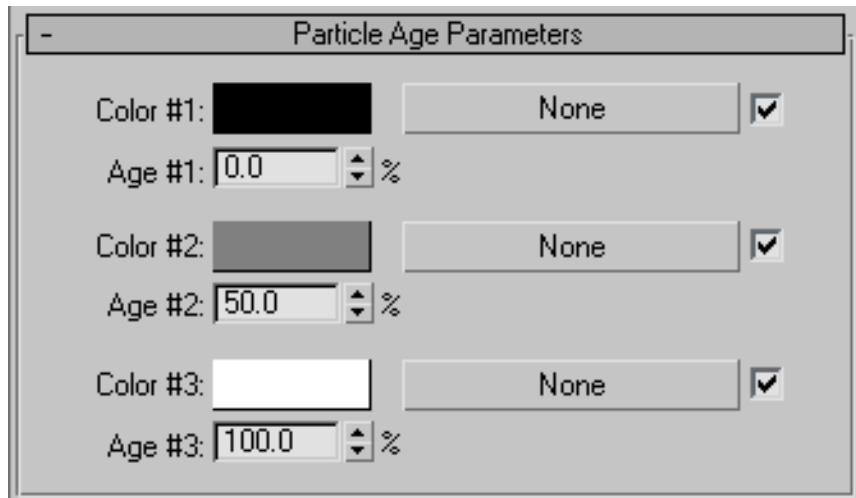

Color #1 Sets the color of a particle at its birth.

Click the button to the right of the color swatch to assign a map instead of a solid color. The check box turns the map on or off.

Age #1 Sets the age where a particle starts changing from Color #1 to Color #2, expressed as a percentage of the particle's entire life.

Color #2 Sets the color of a particle in mid-life. You can also assign a map to this color.

Age #2 Sets the age where a particle's color equals Color #2, expressed as a percentage of the particle's entire life.

Color #3 Sets the color of a particle at its death. You can also assign a map to this color.

Age #3 Sets the age where a particle changes to Color #3, expressed as a percentage of the particle's entire life.

Particle MBlur Map

Material Editor > Maps rollout > Click a Map button. > Material/Map Browser > Particle MBlur

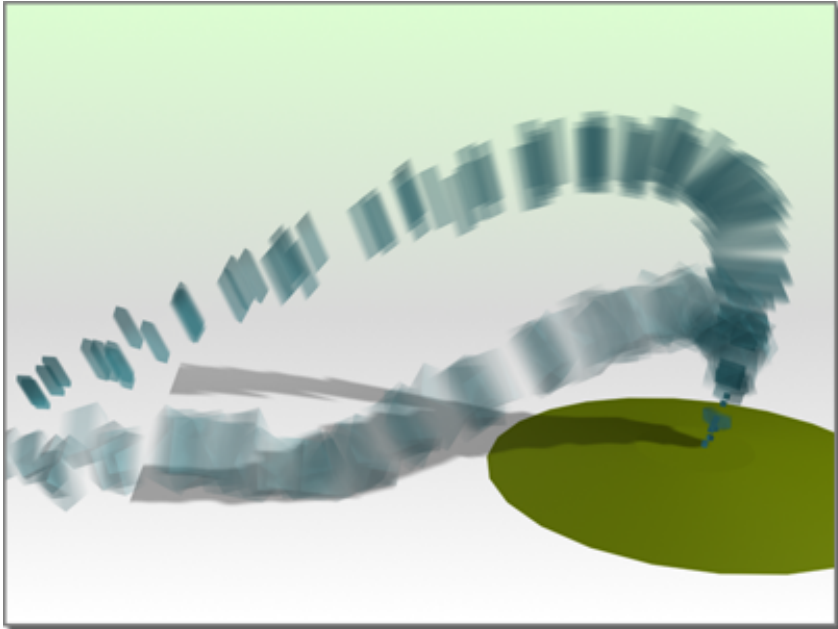

Particle MBlur makes particles blur as they move.

The Particle MBlur (Motion Blur) map is for use with [particle systems](#) on page 8083. The map alters the opacity of the leading and trailing ends of particles based on their rate of motion. The map is usually applied as an opacity map, but you can use it as a diffuse map for special effects.

The following conditions must be in effect to achieve particle motion blur:

- The Particle MBlur map must be in the same material that is assigned to the particles. For best results, it should be assigned as an opacity map
- The particle system must support the Particle MBlur map. Particle systems that support Particle MBlur include PArray, PCloud, Super Spray, and Spray.
- In the particle system's Particle Rotation rollout, in the Spin Axis Controls group, the Direction of Travel/MBlur option must be on.
- In this same group, the Stretch spinner must be greater than 0 to stretch the particles as a percent of their length based on the particle Speed setting.
- The correct type of particle must be used. MBlur works on all particle types except Constant, Facing, Metaparticles, and PArray Object Fragments. Also,

in the Standard Particles category, MBlur does not support the Triangle and SixPoint particle types.

- The material assigned to the particle system must not be a Multi/Sub-Object material.

Interface

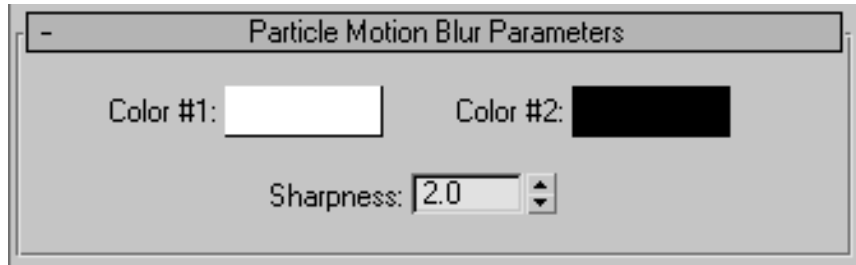

Color #1 A particle approaches this color as it reaches its slowest speed. By default, this color is white to provide the opaque end of the range for an opacity map.

Color #2 A particle approaches this color as it speeds up. As a default, this color is black to provide transparency in an opacity map.

Typically, you don't need to change either of these two colors.

Sharpness Controls the transparency, relative to the speed. If Sharpness is set to 0, the entire particle is blurry and transparent, no matter how slow it is traveling. The default works well in many cases. Default=2.0.

Perlin Marble Map

Material Editor > Maps rollout > Click a Map button. > Material/Map Browser > Perlin Marble



Perlin marble used for the texture of the goblet

The Perlin Marble map generates a marble pattern using the Perline Turbulence algorithm. This map is an alternative to [Marble](#) on page 5883, which is also a 3D material.

See also:

- [Coordinates Rollout \(3D\)](#) on page 5861

Interface

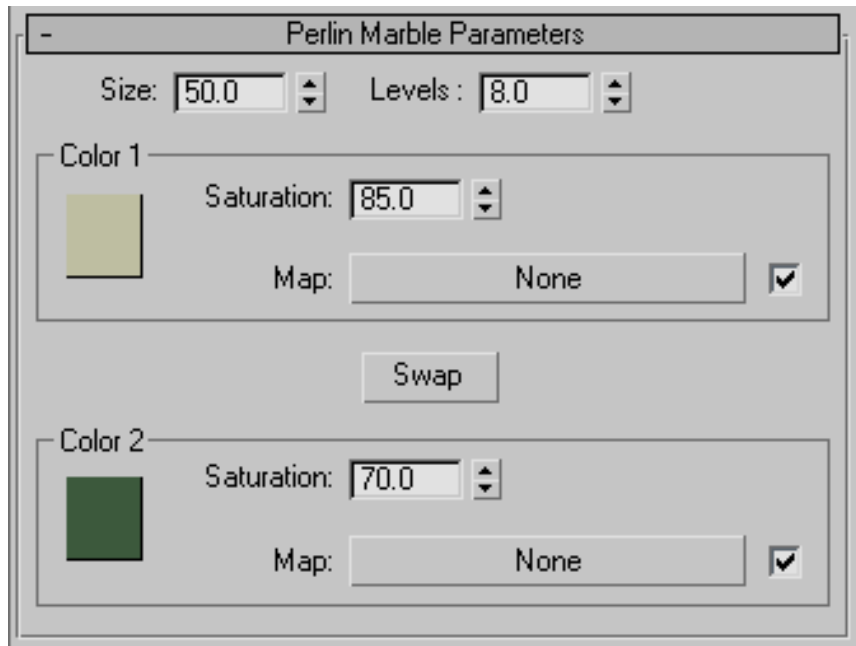

Size Sets the size of the marble pattern. Change this to change the scale of marble, relative to the object's geometry. Default=50.

Levels Sets the number of times the turbulence algorithm is applied. Can range from 1.0 to 10.0. The higher the value, the more complicated the marble pattern. Default=8.0.

Color 1 and Color 2 groups

The controls in these groups are identical. They determine the two main colors of the marble.

Color swatch Click to display the [Color Selector](#) on page 391. and change the color.

Map Click to assign a map instead of a solid color. The check box turns the map on or off.

Saturation Controls the saturation of the color in the map, without altering the color displayed in the color swatch. Lower values darken the color, and

higher values lighten it. Range=1 to 100; Default=85 for Color 1, 70 for Color 2.

Swap Click to swap Color 1 and Color 2.

Planet Map

Material Editor > Maps rollout > Click a Map button. > Material/Map Browser > Planet

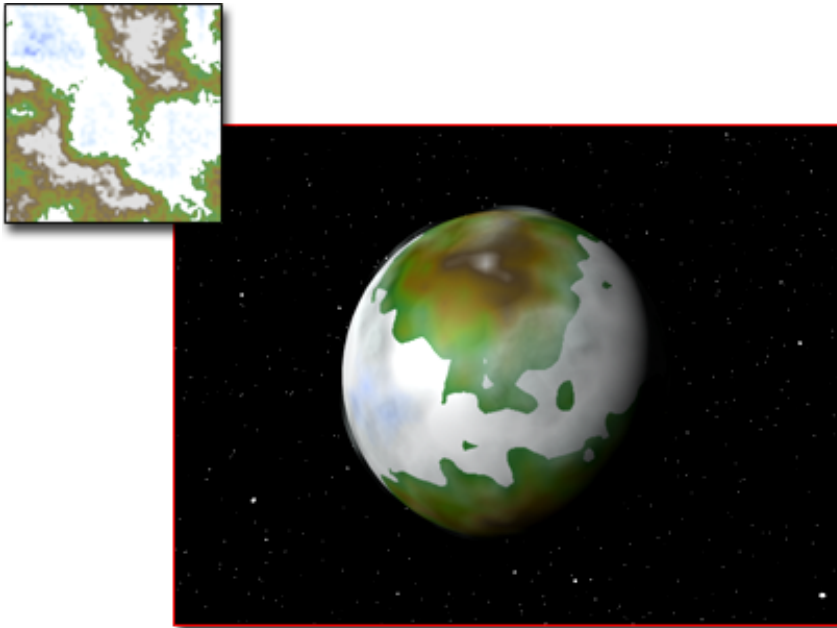

Planet map used to create another world

Planet is a 3D map that uses fractal math to simulate the colors on the surfaces of a planet. You can control the size of continents, percent of ocean coverage, and so on. This map is meant to be used as a diffuse map. It does not work well as a bump map.

TIP The Material Editor's sample slot doesn't show the planet effect very clearly. To help get the effect you want, double-click the sample slot to get a larger sample slot, or assign the map to geometry and render the scene. Another way to preview the planet map is to use the [Material Editor Options dialog](#) on page 5335 to set the 3D Map Sample Scale to equal a main dimension of the object you are applying the map to. For example, if you want to use the planet map on a sphere with a radius of 20, change the map scale from 100 (the default) to 20.

See also:

- [Coordinates Rollout \(3D\)](#) on page 5861

Interface

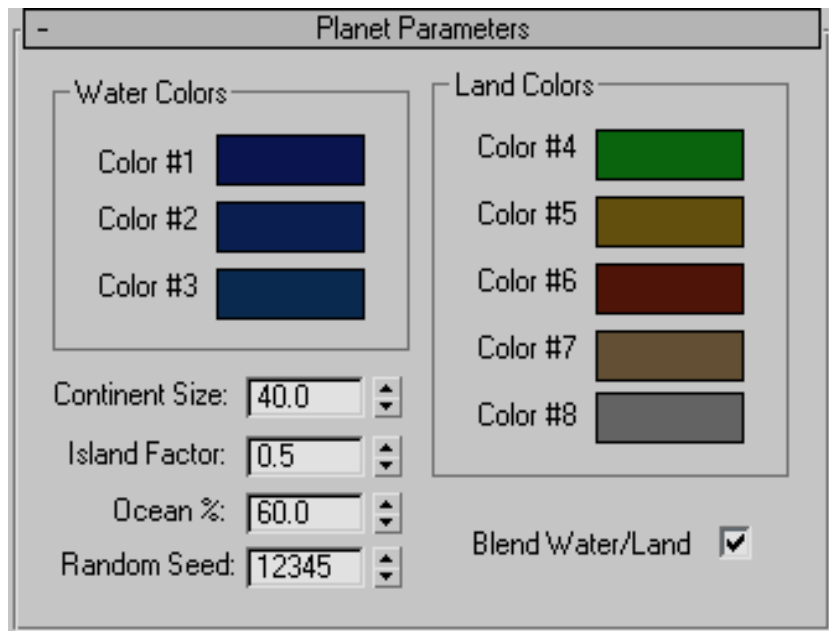

Continent Size Sets the size of the fractal noise pattern used to generate the continents. The higher the value, the larger the continents. Default=40.

Island Factor Sets the size of the fractal noise pattern used to generate islands and mountains. Can range from 0 to 100. At 0, the geography is very low. Higher settings create a more rugged landscape. Default=0.5.

Ocean % Sets the percentage of the planet's surface that is covered by water. Default=60.0.

Random Seed Sets the seed for pseudo-random generation of the pattern. Changing this number can change the pattern completely, even if other settings remain the same. On the other hand, a different Planet map with the same settings including the same Random Seed will appear the same.

Water Colors group

The colors in these three swatches are applied to the water areas of the planet surface.

Water colors Click a swatch to display the [Color Selector](#) on page 391 and change the color. Color #1 is the "center" area of the water mass, Color #2 surrounds Color #1, and Color #3 surrounds Color #2, meeting the land.

Land Colors group

The colors in these five swatches are applied to the land areas of the planet surface. Their arrangement continues that of the water colors.

Land colors Click a swatch to display the [Color Selector](#) on page 391 and change the color. Color #4 is the shoreline of the land, meeting the water; Color #5 comes next, working toward the center of the land mass. Color # 8 is at the center of the land mass.

Blend Water/Land When on, the boundary between water and land is blended, giving a hazy appearance. When off, the boundary between water and land is sharp.

Smoke Map

Material Editor > Maps rollout > Click a Map button. > Material/Map Browser > Smoke

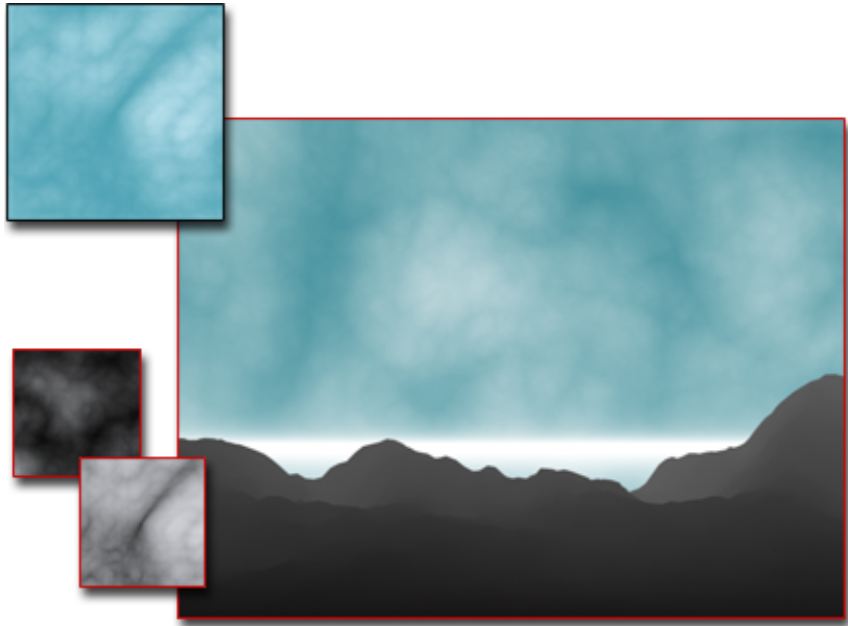

Smoke map used to create clouds in the sky

Smoke is a 3D map that generates amorphous, fractal-based turbulent patterns. It's primarily designed for animated [opacity mapping](#) on page 5470 to simulate the effects of smoke in a beam of light, or other cloudy, flowing mapping effects.

See also:

- [Coordinates Rollout \(3D\)](#) on page 5861

Interface

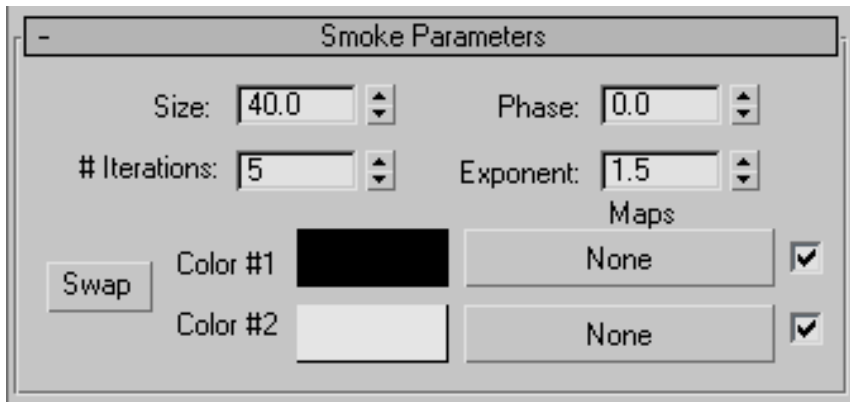

Size Changes the scale of the smoke "clumps." Default=40.

Iterations Sets the number of times the fractal function is applied. The higher the value, the more detail within the smoke, but the longer the calculation time. Default=5.

Phase Shifts the turbulence within the smoke pattern. Animate this parameter to animate the movement of the smoke. Default=0.0.

Exponent Makes color #2, representing the smoke, sharper and more wispy. As this value increases, the smoke "tendrils" become smaller within the pattern. Default=1.5.

Swap Exchanges the colors.

Color #1 Represents the smokeless portion of the effect.

Color #2 Represents the smoke.

Because this map is usually used as an opacity map, you can adjust the luminance of the color values to alter the contrast of the smoke effect.

- Click a color swatch to change the color. Usually you only need to do this to adjust luminance.
- Click a map button to assign a map instead of a solid color. Turn on the check box to activate the map.

Speckle Map

Material Editor > Maps rollout > Click a Map button. > Material/Map Browser
> Speckle

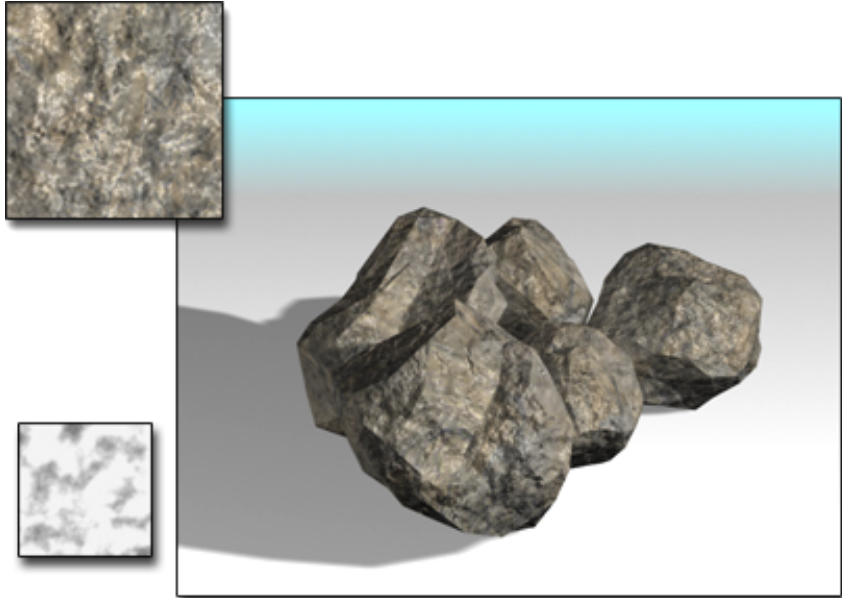

Speckle map used for rocks

Speckle is a 3D map that generates a speckled surface pattern that's useful for [diffuse mapping](#) on page 5460 and [bump mapping](#) on page 5478 to create granite-like and other patterned surfaces.

See also:

- [Coordinates Rollout \(3D\)](#) on page 5861

Interface



Size Adjusts the size of the speckles. Use this to make the speckles match your geometry. Default=60.

Swap Exchanges the two color components.

Color #1 Represents the color of the speckles.

Color #2 Represents the color of the background.

Click one of the swatches to display the [Color Selector](#) on page 391 and change one of these component colors.

Maps Click a button to assign a map that replaces one of the color components. Turning off the check box turns off the associated map (the Speckle map reverts to the associated color component).

Splat Map

Material Editor > Maps rollout > Click a Map button. > Material/Map Browser > Splat

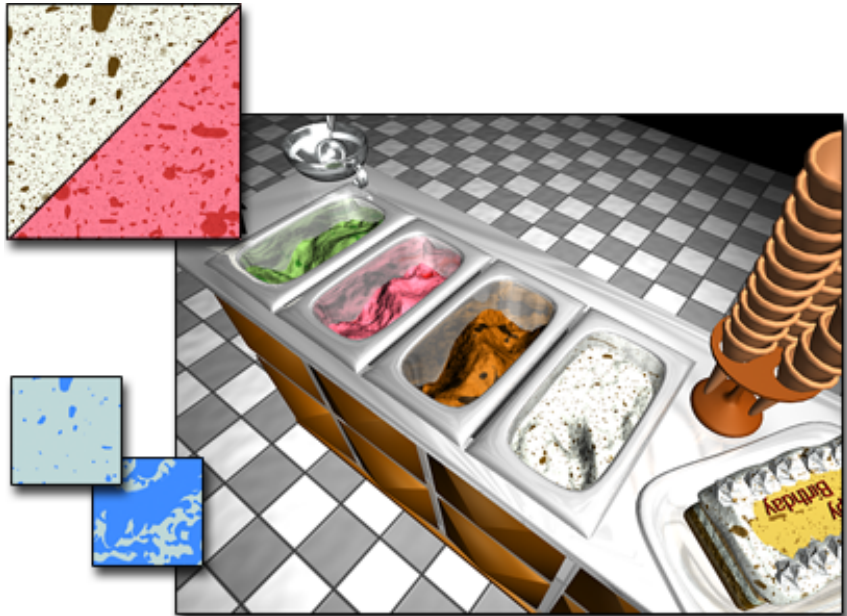

Splat map used for the patterns in ice cream

Splat is a 3D map that generates a fractal surface pattern that is useful as a [Diffuse map](#) on page 5460 for creating a pattern similar to splattered paint.

See also:

- [Coordinates Rollout \(3D\)](#) on page 5861

Interface

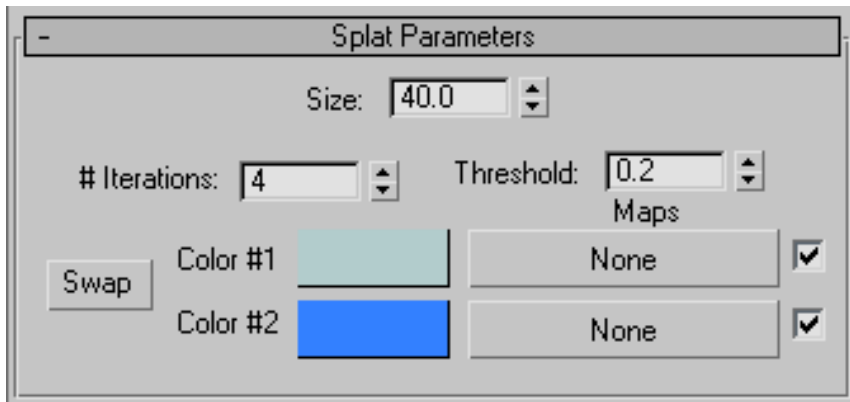

Size Adjusts the size of the splats. Use this to make the splats match your geometry. Default=40.

Iterations Sets the number of times the fractal function is evaluated. The higher the number, the more detailed the splats, but the longer the calculation time. Default=4.

Threshold Determines how much of Color #1 is mixed with Color #2. At 0, only Color #1 is displayed; at 1, only Color #2 is displayed. Default=0.2.

Swap Exchanges the two color components.

Color #1 Represents the color of the background.

Color #2 Represents the color of the splats.

Click one of the swatches to display the [Color Selector](#) on page 391 and change one of these colors.

Maps Assigns a map to replace one of the color components. Turning off the check box turns off the associated map (the Splat map reverts to the associated color component).

Stucco Map

Material Editor > Maps rollout > Click a Map button. > Material/Map Browser > Stucco



Stucco map used for a plaster wall

Stucco is a 3D map that generates a surface pattern that is useful for [bump mapping](#) on page 5478 for creating the effect of a stuccoed surface.

See also:

- [Coordinates Rollout \(3D\)](#) on page 5861

Interface

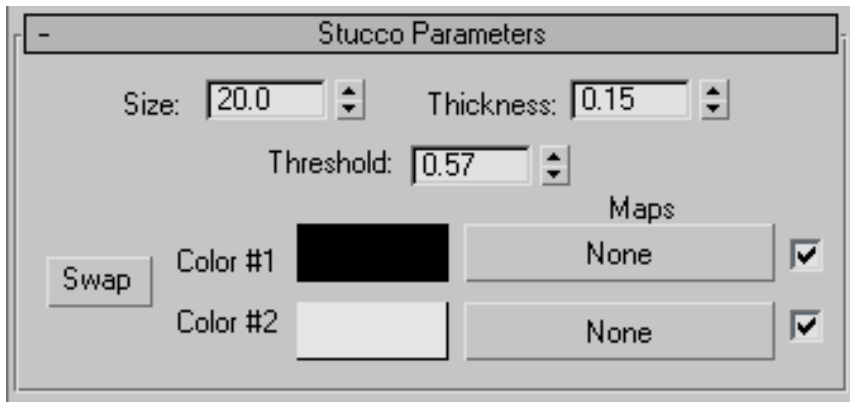

Size Adjusts the size of the indentations. Use this to make the scale of the stucco match your geometry. Default=20.

Thickness Blurs the border between the two colors. At 0, the borders are sharp. The higher the Thickness, the more the borders are blurred and the less distinct the indentations are. When you use Stucco as a bump map, the indentations are very faint at 0.5 and disappear at values not much greater. Default=0.15.

Threshold Determines how much of Color #1 is mixed with Color #2. At 0, only Color #2 is displayed; at 1, only Color #1 is displayed. Default=0.57.

Swap Exchanges the two color components.

Color #1 Represents the color of the indentations.

Color #2 Represents the background stucco color.

Click one of the swatches to display the [Color Selector](#) on page 391 and change one of these component colors.

TIP Because the Stucco map is meant to be used as a bump map, usually you don't need to adjust the default colors.

Maps Assigns a map to replace one of the color components. Turning off the check box turns off the associated map (the Stucco map reverts to the associated color component).

Waves Map

Material Editor > Maps rollout > Click a Map button. > Material/Map Browser
> Waves

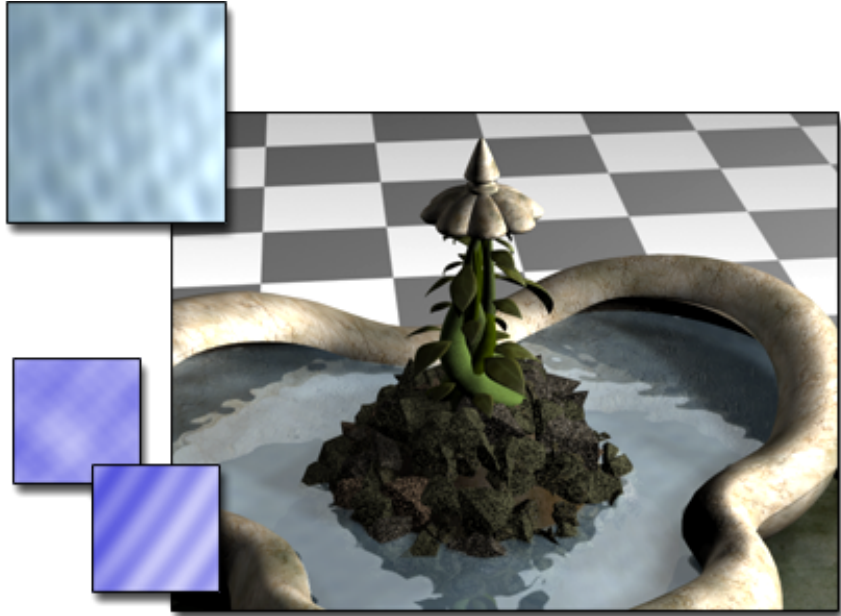

Waves map used for the pool in the fountain

Waves is a 3D map that creates watery or wavy effects. It generates a number of spherical wave centers and randomly distributes them over a sphere. You can control the number of wave sets, the amplitude, and the speed of the waves. This map works effectively as both a diffuse and bump map at the same time. It can also be useful in combination with an opacity map.

Interface

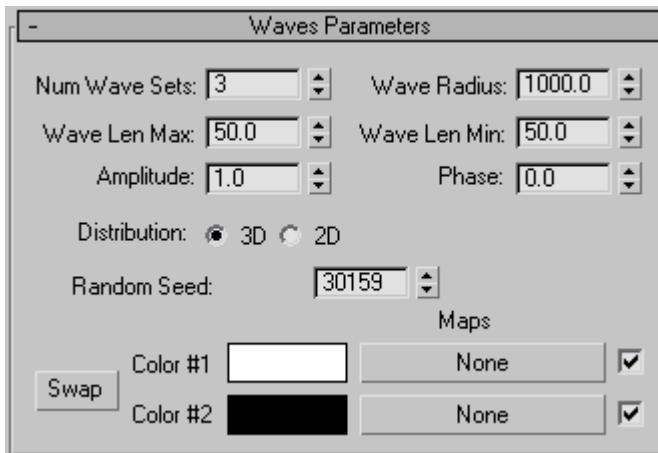

Num Wave Sets Specifies how many wave sets are used in the pattern. Wave sets are groups of radially symmetrical waves that originate from randomly computed points along the surface of an imaginary sphere inside the object (a circle, in the case of 2D wave distribution). For calm water, set this to a low number. Use a high number for choppy water. Range= 1 to 50; Default=10.

Wave Radius Specifies the radius, in 3ds Max units, of the imaginary sphere (3D distribution) or circle (2D distribution) whose surface is the origin of each wave set. A large radius produces large circular wave patterns, while a small radius produces dense, smaller waves. Default=800.

Wave Len Max and Wave Len Min Define the interval used to randomly chose each wave center. If these two values are close together, the water appears more regular. If they're farther apart, the water is less regular. Default Max=50.0; Default Min=5.0.

Amplitude Adjusts the strength and the depth of the waves by increasing the contrast between the two colors. Default=1.0.

Phase Shifts the wave pattern. Animate this parameter to animate the motion of the pattern.

Distribution 3D/2D 3D distributes the wave centers on the surface of an imaginary sphere, affecting all sides of a 3D object. 2D distributes the wave in circles centered on the XY plane, which is more appropriate for flat water surfaces such as oceans and lakes.

Random Number Seed Provides a seed number to generate the water pattern. The pattern changes with each seed, but all other settings are maintained.

Swap Exchanges the colors.

Color #1 and #2 Click the color swatches to change the colors used in the pattern. Use one color for the wave troughs and the other for the wave peaks. You can also click the map buttons to replace one or both colors with a mapped pattern. The check box enables or disables the map.

Wood Map

Material Editor > Maps rollout > Click a Map button. > Material/Map Browser > Wood



Wood map used for the seat of the bench

Wood is a 3D procedural map that renders a wavy grain-like pattern throughout the volume of an object. You can control the direction, thickness, and complexity of the grain.

Wood is primarily intended as a diffuse color map. Two colors assigned to Wood mix to form the grain pattern. Either of the colors can be replaced by other maps.

Wood can also be applied to other map types. When used as a bump map, Wood renders the grain pattern as a three-dimensional engraving of the surface.

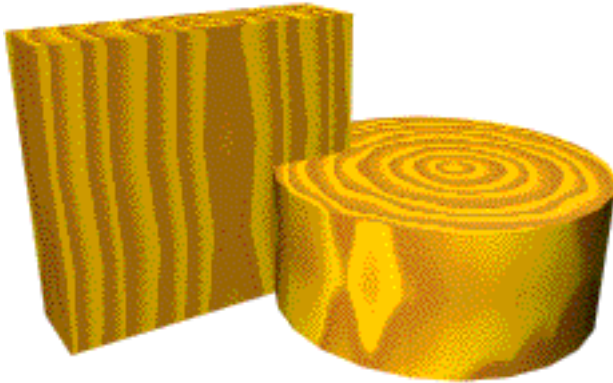

Wood mapped to a box and cylinder

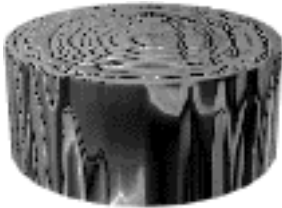

Wood used as a bump map

Procedures

To replace a color:

- 1 Click a color swatch labeled Color #1 or Color #2.
- 2 In the standard [Color Selector](#) on page 391, choose a replacement color. The color updates in the color box and sample slot.

To exchange colors:

- Click Swap.

The position of the two colors is reversed in the color boxes and sample slot.

To replace a color with a map:

- 1 Click a Map bar marked None next to one of the color swatches. This displays the Material/Map Browser.
- 2 Select a map from the list.
The sample slot updates to show the map in place of the color.

Interface

Coordinates rollout

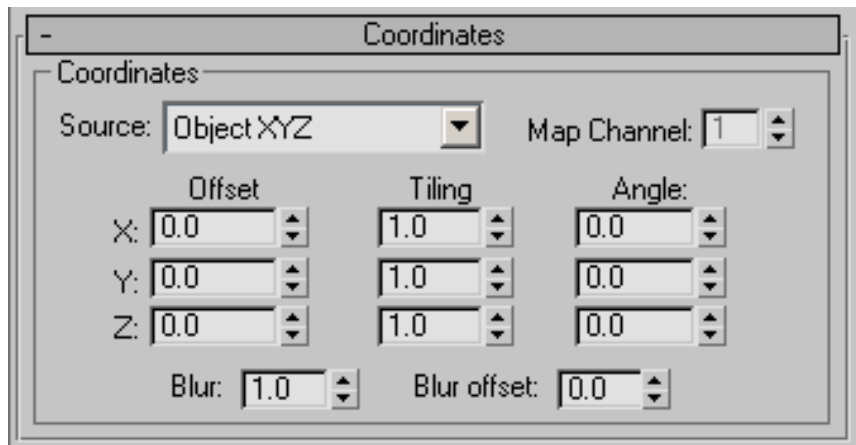

Tiling Controls grain complexity or "distortion." By increasing this parameter along a given axis, the grain becomes increasingly compressed and wavy along that axis. Default=1.0 (X, Y, and Z axes).

Box A shows the default on all three axes. Boxes B and C show progressively higher Tile settings for the X axis. Increasing Tile on other axes produces similar effects.

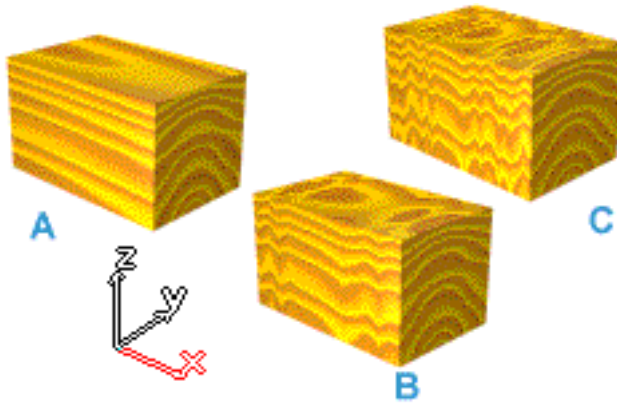

A: Tile, X axis=1.0 (default)

B: Tile, X axis=4.0

C: Tile, X axis=8.0

Grain Thickness=3

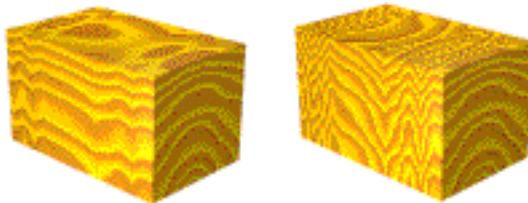

Tile, X axis=4.0 for both

Axial Noise=1 (left), 4 (right)

Grain Thickness=3

By combining Tile with Axial Noise, even greater distortion is possible. The bottom left box is the same as B, with Tile at 4.0 on the X axis. The bottom right box adds Axial Noise at 4.0.

Angle Controls grain direction.

Default Grain: Wood is rendered with the grain running along the X axis of the object. This is illustrated by the left cube below. The default angle is 0 for X, Y, and Z axes.

Rotated Grain: By rotating the direction of the grain around an axis, you change the rendered effect. In the right cube, the Y axis is set to 90. This rotates

the grain direction 90 degrees around the Y axis so that the grain is now running along the Z axis.

Other Angle Effects: Varying a single angle can create distorted grain effects (cylinder at left). Varying the three angles by a uniform amount keeps the grain running parallel through an object (cylinder at right).

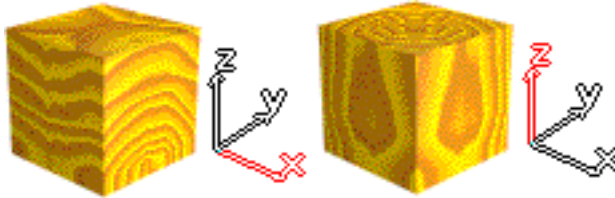

Angle=0,0,0 (defaults) and 0,90,0

Radial, Axial Noise=1 (defaults)

Grain Thickness=3

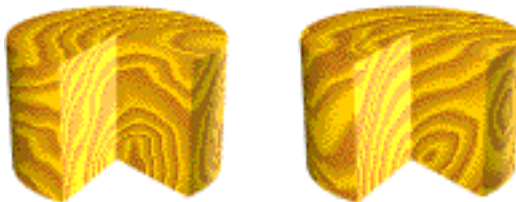

Angle=0,30,0 and 30,30,30

Radial, Axial Noise=1 (defaults)

Grain Thickness=3

(See [Coordinates Rollout \(3D\)](#) on page 5861 for a description of the other parameters in this rollout.)

Wood Parameters rollout

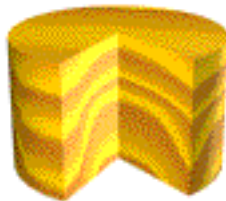
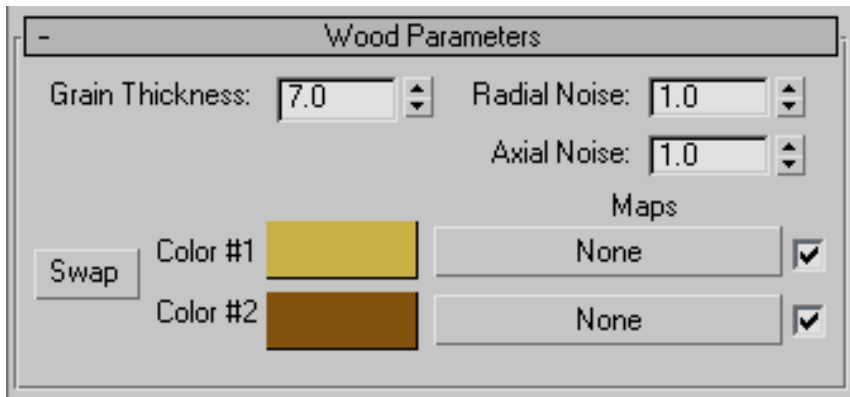

Defaults: Grain Thickness=7, Radial Noise=1.0, Axial Noise=1.0

Grain Thickness Sets the relative thickness of the color bands that make up the grain. Default=7.

The effect of thickness is relative to the context of the object. A grain that appears unrealistically wide on a small table might be acceptable on a large overhead beam.

Decreasing Grain Thickness creates grain lines that are closer together. The effect can resemble the fine grain of slow-growth hardwoods. At 0, grain disappears, resulting in what can look like composition board made from sawdust.

Increasing Grain Thickness creates grain lines that are farther apart. The effect can resemble tropical woods that grow continuously.

Grain thickness is shown increasing with identical noise settings.

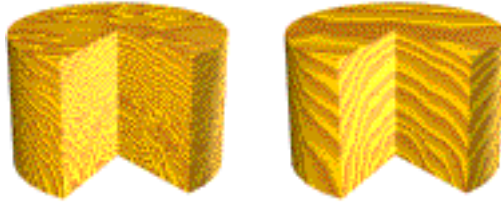

Grain Thickness=1, 3

Radial, Axial Noise=1 (defaults)

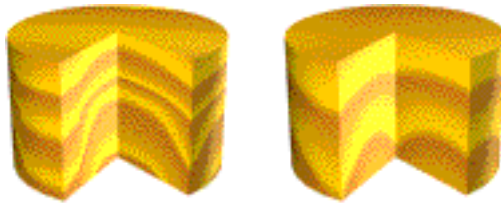

Grain Thickness=7 (default), 14

Radial, Axial Noise=1 (defaults)

Radial Noise Sets the relative randomness of the pattern on a plane perpendicular to the grain, the circular ring structure (cylinder B). Default=1.0.

Axial Noise Sets the relative randomness of the pattern on a plane parallel with the grain, along the length of the grain (cylinder A). Default=1.0.

Noise settings let you set the randomness or "irregularity" of the grain pattern in two directions. Without any noise, rings and grain are uniform and look inorganic (upper-left cylinder). The defaults for both parameters produce moderate irregularities (upper-right cylinder).

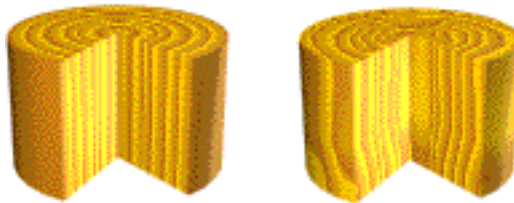

Radial, Axial Noise=0,0 and 1,1

Angle Y=90, Grain Thickness=3

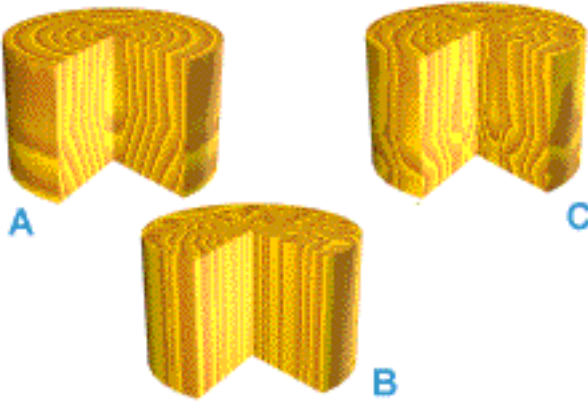

A: Radial, Axial Noise=0,2

B: Radial, Axial Noise=2,0

C: Radial, Axial Noise=2,2

Angle Y=90, Grain Thickness=3

Cylinders A and B show each parameter acting alone. Cylinder C shows the combination of the same settings.

Swap Exchanges the position of the colors.

Colors Selects any two colors for the grain pattern. Defaults=brownish yellow for Color #1 and dark brown for Color #2. Either color can be replaced or swapped.

The choice of colors, along with grain pattern, is the primary way to represent different types of wood. In fairly uniform woods like yellow pine or redwood, the two colors are often near the same settings (examples B and C). Lighting also makes a difference in the apparent colors.

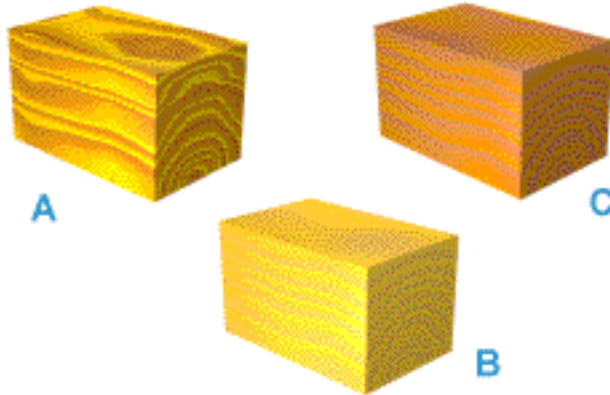

A: Default colors

B: Color #1=RGB 160,125,50

Color #2=RGB 170,135,25

C: Color #1=RGB 140,90,0

Color #2=RGB 130,80,50

Grain Thickness=3

Other settings at defaults

Maps Replace colors with maps. The check boxes enable or disable their associated maps.

You can assign maps to one or both of the Wood color slots. Any kind of map can be used, including Wood. The map overrides the assigned color, which has no effect.

The left box uses defaults. The right box is the same, except that Color #1 has been replaced with a Checker map, whose colors have been changed to wood tones.

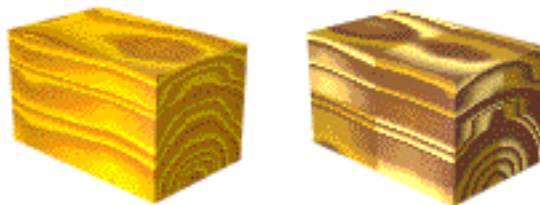

Left: Default

Right: Color #1 replaced with Checker map

Grain Thickness=3

Other settings at defaults

Compositor Maps

Compositors are meant specifically for compositing other colors or maps. In image processing, compositing images refers to superimposing two or more images to combine them.

The following compositor maps are supplied with the software:

Composite on page 5918: Composites multiple maps. Unlike Mix, Composite doesn't have explicit controls for the amount of mixing. Instead, it bases the mix amount on the maps' alpha channel.

Mask on page 5925: A mask is a map itself, used in this case to control where a second map is applied to the surface.

Mix on page 5926: Mix mixes two colors or two maps. You can adjust the amount of mixing using a blend level you specify. The blend level can be mapped.

RGB Multiply on page 5930: Combines two maps by multiplying their RGB and alpha values.

Composite Map

Material Editor > Maps rollout > Click a Map button. > Material/Map Browser
> Composite

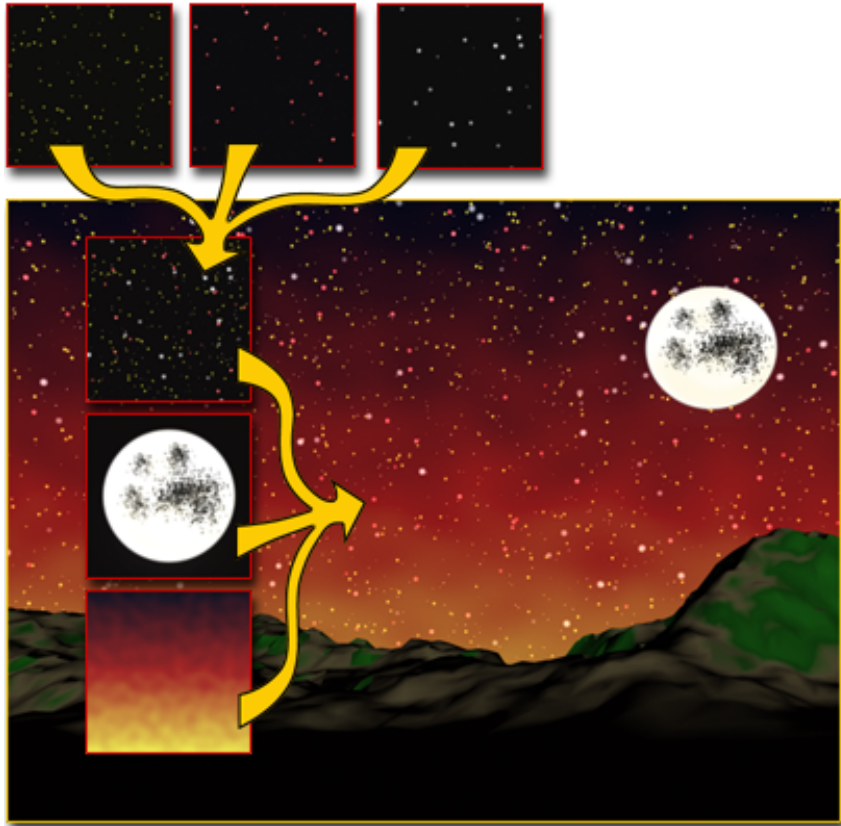

Composite map combines stars, moon, and a glow into the sky.

The Composite map type is made up of other [maps](#) on page 8036, which you layer atop each other using the [alpha channel](#) on page 7905 and other methods. For this type of map, you can use overlay images that already contain an alpha channel, or employ built-in masking tools for overlaying only certain parts of a map.

The controls for a Composite map include the list of the maps it combines along with a blend mode, opacity setting, and mask for each.

Viewports can display the multiple maps in a composite map. For multiple map display, the display driver must be [OpenGL](#) on page 7796 or [Direct3D](#) on page 7802. The [software display driver](#) on page 7794 does not support multiple map display.

NOTE  The Composite map in Autodesk 3ds Max 2009 is a completely revamped version of the previous Composite map, and contains additional functionality including the ability to apply masks and use color correction on both maps and masks, and to use blend modes for different methods of combining the layers.

Procedures

To assign a map or mask:

- 1 On a Layer rollout, click an empty map or mask button. These are the large, square buttons labeled “None.” The map button is on the left side; the mask button is on the right.
The Material/Map Browser opens.
- 2 Choose a map type either by double-clicking its name in the list, or by highlighting its name and then clicking OK. Make any further changes as necessary for the map type, such as assigning an image file for a Bitmap map.

To change the number of map layers:

- To increase the number of layers, on the Composite Layers rollout, click

the  button.

The read-only Total Layers numeric field displays the current number of layers.

- To decrease the number of layers, find the layer to delete and click its



(Delete this layer) button.

To change the order of layers:

- Drag a layer by its title bar to a new location. As you drag the layer, a blue line appears where it will be repositioned. This works the same way as reordering any rollouts.
After you move a layer, the layers are renumbered to remain in order. For example, if there are four layers, and you move Layer 4 above Layer 1, Layer 4 becomes Layer 2, Layer 2 becomes Layer 3, and Layer 3 becomes Layer 4.

Interface

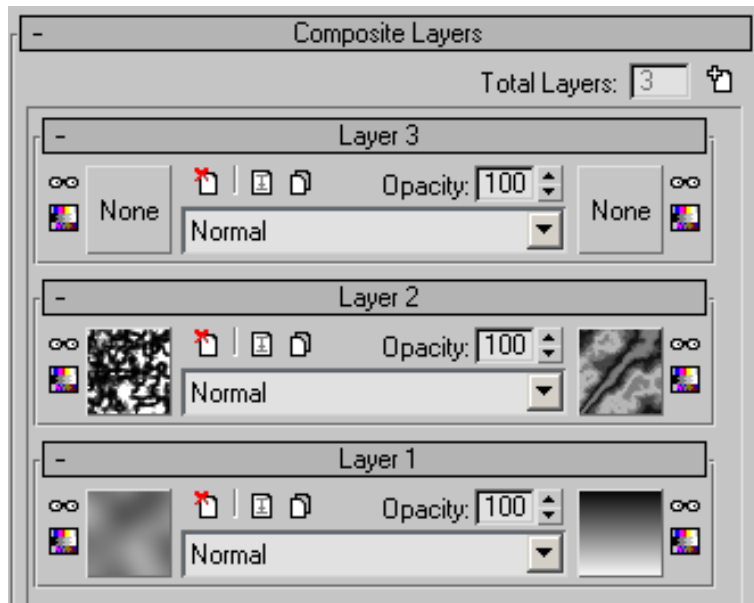

Composite Layers rollout

Total Layers The numeric field shows the number of map layers. To add a

layer at the top of the stack of layers, click the  button.

Layer rollout

The Composite map uses a separate rollout for each layer's controls, with as many rollouts as there are layers. Each layer rollout is titled with the optional name first, followed by "Layer" and then the layer number.

The layers are applied in order of increasing number; the layering in the material reflects the order of layers in the interface. Layer 1 is lowest; layer 2 is immediately above layer 1, and so on.

The map composites layers in the same order. Layer 2 modifies the output of Layer 1; Layer 3 modifies the output of Layer 2, and so on.



Hide this layer When on, the layer is hidden and has no effect on the output. When a layer is hidden, the button looks like this: 



Color Correct This Texture Applies a [Color Correction map](#) on page 5933 to the map and opens the Color Correction map interface. You can use its controls to modify the map colors.



To return to the Composite map interface, click  (Go To Parent) on the Material Editor toolbar.

After the Color Correction map is assigned, you can return to it from the Composite map interface by clicking this button again.

[map] To assign a map to the layer, click this button and then use the Material/Map Browser.

Before assigning a map, the button reads “None.” When a map is assigned, the button image is a thumbnail of the map, and clicking it takes you to the parameters for the map.



Delete this layer Deletes the layer. This function is undoable. Available only when the map contains more than one layer.



Rename this layer Opens a small dialog for naming or renaming the layer.

By default, each layer is named “Layer #” where # is the layer number. If you name a layer, the text you enter precedes this default name; for example, “Decal Layer 3.” The space between the custom name and the default name is inserted automatically. If you’ve already named a layer, that name appears in the renaming dialog when you open it.



Duplicate this layer Creates an exact copy of the layer and inserts it immediately adjacent to the layer.

Opacity The relative transparency of the unmasked portions of the layer. At 100, the layer is completely opaque. As you lower the Opacity value, more of the underlying layers show through.

[mask map] To assign a mask map to the layer, click this button and then use the Material/Map Browser. The mask works the same as the [Mask map](#) on page 5925: Black areas are transparent; white areas are opaque; and gray areas allow degrees of transparency. So, for example, if the layer is to be a decal, the decal image area would be white and the rest of the image map would be black, so underlying layers can show through.

After a mask map is assigned, the button image is a thumbnail of the map, and clicking it takes you to the parameters for the map.



Hide the mask of this layer To turn off the mask temporarily, click

this button. When a mask is hidden, the button looks like this:



Color Correct This Mask Applies a [Color Correction map](#) on page 5933 to the mask map and opens the Color Correction map interface. You can use its controls to modify the map colors.



To return to the Composite map interface, click [Go To Parent](#) on the Material Editor toolbar.

After the Color Correction map is assigned, you can return to it from the Composite map interface by clicking this button again.

[blend mode] Use the drop-down list to choose how the layer pixels interact with those in underlying layers. In the following descriptions, A refers to the current (front) layer and B refers to the result or output of underlying layers.

NOTE Because Layer 1 has no underlying layers, its blend mode setting has no effect.

- **Normal** Displays A without any blending. This is the default setting.
- **Average** Adds A and B and then divides by 2.
- **Addition** Adds each A and B pixel.
- **Subtract** Subtracts A from B.
- **Darken** Compares the values of A and B, and, for each pixel, uses the darker of the two.

- **Multiply** Multiplies the color values of each A and B pixel. Because non-white color channels have values of less than 1.0 (using a range of 0.0 to 1.0), multiplying them tends to darken colors.
- **Color Burn** Colorizes darker pixels from B with the color from A.
- **Linear Burn** Same as Color Burn but with less contrast.
- **Lighten** Compares the A and B pixels at each location and uses the lighter of the two.
- **Screen** Makes the light areas much lighter, and the darker areas somewhat lighter.
- **Color Dodge** Colorizes lighter pixels from B with the A color.
- **Linear Dodge** Same as Color Dodge but with lower contrast.
- **Spotlight** Like Multiply but with twice the brightness.
- **Spotlight Blend** Same as Spotlight but also adds ambient illumination to B.
- **Overlay** Darkens or lightens the pixels depending on the B color.
- **Soft Light** If the A color is lighter than mid-gray, the image is lightened. If the A color is darker than mid-gray, the image is darkened.
- **Hard Light** If a pixel color is lighter than mid-gray, screen mode is applied. If a pixel color is darker than mid-gray, multiply mode is applied.
- **Pinlight** Replaces the B colors depending on the brightness of the A color. If the A color is lighter than mid-gray, B colors darker than the A color are replaced. And vice-versa: If the A color is darker than mid-gray, B colors lighter than the A color are replaced.
- **Hard Mix** Produces either white or black, depending on similarities between A and B.
- **Difference** For each pixel pair, subtracts the darker one from the brighter one.
- **Exclusion** Similar to Difference but with lower contrast.
- **Hue** Uses the color from A; the value (brightness) and saturation from B.
- **Saturation** Uses the saturation from A; the value and hue from B.

- **Color** Uses the hue and saturation from A; the value from B.
- **Value** Uses the value from A; the hue and saturation from B.

Mask Map

Material Editor > Maps rollout > Click a Map button. > Material/Map Browser > Mask



Mask map applies labels to the fire extinguisher.

With the Mask map, you can view one material through another on the surface. The mask controls where a second map is applied to the surface.

By default, lighter (whiter) areas of the mask are opaque, showing the map. Darker (blacker) areas of the mask are transparent, showing the underlying material. You can use Invert Mask to reverse the mask's effect.

Interface

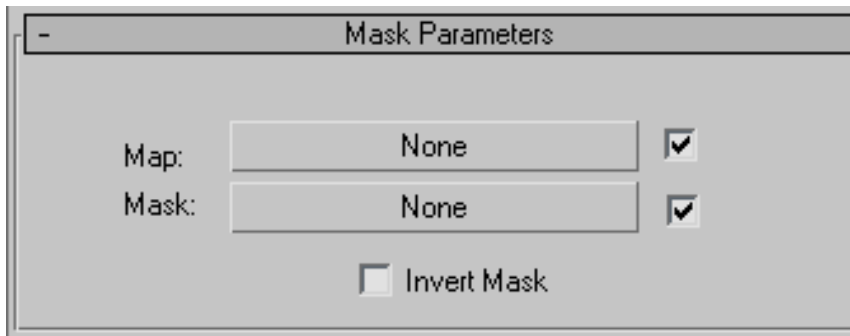

These are the controls for the Mask map:

Map Selects or creates the map to be viewed through the mask.

Mask Selects or creates the map to use as a mask.

Invert Mask Inverts the effect of the mask.

Mix Map

Material Editor > Maps rollout > Click a Map button. > Material/Map Browser
> Mix



Mix map blends skull and crossbones with the reflected scene.

With the Mix map, you can combine two colors or materials on a single side of the surface. You can also animate the Mix Amount parameter, and draw map [morphing](#) on page 8049 function curves to control how the two maps are blended over time.

Viewports can display both maps in a mix map. For multiple map display, the display driver must be [OpenGL](#) on page 7796 or [Direct3D](#) on page 7802. The [software display driver](#) on page 7794 does not support multiple map display.

See also:

- [Output Rollout](#) on page 5774

Procedures

To change a component color:

- 1 In the Mix Parameters rollout, click one of the two color swatches to display the [Color Selector](#) on page 391.
- 2 Adjust the color.

To use a map as a component:

- 1 In the Mix Parameters rollout, click a map button next to one of the two color swatches.
The Material/Map Browser is displayed.
- 2 Select a map type.

To exchange the two component colors:

- In the Mix Parameters rollout, click Swap.

To control the mix amount:

- In the Mix Parameters rollout, adjust the Mix Amount value.
Mix Amount is the percentage of Color #2 used in the mix.
You can also control the mix amount by using a map.

To control the mix amount using a map:

- 1 In the Mix Parameters rollout, click the map button next to Mix Amount.
The Browser appears so you can
- 2 Select a map type.
The intensity of pixels in this mixing map controls the mix. When the intensity is close to 0, one of the component colors or maps is visible; when it is close to full intensity, the other component is visible.

TIP Using a Noise map for the mixing map can give good effects that have a natural appearance.

In the Mix Parameters rollout, Mix Amount is inactive while a map is assigned to this parameter. If Use Curve is off, the mixing map is used as is. If Use Curve is on, you can shift the effect of the mixing map's gradient ramp, offsetting it one way or the other and revealing more or less of the mix components.

To control the mix amount using the mix curve:

- 1 In the Mixing Curve group, turn on Use Curve.
- 2 Change the shape of the curve by adjusting the Transition Zone values.

Interface

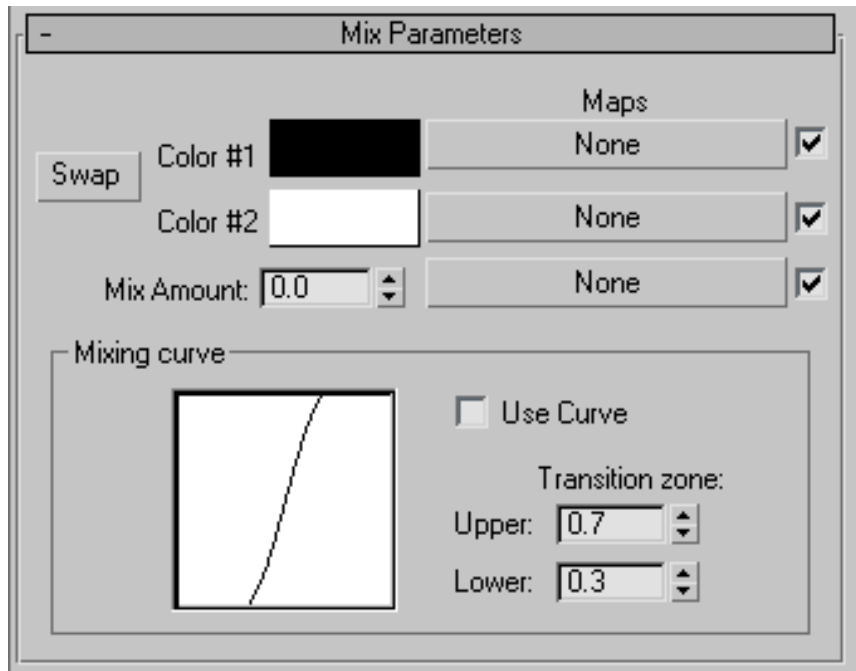

Swap Exchanges the two colors or maps.

Color # 1, Color # 2 Displays the [Color Selector](#) on page 391 to select the two colors to be mixed.

Maps Select or create the bitmaps or procedural maps to be mixed instead of each color.

The check boxes enable or disable their associated maps.

Black areas of the map reveal color #1, and white areas of the map reveal color #2. Gray values reveal intermediate mixes.

Mix Amount Determines the proportion of the mix. 0 means only Color 1 is visible on the surface, 1 means only Color 2 is visible. You can also use a map instead of the mix amount. The two colors will mix in greater or lesser degree according to the intensity of the map.

Mixing Curve group

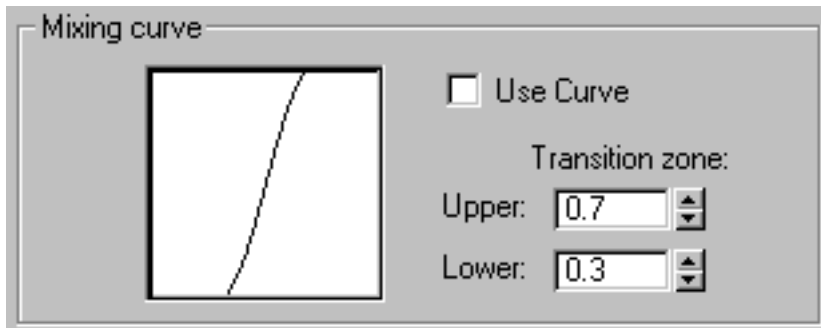

These parameters control how gradual or how sharp the transition between the two colors being mixed will be. (This really only has meaning when you have a map applied to Mix Amount.)

TIP Try mixing two standard materials using a noise map as a mask for some interesting mottled effects.

Use Curve Determines whether the Mixing Curve effects the mix.

Transition Zone Adjusts the level of the upper and lower limits. If the two values are the same, the two materials will meet at a definite edge. Wider ranges give more gradual mixing.

RGB Multiply Map

Material Editor > Maps rollout > Click a Map button. > Material/Map Browser > RGB Multiply

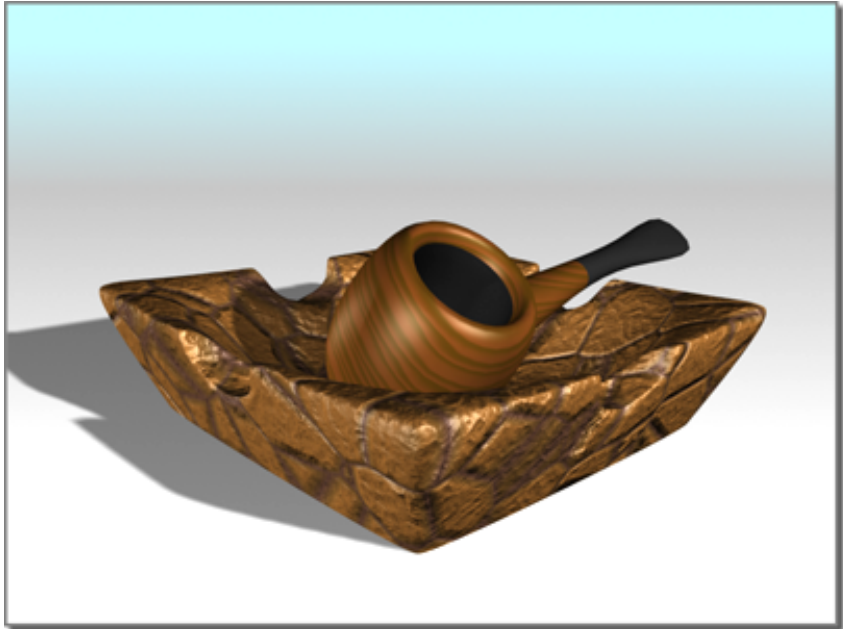

RGB Multiply enhances the texture of the ashtray.

The RGB Multiply map is typically used for [bump maps](#) on page 5478, where you might want to combine two maps to achieve the correct result.

This map combines two maps by multiplying their RGB values. For each pixel, the red of one map is multiplied times the red of the second map, the blue times the blue, and the green times the green.

If the maps have alpha channels, RGB Multiply can output either map's alpha channel, or a new alpha channel created by multiplying the alpha channel values of the two maps.

You can also make one of the maps a solid color. This tints the other map.

Interface

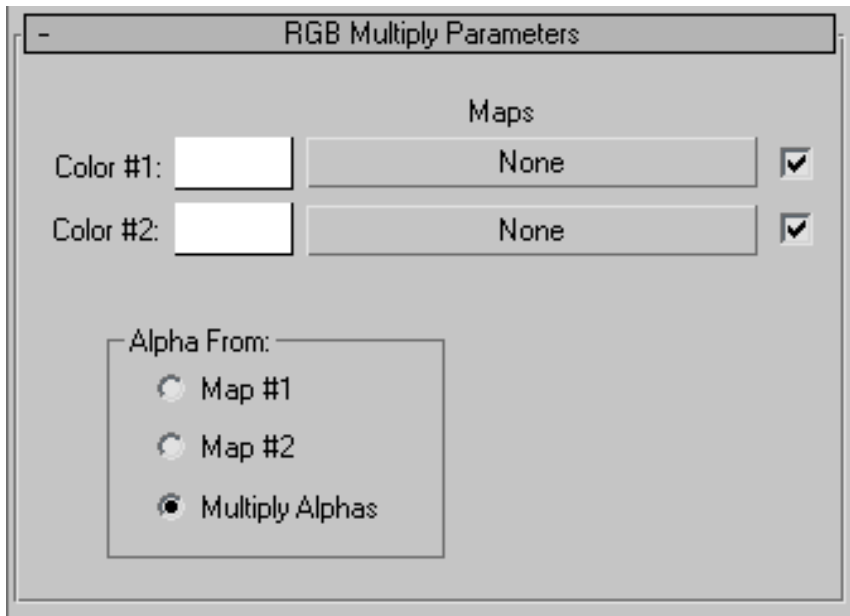

Color #1, Color #2 Click a map button to assign one of the maps. The check box disables or enables the map. To tint one of the maps, turn off the other map and click its color swatch to choose the tint color, using the [Color Selector](#) on page 391.

Alpha From group

The buttons in this group let you determine how to generate alpha for the map. If neither map has an alpha channel, these options have no effect.

Map #1 Uses the first map's alpha channel.

Map #2 Uses the second map's alpha channel.

Multiply Alphas Generates a new alpha channel by multiplying the alpha channels of the two maps.

Color Modifier Maps

Color Modifier maps alter the colors of pixels in a material. Each of the following maps uses a specific method to modify the color:

[Color Correction](#) on page 5933: Adjusts colors with a variety of manipulation methods, using a stack-based approach.

[Output](#) on page 5939: Applies bitmap output functions to parametric maps, such as Checker, that don't have these settings. These functions adjust the colors of the map.

[RGB Tint](#) on page 5942: Tints the color of a map based on red, green, and blue values.

[Vertex Color](#) on page 5943: Displays the effects of assigned vertex colors in the rendered scene. You assign vertex colors from the editable mesh.



Color Correction Map

Material Editor > Maps rollout > Click a Map button. > Material/Map Browser > Color Correction

The Color Correction map provides an assortment of tools for modifying the colors of an incorporated, underlying map, using a stack-based method. Tools for correcting color include monochrome, inversion, custom rewiring of color channels, hue shift, and adjustment of saturation and lightness.

Color-adjustment controls in many cases mirror those found in Autodesk Toxik and Autodesk Combustion.

Interface

IMPORTANT The Color Correction map uses a stack-based approach, with modifications applied per rollout, starting at the top of the interface and ending at the bottom. Settings from the Texture rollout are applied first, then the Channels rollout settings are applied to the output of the Texture rollout, and so on. The order is:

- 1 Texture rollout
- 2 Channels rollout
- 3 Color rollout
- 4 Lightness rollout

Because of this enforced order, it is not possible to reorder the rollouts for this map.

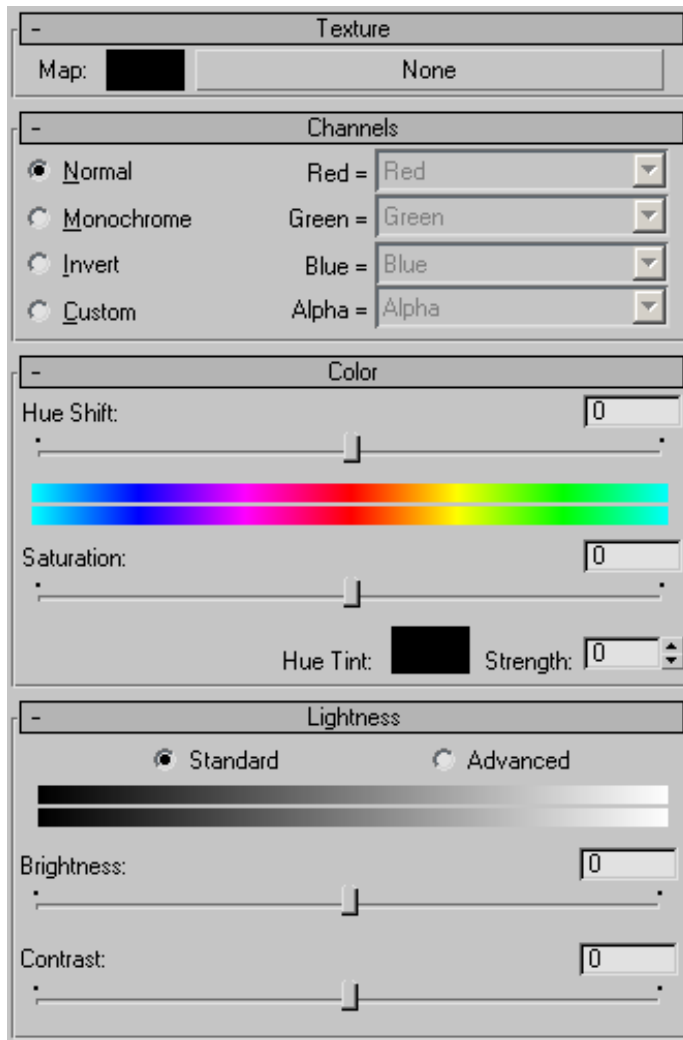

Texture rollout

[color swatch] The software uses this color if no map is specified. To change the color, click the swatch and use the [Color Selector](#) on page 391 controls.

[map button] To specify a map, click this button, initially labeled “None.” After you specify a map using the [Material/Map Browser](#) on page 5290, the button label shows the name and type of the map.

TIP If you replace an existing map with the Color Correction map, the software prompts you to choose whether to keep the old map as a sub-map. If you do so, the old map is placed in this slot.

Channels rollout

[**channel operation**] Choose the initial operation to be performed on the map color channels:

- **Normal** Passes the color channels unaltered to the Color rollout controls.
- **Monochrome** Converts all color channels to shades of gray.
- **Invert** Replaces the red, green, and blue color channels with their inverses. The inverse for each channel is calculated by subtracting the value from the maximum value: 1.0 in the case of floating-point colors, or 255 for eight-bit channels. So, for example, red changes to cyan (green + blue); green changes to magenta (red +blue); and blue changes to yellow (red + green).
- **Custom** Lets you apply different settings to each channel using the remaining controls on the rollout.

TIP You can use one of the preset channel operations (Normal/Monochrome/Invert) as a starting point for customization. Choose the preset, and then choose Custom. The previous settings remain active and available for changing.

Red/Green/Blue/Alpha Lets you specify channel operations on a per-channel basis. Available only when Custom is the active choice. Otherwise these fields show the current setting, such as Monochrome for the RGB channels.

Use the drop-down list to choose an replacement value or channel for each channel:

- **Red/Green/Blue/Alpha** Replaces the channel with the channel you choose. For example, if you set Blue=Red, the blue component of each pixel takes on the current value of the red component of that pixel.
- **Red (Inverse)/Green (Inverse)/Blue (Inverse)/Alpha (Inverse)** Replaces the channel with the inverse of the channel you choose. For example, if you set Blue=Red (Inverse), the blue component of each pixel takes on the inverse of the current value of the red component of that pixel. The inverse for each channel is calculated by subtracting the value from the maximum value: 1.0 in the case of floating-point colors, or 255 for eight-bit channels. So, for example, red changes to cyan (green + blue);

green changes to magenta (red + blue); and blue changes to yellow (red + green).

- **Monochrome** Converts the color channel to grayscale. To determine the grayscale value for a channel, the software adds the values of of the red, green, and blue channels for each pixel and then divides by three. For example, if the RGB values are 0.5, 0.4, and 0.0, then the monochrome value for any channel of that pixel would be 0.3.
- **One** Sets the channel to the highest possible value; in effect, turns it all the way on. For example, if the original color of a pixel in a 24-bit or 32-bit map is R=50; G=75; and B=100, then the result of setting Green=One would be R=50; G=255; and B=100.
- **Zero** Sets the channel to the lowest possible value; in effect, turns it off. For example, if the original color of a pixel is R=50; G=75; and B=100, then the result of setting Green=Zero would be R=50; G=0; and B=100.

Color rollout

This rollout gives you three controls for overall color conversion. These controls work on the output of the Channels rollout. To use the original map, make sure the Channels rollout is set to Normal.

Hue Shift Lets you change colors using a standard Hue spectrum. Use the slider or the numeric control to determine how to remap colors in the map. To reset to 0, right-click the slider. Range=-180 to 180.

This control works the same as the Hue Shift control in Autodesk Combustion and Autodesk Toxik.

Saturation The intensity or purity of the map colors. Lowering the Saturation value removes color, causing the image to tend toward grayscale, while raising it intensifies the color. To modify the value, use the slider or the numeric control. To reset to 0, right-click the slider. Range=-100 to 100.

This control works the same as the Saturation control in Autodesk Combustion and Autodesk Toxik.

Hue Tint Colorizes all non-white map pixels according to the color swatch value. Grayscale values, including black and white, have no effect.

Strength The degree to which the Hue Tint setting affects the map pixels. Range=0 to 100.

Lightness rollout: Standard

The Standard option on the Lightness rollout gives you two easy-to-use controls:

Brightness The overall luminance of the map image. To modify the value, use the slider or the numeric control. To reset to 0, right-click the slider. Range=-100 to 100.

Contrast The difference between brighter and darker portions of the map image. To modify the value, use the slider or the numeric control. To reset to 0, right-click the slider. Range=-100 to 100.

Lightness rollout:Advanced

The Advanced controls are similar to those available in the Photo Lab feature of Autodesk Toxik. This tool lets you simulate camera exposure and photo-development changes in maps. You can change the exposure to brighten or darken a map in incremental steps, providing perceptually relative uniform changes in luminance. Photo-development adjustments can produce images with different color distribution.

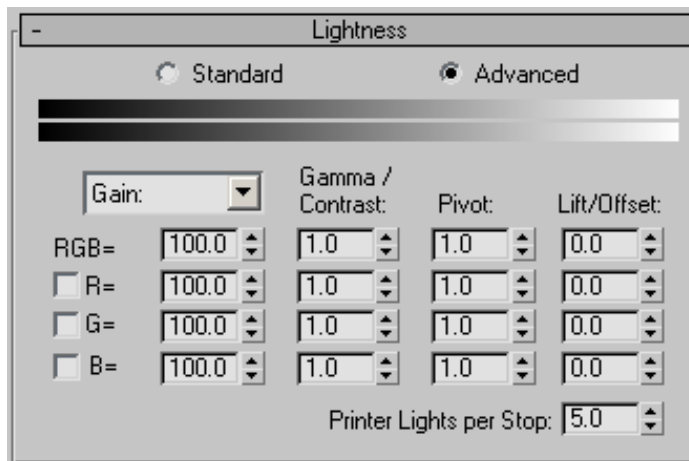

[exposure method] Choose from the drop-down list the method by which to express exposure:

- **Gain** The pixel color values are multiplied by this value.
- **F-Stop** As in photography, increasing by 1 doubles the luminance, and increases gain by a factor of 2.

- **Printer Lights** A definable setting (see Printer Lights per Stop) where increasing this value by the value of the Printer Lights per Stop setting (N) doubles the luminance (N printer lights=1 f-stop)

RGB/R/G/B You can change the settings for all three color channels simultaneously (RGB) and for each channel individually. In addition, you can toggle the settings for the individual channels with the check boxes.

Gamma/Contrast The amount of gamma correction can be expressed in terms of contrast or in terms of the usual gamma exponent. Increasing the gamma exponent decreases contrast.

Pivot Gamma correction is applied about a pivot value. That is, pixel values equal to the pivot value are left unchanged. This is useful when you want to use gamma correction to change the contrast of an map but do not want to affect a particular luminance level.

Lift/Offset The lift is simply a uniform offset added to all the pixel values (different offsets for different color components). Lift is usually applied as the last step of the process and can be used to control the overall brightness of the map.

Printer Lights per Stop When using the Printer Lights exposure method, this setting determines the number of printer lights equivalent to one f-stop; that is, the number required to double or halve the exposure.

Output Map

Material Editor > Maps rollout > Click a Map button. > Material/Map Browser > Output

With Output map, you can apply output settings to procedural maps, such as Checker or Marble, that don't have these settings.

Interface

Output Parameters rollout

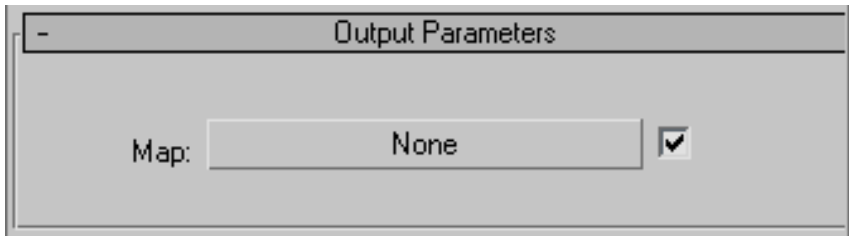

In this rollout, you choose the map to apply the output controls to.

Map Displays a modal version of the Material/Map Browser so you can choose the map type.

The check box turns the map on or off.

Output rollout

The controls in this rollout are the same as for maps with a built-in output option. See [Output Rollout](#) on page 5774.

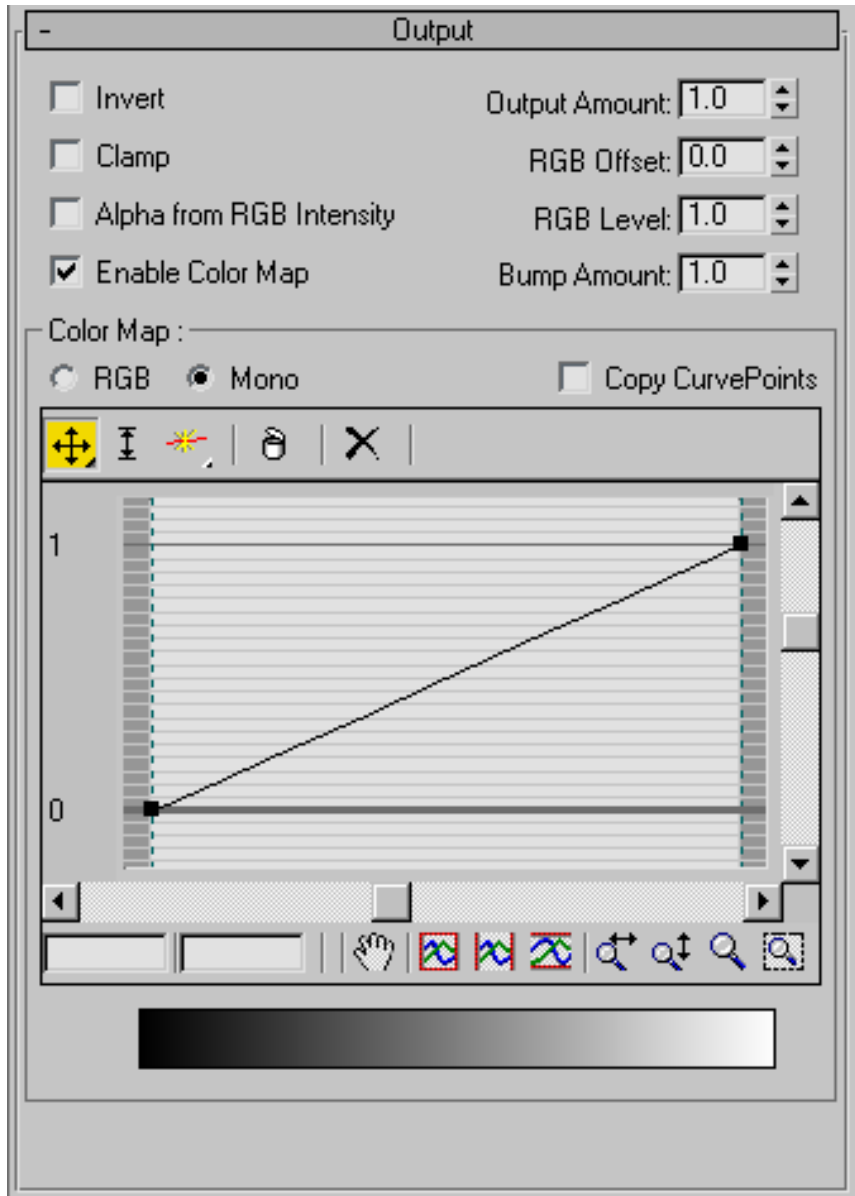

RGB Tint Map

Material Editor > Maps rollout > Click a Map button. > Material/Map Browser > RGB Tint



RGB Tint map

RGB Tint adjusts the value of the three color channels in an image. Three color swatches represent these channels. Changing a color swatch adjusts the value of its associated color channel.

The channels are named Red, Green, and Blue for their default colors, but you can assign them any color. You are not limited to variations of red, green, and blue.

Procedures

To tint a map:

- 1 In the RGB Tint Parameters rollout, click the Map button marked None. The Material/Map Browser is displayed.
- 2 Select the map you want to tint
- 3 Click the R, G, or B color swatch. The [Color Selector](#) on page 391 is displayed.
- 4 Choose a new color. The red, green, or blue value of each pixel in the underlying map changes accordingly.

To change the saturation of one color in an image:

- 1 Click the R, G, or B color swatch.
- 2 On the Color Selector, increase or decrease Value to vary the color from light to dark.

To replace one color with another:

- 1 Click the R, G, or B color swatch.
- 2 On the Color Selector, increase or decrease Hue to change the color.

Interface

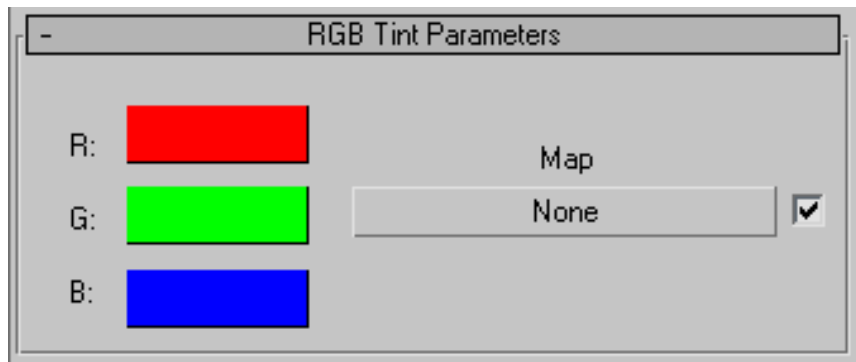

R/G/B The red, green, and blue on page 8105 color swatches display the Color Selector on page 391 to adjust the value of the specific channel.

Map Displays the Material/Map Browser to select the map to be tinted. The check box turns the effect of the map on or off.

Vertex Color Map

Material Editor > Maps rollout > Click a Map button. > Material/Map Browser > Vertex Color



Mapping vertex colors

Vertex Color map makes any vertex coloring applied to an object available for rendering. You can assign vertex colors using the [VertexPaint Modifier](#) on page 1959, the [Assign Vertex Colors utility](#) on page 6038, or the vertex controls for an [editable mesh](#) on page 2086, [editable patch](#) on page 2032, or [editable poly](#) on page 2140.

While vertex color assignment is primarily used for special applications, such as game engines or radiosity renderers, you can also use it to create colorful, gradient surface effects. You can also use it in design visualization: Use the [VertexPaint Modifier](#) on page 1959 to paint your landscape different colors to represent grass, shrubbery, parking areas, etc., and then use Vertex Color map to use the vertex coloring in your rendered images. Incidentally, when you use the [Terrain object's](#) on page 774 Color By Elevation function, the software assigns a material that uses a Vertex Color map as the diffuse component.

TIP To view vertex colors in a viewport, right-click the object, choose Properties from the quad menu, and then turn on Vertex Channel Display in the Display Properties group.

Procedures

To use the vertex color map:

- 1 Assign vertex colors to an object.
- 2 Assign a material to the object, then assign a Vertex Color map to the material's diffuse component.
- 3 Optionally, if manipulating the map channels with the [Channel Info utility](#) on page 6047, choose a map channel or sub-channel to render.
- 4 Render the scene.

Interface

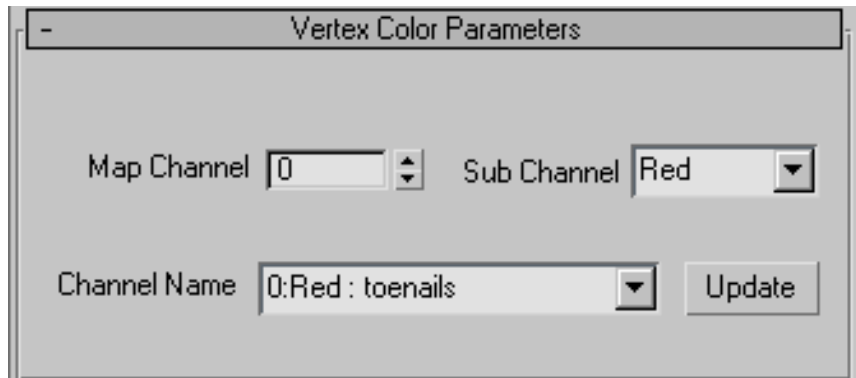

These parameters let you define which map channel or sub-channel is to be rendered. One application is to support usage of the Vertex Color map in conjunction with the [Channel Info utility](#) on page 6047.

The settings are interlinked; changing one parameter will change the other two, as appropriate.

Map Channel Lets you specify which map channel to use. Range=0 to 99. Default=0.

Notes regarding this setting:

- If you set Map Channel to a channel that doesn't contain any vertex coloring data, attempting to render will generate a Missing Map Coordinates error message. To resolve this, apply vertex coloring to that channel.
- By default, the vertex coloring in map channel 1 is a color gradient derived from the UVW texture coordinates by converting UVW values to RGB values. Thus, at UV=0,0 (the lower-left corner of the map), the coloring is black; at UV=1,0, the coloring is red, and at UV=1,1 (the upper-right corner), the coloring is yellow (red + green=yellow). You can change these colors with a tool such as [VertexPaint modifier](#) on page 1959.
- Map Channel cannot be set to a negative value, thus the map doesn't support rendering of the vertex illumination (-1) or vertex alpha (-2) channel.

Sub Channel Lets you can specify that the map will use either the Red, Green, or Blue sub-channel of the specified map channel, or all sub-channels.

Channel Name After assigning the material with the Vertex Color map to an object with named map or vertex-color channels (see [Channel Info Utility](#) on

page 6047), you can click Update, and then, from this drop-down list, choose a named map channel from the object.

Update Refreshes the contents of the Channel Name drop-down list. Use Update after applying the material to an object, or after adding channels to the object.

NOTE There could be conflicts if one material with a Vertex Color map is assigned to objects with different named Map Channels, where one channel's name may be displayed in preference to another's.

Reflection and Refraction Maps

These maps, grouped as "Other" in the [Material/Map Browser](#) on page 5290, are maps that create reflections and refractions. Each of the following maps has specific uses:

[Flat Mirror](#) on page 5946: Generates reflections for flat surfaces. You assign it to faces rather than to the object as a whole.

[Raytrace](#) on page 5952: Creates accurate, fully raytraced reflections and refractions.

[Reflect/Refract](#) on page 5964: Generates reflections or refractions automatically, based on surrounding objects and the environment.

[Thin Wall Refraction](#) on page 5971: Generates refractions automatically, simulating objects and the environment seen through a refractive material such as glass or water.

Flat Mirror Map

Material Editor > Maps rollout > Click a Map button. > Material/Map Browser > Flat Mirror



Flat mirror map reflects the ice-cream shop's interior.

The [Flat Mirror](#) on page 7982 map produces a material that reflects surrounding objects when it is applied to a collection of coplanar faces. You assign it as a material's [reflection map](#) on page 5480.

Reflect/Refract maps don't work well for flat surfaces because each face reflects part of the environment based on where its surface normal points. Using this technique, a large flat face can reflect only a small part of the environment. Flat Mirror automatically generates a reflection that encompasses a larger part of the environment, to better simulate a mirror-like surface.

Rules for Using Flat Mirror

Flat Mirror cannot generate reflections correctly unless you observe these rules:

- Assign Flat Mirror to selected faces only.
There are two ways to do this. You can make the Flat Mirror material a [Multi/Sub-Object](#) on page 5720 material, or you can use the Apply To Faces With ID control.
- If you assign Flat Mirror to multiple faces, the faces must lie in a plane.

- Non-coplanar faces in the same object cannot have the same Flat Mirror material.
In other words, if you want two different planes of an object to have flat reflections, you must use a Multi/Sub-Object material. Assign Flat Mirror to two different sub-materials, and assign different material IDs to the to different planar faces.
- The material ID used by the Flat Mirror sub-material must be unique to the coplanar faces in the object.
If you assign Flat Mirror using Apply to Faces with ID, faces without that ID display the nonreflective components (diffuse color, and so on) of the material with the Flat Mirror reflection map.

Procedures

To assign a flat mirror to one face of an object:

- 1 In the Material Editor, create a standard material.
- 2 Assign a Flat Mirror map as the material's reflection map.
- 3 In the Flat Mirror Parameters rollout > Render group, turn on Apply To Faces With ID, and choose the material ID number the mirrored face will have.
- 4 Follow the next set of steps for assigning the material to the object.

To assign the mirror to a flat surface:

- 1 Select an object.
- 2 In the Modify command panel, apply Edit Mesh to the object.
- 3 Make sure Sub-Object is selected, and choose Face as the sub-object level.
- 4 Select a single face or multiple faces that lie in a single plane.
- 5 Assign the faces the material ID you chose for the Flat Mirror map.
- 6 Assign the material to the object.

To assign a flat mirror using a Multi/Sub-Object material:

- 1 In the Material Editor, create a Multi/Sub-Object material.
- 2 Click one of the unused material buttons in the Multi/Sub-Object material's parameters.

- 3 In the new Standard sub-material, open the Maps rollout and click the map button for Reflection.
- 4 In the Material/Map Browser, choose Flat Mirror, and then click OK. Flat Mirror controls are similar to those for automatic reflection and refraction.
- 5 Apply Edit Mesh to the object, and then in the stack view area of the [modifier stack display](#) on page 7635, choose Face as the sub-object level.
- 6 Select a single face or multiple faces that lie in a single plane.
- 7 Assign the faces the material ID corresponding to the Flat Mirror sub-material slot.

Using a Multi/Sub-Object material, you can apply Flat Mirror to different faces of the object that are not coplanar. However, faces that are not coplanar must use different sub-material slots, otherwise the software doesn't correctly generate the flat mirror reflections.

Interface

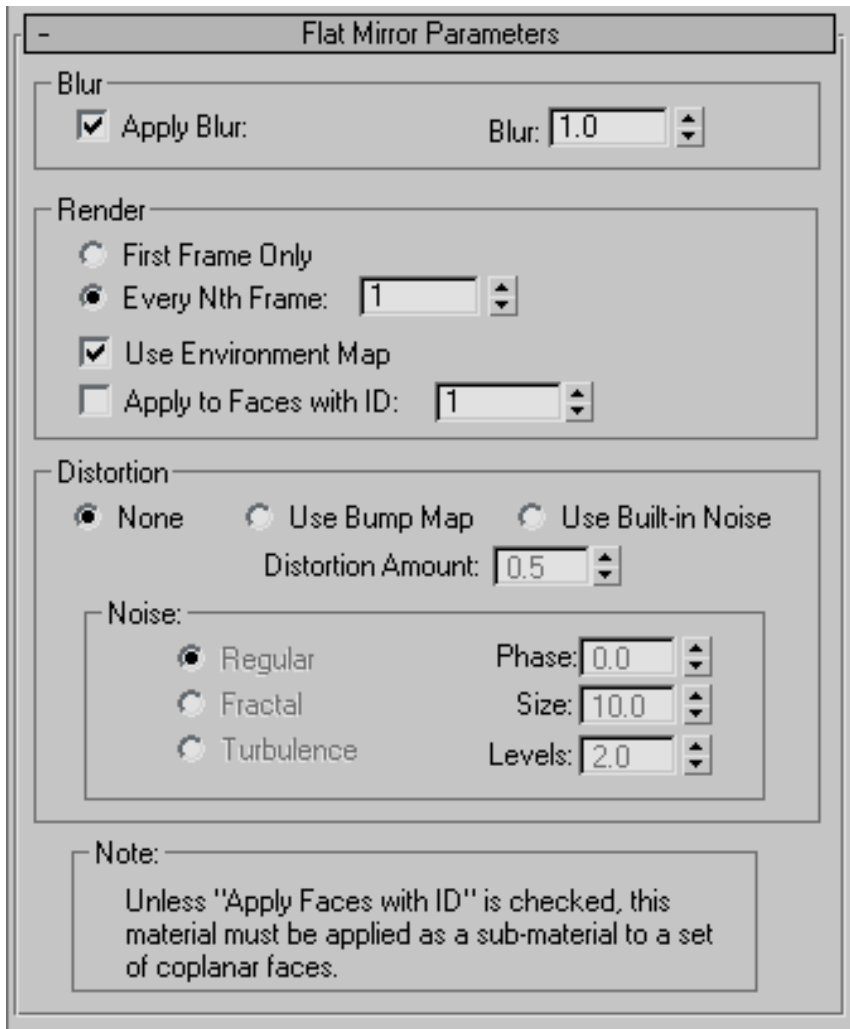

Blur group

Apply Blur Turns on filtering to blur the maps.

Antialiasing is also applied to the Distortion effect, if any, when Apply Blur is turned on.

Blur Affects the sharpness or blurriness of the generated map based on its distance from the object. The farther away the map is, the greater the blurring. Blur is primarily used to avoid [aliasing](#) on page 7904. It's a good idea to use a small amount of blurring for all maps in order to avoid the scintillation or aliasing that can occur when pixel details are reduced off in the distance. Default=1.0.

Render group

First Frame Only The renderer creates the automatic flat mirror only on the first frame.

Every Nth Frame The renderer creates the automatic flat mirror based on the [frame rate](#) on page 7987 set by the spinner.

Use Environment Map When off, environment maps are ignored by the mirror during rendering. It's useful to turn this off when you have mirrors in the scene and you're rotoscoping against a flat screen environment map. A screen environment map does not exist in 3D space the way the other environment-map types do, and will not render properly. Default=on.

Apply to Faces with ID Specifies the material ID number where you want the mirror assigned.

You can assign a flat-mirror material to an object without having to make it a component of a [Multi/Sub-Object](#) on page 5720 material. The restriction is that the other faces on the object must be able to use the nonmirrored properties of the same material (its diffuse color, and so on). If the other faces need completely different material characteristics, you need to use a Multi/Sub-Object material.

For example, if you have an object, such as a box, with unique material IDs for each side, you can use Apply To Faces With ID to specify the side of the box that will show the mirror reflection. The remaining sides of the box will have the same material characteristics, but without the reflection.

Distortion group

To simulate irregular surfaces, you can distort the flat-mirror reflections. Distortion can be based on a bump map or on noise controls built into Flat Mirror material.

None No distortion.

Use Bump Map Distorts the reflection using the material's bump map.

A flat mirror surface that has a Bump map will appear bumpy, but its reflection won't be distorted by the bumps unless you use this option.

Use Built-In Noise Distorts the reflection using the settings in the Noise group.

Distortion Amount Adjusts the amount of distortion to the reflected image. This is the only value that affects the amount of distortion. No matter how high the Bump map's Amount spinner is set, or how extreme the Noise settings, if this Distortion Amount is set to 0, no distortion appears in the reflection itself. This control is inactive when None is chosen.

Noise group

The controls in this group are inactive unless you choose Use Built-In Noise as the active distortion type.

Regular Generates plain noise. Basically the same as Fractal noise with the Levels setting at 1. When the noise type is set to Regular, the Levels spinner is inactive (because Regular is not a fractal function).

Fractal Generates noise using a fractal algorithm. The Levels setting determines the number of iterations for the fractal noise.

Turbulence Generates fractal noise with an absolute value function applied to it to make fault lines.

Phase Controls the speed of the animation of the noise function. A 3D noise function is used for the noise, so that the first two parameters are U and V and the third is phase.

You can animate this parameter to animate the noise effect.

Size Sets the scale of the noise function. Smaller values give smaller chunks of noise.

Levels Sets the number of fractal iterations or turbulence (as a continuous function).

Raytrace Map

Material Editor > Maps rollout > Click a Map button. > Material/Map Browser > Raytrace

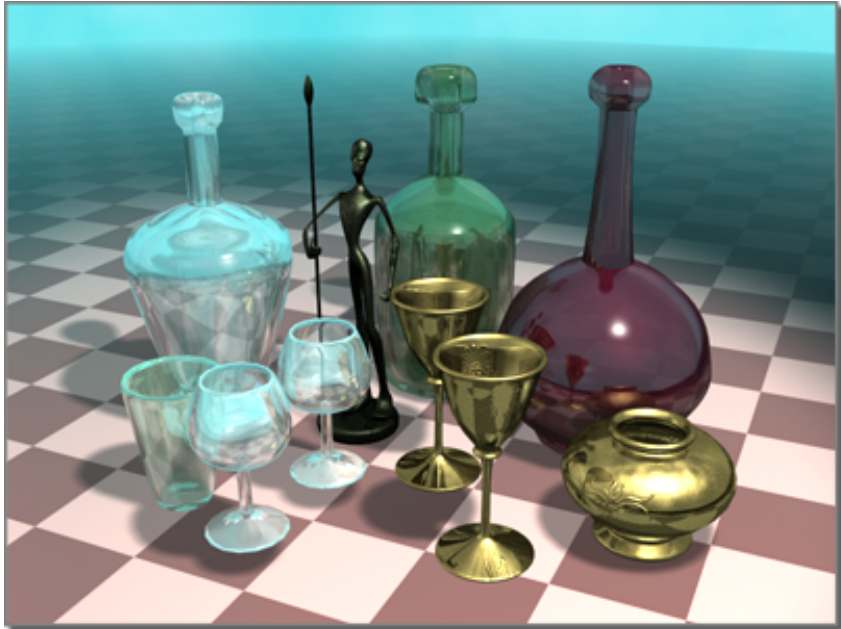

Raytrace map creates highly reflective and refractive surfaces.

Raytrace map provides fully raytraced reflections and refractions. The reflections and refractions it generates are more accurate than those produced by the reflect/refract [map](#) on page 5964. Rendering raytraced objects is slower than using Reflect/Refract. On the other hand, Raytrace is optimized for rendering 3ds Max scenes, and you can further optimize it for your scene by excluding specific objects or effects from raytracing.

You can also use the [Raytrace material](#) on page 5490, which uses the same raytracer to generate accurate, raytraced reflections and refractions. The differences between Raytrace map and Raytrace material are:

- You use Raytrace map as you do other maps. This means you can add raytraced reflections or refractions to any kind of material.
- You can assign Raytrace map to material components other than reflect or refract, although these are the main ways to use this map.
- Raytrace map has more extensive attenuation controls than Raytrace material.
- Raytrace map often renders more quickly than Raytrace material.

Raytrace Map and Raytrace material have the same name because they use the same raytracer and share global parameters.

NOTE Raytracing does not always work correctly in orthogonal viewports (left, front, and so on). It works correctly in perspective viewports and camera viewports.

Interface

The interface for the Raytrace map is contained in four rollouts:

[Raytracer Parameters Rollout](#) on page 5954

[Raytrace: Attenuation Rollout](#) on page 5957

[Raytrace: Basic Material Extensions Rollout](#) on page 5960

[Raytrace: Refractive Material Extensions Rollout](#) on page 5962

Raytracer Parameters Rollout

Material Editor > Maps rollout > Click a Map button. > Material/Map Browser > Raytrace > Raytracer Parameters rollout

This rollout contains the main controls for the [Raytrace map](#) on page 5952.

Interface

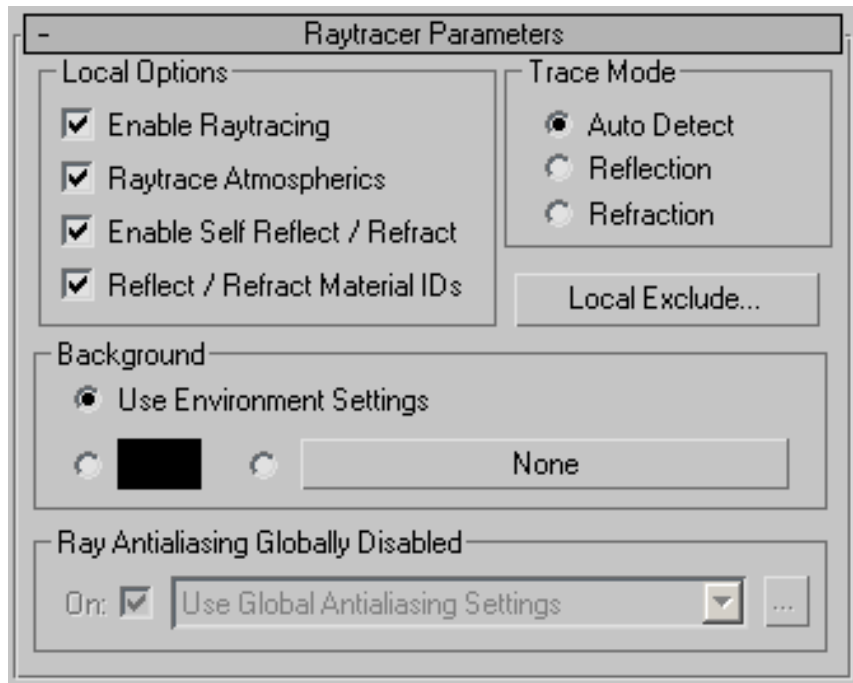

Local Options group

Enable Raytracing Turns the raytracer on or off. Default=on.

Even with raytracing off, Raytrace material and Raytrace map still reflect and refract the environment, including both the environment map for the scene, and the environment map assigned to the Raytrace material.

Raytrace Atmospheric Turns the raytracing of atmospheric effects on or off. Atmospheric effects include fire, fog, volume light, and so on. Default=on.

Enable Self Reflect/Refract Turns self reflection/refraction on or off. Default=on.

Can an object reflect itself? For example, a teapot's body reflects the teapot's handle, but a sphere will never reflect itself. If you don't need this effect, you can improve render time by turning off this toggle.

TIP If you have a transparent object such as glass, and have self reflect/refract turned on, you don't have to make the object [2-sided](#) on page 7893. The raytracer sees back faces when exiting refractive objects.

Reflect/Refract Material IDs When on, the material reflects effects assigned to material IDs in the renderer's [G-buffer](#) on page 7991 on or off. Default=on. By default, Raytrace material and Raytrace map reflect effects assigned to a material's ID, so that G-buffer effects are not lost. For example, if a raytraced object reflects a lamp made to glow with the Video Post Glow filter (Lens Effects Glow), the reflection glows as well.

Trace Mode group

With options in this group, you select whether to cast reflected or refracted rays.

Auto Detect If assigned to the material's Reflection component, the raytracer will reflect. If assigned to Refraction, it will refract. If you assign Raytrace to any other component, you have to manually specify whether you want reflected rays or refracted rays. (Default.)

NOTE Auto Detect might fail when you use Raytrace map in a material with a strong bump map. When you use a strong bump map, choose one of the explicit options.

Reflection Casts reflected rays off the object's surface.

Refraction Casts refracted rays into or through the object's surface.

NOTE Raytrace reflects and transmits the IDs in [material effects channel](#) on page 5348 ([G-buffer](#) on page 7991), so it can create glowing reflections, and so on.

Local Exclude Click to display the local [Include/Exclude dialog](#) on page 5519. An object that is excluded locally is excluded from this map only.

TIP Using exclusion lists is one of the best and simplest ways to speed up the raytracer.

Background group

Use Environment Settings Respects the environment settings of the current scene.

Color Swatch Overrides the environment settings with the specified color.

Map Button Overrides the environment settings with the specified map.

By specifying an environment map, you override the environment map for the scene as a whole. Both reflection and refraction use the scene-wide environment map unless you use this option to specify another map. With this control, you can use different environment maps on a per-object basis, or provide an environment to specified objects when the scene as a whole has none.

Raytraced Reflection and Refraction Antialiaser group

Controls in this group let you override the global antialiasing settings for raytraced maps and materials. They are unavailable if antialiasing is turned off globally. To turn on antialiasing globally, choose Rendering > Raytracer Settings to open the [Raytracer Global Parameters rollout](#) on page 6221.

On When on, uses antialiasing. Default=unavailable unless global antialiasing is turned on; on if global antialiasing is turned on.

Drop-down list Chooses which antialiasing settings to use. There are three options:

- **Use Global Antialiasing Settings** (The default.) Uses the global antialiasing settings.
Click ... to open the [Raytracer Global Parameters rollout](#) on page 6221.
- **Fast Adaptive Antialiaser** Uses the Fast Adaptive antialiaser, regardless of the global setting.
Click ... to open the [Fast Adaptive Antialiaser dialog](#) on page 5522.
- **Multiresolution Adaptive Antialiaser** Uses the Multiresolution Adaptive antialiaser, regardless of the global setting.
Click ... to open the [Multiresolution Adaptive Antialiaser dialog](#) on page 5524.

When you change settings for an antialiaser locally, you don't affect the global settings for that antialiaser.

Raytrace:Attenuation Rollout

Material Editor > Maps rollout > Click a Map button. > Material/Map Browser > Raytrace > Attenuation Rollout

When a ray is reflected off an object or refracted through it, by default the ray travels through space forever, with no [attenuation](#) on page 7915. The controls

in this rollout allow you to attenuate rays, so their strength diminishes over distance.

In the [Raytrace map](#) on page 5952, attenuation is implemented by a clipping algorithm. Objects beyond the maximum attenuation range aren't even considered by the raytracer. Because of this, assigning attenuation can speed up rendering time.

Interface

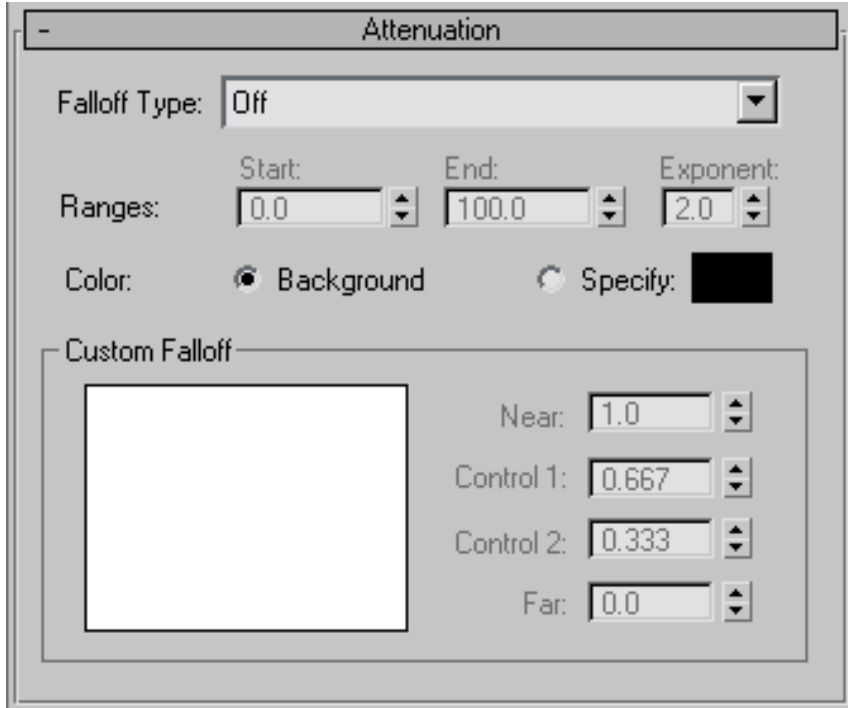

Falloff Type Choose the falloff to use.

- **Off** Turns off attenuation. (Default.)
- **Linear** Sets linear attenuation. Linear attenuation is calculated between the start and end range values.
- **Inverse Square** Sets inverse square attenuation. Inverse square attenuation is calculated beginning at the start range, and doesn't use the end range. Inverse square is the actual attenuation rate for light in the real world. However, it doesn't always give the effect you want in a rendered scene.

- **Exponential** Sets exponential attenuation. Exponential attenuation is calculated between the start and end range values. You also specify the exponent to use.
- **Custom Falloff** Specifies a custom curve to use for attenuation (falloff).

Start Range The distance in world units where attenuation begins. Default=0.0.

End Range Sets the distance in world units where the ray is fully attenuated. Default=100.0.

This is not used by inverse square attenuation.

Exponent Sets the exponent used in exponential falloff. Default=2.0.

This is used only by exponential attenuation.

Color

These controls affect the behavior of light rays as they attenuate out. By default, as a ray fades out, it is rendered as the background color.

You can set a custom color instead.

Background As the ray attenuates out, returns the background (either the scene's background or the background specified locally in the Raytracer Parameters rollout) rather than the actual color of what the reflected/refracted ray sees. (Default.)

Specify Sets the color that is returned by the ray as it attenuates out.

If you choose not to use the background color, black or gray usually work best as the attenuation color,

Custom Falloff group

These controls are inactive unless the Falloff Type is set to Custom Falloff.

Custom Falloff Uses the falloff curve to determine the falloff between the start and the end ranges.

These are the controls for custom attenuation. The custom attenuation curve is at the left. The gray scale bar below the curve shows how the curve will affect the falloff as light rays diminish in strength.

Near Sets the strength of the reflected/refracted ray at the start range distance. This is a normalized percentage that can range from 0.0 to 1.0. Default=1.0.

Control 1 Controls the shape of the curve near the curve start. Default=0.667.

Control 2 Controls the shape of the curve near the curve end. Default=0.333.

Far Sets the strength of the reflected/refracted ray at the end range distance. This is a normalized percentage that can range from 0.0 to 1.0. Default=0.0.

Raytrace: Basic Material Extensions Rollout

Material Editor > Maps rollout > Click a Map button. > Material/Map Browser > Raytrace > Basic Material Extensions Rollout

This rollout contains controls for fine-tuning the effect of the [Raytrace map](#) on page 5952.

Interface

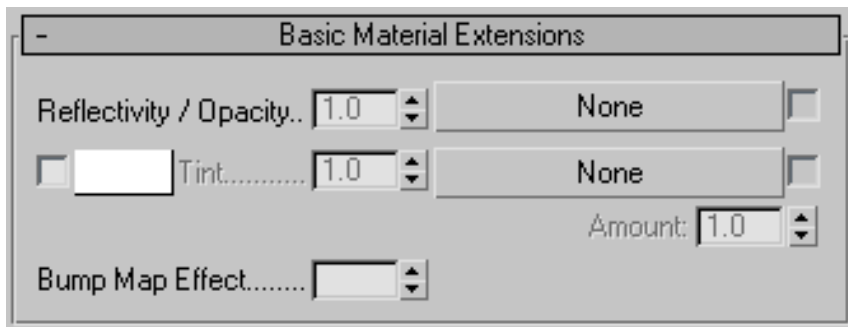

Reflectivity/Opacity These controls affect the intensity of the raytracer's results.

- **Spinner** Controls the amount of raytracing used by the material it is assigned to. Analogous to the Output Amount parameter in the Output rollout of the [Bitmap map type](#) on page 5795.
- **Map button** Assigns a map that controls the amount of raytracing. You can vary the amount of raytracing used over the surface of the object.
- **Check box** Enables or disables the map.

Tint With these controls, you can tint the colors returned by the raytracer. Tinting applies only to reflected colors; it doesn't affect the material's diffuse component.

- **Check box** Turns basic tinting on or off. Default=off.
- **Color swatch** Assigns a tint color for reflections. Default=white.

- **Amount spinner** Sets the amount of tinting used. Default=1.0.
- **Map button** Assigns a map to use for tinting. You can vary the tint colors over the surface of the object.
- **Check box** Enables or disables the map.

Bump Map Effect Controls the effect of a bump map on rays that the surface reflects and refracts. For example, you might want to make a glass object highly bumpy, but reduce the bump effect on refracted parts of the scene.

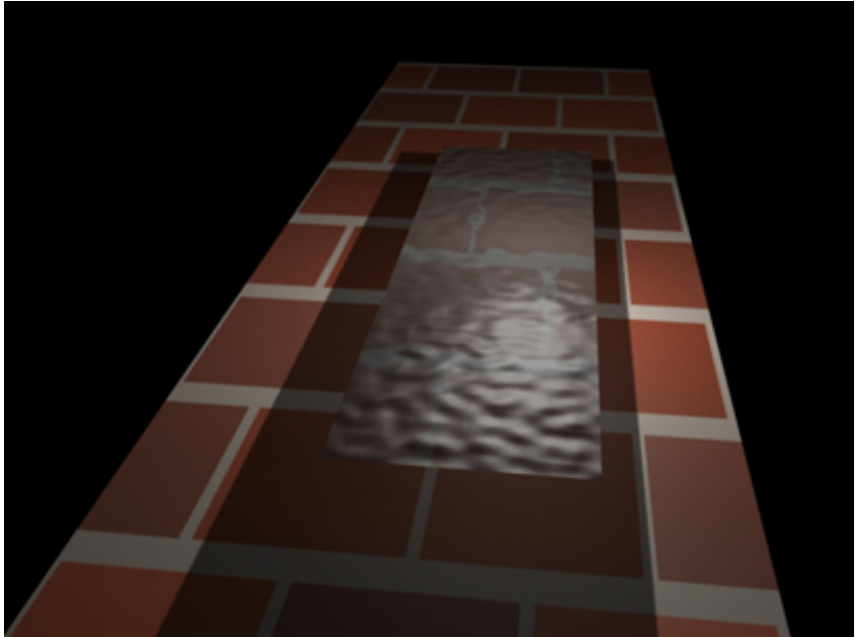

Bump Map Effect equals 1.0.

The refraction of tiles behind the glass is distorted by the bump map.

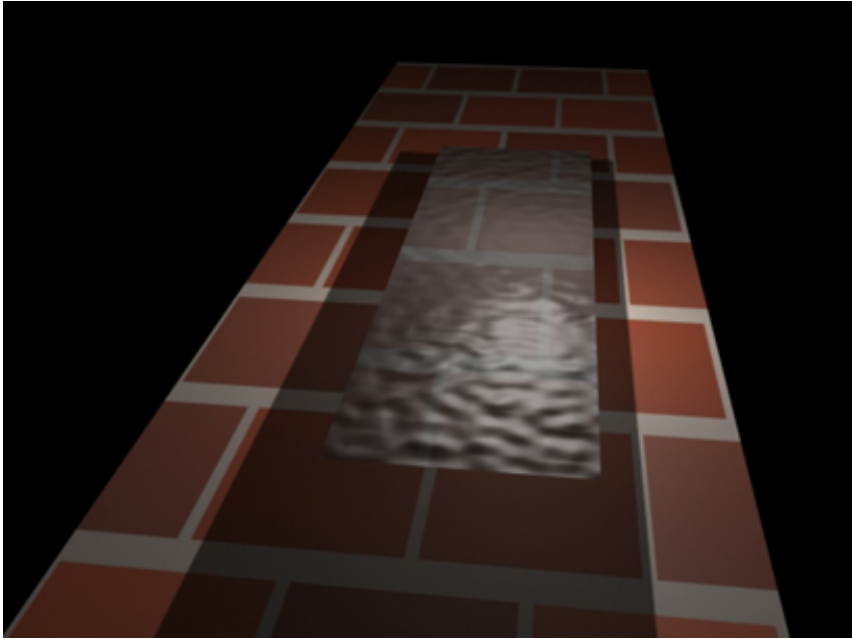

Bump Map Effect equals 0.0.

The refraction of tiles behind the glass is not distorted.

Bump Map Effect is active only when raytracing is enabled.

Raytrace: Refractive Material Extensions Rollout

Material Editor > Maps rollout > Click a Map button. > Material/Map Browser
> Raytrace > Refractive Material Extensions Rollout

With the controls in this rollout, you can fine-tune the effect of the [Raytrace map](#) on page 5952 on a material's refraction component.

Interface

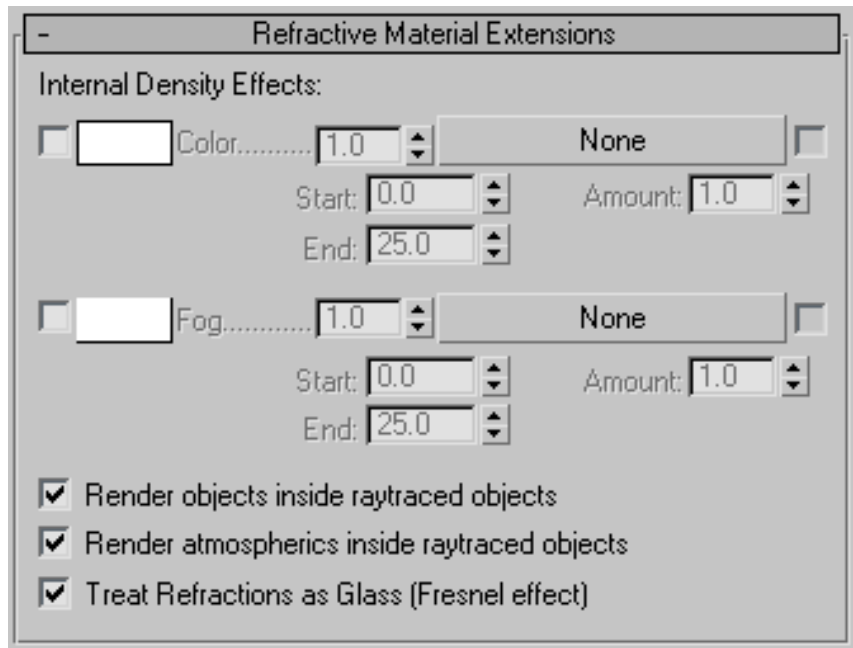

Internal Density Effects

Color With these controls, you can specify a transmission color based on thickness. The density color gives the appearance of color within the object itself, like tinted glass.

- **Enable** Turns color density on or off.
- **Color swatch** Displays a [Color Selector](#) on page 391. Choose the transmission color.
- **Amount** Controls the amount of density color. Reducing this value reduces the density color effect. Range=0 to 1.0. Default=1.0.
- **Color Map** Assigns a map to the density color component. Use the check box to enable or disable the map.
- **Start and End** A thin piece of tinted glass is mainly clear, while a thick piece of the same glass has more color. Start and End Distance, expressed in world units, controls help you simulate this effect. Start is the position in the object where the density color begins to appear (Default=0.0). End

is the position in the object where the density color reaches its full Amount value. To have a lighter effect, increase the End value. To have a heavier effect, reduce the End value.

Fog Density fog is also a thickness-based effect. It fills the object with a fog that is both opaque and self illuminated. The effect is like smoke trapped in a glass, or wax at the tip of a candle. Colored fog in tubular objects can resemble neon tubes.

- **Enable** Turns fog on or off.
- **Color swatch** Displays a [Color Selector](#) on page 391 for choosing the fog color.
- **Amount** Controls the amount of density fog. Reducing this value reduces the density fog effect and makes the fog translucent. Range=0 to 1.0. Default=1.0.
- **Color Map** Assigns a map to the fog component. Use the check box to enable or disable the map.
- **Start and End** Start and End Distance controls, expressed in world units, adjust the fog effect based on the object's dimensions. Start is the position in the object where the density fog begins to appear (default=0.0). End is the position in the object where the density fog reaches its full Amount value. To have a lighter effect, increase the End value. To have a heavier effect, reduce the End value.

Render objects inside raytraced objects Turns the rendering of objects inside raytraced objects on or off. Default=on.

Render atmospheric inside raytraced objects Turns the rendering of atmospheric effects inside raytraced objects on or off. Atmospheric effects include fire, fog, volume light, and so on. Default=on.

Treat Refractions as Glass (Fresnel effect) When on, applies a Fresnel effect to the refraction. This can add a bit of reflection to the refracting object, depending on the viewing angle of the object. When off, the object is refractive only. Default=on.

Reflect/Refract Map

Material Editor > Maps rollout > Click a Map button. > Material/Map Browser > Reflect/Refract

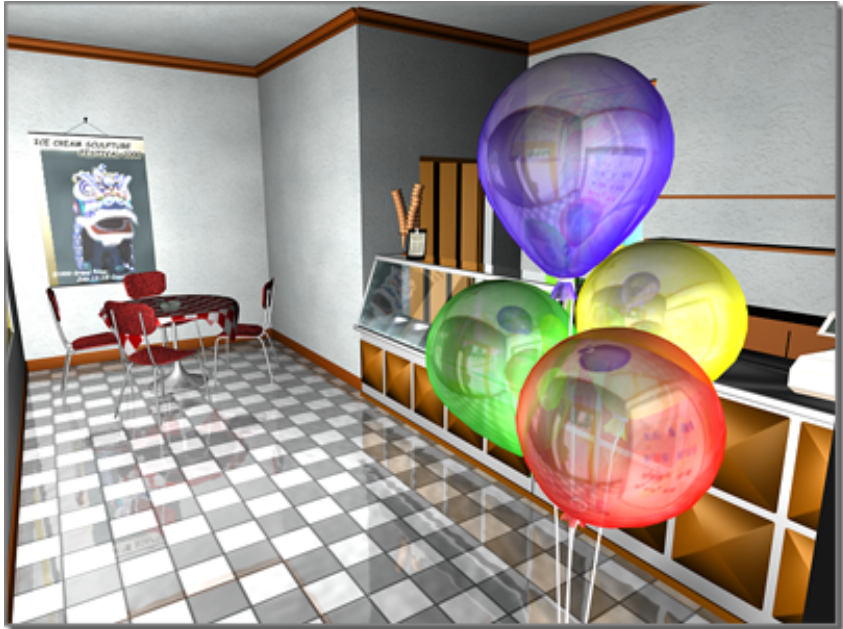

Reflect/Refract map used for the balloons

The Reflect/Refract map produces a reflective or refractive surface. To create reflection, assign this map type as the material's [reflection map](#) on page 5480. To create refraction, assign it as the [refraction map](#) on page 5483.

NOTE A reflective object can reflect another reflective object. In the real world, this creates a virtually infinite number of interreflections. In 3ds Max, you can set the number of interreflections within a range from 1 to 10. You set this Rendering Iterations parameter on the [Render Setup dialog](#) on page 6092.

This map works by using six renderings in the form of a cube that surrounds the objects. Reflect/Refract views the cubic maps from the perspective of the [pivot point](#) on page 8091 of the object, mapping them onto the object's surface as a spherical reflection map.

You can choose to generate the cubic maps automatically, or to load previously created maps.

A reflective surface reflects the surrounding maps like a mirror. A refractive surface creates the illusion that the surrounding maps are seen through the surface.

NOTE Reflect/Refract is meant to be used with curved or irregularly shaped objects. For mirror-like flat surfaces that you want to reflect the environment accurately, use [Flat Mirror](#) on page 5946 material. For more accurate refractions, especially for an object in a refractive medium (such as a pencil in a glass of water), use [Thin Wall Refraction material](#) on page 5971.

Automatic Cubic Maps

When you choose automatic cubic maps, 3ds Max generates the maps based on the perspective of the mapped object's pivot point. Automatic maps are based on the geometry of the scene.

The advantage to using automatic maps is that the six views are automatically generated at rendering time and can be easily updated for each frame of an animation. The disadvantage is that regenerating the maps increases rendering time. In addition, the maps exist only for the rendering and can't be edited or otherwise manipulated.

In the Material Editor, automatic reflections or refractions reflect or refract the background of the sample slot.

Assigning Cubic Maps

When you choose to load cubic maps from files, you use the controls in the From File group. The advantage to using From File is that the bitmap files already exist and take less rendering time. In addition, you can edit the bitmap images. The disadvantage is that it's more difficult to use bitmaps to render an animation because first you need to create the animated bitmaps.

IMPORTANT Assigned cubic maps must be square, and each of the six maps must be the same size.

You can automatically load six bitmaps at once if the six bitmaps have valid cubic-map file names. The first part of all six file names must be the same, and the last part is an underscore followed by a two-letter abbreviation of the map position, as shown in the following table:

Last Part of Cubic Map File Name	Meaning
_UP	Up
_DN	Down

Last Part of Cubic Map File Name	Meaning
_LF	Left
_RT	Right
_FR	Front
_BK	Back

For example, if you have six bitmaps on disk, labeled *view_up.bmp*, *view_fr.bmp*, *view_lf.bmp*, and so on, when you click one of the file buttons and choose the bitmap for that position, all six views are loaded.

If you select a bitmap whose name doesn't follow the convention, or you select one with a valid cubic-map name but assign it to the wrong button, only that bitmap will be loaded.

Since all assigned bitmaps must be the same size, when you assign a new bitmap to one of the windows, the sample slot doesn't update automatically. This avoids generating an error message each time you assign a bitmap. Once you've assigned all six maps and are sure they are square and the same size, click the Reload button to update all of the maps and redisplay the sample slot.

You can also use the Reload button to see your changes after you've edited one of the cubic maps by using a paint program.

Rendering Cubic Maps

The controls in the Render Cubic Map Files group let you generate the maps automatically and save them to disk. Use the To File button to specify the folder and file name of the Up (_UP) bitmaps. Click Pick Object and Render Maps, and then click the object to map. The software creates the files and also assigns them to the six From File map buttons.

Rendering cubic maps has the same effect as automatic with the advantage that map rendering doesn't have to take place at scene rendering time. The disadvantage is that you can't create an automatically animated reflections or refractions this way.

Using Animated Cubic Maps

The cubic maps can be animations instead of bitmaps. Be sure that each is square and all have the same resolution. If you want the animated reflections to match animated changes in the scene, use automatic maps and set them to render every Nth frame.

Procedures

To generate and save cubic maps:

- 1 In the Source group, choose From File.
- 2 In the Render Cubic Map Files group, click the button next to To File.
A file dialog is displayed. Type a name for one of the six cubic bitmap files. You're specifying the name of the Up bitmap. There are two ways to do this:
 - Specify the entire file name; for example, *myview_up.bmp*.
 - Specify the file prefix and extension only; for example, *myview.bmp*.

IMPORTANT You must specify at least a prefix and extension. The "_UP" is added automatically.

- 3 Click Pick Object and Render Maps.
- 4 Click an object in your scene where you want the six views rendered. This is usually the same object where you will apply the material, but it doesn't have to be.

After selecting the object, a window opens temporarily that shows the six views as they render and are saved to disk. Their file names then appear on the six buttons in the From File group. Each of the six file names is identical, except for a two-letter suffix indicating the direction of the rendered view.

Interface

The image shows a software interface titled "Reflect/Refract Parameters". It is organized into several sections:

- Source:** Contains two radio buttons: "Automatic" (selected) and "From File". To the right is a "Size" spinner set to "100" and a checked checkbox for "Use Environment Map".
- Blur:** Contains a checked checkbox for "Apply", a "Blur Offset" spinner set to "0.0", and a "Blur" spinner set to "1.0".
- Atmosphere Ranges:** Contains "Near" and "Far" spinners set to "0.0" and "500.0" respectively, and a "Get From Camera" button.
- Automatic:** Contains two radio buttons: "First Frame Only" (selected) and "Every Nth Frame:" followed by a spinner set to "1".
- From File:** Contains six text input fields labeled "Up:", "Down:", "Left:", "Right:", "Front:", and "Back:". To the right of these fields is a "Reload" button.
- Render Cubic Map Files:** Contains a "To File:" text input field and a "Pick Object and Render Maps" button.

Source Chooses the source of the six cubic maps.

Automatic Automatically generates by looking out in six directions from the pivot of the object with the material, then mapped onto the surface during

rendering. When on, the options in the Automatic group are active, letting you choose whether the maps will be generated only once, or regenerated at specified frames in the animation.

From File When on, you can specify the bitmaps to use.

When From File is active, the controls in the Render Cubic Map Files group are also available. You can generate the six cubic reflection maps automatically and save them to files, where you can load them with the From Files controls.

Size Sets the size of the Reflect/Refract maps. The default value of 100 produces distinct images. Lower values lose progressively more detail.

Use Environment Map When off, environment maps are ignored by Reflect/Refract map during rendering. It's useful to turn this off when you have mirrors in the scene and you're rotoscoping against a flat screen environment map. A screen environment map does not exist in 3D space the way the other environment-map types do, and will not render properly.

Blur group

Apply Turns on filtering to blur the maps.

Blur Offset Affects the sharpness or blurriness of the map without regard to its distance from the object. Use Blur Offset when you want to soften or defocus the details in a map to achieve the effect of a blurred image.

Blur Affects the sharpness or blurriness of the generated map based on its distance from the object. The farther away the map is, the greater the blurring. Blur is primarily used to avoid [aliasing](#) on page 7904. It's a good idea to use a small amount of blurring for all maps in order to avoid the scintillation or aliasing that can occur when pixel details are reduced off in the distance. Default=1.

Atmosphere Ranges group

If your scene contains environmental [Fog](#) on page 6707, the cubic maps must have near and far range settings to properly render the fog from the point of view of the object assigned the material. The Near and Far spinners in this group let you specify a fog range relative to the object.

Near Sets the near range for fog.

Far Sets the far range for fog.

Get From Camera Uses the Near and Far atmosphere range settings of a camera in the scene. Click this option, and then select the camera.

These values aren't dynamically linked to the camera object. They are simply copied from the camera's range values at the time you click the camera. If the camera's range values later change, the map's Near and Far values remain the same.

Automatic group

This controls are active only when Automatic is the active source for the Reflect/Refract maps.

First Frame Only Tells the renderer to create automatic maps only on the first frame.

Every Nth Frame Tells the renderer to create animated auto maps based on the [frame rate](#) on page 7987 set by the spinner.

From File group

These controls are active when From File is active as the Reflect/Refract source. Here you assign the six bitmaps to be used as the cubic maps.

Up / Down / Left / Right / Front / Back Assigns one of the six cubic maps. If the map is one of a set of six with the correct file name, all six are loaded. If the map doesn't follow file naming conventions, or you assign it to a button of a different position (_UP to Front, for example), only that map is assigned. You must assign the others manually.

Reload Reloads the assigned maps and updates the sample slot.

You can edit one or more of the cubic maps using a paint program, then click Reload to update the material and the scene.

Render Cubic Map Files group

To File Choose a file name for the Up map (_UP).

Pick Object and Render Maps Active when you choose a file. Click to turn on, then select the mapped object to render the six cubic maps. Assign the cubic maps to the six From File buttons.

Thin Wall Refraction Map

Material Editor > Maps rollout > Click a Map button. > Material/Map Browser > Thin Wall Refraction



Thin wall refraction

Thin Wall Refraction simulates the "jog," or offset effect, you find when you view part of an image through a plate of glass. For objects that model glass, such as a Box in the shape of a window pane, this map is faster, uses less memory, and provides a much better visual effect than the Reflect/Refract map.

TIP At 100% refraction and opacity, you can see no diffuse color or mapping, and there is not much illusion of a refractive material. The effect is invisible. In the Maps rollout of the parent material, set Refraction Amount to 50%, and in the Basic Parameters rollout, set Opacity to a value greater than 0.

Procedures

To assign the Thin Wall Refraction map to a material:

- 1 Click the Map button for Refraction in the material's Maps rollout.
- 2 In the Material/Map Browser, choose Thin Wall Refraction.
- 3 Adjust the map's parameters.

- 4 In the parent material, set the Refraction Map Amount to 50%.
- 5 Assign the material to an object.

Interface

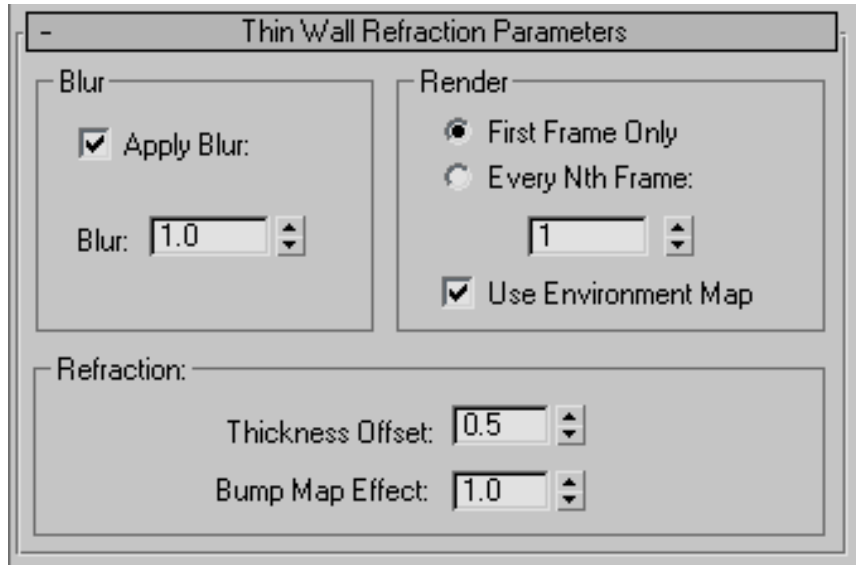

Blur group

These controls are for antialiasing.

Apply Blur Turns on filtering to blur the maps.

Blur Affects the sharpness or blurriness of the generated map based on its distance from the object. The farther away the map is, the greater the blurring. Blur is primarily used to avoid [aliasing](#) on page 7904. It's a good idea to use a small amount of blurring for all maps in order to avoid the scintillation or aliasing that can occur when pixel details are reduced off in the distance. Default=1.0.

Render group

These controls affect how the refraction should behave in animations.

First Frame Only Tells the renderer to create the refracted image only on the first frame.

This is the fastest option. You can use it if the camera and refractive object don't move.

Every Nth Frame Tells the renderer to regenerate the refracted image based on the [frame rate](#) on page 7987 set by the spinner.

Every single frame provides the most accurate result, but takes longest to render.

Use Environment Map When off, environment maps are ignored by the refraction during rendering. It's useful to turn it this off when you have refractions in the scene and you're rotoscoping against a flat screen environment map. A screen environment map does not exist in 3D space the way the other environment map types do, and will not render properly. Default=on.

Refraction group

These controls are specific to the Thin Wall Refraction effect:

Thickness Offset Affects the size of the refractive offset, or jog effect. At 0, there's no offset, and the object can appear invisible in the rendered scene. At 10.0, the offset is at its greatest. Range from 0.0 to 10.0; Default=0.5.

NOTE The IOR (index of refraction) spinner in the parent material's Extended Parameters rollout also affects the offset effect.

Bump Map Effect Affects the magnitude of refraction due to the presence of a bump map. This parameter multiplies the current bump map Amount in the parent material. Reduce this value to reduce the effect of the secondary refraction; increase this value to increase the effect. If there is no bump map assigned, this value has no effect. Default=1.0.

If there is unevenness in the surface of the glass, there is a secondary refraction. Thin Wall Refraction generates this secondary refraction if the material also has a bump map present. The algorithm guesses at the scaling of the secondary refraction, and can create too large an effect. If this happens, scale the effect down by reducing this value to less than one.

mental ray Shaders

In mental ray, a shader is a function that calculates light effects. There can be shaders for lights, cameras (lens shaders), materials, shadows, and so on.

NOTE In 3D modeling, the term “shader” typically refers to an algorithm that specifies how a surface responds to light. (The shaders for standard 3ds Max fall into this category.) With the mental ray renderer, “shader” has a more general sense of *any* algorithm used in rendering.

The [mental ray renderer](#) on page 6230 can render most types of 3ds Max materials and maps. See [3ds Max Materials in mental ray Renderings](#) on page 6239. In addition, if you have enabled mental ray extensions (see [mental ray Preferences](#) on page 7787), you can apply a variety of shaders to materials. Materials designed for use with the mental ray renderer have specific components to which you can assign a shader. And for standard 3ds Max material types, the [mental ray Connection rollout](#) on page 5385 lets you add mental ray shading.

WARNING When you use the scanline renderer, mental ray shaders typically appear as black or white surfaces, or they are ignored entirely.

You assign a mental ray shader the same way you do a map. In the [Material/Map Browser](#) on page 5290, mental ray shaders appear with a yellow icon, instead of the green icon used for maps.



mental ray maps in the browser's list are shown with yellow icons.

The shaders listed in the Browser depend on which type of shader component you have chosen in the Material Editor. For example, when you assign a Surface shader, the Browser lists a variety of shaders and standard 3ds Max maps. But when you assign a more special-purpose Contour shader, the Browser lists only those shaders that generate contour lines.

NOTE Other kinds of special-purpose shaders include shaders for cameras and lights. Buttons to assign camera shaders are found on the Render Setup dialog > [Camera Effects rollout](#) on page 6283, and the controls to assign light shaders are on a light object's [mental ray Light Shader rollout](#) on page 5115. This rollout appears only on the Modify panel, not the Create panel.

The shaders listed in the Browser come from several libraries that are provided with 3ds Max. Shaders created specifically for 3ds Max are described in this document. Shaders provided with the mental images or lume shader libraries have their own online documentation. The following topics link to the descriptions of specific shaders:

- [3ds Max Custom Shaders](#) on page 5982 links to descriptions of the shaders provided in the product-specific library, *3dsmax.mi*.
- [mental images Shader Libraries](#) on page 5977 links to descriptions of the shaders provided in the three standard mental ray libraries from mental images: *base.mi*, *contour.mi*, and *physics.mi*.
- [Shaders in the LumeTools Collection](#) on page 5980 includes links to descriptions of shaders in the lume library, *lume.mi*.
- The [Production Shaders](#) on page 6017 library includes several special-purpose texture shaders, a lens shader, and two output shaders.
- The [Car Paint](#) on page 5607 material is also available as a shader, with the same set of parameters.
- The [mr Sun](#) on page 5173, [mr Sky](#) on page 5176, and [mr Physical Sky](#) on page 5181 shaders are components of the [mental ray Sun and Sky](#) on page 5161 solution.

NOTE When you wire the parameters of an object whose material has mental ray shaders assigned, names of shader parameters might differ from those in the Material Editor interface. Also, parameters not supported by 3ds Max might appear as blanks in the wiring menu.

mental ray Shaders not Provided with 3ds Max

If your installation includes shader libraries other than those listed in this reference (whether obtained from a third-party source, or custom written), then the Browser might list those shaders as well. Documentation for third-party or custom shaders should come from the shader's provider.

Where Shaders Are Installed

Shaders provided with 3ds Max are installed in the subdirectory `\mentalray\shaders_standard\`, below the 3ds Max root directory. The `\include` folder is for the MI include files, and the `\shaders` folder is for the DLLs.

Third-party shaders should *not* be installed in `\shaders_standard`. They should be installed either in `\shaders_3rdparty` or `\shaders_autoload`. If a third-party shader is present in `\shaders_autoload`, it is loaded automatically when you start 3ds Max. If a third-party shader is present in `\shaders_3rdparty`, you must update the file `3rdparty.mi` so it explicitly loads the shader. The MI file `\shaders_3rdparty\3rdparty.mi` contains comments that explain how to add load statements.

NOTE Shaders listed in the MI file are loaded in reverse order: that is, from the bottom of the list to the top.

mental images Shader Libraries

Material Editor > Maps rollout > Click a Map button. > Material/Map Browser > Pick a mental ray shader other than a custom 3ds Max shader or a lume shader.

Note: Shaders appear in the Browser only if the mental ray renderer is the currently active renderer.

The shaders provided with standard libraries from mental images are meant for use with the [mental ray renderer](#) on page 6230. There are three standard libraries: Base Shaders (*base.mi*), Physics Shaders (*physics.mi*), and Contour Shaders (*contour.mi*).

NOTE In the mental image libraries, the names of base shaders have the prefix “mib_” and the names of contour shaders have the prefix “contour_”. These prefixes don't appear in the 3ds Max user interface or in the table that follows. (Names of physics shaders have no conventional prefix.)

The following table lists the mental images library shaders provided with 3ds Max.

TIP When you follow a link to the documentation for mental images library shaders, scroll up a bit in your browser. The links tend to go directly to the shader's declaration code, and often there are some introductory paragraphs directly above the code. If the link goes to the beginning of a section, scroll down instead.

Shader	Library
<i>Ambient/Reflective Occlusion</i>	base
<i>Combi</i>	contour
<i>Contour Composite</i>	contour
<i>Contour Contrast Function Levels</i>	contour
<i>Contour Only</i>	contour
<i>Contour PS (PostScript)</i>	contour
<i>Contour Store Function</i>	contour
<i>Curvature</i>	contour
<i>Depth Fade</i>	contour
<i>DGS Material Photon</i>	physics
<i>Dielectric</i>	base
<i>Factor Color</i>	contour
<i>Layer Thinner</i>	contour
<i>Light Infinite</i>	base
<i>Light Point</i>	base

Shader	Library
<i>Light Spot</i>	base
<i>Opacity</i>	base
<i>Parti Volume</i>	physics
<i>Photon Basic</i>	base
<i>Reflect</i>	base
<i>Refract</i>	base
<i>Shadow Transparency</i>	base
<i>Simple</i>	contour
<i>Texture Remap</i>	base
<i>Texture Rotate</i>	base
<i>Texture Wave</i>	base
<i>Transmat</i>	physics
<i>Transmat Photon</i>	physics
<i>Transparency</i>	base
<i>Two Sided</i>	base
<i>Width From Color</i>	contour
<i>Width From Light</i>	contour
<i>Width From Light Dir</i>	contour

NOTE You can also access the mental images shader help by choosing Help > Additional Help, opening the mental ray 3.6 Reference, and then highlighting mental ray Shader Reference on the Contents panel.

Shaders in the LumeTools Collection

Material Editor > Maps rollout > Click a Map button. > Material/Map Browser > Pick a shader with “(lume)” in its name.

Note: Shaders appear in the Browser only if the mental ray renderer is the currently active renderer.

The LumeTools Collection of shaders provide a variety of naturalistic effects when used with the [mental ray renderer](#) on page 6230. In the Material/Map Browser, the name of these shaders is followed by “(lume).” These are the lume shaders provided with 3ds Max:

- *Beam*
- *Distortion*
- *Edge and Edge Shadow*
- *Facade*
- *Glass*
- *Glow*
- *Landscape*
- *Metal*
- *Mist*
- *Night*
- *Ocean*
- *Stain*
- *Submerge*
- *Translucency*
- *Water Surface*
- *Wrap Around*

■ *Wet-Dry Mixer*

NOTE You can also access the lume shader help by choosing Help > Additional Help, opening the mental ray Reference, and then highlighting LumeTools Collection on the Contents panel.

Connect Parameter to Shader Dialog (mental ray)

Material Editor > mental ray Connection rollout > Click a shader button. > Material/Map Browser > Pick a mental ray shader that returns multiple values.

Material Editor > Shader controls > Click a shader button. > Material/Map Browser > Pick a mental ray shader that returns multiple values.

Material Editor > DGS material > Click a shader button. > Material/Map Browser > Pick a mental ray shader that returns multiple values.

Material Editor > Shader controls > Click a shader return parameter button (to the right of the main shader button).

Note: The mental ray Connection rollout is available in the Material Editor only if you have enabled the mental ray extensions by using the mental ray Preferences panel. In addition, shaders don't appear unless the mental ray renderer is the currently active renderer.

Some mental ray shaders return multiple values. If you choose one of these, a Connect Parameter To Shader dialog appears. Choose one of the return values in the list, and then click OK.

IMPORTANT [UV Coordinates](#) on page 6013 and [XYZ Coordinates](#) on page 6017 are the only shaders with multiple return values provided with 3ds Max. You might encounter multiple return values in shaders provided with other shader libraries or custom shader code.



The components for some mental ray materials and shaders can be assigned other shaders. For these components, the main shader button is accompanied on the right by a small button. If no shader is assigned, or the shader assigned has only a single return value, the button is disabled and shows a dot in the middle. If the shader assigned can return multiple values, text appears in this button, and a tooltip shows the parameter name. Clicking the button displays the Connect Parameter To Shader dialog, allowing you to change the parameter being used.

Interface

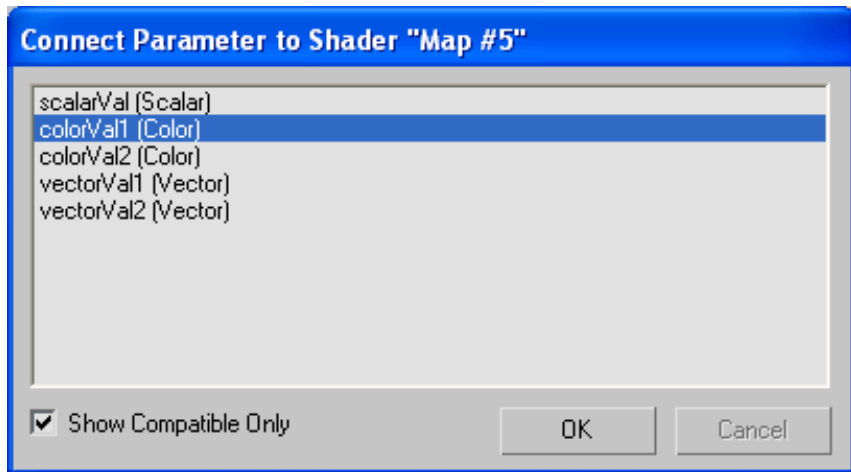

List of return values Lists the parameters that the shader returns. The type of each parameter is indicated in parentheses, following the parameter's name.

Show Compatible Only When on the list shows only the return values whose type is compatible with the component the shader is assigned to. When off, shows all return values from the shader, whether they are compatible or not. Default=on.

3ds Max Custom Shaders

Material Editor > Maps rollout > Click a Map button. > Material/Map Browser > Pick a mental ray shader other than a mental images library shader or a lume shader.

Note: Shaders appear in the Browser only if the mental ray renderer is the currently active renderer.

For use with the [mental ray renderer](#) on page 6230, 3ds Max provides the following custom shaders:

3D Displacement Shader (mental ray)

Material Editor > mental ray Connection rollout > For the Displacement component, turn off the lock button. > Click the button for the Displacement component. > Material/Map Browser > 3D Displacement (3dsmax)

Material Editor > mental ray material > Click the button for the Displacement component. > Material/Map Browser > 3D Displacement (3dsmax)

Note: Shaders appear in the Browser only if the mental ray renderer is the currently active renderer.

A 3D Displacement shader displaces the geometry of surfaces. The effect is similar to displacement mapping of a standard material. You can apply mental ray displacement to any kind of object, unlike standard displacement mapping, which is restricted to surface models (meshes, patches, polys, and NURBS surfaces).

Displaced surfaces are smooth if the displaced polygons share normals; otherwise, the displaced surfaces are faceted. Also, unless normals are shared, faces can become separated in the displaced mesh. To prevent this, make sure adjacent surfaces belong to the same shading group.

When the mental ray renderer is the active renderer, mental ray displacement is the only displacement method used, unless your scene includes a [Displace modifier](#) on page 1344, which always uses standard 3ds Max displacement.

TIP Before you render, you can disable or enable displacement by using the Displacement toggle in the Options group on the [Common Parameters rollout](#) on page 6121.

Global settings for the mental ray displacement method are in the Displacement group on the Render Setup dialog > Renderer panel > [Shadows And Displacement rollout](#) on page 6292.

See also:

- [mental ray Displacement](#) on page 6268
- [mental ray Connection Rollout](#) on page 5385
- [mental ray Material](#) on page 5638

Interface

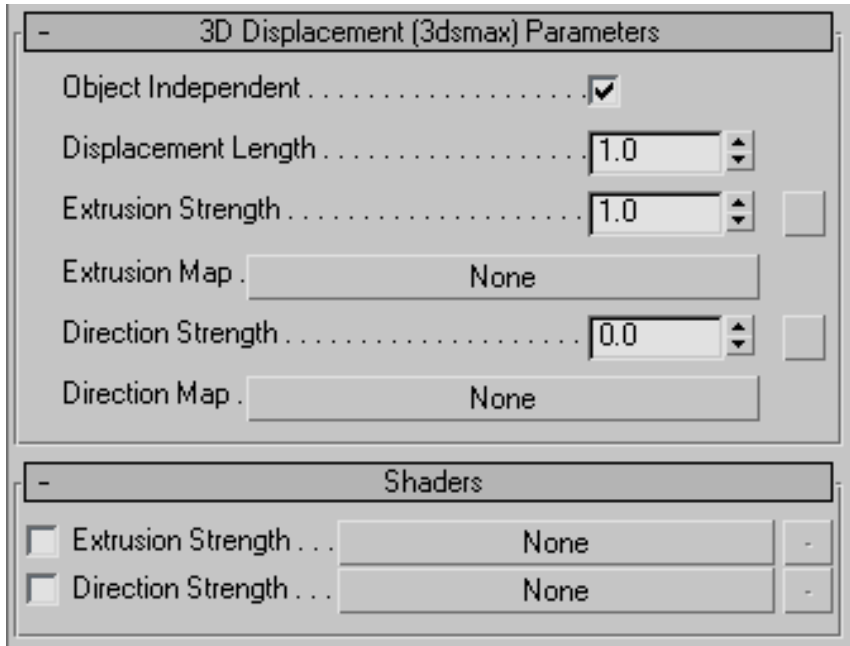

3D Displacement (3dsmax) Parameters rollout

NOTE The button to the right of the Factor and Direction Strength controls is a shortcut shader button. Clicking one of these buttons displays the [Material/Map Browser](#) on page 5290 so you can assign a shader to this component. When a map or a shader has been assigned to a component, this button displays the letter "M," and the comparable button on the Shaders rollout displays the map or shader name.

Object Independent When on, the displacement effect is independent of the size of the object's bounding box. When off, the displacement effect is scaled according to the size of the object. Default=on.

Scaling the displacement based on object size is the standard behavior for regular 3ds Max displacement mapping.

Displacement Length This is the length of displacement when Object Independent is on, the extrusion map is at 100 per cent (white) and the Extrusion Strength equals 1.0. Lower gray levels in the extrusion map, or other

values of Extrusion Strength, scale the amount of displacement. When Object Independent is off, this value is disregarded. Default=1.0.

Extrusion Strength Controls the height of the displacement. This value is a multiplier: at the default value of 1.0, the map's effect is unchanged. Greater values increase the effect of the map, and lower values decrease it. Default=1.0.

Extrusion Map Click to display the [Material/Map Browser](#) on page 5290 and choose a map to use for the displacement. Displacement maps apply the gray scale of the map to generate the displacement. Lighter colors in the 2D image push outward more strongly than darker colors, resulting in a 3D displacement of the geometry.

Direction Strength Controls the strength of the direction shader. Default=0.0.

IMPORTANT Adding a direction shader has no visible effect unless you set Direction Strength to be greater than its default value of zero. (Direction Strength values less than zero have no effect.)

Direction Map Click to display the [Material/Map Browser](#) on page 5290 and choose a shader to use for the map direction. The direction of the displacement is perturbed according to the RGB values of the shader output or map pixels. Red values offset in the U axis, Green values offset in V, and Blue values offset in W (using the object-local UVW coordinates).

Shaders rollout

The controls on this rollout let you assign a map or shader to the Factor or Direction Strength parameters. Click the button for a component to display the [Material/Map Browser](#) on page 5290 and assign the map or shader. Use the toggle at the left to turn the effect of the map off or on.



The button to the right of each main shader button is for shaders that can return multiple parameters. If a shader that returns multiple parameters is assigned to the component, the button's tooltip shows the parameter name. Clicking the button displays a [Connect Parameter To Shader dialog](#) on page 5981, which lets you change which parameter is being used.

IMPORTANT [UV Coordinate](#) on page 6013 and [XYZ Coordinate](#) on page 6017 are the only shaders with multiple return values provided with 3ds Max. You might encounter multiple return values in shaders provided with other shader libraries or custom shader code.

Bump Shader (mental ray)

Material Editor > mental ray material > Click the button for the Surface or Bump component. > Material/Map Browser > Bump (3dsmax)

Note: Shaders appear in the Browser only if the mental ray renderer is the currently active renderer.

The Bump shader provides bump mapping for the mental ray renderer. Bumps are created by perturbing face normals before the object is rendered, using the same method as [bump mapping](#) on page 5478 for the scanline renderer.

WARNING Although you can assign a Bump shader to the Surface component, if you assign *only* a Bump shader, the surface will render as black. For the Surface component, use the Bump shader in a [Shader List](#) on page 6003, or for the [mental ray material](#) on page 5638, use the Bump component itself.

Interface

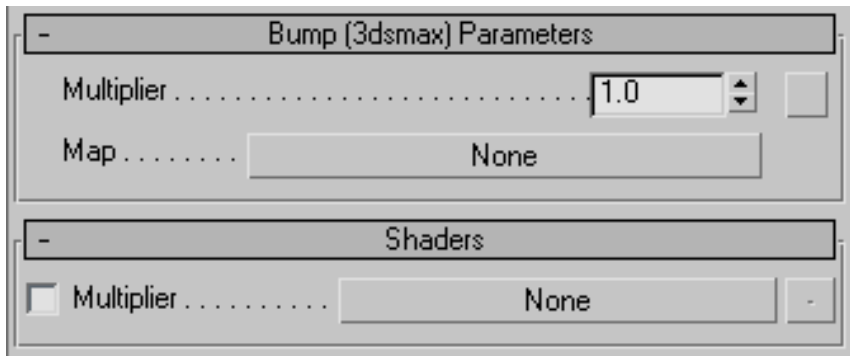

Bump (3dsmax) Parameters rollout

Multiplier Adjust the bump effect by multiplying the map values. Negative Multiplier values reverse the bump effect: hollow areas now protrude, and raised areas become hollow. Default=1.0.

Map Click to display the [Material/Map Browser](#) on page 5290 and choose a map to use for generating bumps. Bump mapping uses the intensity of the map to affect the surface of the material. The intensity affects the apparent bumpiness of the surface: white areas protrude, and black areas recede.

Shaders rollout

The controls on this rollout let you assign a map or shader to the Multiplier parameter. Click the button for a component to display the [Material/Map Browser](#) on page 5290 and assign the map or shader. Use the toggle at the left to turn the effect of the map off or on.



The button to the right of the main shader button is for shaders that can return multiple parameters. If a shader that returns multiple parameters is assigned to the component, the button's tooltip shows the parameter name. Clicking the button displays a [Connect Parameter To Shader dialog](#) on page 5981, which lets you change which parameter is being used.

IMPORTANT [UV Coordinate](#) on page 6013 and [XYZ Coordinate](#) on page 6017 are the only shaders with multiple return values provided with 3ds Max. You might encounter multiple return values in shaders provided with other shader libraries or custom shader code.

DGS Material Shader (mental ray)

Material Editor > mental ray Connection rollout > Unlock the Surface or Photon component. > Click the shader button for the Surface or Photon component. > Material/Map Browser > DGS Material (3dsmax)

Material Editor > mental ray material > Click the button for the Surface or Photon component. > Material/Map Browser > DGS Material (3dsmax)

Note: Shaders appear in the Browser only if the mental ray renderer is the currently active renderer.

DGS stands for Diffuse, Glossy, Specular. This shader is a mental ray phenomenon (a scripted shader tree) that provides a physically accurate simulation of a surface. With the mental ray Connection rollout of a basic 3ds Max material, or a mental ray material, you can assign the DGS Material shader to either the Surface or Photon component.

Despite the similarity in name, this shader is distinct from the [DGS material](#) on page 5615. Both, in turn, provide a custom 3ds Max interface to the “DGS Material Photon” shader that is part of the mental images physics library.

Interface

Parameters rollout

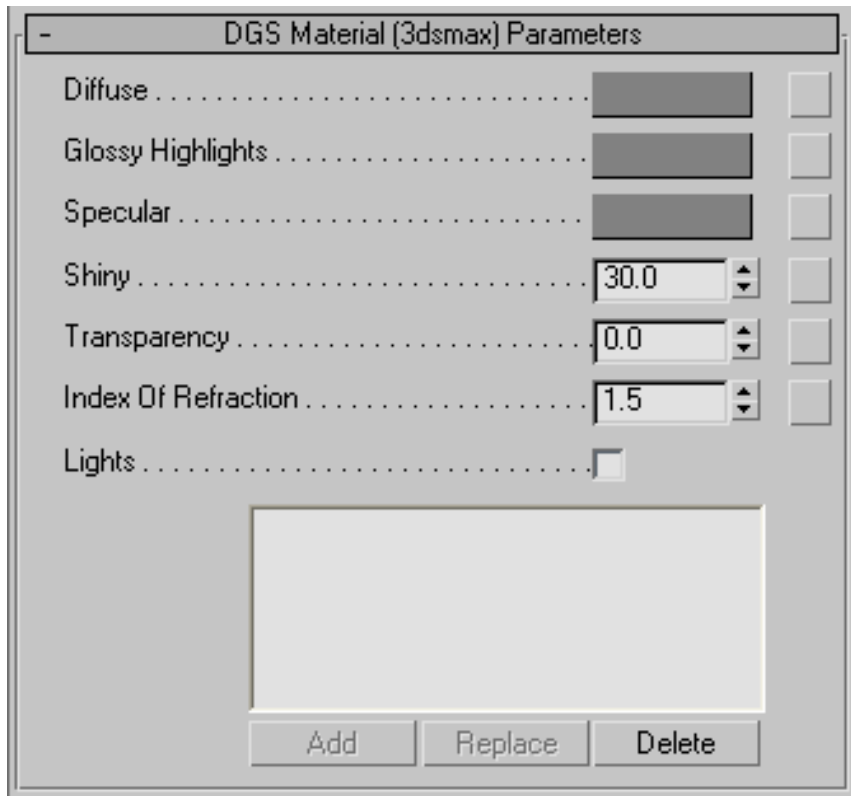

NOTE The button to the right of the first six controls is a shortcut shader button. Clicking one of these buttons displays the [Material/Map Browser](#) on page 5290 so you can assign a shader to this component. When a map or a shader has been assigned to a component, this button displays the letter “M,” and the comparable button on the Shaders rollout displays the map or shader name.

Diffuse Click the color swatch to display a [Color Selector](#) on page 391 and change the material's diffuse color.

Glossy Highlights Click the color swatch to display a Color Selector and change the color of glossy highlights.

Specular Click the color swatch to display a Color Selector and change the color of mirror reflections. When the specular color is white, the material is 100 percent reflective, like a mirror. When the specular color is black, the material does not reflect any of its surroundings.

Shiny Sets the width of glossy highlights. The larger this value, the smaller the highlights. Default=30.0.

Transparency Specifies the transparency. The effective range of Transparency is from 0.0 to 1.0. At 0.0 the material is fully opaque. At 1.0 it is fully transparent. Default=0.0.

WARNING You can set the value of Transparency to be greater than 1.0, but this has no effect. An anomaly of the user interface for shaders in the mental ray and lume libraries, is that spinner values are not “clamped” to lie within their effective ranges, as they are for controls in 3ds Max.

The value of Transparency also indirectly specifies the reflectivity of the material, which is calculated as 1.0 minus the Transparency value.

Index Of Refraction Specifies the IOR. In the physical world, the IOR results from the relative speeds of light through the transparent material and the medium the eye or the camera is in. Typically this is related to the object's density. The higher the IOR, the denser the object. Default=1.5.

See [Extended Parameters Rollout \(Standard Material\)](#) on page 5408 for a list of IOR values for commonly encountered materials.

NOTE When the IOR equals 1.0, there is no refraction, and calculating the transparency can take less time than when the material is refractive.

Lights When on, the material is illuminated only by those lights specified in the list. When Lights is turned off, all lights in the scene affect the material. Default=off.

The remaining light controls are unavailable unless Lights is turned on.

- **List of lights** Displays the lights you have chosen to illuminate this material.
- **Add** Adds a light to the list. Click Add to turn it on, then click the light object in a viewport.
- **Replace** Replaces a light in the list. Highlight a light's name in the list, click Replace to turn it on, then click the replacement light object in a viewport.

- **Delete** Deletes a light from the list. Highlight a light's name in the list, then click Delete.

Shaders rollout

The controls on this rollout let you assign a map or shader to one of the basic parameters of the DGS Material shader. This is comparable to mapping a component of a standard material; by adding shaders, you can create a shader tree that generates complex effects.

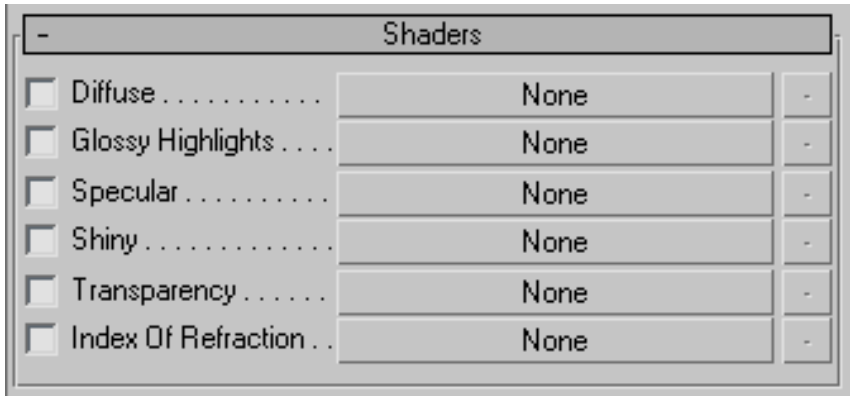

Click the button for a component to display the [Material/Map Browser](#) on page 5290 and assign the map or shader. Use the toggle at the left to turn the effect of the map off or on.



The button to the right of each main shader button is for shaders that can return multiple parameters. If a shader that returns multiple parameters is assigned to the component, the button's tooltip shows the parameter name. Clicking the button displays a [Connect Parameter To Shader dialog](#) on page 5981, which lets you change which parameter is being used.

IMPORTANT [UV Coordinates](#) on page 6013 and [XYZ Coordinates](#) on page 6017 are the only shaders with multiple return values provided with 3ds Max. You might encounter multiple return values in shaders provided with other shader libraries or custom shader code.

For all the DGS Material shader components, the available mental ray shaders are the same:

Shader	Library
Bump on page 5986	3ds Max
DGS Material (this shader)	3ds Max
<i>Dielectric</i>	base
Dielectric Material on page 5992	3ds Max
<i>Edge</i>	lume
<i>Facade</i>	lume
<i>Glass</i>	lume
<i>Glow</i>	lume
<i>Landscape</i>	lume
Material to Shader on page 6001	3ds Max
<i>Metal</i>	lume
<i>Ocean</i>	lume
<i>Opacity</i>	base
<i>Reflect</i>	base
<i>Refract</i>	base
Shader List on page 6003	3ds Max

Shader	Library
<i>Stain</i>	lume
<i>Translucency</i>	lume
<i>Transmat</i>	physics
<i>Transparency</i>	base
<i>Two Sided</i>	base
UV Generator on page 6005	3ds Max
<i>Water Surface</i>	lume
<i>Wet-Dry Mixer</i>	lume
XYZ Generator on page 6013	3ds Max

Dielectric Material Shader (mental ray)

Material Editor > mental ray Connection rollout > Unlock the Surface or Photon component. > Click the shader button for the Surface or Photon component. > Material/Map Browser > Dielectric Material (3dsmax) or Dielectric Material Photon (3dsmax)

Material Editor > mental ray material > Click the button for the Surface or Photon component. > Material/Map Browser > Dielectric Material (3dsmax) or Dielectric Material Photon (3dsmax)

Note: Shaders appear in the Browser only if the mental ray renderer is the currently active renderer.

The Dielectric Material shader creates transparent, refractive materials that are physically accurate. A dielectric material, such as glass, is a material whose surface transmits most light that strikes it at angles close to perpendicular (90 degrees), but reflects most light that strikes at glancing angles (close to zero degrees).

When applied to the Surface component, this shader affects the surface's appearance. When applied to the Photon component, it affects its photon behavior for caustics and global illumination. (The Glass material is a mental ray phenomenon (a scripted shader tree) that is equivalent to a [mental ray material](#) on page 5638 with a Dielectric Material shader assigned to both its Surface and Photon components, with the parameter settings identical for both.)

NOTE This material does not use a shadow shader, so shadows will always be opaque unless you use a Dielectric Material shader for the Photon component, and generate caustics when you render.

Adjacent Refractive Materials

Two controls, Outside Light Persistence and Index Of Refraction (Out), are for situations where you are modeling two adjacent refractive materials. Consider a drink in a martini glass. The glass has an index of refraction (IOR) of 1.5, while the alcohol in the glass has an IOR of about 1.3. To create a physically accurate model of this situation, use *three* glass materials: one for the glass itself, one for the alcohol, and a third material for the surfaces where they touch each other. For this third material, set the “inside” IOR to 1.3, and the outside IOR to 1.5.

Interface

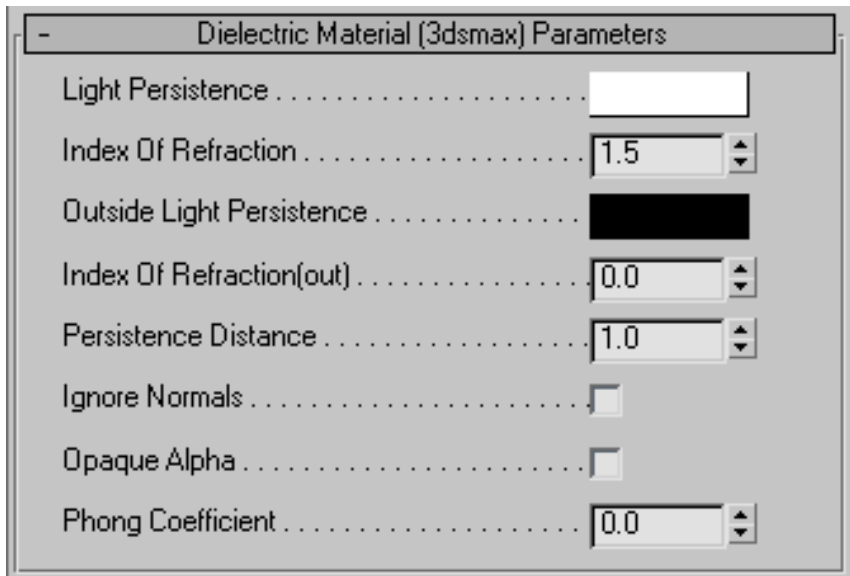

Light Persistence In conjunction with the Persistence Distance, controls the percentage of light that the volume transmits. For example, if the color is set to R=G=B=0.5 and the Persistence Distance is set to 2.0, then objects with a thickness of 2.0 units will appear 50 per cent transparent. Default=white (R=G=B=1.0).

Because transparency depends on the thickness of the object, objects with varying thickness show different transparency depending on the angle from which they are viewed.

Index Of Refraction Specifies the Index Of Refraction (IOR). In the physical world, the IOR results from the relative speeds of light through the transparent material and the medium the eye or the camera is in. Typically this is related to the object's density. The higher the IOR, the denser the object. Default=1.5.

See [Extended Parameters Rollout \(Standard Material\)](#) on page 5408 for a list of IOR values for commonly encountered materials.

Outside Light Persistence In conjunction with the Persistence Distance, controls the percentage of light transmitted on the other side of a surface. When set to the default of black, this control has no effect. See the section "Adjacent Refractive Materials," above. Default=black (R=G=B=0.0).

Index Of Refraction (out) Sets the IOR on the other side of a surface. When set to the default of zero, this control has no effect. See the section “Adjacent Refractive Materials,” above. Default=0.0.

Persistence Distance In conjunction with the Light Persistence color, controls the percentage of light that the volume transmits. It is the distance at which light transmission is reduced to the percentage specified by the Light Persistence RGB values. Default=1.0.

If you specify an Outside Light Persistence color, that setting also uses the Persistence Distance.

Ignore Normals When on, the renderer does not use normals to decide whether a light ray is entering or leaving the object. Normally, the shader uses normals to decide whether a ray is entering or leaving an object. (It is entering if the normal points toward the ray, leaving if the normal points away from the ray.) This can present a problem for rendering objects whose normals are not unified. When Ignore Normals is on, the shader decides whether a ray is entering or leaving the object by counting the number of times the ray has intersected the object. Default=off.

Opaque Alpha When on, refracted rays that touch the environment don't generate a transparent alpha value. (This is how 3ds Max usually treats the environment.) When off, refracted rays that touch the environment render a transparent alpha value, which can help if you plan to use the rendering as part of a composite. Default=off.

Phong Coefficient When greater than zero, generates Phong highlights on the surface. The highlights appear in the sample slot. In general this value must be greater than 10 for highlights to be apparent. Default=0.0.

Environment Shader (mental ray)

Material Editor > mental ray Connection rollout > Assign a shader to the Environment component. > Material/Map Browser > Environment (3dsmax)

Material Editor > mental ray material > Assign a shader to the Environment component. > Material/Map Browser > Environment (3dsmax)

Note: Shaders appear in the Browser only if the mental ray renderer is the currently active renderer.

The Environment shader lets you specify an environment that is local to the material. Controls for the Environment shader are similar to those for a scene's environment on the Render Setup dialog > Environment panel. However, the

local Environment shader doesn't affect the scene background. Instead, it provides an environment that the material can reflect or refract.

If an environment map is present, it generates the reflections or refractions, and they are not ray traced.

Interface

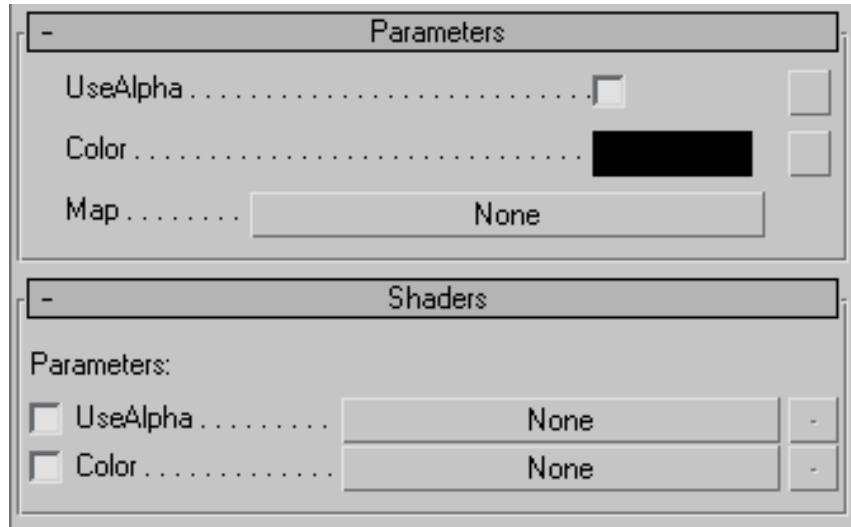

Parameters rollout

NOTE The buttons to the right of the UseAlpha and Color controls are shortcut shader buttons. Clicking one of these buttons displays the [Material/Map Browser](#) on page 5290 so you can assign a shader to this component. When a map or a shader is assigned to a component, this button displays the letter “M,” and the comparable button on the Shaders rollout displays the map or shader name.

UseAlpha When on, uses the map's alpha channel, if it has one. The alpha channel specifies those portions of the map that are transparent or translucent. Default=off.

Color Click the color swatch to display a [Color Selector](#) on page 391 and choose a color to use as the environment.

Map Click the button to display a [Material/Map Browser](#) on page 5290 and choose a map to use as the environment.

Shaders rollout

The controls on this rollout let you assign a map or shader to the UseAlpha and Color parameters. Click the button for a component to display the [Material/Map Browser](#) on page 5290 and assign the map or shader. Use the toggle at the left to turn the effect of the map off or on.



The button to the right of each main shader button is for shaders that can return multiple parameters. If a shader that returns multiple parameters is assigned to the component, the button's tooltip shows the parameter name. Clicking the button displays a [Connect Parameter To Shader dialog](#) on page 5981, which lets you change which parameter is being used.

IMPORTANT [UV Coordinates](#) on page 6013 and [XYZ Coordinates](#) on page 6017 are the only shaders with multiple return values provided with 3ds Max. You might encounter multiple return values in shaders provided with other shader libraries or custom shader code.

Glare Shader (mental ray)

Render Setup dialog > Renderer panel > Camera Effects rollout > Camera Shaders group > Click the Output button. > Material/Map Browser > Glare

The Glare shader, when used as a [camera output shader](#) on page 6289, creates a halo around very bright areas in the rendered image. It's applied in two dimensions after rendering, so it can partially obscure darker objects between the bright area and the camera for greater realism.

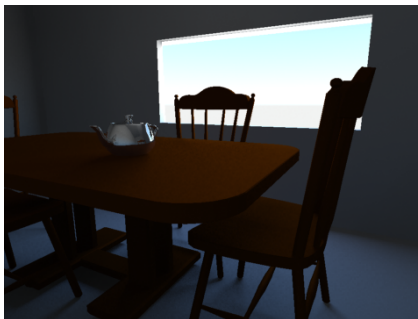

Interior lit by mr Sky Portal; no glare



Interior with Glare shader for output; default Glare settings

NOTE The glare effect from this shader is intended purely for illustrative purposes. It is not designed to be physically accurate and is not suited for precise simulation purposes.

Procedure

To use the Glare shader:

Using and adjusting the Glare output shader requires first assigning it on the Render Setup dialog, and then instancing it in the Material Editor. This procedure delineates the steps for doing so.

- 1 Make sure mental ray is the assigned renderer.
- 2 Open the Render Setup dialog (press F10), and on the Renderer panel, go to the Camera Effects rollout.
- 3 On the Camera Effects rollout, click the Output button (labeled “None” by default).
This opens the Material/Map Browser dialog.
- 4 In the shader list, double-click the Glare entry.
This assigns the shader and closes the browser.
- 5 Render the scene.
If the results are satisfactory, you can stop here. The remaining steps concern adjusting the shader settings.
- 6 Open the Material Editor (press M), and, if necessary, the Render Setup dialog.
- 7 Drag the Output button from the Camera Shaders group on the Render Setup dialog to a sample slot on the Material Editor. When the Instance (Copy) Map dialog prompts you, choose Instance, if necessary, and click OK.
This places an instance of the Glare shader in the sample slot. Editing this instance also modifies the output shader you originally assigned.
- 8 Adjust the Glare Parameters as necessary, rendering as you go to view the results.

Interface

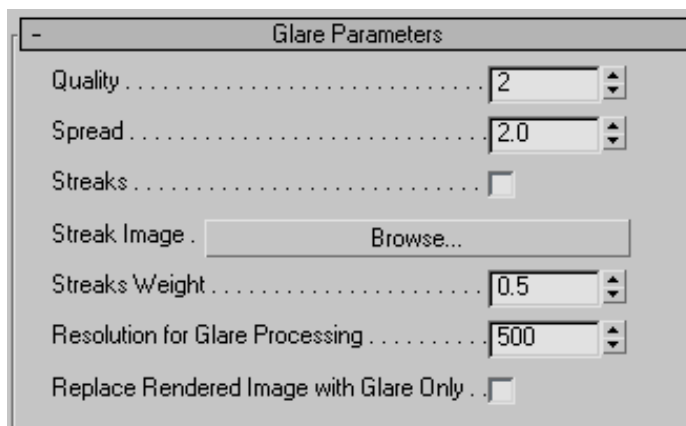

Quality Lets you set the tradeoff between detail and speed. Lower Quality settings cause Glare to run more quickly, but can result in a boxy-looking glare halo, while a higher Quality value gives a better overall effect at the cost of rendering time. A mid-level setting is appropriate for most scenes.

Spread Controls how sensitive Glare is to bright objects. Lower values for Spread produce smaller glare halos while higher values cause larger glare halos. Very high values can cause dark objects to have halos.

TIP The best way to enlarge an object's halo is to increase its brightness, not to increase the Spread value.

Streaks When on, uses an image file you specify to create a streaking effect, such as is visible when looking at bright images through glass or, in photographs, through a camera lens.

Streak Image Click to choose an image file to be used to create the streak effect. This file takes effect only when Streaks is on.

Streaks Weight Controls the blending between the "normal" glare and the streaks image. A value of 0.0 disables streaks, while a value of 1.0 makes the streaks fully visible.

Resolution for Glare Processing An absolute value specifying the image size, in pixels, on which the Glare computation occurs. If you image is rendered at 5000 x 5000 and Resolution for Glare Processing is set to 350, Glare will effectively compute on a 350 x 350 image internally and reapplied on the final image, possibly resulting in an inadequate glare effect.

Replace Rendered Image with Glare Only Generates an overlay image of the glare effect only; the original underlying image is removed. This mode is useful when render speed is critical, so that Glare can be run on a lower-resolution image to produce an overlay, which you can then composite with a higher-resolution underlying image.

Height Map Displacement Shader (mental ray)

Material Editor > mental ray Connection rollout > For the Displacement component, turn off the lock button. > Click the button for the Displacement component. > Material/Map Browser > Height Map Displacement (3dsmax)

Material Editor > mental ray material > Click the button for the Displacement component. > Material/Map Browser > Height Map Displacement (3dsmax)

Note: Shaders don't appear unless the mental ray renderer is the currently active renderer.

The Height Map Displacement shader displaces the geometry of surfaces, and is specifically intended for use with height maps generated by normal mapping; see [Creating and Using Normal Bump Maps](#) on page 6384.

IMPORTANT When applying a material containing this map to an object, the mental ray Displacement > Smoothing option must be off. If such materials are applied to *all* objects in the scene, you can [turn off Smoothing globally](#) on page 6294. Otherwise, turn off smoothing for each object whose material uses a height map via the Object Properties > [mental ray panel](#) on page 322 (turn off Use Global Settings and then turn off Smoothing).

TIP Avoid the temptation to apply MeshSmooth to a model when creating a height map for it. This changes the shape of the model so the height values will not be correct. The low-res model must have exactly the same shape when the map is created and when it is used for displacement. Also, MeshSmooth does not use the same algorithm as the mental ray displacement smoothing, so using both forms of smoothing won't work perfectly. The best results are obtained by not smoothing the low-res model when the map is created and also not using mental ray smoothing.

Also, avoid using a paint program to modify the height map. The values in the height map depend on the shape of both the low-res and high-res models, and it's easy to damage the mathematical accuracy. If you paint any changes onto the map, you must be careful to preserve the faceted look, and avoid the temptation to blur away the facets.

You might try painting in Additive and Subtractive mode to add or subtract to the displacement, because Normal mode will set a fixed displacement, making it difficult for an artist to control the result.

See also:

- [3D Displacement Shader \(mental ray\)](#) on page 5983
- [mental ray Displacement](#) on page 6268
- [mental ray Connection Rollout](#) on page 5385
- [mental ray Material](#) on page 5638

Interface

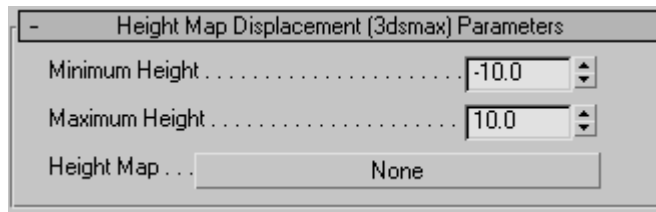

Height Map Displacement (3dsmax) Parameters rollout

Be sure to enter the same values for Minimum and Maximum Height as the equivalents on the Projection Options dialog, as specified below.

Minimum Height The “Min Height” value specified on the [Render to Texture: Projection Options dialog](#) on page 6416 when creating the height map. Default=-10.0.

Maximum Height The “Max Height” value specified on the [Render to Texture: Projection Options dialog](#) on page 6416 when creating the height map. Default=10.0.

Height Map The height map itself (usually a bitmap).

Material to Shader (mental ray)

Material Editor > mental ray Connection rollout > Assign a shader. > Material/Map Browser > Material to Shader

Material Editor > mental ray or DGS material > Assign a shader. > Material/Map Browser > Material to Shader

Note: Shaders appear in the Browser only if the mental ray renderer is the currently active renderer.

Lets you use a regular 3ds Max material as a shader. Depending on the component to which this shader is assigned (Surface, Shadow, Displacement, Volume, and so on), the mental ray renderer uses the appropriate material component.

For example, if you want a mental ray material's Surface component to look like a standard material you have, assign Material To Shader as the Surface shader, and then assign it the standard material.

NOTE Material To Shader doesn't work as an environment background. Use the original 3ds Max material, instead.

TIP To edit the material assigned to Material To Shader, you can drag the button to an unused sample slot in the Material Editor (be sure to choose Instance when prompted). Or you can follow these steps:

- 1 In an unused sample slot, create the material and adjust its settings.
- 2 Save the material to a library.
- 3 Assign the Material To Shader to its component.
- 4 When you click the Material To Shader's shader button, browse from the library and load the material you prepared in advance.

If you need to further adjust the material, you can repeat these steps (without having to reassign the Material To Shader).

Interface

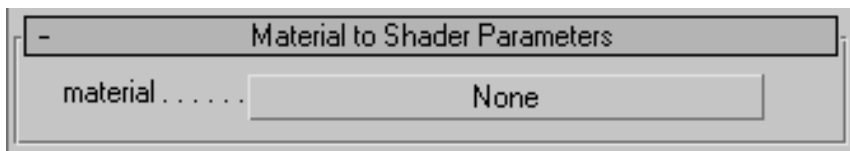

Material button Click to display the [Material/Map Browser](#) on page 5290 and choose the material to use for shading.



mr Labeled Element Shader (mental ray)

Material Editor > any material > Click a map button > Material/Map Browser > mr Labeled Element

Note: Shaders appear in the Browser only if the mental ray renderer is the currently active renderer.

The mr Labeled Element shader doesn't actually function as a shader, but instead works in conjunction with the [mr Labeled Element render element](#) on page 6363 to let you output any branch of a shader tree (a string of nested maps) as a render element. For example, if you use the Checker map as a diffuse map, and you use a Perlin Marble map as one of the two checker colors, you can render only the checker-map components that contain the marble map to a custom element for subsequent compositing.

For details on using the mr Labeled Element shader, see [To use the mr Labeled element](#): on page 6363.

Interface

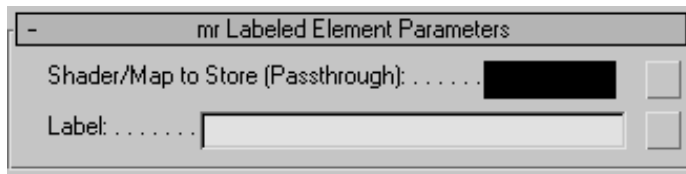

Shader/Map to Store (Passthrough) Click the map button to assign a shader or map or shader/map branch to be passed to the render element. If a shader or map is already assigned, the button is labeled “M”; click the button to edit the shader or map.

Label Enter the same name as that assigned to the render element.

Shader List (mental ray)

Material Editor > mental ray Connection rollout > Assign a shader. > Material/Map Browser > Shader List

Material Editor > mental ray, DGS, or Glass material > Assign a shader. > Material/Map Browser > Shader List

Note: Shaders appear in the Browser only if the mental ray renderer is the currently active renderer.

The Shader List shader provides an interface for constructing a mental ray shader list. A shader list combines the effect of multiple shaders: each shader is called in turn, the first one's output being treated as input to the next, and so on.

Interface

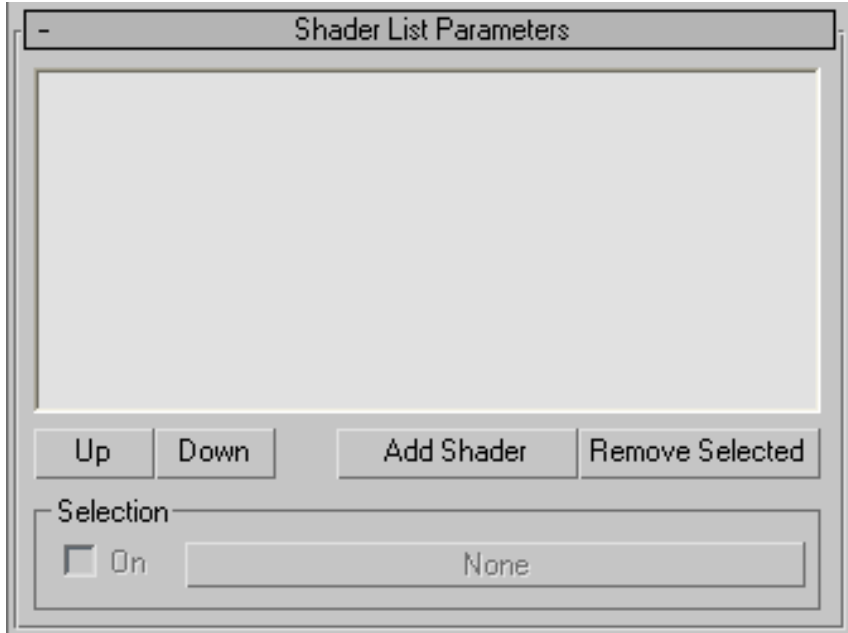

List of shaders Shows the names of the shaders in the list. Highlight a shader's name to alter its position in the list, or to access its parameters.

Each active shader in the list is called in order, from top to bottom.

Up Moves the selected shader up in the list.

Down Moves the selected shader down in the list.

Add Shader Displays a [Material/Map Browser](#) on page 5290 so you can choose a shader to add to the list.

Remove Selected Removes the selected shader from the list.

Selection group

On When on, the shader is active. When off, the shader is inactive and isn't called. You can use this toggle to disable a shader without removing it from the list entirely.

Shader button Shows the name of the currently selected shader. Click the button to view that shader's parameters in the Material Editor.



When you are done adjusting an individual shader's parameters, you can click Go To Parent to return to the Shader List Parameters rollout.

UV Generator Shader (mental ray)

Material Editor > Any shader with a Coords parameter (or other vector value).
> Click the shader button. > Material/Map Browser > UV Generator (3dsmax)

Material Editor > mental ray Connection rollout > Unlock the Surface component and click the shader button. > Material/Map Browser > UV Generator (3dsmax)

Material Editor > DGS material > Assign a shader to any component. > Material/Map Browser > UV Generator (3dsmax)

Note: Shaders appear in the Browser only if the mental ray renderer is the currently active renderer.

The UV Generator shader returns 2D mapping coordinates. You can use its settings to adjust a 2D map. The parameters for this shader are equivalent to parameters on the [Coordinates rollout for 2D maps](#) on page 5782.

Interface

The interface for this shader consists of two rollouts:

[UV Generator Parameters Rollout](#) on page 6006

[Shaders Rollout \(UV Generator\)](#) on page 6010

UV Generator Parameters Rollout

Material Editor > Any shader with a Coords parameter (or other vector value).
> Click the shader button. > Material/Map Browser > UV Generator (3dsmax)
> UV Generator (3dsmax) Parameters rollout

Material Editor > mental ray Connection rollout > Unlock the Surface
component and click the shader button. > Material/Map Browser > UV
Generator (3dsmax) > UV Generator (3dsmax) Parameters rollout

Material Editor > DGS material > Assign a shader to any component. >
Material/Map Browser > UV Generator (3dsmax) > UV Generator (3dsmax)
Parameters rollout

Note: Shaders appear in the Browser only if the mental ray renderer is the
currently active renderer.

The parameters for this shader are equivalent to parameters on the [Coordinates
rollout for 2D maps](#) on page 5782.

Interface

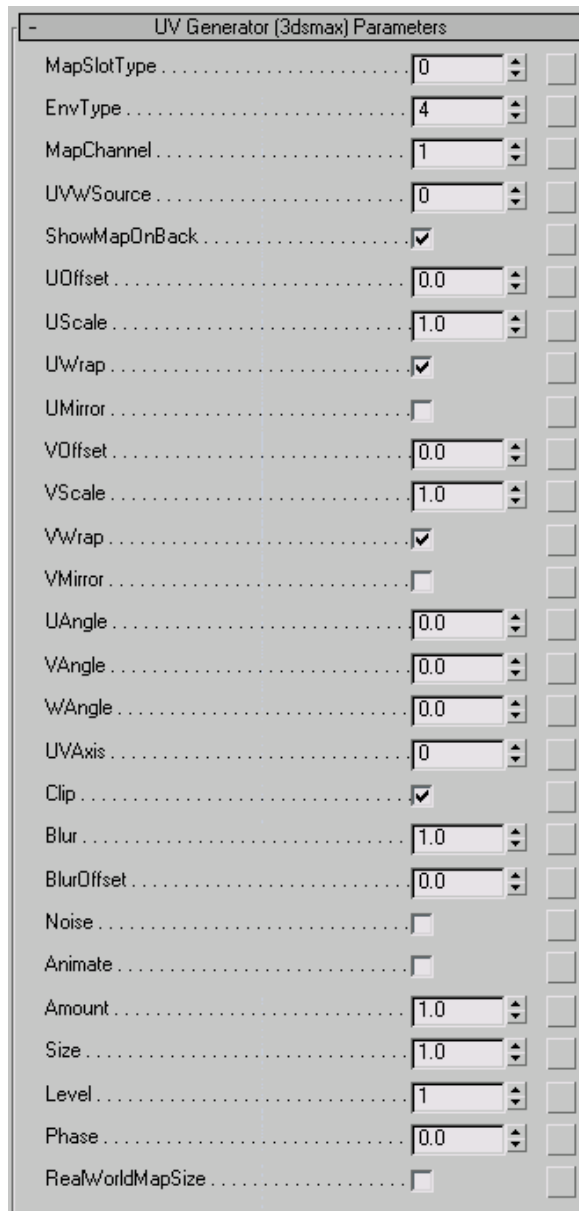

MapSlotType Chooses whether the map is applied as an environment map or a texture map. Default=0 (Texture).

- 0 is for a Texture map.
- 1 is for an Environment map.

EnvType If the map is applied as an environment map, this value chooses the mapping type. If the map is applied as a texture map, this value is ignored. Default=4 (screen).

- 1 is for Spherical.
- 2 is for Cylindrical.
- 3 is for Shrink-Wrap.
- 4 is for Screen.

Screen projection projects as a flat backdrop in the scene. See [UVW Map Modifier](#) on page 1931 for a description of spherical, cylindrical, and shrink-wrap projection.

MapChannel If the map is applied as a texture map and UVWSource is set to 0 (Explicit), this value sets the map channel index; otherwise, this value is ignored. Range=1 to 99. Default=1.

UVWSource If the map is applied as a texture map, this value chooses the source of UVW coordinates. If the map is applied as an environment map, this value is ignored. Default=0 (Explicit).

- 0 is for Explicit.
When Explicit is the source, use MapChannel to set the specific map channel.
- 1 is for Object XYZ.
Object XYZ uses planar mapping based on the object's local coordinates (disregarding the pivot point location). For rendering purposes, planar mapping doesn't project through to the back of the object unless you turn on ShowMapOnBack.
- 2 is for World XYZ.
World XYZ uses planar mapping based on the scene's world coordinates (disregarding the object's bounding box). For rendering purposes, planar mapping doesn't project through to the back of the object unless you turn on ShowMapOnBack.

ShowMapOnBack When on, planar mapping (Planar from Object XYZ, or with the UVW Map modifier) projects through to render on the back of the object. When off, planar mapping doesn't render on the object's back. Default=on.

This toggle is available only when Tiling is off in both dimensions. Its effect is visible only when you render the scene.

NOTE In viewports, planar mapping always projects to the back of the object, whether Show Map On Back is turned on or not. To override this, turn off Tiling.

UOffset Changes the U position of the map in [UV coordinates](#) on page 8161. The map moves in relation to its size. Default=0.0.

For example, if you want to shift the map its full width to the left, and half its width downward from its original position, you enter -1 in the U Offset field and 0.5 in the V offset field.

UScale Determines the number of times the map is [tiled](#) on page 8148 (repeated) along the U axis. Default=1.0.

UWrap Turns tiling on or off in the U axis. Default=on.

UMirror [Mirrors](#) on page 8148 the map left-to-right along the U axis. Default=off.

VOffset Changes the V position of the map in UV coordinates. Default=0.0.

VScale Determines the number of times the map is tiled (repeated) along the V axis. Default=1.0.

VWrap Turns tiling on or off in the V axis. Default=on.

VMirror Mirrors the map top-to-bottom along the V axis. Default=off.

UAngle, VAngle, and WAngle Rotate the map about the U, V, or W axis (in degrees). Default=0.0.

UVAxis Changes the mapping coordinate system used for the map. The default UV coordinates project the map onto the surface like a slide projector. The VW and WU coordinates rotate the map so that it is perpendicular to the surface. Default=0 (UV).

- 0 is for UV.
- 1 is for VW.
- 2 is for WU.

Clip When on, UVs are clipped. When off, UVs are wrapped. Default=on.

Blur Affects the sharpness or blurriness of the map based on its distance from the view. The farther away the map is, the greater the blurring. The Blur value blurs maps in world space. Blur is primarily used to avoid [aliasing](#) on page 7904. Default=1.0.

BlurOffset Affects the sharpness or blurriness of the map without regard to its distance from the view. Blur Offset blurs the image itself in object space. Use this option when you want to soften or defocus the details in a map to achieve the effect of a blurred image. See [Blur / Blur Offset](#) on page 7928. Default=0.0

Noise When on, noise settings affect the map. When off, no noise is applied. Default=off.

Animate Determines if the noise effect is animated. This parameter must be turned on if you intend to animate the noise. Default=off.

Amount Sets the strength of the fractal function, expressed as a percentage. If the amount is 0 there is no noise. If the amount is 100 the map becomes pure noise. Default=1.0.

Size Sets the scale of the noise function relative to geometry. At very small values, the noise effect becomes white noise. At large values, the scale can exceed the scale of the geometry, in which case it has little or no effect. Range=0.001 to 100. Default=1.0.

Level Or iterations: the number of times the function is applied. The effect of the level is dependent on the Amount value. The stronger the amount, the greater the effect of increasing the Level value. Range=1 to 10. Default=1.

Phase Controls the speed of the animation of the noise function. Default=0.0.

RealWorldMapSize Controls the scaling method used for texture mapped materials that are applied to the object. The scaling values are controlled by the Use Real-World Scale settings found on the applied material's Coordinates rollout. Default=on.

Shaders Rollout (UV Generator)

Material Editor > Any shader with a Coords parameter (or other vector value).
> Click the shader button. > Material/Map Browser > UV Generator (3dsmax)
> Shaders rollout

Material Editor > mental ray Connection rollout > Unlock the Surface component and click the shader button. > Material/Map Browser > UV Generator (3dsmax) > Shaders rollout

Material Editor > DGS material > Assign a shader to any component. > Material/Map Browser > UV Generator (3dsmax) > Shaders rollout

Note: Shaders appear in the Browser only if the mental ray renderer is the currently active renderer.

The controls on this rollout let you assign a map or shader to one of the basic parameters of the UV Generator shader. This is comparable to mapping a component of a standard material; by adding shaders, you can create a shader tree that generates complex effects.

Interface

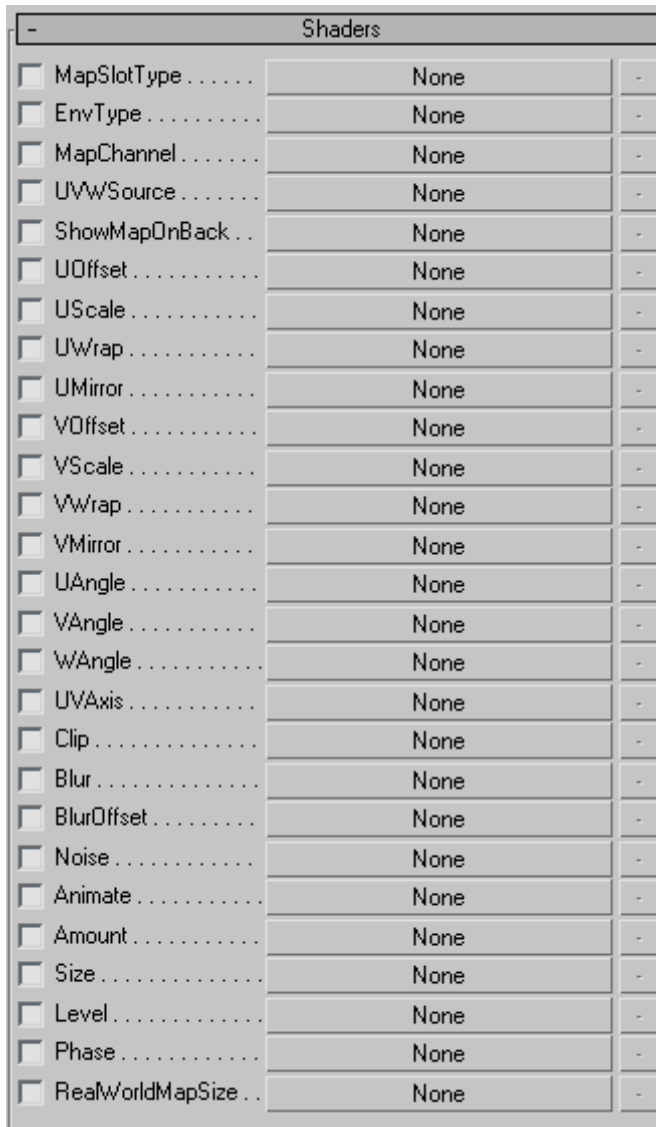

 The button to the right of each main shader button is for shaders that can return multiple parameters. If a shader that returns multiple parameters is assigned to the component, the button's tooltip shows the parameter name.

Clicking the button displays a [Connect Parameter To Shader dialog](#) on page 5981, which lets you change which parameter is being used.

IMPORTANT [UV Coordinates](#) on page 6013 and [XYZ Coordinates](#) on page 6017 are the only shaders with multiple return values provided with 3ds Max. You might encounter multiple return values in shaders provided with other shader libraries or custom shader code.

UV Coordinate Shader (mental ray)

Material Editor > Any shader with a Coords parameter or other vector value.
> Click the shader button. > Material/Map Browser > UV Coordinate (3dsmax)

Note: Shaders appear in the Browser only if the mental ray renderer is the currently active renderer.

This shader is identical to the [UV Generator shader](#) on page 6005, except that it returns two values instead of one.

- The UV coordinate (same value as UV Generator would return)
This value is named UV.
- The UV coordinate's derivative
This value, also a vector, is named dUV.

When you choose this shader, a [Connect Parameter To Shader dialog](#) on page 5981 is displayed, prompting you to choose which of the two values to use. You can later change the choice of value by using the “dot” button to the right of the main shader button.

Interface

The UV Coordinate shader has the same parameters as the UV Generator shader. See [UV Generator Parameters Rollout](#) on page 6006 for a description of the basic settings.

XYZ Generator Shader (mental ray)

Material Editor > Any shader with a Coords parameter (or other vector value).
> Click the shader button. > Material/Map Browser > XYZ Generator (3dsmax)

Material Editor > mental ray Connection rollout > Unlock the Surface component and click the shader button. > Material/Map Browser > XYZ Generator (3dsmax)

Material Editor > DGS material > Assign a shader to any component. > Material/Map Browser > XYZ Generator (3dsmax)

Note: Shaders appear in the Browser only if the mental ray renderer is the currently active renderer.

The XYZ Generator shader returns 3D mapping coordinates. You can use its settings to adjust a 3D map. The parameters for this shader are equivalent to parameters on the [Coordinates rollout for 3D maps](#) on page 5861.

Interface

The interface for this shader consists of two rollouts:

[XYZ Generator Parameters Rollout](#) on page 6014

[Shaders Rollout \(XYZ Generator\)](#) on page 6016

XYZ Generator Parameters Rollout

Material Editor > Any shader with a Coords parameter (or other vector value). > Click the shader button. > Material/Map Browser > XYZ Generator (3dsmax) > XYZ Generator (3dsmax) Parameters rollout

Material Editor > mental ray Connection rollout > Unlock the Surface component and click the shader button. > Material/Map Browser > XYZ Generator (3dsmax) > XYZ Generator (3dsmax) Parameters rollout

Material Editor > DGS material > Assign a shader to any component. > Material/Map Browser > XYZ Generator (3dsmax) > XYZ Generator (3dsmax) Parameters rollout

Note: Shaders appear in the Browser only if the mental ray renderer is the currently active renderer.

The parameters for this shader are equivalent to parameters on the [Coordinates rollout for 3D maps](#) on page 5861.

Interface

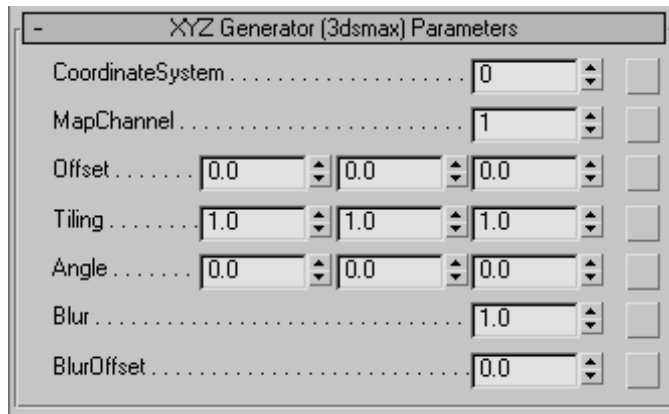

CoordinateSystem Chooses the source coordinate system. Default=0 (Object XYZ).

- 0 is for Object XYZ.
Object XYZ uses the object's local coordinate system.
- 1 is for Explicit Map Channel.
Lets you use the MapChannel value to choose any channel from 1 to 99.
- 3 is for World XYZ.

MapChannel When Explicit Map Channel is the coordinate system source, this value lets you set the map channel; otherwise, it is ignored. Range=1 to 99. Default=1.

Offset Moves the map pattern in X, Y, and Z. Default=(0.0, 0.0, 0.0).

Tiling [Tiles](#) on page 8148 the map pattern in X, Y, and Z, and makes the pattern narrower. Default=(1.0, 1.0, 1.0).

Angle Rotates the map pattern in X, Y, and Z. Default=(0.0, 0.0, 0.0).

Blur Affects the sharpness or blurriness of the map based on its distance from the view. The farther away the map is, the greater the blurring. The Blur value blurs maps in world space. Blur is primarily used to avoid aliasing. Default=1.0.

BlurOffset Affects the sharpness or blurriness of the map without regard to its distance from the view. Blur Offset blurs the image itself in object space. Use when you want to soften or defocus the details in a map to achieve the effect of a blurred image. Default=0.0.

Shaders Rollout (XYZ Generator)

Material Editor > Any shader with a Coords parameter (or other vector value).
> Click the shader button. > Material/Map Browser > XYZ Generator (3dsmax)
> Shaders rollout

Material Editor > mental ray Connection rollout > Unlock the Surface
component and click the shader button. > Material/Map Browser > XYZ
Generator (3dsmax) > Shaders rollout

Material Editor > DGS material > Assign a shader to any component. >
Material/Map Browser > XYZ Generator (3dsmax) > Shaders rollout

Note: Shaders appear in the Browser only if the mental ray renderer is the
currently active renderer.

The controls on this rollout let you assign a map or shader to one of the basic
parameters of the XYZ Generator shader. This is comparable to mapping a
component of a standard material; by adding shaders, you can create a shader
tree that generates complex effects.

Interface

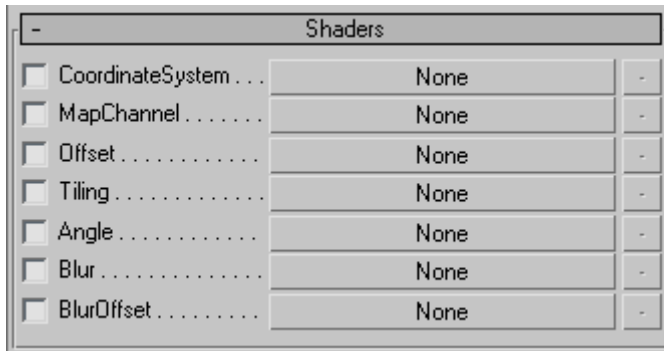

 The button to the right of each main shader button is for shaders that
can return multiple parameters. If a shader that returns multiple parameters
is assigned to the component, the button's tooltip shows the parameter name.
Clicking the button displays a [Connect Parameter To Shader dialog](#) on page
5981, which lets you change which parameter is being used.

IMPORTANT [UV Coordinates](#) on page 6013 and [XYZ Coordinates](#) on page 6017 are the only shaders with multiple return values provided with 3ds Max. You might encounter multiple return values in shaders provided with other shader libraries or custom shader code.

XYZ Coordinate Shader (mental ray)

Material Editor > Any shader with a Coords parameter or other vector value.
> Click the shader button. > Material/Map Browser > XYZ Coordinate (3dsmax)

Note: Shaders appear in the Browser only if the mental ray renderer is the currently active renderer.

This shader is identical to the [XYZ Generator shader](#) on page 6013, except that it returns two values instead of one.

- The XYZ coordinate (same value as XYZ Generator would return)
This value is named XYZ.
- The XYZ coordinate's derivative
This value, also a vector, is named dXYZ.

When you choose this shader, a [Connect Parameter To Shader dialog](#) on page 5981 is displayed, prompting you to choose which of the two values to use. You can later change the choice of value by using the “dot” button to the right of the main shader button.

Interface

The XYZ Coordinate shader has the same parameters as the XYZ Generator shader. See [XYZ Generator Parameters Rollout](#) on page 6014 for a description of the basic settings.



Production Shaders

The Production Shaders category of advanced mental ray shaders comprises several texture shaders, a lens shader, and two output shaders, all covered in this section. Also part of the Production Shaders library is the [Matte/Shadow/Reflection material](#) on page 5622.

Texture Shaders



Environment/Background Switcher (mi)

Environment and Effects dialog > Click Environment Map button. > Material/Map Browser > Environment/Background Switcher (mi)

NOTE Shaders appear in the Browser only if the mental ray renderer is the currently active renderer.

The Environment/Background Switcher map lets you use one map as a background and another as an environment map, to provide environmental reflections.

In typical usage, you use the Environment/Background Switcher as an Environment map. As the Background map you apply a background image, preferably using the [Environment/Background Camera Map \(mi\)](#) on page 6020 shader.

As the Environment/Reflections map, use an environment map. If you have a plain photograph of a chrome ball taken from a similar camera angle as the background, you can use [Environment Probe/Chrome Ball \(mi\)](#) on page 6023 shader for easy, automatic unwrapping, or, if you have a fully unwrapped environment-map image, use a Bitmap map in Spherical Environment mode.

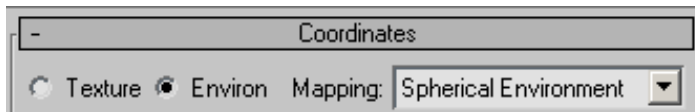

For details, see the following procedure.

NOTE While the Environment/Background Switcher is most commonly used as an environment map, it can be used in other places as well. It will use the Background result for anything that is seen *directly* by the camera, and the Environment/Reflection for anything seen *indirectly*, as in reflections, refractions, etc.

Procedure

To use the Environment/Background Switcher map:

This procedure assumes you have two photographs: one of a background, and another an image of a mirror/chrome ball, both taken from roughly the same camera position. The photo of the chrome ball should be cropped so that it exactly touches the edges of the ball. The best result is obtained if at least the chrome ball photo is HDR, but good results can be achieved with a traditional, non-HDR photograph.

NOTE This workflow applies to stills or video sequences with only slight camera movement. For any complex fly-around camera motion, the simple "auto-unwrapping" performed by the Environment Probe/Chrome Ball shader will not suffice.

- 1 Open the Environment And Effects dialog to the [Environment panel](#) on page 6689.
- 2 On the Common Parameters rollout, click the Environment Map button. This opens the Material/Map Browser.
- 3 From the browser list, choose Environment/Background Switcher (mi). The Environment Map button label now shows the name of the map.
- 4 Open the Material Editor.
- 5 Drag the Environment Map button to a sample sphere in the Material Editor. Confirm the Instance choice.
This displays the Environment/Background Switcher (mi) Parameters rollout in the Material Editor.
- 6 Click the Background map button. From the Material/Map Browser, choose a map; [Environment/Background Camera Map \(mi\)](#) on page 6020 is the recommended choice.
This displays the map's parameters rollout. Click the Map button ("Browse") and choose a bitmap file for the background image.
- 7  Click Go To Parent to return to the Switcher controls.
- 8 Click the Environment/Reflections map button. From the Material/Map Browser, choose a map; [Environment Probe/Chrome Ball \(mi\)](#) on page 6023 is the recommended choice.

This displays the map's parameters rollout. Click the Map button ("Browse") and choose a bitmap file for the background image. Ideally, the bitmap is an HDR photograph of a chrome or mirror ball taken from the camera perspective in the scene, but a non-HDR photo also works well.

Or, if you have a fully unwrapped environment map photo, use it as a Bitmap map and, on the Coordinates rollout, choose Environ and set Mapping to Spherical Environment.

- 9 Adjust the various maps' parameters as necessary and then render the scene.

Interface

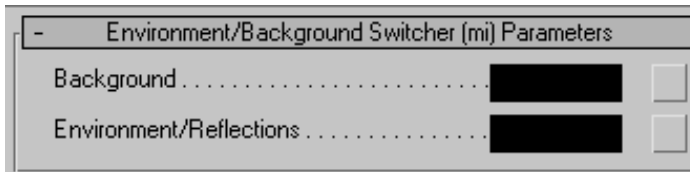

Background Specifies the background color or map. The background shows up wherever it is not blocked by a foreground object, or transmitted by a transparent object.

Environment/Reflections Specifies the environment color or map. This image or color shows up in reflective surfaces.



Environment/Background Camera Map (mi)

Material Editor > Click any map button. > Material/Map Browser > Environment/Background Camera Map (mi)

NOTE Shaders appear in the Browser only if the mental ray renderer is the currently active renderer.

This shader is similar in function to using a Bitmap map with environment mapping set to Screen as an Environment Map. However, Screen mapping simply chooses a pixel from the map based on the coordinates of the currently rendered pixel. This does not work well with reflections.

In contrast, the Environment/Background Camera Map shader correctly renders "back transformation." In other words, for a point seen in a reflection, it takes the reflected point's 3D coordinate, convert it to its matching onscreen position (if any), and looks up the map based on this new 2D location (or returns a special value if the point is offscreen).

Back Transformation

In the following discussion of back transformation in the context of the Environment/Background Camera Map, refer to this illustration:

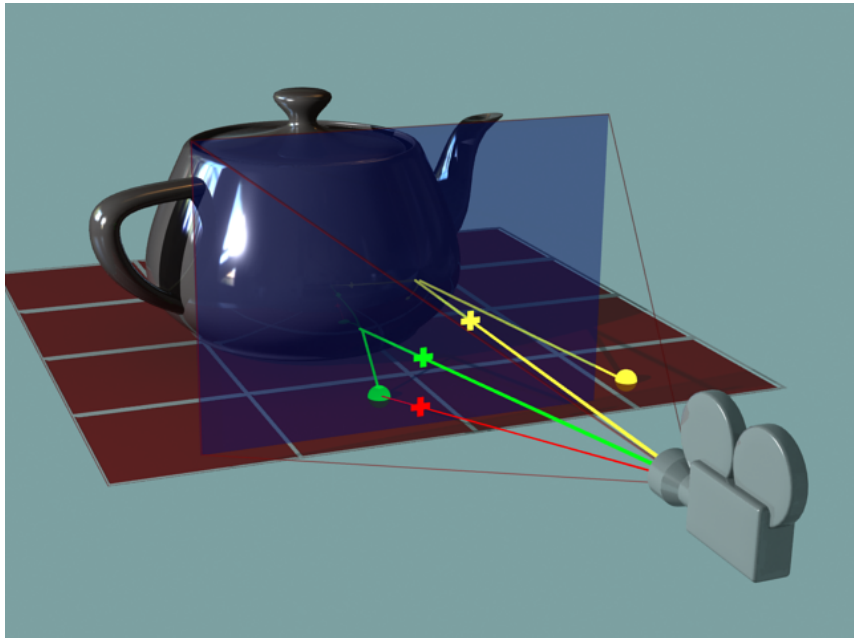

Imagine the green ray coming from the camera hitting the screen (blue rectangle) at the green "+". Using the Bitmap map set to Screen environment mapping mode as the Environment Map, the background-image location corresponding to this screen coordinate will be used for anything that happens to this ray. Even when it hits the teapot and bounces to the floor (green dot), this would be still be textured with the texture background pixel from the green "+" location.

In contrast, the Environment/Background Camera Map shader would transform the point (green dot) to a new screen coordinate (imaginary red ray) and use the value from the red "+" instead.

The yellow ray, however, hits the reflective object at some other location, and its reflected location (yellow dot) is outside the screen. For these cases, the shader would use its Off-screen settings.

Interface

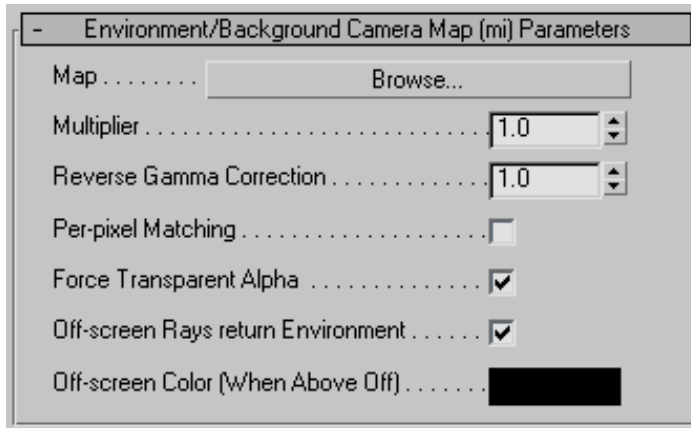

Map Click the Browse button to specify a bitmap file containing the background image. Alternatively, click the map button to specify a procedural map.

Multiplier A multiplier for the background image.

Reverse Gamma Correction Applies inverse gamma correction to the texture.

Per-Pixel Matching Matches the image to the background on a pixel-per-pixel basis, with the bottom-left pixel of the map matched exactly to the bottom-left rendered pixel. If the pixel size of the map differs from the pixel size of the rendered output, the renderer issues a warning. However, it still renders the image, cropping or padding it as necessary.

Force Transparent Alpha When on, forces the background alpha to 0. When off, mental ray uses the actual alpha from the bitmap image or procedural map. If the file contains no alpha data, returns opaque alpha values when off.

Off-screen Rays return Environment When on, uses the scene environment for off-screen points.

Because the shader back-transforms points such as those seen in reflections into screen space, it might happen that parts of surfaces reflect points that are not on the screen. Because the projected map contains data only for points on the screen, this option allows a reasonable alternative for off-screen points.

Off-screen Color (When Above Off) Defines the color of off-screen points when Off-Screen Rays Return Environment (see previous) is off.



Environment Probe/Chrome Ball (mi)

Material Editor > Click any map button. > Material/Map Browser > Environment Probe/Chrome Ball (mi)

NOTE Shaders appear in the Browser only if the mental ray renderer is the currently active renderer.

This shader is intended as an environment shader (apply as an Environment Map), because it looks up based on the ray direction. It maps the proper direction to a point on the chrome ball and retrieves its color.

In the visual effects industry it is common practice to photograph a chrome ball (also known as a “light probe”) on set, as well as a [gray ball](#) on page 6024 for lighting reference.

Ideally, one shoots these at multiple exposures and uses software such as Photosphere (Macintosh) or HDRShop (PC) to combine them into a single high-dynamic-range image and/or unwrap the chrome/gray ball into a spherical environment map.

However, it is often difficult to regain the proper orientation of spherical map so it matches the camera used to render the CG scene. Furthermore, a single photo of a chrome/gray ball contains poor data for certain angles that one might want to avoid seeing in the final render.

These shaders are intended to simplify a special case: When the chrome/gray ball is already shot from the exact camera angle from which the final image is to be rendered.

It simply utilizes the mental ray camera coordinate space and applies the chrome/gray ball in this space, hence the orientation of the reflections will always “stick” to the rendering camera.

For additional information and illustrations, see Help menu > Additional Help > mr Production Shader Library > Chapter 6: Mirror/Gray Ball Shaders.

Interface

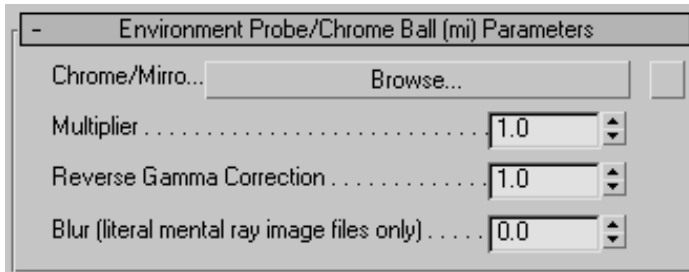

Chrome/Mirror Ball Image Click the Browse button to specify the file containing the chrome ball image. The image should be cropped so the ball exactly touches the edges of the image. Alternatively, click the map button to specify a procedural map.

Multiplier A multiplier for the chrome ball image.

Reverse Gamma Correction Applies an inverse gamma correction to the texture.

Blur (literal mental ray image files only) Blur the image. This applies only to literal mental ray textures; that is, bitmap images specified with the Browse button, rather than maps specified with the map button.



Environment Probe/Gray Ball (mi)

Material Editor > Click any map button. > Material/Map Browser > Environment Probe/Gray Ball (mi)

NOTE Shaders appear in the Browser only if the mental ray renderer is the currently active renderer.

This shader can be used either as an environment shader or a texture shader, because it looks up based on the direction of the surface normal. It will map the normal vector direction to a point on the gray ball and retrieve its color.

In the visual effects industry it is common practice to photograph a [chrome ball](#) on page 6023 (also known as a “light probe”) on set, as well as a gray ball for lighting reference.

Ideally, one shoots these at multiple exposures and uses software such as Photosphere (Macintosh) or HDRShop (PC) to combine these into a single

high-dynamic-range image and/or unwrap the chrome/gray ball into a spherical environment map.

However, it is often difficult to regain the proper orientation of spherical map so it matches the camera used to render the CG scene. Furthermore, a single photo of a chrome/gray ball contains poor data for certain angles that one might want to avoid seeing in the final render.

These shaders are intended to simplify a special case: When the chrome/gray ball is already shot from the exact camera angle from which the final image is to be rendered.

It simply utilizes the mental ray camera coordinate space and applies the chrome/gray ball in this space, hence the orientation of the reflections will always “stick” to the rendering camera.

For additional information and illustrations, see Help menu > Additional Help > mr Production Shader Library > Chapter 6: Mirror/Gray Ball Shaders.

Interface

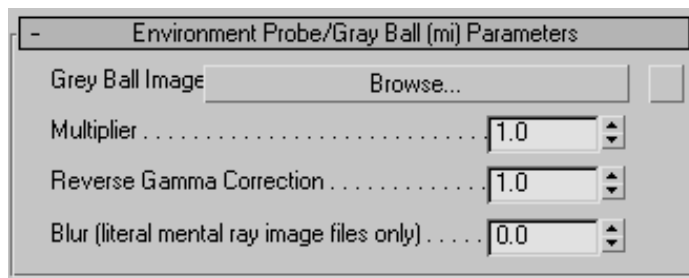

Chrome/Mirror Ball Image Click the Browse button to specify the file containing the gray ball image. The image should be cropped so the ball exactly touches the edges of the image. Alternatively, click the map button to specify a procedural map.

Multiplier A multiplier for the gray ball image.

Reverse Gamma Correction Applies an inverse gamma correction to the texture.

Blur (literal mental ray image files only) Blur the image. This applies only to literal mental ray textures; that is, bitmap images specified with the Browse button, rather than maps specified with the map button.



Utility Gamma & Gain (mi)

Material Editor > Click any map button. > Material/Map Browser > Utility Gamma & Gain (mi)

NOTE Shaders appear in the Browser only if the mental ray renderer is the currently active renderer.

This is a simple shader that applies a gamma and a gain (multiplication) of a color or map. Many similar shaders exist in various OEM integrations of mental ray, so this shader is primarily of interest for standalone mental ray and for cross-platform phenomena development.

The shader can also be used as a simple gamma lens shader, in which case the input is not used, but the eye ray color is used instead.

Interface

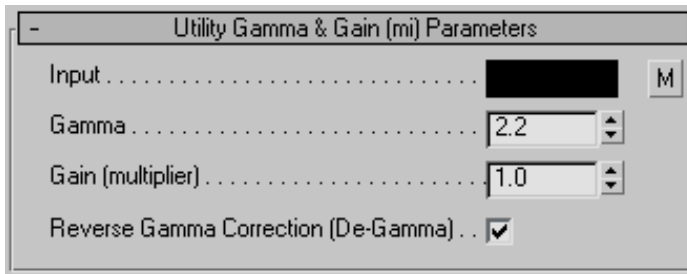

Input Specifies the input color or map.

Gamma The gamma applied to the input.

Gain (multiplier) The multiplier for the input.

Reverse Gamma Correction (De-Gamma) When off, the shader takes the input, multiplies it by the Gain value, and then applies a gamma correction of Gamma to the color. When on, the shader takes the input, applies a reverse gamma correction of Gamma to the color, and then divides it by the Gain value.

Lens Shader



Render Subset of Scene/Masking (mi)

Render Setup dialog > Renderer panel > Camera Effects rollout > Camera Shaders group > Lens button > Material/Map Browser > Render Subset of Scene/Masking (mi)

NOTE Shaders appear in the Browser only if the mental ray renderer is the currently active renderer.

This shader allows re-rendering a subset of the objects in a scene, defined by object or material. It is intended for a “quick fix” solution when almost everything in a scene is perfect, but just one object or material needs a small tweak.

NOTE This shader works for first-generation rays only. Thus, for example, refracted or reflected rays from an object do not show up in the rendering.

Procedure

To use the Render Subset of Scene/Masking map:

- 1 Open the Render Setup dialog to the [Renderer panel](#) on page 6272.
- 2 On the Camera Effects rollout, click the Camera Shaders group > Lens button. This opens the Material/Map Browser.
- 3 From the browser list, choose Render Subset of Scene/Masking (mi). The Lens button label now shows the name of the map.
- 4 Open the Material Editor.
- 5 Drag the Lens button to a sample sphere in the Material Editor. Confirm the Instance choice.
This displays the Render Subset of Scene/Masking (mi) Parameters rollout in the Material Editor.
- 6 Specify an object list or material to render and make any necessary additional settings.

TIP If you specify a material, choose it from the scene (set Browse From to Scene).

- 7 Render the scene.
Only the specified objects render.

Interface

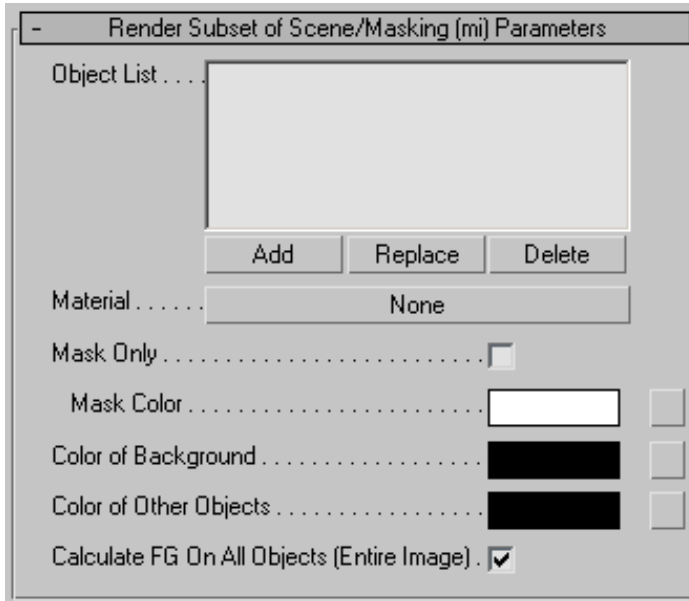

Object List The object or objects to be rendered. Use the Add, Replace, and Delete buttons to edit the list.

Material Specifies a material to render.

NOTE If you specify a material but no objects, all objects containing that material will render. If you specify a material as well as several objects with different materials, only objects with the specified material will render.

NOTE The Render Subset of Scene/Masking shader does not support the [Multi/Sub-Object material](#) on page 5720. However, it does support component materials of a Multi/Sub-Object material.

Mask Only Outputs only the mask color (see following) in the specified objects' locations; this is very fast. Use this if you only want to locate the objects in the scene.

Rays not hitting any objects return the Background color, and rays hitting any object not in the subset return the Other Objects color.

Mask Color The color returned for specified objects when Mask Only is on.

Color of Background The color returned for the background when Mask Only is on.

Color of Other Objects The color returned for non-specified objects when Mask Only is on.

Calculate FG on All Objects (Entire Image) Determines whether the final gather (FG) preprocessing should apply to all objects, or only those in the subset. Because FG blends neighboring FG samples, a given object might use information in FG points coming from nearby objects not in the subset. This is especially true if the objects are coplanar. Therefore it is advised to let the FG prepass "see" the entire scene.

Turning off this option and creating FG points only for the subset of objects is faster, but there is a certain risk of boundary artifacts, especially in animations. If the scene uses a saved FG map, this option can be left off.

Output Shaders



Motion Vector Export (mi)

Render Setup dialog > Renderer panel > Camera Effects rollout > Camera Shaders group > Output button > Material/Map Browser > Motion Vector Export (mi)

NOTE Shaders appear in the Browser only if the mental ray renderer is the currently active renderer.

This shader is intended for those who wish to do compositing work before applying motion blur, or to use a specific third-party motion-blur shader. Its purpose is to export motion in pixel space (mental ray's standard motion vector format is in world space) encoded as a color.

Most third-party tools expect the motion vector encoded as colors where red is the X axis and green is the Y axis. To fit into the confines of a color (especially when not using floating point and a color range extends only from black to white), the motion is scaled by a factor (here called Max Displace) and the resulting value range, which is -1 to 1, is mapped to the color channel's 0 to 1 range. The shader also support a couple of different floating point output modes.

Interface

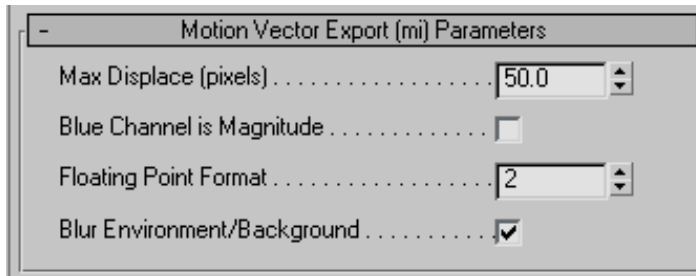

Max Displace (pixels) Sets the maximum encoded motion vector length. Motion vectors of this number of pixels or above are encoded as the maximum value that is possible to express within the limit of the color (that is, white or black).

To maximally utilize the resolution of the chosen image format, it is recommended that you use a Max Displace value of 50.0 (the default) for eight-bit images (which are not really suitable for this purpose) and a value of 2000.0 for 16-bit images. The shader outputs an informational statement of the maximum motion vector encountered in a frame to aid in tuning this parameter. For details, consult the documentation for your third-party motion-blur shader.

If Max Displace is 0.0, motion vectors are encoded relative to the image resolution. For example, for an image 600 pixels wide and 400 pixels high, a movement of 600 pixels in positive X is encoded as 1.0 in the red channel, while a movement 600 pixels in negative X is encoded as 0.0. A movement in positive Y of 400 pixels is encoded as 1.0 in the blue channel etc.

Blue Channel is Magnitude When on, the blue color channel represents the magnitude of the blur, and the red and green channels encode the 2D direction only. When off, the blue channel is unused and the red and green channels encode both direction and magnitude.

Floating Point Format When not set to 0, the shader writes real, floating-point motion vectors into the red and green channels. They are not normalized to

the max displace length, not clipped, and contain both positive and negative values. When this option is used, neither Max Displace nor Blue Channel Is Magnitude have any effect.

The floating-point format options are:

- 1 The actual pixel count is written as-is in floating point.
- 2 The pixel aspect ratio is taken into account such that the measurement of the distance the pixel moved is expressed in pixels in the Y direction, and the X component will be scaled by the pixel aspect ratio. This format is compatible with Autodesk Toxik.

Blur Environment/Background When on, motion vectors are generated for the empty background area controlled by the camera movement.

NOTE This option does not work when the [Scanline rendering algorithm](#) on page 6279 is enabled.



HDR Image Motion Blur (mi)

Render Setup dialog > Renderer panel > Camera Effects rollout > Camera Shaders group > Turn on Output. > Output button > Material/Map Browser > HDR Image Motion Blur (mi)

NOTE Shaders appear in the Browser only if the mental ray renderer is the currently active renderer.

This shader applies fast, grain-free motion blur as a post process. It works by using pixel motion vectors stored in the rendering phase and “smearing” these into a visual simulation of motion blur.

Like using the rasterizer, this means that features such as mirror images or even objects seen through foreground transparent object will “streak” together with the foreground object. Furthermore, since the motion frame buffer only stores one segment, the “streaks” are always straight, never curved.

The major advantage of this method is rendering speed. Scene or shader complexity has no impact. The blur is applied as a mental ray “output shader” that is executed after the main rendering pass. The execution time of the output shader depends on how many pixels need to be blurred, and how far each pixel needs to be “smeared.”

NOTE Because the shader works in post, it does not blur shadows or reflections of moving objects. If these effects are necessary, use standard motion-blur methods.

Interface

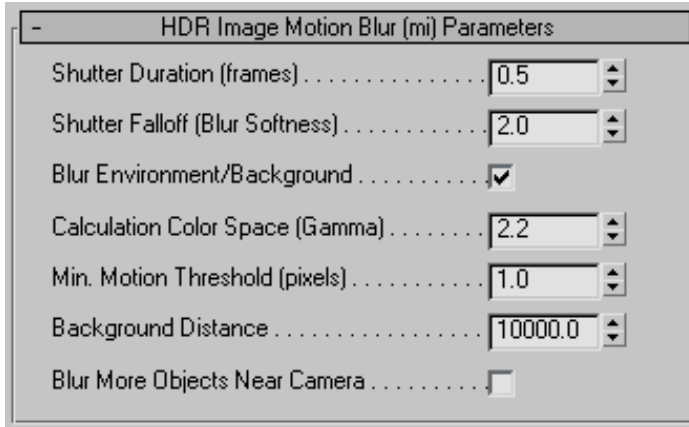

Shutter Duration (frames) The amount of time the shutter is “open.” In practice this means that after the image has been rendered the pixels are smeared into streaks in both the forward and backward direction. Each smear length is half the distance the object moves during the shutter time.

Shutter Falloff (Blur Softness) The drop-off speed of the smear; that is, how quickly it fades to transparent. This setting controls the “softness” of the blur.

NOTE The *perceived* length of the motion blur diminishes as the Falloff value increases, so it might be necessary to compensate by increasing the Shutter Duration value slightly.

Thus, falloff is especially useful for creating the effect of over-bright highlights “streaking” convincingly: By using an inflated shutter length (above the cinematic default of 0.5) and a higher falloff, over-brights have the potential to smear in a pleasing manner.

Blur Environment/Background Determines whether the camera environment (that is, the background) should be blurred by the cameras movement or not. When on, pixels from the environment are blurred, and when off they are not.

NOTE This option does not work when the [Scanline rendering algorithm](#) on page 6279 is enabled.

Calculation Color Space (Gamma) Defines the gamma color space in which blur calculations occur. Because mental ray output shaders act on written frame buffers, and these buffers (unless floating point) already have any gamma correction applied, it is important to apply post effects with the appropriate gamma.

Min. Motion Threshold (pixels) The minimum motion-vector length (measured in pixels) an object must move for blur to be added. If set to 0.0, it has no effect, and every object with even sub-pixel movement will have a slight amount of blur. While this is technically accurate, it might cause the image to be perceived as overly blurry.

Background Distance The distance to the background, which helps the algorithm calculate the depth layout of the scene. This value should be about the same as the scene depth; anything farther from the camera than this distance would be considered "far away" by the algorithm.

Blur More Objects Near Camera When on, the blurring of objects closer to the camera is more opaque than that of more-distant objects. Because this can result in the blurs of objects very close to the camera to be unrealistically opaque, use this option only when necessary; that is, when the blurs of more-distant objects overwrite those of closer objects.

Normal Bump Map

Material Editor > Maps rollout > Click a Map button. > Material/Map Browser > Normal Bump

The Normal Bump map lets you use a texture-baked Normals map (see [Baked Texture Elements](#) on page 6376). Typically you assign it to a material's Bump component, Displacement component, or both. Using the map for Displacement can correct edges that otherwise look unrealistically smooth; however, this adds faces to the geometry.

TIP A Normals map for the indicated material component is generated automatically if you turn on Output Into Normal Bump in the Selected Elements Unique Settings group of the Render To Texture dialog's [Output rollout](#) on page 6406.

Interface

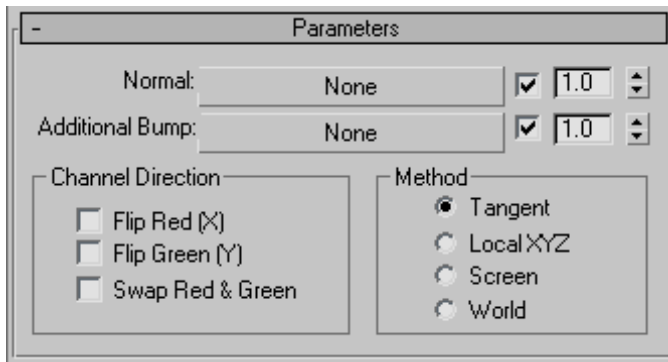

Normal As a rule, contains a Normals map generated by [Render To Texture](#) on page 6371.

Use the toggle to enable or disable use of the map (default=on). Use the spinner to increase or decrease the map's effect.

Additional Bump This optional component can contain an additional map to modify the bump or displacement effect. It is treated as a regular [bump map](#) on page 5478.

Use the toggle to enable or disable use of the map (default=on). Use the spinner to increase or decrease the map's effect.

Channel Direction group

By default, the Normals map's red channel indicates left versus right, while green indicates up versus down (and blue indicates vertical distance). The controls in this group let you adjust that interpretation.

Flip Red (X) Flips the red channel so that left and right are reversed.

Flip Green (Y) Flips the green channel so that up and down are reversed.

Swap Red & Green Swaps the red and green channels so that normal mapping rotates 90 degrees.

Method group

The Method group lets you choose which coordinate to use on the normals. These controls are the same as those in the [Projection Options dialog](#) on page 6416.

- **Tangent** (The default.) Project at a tangent to the target object's surface. This is the method to use for objects that both move and deform, such as animated characters.
- **Local XYZ** Project using the object's local coordinates. This method can be used for stationary or moving objects, but not for objects that deform: if the object deforms, the projection will appear incorrect at some frames.
- **Screen** Project using screen coordinates; that is, flat projection in the Z axis. X is horizontal, increasing in a positive direction to the right; Y is vertical, increasing in a positive direction upward; and Z is perpendicular to the screen, increasing in a positive direction toward the viewer. This method is useful mainly for stationary objects seen only from a single angle; for example, a statue seen through a window.
- **World** Project using world coordinates. This is useful mainly for objects that don't move or deform; otherwise, a moving object with world-projected normals will appear to “swim” through the texture.

Camera Map Per Pixel Map

Material Editor > Maps rollout > Click a Map button. > Material/Map Browser > Camera Map per Pixel

The Camera Map Per Pixel map lets you project a map from the direction of a particular camera. It is meant as an aid to 2D matte painting: You can render a scene, adjust the rendering using an image-editing application, then use this adjusted image as a matte that is projected back onto the 3D geometry.

TIP Final rendering can be slow. Script-driven [network rendering](#) on page 6433 can help improve performance.

Limitations

The Camera Map Per Pixel does not handle these situations:

- Animated objects.
The projection does not use UVW mapping.
- Animated textures.
- Occlusion based on a Z-depth channel is handled in a limited way only.

Procedures

To use Camera Map Per Pixel:

- 1 Create the 3D model.
- 2 Set up a camera.
- 3 Set up the rendering resolution you want.
To get good results, the plate should be at least 2K pixels; 3K to 6K, or higher is recommended.
- 4 Render the scene to an editable image format such as [TIFF](#) on page 7372.
- 5 Render the scene again, this time to a format such as [RPF](#) on page 7366 that has a Z-depth component. Make sure the Z option is turned on.
- 6 Use an image-editing application to make changes you want to the editable image.
- 7 Apply Camera Map Per Pixel to the [diffuse component](#) on page 5460 of the geometry on which you want the matte to appear. Use these settings:
 - Set Camera to the same camera you used for the renderings.
 - Set Texture to the matte image you edited.
 - Set ZBuffer Mask to the Z-depth rendering (the RPF or RLA file).
Adjusting (which usually means increasing) the value of ZFudge can improve the quality of edges of the projection.
Usually it is a good idea to have Remove Back Face Pixels turned on. Another way to adjust the projection edge is to adjust this control's Angle Threshold.

TIP If you have persistent problems with seams, try generating a mask with an alpha channel and using it to clean up the edge of the projection.

If you have multiple mattes to project, you might need to slice geometry to make each map's target a separate object.

Interface

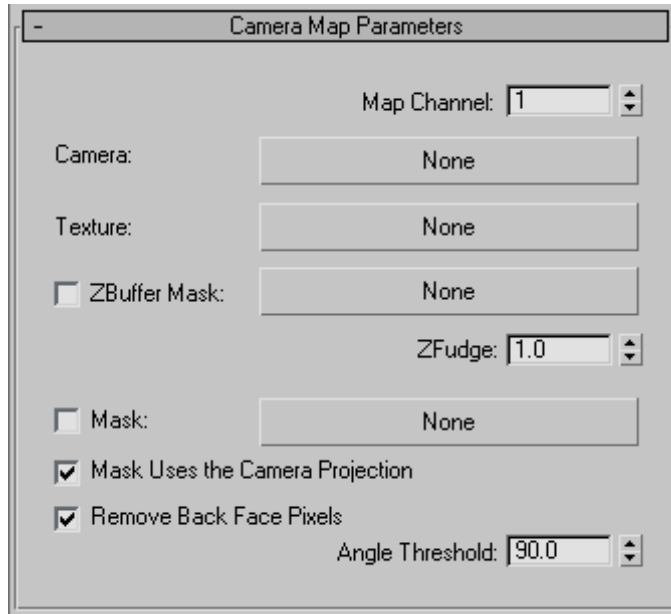

Map Channel Sets which map channel to use. Default=1.

Camera Click to turn on, and then choose a camera in the scene by selecting it in a viewport, or press H to use the [Pick Object dialog](#) on page 228.

Once you have assigned a camera, its name appears on this button.

This camera should be the one used to render the map used in the Texture and ZBuffer Mask components.

Texture Click to assign the texture to project. You can assign any kind of map, but typically this is a [Bitmap](#) on page 5795 that contains an image file that you first rendered from the same camera, and then possibly edited with a different application.

ZBuffer Mask Click to assign a map that contains Z-depth data used to mask the projection from unwanted surfaces. Typically this is an [RPF file](#) on page 7366 or an [RLA file](#) on page 7364 rendered using the same camera, with the Z channel option turned on.

Use the toggle to turn use of the ZBuffer Mask on or off. By default, it is off, and it is not turned on automatically when you assign the ZBuffer Mask.

- **ZFudge** ZFudge values other than 1.0 add a margin of deviation to the use of the Z-depth data, letting you fine-tune the Z-Buffer masking. Default=1.0.

Mask Behaves like the mask in the [Mask map](#) on page 5925 by letting you view one map through another. Black areas of the mask are transparent, white areas are opaque, and gray areas are partially transparent, based on the percentage of the gray.

- **Mask Uses the Camera Projection** When on, the mask uses the same camera projection as the Texture and ZBuffer Mask. When off, it uses the object's UVW coordinates. Default=on.

Remove Back Face Pixels When on, sets the projection to exclude surfaces that face away from the camera, based on the value of Angle Threshold. Default=on.

- **Angle Threshold** Specifies the angle to use as a cutoff when removing backface pixels. Default=90.0.
At the default of 90 degrees, faces perpendicular to the camera, or at a greater angle, are not projected.

Material, Mapping, and Vertex Color Utilities

Assign Vertex Colors Utility

Utilities panel > Utilities rollout > More button > Utilities dialog > Assign Vertex Colors

The Assign Vertex Colors utility assigns vertex colors based on the material assigned to the object and the lighting in the scene. The utility applies a [VertexPaint modifier](#) on page 1959 to the object when Assign To Selected is clicked. Once the VertexPaint modifier has been applied to the object, go to the Modify panel or click Edit to access the VertexPaint tools.

TIP To render vertex colors, you must apply a material that has a [Vertex Color map](#) on page 5943 in its diffuse component. To view vertex colors in viewports, right-click the object, choose [Object Properties](#) on page 305 from the quad menu, and then turn on Vertex Channel Display in the Display Properties group and make sure the drop-down option is set to Vertex Color.

The Assign Vertex Colors utility supports light inclusion or exclusion when using the Scene Lights option.

All of the commands found within the Assign Vertex Color utility are also available from the Modify panel when a VertexPaint modifier has been applied to an object.

Vertex Colors and Radiosity

The Vertex Colors utility supports [radiosity](#) on page 6168. If you use radiosity with assigned vertex colors, be sure to turn on the option Re-Use Direct Illumination From Radiosity Solution. This option is in the Rendering Parameters rollout. See [Radiosity Controls](#) on page 6188. When this option is on, the renderer simply displays the vertex colors assigned by the radiosity solution: strictly speaking, it is not rendering at all.

The additional option Render Direct Illumination, also on the Rendering Parameters rollout, causes direct lighting not to be saved in the corresponding mesh. This corresponds to the options Radiosity, Render Direct Illumination, in which case Assign Vertex Colors gets indirect illumination from the radiosity mesh but renders direct illumination separately; or Radiosity, Indirect Illumination Only, in which case Assign Vertex Colors doesn't apply direct illumination to vertices at all.

See also:

- [VertexPaint Modifier](#) on page 1959
- [Vertex Color Map](#) on page 5943

Procedures

To use the Assign Vertex Colors utility:

- 1 Assign materials to the objects you want to affect. These can be mapped or unmapped materials.
- 2 Light the objects.

- 3 Select the objects you want to affect.
- 4 Open the Object Properties dialog for each object, click to turn off the By Layer button, turn on **Vertex Channel Display**, and click OK.
- 5 Expand the Display Properties rollout in the Display panel and turn on Vertex Colors.
- 6 Access the Assign Vertex Colors utility.
- 7 Choose one of the Light Model options.
- 8 Choose one of the Color Assignment choices.
- 9 Click Assign to Selected.

VertexPaint modifiers are applied to the selected objects, and the vertex colors for the objects are taken from their materials and from the lighting in the scene, depending on the options you choose under Light Model.

Changing the material or the lighting in the scene won't change the vertex colors. To do this, click the Update All button.

NOTE The new vertex colors are stored in the Vertex Paint modifier. If you want to access them, go to the Modify panel and access the parameters in the rollouts there. You can also use the tools found in the Vertex Paint floating dialog to create layers, paint, blur or adjust color. The Vertex Paint floater launches when you go to the Modify panel and the object is selected.

Example: To use the Assign Vertex Colors utility on a specific object:

- 1 Create a sphere with 24 segments.
- 2 Apply a mapped material to the sphere, and turn on Show Map In Viewports.
The mapped sphere is displayed in the viewport.
- 3 Apply a mapped material to the sphere.

NOTE Choose a simple, well-defined map with large, easily-distinguished areas.

- 4 Open the Object Properties dialog for the sphere, turn on Vertex Colors, and click OK.
- 5 Open the Object Properties dialog for the sphere, click to turn off the By Layer button, turn on **Vertex Channel Display**, and click OK. The sphere

turns white because you're now displaying its vertex colors, and they're all white as a default.

- 6 With the sphere selected, open the Assign Vertex Colors utility.
- 7 Choose Shaded and turn on Use Maps.
- 8 Turn on Mapping.
- 9 Click Assign To Selected.

A blurred version of the mapping appears on the sphere. The vertices are now colored based on the material and the lighting in the scene. The mapping is blurred because the resolution of the mesh at 24 segments is much lower than the pixel resolution of the map.

- 10 Go to the Modify panel and note the VertexPaint modifier.
- 11 Move down in the Stack to the creation parameters, click Yes at the warning prompt, and increase the Segments to **70**.
The new vertices shift the already assigned vertices.
- 12 Return to the VertexPaint level of the stack, and click Assign in the Assign Vertex Colors rollout. Had we returned to the Utilities panel, we would have added another Vertex Paint modifier to the stack; clicking Assign in the VertexPaint Modifier only updates that modifier.

TIP Vertex colors will only show up in a rendered scene if you assign the Vertex Color map to the diffuse channel. However, if you do this, you can't properly update your vertex colors with the Assign Vertex Colors utility. The solution is to assign a Blend material to your object. Assign the straight diffuse bitmap to Material 1, and the Vertex Color map to Material 2 of the Blend. Switch to 100 percent of Material 2 when rendering, and 100 percent of Material 1 when updating the vertex colors.

Interface

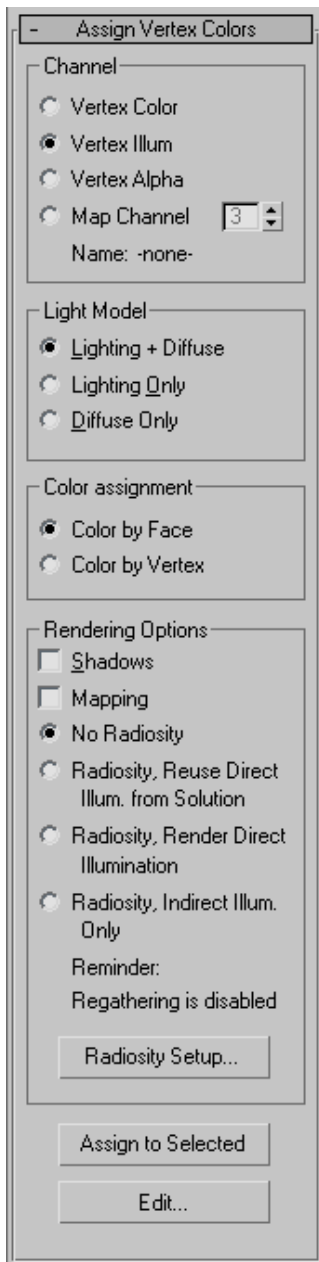

Channel group

Here you'll find tools to choose which channel type the vertex color utility will assign. If you choose map channel, you can also specify the map channel ID number.

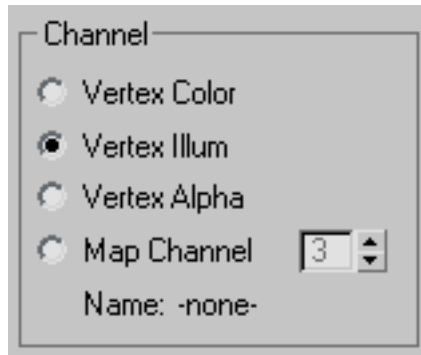

- **Vertex Color** Choose this to assign a vertex color layer.
- **Vertex Illum** Choose this to assign a vertex lighting layer.
- **Vertex Alpha** Choose this to assign a vertex transparency layer.
- **Map Channel** Choose this to assign a specifically numbered map channel.
Map channel spinner
Use this to define the channel number. Available only when Map Channel is chosen.

Name If a channel has a name defined, it will appear here. Channels can be named using the [Channel Info Utility](#) on page 6047.

NOTE Although the Color, Illum, and Alpha channels have specific names, in fact 3ds Max does not enforce what kind of data is saved in them, and any of the three channels can contain four-channel (RGBA) vertex color data.

Light Model group

Provides options that let you specify how the surface of the object appears to be illuminated.

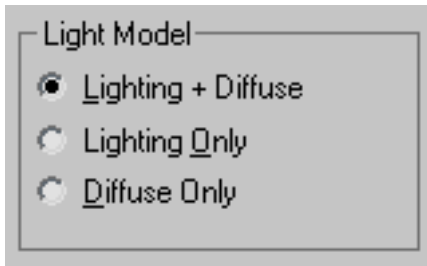

- **Lighting + Diffuse** Uses the current scene lighting and materials to affect the vertex colors.
- **Lighting Only** Uses only lighting to assign vertex colors, ignoring material properties. When this option is chosen, Shadows and Mapping are disabled in the Rendering Options rollout.
- **Diffuse** Uses the material's diffuse color, ignoring the lighting.

Color Assignment group

Lets you specify how colors are interpolated across surfaces.

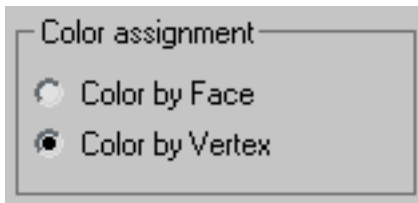

- **Color by Face** (The default.) Colors are interpolated between the center of each face. Color By Face samples fewer points, so it is the quicker method. On the other hand, results are less accurate.
- **Color by Vertex** Colors are interpolated between vertices. For each face, this method uses three points instead of one, so it is slower but usually more accurate. An exception can occur when an object's shadow falls between two vertices: in such a case, the object should occlude lighting, but because only vertices are taken into account, the shadow is not calculated and a "light leak" occurs.

Rendering Options group

The options in this group let you choose whether to include shadows, texture maps, or a radiosity solution in vertex colors.

NOTE You can save a radiosity solution in vertex colors, but not [Light Tracer](#) on page 6154 illumination, which is not stored in the scene's geometry.

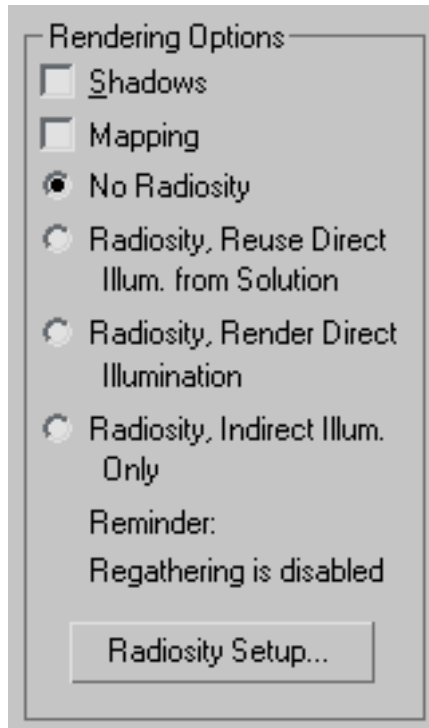

Shadows When on, shadows are used when the vertices are shaded.
Default=off.

TIP You can soften the shadow edge by using the VertexPaint modifier's Paint or Blur tools.

Mapping When on, texture maps are used when the vertices are shaded.
Default=off.

The radio buttons specify how to use radiosity data.

- **No Radiosity** (The default.) Do not use the radiosity solution when assigning vertex colors.

NOTE This option is the only one available unless a [radiosity solution](#) on page 6168 is present in the scene.

- **Radiosity, Reuse Direct Illum. from Solution** Includes radiosity in the vertex color assignments, and uses the direct illumination from the solution.
This is comparable to the choice Re-Use Direct Illumination From Radiosity Solution on the [Rendering Parameters rollout](#) on page 6208.
This choice disables the Shadows toggle, because shadows don't need to be recomputed.
- **Radiosity, Render Direct Illumination** Includes radiosity in the vertex color assignments, but uses a separate pass to render direct illumination. This is comparable to the choice Render Direct Illumination on the [Rendering Parameters rollout](#) on page 6208.
- **Radiosity, Indirect Illum. Only** Includes only indirect illumination from the radiosity solution in the vertex color assignments.
This choice disables the Shadows toggle, because shadows don't need to be recomputed.

Reminder field Displays a message that says whether regathering is enabled or disabled. Regathering provides the most accurate radiosity results, but it can add considerable time to radiosity calculations.

Radiosity Setup Click to display the [Advanced Lighting panel](#) on page 6153 of the Render Setup dialog, where you can set up and generate a radiosity solution.

If the mental ray renderer is the active renderer, this button is not available.

Assign to Selected Assigns vertex colors to the selected objects based on the assigned material, and the choices specified in the preceding group boxes. Assign to Selected creates a VertexPaint modifier and adds it to the stack of the selected objects.

Edit Click to display the [VertexPaint Paintbox](#) on page 1969, the floating dialog that holds the vertex painting tools.

This button is unavailable if you haven't yet clicked Assign To Selected.

Channel Info Utility

Utilities panel > More button > Channel Info > Click Channel Info button.

Tools menu > Channel Info

The Channel Info utility gives game artists and others direct access to objects' channel information that might not otherwise be easily available. All objects in 3ds Max have mapping channels, which hold information pertinent to texture mapping as well as vertex color, illumination, and alpha. Mesh objects also have geometry and vertex-selection channels. The Channel Info utility lets you view an object's channels, give them meaningful names, delete unused channels, and copy information between channels.

The utility's Map Channel Info dialog shows all the channel data for selected objects. It displays the number of channels, the number of vertices per channel, and how much memory the channel uses. It also lets you name channels, as well as clear (or delete), copy, and paste channels. Each of these commands except renaming puts a modifier on the stack to achieve the results.

NOTE Channel Info supports mesh, polygon, and patch objects. It does not support NURBS objects.

See also:

- [Vertex Color Map](#) on page 5943
- [Skin Utilities](#) on page 3875
- [Select By Channel Modifier](#) on page 1659
- [UVW Mapping Add Modifier](#) on page 1954
- [UVW Mapping Clear Modifier](#) on page 1954
- [UVW Mapping Paste Modifier](#) on page 1954

Procedures

To use the Channel Info utility:

- 1 Select an object or objects to use with the utility.

- 2 Open the utility.
The Map Channel Info dialog opens.
- 3 To create a map channel, click any channel and then click the Add button.
The new, empty channel appears at the end of the list.
- 4 Most channels have three components. For example, a mesh or map channel has X, Y, and Z components, and an alpha channel has R, G, and B components. To expand all three-component channels, click the SubComp button. To collapse all expanded channels, click SubComp again.
- 5 To copy one channel to another, click the source channel, click Copy, and then click the destination channel and click Paste.
In some cases, you might need to expand or collapse the component display (see previous step). For example, when copying a vertex selection (vsel) channel to a map channel, you must paste the vsel channel to a component channel.
- 6 To minimize a channel's memory footprint, click the channel and then click the Clear button.
This removes most all or of the data from the channel, so first make sure the data is unnecessary or is available elsewhere. If the cleared channel is the last one in the list, it might be deleted from the list.

Interface

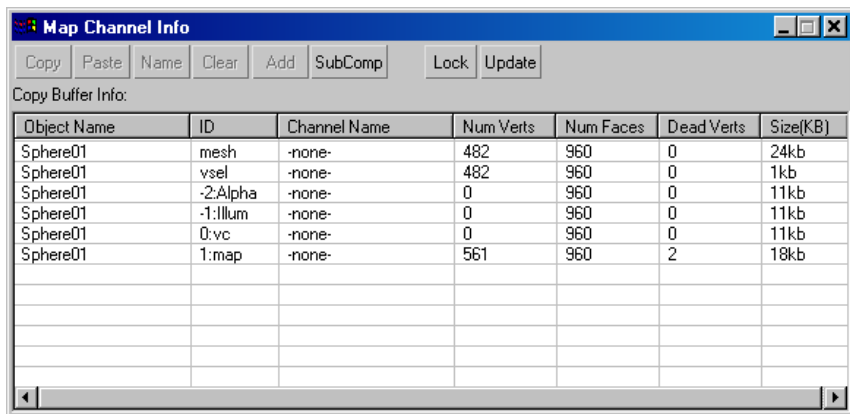

The primary user interface of the Channel Info utility is the Map Channel Info dialog, which you open by clicking the utility's Channel Info button on

the command panel. This modeless dialog shows information about all map channels belonging to the current selection, at the object level. If you change the selection, the dialog automatically updates to reflect the selection.

The dialog consists of two parts: a button toolbar at the top, and a tabular display of map channels belonging to each object in the current selection.

Channel Info toolbar

Copy Copies the channel data from the highlighted channel to the copy buffer, where it becomes available for pasting. After you copy a channel, its name appears on the line below the button toolbar.

Paste Pastes the contents of the copy buffer to the highlighted channel.

You can copy and paste only between channels with the same topology, or you can copy from any channel to a channel with no vertices.

Source and destination channels need not be of the same type. For instance, you can copy from a mesh channel to a map channel, and vice-versa.

Name Lets you rename the highlighted channel. Click this button to open a small dialog that displays the current channel name and lets you edit this name or enter a new one from the keyboard.

Clear Use this function to remove channels or delete data from a map channel (including alpha, illumination, and vertex color channels). Clear has no effect on geometry or vertex selection channels.

The specific result depends on the type of object and which channel you clear. In terms of reducing the object's memory footprint, the utility is most effective with Editable Poly objects.

- **Geometric primitive or Editable/Edit Mesh object** Deletes the highlighted texture map channel if it is the last map channel in the object, and it's not the default map channel (1:map). If the highlighted channel is not the last, Clear deletes all vertices in the channel. The faces remain, so the memory-footprint reduction is partial.

NOTE This also applies to objects that collapse to editable mesh, such as Loft objects.

- **Editable Poly object** Deletes the highlighted texture map channel if it is the last map channel in the object, and it's not the default map channel. If the highlighted channel is not the last, Clear deletes all vertices and faces in the channel.

- **Patch object** Deletes the highlighted texture map channel if it is the last map channel in the object, and it's not the default map channel. If the highlighted channel is not the last, Clear has no effect.

NOTE When you use the Clear function, the software adds a UVW Mapping Clear modifier to the object's modifier stack. You can recover the deleted data by removing the modifier from the stack, or changing its Map Channel setting.

Add Appends a new map channel to the object's channel list. If multiple objects are selected, Add becomes available only after you click a track, so the software knows which object to add the channel to.

NOTE If you apply mapping with a channel number higher than any existing channels, the software automatically creates all intermediate channels. For example, if you apply a UVW Mapping modifier to a standard object and set Map Channel to 5 in the modifier, the software adds map channels 2, 3, 4, and 5.

SubComp Toggles display of the channels' subcomponents. When displayed, you can rename, copy, and paste each subcomponent independently of its parent channel.

Each channel except vsel has three subcomponents. Mesh and map channels' subcomponents are labeled X, Y, and Z; those of alpha, illumination, and vertex color channels are R, G, and B (red, green, and blue).

Lock Retains the current mapping data information in the table even if you change the selection.

For example, if you want to see mapping data for a specific object or objects constantly, first select the objects and then click Lock. Thereafter, if you select different objects in the viewport, the table continues to display the data for the selection when you clicked Lock. If you turn off Lock, the table updates to show data only for the current selection.

If you click Update when Lock is on, the software will refresh the table contents to reflect the current selection, and then retain that data.

Update Refreshes the displayed data to reflect any changes in the objects or mapping, or, when Lock is on, the selection.

For example, if you apply mapping to an object, or change its mapping, click Update to display the changes in the Map Channel Info dialog.

Channel Info table

The table functions similarly to a spreadsheet. If not all rows or columns are visible, you can scroll the table using standard methods, including rolling the

mouse wheel for vertical scrolling. To highlight a row, click anywhere in the row. You can highlight only one row at a time. To resize a column, drag the vertical divider at the right of the column heading. To automatically set a column's width to the size of the longest entry, double-click the vertical divider to the right of the column heading.

Following is a brief explanation of each of the columns in the table:

Object Name The name of the object. If you change the name in the Modify panel, click the dialog's Update button to display the new name in the dialog.

ID The type of channel. The available channel types are:

- **mesh/poly** The object's mesh or poly data, depending on whether it's a mesh or poly object: vertices and faces. You can copy this channel and paste it to any other three-component channel. This channel is not available for patch objects.
- **vsel** The vertex selection. You can copy this channel and paste it to other channels' subcomponents. This channel is not available for patch objects.
- **-2:Alpha** The vertex alpha channel. You can transfer all vertex alpha values between objects with the same topology by copying and pasting this channel. You can apply vertex alpha information to objects with the [VertexPaint modifier](#) on page 1959, and to editable surfaces with the Vertex Properties settings ([editable poly](#) on page 2150) and Surface Properties ([editable mesh](#) on page 2091 and [editable patch](#) on page 2038).
- **-1:illum** The vertex illumination channel. You can transfer all vertex illumination values between objects with the same topology by copying and pasting this channel. You can apply vertex illumination information to objects with the [VertexPaint modifier](#) on page 1959, and to editable surfaces with the Vertex Properties settings ([editable poly](#) on page 2150) and Surface Properties ([editable mesh](#) on page 2091 and [editable patch](#) on page 2038).
- **0:vc** The vertex color (vc) channel. You can transfer all vertex color values between objects with the same topology by copying and pasting this channel. You can apply vertex color information to objects with the [VertexPaint modifier](#) on page 1959, and to editable surfaces with the Vertex Properties settings ([editable poly](#) on page 2150) and Surface Properties ([editable mesh](#) on page 2091 and [editable patch](#) on page 2038).

- **1:map** The default mapping channel. You can transfer all UVW mapping information between objects with the same topology by copying and pasting this channel.
You can create additional mapping channels by various means, including with the Channel Info utility.

Channel Name The name of the channel. By default, a channel has no name, as indicated by the entry “-none-”. To name or rename the channel, click the channel to highlight it and then click the Name button at the top of the dialog, or right-click the channel and choose Name from the right-click menu.

NOTE Most channels can be split into [subcomponents](#) on page 6050. You can name the subcomponents separately from the channel itself.

Num Verts The number of vertices in the channel. To paste one channel to another, they must have the same number of vertices.

Some channels have faces but no vertices. This is typically the case with Alpha, Illumination, and vertex color channels in newly created non-poly objects. In such cases, these channels function as placeholders for the corresponding data should you add it later. They do consume a small amount of memory, so if you have no intention of using a channel, you can save some memory by converting the object to Editable Poly.

Num Faces The number of faces in the channel.

If a channel has faces but not vertices, that means it's a placeholder. See Num Verts, above, for more information.

Dead Verts The number of unused map vertices in the channel. Such vertices can be left over from sub-object editing.

Size(KB) The approximate amount of memory consumed by the channel. Use this figure to check for unused channels that are using up memory.

Clean MultiMaterial Utility

Material Editor > Utilities menu > Clean MultiMaterial

Select an object. > Utilities panel > More button > Clean MultiMaterial > Click Find All button.

The Clean MultiMaterial utility parses Multi/Sub-Object materials and displays any that contain sub-materials are not assigned to any material IDs in the

scene. You can then choose to remove any unused sub-materials, thus consolidating your Multi/Sub-Object materials.

This utility searches an entire scene. You do not need to select objects or materials.

Procedures

To clean all materials:

- 1 Open a scene.
- 2 On the Material Editor, open the Utilities menu and choose Clean MultiMaterial.

The Clean Multi-Materials dialog opens, displaying the following:

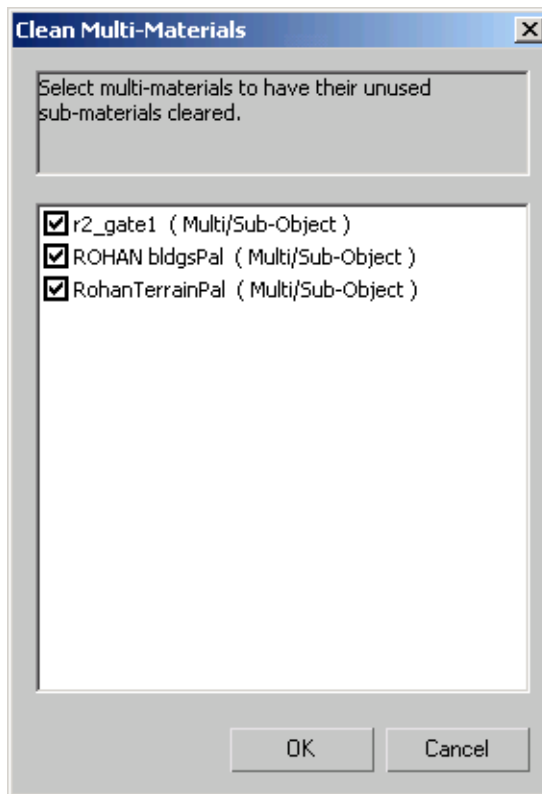

The dialog displays a list of all Multi/Sub-Object materials that contain unassigned sub-materials. All the Multi/Sub-Object materials are automatically turned on, and thus subject to cleaning.

- 3 Click the OK button.

All unused sub-materials are deleted and the dialog closes.

To clean specific Multi/Sub-Object materials:

When you create a Multi/Sub-Object material, you might create extra sub-materials in anticipation of objects that haven't been added to the scene yet. In such cases, you can prevent the utility from removing the extra sub-materials.

- 1 Open a scene.
- 2 On the Material Editor, open the Utilities menu and choose Clean MultiMaterial.

The Clean Multi-Materials dialog opens.

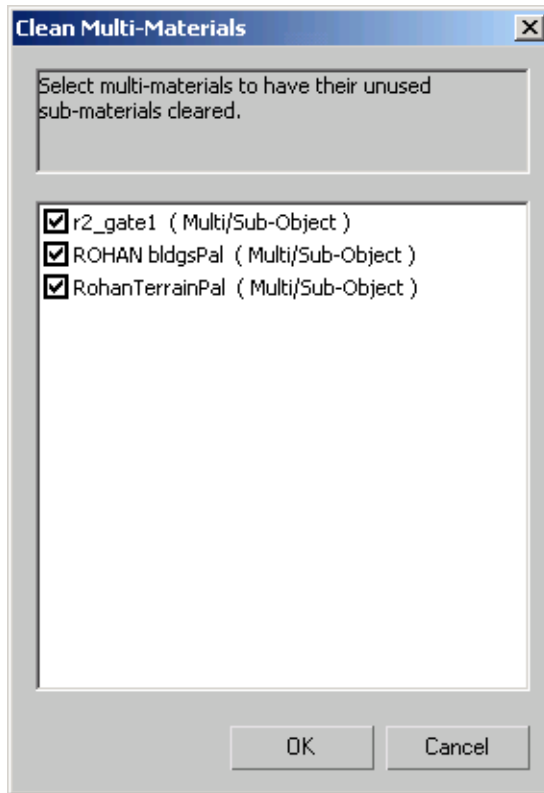

- 3 In the list, turn off any Multi/Sub-Object materials you do not want to clean.

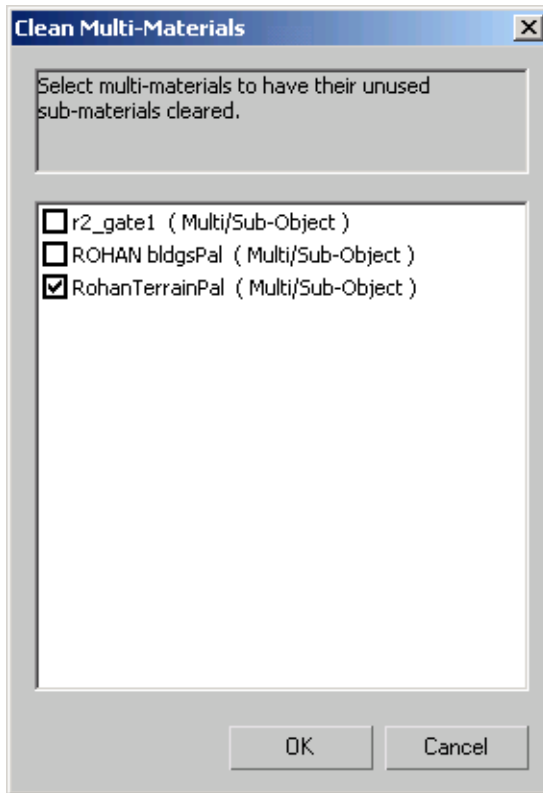

- 4 Click OK.

All unused sub-materials are deleted from the indicated materials and the dialog closes.

Interface

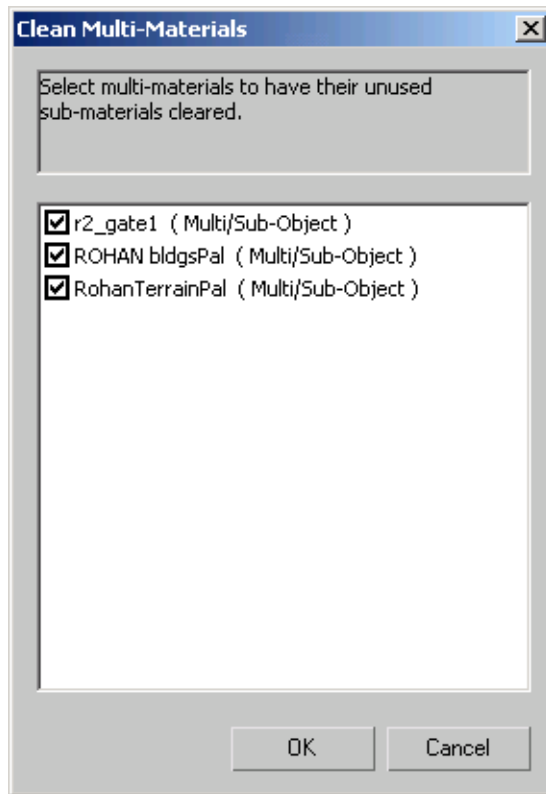

The Clean dialog presents you with a list of all Multi/Sub-Object materials in the scene that contain unassigned sub-materials. You can then select materials from which to remove unassigned sub-materials.

The dialog consists of two parts: a status field at the top and a list of Multi/Sub-Object materials.

Status Field

The Status Field is not interactive. It displays prompts about the unused materials.

Materials list

This list displays Multi/Sub-Object materials that have sub-materials that are not currently being used in the scene. When the Clean MultiMaterial utility opens, it lists all Multi/Sub-Object materials with unused sub-materials and turns them on to be cleaned. Click the check box next to a material name to turn it off and prevent the utility from cleaning it.

Clean Deletes unused sub-materials from Multi/Sub-Object materials that are turned on.

Cancel Cancels the operation.

Instance Duplicate Maps Utility

Material Editor > Utilities menu > Instance Duplicate Map

Utilities panel > More button > Instance Duplicate Maps > Click Find All button.

The Instance Duplicate Maps utility searches an entire scene for materials that have duplicate Bitmap maps and give you the option to instance them. If your scene has different materials that use the same texture maps, creating instances will reduce the load on your video card, which can improve viewport performance.

For example, if you render a scene containing three materials that reference the texture map *MyMap.bmp*, the software searches for that texture map three times: once for each material it is used in. However, if you use the Instance Duplicate Maps utility, you can create instances of the duplicate maps so the renderer will find the first reference to *MyMap.bmp* and use it for any subsequent material that uses the same maps.

This utility searches an entire scene. You do not need to select objects or materials.

NOTE In order to be eligible for instancing, the Bitmap maps must be identical in all aspects with regard to their initial settings. For example, if two materials use the same bitmap image applied as Diffuse maps, but have different initial Tiling settings, their maps aren't eligible for instancing.

Animation is not supported as a criterion for determining duplication, so any differences in the animation of Bitmap map parameters will be lost from the use of this utility. For example, if two materials use the same bitmap image applied as Diffuse maps, and have the same initial Tiling settings, but their

Tiling settings are animated to different subsequent values, after using the utility both maps will have the same animation as the first map.

Procedures

To instance all duplicate maps:

- 1 Open a scene.
- 2 On the Material Editor, open the Utilities menu and choose Instance Duplicate Map.

The Instance Duplicate Maps dialog opens, displaying the following:

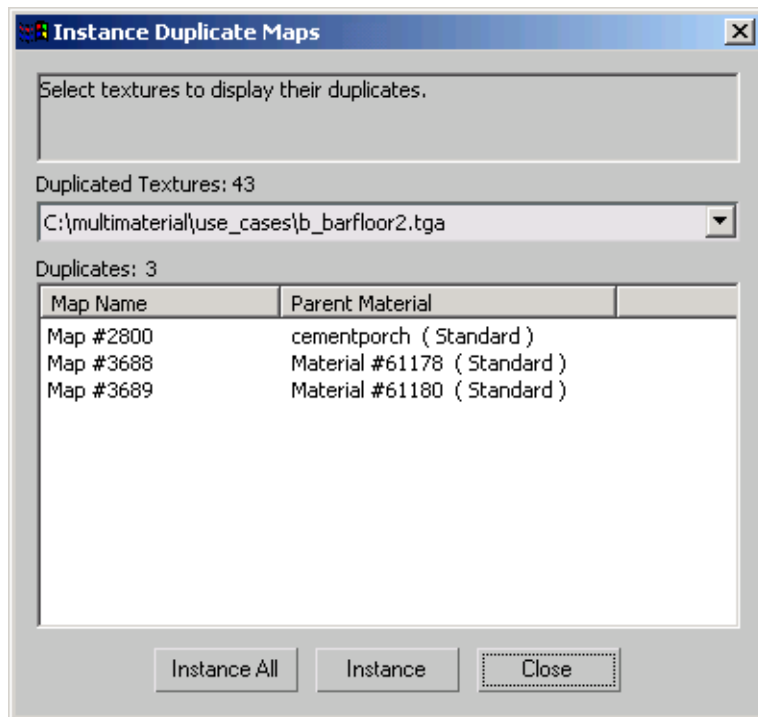

The dialog displays a list of all texture maps found to have exact duplicates in the scene. The search will include all copies found to have identical paths and settings.

- 3 Click the Instance All button.
All identical maps are instanced and the dialog closes.

To instance only specific maps:

Perhaps you only want to instance a few of the texture maps found in specific materials.

NOTE You have to select at least two maps from the Duplicates list

- 1 Open a scene.
- 2 On the Material Editor, open the Utilities menu and choose Instance Duplicate Map.

The Instance Duplicate Maps dialog opens.

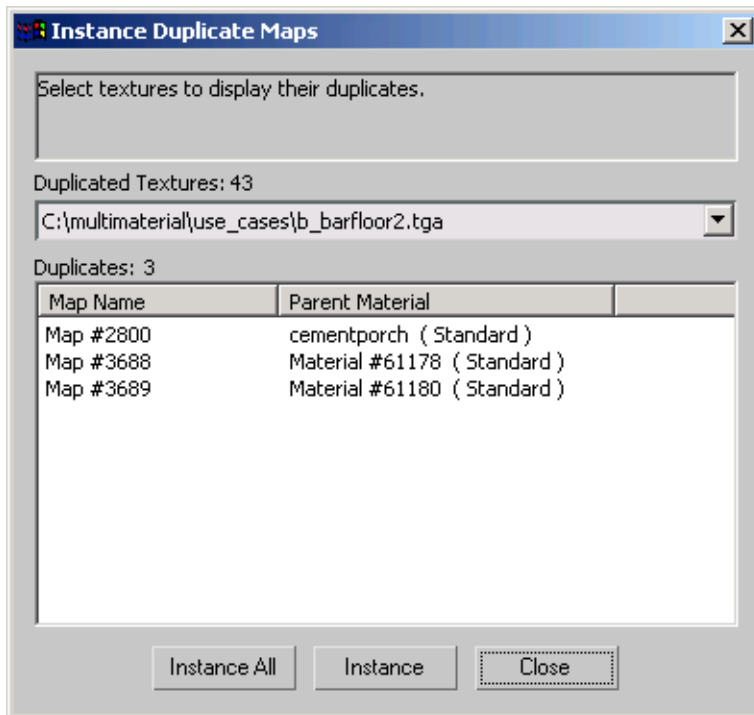

- 3 From the Duplicated Textures list, click the arrow button to open the list of duplicated textures and choose a texture you want to instance.
- 4 From the Duplicate list, select at least two map entries.

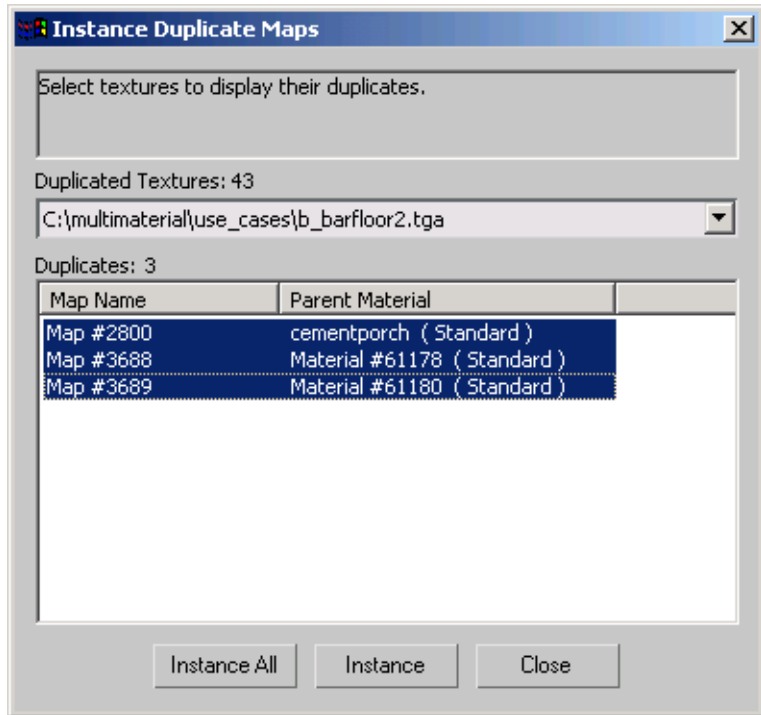

If you don't select at least two entries, you will see a warning in the status field at the top of the dialog.

- 5 Click Instance.

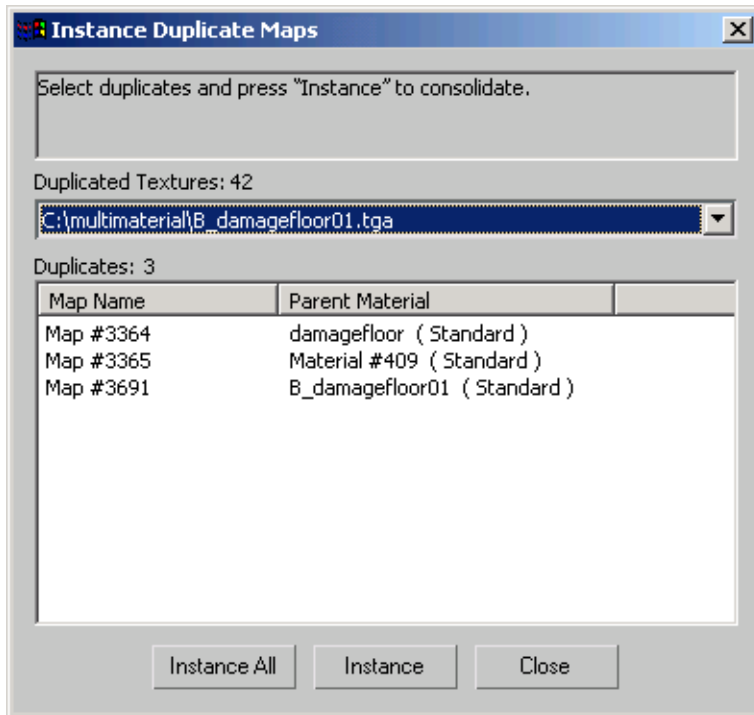

Since all three of the maps were instanced, the dialog now shows there are 42 duplicated textures.

- 6 Continue instancing texture or click Close when you are done.

Interface

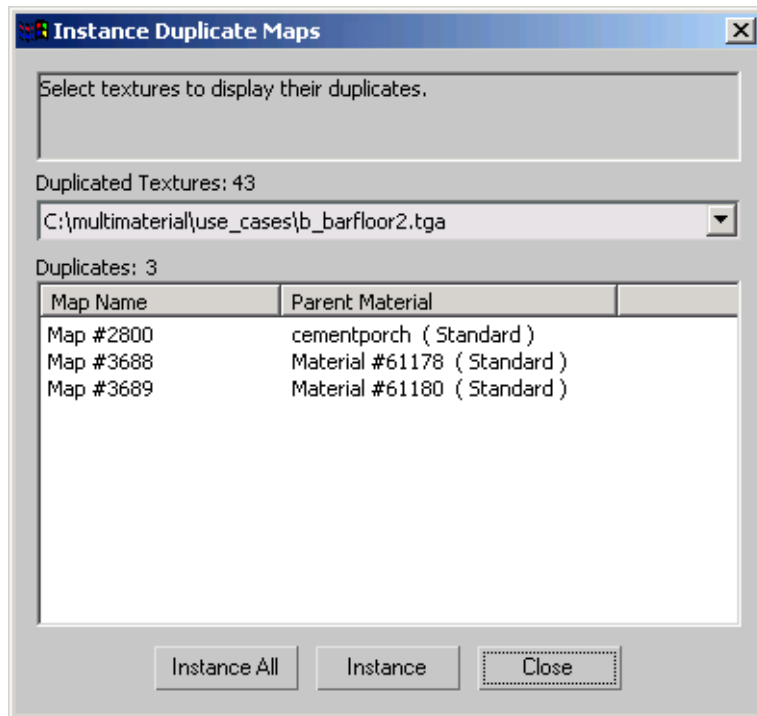

The primary user interface of the Instance Duplicate Maps utility is the Instance Duplicate Maps dialog, which you open from the Utilities menu in the Material Editor. This utility works globally, so you do not need to select objects or materials in order to use it.

The dialog consists of three parts: a status field at the top, a drop menu containing duplicated texture maps and a list of map names and the materials that belong to.

Status Field

The Status Field is not interactive. It shows you prompts and warnings about the duplicate textures and maps. Some of the messages displayed in this section include:

- “No duplicate textures were found in the scene.” – when the utility is run in a scene containing no duplicates.

- “Select duplicates and press “Instance” to consolidate.” – when the utility is run in a scene containing duplicates.
- “The selected duplicates contain parameters that are animated. Animation is not supported as criteria for determining duplication so differences in the animation will be lost.” – when animation is present in a set of duplicates.
- “At least two maps must be selected in order to proceed.” – when the Instance button is pressed with one or no duplicates selected.

Duplicated Textures list

This drop-down list contains all the maps in the scene found to be identical in every way, including texture map path and name, and initial parameter settings. The number after “Duplicated Textures” indicates how many sets were found in the scene. This list appears with the first entry visible and once active can be scrolled using the up/down arrow keys.

Duplicates list

When you choose a texture in the Duplicated Textures list, the software displays its duplicates in the Duplicates list, showing the map name and the name of the parent material. The number after “Duplicates” indicates how many copies were found in the scene. Textures in this list can be chosen individually. Only duplicates chosen in this list will be consolidated into the final instance if you click the Instance button. The name of the resulting instance is that of the first chosen duplicate in the list.

Instance All Performs the consolidation on all duplicates in the scene regardless of selections made from the Duplicated Textures or Duplicates lists.

Instance Performs the consolidation on only the duplicates chosen on the Duplicates list. Selected duplicates will disappear from this list after consolidation. If all are selected, the corresponding texture will disappear from the first list as well.

Close Closes the operation at its current point.

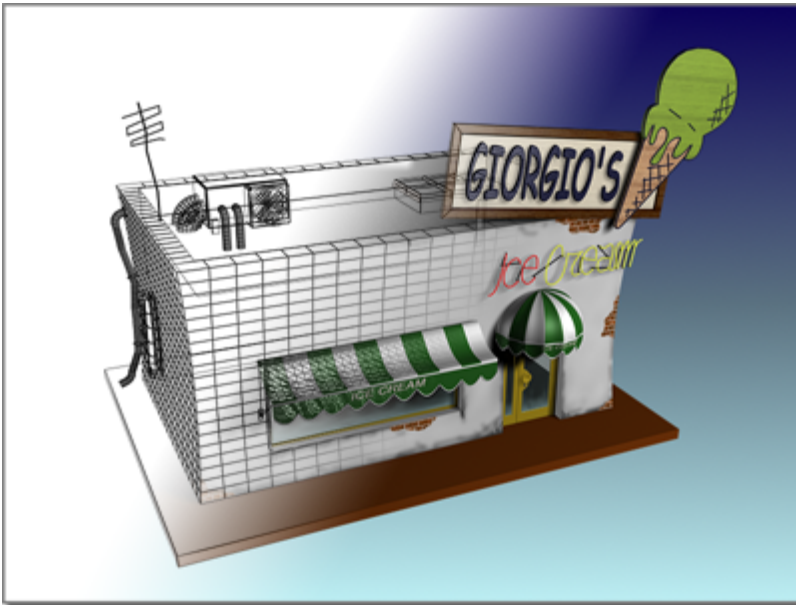

Rendering "fills in" geometry with color, shadow, lighting effects, and so on.

Rendering shades the scene's geometry using the lighting you've set up, the materials you've applied, and environment settings, such as background and atmosphere. You use the [Render Setup dialog](#) on page 6067 to render images and animations and save them to files. The rendered output appears in the [Rendered Frame Window](#) on page 6073, where you can also render and do some setup.

TIP When you render a very large image, you might get a message that says “Error Creating Bitmap,” or that says you are out of RAM. If this happens, turn on the [Bitmap Pager](#) on page 7771 on the Rendering panel of the Preferences dialog. The Bitmap Pager prevents a rendering from stopping unexpectedly due to the lack of sufficient memory. On the other hand, it slows down the rendering process.

NOTE 3ds Max does not append any color-space information to rendered output. If necessary, you can apply a color space such as sRGB to output images in an image-editing program like Adobe Photoshop.

Environments and Rendering Effects

A variety of special effects, such as film grain, depth of field, and lens simulations, are available as rendering effects. Another set of effects, such as fog, are provided as environment effects.

[Environment settings](#) on page 6689 let you choose a background color or image, or choose an ambient color value for when you render without using radiosity. One category of environment settings is the [exposure controls](#) on page 6732, which adjust light levels for display on a monitor.

[Rendering effects](#) on page 6583 provide a way for you to add blur or film grain to a rendering, or to adjust its color balance.

See also:

- [Rendering Commands](#) on page 6091
- [Rendering with ActiveShade](#) on page 6102
- [Rendering Previews](#) on page 6422
- [Network Rendering](#) on page 6433
- [Rendering Effects](#) on page 6583
- [Environment and Atmosphere Effects](#) on page 6687

Object-Level Rendering Controls

You can control rendering behavior at the object level. See [Object Properties](#) on page 305.

Render Setup Dialog

Rendering menu > Render Setup

Main toolbar > Render Setup button

Keyboard > F10



Rendered Frame Window >  Render Setup button

Rendering creates a 2D image or animation based on your 3D scene. It shades the scene's geometry using the lighting you've set up, the materials you've applied, and environment settings such as background and atmosphere.

The Render Setup dialog has multiple panels. The number and name of the panels can change, depending on the active renderer. These panels are always present:

- [Common panel](#) on page 6121
Contains the main controls for any renderer, such as whether to render a still image or an animation, setting the resolution of rendered output, and so on.
- [Renderer panel](#) on page 6138
Contains the main controls for the current renderer.

Additional panels whose presence depends on the active renderer include:

- [Render Elements panel](#) on page 6336
Contains the controls for rendering various image information into individual image files. This can be useful when you work with compositing, image-processing, or special-effects software.
- [Raytracer panel](#) on page 6221
Contains global controls for ray-traced maps and materials.
- [Advanced Lighting panel](#) on page 6153
Contains controls for generating radiosity and light tracer solutions, which can provide global illumination for your scene.
- [Processing](#) on page 6230 and [Indirect Illumination](#) on page 6295 panels
Contain special controls for the [mental ray renderer](#) on page 6230.

At the bottom of the Render Setup dialog are controls that, like those in the [Common Parameters rollout](#) on page 6121, apply to all renderers. These are described in this topic's "Interface" section, below.

TIP When you render a very large image, you might get a message that says "Error Creating Bitmap," or that says you are out of RAM. If this happens, turn on the Bitmap Pager. You turn on the Bitmap Pager in [Rendering Preferences](#) on page 7768. The Bitmap Pager prevents a rendering from hanging because of overuse of memory. On the other hand, it slows down the rendering process.

Choice of a Renderer

Three renderers are provided with 3ds Max. Additional renderers might be available as third-party plug-in components. The renderers provided with 3ds Max are:

- [Default scanline renderer](#) on page 6141
The scanline renderer is active by default. It renders the scene in a series of horizontal lines.
Global illumination options available for the scanline renderer include [light tracing](#) on page 6154 and [radiosity](#) on page 6168.
The scanline renderer can also [render to textures](#) on page 6371 ("bake" textures), which is especially useful when preparing scenes for game engines.
- [mental ray renderer](#) on page 6230
The mental ray renderer created by mental images is also available. It renders the scene in a series of square "buckets."
The mental ray renderer provides its own method of global illumination, and can also generate caustic lighting effects.
In the Material Editor, a variety of [mental ray shaders](#) on page 5974 provide effects that only the mental ray renderer can display.
- [VUE file renderer](#) on page 6334
The VUE file renderer is a special-purpose renderer that generates an ASCII text description of the scene. A view file can include multiple frames, and specify transforms, lighting, and changes of view.

Standard and ActiveShade Renderers

In 3ds Max, there are two different types of renderings. Production rendering is active by default, and is typically the one you use for finished renderings. This type of rendering can use any of the three aforementioned renderers.

The second type of rendering is called [ActiveShade](#) on page 6102. An ActiveShade rendering uses the default scanline renderer to create a preview rendering that can help you see the effects of changing lighting or materials; the rendering updates interactively as you change your scene. Rendering with ActiveShade is, in general, less precise than production rendering.

Another advantage of production rendering is that you can use different renderers, such as the mental ray or VUE file renderer.

To choose between production and ActiveShade rendering, use the radio buttons described in the Interface section, following. To change the renderer assigned to production rendering, use the [Assign Renderer rollout](#) on page 6135.

See also:

- [Render Setup](#) on page 6092

Procedures

To render a still image:

- 1 Activate the viewport to render.



- 2 Click Render Setup.

The Render Setup dialog opens, with the Common panel active.

- 3 On the Common Parameters rollout, check the Time Output group to make sure the Single option is chosen.
- 4 In the Output Size group, set other rendering parameters or use the defaults.
- 5 Click the Render button at the bottom of the dialog.

By default, rendered output appears in the [Rendered Frame Window](#) on page 6073.



TIP To render a view without using the dialog, click [Render](#) on page 6101.

To render an animation:

- 1 Activate the viewport to render.

- 2  Click Render Setup.
The Render Setup dialog opens, with the Common panel active.
- 3 On the [Common Parameters rollout](#) on page 6121, go to the Time Output group and choose a time range.
- 4 In the Output Size group, set other rendering parameters or use the defaults.
- 5 In the Render Output group, click Files.
- 6 On the [Render Output File dialog](#) on page 6086, specify a location, name, and a type for the animation file, and then click Save.
Typically, a dialog appears that lets you configure options for the chosen file format. Change settings or accept the defaults, and then click OK to continue.
The Save File check box turns on.
- 7 Click the Render button at the bottom of the dialog.

NOTE If you set a time range and do not specify a file to save to, the animation is rendered only to the window. This can be a time-consuming mistake, so an alert warns you about it.

TIP  Once you have rendered the animation this way, you can render it again without using the dialog by clicking Render or pressing F9.

Interface

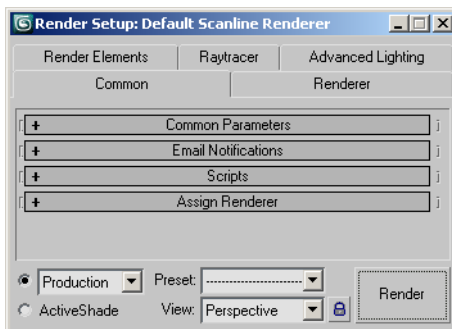

[rendering mode]

- **Production/Iterative** Choose whether to render in [production](#) on page 6101 or [iterative](#) on page 6101 mode. (This is the default.)
- **ActiveShade** Choose to use [ActiveShade](#) on page 6102.

Preset From this drop-down list you can choose a set of preset rendering parameters, or load or save rendering parameter settings. See [Preset Rendering Options](#) on page 6114.

Viewport Chooses the viewport to render. By default, this is the active viewport. You can use this drop-down list to choose a different one. The list contains only currently displayed viewports.



Lock View When on, locks the view to the one shown in the Viewport list. This enables you to adjust the scene in other viewports (which become active as you use them), and then click Render to render the viewport you originally chose. When off, Render always renders the active viewport.

Render Renders the scene.

When ActiveShade is chosen, the name of this button changes to ActiveShade, and clicking it opens a floating [ActiveShade window](#) on page 6102.

If the scene you're rendering contains bitmaps that cannot be located, a [Missing External Files dialog](#) on page 7130 opens. This dialog lets you browse for the missing maps, or continue to render the scene without loading them.

Rendering Progress dialog

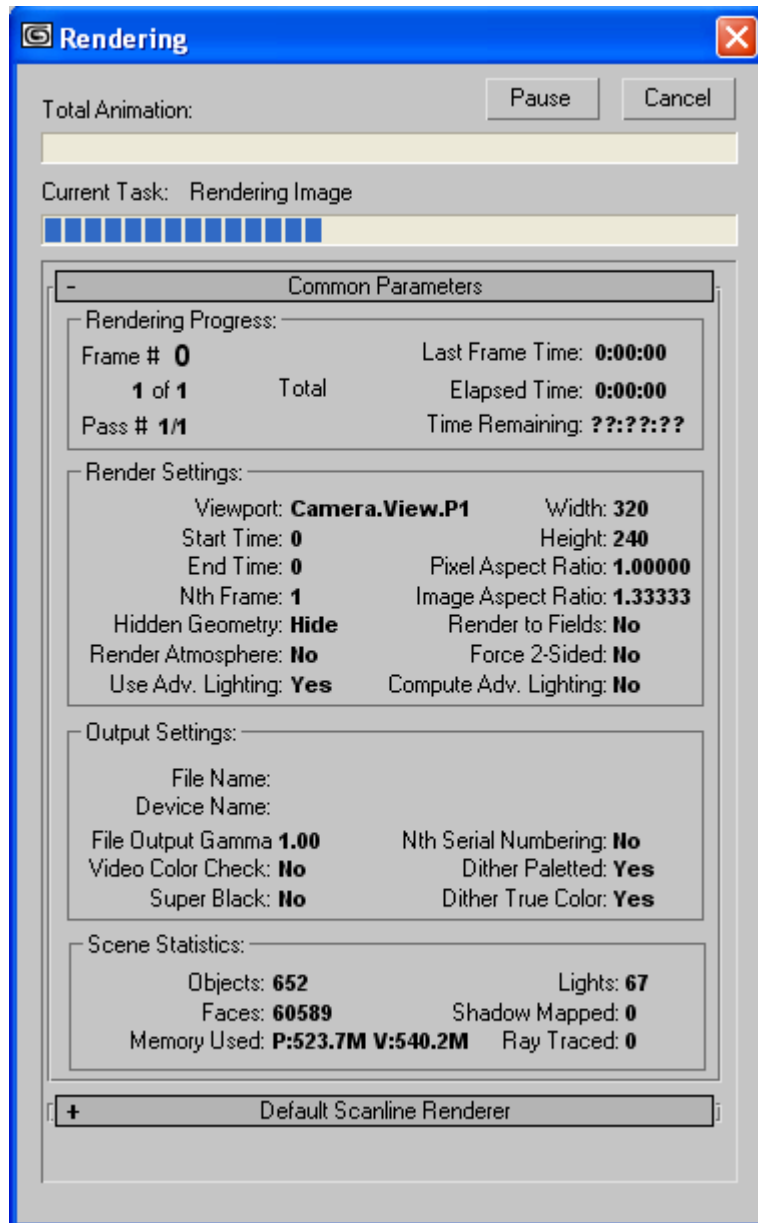

When you click Render, a rendering progress dialog shows the parameters being used, and a progress bar. The rendering dialog has a Pause button to the left of the Cancel button. When you click Pause, the rendering pauses, and the button's label changes to Resume. Click Resume to continue with the rendering.

NOTE The mental ray renderer does not support the Pause button. You can cancel a mental ray rendering, but you can't pause it.

Rendered Frame Window



Main toolbar > Rendered Frame Window

Rendering menu/main toolbar > Render Setup > Render Setup dialog > Render > Rendered Frame Window opens.

Rendering menu/main toolbar > Render > Rendered Frame Window opens.

File menu > View Image File > Choose a file to view. > Open > Rendered Frame Window (reduced functionality) displays the file.

NOTE  The Rendered Frame Window that opens when rendering offers a significantly expanded feature set in Autodesk 3ds Max 2009. Most of these settings already exist elsewhere in the program, but their addition to this dialog means that you can change parameters and re-render your scene without having to resort to other dialogs, thus speeding your workflow considerably.

The Rendered Frame Window displays rendered output. It has controls to:

- Set the area to render (region, etc.).
- Choose the viewport to render.
- Choose a render preset.
- Render the scene.
- Save the image to a file.
- Place a copy of the rendered image on the Windows clipboard, ready for pasting into another graphics application.

- Create a clone of the window. This displays a new window so you can create another rendering and compare it with the previous one.
- Open a new Rendered Frame Window.
- Toggle display of the red, green, and blue color channels.
- Display the [alpha channel](#) on page 7905.
- Display only monochrome (gray scale).
- Clear the image from the window.
- Print the rendered output.
- Change a number of mental ray-specific settings.

When you choose the View Image File command from the File menu, 3ds Max displays still images and image sequences in a feature-reduced version of the Rendered Frame Window. When you view sequentially numbered image files or images in an [IFL file](#) on page 7339, this window displays navigation arrows that let you step through the images.

Procedures

To zoom and pan in the Rendered Frame Window:

You can zoom in and out and pan the image in the Rendered Frame Window. You can even do this *while* a scene is rendering.

- To zoom in, hold down Ctrl and then click. To zoom out, use Ctrl+right-click.
- To pan, hold down Shift and then drag.

If you have a wheel mouse, you can use the wheel to zoom and pan:

- To zoom in or out, roll the wheel.
- To pan, press the wheel and drag.

NOTE You can use any third-button pointing device to pan the image. To enable this, open the Customize menu > Preferences dialog. Go to the [Viewports panel](#) on page 7753, and in the Mouse Control group choose the Pan/Zoom option (this is the default).

Interface

This first section documents the controls on the main Rendered Frame Window. For information about the additional control panel that appears below the main window when using mental ray, see [mental ray Rendering Options](#) on page 6080.

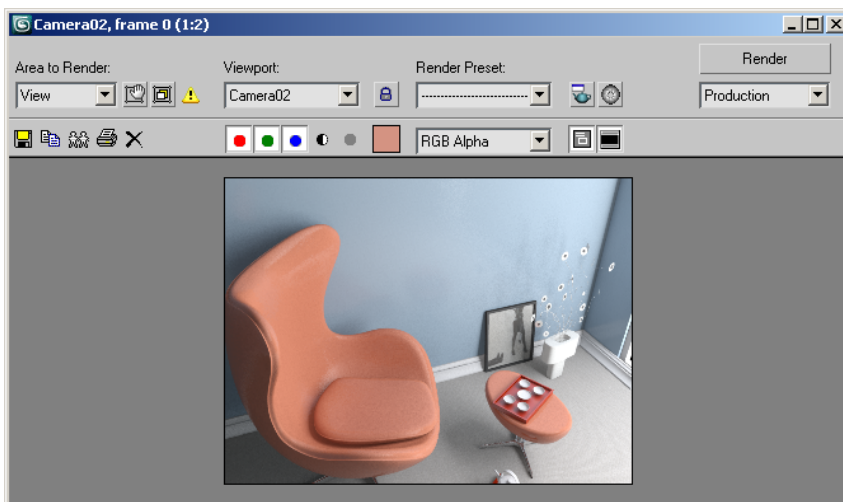

Rendered Frame Window Rendering Controls

These controls provide access to rendering settings such as presets and the viewport to render, as well as the Render command. To toggle display of these controls, click the Toggle UI button at the right end of the Rendered Frame Window toolbar.

Area to Render This drop-down list provides the available [Area to Render](#) on page 6095 options. Choose View, Selected, Region, Crop, or Blowup.

When using Region, Crop, or Blowup, set the region with the Edit Region control (see following) or with the [Edit Render Region command](#) on page 7583 on the viewport right-click menu. Alternatively, you can set the region automatically to the current selection with the Auto Region Selected option (also see following).



Edit Region Enables manipulation of the region window: resize by dragging the handles, and move by dragging inside the window. When Area

To Render is set to Region, you can edit the region both in the Rendered Frame Window and in the active viewport.

If Area To Render is set to View or Selected, clicking Edit Region switches to Region mode.

When Area To Render is set to Crop or Blowup, you can edit the region only in the active viewport, because in those cases the Rendered Frame Window doesn't necessarily reflect the same area as the viewport. Hence, also in Crop and Blowup modes, a [warning icon](#) on page 6076 appears to the right of the Auto Region Selected. The icon's tool tip suggests that you edit the region in the viewport. A warning also appears in Region mode if the Rendered Frame Window area doesn't match the active viewport.

Turning on Edit Region automatically activates the [Show Safe Frame](#) on page 7583 function in the active viewport.

NOTE 3ds Max maintains two separate render regions: one for Region and Crop, and another for Blowup. Changing the Area To Render option activates the relevant render region.

The same command is available from the viewport right-click menu, as [Edit Render Region](#) on page 7583.



Auto Region Selected When on, sets the region for Region, Crop, and Blowup automatically to the current selection. This auto-region is calculated at render time and does not overwrite the user-editable regions.

If Area To Render is set to View or Selected, clicking Auto Region Selected switches to Region mode.



[warning] This warning symbol appears when [Area to Render](#) on page 6075 is set to Crop or Blowup, accompanied by a tool tip that tells you to edit the Crop or Blowup region in the viewport. It also appears in Region mode if the Rendered Frame Window doesn't show the same area as the viewport (that is, if you previously rendered in Crop or Blowup mode).

Viewport Shows the viewport that renders when you click the Render button. The drop-down list contains all visible viewports. To specify a different viewport to render, choose it from the list or activate it in the main user interface.

Activating a different viewport in the main interface automatically updates this setting if Lock To Viewport is off.



Lock To Viewport When on, only the viewport active in the Viewport list renders, even if you activate a different viewport in the main interface. However, you can still choose a different viewport to render from the list. When off, activating a different viewport in the main user interface updates the Viewport value.

The same toggle is available from the viewport right-click menu, as [Lock Render to this View](#) on page 7583.

Render Preset Choose a [preset rendering option](#) on page 6114 from the drop-down list.



Render Setup Opens the [Render Setup dialog](#) on page 6067.



Environment and Effects Dialog (Exposure Controls) Opens the Environment and Effects dialog to the [Environment panel](#) on page 6689. You can set an exposure control on the Exposure Control rollout.

Production/Iterative Choose the result of clicking the Render button:

- **Production** Renders using all the current settings on the Rendered Frame Window, Render Setup, dialog, and so on.
- **Iterative** Ignores network rendering, rendering of multiple frames, file output, export to MI files, and email notification. Also, with the scanline renderer, rendering [Selected](#) on page 6097 leaves the rest of the Rendered Frame Window intact in Iterative mode.
Use this option when doing quick iterations on the image, usually in parts; for example, working on final gather settings, reflections, or specific objects or areas of the scene.

This choice is also available from a drop-down in the bottom-left corner of the Render Setup dialog. And you can render in either mode from the [render flyout](#) on page 6100 on the main toolbar.

Render Renders the scene using the current setup.

Rendered Frame Window toolbar



Save Image Allows you to save the rendered image displayed in the Rendered Frame Window.



Copy Image Places an exact copy of the visible portion of the rendered image on the Windows clipboard, ready for pasting into a paint program or bitmap editing software. The image is always copied as displayed, so, for example, if the [Monochrome button](#) on page 6079 is on, the copied data consists of an eight-bit grayscale bitmap.

NOTE No HDR (high-dynamic-range) data is copied.



Clone Rendered Frame Window Creates another window containing the displayed image. This allows you to render another image to the Rendered Frame Window and compare it with the previous, cloned image. You can clone the Rendered Frame Window any number of times. The cloned window uses the same initial zoom level as that of the original.

NOTE A cloned window provides minimal functionality, and cannot be re-rendered or cloned.



Print Image Sends the rendered image to the default printer as defined in Windows (in Windows XP, see Start menu > Settings > Printers And Faxes). The background prints as transparent.



Clear Clears the image from the Rendered Frame Window.



Enable Red Channel Displays the red channel of the rendered image. When turned off, the red channel is not displayed.



Enable Green Channel Displays the green channel of the rendered image. When turned off, the green channel is not displayed.



Enable Blue Channel Displays the blue channel of the rendered image. When turned off, the blue channel is not displayed.



Display Alpha Channel Displays the [alpha channel](#) on page 7905.



Monochrome Displays an 8-bit grayscale of the rendered image.

Channel Display List Lists any channel rendered with the image. When you choose a channel from the list, it is displayed in the Rendered Frame Window. For most kinds of files, only the RGB and alpha channels are available. If you render an [RPF file](#) on page 7366 or [RLA file](#) on page 7364, additional channels can be present.

The Rendered Frame Window displays nonvisual channels, such as Material Effects or the G-Buffer, using colors it assigns at random to distinct values.

Color Swatch Stores the color value of the last pixel you right-clicked. You can drag this color swatch to other color swatches in the program. Clicking the color swatch displays the [Color Selector](#) on page 391, which displays more information about the color.

You can leave the Color Selector displayed while you right-click over other pixels in the Rendered Frame Window. (Changing the current value in the Color Selector changes the color swatch on the Rendered Frame Window's toolbar, but it does not change the color of pixels in the rendered image.)



Toggle UI Overlays When on, displays the frame that shows the Region, Crop, or Blowup area when one of those options is active. To disable display of the frame, turn off this toggle.

NOTE The frame is still active when not displayed.



Toggle UI When on, all controls are available. When off, disables display of the rendering controls at the top of the dialog as well as the mental ray controls on the separate panel below the dialog. To simplify the dialog interface and allow it to take up less space, turn this off.

TIP When off, you can resize the window smaller than is possible when Toggle UI is on.

Layer This setting appears on the Rendered Frame Window toolbar when you render to the [RPF](#) on page 7366 or [RLA](#) on page 7364 file format. It lets you see the information at different layers of the following channels:

- Z Depth
- Normal
- Non-Clamped Color
- Coverage
- Node Render ID
- Color
- Sub-Pixel Weight
- Sub-Pixel Mask

Layer shows no additional information for other channels. It is useful primarily when the scene contains objects that occlude each other, and you have turned on the Render Occluded Objects toggle for these objects. (See [Object Properties](#) on page 305.) Be aware that rendering occluded objects increases render time.

TIP Rendering occluded objects can help you create 3D effects when you composite images with the Autodesk Combustion software.



Frame-Steps (arrows) When viewing sequentially numbered files (such as *image0005.jpg*) or IFL files, the arrows display the next or the previous file in the sequence. To jump to the first image or the last image in the sequence, hold down Ctrl and click an arrow.

Available only when you use the View Image File command on the File menu.



mental ray Rendering Options

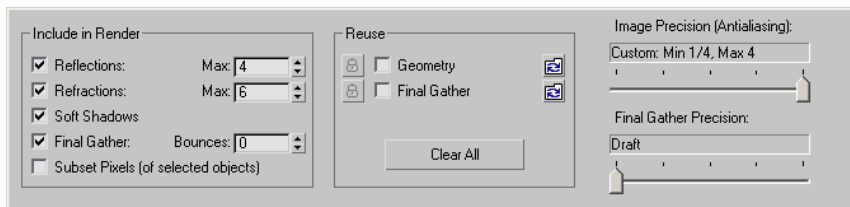

This additional panel appears below the Rendered Frame Window when mental ray is the active renderer.

NOTE Most of the settings on this panel are linked to settings on the Render Setup dialog, as noted in the following descriptions. Changing a setting here makes the same adjustment to the respective Render Setup setting, and vice-versa. If you change a setting here, the Render Setup dialog setting updates automatically, but the reverse is not true. If you change a setting on the Render Setup dialog, to see the change on this panel, you must click the panel.

Include in Render group

Reflections When on, mental ray traces reflections. Turn off to improve performance when you don't require reflections. See [Enable Reflections](#) on page 6281.

- **Max** Sets the number of times a ray can be reflected. At 0, no reflection occurs. At 1, the ray can be reflected once only. At 2, the ray can be reflected twice, and so on. Default=4.

Refractions When on, mental ray traces refraction. Turn off to improve performance when you don't require refraction. See [Enable Refractions](#) on page 6281.

- **Max** Sets the number of times a ray can be refracted. At 0, no refraction occurs. At 1, the ray can be refracted once only. At 2, the ray can be refracted twice, and so on. Default=6.

Soft Shadows When on, renders shadows from area lights normally. When off, renders all area lights or shadows as if they were emitted from point objects, speeding up rendering time. See [Area Lights/Shadows as Points](#) on page 6128.

Final Gather When on, the mental ray renderer uses [final gathering](#) on page 6295 to create global illumination or to improve its quality. Default=on.

The equivalent Render Setup dialog control is [Enable Final Gather](#) on page 6299.

- **Bounces** Sets the number of times mental ray calculates diffuse light bounces for each diffuse ray. Default=0.

The equivalent Render Setup dialog control is [Diffuse Bounces](#) on page 6300.

Subset Pixels (of selected objects) When on, rendering the scene applies only to selected objects. Unlike using the Selected option for rendering, however, using this option takes into account all scene elements that affect its appearance. This includes shadows, reflection, direct and indirect lighting,

and so on. Also, unlike Selected, which replaces the entire contents of the Rendered Frame Window (except for selected objects) with the background color, this option replaces only pixels used by the re-rendered selected objects. Subset pixel rendering is particularly useful when performing iterative rendering and refinement of lighting, shadows, and other scene elements for a particular object or set of objects in the scene. It lets you re-render repeatedly to view the results of isolated changes without disturbing the rest of the rendered output.

TIP Objectionable outlines might appear around objects rendered in Subset Pixel mode at low antialiasing settings. To eliminate any such outlines, increase the [antialiasing setting](#) on page 6083. For best results, use Medium antialiasing (Min 1/4, Max 4) or better.

The equivalent Render Setup dialog control is [Render changes to selected objects only](#) on page 6281.

Reuse group

These commands let you save rendering time by reusing translated geometry and final gather solutions. The Final Gather controls are available only when [Final Gather](#) on page 6081 is on.



Lock Geometry Translation Determines whether changed geometry is retranslated to mental ray format at render time. When on, sub-object-level changes such as vertex editing or adjusting a modifier such as Bend are ignored and don't cause retranslation. However, object-level changes such as moving or rotating an object are retranslated.

The equivalent Render Setup dialog control is Translator Options rollout > Geometry Caching group > [Lock Geometry Translation](#) on page 6321.

Geometry When on, rendering uses geometry caching. During the first render, the translated geometry is saved to the cache file. Then, in subsequent renderings of the same scene, the renderer uses the cached geometry for any unchanged objects instead of retranslating it. Any changed geometry is retranslated. Default=off.

The equivalent Render Setup dialog control is Translator Options rollout > Geometry Caching group > [Enable](#) on page 6321.

NOTE Network rendering does not support this option.



Clear Geometry Cache Deletes the cached geometry.

The equivalent Render Setup dialog control is Translator Options rollout > Geometry Caching group > [Clear Geometry Cache](#) on page 6321.



Lock Final Gather Determines whether or not mental ray uses the final gather map file as is. When off, mental ray can add new final gather points if necessary. When on, mental ray uses only the data in the specified file, and does not generate any new final gather points during the pre-processing stage. Available only Reuse > Final Gather is on (see following). Default=off.

The equivalent Render Setup dialog control is [Read Only \(FG Freeze\)](#) on page 6301.

Final Gather When on, generates (when necessary) and then uses a disk-based final gather map (FGM file) to save rendering time. If no FGM file is specified on the Render Setup dialog > Final Gather rollout (see [Final Gather Map group](#) on page 6300), 3ds Max uses the file name *temp.fgm*.

The equivalent Render Setup dialog control is [Read/Write File](#) on page 6300.



Clear Final Gather Cache Deletes the cached final gather solution.

The equivalent Render Setup dialog control is Final Gather Rollout > Final Gather Map group > [Delete File](#) on page 6301.

Clear All Deletes the cached geometry and final gather solution.

Image Precision/Final Gather Precision

These sliders provide handy presets for groups of antialiasing and final-gather settings.

Image Precision (Antialiasing) Provides presets for a number of recommended combinations of minimum and maximum Samples Per Pixel settings. For details, see [Samples per Pixel group](#) on page 6274.

Final Gather Precision Provides a quick, easy solution for final gather. The default presets are: Draft, Low, Medium, High, Very High, and Custom (the default choice). Available only when Final Gather is on. For details, see [FG Precision Presets](#) on page 6299.

Pixel Data

When you right-click the Rendered Frame Window, the color swatch is updated, and information about the rendering and the pixel beneath the mouse is displayed.

If you hold the right mouse button down while dragging, the information changes with each new pixel the mouse crosses.

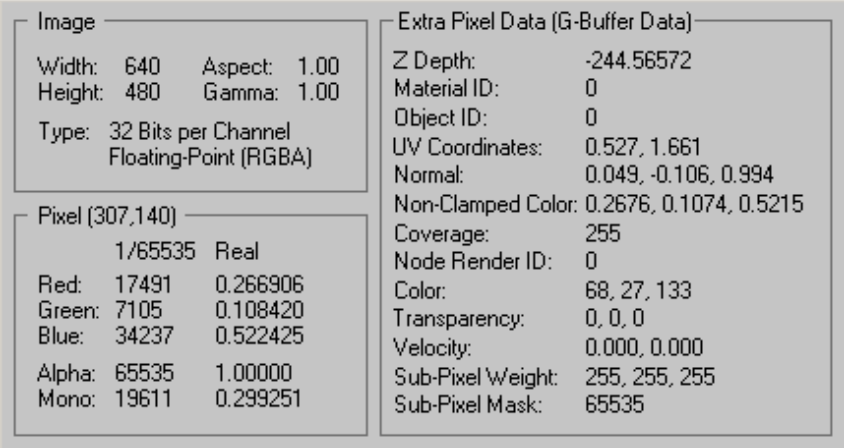

The screenshot shows a window titled 'Pixel Data' with three main sections:

- Image:**
 - Width: 640 Aspect: 1.00
 - Height: 480 Gamma: 1.00
 - Type: 32 Bits per Channel Floating-Point (RGBA)
- Pixel (307,140):**
 - 1/65535 Real
 - Red: 17491 0.266906
 - Green: 7105 0.108420
 - Blue: 34237 0.522425
 - Alpha: 65535 1.00000
 - Mono: 19611 0.299251
- Extra Pixel Data (G-Buffer Data):**
 - Z Depth: -244.56572
 - Material ID: 0
 - Object ID: 0
 - UV Coordinates: 0.527, 1.661
 - Normal: 0.049, -0.106, 0.994
 - Non-Clamped Color: 0.2676, 0.1074, 0.5215
 - Coverage: 255
 - Node Render ID: 0
 - Color: 68, 27, 133
 - Transparency: 0, 0, 0
 - Velocity: 0.000, 0.000
 - Sub-Pixel Weight: 255, 255, 255
 - Sub-Pixel Mask: 65535

The display includes the following information:

Image group

Width The width of the image in pixels.

Aspect The pixel aspect ratio.

Height The height of the image in pixels.

Gamma The gamma value carried in the bitmap file.

Type The type of image, based on color depth. For example, 64 bits (RGBA) or 32 Bits per Channel Floating-Point (RGBA).

Pixel group

Pixel information includes the pixel location in the bitmap, in parentheses following the Pixel group heading. The counting starts at 0. For example, in the above illustration, the pixel in question is the 308th from the left edge and the 141st from the top edge. Also shown in this group are channel values

for red, green, blue, alpha, and monochrome, both as 16-bit integers (0 to 65535) and as floating-point values between 0.0 and 1.0.

NOTE With high-dynamic-range images, the floating-point values can be greater than 1.0 or less than 0.0.

Red The red component value (0 to 65535) and the floating-point value.

Green The green component value (0 to 65535) and the floating-point value.

Blue The blue component value (0 to 65535) and the floating-point value.

Alpha The alpha component value (0 to 65535) and the floating-point value.

Mono The monochrome values of the pixel, using the same formula used by monochrome material map channels such as bump and opacity maps.

Extra Pixel Data (G-Buffer Data) group

If the rendering output uses a format that contains additional channels, such as [RPF](#) on page 7366 or [RLA](#) on page 7364, the informational pop-up shows this data in the Extra Pixel Data group. The group includes all the possible channels. If a channel is not present, its value is displayed as "N/A," for "not applicable."

Z Depth Displays Z-Buffer information in repeating gradients from white to black. The gradients indicate relative depth of the object in the scene.

Material ID Displays the Effects Channel used by a material assigned to an object in the scene. The Effects Channel is a material property set in the Material Editor.

Object ID Displays the G-Buffer Object Channel ID assigned to objects using the [Object Properties dialog](#) on page 305.

UV Coordinates Displays the range of UV mapping coordinates.

Normal Displays the orientation of normal vectors.

Non-Clamped Color Displays the "real" color value delivered to the renderer in RGB order. The renderer uses a floating-point range of 0.0 to 1.0 to represent the range of each color channel. Thus, 1.0 is 100%, or 65535 (real color values can be greater than 1, but are clamped by the renderer to 1).

Coverage Displays the coverage of the surface fragment from which other G-Buffer values (Z Depth, Normal, and so on) are obtained. Z-Coverage values range from 0 to 255.

Node Render ID Displays an object's G-Buffer Object channel.

Color Displays the color returned by the material shader for the fragment.

Transparency Displays transparency returned by the material shader for the fragment.

Velocity Displays the velocity vector of the fragment relative to the screen.

Sub-Pixel Weight Displays the sub-pixel weight of a fragment. The channel contains the fractions of the total pixel color contributed by the fragment. The sum of all the fragments gives the final pixel color. The weight for a given fragment takes into account the coverage of the fragment and the transparency of any fragments that are in front of a given fragment.

Sub-Pixel Mask Displays the sub-pixel alpha mask. This channel provides a mask of 16 bits (4x4) per pixel, used in antialiased alpha compositing.

Render Output File Dialog

Rendering menu > Render Setup > Render Setup dialog > Common panel > Common Parameters rollout > Render Output group > Click Files. > Render Output File

The Render Output File dialog lets you assign a name to the file that the rendering will output. You can also determine the type of file to render. Depending on your choice of file type, you can also set up options such as compression, and color depth and quality.

See also:

■ [Image File Formats](#) on page 7324

Procedures

To name the render output file:

- 1 Choose Rendering > Render Setup, and then in the Render Output group of the Common Parameters rollout, click Files.
This opens the Render Output File dialog.
- 2 Use the Save In field near the top of the dialog to choose the directory in which to save the rendered file.
- 3 In the File Name field, enter the name for the file to be rendered.

TIP If you enter a filename extension as well (for instance: *myimage.bmp*) and then press Tab, the Setup button activates and you can click it to change the file settings.

- 4 Choose the type of file you want to render from the Save As Type drop-down list.

TIP If you entered the filename extension as part of the file name, you can skip this step.

- 5 Click Save to close the Render Output File dialog.
Clicking Save also opens a dialog that lets you set the options for the file format you chose. Adjust these settings (or leave them at their defaults), and then click OK.
- 6 On the Render Setup dialog, click the Render button to render the scene and save the file.

NOTE If a file of the same name already exists, a dialog opens to let you confirm overwriting it. This dialog also provides a check box for automatically overwriting render-output files without being prompted for the duration of the session.

To set up options for the render-output file:

- 1 Choose Rendering > Render and then in the Render Output group of the Common Parameters rollout, click Files.
The Render Output File dialog opens.
- 2 In the File Name field, enter the name for the file to be rendered.
- 3 Navigate the Save In field to choose the directory where you want the rendered file to be saved.
- 4 Choose the type of file you want to render from the Save As Type drop-down list, then click Save.
A dialog is displayed that lets you set the options for the file format you chose. Adjust these settings (or leave them at their defaults), and then click OK.

NOTE You can also view the setup dialog by clicking Setup, if this button is available.

WARNING Make sure the file name extension in the File Name field matches the file type in the Save As Type field. Changing the file type *does not update* the file name automatically. The file options dialog depends on the type indicated by the file name, *not* the type indicated by Save As Type.

- 5 If the Render Output File dialog is still open, click Save.

Interface

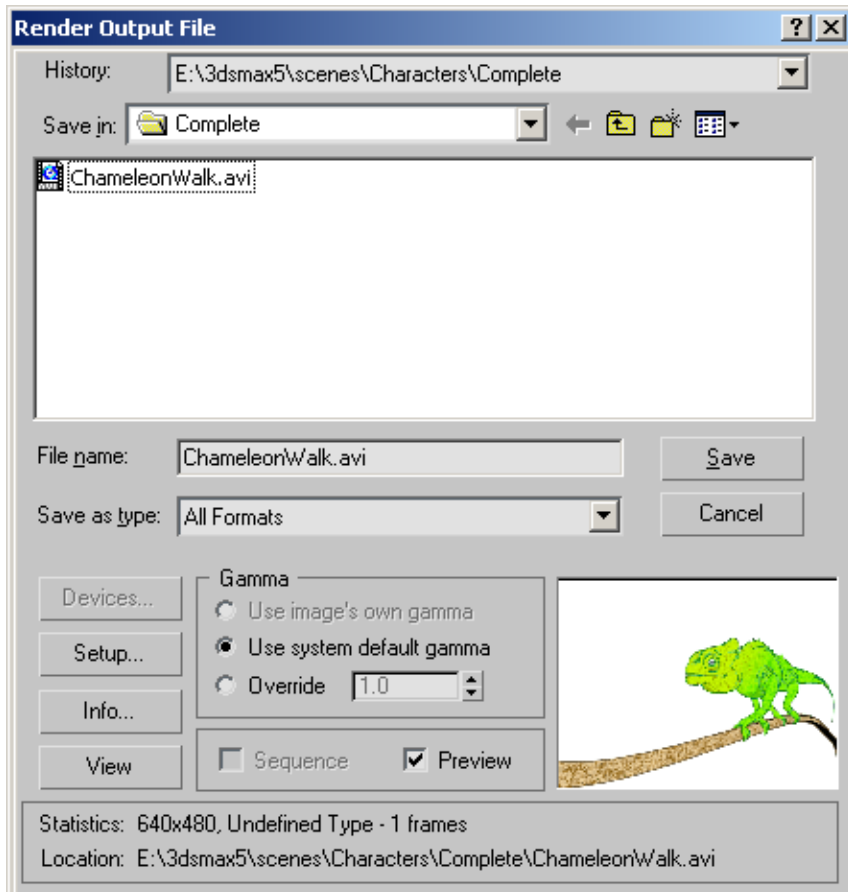

History Displays a list of the most recent directories searched. Whenever an image is selected, the path used is added to the top of the history list as the most recently used path.

The history information is saved in the [3dsmax.ini](#) on page 83 file.

Save In Opens a navigation window to browse other directories or drives.



Up One Level Moves you up a level in the directory structure.



Create New Folder Lets you create a new folder while in this dialog.



View Menu Provides several options for how information is displayed in the list window:

- **Thumbnails:** Displays the contents of a directory as thumbnails, without the details.
- **Tiles:** Displays the contents of a directory as large icons, without the details. If you widen the dialog, these tile across the width.
- **Small Icons:** Displays the contents of a directory as small icons, tiled across the width, without the details.
- **List:** Displays the contents of a directory without the details.
- **Details:** Displays the contents of a directory with full details such as size and date.

List of files Lists the contents of the directory, in the format specified by the View menu.

TIP When the active display format is Details, the contents of the directory are displayed with Name, Size, Type, Date Modified, and Attributes. You can sort the list according to a column's contents by clicking that column's label.

File name Displays the file name of the file selected in the list.

Save as type Displays all the file types that can be saved. This serves as a filter for the list.

NOTE The choice in this field determines the file type saved, regardless of the file name extension entered in the File Name field.

Save Sets the file information for saving upon rendering. Closes the dialog if you haven't changed the output file type.

If you've changed the file type, clicking Save opens the Setup dialog for the specified file type. Change the settings as necessary, and then click OK to close both the Setup and the Output dialogs, or click Cancel to return to the Output dialog.

Cancel Cancels the file save and closes the dialog.

Devices Lets you choose the hardware output device, for example, a digital video recorder. To use the device, the device, its driver, and its 3ds Max plug-in must all be installed on your system.

Setup Displays controls for the selected file type. These vary with each different file format. Change the settings as necessary, and then click OK or Cancel.

Info If you highlight an existing file in the list, clicking Info displays expanded information about the file such as frame rate, compression quality, file size, and resolution. The information here depends on the type of information saved with the file type.

View If you highlight an existing file in the list, clicking View displays the file at its actual resolution. If the file is a movie, the Media Player is opened so the file can be played.

Gamma group

To set up gamma options for the output file, Enable Gamma Correction must be on in the [Gamma panel](#) on page 7758 of the Preferences dialog (Customize > Preferences > Gamma). Otherwise, the Gamma controls are unavailable in the Render Output File dialog.

- **Use Image's Own Gamma** This option is not available in this dialog.
- **Use System Default Gamma** Uses the system default gamma, as set in the Gamma panel of the Preferences dialog.
- **Override** Defines a new gamma for the bitmap that differs from the system default.
Using Override is not recommended for bitmaps that you render. It is better to set a system default value, based on the graphic display you use, and use this same gamma value for all your renderings.

Sequence This is not available in the Render Output File dialog.

NOTE To render a sequence of still images, choose the Active Time Segment or define a range of frames in the Common Parameters rollout of the Render Setup dialog. If you have selected a still image file type, each frame will append a four-digit number to the name you have selected, incremented with each frame.

Preview When on, enables display of the image as a thumbnail.

Image thumbnail Displays a thumbnail of the selected file. Preview must be turned on.

Statistics Displays the resolution, color depth, file type, and number of frames of the selected file.

Location Displays the full path for the file.

Rendering Commands

The main commands for rendering are on the [main toolbar](#) on page 7499 and the [Rendered Frame Window](#) on page 6073. Another way to invoke some of these commands is to use the default [Rendering menu](#) on page 7493, which contains other commands related to rendering.



[Render Setup](#) on page 6092



[Area to Render](#) on page 6095



[Render Production](#) on page 6101



[ActiveShade](#) on page 6102

[ActiveShade Viewport](#) on page 6110

[Preset Rendering Options](#) on page 6114

[Render Last](#) on page 6117

See also:

- [Render Setup Dialog](#) on page 6067
- [Rendering with ActiveShade](#) on page 6102
- [ActiveShade Commands \(Quad Menu\)](#) on page 6111
- [Rendering Effects](#) on page 6583
- [Environment and Atmosphere Effects](#) on page 6687
- [Network Rendering](#) on page 6433

Render Setup

Main toolbar > Render Setup

Rendering menu > Render Setup

Keyboard > F10

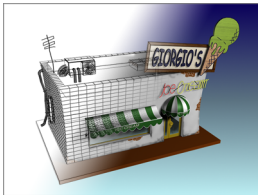

Rendering "fills in" geometry with color, shadow, lighting effects, and so on.

This command opens the [Render Setup dialog](#) on page 6067, which lets you set the parameters for rendering. Rendering creates a still image or an animation. It shades the scene's geometry using the lighting you've set up, the materials you've applied, and environment settings such as background and atmosphere.

Rendering is multi-threaded and multi-processed on multiple-processor configurations. A two-processor or dual-core system can render in nearly half the time a single-processor system can.

Rendering can also take place on multiple systems by using a network. See [Network Rendering](#) on page 6433. For the mental ray renderer, also see [Distributed Bucket Rendering Rollout \(mental ray Renderer\)](#) on page 6326.

Missing Mapping Coordinates

If the renderer finds a parametric object that requires mapping, it automatically sets its Generate Mapping Coordinates toggle before rendering the scene. The toggle remains set after the rendering is done.

In the following cases, however, 3ds Max is unable to supply mapping coordinates automatically:

- Non-parametric objects, such as imported meshes, don't have built-in coordinates.
- Some third-party (plug-in) objects aren't provided with mapping coordinates.

In these cases, 3ds Max is unable to render the scene completely. It displays a [Missing Mapping Coordinates dialog](#) on page 5780 that lists the objects the renderer couldn't map. To resolve the problem apply a [UVW Map modifier](#) on page 1931 to the objects that the dialog lists.

NOTE If a material has Show Map In Viewport set when that material is assigned to an object, the object's Generate Mapping Coordinates toggle is set, if it was not previously set. (The state of Show Map In Viewport is saved with each material.)

Procedures

To render a still image:

- 1 Activate the viewport to render.



- 2 Click Render Setup.

The [Render Setup dialog](#) on page 6067 appears.

- 3 In the Time Output group, make sure Single is on.
- 4 In the Output Size group, set other rendering parameters or use the defaults.
- 5 Click Render.
By default, the rendering appears in a window.

TIP  To render a view without using the dialog, click [Render](#) on page 6101 or use [Render Last](#) on page 6117 (press F9).

To render an animation:

- 1 Activate the viewport to render.

- 2  Click [Render Setup](#).

The [Render Setup dialog](#) on page 6067 appears.

- 3 Open the [Common Parameters rollout](#) on page 6121. Choose a time range in the Time Output group.
- 4 In the Output Size group, set other rendering parameters or use the defaults.
- 5 In the Render Output group, click Files.
- 6 A [Render Output File dialog](#) on page 6086 is displayed.
- 7 Use the file dialog to specify a name and a type for the animation file, and then click Save.

A configuration dialog opens that lets you set the options for the file format you chose. Adjust these settings or leave them at their defaults, and then click OK.

The configuration dialog closes, and on the Render Setup dialog > Common Parameters rollout, the Save File toggle is now available and on.

- 8 Click Render.

NOTE If you set a time range and do not specify a file to save to, the animation is rendered only to the window. This can be a time-consuming mistake, so an alert warns you about it.

TIP  To render a view without using the dialog, click [Render Production](#) on page 6101 or use the Keyboard Shortcut F9 to [Render Last](#) on page 6117.

Area to Render

Rendered Frame Window > Area to Render drop-down list

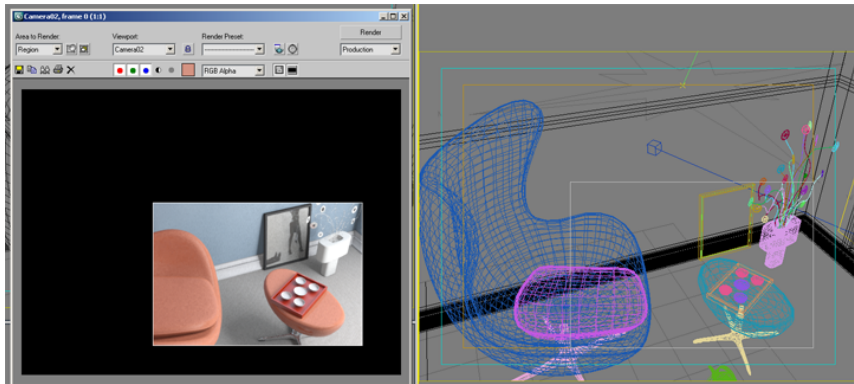

Area To Render lets you render only a portion of the scene.



The Area To Render list on the [Rendered Frame Window](#) on page 6073 lets you specify the portion of the scene that will be rendered.

Procedures

To render only selected objects:

- 1 Open the Rendered Frame Window.
- 2 From the Area To Render drop-down list in the top-left corner of the window, choose Selected.
- 3 Activate the viewport to render.
- 4 Select the objects to render.
- 5 Render the scene.

3ds Max displays a progress dialog that shows the progress of rendering and the rendering parameter settings. To stop rendering, click Cancel in this dialog, or press Esc.

To render a region:

- 1 Activate the viewport to render, or choose it from the Viewport drop-down list on the Rendered Frame Window.



- 2 On the Rendered Frame Window, click the Edit Region button. This automatically sets the Area To Render option to Region, and displays the region window in the Rendered Frame Window and the active viewport. The window has editing handles and a close box (X).
- 3 To move the region window, drag inside it. To adjust its size, drag the handles. To preserve the window's aspect ratio, press and hold Ctrl before you drag a handle.
- 4 Render the scene. 3ds Max renders the region only. In Production mode, the Rendered Frame Window is cleared before rendering, but in Iterative mode, the area of the window outside the region remains intact.

To render a blowup:

- 1 Open the Rendered Frame Window and choose the viewport to render.
- 2 Choose Blowup from the Area To Render list.



- The Edit Region button appears on the Rendered Frame Window, to the right of the Area To Render list, and the Blowup region window is displayed in the active viewport. This window is different from the one used for Region and Crop.
- The Blowup region window does not appear in the Rendered Frame Window because the region extents might exceed the window area, depending on the rendering history.
- 3 To move the window, drag inside it. To adjust the window size, drag its handles. The window is constrained to the aspect ratio of the current output size.
 - 4 Render the scene.

3ds Max displays a progress dialog that shows the progress of rendering and the rendering parameter settings. To stop rendering, click Cancel in this dialog, or press Esc.

Interface

The following choices are available on the Area To Render drop-down list.

NOTE The Box Selected, Region Selected, and Crop Selected options previously available are no longer necessary and have been removed from the software. To achieve the equivalents, combine an Area To Render option with the [Auto Region Selected](#) on page 6076 option on the Rendered Frame Window.

View (The default.) Renders the active viewport.



Selected Renders the currently selected object or objects only. Rendering a selection with the scanline renderer leaves the remainder of the Rendered Frame Window intact. However, mental ray renders the background first, thus effectively clearing the rest of the frame.

TIP Rendering Selected renders the selection in isolation, without any contribution from the rest of the scene, such as shadows, reflections, etc. When rendering with mental ray, to render a selection with full contribution from the other scene contents, use the [Subset Pixels](#) on page 6081 option instead.

 **TIP** To remove any existing image from the window when rendering with the scanline renderer, use the Clear button before rendering.



Region Renders a rectangular region within the active viewport. Using this option leaves the remainder of the Rendered Frame Window intact except when rendering an animation, in which case it clears the window first. Use the Region option when you need to test-render a part of the scene.

When you choose Region from the Area To Render list, the [Edit Region](#) on page 6075 control activates. This causes an editable version of the region to appear in both the Rendered Frame Window and the active viewport. To move the region or change its size, drag either region box or its handles, respectively. If you turn off Edit Region, the region remains visible in the Rendered Frame Window, but is no longer editable. Alternatively, to set the region to the current selection automatically, turn on [Auto Region Selected](#) on page 6076.

 **TIP** To remove any existing image from the window, use the Clear button before rendering.

NOTE Region rendering is meant to create a draft rendering of a selected area of a view. As such, Region rendering uses only an Area filter for antialiasing, regardless of which antialiasing is chosen in the Render Setup dialog.

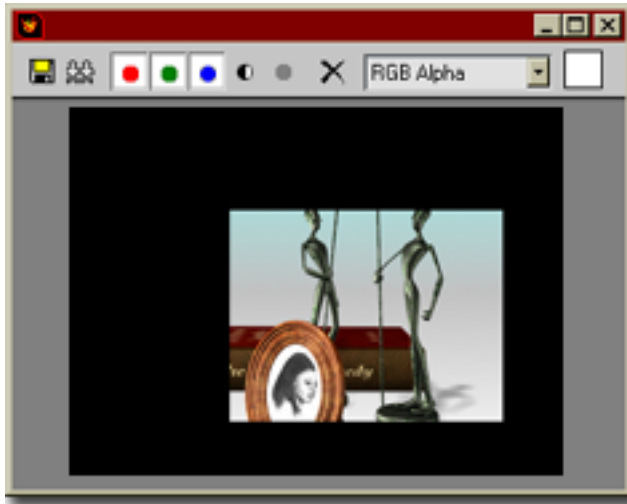

Crop Lets you specify the size of the output image using the same region box that appears for the Region option.



After you choose Crop from the Area To Render list, turn on [Edit Region](#) on page 6075 to cause a rectangular render region to appear in the active viewport. To move the region or change its size, drag the region box or its handles, respectively. Alternatively, to set the region to the current selection automatically, turn on [Auto Region Selected](#) on page 6076.

Blowup Renders a region within the active viewport and enlarges it to fill the output display.



After you choose Blowup from the Area To Render list, turn on [Edit Region](#) on page 6075 to cause a rectangular render region to appear in the active viewport. To move the region or change its size, drag the region box or its handles, respectively. Alternatively, to set the blowup region to the current selection automatically, turn on [Auto Region Selected](#) on page 6076.

Render Flyout

Main toolbar > Render flyout

The Render flyout lets you choose among these buttons:

-  [Render Production](#) on page 6101
-  [Render Iterative](#) on page 6101
-  [ActiveShade](#) on page 6102

The Render buttons let you render the scene using the settings without using the [Render Setup dialog](#) on page 6067. Choosing one of these buttons also changes which rendering settings are active on the Render Setup dialog.

Invoking the Render command from the Rendering menu or by pressing Shift+Q uses the active mode on the Render flyout.

By default, all the rendering options use the [default scanline renderer](#) on page 6141. You can change the renderer assigned to Production or ActiveShade by using the [Assign Renderer rollout](#) on page 6135 on the Render Setup dialog > Common panel.

Render Production

Main toolbar > Render flyout > Render Production

The Render Production command, available on the [Render flyout](#) on page 6100 on the main toolbar, renders the scene using the current production render settings without opening the [Render Setup dialog](#) on page 6067. You can activate Production rendering mode without rendering from the drop-down list in the bottom-left corner of the Render Setup dialog, and in the top-right corner of the Rendered Frame Window.

You assign which renderer to use for production rendering on the [Assign Renderer rollout](#) on page 6135 of the Render Setup dialog > Common panel.

See also:

- [Render Iterative](#) on page 6101
- [ActiveShade](#) on page 6102



Render Iterative

Main toolbar > Render flyout > Render Iterative

The Render Iterative command, available from the [Render flyout](#) on page 6100 on the main toolbar, renders the scene in iterative mode without opening the [Render Setup dialog](#) on page 6067. You can activate Iterative rendering mode without rendering from the drop-down list in the bottom-left corner of the

Render Setup dialog, and in the top-right corner of the Rendered Frame Window.

Iterative rendering ignores file output, network rendering, rendering of multiple frames, export to MI files, and email notification. Use this option when doing quick iterations on the image, usually in parts; for example, working on final gather settings, reflections, or specific objects or areas of the scene.

Also, when rendering in Iterative mode, rendering [Selected](#) on page 6097 or [Region](#) on page 6098 leaves the rest of the Rendered Frame Window intact.

See also:

- [Render Production](#) on page 6101
- [ActiveShade](#) on page 6102

ActiveShade



Main toolbar > Render flyout > ActiveShade

Keyboard > Shift+Q (Uses the Render mode currently active on the toolbar: either Production or ActiveShade)

The ActiveShade button, available from the [Render flyout](#) on page 6100, creates an [ActiveShade](#) on page 6102 rendering in a floating window.

You assign which renderer to use for ActiveShade rendering on the [Assign Renderer rollout](#) on page 6135 of the [Render Setup dialog](#) on page 6067 > Common panel.

See also:

- [Render Production](#) on page 6101
- [Render Iterative](#) on page 6101

Rendering with ActiveShade

Main toolbar > Render flyout > Render (ActiveShade)

Right-click viewport label. > Views > ActiveShade

ActiveShade gives you a preview rendering that can help you see the effects of changing lighting or materials in your scene. When you adjust lights or materials, the ActiveShade window interactively updates the rendering.

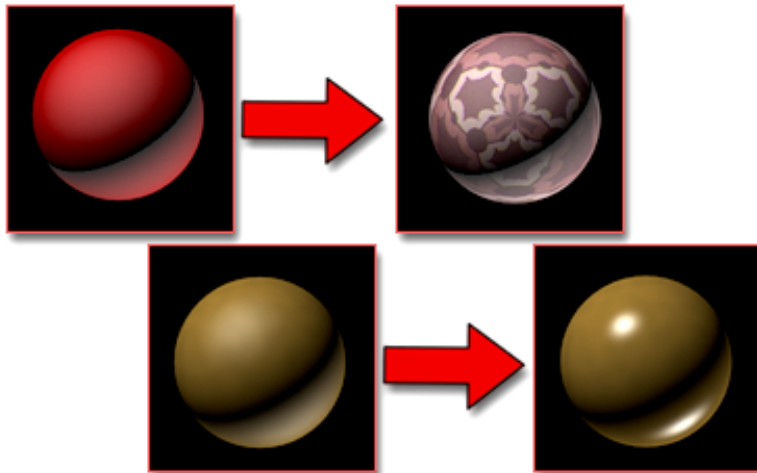
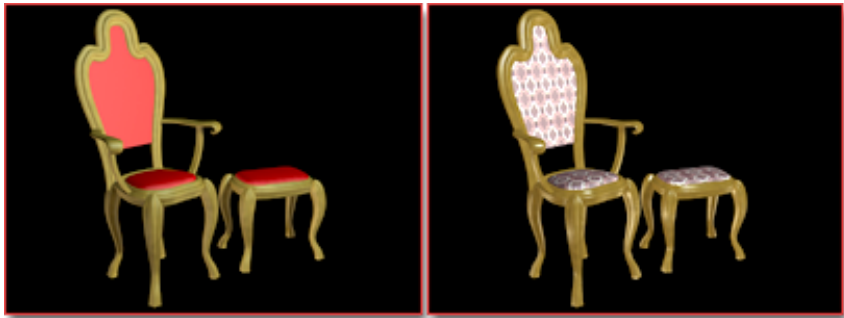

ActiveShade preview of material changes

Above left: Before the update

Above right: After changing the material for the fabric to a mapped material and increasing the highlights on the material for the wood

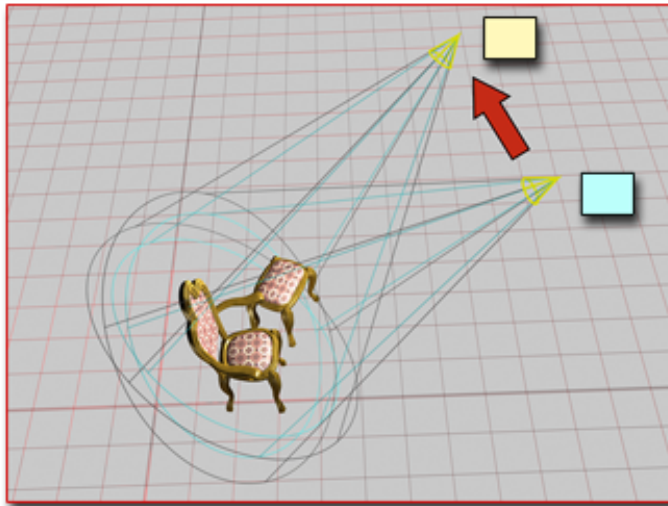

ActiveShade preview of lighting changes

Above left: Before moving a light in a viewport

Above right: After moving the light

There are two ActiveShade options:

- **Viewport** The ActiveShade rendering appears in the active viewport.

-  **Floater** The ActiveShade rendering appears in its own window.

Only one ActiveShade window can be active at a time. If you choose one of the ActiveShade commands while an ActiveShade window is already active, you get an alert that asks whether you want to close the previous one. If the

previous ActiveShade window was docked in a viewport, the viewport reverts to the view it previously showed.

TIP You can drag and drop materials from the [Material Editor](#) on page 5284 to ActiveShade windows and viewports, as you can with other viewports.



NOTE You can't make a maximized viewport an ActiveShade window, or maximize an ActiveShade window.

ActiveShade Commands

When you right-click an ActiveShade window, the [quad menu](#) on page 7516 displays an ActiveShade menu. This menu contains a number of [ActiveShade commands](#) on page 6111.

ActiveShade and Object Selection

If you select an object before you invoke ActiveShade, ActiveShade is done only for that object. This can greatly increase the speed of ActiveShade.

Similarly, once the ActiveShade window is open, the [initialize and update steps](#) on page 7899 (whether automatic or manual) are done only for the selected object.

In a "docked" ActiveShade viewport, you can select objects by right-clicking, turning on Select Object in the Tools (lower-right) quadrant of the quad menu, then clicking the object you want to select. In an ActiveShade viewport, only one object at a time can be selected.

TIP When an object in an ActiveShade window has a mapped material, select it before you change a map or adjust its parameters.

What ActiveShade Does and Doesn't Do

For the sake of interactivity, the ActiveShade window is limited in what it can update interactively. An ActiveShade rendering is typically less precise than a final production rendering.

TIP When you change geometry by transforming it or modifying it, right-click the ActiveShade window and choose Tools > Initialize from the quad menu (lower-right quadrant). This updates the ActiveShade rendering.

- Moving an object does not update the ActiveShade window.
- Applying a modifier or otherwise changing object geometry does not interactively update the ActiveShade window.
- Reflections are rendered only in the Initialize pass.
- Materials are displayed as RGBA data with 8 bits per channel.
- Multiple changes to a material might lead to deterioration in image quality. If you see this happening, right-click the ActiveShade window and choose Tools > Initialize from the quad menu (lower-right quadrant).
- Masks are reduced from 8x8 to 4x4 subdivisions per pixel. The mask is corrected to 6-bit opacity (0 to 63 rather than 0 to 255). This might result in some visual noise around object edges.
- Because of the preceding item, filters are coarser than in full-scale renderings, but they still have significant subpixel information.
- There is a limitation of 16 subdivisions per pixel. Because of this, any objects behind the sixteenth occluding object for a given pixel will be ignored. Rendered back faces count as separate objects.
- Reshading uses compressed normals and other direction vectors. This should have no visible effect.
- ActiveShade does not render atmospheric effects, rendering effects, or ray-traced shadows (the only shadows it can render are shadow-mapped shadows).

Procedures

To display an ActiveShade window in a viewport:

- Right-click the viewport label, choose Views, and then ActiveShade.



NOTE You can't make a maximized viewport an ActiveShade window, or maximize an ActiveShade window.

To display a free-floating ActiveShade window:



- Choose ActiveShade from the [Render flyout](#) on page 6100.

NOTE As with the Render command, the ActiveShade window respects the Output Size setting from the [Render Setup dialog](#) on page 6067. To use a different render size, set it first with Render Setup, and then open the ActiveShade window.

To update an ActiveShade window after moving an object or changing object geometry:

- 1 Right-click the ActiveShade window.
- 2 In the Tools (lower-right) quadrant of the quad menu, choose Initialize.

To see the toolbar in an ActiveShade viewport:

- 1 Click the viewport to make it active.
- 2 Press the Spacebar to display the toolbar.
Pressing spacebar again toggles the toolbar off, and so on.
You can also turn toolbar display on or off by right-clicking and using the quad menu.

To change an ActiveShade viewport to another kind of viewport:

- 1 Turn on the toolbar in the ActiveShade viewport.
- 2 Right-click the toolbar.
- 3 In the pop-up menu, choose the type of view to display.
You can also restore the viewport to its previous status by right-clicking the viewport and choosing View (upper-left) quad > Close.

To zoom and pan in an ActiveShade window:

You can zoom in and out and pan the image in the ActiveShade window. You can even do this *while* a scene is rendering.

- 1 Hold down Ctrl and then click to zoom in, right-click to zoom out.
- 2 Hold down Shift and then drag to pan. (The window must be zoomed in.)

If you have a three-button mouse, you can use its third button or wheel to zoom and pan:

- 1 Roll the wheel to zoom in or out.
- 2 Press the wheel, and drag to pan.

NOTE You can use any third-button pointing device to pan the image. To enable this, choose the Pan/Zoom option on the [Viewports panel](#) on page 7753 of the Preferences dialog

Interface

Both the viewport and floating versions of the ActiveShade window have the same controls as a [Rendered Frame Window](#) on page 6073. In an ActiveShade viewport, the toolbar is off by default. In a floating ActiveShade window, the toolbar is always visible.

TIP In an active ActiveShade viewport, you can toggle toolbar display by pressing the Spacebar. (This is a main user interface shortcut, so the Keyboard Shortcut Override Toggle can be either on or off.)

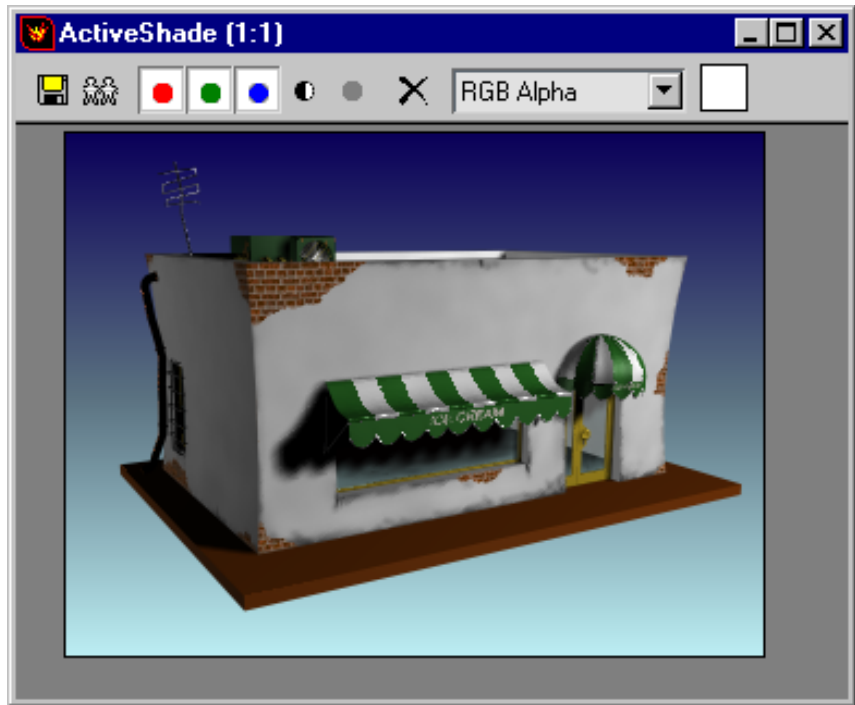

TIP If you clear the image, you can redisplay it by right-clicking the ActiveShade window and choosing Tools > Initialize or Tools > Update Shading from the lower-right quadrant of the quad menu.

ActiveShade Floater

Main toolbar > Render flyout > ActiveShade

To create an ActiveShade rendering in its own window, choose the ActiveShade command from the Render flyout on the main toolbar.

You can open only one ActiveShade window at a time. If you change a viewport to an ActiveShade view while a floating ActiveShade window is open, you get a message that asks whether you want to close the floating window or stop the operation.

See also:

- [Rendering with ActiveShade](#) on page 6102

- [ActiveShade Commands \(Quad Menu\)](#) on page 6111
- [ActiveShade Initialize and Update](#) on page 7899

ActiveShade Viewport

Right-click viewport label. > Views > ActiveShade

Creates an [ActiveShade rendering](#) on page 6102 that is "docked" in a viewport.

Only one ActiveShade rendering can be displayed at a time. If you try to display a floating ActiveShade window while an ActiveShade viewport is displayed, you get a message that asks whether you want to close the docked ActiveShade rendering, or stop the operation. If you go ahead and close the docked ActiveShade rendering, the viewport reverts to the view it previously showed.

ActiveShade Commands

When you right-click an ActiveShade viewport, the [quad menu](#) on page 7516 displays an ActiveShade menu. This menu contains a number of [ActiveShade commands](#) on page 6111.

ActiveShade and Object Selection

If you select an object before you invoke ActiveShade, ActiveShade is done only for that object. This can greatly increase the speed of ActiveShade.

Similarly, once the ActiveShade window is open, the [initialize and update steps](#) on page 7899 (whether automatic or manual) are done only for the selected object.

In a "docked" ActiveShade viewport, you can select objects by right-clicking, turning on Select Object in the Tools (lower-right) quadrant of the quad menu, then clicking the object you want to select. In an ActiveShade viewport, only one object at a time can be selected.

TIP When an object in an ActiveShade window has a mapped material, select it before you change a map or adjust its parameters.

Procedures

To display the toolbar for the ActiveShade viewport:

- Press the Spacebar.
The Spacebar toggles the toolbar display. In viewports, the toolbar is off by default.
(This is a main user interface shortcut, so the Keyboard Shortcut Override Toggle can be either on or off.)

The controls on the toolbar for an ActiveShade viewport are the same as for a [floating ActiveShade window](#) on page 6109.

To change the ActiveShade viewport to another kind of viewport, do one of the following:

- Right-click the ActiveShade viewport, and choose Close from the View (upper-left) quadrant of the quad menu.
The viewport reverts to the view it previously showed.
- If the toolbar is not visible, press the Spacebar to display it, then right-click the toolbar and choose the kind of view to display.

ActiveShade Commands (Quad Menu)

When you right-click an ActiveShade window, the lower-left quadrant of the quad menu displays a set of commands for [ActiveShade](#) on page 6102.

Interface

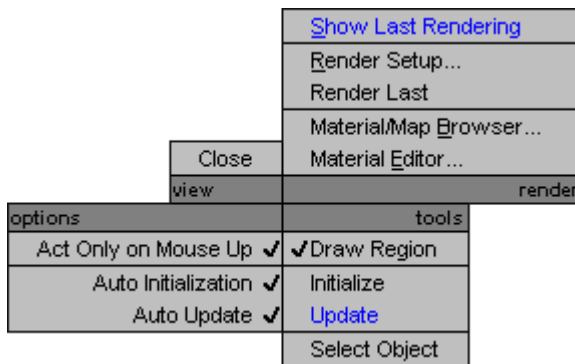

Render quadrant (upper right)

These are general-purpose commands.

Show Last Rendering Displays the last rendering in a [Rendered Frame Window](#) on page 6073. Not available if no rendering has been made during this session.

Render Setup Displays the [Render Setup dialog](#) on page 6067. When you use the ActiveShade quad menu, Render Setup is set to render the ActiveShade window initially.

Render Last Repeats the last render, using the last viewport from which you rendered.

Material/Map Browser Opens a modeless [Material/Map Browser](#) on page 5357 dialog.

Material Editor opens the [Material Editor](#) on page 5284.

Tools quadrant (lower right)

These are the commands that perform ActiveShade operations.

Draw Region When on, lets you draw a rectangular region of the ActiveShade window. While it is active, only the region is updated by interactive reshading. This can save time, and also help you concentrate on just a portion of the image to be rendered. Default=off.

To turn off Draw Region, click outside the rectangular region. The entire ActiveShade window is updatable again.

Initialize Initializes the ActiveShade window. To keep the ActiveShade window current, you need to choose Initialize after transforming, modifying, or otherwise changing geometry. If you have turned off Automatic Reinitialization, you also need to choose Initialize after you update a mapped material.

Rendering can be slow. The initialize pass is meant to take care of the most time-consuming portions of rendering, to allow the update pass to take place as quickly as possible. Initialization includes the following steps:

- Evaluate the scene geometry into meshes.
- Apply space warps.
- Do transformations and clipping.
- Evaluate textures and shade materials.

- Perform optimizations to speed later processing, such as merging fragments from the same surface that are in the same pixel.

The result of initialization is a buffer. This is a compressed rendering that, like a [G-Buffer](#) on page 7991, contains the rendering plus additional information used by the second step, updating.

During the initialize pass, progress is indicated by a row of pixels (white by default) that traverses the top edge of the ActiveShade window.

Update Updates the ActiveShade window. Updating shading takes the buffer created by the first pass, initialization, and uses information in that buffer to change the color of pixels when you make changes to lights and materials in the scene.

During the update pass, progress is indicated by a row of pixels (white by default) that descends the right edge of the ActiveShade window.

To keep the ActiveShade window current, you need to choose Update Shading if you have previously turned off Automatic Shading Update.

Select Object (viewports only) When on, you can select an object in the ActiveShade window by clicking. You can select only one object at a time.

When an object is selected in the ActiveShade window, the Initialize pass resamples textures for that object alone. This improves the window's rendering speed, and is useful when you are adjusting texture display.

Toggle Toolbar (viewports only) Toggles display of the ActiveShade window toolbar in viewports.

Keyboard shortcut: Spacebar



NOTE The [Keyboard Shortcut Override toggle](#) on page 7858 must be on for the spacebar to toggle the ActiveShade toolbar.

Options quadrant (lower left)

These commands control how the ActiveShade window behaves.

Act Only On Mouse Up When on, changes you make to light and material parameters (for example, the RGB or Multiplier spinners) update the ActiveShade window only after you release the mouse. When off, changes to these parameters are updated immediately, as you drag the mouse. Default=on. Turning off Act Only On Mouse Up can make the ActiveShade window more responsive to changes, but it can also slow performance.

Auto Initialization When on, changes you make to textures (mapped materials) automatically cause the ActiveShade window to initialize. Default=on.

Initialization can be time consuming in complex scenes. To save time, you can turn off Automatic Reinitialization, or use Draw Region to restrict initialization and shading updates to only a portion of the scene.

Auto Update When on, changes you make to lighting, and materials without maps, automatically cause an update of the ActiveReshade window. Default=on.

View quadrant (upper left)

Close Closes the ActiveShade window. If the ActiveShade window was docked in a viewport, the viewport reverts to the view it previously displayed.

Preset Rendering Options

Render Setup dialog > Preset drop-down list (near the bottom of the panel)

Rendered Frame Window > Render Preset drop-down list (in the top row of controls)

[Render Shortcuts toolbar](#) on page 7506 > drop-down list

Preset rendering options are available on the [Render Setup dialog](#) on page 6067, the [Rendered Frame Window](#) on page 6073, and the [Render Shortcuts toolbar](#) on page 7506. Some of the presets are tailored for relatively quick, preview renderings; others are for slower but higher quality renderings. You can save and load presets as RPS files.

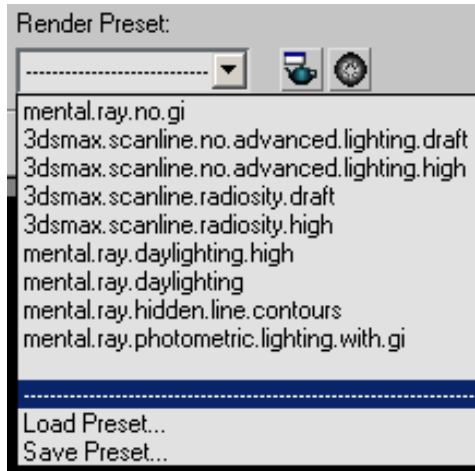

In addition to the default presets that ship with 3ds Max, you can create your own. At the bottom of the Preset list, two choices let you use and create your own custom presets:

Load Preset When you choose Load Preset, 3ds Max opens a file selector dialog that lets you choose the RPS file to load.

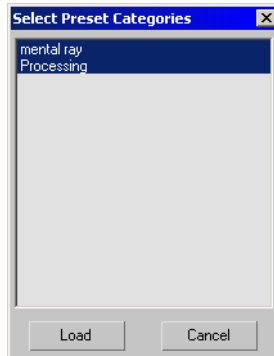

Each category corresponds to one panel of the Render Setup dialog. Choose which panel's settings you want to load from the RPS file, and click Load. Once you load a custom preset file, its name appears on the drop-down list, along with the default choices.

IMPORTANT Although you assign the renderer on the Common panel of the Render Setup dialog, the renderer assignment is *not* among the Common category settings in the RPS file. Instead, each preset has a separate category for the current renderer assignment. For example, if the current renderer is the Default Scanline Renderer, the Select Preset Categories dialog will have a category labeled *Default Scanline Renderer*.

Save Preset When you choose Save Preset, 3ds Max first opens a file selector dialog that lets you name the RPS file. After that, the Select Preset Categories dialog opens.

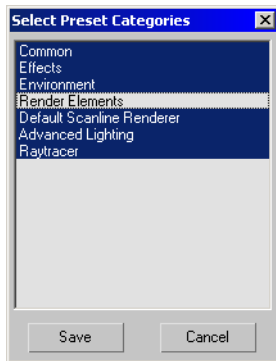

Each category corresponds to one panel of the Render Setup dialog. Choose which panel's settings you want to save, and then click Save. Once you save a custom preset file, its name appears on the drop-down list, along with the default choices.

IMPORTANT Even though the renderer is assigned on the Common panel of the Render Setup dialog, the renderer assignment is *not* saved with the Common category in the RPS file. The renderer assignment has its own category on the Select Preset Categories dialog. For example, if the current renderer is the Default Scanline Renderer, the Select Preset Categories dialog will have a category labeled *Default Scanline Renderer*.

The RPS files that provide the default presets are in the `\renderpresets` subfolder of the program folder. We recommend you save your own presets in this subfolder as well. If you choose a different location, 3ds Max saves the full path name. (You can also use the Configure User Paths dialog > [File I/O panel](#) on page 7733 > RenderPresets setting to specify a custom location.)

Render Last

Keyboard > F9

The Render Last command repeats the last render (whether a render view, render region, render blowup, or render selected) using the last viewport from which you rendered.

WARNING Render Last does not save to a file, even if the previous rendering did so.

Print Size Wizard

Rendering menu > Print Size Assistant

The Print Size Wizard feature is useful when you plan to print a rendered image. It lets you specify output size, resolution, and orientation in terms of the printed image; that is, using a standard measuring system rather than pixels. It also indicates the approximate uncompressed size of the image file. You can render directly from the wizard on your computer or over a network, or transfer the settings to the [Render Setup dialog](#) on page 6067.

Procedures

To use the Print Size wizard:

- 1 Set up a scene to render.
- 2 From the Rendering menu, choose Print Size Assistant.
- 3 Choose a preset paper size, or specify a custom size in inches or millimeters. Alternatively, specify an image size in pixels.
- 4 Choose or specify a DPI (dots per inch) ratio for the printed output.
- 5 Choose an output orientation: Portrait or Landscape.
- 6 When ready to render to a file, turn on Save File, click the Files button, and use the resulting Select TIFF File dialog to specify an output image file.
- 7 Do one of the following:
 - To render immediately, click Render.
 - To set further rendering properties, click Render Setup.

Interface

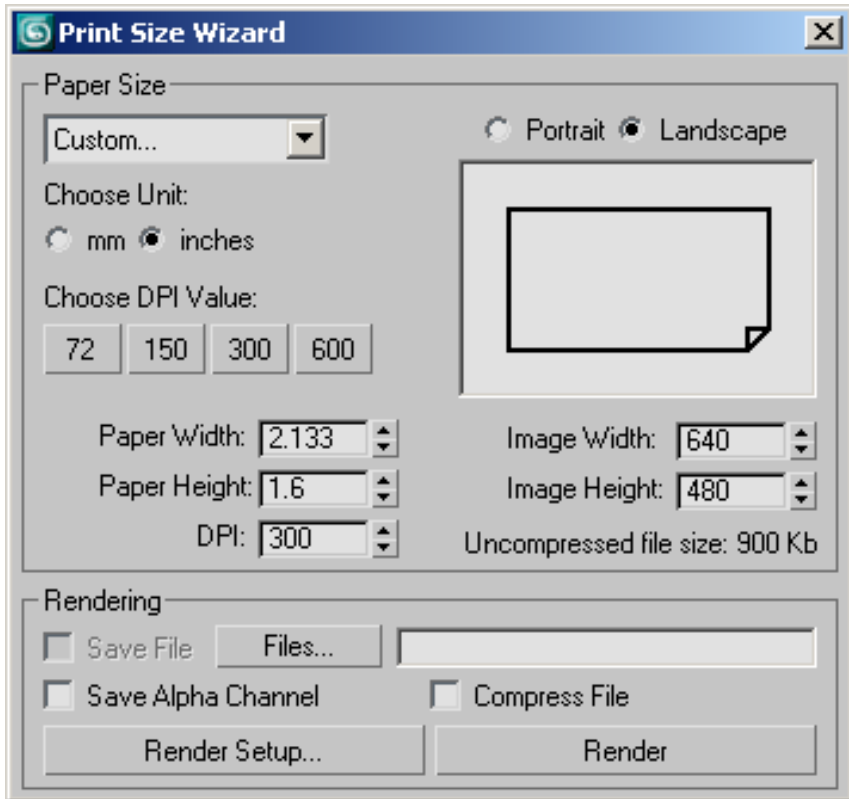

Paper Size group

drop-down list The Paper Size drop-down list lets you choose from several standard print resolutions and aspect ratios. Choose one of these formats, or leave it set to Custom to use the other controls in the Paper Size group. These are the options you can choose from on the list:

- Custom
- A - 11 x 8.5 in. (at 300 dpi)
- B - 17 x 11 in. (at 200 dpi)
- C - 22 x 17 in. (at 150 dpi)
- D - 34 x 22 in. (at 100 dpi)

- E - 44 x 34 in. (at 75 dpi)
- A0 - 1189 x 841 mm (at 75 dpi)
- A1 - 841 x 594 mm (at 100 dpi)
- A2 - 594 x 420 mm (at 150 dpi)
- A3 - 420 x 297 mm (at 200 dpi)
- A4 - 297 x 210 mm (at 300 dpi)
- A5 - 210 x 148 mm (at 300 dpi)
- Letter (11 x 8.5 in. at 300 dpi)
- Legal (14 x 8.5 in. at 300 dpi)
- Tabloid (17 x 11 in. at 300 dpi)

TIP You can customize the Paper Size list by editing the file *plugcfg\printwiz.ini*. If you choose to edit the file, first be sure to save a backup copy of the original.

Portrait/Landscape Choose Portrait for vertically oriented output or Landscape for horizontal output. The window image provides a graphic depiction of the orientation.

NOTE Changing between Portrait and Landscape simply switches the Width and Height settings. The actual orientation depends on the image dimensions. For example, if you choose Portrait, and then specify a custom size whose width is greater than its height, the resulting orientation will be horizontal.

TIP After changing this setting, be sure to preview the image using the [Show Safe Frame](#) on page 7583 function from the viewport right-click menu. This shows how the output orientation corresponds to the viewport.

Choose Unit Lets you specify whether the measurement units for Paper Width and Paper Height are in millimeters (mm) or inches.

Choose DPI Value Provides four buttons for commonly used dots-per-inch settings: 72, 150, 300, and 600. Click one to set it in the DPI property, below.

Paper Width/Height Specifies the output width and height in mm (millimeters) or inches, depending on which is chosen under Choose Unit.

NOTE Changing either setting also changes the corresponding Image size setting.

Image Width/Height Specifies the output width and height in pixels.

NOTE Changing either setting also changes the corresponding Paper size setting.

DPI Specifies the output resolution in dots per inch. The easiest way to set this is by clicking one of the buttons under Choose DPI Value. If you're using a different resolution, set it here manually.

Only [TIFF files](#) on page 7372 support DPI information. If you render to a different image format, you might have to later adjust the image resolution using an image-processing application.

NOTE Changing the DPI setting also changes the Image Width/Height settings, keeping the same aspect ratio.

Uncompressed File Size Displays the size of the rendered TIFF image file if no compression is used.

Rendering group

Rendering directly from the Print Size Wizard allows you to output the current frame to a disk file in [TIFF format](#) on page 7372. This format is commonly used in the publishing industry. To render to a different format, use the wizard's Render Setup button.

Save File When on, the software saves the rendered image to disk when you render. Save File is available only after you specify the output file using the Files button. Default=off.

Files Opens the Select TIFF File dialog, which lets you specify the output file name and location. If, during the current session, you already rendered an image to disk using the [Render Setup dialog](#) on page 6067, the last file name you used appears in this field.

Save Alpha Channel When on, the software includes an eight-bit [alpha channel](#) on page 7905 in the rendered [TIFF file](#) on page 7372. Default=off.

Compress File When on, uses compression when saving the file.

Render Setup Opens the [Render Setup dialog](#) on page 6067 and transfers any settings (such as image size) you've made in the Print Size Wizard. Here you can make further changes and then render the scene.

Render Renders the scene to the [Rendered Frame Window](#) on page 6073. Also renders to a disk file if you've turned on Save File and specified a file name.

Common Panel (Render Setup Dialog)

[Render Setup dialog](#) on page 6067 > Common panel

The Common panel of the Render Setup dialog contains controls that apply to any rendering, regardless of which renderer you have chosen, and that lets you choose renderers.

Interface

[Common Parameters Rollout \(Render Setup Dialog\)](#) on page 6121

[Email Notifications Rollout](#) on page 6131

[Scripts Rollout \(Render Setup Dialog\)](#) on page 6133

[Assign Renderer Rollout](#) on page 6135

Common Parameters Rollout (Render Setup Dialog)

Rendering menu > Render Setup > Render Setup dialog > Common panel > Common Parameters rollout

The Common Parameters rollout sets parameters common to all renderers.

Procedures

To set the size of the image, do one of the following:

- 1 In the Output Size group, click one of the preset resolution buttons.
- 2 In the Output Size group, choose one of the pre-formatted film or video formats from the drop-down list.
- 3 In the Output Size group, choose Custom from the drop-down list, and then adjust the Width, Height, and Aspect Ratio values manually.

TIP Smaller images render much more quickly. For example, you can use 320 x 240 to render draft images, then change to a larger size for your final work.

To save the rendered still image in a file:

- 1 In the Render Output group, click Files.

- 2 In the file dialog, specify a name and a type for the image file, and then click OK.

The Save File toggle turns on.

You can later turn off Save File if you want only to view the rendering on screen.

NOTE The file dialog has a Setup button. This displays a subdialog that lets you choose options specific to the file type you are saving to.

To alter the pixel aspect ratio:

- In the Output Size group of the Render Setup dialog > Common panel > Common Parameters rollout, adjust the Pixel Aspect setting to fit the requirements of your output device.

The Image Aspect field updates to show the aspect ratio of the rendered output.

If you alter the pixel aspect ratio but also render to a window or a file, the rendered image might appear distorted.

To speed up rendering time for the purpose of a test (or draft) rendering:

- 1 In the Options group of the Common Parameters panel, turn on Area Lights/Shadows As Points.
- 2 Set any other parameters and click Render.

All area and linear lights in the scene are treated as point lights during the rendering. This reduces rendering time, however some quality is lost. When you are ready to render at high quality, you can simply turn off Area Lights/Shadows As Points and render again.

NOTE Scenes with [radiosity](#) on page 6168 are not affected by the Area Lights/Shadows As Points toggle, as area lights do not have a significant effect on the performance of a radiosity solution.

Interface

Common Parameters

Time Output

Single Every Nth Frame:

Active Time Segment: 0 To 100

Range: To

File Number Base:

Frames:

Output Size

Custom Aperture Width(mm):

Width: 320x240 720x486

Height: 640x480 800x600

Image Aspect: Pixel Aspect:

Options

Atmospheric Render Hidden Geometry

Effects Area Lights/Shadows as Points

Displacement Force 2-Sided

Video Color Check Super Black

Render to Fields

Advanced Lighting

Use Advanced Lighting

Compute Advanced Lighting when Required

Bitmap Proxies

Using Bitmap Proxies for Rendering

Render Output

Save File

Put Image File List(s) in Output Path(s)

Autodesk ME Image Sequence File (.imsq)

Legacy 3ds max Image File List (.iff)

Use Device

Rendered Frame Window Net Render

Skip Existing Images

Time Output group

Select which frames you want to render.

Single Current frame only.

Active Time Segment The [Active Time Segment](#) on page 7898 is the current range of frames as shown in the time slider.

Range All the frames between and including the two numbers you specify.

Frames Nonsequential frames separated by commas (for example, 2,5) or ranges of frames, separated by hyphens (for example, 0-5).

- **File Number Base** Specifies the base file number, from which the file name will increment. Range= -99,999 to 99,999. Available only for Active Time Segment and Range output.
- **Every Nth frame** Regular sample of frames. For example, type 8 to render every 8th frame. Available only for Active Time Segment and Range output.

For example, if the Range of frames is set to 0-3, Every Nth Frame is 1, and the File Number Base is 15, the output files are *file0015*, *file0016*, *file0017*, *file0018*.

You can specify a negative number base, as well. For example, if you're rendering frames 50-55, and set the File Number Base to -50, the result is *file-050*, *file-051*, *file-052*, *file-053*, *file-054*, *file-055*.

NOTE If you begin render a range of frames, but haven't assigned a file in which to save the animation (using the [Files button](#) on page 6129), an alert box appears to warn you about this. Rendering animations can take a long time, and usually it doesn't make sense to render a range without saving all frames to a file.

Output Size group

Select one of the predefined sizes or enter another size in the Width and Height fields (in pixels). These controls affect the image's [aspect ratio](#) on page 7914.

Drop-down list The Output Size drop-down list lets you choose from several standard film and video resolutions and aspect ratios. Choose one of these formats, or leave it set to Custom to use the other controls in the Output Size group. These are the options you can choose from on the list:

- Custom
- 35mm 1.316:1 Full Aperture (cine)

- 35mm 1.37:1 Academy (cine)
- 35mm 1.66:1 (cine)
- 35mm 1.75:1 (cine)
- 35mm 1.85:1 (cine)
- 35 MM Anamorphic (2.35:1)
- 35 MM Anamorphic (2.35:1) (Squeezed)
- 70mm Panavision (cine)
- 70mm IMAX (cine)
- VistaVision
- 35mm (24mm X 36mm) (slide)
- 6cm X 6cm (2 1/4" X 2 1/4") (slide)
- 4" X 5" or 8" X 10" (slide)
- NTSC D-1 (video)
- NTSC DV (video)
- PAL (video)
- PAL DV (video)
- HDTV (video)

NOTE The values of the Image Aspect and Width and Height buttons can change, depending on which output format you select from this list.

Aperture Width (mm) Lets you specify an aperture width for the camera that creates the rendered output. Changing this value changes the camera's Lens value. This affects the relationship between the Lens and the FOV values, but it doesn't change the camera's view of the scene.

For example, if you have a Lens setting of 43.0 mm, and you change the Aperture Width from 36 to 50, when you close the Render Setup dialog (or render), the camera Lens spinner has changed to 59.722, but the scene still looks the same in the viewport and the rendering. If you use one of the preset formats rather than Custom, the aperture width is determined by the format, and this control is replaced by a text display.

Width and Height Let you set the resolution of the output image by specifying the width and the height of the image, in pixels. With Custom format, you can set these two spinners independently. With any other format, the two spinners are locked to the specified aspect ratio, so adjusting one alters the other. The maximum width and height is 32,768 x 32,768 pixels.

Preset resolution buttons (320x240, 640x480, and so on) Click one of these buttons to choose a preset resolution. You can customize these buttons: right-click a button to display the [Configure Preset dialog](#) on page 6130, which lets you change the resolution specified by the button.

Image Aspect Lets you set the aspect ratio of the image. Changing this value changes the Height value to maintain the correct dimensions for the active resolution. When you use a standard format rather than Custom, you can't change the aspect ratio, and this control is replaced by a text display.

In 3ds Max, the Image Aspect value is always expressed as a multiplier value. In written descriptions of film and video, often aspect ratio is also described as a ratio. For example, 1.33333 (the default Custom aspect ratio) is often expressed as 4:3. This is the standard aspect ratio for broadcast video (both [NTSC](#) on page 8059 and [PAL](#) on page 8078) when letterboxing is not used. (Letterboxing shows the full width of a wide-screen film format, framed by black regions above and below.)



When using a custom output size, the lock button to the left of Image Aspect locks the aspect ratio. When it is on, the Image Aspect spinner is replaced by a label, and the Width and Height spinners are locked to each other; adjusting one alters the other to maintain the aspect-ratio value. In addition, when the aspect ratio is locked, altering the Pixel Aspect value alters the Height value to maintain the aspect-ratio value.

NOTE In viewports, the camera's cone changes to reflect the image aspect ratio you set in the Render Setup dialog. This change takes place when you exit the Render Setup dialog.

Pixel Aspect Sets the aspect ratio of the pixels for display on another device. The image might look squashed on your display but will display correctly on the device with differently shaped pixels. If you use one of the standard formats rather than Custom, you can't change the pixel aspect ratio and this control is disabled.



The lock button to the left of Pixel Aspect locks the pixel-aspect ratio. When it is on, the Pixel Aspect spinner is replaced by a label, and you can't change the value. This button is available only with the Custom format.

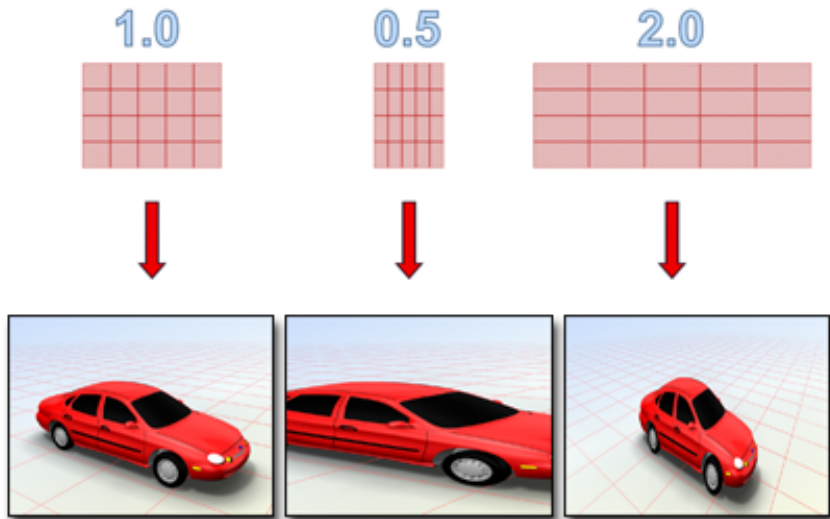

Images with different pixel aspects appear stretched or squashed on a monitor with square pixels.

NOTE For standard [NTSC](#) on page 8059, the pixel aspect ratio is 0.9. If you are creating 16:9 (0.778) anamorphic images for NTSC, the pixel aspect ratio should be 1.184. (As in the previous discussion of Image Aspect, this assumes the image is not letterboxed.)

Options group

Atmospherics Renders any applied atmospheric effects, such as volume fog, when turned on.

Effects Renders any applied rendering effects, such as Blur, when turned on.

Displacement Renders any applied displacement mapping.

Video Color Check Checks for pixel colors that are beyond the safe [NTSC](#) on page 8059 or [PAL](#) on page 8078 threshold and flags them or modifies them to acceptable values.

By default, "unsafe" colors render as black pixels. You can change the color check display by using the [Rendering panel](#) on page 7768 of the [Preference Settings dialog](#) on page 7743.

Render to Fields Renders to video [fields](#) on page 7973 rather than frames when creating animations for video.

Render Hidden Geometry Renders all geometric objects in the scene, even if they are hidden.

Area Lights/Shadows as Points Renders all area lights or shadows as if they were emitted from point objects, speeding up rendering time.

This switch is also available on the Rendered Frame Window as [Soft Shadows](#) on page 6081.

TIP This option is useful for draft renderings, as point lights render much faster than area lights.

NOTE Scenes with [radiosity](#) on page 6168 are not affected by this toggle, as area lights do not have a significant effect on the performance of a radiosity solution.

Force 2-Sided [2-Sided rendering](#) on page 7893 renders both sides of all faces. Usually, you'll want to keep this option off to speed rendering time. You may want to turn it on if you need to render the inside as well as the outside of objects, or if you've imported complex geometry in which the face normals are not properly unified.

NOTE This switch does not apply to objects that use the mental ray material [Arch & Design](#) on page 5544. In such cases, turn on the material's Advanced Rendering Options rollout > [Back Face Culling check box](#) on page 5573.

Super Black [Super Black rendering](#) on page 8141 limits the darkness of rendered geometry for video compositing. Leave off unless you're sure you need it.

Advanced Lighting group

Use Advanced Lighting When on, the software incorporates a [radiosity solution](#) on page 6168 or [light tracing](#) on page 6154 in the rendering.

Compute Advanced Lighting When Required When on, the software computes radiosity when required on a per-frame basis.

Normally, when rendering a series of frames, the software calculates radiosity only for the first frame. If, in an animation, it might be necessary to recalculate the advanced lighting in subsequent frames, turn this option on. For example, a brightly painted door might open and affect the coloring of a nearby white wall, in which case the advanced lighting should be recalculated.

Bitmap Proxies group

Displays whether 3ds Max is using full-resolution maps or bitmap proxies for rendering. To change this setting, click the Setup button.

Setup Click to open the [Global Settings and Defaults for Bitmap Proxies dialog](#) on page 7115.

Render Output group

Save File When on, the software saves the rendered image or animation to disk when you render. Save File is available only after you specify the output file using the Files button.

Files Opens the [Render Output File dialog](#) on page 6086, which lets you specify the output file name, format, and location.

You can render to any of the still or animated [image file formats](#) on page 7324 that are writable.

If you render multiple frames to a still-image file format, the renderer renders individual frame files and appends sequence numbers to each file name. You can control this with the [File Number Base setting](#) on page 6124.

Put Image File List(s) in Output Path(s) Turn on to create an [image sequence \(IMSQ\) file](#) on page 7346, and save it in the same directory as the rendering. Default=off.

3ds Max creates one IMSQ file (or IFL file) per [render element](#) on page 6336. The files are created when you click Render or Create now. They are generated before the actual rendering.

Image sequence files can be created by the following kinds of rendering:

- The Render Setup dialog
- The Render command
- Batch rendering
- Command-line rendering
- MAXScript rendering

- ActiveShade rendering

They are *not* created by the following kinds of rendering:

- Rendering to textures
- Video Post rendering
- Rendering a panorama

- **Create Now** Click to create the image sequence file “by hand.” You must first choose an output file for the rendering itself.
- **Autodesk ME Image Sequence File (.imsq)** When chosen (the default), creates an [Image Sequence \(IMSQ\) file](#) on page 7346.
- **Legacy 3ds max Image File List (.ifl)** When chosen, creates an [Image File List \(IFL\) file](#) on page 7339 of the kind created by previous versions of 3ds Max.

Use Device Sends the rendered output to a device such as a video recorder. First click the Devices button to specify the device, for which an appropriate driver must already be installed.

Rendered Frame Window Displays the rendered output in the [Rendered Frame Window](#) on page 6073.

Net Render Enables [network rendering](#) on page 6433. If this is on, when you render you'll see the [Network Job Assignment dialog](#) on page 6481.

Skip Existing Images When activated and Save File is on, the renderer will skip images in a sequence that have already been rendered to disk.

Configure Preset Dialog

Main menu > Render Setup > Render Setup Dialog > Common panel > Common Parameters rollout > Output Size group > Right-click a preset resolution button. > Configure Preset dialog

This dialog lets you change the preset resolution on a button in the Output Size group of the Common Parameters rollout.

Interface

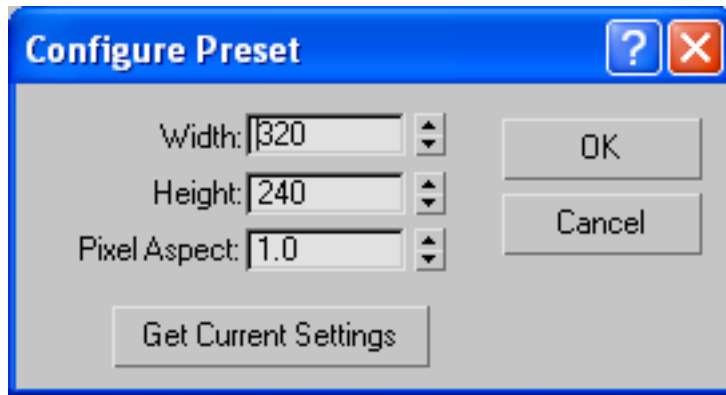

Width Sets the output width, in pixels.

Height Sets the output height, in pixels.

Pixel Aspect Sets the output pixel aspect ratio.

Get Current Settings Gets the current Width, Height, and Pixel Aspect settings from the Output Size group, and assigns them to the spinners on this dialog.

Email Notifications Rollout

Rendering menu/main toolbar > Render Setup > Render Setup dialog > Common panel > Email Notifications rollout

This rollout lets a rendering job send email notifications, as network rendering does. Such notifications can be useful when you launch a lengthy render, such as an animation, and don't care to spend all your time near the system doing the rendering.

Interface

The screenshot shows a dialog box titled "Email Notifications". At the top, there is a checked checkbox labeled "Enable Notifications". Below this is a section titled "Categories" which contains three checkboxes: "Notify Progress" (unchecked), "Notify Failures" (checked), and "Notify Completion" (unchecked). The "Notify Progress" checkbox is followed by the text "Every Nth Frame:" and a spin box containing the number "1". Below the "Categories" section is another section titled "Email Options" which contains three text input fields: "From:", "To:", and "SMTP Server:".

Enable Notifications When on, the renderer sends an email notification when certain events happen. Default=off.

Categories group

Notify Progress Sends emails to indicate rendering progress. An email is sent every time the number of frames specified in Every Nth Frame has completed rendering. Default=off.

- **Every Nth Frame** The number of frames used by Notify Progress. Default=1.

TIP If you turn on Notify Progress, almost certainly you want this value to be greater than the default!

Notify Failures Sends an email notification only if something occurs to prevent the completion of a rendering. Default=on.

Notify Completion Sends an email notification when a rendering job is complete. Default=off.

Email Options group

From Enter the email address of the person who initiates the rendering job.

To Enter the email address of the person who needs to know the rendering status.

SMTP Server Enter the numeric IP address of the system you use as a mail server.

Scripts Rollout (Render Setup Dialog)

Rendering menu/main toolbar > Render Setup > Render Setup dialog > Common panel > Scripts rollout

The Scripts rollout lets you specify scripts to run before and after rendering. The script to execute can be:

- A MAXScript file (MS)
- A macro script (MCR)
- A batch file (BAT)
- An executable file (EXE)

If relevant to its format, the script can have command-line arguments.

The pre-render script is executed before rendering (but *after* any other MAXScript scripts that are registered using the #preRender callback mechanism). The post-render script is executed after rendering has completed. You can also use the “Execute Now” buttons to run the scripts “by hand.”

Interface

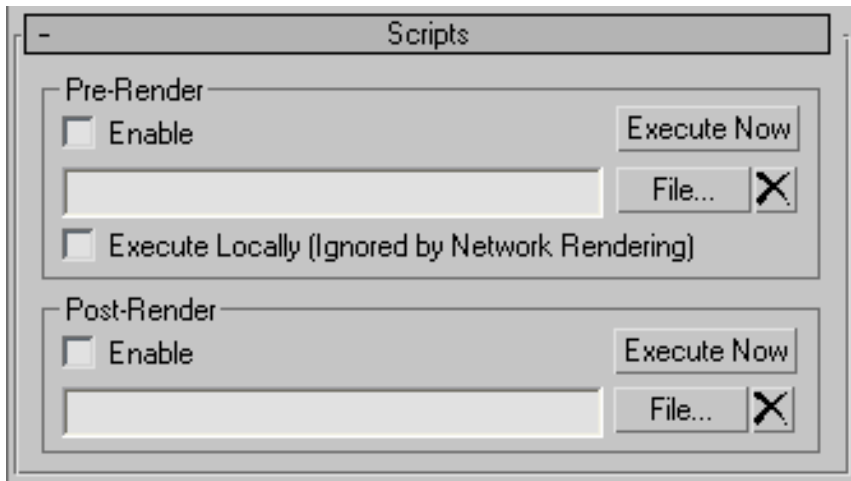

Pre-Render group

Specifies a script to run before you render.

Enable When on, the script is enabled.

Execute Now Click to execute the script “by hand.”

File name field When a script is selected, this field shows its path and name. You can edit this field.

File Click to open a file dialog and choose the pre-render script to run.



Delete File Click to remove the script.

Execute Locally (Ignored by Network Rendering) When on, the script must run locally. If you use network rendering, the script is ignored. Default=off.

Post-Render group

Specifies a script to run after you render.

Enable When on, the script is enabled.

Execute Now Click to execute the script “by hand.”

File name field When a script is selected, this field shows its path and name. You can edit this field.

File Click to open a file dialog and choose the post-render script to run.



Delete File Click to remove the script.

Assign Renderer Rollout

Rendering menu/main toolbar > Render Setup > Render Setup dialog > Common panel > Assign Renderer rollout

The Assign Renderer rollout displays which renderers are assigned to the production and ActiveShade categories, as well as the sample slots in the Material Editor.

The Render flyout on the toolbar also lets you choose which renderer to use:



- The Render Production and Render Iterative buttons use the production renderer.



- The ActiveShade button uses the ActiveShade renderer.

These are the renderers that ship with 3ds Max:

[Default Scanline Renderer](#) on page 6141

[mental ray Renderer](#) on page 6230 (not available for ActiveShade)

[VUE File Renderer](#) on page 6334 (not available for ActiveShade)

Additional renderers might be available if you've installed them as plug-ins.

Interface

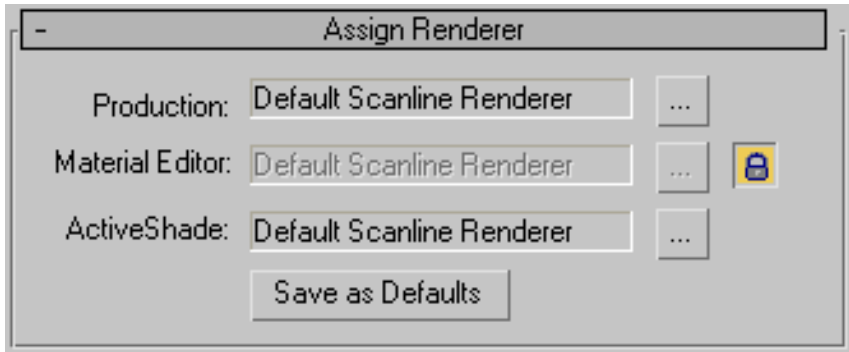

For each rendering category, the rollout shows the name of the renderer currently assigned, and a button that lets you change the assignment.

Choose Renderer (“...”) Click the button with the ellipsis to change the renderer assignment. The button displays a [Choose Renderer dialog](#) on page 6136.

- **Production** Chooses the renderer used to render graphic output.
- **Material Editor** Chooses the renderer used to render [sample slots](#) on page 5304 in the Material Editor.



By default, the sample slot renderer is locked to be the same as the production renderer. You can turn off the lock button to assign a different renderer for sample slots.

- **ActiveShade** Chooses the [ActiveShade](#) on page 6102 renderer used to preview the effects of lighting and material changes in the scene. The only ActiveShade renderer that ships with 3ds Max is the default scanline renderer.

Save as Defaults Click to save the current renderer assignments as defaults, so they will be active the next time you restart 3ds Max.

Choose Renderer Dialog

Rendering menu/main toolbar > Render Setup > Render Setup dialog > Common panel > Assign Renderer rollout > Click a Choose Renderer (“...”) button.

This dialog appears when you click one of the Choose Renderer (“...”) buttons on the [Assign Renderer rollout](#) on page 6135.

Procedures

To change the renderer assigned to the category you picked, do one of the following:

- Highlight another renderer's name in the list, and then click OK.
- Double-click another renderer's name in the list

Interface

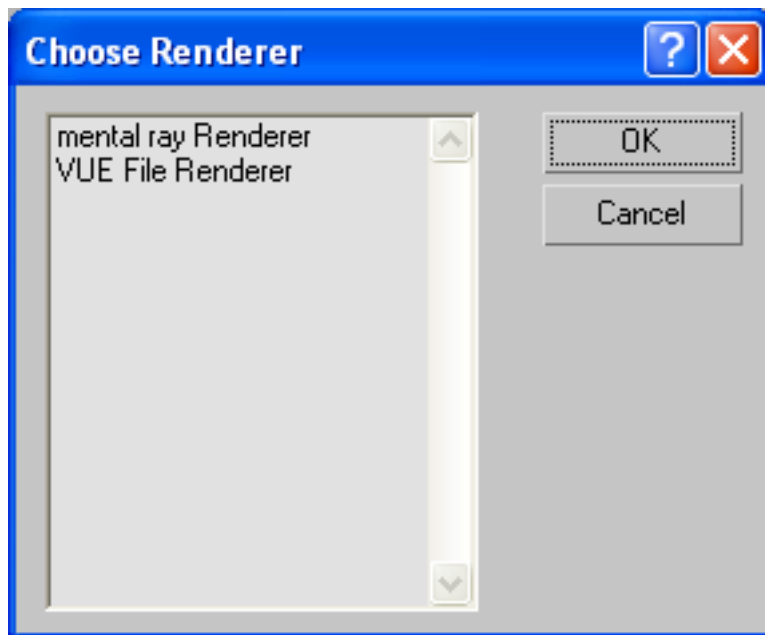

The scrollable list shows the names of renderers that you can assign, exclusive of the renderer that is currently assigned to the rendering category you are reassigning.

Renderers

Renderer Panel (Render Setup Dialog)

Rendering menu/main toolbar > Render Setup > Render Setup dialog > Renderer panel

The Render Setup dialog > Renderer panel contains the main controls for the active renderer. Depending on which renderer is active, additional panels can become available.

TIP The [default scanline renderer](#) on page 6141 and the [mental ray renderer](#) on page 6230 have different and unique capabilities. Based on these, you decide which renderer you want to use for each scene. It is a good idea to design materials with a particular renderer in mind. The [mental ray Connection rollout](#) on page 5385 lets you add features unique to the mental ray renderer to basic 3ds Max materials.

Interface

When the Default Scanline Renderer Is Active

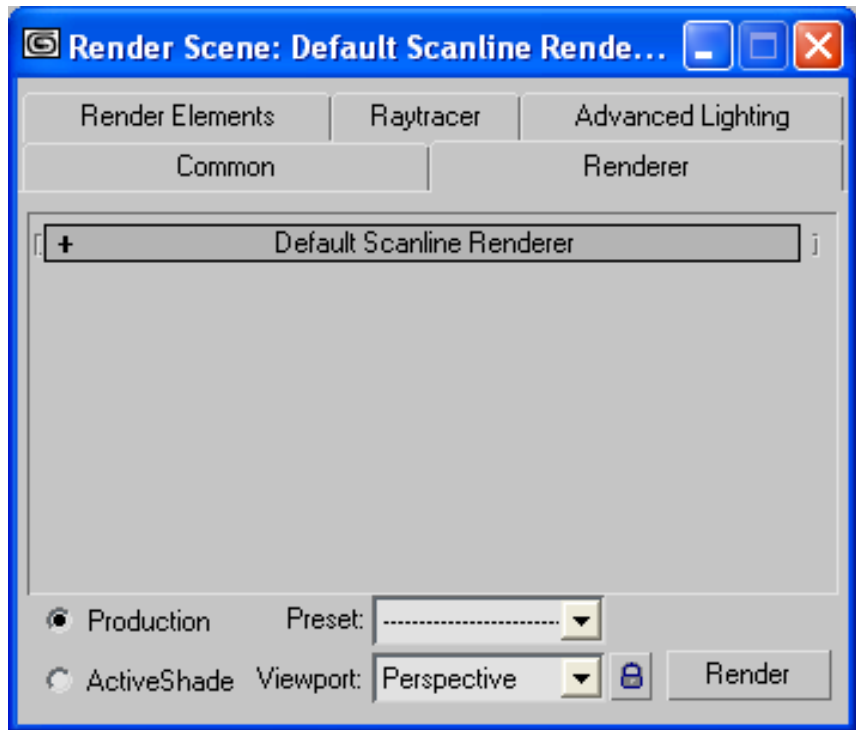

The Renderer panel contains a single rollout:

[Default Scanline Renderer Rollout](#) on page 6141

Additional panels are:

- [Advanced Lighting Panel](#) on page 6153
- [Raytracer Panel](#) on page 6221
- [Render Elements panel](#) on page 6336

When the mental ray Renderer Is Active

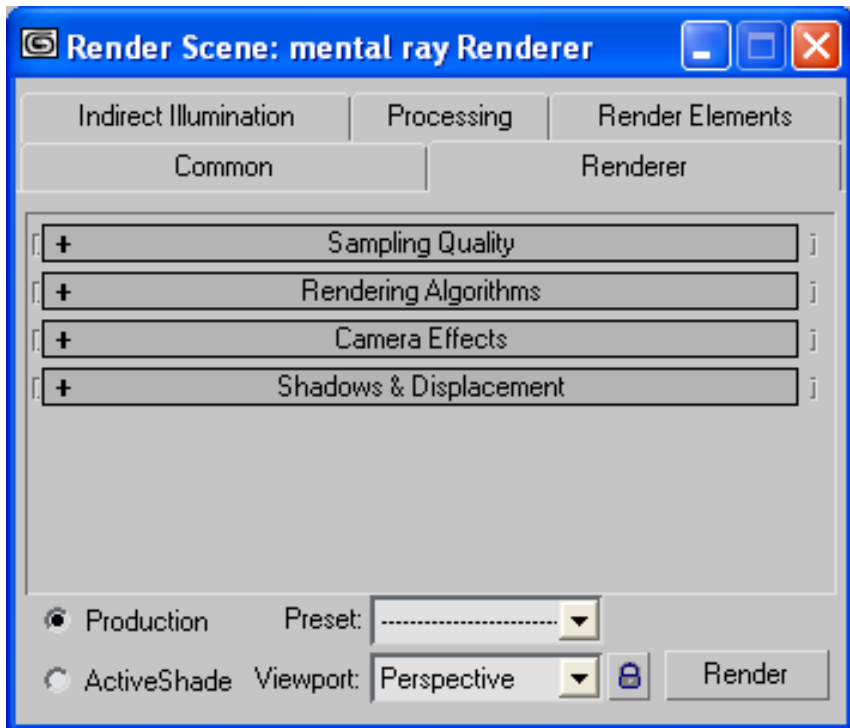

The renderer panel contains these rollouts:

[Sampling Quality Rollout \(mental ray Renderer\)](#) on page 6272

[Rendering Algorithms Rollout \(mental ray Renderer\)](#) on page 6277

[Camera Effects Rollout \(mental ray Renderer\)](#) on page 6283

[Shadows & Displacement Rollout \(mental ray Renderer\)](#) on page 6292

Additional panels are:

- Indirect Illumination panel
 - [Caustics and Global Illumination Rollout \(mental ray Renderer\)](#) on page 6306
 - [Final Gather Rollout \(mental ray Renderer\)](#) on page 6295
- Processing panel
 - [Translator Options Rollout \(mental ray Renderer\)](#) on page 6316

[Diagnostics Rollout \(mental ray Renderer\)](#) on page 6324

[Distributed Bucket Rendering Rollout \(mental ray Renderer\)](#) on page 6326

When the VUE File Renderer Is Active

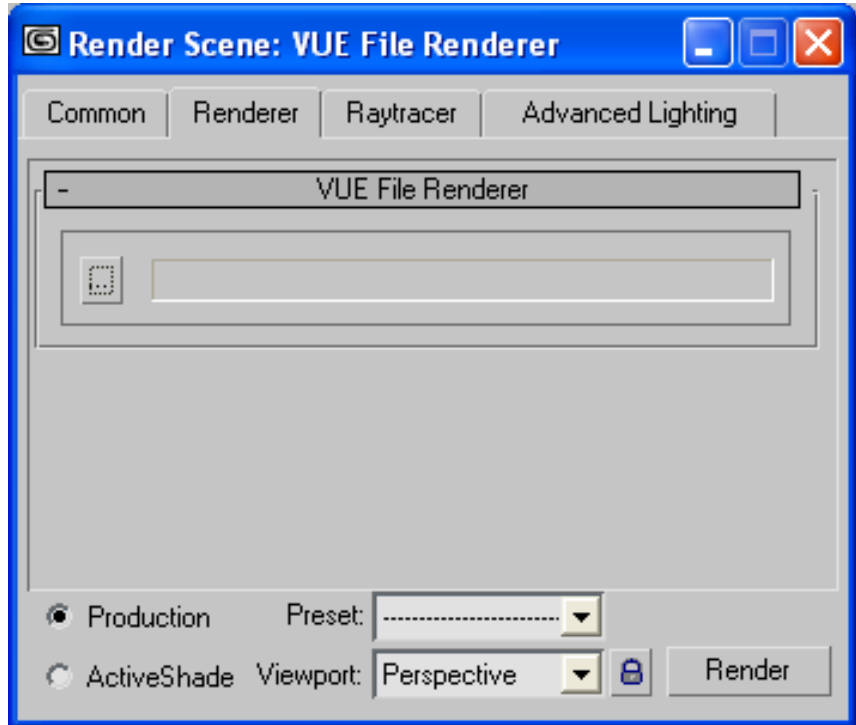

The Renderer panel contains a single rollout:

[VUE File Renderer](#) on page 6334

Default Scanline Renderer Controls

Default Scanline Renderer Rollout

Main toolbar/Rendering menu > Render Setup > Render Setup dialog > Assign Renderer rollout > Choose Default Scanline Renderer as the production renderer. > Renderer panel > Default Scanline Renderer rollout

This rollout sets parameters for the default [scanline renderer](#) on page 8116.

NOTE If your scene includes animated bitmaps (e.g., AVI files), including materials, projector lights, environments, and so on, each animation file is reloaded once per frame. If your scene uses multiple animations, or if the animations are themselves large files, this reloading can hamper rendering performance. To improve performance, use image sequences (each animation frame in a separate image file) instead.

Environment Alpha Toggle and Filtering

To control whether or not the renderer uses the environment map's alpha channel in creating the alpha for the rendered image, choose **Customize > Preferences > Rendering** on page 7768, and then turn on **Use Environment Alpha** in the **Background** group. If **Use Environment Alpha** is off (the default), the background receives an alpha value of 0 (completely transparent). If **Use Environment Alpha** is on, the alpha of the resulting image is a combination of the scene and the background image's alpha channel. Also, when you render to [TGA files](#) on page 7370 with [premultiplied alpha](#) on page 8096 turned off, turning on **Use Environment Alpha** prevents incorrect results.

You can also control whether or not a background image is affected by the renderer's antialiasing filter. Choose **Customize > Preferences > Rendering**, and then turn on **Filter Background** in the **Background** group. Default=off.

TIP If you plan to composite 3ds Max objects in another program such as Combustion or Photoshop, render the objects against a black background. Otherwise, a fringe of environment or background color can appear around the 3ds Max objects.

Plate Match Filtering

This section describes the Plate Match/MAX R2 antialiasing filter (see [Antialiasing group](#) on page 6146 for descriptions of other filtering options).

In versions of 3ds Max prior to R2.5, antialiasing affected only geometric edges, with the filtering of bitmaps being controlled in the **Bitmap Map** parameters (pyramidal, summed area, or no filtering). Current antialiasing filters affect every aspect of the object, filtering textures along with geometric edges.

While the method used in R2.5 and subsequent versions provides superior results, this method also produces inconsistencies when rendering objects that are supposed to match the environment background, because the antialiasing filters do not affect the background by default (**FilterBackground=0**).

in the [Renderer] section of the [3dsmax.ini](#) on page 83 file or Customize menu > Preferences > Rendering tab > Background group > Filter Background). In order to correctly match an object's map to an unfiltered background image, you need to use the Plate Match/MAX R2 filter so the texture is not affected by the antialiasing.

There are three ways you can render objects to blend seamlessly into a background environment:

- Assign a [matte/shadow material](#) on page 5699.
- Assign a 100% self-illuminated diffuse texture to an object using [Camera Mapping](#) on page 1223.
- Assign a 100% self-illuminated diffuse texture using Environment/Screen projection (see [Coordinates Rollout \(2D\)](#) on page 5782). Use Plate Match/MAX R2 antialiasing when you need to match foreground objects with an unfiltered background, or when you need to match the antialiasing qualities of the 3ds Max 2 renderer.

Procedures

To set up an object for motion blurring:

- 1 Select the object to blur.
- 2 Right-click the object, and then choose Properties from the quad menu. The Object Properties dialog is displayed.
- 3 In the Motion Blur group, click By Layer to change it to By Object. The other Motion Blur controls are now enabled.
- 4 In the Motion Blur group, choose either Object or Image.
- 5 If you chose Image, you can adjust the Multiplier spinner. This increases or decreases the length of the blurred object's streak.
- 6 Click OK.

To add motion blur when you render the animation:

- 1 Click Render Setup. The Render Setup dialog appears.

- 2 On the Default Scanline Renderer rollout, turn on Apply in the Object Motion Blur group or the Image Motion Blur group.
 - For Object Motion Blur, set Duration, Duration Subdivisions, and Samples.
 - Increase Duration to exaggerate the motion blur effect. Decrease it to make the blur more subtle.
 - If Samples is less than Duration Subdivisions, the slices used are selected randomly, giving a grainy look to the blur. If Samples equals Duration Subdivisions, the blur is smooth. The smoothest blur results from larger, equal values of these two parameters, but be aware that this can slow down rendering by a factor of three to four.
 - For Image Motion Blur, adjust Duration and Apply to Environment Map.
 - Increase Duration to exaggerate the streaking. Decrease it to make it more subtle.
- 3 Turn on Apply to Environment map to have camera orbit movement blur the environment map. This works only with Spherical, Cylindrical, or Shrink-Wrapped environments.
- 4 Set other rendering parameters, and then click Render.

Interface

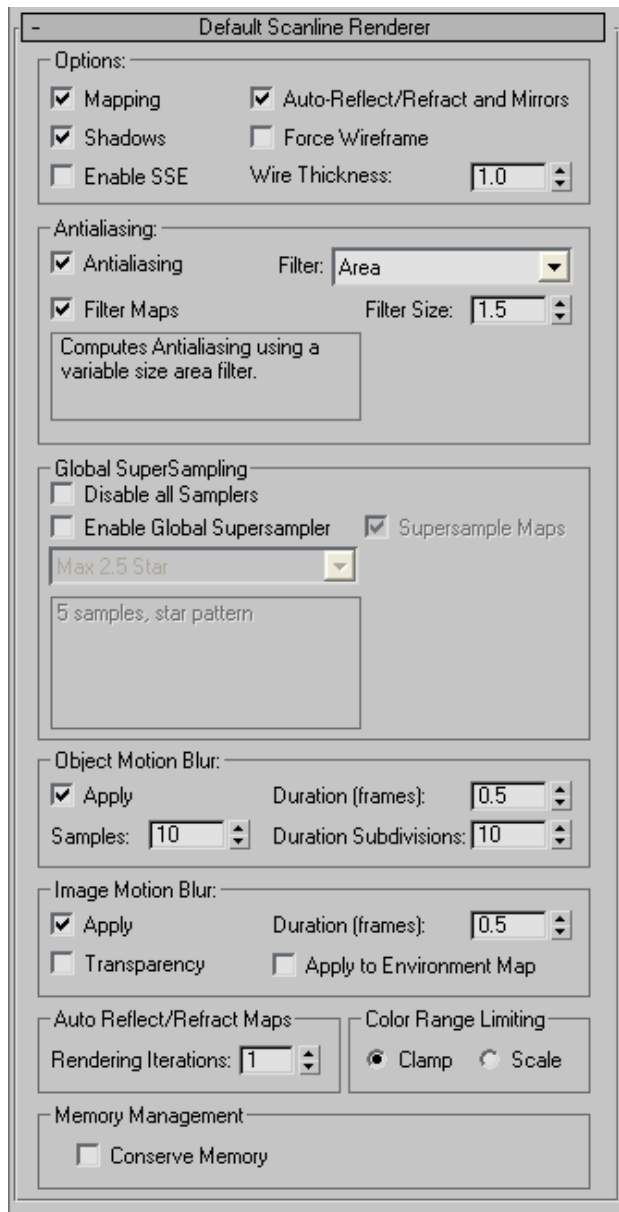

Options group

Mapping Turn off to ignore all mapping information to speed up rendering for tests. Affects automatic reflections and environment maps as well as material mapping. Default=on.

Auto Reflect/Refract and Mirrors Ignores automatic reflection/refraction maps to speed up rendering for tests.

Shadows When off, cast shadows aren't rendered. This can speed up rendering for tests. Default=on.

Force Wireframe Set to render all surfaces in the scene as wireframes. You can choose the thickness of the wireframe in pixels. Default=1.

Enable SSE When on, rendering uses Streaming SIMD Extensions (SSE). (SIMD stands for Single Instruction, Multiple Data.) Depending on the CPU (or CPUs) of your system, SSE can improve render time. Default=off.

Antialiasing group

Antialiasing [Antialiasing](#) on page 7904 smoothes the jagged edges that occur along the edges of diagonal and curves lines when rendering. Turn off only when you are rendering test images and greater speed is more important than image quality.

Turning off Antialiasing disables the Force Wireframe setting. Geometry renders according to the material assigned it even if Force Wireframe is turned on.

Turning off Antialiasing also disables [render elements](#) on page 6336. If you need to render elements, be sure to leave Antialiasing on.

Filter drop-down list Lets you select a high-quality table-based filter to apply to your rendering. Filters are the last step in antialiasing. They work at the sub-pixel level and allow you to sharpen or soften your final output, depending on which filter you select. Below the controls in this group, 3ds Max displays a box with a brief description of the filter and how it is applied to your image.

TIP Render Region and Render Selected give reliable results only when rendered with the Area filter.

The following table describes the available antialiasing filters.

Name	Description
Area	Computes antialiasing using a variable-size area filter. This is the original 3ds Max filter.
Blackman	A 25-pixel filter that is sharp, but without edge enhancement.
Blend	A blend between sharp area and Gaussian soften filters.
Catmull-Rom	A 25-pixel reconstruction filter with a slight edge-enhancement effect.
Cook Variable	A general-purpose filter. Values of 1 to 2.5 are sharp; higher values blur the image.
Cubic	A 25-pixel blurring filter based on a cubic spline.
Mitchell-Netravali	Two-parameter filter; a trade-off of blurring, ringing, and anisotropy. If the ringing value is set higher than .5 it will impact the alpha channel of the image.
Plate Match/MAX R2	Uses the 3ds Max 2 method (no map filtering) to match camera and screen maps or matte/shadow elements to an unfiltered background image. See the section “Plate Match Filtering,” above, for a discussion of how and why you might want to use this filter.
Quadratic	A 9-pixel blurring filter based on a quadratic spline.

Name	Description
Sharp Quadratic	A sharp nine-pixel reconstruction filter from Nelson Max.
Soften	An adjustable Gaussian softening filter for mild blurring.
Video	A 25-pixel blurring filter optimized for NTSC and PAL video applications.

Filter Maps Turns on or off the filtering of mapped materials. Default=on.

TIP Leave Filter Maps turned on unless you are making test renderings and want to speed up rendering time and save memory.

Filter Size Allows you to increase or decrease the amount of blur applied to an image. This option is available only when a Soften filter has been selected from the drop-down list. The spinner is unavailable when any other filter has been selected.

Setting the Filter Size to 1.0 effectively disables the filter.

NOTE Some filters show additional, filter-specific parameters below the Filter Size control.

When you [render separate elements](#) on page 6336, you can explicitly enable or disable the active filter, on a per-element basis.

Global SuperSampling group

Disable all Samplers Disables all [supersampling](#) on page 8141. Default=off

NOTE SuperSampling settings are ignored by the [mental ray Renderer](#) on page 6230, which has its own sampling method.

Enable Global Supersampler When on, applies the same supersampler to all materials. When turned off, materials set to use the global settings are controlled by the settings appearing in rendering dialog. All other controls in the Global SuperSampling group of the rendering dialog will become disabled, except for the Disable All Samplers. Default=on.

Supersample Maps Turns on or off supersampling for mapped materials. Default=on.

TIP Leave Supersample Maps on unless you are making test renderings and want to speed up rendering time and save memory.

Sampler drop-down list Lets you choose which supersampling method to apply. Default=Max 2.5 Star.

The options for a supersampling method are the same as those that appear on the [SuperSampling rollout](#) on page 5381 in the Material Editor. Some methods offer expanded options that let you better control the quality of the supersampling and the number of samples taken during rendering.

Object Motion Blur group

You determine which objects have [object motion blur](#) on page 8063 applied to them by setting Object in the Motion Blur group of the Properties dialog for that object. Object motion blur blurs the object by creating multiple "time-slice" images of the object for each frame. It takes camera movement into account. Object motion blur is applied during the scanline rendering process.

Apply Turns object motion blur on or off globally for the entire scene. Any objects that have their Object Motion Blur property set are rendered with motion blur.

Duration Determines how long the "virtual shutter" is open. When this is set to 1.0, the virtual shutter is open for the entire duration between one frame and the next. Longer values produce more exaggerated effects.

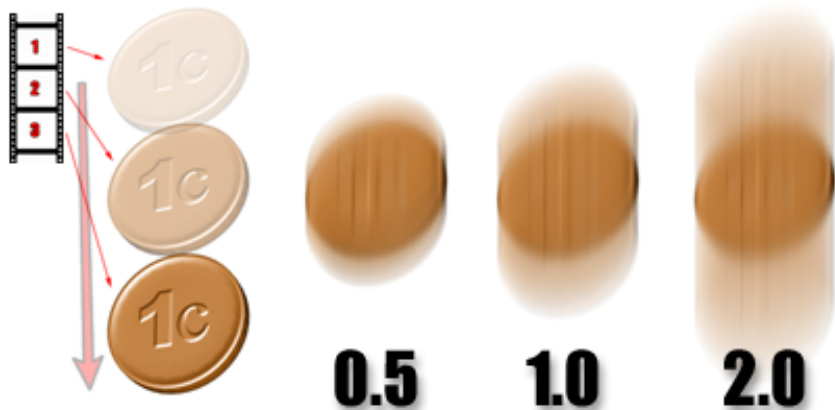

The effect of changing duration.

Samples Determines how many Duration Subdivision copies are sampled. The maximum setting is 32.

When Samples is less than Duration, random sampling within the duration occurs (which is why there might be a slight granular look to the motion blur). For example, if Duration Subdivision=12 and Samples=8, there are eight random samples out of 12 possible copies within each frame.

When Samples=Duration, there is no randomness (and if both numbers are at their maximum value (32), you get a dense result (which costs between 3–4 times the normal rendering time for that specific object).

If you want to obtain a smooth blur effect, use the maximum settings of 32/32. If you want to cut down rendering time, values of 12/12 will give you much smoother results than 16/12.

Because sampling happens within the duration, the Duration value always has to be less than or equal to Samples.

Duration Subdivisions Determines how many copies of each object are rendered within the Duration.

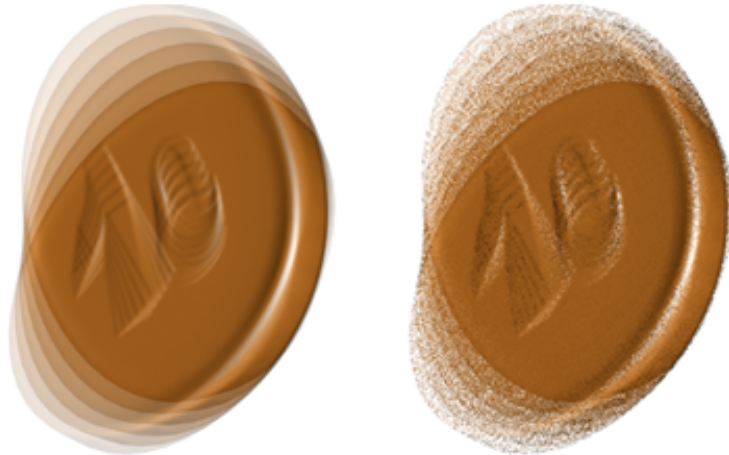

Left: Same value for Samples and Subdivisions.

Right: Samples value is less than Subdivisions.

Image Motion Blur group

You determine which objects have [image motion blur](#) on page 8010 applied to them by setting Image in the Motion Blur group of the Properties dialog for that object. Image motion blur blurs the object by creating a smearing effect rather than multiple images. It takes camera movement into account. Image motion blur is applied after scanline rendering is complete.



The coin on the right has Image Motion Blur applied

You can't put image motion blur on objects that change their topology.

TIP When blurred objects overlap, sometimes blurring doesn't work correctly and there are gaps in the rendering. Because image motion blur is applied *after* rendering, it can't account for object overlap. To fix this problem, render each blurred object separately, to a different layer, and then composite the two layers using the Alpha Compositor in Video Post.

NOTE Image motion blur doesn't work for NURBS objects that are animated so their tessellation ([surface approximation](#) on page 2554) changes over time. This happens when sub-objects are animated independently of the top-level [NURBS model](#) on page 8061. Nor does image motion blur work on any of the following:

- Anything with an Optimize.
- Any primitive with animated segments.
- MeshSmooth of any type with a "Smoothness" value (under iterations) other than 1.
- MeshSmooth on polygons with Keep Faces Convex on.
- Anything with Displacement Material.

In general, if you have objects with changing topology, use scene or object motion blur rather than image motion blur.

Apply Turns image motion blur on or off globally for the entire scene. Any objects that have their Image Motion Blur property set are rendered with motion blur.

Duration Specifies how long the "virtual shutter" is open. When this is set to 1.0, the virtual shutter is open for the entire duration between one frame and the next. The higher the value, the greater the motion blur effect.

Apply to Environment Map When set, image motion blur is applied to the environment map as well as to the objects in the scene. The effect is noticeable when the camera orbits.

The environment map should use Environment mapping: Spherical, Cylindrical, or Shrink-Wrap. The image motion blur effect doesn't work with Screen-mapped environments.

Transparency When on, image motion blur works correctly with transparent objects that overlap. Applying image motion blur to transparent objects can increase rendering time. Default=off.

Auto Reflect/Refract Maps group

Rendering Iterations Sets the number of inter-object reflections in non-flat automatic reflection maps. Although increasing this value can sometimes enhance image quality, it also increases rendering time for reflections.

Color Range Limiting group

Color Range Limiting allows you handle over-brightness by toggling between either Clamping or Scaling color components (RGB) that are out of range (0 to 1). Typically, specular highlights can cause color components to rise above range while using filters with negative lobes can cause color components to be below range. You choose one of two options to control how the render handles out of range color components:

- **Clamp** To keep all color components in range Clamp will change any color with a value greater than 1 down to 1 while any color below 0 will be clamped at 0. Any value between 0 and 1 will not change. Very bright colors tend to render as white when using Clamp since hue information can be lost in the process.
- **Scale** To keep all color components in range Scale will preserve the hue of very bright colors by scaling all three color components so that the maximum component has a value of 1. Be aware that this will change the look of highlights.

Memory Management group

Conserve Memory When on, rendering uses less memory at a slight cost of memory time. Memory saved is in the range of 15 to 25 percent. The time cost is about four percent. Default=off.

Advanced Lighting Panel

Rendering menu > Render Setup > Render Setup dialog > Assign Renderer rollout > Set Production to Default Scanline Renderer. > Advanced Lighting panel > Select Advanced Lighting rollout

Main toolbar > Render Setup > Render Setup dialog > Assign Renderer rollout > Set Production to Default Scanline Renderer. > Advanced Lighting panel > Select Advanced Lighting rollout

The Advanced Lighting rollout lets you select one of the advanced lighting options. Two are provided with the [default scanline renderer](#) on page 6141:

- [Light Tracer](#) on page 6154
- [Radiosity](#) on page 6168

The Light Tracer provides soft-edged shadows and color bleeding for brightly-lit scenes such as outdoor scenes. Radiosity provides physically accurate modeling of the light in a scene.

Interface

Until you choose an advanced lighting option, the Advanced Lighting panel displays a single rollout, Select Advanced Lighting.

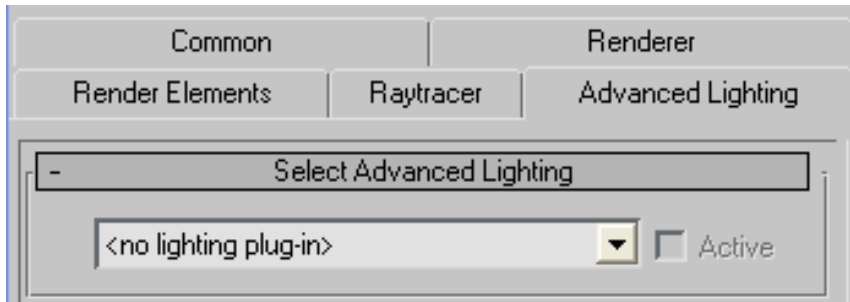

List of plug-ins Choose an advanced lighting option from this drop-down list. Default=No advanced lighting chosen.

Active When an advanced lighting option is chosen, use Active to toggle whether the advanced lighting is used when you render your scene. Default=On.

Light Tracer

Rendering menu/main toolbar > Render Setup > Render Setup dialog > Choose Default Scanline Renderer as the active production renderer. > Advanced Lighting panel > Select Advanced Lighting rollout > Choose Light Tracer from the drop-down list.



Character lit by Skylight and one spotlight, and rendered with light tracing

Model by Sonny Sy — orange_3D@yahoo.com — www.geocities.com/orange_3D

The Light Tracer provides soft-edged shadows and color bleeding for brightly-lit scenes such as outdoor scenes. It is typically used in conjunction with a [Skylight](#) on page 5065. Unlike [radiosity](#) on page 6168, the Light Tracer does not attempt to create a physically accurate model, and can be easier to set up.



Outdoor scene lit by [Skylight](#) and rendered with light tracing

TIP While you can use light tracing for indoor scenes, radiosity is usually the better choice in such cases.

Previewing the Effect of Light Tracing

- To get a quick preview of the effect the Light Tracer will have, lower the values of Rays/Sample and Filter Size. The result will be a grainy version of the full effect.
- Another way to get a quick preview is to make sure Adaptive Undersampling is turned on. In this group, set the Initial Sample Spacing sampling and the Subdivide Down To setting to the same value. In the General Settings group, lower the value of Rays/Sample, and set Bounces equal to 0.0. This gives a rather blotchy but fast preview of the rendering. Increase the Rays/Sample and Filter Size values to improve the image quality.

In general, you can get good, fairly quick results with a lower Filter Size value as long as Rays/Sample has a high value and Adaptive Undersampling is on.

Other Tips for Using the Light Tracer

- To improve rendering time, use the [Object Properties dialog](#) on page 305 to disable light tracing (or radiosity solving) for objects that don't have a great impact on the final effect.

TIP You can also use the [Advanced Lighting Override material](#) on page 5734 to alter the effect of light tracing on particular objects. For example, if you encounter visual artefacts with a bump-mapped material, convert it to an Advanced Lighting Override material and reduce the Indirect Light Bump Scale value.

- Experiment with the Adaptive Undersampling group settings, which restrict light tracing to the areas of your scene that need it.
- To increase the amount of color bleeding, increase the values of both Bounces and Color Bleed. Color bleeding is usually a subtle effect.
- If there are glass objects in the scene, increase the Bounces value to an amount greater than 0. But be aware that this increases rendering time.
- If the main scene lighting is a [Skylight](#) on page 5065, and you need specular highlights in your scene, add a second light: for example, a Directional light that parallels the Skylight. Make sure Shadows are turned on for this light, and on the light's [Advanced Effects rollout](#) on page 5108, turn off Diffuse.
If the objects with highlights don't greatly affect shadows or color bleeding, you can leave Diffuse on for this light, and use Object Properties to exclude the objects from light tracing.
- Set Key filters are not taken into account when you animate Light Tracer settings. If you wish to use Set Key to create keys for animating the Light Tracer parameters, Shift+right-click the spinner to create those keys.

IMPORTANT If you use a texture map with the Skylight, you should use an image-processing program to *thoroughly* blur the map before using it. This helps reduce variance and the number of rays needed for light tracing. You can blur the map beyond recognition, and it will still look correct when used for regathering.

Procedures

To set up a scene for the Light Tracer:

This is a typical use case:

- 1 Create the geometry for an outdoor scene.
- 2 Add a [Skylight](#) on page 5065 to illuminate it.
One or more spotlights can also work well. If you use the physically based IES Sun or IES Sky lights, using an [exposure control](#) on page 6732 is essential.
- 3 Choose Rendering > Advanced Lighting > Light Tracer.
This opens the Render Setup dialog to the Advanced Lighting panel and activates Light Tracer.
- 4 Adjust the Light Tracer parameters, activate the viewport to render, and then activate the Common panel.
- 5 Adjust your rendering settings, and then click the Render button at the bottom of the dialog.
The scene renders with soft-edged shadows and color bleeding.

Interface

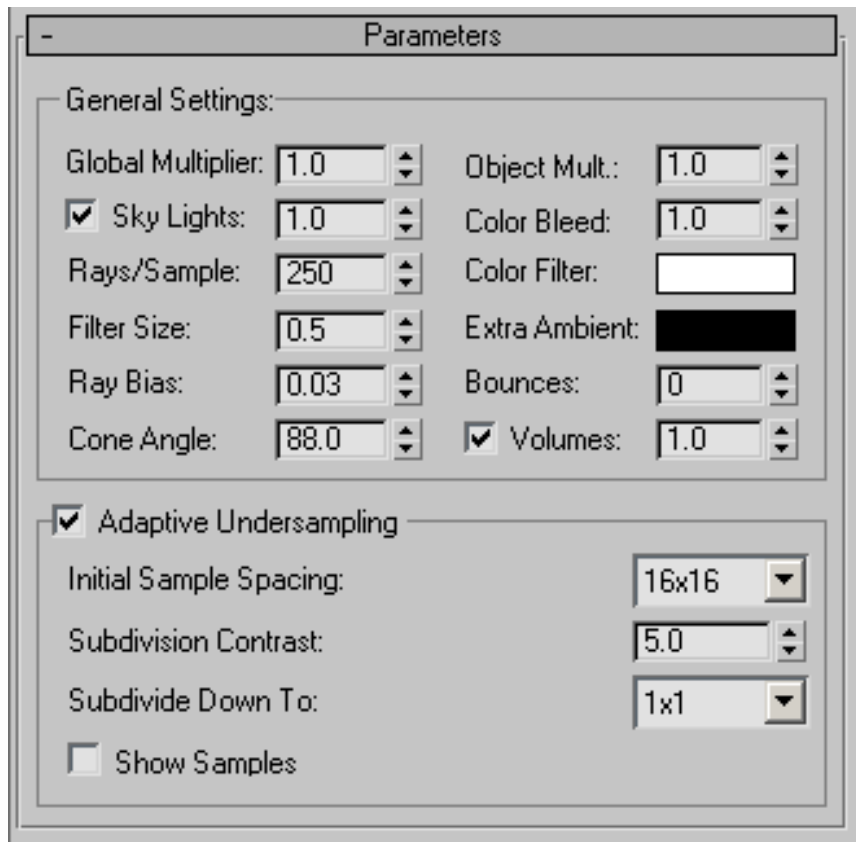

General Settings group

Global Multiplier Controls the overall lighting level. Default=1.0.

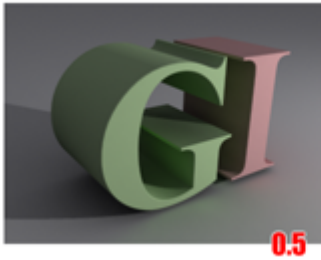

Left: Lower Global Multiplier value

Right: Higher Global Multiplier value

Object Multiplier Controls the level of light reflected by objects in the scene. Default=1.0.

NOTE This setting has little effect unless Bounces is greater than or equal to 2.

Sky Lights [toggle] When on, enables regathering from the Skylights in the scene. (A scene can contain more than one Skylight.) Default=on.

Sky Lights [amount] Scales the intensity of the Skylights. Default=1.0.

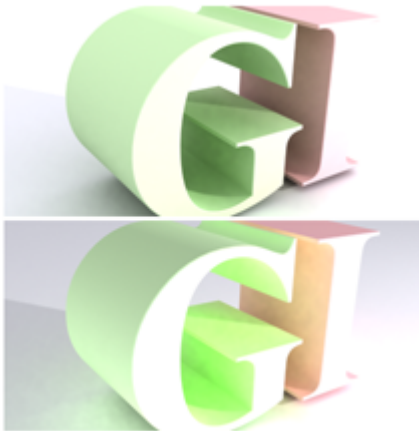

Above: Increasing the Sky Lights value

Below: Increasing the Object Multiplier value

Color Bleed Controls the strength of color bleeding. Color bleeding results when light is interreflected among scene objects. Default=1.0.

NOTE This setting has little effect unless Bounces is greater than or equal to 2.

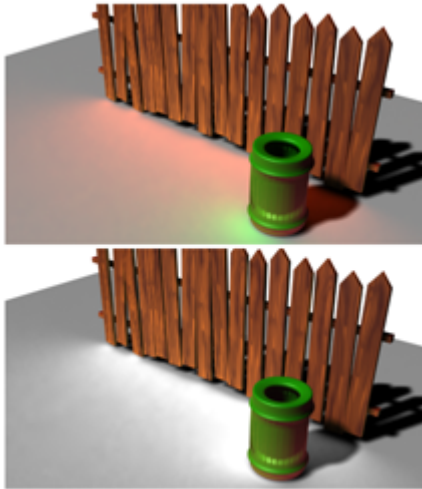

Above: Excessive color bleeding

Below: Color bleeding eliminated by setting Color Bleed to 0.0

Rays/Sample The number of rays cast per sample (or pixel). Increasing this value increases the smoothness of the effect, at a cost of render time. Decreasing this value results in a grainier effect, but renders more quickly. Default=250.

TIP To get a “first draft” preview of the effect of light tracing, reduce the value of Rays/Sample and the Filter Size.

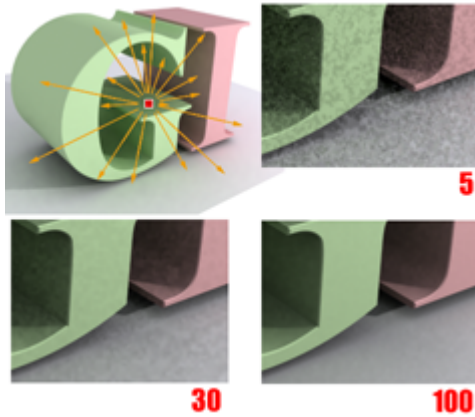

Changing the number of rays per sample

The higher the value, the less grain

Color Filter Filters all light falling on objects. Set to a color other than white to tint the overall effect. Default=white.

Filter Size The size, in pixels, of the filter used to reduce noise in the effect. Default=0.5.

TIP Filter Size is especially useful when Adaptive Undersampling is turned off, and Rays/Sample has a low value.

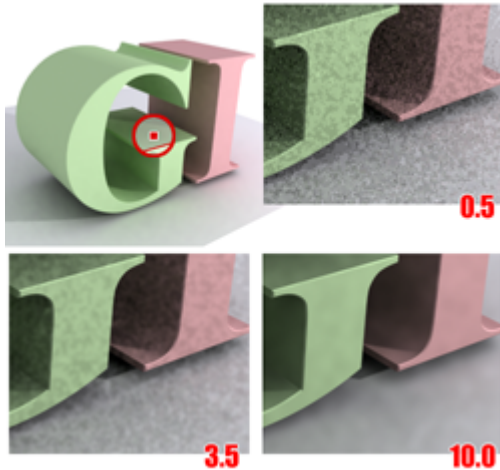

Changing the Filter Size value

Increasing Filter Size reduces noise in the rendering.

Extra Ambient When set to a color other than black, adds that color as extra ambient light on objects. Default=black.

Ray Bias Ray Bias, like [Ray-Trace Bias for shadows](#) on page 8102, adjusts the positioning of the bounced light effects. Use it to correct rendering artifacts, such as the banding that can occur when an object casts shadows on itself. Default=0.03.

Bounces The number of light-ray bounces that are traced. Increasing this value increases the amount of color bleeding. Lower values give faster results with less accuracy, and typically produce darker images. Higher values allow more light to flow through the scene, resulting in brighter, more accurate images at a cost of rendering time. Default=0.

When Bounces equals 0, the Light Tracer disregards volumetric lighting.

TIP If your scene has transparent objects such as glass, increase Bounces to be greater than zero. Be aware that this increases rendering time.

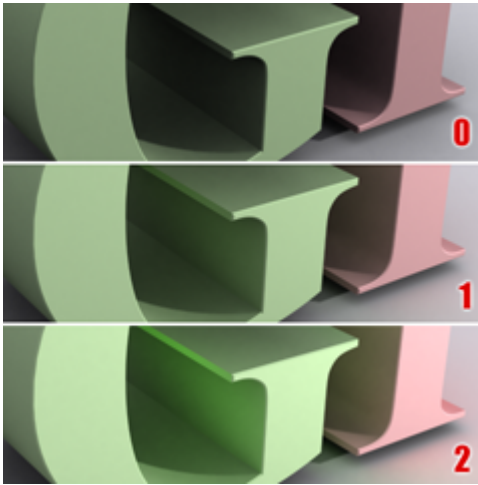

Increasing the number of bounces increases the level of global illumination and the amount of color bleeding in the rendering.

Cone Angle Controls the angle used for regathering. Reducing this value can result in slightly higher contrast, especially in regions where lots of small geometry casts shadows on a larger structure. Range=33.0 to 90.0. Default=88.0.

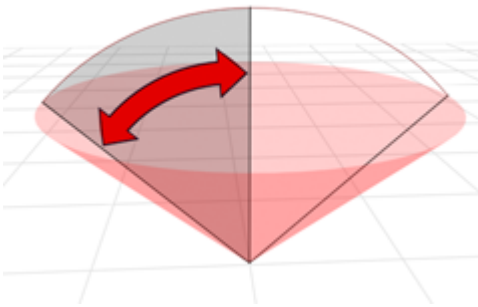

All rays initially cast are limited by the cone angle

Volumes [toggle] When on, the Light Tracer regathers light from volumetric lighting effects such as [Volume Light](#) on page 6721 and [Volume Fog](#) on page 6713. Default=on.

For volumetric lighting to work with light tracing, Bounces must be greater than 0.

Volumes [amount] Multiplies the amount of light regathered from volumetric lighting effects. Increase to increase their impact on the rendered scene, decrease to decrease their effect. Default=1.0.

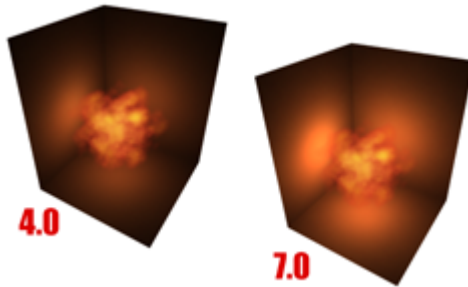

Increasing the Volumes value increases the effect of volumetric lighting in the rendering.

Adaptive Undersampling group

These controls can help you speed up rendering time. They reduce the number of light samples taken. The ideal settings for undersampling vary greatly from scene to scene.

Undersampling initially takes samples from a grid superimposed on the pixels of the scene. Where there is enough contrast between samples, it subdivides that region and takes further samples, down to the minimum area specified by Subdivide Down To. Lighting for areas not directly sampled is interpolated.

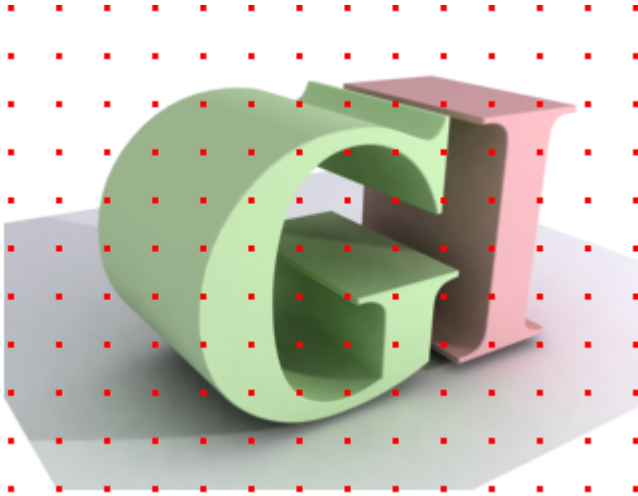

Initial sampling uses a regular grid.

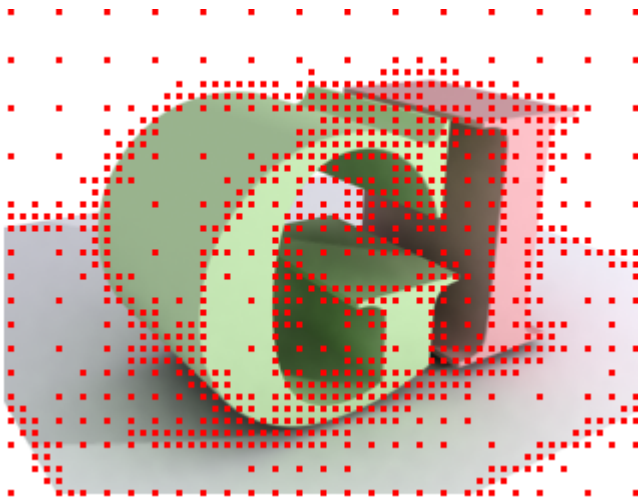

Adaptive undersampling concentrates on transition areas.

TIP If you use adaptive undersampling, try adjusting the Subdivision Contrast value to obtain the best results. The effect of this control depends on the value of Rays/Sample.

Adaptive Undersampling When on, the Light Tracer uses undersampling. When off, it samples every pixel. Turning this off can increase the detail of the final rendering, but at a cost of rendering time. Default=on.

Initial Sample Spacing The grid spacing for the initial samples of the image. This is measured in pixels. Default=16x16.

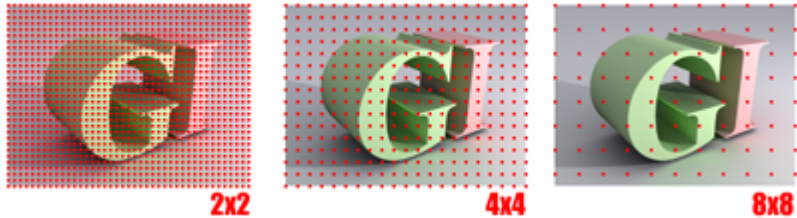

Initial sample spacing values

Subdivision Contrast The contrast threshold that determines when a region should be further subdivided. Increasing this value causes less subdividing to occur. Too low a value can cause unnecessary subdividing. Default=5.0.

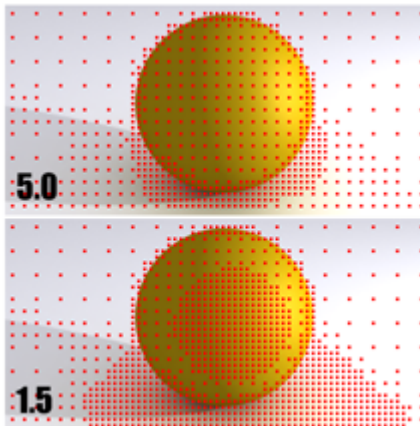

Decreasing the subdivision contrast threshold can reduce noise in soft shadows and bounced lighting.

Subdivide Down To The minimum spacing for a subdivision. Increasing this value can improve render time at a cost of accuracy. Default=1x1.

Depending on the scene geometry, grids larger than 1x1 might still be subdivided below this specified threshold.

Show Samples When on, sample locations render as red dots. This shows where the most sampling has taken place, which can help you choose the optimal settings for undersampling. Default=off.

Modeling Global Illumination with Radiosity

Radiosity is rendering technology that realistically simulates the way in which light interacts in an environment.

This topic provides you with a conceptual overview of what radiosity is and how this global illumination technique relates to other rendering techniques available in 3ds Max. This information will help you decide which technique is most suitable for the visualization task you want to perform. By more accurately simulating the lighting in your scene, radiosity offers you significant benefits over standard lights:

- **Improved Image Quality:** The radiosity technology of 3ds Max produces more accurate [photometric](#) on page 8088 simulations of the lighting in your scenes. Effects such as indirect light, soft shadows, and color bleeding between surfaces produce images of natural realism that are not attainable with standard scanline rendering. These images give you a better, more predictable representation of what your designs will look like under specific lighting conditions.
- **More Intuitive Lighting:** In conjunction with radiosity techniques, 3ds Max also provides a real-world lighting interface. Instead of specifying lighting intensity with arbitrary values, light intensity is specified using photometric units (lumens, candelas, and so on). In addition, the characteristics of real-world lighting fixtures can be defined using industry-standard Luminous Intensity Distribution files (such as [IES](#) on page 5034, [CIBSE](#) on page 7935, and [LTLI](#) on page 8029), which are obtainable from most lighting manufacturers. By being able to work with a real-world lighting interface, you can intuitively set up the lighting in your scenes. You can focus more on your design exploration than on the computer graphic techniques required to visualize them accurately.

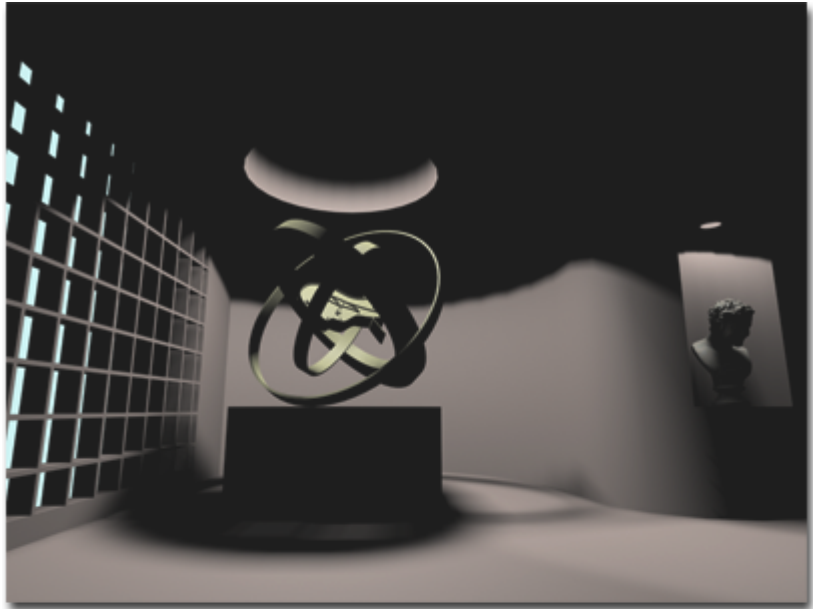

Top: A scene rendered without radiosity.

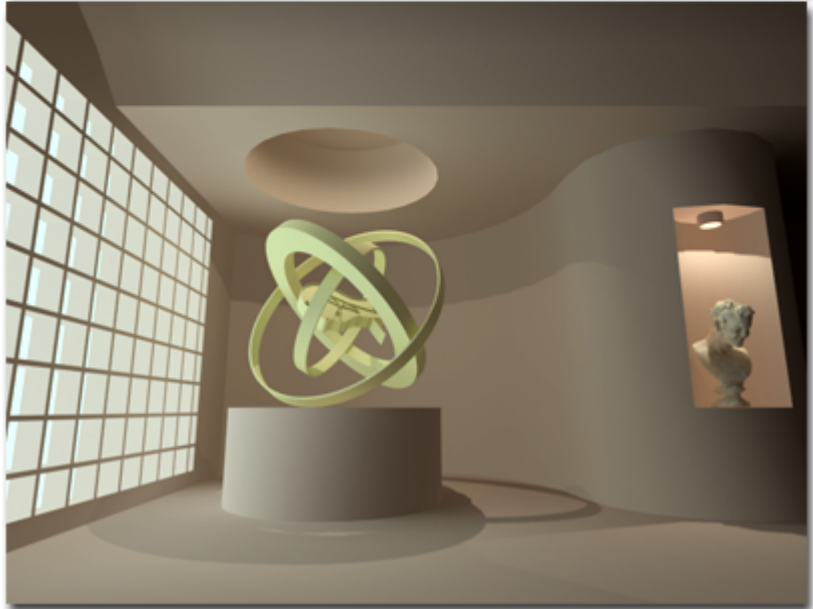

Bottom: The same scene rendered with radiosity.

Computer Graphics Rendering

The 3D models created in 3ds Max contain geometric data defined in relationship to a 3D Cartesian coordinate system, referred to as [world space](#) on page 8175. The model also contains other information about the material of each of the objects and the lighting in the scene. The image on a computer monitor is made up of many illuminated dots, called [pixels](#) on page 8092. The task in creating a computer graphics image of a geometric model is to determine the color for each pixel based on the model information and a specific viewpoint (camera).

The color of any specific point on a surface in a model is a function of the physical material properties of that surface and the light that illuminates it. Two general shading algorithms: *local illumination* and *global illumination* are used to describe how surfaces reflect and transmit light.

Local Illumination

Local illumination algorithms describe only how individual surfaces reflect or transmit light. Given a description of light arriving at a surface, these mathematical algorithms, called *shaders* in 3ds Max, predict the intensity, color, and distribution of the light leaving that surface. In conjunction with a material description, different shaders will determine, for example, if a surface will appear like plastic or metal or if it will appear smooth or rough. 3ds Max provides a robust interface for defining a wide array of different surface materials.

After defining how an individual surface interacts with light at the local level, the next task is to determine where the light arriving at the surface originates. With the standard [scanline rendering system](#) on page 8116 of 3ds Max, only the light coming directly from the light sources themselves is considered in the shading.

For more accurate images, however, it is important to take into account not only the light sources, but also how all the surfaces and objects in the environment interact with the light. For example, some surfaces block light, casting shadows on other surfaces; some surfaces are shiny, in which case we see in them the reflections of other surfaces; some surfaces are transparent, in which case we see other surfaces through them; and some surfaces reflect light onto other surfaces.

Global Illumination

Rendering algorithms that take into account the ways in which light is transferred between surfaces in the model are called global illumination

algorithms. 3ds Max offers two global illumination algorithms as an integral part of its production rendering system: *ray-tracing* and *radiosity*.

Before an explanation of how ray-tracing and radiosity work, it's useful to understand how light is distributed in the physical world. Consider, for example, the room shown in the illustration below.



Kitchen lit by two lights

This kitchen above has two light sources. One theory of light considers the light in terms of discrete particles called photons, that travel from the light source until they encounter some surface in the kitchen. Depending on the surface material, some of these photons are absorbed and others are scattered back out into the environment. The fact that photons traveling at a particular wavelength are absorbed while others are not is what determines the color of the surface.

Surfaces that are very smooth reflect the photons in one direction, at an angle equal to the angle at which they arrive at the surface, the angle of incidence. These surfaces are known as specular surfaces, and this type of reflection is known as specular reflection. A mirror is an example of a perfectly specular surface. Of course, many materials display some degree of both specular and diffuse reflection.

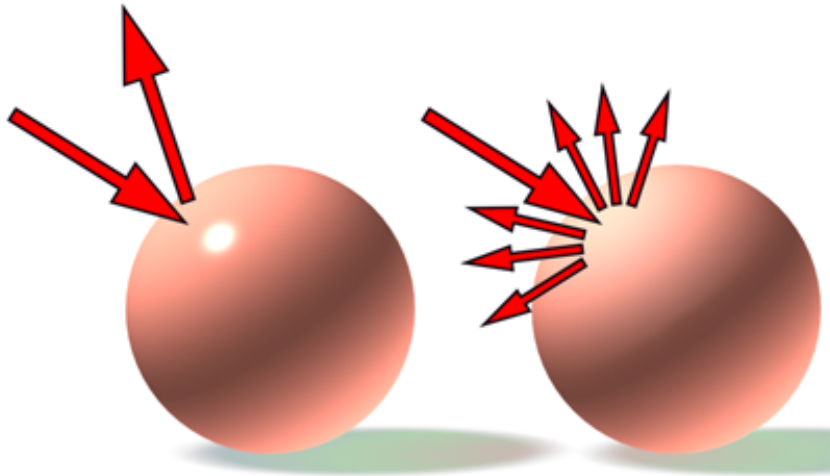

Left: Specular reflection

Right: Diffuse reflection

The way in which the photons are reflected from a surface depends primarily on the smoothness of the surface. Rough surfaces tend to reflect photons in all directions. These are known as diffuse surfaces, and this type of reflection is known as diffuse reflection (shown above). A wall painted with flat paint is a good example of a diffuse surface.

The final illumination of the kitchen is determined by the interaction between the surfaces and the billions of photons emitted from the light source. At any given point on a surface, it is possible that photons have arrived directly from the light source (direct illumination) or else indirectly through one or more bounces off other surfaces (indirect illumination). If you were standing in the kitchen, a very small number of the photons in the room would enter your eye and stimulate the rods and cones of your retina. This stimulation would, in effect, form an image that is perceived by your brain.

In computer graphics we replace the rods and cones of a retina with the pixels of the computer screen. One goal of a global illumination algorithm is to re-create, as accurately as possible, what you would see if you were standing in a real environment. A second goal is to accomplish this task as quickly as

possible, ideally in real time (30 images per second). Currently, no single global illumination algorithm can accomplish both goals.

Ray-Tracing

One of the first global illumination algorithms developed is known as ray-tracing. The ray-tracing algorithm recognizes that although billions of photons may be traveling about the room, the photons we primarily care about are the ones that enter the eye. The algorithm works by tracing rays backward, from each pixel on the screen into the 3D model. In this way, we compute only the information needed to construct the image. To create an image using ray-tracing, the following procedure is performed for each pixel on the computer screen.

- 1** A ray is traced back from the eye position, through the pixel on the monitor, until it intersects with a surface. We know the reflectivity of the surface from the material description, but we do not yet know the amount of light reaching that surface.
- 2** To determine the total illumination, we trace a ray from the point of intersection to each light source in the environment (shadow ray). If the ray to a light source is not blocked by another object, the light contribution from that source is used to calculate the color of the surface.
- 3** If an intersected surface is shiny or transparent, we also have to determine what is seen in or through the surface being processed. Steps 1 and 2 are repeated in the reflected (and, in the case of transparency, transmitted) direction until another surface is encountered. The color at the subsequent intersection point is calculated and factored into the original point.
- 4** If the second surface is also reflective or transparent, the ray-tracing process repeats, and so on until a maximum number of iterations is reached or until no more surfaces are intersected.

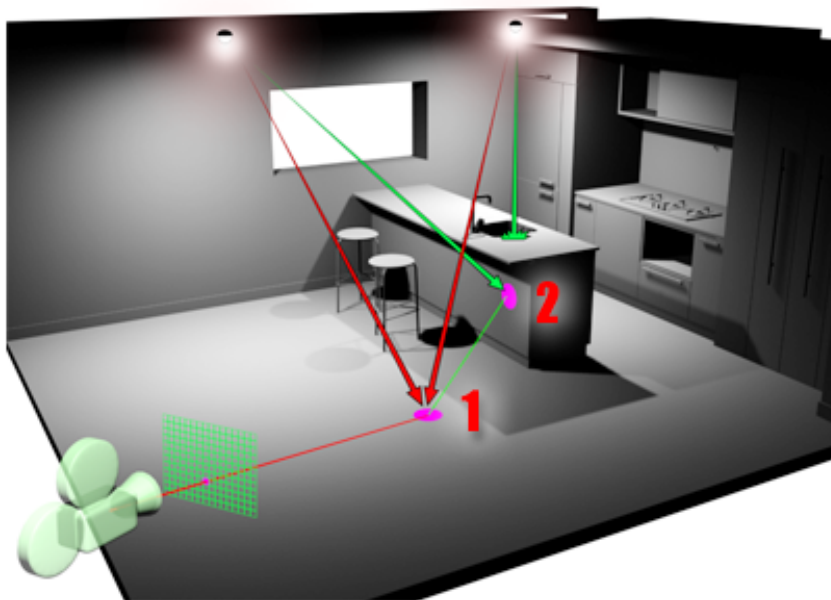

Ray-tracing: Rays are traced from the camera through a pixel, to the geometry, then back to their light sources.

The ray-tracing algorithm is very versatile because of the large range of lighting effects it can model. It can accurately account for the global illumination characteristics of direct illumination, shadows, specular reflections (for example, mirrors), and refraction through transparent materials. The main disadvantage of ray-tracing is that it can be very slow for environments of even moderate complexity. In 3ds Max, ray-tracing is used selectively on objects with [ray-trace materials](#) on page 5490 that specify ray-tracing as their shading option. Ray-tracing can also be specified for light sources as the method for rendering the shadows they cast.

A significant disadvantage of both ray-tracing and scanline rendering is that these techniques do not account for one very important characteristic of global illumination, diffuse inter-reflections. With traditional ray-tracing and scanline rendering, only the light arriving directly from the light sources themselves is accurately accounted for. But, as shown in the room example, not only does light arrive at a surface from the light sources (direct lighting), it also arrives from other surfaces (indirect lighting). If we were to ray-trace an image of the kitchen, for example, the areas in shadow would appear black because they

receive no direct light from the light sources. We know from experience, however, that these areas would not be completely dark because of the light they would receive from the surrounding walls and floor.

In scanline rendering and traditional ray-tracing (versions of 3ds Max prior to v5), this indirect illumination is usually accounted for simply by adding an arbitrary *ambient light* value that has no correlation to the physical phenomena of indirect illumination and is constant throughout space. For this reason, scanline and ray-traced images can often appear very flat, particularly renderings of architectural environments, which typically contain mostly diffuse surfaces.

Radiosity

To address this issue, researchers began investigating alternative techniques for calculating global illumination, drawing on thermal engineering research. In the early 1960s, engineers developed methods for simulating the radiative heat transfer between surfaces to determine how their designs would perform in applications such as furnaces and engines. In the mid-1980s, computer graphics researchers began investigating the application of these techniques for simulating light propagation.

Radiosity, as this technique is called in the computer graphics world, differs fundamentally from ray-tracing. Rather than determining the color for each pixel on a screen, radiosity calculates the intensity for all surfaces in the environment. This is accomplished by first dividing the original surfaces into a mesh of smaller surfaces known as *elements*. The radiosity algorithm calculates the amount of light distributed from each mesh element to every other mesh element. The final radiosity values are stored for each element of the mesh.

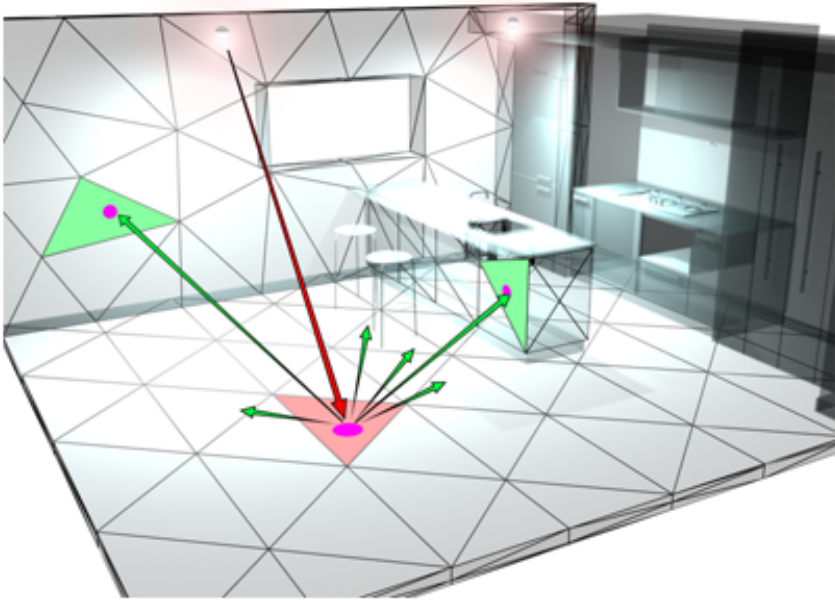

Radiosity: A ray of light that hits a surface is reflected by multiple diffuse rays, which can themselves illuminate other surfaces. Surfaces are subdivided to increase accuracy of the solution.

In early versions of the radiosity algorithm, the distribution of light among mesh elements had to be completely calculated before any useful results could be displayed on the screen. Even though the result was view-independent, the preprocessing took a considerable amount of time. In 1988, progressive refinement was invented. This technique displays immediate visual results that can progressively improve in accuracy and visual quality. In 1999, the technique called stochastic relaxation radiosity (SRR) was invented. The SRR algorithm forms the basis of the commercial radiosity systems provided by Autodesk.

An Integrated Solution

Although the ray-tracing and radiosity algorithms are very different, they are in many ways complementary. Each technique has advantages and disadvantages.

Lighting Algorithm	Advantages	Disadvantages
Ray-Tracing	Accurately renders direct illumination, shadows, specular reflections, and transparency effects. Memory Efficient	Computationally expensive. The time required to produce an image is greatly affected by the number of light sources. Process must be repeated for each view (view dependent). Doesn't account for diffuse interreflections.
Radiosity	Calculates diffuse interreflections between surfaces. Provides view independent solutions for fast display of arbitrary views. Offers immediate visual results.	3D mesh requires more memory than the original surfaces. Surface sampling algorithm is more susceptible to imaging artifacts than ray-tracing. Doesn't account for specular reflections or transparency effects.

Neither radiosity nor ray-tracing offers a complete solution for simulating all global illumination effects. Radiosity excels at rendering diffuse-to-diffuse inter-reflections, and ray-tracing excels at rendering specular reflections. By integrating both techniques with a production quality scanline rendering system, 3ds Max offers the best of both worlds. After you create a radiosity

solution, you can render a two-dimensional view of it. In your 3ds Max scene, ray-tracing adds effects in addition to those that radiosity provides: lights can provide ray-traced shadows, and materials can provide ray-traced reflections and refractions. The rendered scene combines both techniques, and appears more realistic than either technique alone could provide.

By integrating ray-tracing and radiosity, 3ds Max offers a full range of visualization possibilities, from fast, interactive lighting studies to images of exceptional quality and realism.

See also:

- [How Radiosity Works in 3ds Max](#) on page 6178
- [Radiosity Workflows](#) on page 6181
- [Animation with Radiosity](#) on page 6186
- [Radiosity Controls](#) on page 6188
- [Lighting Analysis](#) on page 6219
- [Radiosity Preferences](#) on page 7786
- [Advanced Lighting Override Material](#) on page 5734

How Radiosity Works in 3ds Max

This is an overview of how radiosity works in 3ds Max:

- 1 Object by object, 3ds Max loads a copy of the scene into the radiosity engine.
- 2 3ds Max subdivides each object according to the Global Subdivision Settings in the Radiosity Meshing Parameters rollout, or according to the object's individual object properties, if those differ from the global settings.
- 3 3ds Max emits a certain amount of rays, based on the average scene reflectance and number of polygons. The brightest light source will have more rays to emit than the weakest light source.
- 4 These rays bounce around randomly in the scene and deposit energy on the faces.
- 5 3ds Max updates the viewports by taking all the energy from the faces and spreading it to the closest vertex.

See the section that follows, “Refinement Steps for Radiosity,” for a more detailed description of the solution process.

Refinement Steps for Radiosity

The radiosity process involves three stages of increasing refinement. The first two stages occur during the primary radiosity processing, and the third stage can be used during the final rendering.

Within each of the first two stages, you can stop and start the processing at any time. This can be useful for evaluating interim results or increasing the level of accuracy you desire. For example, you can interrupt the Initial Quality stage at 50% and jump ahead to the Refine stage if you wish. However, once you enter the Refine stage, you cannot continue further iterations of Initial Quality unless you restart the solution.

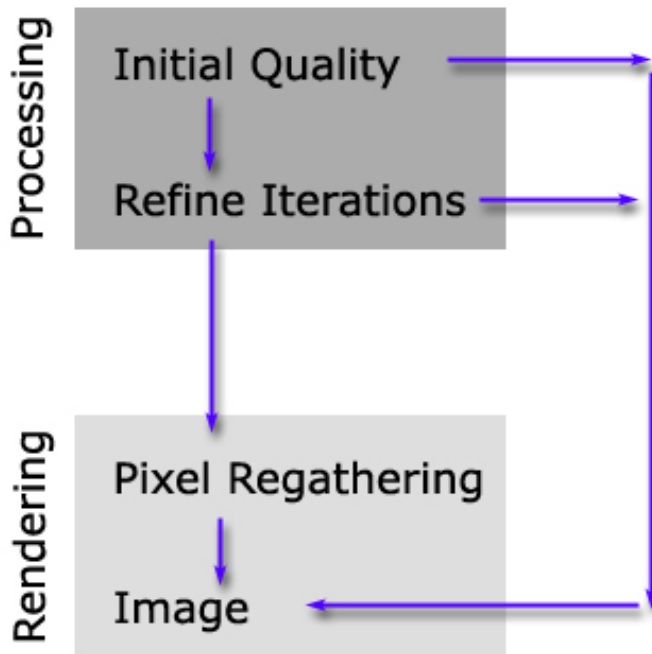

The stages of a radiosity solution are Initial Quality, Refine, and then Regathering.

1 Initial Quality

In the Initial Quality stage, the distribution of diffuse lighting in the scene is calculated by essentially mimicking the behavior of real photons. Rather than tracing the path of an essentially infinite number of photons, statistical methods are used to choose a much smaller set of “photon rays” whose distribution in space is representative of the actual distribution. As with any statistical sampling process, the greater the number of rays used in the approximation, the greater the accuracy of the solution. During the initial quality stage, the overall appearance of the lighting level of the scene is established. The results can be interactively displayed in shaded viewports.

The initial quality stage performs repeated passes, which are shown in the dialog's progress bar.

2 Refine Iterations (All Objects) and Refine Iterations (Selected Objects)

Because of the random nature of the sampling during the initial quality stage, some of the smaller surfaces or mesh elements in the scene might miss being hit by enough rays (or any rays at all). These small surfaces remain dark, and result in the appearance of “variance” or dark spots. To alleviate these artifacts, the Refine stage “regathers light” at every surface element.

You can perform the Refine stage for the entire scene, or for selected objects in the scene.

3 Regathering

Even after the Refine stage, it is still possible for visual artifacts to appear in a scene because of the topology of the original model. These artifacts sometimes appear as shadow or light “leaks.” To eliminate even these model-based artifacts, a third, optional refinement stage known as Pixel Regathering occurs at the time of image rendering. This involves a final “regather” process for each pixel of the image. Regathering can add a considerable amount of time to the rendering of a final image, but it also produces the most detailed and artifact-free images possible.

One benefit of using Regathering is that it means the initial modeling and mesh resolution don't need to be nearly as “refined” or “tight” as would otherwise be required.

Radiosity Workflows

The following sections describe how to set up a scene for use with radiosity.

Set Units Correctly Before Processing Radiosity

For imported geometry, you must make sure that units are consistent in your scene before processing radiosity (for example, a wall is 8 feet high, not 8 kilometers high). Units in 3ds Max must match the units of the model because the radiosity engine always uses an inverse square falloff for lights. Therefore, distance is crucial.

To make sure your units are setup correctly, use the [Units Setup dialog](#) on page 7809. The Scene Unit is the most important unit in this dialog. This is the

unit that 3ds Max uses for its calculations. The Display Unit is just a tool that lets you customize how units are displayed in the user interface.

The following two scenarios show how to set unit scales after importing geometry that has been created using different units than what is currently set in 3ds Max:

Example 1: You import a table that was created in AutoCAD using metric scale. The table is 9 units long, which corresponds to an actual length of 90 centimeters. When the table is imported into 3ds Max, it will measure 9 scene units. Therefore, in the Units Setup dialog, you must set Scene Unit Scale to 1 Unit=10 centimeters. Your table is now the correct units because it is 90 centimeters long in 3ds Max model.

Example 2: You have an AutoCAD model that was created using Architectural Units. The model is a room measuring 20'-4" long. In AutoCAD, Architectural Units are stored as inches. Therefore, before importing the model to 3ds Max, make sure to set the Scene Unit Scale to 1 Unit=1 inch. Once imported to 3ds Max, the room will measure 244 units long (20*12+4").

TIP Use the [Measure Distance tool](#) on page 2613 to quickly check dimensions in 3ds Max.

Physically Based Workflow

Use [radiosity](#) on page 6168 to create physically based lighting simulations. When doing so, keep in mind the following:

- **Scene dimensions:** Make sure your scenes are accurately dimensioned, with consistent units (a light bulb in a room 120 meters high would look a lot different than it would in a room 120 inches high).
- **Lights:** You should work exclusively with [Photometric lights](#) on page 5005. You should also make sure that the light intensities are within a normal range.
- **Natural Lighting:** To simulate natural light, you should only use [IES sun](#) on page 5154 and [IES Sky](#) on page 5157. These provide accurate photometric representations of sunlight and skylight based on a specified location, date and time.
- **Material Reflectance:** You should ensure that the materials you use in your scene have a [reflectance value](#) on page 5324 within the range of the physical materials they represent. For example, a painted white wall should have a maximum reflectance of approximately 80%; however, a pure white color

material (RGB:255, 255, 255) would have a reflectance of 100%. This means that the material reflects 100% of the energy received.

- **Exposure Control:** The exposure control is the equivalent of the aperture of a camera. Make sure you enable the exposure control and set a value that provides the final results you desire.

To process radiosity for photometric lights using a physically based workflow:

- 1 Ensure that your geometry is set to a physically correct scale and that the materials have valid reflectance values.
- 2 Place photometric lights in your scene. The benefit of this workflow is that it allows you to place lights in your scene the same way you would in the real world. You can create new photometric lights or, using the [asset browser](#) on page 7132, drag and drop preset [luminaire objects](#) on page 295 from the included library.
You can also refer to [Common Lamp Values](#) on page 5014.
- 3 Choose Rendering > Environment to display the [Environment panel](#) on page 6689. Select the type of exposure control you want to use (typically [Logarithmic](#) on page 6740).



- 4 To preview the lighting, click Render.

At this stage, no processing of radiosity occurs, but you can quickly confirm that the direct lighting is correct. If you like, adjust the position of the lights.

- 5 Choose Rendering > Advanced Lighting > Radiosity, and then confirm any alerts that appear. On the Select Advanced Lighting rollout, make sure Active is on.
- 6 To process radiosity, on the Radiosity Processing Parameters rollout, click Start.

Once the Radiosity calculation has been completed, you should see your results in the viewports. The light levels are stored with the geometry and you can navigate the model interactively without reprocessing the scene.



- 7 Click Render again.

The renderer calculates the direct lighting and shadows and then integrates the radiosity solution (indirect lighting) as a modulated ambient light.

Lighting Analysis

After you generate a radiosity solution, you can use the [Lighting Analysis tool](#) on page 6219 to analyze the lighting levels in your scene. This dialog provides data on material reflectance, transmittance, and luminance.

You can also visualize the light levels in the scene interactively with the [Pseudo Color Exposure Control](#) on page 6753. Rendering to the Rendered Frame Window displays an additional rendered frame with a legend below the image. The legend correlates lighting levels and color values.

If you need to generate a lighting report, you can use the [Lighting Data Exporter utility](#) on page 6759 to export the luminance and illuminance data to a 32-bit LogLUV [TIFF file](#) on page 7372 or a pair of [PIC files](#) on page 7359 (one each for luminance and illuminance).

NOTE To obtain the most accurate quantitative analysis of lighting levels, avoid using colored materials and diffuse maps.

Non-Physically Based Workflow

You don't necessarily have to work with physically based lights and materials in order to incorporate radiosity effects into your renderings. But there are a number of issues that you need to consider:

- **Lights:** Because the radiosity engine is physically based, the engine interprets [Standard lights](#) on page 5049 as [Photometric lights](#) on page 5005. For example, a Standard Spot light with a multiplier value of 1.0 is translated as a Physically Based Spot light with an intensity value of 1500 candelas (default value). This translation value corresponds to the Physical Scale value in the various exposure controls. In addition, if your Standard lights use custom attenuation settings (for example, no attenuation, manual attenuation, or linear decay), the radiosity engine always solves for these lights using inverse square attenuation, which is physically correct. This means that the amount of energy that bounces between surfaces might not be equivalent to the way the Standard lights render.

- **Natural Lighting:** To simulate natural lighting without using the physically based workflow described above, you can use only a [Direct Light](#) on page 5057 for the Sun and [Skylight](#) on page 5065 to produce [skylight](#) on page 8129.
- **Exposure Control:** Standard lights are not physically based, so use the [Logarithmic Exposure Control](#) on page 6740 for the radiosity solution. Be sure to turn on Affect Indirect Only. The Brightness and Contrast controls of the exposure control will affect only the radiosity solution and your lights will render as usual.

To process radiosity with standard lighting:

- 1 Ensure that your geometry is set to a physically correct scale.



- 2 On the Create panel, click Lights. Create and position [standard lights](#) on page 5049 in your scene.



- 3 To preview the lighting, click Render.

At this stage, the radiosity is not processed, but you can quickly confirm that the direct lighting is correct. Adjust the position of the lights if desired.

- 4 Choose Rendering > Advanced Lighting > Radiosity and confirm any alerts that appear. On the Select Advanced Lighting rollout, make sure Active is on.
- 5 To process radiosity, on the Radiosity Processing Parameters rollout, click Start. Once the Radiosity calculation has been completed, you should see your results in the viewports.
- 6 To display the [Environment panel](#) on page 6689, where you set exposure controls, in the Interactive Tools group of the Radiosity Processing Parameters rollout, click Setup.
- 7 When working with non-physically based lights, always use the [Logarithmic Exposure Control](#) on page 6740. On the Logarithmic Exposure Control Parameters rollout, turn on Affect Indirect Only.

This causes the exposure control to affect only the results of the radiosity solution. This way you maintain the way your direct lights render without radiosity. Use the Brightness and Contrast controls of the exposure control

to adjust the intensity of the radiosity solution to match the lighting at an appropriate level.

TIP You can use the thumbnail preview to adjust brightness and contrast interactively.



8 To render the scene after radiosity processing, click Render.

Summary

The following table is designed to help you obtain good results with radiosity.

	Physically Based Workflow	Non-Physically Based Workflow
Lights	Photometric Lights on page 5005	Standard Lights on page 5049
Daylight	IES Sun on page 5154 and IES Sky on page 5157	Directional Light on page 5057 and Skylight on page 5065
Exposure Control	Any	Logarithmic on page 6740 – turn on Affect Indirect Only.
Units	Make sure your scene is set to the appropriate scale.	Make sure your scene is set to the appropriate scale.

Animation with Radiosity

By default, a [radiosity solution](#) on page 6168 is calculated at the current frame. If you are animating objects and you want to perform a radiosity solution at every frame, turn on Compute Advanced Lighting When Required in the

Render Setup dialog > Common panel > [Common Parameters rollout](#) on page 6121 > Advanced Lighting group.

Once the renderer starts processing each frame of your animation, it computes the radiosity solution for each frame as required. This occurs, for example, when an object moves or a light intensity changes. If nothing changes in the scene from one frame to the next, the radiosity engine does not recalculate the solution.

NOTE Due to the random statistical sampling used by the radiosity engine, there might be some flickering between frames. If this occurs, increase the value of Initial Quality or the number of Refine Iterations to solve the problem.

TIP Before launching a lengthy animation with radiosity, process a radiosity solution manually for a single frame to make sure the results are acceptable.

TIP If you animate only the camera as in an architectural walkthrough, you can save time by calculating a radiosity solution for only the first frame of the animation. You can then reuse it in all subsequently rendered frames by turning off Compute Advanced Lighting When Required on the Common Parameters rollout of the Render Setup dialog.

Avoid using the [Automatic Exposure Control](#) on page 6735 for animations. This exposure control can change from frame to frame, creating a flickering effect.

Object Animation

The radiosity solution is calculated for each frame if any object is animated in the scene (the default is to calculate the current frame only). You specify the parameters (goals/quality) you want to reach on the Advanced Lighting panel. Before rendering the entire animation, we recommend first running a solution to verify that it's successful. These parameters are then reprocessed for each frame.

You go to the Render Setup dialog > Common Parameters rollout and enable the option Compute Advanced Lighting When Required, and then render the scene. The radiosity is processed for the first frame and then rendered. 3ds Max then moves to the next frame, processes radiosity, renders, and so on.

Camera Animation

If objects remain static in the scene and only the camera moves, you can solve radiosity at frame 0, and when you render the animation, turn off Compute Advanced Lighting When Required.

Radiosity Controls

Render Setup dialog > Choose Default Scanline Renderer as the production renderer. > Advanced Lighting panel > Choose Radiosity.

Rendering menu > Advanced Lighting > Radiosity > Render Setup dialog > Advanced Lighting panel > Radiosity is chosen.

Radiosity is a technique to calculate indirect light. Specifically, radiosity calculates the interreflections of diffuse light among all the surfaces in a scene. To make this calculation, radiosity takes into account the lighting, materials, and environment settings in the scene.

Radiosity processing is distinct from the rendering process. You can render without radiosity. However, to render *with* radiosity, you must calculate radiosity first.

Once a radiosity solution for a scene exists, you can use it in multiple renderings, including multiple frames of an animation. If the scene contains moving objects, radiosity might need to be recalculated; see [Animation with Radiosity](#) on page 6186.

For an overview of radiosity and how radiosity works in 3ds Max, see [Radiosity Solution](#) on page 6168.

For suggestions regarding workflow for using radiosity, see [Radiosity Workflows](#) on page 6181.

NOTE Radiosity is a method for *global illumination*.

IMPORTANT If the dimensions of your scene are not realistic, then radiosity cannot show realistic lighting.

See also:

- [Modeling Global Illumination with Radiosity](#) on page 6168
- [How Radiosity Works in 3ds Max](#) on page 6178
- [Radiosity Workflows](#) on page 6181
- [Animation with Radiosity](#) on page 6186
- [Lighting Analysis](#) on page 6219
- [Radiosity Preferences](#) on page 7786

- [Advanced Lighting Override Material](#) on page 5734

Procedures

To set units correctly:

Follow these steps if your scene does not already use real-world units.

-  1 Right-click 3D Snap Toggle and on the Snaps panel, turn off all the settings. Then turn on Vertex to enable vertex snapping. Close the dialog.
- 2 Use Tools > Measure Distance to measure some object in the scene for which you know the size; for example, a door or window. The distance displays in the Coordinate Display of the status bar.
- 3 Choose Customize > Units Setup and adjust the Scene Unit Scale.
For example, if your object measures 35 scene units long, and your model uses US Standard measurement, then you would enter 1 for the scale, and choose Inches from the drop-down list. This would give you an object 35 inches long.

If your object measures 90 scene units long, and your model uses Metric measurement, then you would enter 1 for the scale, and select Centimeters from the drop-down list. This would give you an object 90 centimeters long.

Example: To process radiosity with photometric lighting:

- 1 Use a scene that has geometry set to the correct scale. For more information, see [To set units correctly](#) on page ?.
For example, if the ceiling is 96 scene units high in the model, make sure the units are set to US Standard (inches) and not Metric.
-  2 On the Create panel, click Lights.
- 3 Choose Create > Photometric Lights > Target Point Light.
- 4 Choose Photometric from the drop-down list. (The default is Standard.)
- 5 In the Object Type rollout, click Target Point.

- 6 Drag in a viewport. The initial point of the drag is the location of the light, and the point where you release the mouse is the location of the target.

The light is now part of the scene.

- 7 Set the creation parameters.



TIP You can use the Move transform to adjust the location of the light or its target.

- 8 On the Modify panel, adjust the light's settings.
- 9 To preview the lighting, click Render.
Make any changes you need to adjust the rendering.
- 10 Choose Rendering menu > Environment to open the [Environment panel](#) on page 6689 of the Environment And Effects dialog.
- 11 On the Exposure Control rollout of the Environment panel, choose Logarithmic Exposure Control from the drop-down list. Click Render Preview.
The thumbnail preview shows the effect of exposure control.
- 12 On the [Logarithmic Exposure Control rollout](#) on page 6740, adjust the settings until the scene lighting is acceptable. For example, a brightness of 65 and a contrast of 50 can be good values for interior scenes.
The thumbnail preview updates as you adjust settings.
- 13 Choose Rendering > Advanced Lighting > Radiosity to display the Advanced Lighting panel with Radiosity chosen as the advanced lighting type.
The rollouts for radiosity are displayed.
- 14 Choose Rendering > Radiosity to display the Radiosity panel.
- 15 On the [Radiosity Processing Parameters rollout](#) on page 6193, click Start to begin processing radiosity.
- 16 To render the scene after radiosity processing completes, click Render.

Example: To process radiosity with standard lighting:

Photometric lights are recommended for use with radiosity. But if you are working on a scene that already contains standard lights, you can follow these guidelines.

- 1 Create or load a scene containing the appropriate geometry for lighting. There is no need to adjust any scale factors.



- 2 On the Create panel, click Lights.
Standard is the default choice of light type.

- 3 In the Object Type rollout, click a light type such as Target Spot.

- 4 Drag in a viewport. The initial point of the drag is the location of the spotlight, and the point where you release the mouse is the location of the target.

The light is now part of the scene.

- 5 Set the creation parameters for the light.



- 6 To preview the lighting, click Render.

Make any changes you need to adjust the rendering.

- 7 Choose Rendering > Advanced Lighting to display the Advanced Lighting panel. On the Select Advanced Lighting rollout, choose Radiosity as the advanced lighting type.

The rollouts for radiosity are displayed.

- 8 Choose Rendering > Advanced Lighting > Radiosity to display the Advanced Lighting panel with Radiosity chosen as the advanced lighting type.

The rollouts for radiosity are displayed.

- 9 On the Radiosity Processing rollout, under Interactive Tools, click Setup to display the [Environment panel](#) on page 6689 where you set exposure controls.

NOTE The exposure controls allow you to control only the intensity of the indirect lighting. 3ds Max retains the original intensity and effect for the direct lighting.

- 10 On the Exposure Control rollout of the [Environment panel](#) on page 6689, choose Logarithmic Exposure Control from the drop-down list.
- 11 On the [Logarithmic Exposure Control rollout](#) on page 6740, turn on Affect Indirect Only.
- 12 On the same rollout, use the Physical Scale setting to assign the standard light a photometric value in candelas.
- 13 Render the scene again after radiosity processing.

Interface

Radiosity controls appear as rollouts on the Advanced Lighting panel of the Render Setup dialog. To choose radiosity, use the [Select Advanced Lighting rollout](#) on page 6153.

[Radiosity Processing Parameters Rollout](#) on page 6193

[Radiosity Meshing Parameters Rollout](#) on page 6200

[Light Painting Rollout \(Radiosity\)](#) on page 6206

[Rendering Parameters Rollout \(Radiosity\)](#) on page 6208

[Statistics Rollout \(Radiosity\)](#) on page 6217

Radiosity Rollouts

Radiosity Processing Parameters Rollout

Rendering menu/main toolbar > Render Setup > Render Setup dialog > Choose Default Scanline Renderer as the active production renderer. > Advanced Lighting panel > Select Advanced Lighting rollout > Choose Radiosity from the drop-down list. > Radiosity Processing Parameters rollout

Contains the main controls for processing a radiosity solution.

Interface

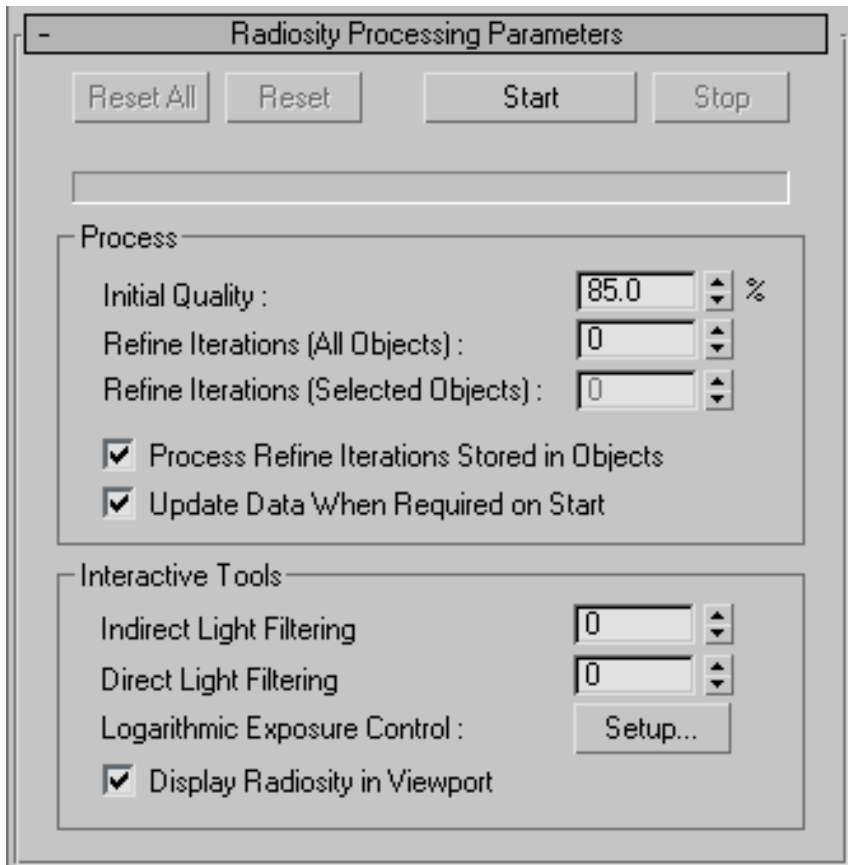

Reset All When you click Start, a copy of the 3ds Max scene is loaded into the radiosity engine. Clicking Reset All clears all the geometry from the engine.

Reset Clears the light levels from the radiosity engine, but doesn't clear the geometry.

Start Starts the radiosity processing. Once the radiosity solution has reached the percentage amount specified by Initial Quality, this button changes to Continue.

If you click Stop *before* reaching the full Initial Quality percentage, then clicking Continue causes radiosity processing to resume, until the full percentage is reached, or you click Stop once more. You can click Stop and then Continue more than once.

In addition, you can calculate radiosity up to an Initial Quality less than 100 percent, then later increase the value of Initial Quality, click Continue, and resume solving radiosity.

In either case, Continue saves time by avoiding regenerating the radiosity solution from scratch.

Once the full Initial Quality percentage has been reached, clicking Continue has no effect.

Stop Stops the radiosity processing. The Start menu changes to Continue. You can later click Continue to resume radiosity processing, as described for the Start menu.

Keyboard shortcut: Esc

Process group

The options in this group set the behavior of the first two stages of the radiosity solution, Initial Quality and Refine.

Initial Quality Sets the quality percentage at which to stop the Initial Quality stage, up to 100%. For example, if you specify 80%, you will get a radiosity solution that is 80% accurate in energy distribution. A goal of 80 to 85% is usually sufficient for good results.

During the Initial Quality stage, the radiosity engine bounces rays around the scene and distributes energy on surfaces. Between each iteration, the engine measures the amount of variance (noise between surfaces) that was computed.

Most of the brightness of the scene is distributed in the early iterations. The contribution to the scene's average brightness decreases logarithmically between iterations. After the first few iterations, the brightness of the scene does not increase much, but subsequent iterations reduce the variance in the scene.

NOTE The “quality” refers to the accuracy of energy distribution, not to the visual quality of the solution. Even at a high Initial Quality percentage, the scene can still show considerable variance. This variance is resolved by the subsequent stages of the solution.

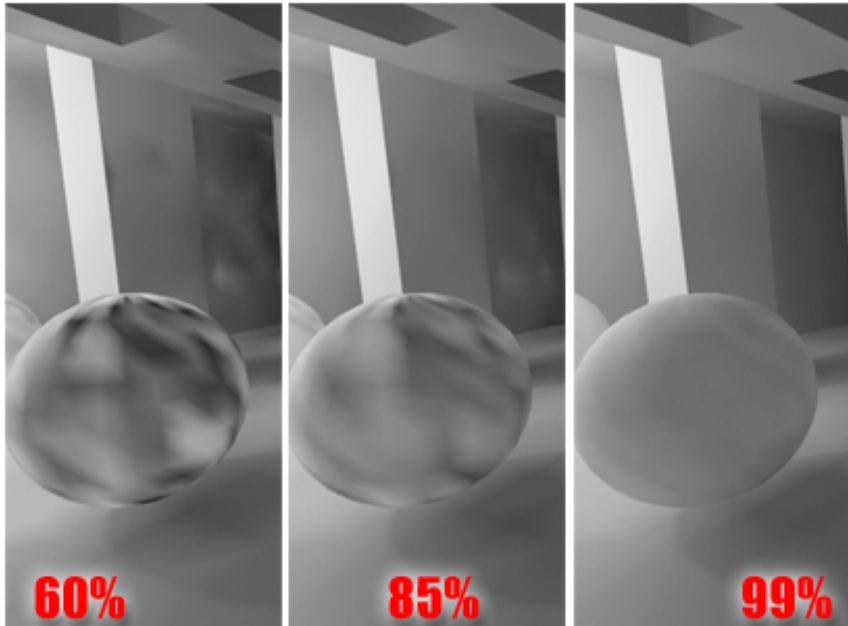

Increasing the percentage value of Initial Quality.

Increasing quality does not greatly increase the average brightness of the scene, but it decreases the variance between different surfaces in the scene, such as the faces of the sphere.

Refine Iterations (All Objects) Sets the number of Refine iterations to perform for the scene as a whole. The Refine Iterations stage increases the quality of the radiosity processing on all objects in the scene. Gathers energy from each face in order to reduce the variance between faces using a different process from the Initial Quality stage. This stage does not increase the brightness of the scene, but it improves the visual quality of the solution and significantly reduces variance between surfaces. If you don't reach an acceptable result after processing a certain number of Refine iterations, you can increase the number and continue processing.

TIP If you plan to use Regathering at render time, you generally don't need to perform the Refine stage to get good-quality final renderings.

NOTE After 3ds Max processes Refine Iterations, Initial Quality is disabled and you can't change it until you click Reset or Reset All.

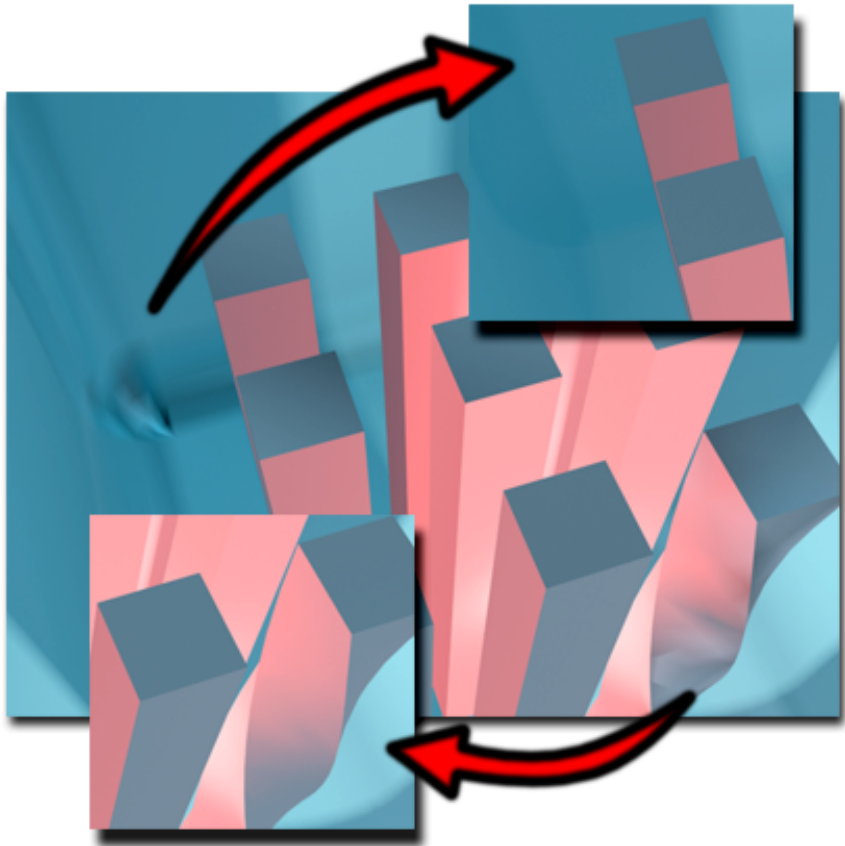

Large image with no iterations has areas of uneven illumination.

Inset images: After a number of iterations, the uneven areas have been corrected.

Refine Iterations (Selected Objects) Sets the number of Refine iterations to perform for selected objects, using the same method as Refine Iterations (All Objects). Make an object selection and then set the number of iterations you require. Refining selected objects rather than the entire scene can save a lot

of processing time. Typically, this option is useful for objects that have a lot of small surfaces and show a lot of variance, such as railings or chairs or highly subdivided walls.

NOTE After 3ds Max processes Refine Iterations, Initial Quality is disabled and you can't change it until you click Reset or Reset All.

Process Refine Iterations Stored in Objects Each object has a radiosity property called Refine Iterations. Each time you refine an object selection, the number of steps stored with these objects is incremented.

When you reset the radiosity solution and then start it again, the steps for each object are refined automatically, provided this toggle is turned on. This is useful when you are creating animations, when the radiosity needs to be processed at every frame, and the same level of quality between frames has to be maintained.

Update Data When Required on Start When on, the radiosity engine must be reset and then recalculated if the solution is invalidated. In this case, the Start menu changes to read Update & Start. When this is pressed, the radiosity solution is reset and the calculation starts over again.

When this toggle is off, the radiosity solution does *not* need to be reset if it is invalidated. You can continue processing your scene with the invalid solution.

NOTE The radiosity solution is invalidated any time an object or light is added, removed, moved, or altered in any way.

Interactive Tools group

The options in this group help you adjust the display of the radiosity solution in the viewport and in the rendered output. These controls take effect immediately on an existing radiosity solution and do not require any additional processing for you to see their effects.

Indirect Light Filtering Reduces the amount of noise between surface elements by averaging the indirect lighting levels with the surrounding elements. A value of 3 or 4 is usually sufficient. If you use too high a value, you risk losing detail in the scene. Because Indirect Light Filtering is interactive, you can readily evaluate the result and adjust it as you need.

Direct Light Filtering Reduces the amount of noise between surface elements by averaging the direct lighting levels with the surrounding elements. A value of 3 or 4 is usually sufficient. If you use too high a value, you risk losing detail in the scene. Direct Light Filtering is interactive, so you can readily evaluate the result and adjust it as you need.

NOTE Direct Light Filtering works only when you use [Shoot Direct Lights](#) on page 6205. If you're not using Shoot Direct Lights, everything is considered indirect lighting.

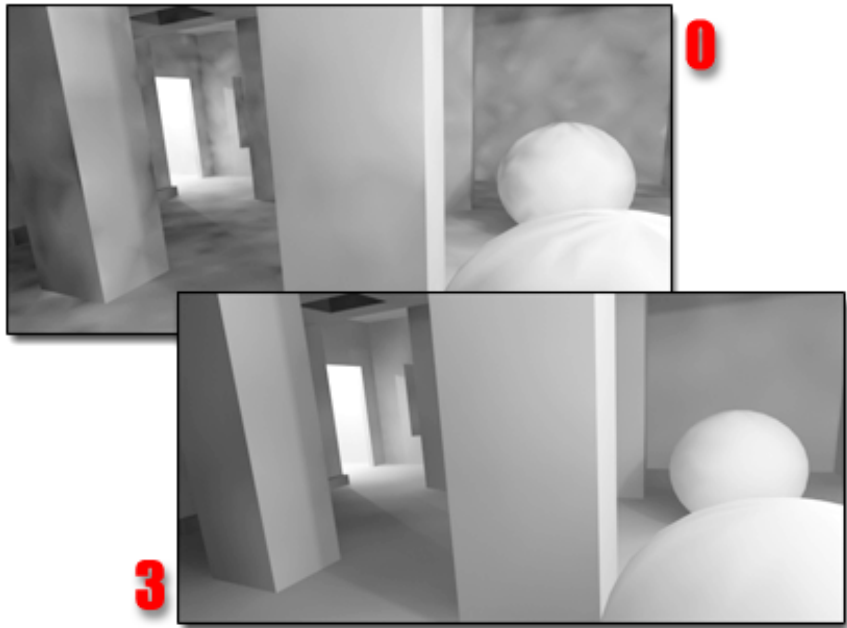

For a 65% quality solution, increasing the Indirect Light Filtering value from 0 to 3 creates a smoother diffuse light. The results are comparable to a much higher-quality solution.

No Exposure Control Selected Displays the name of the current exposure control.

(When you change the exposure control by choosing Rendering menu > Environment, the name display in the Radiosity dialog updates automatically.)

- **Setup** Click to display the [Environment panel](#) on page 6689, where you access the Exposure Control rollout; there, you can choose the exposure control and set its parameters.

Display Radiosity in Viewport Toggles the display in the viewports between radiosity and standard 3ds Max shading. You might want to do turn off radiosity shading to increase display performance.

Radiosity Meshing Parameters Rollout

Render Setup dialog > Choose Default Scanline Renderer as the active production renderer. > Advanced Lighting panel > Select Advanced Lighting rollout > Choose Radiosity from the drop-down list. > Radiosity Meshing Parameters rollout

Controls the creation of a radiosity mesh and its size in world units.

In order to create the lighting of a scene, the software calculates the intensity for discrete points in the environment by subdividing the original surfaces into elements which are part of a *radiosity mesh*. This rollout allows you to determine whether you want a mesh or not, and to specify the size of the mesh elements in world units. For quick tests, you might want to turn off the mesh globally. The scene will look flat, but the solution will still give you a quick impression of the overall brightness.

The finer the mesh resolution is, the more accurate the lighting detail will be. But there is a trade-off in time and memory.

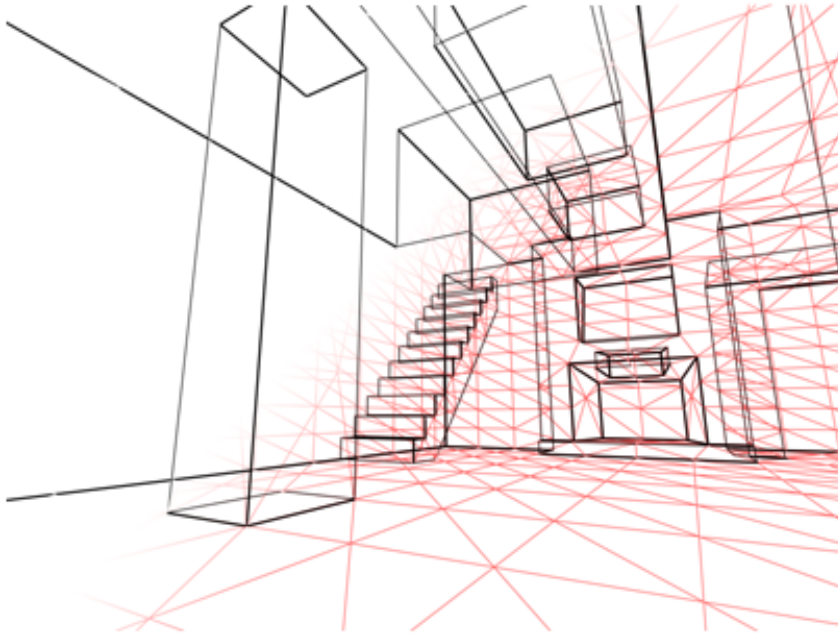

Meshing (shown in light red) subdivides flat surfaces in the scene.

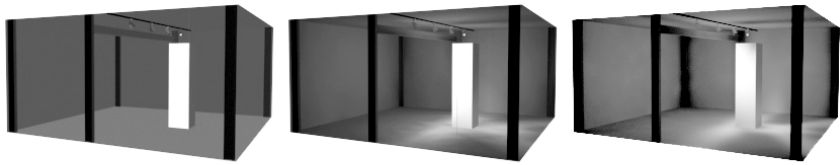

Left: No mesh. The solution looks very flat.

Middle: Coarse mesh, every 24 inches. The lighting improves.

Right: Fine mesh, every 4 inches. The lighting reveals more subtle effects.

NOTE A tight meshing is not necessary when you use the regathering feature on the [Rendering Parameters rollout](#) on page 6208.

Interface

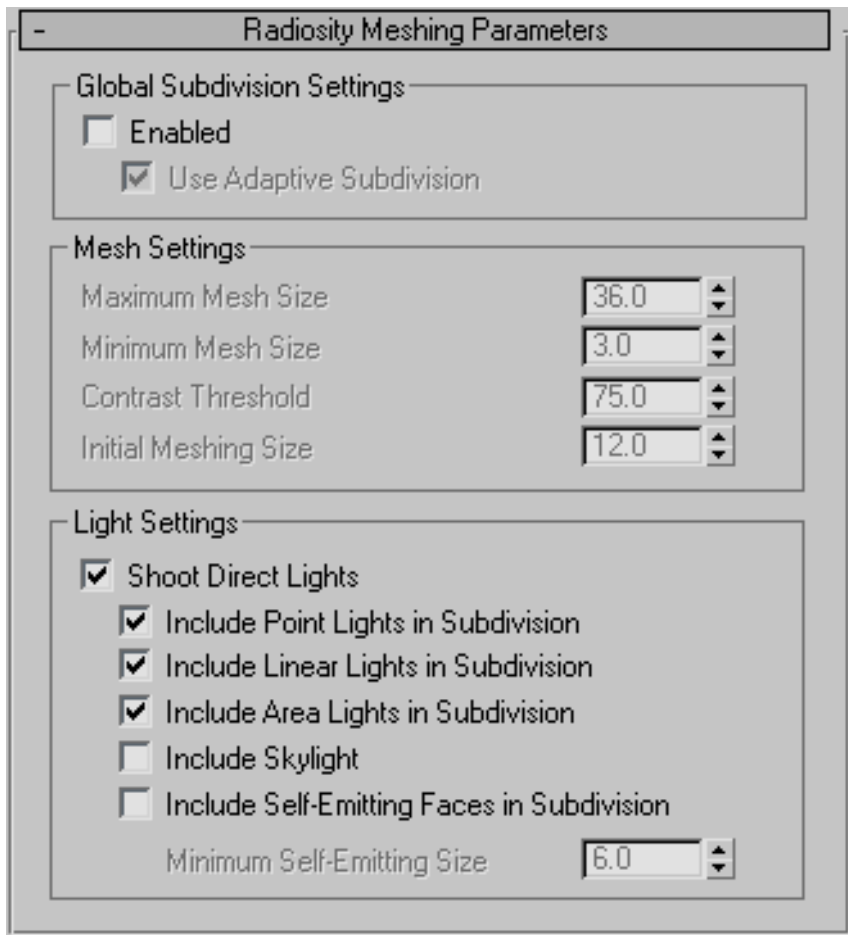

NOTE You can override the subdivision settings in this group with the [Advanced Lighting panel](#) on page 316 of the Object Properties dialog. This allows you to have a different mesh resolution on some objects. For example, you might want to have a finer mesh on an important wall surface that you know will have a lot of detail. To display the Object Properties dialog, right-click a selected object and choose Properties from the quad menu.

Global Subdivision Settings group

Enabled Turns on the radiosity mesh for the entire scene. Turn off the mesh when you want to perform quick tests.

- **Use Adaptive Subdivision** Turns adaptive subdivision on and off.
Default=on.

NOTE The Mesh Settings group parameters Minimum Mesh Size, Contrast Threshold, and Initial Meshing Size are available only when Use Adaptive Subdivision is on.

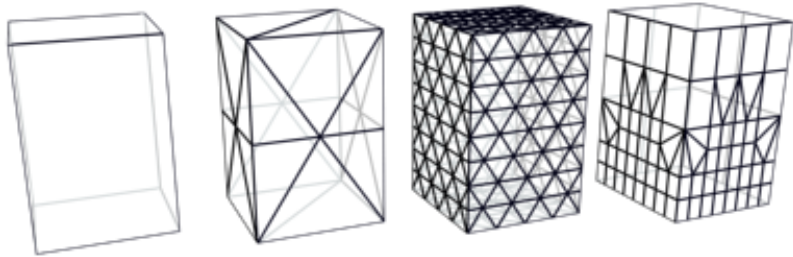

Left: A simple box with no subdivision

Middle Left: The box faces are subdivided

Middle Right: The box faces are subdivided with a smaller Meshing Size

Right: The box faces are subdivided with Adaptive Subdivision

Mesh Settings group

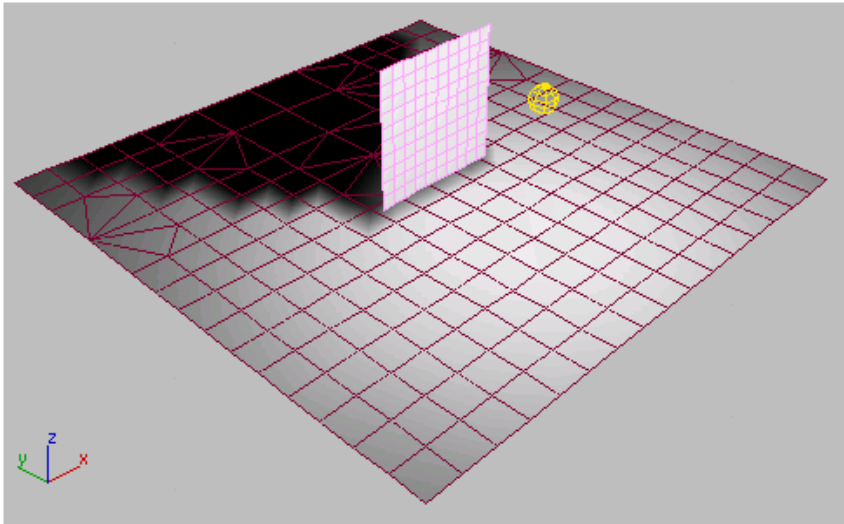

Adaptive Subdivision using the default mesh and light settings

Max Mesh Size The size of the largest faces after adaptive subdivision. Default=36" for imperial units and 100cm for metric units.

When Use Adaptive Subdivision is turned off, Max Mesh Size sets the size of the radiosity mesh in world units.

Min Mesh Size Faces are not divided smaller than the minimum mesh size. Default=3" for imperial units and 10cm for metric units.

Contrast Threshold Faces that have vertex illuminations that differ by more than the Contrast Threshold settings are subdivided. Default=75.0.

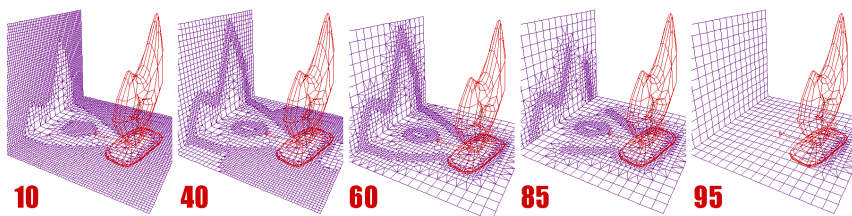

Radiosity solutions with different Contrast Threshold values. The best solution is at the center, with Contrast Threshold=60.

Initial Meshing Size When improving the face shape, faces that are smaller than the Initial Meshing Size are not subdivided. The threshold for deciding whether a face is poorly shaped also gets larger as the face size is closer to the Initial Mesh Size. Default=12 inches (1 foot) for US Standard units and 30.5cm for metric units.

Light Settings group

Shoot Direct Lights When adaptive subdivision or shoot direct lights is on, the direct lighting on all of the objects in the scene is calculated analytically, based on the following switches. Lighting is analytically computed without modifying the object's mesh which produces lighting that is less noisy and more pleasing to the eye. This switch is implicitly enabled when using adaptive subdivision since it is a requirement. Default=on.

This switch is available when the Use Adaptive Subdivision switch is turned off.

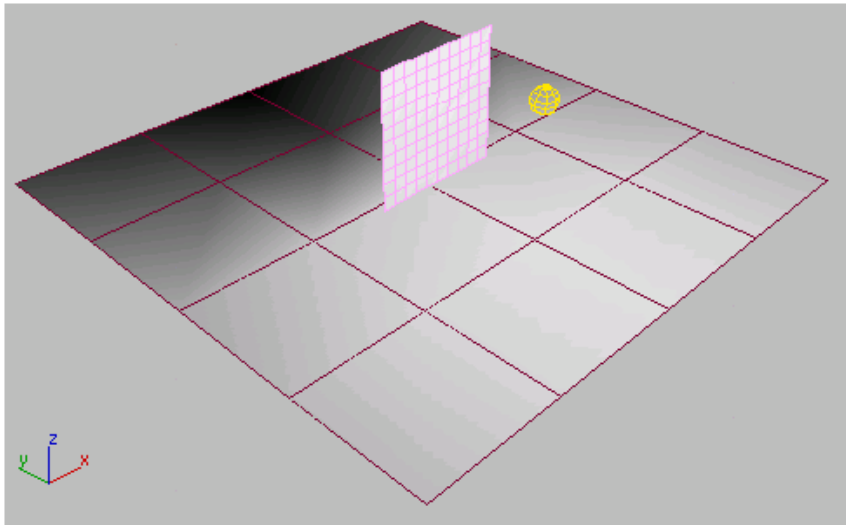

Adaptive Subdivision with light settings turned off

NOTE Lighting from lights that are not included while shooting direct light are calculated using random sampling. These lights also are not able to affect the adaptive subdivision of objects.

Include Point Lights in Subdivision Controls whether point lights are used when shooting direct lights. If this switch is off, then point lights are not included in illumination calculated directly at vertices. Default=on.

Include Linear Lights in Subdivision Controls whether linear lights are used when shooting direct lights. If this switch is off, then linear lights are not used in calculating the illumination at vertices. Default=on.

Include Area Lights in Subdivision Controls whether area lights are used when shooting direct lights. If this switch is off, then area lights are not used in illumination calculated directly at vertices. Default=on.

Include Skylight When turned on, skylight is used when shooting direct lights. If this switch is turned off, then skylight is not used in illumination calculated at vertices directly. Default=off.

Include Self-Emitting Faces in Subdivision This switch controls how self-emitting faces are used when shooting direct lights. If this switch is turned off, then self-emitting faces are not used in illumination calculated at vertices directly. Default=off.

Minimum Self-Emitting Size This is the minimum size that a self-emitting face will be subdivided when calculating its illumination. Minimum size is used rather than the number of samples to allow larger faces to be sampled more than smaller ones. Default=6.0.

Light Painting Rollout (Radiosity)

Rendering menu/main toolbar > Render Setup > Render Setup dialog > Choose Default Scanline Renderer as the active production renderer. > Advanced Lighting panel > Select Advanced Lighting rollout > Choose Radiosity from the drop-down list. > Light Painting rollout

The light painting tools in this rollout allow you to touch up shadowed and illuminated areas manually. You can use these tools to touch up shadow and light-leak artifacts without having to do additional remodeling or radiosity processing. Using Pick Illumination, Add Illumination, and Remove Illumination, you can add or remove illumination on one selection set at a time.

To use the light painting tools, you first select objects, and then choose a light painting tool: Pick Illumination, Add Illumination, or Remove Illumination. The active button is highlighted in yellow, and when it is over a selected object, the cursor changes to a crayon icon for the Add and Remove Illumination tools, or to an eyedropper icon for Pick Illumination.

You can pick, add, or remove illumination through objects. For example, if you select the floor as an object, you can work under the bookshelf, by working through it. Once in light painting mode, you can't select another object unless you cancel the operation.

Interface



Intensity Specifies the intensity of the illumination in lux or candelas depending on the units you have selected in the [Customize > Units Setup dialog](#) on page 7809.

Pressure Specifies the percentage of the sampled energy to be used when you add or remove illumination.



Add Illumination Adds illumination starting at the vertex of a selected object. 3ds Max adds illumination based on the amount in the Pressure spinner. The pressure amount corresponds to a percentage of the sampled energy. For example, if a wall has about 2,000 lux on it, Add Illumination adds 200 lux to the surface of the selected object.



Remove Illumination Removes illumination starting at the vertex of a selected object. 3ds Max removes illumination based on the amount in the Pressure spinner. The pressure amount corresponds to a percentage of the sampled energy. For example, if a wall has about 2,000 lux on it, Remove Illumination removes 200 lux from the surface of the selected object.



Pick Illumination Samples the amount of illumination from a surface that you select. To save you from inadvertently making bright or dark spots, Pick Illumination uses an amount of illumination relative to the surface illumination you sample. Click the button, and move the eyedropper cursor over the surface. When you click a surface, the amount of illumination in lux or candelas is reflected in the Intensity spinner. For example, if you used Pick Illumination over a wall that has 6 lux of energy, then 0.6 lux displays in the

Intensity spinner. The amount of illumination 3ds Max adds or removes on the surface will be this value multiplied by the Pressure value.

Clear Clears all the changes you made. Processing additional radiosity iterations or changing the filtering amount will also discard any changes to the solution you made with the light painting tool.

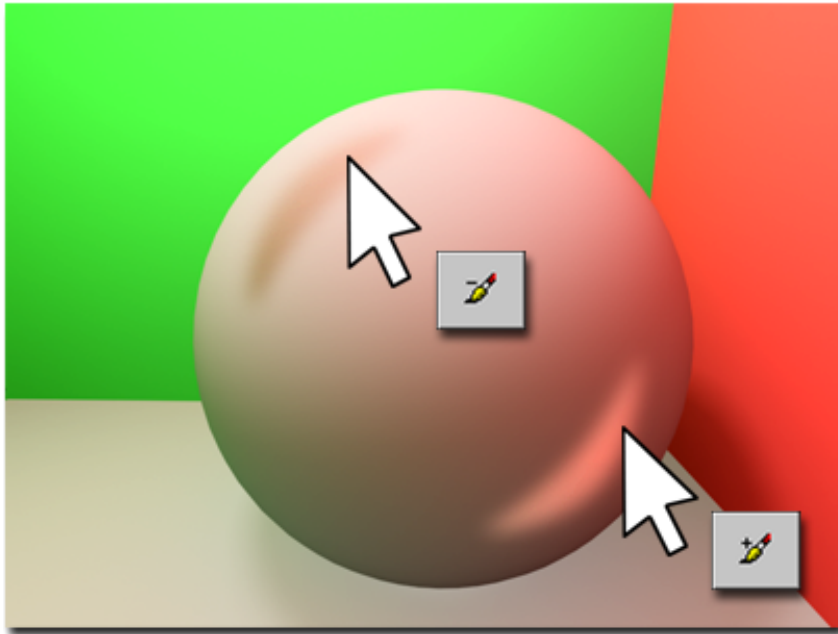

Using light painting to add or remove light in a radiosity solution.

Rendering Parameters Rollout (Radiosity)

Rendering menu/main toolbar > Render Setup > Render Setup dialog > Choose Default Scanline Renderer as the active production renderer. > Advanced Lighting panel > Select Advanced Lighting rollout > Choose Radiosity from the drop-down list. > Rendering Parameters rollout

Provides parameters for controlling how to render the radiosity-processed scene.

By default, when you render, 3ds Max first recalculates the shadows from light objects, and then adds the result of the radiosity mesh as ambient light.

The first two options on the rollout control how the renderer treats direct illumination. Re-Use Direct Illumination From Radiosity Solution provides a quick render that displays colors from the radiosity mesh. Render Direct Illumination uses the scanline renderer to provide direct illumination and shadows. This second option is usually slower but more accurate. With Render Direct Illumination, the radiosity solution provides only the indirect lighting.

When you choose the Render Direct Illumination method, you can turn on regathering to correct artifacts and shadow leaks. Regathering provides the slowest but the best-quality rendering.

NOTE Regathering is extremely intensive for your CPU and uses a lot of RAM, so it might not be practical for print-resolution images (for example, 4000 x 4000 pixels).

Interface

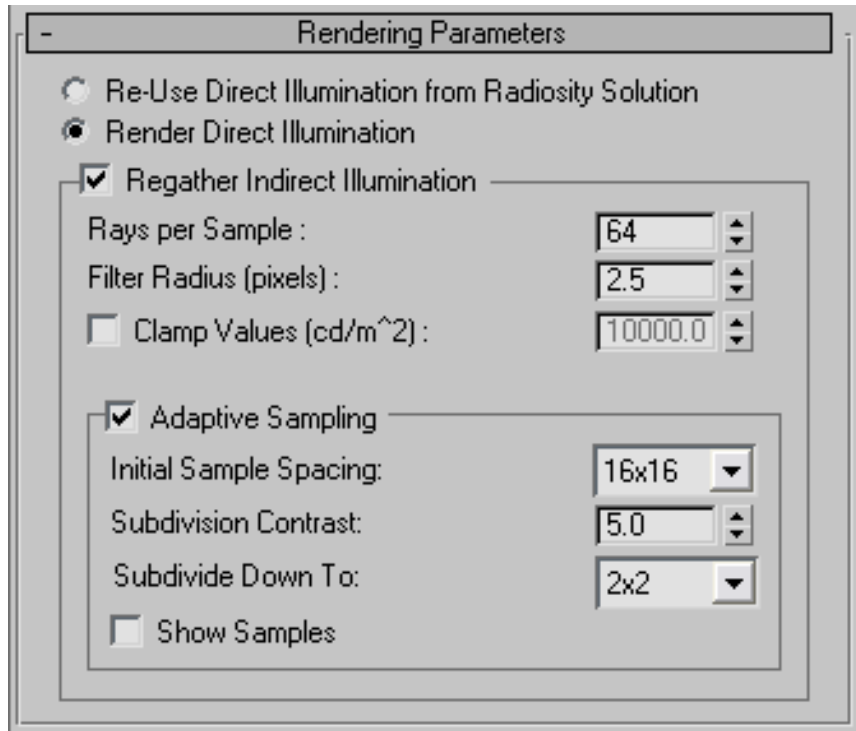

Re-Use Direct Illumination from Radiosity Solution 3ds Max doesn't render direct lights, but uses the direct lighting stored in the radiosity solution. If

you turn on this option, the Regather Indirect Illumination option is disabled. The quality of shadows in the scene depends on the mesh resolution. Capturing fine shadow details might require a fine mesh, but in some situations this option can speed up overall rendering time, especially for animations, because the lights don't have to be recalculated by the scanline renderer.

If you are using the [Assign Vertex Colors utility](#) on page 6038, turn this option on.

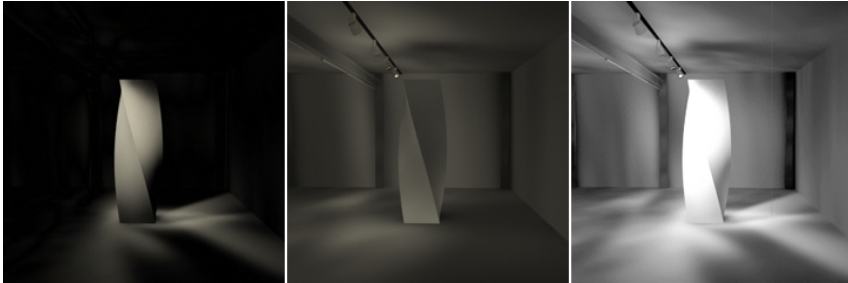

Left: Direct light only is stored in the radiosity mesh.

Middle: Indirect light only is stored in the radiosity mesh.

Right: Direct and indirect light both stored in the radiosity mesh (the shadows are usually very coarse).

WARNING If you choose this option but haven't generated a radiosity solution, rendering generates a completely black image.

Render Direct Illumination 3ds Max renders shadows from the lights at each rendering frame, and then adds indirect light from the radiosity solution. This is the default rendering mode.

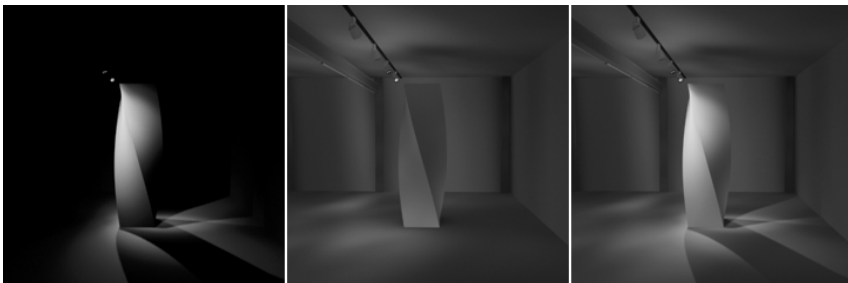

Left: Direct light calculated only by the scanline renderer.

Middle: Indirect light calculated only by the radiosity mesh.

Right: Direct and indirect light combined.

Regather Indirect Illumination In addition to recalculating all the direct lighting, 3ds Max recalculates the indirect lighting at each pixel by regathering illumination data from the existing radiosity solution. Using this option can produce the most accurate, artifact-free images, but it can add a considerable amount of rendering time.

NOTE If you know that you want to use the regathering option, then typically you don't need as dense a mesh for the radiosity solution. Even if you don't subdivide the surfaces at all and do an Initial Quality of 0%, the regathering will work, and might provide an acceptable visual result (useful for quick tests as well). However, accuracy and subtle details depend on the quality of the radiosity solution stored in the mesh. The radiosity mesh is the foundation for the regathering process.

In the following illustrations, solutions were processed with an Initial Quality of 0%. There is a high variance between small surfaces when a dense mesh is used. Regathering gives acceptable results regardless of mesh density. But more subtle details appear with a denser mesh; for example, at the base of the sculpture.

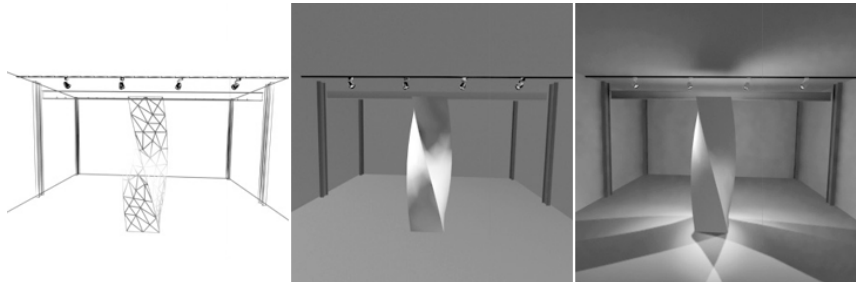

No mesh

Left: Model subdivision

Middle: Viewport result

Right: Result of regathering

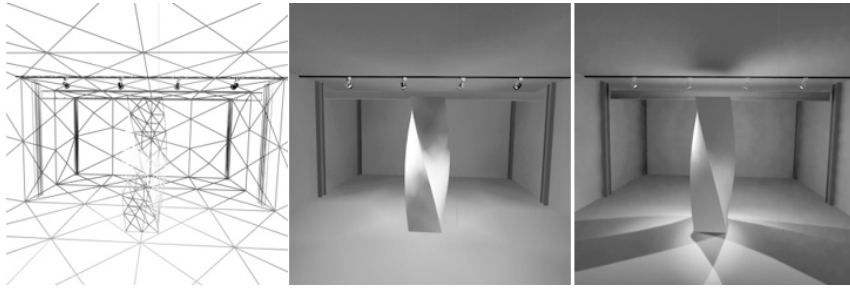

Coarse mesh

Left: Model subdivision

Middle: Viewport result

Right: Result of regathering

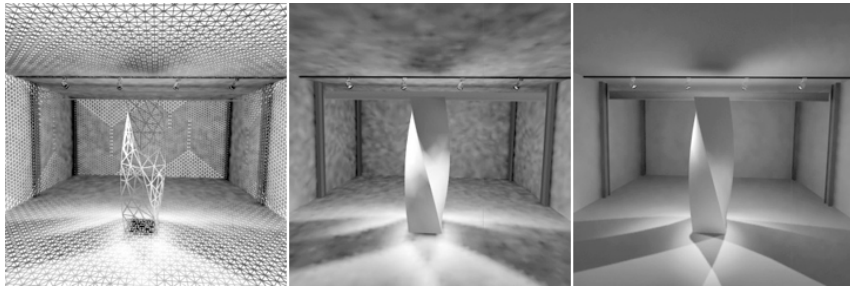

Fine mesh

Left: Model subdivision

Middle: Viewport result

Right: Result of regathering

Rays per Sample The number of rays 3ds Max casts for each sample. 3ds Max casts these rays randomly in all directions to calculate (“regather”) the indirect illumination from the scene. The more rays per sample, the more precise the sample will be. Fewer rays per sample produce more variance, creating a more grainy effect. Processing speed and precision are affected by this value. Default=64.

Filter Radius (pixels) Averages each sample with its neighbors in order to reduce the noisy effect. Default=2.5 pixels.

NOTE Pixel radius varies according to the output resolution. For example, a 2.5 radius is OK for NTSC resolution, but it might be very large for smaller images, or too precise for very large images.



Pixel radius of 2

Left: 10 rays per sample

Middle: 50 rays per sample

Right: 150 rays per sample

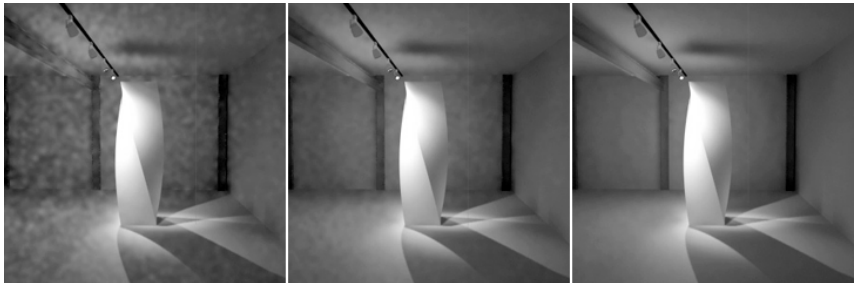

Pixel radius of 5

Left: 10 rays per sample

Middle: 50 rays per sample

Right: 150 rays per sample

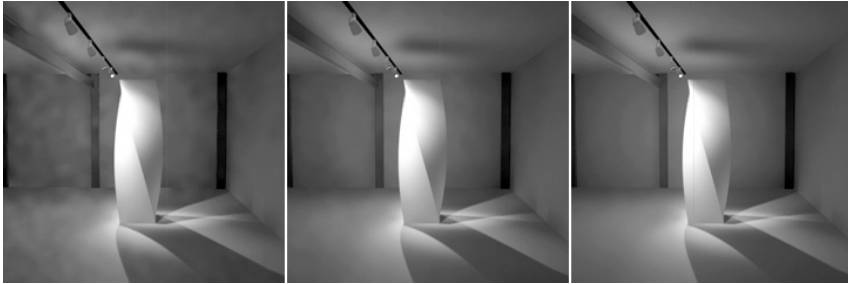

Pixel radius of 10

Left: 10 rays per sample

Middle: 50 rays per sample

Right: 150 rays per sample

Increasing the number of rays per sample can greatly increase rendering time. The images on the right can take nearly six times as long to render as the images on the left. Increasing the filter radius also increases render time, but not as dramatically.

Clamp Values (cd/m^2) This control is expressed as a luminance value. Luminance (candelas per meter squared) represents how brightly you perceive a material. Clamp Value sets an upper limit on the luminance that will be considered in the Regathering stage. Use it to avoid the appearance of bright spots.

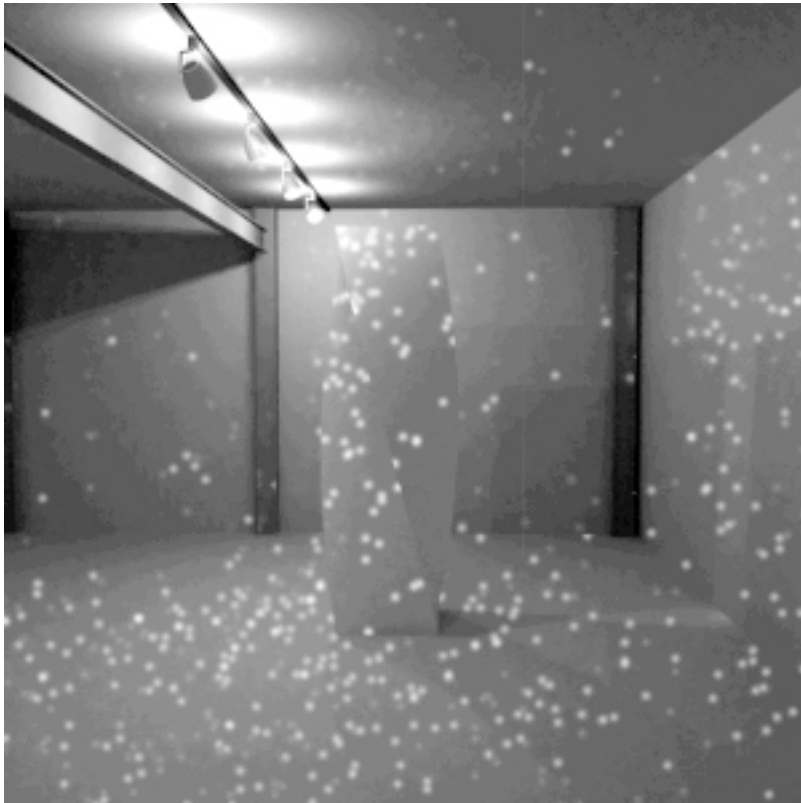

Bright polygons in the scene can create a “sparkle” effect of bright spots.

These bright spots are artifacts not of the number of samples cast, but rather of the presence of bright polygons in your scene. During the Initial Quality stage, this bright energy gets bounced in random directions, leading to a “sparkle” effect. Typically you can detect these polygons before regathering. During the final Regathering stage, bright spots can be avoided by setting Clamp Values somewhat below the luminance of these bright surfaces and spots.



Bright spots have been reduced by clamping.

TIP You can query the luminance of these surfaces by using the [Lighting Analysis tool](#) on page 6219.

TIP Use [Render Region](#) on page 6095 to render just the area of the bright spots to find rapidly the right clamp value to use.

Be careful with this control: Clamp Values let you clamp any intensity, and the rendering might become darker than it should be because you have clamped indirect illumination that is to be expected, thus dimming the effect of the radiosity solution.

Adaptive Sampling group

These controls can help you shorten rendering times. They reduce the number of light samples taken. The ideal settings for adaptive sampling vary greatly from scene to scene.

Adaptive sampling initially takes samples from a grid superimposed on the pixels of the scene. Where there is enough contrast between samples, it subdivides that region and takes further samples, down to the minimum area specified by Subdivide Down To. Lighting for areas not directly sampled is interpolated.

TIP If you use adaptive sampling, try adjusting the Subdivision Contrast value to obtain the best results.

Adaptive Sampling When on, the radiosity solution uses adaptive sampling. When off, it does not. Turning off adaptive sampling can increase the detail of the final rendering, but at a cost of rendering time. Default=off.

Initial Sample Spacing The grid spacing for initial samples of the image. This is measured in pixels. Default=16x16.

Subdivision Contrast The contrast threshold that determines when a region should be further subdivided. Increasing this value causes less subdividing to occur. Reducing this value can cause unnecessary subdivide. Default=5.0.

Subdivide Down To The minimum spacing for a subdivision. Increasing this value can improve render time at a cost of accuracy. Default=2x2.

Depending on the scene geometry, grids larger than 1x1 might still be subdivided below this specified threshold.

Show Samples When on, sample locations render as red dots. This shows where the most sampling has taken place, which can help you choose the optimal settings for adaptive sampling. Default=off.

Statistics Rollout (Radiosity)

Rendering menu/main toolbar > Render Setup > Render Setup dialog > Choose Default Scanline Renderer as the active production renderer. > Advanced Lighting panel > Select Advanced Lighting rollout > Choose Radiosity from the drop-down list. > Statistics rollout

Lists information about the radiosity processing.

Interface

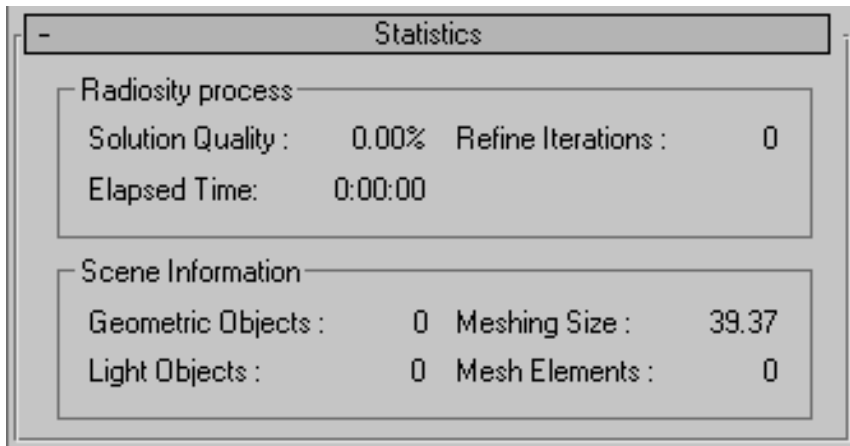

Radiosity process group

Lists the current level of quality and number of refine iterations in the radiosity process.

Solution Quality The current level of quality in the radiosity process.

Refine Iterations The number of refine iterations in the radiosity process.

Elapsed Time The time spent processing the solution since the last reset.

Scene Information group

Lists information on the radiosity processing of the scene.

Geometric Objects Lists the number of objects processed.

Light Object Lists the number of light objects processed.

NOTE Self-illuminated objects count as one light per face.

Meshing Size Lists the size of radiosity mesh elements in world units.

NOTE Transparent, 2-sided, and translucent objects' faces are counted twice.

Mesh Elements Lists the number of elements in the mesh processed.

Lighting Analysis

Select an object that has radiosity solution information. > Rendering menu > Advanced Lighting > Lighting Analysis

To query light levels, analyze the data, and produce reports, use the Lighting Analysis dialog. This dialog provides rendering data on material reflectance, transmittance, and luminance.

For example, a lighting engineer might need to know if light fixtures in a scene provide an even level of illumination on the walls of a building. The engineer uses the Lighting Analysis dialog after placing the lights in the ceiling and processing radiosity. The engineer inspects the light levels and material reflectance in the scene and then adjusts the brightness of lights, changes units, or reduces material reflectance.

To use the Lighting Analysis tools, a radiosity solution must be calculated and displayed in the scene. For better feedback, use it in conjunction with the [Pseudo Color Exposure Control](#) on page 6753. This tool maps luminances or illuminances to pseudo colors that show the brightness of the values 3ds Max converts.

TIP You can also export [LogLUV TIFF files](#) on page 7372 or [PIC files](#) on page 7359 for analysis by other software; do this by using the [Lighting Data Exporter utility](#) on page 6759.

See also:

- [Modeling Global Illumination with Radiosity](#) on page 6168
- [Radiosity Workflows](#) on page 6181
- [Radiosity Controls](#) on page 6188
- [Radiosity Preferences](#) on page 7786
- [Lighting Data Exporter Utility](#) on page 6759

Interface

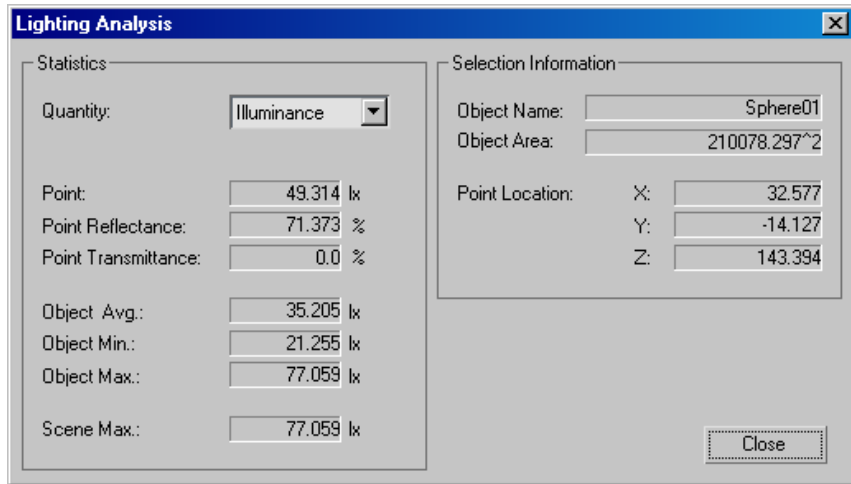

Statistics group

Displays the radiosity solution lighting statistics for the object you select.

Quantity Indicates the desired photometric value:

- **Luminance** The amount of energy leaving a surface.
- **Illuminance** The amount of energy arriving at a surface.

Point The luminance or illuminance at the point on the object where you clicked.

Point Reflectance The reflectance of the surface material at the point on the object where you clicked.

Point Transmittance The transmittance of the surface material at the point on the object where you clicked.

Object Avg The amount of light intensity for the object as a whole.

Object Min The object's minimum luminance or illuminance value.

Object Max The object's maximum luminance or illuminance value.

Scene Max The scene's highest luminance or illuminance value.

Selection Information group

Object Name The name of the selected object.

Object Area The area size of the selected object.

Point Location The X,Y,Z coordinate of the point on an object you clicked.

Raytracer Panel

Raytracer Global Parameters Rollout

Rendering menu > Raytracer Settings

Rendering menu/main toolbar > Render Setup > Render Setup dialog > Choose Default Scanline Renderer as the active production renderer. > Raytracer panel > Raytracer Global Parameters rollout

These parameters control the raytracer globally. That is, they affect *all* Raytrace materials and Raytrace maps in your scene. They also affect the generation of [Advanced Ray-traced shadows](#) on page 8103 and [Area shadows](#) on page 7913.

NOTE These controls adjust ray-trace settings for the scanline renderer only. The settings of these controls have no impact on the mental ray renderer, which has its own ray-tracing controls.

Interface

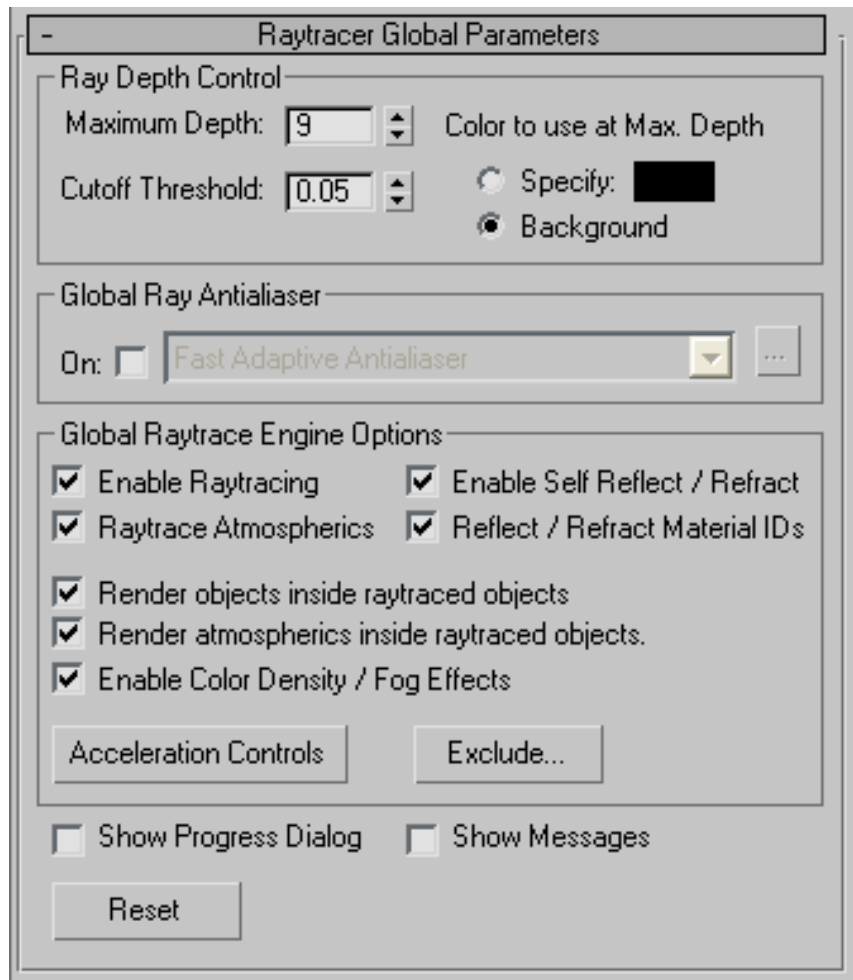

Ray Depth Control group

Ray depth, also known as recursion depth, controls how many times the renderer allows a ray to bounce before it is considered lost or trapped.

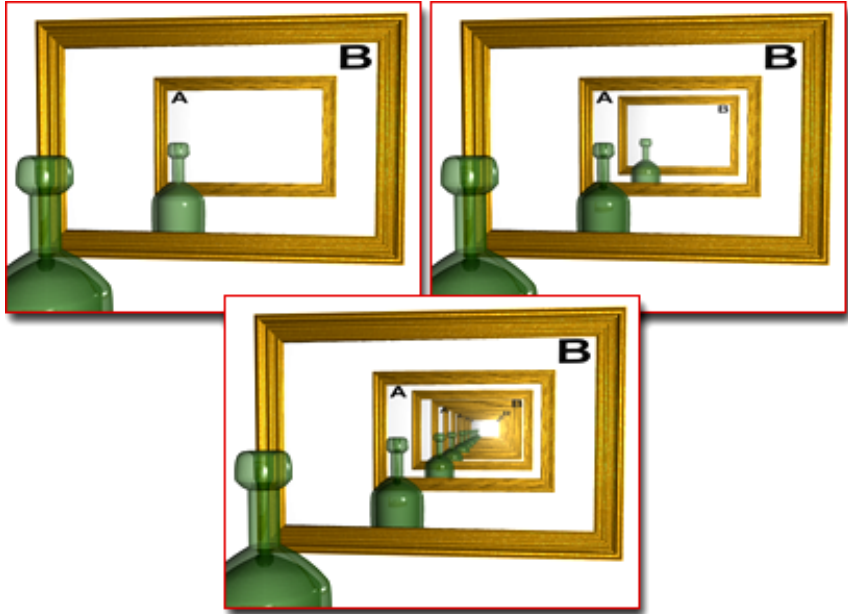

Upper left: Ray depth is zero

Upper right: Ray depth of 2

Lower middle: Extremely high ray depth

Maximum Depth Sets the maximum recursion depth. Increasing this value potentially increases the realism of your rendered scene, at a cost of rendering time. You can reduce this value to reduce rendering time. Range=0 to 100. Default=9.

Cutoff Threshold Sets a cutoff threshold for adaptive ray levels. If the contribution of any ray to the final pixel color drops below the cutoff threshold, the ray is terminated. Default: 0.05 (5% of the final pixel color). This can speed up your rendering time considerably.

Color to use at Max Depth As a rule, when a ray reaches the maximum depth, it is rendered the same color as the background environment. You can override the color returned at maximum depth by either selecting a color, or setting an alternative environment map. This can make the "lost" ray invisible in the scene.

TIP If you are having trouble with getting complex objects to render, especially glass, specify the maximum recursion color to something obvious, like magenta, and your background color to something that contrasts, like cyan. The chances are that a lot of your rays are getting lost in either maximum recursion or just being shot off into the world, totally missing anything you think they should strike. Try rendering the scene again. If this is the problem, try reducing the Maximum Depth value.

- **Specify** Specifies what color the raytracer returns when the ray is considered lost or trapped. Click the color swatch to change this color.
- **Background** (The default.) Returns the background color when the ray is considered lost or trapped. For Raytrace material, the background color is the global environment background or the environment specified locally for the material. For Raytrace map, the background color is either the global environment background, or is set locally in the [Raytracer Parameters rollout](#) on page 5954.

Global Ray Antialiaser group

Controls in this group let you set global antialiasing for raytraced maps and materials.

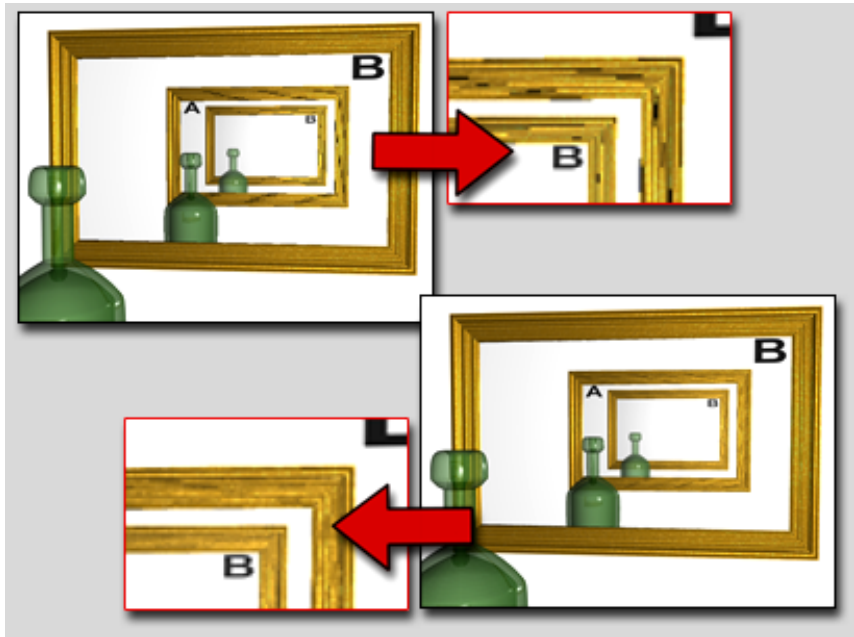

Above: No antialiasing

Below: Antialiasing of reflections

TIP Turning on Supersample for a Raytraced material (in the [Raytrace Basic Parameters rollout](#) on page 5493) usually provides adequate antialiasing. Use one of the raytrace antialiasers (Fast Adaptive or Multiresolution Adaptive) when you want to blur reflections or refractions.

On When on, uses antialiasing. Default=off.

Drop-down list Chooses which antialiasing settings to use. There are two options:

- **Fast Adaptive Antialiaser** Uses the Fast Adaptive antialiaser, regardless of the global setting.
Click ... to open the [Fast Adaptive Antialiaser dialog](#) on page 5522.
- **Multiresolution Adaptive Antialiaser** Uses the Multiresolution Adaptive antialiaser, regardless of the global setting.
Click ... to open the [Multiresolution Adaptive Antialiaser dialog](#) on page 5524.

Global Raytrace Engine Options group

These options are comparable to the local options on [Extended Parameters rollout](#) on page 5502 and the [Raytracer Controls rollout](#) on page 5506. Their setting affects all Raytrace materials and Raytrace maps in the scene, unless you set local overrides.

Enable Raytracing Turns the raytracer on or off. Default=on.

Even with raytracing off, Raytrace material and Raytrace map still reflect and refract the environment, including both the environment map for the scene, and the environment map assigned to the Raytrace material.

Raytrace Atmospheric Turns the raytracing of atmospheric effects on or off. Atmospheric effects include fire, fog, volume light, and so on. Default=on.

Enable Self Reflect/Refract Turns self reflection/refraction on or off. Default=on.

Can an object reflect itself? For example, a teapot's body reflects the teapot's handle, but a sphere will never reflect itself. If you don't need this effect, you can improve render time by turning off this toggle.

TIP If you have a transparent object such as glass, and Enable Self Reflect/Refract is on, you don't have to make the object [2-sided](#) on page 7893. The raytracer sees back faces when exiting refractive objects.

Reflect/Refract Material IDs When on, the material reflects effects assigned to material IDs in the renderer's [G-buffer](#) on page 7991 on or off. Default=on. By default, Raytrace material and Raytrace map reflect effects assigned to a material's ID, so that G-buffer effects are not lost. For example, if a raytraced object reflects a lamp made to glow with the Video Post Glow filter (Lens Effects Glow), the reflection glows as well.

Render objects inside raytraced objects Toggles the rendering of objects inside raytraced objects. Default=on.

Render atmospheric inside raytraced objects Toggles the rendering of atmospheric effects inside raytraced objects. Atmospheric effects include fire, fog, volume light, and so on. Default=on.

Enable Color Density / Fog Effects Toggles the color density and fog features.

Acceleration Controls Opens the [Raytracing Acceleration Parameters dialog](#) on page 5518.

Exclude Opens the [Raytrace Exclude/Include dialog](#) on page 5519, which lets you exclude objects from ray-tracing.

Show Progress Dialog When on, rendering displays a window with progress bars titled Raytrace Engine Setup. Default=on.

Show Messages When on, displays a window, Raytrace Messages, that shows status and progress messages from the raytrace engine. Default=off.

Using Multi-Pass Rendering Effects

Create panel > Cameras > Target button or Free button > Parameters rollout > Multi-Pass Effect group

Multi-pass rendering effects use multiple renderings of the same frame, with slight camera movement between each rendering. The multiple passes simulate the blurring that film in a camera would register under certain conditions. The included multi-pass effects are provided:

- [Depth of field](#) on page 5230 (Default Scanline Renderer)

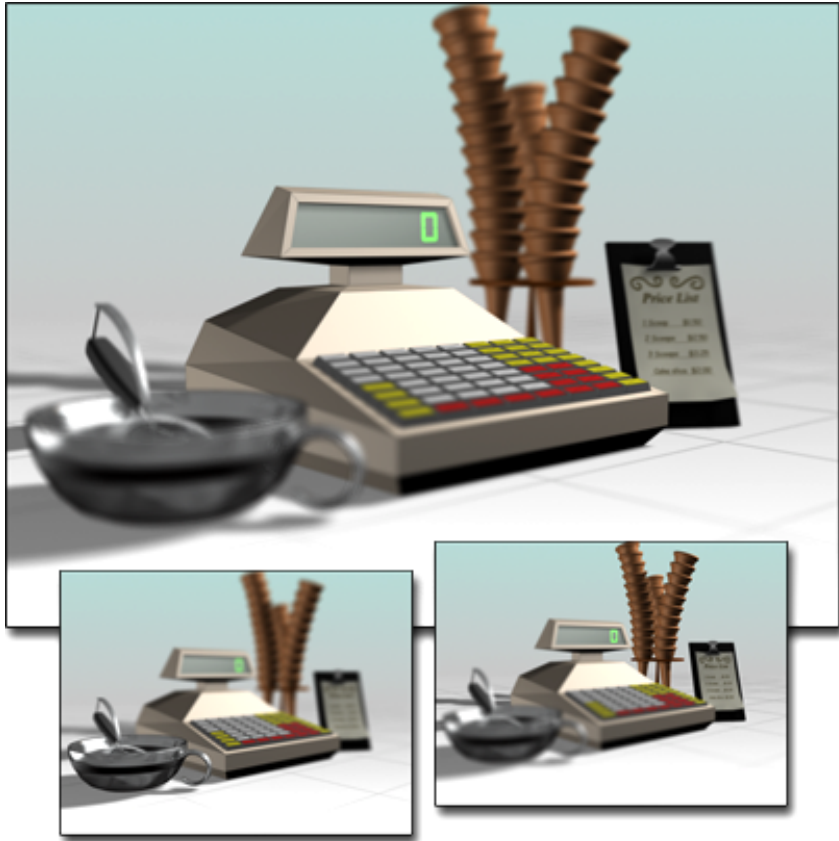

Multi-pass depth of field

Top: Focus is in the middle distance; near and far objects are blurred.

Bottom left: Focus on near objects, far objects are blurred.

Bottom right: Focus on far objects, near objects are blurred.

- [Motion blur](#) on page 5234 (Default Scanline Renderer)



Above: Motion blur applied to wings of the flying dragon

Below: Multiple passes appear in successive refreshes of the Rendered Frame Window.

- [Depth of Field \(mental ray\)](#) on page 5229

See also:

- [Motion Blur with the mental ray Renderer](#) on page 6248
- [Depth of Field with the mental ray Renderer](#) on page 6249

mental ray Renderer

The mental ray® renderer from mental images® is a general-purpose renderer that can generate physically correct simulations of lighting effects, including [ray-traced reflections and refractions](#) on page 6245, [caustics](#) on page 6255, and [global illumination](#) on page 6261.

NOTE mental images and mental ray are registered trademarks, and photon map is a trademark of mental images GmbH & Co. KG, Berlin, Germany.



Scene rendered with the default 3ds Max scanline renderer



Same scene rendered with the mental ray renderer

The second rendering, done with the mental ray renderer, shows caustics cast by refraction through the martini glass. Caustics are also visible in the reflection on the cocktail shaker.

The mental ray renderer in 3ds Max supports the mental ray version 2 (mi2) and version 3 (mi3) formats. It does not support the mental ray version 1 (mi1) format.

Differences Between the mental ray Renderer and the Default Scanline Renderer

Compared to the default 3ds Max scanline renderer, the mental ray renderer relieves you of the need to simulate complex lighting effects "by hand" or by generating a radiosity solution. The mental ray renderer is optimized to use multiple processors and to take advantage of incremental changes for efficient rendering of animations.

Unlike the default 3ds Max renderer, which renders scanlines from the top of the image downward, the mental ray renderer renders rectangular blocks called *buckets*. The order in which the buckets are rendered can vary, depending on the method you choose. By default, mental ray uses the Hilbert method, which picks the next bucket to render based on the cost of switching to the next

one. Because objects can be discarded from the memory to render other objects, it's important to avoid having to reload the same object multiple times. This is especially important when you have enabled placeholder objects (see the Processing panel > [Translator Options rollout](#) on page 6316).

If you use distributed rendering to render a scene, it might be hard to understand the logic behind the rendering order. In this case, the order has been optimized to avoid sending lots of data over the network. Each CPU is assigned a bucket as the bucket becomes available, so different buckets can appear in the rendered image at different times. See the Renderer panel > [Sampling Quality rollout](#) on page 6272.

NOTE The mental ray renderer can also be run in a standalone fashion, using a command-line interface based on the mi2 or mi3 scene description format. This is described in the manual *mental ray Programming*, which is written for programmers writing custom [shaders](#) on page 8123.

See also:

- [Getting Good Results with mental ray Rendering](#) on page 6235
- [3ds Max Materials in mental ray Renderings](#) on page 6239
- [mental ray Concepts](#) on page 6245
- [Enhancements to Standard Features](#) on page 6241

Procedures

To use the mental ray renderer:

- 1 Choose Rendering menu > Render Setup. The Render Setup dialog opens.
- 2 On the Common panel, open the Assign Renderer rollout, and then click the “...” button for the Production renderer.
The Choose Renderer dialog opens.
- 3 On the Choose Renderer dialog, highlight *mental ray Renderer* and then click OK.

TIP After you make the mental ray renderer the active production renderer, you can make the mental ray renderer the default renderer for all new scenes by clicking Save As Defaults. This is a convenient way to avoid extra setup time.

Now the Render Setup dialog contains the mental ray controls. You can choose to render the scene with the built-in mental ray renderer, or simply to translate the scene and save it in an *MI on page 8044* file that you can render later, perhaps on a different system. Controls for choosing whether to render, save to an MI file, or both, are on the [Translator Options rollout](#) on page 6316.

Rendering with the mental ray Renderer

Rendering menu/main toolbar > Render Setup > Render Setup dialog > Common panel > Assign Renderer rollout > Choose mental ray Renderer as the Production renderer.

To use the mental ray translator and renderer, you must first choose mental ray as the production renderer, as described the "Procedures" section below. Once you have chosen mental ray rendering, the Render Setup dialog displays panels and rollouts that control the mental ray renderer.

Common Parameters Rollout

When you render with mental ray, controls on the Render Setup dialog > Common panel > Common Parameters rollout remain the same, and function just as they do with the default scanline renderer.

Limitations

The mental ray renderer does not support certain rendering features, as described here.

- Output dithering options aren't supported (in Main menu > Customize > Preferences > Preference Settings dialog > Rendering panel > Output Dithering group).
- The mental ray renderer does not fully support G-buffer options in post processing and image file output. The mental ray renderer generates all required G-buffer channels, but does not include transparency information. If two transparent objects overlap each other, the mental ray render generates information only for the frontmost object.
- When you use a bitmap as an environment (that is, as a background), the mental ray renderer samples and filters it. This can result in unwanted blurring. To prevent background blurring, render the scene against a solid-color background, and then composite the rendered scene with the background image.

- Sometimes when you render objects that have no thickness, or an Extrude modifier with zero thickness, the mental ray renderer generates rendering artifacts that appear as streaks. In some cases, you can fix this by turning on Force 2-Sided on the Render Setup dialog's Common Parameters rollout. If the streaks persist, give the object or the Extrude modifier a nonzero thickness.

See also:

- [Sampling Quality Rollout \(mental ray Renderer\)](#) on page 6272
- [Camera Effects Rollout \(mental ray Renderer\)](#) on page 6283
- [Caustics and Global Illumination Rollout \(mental ray Renderer\)](#) on page 6306
- [Final Gather Rollout \(mental ray Renderer\)](#) on page 6295
- [Shadows & Displacement Rollout \(mental ray Renderer\)](#) on page 6292
- [Rendering Algorithms Rollout \(mental ray Renderer\)](#) on page 6277
- [Translator Options Rollout \(mental ray Renderer\)](#) on page 6316
- [Distributed Bucket Rendering Rollout \(mental ray Renderer\)](#) on page 6326

Procedures

To use the mental ray renderer:

- 1 Choose Rendering menu > Render Setup. The Render Setup dialog opens.
- 2 On the Common panel, open the Assign Renderer rollout, then click the “...” button for the Production renderer.
The Choose Renderer dialog is displayed.
- 3 On the Choose Renderer dialog, highlight *mental ray Renderer* and then click OK.

Now, when you render, the Render Setup dialog appears with the mental ray controls. You can choose to render the scene with the built-in mental ray renderer, or simply to translate the scene and save it in an *MI* on page 8044 file that you can render later, perhaps on a different system. Controls for choosing whether to render, save to an MI file, or both, are on the [Translator Options](#) on page 6316 rollout.

To make the mental ray Renderer the default renderer for new scenes:

- After you make the mental ray renderer the active production renderer, click Save As Defaults on the Assign Renderer rollout.

Getting Good Results with mental ray Rendering

Although the mental ray renderer is relatively easy to use once you've set it up correctly, there are several "gotchas" that you might encounter immediately, especially if you're primarily accustomed to the 3ds Max scanline renderer and its workflow. For example, see [3ds Max Materials in mental ray Renderings](#) on page 6239. Following are some basic rules of thumb for using mental ray in 3ds Max:

Using Lights with the mental ray Renderer

When you set up a scene for rendering with the mental ray renderer, keep the following tips in mind:

- The Overshoot parameter for lights doesn't work when you use mental ray to render shadow-mapped shadows. To use Overshoot, use ray-traced shadows.
- Excluding an object from shadow casting doesn't work when you use mental ray to render shadow-mapped shadows. To exclude objects from shadow casting, use ray-traced shadows. (The Exclude button is on a light's General Parameters rollout.)
- When you assign a map to object shadows in the light's Shadow Parameters rollout, the mental ray renderer does not recognize the toggle for the map (to the left of the Map button), and renders the map whether the toggle is on or off. To stop using the map, you must click the Map button and in the Material/Map Browser, assign NONE as the map type.
- Using the default scanline renderer, you can set a light to have a value of zero, with a shadow color of white, and a shadow density of -1. With these settings, the light casts shadows but does not illuminate the scene. To get the same effect using the mental ray renderer, the light value must not be zero. Instead, set it to a value close to zero (for example, 0.001 or -0.001).
- The mental ray renderer disregards the bias parameters in the Shadow Map Params rollout and the Ray Traced Shadow Params rollout.

- The mental ray renderer assumes that all directional lights come from infinity, so objects that are behind the direct light object in the 3ds Max scene will also be illuminated.

Ray Tracing

The mental ray ray tracer is fast and provides excellent quality images, but it's important to use it correctly.

The mental ray renderer does not fully support cubic maps for [Reflect/Refract maps](#) on page 5964. It uses them if they have already been generated by the default scanline renderer, but it does not generate them. If Source > From File is active and the mental ray renderer can find the six cubic maps, it uses them. If Source > Automatic is active, or if the cubic maps cannot be found, the mental ray renderer generates ray-traced reflections or refractions instead.

Ray Tracing Setup

On the rendering menu, Ray Tracer Settings and Raytrace Global Include/Exclude are disabled while the mental ray renderer is active. These controls adjust ray-trace settings for the scanline renderer only. The settings of these controls have no impact on the mental ray renderer. The ray-tracing controls for mental ray appear on the Renderer panel > [Rendering Algorithms rollout](#) on page 6277.

TIP While the mental ray renderer ignores the global inclusion or exclusion settings for the ray tracer, you *can* enable or disable ray-tracing at the local level of a Raytrace material or map.

Ray Tracing Rules of Thumb

Say you're rendering a (lathed) wineglass, with an inner and outer surface and a piece of geometry representing the wine. The wine geometry is just slightly smaller than the inner surfaces of the wineglass, and capped with a flat top. Now, you go to render the glass. After rendering the scene, however, there's something wrong: the inner surfaces of the glass don't seem reflective enough, and the wine isn't refracting properly. What's wrong?

It's possible that you have the number of reflections and refractions set too low for the number of surfaces you have. To check this, go to the Renderer panel > [Rendering Algorithms rollout](#) on page 6277 and look at the Maximum Trace Depth settings. If you haven't changed the parameters, then you should see Max. Reflections and Max. Refractions set to the default of 6, and Max. Depth set to 6.

There's the problem: you actually have six surfaces that need to be traced by the light rays for *both* reflections and refractions. The way to always calculate the number of rays needed for a scene is to take the ray-traced objects in your scene and draw an imaginary line through them, originating at the point of view. Then, count the number of surfaces the line intersects.

For the wineglass and wine, you need at least six reflections and refractions that correspond to the following surfaces:

- Near outer glass surface ("near" relative to your Camera viewpoint)
- Near inner glass surface
- Near wine surface
- Far wine surface
- Far inner glass surface
- Far outer glass surface

Therefore, increase the value of Max. Depth to 12.

Caustics and Global Illumination

Before rendering with caustics, there are several things you need to set up in your scene:

- For caustics to work properly, the generating object must use a material that contains some degree of shininess, reflectivity, or refraction. Assign a Raytrace or other map as either a Reflection map or Refraction map before you render caustics.
- Most often, you'll be using very shiny, highly reflective materials (such as chrome and other metals), or transparent or translucent materials (such as glass goblets or water), to generate caustics in your scene. If you're using a glassy material, make sure it's double-sided to create the proper results.
- Make sure you have [object properties](#) on page 322 set to Receive Caustics or Generate Caustics (or both). To set up these properties, right-click an object and choose Properties. For example, if you're rendering a wineglass on a tabletop, you probably want the wineglass both to generate and receive caustics (so that caustics are scattered within the glass itself), and the tabletop only to receive caustics (unless it's chrome, say, instead of wood).
- If the rendering of your scene is washed out by light, double-check the Multiplier settings: one in the Basic group of the [Final Gather rollout](#) on

page 6295, and one each in the Caustics and Global Illumination (GI) groups of the Indirect Illumination panel > [Caustics And Global Illumination rollout](#) on page 6306. These apply to all lights in the scene. Reducing the Multiplier values can eliminate washout.

If a single light object is causing the problem, you can reduce the Energy multiplier's value in that light object's [mental ray Indirect Illumination rollout](#) on page 5112, available on the Modifier panel.

- To improve the quality of caustics, go to the [Caustics group](#) on page 6309 of the [Caustics And Global Illumination rollout](#) on page 6306 and increase the Max Num. Photons Per Sample setting.
- Be careful of the total number of photons you're emitting: A very high number (100,000 and above) can dramatically increase your rendering time. Then again, for some simple scenes, you might actually be able to set these to 1,000,000 and still render in an acceptable amount of time.

WARNING The number of photons specified for each light indicates the number of photons that need to be stored for each light, not the number of photons to be shot. This is an important distinction: If a light points in a direction where there is no surface, the mental ray renderer might shoot photons forever. In the [Messages Window](#) on page 6244, the mental ray renderer displays warnings that no photons are being stored. To avoid the slowdowns related to this issue, make sure that every light points in the direction of a surface (this is sometimes impossible to do with omni lights). Another way to avoid this problem is to add a big sphere around your entire model.

- In general, use an exposure control. The [mr Photographic Exposure Control](#) on page 6744 works particularly well for adjusting overall exposure.

Coincident Faces

When it encounters coincident faces, the mental ray renderer can produce artifacts, because it can't decide which face is nearer the camera (neither is). To fix this, move or scale one of the objects so faces are no longer coincident.

Backface Culling

mental ray rendering correctly performs backface culling, and renders one-sided faces much as the scanline renderer does.

3ds Max Materials in mental ray Renderings

For the most part, the mental ray renderer treats 3ds Max maps and materials the same way the default scanline renderer does. The exceptions are listed below. In general, if the mental ray renderer does not recognize a map or material, it renders it as opaque black.

WARNING The mental ray renderer does not necessarily support maps or materials provided as plug-ins from third-party vendors. It supports third-party maps and materials only if the vendor has explicitly used the mental ray SDK to add support for the mental ray format. Unless the third-party vendor clearly specifies mental ray support, you should assume the map or material is unsupported, and will render as black.

See also:

- [mental ray Renderer](#) on page 6230
- [Getting Good Results with mental ray Rendering](#) on page 6235

Issues for Reflections and Refractions

The maps used to create reflections or refractions, Flat Mirror, Raytrace, Reflect/Refract, and Thin Wall Refraction, are supported by the mental ray renderer. However, the mental ray renderer simply uses these maps as indications to use its own ray-tracing method, leading to some restrictions on which parameters are supported, as described in the sections “Materials” and “Maps,” below.

Map Blurring

When reflections and refractions are ray traced, applying Blur (or Distortion, in Flat Mirror) does not apply to reflections or refractions of environment maps. In general, Blur and Distortion render differently than they do with the default scanline renderer, and you might have to experiment with parameter values to get a comparable rendering result.

TIP If Blur effects are not rendering well with the mental ray renderer, try increasing the Maximum number of samples in the Renderer panel > [Sampling Quality Rollout](#) on page 6272.

Materials

The mental ray renderer does not support these materials:

- Advanced Lighting Override material
- Lightscape material
- Morpher material

Raytrace Material

The mental ray renderer supports all Raytrace material settings except for the antialiasing parameters and the settings found under Rendering > Raytracer Settings and Rendering > Raytrace Global Include/Exclude. All these options are specific to the default scanline renderer.

TIP While the mental ray renderer ignores the global inclusion or exclusion settings for the ray tracer, you *can* enable or disable ray-tracing at the local level of a Raytrace material or map.

Maps

- Bitmap
The mental ray renderer can't use the Progressive JPEG (.jpg) format as a bitmap. Also, Summed Area filtering is not supported (in the Filtering group of the Bitmap Parameters rollout).
PSD files are supported, but are translated into binary data, and because of this, consume a lot of memory and increase render time. To reduce the time involved, convert the PSD file to a format such as BMP.
The same is true of TIFF files. In addition, there are certain TIFF subformats that the mental ray renderer does *not* support; specifically, LZW, CCIT (fax), or JPEG compression; non-RGB color models such as CMYK, CIE, or YCbCr; or multiple images in the same file (in this case, only the first image is used). The mental ray renderer does support bilevel (1-bit), grayscale (4- or 8-bit), color map (4- or 8-bits), RGB(A) (8-, 16-, or 32-bit) TIF images, and TIF files with image strips.
- Combustion map
The mental ray renderer doesn't support this map.
- Flat Mirror map
Flat Mirror is supported by the mental ray renderer, except for the First Frame Only and Every Nth Frame parameters.

- **Raytrace map**
The mental ray renderer supports all Raytrace map settings except for the antialiasing parameters.
- **Reflect/Refract map**
This map tells the mental ray renderer to use ray-traced reflections and refractions. Most parameters are supported, but the parameters Blur Offset, First Frame Only, Every Nth Frame, and Atmosphere Ranges are not supported.

NOTE The mental ray renderer does not fully support cubic maps for Reflect/Refract maps. It uses cubic maps if they have already been generated by the default scanline renderer, but it does not generate them. If Source > From File is active and the mental ray renderer can find the six cubic maps, it uses them. If Source > Automatic is active, or if the cubic maps cannot be found, the mental ray renderer generates ray-traced reflections or refractions instead.

Enhancements to Standard Features

The primary interface to the mental ray renderer consists of rollouts on the Render Setup dialog. To choose the mental ray renderer, use the [Assign Renderer rollout](#) on page 6135, as described in [this procedure](#) on page ?.

In addition, object properties, lights, and the Material Editor have additional controls to support mental ray rendering. Last but not least, 3ds Max offers a special mr Proxy object for speeding up rendering of large, complex scenes.

Object Properties Enhancements

Parameters on the [mental ray panel](#) on page 322 of the Object Properties dialog support displacement as well as the mental ray indirect illumination features: [final gather](#) on page 6295, [caustics](#) on page 6255, and [global illumination](#) on page 6261.

mental ray Proxy Object

When working with high-resolution geometry, you can save memory and translation time by using the special [mr Proxy object](#) on page 597 as a stand-in for your models.

Light Object Enhancements

Along with the mental ray renderer, mental ray-specific area light objects and light settings are provided.

Light Objects

The [area light](#) on page 7909 is a feature of the mental ray renderer. Instead of a point source, it emits light from a broader area around the source. There are two basic types of mental ray area light: [mr Area Omni Light](#) on page 5070 and [mr Area Spotlight](#) on page 5073. An additional, special-purpose mental area light is the [mr Sky Portal](#) on page 5186. Area lights create soft-edged shadows. This can help improve the realism of your rendering.

NOTE To render soft-edged shadows, shadows must be ray-traced, not shadow-mapped: see the Renderer panel > [Shadows & Displacement Rollout](#) on page 6292.

In 3ds Max, area lights are created and supported by the MAXScript scripts, *light-mentalray_areaomni.ms* and *light-mentalray_areaspot.ms*. Both scripts are found in the `\stdplugins\stdscripts\` folder within the program install directory. Because of this, when you create an area light, you actually create a target spot or omni light for which the mental ray renderer uses the parameters on the Area Light Parameters rollout. If you render with the default scanline renderer, the light behaves like any other target spot or omni light. (You can change a light from one type to another using the Type drop-down list on the light's General Parameters rollout.)

For area lights rendered with the mental ray renderer, you can still set and use other lighting parameters, such as color, the Multiplier value, the spotlight cone, and so on. Shadow maps are an exception. The mental ray renderer ignores the light's local shadow map settings. Area lights always use ray-traced shadows.

TIP You can use a MAXScript utility to convert standard 3ds Max light objects to area lights, as described in [this procedure](#) on page ?.

Light Settings

The [mental ray Indirect Illumination rollout](#) on page 5112 has been added to light objects to support the mental ray renderer's indirect illumination effects of [caustics](#) on page 6255 and [global illumination](#) on page 6261.

The [mental ray Light Shader rollout](#) on page 5115 has been added so you can add mental ray light shaders to light objects.

IMPORTANT To see the mental ray rollouts for lights, you must use [mental ray Preferences](#) on page 7787 to enable mental ray extensions. These rollouts appear only on the Modify panel, not on the Create panel.

Camera Enhancements

On the [Parameters rollout](#) on page 5210, a “Depth Of Field (mental ray)” choice appears on the Multi-Pass Effect drop-down list to support the mental ray renderer's depth-of-field effects. To use this, turn on both Enable in the camera's Multi-Pass Effect group (default=off), and Depth Of Field on the Render Setup dialog > Renderer panel > [Camera Effects rollout](#) on page 6283.

You can also assign mental ray lens, output, and volume shaders to cameras. These controls are also on the Render Setup dialog > Camera Effects rollout. (This rollout also contains some contour-shading controls.)

NOTE When you use the mental ray renderer, reflected or refracted light rays do not always respect a camera's clipping planes (set in the Clipping Planes group of the Parameters rollout). Also, large clipping-plane values can cause poor quality in the rendering of shadow maps. To fix this, narrow the clipping range or switch to ray-traced shadows.

Material Editor Enhancements

The Material Editor works as it does with the default scanline renderer. Certain materials and maps, or some of their controls, aren't supported by the mental ray renderer; see [3ds Max Materials in mental ray Renderings](#) on page 6239.

By default, the Material Editor sample slots use the currently active renderer: typically this is either the default scanline renderer or the mental ray renderer. You assign the renderer for sample slots with the Render Setup dialog > Common panel > [Assign Renderer rollout](#) on page 6135.

When mental ray extensions are enabled (using [mental ray Preferences](#) on page 7787) and the mental ray renderer is active, the Material Editor displays these additional mental ray features:

- A [mental ray Connection rollout](#) on page 5385 lets you add mental ray shaders to 3ds Max materials.
- When you click a material's Type button, the Material/Map Browser displays additional [mental ray materials](#) on page 5543.
- When you click a map or shader button, the Material/Map Browser displays additional [mental ray shaders](#) on page 5974.

Shaders are provided in [shader library \(MI\) files](#) on page 8044. Some shaders are customized for 3ds Max, some are provided by the lume library, and most are provided by mental images libraries. Settings for the custom 3ds Max shaders are provided in this reference. Settings for the third-party lume and mental images shaders are provided in their own help files. This reference links to those descriptions; see [Shaders in the LumeTools Collection](#) on page 5980 and [mental images Shader Libraries](#) on page 5977.

mental ray Messages Window

Rendering menu > mental ray Message Window

The mental ray Messages window displays log messages (other than debug messages) generated by the mental ray renderer.

Interface

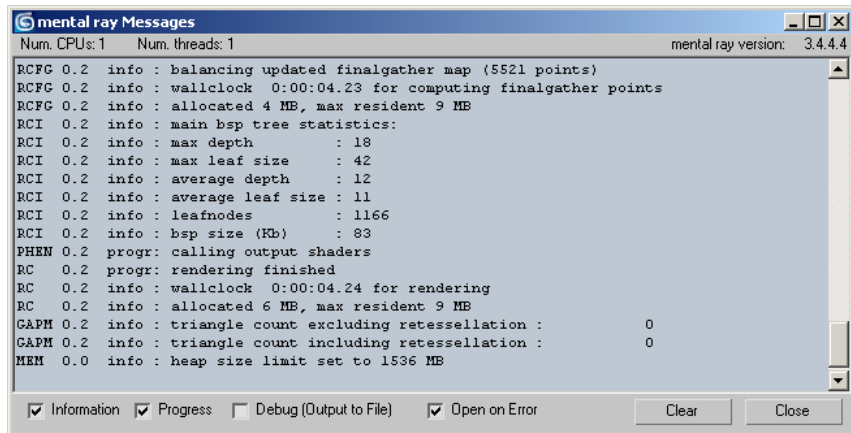

Example of mental ray Messages window

Three status fields appear above the messages area:

- **Num. CPUs** Shows the number of CPUs in use.
- **Num. threads** Shows the number of threads being rendered.
- **mental ray version** Shows the current mental ray renderer version, in detail.

The options beneath the messages area are equivalent to options on the [mental ray Preferences dialog](#) on page 7787.

Information When on, the mental ray renderer generates information messages. Default=off.

This is equivalent to the preference, Show/Log Information Messages.

Progress When on, the mental ray renderer generates progress messages. Default=off.

This is equivalent to the preference, Show/Log Progress Messages.

Debug (Output to File) When on, the mental ray renderer generates debug messages. Default=off.

This is equivalent to the preference, Log Debug Messages (To File).

NOTE Debug messages are never displayed by the Messages Window. They are numerous, and would make it difficult to find or read other messages.

Open on Error When on, the Messages Window is displayed if the mental ray renderer logs an error message. Default=off.

This is equivalent to the preference, Open Message Window On Error.

Clear Click to clear all messages from the messages area.

mental ray Concepts

These topics describe what the mental ray renderer can do, and explain how it accomplishes these effects. For more technical detail about mental ray capabilities, see the mental ray Reference, available from Help menu > Additional Help, and the books *Programming mental ray* and *Rendering with mental ray*, both by Thomas Driemeyer.

Ray-Traced Reflections and Refractions with the mental ray Renderer

The mental ray renderer can generate reflections and refractions by ray tracing. Ray tracing traces the path of rays sampled from the light source. Reflections and refractions generated this way are physically accurate.



Ray-traced reflections and Refractions

To reduce the time required to generate reflections and shadows, rays are limited by *trace depth*. Trace depth limits the number of times a ray can be reflected, refracted, or both.

You can turn off ray tracing. In this case, the mental ray renderer uses scanline rendering only. Turning off ray tracing makes the controls for all the effects that are specific to mental ray unavailable in the Renderer's rollouts.

Ray tracing uses one of two [ray-trace acceleration methods](#) on page 8102.

You enable ray tracing and set trace depth with the Render Setup dialog > Renderer panel > [Rendering Algorithms rollout](#) on page 6277 controls.

Shadows with the mental ray Renderer

The mental ray renderer can generate shadows by ray tracing. Ray tracing traces the path of rays sampled from the light source. Shadows appear where rays have been blocked by objects. Ray-traced shadows have sharp edges.



Ray-traced shadows

Turning off caustics makes the outlines of shadows in this scene easier to see.

You can tell the mental ray renderer to use [shadow maps](#) on page 8126 instead of ray-traced shadows. This can improve performance at a cost of accuracy.

Shadow controls are on the Render Setup Dialog > Renderer panel > [Shadows & Displacement rollout](#) on page 6292.

Shadow Generators and the mental ray Renderer

Light objects in 3ds Max let you choose a shadow generator: Ray Traced, Advanced Ray Traced, Shadow Map, and so on. Because the mental ray renderer supports only two kinds of shadow generation, ray tracing and shadow maps, some of the 3ds Max shadow generators aren't fully supported.

In 3ds Max, a special shadow generator type, *mental ray Shadow Map*, is provided to support the mental ray renderer. If shadows are enabled (on the [Shadows & Displacement rollout](#) on page 6292 of the Render Setup dialog) but shadow maps are not enabled, then shadows for all lights are generated using the

mental ray ray-tracing algorithm. If shadow maps are enabled, then shadow generation is based on each light's choice of shadow generator:

- **mental ray Shadow Map** Shadows are generated using the mental ray shadow-map algorithm.
- **Shadow Map** Settings on the Shadow Parameters rollout are translated into a mental ray equivalent before shadows are generated. The quality of shadows generated this way might not always meet expectations.
- **Area Shadows, Advanced Ray Traced Shadows, or Ray Traced Shadows** Shadows are generated using the mental ray ray-tracing algorithm.

Motion Blur with the mental ray Renderer

Motion blur is a way to enhance the realism of a rendered animation by simulating the way a real-world camera works. A camera has a shutter speed, and if significant movement occurs during the time the shutter is open, the image on film is blurred.

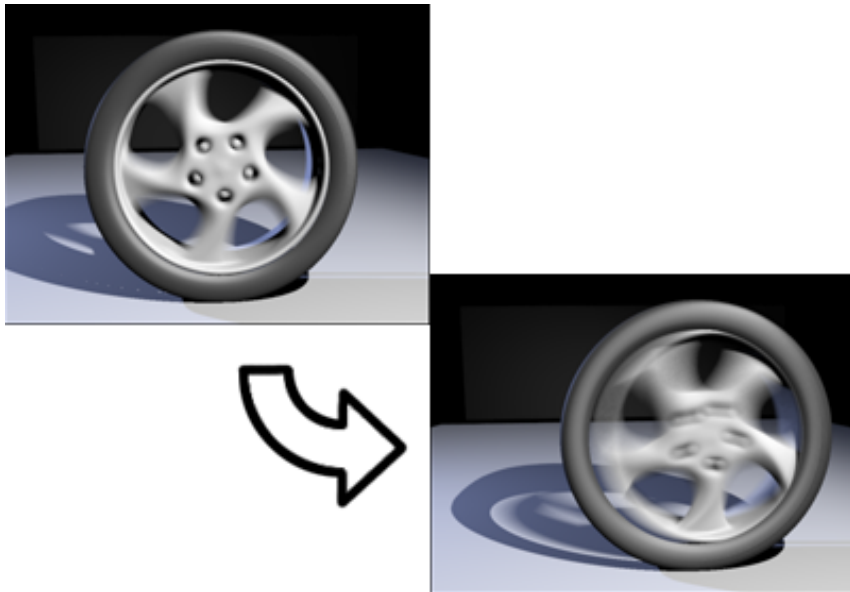

Motion blur added to rendering of an animated wheel as it speeds up and rolls forward

To render motion blur with the mental ray renderer, you must turn on ray tracing (the Ray Trace parameter) on the Render Setup dialog > Renderer panel > [Rendering Algorithms rollout](#) on page 6277.

The mental ray renderer uses a Shutter parameter to control motion blur. This simulates the shutter speed of a camera. At 0.0, there is no motion blurring. At 1.0, the maximum amount of motion blurring occurs. Values between zero and one adjust the amount of motion blur. The closer to 1.0, the greater the blurring.

You turn on motion blur and adjust shutter speed on the Render Setup Dialog > Renderer panel > [Camera Effects rollout](#) on page 6283.

If you render using [shadow maps](#) on page 8126, then by default mental ray applies motion blur to these as well. See the Render Setup dialog > Renderer panel > [Shadows & Displacement rollout](#) on page 6292.

TIP mental ray motion blur is not recommended for use with particle systems, as this can increase rendering time considerably. Use a [Particle MBlur map](#) on page 5891 instead.

NOTE Motion blur with the mental ray renderer does not always follow curving trajectories. Increasing the value of Motion Segments can help, but this works better for rotary motion than for traveling motion.

Depth of Field with the mental ray Renderer

Depth of field is a way to enhance the realism of a rendering by simulating the way a real-world camera works. With a broad depth of field, all or nearly all of a scene is in focus. With a narrow depth of field, only objects within a certain distance from the camera are in focus.

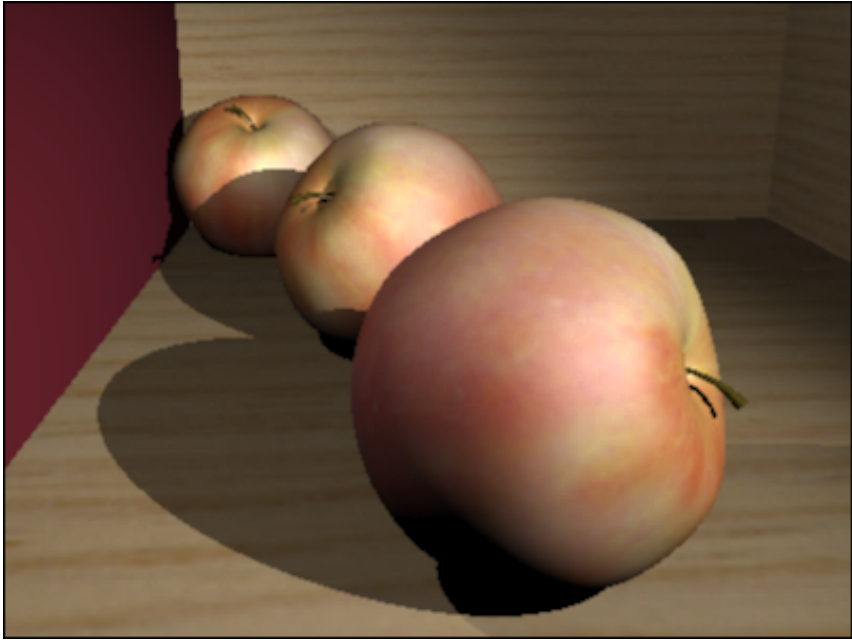

Scene rendered using no depth of field
All apples are equally in focus.

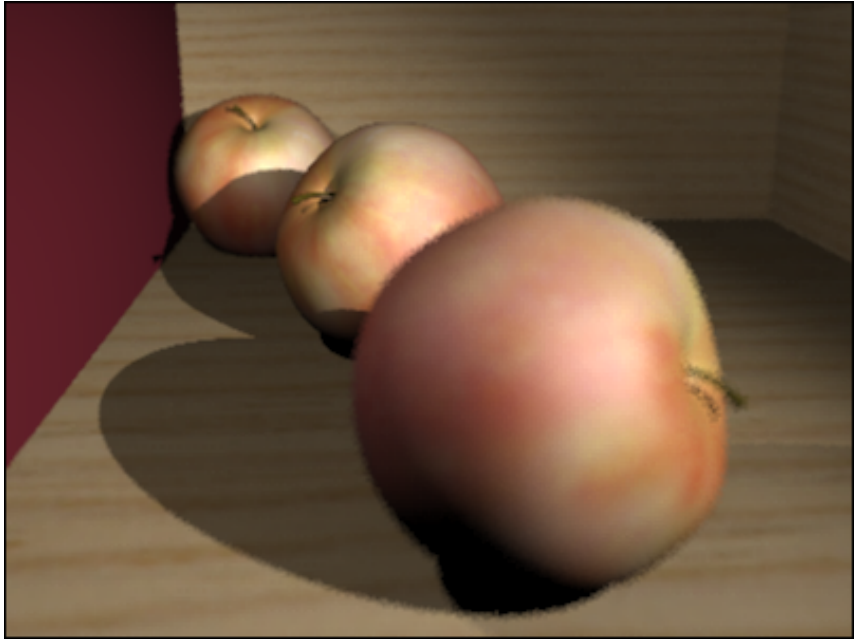

Same scene using depth of field to control focus

The middle apple is clearer than the other two.

To render depth-of-field effects with mental ray, ray tracing (the Ray Trace toggle) must be enabled on the Render Setup dialog > Renderer panel > [Rendering Algorithms rollout](#) on page 6277. You must also enable depth of field for the camera: in the camera's Multi-Pass Effect group, choose "Depth Of Field (mental ray)" as the depth-of-field type. (If you choose the scanline renderer's Depth Of Field option, the rendering that results can be out of focus.)

The mental ray renderer uses the camera's target distance and f-Stop parameters to control the depth-of-field effect.

The camera's target distance determines the focus plane. The focus plane is the distance from the camera at which the scene is completely in focus.

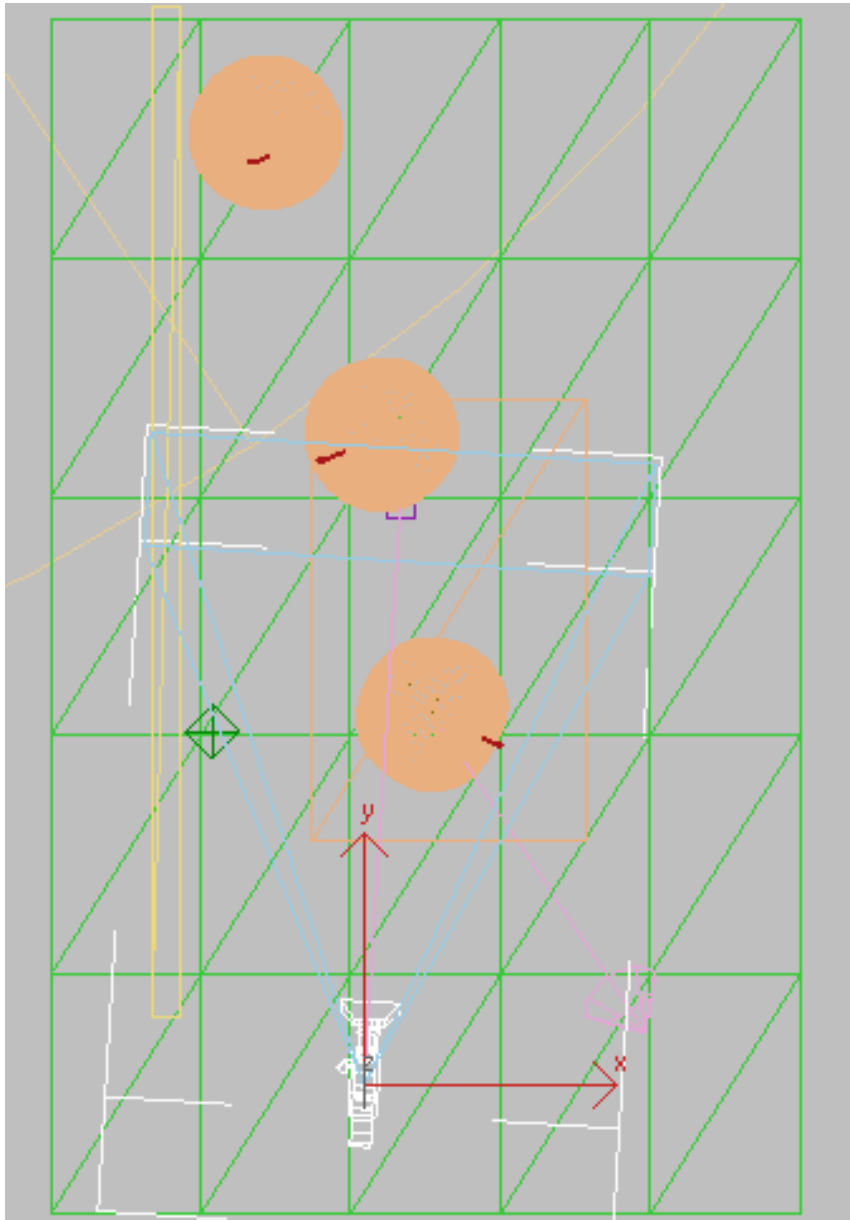

Focus plane in relation to a camera

Here it is set to the middle apple, as in the previous renderings.

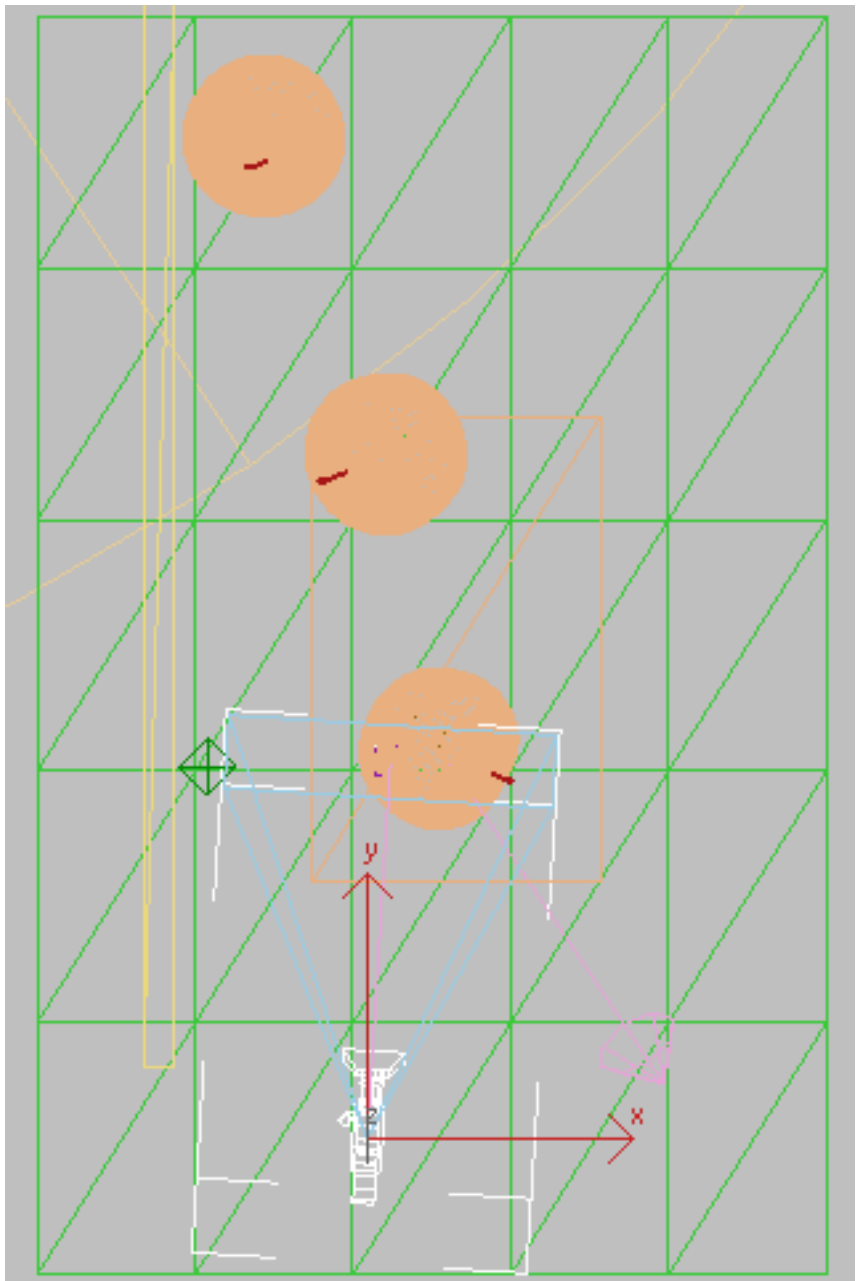

Focus plane in relation to a camera

Here it is set to the nearest apple, as in the renderings that follow.

The f-stop controls the amount of blurring at distances other than the focus plane distance. In a real-world camera, the f-stop measures the size of the lens's aperture. The lower the f-stop value, the larger the aperture and the narrower the depth of field. So increasing the f-stop value broadens the depth of field, and decreasing the f-stop value narrows the depth of field.



**Decreasing the f-stop to narrow depth of field
Focal plane set at the nearest apple, and f-stop set to 0.1.**

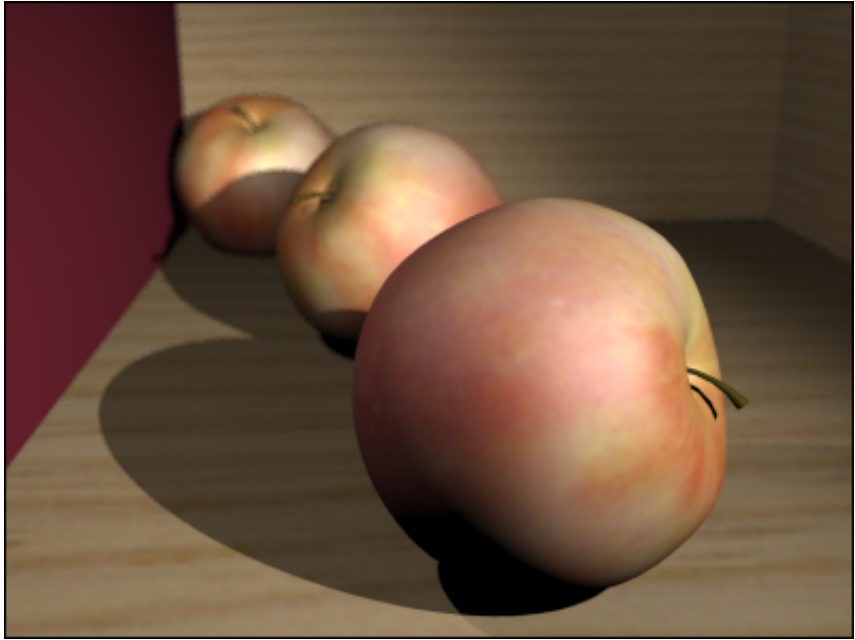

Increasing the f-stop to broaden depth of field

Focal plane in same location, f-stop increased to 1.0.

You set the f-Stop in the camera's Depth Of Field rollout. See [Depth of Field Parameter \(mental ray Renderer\)](#) on page 5229.

NOTE For Perspective viewports, which have no camera, the Render Setup dialog > Renderer panel > [Camera Effects rollout](#) on page 6283 has explicit Focus Plane and f-Stop settings.

Caustic Lighting Effects

Caustics are the effects of light cast onto an object via reflection off or refraction through another object.

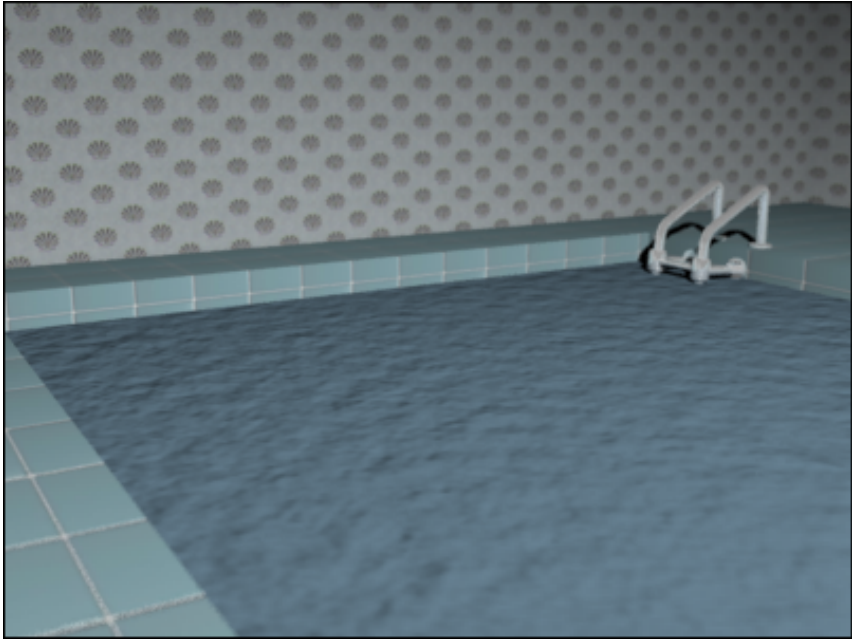

Swimming pool rendered without caustics

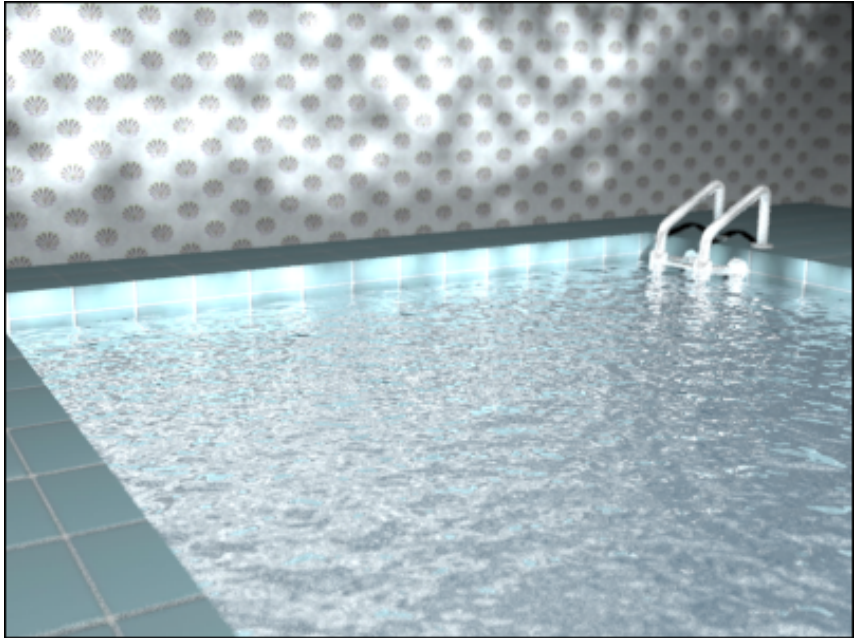

Reflective caustics added to swimming pool

To calculate caustics, the mental ray renderer uses the [photon map technique](#) on page 8090. (Ray tracing can't generate accurate caustics, and they aren't provided by the default scanline renderer.)

You enable caustics on the Render Setup dialog > Indirect Illumination panel > [Caustics And Global Illumination rollout](#) on page 6309. In addition, you must designate:

- Which light objects can create caustics.
- Which renderable objects can generate caustics.
- Which renderable objects can receive caustics.

The settings for generating and receiving caustics are on the Object Properties dialog > [mental ray Panel](#) on page 322.



Refractive caustics rendered with the default of Radius turned off.
Radius size is based on scene extents; specifically, 1/100 the radius of the full scene.



Radius value explicitly set to 1.0



Radius value increased to 2.5.

Filter type changed to Cone.



Photon count increased to 50,000 (in Global Light Properties group) for greater detail in the caustics.

Global Illumination with the mental ray Renderer

Global illumination enhances the realism in rendered images by simulating all light interreflection effects in a scene (except [caustics](#) on page 6255). It generates such effects as "color bleeding," where for example, a white shirt next to a red wall appears to have a slight red tint.

The mental ray renderer offers two distinct toolsets for achieving global illumination: [photon tracing](#) on page 6310 and [final gathering](#) on page 6295. The primary difference between the two is that photon tracing goes from the light source toward the ultimate illuminated target (taking bounces into account), and final gathering goes the opposite way: from the illuminated surface toward the light source. You can use either of these toolsets separately, or combine them for optimal rendered results.

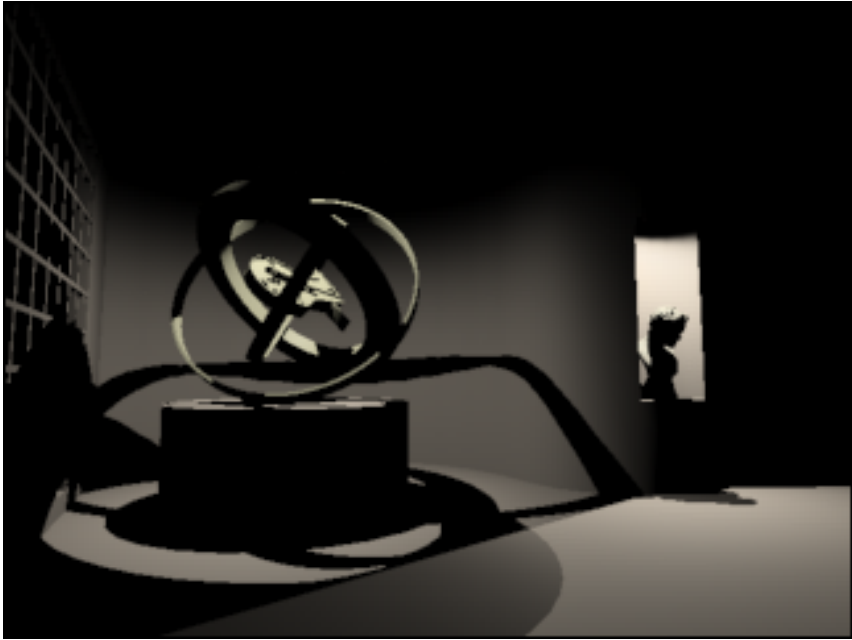

Scene rendered without global illumination

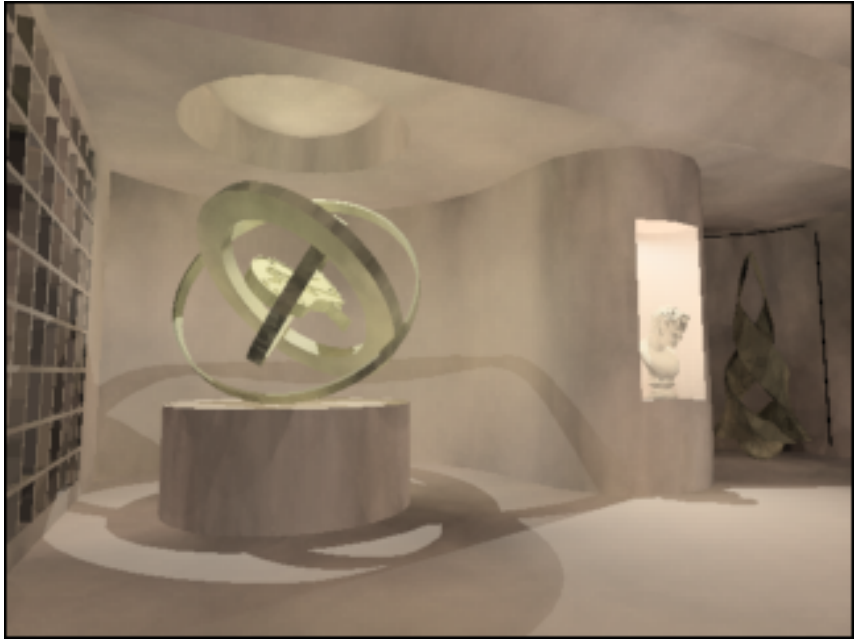

Same scene with global illumination



Global illumination made smoother by final gather

To calculate global illumination, the mental ray renderer uses the [photon map technique](#) on page 8090.

NOTE The mental ray renderer generates global illumination without requiring you to generate a radiosity solution. A photon map is a model of global illumination in its own right.

NOTE In order to use global illumination in mental ray, the photons must be able to bounce among two or more surfaces. This can be accomplished by having a single object with some concavity in its surface that's exposed to the light source, or at least two objects, and at least one object must be set to receive global illumination (see [mental ray Panel \(Object Properties Dialog\)](#) on page 322). Otherwise you'll receive error messages and no photons will be stored.

Using a photon map can cause rendering artifacts such as dark corners and low-frequency variations in the lighting. You can reduce or eliminate these artifacts by turning on [final gathering](#) on page 6295, which increases the number of rays used to calculate global illumination.

You enable global illumination on the Render Setup dialog > Indirect Illumination panel > [Caustics And Global Illumination rollout](#) on page 6306,

and final gathering on the [Final Gather rollout](#) on page 6295. In addition, you must designate:

- Which light objects can generate global illumination.
- Which renderable objects can generate global illumination.
- Which renderable objects can receive global illumination.

The settings for generating and receiving global illumination are on the Object Properties dialog > [mental ray Panel](#) on page 322. By default, all objects in 3ds Max are set to generate and receive global illumination.

mental ray Volume Shading

Volume shading shades a three-dimensional volume, rather than a surface. Typically, volume shaders provide atmospheric effects such as mist and fog.



Model rendered with no volume effect

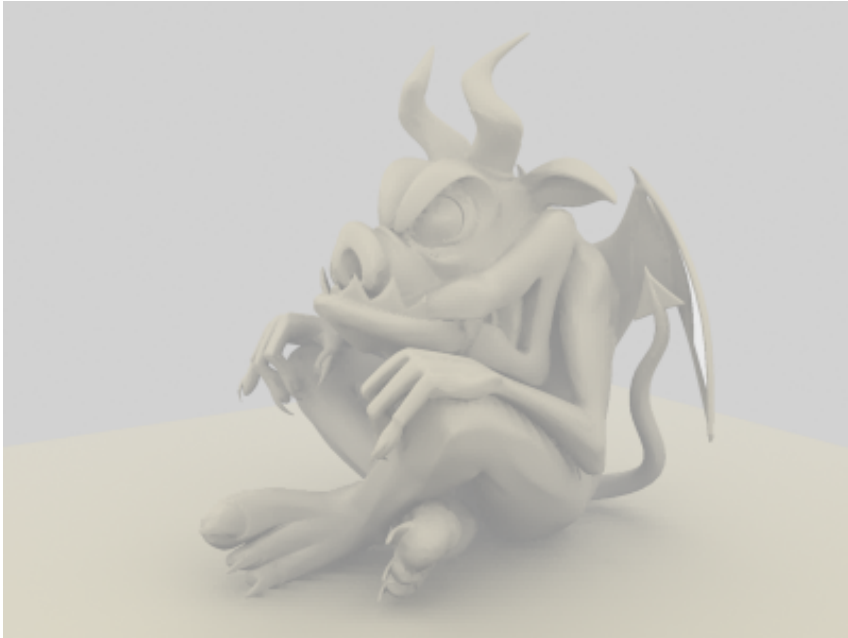

Same model rendered in mist

Mist applied as a camera volume shader; realistic falloff on

There are two ways to assign a volume shader:

- To a camera
This effectively makes the entire scene a single volume.
- To a material
This makes a volume out of objects to which the material is applied.
Usually when you assign a volume shader to a material, you want to make its surface transparent so the shading within the volume is visible. You can do this with the mental images *Transmat shader*.

To assign a volume shader to a camera, use the Render Setup dialog. To assign a volume shader to a material, use the material's Volume shader component. This component is found on the [mental ray Connection rollout](#) on page 5385, and in the [mental ray material](#) on page 5638 itself. See the “Procedures” that follow.

Procedures

To apply volume shading to a camera:



- 1 On the main toolbar, click Render Setup.

If the active renderer is not already the mental ray renderer, go to the Common panel, and on the Assign Renderer rollout, click the “...” button for the Production renderer. A Choose Renderer dialog is displayed. Highlight “mental ray Renderer” in the list, and then click OK.

- 2 Click the Renderer tab to go to the Renderer panel. On the Camera Effects rollout, find the Camera Shaders group, and click Volume.
The [Material/Map Browser](#) on page 5290 is displayed.
- 3 Choose a volume shader from the list in the Browser, and then click OK.

To apply volume shading to an object:

- 1 Choose Customize > Preferences. Go to the mental ray panel, and turn on Enable Mental Ray Extensions.



- 2 On the main toolbar, click Render Setup.

If mental ray is not already the active renderer, go to the Common panel, and on the Assign Renderer rollout, click the “...” button for the Production renderer. The Choose Renderer dialog opens. Highlight “mental ray Renderer” in the list and then click OK.

Leave the Render Setup dialog open, or minimize it.



- 3 Open the Material Editor. Use the [mental ray Connection rollout](#) on page 5385 to assign a volume shader to the Volume component.

Another technique would be to use the [mental ray material](#) on page 5638, and assign a shader to the Volume component.



- 4 Also on the mental ray Connection rollout, click the lock button to unlock the Surface component. Click the shader button (“None”) and use the Browser to assign the Transmat (physics) shader to the surface.
(If you are using the mental ray material, you don't need to first unlock the Surface component.)

- 5 Apply the material to objects you wish to use as shaded volumes.

mental ray Displacement

Displacement shading with the mental ray renderer is similar to [displacement mapping](#) on page 5487 of standard materials. One advantage of using mental ray displacement is that the additional polygons of displaced surfaces are stored only in the mental ray scene database, not in your 3ds Max scene, so they do not increase the memory requirements of your scene, except at render time. This can be a big improvement in performance over displacement mapping with standard materials and the scanline renderer.

Procedures

To add displacement to a mental ray rendering:

- 1 Choose Customize > Preferences. Go to the mental ray panel, and turn on Enable Mental Ray Extensions.



- 2 On the main toolbar, click Render Setup.

If the active renderer is not already the mental ray renderer, go to the Common panel, and on the Assign Renderer rollout, click the “...” button for the Production renderer. A Choose Renderer dialog is displayed. Highlight “mental ray Renderer” in the list, and then click OK.

Leave the Render Setup dialog open, or minimize it.



- 3 Open the Material Editor.



- 4 On the mental ray Connection rollout, click the lock button to unlock the Displacement component. Click the shader button (“None”) and use the Browser to assign a displacement shader to the surface.

WARNING This overrides any displacement assigned to the base material as a standard map.

Another technique would be to use the [mental ray material](#) on page 5638, and assign a shader to the Displacement component. (If you are using

the mental ray material, you don't need to first unlock the Displacement component.)

- 5 Apply the material to objects you wish to show the displacement.

mental ray Contour Shading

Contour shading lets you render vector-based contour lines. Contours are similar to the ink component of the Ink 'n Paint material.



Model rendered without contours



Model with contours added to the rendering

Simple contour shader

You add contour rendering by assigning one of the contour shaders to the Contour component of a material. (This component is found on the [mental ray Connection rollout](#) on page 5385 and on the mental ray material's [Advanced Shaders rollout](#) on page 5646). Then when you render, use the [Camera Effects rollout](#) on page 6283 to enable contours.

On the Camera Effects rollout, additional shaders can modify the contours, or control how they are rendered. For example, if you assign a Contour Only shader to the Contour Output component, the rendering consists of just the contours, and not the shaded model.



Rendering of the model's contours only

Contours Only output shader, background set to white

NOTE Contour shading does not work with distributed bucket rendering.

Procedures

To add contours to a mental ray rendering:

- 1 Choose Customize > Preferences. Go to the mental ray panel, and turn on Enable Mental Ray Extensions.



- 2 On the main toolbar, click Render Setup.

If the active renderer is not already the mental ray renderer, go to the Common panel, and on the Assign Renderer rollout, click the “...” button for the Production renderer. A Choose Renderer dialog is displayed. Highlight “mental ray Renderer” in the list, and then click OK.

Leave the Render Setup dialog open, or minimize it.



- 3 Open the Material Editor. For the materials of objects you want to render with contours, use the [mental ray Connection rollout](#) on page 5385 to assign a shader to the Contour component.

Another technique would be to use the [mental ray material](#) on page 5638, and assign shaders to both the Surface and Contour components.

TIP The *Simple contour shader* renders uniform lines whose color and width you can control. The other contour shaders provide variant contour styles with more direct user controls.

- 4 On the Render Setup dialog, go to the Renderer panel. On the Camera Effects rollout, turn on Enable in the Contours group.

To simply add contour lines to a rendering, leave the shaders in the Camera Effects rollout set to their defaults. For other options, see [Camera Effects Rollout \(mental ray Renderer\)](#) on page 6283.

mental ray Renderer Interface

Render Setup dialog > Renderer panel/Indirect Illumination panel/Processing panel

This section covers the Render Setup dialog panels specific to mental ray rendering:

- **Renderer panel**
- **Indirect Illumination panel**
- **Processing panel**

For information on the common rendering panels, see:

- [Common Panel \(Render Setup Dialog\)](#) on page 6121
- [Render Elements Panel and Rollout](#) on page 6336

NOTE  In Autodesk 3ds Max 2009, a number of default settings have been changed to improve quality, convenience, or rendering time when you use the mental ray renderer.

Renderer Panel (mental ray)

Rendering menu/main toolbar > Render Setup > Render Setup dialog > Indirect Illumination panel

Note: The Processing panel appears only when mental ray is the active renderer.

The Indirect Illumination panel controls concern themselves with methods for rendering bounced light within an environment, including final gathering, caustics, and photons.

Sampling Quality Rollout (mental ray Renderer)

Rendering menu/main toolbar > Render Setup > Render Setup dialog > Renderer panel > Sampling Quality rollout

Note: The Sampling Quality rollout appears only when the mental ray renderer is the currently active renderer.

The controls on this rollout affect how the mental ray renderer performs [sampling](#) on page 8112 for antialiasing rendered images.

Procedures

To use low sampling for previews:

- Leave the Minimum and Maximum values at their default settings of 1/4 and 4, or reduce them to 1/16 and 1/4.

TIP Do not assign Minimum and Maximum the same value.

To use high sampling for final renderings:

- Increase the Minimum and Maximum values to 4 and 16, respectively, or to higher values.

TIP Do not assign the same value to both Minimum and Maximum.

To view the sampling pattern:

- On the [Diagnostics rollout](#) on page 6324, choose Sampling Rate, then render the scene.

Instead of rendering the image, mental ray draws a diagram that shows the range of applied sampling values. White lines indicate edges in the scene, where the mental ray renderer took the maximum number of samples. If fractional sample limits are used (sampling down), lighter dots indicate the higher value while darker dots indicate the lower value.

To assist with analysis, View Samples also draws red lines around each bucket, or separately rendered block.

When the Minimum and Maximum number of samples are equal, the diagram shows all buckets as white.

Interface

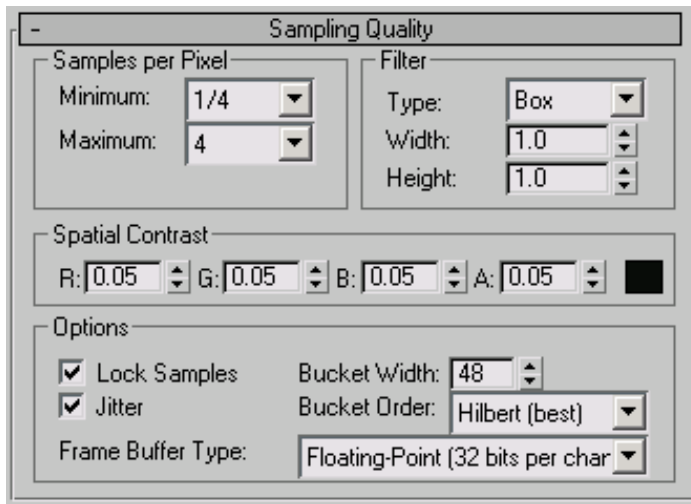

Samples per Pixel group

Set the minimum and maximum sample rates for antialiasing the rendered output.

NOTE Presets for several sample rate combinations are available on the Rendered Frame Window as the [Image Precision \(Antialiasing\) slider](#) on page 6083.

Minimum Sets the minimum sample rate. The value represents the number of samples per pixel. A value greater than or equal to 1 indicates that one or more samples are computed per pixel. A fractional value indicates that one sample is computed for every N pixels (for example, 1/4 computes a minimum of one sample for every four pixels). Default=1/4.

Maximum Sets the maximum sample rate. If neighboring samples find a difference in contrast that exceeds the contrast limit, the area containing the contrast is subdivided to the depth specified by Maximum. Default=4.

The values of the Minimum and Maximum lists are "locked" together so that the value of Minimum can't exceed the value of Maximum.

Filter group

Filter type Determines how multiple samples are combined into a single pixel value. Can be set to Box, Gauss, Triangle, Mitchell, or Lanczos. Default=Box.

TIP For most scenes the Mitchell filter gives the best results.

- **Box filter:** Sums all samples in the filter area with equal weight. This is the quickest sampling method.
- **Gauss filter:** Weights the samples using a Gauss (bell) curve centered on the pixel.
- **Triangle filter:** Weights the samples using a pyramid centered on the pixel.
- **Mitchell filter:** Weights the samples using a curve (steeper than Gauss) centered on the pixel.
- **Lanczos filter:** Weights the samples using a curve (steeper than Gauss) centered on the pixel, diminishing the effect of samples at the edge of the filter area.

Width and Height Specify the size of the filtered area. Increasing the value of Width and Height can soften the image, however it will increase rendering time.

Default=Depends on the Filter type you choose:

- **Box filter:** Width=1.0, Height=1.0
- **Gauss filter:** Width=3.0, Height=3.0
- **Triangle filter:** Width=2.0, Height=2.0
- **Mitchell filter:** Width=4.0, Height=4.0
- **Lanczos filter:** Width=4.0, Height=4.0

Spatial Contrast group

This control sets the contrast value used as thresholds to control sampling. Spatial contrast applies to each still image.

If neighboring samples in a frame differ by more than this color, the mental ray renderer does recursive supersampling (that is, more than one sample per pixel), up to the depth specified by the [Maximum samples per pixel](#) on page 6274 value. Increasing the Spatial Contrast values decreases the amount of sampling done, and can speed the rendering of a scene at the cost of image quality.

- **R, G, B** Specify the threshold values for the red, green, and blue components of samples. These values are normalized, and range from 0.0

to 1.0, where 0.0 indicates the color component is fully unsaturated (black, or 0 in eight-bit encoding) and 1.0 indicates the color component is fully saturated (white, or 255 in eight-bit encoding). Default=(0.05, 0.05, 0.05).

- **A** Specifies the threshold value for the alpha component of samples. This value is normalized, and ranges from 0.0 (fully transparent, or 0 in eight-bit encoding) to 1.0 (fully opaque, or 255 in eight-bit encoding). Default=0.05.
- **[color swatch]** Click to display a [Color Selector](#) on page 391 to let you specify the R, G, and B threshold values interactively.

Options group

Lock Samples When on, the mental ray renderer uses the same sampling pattern for every frame of an animation. When off, the mental ray renderer introduces a quasi-random (Monte Carlo) variation in the sample pattern from frame to frame. Default=on.

Varying the sample pattern reduces rendering artifacts in animations.

Jitter Introduces a variation into sample locations; see [Sampling](#) on page 8112. Turning on Jitter can help reduce aliasing. Default=on.

Bucket Width Determines the size of each bucket in pixels. Range=4 to 512 pixels. Default=48 pixels.

To render the scene, the mental ray renderer subdivides the image into rectangular sections, or “buckets.” Using a smaller bucket size causes more image updates to be generated during rendering. Updating the image consumes a certain amount of CPU cycles. For scenes with little complexity, smaller buckets can increase the rendering time, while larger buckets can make things render faster. For more complex scenes, the reverse is true.

Bucket Order Lets you specify the method by which mental ray chooses the next bucket. If you are using placeholders or distributed rendering, use the default Hilbert order. Otherwise, you can choose a method based on how you prefer to see the image appear as it renders in the Rendered Frame Window.

- **Hilbert (best)** (The default.) The next bucket chosen is the one that will trigger the fewest data transfers.

TIP Always use Hilbert order when you use placeholders (see the [Translator Options rollout](#) on page 6316) or distributed rendering (see the [Distributed Bucket Rendering rollout](#) on page 6326).

- **Spiral** The buckets begin at the center of the image, and spiral outward.

- **Left to right** Buckets are rendered in columns, from bottom to top, left to right.
- **Right to left** Buckets are rendered in columns, from bottom to top, right to left.
- **Top-down** Buckets are rendered in rows, from right to left, top to bottom.
- **Bottom-up** Buckets are rendered in rows, from right to left, bottom to top.

Frame Buffer Type Lets you choose the bit depth of the output frame buffer:

- **Integer (16 bits per channel)** Outputs 16 bits per channel of color information. This is the default output format.
- **Floating-Point (32 bits per channel)** Outputs 32 bits per channel of color information. This method supports high-dynamic-range imagery (HDRI).

Rendering Algorithms Rollout (mental ray Renderer)

Rendering menu/main toolbar > Render Setup > Render Setup dialog > Renderer panel > Rendering Algorithms rollout

The controls in this rollout let you choose whether to render using ray-tracing, scanline rendering, or both. You can also choose the method used to accelerate ray-tracing.

The Trace Depth controls the number of times each ray can be reflected, refracted, or both.

Procedures

To set trace depth for reflections and refractions:

- 1 Count the number of times you want an object to be reflected or refracted in the scene.
- 2 On the mental ray: Rendering Algorithms rollout, turn on Enable Reflections and enable Refractions.
- 3 Set Max. Reflections to the number of reflections you want, and Max. Refractions to the number of refractions you want.

- 4 Set Max. Trace Depth to the sum of the values for Max Reflections and Max Refractions.

The greater the number of reflections and refractions, the more slowly your scene will render. On the other hand, too low a value for Max. Reflections or Max. Refractions (or Max. Trace Depth, controlling both) can make your rendering look unrealistic.

Interface

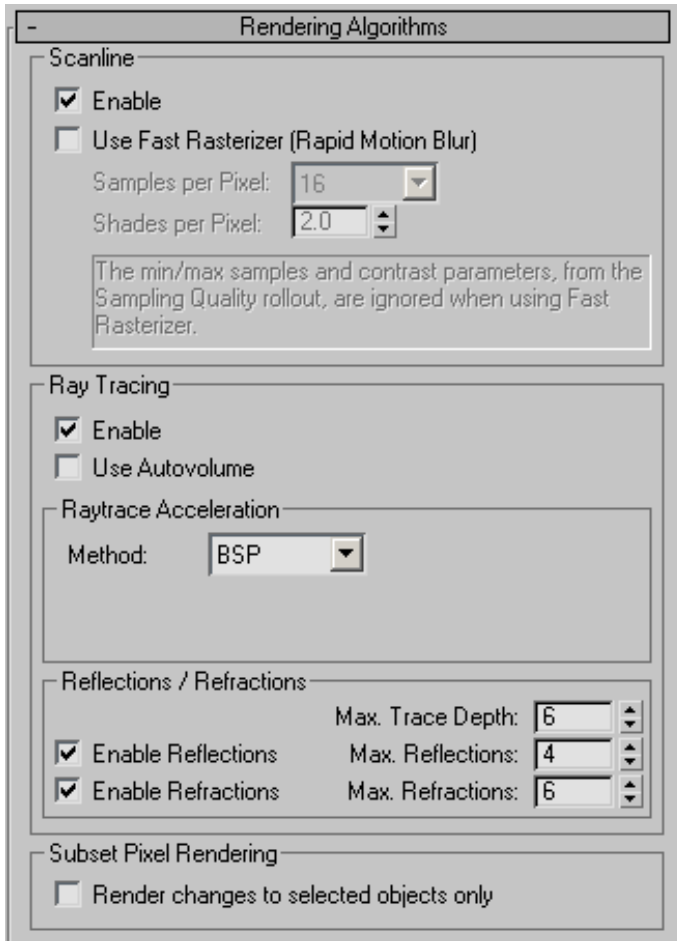

By default, both Scanline and Ray Tracing are enabled, which lets the mental ray renderer use the two methods in combination to render the scene. Scanline

rendering is used for direct illumination (“primary rays”) only; ray tracing is used for indirect illumination (caustics and global illumination) as well as reflections, refractions, and lens effects.

You can disable one or the other option, but not both. For example, if only ray tracing is enabled and you turn it off, 3ds Max enables scanline rendering.

Scanline group

Enable When on, the renderer can use scanline rendering. When off, the renderer uses the ray-tracing method only. Scanline rendering is faster than ray tracing, but cannot generate reflections, refractions, shadows, depth of field, or indirect lighting. Default=on.

Use Fast Rasterizer (Rapid Motion Blur) When on, uses a fast rasterizer method to generate the first generation of rays to trace. This can improve rendering speed. Default=off.

This option works well with object motion blur, and also with scenes that have no motion blur.

The following settings are available for the fast rasterizer:

- **Samples per Pixel** Controls the number of samples per pixel used by the fast rasterizer method. More samples result in greater smoothness, at a cost of render time. Range=1 to 225. Default=16.
- **Shades per Pixel** Controls the approximate number of shading calls per pixel. Greater values result in more accurate renderings, at a cost of render time. Range=0.1 to 10000 (ten thousand). Default=2.0.

NOTE mental ray provides a Time Samples setting specifically for motion blur in the fast rasterizer. When Use Fast Rasterizer is on, the Camera Effects rollout >[Time Samples](#) on page 6287 label changes to Time Samples (Fast Rasterizer) to indicate that this version of Time Samples is now in effect.

Ray Tracing group

Enable When on, mental ray uses ray tracing to render reflections, refractions, lens effects (motion blur and depth of field), and indirect lighting (caustics and global illumination). When off, the renderer uses the scanline method only. Ray tracing is slower but more accurate and more realistic. Default=on.

To render reflections, refractions, depth of field, and indirect lighting (caustics and global illumination), Ray Tracing must be enabled.

Use Autovolume When on, uses the mental ray *autovolume* mode. This lets you render nested or overlapping volumes such as the intersection of two spotlight beams. Autovolume also allows a camera to move through the nested or overlapping volumes. Default=off.

To use Autovolume, Ray Trace must be on, Scanline must be off, and the shadow mode must be set to Segments. (You set the shadow mode on the [Shadows And Displacement rollout](#) on page 6292.) If these conditions aren't met when you click to turn on Autovolume, an alert warns you about this, and gives you the option of making the appropriate setting changes.

Raytrace Acceleration Group

Method The drop-down list sets which algorithm to use for [raytrace acceleration](#) on page 8102. The other controls in this group box change, depending on which acceleration method you choose. These are the alternatives:

■ BSP

(The default.) The BSP method has Size and Depth controls. See [Ray-Trace Acceleration: Parameters for the BSP Method](#) on page 6282.

This method is the fastest on a single-processor system. Use it for small-to-medium size scenes (less than one million triangles) on a single processor. BSP is also the best method to use when ray tracing is turned off.



■ BSP2

The BSP2 method is configured automatically by mental ray and has no controls. This method is optimized for large scenes containing more than a million triangles.

BSP2 requires less memory than BSP and is able to flush memory when necessary. However, there could be a small performance loss when using it with smaller scenes.

Reflections/Refractions group

Trace depth controls the number of times a light ray can be reflected or refracted. At 0, no reflection or refraction occurs. Increasing these values can increase the complexity and realism of a scene, at a cost of greater rendering time.

TIP In some cases, you might want to set Max. Refractions high and Max. Reflections low. For example, you might have the camera looking through several glasses that are lined up, so they're overlapping from the camera's point of view. In this situation, you might want the light rays to refract twice for each glass (once for each layer), so you'd set Max. Refractions to $2 \times [\text{number of glasses}]$. However, to save rendering time, you could set Max. Reflections to 1, resulting in accurate multi-layer refraction with a relatively fast rendering time.

Max. Trace Depth Limits the combination of reflection and refraction. Tracing of a ray stops when the total number of reflections and refractions reaches the Max. Trace Depth. For example, if Max. Trace Depth is set to 3 and the two trace depths are both set to 2, a ray can be reflected twice and refracted once, or vice-versa, but it can't be reflected and refracted four times. Default=6.



Enable Reflections When on, mental ray traces reflections. Turn off to improve performance when you don't require reflections.

- **Max. Reflections** Sets the number of times a ray can be reflected. At 0, no reflection occurs. At 1, the ray can be reflected once only. At 2, the ray can be reflected twice, and so on. Default=4.

These controls are also available on the Rendered Frame Window, as Include In Render > [Reflections and Max](#) on page 6081.



Enable Refractions When on, mental ray traces refraction. Turn off to improve performance when you don't require refraction.

- **Max. Refractions** Sets the number of times a ray can be refracted. At 0, no refraction occurs. At 1, the ray can be refracted once only. At 2, the ray can be refracted twice, and so on. Default=6.

These controls are also available on the Rendered Frame Window, as Include In Render > [Refractions and Max](#) on page 6081.

Subset Pixel Rendering group



Render changes to selected objects only When on, rendering the scene applies only to selected objects. Unlike using the [Selected](#) on page 6097 option for rendering, however, using this option takes into account all scene elements that affect its appearance. This includes shadows, reflection, direct and indirect lighting, and so on. Also, unlike Selected, which replaces the entire contents of the Rendered Frame Window (except for selected objects)

with the background color, this option replaces only pixels used by the re-rendered selected objects.

Subset pixel rendering is particularly useful when performing iterative rendering and refinement of lighting, shadows, and other scene elements for a particular object or set of objects in the scene. It lets you re-render repeatedly to view the results of isolated changes without disturbing the rest of the rendered output.

This setting is also available on the Rendered Frame Window, as [Subset Pixels \(of selected objects\)](#) on page 6081.

Ray-Trace Acceleration: Parameters for the BSP Method

Rendering menu/main toolbar > Render Setup > Render Setup dialog > Renderer panel > Rendering Algorithms rollout > Raytrace Acceleration group > Choose BSP as the Raytrace Acceleration method.

When you choose BSP as the Raytrace Acceleration method on the [Rendering Algorithms rollout](#) on page 6277, the parameters described here are displayed. BSP stands for Binary Space Partitioning.

NOTE If the scene contains too many faces (triangles) to fit in a tree of the size specified by the Size and Depth parameters, mental ray disregards the Size value and creates larger leaf nodes. This can significantly slow down rendering. To avoid this problem, increase the value of Depth.

Interface

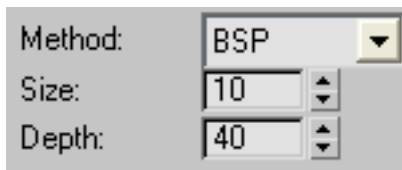

Size Sets the maximum number of faces (triangles) in the leaf of a BSP tree. Increasing the Size value reduces memory consumption but increases rendering time. Default=10.

Depth Sets the maximum number of levels in the BSP tree. Increasing the Depth value reduces rendering time, but increases memory consumption and preprocessing time. Default=40.

TIP For large scenes, increasing the Depth value to 50 or more can greatly improve rendering time.

Camera Effects Rollout (mental ray Renderer)

Rendering menu > Render Setup > Render Setup dialog > Renderer panel > Camera Effects rollout

Rendering menu/main toolbar > Render Setup > Render Setup dialog > Renderer panel > Camera Effects rollout

Note: The Camera Effects rollout appears only when the mental ray renderer is the currently active renderer.

The controls in this rollout are for the camera effects [depth of field](#) on page 6249 and [motion blur](#) on page 6248, as well as for [contour shading](#) on page 6269 and adding camera shaders.

Procedures

To use depth of field for a Camera view:

- 1 On the camera's Parameters rollout, in the Multi-Pass Effect group, turn on Enable and choose Depth Of Field (mental ray).
- 2 Set the camera's target distance to the range at which you want objects to be clearly in focus.
For a Target camera, you can select the camera's target object and move it. For a Free camera, you adjust the Target Distance on the Parameters rollout.
- 3 On the Camera's Depth Of Field rollout, decrease the f-Stop value to narrow the depth of field, or increase the f-Stop value to broaden the depth of field.
You might need to experiment with f-Stop values to get the effect you want.
- 4 Render the scene.

To use depth of field for a Perspective view:

- 1 On the Render Setup dialog, go to the Renderer panel > Camera Effects rollout, and in the Depth Of Field (Perspective Views Only) group, turn on Enable.

- 2 Set the Focus Plane distance to the range at which you want objects to be clearly in focus.
- 3 Decrease the f-Stop value to narrow the depth of field, or increase the f-Stop value to broaden the depth of field.

You might need to experiment with f-Stop values to get the effect you want. If you have trouble getting good results with f-Stop, use the drop-down list to change the method to In Focus Limits, then adjust the Near and Far values to enclose the region of the scene you want to be clearly in focus.

- 4 Render the scene.

To use motion blur:

- 1 Select each object you want to be blurred by motion, right-click and choose Properties, then on the Object Properties dialog > General panel, make sure that in the Motion Blur group, Enable is turned on and Object is chosen.

The mental ray renderer won't generate motion blur if Image is the chosen type.

- 2 On the Render Setup dialog, go to the Renderer panel > Camera Effects rollout, and in the Motion Blur group turn on Enable.

NOTE With the mental ray renderer, don't use Motion Blur as a Multi-Pass Effect.

- 3 Increase the Shutter value to increase the blurriness caused by motion blur.
- 4 On the Render Setup dialog, go to the Rendering Algorithms rollout, and make sure Ray Trace is turned on.

Motion blur is not rendered when the mental ray renderer uses scanlines only.

- 5 Render the scene.

To render with contours:

- 1 Use the mental ray Connection rollout to assign a contour shader to an object's material.

The mental ray material also lets you assign a contour shader.

- 2 On the Render Setup dialog > Renderer panel > Camera Effects rollout, in the Contours group, turn on Enable.
- 3 Change the contour output shader if you so desire.

NOTE By default, only one contour contrast and store shader are provided with 3ds Max. You can adjust the contour contrast shader's settings; the contrast store shader has no parameters.

- 4 Render the scene.

To change a contour output shader:

NOTE By default, only one contour contrast and store shader are provided with 3ds Max. You can adjust the contour contrast shader's settings; the contour store shader has no parameters.

- 1 Click the button for the Contour Output shader.
The Material/Map Browser is displayed.
- 2 Choose a contour output shader from the Browser list, and then click OK.

To assign a camera shader:

- 1 Click the button for a camera Lens, Output, or Volume shader.
The Material/Map Browser is displayed.
- 2 Choose a shader from the Browser list, and then click OK.

To adjust the settings for a contour or camera shader assigned on this rollout:



- 1  Open the Material Editor.
If you need to, arrange the open dialogs so you can see the Material Editor and the Render Setup dialog at the same time.
- 2 Drag the shader button from the Render Setup dialog to an unused sample slot in the Material Editor.
An Instance (Copy) Map dialog is displayed. *Be sure to choose Instance*, and then click OK.

If you don't choose Instance, changes you make to the shader settings in the Material Editor won't have any effect on the Render Setup dialog.

TIP If you forgot to choose Instance, change the shader settings as you choose, and then drag the shader's sample slot or its Type button back to the button in the Render Setup dialog. This updates the Render Setup dialog copy of the shader.

The Material Editor displays the shader parameters rollout.

- 3 Adjust the parameters.

Interface

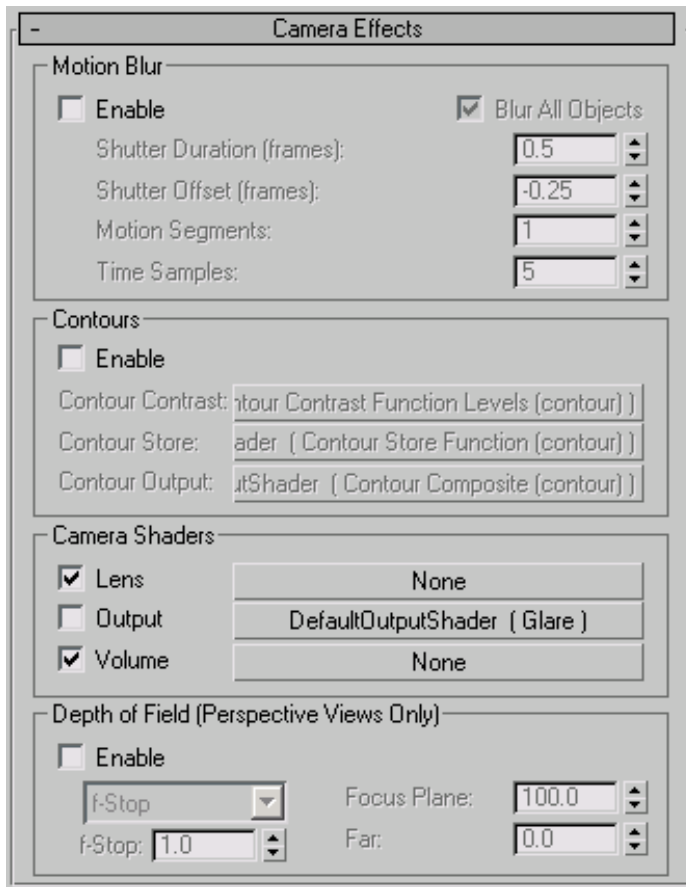

Motion Blur group

TIP mental ray motion blur is not recommended for use with particle systems, as this can increase rendering time considerably. Use a [Particle MBlur map](#) on page 5891 instead.

NOTE Motion blur with the mental ray renderer does not always follow curving trajectories. Increasing the value of Motion Segments can help, but this works better for rotary motion than for traveling motion.

The Rendering Control Properties (lower-right) quad of the rendering quad menu (Ctrl+Alt+right-click) has a Motion Blur toggle for a single, selected object. You can turn on Motion Blur for lights and cameras: moving lights and cameras can generate motion blur when rendered with mental ray.

Enable When on, the mental ray renderer calculates [motion blur](#) on page 6248. Default=off.

Blur All Objects Applies motion blur to all objects, regardless of their object property setting. Default=on.

Shutter Duration (frames) Simulates the shutter speed of a camera. At 0.0, there is no motion blurring. The greater the Shutter Duration value, the greater the blurring. Default=0.5.

Shutter Offset (frames) Sets the beginning of the motion-blur effect relative to the current frame. The default value, 0.0, centers the blurring around the current frame for a photorealistic effect. Default=-0.25.

Motion Segments Sets the number of segments for calculating motion blur. This control is for animations. If motion blur appears to be tangential to the actual motion of an object, increase the Motion Segments value. Larger values result in more accurate motion blur, at a cost of rendering time. Default=1.

Time Samples When the scene uses motion blur, controls the number of times the material is shaded during each time interval (set by [Shutter Duration](#) on page 6287). Range=0 to 100. Default=5.

By default, the material is shaded only once, and then blurred. If the material changes rapidly during the shutter interval, it might be useful to increase this value, in order to obtain more accurate motion blur. Rapid changes in reflections or refractions might require a higher Time Samples value.

NOTE When Rendering Algorithms rollout > [Use Fast Rasterizer](#) on page 6279 is on, the label for this parameter changes to Time Samples (Fast Rasterizer) to indicate that this version of Time Samples is now in effect. The default value for the Fast Rasterizer version of Time Samples is 1, and the range is 1 to 128. If you change the value for either version, the software remembers the changed setting when you switch.

Contours group

These controls enable contours, and let you use shaders to adjust the results of a contour shader. You assign the primary contour shader to the Contour component of the [mental ray Connection rollout](#) on page 5385 or a mental ray material (see [Advanced Shaders Rollout \(mental ray Material\)](#) on page 5646).

NOTE Contour shading does not work with distributed bucket rendering.

Enable When on enables rendering of contours. Default=off.

Click a button to change a shader assignment for adjusting contours. A default is already assigned to the three components, as the button labels indicate.

Contour Contrast The contour contrast component can be assigned the following shader:

Shader	Library
<i>Contour Contrast Function Levels</i>	contour

Contour Store This component stores the data on which contours are based. It can be assigned the following shader, which has no parameters to set:

Shader	Library
<i>Contour Store Function</i>	contour

Contour Output The contour output component can be assigned one of these shaders:

Shader	Library
<i>Contour Composite</i>	contour
<i>Contour Only</i>	contour

Shader	Library
<i>Contour PS (PostScript)</i>	contour

To adjust the settings for a shader assigned to one of these components, drag the shader's button to an unused Material Editor sample slot. When prompted to use an instance or a copy, *be sure to choose Instance*. (If you edit a copy of the shader, you will have to drag the sample slot back to the shader button on the Camera Effects rollout before you see any changes take effect.)

Camera Shaders group

These controls let you assign mental ray camera shaders. Click a button to assign a shader to that component. After a shader is assigned, its name appears on the button. Use the toggle on the left to temporarily disable a shader that has been assigned.

Lens Click to assign a lens shader. This component can be assigned one of these shaders:

Shader	Library
<i>Distortion</i>	lume
<i>Night</i>	lume
Shader List on page 6003 (Lens)	3ds Max
<i>Wrap Around</i>	lume

Output Click to assign a camera output shader. These are the output shaders you can assign:

Shader	Library
Glare Shader (mental ray) on page 5997 (The default.)	lume
Shader List on page 6003 (Output)	lume

Volume Click to assign a volume shader to the camera. These are the volume shaders you can assign:

Shader	Library
<i>Beam</i>	lume
Material to Shader on page 6001	3ds Max
<i>Mist</i>	lume
<i>Parti Volume</i>	physics
Shader List on page 6003 (Volume)	3ds Max
<i>Submerge</i>	lume

NOTE You can also assign Volume shaders to the Volume component of the [mental ray Connection rollout](#) on page 5385 and the mental ray material (see [Material Shaders Rollout \(mental ray Material\)](#) on page 5638).

Depth of Field (Perspective Views Only) group

These controls are comparable to the depth-of-field controls for cameras. They apply only to Perspective viewports. You can render depth-of-field effects for either Camera or Perspective views. Depth-of-field effects don't appear when you render orthographic viewports.

For a Perspective view, use the controls in this group. For a Camera view, choose "Depth Of Field (mental ray)" as the multi-pass rendering effect, then adjust the f-Stop setting. See [Depth of Field Parameter \(mental ray Renderer\)](#) on page 5229.

Enable When on, the mental ray renderer calculates [depth-of-field](#) on page 6249 effects when rendering a Perspective view. Default=off.

[**method drop-down list**] Lets you choose the method for controlling depth-of-field. Default=f-Stop.

- **f-Stop** Controls depth-of-field with the f-Stop setting.
- **In Focus Limits** Controls depth-of-field with the Near and Far values.

In most cases, the f-Stop method is easier to use. The In Focus Limits method can help when the scale of objects in the scene makes it difficult to control depth of field using the f-Stop value alone.

Focus Plane For Perspective viewports, sets the distance from the camera, in 3ds Max units, at which the scene is completely in focus. Default=100.0.

For Camera viewports, the focus plane is set by the camera's target distance.

f-Stop When f-Stop is the active method, sets the f-stop for use when you render Perspective views. Increasing the f-stop value broadens the depth of field, and decreasing the f-stop value narrows the depth of field. Default=1.0.

The f-Stop can have a value less than 1.0. This is not realistic in terms of an actual camera, but it can help you adjust the depth of field for scenes whose scale does not use realistic units.

Near and Far When In Focus Limits is the active method, these values set the range, in 3ds Max units, within which objects are in focus. Objects lose focus when they are closer than the Near value or farther than the Far value. These values are approximate, because the transition from in-focus to out-of-focus is gradual, not abrupt.

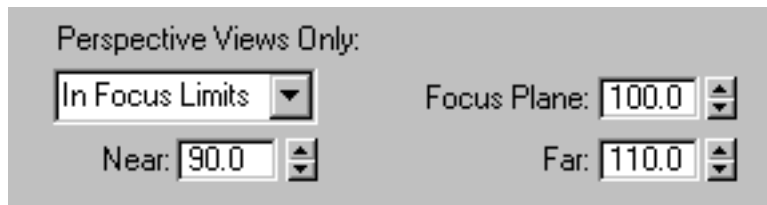

The Near and Far values are related to each other and to the value of Focus Plane. Changing the value of Near changes Far as well, and vice versa. Specifically, if

H = Hyperfocal distance, the Focus Plane value at which the Far limit becomes infinity

D = The Focus Plane distance

Dn = The Near distance

Df = The Far distance

Then

$Dn = HD / (H + D)$

$Df = HD / (H - D)$

Shadows & Displacement Rollout (mental ray Renderer)

Rendering menu/main toolbar > Render Setup > Render Setup dialog > Renderer panel > Shadows & Displacement rollout

Note: The Shadows & Displacement rollout appears only when the mental ray renderer is the currently active renderer.

The controls in this rollout affect [shadows](#) on page 6246 and [displacement](#) on page 6268.

NOTE You can disable displacement globally by turning off Displacement in the Options group on the [Common Parameters rollout](#) on page 6121.

Interface

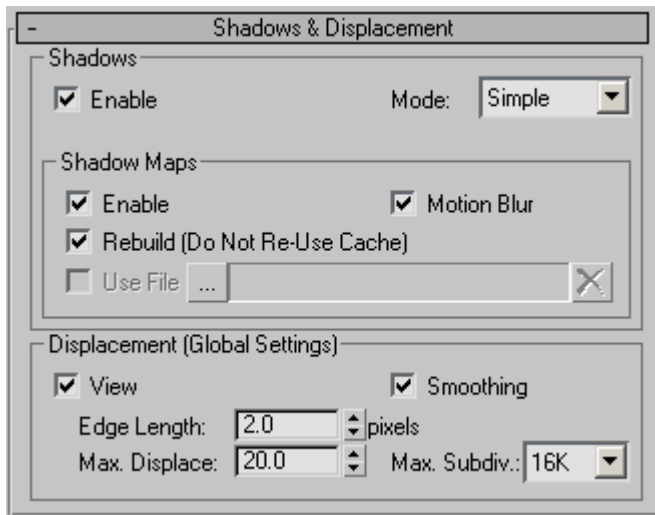

Shadows group

Enable When on, the mental ray renderer renders shadows. When off, no shadows are rendered. Default=on.

When Enable is off, the other shadow controls are unavailable.

Mode The shadow mode can be Simple, Sort, or Segments. Default=Simple.

- **Simple** Causes the mental ray renderer to call shadow shaders in a random order.
- **Sort** Causes the mental ray renderer to call shadow shaders in order, from the object to the light. Sort applies to third-party, external shadow [shaders](#) on page 8123.
- **Segments** Causes the mental ray renderer to call shadow shaders in order along the light ray from the volume shaders to the segments of the light ray between the object and the light.

TIP Choose Simple for regular shadows, Segments for volume shadows.

Shadow Maps group

These controls specify a [shadow map](#) on page 8126 used to render shadows. When you specify a shadow map file, the mental ray renderer uses the shadow map instead of ray-traced shadows.

To stop using a shadow map and use ray-traced shadows, delete the map's name from the file name field.

Enable When on, the mental ray renderer renders shadow-mapped shadows. When off, all shadows are ray-traced. Default=on.

When Enabled is off, the other controls in this group are unavailable.

If shadows are enabled but shadow maps are not enabled, then shadows for all lights are generated using the mental ray ray-tracing algorithm. If shadow maps are enabled, then shadow generation is based on each light's choice of shadow generator:

- **mental ray Shadow Map** Shadows are generated using the mental ray shadow-map algorithm.
- **Shadow Map** Settings on the Shadow Parameters rollout are translated into a mental ray equivalent before shadows are generated. The quality of shadows generated this way might not always meet expectations.
- **Area Shadows, Advanced Ray Traced Shadows, or Ray Traced Shadows** Shadows are generated using the mental ray ray-tracing algorithm.

Motion Blur When on, the mental ray renderer applies [motion blur](#) on page 6248 to shadow maps. Default=on.

WARNING Turning on Motion Blur for both cameras and shadows can cause shadows to shift position. To avoid this effect, turn on motion blur for cameras only.

Rebuild (Do Not Re-Use Cache) When on, the renderer saves the recalculated [shadow map \(.zt\) file](#) on page 8177 to the file specified by the Browse button. Default=on.

- **Use File** When on, the mental ray renderer either saves the shadow map to a ZT file, or loads an existing file. The state of Rebuild determines whether the ZT file is saved or loaded. This option is unavailable until you click the ellipsis button (see following) to provide a name for the ZT file.
- **... [browse]** Click to display a file selector dialog, which lets you specify a name for the shadow map ZT file and the folder where it is saved.
- **File name** After you specify a shadow map file (see preceding), this field displays its name and path.
-  **Delete File** Click to delete the current ZT file.

Displacement group

View Defines the space for displacement. When View is on, the Edge Length specifies the length in pixels. When off, the Edge Length is specified in world space units. Default=on.

Smoothing Turn off to have the mental ray renderer correctly render height maps. Height maps can be generated by normal mapping; see [Creating and Using Normal Bump Maps](#) on page 6384.

When using only height maps in the scene, make sure this option is off. If some objects in the scene use height maps while others use standard displacement, apply smoothing on a per-object basis (see [mental ray Panel \(Object Properties Dialog\)](#) on page 322).

When on, mental ray simply smoothes the geometry using the interpolated normals, making the geometry look better. This result, however, cannot be used for height map displacement because smoothing affects geometry in a way that is incompatible with height mapping.

Edge Length Defines the smallest potential edge length due to subdivision. The mental ray renderer stops subdividing an edge once it reaches this size. Default=2.0 pixels.

Max. Displace Controls the maximum offset, in world units, that can be given to a vertex when displacing it. This value can affect the bounding box of an object. Default=20.0.

TIP If displaced geometry appears to be “clipped,” try increasing the value of Maximum Displace.

NOTE When using placeholders (see the [Translator Options rollout](#) on page 6316), if this value is larger than it needs to be, it can reduce performance. If you experience slow times while displaced objects when Use Placeholder Objects is on, try lowering the Max. Displace value.

Max. Subdiv. Controls the extent to which mental ray can recursively subdivide each original mesh triangle for displacement. Each subdivision recursion potentially divides a single face into four smaller faces. Choose the value from the drop-down list. Range=4 to 64K (65,536). Default=16K (16,384). For example, using the default value means that mental ray can subdivide each displaced mesh triangle into as many as 16,384 smaller triangles.

Indirect Illumination Panel

Rendering menu/main toolbar > Render Setup > Render Setup dialog > Indirect Illumination panel

Note: The Processing panel appears only when mental ray is the active renderer.

The Indirect Illumination panel controls concern themselves with methods for rendering bounced light within an environment, including final gathering, caustics, and photons.

Final Gather Rollout (mental ray Renderer)

Rendering menu/main toolbar > Render Setup > Render Setup dialog > Indirect Illumination panel > Final Gather rollout

Note: The Indirect Illumination panel appears only when the mental ray renderer is the currently active renderer.

Final gathering is a technique for estimating global illumination for a given point by either sampling a number of directions over the hemisphere over that point (such a set of samples is called a *final gather point*), or by averaging a number of nearby final gather points since final gather points are too

expensive to compute for every illuminated point. In the former case, the hemisphere orientation is determined by the surface normal of the triangle on whose surface the point lies.

For diffuse scenes, final gathering often improves the quality of the global illumination solution. Without final gathering, the global illumination on a diffuse surface is computed by estimating the photon density (and energy) near that point. With final gathering, many new rays are sent out to sample the hemisphere above the point to determine the incident illumination. Some of these rays strike diffuse surfaces, and the global illumination at those points is then computed by the material shaders at these point, using illumination from the photon map, if available, and from other material properties. Other rays strike specular surfaces and do not contribute to the final gather color (since that type of light transport is a secondary caustic). Tracing many rays (each with a photon map lookup) is very time-consuming, so it is done only when necessary. In most cases, interpolation and extrapolation from previous nearby final gathers is sufficient.

Final gathering is also useful without photon tracing; this takes only first-bounce indirect light into account but often gives good results where complete physical accuracy is not required.



Interior rendered with final gathering only

Final gathering is useful in scenes with slow variation in the indirect illumination, such as purely diffuse scenes. For such scenes, final gathering eliminates photon map artifacts such as low-frequency noise and dark corners. With final gathering, fewer photons are needed in the photon map and,

because each final gather averages over many values of indirect illumination, lower accuracy is sufficient.

In film production work, final gathering increasingly replaces photon mapping, except for caustics. Without multiple-bounce effects, which are performed by photons by default and by final gathering only if the shaders adjusts the trace depth, tends to have far less impact on the final image than the first bounce that final gathering supports by default. Although physical correctness is lost, this is often sufficient for film production, and final gathering is easier to control than photons emanating from distant light sources. However, for accurate indoor illumination simulations and other CAD-related applications, photon mapping is still the method of choice.

Procedures

To use an environment map as a final gather light source:

Illumination from which final gathering is derived can be provided by an actual light source, of course, but it can also be provided by an object to which a self-illuminated material is applied, or even an environment map. In the latter case, follow this procedure:

- 1 Add a [skylight](#) on page 5065 to the scene.
- 2 Do either of the following:
 - On the Skylight Parameters rollout, make sure Sky Color (the default) is chosen, click the map button (“None”) to open the Material/Map Browser dialog and then choose a map.
 - On the Skylight Parameters rollout, choose Use Scene Environment. Use the [Environment panel](#) on page 6689 controls to assign an environment map.

Thereafter, rendering with final gather enabled take the skylight map into account when calculating final gather illumination.

TIP For extra realism, use an [HDR image](#) on page 7334 as a [Bitmap map image](#) on page 5795.

Enable Final Gather When on, the mental ray renderer uses [final gathering](#) on page 7978 to create global illumination or to improve its quality. Default=on. This setting is also available on the Rendered Frame Window, as [Final Gather](#) on page 6081.

TIP Without final gathering, global illumination can appear to be patchy. But final gathering increases rendering time. Leave Final Gather off to preview the scene, and then turn it on for the finished rendering. (Increasing the number of photons used to calculate global illumination can also improve global illumination.)

Multiplier / color swatch Use these to control the intensity and color of the indirect light accumulated by final gathering. The defaults, 1.0 and white, produce physically correct rendering.

This is useful for adjusting the contribution of the final gather effect, thus improving the quality of an image.

FG Precision Presets Provides a quick, easy solution for final gather. The default presets are: Draft, Low, Medium, High, Very High, and Custom (the default choice). Available only when Enable Final Gather is on.

The presets affect the following settings:

- Initial FG Point Density
- Rays per FG Point
- Interpolate Over Num. FG Points

The preset settings are defined in the text file *mentalray_fg_presets.ini*, found in the *\plugcfg* folder in the program installation. You can modify the existing presets and add new ones by editing this file.

This setting is also available on the Rendered Frame Window, as [Final Gather Precision](#) on page 6083.

Initial FG Point Density A multiplier for the density of final gather points. Increasing this value increases the density (and thus the quantity) of final gather points in the image. The points will therefore be closer together and more numerous. This parameter is useful for solving geometry problems; for example, near edges or corners. Default=1.0.

TIP When adjusting final render settings it's often helpful to visualize the final gather points; to do so, turn on [Diagnostics](#) on page 6324 and choose the Final Gather option.

Rays per FG Point Sets how many rays are used to compute indirect illumination in a final gather. Increasing this value makes global illumination less noisy, but also increases rendering time. Default=250.

Interpolate Over Num. FG Points Controls the number of final gather points that are used for an image sample. It is useful for solving noise problems and getting smoother results.

For each final gather point, mental ray interpolates (averages) indirect light values over the nearest N final gather points, with N specified by the value of this parameter, as opposed to points within the specified radii as with the [alternate method](#) on page 6305. Increasing the value increases the smoothness of the result, and the required number of calculations, hence the render time (but not as much as you might expect).

This setting is unavailable when [Use Radius Interpolation Method](#) on page 6305 is enabled.

Diffuse Bounces Sets the number of times mental ray calculates diffuse light bounces for each diffuse ray. Default=0.

Like Maximum Reflections and Maximum Refractions, this value is subject to the restriction of Max Depth. If you set Diffuse Bounces higher than Max Depth, the latter setting is automatically raised to the Diffuse Bounces value in the MI output file, but this is not reflected in the 3ds Max interface.

This setting is also available on the Rendered Frame Window, as [Bounces](#) on page ?.

NOTE When [Global Illumination](#) on page 6310 is on, changing this setting has no effect.

Weight Controls the relative contribution of the diffuse bounces to the final gather solution. The value scales from "using no diffuse bounces" (value=0.0) to "use full diffuse bounces" (value=1.0). Default=1.0.

Final Gather Map group

These controls tell mental ray how to calculate the final gather map for indirect illumination. The map uses the [FGM file format](#) on page 7971.

Read/Write File When on, the mental ray renderer saves the final gather map to the specified FGM file, if it doesn't already exist. If the file exists, mental ray loads it and uses the map data it contains instead of generating a new one.

This setting is available on the Rendered Frame Window as Reuse > [Final Gather](#) on page 6083.



Read Only (FG Freeze) Determines whether or not mental ray uses the final gather map file as is. When off, mental ray can add new final gather points if necessary. When on, mental ray uses only the data in the specified file, and does not generate any new final gather points during the pre-processing stage. It can still generate new final gather points while rendering when using the radius method. Available only when you've specified an FGM file. Default=off.

This setting is available on the Rendered Frame Window as Reuse > [Lock Final Gather](#) on page 6083.

... **[Browse]** Click to display a file selector dialog, which lets you specify a name for the final gather map (FGM) file, and the folder where it is saved.

[file name] After you specify a final gather map file using the browse control (see preceding), the name field displays its name and path.

This field can also be filled automatically with the default path and the file name *temp.fgm* by turning on the Rendered Frame Window > Reuse group > [Final Gather](#) on page 6083 check box.



Delete File Click to delete the current FGM file.



Generate Final Gather Map Now Processes the final gather pass for all animation frames (as specified in the Common Parameters rollout > [Time Output group](#) on page 6124). Generates the maps to the specified file without rendering the scene. To reduce flicker when rendering an animation with a networked render farm, use this function first to generate the final gather solution for all frames, and then turn on Read Only (FG Freeze) before rendering.

Advanced group

Noise Filtering (Speckle Reduction) Applies a median filter using neighboring final gather rays that are shot from the same point. This parameter lets you choose a value from a drop-down list. The options are None, Standard, High, Very High, and Extremely High. Default=Standard.

The practical effect of increasing the Noise Filtering value is to make the scene illumination smoother, at a cost of render time. However, increasing filtering can also make the illumination somewhat darker.

Noise Filtering works by eliminating stray rays that are considerably brighter than most of the rest. For example, in a situation in which most of the rays

are within 10 percent of each others' brightness, but a few are 50 percent brighter than the rest, using Noise Filtering will tend to disregard the latter rays in computing the Final Gather solution.

As a result, in low-light situations, setting Noise Filtering=None can greatly increase the overall illumination. In the following rendered image, an interior scene, lit only by skylight entering through the window, is very dark with Noise Filtering set to Standard (Diffuse Bounces=1).

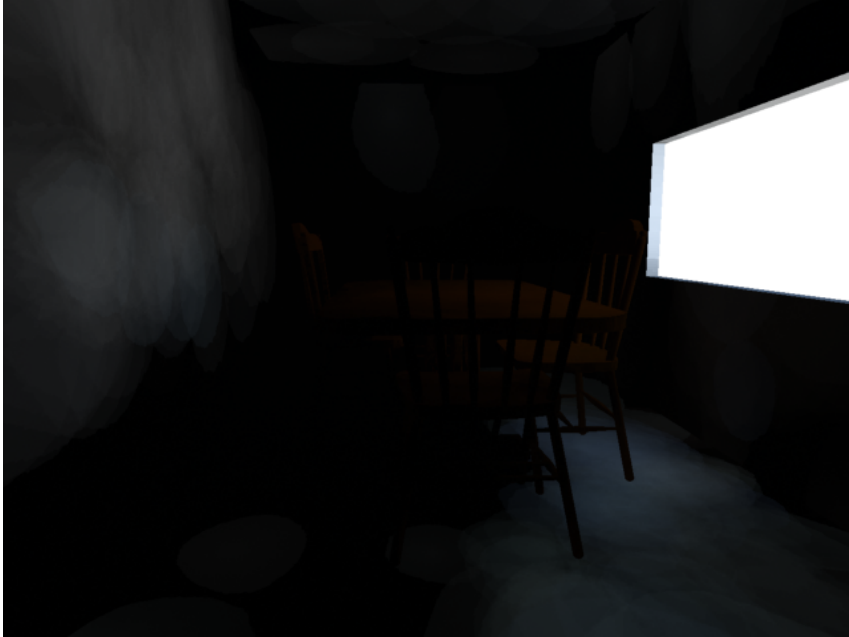

Noise Filtering=Standard

In the next illustration, the same scene renders much brighter with Noise Filtering set to None. Note, however, the unevenness of the illumination.



Noise Filtering=None

In cases like this, you can achieve superior results with slightly longer rendering times by setting Noise Filtering to Standard and using a [sky portal](#) on page 5186 in the window opening, as shown in the following illustration:



Noise Filtering=Standard + Sky Portal

The above illustration is also improved by the realistic shadows cast by the chair and table legs from the Sky Portal light.

Draft Mode (No Precalculations) When on, final gathering skips the precalculation phase. This results in a rendering with artifacts, but begins rendering more quickly, so it can be useful when you want to do a series of trial renderings. Default=off.

Trace Depth group

The Trace Depth controls are similar to those for calculating reflections and refractions, but they refer to the light rays used by final gathering, rather than to rays used in diffuse reflection and refraction.

Max. Depth Limits the combination of reflection and refraction. Reflection and refraction of a light ray stop when the total number of both equals the Maximum Depth setting. For example, if Maximum Depth equals 3 and the trace depths each equal 2, a ray can be reflected twice and refracted once, or vice versa, but it can't be reflected and refracted four times. Default=2.

Max. Reflections Sets the number of times a ray can be reflected. At 0, no reflection occurs. At 1, the ray can be reflected once only. At 2, the ray can be reflected twice, and so on. Default=5.

Max. Refractions Sets the number of times a ray can be refracted. At 0, no refraction occurs. At 1, the ray can be refracted once only. At 2, the ray can be refracted twice, and so on. Default=5.

Use Falloff (Limits Ray Distance) When on, uses the Start and Stop values to limit the length of light rays used for regathering before using the environment color. This can help improve regathering time, especially for scenes that are not fully enclosed by geometry. Default=off.

- **Start** Specifies the distance, in 3ds Max units, at which rays begin. You can use this value to exclude geometry that is too close to the light source. Default=0.0.
- **Stop** Specifies the maximum length, in 3ds Max units, of a light ray. If the ray reaches this limit without encountering a surface, then the environment is used for shading. Default=0.0.

FG Point Interpolation group

These settings provide access to the legacy method of final gather point interpolation.

Use Radius Interpolation Method When on, makes the remaining controls in this group available. Also makes the [Interpolate Over Num. FG Points checkbox](#) on page 6300 unavailable, indicating that these controls override that setting.

Radius When on, sets the maximum radius within which final gathering is applied. Reducing this value can improve quality at a cost of rendering time. If Radii In Pixels is off, the radius is specified in world units, and defaults to 10 percent of the maximum circumference of the scene. If Radii In Pixels is on, default=5.0 pixels.

If both Radii In Pixels and Radius are off, the maximum radius is the default value of 10 percent of the maximum scene radius, in world units.

Radii in Pixels When on, the radii values are specified in pixels. When off, radii units depend on the value of the Radius toggle. Default=off.

Min. Radius When on, sets the minimum radius within which final gathering must be used. Decreasing this value can improve render quality but increase rendering time. Unavailable unless Radius is turned on. Default=0.0. If Radii In Pixels is on, default=0.5.

TIP In general, increasing the [point density](#) on page 6299 is better than decreasing Min. Radius.

TIP To minimize flickering in animations, keep the two Radius values as close to each other as possible.

Caustics and Global Illumination Rollout (mental ray Renderer)

Rendering menu/main toolbar > Render Setup > Render Setup dialog > Indirect Illumination panel > Caustics and Global Illumination rollout

Note: The Indirect Illumination panel appears only when the mental ray renderer is the active renderer.

The controls in this rollout are for the effects of [caustics](#) on page 6255 and [global illumination](#) on page 6261.

Procedures

To render with caustics:

- 1 Select each object you want to generate caustics, either by reflection or refraction. Right-click and choose Properties, then on the mental ray panel of the Object Properties dialog, turn on Generate Caustics.
Objects receive caustics by default. If you think this value might have changed for the objects you want to receive caustics, use those objects' Object Properties dialog to make sure Receive Caustics is turned on. Also, to speed rendering time, you might want to turn off Receive Caustics for those objects that don't need to show them.
- 2 On the Render Setup dialog, go to the Caustics And Global Illumination rollout and turn on Caustics.
- 3 Adjust the caustics parameters to get the effect you want.
- 4 Render the scene.

To render with global illumination:

Objects generate and receive global illumination by default. If you think these settings might have changed for any objects in the scene, use the Object Properties dialog to make sure the proper settings are enabled.

- 1 Select each object you want to generate and/or receive global illumination. Right-click and choose Properties, then on the mental ray panel of the Object Properties dialog, turn on Generate Global Illumination and/or Receive Global Illumination. Also, to speed rendering time, you might want to turn off Receive Global Illumination for those objects that don't need it.
- 2 On the Render Setup dialog, go to the Indirect Illumination panel > Caustics And Global Illumination rollout > Global Illumination (GI) group and turn on Enable.
- 3 Adjust the global illumination parameters to get the effect you want.
- 4 For the final rendering, turn on Final Gather as well as Global Illumination. See [Final Gather Rollout \(mental ray Renderer\)](#) on page 6295.
- 5 Render the scene.

Interface

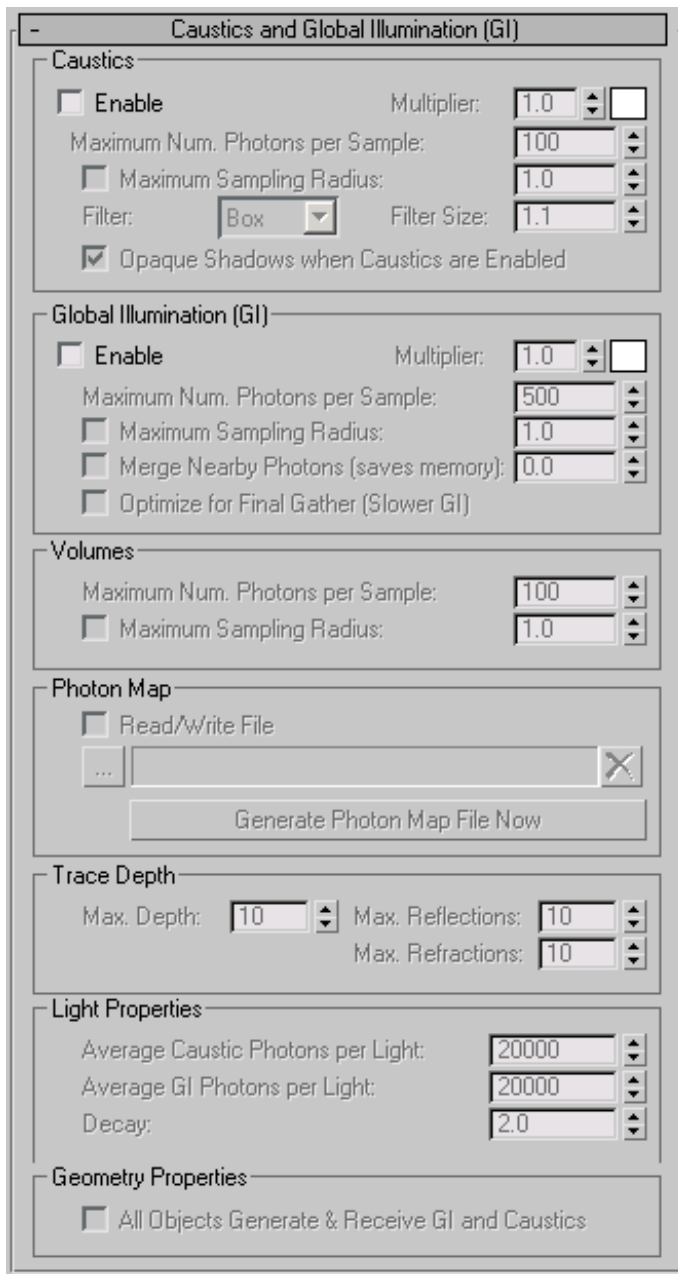

Caustics group

IMPORTANT For caustics to render, you must also make sure to set up these other conditions in your scene:

- At least one object must be set to generate caustics. This is off by default.
- At least one object must be set to receive caustics. This is on by default.
- At least one light must be set to generate caustics. This is off by default.

The settings for generating and receiving caustics are located on the Object Properties dialog > [mental ray Panel](#) on page 322.

Enable When on, the mental ray renderer calculates caustics effects.
Default=off.

Multiplier/color swatch Use these to control the intensity and color of the indirect light accumulated by caustics. The defaults, 1.0 and white, produce physically correct rendering.

This is useful for adjusting the contribution of the caustics effect, thus improving the quality of an image.

Maximum Num. Photons per Sample Sets how many photons are used to compute the intensity of the caustic. Increasing this value makes caustics less noisy but also more blurry. Decreasing this value makes caustics more noisy but less blurry. The larger the Samples value, the greater the rendering time.
Default=100.

TIP To preview a caustic, set Samples to 20, then increase the value for a final rendering.

Maximum Sampling Radius When on, the spinner value sets the size of photons. When off, each photon is calculated to be 1/100 of the radius of the full scene. Maximum Sampling Radius default=off; value default=1.0.

In many cases, the default photon size (Radius=off) of 1/100 the scene size gives useful results. In other cases, the default photon size might be too large or too small.

When photon reflections overlap, the mental ray renderer uses sampling to smooth them together. Increasing the number of samples increases the amount of smoothing and can create more natural-looking caustics. When photons have a small radius and don't overlap, the Samples setting has no effect. Low Radius values with a large number of photons result in dotted caustics.

Filter Sets the filter to use for sharpening caustics. Can equal Box, Cone, or Gauss. The Box option requires less rendering time. The Cone option makes caustics appear sharper. Default=Box.

The Gauss filter uses a Gauss (bell) curve, and can be smoother than the Cone filter.

Filter Size Controls the sharpness of caustics when you choose Cone as the caustic filter. This value must be greater than 1.0. Increasing the value makes caustics more blurry. Decreasing the value makes caustics sharper, but also slightly more noisy. Default=1.1.

Opaque Shadows when Caustics Are Enabled When on, shadows are opaque. When off, shadows can be partially transparent. Default=on.

Opaque shadows render more quickly than transparent shadows.

Global Illumination (GI) group

These settings let you control the usage of photons by mental ray for generating [global illumination](#) on page 6261. By default, all objects generate and receive global illumination. The settings for generating and receiving GI are located on the Object Properties dialog > [mental ray Panel](#) on page 322.

NOTE In order to render global illumination in mental ray, the photons must be able to bounce among two or more surfaces. This can be accomplished by having a single object with some concavity in its surface that's exposed to the light source, or at least two objects, and at least one object must be set to receive global illumination (see [mental ray Panel \(Object Properties Dialog\)](#) on page 322). Otherwise you'll receive error messages and no photons will be stored.

Enable When on, the mental ray renderer calculates global illumination. Default=off.

Multiplier/color swatch Use these to control the intensity and color of the indirect light accumulated by global illumination. The defaults, 1.0 and white, produce physically correct rendering.

This is useful for adjusting the contribution of the GI effect, thus improving the quality of an image.

Maximum Num. Photons per Sample Sets how many photons are used to compute the intensity of the global illumination. Increasing this value makes global illumination less noisy but also more blurry. Decreasing this value makes global illumination more noisy but less blurry. The larger the Samples value, the greater the rendering time. Default=500.

TIP To preview global illumination, set Samples to 100, then increase the value for a final rendering.

Maximum Sampling Radius When on, the numeric value sets the size of photons. When off, each photon is calculated to be 1/10 of the radius of the full scene. Default=off, 1.0.

In many cases, the default photon size (Maximum Sampling Radius=off) of one-tenth the scene size gives useful results. In other cases, the default photon size might be too large or too small.

When photons overlap, the mental ray renderer uses sampling to smooth them together. Increasing the number of samples increases the amount of smoothing and can create more natural-looking caustics. When photons have a small radius and don't overlap, the Samples setting has no effect. For global illumination, photons should overlap. To get good results, you might need to turn on Maximum Sampling Radius and increase the photon size.

Merge Nearby Photons (saves memory) Enables reduction of the memory footprint of the photon map. When on, use the numeric field to specify the distance threshold below which mental ray merges photons. The result is a smoother, less-detailed photon map that uses significantly less memory. Default=off, 0.0.

NOTE Loading a legacy file uses the default value of 0.0. Also, using a value of 0.0 is equivalent to turning the feature off.

Optimize for Final Gather (Slower GI) If turned on before you render the scene, the mental ray renderer computes information to speed up the regathering process. Specifically, each photon stores additional information about how bright its neighbors are. This is particularly useful when combining Final Gather with Global Illumination, in which case the additional information allows Final Gather to quickly determine how many photons exist in a region. The fast lookup computation can take a long time, but it can greatly reduce the total rendering time. Default=off.

The fast lookup computation can be stored as additional data inside a [photon map file](#) on page 8093, and then reused in subsequent renderings.

Volumes group

The controls in this group and the ones that follow are for the [photon maps](#) on page 8090 used to calculate caustics and global illumination. This group controls volumetric caustics. Volumetric caustics require a material to have a volume shader assign to its Photon Volume component.

Maximum Num. Photons per Sample Sets how many photons are used to shade the volume. Default=100.

Maximum Sampling Radius When on, the numeric setting determines the size of photons. When off, mental ray calculates each photon to be one-tenth the size of the [scene extents](#) on page 8117. Default: off; value=1.0.

The numeric setting is unavailable when the check box is off.

Photon Map group

These controls tell mental ray how to calculate the photon map for indirect illumination.

NOTE If you've specified a photon map here, mental ray continues to use that map instead of generating a new one. To cause the photon map file to be rebuilt, delete the existing file.

Read/Write File When on, if the specified photon map ([PMAP](#) on page 8093) file does not yet exist, mental ray generates a new map file when rendering. If the specified file does exist, mental ray loads and uses the file.

This option becomes available after you click Browse (“...”) and provide a name for the PMAP file.

... **[browse]** Click to display a file selector dialog, which lets you specify a name and path for the photon map (PMAP) file. This automatically turns on Read/Write File.

[file name] When you have used the [...] button to specify a photon map file, this field displays its name and path.



Delete File Click to delete the current PMAP file.



Generate Photon Map Now Processes the photon-mapping pass for all animation frames (as specified in the Common Parameters rollout > [Time Output group](#) on page 6124). Generates the photon maps to the specified file without rendering the scene. To reduce flicker when rendering an animation with a networked render farm, use this function first to generate the GI solution for all frames, and then make sure Read/Write File (see preceding) is on before rendering.

Trace Depth group

The Trace Depth controls are similar to those for calculating reflections and refractions, but they refer to the photons used by caustics and global illumination, rather than to rays used in diffuse reflection and refraction.

Max. Depth Limits the combination of reflection and refraction. Reflection and refraction of a photon stop when the total number of both equals the Maximum Depth setting. For example, if Maximum Depth equals 3 and the trace depths each equal 2, a photon can be reflected twice and refracted once, or vice versa, but it can't be reflected and refracted four times. Default=10.

Max. Reflections Sets the number of times a photon can be reflected. At 0, no reflection occurs. At 1, the photon can be reflected once only. At 2, the photon can be reflected twice, and so on. Default=10.

Max. Refractions Sets the number of times a photon can be refracted. At 0, no refraction occurs. At 1, the photon can be refracted once only. At 2, the photon can be refracted twice, and so on. Default=10.

Light Properties group

Controls in this group affect how lights behave when calculating indirect illumination. By default, the energy and photon settings apply to all lights in a scene. Use the [mental ray Indirect Illumination rollout](#) on page 5112 for light objects to adjust an individual light either by multiplying the global values, or by setting local values (using multipliers is the recommended method).

Average Caustic Photons per Light Sets the number of photons emitted by each light for use in caustics. This is the number of photons in the [photon map](#) on page 8090 used for caustics. Increasing this value increases the accuracy of caustics, but also increases the amount of memory used and the length of render time. Decreasing this value improves memory usage and render time, and can be useful for previewing caustic effects. Default=10000.

Average GI Photons per Light Sets the number of photons emitted by each light for use in global illumination. This is the number of photons in the photon map used for global illumination. Increasing this value increases the accuracy of global illumination, but also increases the amount of memory used and the length of render time. Decreasing this value improves memory usage and render time, and can be useful for previewing global-illumination effects. Default=10000.

Decay Specifies how photon energy decays as it moves away from each light source. This value is given by $1/(distance^{decay})$, where *distance* is the distance

between the light source and an object, and *decay* is the value of this setting. Default=2.0.

The most common values are:

- **0.0** The energy doesn't decay, and photons can provide indirect illumination throughout the scene.
- **1.0** The energy decays at a linear rate, proportionally to its distance from the light. That is, a photon's energy is $1/distance$, where *distance* is the distance from the light source.
- **2.0** (The default.) The energy decays at an inverse square rate. That is, a photon's energy is the inverse of the square of the distance from the light source: $1/distance^2$.

In the real world, light decays at an inverse square rate (Decay=2.0), but this gives strictly realistic results only if you provide a realistic value for the energy of the light. Other values of Decay can help you adjust indirect illumination without worrying about physical accuracy.

NOTE Decay values of less than 1.0 are not recommended, and can cause rendering artifacts.

Geometry Properties group

All Objects Generate & Receive GI and Caustics When on, at rendering time, all objects in the scene can generate and receive caustics and global illumination, regardless of their local object properties settings. When off, an object's local object properties determine whether it generates or receives caustics or global illumination. Turning this on is an easy way to ensure that caustics and global illumination are generated, though it can increase rendering time. Default=off.

This setting does not alter the object's local object properties settings for mental ray. When you turn off All Objects Generate & Receive GI And Caustics, the prior object properties settings are in effect once again.

Processing Panel

Rendering menu/main toolbar > Render Setup > Render Setup dialog > Processing panel

Note: The Processing panel appears only when mental ray is the active renderer.

The Processing panel is an additional [Render Setup dialog](#) on page 6067 panel whose controls relate to managing how the renderer operates. It also lets you generate diagnostic renderings in pseudo color.

Interface

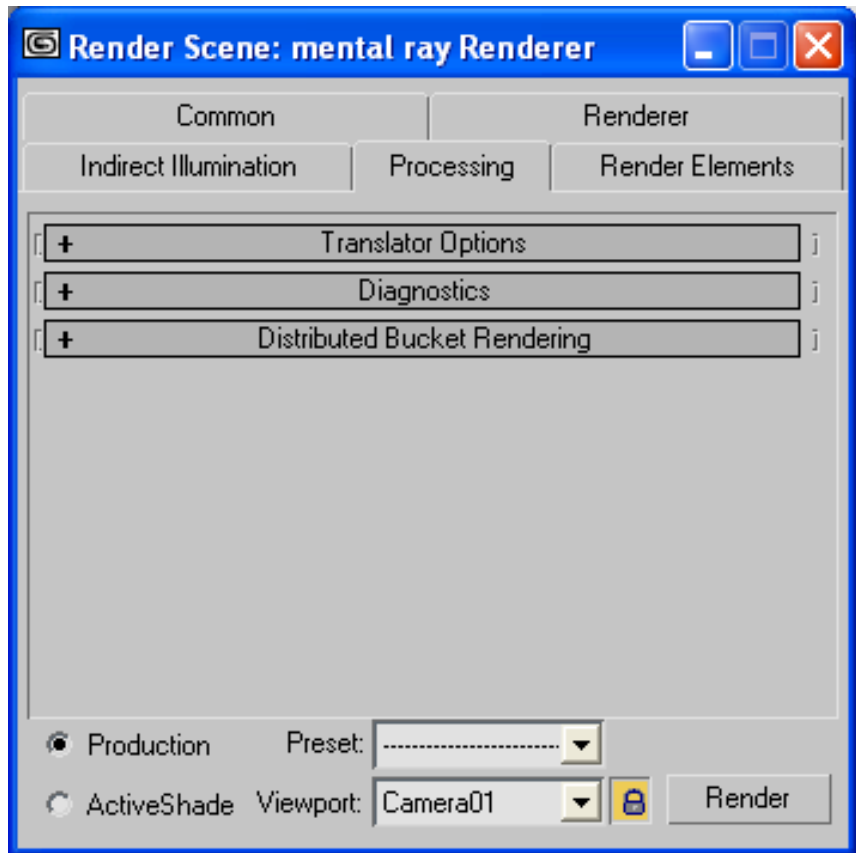

The Processing panel contains three rollouts:

[Translator Options Rollout \(mental ray Renderer\)](#) on page 6316

[Diagnostics Rollout \(mental ray Renderer\)](#) on page 6324

[Distributed Bucket Rendering Rollout \(mental ray Renderer\)](#) on page 6326

Translator Options Rollout (mental ray Renderer)

Rendering menu/main toolbar > Render Setup > Render Setup dialog > Processing panel > Translator Options rollout

Note: The Processing panel appears only when the mental ray renderer is the currently active renderer.

Controls in this rollout affect the operation of the mental ray renderer with respect to translation of the scene to the format the renderer requires. They also let you save the translated scene to an [MI file](#) on page 8044, which you can then use with a standalone renderer. The translated output uses the mental ray version 3 (mi3) format. The translator does not support mental ray version 1 (mi1).

See also:

- [Distributed Bucket Rendering Rollout \(mental ray Renderer\)](#) on page 6326

Procedures

To save the mental ray renderer settings:

- When you have a set of rendering settings you want to keep, go to the Render Setup dialog and open the Preset drop-down list at the bottom. Choose Save Preset (at the bottom of the list), enter a file name, and click Save. Next, use the Select Preset Categories dialog to highlight the parameter categories to store in the preset and click Save. Thereafter you can choose your custom setup from the Preset drop-down list.

To create a rendering from multiple passes:

- 1 Use the [Render Type](#) on page 6095 > Selected option to choose only a portion of the scene to render.
- 2 On the Translator Options rollout, in the Render Passes group, click the ellipsis [...] button next to Save.
- 3 A Save As dialog is displayed. Use it to enter a name and location for the PASS file.
- 4 Click Render.
The partial rendering is saved in the PASS file you specified.

- 5 Repeat steps 1 through 4 until you have generated all the passes for the rendering (or all the passes but the last).

WARNING If your scene includes an environment, render it only in the final pass. Rendering the environment in multiple passes is time consuming, and can lead to artifacts such as unwanted color changes to the background. Render all passes but the last one using a default black background.

- 6 In the Render Passes group, click Add to add the various pass files to the list.

- 7 Turn on Merge.

At this point, you might also want to turn off Save, unless you want the final result to be saved as a PASS file as well as a rendering.

- 8 Click Render.

The rendering consists of all the passes merged into one.

TIP For some purposes, you might want to create the passes, then create a new 3ds Max scene with no objects, set the rendering resolution to match the passes, you created, then merge the passes as described in steps 7 and 8 above.

Interface

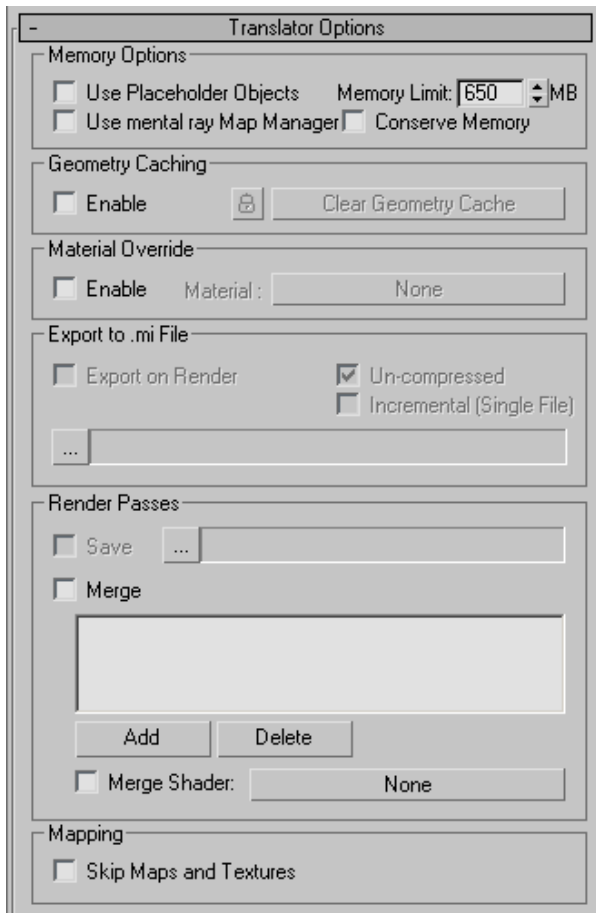

Memory Options group

Use Placeholder Objects When on, 3ds Max sends geometry to the mental ray renderer only on demand. Initially, the mental ray scene database is populated only with the size (bounding box) and position of objects in the 3ds Max scene. When the mental ray renderer renders a bucket that contains an object, the object's geometry is sent to the rendering engine only at that point. Default=off.

This option can improve rendering speed when a large amount of the scene's geometry is outside of the view you are rendering.

TIP When you use placeholders, 3ds Max *always* [calculates buckets in Hilbert order](#) on page 6276.

When the mental ray renderer is low on memory (as defined by the Memory Limit setting), Use Placeholder Objects enables it to increase available memory by deleting object geometry from the scene database. This can dramatically reduce memory usage, but with a possible cost in rendering speed.

Memory Limit The mental ray renderer keeps a count of the memory it uses at render time. If it reaches the specified memory limit and Use Placeholder Objects (see preceding) is on, 3ds Max discards the geometry for some objects in order to allocate memory for other objects. If Use Placeholder Objects is off, or if after deleting geometry more memory is still needed, the renderer releases texture-map memory as well. Default=650 MB.

TIP If you'd like to use a different Memory Limit setting on a regular basis without having to change the value manually every time, store the value in a [rendering preset](#) on page 6114 and then be sure to load that preset before rendering.

Use mental ray Map Manager When on, maps are read from disk and if necessary, translated to a format that the mental ray renderer can read. When off, maps are accessed directly from memory, and translation is unnecessary. Default=off.

Following is a complete list of differences between turning this option on and off:

When on:

- mental ray reads textures directly from disk (mental ray is able to flush textures out of memory when memory is low). Also, textures are loaded only if needed.
- mental ray uses its built-in pyramid filtering system. These pyramid lookup tables can be flushed out of memory when memory is low.
- Texture formats not supported directly by mental ray are read by 3ds Max and sent, before rendering begins, as binary data to mental ray.

When off:

- 3ds Max reads the textures from disk, and then sends individual pixel colors to mental ray as they are needed.

NOTE 3ds Max reads the textures from disk and keeps them stored in memory between renders. This can make renders faster, because the bitmaps don't need to be reloaded every time. 3ds Max will not read the texture from disk if it was already loaded previously (for example, in a previous render, for a Material Editor preview, or for displaying the map in a viewport).

- Rendering uses a pyramid filter shader that is identical to the standard 3ds Max pyramid filter system.

Turning this option on is useful for large scenes that take a lot of memory to render. Turning it off is quicker, because textures already loaded in memory don't have to be reloaded by mental ray. But turning it off might use more memory and doesn't allow for flushing when memory is low, unless you use the 3ds Max [bitmap pager](#) on page 7768.

NOTE Turning the option on and off might result in very small differences between rendered images because of the different algorithms used in the mental ray map manager and the 3ds Max map manager.

You *must* turn on “Use mental ray Map Manager” when performing these actions:

- Using distributed bucket rendering.
See [Distributed Bucket Rendering Rollout \(mental ray Renderer\)](#) on page 6326.

When rendered with distributed bucket rendering and the mental ray map manager, images with textures can look different than when rendered with 3ds Max alone, because the filtering technique is different.

- Exporting to an MI file.
See below.

Conserve Memory Tells the translator to be as memory efficient as it can. This can slow down the translation process, but reduces the amount of data being sent to the mental ray renderer. Default=off.

This option is useful when you are trying to render a huge scene and time is not necessarily an issue. When you render to an MI file, this option can also help reduce the size of the output file.

When on, this toggle also tells the mental ray renderer to save frames as temporary *.map* files. This allows you to render extremely large frames without running out of random-access memory.

The location of the temporary map files is chosen in the following order:

- 1 If the file `\[program folder]\mentalray\rayrc` contains a registry entry called `_MI_REG_FBDIR`, the renderer uses this directory.

The entry should have the form

```
registry "{_MI_REG_FBDIR}" value "<path>" end registry
```

where `<path>` is the directory you want to use.

- 2 If the `rayrc` file has no registry entry, the renderer uses the directory specified by the `TMPDIR` environment variable.
- 3 If there is no `TMPDIR` environment variable, the renderer uses the directory specified by the `TEMP` environment variable.



Geometry Caching group

Geometry caching lets you save the translated scene contents to a temporary file for reuse in subsequent renders. This can save time by omitting the translation step, especially with geometry-heavy scenes. Two levels of caching are available: standard and locked.

Enable When on, rendering uses geometry caching. During the first render, the translated geometry is saved to the cache file. Then, in subsequent renderings of the same scene, the renderer uses the cached geometry for any unchanged objects instead of retranslating it. Any changed geometry is retranslated. Default=off.

This control is available on the Rendered Frame Window lower panel as Reuse > [Geometry](#) on page 6082.



Lock Geometry Translation When on, sub-object-level changes such as vertex editing or adjusting a modifier such as Bend are ignored and don't cause retranslation. However, object-level changes such as moving or rotating an object are retranslated.

This control is available on the Rendered Frame Window lower panel as Reuse

> [Lock Geometry Translation](#) on page 6082 ( button).

Clear Geometry Cache Deletes the cached geometry.

This control is available on the Rendered Frame Window lower panel as Reuse > [Clear Geometry Cache](#) on page 6083.

Material Override group

Material Override allows you to render a scene with all its materials replaced by a single master material. For example, if you need to do a wireframe pass, you can create a Wire material and then specify it here. When you render, *all* surfaces will use the Wire material.

Enable When on, rendering uses the override material for all surfaces. When off, surfaces are rendered with the material applied to them in the scene. Default=off.

Material Click to display the [Material/Map Browser](#) on page 5290 and choose a material to use as the override. Once you have chosen an override material, this button displays the material name.

Export to .mi File group

These controls let you save the translated scene in a mental ray [MI file](#) on page 8044. Before exporting, you must specify an export file by clicking the ellipsis [...] button.

NOTE Exporting to an MI file is not available when you [render to texture](#) on page 6371.

Export on Render When on, saves the translated file to an MI file *instead of rendering* when you click Render. Available only after you have clicked the ellipsis [...] button to specify an MI file. Default=off.

Un-compressed When on, the MI file is not compressed. When off, the file is saved in a compressed format. Default=on.

Incremental (Single File) When on, exports an animation as a single MI file that contains a definition of the first frame and descriptors of the incremental changes from frame to frame. When off, exports each frame as a separate MI file. Default=off.

When you export an animation, turning on Incremental can save a considerable amount of disk space.

- ... **[browse]** Click to display a file selector dialog, which lets you specify a name for the MI file, and the folder where it is saved.
- **File name** After you've used the ellipsis [...] button to specify an MI file, this field displays its name and path.

Render Passes group

Controls in this group let you create a rendering out of multiple passes that render portions a scene. This can be a useful way to render large scenes or scenes that have complex effects. It can also be a way to divide the labor on a composited (“merged”) rendering. See the “Procedures” section, above, for more information.

NOTE You cannot render to passes when you [render to texture](#) on page 6371.

Save When on, saves the image currently being rendered (prior to merging) inside the specified PASS file.

- **... [browse]** Click to display a file selector dialog, which lets you specify a name for the PASS file and the folder where it is saved.
- **File name** After you have specified a PASS file, the name field displays its name and path.

If you are rendering a time segment (that is, an animation), the PASS files are created with sequence numbers appended to the main file name (for example, *test0000.pass*, *test0001.pass*, and so on).

Merge When on, the PASS files specified in the list will be merged into the final rendering.

- **List of PASS files** Lists the PASS files that will be merged into the final rendering (possibly including the pass that is currently being rendered and saved).
- **Add** Click to add a PASS file to the list.
If you choose a PASS file with a sequence number appended to its name, 3ds Max asks if you want to use the individual file or the entire sequence.
- **Delete** Click to delete the highlighted PASS file from the list.

Merge Shader Lets you choose the shader used to merge the PASS files. Clicking the shader button displays a Material/Map Browser so you can choose the shader (when a shader is chosen, its name appears on the button). When the toggle is on, this shader is used for merging.

IMPORTANT No merge shaders are provided with 3ds Max. This option is provided for users who plan to write a custom merge shader appropriate to their particular compositing project.

Mapping group

Skip Maps and Textures When on, rendering ignores maps and textures, including projection maps, and uses only surface colors (diffuse, specular, and so on). Default=off.

Turning off maps can be useful, and save time, when you are adjusting global illumination.

Diagnostics Rollout (mental ray Renderer)

Rendering menu/main toolbar > Render Setup > Render Setup dialog > Processing panel > Diagnostics rollout

Note: The Processing panel appears only when the mental ray renderer is the currently active renderer.

The tools on the Diagnostics rollout can help you understand why the mental ray renderer is behaving in a certain way. The Sampling Rate tool, in particular, can help explain the renderer's performance.

Each of these tools generates a rendering that is not a photorealistic view, but a schematic representation of the functionality you have chosen to analyze.

Interface

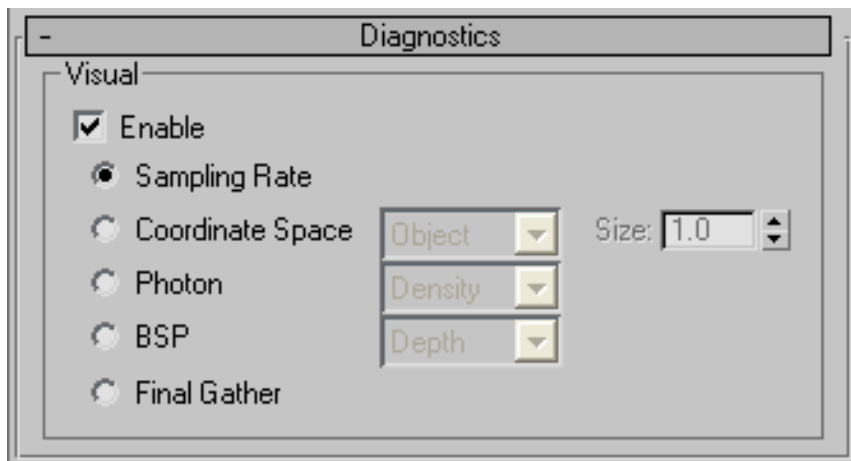

Enable When on, the renderer renders the graphic representation for the tool you have chosen.

Sampling Rate When chosen, renders an image that shows where samples were collected during rendering; see [Sampling \(mental ray Renderer\)](#) on page 8112. This can help you adjust the contrast and other sampling parameters.

Coordinate Space Renders an image that shows the coordinate space of objects, the world, or camera.

- **Object** Shows local coordinates (UVW). Each object has its own coordinate space.
- **World** Shows world coordinates (XYZ). The same coordinate system applies to all objects.
- **Camera** Shows camera coordinates, which appear as a rectangular grid superimposed on the view.

Size Sets the size of the grid. Default=1.0.

TIP To avoid busy moiré patterns in the grid, increase the value of Size.

Photon Renders the effect of a photon map in the screen. This requires that a photon map be present (to render caustics or global illumination). If no photon map is present, the Photon rendering looks just like the nondiagnostic rendering of the scene: the mental ray renderer first renders the shaded scene, then replaces it with the pseudocolor image.

- **Density** Renders the photon map as it is projected into the scene. High density is displayed in red, and lower values render in increasingly cooler colors.
- **Irradiance** Similar to the Density rendering, but shades the photons based on their irradiance. The maximum irradiance is rendered in red, and lower values render in increasingly cooler colors.

BSP Renders a visualization of the parameters used by the tree in the [BSP ray-trace acceleration method](#) on page 6282. If a message from the renderer reports excessively large depth or size values, or if rendering seems unusually slow, this can help you locate the problem.

- **Depth** Shows the depth of the tree, with top faces in bright red, and increasingly deep faces in increasingly cool colors.
- **Size** Shows the size of leaves in the tree, with differently sized leaves indicated by different colors.

NOTE The BSP diagnostic works with the BSP method only; the BSP2 method does not support it.

Final Gather Renders the scene with pre-processing final-gather points displayed as green dots, and tile-rendering (final render) final-gather points displayed as red dots.

For animation purposes, the presence of red dots is undesirable. To resolve this, use the [Interpolate Over Num. FG Points setting](#) on page 6300 instead of the [Radius Interpolation Method](#) on page 6305, or, if you prefer the latter, keep the Min. Radius setting as close as possible to the Radius setting; that is, the maximum radius.

Distributed Bucket Rendering Rollout (mental ray Renderer)

Rendering menu/main toolbar > Render Setup > Render Setup dialog > Processing panel > Distributed Bucket Rendering rollout

Note: The Processing panel appears only when the mental ray renderer is the currently active renderer.

Controls on this rollout are for setting up and managed distributed bucket rendering. With distributed rendering, multiple networked systems can all work on a mental ray rendering. Buckets are assigned to systems as they become available.

While distributed bucket rendering can be used for offline rendering of animation frames, as in standard network rendering, it's best suited for speeding up the rendering of single images as you work. Especially when rendering high-resolution still images, you can get much faster results with distributed bucket rendering.

TIP When you use distributed bucket rendering, be sure to:

- Turn on Use Placeholder Objects on the [Translator Options rollout](#) on page 6316.
When placeholder objects are enabled, geometry is sent to the renderer only on demand.
- Leave Bucket Order set to Hilbert on the [Sampling Quality rollout](#) on page 6272.
With Hilbert order, the sequence of buckets to render uses the fewest number of data transfers.

NOTE Contour shading does not work with distributed bucket rendering.

NOTE You cannot use distributed bucket rendering when you [render to texture](#) on page 6371.

IMPORTANT To use distributed bucket rendering, you must set up host systems that are capable of running the mental ray renderer. There are two ways to do so: set up satellite systems, or install mental ray standalone licensing on remote hosts.

Satellite Systems

“Satellite” processors allow any owner of a 3ds Max license to freely use up to eight slave CPUs to render an image using distributed bucket rendering (not counting the one, two, or four processors on the “master” system that runs 3ds Max).

Each satellite system must have the following files installed:

- *rayrc*
- *raysat_3dsmax<X>.bat*
- *raysat_3dsmax<X>.exe*
- *raysat_3dsmax<X>server.exe*

where <X> is the current 3ds Max version number.

You can use the 3ds Max installation program to install these files: see the *Installation Guide* for more information.

In addition, information about each satellite should be stored in the [RAYHOSTS file](#) on page 8104. You can set up satellite systems by using the Add button on the Distributed Bucket Rendering rollout, as described in the “Interface” section, below.

Host Systems with SPM Licenses

When you use mental ray SPM licenses, remote hosts (that is, all systems other than the one running 3ds Max) must have the mental ray renderer (*ray.exe*) and a mental ray SPM license server running. To obtain this, you must run the mental ray installer on all remote hosts, then configure and run the SPM license server. Instructions about how to do so are provided with the mental ray renderer sold by mental images.

Once the remote hosts have been configured to run a licensed instance of *ray.exe*, you can use them for distributed rendering simply by naming them in the [RAYHOSTS file](#) on page 8104. You can add hosts to the RAYHOSTS file

using the Add button described in the “Interface” section, below, just as you would add a satellite processor.

Batch Rendering (Using Backburner or the Command Line)

You can launch distributed bucket rendering from the command line, using *3dsmaxcmd.exe*.

If you use satellite processors, you cannot use Backburner to manage distributed bucket rendering. When host processors have SPM licenses, you can use Backburner to manage distributed bucket rendering.

You can use the environment variable `MRMAX_OFFLINE_DBR_OVERRIDE` to control whether batch rendering uses distributed bucket rendering. The state of this variable overrides the “DBR enable” flag. If it is set to “yes,” “true,” or “on,” distributed bucket rendering is enabled; if it is set to “no,” “false,” or “off,” distributed bucket rendering is disabled. All other values of this variable are ignored.

See also:

- [Translator Options Rollout \(mental ray Renderer\)](#) on page 6316

Procedures

To use mental ray distributed rendering:

- 1 On the Render Setup dialog, go to the Processing panel. On the Distributed Bucket Rendering rollout, turn on Distributed Render.

NOTE The Net Render option on the Common Parameters rollout has no effect on distributed bucket rendering.

- 2 Click to select the names of those satellite or host systems you want to use for distributed rendering.
You can click All to select all the host names in the list, or None to select none of the hosts.
- 3 If other host systems have maps installed on them, with *exactly* the same file names and path names as on your local host, turn on Distributed Maps.
With Distributed Maps turned on, remote renderers can use their local copy of maps, which saves time.

4 Render the scene.

Each system renders the buckets assigned to it. The final rendering appears on your local system, with buckets “arriving” in an indeterminate order.

Example: To use mental ray distributed bucket rendering with Backburner:

This procedure demonstrates how to multiply the number of CPUs used for rendering without having to purchase mental ray standalone licenses, using the 3ds Max satellite technology.

If you have a few machines with 3ds Max licensed, and many machines without, you can use both the distributed rendering technology and Backburner so a rendering job would use 10 CPUs per Backburner server, thereby increasing the rendering speed.

For the purpose of this procedure, we're using a render farm comprising three machines named A, B, and C, each running a licensed copy of 3ds Max.

NOTE The number of machines you can use depends on the number of machines running licensed copies of 3ds Max. You are able to use only eight external (or satellite) CPUs per licensed copy of 3ds Max: four dual-processor machines or eight single-processor machines (or equivalent).

- 1 Choose which machines (other than machines A, B, and C) will serve as satellites, install 3ds Max on each, and write down each machine's IP address.
- 2 Use the Windows Notepad program or a text editor to open the *max.rayhosts* file on machine A, located in *mentalray* subdirectory within the program folder.
- 3 In the *max.rayhosts* file, under the “localhost” entry enter the IP address of each satellite CPU to be used; up to eight in all (see Figure 1).

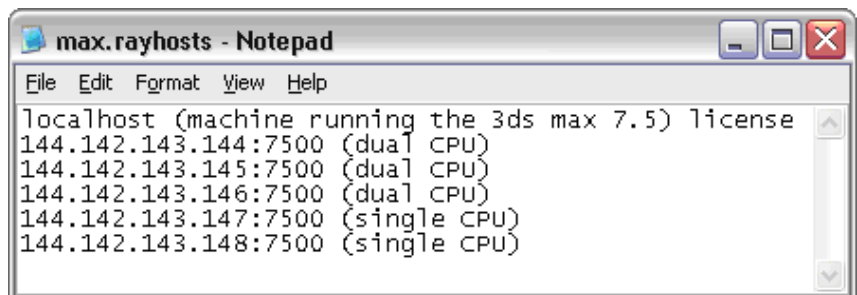

Figure 1 - Example of a rayhost file

- 4 Repeat the previous step on machines B and C with the remaining IP addresses.
- 5 Launch Backburner Manager on the machine submitting the job or any other machine. Launch the Backburner Server on machines A, B, and C.

WARNING It is necessary for the machine running the Backburner Server to have 3ds Max licensed. A mental ray standalone license will not enable you to use the distributed bucket rendering feature, and Backburner will prompt you with a license error.

- 6 On the machine submitting the job choose mental ray as the renderer, and then turn on Use Placeholder Objects, Use mental ray Map Manager (see Figure 2), and the Distributed Render (see Figure 3).

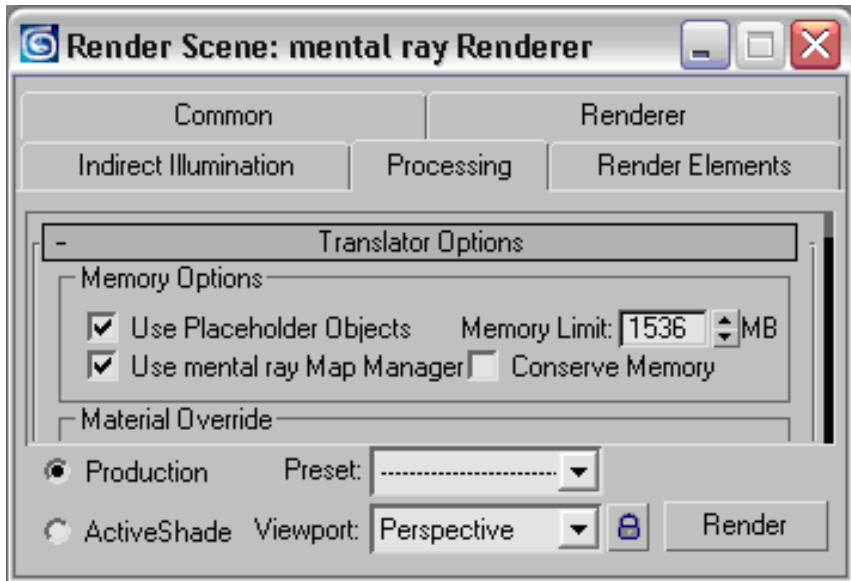

Figure 2 – Translator Options

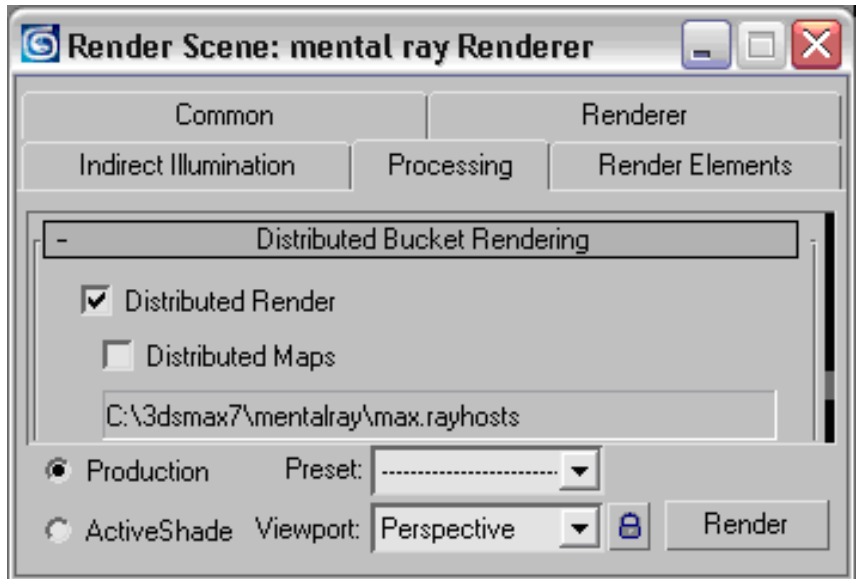
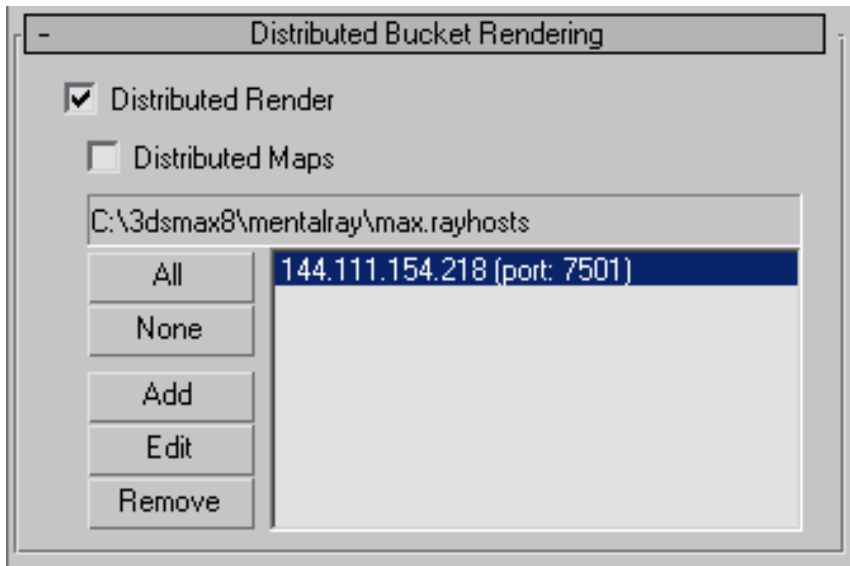

Figure 3 – Distributed Bucket Rendering

- 7 Submit the job to the Backburner network rendering farm.

The job is submitted to the network rendering farm and is picked up by machines A, B, and C. Each machine uses its internal CPU as well as its satellite CPUs to render the job.

Interface



Distributed Render When on, the mental ray renderer can use multiple satellite or host systems for distributed rendering. The list specifies which systems to use. Default=off.

NOTE The Net Render option on the Common Parameters rollout has no effect on distributed bucket rendering.

The other distributed rendering controls are unavailable unless Distributed Render is on.

Distributed Maps When on, specifies that all texture maps can be found on each of the slave machines doing distributed rendering. This saves time by avoiding the necessity for mental ray to distribute all the maps to each slave via TCP/IP. When off, specifies that all maps used in rendering reside on the local system; that is, the system on which you start rendering. Default=off.

If Distributed Maps is on but the maps are not found on the slaves, those maps simply will not render on the slaves, and rendered output will be incorrect. Also, an error message will appear in the mental ray message window.

If you are doing local rendering only, this setting has no effect.

Maps on all systems in distributed rendering must have *exactly* the same name and directory path.

[name field] Displays the [RAYHOSTS file's](#) on page 8104 name and path.

[list of hosts] After you choose a RAYHOSTS file, this list shows the host systems available for distributed mental ray rendering. You can use this list to choose only those hosts you want to use for this particular rendering. When you render with Distributed Render on, the mental ray renderer uses only the hosts whose names are highlighted in this list. Click a host name to select it. To deselect a selected host name, click it again.

NOTE The RAYHOSTS file, and therefore the host list, can contain duplicate entries. However, before you render you must select only processors that are not duplicates; otherwise, at render time 3ds Max will display an error message.

If Distributed Render is on but the list of hosts is empty when you click Render, 3ds Max will not perform distributed bucket rendering.

All Highlights all system names in the hosts list.

None Clears the highlight from all system names in the hosts list.

Add Click to display an [Add/Edit DBR Host dialog](#) on page 6334, which lets you add a host processor to the RAYHOSTS file.

Edit Click to display the [Add/Edit DBR Host dialog](#) on page 6334, and edit the highlighted host processor's entry in the RAYHOSTS file. Available only when a single list entry is highlighted.

Remove Click to remove the currently highlighted host processors from the list and the RAYHOSTS file. Available only when one or more list entries are highlighted.

Clicking Remove displays a Remove Selected Hosts dialog, which warns you that the host descriptors will be removed from both locations:

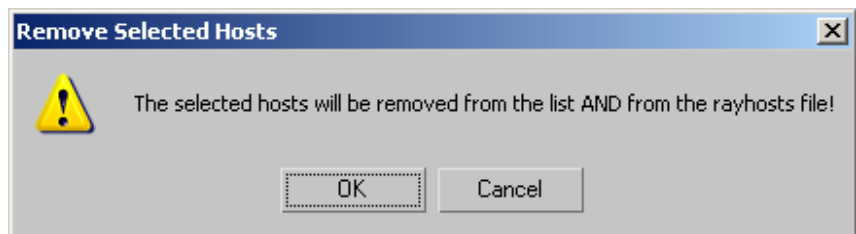

To restore a host that you have removed, use the Add button once again.

Add/Edit DBR Host Dialog

The Add/Edit DBR (Distributed Bucket Rendering) Host dialog opens when you click Add on the [Distributed Bucket Rendering rollout](#) on page 6326. It lets you add a host (or “satellite”) processor to use when you render using distributed buckets. As the text on the dialog reminds you, the new host is added to the text of the [RAYHOSTS file](#) on page 8104.

Interface

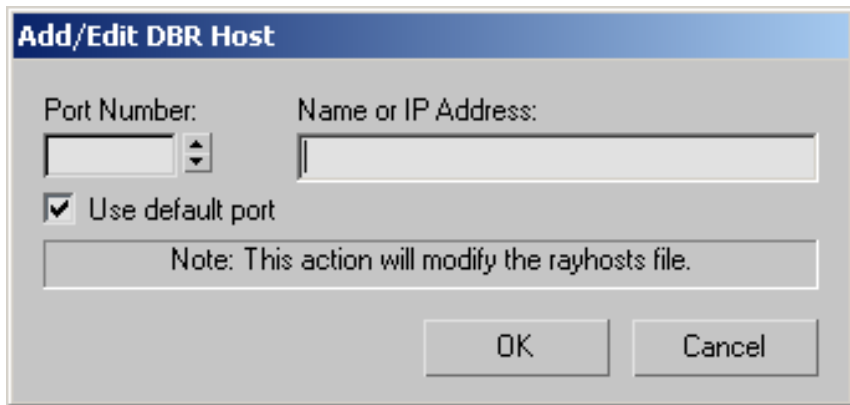

Port Number Lets you enter a port number for the processor. This control is unavailable unless you turn off Use Default Port. When Use Default Port is off, the default port value appears in this field.

Name or IP Address Enter the name or the numeric IP address of the processor you want to add.

Use Default Port When on, 3ds Max assigns a port number to the new processor. The Port Number control is unavailable while Use Default Port is on. Default=on.

VUE File Renderer

Rendering menu > Render Setup > Render Setup dialog > Common panel > Assign Renderer rollout > Choose VUE File Renderer as the active production renderer. > Renderer panel > VUE File Renderer rollout

The VUE File Renderer creates VUE (.vue) files. [VUE files](#) on page 8165 use an editable ASCII format.

Procedures

To create a .vue file:

- 1 Use the Render Setup dialog > Assign Renderer rollout to assign the VUE File Renderer as the Production renderer.
You can't assign the VUE File Renderer to be the ActiveShade renderer.
- 2 Activate a camera viewport.

NOTE You must render from a camera viewport in order to include the coordinates for the camera itself.

- 3 Use the VUE File Renderer rollout to specify a file name.
- 4 Render the scene.

The VUE file is written to disk. The [Rendered Frame Window](#) on page 6073 is displayed, but it doesn't display an image.

Interface

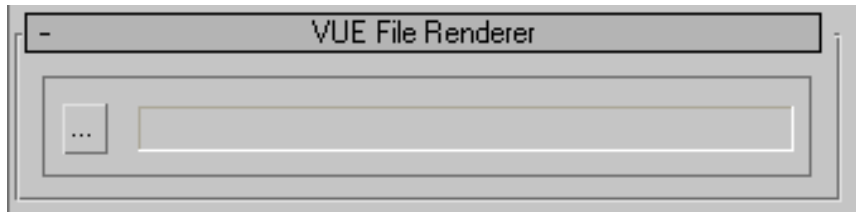

... **[Browse]** Click to open a file selector dialog and then specify a name for the VUE file to create.

[File name] The text field displays the name of the file.

Rendering Elements Separately

Rendering to elements lets you separate various types of information in the rendered output into individual image files. This can be useful when you work with some image-processing, compositing, and special-effects software.

Render Elements Panel and Rollout

Rendering menu/main toolbar > Render Setup > Render Setup dialog > Render Elements panel > Render Elements rollout

This topic describes the available types of render elements and how to use them.

These are the elements you can choose to render separately:

- **Alpha:** A grayscale representation of the alpha channel, or transparency, of the scene. Transparent pixels appear in white (value=255) and opaque in black (value=0). Translucent pixels appear in gray. The darker the pixel, the more transparent it is.
The alpha channel can be useful when you composite elements.
- **Atmosphere:** The atmospheric effects in the rendering.
- **Background:** The background of the scene.
Other elements do not include the scene background. Include this element if you want to use the background in compositing.
The background is not trimmed against geometry, so elements should be composited *over* the background. See [Compositing Rendered Elements](#) on page 6342.
- **Blend:** A custom combination of the previous elements.
The Blend element displays an additional [Blend Element Parameters](#) rollout on page 6355.
- **Diffuse:** The diffuse component of the rendering.
The Diffuse element displays an additional [Diffuse Texture Element](#) rollout on page 6370.
- **Hair and Fur:** The component of the rendering created by the [Hair and Fur modifier](#) on page 1119. See [Hair and Fur Render Element](#) on page 6356.
- **Illuminance HDR Data:** Generates an image containing 32-bit floating-point data that can be used for analyzing the amount of light that falls on a surface perpendicular to its normal. The illuminance data ignores material characteristics such as reflectance and transmittance.

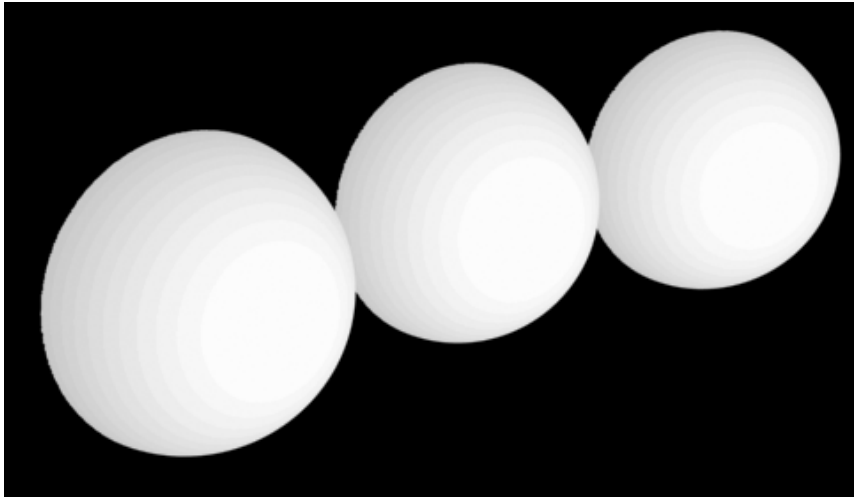

Illuminance is not related to surface properties.

For best results, render with mental ray or another renderer that supports 32-bit floating-point output and set the output format to PIC, HDR, or EXR. If using the scanline renderer or another renderer that doesn't support 32-bit floating-point output, set the Scale Factor parameter, which acts as a multiplier, to adjust the range of values for the output data.

- **Ink:** The Ink component (borders) of [Ink 'n Paint materials](#) on page 5742.
- **Lighting:** The effect of direct and indirect lights and shadows in the scene. The Lighting element displays an additional [Lighting Texture Element rollout](#) on page 6356.
- **Luminance HDR Data:** Generates an image containing 32-bit floating-point data that can be used for analyzing the perceived brightness of a surface after light has been “absorbed” by the material of the surface. The luminance data considers material characteristics such as reflectance and transmittance.

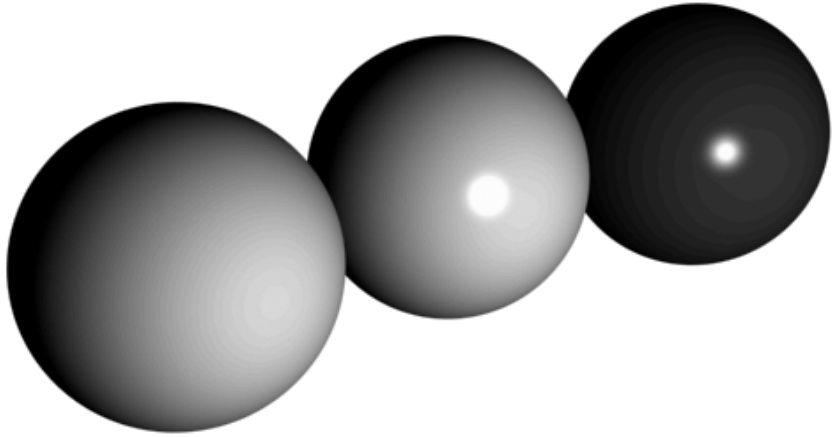

Luminance takes surface properties into account.

For best results, render with mental ray or another renderer that supports 32-bit floating-point output and set the output format to PIC, HDR, or EXR. If using the scanline renderer or another renderer that doesn't support 32-bit floating-point output, set the Scale Factor parameter, which acts as a multiplier, to adjust the range of values for the output data.

- **Material ID:** Retains the material ID information assigned to an object. This information is useful when you are making selections in other image-processing or special-effects applications, such as Autodesk Combustion. For example, you could select all of the objects with a given material ID in Combustion. The material ID corresponds to the value you set for the material with the material ID channel. Any given material ID will always be represented by the same color. The correlation between a specific material ID and a specific color is the same in Combustion. See [Material ID Channel](#) on page 5348.
- **Matte:** Renders a matte mask, based on selected objects, material ID channel (effects IDs), or G-Buffer IDs. The Matte element displays an additional [Matte Texture Element rollout](#) on page 6357.
- **mr A&D:** These elements render various components of the Arch & Design material to HDR compositors such as Autodesk Toxik. For details, see [mr A&D Elements](#) on page 6358.

- **mr Labeled Element:** Renders a branch of a map tree that you specify using a label. For details, see [mr Labeled Element Parameters Rollout](#) on page 6363
- **mr Shader Element:** Outputs the raw contribution of any mental ray shader in the scene. This includes standard 3ds Max materials and maps that are converted to mental ray shaders in the translation process. For details, see [mr Shader Element Parameters Rollout](#) on page 6365
- **Object ID:** Retains the object ID information assigned to the object. Roughly comparable to the material ID, the object ID information is useful for selecting objects based on an arbitrary index value in another image-processing or special-effects application. If you know that you will want to select several objects at once, at a later time, you can assign them all the same object ID in 3ds Max. By rendering with the object ID, this information will be available in other applications.

You assign the object ID with the Object Properties dialog > General panel > [Object Channel parameter](#) on page 315. A given object ID is always represented by the same (arbitrary) color. The correlation between a specific material ID and a specific color is the same in Combustion.

When an Object ID entry is highlighted in the [element rendering list](#) on page 6347, the Object ID Element rollout appears on the Render Elements panel. This rollout lets you choose whether to base the render color of a given object ID on the object color or the Object ID. If you choose Object Color, the render color is the object's base color, as shown on the Create panel > Name And Color rollout and at the top of the other command panels, and is not based on the Object ID. If you choose Object ID, an arbitrary color is assigned to each object based on its Object ID.
- **Paint:** The Paint component (surfaces) of [Ink 'n Paint materials](#) on page 5742.
- **Reflection:** The reflections in the rendering.
- **Refraction:** The refractions in the rendering.
- **Self-Illumination:** The self-illumination component of the rendering.
- **Shadow:** The shadows in the rendering. This element saves black-and-white shadows only. See [Compositing Rendered Elements](#) on page 6342.

NOTE The mental ray renderer does not include shadows created by [global illumination](#) on page 6306 and [final gathering](#) on page 6295 in the Shadow render element output.

- **Specular:** The specular component of the rendering.
- **Velocity:** The motion information which can be used in other applications for things such as creating motion blur or retiming an animation. The Velocity element displays an additional [Velocity Element Parameters rollout](#) on page 6367.
- **Z Depth:** A grayscale representation of the Z depth, or depth within the view, of objects within the scene. The nearest objects appear in white, and the depth of the scene in black. Intermediate objects are in gray, the darker the deeper the object is, within the view. The Z Depth element displays an additional [Z Element Parameters rollout](#) on page 6369.

When you render one or more elements, a normal complete rendering is also generated. In fact, the element renderings are generated during the same rendering pass, so rendering elements costs little extra render time.

Rendering to elements is available only when you do production rendering with the default [scanline renderer](#) on page 6141 or the [mental ray renderer](#) on page 6230.

NOTE The default scanline renderer supports a maximum of 32 render elements per scene. The mental ray renderer does not limit the number of render elements. If you're using a third-party renderer, check the product documentation for a possible limit on the number of render elements.

NOTE When using the default scanline renderer, [Antialiasing](#) on page 6146 must be on in order to render elements. With Antialiasing off, rendering elements is disabled.

Example

Here is a rendering of a fountain, against a checkered background, and various elements.

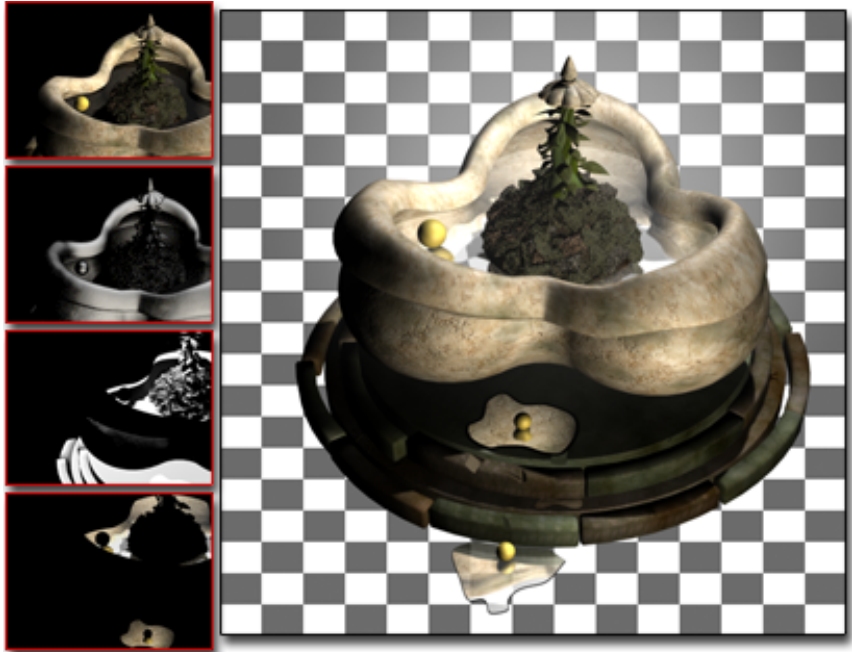

On the right is the fully rendered fountain.

On the left, from top to bottom, are diffuse, specular, shadow, and reflection elements.

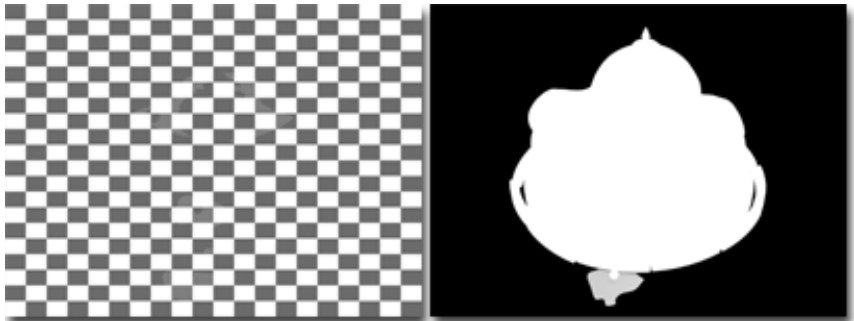

Two more elements not directly related to the objects in the scene, but important when compositing the image to other sources:

on the left is the background, on the right is the alpha channel.

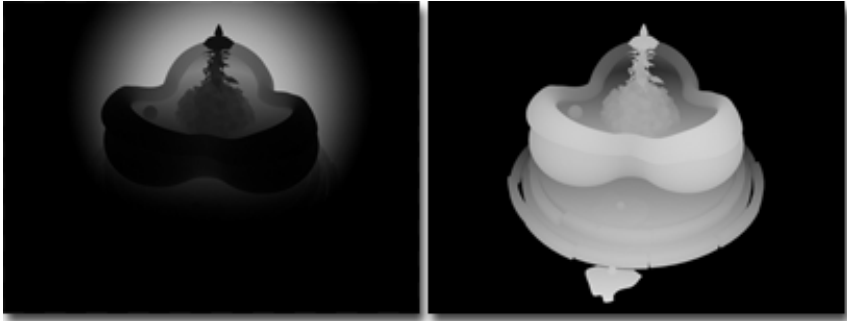

On the left is an atmosphere element, in this example, a light fog on the back side of the fountain.

On the right is the Z-depth. The fog uses the depth of the image and objects to determine its density. The Z-depth element contains these depth values.

Compositing Rendered Elements

In general, you can composite elements using additive composition, which is independent of the compositing order.

The main exceptions are the background element, atmospheres, and shadows.

- **Background:** The background is not trimmed against geometry, the background should be composited *under* the other elements.
- **Atmosphere:** The atmosphere element should be composited *over* all other elements.
- **Black-and-white shadows:** Black-and-white shadows should be composited over the rest of the image (aside from the atmosphere), to dim color in the shadowed areas. This technique does not take colored lighting into account.

In other words, the layers when you composite using black-and-white shadows appear like this:

Top: Atmosphere

Second from top: Shadow element

Middle: Diffuse + Specular + ... (other elements)

Bottom: Background

"Screen" Compositing for Specular and Reflection Elements

The other exception to additive composition is when specular or reflection elements have been generated by certain material shaders. These shaders generate specular and reflection elements you must composite differently:

- Anisotropic
- Multi-Layer
- Oren-Nayar-Blinn

Shaders are assigned on a per-material basis, in the Material Editor. If you render specular or reflection elements in a scene that uses these shaders, then composite them with the diffuse and other foreground components (aside from colored shadows, as described above), by overlaying them using an operation called "Screen" in some compositing programs.

Screen compositing uses this formula to combine elements:

Background * (1 - Foreground) + Foreground

The background is multiplied by the inverse of the foreground color, and then the foreground color is added to the result.

For more information, see the documentation for the compositing program you use.

Procedures

To have the Render Elements dialog assign names to the rendered element files automatically:

- 1 Assign an output file name and file type for the (entire) rendered scene using the Files button [Files](#) on page 6129 on the Common Parameters rollout of the Render Setup dialog.
- 2 On the Render Elements rollout, use the Add button to specify elements for rendering (see following procedure).

To render elements to files without rendering the entire scene to a file, follow this procedure, and then turn off Common panel > Common Parameters rollout > Render Output group > Save File.

To add an element for rendering:

- 1 Click Add.

- 2 On the Render Elements dialog, do one of the following:
 - Highlight the name of an element, and then click OK.
 - Double-click the name of an element.
If you have assigned a file name for the entire rendering, the new element is assigned a file name automatically. Otherwise, use the Files button in the Selected Element Parameters group to assign an output file name and file type for the element rendering.
- 3 If the element is one (such as Blend or Z Buffer) that has additional parameters, adjust these parameters in the appropriate rollout.

To render the separate elements:

- 1 Add the elements you want to render.

TIP You can use the Enable button (in the Selected Element Parameters rollout) to disable individual elements for a particular rendering pass.

- 2 If you haven't assigned file names automatically (see the first procedure, preceding), use the Browse [...] button in the Selected Element Parameters group to assign an output file name and file type for the element rendering.
- 3 Make sure Elements Active (at the top of the Render Elements rollout) is turned on, and then click Render to render the scene.
The rendered elements are also displayed on the desktop, each in its own window. (The windows cascade on top of each other.)

To generate a Combustion™ workspace (CWS) file that contains the rendered elements:

- 1 In the Output to Combustion group, turn on Enable.
If you have assigned a file name for the entire rendering, the new element is assigned a file name automatically. Otherwise, use the Files button in the Output to Combustion group to assign an output file name for the CWS file.
- 2 If you want to change the file or pathname click ... [ellipsis].
- 3 Do one of the following:
 - Render the scene. The CWS file is created at the time of the rendering.
 - Create Combustion Workspace Now.

Use this button to create a Combustion workspace at any time. You do not have to render for the workspace to be created.

NOTE This only works if there is at least one Render Element selected and if your Render Output file type (set on the Common panel) is AVI, RPF, CIN, JPG, PNG, MOV, RGB, RLA, TGA, TIF, or EXR.

Interface

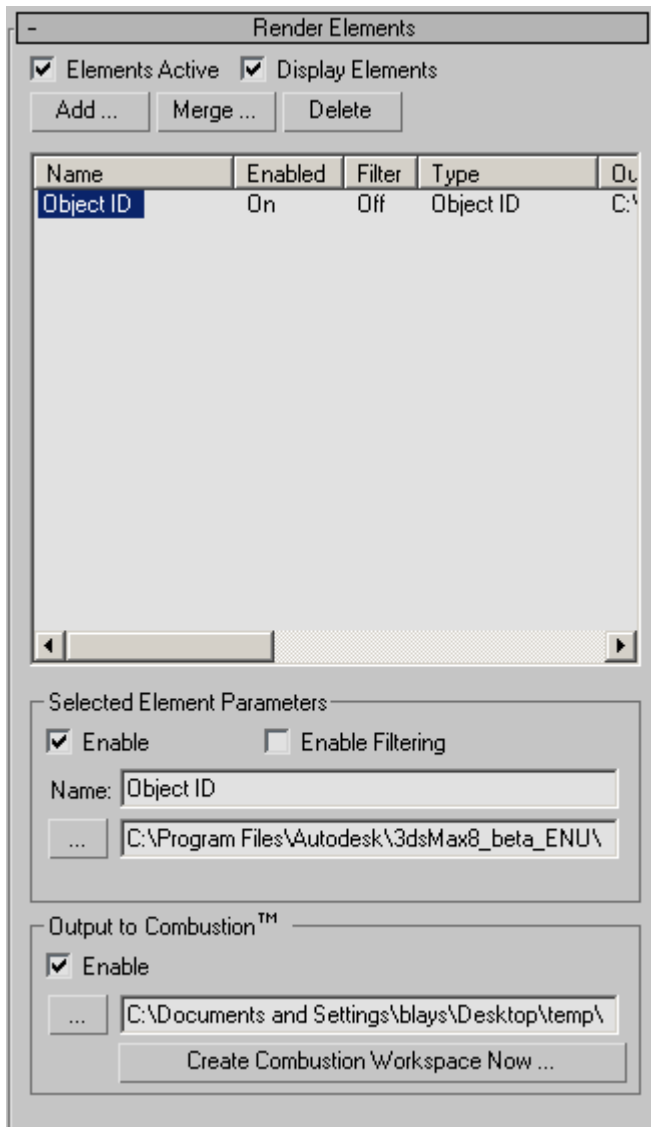

Add Click to add a new element to the list. This button displays the [Render Elements dialog](#) on page 6349.

Merge Click to merge the render elements from another 3ds Max scene. Merge displays a file dialog so you can select the scene file to get the elements from. The list of render elements in the selected file is added to the current list.

Delete Click to delete the selected elements from the list.

Elements Active When on, clicking Render renders the separate elements. Default=on.

Display Elements When on, each rendered element is displayed in its own window, which is a feature-reduced version of the [Rendered Frame Window](#) on page 6073. When off, the elements are rendered to files only. Default=on. The windows for each rendered element open cascaded on top of each other. Move one element's window to see another's.

Element Rendering list

This scrollable list shows the elements to render separately, and their status. To resize the columns in the list, drag the border between two columns.

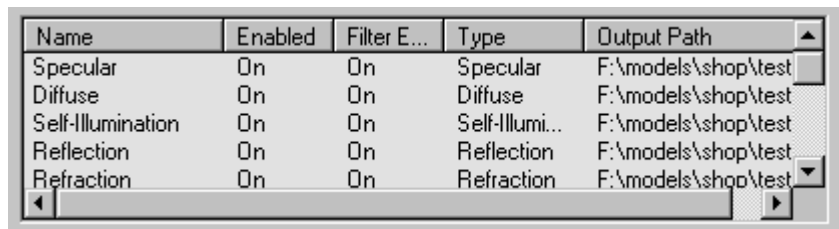

Name	Enabled	Filter E...	Type	Output Path
Specular	On	On	Specular	F:\models\shop\test
Diffuse	On	On	Diffuse	F:\models\shop\test
Self-Illumination	On	On	Self-Illumi...	F:\models\shop\test
Reflection	On	On	Reflection	F:\models\shop\test
Refraction	On	On	Refraction	F:\models\shop\test

The list includes the following columns:

Name Shows the name of the element. You can change the default name of elements, in the Selected Element Parameters group.

To select an element, click its name in the list. Use Ctrl+click to select additional elements, or Shift+click to select a contiguous group of additional elements.

Enabled Shows whether the element is enabled.

Filter Shows whether the active antialiasing filter is enabled for the element.

Type Shows what type of element this is.

This field is useful if you have changed the name of an element.

Output Path Shows the path and file name for the element.

Selected Element Parameters group

These controls are for editing selected elements in the list.

Enable Turn on to enable rendering the selected elements. Turn off to disable rendering. Default=on.

The Enabled column of the elements list shows whether or not an element is enabled.

Enable Filtering When on, applies the active [antialiasing filter](#) on page 6146 to the rendered element. When off, the rendered element does not use the antialiasing filter. Default=on.

The Filter column of the elements list shows whether or not the filter is enabled for an element.

Disabling antialiasing can improve rendering time, although the rendered element that results might appear jagged.

NOTE Turning off Enable Filter disables only general antialiasing and map filtering. Edge blending still occurs when this switch is off.

Name Shows the name of the currently selected element. You can type in a custom name for the element.

This control is unavailable when multiple elements are selected.

[...] **(Browse)** The text box lets you enter a path and file name for the element. Alternatively, click the [...] (ellipsis) button to open the [Render Element Output File dialog](#) on page 6350, which lets you choose a folder, file name, and file type for the element.

This control is available only when a single element is highlighted.

NOTE If you first assign a file name and path for the complete rendering on the Render Setup dialog > [Common Parameters rollout](#) on page 6121, the render elements feature uses this name and path automatically as the basis for names of the various elements. It appends an underscore (_) and then the name of the element to the basic file name.

For example, if the render file name is "C:\render\image.jpg", when you add a Specular render element, the default path and file name for the rendered specular element is "C:\render\image_specular.jpg".

Similarly, when you enable output to a [Combustion workspace \(CWS\) file](#) on page 7329, the file name you assigned is the default name of the CWS file.

For example, if the render file name is "C:\image.jpg", when you enable Combustion output, the default path and file name is "C:\image.cws".

Output to Combustion group

When on, generates a [Combustion Workspace \(CWS\) file](#) on page 7329 that contains the elements you are rendering. You can use this file in the Combustion software, and you can use Combustion workspaces in the [Combustion map](#) on page 5811.

WARNING If you are rendering elements to composite over a background, make sure that the file format for the Diffuse, Shadows, and Alpha elements supports an alpha channel. The formats we recommend for this purpose are: [RLA](#) on page 7364, [RPF](#) on page 7366, [PNG](#) on page 7360, or [TGA](#) on page 7370.

WARNING 3ds Max supports some file types that Combustion does not. For use with Combustion, do not render elements as EPS files. If you render to this format, the CWS file is not saved. See your Combustion documentation for more information on supported file formats.

Enable When on, creates a CWS file that contains the elements you have rendered.

[...] (**Browse**) The text box lets you enter a path and file name for the CWS file. Alternatively, click the [...] (ellipsis) button to open the Save To Combustion dialog, which lets you choose a folder and file name for the CWS file.

Create Combustion Workspace Now When clicked, creates a Combustion workspace (CWS file). This button makes it possible to create a Combustion workspace without rendering.

NOTE You must add at least one render element for this file to be created and the Render Output type on the Common panel must be set to AVI, RPF, CIN, JPG, PNG, MOV, RGB, RLA, TGA, TIF, or EXR.

Render Elements Dialog

Rendering menu/main toolbar > Render Setup > Render Setup dialog > Render Elements panel > Render Elements rollout > Add button > Render Elements dialog

This dialog lets you choose elements to render.

Procedures

To choose an element to render separately, do one of the following:

- Highlight the element's name in the list, and then click OK.
- Double-click the element's name in the list.

To highlight multiple elements, do any of the following and then click OK:

- To highlight non-contiguous elements, click an element's name in the list, and then Ctrl+click further elements.
- To highlight contiguous elements, drag from the first to the last.
- To highlight contiguous elements, click the first element's name in the list, and then Shift+click another element.

Interface

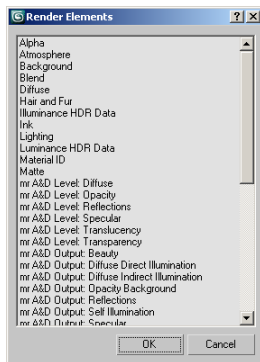

The scrolling list shows the names of elements you can render separately. These are described in [Render Elements Panel and Rollout](#) on page 6336.

Render Element Output File Dialog

Rendering menu/main toolbar > Render Setup > Render Setup dialog > Render Elements panel > Render Elements Rollout > Selected Element Parameters group > Browse ([...]) button

The Render Element Output File dialog lets you assign a name to a file that saves one element of the rendering. You can also determine the type of file

to render, and set up options such as compression, color depth, and quality, depending on the file type.

See also:

- [Image File Formats](#) on page 7324

Procedures

To specify the render element output file and its settings:

- 1** Choose Rendering > Render Setup, and then, on the Render Elements rollout, in the Selected Element Parameters group, click the Browse ([...]) button.
The Render Element Output File dialog opens.
- 2** In the File Name field, enter the name for the file to be rendered.
- 3** Navigate the Save In field to choose the directory where you want the rendered file to be saved.
- 4** In the Save As Type field, choose the type of file you want to render.
- 5** Click Save to open the Setup dialog for the specified output file type.
Thereafter, the Setup button becomes available on the Render Element Output File dialog; you can click this to change the settings.
- 6** Change any settings as necessary, and then click OK to close the Render Element Output File dialog. Alternatively, clicking Cancel returns you to the Render Element Output File dialog.
- 7** Click Render to render and save the file.

Interface

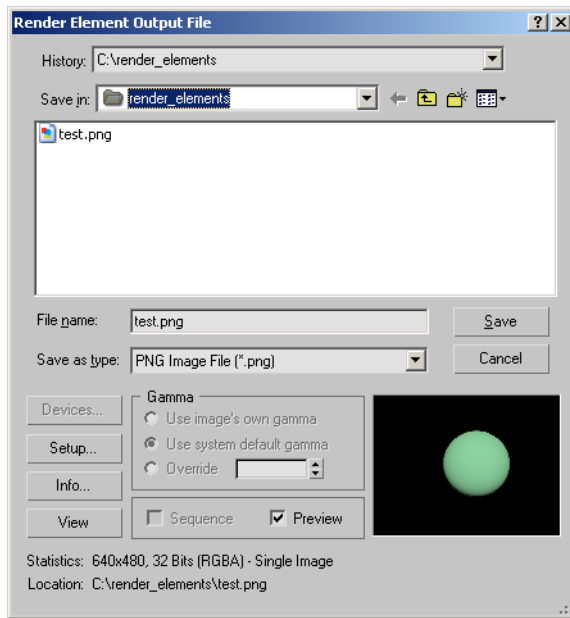

History Displays a list of the most recent directories searched. Whenever an image is selected, the path used is added to the top of the history list as the most recently used path.

The history information is saved in the [3dsmax.ini](#) on page 83 file.

Save In Opens a drop-down list to browse other directories or drives.



Up One Level Moves to the next-highest level in the directory structure.



Create New Folder Lets you create a new folder while in this dialog.



View Menu Provides several options for how information is displayed in the list window:

- **Thumbnails:** Displays the contents of a directory as thumbnails, without the details.
- **Tiles:** Displays the contents of a directory as large icons, without the details. If you widen the dialog, these tile across the width.

- **Small Icons:** Displays the contents of a directory as small icons, tiled across the width, without the details.
- **List:** Displays the contents of a directory without the details.
- **Details:** Displays the contents of a directory with full details such as size and date.

List of files Lists the contents of the directory, in the format specified by the View menu.

TIP When the active display format is Details, the contents of the directory are displayed with Name, Size, Type, Date Modified, and Attributes. You can sort the list according to a column's contents by clicking that column's label.

File Name Displays the file name of the file selected in the list.

Save as File Type Displays all the file types that can be saved. This serves as a filter for the list.

NOTE The choice in this field determines the file type saved, regardless of the extension entered in the File Name field.

Save Sets the file information for saving upon rendering. Closes the dialog if you haven't changed the output file type.

If you've changed the file type, clicking Save opens the Setup dialog for the specified file type. Change the settings as necessary, and then click OK to close both the Setup and the Output dialogs, or click Cancel to return to the Output dialog.

Cancel Cancels the selection and closes the dialog.

Devices Lets you choose the hardware output device, for example, a digital video recorder. To use this function, the device, its driver, and its 3ds Max plug-in must all be installed on your system.

Setup Click to open a dialog with controls for the output file type. These vary with each different file format.

NOTE The Setup button becomes available after you specify a file name or type. If you first choose a type from the Save As Type drop-down list, click anywhere on the dialog to activate Setup. If you first enter a file name and extension (such as *test.png*), press Tab to activate Setup. Also, clicking Setup uses the filename extension, even if it doesn't agree with the Save As Type setting.

Info Displays expanded information about a highlighted file such as frame rate, compression quality, file size, and resolution. The information available depends on the file type.

View Displays the file at full resolution. If the file is a movie, Windows Media Player opens to play the file.

Sequence This is not available in the Render Element Output File dialog.

NOTE To render a sequence of still images, choose the Active Time Segment or define a range of frames on the Common Parameters rollout of the Render Setup dialog. If you are rendering to a still-image file type, the software appends a four-digit frame number to the file name name, incremented with each frame.

Preview When on, enables display of the image as a thumbnail in the Image Window.

Image Window Displays a thumbnail of the selected file, when Preview is turned on.

Gamma group

To set up gamma options for the output file, Enable Gamma Correction must be on in the [Gamma panel](#) on page 7758 of the Preferences dialog (Customize > Preferences > Gamma). Otherwise, the Gamma controls are unavailable in the Render Output File dialog.

- **Use Image's Own Gamma** This option is not available in this dialog.
- **Use System Default Gamma** Uses the system default gamma, as set on the [Gamma panel of the Preferences dialog](#) on page 7758.
- **Override** Defines a new gamma for the bitmap that differs from the system default.
Using Override is not recommended for element bitmaps. Using the system default gamma value ensures that all elements have consistent renderings.

Statistics/Location

Statistics Displays the resolution, color depth, file type, and number of frames of the highlighted file.

Location Displays the full path and name of the highlighted file.

Blend Element Parameters Rollout

Rendering menu/main toolbar > Render Setup > Render Setup dialog > Render Elements panel > Render Elements rollout > Add button > Render Elements dialog > Add Blend element to the elements list (or select an existing Blend element in the list).

The Blend element is a custom combination of several other elements. By default, all elements are turned on in this rollout, and the Blend rendering is identical to the full, normal rendering, except for the scene background. Use the check boxes to choose your own combination of elements to appear in the Blend rendering.

Interface

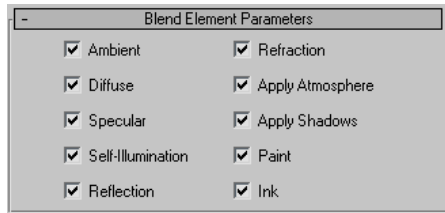

Ambient When on, include the ambient color component. Default=on.

Diffuse When on, include the diffuse color component. Default=on.

Specular When on, include the specular color component. Default=on.

Self-Illumination When on, include self-illumination. Default=on.

Reflection When on, include reflections. Default=on.

Refraction When on, include refractions. Default=on.

Apply Atmosphere When on, include atmospheric effects. Default=on.

Apply Shadows When on, include shadows. Default=on.

Paint When on, include the Paint component of [Ink 'n Paint materials](#) on page 5742. Default=on.

Ink When on, include the Ink component of Ink 'n Paint materials. Default=on.

Hair and Fur Render Element

Rendering menu/main toolbar > Render Setup > Render Elements panel > Add > Render Elements dialog > Hair and Fur

The Hair And Fur render element produces an additional image that depicts only the elements in the scene generated by the [Hair And Fur modifier](#) on page 1119. This image can be used for compositing.

NOTE The Hair And Fur render element supports only the [“buffer” rendering method](#) on page 6590 using the default scanline and mental ray renderers.

Lighting Texture Element Rollout

Rendering menu/main toolbar > Render Setup > Render Setup dialog > Render Elements panel > Render Elements rollout > Add button > Render Elements dialog > Add Lighting element to the elements list (or highlight an existing Lighting element in the list).

The lighting element contains the effects of lighting within the scene, including color, shadows, direct and indirect light.

This rollout lets you determine which parts of the lighting are included in the rendering.

Interface

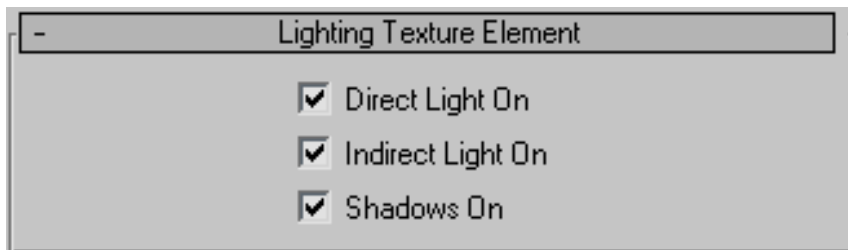

Direct Light On When on, the render element includes information from any direct lights in the scene. The light's color and projection map should appear.

NOTE The final color for direct lighting takes surface normals into consideration.

Indirect Light On When on, the render element includes information from ambient or bounced lighting in the scene.

NOTE When using radiosity, expect effects such as color bleed.

Shadows On When on, the render element includes shadows.

Matte Texture Element Rollout

Rendering menu/main toolbar > Render Setup > Render Setup dialog > Render Elements panel > Render Elements rollout > Add button > Render Elements dialog > Add Matte element to the elements list (or highlight an existing Matte element in the list).

The Matte render element displays a matte mask for a selected object, [material effects channel \(effect ID\)](#) on page 5348, or [G-Buffer ID](#) on page 7991. Each matching element is represented with a white pixel on the mask.

For more info on matte behavior, see [Matte Object](#) on page 8042.

WARNING The Matte render element does not work for objects to which the [mental ray material](#) on page 5638 is applied.

Interface

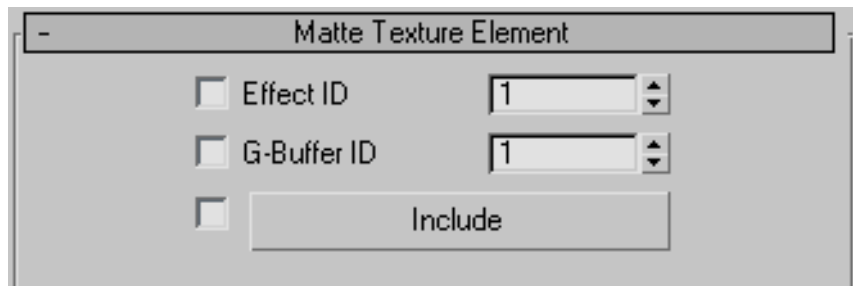

Effect ID Sets the [material effects channel](#) on page 5348 to include in the Matte render element.

G-Buffer ID Sets the [G-Buffer ID](#) on page 7991 to include in the Matte render element.

Include Opens the [Exclude/Include dialog](#) on page 5096, where you can select objects in the scene to exclude or include in your Matte mask.

When *including*, all selected objects are rendered with white pixels.

When *excluding*, all pixels are white, by default. Selected objects are rendered as black pixels.

WARNING If you use Exclude, make sure the Effect ID and G-Buffer ID parameters are not on. These modes provide inferior results when used in combination.



mr A&D Elements

Rendering menu/main toolbar > Render Setup > Render Setup dialog > Render Elements panel > Render Elements rollout > Add button > Render Elements dialog > Add one or more mr A&D elements to the elements list (or highlight an mr A&D entry in the list).

NOTE As their names suggest, these render elements pertain only to objects to which the [Arch & Design material](#) on page 5544 is applied, rendered with mental ray.

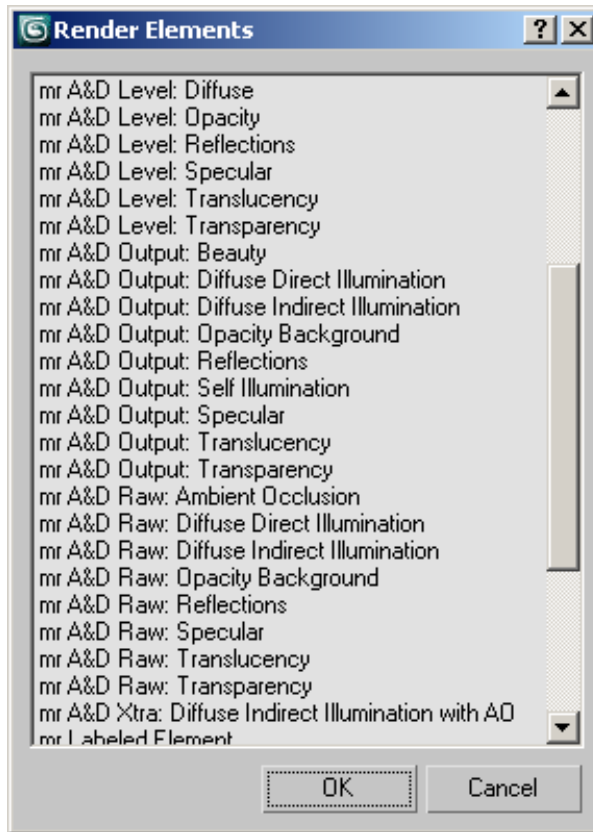

The mr A&D elements let you specify as render elements the most important components of the [Arch & Design material](#) on page 5544, generally in three different contribution types: raw, level, and output. You can save these as HDR image files for subsequent compositing in a program such as Autodesk Toxik.

With most of the elements, *raw* is the unscaled contribution, and *level* is the scaling, and the *output* component, calculated by multiplying the raw and level components, is the resultant contribution of the element to the full rendered output. The level is often related to an input parameter (or combinations thereof), and has been modified to abide by the energy-conservation feature of the Arch & Design material.

Hence the elements contain some redundancy: For example, if you just want the current reflections in a separate channel, use the Output Reflections element, but if you want more control over the amount of reflections in

post-production, you can instead use Raw Reflections and Level Reflections, multiplying them (with optional, additional processing) in the compositing phase prior to adding them to the final color.

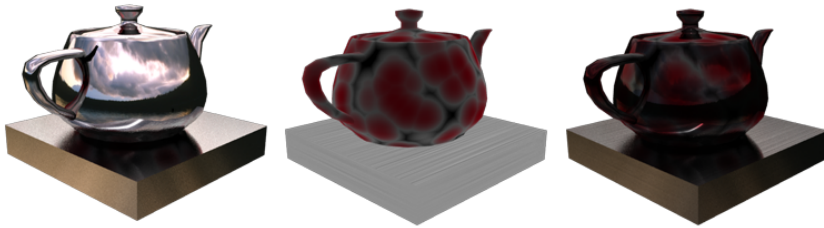

Reflections: Raw (left) * Level (center) = Output (right)

NOTE In order to maintain a correct compositing equation, the effects of the [mr Photographic exposure control](#) on page 6744 are intentionally excluded from the A&D render elements output.

TIP When rendering mr A&D elements for compositing in an HDR application like Toxik, be sure to set [Frame Buffer Type](#) on page 6277 to Floating-Point (32 bits per channel), which allows raw-element values to exceed 1.0, and save output files in the [OpenEXR format](#) on page 7349.

List of All Outputs

Following is a list of all available render elements for the Arch & Design material (each has the “mr A&D” prefix):

- **Output: Beauty** The main, blended output. It is identical to the single output of the Arch & Design material.
- **Diffuse Direct Illumination** Output is the resulting [diffuse](#) on page 5547 component after lighting, including textures. Raw is the diffuse lighting itself, without textures, and Level Diffuse is the diffuse texture color adjusted by the energy conservation.
- **Diffuse Indirect Illumination** Output is the resulting indirect illumination, including [ambient occlusion](#) on page 5564 effects, multiplied by the diffuse color. Raw is the raw result from indirect illumination. There is no Level component.
- **Ambient Occlusion** Raw is the raw contribution of the [ambient occlusion](#) on page 5564.

- **Diffuse Indirect Illumination with AO** Xtra is the indirect illumination affected by ambient occlusion but *without* being multiplied by the diffuse color.
- **Opacity** Output (Opacity Background) is the final contribution of any background of the object as a result of the input [cutout](#) on page 5578 opacity (as determined by the assigned map) being less than 1.0. Raw contains the background without scaling by the opacity. If the cutout opacity is 1.0, these outputs contain black, because no transparency is rendered in such cases.
The Level output contains the actual opacity itself. Care must be taken if opacity equals zero, because this mean that the material has performed no shading whatsoever and none of the other outputs will contain any value at all.
- **Reflections** Output is the resulting [Reflection group](#) on page 5548 component. Raw is the unalloyed (full-intensity) reflection, and Level is the actual reflectivity, including reflection color and [BRDF](#) on page 5557 settings.

WARNING The Arch & Design material samples very-low-level reflections in the rendering phase at low quality (for performance), so avoid doing huge modifications to reflection intensity in post.

- **Self Illumination** Output contains the [Self Illumination \(Glow\)](#) on page 5559 component.
- **Specular** Output is the resulting specular component. Raw is determined by the Reflection > [Glossiness](#) on page 5549 value and the [Anisotropy](#) on page 5556 settings, while Level is determined by the [BRDF](#) on page 5557 settings, the [Reflectivity](#) on page 5548 and Reflection > [Color](#) on page 5549 values, and the [Relative Intensity of Highlights](#) on page 5571 value.
- **Translucency** Translucency is the combined result of the [Weight](#) on page 5554 and [Color](#) on page 5555 settings. Output is the resulting translucency component, Raw is the raw translucency, and Level is the actual translucency level, adjusted by the energy conservation.
- **Transparency** Transparency is the combined result of the [Refraction group](#) on page 5569 settings, including the Translucency settings. Output is the resulting transparency component, Raw is the raw transparency, and Level is the actual transparency level, adjusted by the energy conservation.

Proper Compositing

Due to the redundancy available in the outputs, there are several ways to composite them to yield the same result as the beauty render. Here we outline two compositing pipelines in equation form. You can use these in Autodesk Toxik and other HDR compositing applications.

First we have the “simple” variant, which is simply a sum of the various result parameters. This version allows only minimal post-production changes to the overall balance between the materials. Its advantage is in not needing as many files, as well as working reasonably well in non-floating-point compositing.

```
Beauty = Output Diffuse Direct Illumination + Output Diffuse Indirect Illumination + Output Specular + Output Reflections + Output Transparency + Output Translucency + Self Illumination
```

Then we have the more “complex” variant, which uses the various raw and level outputs, thus allowing much greater control in post production.

Note that the raw outputs need to be stored and composited in floating point to maintain the dynamic range. The level outputs always stay in the 0.0-1.0 range and do not require floating-point storage.

```
Beauty = Level Diffuse * (Raw Diffuse Direct Illumination + (Raw Diffuse Indirect Illumination * Raw Ambient Occlusion)) + Level Specular * Raw Specular + Level Reflections * Raw Reflections + Level Transparency * Raw Transparency + Level Translucency * Raw Translucency + Self Illumination
```

Interface

All mr A&D render elements have the same settings:

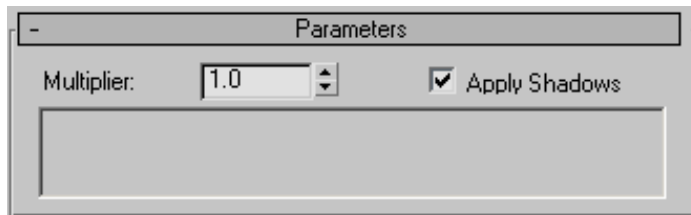

Multiplier Scales the brightness of the output.

TIP When rendering A&D elements for compositing in Autodesk Combustion, bear in mind that Combustion does not support HDR imagery, so to avoid clamping it will be necessary to adjust the Multiplier value for each element.

Apply Shadows When on, the output includes shadows cast on the surface.



mr Labeled Element Parameters Rollout

Rendering menu/main toolbar > Render Setup > Render Setup dialog > Render Elements panel > Render Elements rollout > Add button > Render Elements dialog > Add mr Labeled Element to the elements list (or highlight an mr Labeled Element entry in the list).

The mr Labeled Element is a render element that lets you output one or more branches of a material tree to a custom render element. (A branch comprises a map or shader and any sub-elements, such as maps assigned to the map's map slots.)

To use this element, assign the [mr Labeled Element shader](#) on page 6003 as the parent of the branch to render, give it a label, and then use the same label for the render element. For details, see the following procedure.

Procedure

To use the mr Labeled element:

- 1 In the Material Editor, determine which branch of a material to output as a separate element. For example, an Arch & Design material might contain a Gradient map assigned as a Diffuse > Color shader, and one of the Gradient maps could be assigned a Checker map, and one of the Checker maps could be assigned a Noise map. This procedure will assume you want to render the Checker map and its constituent Noise map to an element.

So the material structure would be like this:

A&D material > Gradient (Diffuse Color) > Checker (Gradient Color #1)
> Noise (Checker Color #1)

- 2 In the Material Editor, click the map button at the top of the branch you want to output. In this example, you'd click the Diffuse > Color map button in the Arch & Design material to open the Gradient map settings. You'd then click the first map button (Color #1) on the Gradient Parameters rollout to open the Checker map settings.

- 3 Click the map button just above the map rollouts on the right side of the Material Editor (in this example, Checker) to open the Material/Map Browser.
- 4 On the Material/Map Browser, double-click the mr Labeled Element item. This opens the Replace Map dialog.
- 5 Make sure “Keep old map as sub-map?” is chosen, and then click OK.
- 6 You now see the mr Labeled Element Parameters rollout. If you click the Shader/Map To Store (Passthrough) button, labeled “M”, you can access the branch that will be output to the render element: the Checker map containing the Noise map.
- 7 If you clicked the M button, go back up to the parent mr Labeled Element shader, and then enter a name for the element in the Label field. In this example, the name could be **checker/marble branch**.

The material structure would now be like this (new map in italics):

A&D material > Gradient (Diffuse Color) > *mr Labeled Element shader (Gradient Color #1)* > Checker (mr Labeled Element shader map) > Noise (Checker Color #1)

- 8 On the Render Setup dialog > Render Elements panel > Render Elements rollout, click Add. Choose the mr Labeled Element item from the list.
- 9 On the Parameters rollout for the element, enter the name you specified in step 7 in the Label field.
- 10 Set up the other Render Element parameters as necessary and then render the scene.

Your custom element is rendered to an image file.

The following illustration shows the example described in the preceding procedure. The left-hand image shows the full material, with the Noise inside the Checker inside the Gradient, and the right-hand image shows a labeled element containing only the Noise inside the Checker. The element renders only the part of the Checker map that is used by the Gradient map.

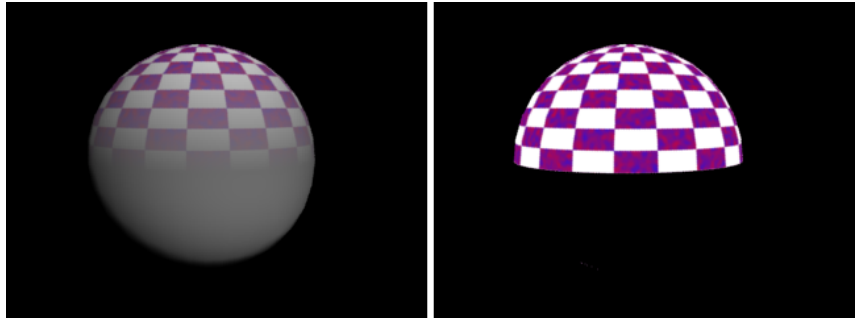

Left: Full rendering; Right: Labeled element

Interface

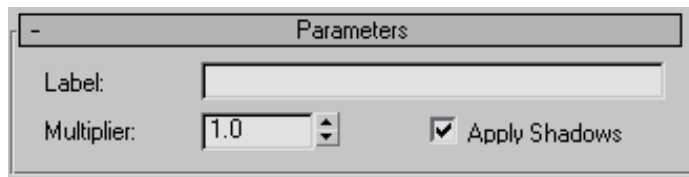

Label Enter the name of the element you specified in the mr Labeled Element Shader > Label field.

Multiplier Scales the brightness of the rendered output.

Apply Shadows When on, the output includes shadows cast on the surface.

mr Shader Element Parameters Rollout

Rendering menu/main toolbar > Render Setup > Render Setup dialog > Render Elements panel > Render Elements rollout > Add button > Render Elements dialog > Add mr Shader Element to the elements list (or highlight an mr Shader Element entry in the list).

The mr Shader element outputs the raw contribution of any mental ray shader in the scene. This includes standard 3ds Max materials and maps that are converted to mental ray shaders in the translation process. The output of this element does not figure into the final rendered output.

For example, you could use the mr Shader element to render a few different ambient occlusion passes (see [mental images Shader Libraries](#) on page 5977).

NOTE The mr Shader element is intended primarily for rendering shaders, not full materials. While you can, in most cases, most "material-style" shaders might contain their own code to write to render elements, and in some circumstances this can cause odd conflicts. For example, piping a Standard material through a [Material To Shader shader](#) on page 6001 into the mr Shader element is not recommended because it could cause the Standard material's render element to collide with the original render elements from the main render.

Procedure

To use the mr Shader element:

- 1 In the Material Editor, determine which shader to output as a separate element. For example, an Arch & Design material might contain a Gradient map assigned as a Diffuse > Color shader, and one of the Gradient maps could be assigned a Checker map, and one of the Checker maps could be assigned a Noise map. This procedure will assume you want to render the Checker map and its constituent Noise map to an element.

So the material structure would be like this:

A&D material > Gradient (Diffuse Color) > Checker (Gradient Color #1)
> Noise (Checker Color #1)

- 2 On the Render Setup dialog > Render Elements panel > Render Elements rollout, click Add. Choose the mr Shader Element item from the list.
- 3 On the Parameters rollout for the element, click the Shader button; this opens the Material/Map Browser dialog.
- 4 Make sure Browse From on the dialog is set to Scene. If the object to which the shader is applied is selected, you could also choose Selected. In the material tree, highlight the shader to output as an element.

NOTE Any subordinate shaders are also included in the element output.

- 5 Set up the other Render Element parameters as necessary and then render the scene.

Your Shader element is rendered to an image file.

The following illustration shows the example described in the preceding procedure. The left-hand image shows the full material, with the Noise

inside the Checker inside the Gradient, and the right-hand image shows a Shader element containing only the Noise inside the Checker. The element renders the entire Checker map even though only part of it is used by the Gradient map.

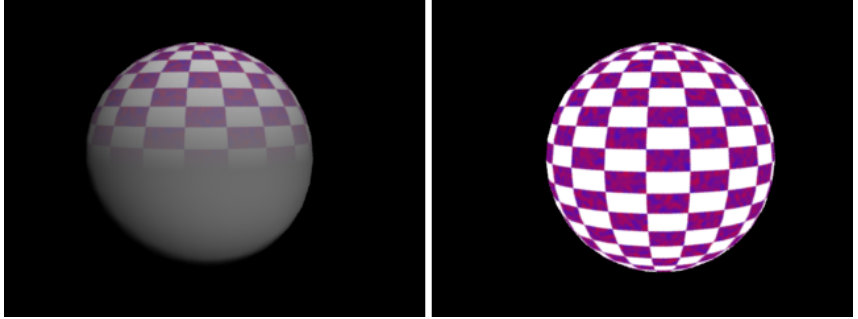

Left: Full rendering; Right: Shader element

Interface

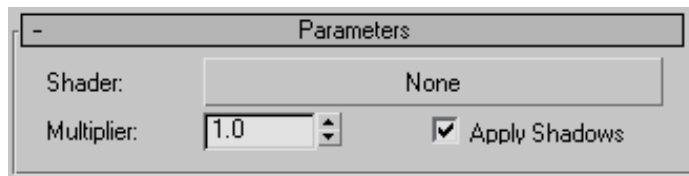

Shader The shader to render as an element. Click the button and then choose a shader or material from the list in the Material/Map Browser. Typically you'd want the element to output a shader in the scene, so you'd make sure Browse From is set to Selected or Scene.

Multiplier Scales the brightness of the rendered output.

Apply Shadows When on, the output includes shadows cast on the surface.

Velocity Element Parameters Rollout

Rendering menu/main toolbar > Render Setup > Render Setup dialog > Render Elements panel > Render Elements rollout > Add button > Render Elements dialog > Add Velocity element to the elements list (or highlight an existing Velocity element in the list).

The Velocity element generates a rendering that contains information about the motion of objects in the frame. You can use the Velocity rendering to generate motion blur when you use a composition application such as Combustion or Flame. There are plug-ins for compositors that generate motion blur; for example, those created by RE:Vision Effects, Inc.

The advantages of rendering a Velocity element are that the composition application might give you finer control over the motion blur than 3ds Max does; you can render a “beauty” frame that does not contain motion blur; and the Velocity element is quicker to render than using one of the 3ds Max motion-blur effects.

Another use of the Velocity element is to re-time clips rendered in 3D. There are specialized applications that allow you to re-time an image sequence, using velocity data to generate more accurate inbetween frames.

In the Velocity rendering, the motion information is saved as RGB color information: red saves movement on the X axis, green saves Y-axis movement, and blue saves Z-axis movement, relative to the plane of the rendered frame.

The mental ray renderer supports this element, but *the mental ray Motion Blur camera effect must be turned off*. Also, some mental ray materials do not support render elements.

Controls on the element's rollout let you improve the precision of the motion data saved in the rendering. See the procedure, following.

Procedures

To render a velocity element for an animation sequence:

- 1 On the Render dialog > Render Elements panel > Render Elements rollout, click Add. In the Render Elements dialog that appears, highlight Velocity, and then click OK.
- 2 Highlight the Velocity element in the Element Rendering list.
- 3 On the Velocity Element Parameters rollout, turn on Update, then render several test frames. (Choose frames where object velocity appears to be the greatest.)
- 4 After each test frame, make a note of the Maximum Velocity value. If you need to do so, enter the largest of these values as the Maximum Velocity to use.

Having a specific Maximum Velocity value will give you more accurate velocity data.

- 5 Turn off Update.
Now the Maximum Velocity will remain constant.
- 6 Render the animation.

Interface

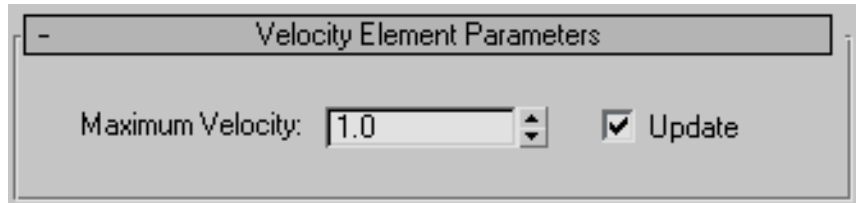

Maximum Velocity Enter a Maximum Velocity value based on the result collected by Update. Setting a Maximum Velocity increases the precision of the motion information. See the procedure, above: [Procedures](#) on page 6368. Default=1.0.

Update Turn on when you render test frames, as described in the above procedure. After each rendering, Maximum Velocity is set to the value recorded by update. Use the largest of these values, and then turn off Update before you render the full animation. Default=off.

NOTE The Update control does not work with mental ray distributed bucket rendering.

Z Element Parameters Rollout

Rendering menu/main toolbar > Render Setup > Render Setup dialog > Render Elements panel > Render Elements rollout > Add button > Render Elements dialog > Add Z Depth element to the elements list (or select an existing Z Depth element in the list).

The Z-depth element is a grayscale representation of the Z depth, or depth within the view, of objects within the scene. The nearest objects appear in white, and the depth of the scene in black. Intermediate objects are in gray. The darker the gray, the deeper the object is, within the view.

This rollout lets you adjust what portion of the scene is shown in the Z-depth rendering. By default, the rendering includes objects near the front of the view (Z Min=100.0), and extends for 300 3ds Max units into the scene (Z

Max=300.0). If your scene is deeper than 300 units, you need to increase the value of Z Max.

You can use the Update option to let the software automatically determine the depth extents of objects in the rendered view.

Interface

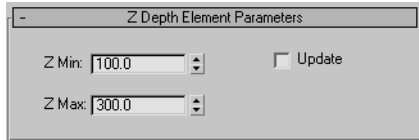

Z Min The minimum distance to include in the Z-depth rendering. This is a value in 3ds Max units, and cannot be less than 0.0. Default=100.0

Z Max The maximum distance to include in the Z-depth rendering. This is a value in 3ds Max units. Default=300.0

Update Lets the software automatically determine the depth range of objects in the rendered view. When on, after completion of a rendering, the software changes the Z Min and Z Max values to reflect what the renderer determined. Typically, you would make a single test rendering with this on, and then turn off the check box.

Diffuse Texture Element Rollout

Rendering menu/main toolbar > Render Setup > Render Setup dialog > Render Elements panel > Render Elements rollout > Add button > Render Elements dialog > Add Diffuse element to the elements list (or select an existing Diffuse element in the list).

The Diffuse render element displays the diffuse color component of objects in the scene.

Interface

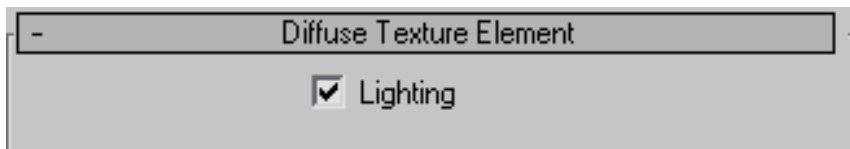

Lighting When on, the diffuse render element displays the color of objects *after* lighting has been applied.

When Lighting is turned off, the element displays the diffuse color of objects before the lighting gets applied. For textured objects, this will look like a 3D projection of the texture. However, objects with a single color will look “flat”.

Render to Texture

Make sure the default scanline renderer or the mental ray renderer is the active renderer. > Select one or more objects. > Rendering menu > Render To Texture

Rendering to texture, or “texture baking,” allows you to create texture maps based on an object's appearance in the rendered scene. The textures are then “baked” into the object: that is, they become part of the object via mapping, and can be used to display the textured object rapidly on Direct3D devices such as graphics display cards or game engines.

You can render to textures using the [mental ray renderer](#) on page 6230

Typical Texture Baking Method

- 1 Set up a scene with lighting.



Banana object in a lighted room

- 2 Select the objects whose textures you want to bake.

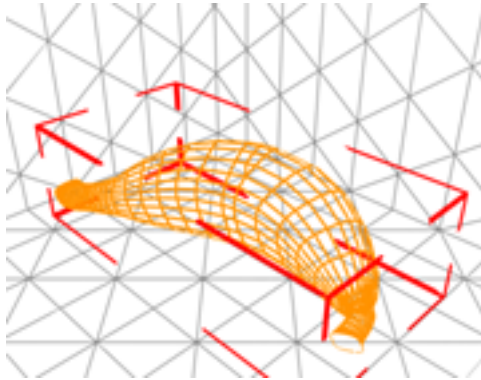

Banana object selected

- 3 Choose Rendering > Render To Texture.
- 4 A [Render To Texture dialog](#) on page 6397 appears. In this dialog, you choose which [elements](#) on page 6376 of the rendering you want to bake. Elements are aspects of the rendering such as diffuse color, shadows, alpha (transparency/opacity), and so on.

In this dialog, you can also choose various [display options](#) on page 6383 for showing the baked texture in shaded viewports.

TIP If you have a Direct3D graphics display driver, you can use [DirectX viewport shaders](#) on page 5393 to view the baked texture in shaded viewports. They show how the baked texture will appear on DirectX devices.

- 5 Click Render.

After you click Render in the Render To Texture dialog, a number of things happen. (This is a typical set of events; the dialog gives you a lot of control over how texture baking actually occurs.)

- The elements you chose are rendered, each to its separate bitmap file.

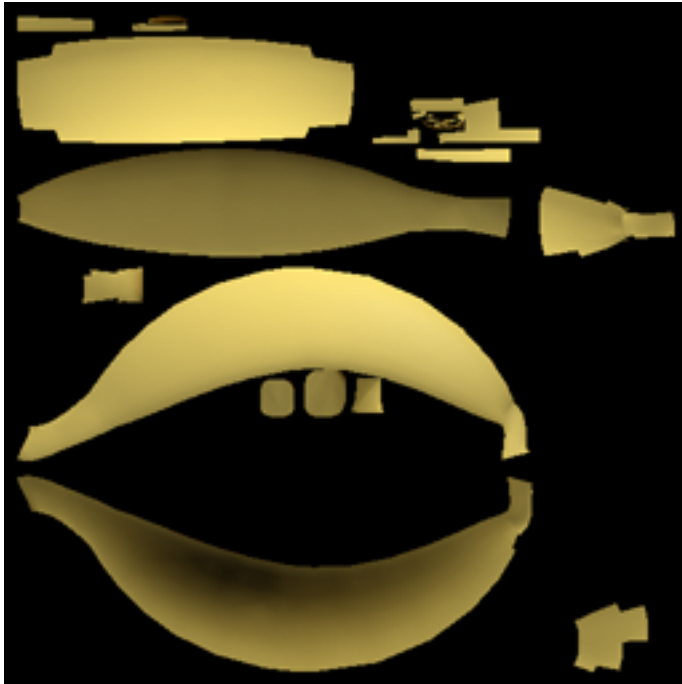

Lighting map of the banana

By default, the texture type is [Targa](#) on page 7370, and the element maps are placed in the *\images* subfolder of the folder where you installed the program.

The new textures are “flat”: In other words, they are organized according to groups of object faces.

- In the modifier stack, a new modifier is applied to the object. It is called Automatic Flatten UVs. It is simply an [Unwrap UVW modifier](#) on page 1841, automatically applied.

This modifier manages the mapping of the flattened texture to faces of the object, and lets you adjust that mapping if necessary.

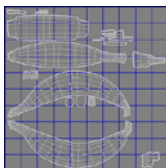

Flattened texture-mapping coordinates for the banana

- A [Shell material](#) on page 5732 is applied to the object. This material is a container for both the object's original material (you don't lose those maps and settings), and the newly created baked material, with its new textures. The Shell material lets you access both materials and adjust their settings, if necessary. It also lets you choose which material to view, the original material or the texture-baked material, in shaded viewports or in renderings.

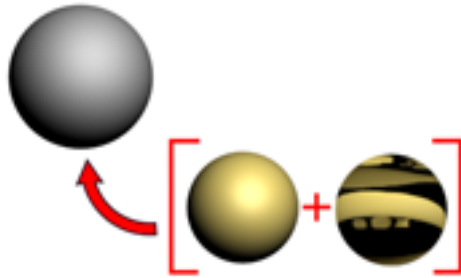

New shell material contains the banana's original material (below left) and the baked texture (below right).

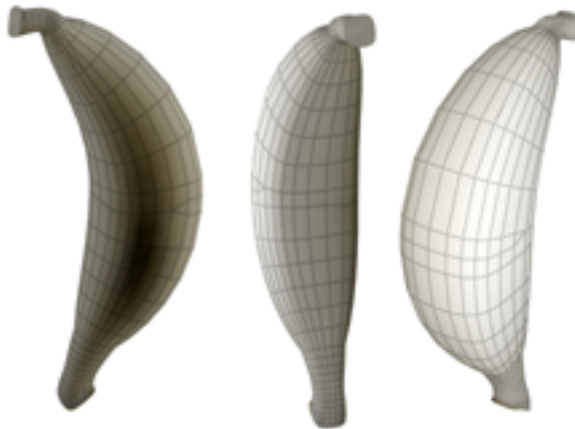

Rendered light map applied to the banana



With the light map, banana appears lit even when lights are turned off.

That is texture baking in a nutshell.

For best results, Logarithmic exposure control is recommended for Render To Texture.

If Linear or Automatic exposure controls are used, each object will have different lighting levels, generating a different histogram. Each object renders as if it had a different light level and in some cases, you may not get a rendering at all. This happens because Linear and Automatic exposure controls are view dependent.

Logarithmic Exposure Control is not view dependent, and will reproduce the image correctly. See the [Exposure Controls](#) on page 6732 topic for more information about Linear, Automatic and Logarithmic exposure controls.

See also:

- [Baked Texture Elements](#) on page 6376
- [Target Map Slot Assignments](#) on page 6383
- [Render to Texture Dialog](#) on page 6397
- [Render to Texture: General Settings Rollout](#) on page 6399
- [Render to Texture: Objects to Bake Rollout](#) on page 6401

- [Render to Texture: Output Rollout](#) on page 6406
- [Render to Texture: Baked Material Rollout](#) on page 6410
- [Render to Texture: Automatic Mapping Rollout](#) on page 6413
- [Render to Texture: Add Texture Elements Dialog](#) on page 6415
- [Shell Material](#) on page 5732
- [DirectX Manager Rollout](#) on page 5393
- [LightMap Shader Rollout](#) on page 5760
- [Metal Bump Shader Rollout](#) on page 5761

Baked Texture Elements

Select objects. > Rendering menu > Render to Texture > Render to Texture dialog > Output rollout > Click Add. > Add Texture Elements dialog > Choose elements to render.

When you render to texture or “bake” a texture, you choose one or more elements to render. These elements save aspects of the rendered scene: its geometry, lighting, shadows, and so on. Some texture elements can display in shaded viewports; others require a [DirectX viewport shader](#) on page 5393 to view in 3ds Max.

When you add an element to render, it appears in a list in the [Objects To Bake](#) on page 6401 rollout. In the list, you can disable or enable rendering of that individual map, or select it to adjust which components it will include.

NOTE Automatically generated reflections and refractions do not work well with rendered textures, although they are included in the Complete and Blend texture maps.

The available element maps are described in the sections that follow.

Limitations of Composite and Blend Materials

If the object has a Composite or Blend material applied to it, only certain elements render correctly. Which elements render correctly depend on the renderer you are using.

The default scanline renderer renders only these elements of a Composite or Blend material correctly:

- Diffuse color
- Specular color
- Reflections
- Ambient color
- Self-illumination color
- Refractions

The mental ray renderer renders only these elements of a Composite or Blend material correctly:

- Lighting
- Shadows
- Normals

Component Options (Unique Settings)

Many element maps let you choose to include or not include components of the rendered scene. When your element to render is highlighted in the list, these options appear on the Selected Element Unique Settings group.

See also:

- [Render to Texture](#) on page 6371
- [Render to Texture Dialog](#) on page 6397

Complete Map

A complete map saves most surface properties of the rendered object; specifically:

- Lighting
- Diffuse color
- Specular color

- Reflections
- Shadows
- Ambient color
- Self-illumination color
- Refractions

Component Options (Selected Elements Unique Settings)

For a complete map, you can choose not to render shadows.

Specular Map

A specular map saves only the specular color of the object.

Component Options (Selected Elements Unique Settings)

For a specular map, you can choose not to render lighting or shadows.

Diffuse Map

A diffuse map saves only the diffuse color of the object.

Component Options (Selected Elements Unique Settings)

For a diffuse map, you can choose not to render lighting or shadows.

Shadows Map

A shadows map saves only the shadows cast onto the object.

Component Options (Selected Elements Unique Settings)

There are no unique settings for a shadows map.

Lighting Map

A lighting map saves only the lighting cast onto the object.

Component Options (Selected Elements Unique Settings)

For a lighting map, you can choose not to render shadows, direct light, or indirect light.

Normals Map

A normals map saves a color gradient that indicates the direction of normals on the surface of the object. With a normals map, Direct3D rendering can make simple geometry appear more complex.

With DirectX 8, you can view a normals map in shaded viewports by using the [Metal Bump Direct3D viewport shader](#) on page 5761.

With DirectX 9, you can view a normals map in any shaded viewport.

Component Options (Selected Elements Unique Settings)

There are two unique settings for a normals map:

Output into Normal Bump When on, assigns a Normal Bump map to the Target Map Slot, and places the rendered Normal Bump map in the Normal component of the [Normal Bump map](#) on page 6033. Default=off.

Render Height Map into Alpha Channel When on, renders a grayscale height map and assigns it to the alpha channel of the Normal map. If you are rendering to a file type that doesn't have an alpha channel, this setting has no effect. Default=off.

Height Map

A height map is a grayscale map that stores the relative height of the source object when you render with normal projection. (See [Creating and Using Normal Bump Maps](#) on page 6384.) You can use the height map as a displacement map on the target object. This is a way to add detail to the edges of the low-resolution object, because edges are not affected by the normal bump map itself.

NOTE When using a height map as a displacement map with the mental ray renderer, be sure to use the [Height Map Displacement shader](#) on page 6000. Also, turn off Smoothing, either [globally](#) on page 6294 or for the individual object on the Object Properties dialog > [mental ray panel](#) on page 322. In addition, when rendering with mental ray, if you're applying the height map to a standard material, apply the map as a Displacement map on the [mental ray Connection rollout](#) on page 5385 (unlock the map first), not on the Maps rollout.

TIP Using a paint program such as Adobe Photoshop on a height map is possible, but prone to error. The values in the height map depend on the shapes of both the low-resolution and high-resolution models, and it's easy to damage the mathematical accuracy. If you paint any changes onto the map, be careful to preserve the faceted look, and avoid the temptation to blur away the facets. You might try painting in Additive or Subtractive mode, to add to or subtract from the displacement, because Normal mode will set a fixed displacement, making it difficult for an artist to control the result.

Component Options (Selected Elements Unique Settings)

There are no unique settings for a height map.

Blend Map

A blend map is like a complete map, except that all its components, not just shadows, are optional.

Component Options (Selected Elements Unique Settings)

For a blend map, you can choose not to render any of the following components:

- Lighting
- Diffuse color
- Specular color
- Reflections
- Shadows
- Ambient color
- Self-illumination color
- Refractions

Alpha Map

An alpha map saves only the alpha channel of the rendered object.

Component Options (Selected Elements Unique Settings)

There are no unique settings for an alpha map.

Ambient Occlusion (MR) Map

Use an ambient occlusion map when you want the surface information to describe how much ambient light the surface can receive. The ambient occlusion map considers the obstruction of the light by surface contours and surrounding objects. By using the ambient occlusion map when rendering, you do not need to set up special lighting, replace materials on the objects, or use with global overrides because the ambient occlusion map already accounts for these settings.

You can use ambient occlusion maps with or without a Projection modifier and for many different purposes. Use them to mask layers in Adobe Photoshop, for items such as painted edits and texture maps. Also use them as dirt maps, or as masks for reflections or specular light.

NOTE By default, the shader used by the Ambient Occlusion bake element excludes the low-resolution object from the ambient occlusion calculations whenever performing projection-mapped texture baking. However, if the Projection Mapping option [Include Working Model](#) on page 6419 is enabled, then the occlusion rays will include the working model. In this case, projection rays also include the working model. No undesired blank areas appear on the map, because there are no cases where a projection ray passes through the lo-res model to hit a point on the high-res model that is completely occluded by the low res.

NOTE This map is available only when the mental ray renderer is active.

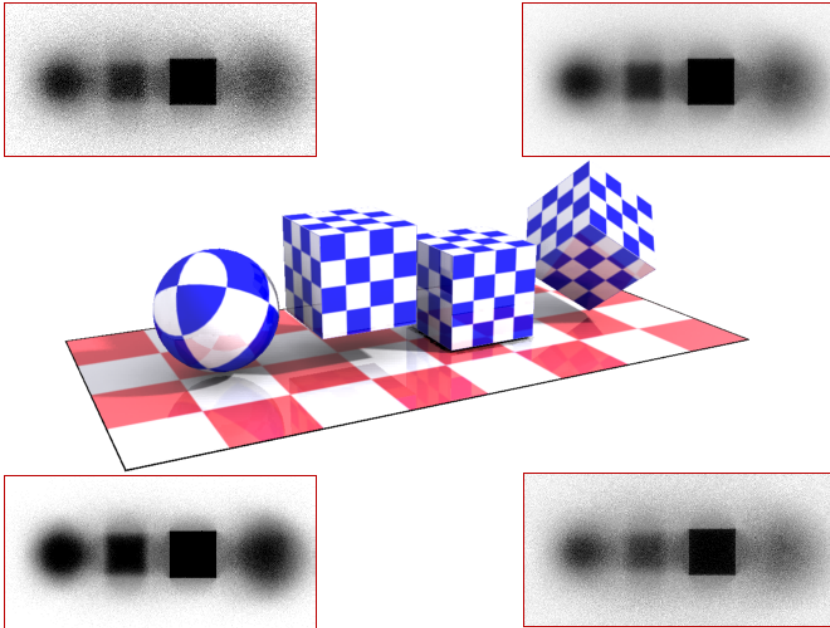

Original scene surrounded by rendered-to-texture ambient occlusion maps of the floor object

Top left: Samples=8; Spread=0.8

Top right: Samples=32; Spread=0.8

Bottom left: Samples=16; Spread=0.5

Bottom right: Samples=16; Spread=0.99

Component Options (Selected Elements Unique Settings)



For an ambient occlusion map, you can set the following unique settings:

Samples Sets the number of rays cast. More rays results in a smoother image. Default=16.

Spread Sets the spread of the ray, creating a cone shape. With a value of 0.0 a single point is sampled; with a value of 1.0 the entire hemisphere is sampled. Range=0.0–1.0. Default=0.8.

NOTE You can set Spread to values greater than 1.0, but only values within the specified range are useful.

Bright Sets the color in the map where no occlusion occurs. The default color is white. Click the swatch to change the color.

Max distance Sets the range within which geometry is probed. A value of 0.0 samples the entire scene. For non-zero values, only objects within this range are sampled. Default 0.0.

Dark Sets the color in the map where complete occlusion occurs. The default color is black. Click the swatch to change the color.

NOTE Colors between the Bright and Dark values are used to indicate partial occlusion.

Falloff Defines the amount of falloff of the ray. The greater the value, the greater the falloff. Default=1.0.

Target Map Slot Assignments

Select objects. > Rendering menu > Render to Texture > Render to Texture dialog > Output rollout > Target Map Slot: drop-down list > Specify how baked textures appear in the material.

When you bake textures (render to texture), you have more control for how the baked texture displays in shaded viewports. You set these in the [Output rollout](#) on page 6406 of the Render To Texture dialog. Using the Target Map Slot assignments, you can specify in detail which maps will be rendered to which slots of the existing material.

NOTE The first time you use Render To Texture, all Target Map Slot assignments are blank. After you set them and render the baked texture, those settings become the default Target Map Slot settings for future modelling sessions. 3ds Max stores the Target Map Slot assignments in the *texturebake.ini* file in the *plugcfg* folder within the program directory.

Creating and Using Normal Bump Maps

Normal bump mapping is a way of adding high-resolution detail to low-polygon objects. It is especially useful for real-time display devices such as game engines, and it can also be used in rendered scenes and animations.

A normals map is a three-color map, unlike the grayscale maps used for regular bump mapping (see [Bump Mapping](#) on page 5478). The red channel encodes the left-right axis of normal orientation, the green channel encodes the up-down axis of normal orientation, and the blue channel encodes vertical depth.

Basic Workflow

3ds Max provides a number of different ways to create and use normal bump mapping, but the most straightforward and simplest workflow involves these steps:

- 1 Create a detailed, high-resolution model.
- 2 Create a simpler, low-resolution model.
The low-resolution model should have the general shape and outlines of the high-resolution model, and typically it should be a bit smaller, so that projected detail in the high-res model will appear to be above its surface.
- 3 Select the low-res model.
- 4 Choose Rendering > Render to Texture.
The Render To Texture dialog appears.
- 5 On the Objects To Bake rollout, in the Projection Mapping group, click Pick.
A selection dialog appears.
- 6 Choose the high-res object, and then click Add.
3ds Max applies a [Projection modifier](#) on page 1628 to the low-res object.
- 7 In the Projection Mapping group, turn on Enable.

NOTE At this stage, often you will click Options to display the [Projection Options dialog](#) on page 6416, which has a variety of settings for how to generate the projection.

- 8 On the Output rollout, add a NormalsMap element (see [Baked Texture Elements](#) on page 6376). Assign Bump as its target map slot.
- 9 In the Selected Elements Unique settings group, turn on Output Into Normal Bump.
- 10 Click Render.
3ds Max renders the Normals map, which stores normals data from the high-res object. As for other kinds of texture baking, it creates a Shell material and applies that to the low-res object, with the Normals map assigned as the bump component.

Components of Normal Bump Mapping

In the 3ds Max interface, controls for normal bump maps appear in three locations:

- The Render To Texture dialog
Specifically, normal projection controls are found on the [Objects To Bake rollout](#) on page 6401 and the [Output rollout](#) on page 6406.
- The [Projection modifier](#) on page 1628
You can apply a Projection modifier yourself, or let Render To Texture do so automatically.
- The [Normal Bump map type](#) on page 6033
Render To Texture creates this automatically if you turn on Output Into Normal Bump (step 9, above).

Viewing Normal Bump Maps

If your display driver uses DirectX 8, you can view normal maps in viewports by using the [Metal Bump shader](#) on page 5761. If your graphics driver is DirectX 9, you can view normal maps in any shaded viewport. See [Direct3D Driver Setup Dialog](#) on page 7800.

If your display driver is Software or OpenGL, you can't view normal maps in viewports. However, you can still render them and use normal mapping in renderings.

Normal Projection with Sub-Object Selections

You can associate different sub-object selections with different high-resolution geometry. See [Reference Geometry Rollout \(Projection Modifier\)](#) on page 1633.

Troubleshooting Normal Bump Maps

Because of the variety of geometry and different situations that can arise, normal bump maps sometimes give unexpected results. Usually there is a workaround for the problem, or more than one. This topic describes some situations that can arise, and ways to correct them.

Parallel Projection Loses Detail

If the projection cage is set up so projected rays run parallel to part of the high-resolution geometry, that portion of geometry can be lost in the normal bump map.

For example, in this scene, the normal bump map is based on a high-resolution cylinder that has indentations at the top and bottom.

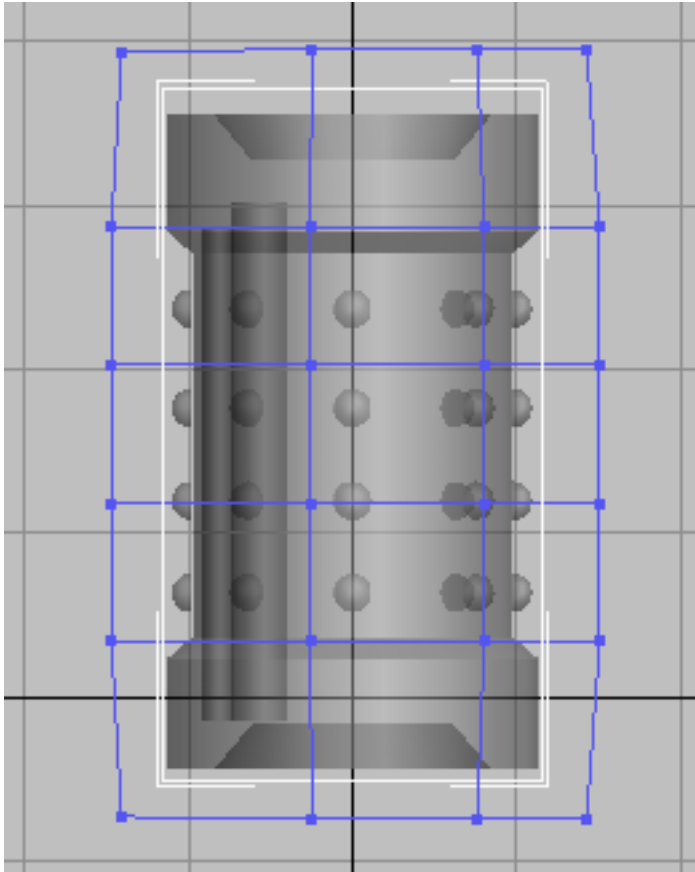

Default cage around high-res cylinder

However, the normal bump map does not show the end indentations.



Indentation is missing from top and bottom of the cylinder's normal bump map.

The reason is that with the default projection cage, the rays parallel the sides of the indentation, and so details are lost.

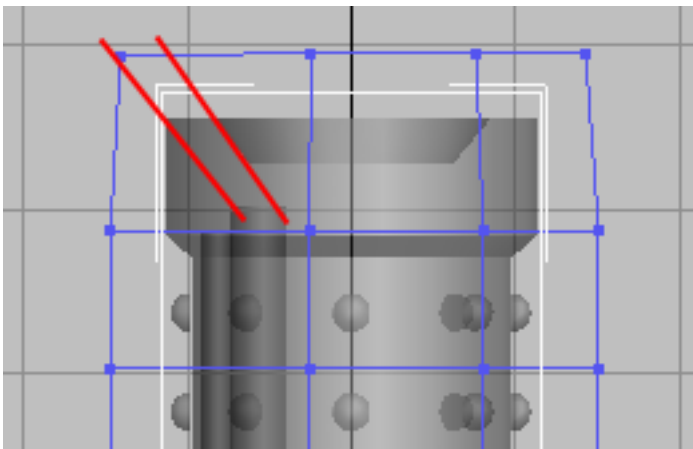

Projection rays (shown in red) parallel the sides of the indentation.

To correct the problem, you can move the end of the cage upward, and scale it inward a little, so the rays don't run so nearly parallel to the side of the indentation.

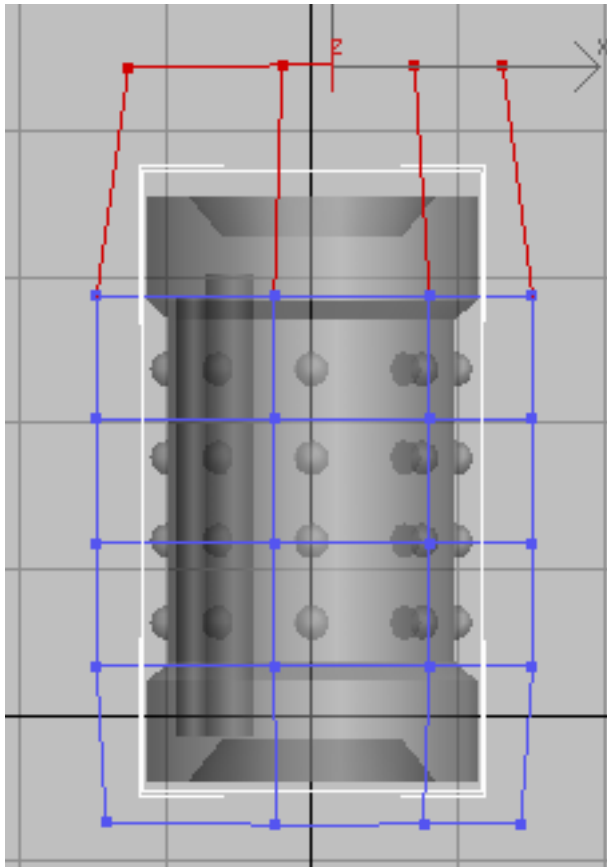

Raising and scaling the upper end of the projection cage.

When the cage is adjusted this way, the indentation appears in the normal bump map.

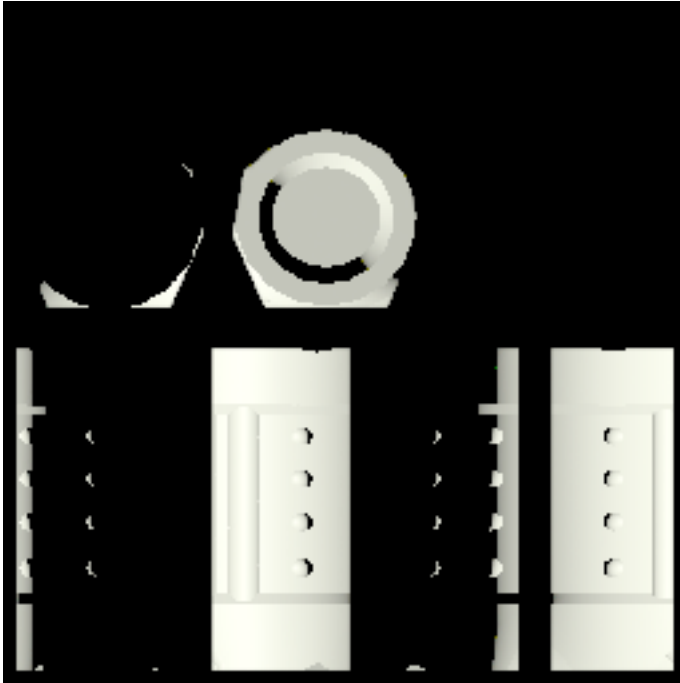

With the corrected cage, the upper indentation appears correctly in the normal bump map.

TIP In situations like this, another solution can be to use Break on the vertices in the region of the *low-resolution object* where detail is missing from the map. This increases the number of vertices in the cage, and reduces the chances of geometry being missed. If you use this method, it is likely you will need to make further adjustments to the projection cage, as well.

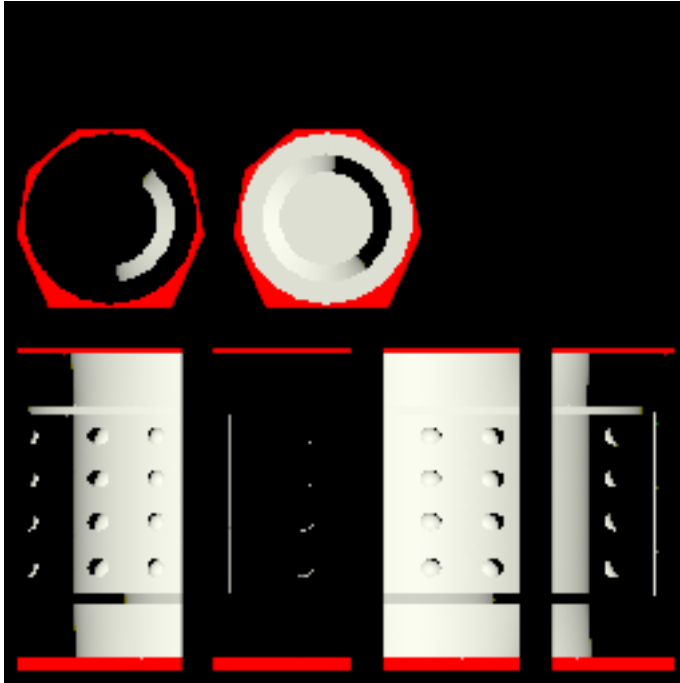

Breaking low-res vertices causes the indentations to render in the normal bump map. However, projection now misses some areas of the geometry, so the cage needs to be adjusted further.

Flipped Seams in Tangent Space

When you use tangent space for your normal bump map, usually the values used for the tangents are consistent between the hardware shader, renderers, and third-party applications. However, sometimes portions of the geometry are flipped, relative to each other, causing discontinuities when you render or use a hardware shader. Tangent space is the default option for normal bump mapping, and it is the method you should use for objects that both move and deform, such as animated characters. This problem does not arise when you use the other coordinate spaces: world, screen, or local.

For example, in the following scene, the pants show discontinuities. They are flipped relative to each other, as the arrows show.

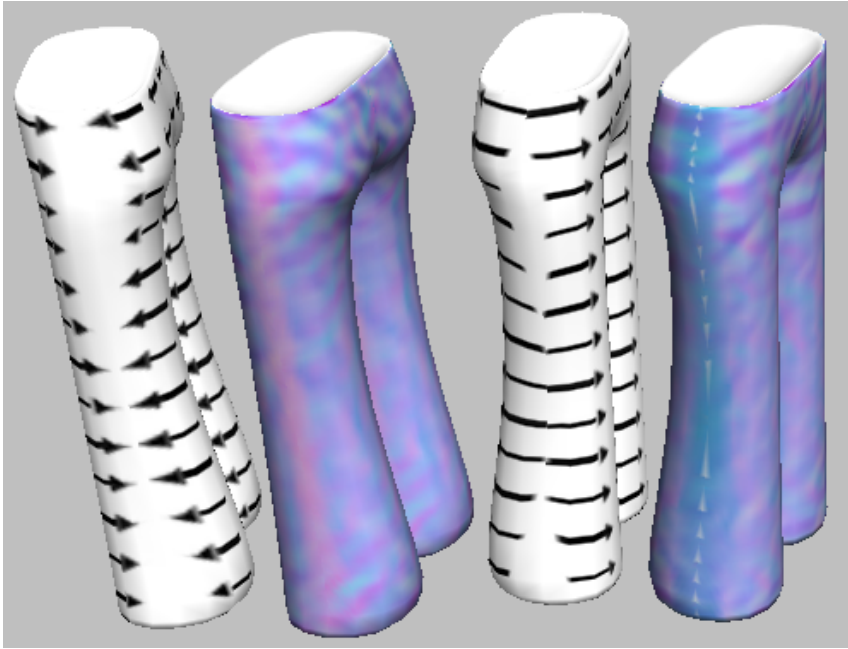

Flipped seams in rendering of pants

Left: Left side shows a discontinuous red stripe

Right: Right side shows a discontinuous blue stripe

The arrows show how the maps are misaligned.

When you render a normal bump map, you can generally see flipped areas as showing a “flare” of reddish color to the right, and of bluish color to the left.

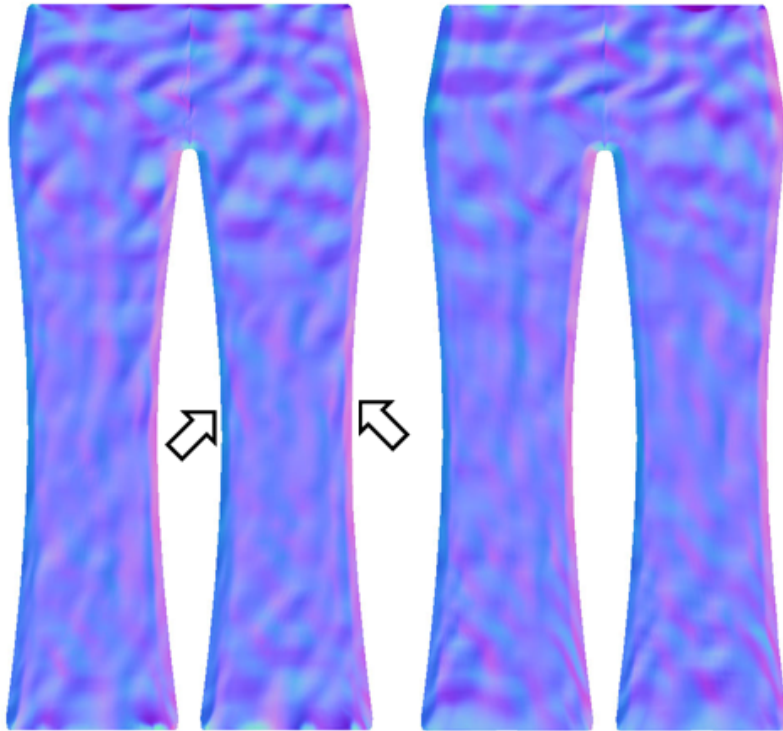

Uncorrected normal bump map shows blue and red “flares.”

The solution is to use the UVW Unwrap modifier's Flip Horizontal command for those sub-object selections that show flaring, or an excess of red areas.

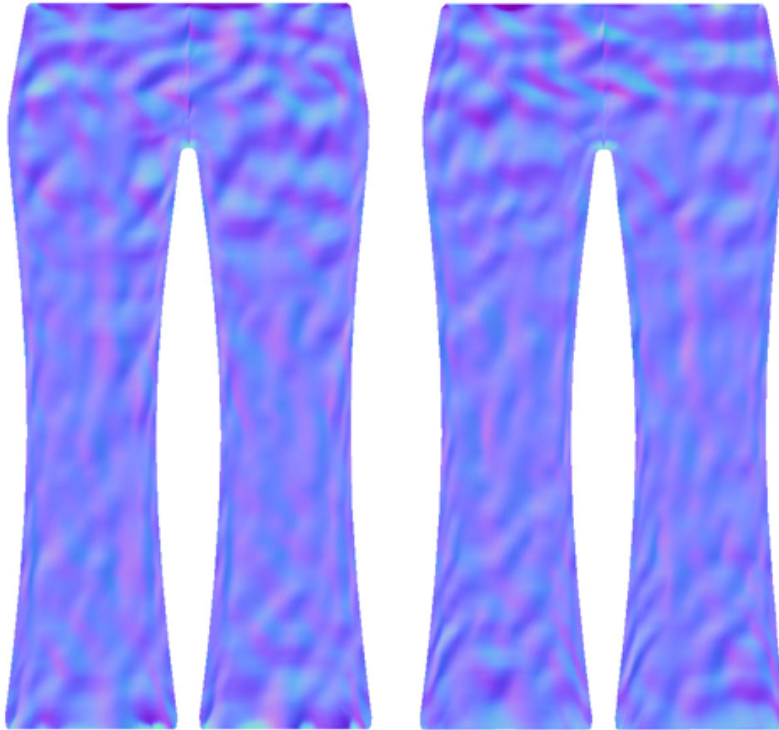

Normal bump maps corrected using Flip Horizontal
Red and blue are more evenly distributed, with blue predominating.

With the maps corrected, the full rendering, whether with 3ds Max or a hardware renderer, looks better.

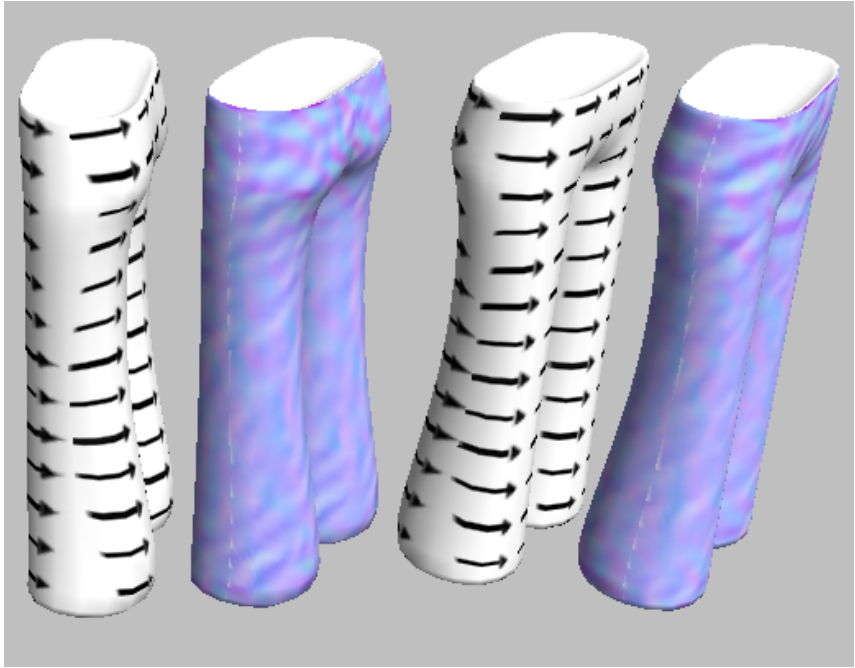

Corrected normal maps render more smoothly, without discontinuity.

The arrows show how the maps are correctly aligned to wrap around the pant legs.

Noise when Rendering a Normal Bump Map with the mental ray Renderer

If you use the mental ray renderer to render a normal bump map, and the model has overlapping faces (for example, where the low-resolution and high-resolution objects overlap in space), then the normal bump map can show noise where the faces overlap.

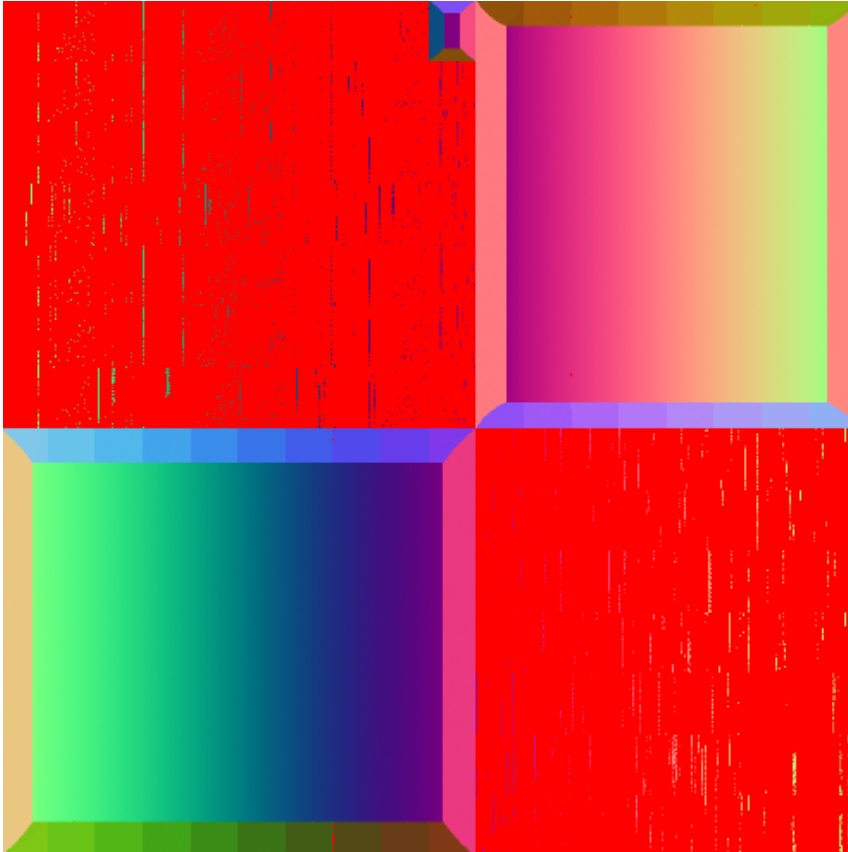

Red areas show noise from overlapping faces

The workaround is to adjust either the high-res or the low-res object so that faces are not coincident. One way to do so is to use a [Push modifier](#) on page 1646. After you have generated the normal map, you can turn off the Push modifier.

TIP If another object in the scene continues to cause problems with the map rendering, you can make it invisible to normal projection by going to its Object Properties dialog, and in the Rendering Control group, turning off Visible To Reflection/Refraction.

Overlapping UV Coordinates

Overlapping UV coordinates can cause rendering errors in Render To Texture. The problem is especially noticeable on objects that have mirrored UVs, or symmetrical mapping. If you are working with a character or other model that has mirrored UVs, we recommend that you follow this procedure:

- 1 Either add an Unwrap modifier or go into an existing Unwrap modifier where the symmetry exists.
- 2 Move half of the overlapping texture coordinates on the W axis so that they're slightly offset from the other half.
Render To Texture will use the texture coordinates with the higher W value.

Edit Normals Modifier Makes Normal Bump Mapping Incorrect

Don't apply an [Edit Normals modifier](#) on page 1354 to the low-res object. Normal bump projection relies on the low-res object having standard normals, and altering them causes normal bump maps to have unpredictable results.

Render to Texture Dialog

Rendering menu > Render To Texture > Render to Texture dialog

Rendering to texture, or “texture baking,” is controlled by this dialog. Most of this dialog's controls are contained in its rollouts.

See also:

- [General Settings rollout](#) on page 6399
- [Objects To Bake Rollout](#) on page 6401
- [Output Rollout](#) on page 6406
- [Baked Material Rollout](#) on page 6410
- [Automatic Mapping Rollout](#) on page 6413

Procedures

To bake an object's texture:

There are a lot of options for rendering to textures. These are the basic overall steps.

- 1 Select an object.
Ideally, the object will have a texture assigned to it, or lights and shadows that fall on it, and so on.
- 2 Choose Rendering > Render To Texture.
- 3 In the same dialog, go to the Output rollout.
- 4 Click Add, and in the Add Texture Elements dialog, choose the element(s) you want to render.
- 5 Set Target Map Slots, if necessary.
- 6 Click Render.
The elements you chose to render are rendered to files, and the baked texture is displayed in shaded viewports.

To bake the texture of multiple objects:

- 1 Set up the texture-baking parameters of each object you want to bake. This corresponds to steps 2 through 5 of the previous procedure.
- 2 In the Objects To Bake rollout, change All Selected to All Prepared.
- 3 Click Render.
Textures are rendered for all the objects you previously set up.

Interface

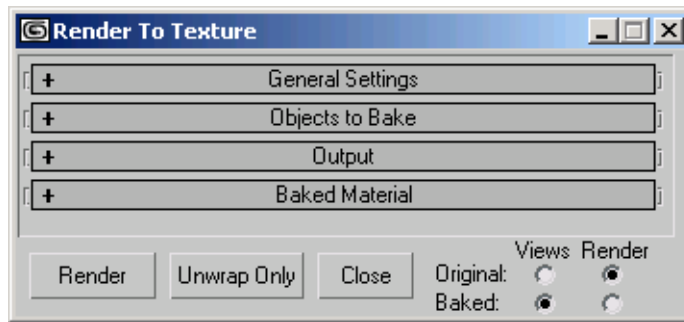

Render Renders the scene, or the elements listed in the Objects To Bake rollout.

Unwrap Only Applies the Automatic Flatten UVs modifier to all selected objects without rendering anything.

Close Closes the dialog and saves any changes to settings you have made.

Original/Baked When set to Views, the original or baked material is displayed in the viewports. When set to Render, the original or baked material is used in the rendering.

Render to Texture: General Settings Rollout

Rendering menu > Render To Texture > Render to Texture dialog > General Settings rollout

This rollout has the texture-baking controls for the current scene. It lets you control automatic unwrapping of the baked textures, map size, render settings, and where texture renderings are saved.

See also:

- [Render to Texture](#) on page 6371
- [Render to Texture Dialog](#) on page 6397
- [Render to Texture: Objects To Bake Rollout](#) on page 6401
- [Render to Texture: Output Rollout](#) on page 6406
- [Render to Texture: Baked Material Rollout](#) on page 6410

- [Render to Texture: Automatic Mapping Rollout](#) on page 6413

Interface

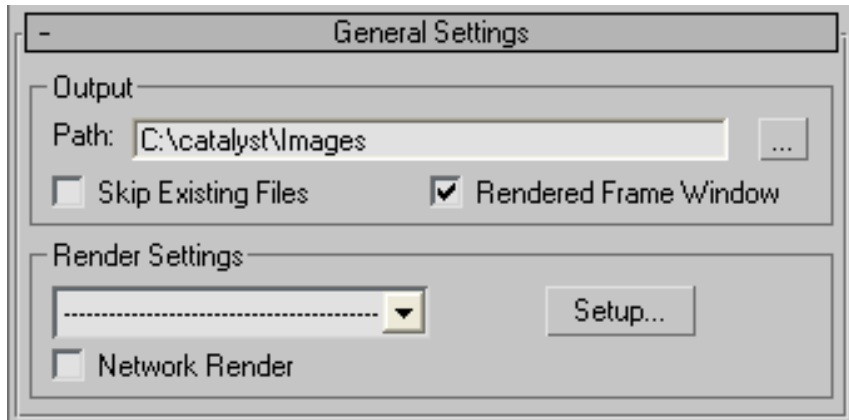

Output group

Text field Specifies the folder where the rendered texture will be saved. You can enter a different folder name in this field. Default=the *Images* subfolder of the folder where you installed 3ds Max.

 Click the ellipsis button to display a dialog that lets you browse to the directory where you want the rendered texture to be saved.

Skip Existing Files Allows you to render only those maps that do not already exist.

Rendered Frame Window When on, displays the complete map in a [Rendered Frame Window](#) on page 6073 as the elements are rendered. When off, does not open the Rendered Frame Window. Default=on.

NOTE The Rendered Frame Window does not open when you use Render To Texture with the mental ray renderer. Instead, 3ds Max displays a progress dialog.

Render Settings group

These controls let you choose and set up Render Presets as well as activate network rendering.

Drop menu Lets you choose [Load Preset](#) on page 6114. A Render Presets Load dialog appears where you can select an RPS file.

Setup Displays the [Render dialog](#) on page 6067, where you can adjust production settings, draft settings, or both.

Network Render When on, you can assign the rendering task to Server systems. If you click Render, the [Network Job Assignment dialog](#) on page 6481 displays where you can specify a server, or multiple servers, to take on the task. Default=off.

3ds Max can use the [Split Scan Lines option](#) on page 6486 when rendering to textures with a render farm. However, if you enable projection mapping and turn on Sub-Object Levels, this option is unavailable.

Render to Texture: Objects to Bake Rollout

Rendering menu > Render To Texture > Render to Texture dialog > Objects to Bake rollout

This rollout has controls for the texture baking of individual objects. It lets you choose which map channel the texture will use, which elements will be rendered, and at what sizes. It also lets you control filename generation, and assign the format of rendered texture elements.

See also:

- [Render to Texture](#) on page 6371
- [Render To Texture Dialog](#) on page 6397
- [Render To Texture: General Settings Rollout](#) on page 6399
- [Render To Texture: Output Rollout](#) on page 6406
- [Render To Texture: Baked Material Rollout](#) on page 6410
- [Render to Texture: Automatic Mapping Rollout](#) on page 6413

Interface

Objects to Bake

Object and Output Settings

Preset:

Name	Object Channel	Sub-Object Channel	Edge Padding
Plane01	3		2

Selected Object Settings

Enabled Padding:

Projection Mapping

Enabled (No Projection Modifier) Pick... Options...

Object Level Sub-Object Levels

Put to Baked Material Put to Baked Material

Full Size Proportional

Mapping Coordinates

Object: Use Existing Channel Channel:

Use Automatic Unwrap

Sub-Objects: Use Existing Channel Channel:

Use Automatic Unwrap

Individual All Selected All Prepared

Object and Output Settings group

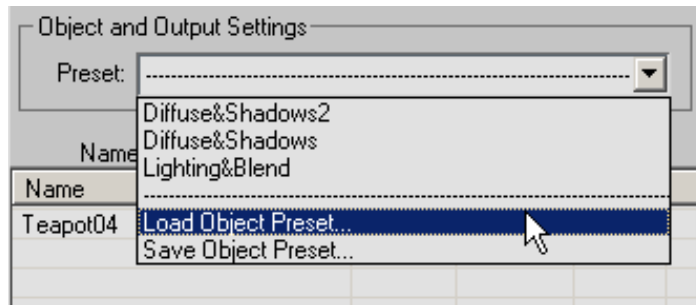

This drop-down list lets you save presets comprising all current Render To Texture settings, including map types and sizes, from a single object and then load a preset onto any number of objects. Render To Texture presets use the RTP filename extension. Presets contain all settings on the Objects to Bake and [Output](#) on page 6406 rollouts and the [Projection Options dialog](#) on page 6416. The only exceptions are the Object Level and Sub-Object Levels radio buttons in the Objects To Bake rollout > Projection Mapping group and the Use Automatic Unwrap > Channel numeric values in the Objects To Bake rollout > Mapping Coordinates group.

Preset Use the upper part of the drop-down list to choose an existing preset to load. The preset is applied to all objects in the objects list. The list contains up to the last 10 maps in the order that they were loaded or saved, with the most recent at the top.

After you choose a preset to load, a dialog appears showing you the path and name of the file containing the preset. Confirm or deny loading the preset by clicking Continue or Cancel, respectively.

In addition, if Projection Mapping is enabled, the dialog might contain related messages. For example, if the target object needs a Projection modifier, the dialog suggests that you use the Pick function to add one.

Load Object Preset Lets you load a preset that's not on the list. The preset is applied to all objects in the objects list. This command appears only when the list of objects contains one or more entries.

Save Object Preset Lets you save the current settings to a preset for later reuse.

NOTE You can save a preset only when the list of objects contains a single entry.

Object list

List of objects Shows all selected objects. Because the dialog is modeless, you can change the selection while it's open, and the list updates dynamically.

- **Name column** Lists the object's name.
- **Map Channel column** Lists the object's current map channel setting.
- **Edge Padding column** Lists the object's current edge padding setting.

Selected Object Settings group

Enable When on, the Channel and Padding controls are used for individual, all selected, and all prepared objects. When off, only selected object texture rendering uses these settings; “whole scene” rendering does not. Default=off.

Padding The amount, in pixels, that edges are allowed to overlap in the flattened (“unwrapped”) texture. Default=2 pixels.

If the baked texture shows visible seams when you view it in shaded viewports or renderings, try increasing this value.

Projection Mapping group

This group contains the controls for generating a normal bump projection. See [Creating and Using Normal Bump Maps](#) on page 6384

Enabled When on, normal bump projection is enabled using a [Projection modifier](#) on page 1628. When off, the Projection modifier is not used. Default=off. To generate a normal map rather than a normal bump map, leave Enabled turned off.

Modifier drop-down list When an object has been chosen, this list shows the Projection modifier. If multiple Projection modifiers have been assigned, their names are visible in the list as well.

Pick Click to designate the high-resolution object from which the Projection modifier will derive normals. This opens the Add Targets dialog, which works like the [Select From Scene dialog](#) on page 228 to let you select one or more objects on which to base the normal map.

Options Click to open the [Projection Options dialog](#) on page 6416, which contains various normal bump projection settings. When Individual is chosen (at the bottom of the Objects To Bake rollout), the options affect the selected object; when All Selected or All Prepared is chosen, the options apply to all selected or prepared objects.

Object Level When on, projects from the object level of the high-resolution object. Default=on.

- **Put to Baked Material** (The default.) When chosen, the object-level projection is rendered in the baked material.

Sub-Object Levels When on, uses the active sub-object selection, and makes the Mapping Coordinates group > Sub-Objects controls available. Default=on.

- **Put to Baked Material** When chosen, the sub-object level projection is rendered in the baked material.

The following options apply to sub-object rendering, when only a portion of the geometry is being rendered to the normal bump map:

- **Full Size** (The default.) When chosen, the size of the normal bump map is the same as if all geometry were being rendered.
- **Proportional** When chosen, the size of the normal bump map is fitted to the size of sub-object selection. The Proportional Multiplier on the Projection modifier's [Reference Geometry rollout](#) on page 1633 can change the default size of the proportional map.

For example, consider a plane that is 4 segments x 4 segments. Each "poly" in the plane is a separate sub-object, for a total of 16 sub-objects. If the output Map Size is 64, the object rendering output is 64 x 64 pixels. If Full Size is chosen, each sub-object rendering is also 64 x 64 pixels. If Proportional is chosen, each sub-object rendering is 16 x 16 pixels. If you change Proportional Multiplier to 2.0 in the Projection modifier, each sub-object rendering is now 32 x 32 pixels.

Mapping Coordinates group

Object These controls are for basing the rendered texture on the object level of the source object.

- **Use Existing Channel** When chosen, unwrapping uses an existing map channel.
- **Channel** When Use Existing Channel is active, lets you choose the channel to use for unwrapping.
- **Use Automatic Unwrap** (The default.) When chosen, uses automatic unwrapping, and applies an [“Automatic Flatten UVs” \(Unwrap UVW\) modifier](#) on page 1841 to the objects whose texture is being rendered.

Sub-Objects These controls are for basing the rendered texture on a sub-object selection of the source object.

- **Use Existing Channel** When chosen, unwrapping uses an existing map channel.
- **Channel** When Use Existing Channel is active, lets you choose the channel to use for unwrapping.
- **Use Automatic Unwrap** (The default.) When chosen, uses automatic unwrapping, and applies an [“Automatic Flatten UVs” \(Unwrap UVW\) modifier](#) on page 1841 to the objects whose texture is being rendered.

Clear Unwrappers Clears the unwrap modifiers from the stack.

The radio buttons at the bottom of the rollout let you choose which objects to bake. See [Render To Texture Dialog](#) on page 6397 for procedures.

- **Individual** Allows you to select each object and choose a set of output maps and targets for it. The list will display all selected objects.
- **All Selected** (The default.) Displays all the selected objects.
- **All Prepared** The list will display all visible and unfrozen objects in the scene, selected or not, which have unwrapped mapping on them.

Render to Texture: Output Rollout

Rendering menu > Render To Texture > Render to Texture dialog > Output rollout.

This rollout lets you specify the elements to render and their attributes.

See also:

- [Render to Texture](#) on page 6371
- [Render to Texture Dialog](#) on page 6397
- [Render to Texture: General Settings Rollout](#) on page 6399
- [Render to Texture: Objects To Bake Rollout](#) on page 6401
- [Render to Texture: Baked Material Rollout](#) on page 6410
- [Render to Texture: Automatic Mapping Rollout](#) on page 6413

Interface

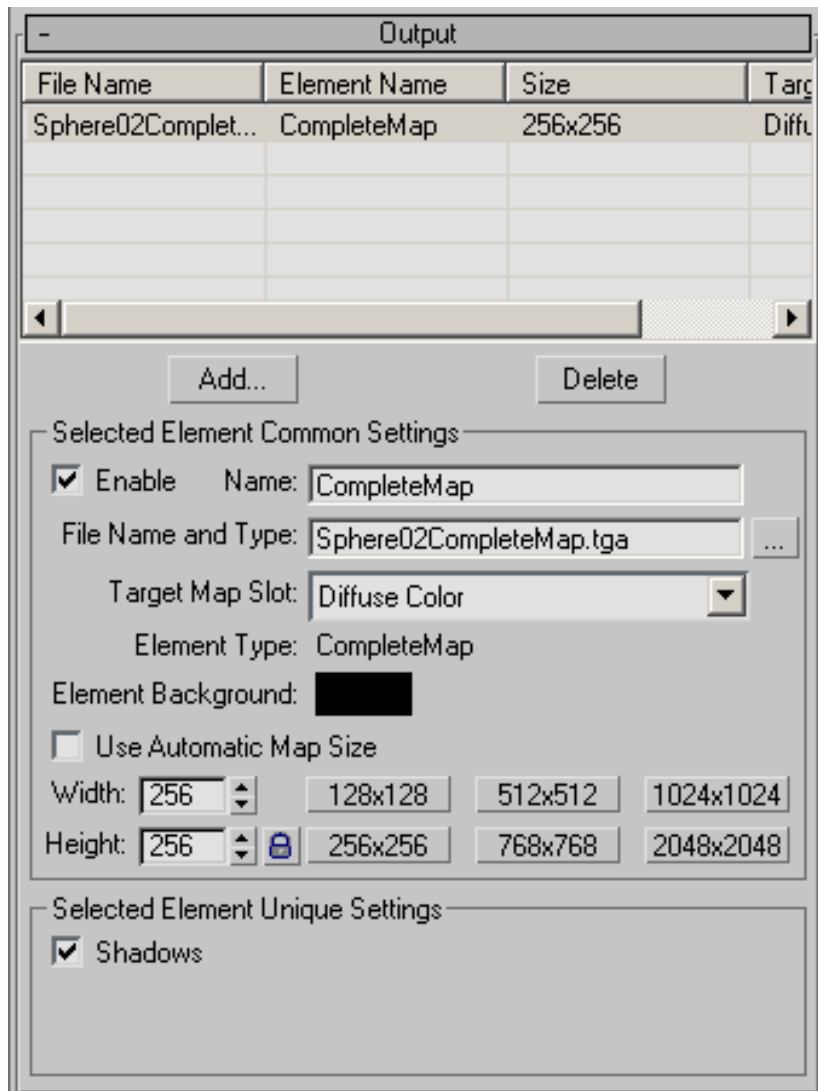

Output List Shows maps names, element names, map sizes and designated map slots.

- **File Name column** Lists the name of the map that will be generated.
- **Element Name column** Shows the element corresponding to the map.

- **Size column** Displays the map size.
- **Target Map Slot column** Shows which map slot will be occupied by the baked texture in the material.

The output list can display entries in black, gray and blank. If a group of objects is selected that has already has output assignments, maps that are shared by all will appear black, maps not shared by all will appear gray. If resolutions or target types are shared they will appear black, if not they will be blank.

Add Click to display an [Add Texture Elements dialog](#) on page 6415 to choose one or more element types to add to the list.

See [Baked Texture Elements](#) on page 6376 for a description of the different element choices.

Delete Click to remove the currently highlighted element from the list.

Selected Element Common Settings group

Enable When on, renders this element. When off, disables rendering of this element. Default=on.

Name Enter the element component of the file name. Default=the name of the element type.

File Name and Type Enter the file name of the rendered texture. Default=the object name followed by the element name, and [TGA format](#) on page 7370.

This field is disabled if All Selected or All Prepared is turned on in the [Objects To Bake rollout](#) on page 6401.



Click this button to display a file dialog you use to choose a name, directory, and file format for the rendered texture.

NOTE The File Name and Type setting specifies the path and filename only for the selected element. To set a folder where all baked textures will be stored, set the path in the Output group on the [General Settings rollout](#) on page 6399.

Target Map Slot Display all Map Types available to the materials assigned to the objects selected minus the ones already slated for output in the current Render To Texture session.

If more than one object is selected the all map types common to all the selected objects will be listed. If you choose to [Create New Baked](#) on page 6410, then the slots for the new baked material type will be displayed.

Element Type This read-only field displays the type of element, such as CompleteMap, that you specified when you added the element.

By default, the element name is the same as its type, but you can change it using the Name field. Element Type remains constant.

Element Background Lets you set the background color of the rendered output for the highlighted element.

Use Automatic Map Size When on, sets the texture size automatically, using the values on the [General Settings rollout](#) on page 6399. When off, the texture is the size specified by the following controls in this rollout. Default=off.

Width/Height Lets you specify dimensions for the texture. Range=0 to 8192. Default=256.

NOTE Increasing texture resolution increases render time.

To force the texture to be square, often a requirement with real-time 3D rendering engines, click the lock button next to Height.

Preset resolution buttons (128x128, ...) Click a button to specify a preset resolution for the texture.

Selected Element Unique Settings group

The contents of the Selected Element Unique Settings group vary depending on the active element. But the group always shows a list of toggles for various components of a scene, and by default, all toggles are on.

The following table shows which components apply to which elements (if the table shows “none,” the Selected Elements Unique settings group is not displayed):

Map Type	Components
Complete	Shadows
Specular	Lighting Shadows
Diffuse	Lighting Shadows

Map Type	Components
Shadows	(none)
Lighting	Shadows Direct Light On Indirect Light On
Normals	Output into Normal Bump Render Height Map into Alpha Channel
Blend	Lighting Diffuse Specular Reflection Shadows Ambient Self-Illumination Refraction
Alpha	(none)
Height	(none)

For a fuller description of the rendered texture elements, see [Baked Texture Elements](#) on page 6376.

Render to Texture: Baked Material Rollout

Rendering menu > Render To Texture > Render to Texture dialog > Baked Material rollout

Material Baking operates on the entire Render To Texture session. It is not set per individual object.

NOTE When you use Network Rendering, the Render To Baked Material option is disabled.

See also:

- [Render to Texture](#) on page 6371
- [Render To Texture Dialog](#) on page 6397
- [Render to Texture: General Settings Rollout](#) on page 6399
- [Render to Texture: Objects To Bake Rollout](#) on page 6401
- [Render to Texture: Output Rollout](#) on page 6406
- [Automatic Mapping Rollout](#) on page 6413

Interface

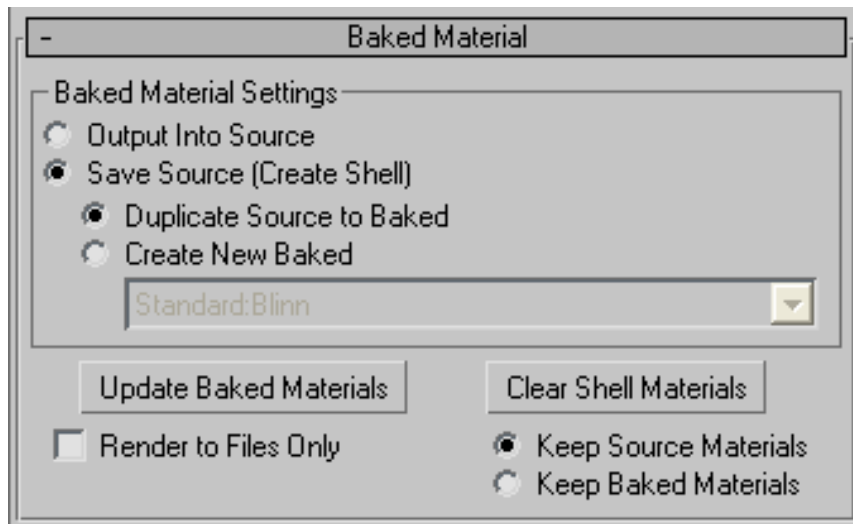

Baked Material Settings group

Output Into Source When on, replaces any target map slot in the object's existing material. Care should be used with this option, because the material replacement cannot be undone.

NOTE If a selected object to be rendered has a multi/sub-object material assigned to it, the workflow will not change and the results will be as follows: output into source will put the resulting map in all sub-material slots that match, instancing all identical maps, if a sub-material doesn't have the selected output type it will be ignored; duplicate in baked will duplicate the entire Multi/Sub-Object Material into the baked material and perform the above output; create new baked will create a new single standard material.

Save Source (Create Shell) Makes a new Shell material and assigns it to the object. When this option is turned on, you can then choose to either Duplicate Source To Baked, or to Create New Baked.

Duplicate Source To Baked Makes a copy of the existing material as the Baked material.

Create New Baked Puts a new material in the Baked Material slot. The type of the new material is set by the drop-down list below and subsequently determining the available Target Map Slots in the Output rollout.

Shader list Allows you to specify a shader to be used for the newly baked texture.

Update Baked Materials Builds a Shell material for all selected objects, and populates the baked material according to the current Render To Texture settings.

Clear Shell Materials Removes the [Shell material](#) on page 5732 applied to the texture-baked object, and replaces it with either the original material or the texture-baked material.

The radio buttons below Clear Shell Materials give you a choice of which material in the Shell material to retain:

- **Keep Source Materials** When chosen, the original material replaces the Shell material.
- **Keep Baked Materials** When chosen, the baked material replace the Shell material.

NOTE If you have already rendered a baked texture and decide you want to render with a different shader from the list, you must first click Clear Shell Materials and then re-render.

Render to Files Only When turned on, the baked texture files are rendered to the folder you've specified in the Output Path field of the [General Settings rollout](#) on page 6399. Default=off

Render to Texture:Automatic Mapping Rollout

Rendering menu > Render To Texture > Render to Texture dialog > Automatic Mapping rollout

These are options specify how Render To Texture should behave when it automatically flattens UVs or chooses the map size of a baked texture.

See also:

- [Render to Texture](#) on page 6371
- [Render To Texture Dialog](#) on page 6397
- [Render to Texture: General Settings Rollout](#) on page 6399
- [Render to Texture: Objects To Bake Rollout](#) on page 6401
- [Render to Texture: Output Rollout](#) on page 6406
- [Render to Texture: Baked Material Rollout](#) on page 6410

Interface

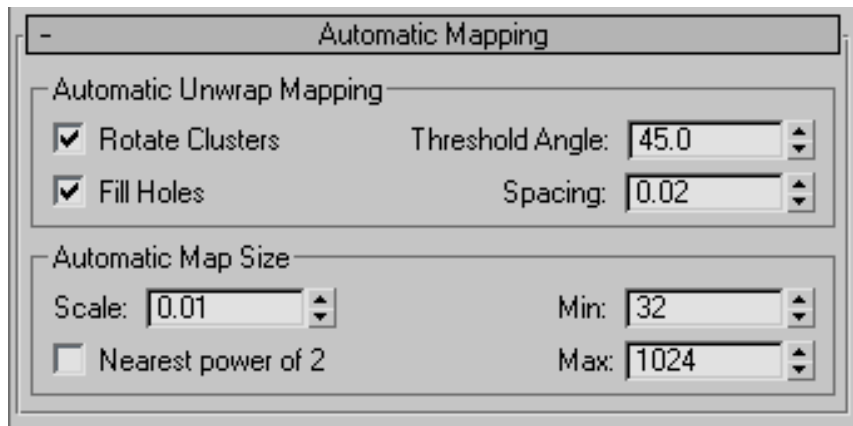

Automatic Unwrap Mapping group

These are options for how to flatten UVs when Use Automatic Map is chosen in the Objects To Bake rollout's Mapping Coordinates group.

NOTE These controls are also provided by the Unwrap UVW modifier's [Flatten Mapping dialog](#) on page 1892.

Rotate Clusters Controls whether clusters are rotated to minimize the size of their bounding box. For example, the bounding box of a rectangle rotated 45 degrees occupies more area than one rotated 90 degrees. Default=on.

Threshold Angle The angle used to determine the face clusters to be mapped. Default=45.0.

As faces are gathered to be mapped, the modifier uses this parameter to determine which faces get put in a cluster. This is the maximum angle that can exist between faces in a cluster.

The higher this number, the larger the clusters will be, with consequently greater distortion introduced as a result of texture faces' proportions deviating from their geometry-equivalent faces.

Fill Holes When turned on, smaller clusters will be placed in empty spaces within larger clusters to take the most advantage of the available mapping space. Default=on.

Spacing Controls the amount of space between clusters. Default=0.02. The higher this setting, the larger the gap that appears between clusters.

Automatic Map Size group

Rendering to texture can choose a map size for you. Automatic map sizing is enabled or disabled by a toggle on the [Output rollout](#) on page 6406. The controls in this group specify how to create the map, when Automatic Map Size is enabled. Automatic map sizing computes the total surface area of all objects in the selection, then multiplies that value by Scale, and creates a square texture map of those dimensions.

Scale The amount by which to scale the total surface area of generated texture. Default=0.01.

Nearest power of 2 When on, rounds the map dimensions (length and width) to the nearest power of 2. Default=off.

Min The minimum size, in pixels, of the length and width of the automatically sized map. Default=32.

Max The maximum size, in pixels, of the length and width of the automatically sized map. Default=1024.

Render to Texture:Add Texture Elements Dialog

Rendering menu > Render To Texture > Render to Texture dialog > Output rollout > Click Add to add a texture element. > Add Texture Elements dialog

This dialog lets you choose which elements will be part of a baked material. Each element is an individual bitmap. When you display a baked texture in shaded viewports, some elements might not display.

NOTE If the [Direct3D display driver](#) on page 7802 is active, you can use a [DirectX viewport shader](#) on page 5393 to enhance baked texture display.

Interface

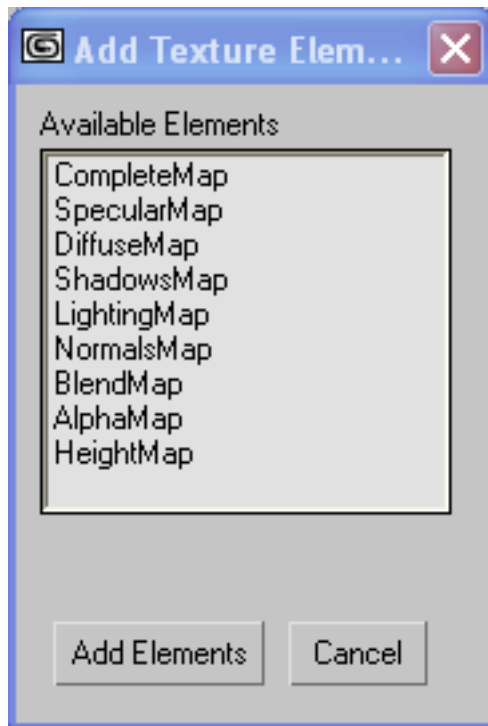

Available Elements Lists the elements available for rendering. See [Baked Texture Elements](#) on page 6376 for a description of the available elements. Click an element to select it. Use Ctrl+click to select (or deselect) additional elements individually. Use Shift+click to select a group of contiguous elements.

You can also double-click a single element name to add it to the list and close the dialog.

Add Elements Click to add these elements to the list in the [Objects To Bake rollout](#) on page 6401 of the Render To Texture dialog.

Render to Texture: Projection Options Dialog

Rendering menu > Render To Texture > Render to Texture dialog > Objects To Bake rollout > Projection Mapping group > Click Options. > Projection Options dialog

This dialog displays options for normal bump projection.

Interface

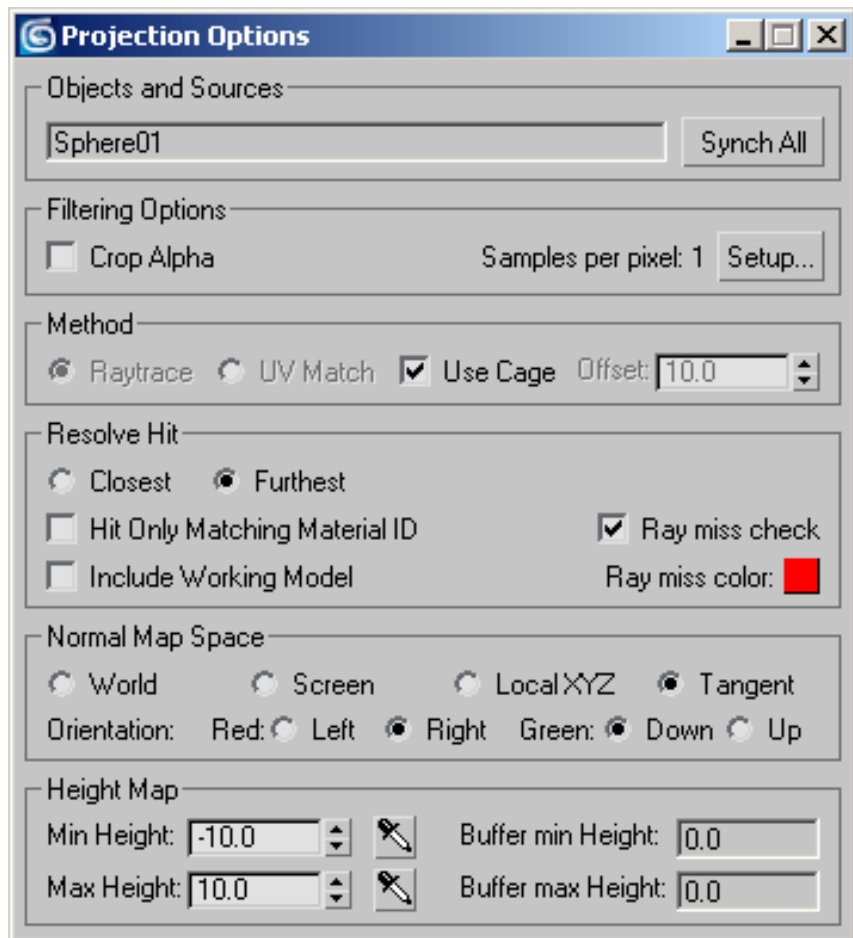

Objects and Sources group

The text field displays the name of the projection's source object. If more than one object is selected, it displays the source option chosen in the Render To Texture dialog: a single object name for Individual, or "All Selected" (the default), or "All Prepared."

Synch All Click to set all Render-To-Texture sources to use the active source object and the other current Projection Options settings. This button is available only when there is an individual source object.

Filtering Options group

Crop Alpha Removes antialiasing from the alpha channel.

Global Supersampler When the default scanline renderer is active, the text field shows the type of global supersampling that is currently in use. When the mental ray renderer is active, it shows the number of samples per pixel. Default=None.

- **Setup** Click to set up global sampling. When the default scanline renderer is active, clicking Setup displays the Render dialog's [Default Scanline Renderer rollout](#) on page 6141, whose Global Supersampling group lets you globally enable supersampling, and choose the supersampling method. When the mental ray renderer is active, clicking Setup displays the Render dialog's [Sampling Quality rollout](#) on page 6272, which lets you adjust the level of sampling.

Method group

These controls let you choose how to use normals from the source object.

- **Raytrace** (The default.) When chosen, normals are ray-traced between the source and target objects. The objects need to be perfectly aligned in [world space](#) on page 8175. When you view both high-res and low-res objects in viewports, they must line up with each other exactly. There are no special requirements for the mapping coordinates of the high-res objects.
- **UV Match** When chosen, normals are obtained by matching the target object's local UV coordinates to those of the source. The objects' [UV coordinates](#) on page 8161 need to be perfectly aligned. If you look at the objects using the Unwrap UVW modifier's [Edit UVWs dialog](#) on page 1859, the low-res and high-res objects must be lined up with each other exactly. The high-res object needs to have mapping coordinates on the same map channel you are using for the low-res object. Typically, the high-res object will have an Unwrap UVW modifier assigned to it, but this is not required.

With this option, the high-res object does not need to be in the same physical location as the low-res object.

TIP You can reset the cage (on the [Cage rollout](#) on page 1635), because UV Match does not use it.

Use Cage When on, bases projection on the Projection modifier's cage sub-object. When off, uses an offset instead. Default=on.

Offset Enabled only when Use Cage is turned off. Offset is the distance above the surface of the source object from which normals are projected. Default=10.0 units.

Resolve Hit group

The two radio buttons are for scenes that have semitransparent objects, in which case more than one hit can be found for each ray. The remaining controls in this group are additional projection controls.

- **Closest** If there are multiple hits, use the closest object.
- **Furthest** (The default.) If there are multiple hits, use the farthest object.

Hit Only Matching Material ID When on, projection is only between material IDs that match. Turning this option on enables a single map to contain normal bump projections from different high-res source geometry. Default=off.

Include Working Model When on, bakes from the source object if no target object can be found. Default=off.

Turning on Include Working Model can be a quick fix when a lot of the projected rays miss the target object (the Ray Miss Color will be apparent in the rendered normals map). However, if the low-res object occludes the high-res object, then Include Working Model will not have the desired effect, and the normal map will not show high-res details that you want it to. In this case, adjust the Projection modifier's cage.

This toggle is also useful when the high-res geometry is discontinuous (for example, a lattice or an array of cylinders).

Ray miss check When on, bakes missed rays as well as rays that hit into the rendered texture, using the Ray Miss Color. Default=on

- **Ray miss color** This color is baked into the texture when projection fails to hit the target geometry. Click the color swatch to display a [Color Selector](#) on page 391 and change the color used for missed rays. Default=red.

Normal Map Space group

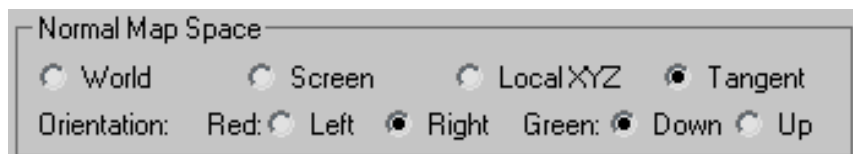

There are four methods for projecting the normals:

- **World** Project using world coordinates. This is useful mainly for objects that don't move or deform; otherwise, a moving object with world-projected normals will appear to “swim” through the texture.
- **Screen** Project using screen coordinates; that is, flat projection in the Z axis. This method is useful mainly for stationary objects seen from a single angle only; for example, a statue seen through a window.
- **Local XYZ** Project using the object's local coordinates. This method can be used for stationary or moving objects, but not for objects that deform: if the object deforms, the projection will appear incorrect at some frames.
- **Tangent** (The default.) Project at a tangent to the target object's surface. This is the method to use for objects that both move and deform, such as animated characters.

Orientation

The orientation settings determines what the red and green colors will indicate in your normal map. The orientation settings are different for the Tangent method than for the other methods.

The correct setting for red and green depend on what kind of hardware shader or texture will be used to view the map. Different shaders have different requirements. The Normal Bump map has controls to flip the red and green; the Normal Bump texture should work correctly if the map was created with the default X and Y or Left and Right settings, but if the map was created with different settings, change the Normal Bump settings to make the map render correctly, instead of rendering a whole new map.

Orientation: Tangent



For the Tangent method red indicates normals that are pointed either left or right and green indicates normals that are pointed up or down.

As an example, if you use Tangent mode with Red set to right and Green set to down, areas that are red in your normal map would indicate that the normals were facing towards the right and areas that were green would indicate that your normals were facing downwards.

The following are the possible values for the Tangent method:

- **Red** Can be Left or Right. Default=Right.

- **Green** Can be Up or Down. Default=Down.

Orientation: World, Screen, and LocalXYZ

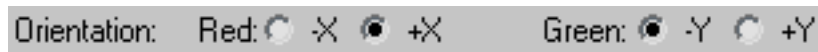

For World, Screen, and LocalXYZ, red indicates that the normals are pointed toward either a positive or negative X value, while green indicates that the normals are pointed toward either a positive or negative Y value.

For example, if you use World mode with Red set to $-X$ and Green set to $-Y$, areas that are red in your normal map indicate that the normals face toward $-X$, and green areas indicate that the normals face toward $-Y$.

The following are the possible values for World, Screen, and Local XYZ methods:

- **Red** Can be $-X$ or $+X$. Default= $+X$.
- **Green** Can be $-Y$ or $+Y$. Default= $+Y$.

Height Map group

Min Height Sets a minimum height for displaced normals. Default=0.0 units.

Max Height Sets a maximum height for displaced normals. Default=10.0 units.



Min and Max Height eyedropper Enable the eyedropper to pick the minimum or maximum height for the displaced normals by picking or dragging in a viewport. With the button enabled, click at the desired height. You can also drag this value until the desired result is achieved. The minimum or maximum height value is updated based on your selection.

Buffer min Height After you render a normal bump projection, this value is set to the minimum distance that a projection ray travelled. Default=0.0.

Buffer max Height After you render a normal bump projection, this value is set to the maximum distance that a projection ray travelled. Default=0.0.

If you want to use the Height Map texture element, you can render a normal bump map to obtain the Buffer values, and then set Min Height and Max Height accordingly, in order to get the best-looking possible Height Map.

Rendering Previews

A preview is an [AVI file](#) on page 7326 that can help you preview the animation in your scene. The preview uses lighting but not materials, so it renders much more quickly than a fully rendered animation.

The preview commands are on the [Animation menu](#) on page 7490.

[Make Preview](#) on page 6422

[View Preview](#) on page 6425

[Rename Preview](#) on page 6425

Make Preview

Animation menu > Make Preview

Make Preview displays the Make Preview dialog, enabling you to create an [AVI](#) on page 7326 file or custom file type preview of the animation in the current viewport. You can also render a preview to a specified device.

When the preview is complete, the software starts the Media Player with the preview *_scene.avi* file ready to play. (If you don't want the Media Player to start, choose Customize > Preferences > General and, in the UI Display group, turn off [Autoplay Preview File](#) on page 7744.)

NOTE Do not open any other program windows that cover up the viewport while rendering a preview. Anything that covers the viewport will be rendered into the preview AVI file.

Procedures

To create a preview:

- 1 Choose Animation menu > Make Preview.

The Make Preview dialog appears.

- 2 Change the preview parameters or accept the defaults, and then click OK.

If the output type is AVI, the software renders the preview and saves it in a file called *_scene.avi*, in the path specified by [Configure User Paths > File I/O](#) on page 7733 > Preview. Immediately after rendering the preview, the software runs Media Player with this animation loaded.

3 View the preview by clicking Play in Media Player.

If you dismiss Media Player and then want to view the preview again, choose Animation > View Preview. This restarts Media Player with *_scene.avi*.

You can save the preview under a different name, so it won't be overwritten the next time you make a preview. To do so, use Animation > [Rename Preview](#) on page 6425.

Interface

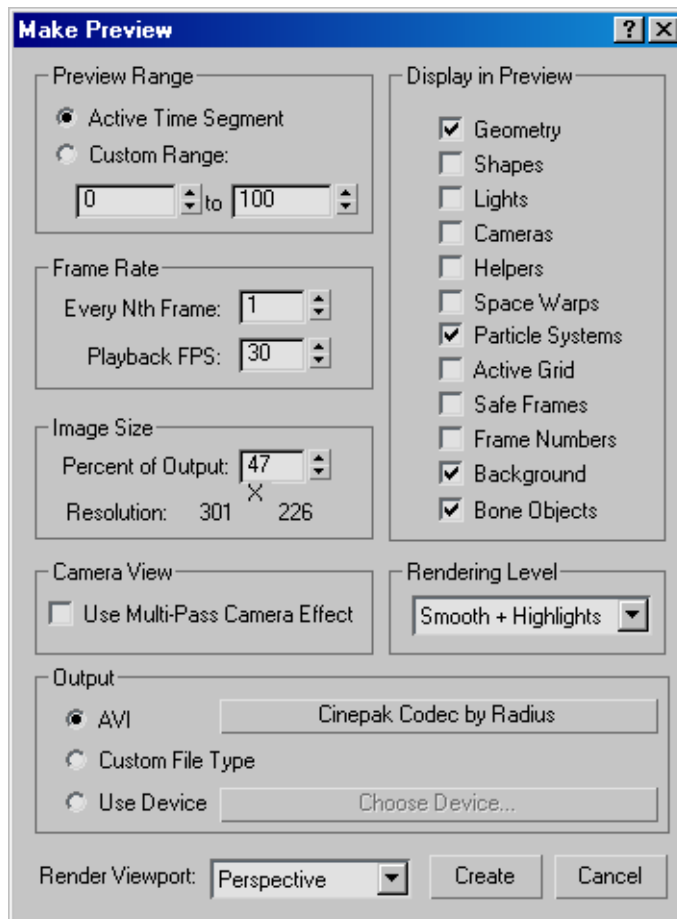

Preview Range group

Specifies the frames to be included in the preview, either the [active time segment](#) on page 7898 or a custom range of frames.

Frame Rate group

Specifies the playback [frame rate](#) on page 7987 in frames per second. Use Every Nth Frame to preview a regular sampling of the animation. For example, a value of 8 includes only every eighth frame in the preview.

Image Size group

Sets the resolution of your preview as a percentage of the current output resolution. You set the output resolution on the Render Setup dialog. For example, if the rendering output resolution is 640x480, and you set Percent Of Output to 50, the preview resolution is 320x240.

NOTE The size of the preview image is limited by the size of the viewpanel region (the region that contains the viewports). The setting is clamped to the maximum value that allows the preview image to fit in the viewpanel region.

Display in Preview group

Specifies the types of objects to include in the preview. Frame Numbers prints a frame number in the upper-left corner of each frame of the AVI file. Background includes the assigned viewport background in the preview.

Camera View group

Specifies whether the preview should include [multi-pass rendering effects](#) on page 6227.

Rendering Level group

Rendering Level drop-down list Specifies the [viewport rendering method](#) on page 7819 to use in the preview.

Output group

Specifies the preview output format.

AVI When chosen, the preview is output as an AVI file. The button to the right displays the current AVI [codec](#) on page 7936. Click it to adjust the assigned

codec, or choose a different codec. The quality of your output AVI file depends on the type of codec you use and the codec settings, which vary. For the highest visual quality, choose the highest compression quality. The higher the compression quality, the lower the compression, and the larger the resultant file.

Custom File Type Outputs the preview to the specified file format. When this option is chosen, and the Create button is clicked, a file selector appears, where you name the file and specify the output file type. For example, you can output the preview as a Quicktime movie by specifying a file name with a *.mov* extension. If you specify a single-image format, such as *.tga*, the preview is output as a series of sequentially numbered files.

Use Device Lets you output the preview to an external device, such as a digital recorder. The button at right displays the name of the currently assigned device. Click it to either change the settings of the device, or assign a different device.

Render Viewport This list shows the names of the currently visible viewports, letting you choose which viewport to render from within the Make Preview dialog. Default=active viewport.

View Preview

Animation menu > View Preview

View Preview displays the Windows-standard Media Player to view the current preview file.

When you use Make Preview, 3ds Max stores the output preview in a file called *_scene.avi* by default. View Preview loads this file. If you want to keep the preview file, use Rename Preview to save it under another file name, otherwise, the next Make Preview will overwrite *_scene.avi*.

The Media Player has its own Help system.

Rename Preview

Animation menu > Rename Preview

Rename Preview renames the *_scene.avi* preview file.

When you use Make Preview, 3ds Max stores the output preview in a file called *_scene.avi* by default. View Preview loads this file. If you want to keep the

preview file, use Rename Preview to save it under another file name; otherwise, the next Make Preview will overwrite *_scene.avi*.

Procedures

To rename the preview file:

- 1 Choose Animation > Rename Preview.
- 2 Specify a folder and a name for the preview file.
- 3 Click Save.

Panorama Exporter Utility

Rendering menu > Panorama Exporter

Utilities panel > Utilities rollout > More button > Utilities dialog > Panorama Exporter

The Panorama Exporter is a rendering utility that lets you create and then view 360 degree spherical panoramas.

NOTE You need at least one camera in your scene to use the Panorama Exporter.

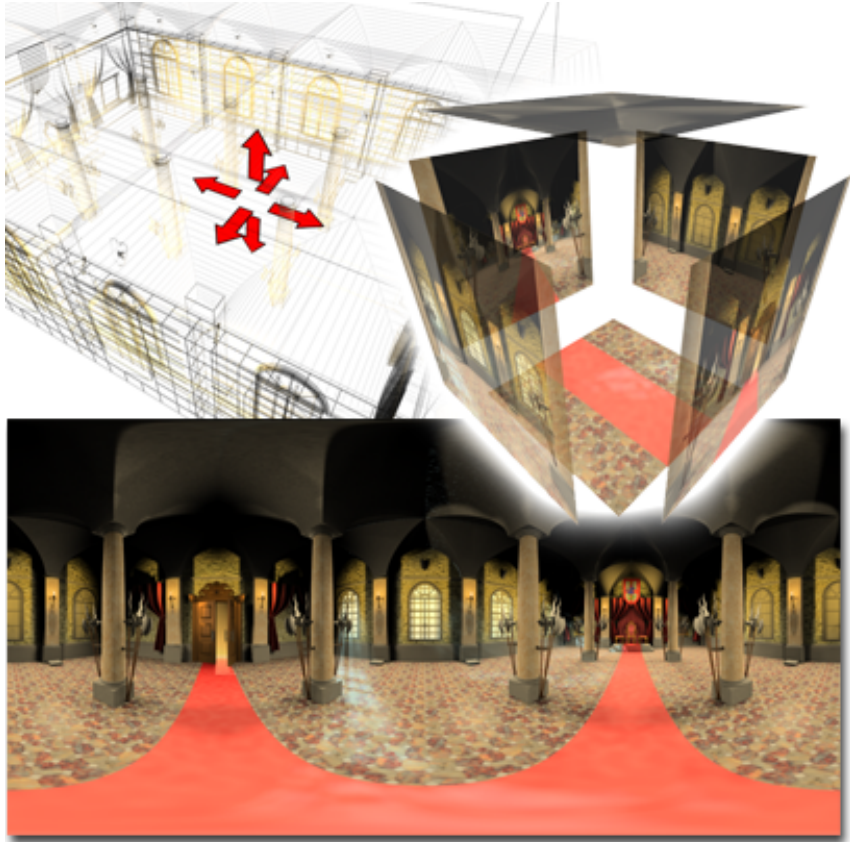

Panorama Exporter creates a 360-degree spherical rendering.

Interface

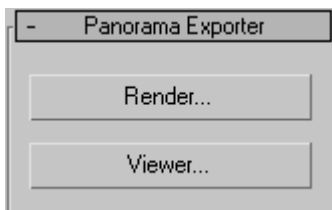

The Panorama Exporter rollout has two buttons, which let you create or view a panoramic rendering.

Render Opens the [Render Setup dialog](#) on page 6428 for the Panorama Exporter.

Viewer Opens the [Panorama Exporter viewer](#) on page 6431.

Panorama Exporter Render Setup Dialog

Rendering menu > Panoramic Exporter > Render button

Utilities panel > Utilities rollout > More button > Utilities dialog > Panorama Exporter > Render button

The Panorama Exporter Render Setup dialog is a [modal](#) on page 8045 version of the [Render Setup dialog](#) on page 6067 specially configured for generating panoramic output.

NOTE You need at least one camera in your scene to use the Panorama Exporter.

TIP For best results, high resolutions might be necessary. We recommend a resolution of 2048x1024 or higher unless you're working on drafts.

Interface

This topic covers the main rollout parameters. Additional rollouts might be available depending on the current renderer. For more information, see [Render Setup dialog](#) on page 6067.

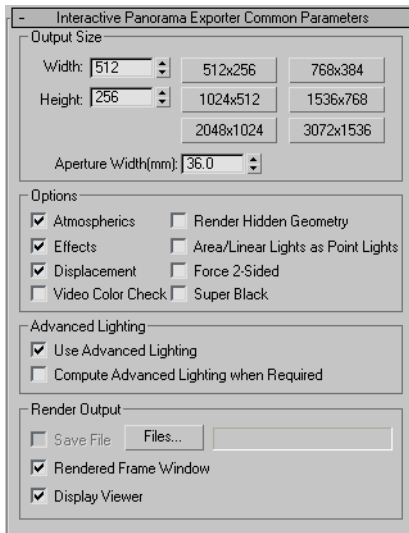

Output Size group

Choose one of the predefined sizes or enter another size in the Width and Height fields (in pixels). These controls affect the image's [aspect ratio](#) on page 7914.

Width and Height Lets you set the resolution of the output image by specifying the width and the height of the image, in pixels.

Preset resolution buttons (512x256, 1024x512, and so on) Click one of these buttons to choose a preset resolution.

Aperture Width Lets you specify an aperture width for the camera that creates the rendered output. Changing this value changes the camera's Lens value. This affects the relationship between the Lens and the FOV values, but it doesn't change the camera's view of the scene.

For example, if you have a Lens setting of 43.0 mm, and you change the Aperture Width from 36 to 50, when you close the Render Setup dialog (or render), the camera Lens spinner has changed to 59.722, but the scene still looks the same in the viewport and the rendering. If you use one of the preset formats rather than Custom, the aperture width is determined by the format, and this control is replaced by a text display.

Options group

Atmospherics Renders any applied atmospheric effects, such as volume fog, when turned on.

Render Hidden Geometry Renders all geometric objects in the scene, even if they are hidden.

Effects Renders any applied rendering effects, such as Blur, when turned on.

Area/Linear Lights as Point Lights Renders all area or linear lights as if they were point lights, speeding up rendering time.

Displacement Renders any applied displacement mapping.

Force 2-Sided [2-sided rendering](#) on page 7893 renders both sides of all faces. Usually, you'll want to keep this option off to speed rendering time. You might want to turn it on if you need to render the inside as well as the outside of objects, or if you've imported complex geometry in which the face normals are not properly unified. Default=off.

Video Color Check Checks for pixel colors that are beyond the safe [NTSC](#) on page 8059 or [PAL](#) on page 8078 threshold and flags them or modifies them to acceptable values.

By default, "unsafe" colors render as black pixels. You can change the color check display by using the [Rendering panel](#) on page 7768 of the [Preference Settings dialog](#) on page 7743.

TIP This is useful for draft renderings, as point lights render much faster than area lights.

NOTE Scenes with [radiosity](#) on page 6168 are not affected by this toggle, as area lights do not have a significant effect on the performance of a radiosity solution.

Super Black [Super Black rendering](#) on page 8141 limits the darkness of rendered geometry for video compositing.

TIP Leave this off unless you're sure you need it.

Advanced Lighting group

Use Advanced Lighting When on, the software incorporates a [radiosity solution](#) on page 6168 or [light tracing](#) on page 6154 in the rendering.

Compute Advanced Lighting When Required When on, 3ds Max computes radiosity when required on a per-frame basis.

Normally, when rendering a series of frames, 3ds Max calculates radiosity only for the first frame. If, in an animation, it might be necessary to recalculate the advanced lighting in subsequent frames, turn this option on. For example, a brightly painted door might open and affect the coloring of a nearby white wall, in which case the advanced lighting should be recalculated.

Render Output group

Save File Saves the rendered panorama to disk. This is unavailable until you have defined a file name by clicking the Files button.

Files Lets you specify the name, location, and file type for the rendered panorama file.

Rendered Frame Window Enables or disables the panorama exporter's rendering display.

Display Viewer When on, the [Panorama Exporter viewer](#) on page 6431 opens upon rendering the panoramic rendering.

Viewport Chooses the camera viewport to render. When you render a panorama, this drop-down list shows only the cameras in the scene.

Render Click to render the panorama.

Cancel Click to cancel the rendering.

Close Click to close the dialog, saving any changes you've made.

Panorama Exporter Viewer

Renderingmenu > Panoramic Exporter > Viewer button

Utilities panel > Utilities rollout > Panorama Exporter > Viewer button

The Panorama Exporter viewer lets you navigate a rendered panorama. You can use the viewer to export the panorama rendering with a cylindrical, spherical, or QuickTime VR format.

NOTE Exporting to QTVR format requires that QuickTime® 5 or higher be installed on your system. You can download the latest version from <http://www.apple.com/quicktime/download>. For QTVR export, you must choose the “Recommended Install” rather than a custom or minimal installation. In particular, your installation must include these components:

- QuickTime Authoring
 - QuickTime Internet Extras
 - QuickTime Essentials
-

Procedures

To navigate a rendered panorama:

- 1 Hold down the left button to rotate the camera around the panorama.
If you move the mouse, the camera rotates in that direction until you move the mouse again. (The view of the panorama moves in the opposite direction from the mouse and camera.)
- 2 Hold down the middle button and move the mouse up and down to zoom in and out.
- 3 Hold down the right button and move the mouse to rotate the camera around the panorama.
With the right button, you must drag the mouse to see any movement, and the view of the panorama moves in the same direction as the mouse.

To export a rendered panorama:

- 1 Open a rendered panorama in the Panorama Exporter Viewer.
- 2 Click File > Export.
Choose Cylinder, Sphere, or QuickTimeVR to set the format for your exported file.

A dialog opens, prompting you to enter the name, location, and type of file.

Network Rendering

Network rendering is a means of mass-processing multiple rendering tasks or jobs. In order to facilitate network rendering, Autodesk Backburner™ is installed with 3ds Max. The Backburner software is responsible for coordinating how job assignments are processed.

You can perform network rendering with both the default scanline and mental ray renderers. In its most efficient form, network rendering uses multiple computers, connected over a network, to perform rendering tasks; typically the rendering of animations with hundreds or thousands of frames. Even a small network of three or four PCs can save substantial rendering time and help you meet deadlines.

However, network rendering can be equally useful if you have only a single PC and need to render a number of images. You can assign the jobs that need to be rendered and Backburner can manage the rendering of each job while you're away from the computer. Commonly, jobs are assigned submitted just before you leave the office. When you arrive the next morning, all your rendering are waiting for you to review.

Network rendering is designed to render whatever is set up in your scene; that is, it will render the viewport, part of a viewport, camera view, and so on, as saved in the scene file. You can also pass batch-rendering tasks to Backburner from the [Batch Render tool](#) on page 6553. You can queue up tasks from any number of cameras in a scene. Each task can load a save scene state or use a particular rendering preset.

The requirements and procedures presented here assume you are the administrator of a closed network set up exclusively for network rendering. In practice, you can use the network for file sharing and other purposes, but if conflicts arise, you might need to cancel those uses. The easiest network to set up, operate, and maintain is one dedicated to rendering.

NOTE For specific information about setting up network rendering on a single system, refer to [Basic Procedure 1: Single-System Network Rendering](#) on page 6436.

If you're a system administrator for a more complex network, you can use the information in this file as a guideline. The basic approach is the same for any network.

IMPORTANT It is strongly recommended that you follow these procedures for setting up and running network rendering. Do not attempt network rendering without reading the instructions that follow.

The links on this page are ordered like chapters in a manual: a sequence of major topics containing more specific nested topics. Links marked *Next Step* indicate the next topic in the sequence. Moving from one topic to the next takes you through the necessary steps to set up your network for rendering.

NOTE Network rendering functions are also available from MAXScript. See “Network Render Interface” and “Interface: NetRender” in the MAXScript Reference.

About Backburner

Network rendering is performed by software named Backburner. Functionality is primarily the same as in previous versions of 3ds Max with the addition of the following:

- The [Batch Render tool](#) on page 6553 can pass a queue of rendering tasks to the Network Job Assignment dialog. When submitted, Backburner manages the rendering of all the active tasks and
- You can now assign various servers to groups in Backburner. From the Network Job Assignment dialog you can choose a group as the current set of servers.

Backburner Documentation

The following table summarizes the Backburner Documentation set.

For Information About:	See:
Using Autodesk Backburner with 3ds Max	This Network Rendering section.
Autodesk Backburner User Interface (Manager, Server, and Monitor), Troubleshooting, and Administering Autodesk Backburner	<i>Autodesk Backburner User's Guide</i> (In 3ds Max go to Help > Additional Help > Backburner User's Guide)
Autodesk Backburner Configuration	<i>Autodesk Backburner Installation Guide</i> (In 3ds Max go to Help > Additional Help > Backburner Installation Guide)

About Mental Ray

Network rendering with the mental ray Renderer

The mental ray renderer supports network rendering via Backburner and the command line. The steps for setting up and submitting jobs are exactly the same as those you'd use for the scanline renderer. No additional licensing or fees are necessary.

Next Step

[How Network Rendering Works](#) on page 6448

See also:

- [Checking Requirements](#) on page 6461
- [Setting Up for Network Rendering](#) on page 6463
- [Basic Procedures for Network Rendering](#) on page 6435
- [Network Job Assignment Dialog](#) on page 6481
- [The Queue Monitor Application](#) on page 6522
- [Installing Network Services](#) on page 6503
- [Batch Rendering](#) on page 6548
- [Troubleshooting Guide](#) on page 6455

Basic Procedures for Network Rendering

This topic contains basic procedures to follow when network rendering with 3ds Max. The following conditions are assumed:

- 3ds Max has been installed on all machines to use as rendering servers.
Note: You needn't license the software on machines to be used only as rendering servers.

- All network communications and protocols are installed and operating correctly.
- The computers run Windows XP Pro, Windows 2000, or NT 4.0. Limitations of other operating systems could cause network rendering to be unreliable.
- All of the computers have names that start with letters. Machine names that start with a number will fail.
- You haven't previously attempted network rendering. If you have already attempted network rendering and want to return to the original state, delete everything in the `\Program Files\Autodesk\Backburner\Network` folder except `nrres.dat`.
- Manager and Server have not been installed as services.

Summary of Procedures

- Procedure 1 - Use this procedure for configuring a single system to render jobs to itself; in other words, to perform batch rendering that is managed by Backburner.
- Procedure 2 - Use this procedure for configuring a Backburner Manager system to render to one or more Backburner Server systems. The Manager system will *not* be involved in the rendering tasks.
- Procedure 3 - Use this procedure for configuring the Backburner Manager *and* Backburner Server systems to render tasks together.

Special Consideration for Procedures 2 and 3

To use a render farm, you must output a frame sequence in a still-image file format; for example, a series of BMP files. You cannot render animated file formats such as AVI or MOV to multiple systems. You must render animated files to a single system. When rendering to an animated file format, the Use All Servers check box in the Network Job Assignment dialog is unavailable.

Basic Procedure 1: Single-System Network Rendering

This procedure describes usage of network rendering on a single computer. The main advantage to this method over standard rendering is that you can

submit multiple rendering jobs for the computer to render. In effect, this lets you perform batch rendering.

- 1  Go to Start menu > Programs > Autodesk > Backburner and choose the Manager menu item.

This starts Manager and creates the *backburner.xml* file in the *Backburner\Network* folder.

When you run Manager for the first time, you will see the Backburner Manager General Properties dialog, shown below.

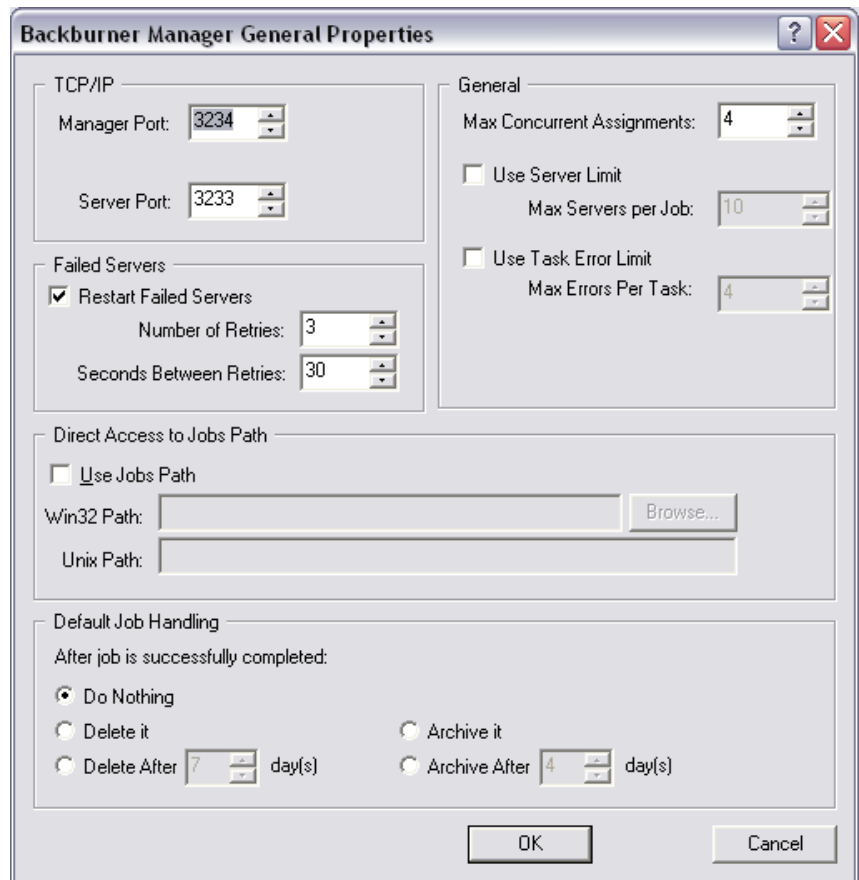

Backburner Manager General Properties dialog.

- 2 Click OK to accept the default settings.
The Backburner Manager dialog displays.



- 3 Go to Start menu > Programs > Autodesk > Backburner and choose the Server menu item.

This starts Server and creates the server data that is stored in the *backburner.xml* file.

You will see the Backburner Server General Properties dialog, shown below, when you run Server for the first time.

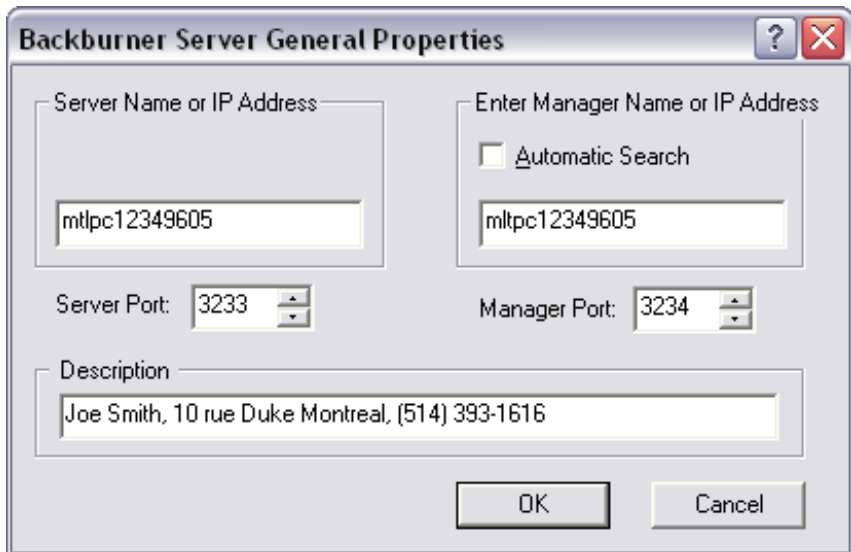

Backburner Server General Properties dialog.

- 4 Click OK to accept the default settings.
The Backburner Server dialog displays. After a few moments, messages appear in both the Server and Manager windows indicating that the Server has successfully registered with the Manager.
- 5 Start 3ds Max and load the first scene you want to render.



- 6 From the Rendering menu, choose Render Setup, or click the toolbar Render Setup button.

- 7 Set the rendering parameters and specify an output file name. In the Render Output group on the Common tab, turn on Net Render, and then click the Render button.

The Network Job Assignment dialog appears.

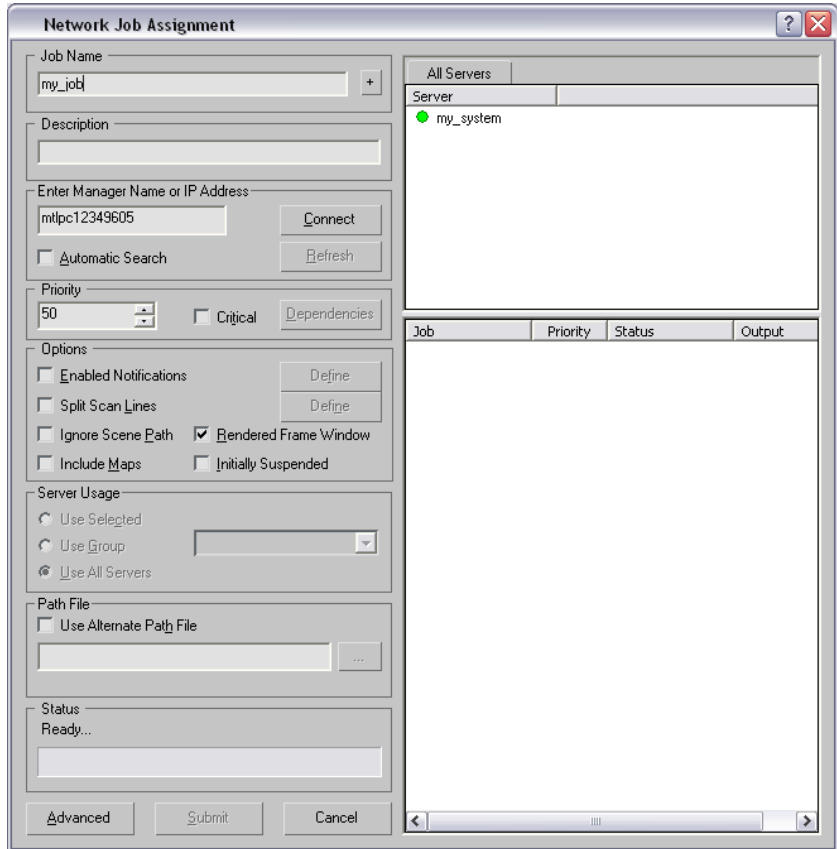

Network Job Assignment dialog showing the server station that is also running Manager.

- 8 Enter a job name (it's a good idea to change the default name) and then click the Connect button.

The name of your computer (that is, the Server) appears in the Server window to the right. It has a green dot next to it meaning that it is a Server system that is ready to start rendering.

- 9 Click the Server name to highlight it in the list window, and then click the Submit button.

The Manager submits the job to the Server, both running only on this system, and the Server begins rendering each still frame or the animation.

- 10 To render additional jobs, load each into 3ds Max, and then repeat steps 6-9.

You can submit as many jobs as you like. The software will queue the jobs up and render them in the order that you submitted them.

Basic Procedure 2: Network Rendering from Server (not Manager)

When rendering across a network, you first assign one machine to be Manager, and then any number of others as Servers. In this procedure, you won't use the Manager as a rendering Server.



- 1 Go to Start menu > Programs > Autodesk > Backburner and choose the Manager menu item.

This starts Manager and creates the *backburner.xml* file in the *Backburner\Network* folder.

When you run Manager for the first time, you will see the Backburner Manager General Properties dialog, shown below; this is normal.

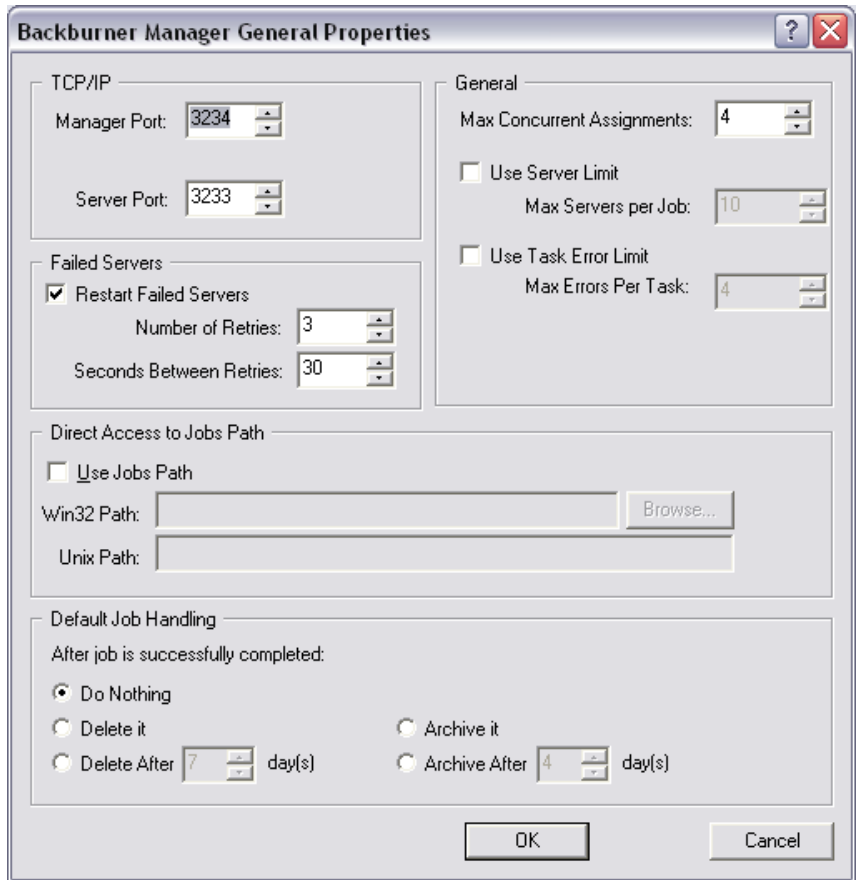

Backburner Manager General Properties dialog.

- 2 Click OK to accept the default settings.
The Backburner Manager dialog displays.

- 3 Move to a Server system.

- 4  Go to Start menu > Programs > Autodesk > Backburner and choose the Server menu item.

This starts Server and creates the server data that is stored in the *backburner.xml* file.

You will see the Backburner Server General Properties dialog box, shown below, when you run Server for the first time.

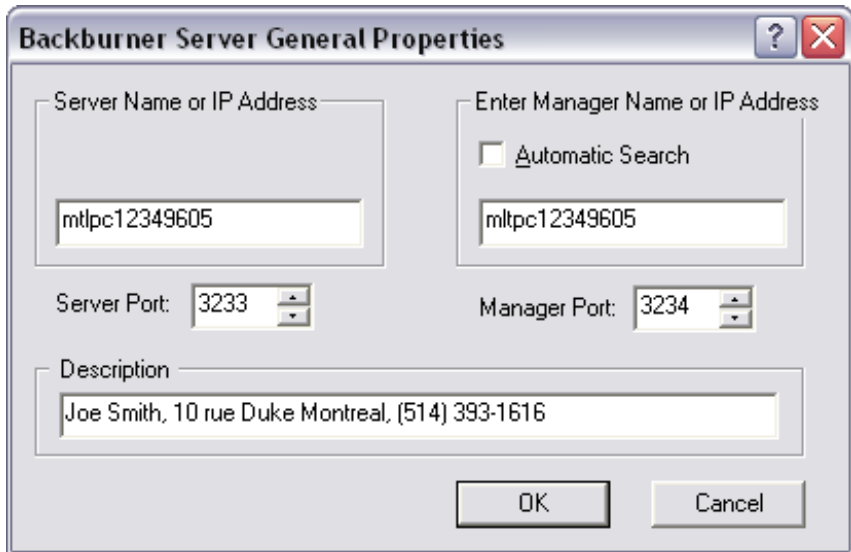

Backburner Server General Properties dialog.

- 5 Click OK to accept the default settings.
The Backburner Server dialog displays. After a few moments, messages appear in both the Server and Manager windows indicating that the Server has successfully registered with the Manager.
- 6 Repeat steps 3-5 on all the Server systems you intend to make available for your rendering jobs.
- 7 Return to the Manager system, start 3ds Max, and load the first scene you want to render.
- 8  From the Rendering menu, choose Render Setup, or click the toolbar Render Setup button.
- 9 Set the rendering parameters and specify an output path and file name.

TIP So that the Servers can find the output path, specify the path in the Render Output File dialog starting with Save In > My Network Places. Then navigate to the output folder, specify a file name and output format (Save As Type), and click Save.

- 10 In the Render Output group, turn on Net Render, and then click the Render button.

The Network Job Assignment dialog appears.

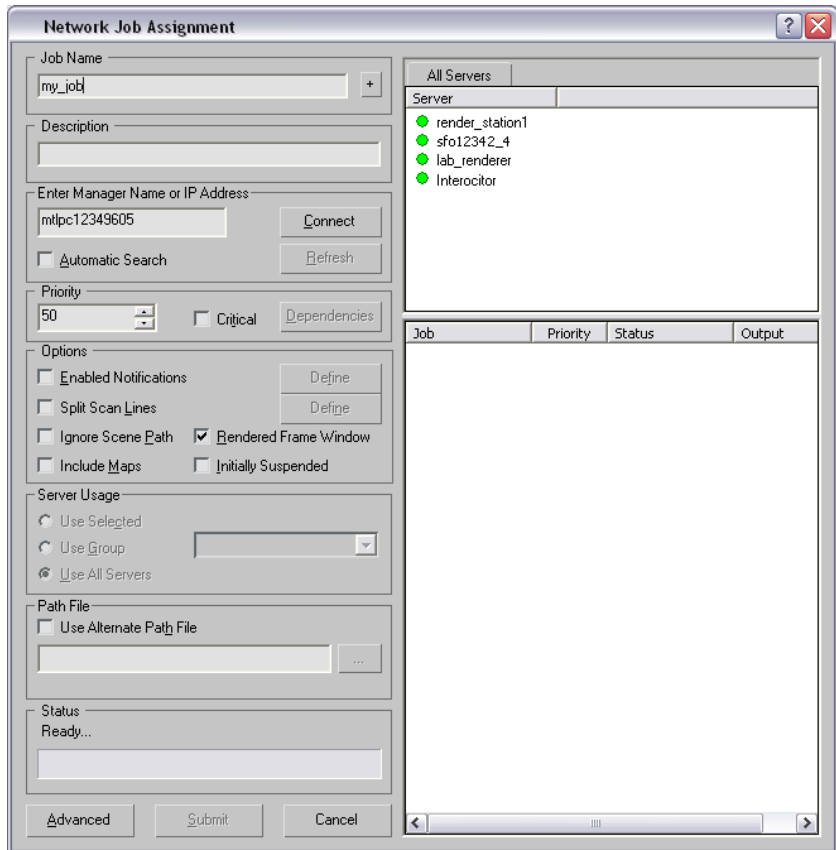

Network Job Assignment dialog showing all the server stations. The manager station is excluded.

- 11 Enter a job name (it's a good idea to change the default name) and then click the Connect button.

The names of all Servers appear in the Server window to the right. Those with green dots next to their names are ready to start rendering.

By default, all the Servers that are listed will take part in the rendering job. To assign a specific Server to render a job, first turn off Use All Servers in the Options group, and then highlight the server(s) that you want to render the job.

- 12 Click the Submit button.

The Manager submits the job to the Servers, which begin rendering .

At this point, you can load and submit additional scenes. When the first job is complete, the next job will automatically begin rendering on the Servers.

Basic Procedure 3: Network Rendering from Manager and Servers

When rendering across a network, you first assign one machine to be Manager, and then any number of others as Servers. In this procedure, you'll use the Manager computer as a rendering Server as well.



- 1 Go to Start menu > Programs > Autodesk > Backburner and choose the Manager menu item.

This starts Manager and creates the *backburner.xml* file in the *Backburner\Network* folder.

When you run Manager for the first time, you will see the Backburner Manager General Properties dialog, shown below; this is normal.

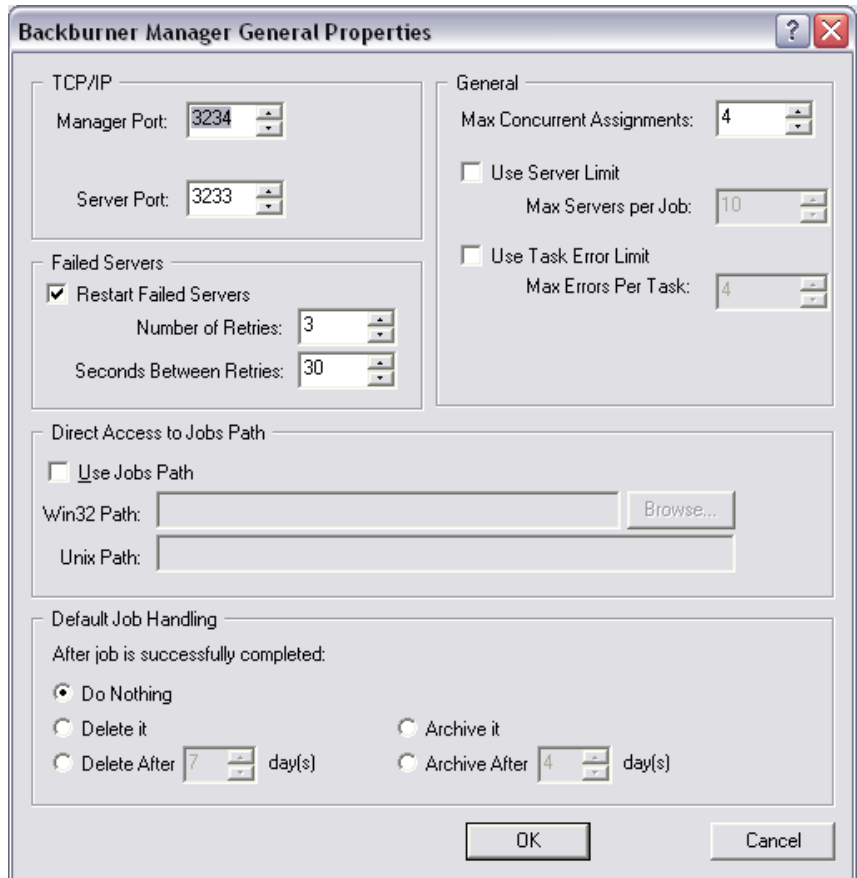

Backburner Manager General Properties dialog.

- 2 Click OK to accept the default settings.
The Backburner Manager dialog displays.



- 3 On the same computer, go to Start menu > Programs > Autodesk > Backburner and choose the Server menu item.

This starts Server and creates the server data that is stored in the *backburner.xml* file.

You will see the Backburner Server General Properties dialog box, shown below, when you run Server for the first time.

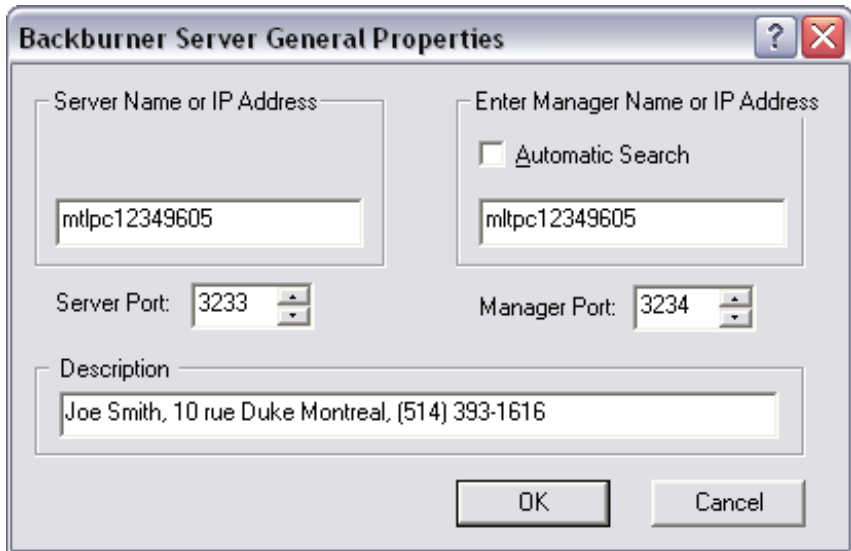

Backburner Server General Properties dialog.

- 4 Click OK to accept the default settings.
The Backburner Server dialog displays. After a few moments, messages appear in both the Server and Manager windows indicating that the Server has successfully registered with the Manager.
- 5 Repeat steps 3-4 on all the Server systems you intend to make available for your rendering jobs.
- 6 Return to the Manager system, start 3ds Max, and load the first scene you want to render.
- 7  From the Rendering menu, choose Render Setup, or click the toolbar Render Setup button.
- 8 Set the rendering parameters and specify an output path and file name.

TIP So that the Servers can find the output path, specify the path in the Render Output File dialog starting with Save In > My Network Places. Then navigate to the output folder, specify a file name and output format (Save As Type), and click Save.

- 9 In the Render Output group, turn on Net Render, and then click the Render button.
The Network Job Assignment dialog appears.

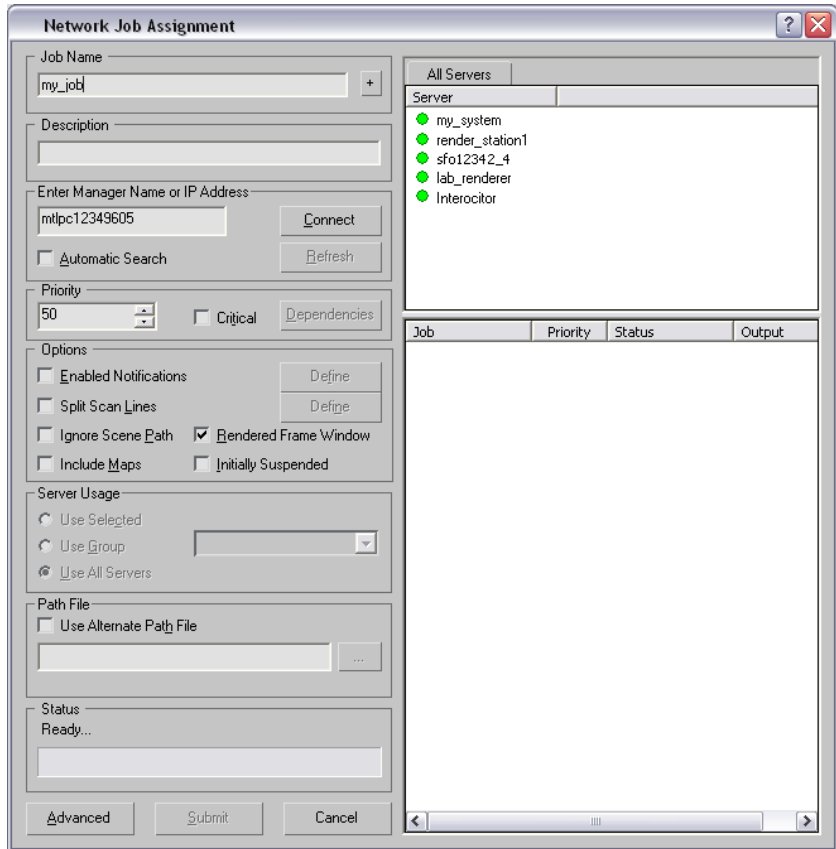

Network Job Assignment dialog showing all the server station plus the manager station that is running Server.

- 10 Enter a job name (it's a good idea to change the default name) and then click the Connect button.
The names of all Servers appear in the Server window to the right. Those with green dots next to their names are ready to start rendering.
By default, all the Servers that are listed will take part in the rendering job. To assign a specific Server to render a job, first turn off Use All Servers

in the Options group, and then highlight the server that you want to render the job.

- 11 Click the Submit button.

The Manager submits the job to the Servers, which begin rendering .

At this point, you can load and submit additional scenes. When the first job is complete, the next job will automatically begin rendering on the Servers.

How Network Rendering Works

Rendering networks are sometimes called “render farms.”

In the software, one computer is set up as the network Manager. The Manager “farms out” or distributes the work to rendering Servers. You can also have the same computer function simultaneously as both Manager and Server, so computing cycles don't go to waste.

Once rendering is under way, the Queue Monitor program lets you directly monitor and control the operation of the network rendering workload. The Queue Monitor allows you to edit job settings as well as to activate, deactivate, and reorder both jobs and servers involved in your render farm.

Important: When rendering using a render farm, it is recommended to render with single-frame formats such as BMP or PNG. Movie file formats such as AVI output all frames into a single file which cannot be split between different servers to take advantage of network rendering.

How Work Is Divided

The software breaks up the task of network rendering among the rendering Servers, assigning one frame at a time to each Server. The completed output of the Servers accumulates in a common, shared directory.

Rendered frame files can also be written to a local directory on each machine, if the same path defines the directory. Frame files are sequentially numbered, making them easy to assemble later.

The Manager takes a number of different factors into account in determining how to assign frames and jobs, always striving for the most efficient usage of the rendering network. An idle rendering Server is automatically detected by the Manager and is considered for job or frame assignment. If a Server goes

off-line for some reason, the Manager reclaims the Server's current frame and reassigns the frame to the next available rendering Server.

The Basic Process

Following is a step-by-step description of the sequence of events when you use network rendering:

- 1 The user submits a job to the network Manager.
- 2 On the submitting machine, the MAX file gets zipped up. If the user turned on Include Maps, all maps and XRefs are also zipped up.
- 3 Once the file is zipped up, the ZIP file is copied to the Manager machine's *Backburner\Network\jobs\<jobname>* folder. In the folder is an XML file describing the job itself, specifying frame size, output filename, frame range, render settings, etc.
- 4 Once the Manager receives the ZIP and XML files, it looks to see which servers are sitting idle and can render jobs. It assigns the job to four servers at a time. (This is the Max Concurrent Assignments setting on the Manager General Properties dialog. See [Starting Network Rendering](#) on page 6450).
- 5 Each Server machine receives the ZIP and XML files into the *Backburner\Network\jobtemp* folder.
- 6 The MAX file gets unzipped, along with the maps and XRefs if they were included.
- 7 3ds Max is launched and loads the MAX file. If the maps and XRefs were not included, the software searches for them as they are defined in the MAX file. For instance, if an XRef is in *d:\foo\xref.max*, the Server will look for *xref.max* in *d:\foo* on the local machine. If there are additional map paths set in the [3dsmax.ini](#) on page 83 file on the rendering server, it will search in those paths as well. If it does not find the maps and XRefs, the server fails for that particular job.

This is why it is important to use UNC paths for all maps and XRefs in your scene file, so that all render servers can find them. However, if the maps and XRefs were included, then 3ds Max will get the ones that were unzipped into the *jobtemp* folder.
- 8 When a frame is finished rendering, 3ds Max on the Server saves the frame to the location specified via the Render Setup dialog before you submitted it.

- 9 Once a Server successfully renders one frame, the Manager assigns a block of frames to the server to render; it might assign 20 consecutive frames. This minimizes the amount of communication needed between the Server and Manager.
- 10 The Server continues rendering frames for the job until the job is done.
- 11 The Server then closes 3ds Max, and goes idle. If the queue contains additional jobs, the Server picks up the next job and starts the process all over again.

You can use this explanation to help determine the basic requirements for your network rendering setup, based on the type of usage. If your frames render quickly, you'll need a fast file server machine to handle the constant output from a number of different rendering servers. The same holds true of your scene uses a large quantity of map files that are stored in a central location. If you typically render large files, rendering will take longer, and most of the bandwidth will be required at the start, when the files are distributed to the rendering servers.

Next Step

[Checking Requirements](#) on page 6461

Starting Network Rendering

Once you've set up the network rendering system and [software](#) on page 6474, there are two steps to starting a network rendering session:

- Start the Manager program on one machine and the Server program on every other machine in the network. See [Basic Procedures for Network Rendering](#) on page 6435. The machine being used as a manager can also be used as a rendering server.
- Start a rendering job from the software on a networked machine with an authorized copy of 3ds Max.

The Manager and Server programs need to be started and left running during a network rendering session. Either program remains in operation until you shut it down or shut down the machine.

When you've set up the Manager and Server network services, you're ready to submit an animation to the network rendering queue. There are two stages to starting network rendering:

- On the Render dialog, set all desired rendering parameters, including resolution and rendered output file type, and render the scene. In 3ds Max, you can render from the [Render Setup dialog](#) on page 6067, or the [Render To Texture dialog](#) on page 6397.
- In the Render dialog, set all desired rendering parameters, including resolution and rendered output file type, and render the scene.
- Turn on Net Render, found in the Render Output, Render Settings or Output groups, and then click Render to open the [Network Job Assignment dialog](#) on page 6481, which lets you make final decisions about the job and submit your animation to the rendering servers.

Next Step

[Network Rendering Manager](#) on page 6509

[Network Rendering Server](#) on page 6516

Procedures

These procedures explain how to start and submit a network rendering job in 3ds Max.

This procedure explains how to render a job over the network, once the Backburner Manager and Server are running. (See the *Autodesk Backburner Installation Guide* for information on setting up the Backburner Manager and Server.)

To start the Manager program:

- 1 Run the Manager program from the Start menu > Programs > Autodesk > Backburner folder.

The first time you run the Manager after installation or after deleting the *backburner.xml* file, the Manager Properties dialog appears. In most cases, you can accept the default settings and click OK to continue.

Thereafter, when you start the Manager, its window appears and the "Starting Network Manager" message is displayed in the window. The machine is now running the Manager in Desktop mode. You can leave this window open to see messages relating to what the Manager and Servers are doing as they appear, or you can minimize it, whereupon it

resides in the taskbar tray. To reopen the window when minimized, click its icon in the taskbar tray.

NOTE If you're running Windows 2000 and have the NetBEUI protocol installed, and you have unplugged your network cable, when you start the manager, you'll see an error message, "Error starting network subsystem, cannot start manager." If this happens, reconnect the network cable and try again.

- 2 Alternatively, you can run the Manager as a service, as described in "Setting Up Backburner Manager as a Windows Service" in the *Autodesk Backburner Installation Guide*. Once set up, the Manager automatically starts when you boot the system and it's always available.

To start the Server program:

- 1 Run the Server program from the Start menu > Programs > Autodesk > Backburner folder.

The first time you run the Server after installation or after deleting the *backburner.xml* file, the Server Properties dialog appears. By default, Automatic Search is turned on, and the subnet mask is set to 255.255.255.0. This should work with most networks. Alternatively, turn off Automatic Search and enter the manager name or its IP address in the Manager Name or IP Address field.

Thereafter, when you start the Server, its window appears and the "Starting Backburner Server" message is displayed in the log window. After a few seconds you should also see the "Registration to (manager IP address) accepted" message in the Server window. This message indicates that the server has found the manager and is correctly communicating with it. If you do not see the "Registration to ..." message in the Server window, see "Troubleshooting Backburner" in the *Autodesk Backburner User's Guide*.

The machine is now running as a rendering Server in Desktop mode. You can leave this window open to see other messages as they appear, or you can minimize it to the taskbar tray. To reopen the window when minimized, click its icon in the taskbar tray.

- 2 Alternatively, you can run the Server as a service, as described in [Network Rendering Server](#) on page 8058. Just running the Manager as a service, once it's installed and started, it's always available, even after rebooting.

To start a network rendering job:

- 1 Start the Backburner Manager and Backburner Server.
- 2 Start the software on a machine with an authorized copy of the program.
- 3 Open the scene you want to render.
- 4 Choose Rendering menu > Render Setup to display the Render Setup dialog.
You can also render from the Execute Video Post dialog or the Render To Texture dialog.
- 5  In the Render Output group, click the ellipsis button to display the Render Output File dialog.
- 6 In the File Name field, enter the [Universal Naming Convention \(UNC\)](#) on page 8160 name of the output directory, followed by the name of the output file. For example:
`\\machine1\project1\images\output.tga`
As an alternative to entering the UNC name from the keyboard, you can go to Save In > My Network Places and navigate to the machine and shared directory where you want the servers to write the rendered frames. After selecting the machine and shared directory in the Map Network Drive dialog, enter the output file name (for example, *output.tga*), and then click OK. The software automatically converts the shared directory to the UNC format.
If the output directory is mounted, enter the name and extension of the output file and choose the drive mounted for the output directory from the Save In list.
- 7 Click OK to display the Setup Options dialog for the file format type you have selected.
- 8 Make the desired settings and click OK.
- 9 Click OK again to return to the Render Setup dialog.
Save File is turned on once you assign an output file.
- 10 After setting any other rendering parameters, turn on Render Output group > Net Render and click Render.
The Network Job Assignment dialog appears.

If you use Video Post, set the file location with an Add Image Output Event. After you click Execute Sequence, be sure to turn on Net Render before you click Render.

To submit a network rendering job:

- 1 Start the Backburner Manager and Backburner Server.
- 2 On the Network Job Assignment dialog, make sure the Automatic Search option is on, and then click Connect.

In most cases, the software detects the Manager machine and displays its attached Servers in the Server list. If auto-detect fails, turn off Automatic Search and manually enter the name or IP address of the network machine acting as the Manager, and then click Connect.

All rendering Servers running under the network Manager should be listed with green dots next to them. Even if a server is running an interactive session of the software, it will still render an assigned job by launching a second copy of the software.

- 3 By default, the job will use all available Servers. To use only specific Servers, turn off Use All Servers and choose the machines you want to use from the Server list.

- 4 Click Submit.

The job is submitted to the Manager, which then distributes the job to the machines assigned in the Network Job Assignment dialog. Network rendering begins.

When network rendering begins on a rendering Server, the Rendering dialog appears on machines running *serverapp.exe*. If a machine is running the service version, no dialog appears.

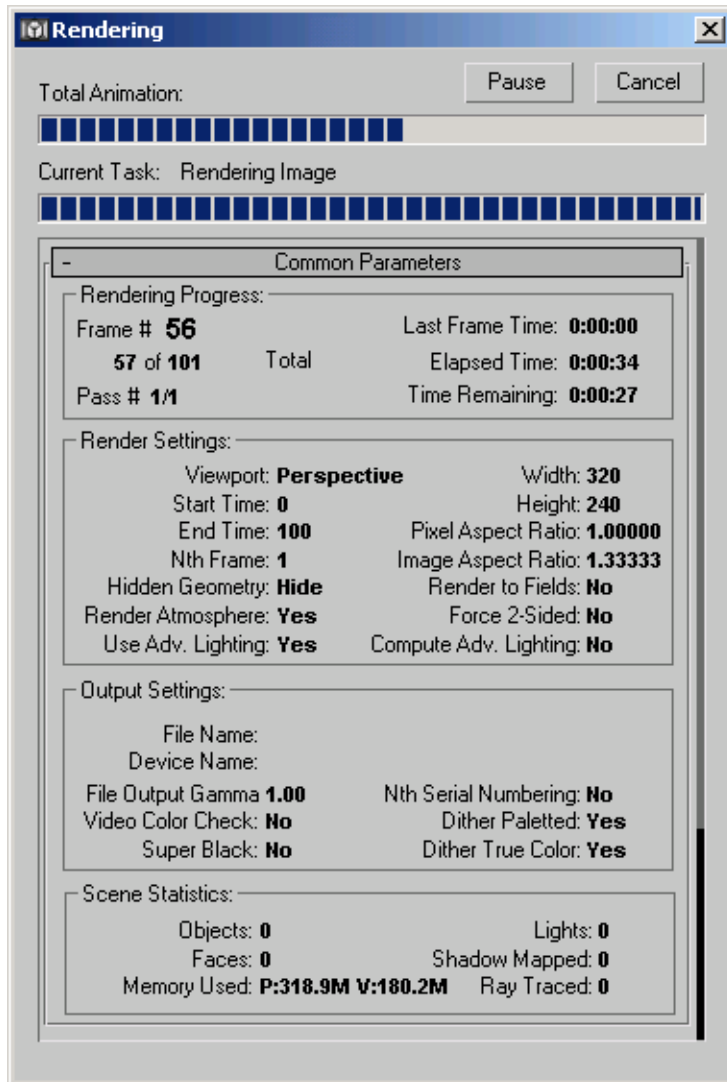

Troubleshooting Guide

This is a guide to solving common problems associated with network rendering. Solutions to these problems vary, depending on whether you are using the

network rendering programs as installed Windows Services, or running them in Desktop mode. Also see “Troubleshooting Backburner” in the *Autodesk Backburner User’s Guide*.

PROBLEM:When I try to assign a job in the Network Job Assignment dialog, some of the servers display a gray or yellow icon.

SUGGESTION

Regardless of their state in the Network Job Assignment dialog, servers can always be assigned new jobs.

The gray icon means that the server is currently not available to render a job. This state can occur for several reasons, including:

- The server has not been correctly started. (See “Setting Up Backburner Server” in the *Autodesk Backburner Installation Guide*.)
- The server has been disallowed for the current time period in the Properties dialog of the Monitor. (See “Setting the Availability for Rendering Nodes” in the *Autodesk Backburner User’s Guide*.)
- The server has experienced abnormal termination.
If you've checked for and corrected these conditions and the servers are still unavailable, stop running Server on each of the problem machines, and restart the service after a few seconds. This "purges" the server and may solve the problem. Then click Refresh in the Network Job Assignment dialog to display the most recent information about the server.

The yellow icon means that the server is busy rendering another job. If the server should not be busy, verify that the queue is clear of jobs by opening the Queue Monitor and connecting to the Manager. If the queue is clear of rendering jobs and the server is still flagged as busy, stop running server on each of the problem machines, and restart the service after a few seconds.

PROBLEM:When I submit a job to be rendered, the server fails.

SUGGESTION

Servers can fail for a variety of reasons during a network render job. Many of these reasons are covered in “Troubleshooting” in the *Autodesk Backburner User’s Guide*. One reason that is specific to 3ds Max which can cause a server to fail is the presence of a scene which does not contain texture coordinates.

All errors are recorded in the appropriate log file. You can learn more about log files in “Configuring Backburner Log Files” in the *Autodesk Backburner User’s Guide*.

Here are some of the error messages related to 3ds Max, along with a likely cause, that you will see in the Errors tab of the Queue Monitor when a failed server is selected:

ERR: ----- Render Error:

ERR: D:\MAPS\3DS.CEL [where this is the location of a map in the submitted scene]

The Server could not find *3ds.cel* in the local path specified, which means that the path to this map is not been correct for network rendering. To fix the problem, do one of the following:

- If all maps are being shared from a single directory, make sure the directory is correctly shared with full permissions. See [Sharing a Directory](#) on page 6477.
- Make sure that you have used either the full UNC path name for the bitmaps or that the *maps* directory has been mounted to the same drive letter on each machine. In this case, verify that particular path has been added to the Configure User Paths dialog > [External Files panel](#) on page 7735 of every server's local version of the software or that the particular path was used when assigning bitmaps in the scene to be rendered.
- Verify the bitmaps still reside in the shared directory.
- Add an Alternate Map Path on the Network Job Assignment dialog that points to the folder containing the missing map.

ERR: Object (UVW 1): Sphere01 requires texture coordinates and may not render correctly

Open the scene and make sure the errant object is assigned texture coordinates. This can be as simple as adding a UVW Map modifier to the object.

ERR: Frame error

Texture coordinates must be applied to the specified object to render it on the server.

ERR: Load Error: Missing DLL'S

Following this error, you will also receive a listing of each of the missing DLLs in the scene. Files needed by the server are not available to render the job.

Make sure that all the plug-in DLLs used in a job reside on each of the servers rendering the job.

ERR: Job not found. Ok if just deleted

When you delete a job, the Manager sends out a notification to all clients (Monitors) telling that the job has changed. This is the same message sent when the job completes, gets suspended, resumed, etc. The monitors in turn request the job status from the manager. The manager doesn't find the job (it was just deleted) and returns this error to the monitor.

ERR: Targa - The device is not ready. (0x15)

ERR: Frame error

The server could not write the output file. "Targa" represents the file output type, and will change depending on the output file type you selected. This problem can occur for several reasons:- If you are running the Backburner Server as an installed Windows service, make sure that the user account that the service is logged to has adequate permissions. Administrative permissions are recommended.

- Check to make sure the target output directory is shared, with both read and write permissions.
- Verify that the path for saving file output on the Render Setup dialog (or the Output Event dialog in Video Post) is set to a valid UNC path name.
- If you are writing to a shared directory mounted locally on each server, verify that the directory is mounted to the same drive letter on each server, and that the file output path is set for that drive letter.

PROBLEM: The Server fails to render a frame and displays the following error:

Rebooting 3ds Max by force due to load timeout.

SUGGESTION

The Server has exceeded either the Wait For 3ds Max To Load or Wait For 3ds Max To Render value. This is usually caused by attempting to render large files over the network. Increase these values in the [Advanced Settings dialog](#) on page 6497.

PROBLEM: I cannot assign more than one server to a job in the Network Job Assignment dialog.

If the output of a network-rendering job is an AVI or MOV file, or a single user device, the job can be assigned to a single server only. The Network Job Assignment dialog changes, depending on the file output type of a job. For example, if you are network rendering to one of the file formats above, the All and None buttons do not appear and the dialog title bar contains the word "Single."

If a job that has an AVI or MOV file output type is stopped for any reason (to deactivate it, or because a machine goes down), re-rendering the file restarts at the first frame. Frames cannot be appended later to these file types.

SUGGESTION

To take advantage of the distributed power of network rendering we suggest you first render to a series of Targa files. Then use the Targa files as either an animated background in an empty 3ds Max scene, or as an image input event in Video Post and render the sequence out to the desired output type (for example, AVI).

PROBLEM: When I click the Render button on the Render Setup dialog, I get an error dialog stating:

Error Retrieving Configuration File

This error usually is the result of a corrupt installation of the Backburner applications which caused an errant registry setting.

SUGGESTION

Try reinstalling the Backburner components of the program or manually edit the system registry.

Editing the registry:

- 1 Choose Start > Run.
- 2 Enter RegEdit and click OK
- 3 Browse to HKEY_LOCAL_MACHINE > SOFTWARE > Autodesk > Backburner > 2008.1
- 4 Check the CfgPath entry. Make sure the value is set to *c:\Program Files\Autodesk\Backburner\Network\nrapi.conf*.

5 Close the Registry Editor.

PROBLEM: Backburner not found message when clicking Render button:

Cannot network render. Backburner not found or not installed.

This error dialog appears because the path to Backburner is either not set properly in the Path environment variable or Backburner is missing altogether.

SUGGESTION

Verify that the Path variable is set properly and make sure you've installed the latest version of Backburner.

PROBLEM: Clicking Render button results in Backburner plugin error:

Error creating 3ds Max plugin instance for Backburner.

The path to 3ds Max is not set in the PlugPath section of the *\Backburner\Network\nrapi.conf* file.

SUGGESTION

Verify the presence of the *\Backburner\Network\nrapi.conf* file and check the PlugPath. It should look like this:

```
PlugPath=C:/Program Files/Autodesk/Backburner/
```

PROBLEM: The manager and server windows display strange, garbled text:

Your error message includes @#\$\$#@.

This error occurs if the *nrres.dat* file is missing or damaged. This file is located in: *C:\Program Files\Autodesk\Backburner\Network*

SUGGESTION

Copy the *nrres.dat* file from another system that is not exhibiting the problem, or reinstall Backburner.

System Setup

Checking Requirements

Checking Requirements

Setting up even a small render farm can require a substantial amount of time. As a first step, verify that your proposed network meets the basic requirements. You should also be acquainted with the software required to render over the network.

Hardware Requirements

- One machine on the network must have the software set up and authorized. This system is used to submit network rendering jobs.
- One machine runs a network manager to communicate with rendering servers. You can set up any machine in the network for this purpose. No authorization is required if this machine will not run as a 3ds Max Workstation.
- To install the software, at least one machine needs a DVD-ROM drive mounted for access over the network. Instructions for setting up the network-rendering software are found in the [Setting Up Rendering Software](#) on page 6474 section.
- Other machines operate as rendering servers. No authorization is required on these machines.
Rendering servers should meet the minimum requirements for running the software. To improve rendering performance, use machines with faster processors, additional memory, and more swap space. A rendering server does not require a monitor while rendering, although it's helpful to have one for setup. Display adapters and accelerators make no difference in rendering performance.

Network Requirements

For operating system requirements, see “Backburner Component Requirements” in the *Autodesk Backburner Installation Guide*. You must also be connected over a network with TCP/IP protocol properly installed. See Instructions for [configuring TCP/IP for network rendering](#) on page 6466.

Software Requirements

One authorized copy of the software is the minimum requirement. With this one copy, you can set up the software on multiple machines for the purpose of network rendering. Later topics provide explicit details for doing a custom setup on each machine. During this setup, programs required to render over a network are installed and registered.

Four separate programs interact to accomplish network rendering. The following descriptions identify these programs and provide an overview of their use.

- **3dsmax.exe**

3ds Max is used to launch job assignments. You submit a network rendering job from the Render Setup, Render to Texture, or Execute Video Post dialog. The application is also used by the rendering servers to render the job.

- **manager.exe**

When run, this application sets up one computer as a network manager. Alternatively, you can run Manager as a service by installing *managersvc.exe*. See [Installing Network Services](#) on page 6503.

The manager program manages communication with the rendering servers during a network rendering job. This can be set up on any machine in the network. However, if large files are to be submitted and many rendering servers are going to be used, a fast computer with a large amount of disk space is the best choice. In almost all network-rendering scenarios, you only have a single manager running on the entire network.

- **server.exe**

When run, this application sets up the computer it's run on to be used as a rendering server. Alternatively, you can run Server as a service by installing *serversvc.exe*. See [Installing Network Services](#) on page 6503.

The server program sends its local IP address to the Manager program, which in turn registers the Server so it will be available for network rendering a job assignment. When the server receives a job from the network manager, it launches a local copy of the software to perform the rendering. The server then sends the completed frame to a target directory and begins rendering the next frame sent to it by the manager. The server shuts down the *3dsmax.exe*/*3dsviz.exe* process when it is no longer needed.

- **monitor.exe**

This standalone program, named Queue Monitor, provides a Windows interface that lets you monitor and schedule network rendering. Since the Queue Monitor is a standalone program, you can start it at any time from

any computer in your network. The only requirement is that you establish a TCP/IP connection with the computer running the manager.

You can load Queue Monitor on each rendering server and use it to monitor rendering progress locally. You can also connect with Queue Monitor remotely using Windows NT Remote Access.

Setting Up for Network Rendering

Whenever different groups need to cooperate on a project, accurate communication and common procedures are essential. A rendering farm is such a project.

Network setup can be difficult to configure, but you only need to do it once. Take your time to get the right setup. Read each topic in order and complete the steps described.

These instructions are for creating a new network dedicated specifically to network rendering. If you are configuring network rendering for an existing network or for a network that will be used for other purposes, these instructions are intended as a reference example only.

Next Step

[Setting Up TCP/IP](#) on page 6463

See also:

- [Setting Up Rendering Software](#) on page 6474
- [Setting Up Directories](#) on page 6475
- [Initial Setup for Manager and Server Programs](#) on page 6501

Setting Up TCP/IP

The software uses the standard network protocol, TCP/IP, for network rendering. TCP/IP is a two-part acronym. *TCP* (Transport Control Protocol) communicates data between applications. *IP* (Internet Protocol) communicates data between an application and the physical network. Each computer in your rendering network needs to be configured for this protocol.

Before continuing, be sure that:

- You have administrative privileges on each machine.
- The network is operational, with network adapter cards installed in each machine.

The TCP/IP protocol requires a device, called a network adapter or Network Interface Controller (NIC), to bind with in order to communicate with other machines. Typically, the network adapter is a network card, but if you are linked to the Internet by modem, a dial-up adapter (the modem) is used.

TCP/IP uses IP addresses to identify the computers on a network. For convenience, you can assign real names to computers. An IP address is a serial number of four integers separated by periods, for example, *192.100.100.1*.

IP addresses can be fixed (as in the example above) or automatic, supplied dynamically each time you connect to the network by a system known as DHCP (Dynamic Host Configuration Protocol).

The software uses the NIC number, which can be thought of a unique serial number assigned to each network card, to identify each machine in the network. This allows the use of DHCP since the IP address usually changes when a machine using DHCP is rebooted.

In some cases, you may want to specify a fixed IP address, for example:

- When you have more than one Manager running on the same network, each with its own set of dedicated Servers, you need to specify which Manager to use. DHCP can be used in this case, but you will have to specify the Manager name instead of its IP address.
- The second case is when the Server or Queue Monitor is outside the local network (as in the case of a WAN or a multi-segmented network connected through a router). In this case, Servers connected to the same network can still use DHCP, provided the Manager has a fixed name and IP address.
- If your network is set peer-to-peer without an NT server (as is the case with most home networks), it is easier to set the machines with permanent, fixed IP addresses.
- Finally, you can use [batch rendering](#) on page 6548 without being connected to a network. In that case, you will need to set up a fixed TCP/IP address and configure the Microsoft Loopback adapter.

In the case of fixed addresses, it is important that IP addresses be properly assigned. In this step, you make up a list of machine names and their

corresponding IP addresses to use during TCP/IP configuration. The list will also be used when installing the software's rendering services.

Using the Manager name is particularly useful when its IP address is assigned dynamically via DHCP, and can change from session to session.

On a closed network, you don't have to worry much about conflicts with the IP addresses of other network domains. However, the addresses need to follow a consistent pattern and each must be unique within your network.

WARNING On an open network, such as those in many large corporations, *do not* alter IP addresses in any way. In such cases, to avoid potentially disastrous consequences, always work with your system administrator to make IP address changes.

Procedures

To create machine names and IP addresses:

- Create a list of machine names and IP addresses.
Unless you have specific needs for later compatibility with another network, use the following list as a model.

Since the Manager machine can also act as a server, start naming your servers to match their IP addresses as shown in the list below. Remember, any one machine can act as a manager under network rendering. Like an IP address, each name must be unique. Also keep in mind that you must not use the numbers 0 or 255 in the last group (or octet) of an IP address as they are reserved.

WARNING Machine names should *not* start with numbers or have spaces or underscores in them, as those will result in illegal names in TCP/IP. This will cause unexpected behavior in the network rendering system.

Machine Name	IP Address
server001	192.100.100.1
server002	192.100.100.2
server003	192.100.100.3
...	...

Machine Name	IP Address
server254	192.100.100.254

Configuring TCP/IP

From the previous step, [Setting Up TCP/IP](#) on page 6463, you should have a list of machine names and IP addresses. With that list, go to each machine and follow these procedures.

On an open network, such as those in many large corporations, *do not* alter IP addresses, machine names, workgroup names, or domain names in any way. In such cases, to avoid potentially disastrous consequences, always work with your system administrator to make IP address changes.

Procedures

Some of the following procedures are for Windows XP Professional; others are for Windows 2000. Find your operating system at the end of the procedure heading and follow that set of instructions.

NOTE During the writing of these procedures, Windows XP was set to display a Classic Windows interface.

To assign a name and workgroup or domain (Windows 2000):

- 1 From the Windows taskbar, open Start menu > Settings > Control Panel > System.

This displays the System Properties dialog.

- 2 Click the Network Identification tab, and then click the Properties button to display the Identification Changes dialog.

If you've already assigned a name to the computer, the name should appear in the Computer Name field on the Network Identification tab. Check this name against your list.

- 3 To change the name, in the Computer Name field, enter a name for the machine.
 - The first character of a valid machine/host name must not be a numeral.
 - Do not use underscores or spaces in the machine/host name.
- 4 In the Member Of group, enter either a workgroup or domain name, depending on how your network is going to be set up.

Workgroup An organizational unit that is used to group computers that don't belong to a domain. If you are setting up a simple network for the purpose of Network Rendering, use the Workgroup option.

Domain A more complex way of grouping servers that share a common security policy and user account database. A domain requires you to set up a Primary Domain controller. You should select the Domain option only if your Network Administrator has a Domain already set up and functioning correctly.

To assign a name and workgroup or domain (Windows XP):

- 1 From the Windows taskbar, open Start menu > Settings > Control Panel > System.

This displays the System Properties dialog.
- 2 Click the Computer Name tab, and then click the Change button to display the Computer Name Change dialog.

If you've already assigned a name to the computer, the name should appear in the Computer Name field on the Computer Name tab. Check this name against your list.
- 3 To change the name, in the Computer Name field, enter a name for the machine.
 - The first character of a valid machine/host name must not be a numeral.
 - Do not use underscores or spaces in the machine/host name.
- 4 In the Member Of group, enter either a workgroup or domain name, depending on how your network is going to be set up.

Workgroup An organizational unit that is used to group computers that don't belong to a domain. If you are setting up a simple network for the purpose of Network Rendering, use the Workgroup option.

Domain A more complex way of grouping servers that share a common security policy and user account database. A domain requires you to set up a Primary Domain controller. You should select the Domain option only if your Network Administrator has a Domain already set up and functioning correctly.

To add the TCP/IP protocol (Windows 2000):

- 1 From the Windows taskbar, open Start menu > Settings > Network and Dial-up Connections > Local Area Connection.

This opens the Local Area Connection Status dialog.

- 2 Click the Properties button.

This opens the Local Area Connection Properties dialog.

- 3 Check the list for "Internet Protocol (TCP/IP)".

If you find this listing, TCP/IP is installed on this machine. Go on to either of these procedures in the current topic:

- [To configure TCP/IP in DHCP mode](#) on page ?

- [To configure TCP/IP with fixed IP addresses](#) on page ?

If TCP/IP is not installed, make sure none of the list items is highlighted (click in a blank area of the list), and complete the remaining steps in this procedure.

- 4 Click the Install button.

This opens the Select Network Component Type dialog.

- 5 In the list, click Protocol, and then click the Add button.

- 6 In the Select Network Protocol dialog, select Internet Protocol (TCP/IP), and then click OK.

A message appears: "Do you want to use DHCP?". Consult your system administrator to see if your network is DHCP-compatible; if it is, click "Yes". If you are unsure, click "No" and proceed to set your workstations with fixed IP addresses.

TCP/IP is added to the list of installed protocols.

- 7 Click the Close button.

To add the TCP/IP protocol (Windows XP):

- 1 From the Windows taskbar, open Start menu > Settings > Network Connections.
This opens the Network Connections dialog.
- 2 Right-click Local Area Connection and click the Properties button.
This opens the Local Area Connection Properties dialog.
- 3 Check the list for "Internet Protocol (TCP/IP)".
If you find this listing, TCP/IP is installed on this machine. Go on to either of these procedures in the current topic:
 - [To configure TCP/IP in DHCP mode](#) on page ?
 - [To configure TCP/IP with fixed IP addresses](#) on page ?
If TCP/IP is not installed, make sure none of the list items is highlighted (click in a blank area of the list), and complete the remaining steps in this procedure.
- 4 Click the Install button.
This opens the Select Network Component Type dialog.
- 5 In the list, click Protocol, and then click the Add button.
- 6 In the Select Network Protocol dialog, select Internet Protocol (TCP/IP), and then click OK.
A message appears: "Do you want to use DHCP?". Consult your system administrator to see if your network is DHCP-compatible; if it is, click "Yes". If you are unsure, click "No" and proceed to set your workstations with fixed IP addresses.
TCP/IP is added to the list of installed protocols.
- 7 Click the Close button.

To configure TCP/IP in DHCP mode (Windows 2000):

- 1 From the Windows taskbar, open Start menu > Settings > Network and Dial-up Connections > Local Area Connection.
This opens the Local Area Connection Status dialog.
- 2 Click the Properties button.
This opens the Local Area Connection Properties dialog. You should see your network adapter card listed as "Connect Using" at the top of this

dialog. If your adapter is not listed, follow the instructions in Windows 2000 documentation on adapter setup.

- 3 In the list, highlight Internet Protocol (TCP/IP) and click Properties. The Internet Protocol (TCP/IP) Properties dialog appears.
- 4 Make sure the option "Obtain an IP address automatically" is chosen.
- 5 Click OK to close each dialog in turn. Windows 2000 finishes configuring the software.
- 6 Reboot the computer to complete the configuration.
- 7 Repeat all the steps on this page on every machine in your network.

To configure TCP/IP in DHCP mode (Windows XP):

- 1 From the Windows taskbar, open Start menu > Settings > Network Connections. This opens the Network Connections dialog.
- 2 Right-click Local Area Connection and click the Properties button. This opens the Local Area Connection Properties dialog. You should see your network adapter card listed as "Connect Using" at the top of this dialog. If your adapter is not listed, follow the instructions in Windows XP documentation on adapter setup.
- 3 In the list, highlight Internet Protocol (TCP/IP) and click Properties. The Internet Protocol (TCP/IP) Properties dialog appears.
- 4 Make sure the option "Obtain an IP address automatically" is chosen.
- 5 Click OK to close each dialog in turn. Windows XP finishes configuring the software.
- 6 Reboot the computer to complete the configuration.
- 7 Repeat all the steps on this page on every machine in your network.

To configure TCP/IP with fixed IP addresses (Windows 2000):

- 1 From the Windows taskbar, open Start menu > Settings > Network and Dial-up Connections > Local Area Connection. This opens the Local Area Connection Status dialog.
- 2 Click the Properties button.

This opens the Local Area Connection Properties dialog. You should see your network adapter card listed as "Connect Using" at the top of this dialog. If your adapter is not listed, follow the instructions in Windows 2000 documentation on adapter setup.

- 3 In the list, highlight Internet Protocol (TCP/IP) and click Properties. The Internet Protocol (TCP/IP) Properties dialog appears.
- 4 Choose "Use The Following IP Address".
- 5 In the box for IP Address, enter the address for that machine. Check your list to make sure the entry is correct.
- 6 In the box for Subnet Mask, type these numbers (these are the same for every machine):
255.255.255.0
If you are on a large corporate network, this subnet mask might be different. In this case, use the mask that your network administrator specified. Also, change the network mask when setting up a server to connect to a manager as well as in the Network Job Assignment dialog to match the subnet mask in order for Automatic Search to work.
- 7 Click OK to close each dialog in turn. Windows 2000 finishes configuring the software.
- 8 Reboot the computer to complete the configuration.
- 9 Repeat all the steps on this page on every machine in your network. Remember that each machine needs to have a unique IP Address and machine name so no conflicts arise.

To configure TCP/IP with fixed IP addresses (Windows XP):

- 1 From the Windows taskbar, open Start menu > Settings > Network Connections.
This opens the Network Connections dialog.
- 2 Right-click Local Area Connection and click the Properties button.
This opens the Local Area Connection Properties dialog. You should see your network adapter card listed as "Connect Using" at the top of this dialog. If your adapter is not listed, follow the instructions in Windows 2000 documentation on adapter setup.
- 3 In the list, highlight Internet Protocol (TCP/IP) and click Properties.

The Internet Protocol (TCP/IP) Properties dialog appears.

- 4 Choose “Use The Following IP Address”.
- 5 In the box for IP Address, enter the address for that machine.
Check your list to make sure the entry is correct.
- 6 In the box for Subnet Mask, type these numbers (these are the same for every machine):
255.255.255.0
If you are on a large corporate network, this subnet mask might be different. In this case, use the mask that your network administrator specified. Also, change the network mask when setting up a server to connect to a manager as well as in the Network Job Assignment dialog to match the subnet mask in order for Automatic Search to work.
- 7 Click OK to close each dialog in turn.
Windows XP finishes configuring the software.
- 8 Reboot the computer to complete the configuration.
- 9 Repeat all the steps on this page on every machine in your network.
Remember that each machine needs to have a unique IP Address and machine name so no conflicts arise.

Creating a Special User Account

If you run the Server as a Service, you should create a special user account, which gives the Server the right to access other machines on the network for necessary maps, xrefs and output directories. This account must be identical across all rendering server machines.

By assigning a user to the rendering Server service, you configure the rendering server to operate with the permissions and access rights of that user account. Without this assignment, the rendering server operates with system permissions, which do not let the server service access map, xref, image, or output directories on other machines.

NOTE These steps require you to have administrative privileges on every machine where you set up this account.

For the following procedures, Windows XP was set to display a Classic Windows interface.

Procedures

To create a new user (Windows 2000 and XP):

- 1 From the Start menu, select Settings > Control Panel > Administrative Tools > Computer Management.
- 2 In the Computer Management dialog, go to System Tools > Local Users and Groups > Users.
- 3 In the right-hand pane, right click in a blank area and choose New User to display the New User dialog. If the New User option is unavailable, you don't have the required administrative privileges.
- 4 In the New User dialog, do the following:
 - Enter a user name for the new account in the Username text box. This can be any name, but it should be the same across all network rendering machines.
 - Enter a password for the new account in the Password and Confirm Password boxes. Like the user name, this password needs to be the same for all rendering servers.
 - Turn off "User Must Change Password At Next Logon" and turn on "Password Never Expires". This will bypass errors when you assign this special user account to the rendering service.
 - Click Create to create the new user and password. When the network is part of a domain it is a good idea to have your network administrator create a special user account on the domain. This user account would have read/write access to the network servers where maps, xrefs and frames are stored.
 - Click Close.
- 5 Do not close Administrative Tools.

To assign a user to a rendering service (Windows 2000 and XP):

Do the following on every computer used as a rendering server:

- 1 Make sure each server system is set up with the [Network Rendering Server](#) on page 6516 running as a service.
- 2 From the Administrative Tools windows, choose Services to display the Services dialog.

- 3 From the Service list, right-click the Backburner Server item.
- 4 Choose Properties to display the Properties dialog.
- 5 On the Log On tab, choose This Account and enter the name of the new user you created for the special user account.
If a user account was created on the domain, you would enter [domain name]\[user name] as This Account, or you can browse the domain for the user.
- 6 In Password and Confirm Password fields, enter the password for the special user account.
- 7 Click OK to exit the Properties dialog.
- 8 If the service is started, stop it by right-clicking the item and choosing Stop.
- 9 Right-click the item and choose Start to restart the service with the newly assigned user.

NOTE If you did not turn off “User Must Change Password At Next Logon” when setting up the new account, you will encounter errors. You will need to re-login the newly assigned user so you can first change the password. Once the password is changed, the Backburner Server should start.

- 10 Close the Services dialog

Setting Up Rendering Software

When you've configured the computers on your rendering network for TCP/IP, you're ready to load the software.

You need to install 3ds Max on each system you plan to use for network rendering. After you've installed 3ds Max on all the systems, at least one of them needs to be authorized. This is the copy of the software that you will run interactively and is used to submit jobs for network rendering.

Refer to the Installation Guide for details about installing 3ds Max.

NOTE A system using the scanline renderer, that is intended to act a dedicated rendering server, does not require authorization for 3ds Max.

Setting Up Directories

During network rendering, common directories (directories that are shared across the network) allow access to files needed by all the rendering servers. You can organize, share, and (if necessary) mount these directories.

There are two types of common directories:

- **Map directories** One or more directories where maps and images are stored. These can be both project-specific and general locations.
- **Output directory** A single directory where completed frames are sent from each rendering server, also called the target directory. You specify this directory for each job. This can also be a local directory on each machine.

The network rendering system uses the Universal Naming Convention (UNC) to identify directories and files. UNC names begin with a double backslash and do *not* include a drive letter. This is the convention:

`\\machine_name\directory\subdirectory\filename`

IMPORTANT To simplify network rendering, use UNC names whenever possible within a 3ds Max scene, even if the directory is on the local machine.

TIP When entering UNC names, omit the \\ before the computer name until you've entered the entire path and file name. This eliminates search delays when entering UNC path names into file selection dialogs.

Some networks require drive letters instead of UNC names. Directories on such networks can be mounted as drive letters and shared over the network. See [Mounting a Directory](#) on page 6478.

Organizing Directories

Correctly organizing directories is critical to the success of your rendering farm. Every element in a scene needs to be available to each server for a complete rendering. The goal is to give every machine in your network the same "picture" of where files are located. Follow these rules when organizing your directories:

- [Share directories](#) on page 6477 to make them available to the network.
- Use UNC file specification when assigning maps files and output directories, even when the directory is on a local machine.

Creating Map Directories

As you assign materials in a scene, the software stores the complete path to each map you use. The program searches for that particular location. If necessary, the program continues to look through the directory containing the scene file and its subdirectories.

Maps, specific to a project, should be kept in a dedicated directory that has been set up for that project. You can create subdirectories below this directory to organize files. This directory needs to be shared using Windows Explorer.

Maps for general use, such as texture libraries, can be organized as you choose. The computers containing such libraries need to be on the network, and the directories need to be shared.

Creating a Common Output Directory

A common output directory is a single directory on one hard disk where rendered frames accumulate during network rendering. When creating a common output directory, follow these guidelines:

- Decide on a machine to accept final output. It should have enough disk space to store the largest completed animation file you're likely to render.
- Create or choose a directory for final output.
- Share that directory as a resource available to the network.

Creating a Local Output Directory

A local output directory lets you use available storage on each rendering server. Rendered frame files are sequentially numbered when assigned by the network manager. When you collect the finished frames, they automatically sort in the proper order. When creating a local output directory, follow these guidelines:

- Use the same path and name for all local directories. For example, use `\3dsmax_files\images\`.
- Use the same path and name for all local directories. For example, use `\Program Files\Autodesk VIZ 2008\images`.
- Specify this path for the output directory when you start network rendering. All rendering servers will then send their output to this local directory.

On any one rendering job, use either a common or local output directory. They cannot be mixed.

See also:

- [Mounting a Directory](#) on page 6478
- [Using Configure User Paths](#) on page 6479

Sharing a Directory

You share a directory from the machine where the directory is located. This gives other machines on your network access to that directory. The instructions below are general. See your Windows Vista, Windows XP, or Windows 2000 documentation for details.

Next Step

[Initial Setup for Manager and Server Programs](#) on page 6501

See also:

- [Mounting a Directory](#) on page 6478
- [Using Configure User Paths](#) on page 6479

Procedures

To share a directory:

- 1 Go to the machine that contains the directory you want to share.
- 2 In Windows Explorer, right-click the directory to share, and then choose Sharing from the right-click menu.
- 3 If using Windows XP or Windows 2000, on the Sharing tab, choose the Share This Folder option.
- 4 If using Windows NT4, on the Sharing tab, select the Shared As option.
- 5 Use the default Share Name.
- 6 Click Permissions and make sure permissions are set to Everyone/Full Control. Click OK to exit the Permissions dialog.

- 7 Click OK to accept the changes.

NOTE If you plan to use more than 10 rendering servers, both the output path and location of all scene maps should be on a system running Windows XP or Windows 2000 Server, as both Windows XP Professional and Windows 2000 Professional have a limit of 10 simultaneous connections.

Mounting a Directory

You can mount a directory to a drive letter as an alternative to using [UNC names](#) on page 8160. In mixed UNIX/XP/2000 networks, for example, you might need to mount the output directory.

For network rendering, you mount (or map) the directory on all machines in the network. This gives all rendering servers access to the shared directory.

Before beginning this setup, choose a common drive letter for all servers to mount. If you have other drives mounted, you might need to switch assignments to free the drive letter for this mount.

If a Map or Target directory is on a rendering server, mount the directory on this machine like all the others, even if the directory is on the local disk.

When using a mounted directory, be sure that the directory to be mounted is correctly shared. When assigning bitmaps, always use the path with the common drive letter.

The steps below are general. See your Windows XP or 2000 documentation for more details.

NOTE During the writing of these procedures, Windows XP was set to display a Classic Windows interface.

See also:

- [Sharing a Directory](#) on page 6477
- [Using Configure User Paths](#) on page 6479

Procedures

To map a directory to a drive letter (Windows 2000 or XP):

- 1 In Windows Explorer, choose Tools > Map Network Drive to display the Map Network Drive dialog.
- 2 Set the Drive drop-down menu value to the common drive letter you've chosen.
- 3 In Folder, enter the exact location of the output directory, using UNC convention.
You can also map a directory to a drive letter by choosing the machine and shared directory with the Browse button in the Map Network Drive dialog.
- 4 Click Finish to complete the mount.

NOTE If the drive maps to a server on a large corporate network, you may be required to enter your user name and password to gain access.

Using Configure User Paths

Render-only machines do not require any form of authorization. However, you cannot use unauthorized versions of the software to access the [Configure User Paths dialog](#) on page 7729 to specify alternative locations for servers to search for bitmap files.

If you do not want to concern yourself with configuring paths on render-only machines (servers), then turn on the Use Alternate Map Path or Include Maps option on the [Network Job Assignment dialog](#) on page 6481.

The Use Alternate Map Paths option lets you specify an alternate folder where the rendering server can look for bitmaps if they are not found in the primary bitmap path.

If using Include Maps, network rendering will take care of making copies of the bitmaps and send them to the server assigned for rendering. When the rendering job is done, the copies are erased from the server hard drive. The files are placed in a `\network\serverjob` subdirectory of the software.

If a server cannot find a bitmap image in the path specified in the file, it then searches the paths listed in its own Bitmaps panel. Only after searching in all locations will the server fail due to missing maps. If you have followed

instructions in the previous topics ([Setting Up Directories](#) on page 6475, [Sharing a Directory](#) on page 6477, and [Mounting a Directory](#) on page 6478), then you know that a common map directory on the network is the best way to proceed. Use the following steps to properly configure your paths on the machine running the authorized copy of the software and on the servers meant for render-only purposes.

See also:

- [Sharing a Directory](#) on page 6477
- [Mounting a Directory](#) on page 6478

Procedures

To add bitmap paths to the External Files panel from within the software:

- 1 Run the software on a machine running an authorized copy of the program.
- 2 Choose Customize > Configure User Paths to open the Configure User Paths dialog, and then click the External Files tab, if necessary.
- 3 Use the Add button to specify the paths ([UNC](#) on page 8160 or mounted) to every directory on the network where bitmap files are stored for rendering. Make sure you use UNC or mounted directories, even if the maps are on the local drive.
- 4 Click OK.

To add bitmap paths to render-only machines using the initialization file:

Use the following steps if you do not want to authorize the software on the server machine(s).

- 1 Install the 3ds Max core software on the server station(s).
- 2 Copy the [3dsmax.ini](#) on page 83 file from your authorized 3ds Max workstation to the program directory of each of your server(s).

If you followed the previous procedure, the copied initialization file contains information about UNC or mounted directories that stores the required bitmap files.

NOTE To prevent mishaps, it is usually a good idea to edit the INI file once it is copied to the server. Remember that the server machine can be configured differently than your 3ds Max workstation: The drive letter, program directory, and subdirectories may be different. Use a word processor to edit all entries under the [Directories] section to match entries of the server machine.

For example:

```
[Directories]
Fonts=d:\3dsmax\fonts
Scenes=d:\3dsmax\scenes
Import=d:\3dsmax\meshes
Export=d:\3dsmax\meshes
...
```

Network Job Assignment Dialog

Rendering menu > Render Setup > Render Setup dialog > Turn on Net Render (Render Output group) > Render

Rendering menu > Render To Texture > Render To Texture dialog > Turn on Net Render (Render Settings group) > Render

Rendering menu > Video Post > Set up a sequence with an Image Output Event > Turn on Net Render (Output group) > Render

Use the Network Job Assignment dialog to name rendering jobs, specify the computers that will participate in the rendering, and submit jobs to the rendering servers.

You can submit as many jobs as you like in a single session. Open each file you want to render and submit it following the standard procedure. Each job is placed behind the last one submitted. If you submit a job in which the frame output name is the same as another job in the queue, a warning dialog asks you if you want to overwrite the output frames from the other job.

You can divide the work of rendering a single image among any number of rendering servers. This is particularly useful when rendering a single, extremely high-resolution image intended for print. To use this feature, turn on the [Split Scan Lines option](#) on page 6486.

Procedures

To use the Network Job Assignment dialog:

The Network Job Assignment dialog is accessible when you turn on the Net Render toggle. The Net Render toggle can be accessed from three different dialogs used for rendering.

- 1 Rendering menu > Render Setup > Render Setup dialog > Render Output group
- 2 Rendering menu > Render To Texture > Render Setup dialog > Render Settings group
- 3 Video Post dialog > Execute Sequence > Execute Video Post dialog > Output group
- 4  In the Render Setup dialog > Render Output group, click the ellipsis button and then specify an output file name and path using [Universal Naming Convention \(UNC\)](#) on page 8160. The easiest way to specify a UNC path is to start with Save In > My Network Places.
- 5 Turn on Net Render.
- 6 Click the Render button.
The Network Job Assignment dialog appears.
- 7 On the Network Job Assignment dialog, specify a job name.
By default, this is the file name of the current scene. Click the plus (+) button next to the Job Name field to increment the job name. Unlike the plus button in the file dialogs, this button does not automatically launch the job.

NOTE The software does not let you submit multiple jobs with the same name.

- 8 Determine whether to find the Manager automatically or manually. By default, the software searches automatically for the Manager using a network mask that you specify in the dialog. Alternatively, turn on Manual Search and enter the name or IP address of the computer running the Manager program.
- 9 Click Connect to continue.
You see a listing of all servers available for network rendering. Each server is marked with a colored icon to denote its current status:

Green Running and not rendering any jobs.

Yellow Rendering another job. You can assign jobs to busy servers, and the jobs will be rendered in the order received.

Red Failed. Try rebooting the server or see [Troubleshooting](#) on page 6455 for more information on failed servers.

Gray Absent. Verify that the Server is currently running and that it has not been "Disallowed" in the Week Schedule. See "Scheduling the Availability of a Render Node Using the Backburner Monitor" in the *Autodesk Backburner User's Reference*.

If a rendering Server is running on a workstation that also has an interactive session of the software, you can still select that machine for rendering. A second copy of the software is launched to execute the network render.

You can view statistics of a particular Server by right-clicking its name and choosing Properties.

- 10 Determine whether you will use the selected server, all servers, or a group of servers.
- 11 Click Submit to send the job to the rendering queue.

Interface

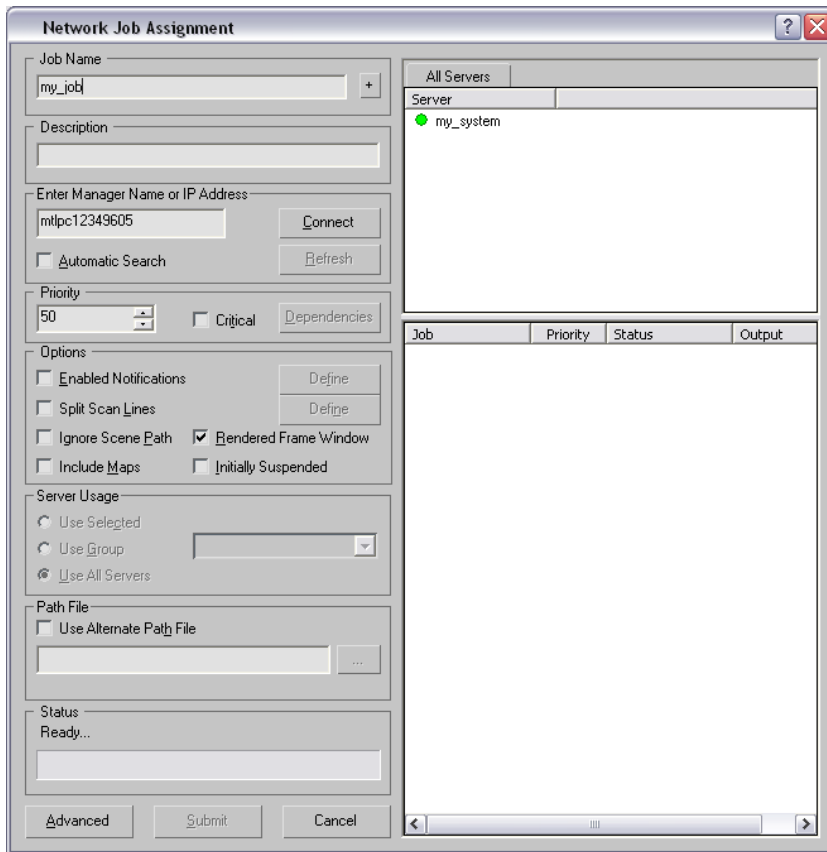

Job Name Provides a field for you to name the job (mandatory). The + button beside the field adds incremental numbering (Job01, Job02, and so on).

NOTE The software does not let you submit multiple jobs with the same name.

Description Enter an optional description of the job.

Enter Subnet Mask/Enter Manager Name or IP Address group

Enter Manager Name or IP Address When Automatic Search is turned off, enter the name of the [Network Manager](#) on page 8057 machine or its IP address.

Enter Subnet Mask When Automatic Search is on, enter a subnet mask for automatic search. For information on using subnet masks.

Connect/Disconnect Connects to the network Manager. The software preserves the connection as a global setting so that you need to change it only when you want to specify an alternative Manager. If connected to the network manager, click Disconnect to disconnect from the current manager so you can choose a different manager.

Automatic Search Determines whether the software connects to a specific manager or searches for one using a subnet mask when you click Connect. When off, the software attempts to connect to the manager you specify in this group. When on, it searches the network for a manager using the specified subnet mask.

Refresh Updates the Server and Job lists.

By default, all servers are used for the job. When the Options group > Use All Servers check box is turned off, you can choose one or more servers to render the job. If rendering to a multiple-frame file format, such as an AVI or MOV file, you can choose only one server.

Priority group

Priority Specifies a priority ranking for the job. The lower this setting, the higher the job priority. Default=50.

For example, consider a job with priority 1 (Job B) that is submitted to a network manager that's already rendering a job with priority 2 (Job A). Because Job B has a higher priority, Job A will be suspended and Job B rendered. When Job B is finished, the software will resume rendering Job A.

If two or more jobs have the same priority, they're executed in order of submission.

Critical Sends the job to the head of the queue, preempting the existing jobs. If a server is currently rendering and a critical job is sent to the queue, the server will stop rendering its current job and begin rendering the new, critical job. When finished with the critical job, the server returns to the next job it has been assigned in the queue.

Dependencies Opens the [Job Dependencies dialog](#) on page 6490, which you can use to specify existing jobs that must finish before the current job can start.

Options group

Enabled Notifications Lets the software send rendering-related messages via email. When this is on, its Define button becomes available. For information, see the [Notifications dialog](#) on page 6492 topic.

Define Opens the Notifications dialog, which lets you set notifications parameters.

Split Scan Lines Lets you subdivide the rendering of each frame among the rendering servers. This is useful when rendering a single, extremely high-resolution image intended for printing. For information, see the [Strips Setup dialog](#) on page 6494 topic.

When Split Scan Lines is on, its Define button becomes available.

NOTE This feature does not support Render Elements. Also, it's unavailable when rendering to textures with projection mapping enabled and Sub-Object Levels on.

Define Opens the Strips Setup dialog, which lets you set parameters for the Split Scan Lines option.

Ignore Scene Path When off, the server attempts to copy the scene file from the manager to the server. If the manager is running on Windows 2000 Professional, only 10 servers will copy the file from the manager; any machines over the limit 10 will use TCP/IP to retrieve the file. When turned on, the servers get the file via TCP/IP only. Default=off.

Rendered Frame Window During rendering, displays the Rendered Frame Window on all servers running *serverapp.exe* (not *serversvc.exe*). Default=on.

Include Maps Archives the scene, with all of its maps, any inserted Xrefs and their maps, into a proprietary-format compressed file. The compressed file is sent to each Server, where it is uncompressed into a temporary directory named *serverjob* in the *\network* subdirectory of the program and rendered. Default=off.

Use this feature if you have access only to Servers that exist over the Internet or if you have a slow network setup. It is not meant for heavy production use. However, if you don't use it, you must first ensure that all network servers have access to all map and Xref paths referred to in the scene.

Initially Suspended Adds the named job to the queue in an inactive state. The job is not started until you activate it manually from the Backburner Monitor. See "Monitoring and Managing Jobs" in the *Autodesk Backburner User's Guide*.

Server Usage Group

You choose between using all available servers, all servers in a group, or selected servers. See “Configuring Server Groups” in the *Autodesk Backburner User’s Guide* for an explanation of how to set up server groups. In a 3ds Max setup it can be useful to set up servers in groups. For example, during busy times you can assign high priority jobs to a group of high performance servers.

Use Selected Uses only the servers that you have highlighted in the Server list.

Use Group Uses all of the servers in a group.

TIP Note that the servers are assigned to a group in the Autodesk Backburner monitor.

Group drop-down list Choose the group of servers that you want to use for your render.

Use All Servers Uses all Servers in the active Server group for rendering the job. Available only after you submit a multi-frame rendering job.

Path File Group

Use Alternate Path File Allows you to specify an alternate path file in the MXP format that rendering servers can use to find bitmaps that are not found on the primary map paths. When on, you can manually enter the path and file name in the field below the check box, or click the ellipsis button and browse to the MXP file.

NOTE Create MXP files with [Configure User Paths](#) on page 7729.

Status group

Displays text messages describing the current status of the job assignment.

Server list

The Server list, located on the upper-right side of the Network Job Assignment dialog, displays all [network rendering servers](#) on page 8058 registered with the

network manager after you connect to the manager. There are two types of tabs in the Server list:

- **All Servers** Lists all of the available servers that can be used for your render. When this tab and Use All Servers are enabled, all servers will be used to render the job.
- **[group name]** Lists all of the servers assigned to a group. When this tab and Use Group are enabled, all servers listed on the tab will be used to render the job.

NOTE If a server is unavailable it will be skipped and the next available server will be used.

If more groups are available than can fit in the space above the list, arrow buttons for scrolling the group list horizontally appear above the list's top-right corner. Click these arrow buttons to scroll the list left or right to view additional group tabs.

By default, each Server is marked with a colored status icon:

- **Green** Running and not rendering any jobs.
- **Yellow** Rendering another job. You can assign jobs to busy Servers, and the jobs will be rendered in the order received.
- **Red** Failed. Try rebooting the Server or see [Troubleshooting](#) on page 6455 for more information on failed Servers.
- **Gray** Absent. Verify that the network Server is currently running and that it has not been "Disallowed" in the Backburner Monitor. See "Launching the Backburner Monitor" in the *Autodesk Backburner User's Guide* for information on viewing activities in the monitor.

NOTE You can change the height of the server list window relative to the job list window below it by dragging the partition vertically.

Server list right-click menu

By default, servers are listed by name only. To see more information about a server, right-click its name in the list. A menu appears with these options:

Properties Displays the Server Properties dialog, which shows aspects of the server hardware and operating system, including memory and disk space.

All Server Details This toggle, when on, displays all details about each server to the right of its name. When off, restores the last saved set of partial server details unless the last saved set was All Server Details, in which case it restores the default set: name only. See the following item for the list of available details.

NOTE You can see more details by scrolling the list with the horizontal scroll bar at the bottom, or by widening the dialog by dragging its right side with the mouse.

Partial Server Details Opens the Set Server Property Tabs dialog, which lets you specify which details are shown in the Server list. The dialog provides check boxes for turning on and off the display of these details:

- Status: See [Server list](#) on page 6487 for status details.
- Number of CPUs
- Total Physical Memory - in bytes
- Operating System
- Work Disk Space - in megabytes
- Historical Performance Index - see note below
- Handle - a hexadecimal identification number for the machine
- User - current user name

NOTE The Historical Performance Index value, listed under the Perf. Index heading in the Server list window, offers information on the relative speed of the listed servers. The fastest machine is rated at 1.0, while the other servers are rated as fractions of the fastest. A machine whose average is twice as long would receive a .50 index. Each machine is rated by measuring the time it takes to complete each frame, and the accumulated time is divided by the number of frames, resulting in the average time per frame, in seconds.

Several factors can affect a machine's performance. CPU power isn't necessarily a concern when large file transfers are involved. For example, if a certain job uses several map files from a centralized server, the performance of the network throughput plays a much larger part than CPU performance, as most machines will spend the majority of the time reading maps. On the other hand, if the machine has all maps locally it will have a huge advantage (local access versus network access) regardless of which CPU it is using. The performance index provides you with information regarding your servers' rendering performance

to help analyze your network rendering setup and better distribute the workload.

Job list

The job list, located on the lower-right side of the Network Job Assignment dialog, displays all jobs submitted to the network manager. Also shown are each job's priority, status, and output file path.

To change job settings and manage jobs, use the Backburner Monitor. See “Modifying Job Settings” and “Monitoring and Managing Jobs” in the *Autodesk Backburner User’s Guide*.

Advanced Opens the [Advanced Settings dialog](#) on page 6497, where you can make settings for Per-Job Timeouts, TCP port number, Pre-Render MAXScripts and Job Handling.

Submit Click Submit to exit this dialog and send the current job to the Network Manager, which places it in the queue for rendering.

When you submit a rendering job, if the output file name to be used by the job is the same as that used by an existing job, you're asked if you want to overwrite the existing file(s). Also, if the name of the submitted job replicates one already in the rendering queue, an alert notifies you; click OK, change the job name, and submit it again.

NOTE Submitting a job creates a folder for the job on the manager machine in the `\Program Files\Autodesk\Backburner\Network\jobs\` folder. In that folder is a compressed file with a `.maz` extension containing the scene file. You can extract the scene from the command prompt using the `maxunzip.exe` program, found in the 3ds Max program directory. For example, to extract a file named `testfile.maz`, assuming the program is installed in a folder named `\3ds Max 2009\`, open the command prompt, navigate to the `\Program Files\Autodesk\Backburner\Network\jobs` folder, and enter this: “**\Program Files\Autodesk\3ds Max 2009\maxunzip**” **testfile.maz**. You must specify the `.maz` file-name extension; otherwise you'll get an error message.

Cancel Discards changes and exits the dialog.

Job Dependencies Dialog

Rendering menu > Render Setup > Render Setup dialog > Turn on Net Render (Render Output group). > Render > Network Job Assignment dialog > Connect to a Manager. > Priority group > Dependencies

Rendering menu > Render To Texture > Render To Texture dialog > Turn on Net Render (Render Settings group) > Render > Network Job Assignment dialog > Connect to a Manager. > Priority group > Dependencies

Rendering menu > Video Post > Set up a sequence with an Image Output Event > Turn on Net Render (Output group) > Render > Network Job Assignment dialog > Connect to a Manager. > Priority group > Dependencies

This dialog lets you specify jobs that shouldn't begin rendering until other jobs finish. Use the two lists and the Add and Remove buttons to build a list of jobs that must finish rendering before the current job can start.

Interface

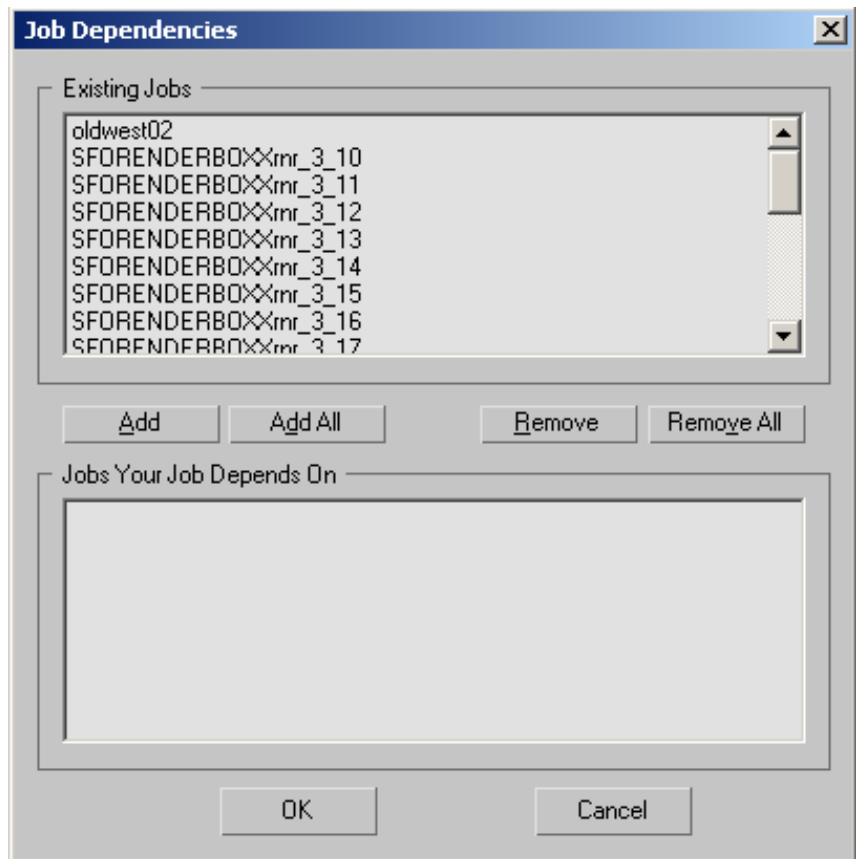

Existing Jobs list Lists all previously submitted jobs. To specify a dependency for the current job, add one or more of these to the Jobs Your Job Depends On list.

Add Select one or more jobs your job is to depend on, and then click Add to add them to the Jobs Your Job Depends On list.

Add All Adds all jobs in the Existing Jobs list to the Jobs Your Job Depends On list.

Remove Removes highlighted jobs from the Jobs Your Job Depends On list.

Remove All Removes all jobs from the Jobs Your Job Depends On list.

Jobs Your Job Depends On list Lists all previously submitted jobs. To specify a dependency for the current job, add one or more of these to the Jobs Your Job Depends On list.

Notifications Dialog

Rendering menu > Render Setup > Render Setup dialog > Turn on Net Render (Render Output group) > Render > Network Job Assignment dialog > Options group > Turn on Enabled Notifications. > Define

Rendering menu > Render To Texture > Render To Texture dialog > Turn on Net Render (Render Settings group) > Render > Network Job Assignment dialog > Options group > Turn on Enabled Notifications. > Define

Rendering menu > Video Post > Set up a sequence with an Image Output Event > Turn on Net Render (Output group) > Render > Network Job Assignment dialog > Options group > Turn on Enabled Notifications. > Define

This dialog lets a network rendering job send notifications via email. Such notifications can be useful when you launch a lengthy render, such as an animation, and don't care to spend all your time near the network manager system.

See also:

- “Configuring Backburner Log Files” in the *Autodesk Backburner User’s Guide*

Interface

Notifications

Categories

Notify Progress Every Nth Frame:

Notify Failures

Notify Completion

Email Options

Send Email Include Summary

From:

To:

SMTP Server:

OK Cancel

Categories group

Notify Progress Triggers a notification to indicate rendering progress. A notification is triggered every time the number of frames specified in Every Nth Frame has completed rendering. Default=off.

Every Nth Frame The number of frames used by Notify Progress. Default=1.

Notify Failures Sends an email notification only if something occurs to prevent the completion of a rendering. Default=on.

Notify Completion Sends an email notification when a rendering job is complete. Default=on.

Email Options group

Send Email Notifies via email.

Include Summary Includes a summary of the network rendering progress with the notification email. Available only when Send Email is turned on.

From Enter the email address of the person who initiates the rendering job.

To Enter the email address of the person who needs to know the rendering status.

SMTP Server Enter the numeric IP address of the system you use as a mail server.

Strips Setup Dialog

Rendering menu > Render Setup > Render Setup dialog > Common tab > Turn on Net Render (Render Output group) > Render > Network Job Assignment dialog > Options group > Turn on Split Scan Lines. > Define

The Strips Setup dialog lets you specify how to split up the rendering of a single, large image among several different servers on the network. The software automatically subdivides the rendering based on settings you provide, and then fits the pieces together into the final image.

NOTE A version of this feature was known as Region Net Render in previous versions of the software.

Procedures

To render a large image with a networked render farm:

- 1 Set up a scene to render.
- 2 Set up your system for [network rendering](#) on page 6433.
- 3 From the Rendering menu, choose Render Setup.
The Render Setup dialog opens, with the Common tab active.
- 4 In the Output Size group, specify the size to render.
- 5 In the Render Output group, specify an output file name and location, and turn on Net Render.
- 6 Click the Render button.

The Network Job Assignment dialog appears.

- 7** In the Options group, turn on Split Scan Lines, and then click Define. The Strips Setup dialog appears. The dialog displays the output resolution, and lets you determine how to split up the rendering job by specifying the number of horizontal strips into which the image will be subdivided.
- 8** Specify the vertical size of each strip in pixels or as a percentage of the total image height, or set the number of strips. Changing one also changes the other.
- 9** Set the overlap in pixels or as a percentage.
Using overlap isn't always necessary, but if you notice anomalies where the strips meet, increase this value.
- 10** Connect to the manager, specify a job name, choose one or more servers on which to render, and then click Submit.
The job is sent to the network rendering manager, which supervises the network rendering job. The job consists of first rendering each slice, and then combining, or "stitching," the slices into the final image.
- 11** Monitor the job via the Backburner Monitor. See "Monitoring and Managing Jobs" in the *Autodesk Backburner User's Guide*.
Rendering and stitching passes are designated "Slice Pass" and "Stitch Pass," respectively. When all slices are finished, the job status will be Complete.

Interface

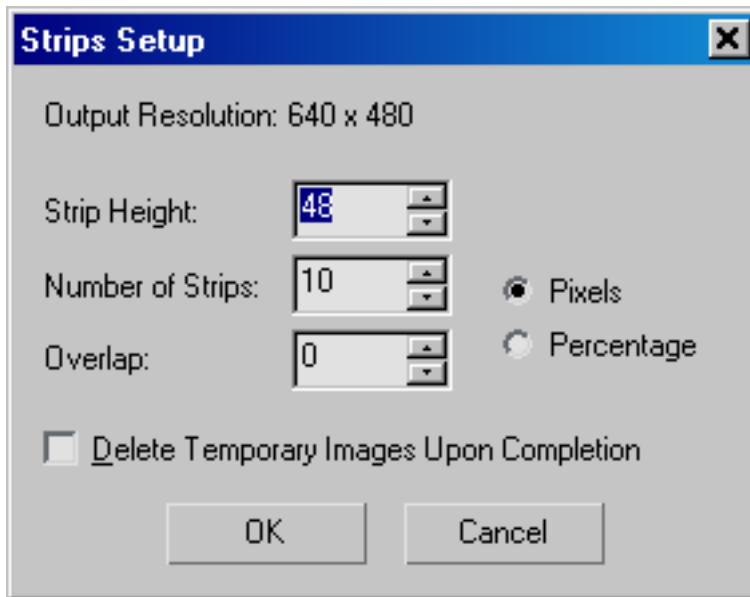

Output Resolution This read-only field displays the horizontal and vertical resolution of the final image, in pixels.

Strip Height Sets the height of each horizontal strip in pixels or as a percentage of the total height. Default=10 percent of the total image height, in pixels.

This setting is interdependent with and inversely proportional to the Number Of Strips setting; increase one, and the software decreases the other.

Number of Strips Sets the number of horizontal strips to be rendered by the available servers. Default=10.

The value determines the maximum number of machines to which the job can be farmed out. For example, if you use the default setting of 10 strips, the job can be performed by 10 machines at most. In that case, assuming equal performance of all 10, rendering would take approximately one-tenth the time required by one machine.

TIP For optimal results with render farms that comprise machines of different speeds, use a value high enough that the job can be completed most efficiently. For example, consider a two-server network with one machine four times as fast as the other. If you set Number Of Strips to 2, the job won't be finished until the slower machine renders its half of the final image. But if you set Number Of Strips to 4, the faster machine can render three of the strips while the slower machine renders one, effectively halving the total render time.

This setting is interdependent with and inversely proportional to the Strip Height setting; increase one, and the software decreases the other.

Overlap Set the amount by which each strip overlaps the adjoining one(s). You can set this in pixels or as a percentage of the final image height.

A certain amount of overlap is necessary to compensate for image artifacts created by antialiasing and render effects. If you notice anomalies where the image slices meet, try increasing the Overlap setting.

Pixels/Percentage Determines whether the Strip Height and Overlap settings represent pixels or a percentage of the final image height. Choosing a different option automatically changes the two values accordingly.

Delete Temporary Images Upon Completion Deletes the “slice” images after the final image is created. Default=off.

Advanced Settings Dialog

Rendering menu > Render Setup > Render Setup dialog > Render Output group > Turn on Net Render > Render > Network Job Assignment dialog > Advanced

Rendering menu > Render To Texture > Render To Texture dialog > Turn on Net Render (Render Settings group) > Render > Network Job Assignment dialog > Advanced

Rendering menu > Video Post > Set up a sequence with an Image Output Event > Turn on Net Render (Output group) > Render > Network Job Assignment dialog > Advanced

The Advanced Settings dialog lets you set job timeouts on a per-job basis, assign the TCP port number, specify pre-render scripts and affect job handling and archive settings.

Interface

Advanced Settings

Per Job Timeouts

Enable Values in Minutes

Wait for MAX to Load:

Wait for MAX to Render:

Wait for MAX to Unload:

Connection to Manager

TCP Port Number:

Submit Job As: 32-Bit 64-Bit

Server Assignment Limit

Enable Limit

Max Server Count:

Job Handling

Enable task blocking

Override Global Settings

After job is successfully completed:

Do Nothing

Delete it

Archive it

Delete After day(s)

Archive After day(s)

Defaults OK Cancel

Per Job Timeouts Group

Enable Turns on the ability to set timeouts on a per-job basis. The remaining settings in this group become available only when Enable is turned on.

Wait for MAX to Load Specifies the amount of time after a job is submitted that the Manager waits for a server to report that it received the frame and is

rendering. If this value is exceeded, an error message is logged for a failed frame, and the frame is assigned to a different server.

Wait for MAX to Render Specifies the amount of time the manager waits between when a server reports that it has started and finished rendering a frame. If a server exceeds the specified value, it is flagged as "failed" by the manager, and no more frames from that job are sent to it.

Wait for MAX to Unload When a job is complete, the manager tells the server to unload the software, then waits for a reply from the server saying 3ds Max is down and it's ready for a new job. This spinner specifies the amount of time the Manager will wait for the Server to reply to this notification. If a server exceeds the specified value, it is flagged as "failed" by the manager, and no more frames are sent to it.

Connection to Manager group

Use this setting to specify the Manager for this job.

TCP Port Number Specifies the port number of the Manager to which this job is to report.

Submit Job As radio button Specifies which platform your scene is rendered on. Use this button when you want to render your scene on a different platform (either 32- or 64-bit) from the platform where you created your scene. This is particularly useful in situations where you are working on a given platform which differs from the platform of the render farm. The most consistent results are achieved when you submit jobs are created and rendered on the same platform.

NOTE This is an advanced option provided to accommodate specific render farm configurations. By default this option is set to the most compatible platform that avoids rendering to platforms where data-loss may result.

Server Assignment Limit

Enable Limit Sets the maximum number of servers that will be allocated for a specific job. This limit can be overridden with the Use Server Limit field in the Backburner Manager General Properties dialog , so that the administrator of a render farm can control job sharing globally.

MAX server count Specifies the number of servers.

Job Handling group

Enable Task Blocking Allows the job to override the task blocking set in the Manager. Some jobs will have their frames processed more efficiently if task blocking is turned off. Default=on.

Override Global Settings This switch lets you override job archiving settings made in the Backburner Manager General Properties dialog. It lets you set the archive settings for the job about to be submitted. When Override Global Settings is turned on, the following three switches become active. Default=off.

NOTE Any setting made while Override Global Settings is turned on, remains active from one 3ds Max session to the next. For example, if you choose to leave jobs in the queue, submit the job and exit 3ds Max, the setting will be active when you choose to submit jobs in the future.

Leave It In The Queue This switch tells the network manager to leave the job in the queue without deleting it or archiving it.

You might use this switch if you are submitting a job that might need to be re-rendered at a higher resolution without making any other changes to the scene.

Archive It When turned on, the job is archived when the rendering is complete. Default=on.

Archiving is useful when you submit a final version of the scene and you know that there won't be any more changes to the scene. Before submitting the job, you set the job to archive upon completion.

Delete It Upon completion, the job is deleted from the queue when this switch is turned on.

If the scene you're network rendering is just a test shot and you're just doing a quick test of the scene, you don't really want to keep the job in the queue once it's completed. Before submitting the job, turn on this switch.

Defaults Returns all settings to their defaults.

OK Accepts any changes and closes the dialog.

Cancel Closes the dialog without saving changes.

Manager and Server

Initial Setup for Manager and Server Programs

The files necessary for network rendering are copied to the Backburner root directory when you install the software. Two of these files, *manager.exe* and *server.exe*, require initialization before they can be run. Set up the Manager program first, then the Server. When you're finished, you can start network rendering. After setup, you can run both Manager and Server as services by installing *managersvc.exe* and *serversvc.exe*, respectively.

You need to initialize only one machine as network Manager. This can be any machine on the network, and can be used on a machine running the Server, 3ds Max, or both.

You need to initialize every machine used as a rendering Server. This is done once to establish the connection between the rendering Server and the network Manager.

The Manager and Server programs can be run in application mode as explained in the procedures that follow, or as Windows 2000 or XP services, in which case they run in the background and provide less feedback on the progression of the rendering job. To learn more about installing these programs as services, see [Installing Network Services](#) on page 6503.

Initialization is done only once for each service. Each initialization process creates or updates the following:

- A subdirectory called *\Network* under the Backburner root directory, containing several further subdirectories, including *\Jobs*, *\Servers*, and *\ServerJob*. By default, the Backburner directory is called *Backburner*, and is found in the *\Program Files\Autodesk* directory.
- A file with initialization parameters (*backburner.xml*).
- A log file that keeps track of what the services do (*backburner.log*).

Next Step

[Starting Network Rendering](#) on page 6450

Procedures

To initialize the Manager program:



- Run the Manager program from the Start menu > Programs > Autodesk > Backburner menu.

The first time you launch the Manager, it creates the *backburner.xml* file, which stores the manager configuration settings.

The Backburner Manager General Properties dialog also appears the first time you run Manager. In most cases, you can safely proceed by accepting the default settings and clicking OK. Thereafter, you can modify the configuration settings by choosing Edit menu > General Settings to open the General Properties dialog. For the new settings to take effect, you need to close the manager and restart it.

The settings in the General Properties dialog are described in depth in [Backburner Manager General Properties Dialog](#) on page 6512.

To initialize the Server program:



- 1 Run the Network Rendering Server program from the Start menu > Programs > Autodesk > Backburner menu.

The first time you run Server, its General Properties dialog appears.

- 2 By default, the Subnet Mask field is set to 255.255.255.0 with the Automatic Search option turned on. In most cases, you should leave this option on. The software detects the machine acting as the manager.

At this point, do not make any other changes in the software's Backburner Server General Properties dialog. Settings in the this dialog are described in detail in [Backburner Server General Properties Dialog](#) on page 6520.

- 3 Click OK on the Backburner Server General Properties dialog to save the current configuration.
- 4 The Server starts, and attempts to connect to a Manager automatically. If no Manager is found on the network, the Server times out and reports that the Manager is not responding.
- 5 If the Server eventually fails to connect to the Manager:
 - Check the subnet mask setting in your TCP/IP network configuration. If it is set to something other than 255.255.255.0, in the Server

application, go to Edit menu > General Settings, in the dialog, set the subnet mask to match it and click OK. You will need to shut down the Server application and restart it for the changes to take effect.

- If you do not want the Server to connect automatically or the Server will not connect automatically to the Manager, go to Edit menu > General Settings and turn off Automatic Search. Click in the Manager Name Or IP Address field and enter the name or IP address of the workstation running Manager, and then click OK. You will need to shut down the Server application and restart it for the changes to take effect.

This updates the [backburner.xml](#) on page 6508 file, which now stores the Server configuration settings. The next time the Server is run, the application is launched and the configuration settings are used.

This completes Server initialization.

Installing Network Services

To install the network Manager and network Server as network services under Windows 2000 or XP, start by doing the following:

- 1 Run the Application versions of the Manager and Server to properly configure the applications and make your rendering network operational.
- 2 Use your network in production so you are sure it is running reliably.
Do not proceed unless these conditions are met.

Installing the network Manager and rendering Servers as Windows 2000 or XP services allows background rendering and is convenient, but it also means that you have less information on the rendering server's screen about problems when they occur. This is why your network needs to be running smoothly before taking this step. Running the Manager and Server as services does not change the information shown in the Queue Monitor.

In the procedures that follow, the Manager and Server services are installed and registered under Windows 2000 or XP. This installation replaces the use of application mode (running the Manager and Server manually each time you want to use them). The services are started automatically every time you boot the computer, but can also be set for manual startup. The *\Network* subdirectory and initialization and LOG files from application mode remain

in place, but the services operate under Windows 2000 or XP instead of in a separate process.

You can run the Manager and Server as services directly from a Command Prompt window or the Run dialog using the `-i` switch (install as a service). Then go to Services and start the Manager and/or Server, or reboot.

To remove the Manager or Server once it has been installed as a service, you must run the program directly from a Command Prompt window or the Run dialog using the `-r` switch (remove service).

See also:

- [Creating a Special User Account](#) on page 6472

Procedures

To set up the Manager as a service:

- 1 Go to the machine on which you will install the Manager as a service.
- 2 Open a Command Prompt window and change the directory to the program's root directory (for example, `\Program Files\Autodesk\Backburner\`).
- 3 Type `managersvc -i`
The following message should be displayed:
Backburner Manager ... Service Installed
- 4 Go to Windows Control Panel > Administrative Tools > Services, right-click *Backburner Manager*, and choose Start.
If you choose Properties from the right-click menu, you can also set users, passwords, and other parameters.

To set up the Server as a service:

- 1 Go to the machine on which you will install the Server as a service.
- 2 Open a Command Prompt window and change the directory to the Backburner root directory.
- 3 Type `serversvc -i`
The following message should be displayed:
Backburner Server ... Service Installed

- 4 Go to Windows Control Panel > Administrative Tools > Services, right-click *Backburner Server*, and choose Start.
If you choose Properties from the right-click menu, you can also set users, passwords, and other parameters.
- 5 Repeat these steps on every machine on which you want to set up Server as a service.

Logging Properties Dialog

Windows Start menu > Programs > Autodesk > Backburner > Manager or Server > Edit menu > Log Settings

The Logging Properties dialog lets you specify the types of messages that appear in the list window on the Manager or Server window and those that are sent to a log file. Each type of log message is explained below.

Log Message Types

Error

Fatal errors that halt a server's rendering of a job. These errors are preceded by a red "ERR" in the Manager or Server list window, and include the following:

- Failed Renderings and Frame Errors (caused by missing bitmaps, missing texture coordinates, invalid output directory, etc.)
- Manager not found
- Error registering server(s)
- Error writing output file
- Error Starting 3ds Max
- Loading timeouts

NOTE You can see a more detailed explanation for server failure in the Queue Monitor's Server list window.

Warning

Non-fatal warning information. These errors are preceded by a brown "WRN" in the Manager or Server list window, and include the following:

- Manager and/or Servers shutting down
- Server(s) flagged as failed
- Loading timeout set too low
- Rendering timeout set too low

Info

General information about the current status of the Manager or Server. These errors are preceded by a aqua "INF" in the Manager or Server list window, and include the following:

- Booting Network Manager/Server
- Connection to Server(s)
- Registration to Manager
- Job Submitted
- Job Received
- Frame Complete

Debug and Debug Extended

Detailed information about TCP/IP packets and the current state of the Manager and Server. Debug Extended provides a more verbose listing than Debug. When in doubt, use both. These messages are preceded by a blue "DBG" in the Manager or Server list window, and include the following:

- TCP/IP Packets sent and received
- TCP/IP Packet collection
- Command Line Arguments used to launch 3ds Max
- Frames Assigned
- Log files creation and sent

■ Assignment Threads

Interface

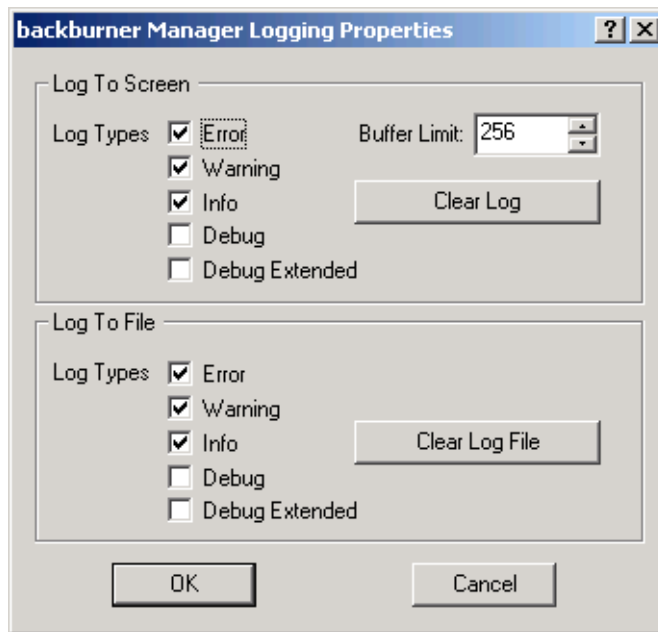

Log To Screen group

The Log To Screen options determine which types of messages are displayed in the list window of the Manager or Server window.

Turn on each type of message that you want to be displayed. Error, Warning, and Info are on by default.

Log To File group

The Log To File options determine which messages saved to log files. These are the same messages that appear on the screen. Turn on any of the following categories to save it in a log file. When any one of these categories is turned on, a *manager.log* file or *server.log* file is created in your `\network` directory. Error, Warning, and Info are on by default.

Buffer Limit Specifies the maximum size of the buffer holding the messages.

Clear Log Clears the buffer holding the messages in the list window.

Clear Log File Deletes the associated *manager.log* and/or *server.log* file.

WARNING Log files are cleared only when you click the Clear Log File button. When categories are enabled for either or both log files, the files will continue to grow in size each time you render.

The *backburner.xml* File

When you run the Manager, Server, or Queue Monitor application, or access the Network Job Assignment dialog, the software creates or updates an initialization file named *backburner.xml* in the *\Network* subdirectory of the Backburner directory.

You can change most of the settings in the *backburner.xml* file using the [Manager Properties dialog](#) on page 6512 and [Server Properties dialog](#) on page 6520.

You can change the parameters listed here only by editing the XML file in a text editing application, such as Notepad. Do so only if you are experiencing network problems with the network renderer.

Make sure the Manager and Server applications are shut down (or services uninstalled) before editing the *backburner.xml* file. The changes will take place when the Manager and/or Server are restarted.

backburner.xml

- **MaxBlockSize** Located under the `<GeneralCfg>` heading, this value is the maximum size of a data packet sent when transferring large blocks, such as projects. For slow connections like modems, it uses a smaller packet size, for example, 1024.
- **Acknowledgment Timeout** Located under the `<TimerCfg>` heading as `AckTimeout`, this value is the amount of time (in seconds) that the system will wait for an acknowledgment of commands (like Ping) sent back and forth between the Manager and Server. Default=20 seconds.
- **Acknowledgment Retries** Located under the `<TimerCfg>` heading as `AckRetries`, this value determines how many times the sender retries if no acknowledgment is received. The default is six tries. After that, the machine is considered down and is put off-line.

Network Rendering Manager



Windows Start menu > Programs > Autodesk > Backburner > Manager

The application version of the network rendering Manager provides a graphical user interface for control and monitoring purposes. It runs as a foreground process on your desktop, and remains active unless specifically shut down. Its components include a menu bar, list window, and status bar.

Once you initially set up the Manager using the application version, you can run it as a service from then on. The service version provides no user interface, but once it's installed as a service and started, it's always available when the system is booted. Whichever version you use, you can monitor and control the rendering queue and system with the [Queue Monitor](#) on page 6522.

To start the Manager service, execute the following from a Command Prompt window or the Start menu > Run function:

```
"[drive letter]:\Program Files\Autodesk\Backburner\managersvc.exe" -i
```

Replace "[drive letter]" with the letter of the drive the software is installed on. If you used a different install path, change the command line accordingly.

Then either reboot the computer or go to Control Panel > Administrative Tools > Services and start the service. Thereafter the service will remain resident and active, even surviving reboots.

NOTE When you run the Manager program, you might see this warning message: Job share not defined. This happens if neither the program folder nor the drive on which it resides is [shared](#) on page 6477. Normally, the servers copy files to be network rendered from the source machine using standard Windows file-copy routines, which require sharing to be in effect. If sharing is not in effect, the manager issues the warning, and then the servers use TCP/IP to copy the files. To avoid getting the warning message, you can implement sharing, but it's not really necessary.

To remove the manager service from memory, execute the following from a Command Prompt window or the Start menu > Run function:

```
"[drive letter]:\Program Files\Autodesk\Backburner\managersvc.exe" -r
```

TIP You can run multiple Managers on the same network. This is especially useful when using many rendering Servers, to lessen the burden on individual Managers. When using multiple Managers, it is best to turn off Automatic Search on the rendering servers and specify a Manager to which to connect, otherwise the rendering servers will connect to the first Manager they find.

Interface

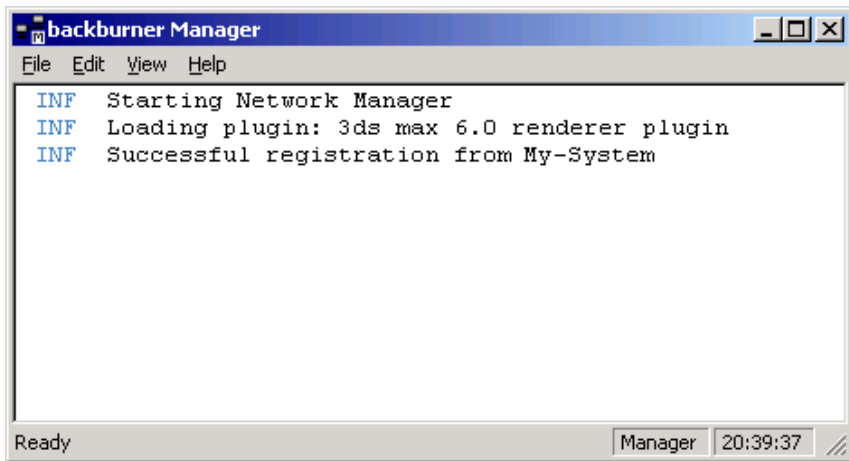

Menu bar

The menu bar provides access to the functions available in the Network Rendering Manager application.

File menu

Close Closes the window and minimizes the application to the taskbar tray. The application remains active when you close it with this menu item or the close box (X) in the upper-right corner.

Shutdown Quits the application and removes it from memory.

Edit menu

General Settings Opens the [Backburner Manager General Properties dialog](#) on page 6512.

Log Settings Opens the [Backburner Manager Logging Properties dialog](#) on page 6505, which lets you filter the types of messages to appear in the list

window, and specify whether the messages are sent to the list window or a log file.

View menu

Status Bar Toggles the display of the status bar, which appears at the bottom of the Server window. When on, a check mark appears next to this menu item. Default=on.

Font Size Lets you choose the size of text that appears in the list window. Choices range from Smallest to Largest.

Autoscroll List Toggles automatic scrolling of the list window. When on, new items that appear in the list window cause previous contents to scroll up. When off, you must scroll the window manually to see the latest entries after it fills up. Default=on.

Help menu

About Manager Displays information about the Manager program, including version and copyright.

List Window

This area of the Manager interface lists different types of information regarding the current status of the Manager. Depending on the selections made in the [Logging Properties dialog](#) on page 6505, messages are displayed alerting the user, for example, to the following:

- Connection and registration between the Manager and Server(s)
- New job assignments
- Which machine is the queue controller (that is, running Queue Monitor)
- Frames assigned/rendered
- Acknowledge packets sent between the Manager and Server(s)
- Manager/Server(s) shutting down
- Any rendering errors encountered
This information can be filtered using the [Logging Properties dialog](#) on page 6505.

Manager General Properties Dialog

Windows Start menu > Programs > Autodesk > Backburner > Manager > Edit menu > General Settings > General Properties dialog

The Manager Properties dialog contains the configuration settings for the Network Manager. The default settings should work in most cases, but certain situations may require adjustments. The information specified in the Manager Properties dialog is written to and contained in *backburner.xml* (in the *\Network* subdirectory). If you run the Manager and the *backburner.xml* file does not exist, you're prompted to configure it with this dialog. When configuration is complete, click OK to run the Manager.

Interface

The screenshot shows the 'Backburner Manager General Properties' dialog box. It is divided into several sections:

- TCP/IP:** Contains two spinners: 'Manager Port' set to 3234 and 'Server Port' set to 3233.
- Failed Servers:** Includes a checked checkbox for 'Restart Failed Servers', a spinner for 'Number of Retries' set to 3, and a spinner for 'Seconds Between Retries' set to 30.
- General:** Contains a spinner for 'Max Concurrent Assignments' set to 4, and two unchecked checkboxes: 'Use Server Limit' (with a spinner for 'Max Servers per Job' set to 10) and 'Use Task Error Limit' (with a spinner for 'Max Errors Per Task' set to 4).
- Direct Access to Jobs Path:** Features an unchecked checkbox for 'Use Jobs Path', a text field for 'Win32 Path' with a 'Browse...' button, and an empty text field for 'Unix Path'.
- Default Job Handling:** Shows the instruction 'After job is successfully completed:' followed by four radio button options: 'Do Nothing' (selected), 'Delete it', 'Delete After 7 day(s)', and 'Archive it'. The 'Archive After 4 day(s)' option is also visible.

At the bottom of the dialog are 'OK' and 'Cancel' buttons.

TCP/IP group

The two spinners in the TCP/IP group box specify the port numbers to be used by the software. These numbers must be unique to the software, but every Server must have the same number.

Manager Port Specifies the port number used by the network Manager.

Server Port Specifies the port number used by the network Server(s).

NOTE Port numbers are like extensions for different users of the same phone number. They represent two channels of communication between the Server and the Manager. Only a trained network administrator should change these settings.

General group

Max(imum) Concurrent Assignments Specifies the number of jobs the Manager sends out at once. This number is dependent upon the speed of the processor on the Manager machine, the size of the jobs being sent out, and the speed of the network system. Generally, a default value of 4 is adequate. You may want to decrease the value in case the jobs are huge and you have a modest setup. Similarly, you may want to increase this value if you have a high-end setup and the jobs are small. Be aware that too high a value may result in an increased number of timeouts because the jobs are sent faster than the Servers can handle them. In such a case, decrease the value or leave it at the default.

User Server Limit Sets the maximum number of servers that will be allocated for a specific job. This feature overrides the server limit settings in the 3ds Max [Advanced Settings Dialog](#) on page 6497.

Task Error Limit Defines the number of times a server will retry a task before suspending the task. This option is available only in the Manager General Properties dialog.

Failed Servers group

This option allows the Manager to automatically restart Servers that have failed jobs.

Restart Failed Servers Activate to enable automatic Server restarting. If this option is turned off, the Server will not attempt to render the job again after the first failure. Default=on.

Number of Retries Specifies the number of times the Manager attempts to restart a failed Server. Default=3. Range=1 to 1024.

Seconds Between Retries The time, in seconds, between each retry. Default=30.

NOTE The state of a Server is kept on a per-job basis. If Restarts Failed Servers is turned on, the Manager keeps track of when a Server fails a particular job. The Manager regularly goes through the list of Servers for that job, checking for failures. If one is found, the Manager checks how long it has been since it failed. If the time elapsed is greater than the specified Seconds Between Retries, the Manager decreases the Number of Retries by one and resets the failed flag from the Server.

If a Server fails repeatedly on a specific job (failures are monitored on a per-job basis), the failure count reaches the specified Number of Retries, and the Manager stops trying to restart that Server for that particular job. If, on the other hand, a Server restarts and completes a frame, it is flagged as active and resumes rendering until the job is complete.

Direct Access To Jobs Path group

Job paths can be useful when dealing with situations where it's not conducive to have jobs placed on the manager system. Such situations might be as follows:

- You have a lack of drive space on the C: drive where Backburner is installed. Drive D: has plenty of space so you set up a folder called *MyJobs* where jobs will be placed when submitted. Enter a UNC path such as `\\machinename\MyJobs`.
- You're running a large render farm that causes a lot of network traffic on the manager system that you use concurrently to build models. To alleviate the traffic, you set up a shared job folder, *backburnerJobs* for example, on a file server that is separate from the manager system. The UNC job path would be set to `\\fileserver\backburnerJobs` and jobs you submit will be placed on the file server.

Use Jobs Path Turning on this switch allows you to define the location of jobs to be somewhere other than on the manager machine. This tells the render servers to get the job files from the new location, therefore minimizing the file I/O traffic on the manager.

Win32 Path Enter the path where jobs are located into this field or click the Browse button to the right to search your system for the job location.

Unix Path This field functions the same as the Win32 path except you can enter a Unix path structure.

Default Job Handling group

The settings in the Default Job Handling group allow a user to archive a completed job to a specified location after x number of days, delete a completed job after x number of days or just leave the job indefinitely in the queue.

Using these controls lets you maintain the job queue, clearing completed jobs that can cause excess overhead and stress to the manager system, thus instigating performance problems. The archiving functionality allows you to automatically store files used for completed jobs.

NOTE These settings can be overridden from the [Advanced Settings dialog](#) on page 6497 accessed from the [Network Job Assignment dialog](#) on page 6481.

Do Nothing When turned on, a completed job is left in the queue.

Use this switch if you are submitting a job that may need to be re-rendered at a higher resolution without making any other changes to the scene.

Delete It Upon completion, the job is deleted from the queue when this switch is turned on.

If the scene you're rendering is just a test shot and you're just doing a quick test of the scene, you don't really want to keep the job in the queue once it's completed.

Delete After ... Day(s) Upon completion, the job is kept in the queue for the specified number of days. Once the number of days are exceeded, the job is then deleted from the queue.

Archive It When turned on, the job is archived when the rendering is complete. Default=on.

Archiving is useful when you submit a final version of the scene and you know that there won't be any further changes.

Archive After ... Day(s) Upon completion, the job is kept in the queue for the specified number of days. Once the number of days are exceeded, the job is archived.

Network Rendering Server

Windows Start menu > Programs > Autodesk > Backburner > Server

The application version of the network rendering Server provides a graphical user interface for control and monitoring purposes. It runs as a foreground

process on your desktop, and remains active unless specifically shut down. Its components include a menu bar, list window, and status bar.

Once you initially set up the server using the application version, you can run it as a service from then on. The service version provides no user interface, but once it's installed as a service and started, it's always available when you boot the system. Whichever version you use, you can monitor and control the rendering queue and system with the [Queue Monitor](#) on page 6522.

To start the server service, execute the following from a Command Prompt window or the Start menu > Run function:

```
"[drive letter]:\Program Files\Autodesk\Backburner\serversvc.exe" -i
```

Replace "[drive letter]" with the letter of the drive the software is installed on. If you used a different install path, change the command line accordingly.

Then either reboot the computer or go to Control Panel > Administrative Tools > Services and start the service. Thereafter the service will remain resident and active, even surviving reboots.

NOTE In order for the rendering servers to be able to save the frames to the specified location, set the logon for the installed service to a user name and password that exists on the network. Also, that user name must have sufficient read/write permissions to get the required bitmaps and xrefs for the scene to render as well as write the frames to specified location.

To remove the server service from memory, execute the following from a Command Prompt window or the Start menu > Run function:

```
"[drive letter]:\Program Files\Autodesk\Backburner\serversvc.exe" -r
```

Procedures

To start/stop the server service upon logoff/logon:

If you work on a computer that's part of a render farm, you probably don't want the computer to be available for rendering while you're using it. By following this procedure, you can have the computer automatically turn off the server service while you're logged on, and turn it back on when you log off.

- 1 Install the Backburner Server as a service that starts automatically at startup, as described above. This is the default setup for the server service. You'll start by creating two batch files.
- 2 Open a text editor such as Notepad and enter the following line:

```
net start backburner_srv_200
```

- 3 Save this as a text file named **Netstart_BB_Server.bat**.

- 4 Create a new file containing the following line:

```
net stop backburner_srv_200
```

- 5 Save this as a text file named **Netstop_BB_Server.bat**.

Next, you'll to edit the logon and logoff policy for the system.

- 6 Go to the Windows Start menu, choose the Run command, and enter **gpedit.msc**.

The Group Policy dialog appears. It lets you edit and manage the Group Policy for the system.

- 7 In the dialog, expand User Configuration > Windows Settings, and then click Scripts (Logon/Logoff).

The right-hand pane lists Logon and Logoff.

- 8 In the right pane, right-click Logon and choose Properties.

- 9 In the Properties dialog, click Add, click Browse, and browse to the *Netstop_BB_Server.bat* file you created. Click OK twice to close the Logon Properties dialog.

- 10 Similarly, open the Properties dialog for Logoff and specify the *Netstart_BB_Server.bat* file.

- 11 Close the Group Policy dialog.

You have now set up the system to stop the Backburner service at any user logon, and to start it at any user logoff.

Interface

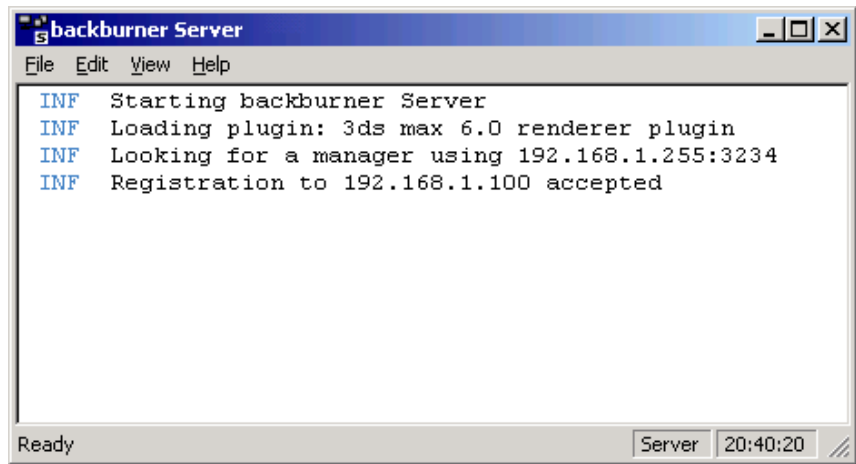

Menu bar

The menu bar provides access to the functions available in the Network Rendering Server application.

File menu

Close Closes the window and minimizes the application to the taskbar tray. The application remains active when you close it with this menu item or the close box (X) in the upper-right corner.

Shutdown Quits the application and removes it from memory.

Edit menu

General Settings Opens the [Network Server General Properties dialog](#) on page 6520.

Log Settings Opens the [Network Server Logging Properties dialog](#) on page 6505, which lets you filter the types of messages to appear in the list window, and specify whether the messages will be sent to the list window, a log file, or both.

View menu

Status Bar Toggles the display of the status bar, which appears at the bottom of the Server window. When on, a check mark appears next to this menu item. Default=on.

Font Size Lets you choose the size of text that appears in the list window. Choices range from Smallest to Largest.

Autoscroll List Toggles automatic scrolling of the list window. When on, new items that appear in the list window cause previous contents to scroll up. When off, you must scroll the window manually to see the latest entries after it fills up. Default=on.

Help menu

About Server Displays information about the Server program, including version and copyright.

List Window

This area of the Server interface lists different types of information regarding the current status of Server. Depending on the selections made in the [Logging Properties dialog](#) on page 6505, messages are displayed alerting the user, for example, to the following:

- Connection and registration between the Manager and Server(s)
- New job assignments
- Frames assigned/rendered
- Acknowledge packets sent between the Manager and Server(s)
- Manager/Server(s) shutting down
- Any rendering errors encountered
This information can be filtered using the [Logging Properties dialog](#) on page 6505.

Server General Properties Dialog

Windows Start menu > Programs > Autodesk > Backburner > Server > Edit menu > General Settings > General Properties dialog

The Server General Properties dialog contains configuration settings for the Network Rendering Servers. The default settings in this dialog work in most cases, but certain situations may require adjustment of these settings, mostly the Manager or IP settings in case the Automatic detection fails. The information specified in the Server Properties dialog is contained in the *backburner.xml* file (in the \Network subdirectory). If you run Server and the *backburner.xml* file does not exist or does not contain information pertinent to the Server, the *backburner.xml* file is created or updated.

Interface

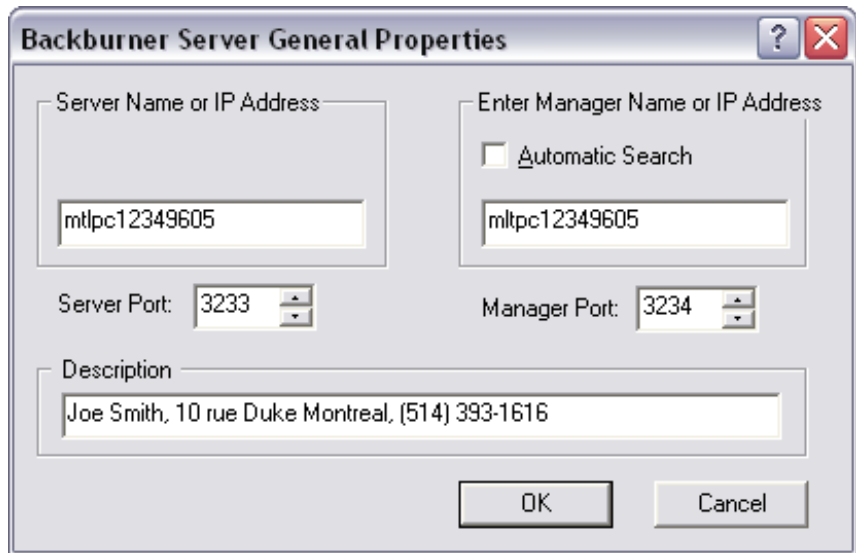

The screenshot shows the 'Backburner Server General Properties' dialog box. It features a title bar with a help icon and a close button. The dialog is divided into several sections: a 'Server Name or IP Address' field containing 'mltpc12349605', an 'Enter Manager Name or IP Address' field also containing 'mltpc12349605', an unchecked 'Automatic Search' checkbox, a 'Server Port' spinner set to 3233, a 'Manager Port' spinner set to 3234, and a 'Description' text area containing 'Joe Smith, 10 rue Duke Montreal, (514) 393-1616'. At the bottom, there are 'OK' and 'Cancel' buttons.

TCP/IP group

Manager Port Specifies the port number used by the Network Manager.

Server Port Specifies the port number used by the Network Server(s).

These settings specify the port number to be used by the software. These numbers must be unique to the software, but every Server must have the same number.

NOTE Port numbers are like extensions for different users of the same phone number. They represent two channels of communication between the Server and the Manager. Only a trained network administrator should change these settings.

Automatic Search When on, starting the Server searches for a Manager using the default subnet mask of 255.255.255.0. In most cases, you should leave this option on. The software will detect the machine acting as a Manager. The Server may fail to detect a Manager if the network subnet mask (in the Windows TCP/IP Network Configuration dialog) is set to some other value than the standard 255.255.255.0.

If that is the case, change the subnet mask setting in the Server General Properties dialog to match the system setting. Start the Server again and it should detect the Manager. When multiple Managers are running on the same network, you may want to turn off Automatic Search and specify which Manager the Server should connect to. Otherwise, the Server connects to the first Manager it finds.

Enter Subnet Mask/Manager Name or IP Address With Automatic Search turned on, specifies the subnet mask used to search for the Manager. With Automatic Search turned off, specifies the IP address or DNS name of the Manager to which to connect. Use the Manager system's name or IP address when multiple Managers are running on the same subnet. Use the Manager system's IP address to avoid any problems or conflicts caused by improper implementation of the Domain Name System.

Queue Monitor

The Queue Monitor Application



Windows Start menu > Programs > Autodesk > Backburner > Monitor

The Queue Monitor application (*monitor.exe*) lets you manage, view, and receive status updates about all jobs currently submitted to the network rendering queue. This executable file is copied to the Backburner root directory during setup, and is available from the Start menu.

NOTE In previous versions of 3ds Max, this program was called *Queue Manager*.

Queue Monitor helps you adapt to changing needs and priorities. Jobs can be activated, deactivated, reordered, and removed, and servers can be unassigned to free up resources on workstations, or brought back online as they become available again.

You can run Queue Monitor from any computer connected to the rendering network. Once started, you can connect to any available network Manager. You can launch as many Queue Monitors as you want from anywhere on your network and connect to a Manager machine. All except the first Queue Monitor connecting to the Manager appear in "read only" mode. If there is already a Queue Monitor connected to the Manager, subsequent connections alert you that you are in read-only mode, and "Read Only" appears in the title bar. In read-only mode, you can view network render activity, but cannot change anything in the queue unless you [obtain queue control](#) on page 6526.

To view all current jobs in the rendering queue, you first connect to the Manager that all of the servers are "talking to." To do this, you can either connect automatically to the Manager by searching with a subnet mask, or connect to a specific Manager by supplying the IP address or machine name of the machine where you started the Manager.

See also:

- [Viewing Jobs and Servers with the Queue Monitor](#) on page 6540
- [Activating and Deactivating Jobs in the Queue](#) on page 6544
- [Activating and Deactivating Servers in the Queue](#) on page 6545
- [Managing Jobs in the Queue](#) on page 6546

Procedures

To view all current jobs in the rendering queue:



- 1 On the Queue Monitor toolbar, click the Connect button.
The Connect To Manager dialog appears.
- 2 After you connect to a Manager once, the dialog remembers the Manager information and you can just click OK to connect to the same Manager.
If this is the first time you're connecting, or you're connecting to a different Manager, and you're using Automatic Search, just click OK. If you're not using Automatic Search, you need to specify the Manager to connect to. In the text field, enter the name or IP address of a network Manager. This is the same information you specified in the [Server General Properties dialog](#) on page 6520.
- 3 Click OK.

The Queue Monitor connects to the network Manager and activates its various display windows.

To suspend a job:

As requirements change, you can temporarily deactivate an active or pending job in the rendering queue, or reverse the process and restart jobs that are inactive.

When you suspend a job, the Servers assigned to the job either drop the frame they are rendering or finish writing the frame, depending on where they are in the rendering process. The next pending job becomes active and begins to render.

NOTE You can activate or deactivate multiple jobs at the same time.

- 1 Select one or more active or pending jobs in the Job list.
- 2 Do one of the following:

-  Click the Suspend button on the toolbar.
- Choose Suspend from the Jobs menu.
- Right-click a highlighted job name in the Job list to display a pop-up menu, and then choose Suspend.



If necessary, use Refresh to view the new queue status.

To activate a suspended job:

- 1 Select the suspended job (denoted by a gray movie-frame icon).



The Activate button on the toolbar becomes active.

- 2 Click Activate, or use the menu bar or right-click menu.

The job becomes either Started or pending in the queue (Active), depending on whether or not another job is currently rendering.

Interface

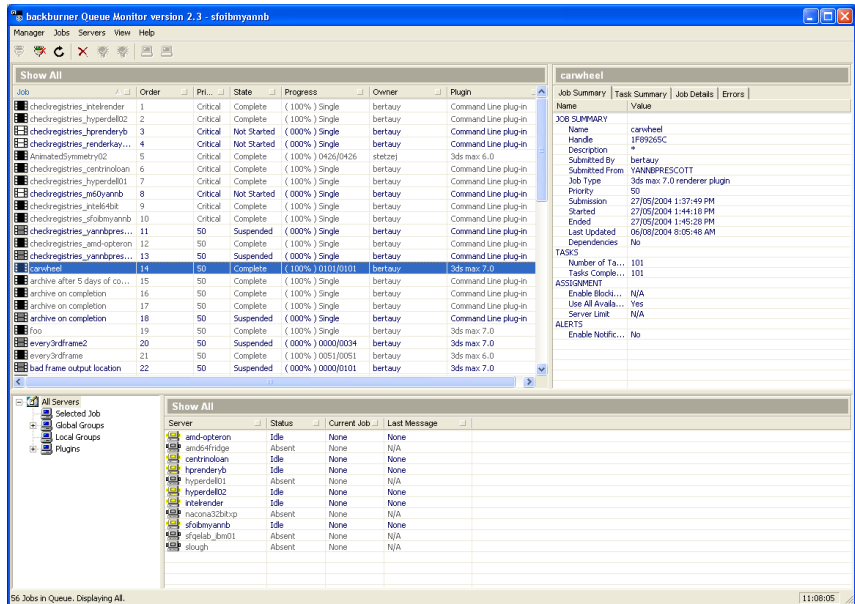

The Queue Monitor user interface comprises a menu bar, a toolbar, a status display, and four windows: job list, job information, server tree view (or hierarchical list), and server list.

Menu bar

The menu bar includes these menus and functions:

Manager menu

Use to control aspects of the Queue Monitor and the network Manager.

Connect Connects to a Manager using the Connect To Manager dialog. In the dialog, turn on Auto Search to search for a Manager using the specified subnet mask, or turn off Auto Search to search for a Manager using a specific Manager name or IP address. Click OK to perform the search, or Cancel to exit without connecting.

If the Manager is found, current Servers and jobs appear in their respective lists in the Queue Monitor. If the Manager cannot be found, an alert appears.

Disconnect Disconnects from the current Manager. Available only after a connection is made.

Auto-Connect When this switch is turned on, you can automatically connect to a manager without the Connect To Manager dialog appearing. Whatever setting have been made in the Connect To Manager dialog will be used.

Request Queue Control Lets you gain control over the rendering queue. Available only when Queue Monitor is running on two or more machines in the network, and your copy was not the first one run.

When you request queue control, a dialog appears on the controlling machine informing that user of the request. The dialog counts down 10 seconds, and if no response is made during that time, or the OK button is clicked, control transfers to the requesting Queue Monitor, which then informs the requestor of the transfer. If the request is denied, the requesting user is informed of that fact.

Request Client List Displays a dialog listing the rendering servers on the network, and showing which is the controller (i.e., the active Queue Monitor) and the user name. Use this to determine which server is currently controlling the queue.

Auto-Refresh When on, Queue Monitor automatically updates the information in its windows every 20 seconds, or whenever information changes if information changes less frequently. When off, to update the windows you must click the toolbar [Refresh button](#) on page 6529. Default=on.

Unless you are the only person managing the queue, we recommend leaving Auto-Refresh on. The danger of turning it off is the possibility of getting out of sync with the state of the queue. For instance, if another person deletes a job and you decide to edit that job, when you finish editing that job, the Manager will send you an error message saying the job no longer exists.

Module Info Report Choosing this command opens the [Module Info Report dialog](#) on page 6533. For troubleshooting purposes, this command lets you generate a delimited file that shows you the version and location of Backburner plug-ins and the Backburner application itself for each network rendering system.

Properties Opens a window that displays information about the current setup of the machine that is running the network Manager, including job and server statistics, the Manager's system configuration, and TCP/IP statistics.

Exit Quits the Queue Monitor program.

Jobs menu

Use to obtain information about rendering jobs. Most Jobs menu functions are available only when at least one job is highlighted in the Job list, and many require that only one job be highlighted.

These commands are also available by right-clicking a job in the job list.

Edit Settings Opens the [Job Settings dialog](#) on page 6535, with settings for job-related functions such as frame range and output size.

Change Priority Opens the Change Job Priority dialog, which lets you set a new priority or set the job to be critical.

If you change a job's priority so that a different job moves to the beginning of the list, the software pauses the current job and begins rendering the newly elevated job.

Clone Job Makes an identical copy of the highlighted job and adds it to the end of the list.

Dependencies Opens the [Job Dependencies dialog](#) on page 6490, which you can use to specify existing jobs that must finish before the current job can start.

Report Opens the [Job Report dialog](#) on page 6541 for generating text files containing job reports.

Column Chooser Opens the Job Columns dialog, with additional columns you can drag into the Job list title row. As you drag a column over the title row, arrows appear indicating where the column will be inserted.

To remove a column, right-click its title and then choose Remove This Column. You cannot remove the Job or Order column.

Activate Starts a suspended job or jobs.

Suspend Pauses an active job or jobs.

Restart Job Starts a job over at the first frame set in Job Settings.

Archive Job Archives a job currently stored in the queue. Archived jobs are removed from the Job queue and stored in the Job Archives.

Job Archives Accesses the Job Archives where jobs are stored after clicking the Archive Jobs command or if they're assigned to automatically archive upon completion. Choosing this command opens the [Job Archive dialog](#) on page 6543 where you can choose to Delete, Activate or Refresh jobs.

Delete Removes the highlighted job or jobs from the queue.

Servers menu

Use to control and obtain information about job servers.

These commands are also available by right-clicking a server in the server list.

Assign to Selected Jobs Assigns the highlighted servers or servers to the highlighted job or jobs.

Remove from Selected Jobs Removes the highlighted job or jobs from the highlighted servers or servers.

Remove from Selected Group Removes the highlighted server or servers from the highlighted group in the tree view.

Column Chooser Opens the Server Columns dialog, with additional columns you can drag into the Server list title row. As you drag a column over the title row, arrows appear indicating where the column will be inserted.

To remove a column, right-click its title and then choose Remove This Column. You cannot remove the Job or the Order column.

Week Schedule Opens the [Week Schedule dialog](#) on page 6547 for the highlighted server, for defining when the server is available to render jobs.

Delete Server Lets you remove the current server from the server list, making it unavailable for rendering jobs.

Properties Opens a window that displays information about the current setup of the machine that is running the network Manager, including job and server statistics, the Manager's system configuration, and TCP/IP statistics.

Reset Server Index Lets you set the Performance parameter back to 0. Use this if you've changed the server setup (for instance, you've added memory or substituted a faster machine) and want to reevaluate the servers' relative performance during a rendering job.

View menu

Toolbar Toggles display of the Queue Monitor toolbar.

Status Bar Toggles display of the Queue Monitor status bar. When on, the status bar appears at the bottom of the Queue Monitor window and displays [status prompts](#) on page 6533.

Save View... Saves the current window view with column and filter settings.

Load View... Loads a saved view.

Help menu

About Queue Monitor Displays information about the Queue Monitor program, including version and copyright.

Toolbar



Contains buttons for performing various common Queue Monitor functions.



Connect See [Connect](#) on page 6525.



Disconnect See [Disconnect](#) on page 6525.



Refresh Forces the Queue Monitor to update the information shown in its windows.

The software automatically refreshes the windows every 10 seconds when information is changing.



Delete Removes the highlighted job or jobs from the queue.



Activate Starts a suspended job or jobs.



Suspend Pauses an active job or jobs.



Assign Server Assigns the highlighted servers or servers to the highlighted job or jobs.



Remove Server Removes the highlighted job or jobs from the highlighted servers or servers.

Job List

The Job List window lists all current jobs, along with progress and status. Additionally, a status icon before each job's name provides a graphical indication of its status. See [Viewing Jobs and Servers with the Queue Monitor](#) on page 6540.

Right-click a job name to access the [Jobs menu](#) on page 6527.

Click a column title to sort the list by the column contents (alternating clicks sort in ascending and descending order). Right-click a column title to access a menu that lets you sort the column, specify its alignment, remove the column (if it's optional), access the Column Chooser for adding optional columns, and display only the default columns.

Job Information Window

The Job Information window contains tabs for viewing information about different aspects of a single highlighted job in the Job List window. If no job is highlighted or multiple jobs are highlighted, this window is blank.

You can sort and filter columns in the Job Information Window. Click  in the column you wish to filter and select the Column Filter options.

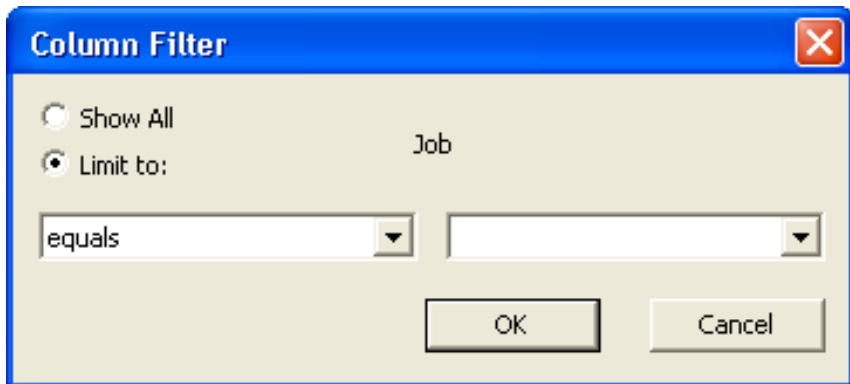

Job Summary Lists important job-related information, including Job Options settings and Output settings.

Task Summary Lists frames in the job (under “Task ID”), along with each frame's status, rendering time, rendering server, and date and time of assignment.

Right-click the frame you wish to view under “Task ID” to view its output file. This is available only for completed tasks.

Job Details Lists the job's rendering parameters, scene statistics, and gamma settings.

Errors Lists each frame for which an error occurred, which server registered the error, and a description of the error, including missing maps, missing texture coordinates, and invalid output directories.

Server Tree View

This window presents a hierarchical list of all Server groups, lets you create, delete, and rename global and local Server groups, and see which Servers can render your job.

Server groups are logical combinations of Servers that you can use to easily assign specific Servers to render a job. Global groups are available to all machines in the rendering network, while local groups are available only on the computer on which they are created. To create a global or local Server group, right-click any item in the Server Tree view, and choose Create Global Group or Create Local Group. After you choose either command, the new group appears in its respective category with the name New Global/Local Group; at this point, you can rename it by typing a new name.

After you define a group, its name shows up as a tab in the Server list in the [Network Job Assignment dialog](#) on page 6481. Only global groups appear on machines other than the one on which they're created.

To remove a Server group, right-click its name in the Server Tree view and choose Delete Group. To rename a Server group, right-click its name in the Server Tree view, choose Rename Group, and then enter a new name.

Following is a list of default list entries in the view. Click the item for the described result.

All Servers Shows all Servers assigned to the current manager.

Global Groups Click the + icon next to this entry, if it exists, to display global Server groups. To see the Servers in a global group, click the group name.

Local Groups Click the + icon next to this entry, if it exists, to display local Server groups. To see the Servers in a local group, click the group name.

Plugins Shows which applications can be controlled with the render network. Click the + icon next to this entry, if it exists, to display applications available on the render network. To see the Servers that have a particular rendering application installed, click the renderer name.

Server List

The Server List window shows all Servers in the current group (selected in the Server Tree view). For each listed server, the windows displays, by default, its status, the job it's currently rendering (if any), and the last message it sent to the Manager. Additional, optional details can be shown using the Column Chooser command.

Click a column title to sort the list by the column contents (alternating clicks sort in ascending and descending order). Right-click a column title to access a menu that lets you sort the column, specify its alignment, remove the column (if it's optional), access the Column Chooser for adding optional columns, and display only the default columns.

You can sort and filter columns in the Server List Window. Click  in the column you wish to filter and select the Column Filter options.

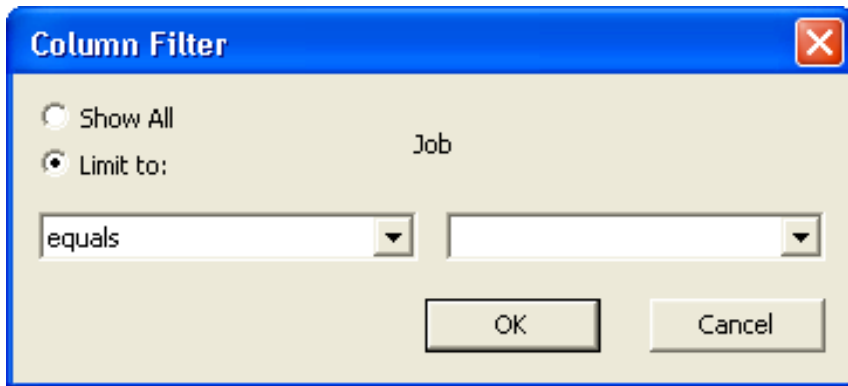

A status icon before each server's name provides a graphical indication of its status. See [Viewing Jobs and Servers with the Queue Monitor](#) on page 6540.

Right-click a server name to access the [Servers menu](#) on page 6528.

Status Prompt

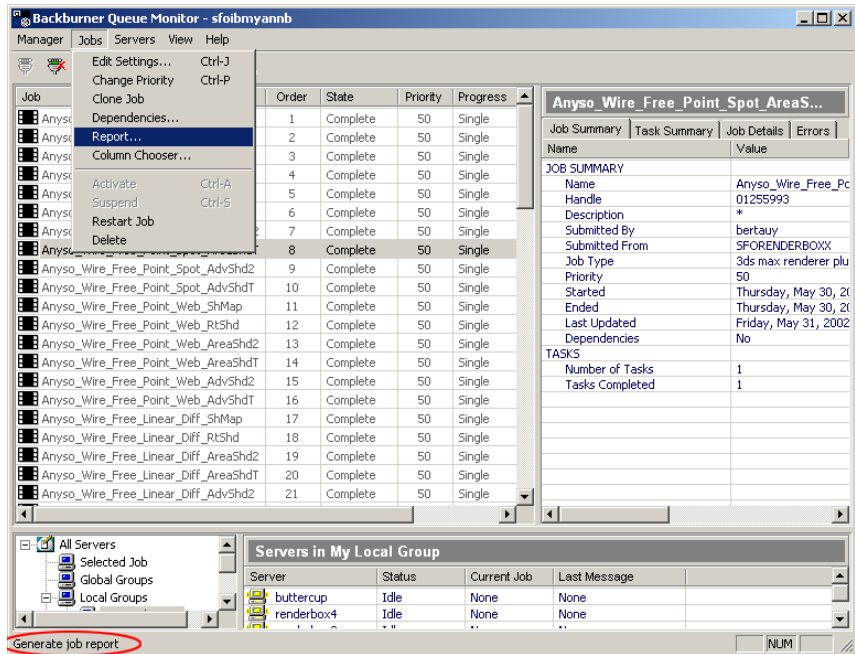

Visible at the bottom of the Queue Monitor window, the status prompt provides a non-interactive display of activity in the Queue Monitor and provides help information on the command over which the mouse cursor is positioned.

Module Info Report Dialog

Windows Start menu > Programs > Autodesk > Backburner > Monitor > Highlight a job. > Jobs menu > Report

You can generate delimited ASCII reports containing detailed statistics about the version and location of Backburner plug-ins and the Backburner application itself for each network rendering system.

Interface

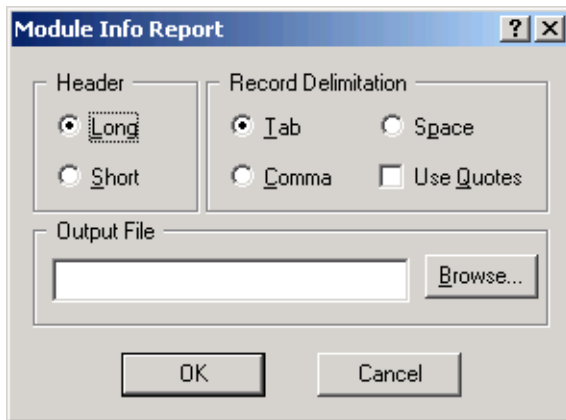

Header group

Specifies the type of header to include in the report file, in addition to the body information.

Long Adds a heading to the report.

Short Includes only the column titles in the report.

Record Delimitation group

Specifies the type of delimiter used between the fields. For example, if you use a tab delimiter, the report will import correctly into Microsoft's Excel or Access applications.

Tab Inserts a tab between fields in the report.

Space Inserts a space between fields in the report.

Comma Inserts a comma between fields in the report.

Use Quotes Brackets each field with double quotes.

Output File group

(Text Field) Specifies the report's file name. You can specify a complete path, if you want. By default, the path is the directory containing the *monitor.exe* file.

TIP If you use a shortcut icon to launch Queue Monitor, you can specify the path for your report's output file in the Start In field in the Properties dialog for the shortcut.

Browse Displays a file selector where you can specify a file path for the report.

Queue Monitor: Job Settings Dialog

Windows Start menu > Programs > Autodesk > Backburner > Monitor > Highlight a job. > Jobs menu > Edit Settings

Windows Start menu > Programs > Autodesk > Backburner > Monitor > Highlight a job. > right-click menu > Edit Settings

NOTE This topic covers the 3ds Max-specific aspects of the [Queue Monitor](#) on page 6522.

Use the Job Settings dialog to change job-related settings such as frame range, output size, and output directory, without having to use the Render Setup dialog and resubmit the job.

You can change job settings for a job while it's suspended or while it's rendering. By default in either case, after you click OK to exit the dialog, the rendering job restarts from the first frame. You can turn this feature off with the Restart Job option.

Most settings are either toggle switches or editable from the keyboard. To change a toggle setting, double-click its entry (in the right-hand column). If a setting is editable, its value turns green when you click it. To change an editable setting, click it to get the keyboard cursor, and then enter a new value from the keyboard. If you double-click the value when it's green, it highlights, and anything you type replaces it.

NOTE Your machine must have control of the network for this Job Settings Dialog to be accessible.

Interface

Job Settings	
Job Name	cc_renderelements
Job Description	*
Restart Job	No
Override Global Blocking Tasks	Yes
Enable Blocking Tasks	Yes
Use All Available Servers	Yes
Server Limit	0
3ds max: General Settings	
Frame Sequence	Range
First Frame	0
Last Frame	0
Every Nth	1
Frames	
Width	640
Height	480
Render Options	
Skip Existing Frames	No
Display RFW	Yes
Gamma Correction	Disabled
Input Gamma	1.0000
Output Gamma	1.0000
Pixel Aspect Ratio	1.0000
Render Elements	Enabled
Video Color Check	No
Two Sided	No
Render Hidden	No
Render Atmosphere	Yes
Super Black	No
Dither 256	Yes
Dither True Color	Yes
Render Fields	No
Displacements	Yes
Scene Effects	Yes
Multithread	Yes
Use Area Lights	Yes
Use Advanced Lighting	Yes
Compute Advanced Lighting	No
Field Order	Odd
Outputs	
Output 0 Path	c:\3dsmax7\images\scenetest
Output 0 Gamma	0.0000
Render Elements	
Element 0 Atmosphere	Atmosphere
Element 0 Enabled	Yes
Element 0 Output	c:\3dsmax7\images\scenetest_Atmosphere
Element 0 Filter	Enabled
Element 0 Atmosphere	Applied
Element 0 Shadows	Not Applied
Render Elements	
Reflection	
Element 1 Enabled	No
Element 1 Output	
Element 1 Filter	Enabled
Element 1 Atmosphere	Not Applied
Element 1 Shadows	Not Applied
Alternate Paths	
Alternate Bitmap Path	
Alternate Xref Path	
Timeouts	
Wait to load	20
Wait to unload	10
Wait to render	600
Notifications	
Enable Notifications	No
Notify Failures	Yes
Notify Progress	Yes
Notify Completion	Yes
Notify Progress Every Nth Task	10
Send Emails	No
Alert Email From	
Alert Email To	
Alert Email Server	

OK Cancel

Job Name group

The job name cannot be changed from this dialog.

Job Description Displays a brief description of the job. Editable from keyboard.

Restart Job When on (Yes), changing one or more job settings in the middle of a rendering job causes the job to restart at the first frame in the range, so all frames are rendered with the same settings. When off (No), the job continues rendering without restarting. Toggled by double-clicking the entry. Default=No.

You might want to turn this off if you're rendering an animation test and change a relatively minor setting, such as Video Color Check, in the middle of a job. For final renderings, you should always restart a job from the beginning after changing job settings.

Override Global Blocking Tasks This setting corresponds with the Override Global Settings as set in the [Advanced Setting dialog](#) on page 6497. Default=Yes.

Enable Blocking Tasks A Yes/No toggle that controls task blocking as set in the Advanced Setting dialog. When set to Yes, the task blocking set in the Manager General Properties dialog is active. Toggled by double-clicking the entry. Default=Yes.

Use All Available Servers Uses all servers in the active Server group for rendering the job.

[program name] General Settings group

Frame Sequence This toggle setting alternates between Frames and Range, and, by default, uses the Range and Frames settings in the [Render Setup dialog](#) on page 6067. When set to Range, the job uses the First/Last Frame and Every Nth settings; when set to Frames, the job uses the Frames setting. Toggled by double-clicking the entry. Default=Range.

First Frame Displays the first frame in the range to be rendered. Defaults to the first frame as submitted. Editable from keyboard.

Last Frame Displays the last frame in the range to be rendered. Defaults to the last frame as submitted. Editable from keyboard.

Every Nth Regular sample of frames. For example, enter 8 to render every 8th frame. Editable from keyboard.

Frames Non-sequential frames separated by commas (for example, 2,5) or ranges of frames separated by hyphens (for example, 0-5). Editable from keyboard.

Width/Height Lets you set the resolution of the output image by specifying the width and the height of the image, in pixels. Defaults to the output size as submitted. Editable from keyboard.

Render Options group

These settings are the same as those found on the Render Setup dialog > [Options group](#) on page 6127, with several additions:

Skip Existing Frames When on, the software checks the output path for existing rendered frames, and doesn't render them again. When off, starting or restarting a job always begins rendering with the first frame, overwriting any existing frames. Toggled by double-clicking the entry. Default=No.

Display RFW Displays the Rendered Frame Window on all servers during rendering. Toggled by double-clicking the entry. Default=Yes.

Gamma Correction When enabled, lets you define a new gamma for the bitmap, using the Input/Output Gamma settings. Toggled by double-clicking the entry. Default=Disabled.

Input/Output Gamma Change system input and output gamma settings for processing bitmaps. See [Gamma Preferences Settings](#) on page 7758 > Bitmap Files group. Editable from keyboard.

Pixel Aspect Ratio Sets the shape of the pixels for display on another device. The image may look squashed on your display but will display correctly on the device with differently shaped pixels. Editable from keyboard.

Render Elements When enabled, renders any [render elements](#) on page 6349 in the scene. Toggled by double-clicking the entry. Default=Enabled.

Video Color Check Checks for pixel colors that are beyond the safe NTSC or PAL threshold. Toggled by double-clicking the entry. Default=No.

Two Sided 2-Sided rendering renders both sides of all faces. Toggled by double-clicking the entry. Default=No.

Render Hidden Renders all geometric objects in the scene, even if they are hidden. Toggled by double-clicking the entry. Default=No.

Render Atmosphere Renders any applied atmospheric effects, such as volume fog, when set to Yes. Toggled by double-clicking the entry. Default=Yes.

Super Black Limits the darkness of rendered geometry for video compositing. Toggled by double-clicking the entry. Default=No.

Dither 256 Intersperses pixels when rendering to an eight-bit image format for a greater apparent color range. Toggled by double-clicking the entry. Default=Yes.

Dither True Color Intersperses pixels when rendering to a 24-bit (or higher) image format for a greater apparent color range. Toggled by double-clicking the entry. Default=Yes.

Render Fields Renders to video fields rather than frames when creating animations for video. Toggled by double-clicking the entry. Default=No.

Displacements Any displacement mapping is rendered. Toggled by double-clicking the entry. Default=Yes.

Scene Effects Any applied rendering effects, such as Blur, are rendered when turned set to Yes. Toggled by double-clicking the entry. Default=Yes.

Multithread Causes the software to treat the rendering task as separate threads. This option works with multiprocessor systems. Toggled by double-clicking the entry. Default=Yes.

Field Order Selects the [field](#) on page 7973 order of rendered images when the Render Fields option is turned on. Default=Odd.

Some video devices require that the even field be first, other video devices require that the odd field be first. Determine the correct field order for your video device. If the video output of your device is strobing or appears jittery, it may be due to incorrect field order. Try changing this parameter and re-rendering your animation.

Alternate Paths group

Comparable to setting the alternate paths in the [Network Job Assignment dialog](#) on page 6481.

Alt Bitmap Path Lets you enter an alternate path where the servers search for bitmaps. Editable from keyboard.

Alt XRef Path Lets you enter an alternate path where the servers search for XRefs. Editable from keyboard.

Timeouts group

These settings are covered in [Advanced Settings Dialog](#) on page 6497.

Notifications group

These settings are covered in [Notifications Dialog](#) on page 6492.

Viewing Jobs and Servers with the Queue Monitor

All rendering jobs submitted to the network rendering queue are shown in the Job list window, located on the upper-left side of the Queue Monitor dialog, immediately below the toolbar. Below it is the Server list window, which shows all servers attached to the manager and their status.

Interface

Each job is denoted by an icon reflecting its current status. The servers are also denoted by specific icons that reflect their current status.

Job Icons



Job is started and has rendered one or more frames. The job is either currently rendering or is awaiting an available server.



Job is active, but has not yet rendered any frames.



Job is suspended.

The job was submitted as suspended or was suspended with the Queue Monitor. Suspended jobs must be manually reactivated to give them a started or active status.



Job is in an error condition.

In the Queue Monitor, check the Errors tab in job information window, to the right of the jobs list, for details regarding the error, such as missing bitmaps, plug-ins, texture coordinates. See [Troubleshooting](#) on page 6455.



Job is completed.

All frames in the sequence have been rendered successfully. You may delete this job from the queue if you want.

Server Icons

A bar through the server icon indicates that it's assigned to the currently highlighted job or jobs.



Server is active.

The server is rendering the current started job.



Server is absent.

The server is assigned to the rendering task but is not currently rendering. This can occur, for example, when the server is turned off or is not running the Server application.



Server is in an error condition.

Check the Server list Job Status column in the Queue Monitor for details regarding the error, such as missing bitmaps, plug-ins, texture coordinates. See [Troubleshooting](#) on page 6455.



Server is idle.

The server can be assigned the highlighted job with the toolbar Assign Server button.

Job Report Dialog

Windows Start menu > Programs > Autodesk > Backburner > Monitor > Highlight a job. > Jobs menu > Report

You can generate ASCII reports containing detailed statistics about a particular job selected in the Job Queue list.

See also:

- [Week Schedule Dialog](#) on page 6547

Interface

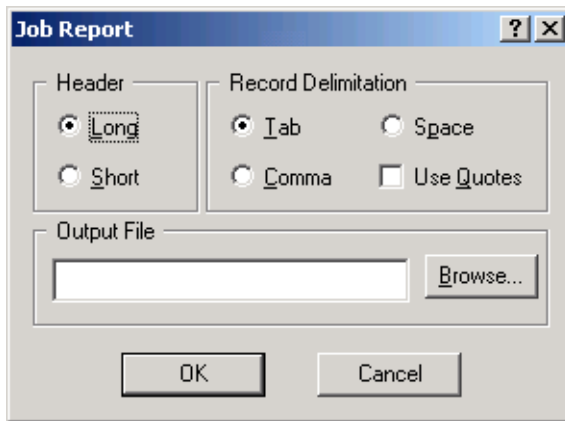

Header group

Specifies the type of header to include in the report file, in addition to the body information.

Long Includes information above the body of information, including Job Name, Submitted by, Frame Start/End, Output Width/Height, Pixel Aspect Ratio, and Image Aspect Ratio.

Short Includes only the column titles in the report.

Record Delimitation group

Specifies the type of delimiter used between the fields. For example, if you use a tab delimiter, the report will import correctly into Microsoft's Excel or Access applications.

Tab Inserts a tab between fields in the report.

Space Inserts a space between fields in the report.

Comma Inserts a comma between fields in the report.

Use Quotes Brackets each field with double quotes.

Toolbar

The Job Archives toolbar has three commands.

Delete Deletes a selected job from the archive. You are warned and must accept confirmation before the deletion to occurs. This button is active only when a job is selected.

Activate When you select a job from the list, you can click the Activate button. When a job is activated, it is removed from the Job Archives and placed back in the Job list in the [Queue Monitor](#) on page 6522. Then you can choose to [Edit Settings](#) on page 6535 and restart the job.

Refresh Forces the Job Archives dialog to update the information shown in the job list

Job List

The Job List shows the Job Name, Owner, Description, Type (render plugin), original Submission date, and Completion date. Unlike other lists in the Queue Monitor, you cannot add or remove columns. You can make multiple selections of jobs by holding down either the SHIFT or CTRL keys.

Activating and Deactivating Jobs in the Queue

As requirements change, you can deactivate an active or pending job in the rendering queue, or reverse the process and restart jobs that are inactive.

When you deactivate a job, the servers assigned to the job either drop the frame they are rendering or finish writing the frame, depending on where they are in the rendering process. The next pending job becomes active and begins to render.

You can reactivate a suspended job, or a job that was submitted as Initially Suspended from the Network Job Assignment dialog.

Procedures

To deactivate a job:

- 1 Select a started or active job in the Job list.

- 2 Do one of the following:
 - Click the Suspend button on the toolbar (the red light-bulb icon).
 - Choose Jobs menu > Suspend.
 - Right-click the job name to display a pop-up menu, and then choose Suspend.
If necessary, click the toolbar Refresh button to view the new queue status.

To activate a suspended job:

- 1 Select the inactive job (denoted by a gray box).
The Activate button on the toolbar becomes active.
- 2 Click Activate, or use the menu bar or right-click menu.
The job becomes either started or active in the queue, depending on whether or not another job is currently rendering and whether or not any of the job's frames have already rendered.

Activating and Deactivating Servers in the Queue

When prioritizing jobs and dividing up the network render load, you might need to pull individual servers off one job and place them on another.

When you remove a server from the current rendering job, and the server is assigned to another started or active job, it is used by that job. If the server has no further job assignments, it stops rendering.

You can assign machines that become available for network rendering to any job.

You can tell whether a server is assigned to a particular job by highlighting the job in the Queue Monitor > Job list and looking at the server's icon in the Server list. If a horizontal bar appears through the server icon, then it is assigned to the job; if no bar appears, then it isn't assigned to the job.

Alternatively, just highlight the job and then click Selected Job in the Server Tree view, to list only servers assigned to that job.

Next Step

[Managing Jobs in the Queue](#) on page 6546

Procedures

To remove a server or servers from the highlighted rendering job or jobs:

- Highlight the server in the Server list and click the Remove Server icon on the toolbar.

To assign an unassigned server or servers to highlighted rendering job(s), do one of the following:

- 1 Highlight the unassigned server(s) in the servers list and choose Assign To Selected Jobs from the Servers menu.
- 2 Right-click the server name in the queue list to display the pop-up menu and choose Assign To Selected Jobs.

Managing Jobs in the Queue

Reordering lets you change the job order in the queue to meet changing deadlines or priorities. You can delete jobs from the queue at any time.

Procedures

To re-order a job in the queue:

- 1 In the Job list window of the Queue Monitor, right-click the job to move.
- 2 Choose Change Priority, and use the Change Job Priority dialog to set a new Priority value.

NOTE You can reorder multiple jobs at the same time. They will end up with the same priority.

To delete a single job from the job queue, do one of the following:

- 1 Highlight the job and then click Delete on the toolbar.
- 2 Use the right-click menu > Delete command.

You can delete multiple jobs by first highlighting the jobs by using the CTRL or SHIFT keys and then clicking the Delete button or Jobs menu > Delete.

Week Schedule Dialog

Queue Monitor > Highlight a Server and right-click. > Week Schedule

Queue Monitor > Highlight a Server. > Servers menu > Week Schedule

By default, all servers are available at all times. Using the Queue Monitor's Week Schedule feature, you can arrange the hours during which each server is available for network rendering.

You can specify certain hours for any day of the week. This is useful, for example, if the server is used as a modeling workstation during normal business hours and you do not want it being used as a network render server during this time.

Procedures

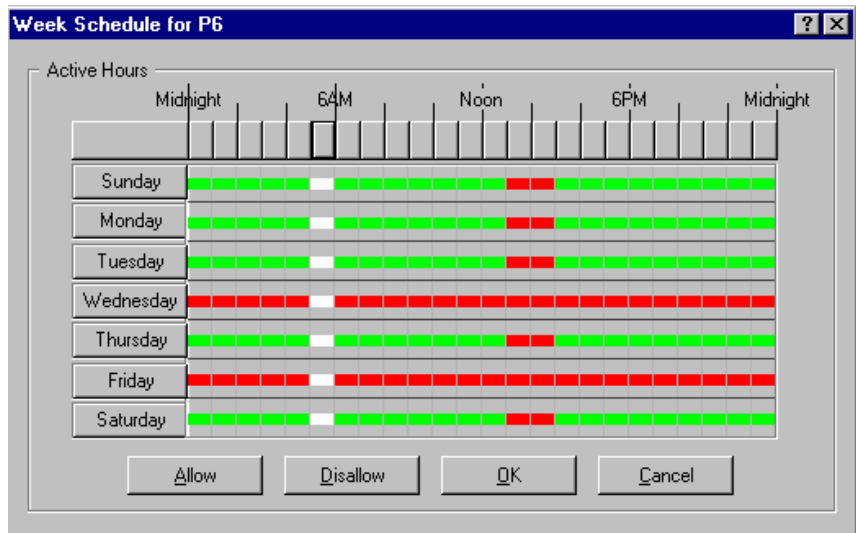

To schedule a set of active hours for a server or servers:

- 1 In Queue Monitor's Server list, right-click a Server and choose Week Schedule, or select one or more Servers and choose Servers menu > Week Schedule.

- 2 In the dialog that appears, select a time using one of the following methods:
 - Select a one-hour block for network rendering by clicking one of the top buttons.
 - Select an entire day by clicking a side button.
 - Select the entire week by clicking the large top-left button. The selection is shown in white.
- 3 Click the Allow button. The selection is shown in green. (By default, all hours are allowed).
- 4 To apply the time selection to the selected Server, click OK.

To schedule hours when servers are unavailable:

- 1 In Queue Monitor's Server list, right-click a Server and choose Week Schedule, or select a Server and choose Servers menu > Week Schedule.
- 2 In the dialog that appears, select a time using one of the following methods:
 - Select a one-hour block for network rendering by clicking one of the top buttons.
 - Select an entire day by clicking a side button.
 - Select the entire week by clicking the large top-left button. The selection is shown in white.
- 3 Click the Disallow button. The selection is shown in red.
- 4 To apply the time selection to the selected Server, click OK.

Batch Rendering

“Batch rendering” is a term used to describe the process of rendering a series of tasks or jobs that have been assigned to a queue. Batch rendering is useful when you need to render images without supervision or when you want to render a number of test studies showing different day or night lighting, or for producing shadow studies of various sun angles. Batch rendering can also be used when you want to see how your project looks from different camera viewpoints.

Several methods for setting up batch rendering are available in 3ds Max. These methods entail using the [Batch Render tool](#) on page 6553 or [network rendering](#) on page 6433 with Backburner, or a combination of the two.

The three available methods for setting up batch rendering are as follows:

- Build a queue of camera tasks that are managed by the Batch Render tool. If you have a MAX file that contains one or more cameras and saved [scene states](#) on page 7399, you can set up a camera queue to render different camera viewpoints. Each camera can be set to automatically load a scene state to give you several visualizations of your model.
- Set up a series of jobs as network rendering assignments to be coordinated by Backburner. If you have a number of separate scenes that are part of a single project or part of several projects, use network rendering even if you're rendering to a single computer. Use this method also if you have scenes that don't have a camera set up and you want to render a Perspective, Front, Left or Right viewport view.
- Use the Batch Render tool to set up a queue of camera tasks to render different views and pass them to Backburner for rendering management. The Batch Render tool has an option to send each camera task in the batch render list as a separate network rendering job. Use this method if you want to split the rendering of the different views among multiple computers.

See also:

- [Batch Rendering - Batch Render Dialog](#) on page 6553

Quick Start Batch Rendering

The following provides bare-bone steps on how to set up and use the Backburner Manager and Server utilities to perform batch rendering.

If your system is already properly configured for TCP/IP protocols (for example, your computer has an internet connection), information in this topic will help you get started with batch rendering in a few basic steps.

Procedures

To render in batch mode:

You need Windows XP (Home or Professional) Service Pack 1 (or higher) or Windows 2000 Service Pack 4.

NOTE Backburner rendering is not supported under Windows 95, 98 or ME.

- 1 Run the Backburner Manager and Server applications from the Start menu, in the same program group as 3ds Max.
- 2 Start 3ds Max, and load the first scene you want to batch render.
- 3 Open the Render Setup dialog and adjust the various rendering parameters for the way you want to render the scene, including active viewport, file output, etc.
- 4 Turn on Net Render in the Render Output group, and then click Render.
- 5 In the resulting [Network Job Assignment dialog](#) on page 6481, click the Connect button.
- 6 Click the Submit button.

NOTE Each job should have a unique output file name and/or path to avoid overwriting output files. If you get an alert dialog that says, "Another job is using the same output name...", you can click the No button, click Cancel to exit the Network Job Assignment dialog, and then change the output name and/or path. Otherwise, you can click the Yes button and let the job overwrite the frames from the other job in the queue.

- 7 Load the next scene you want rendered, and then repeat steps 4 through 7.

Once you've submitted all rendering jobs, you can exit 3ds Max, if you want. If power is lost before all jobs are rendered (either by accident or by intentional powering down of your computer), when you restart the Backburner Manager and Server programs, the rendering process will resume where it left off.

Using Backburner for Batch Rendering

Using Backburner for batch rendering is a simple matter of starting the software, running the Backburner Manager and Server programs, specifying

the scenes you want rendered, and then proceeding with the rendering. In this case, Backburner coordinates a series of rendering tasks that are network rendered on a single computer.

The process is very similar to rendering over a network. With network rendering, the scenes you submit to the rendering queue are called 'jobs'. The following steps show how to submit multiple jobs to the rendering queue.

Your system has to be properly configured in the TCP/IP protocol (see “TCP/IP Settings” in the *Autodesk Backburner Installation Guide*) to perform Backburner batch rendering. If you do not have a network card or if you are not connected to the internet, then you may need to configure TCP/IP with the Microsoft Loop Back Adapter.

NOTE  Batch rendering by means of Backburner differs from batch rendering with the [Batch Render tool](#) on page 6553. However, you can use the Batch Render tool to create a queue of rendering tasks and then pass the tasks to Backburner to coordinate the rendering process.

Network Files

When Backburner Manager begins a job, a series of files are created in the `\network\jobs` folder of your Backburner folder. Among other things, this means that you can shut down your computer completely (either on purpose or by accidental power failure), and when you next start Backburner Manager and Server, they'll pick up where they left off and continue with your rendering queue.

NOTE The exception to the above rule is when rendering multiframe file formats, such as AVI and MOV. Due to limitations in these file formats, if you stop in the middle of rendering one of these files, when you begin rendering again, the entire file will have to be rendered from the beginning.

Procedures

To batch render several jobs:

- 1 Start 3ds Max.
- 2 Start Backburner Manager.
The Backburner Manager window appears. Its window displays the words: “Starting Network Manager.”
- 3 Start Backburner Server.

The Backburner Server window appears. Its window displays the words: "Starting Backburner Server," followed by additional startup messages.

- 4 In 3ds Max, load the first scene you want rendered.
- 5 Activate the viewport you want rendered, and click the Render Setup button on the toolbar.
- 6 Set up the various rendering parameters as you would if you were rendering only this scene.
- 7 In the Render Output group, turn on Net Render.
- 8 Click Render.

To assign network jobs:

At this point, the [Network Job Assignment dialog](#) on page 6481 appears. Its main purpose is submit the current job to the Backburner Manager with all its render settings, including job name and net rendering specifics. The Backburner Manager then takes over and begins the rendering process.

- 1 In the Job Name field, either accept the default name (the name of the scene), or specify a new one.
- 2 Click the Connect button to connect the software to the Manager. After a moment, your TCP/IP address appears in the field over the window, and the Server appears in the window.
- 3 Click the server in the window so that its icon displays a green circle with an arrow through it.
- 4 Click the Submit button.

NOTE Each job should have a unique output file name and/or path to avoid overwriting output files. If you get an alert dialog that says, "Another job is using the same output name...", you can click the No button, click Cancel to exit the Network Job Assignment dialog, and then change the output name and/or path. Otherwise, you can click the Yes button and let the job overwrite the frames from the other job in the queue.

- 5 The Job Assignment dialog goes away, and the rendering begins. The Manager reports: "Job (job name) submitted." The Server reports that it has received the job, and then begins reporting each frame it's completed.
- 6 At this point, you can open the next scene to be rendered, and then repeat the steps, beginning with step 4 in the previous procedure.

Once you've submitted the jobs you want rendered, you can exit 3ds Max (do not shut down the Backburner Manager or Server), or you can begin working on a new scene, or editing an old scene. Keep in mind, however, that your processor is spending most of its time working on rendering, so your computer will be slower than usual.

If you need to monitor the batch render processes, you can use the Backburner monitor for that purpose. (See "Understanding the Backburner Monitor" in the *Autodesk Backburner User's Guide*.)

Batch Rendering - Batch Render Dialog

Rendering menu > Batch Render

The Batch Render tool offers you an efficient, visual approach to setting up a sequence of different tasks or scene states to render automatically. From the Batch Render dialog, you control the following:

- Image resolution, pixel aspect ratio or time sequence if it differs from the default rendering settings found on the [Render Setup dialog](#) on page 6067.
- Whether to render a specific camera view or the active viewport.
- Which camera view to render.
- The output path where rendered images get stored.
- Which [scene state](#) on page 7399 is restored prior to rendering.
- Which [rendering preset](#) on page 6114 is used per rendered view.
- Whether all the batch rendering tasks should be sent to Backburner for [network rendering](#) on page 6433 by multiple systems for even faster rendering.
- Exporting the batch rendering tasks and all parameters set in the Batch Render dialog to a BAT file for later [command line rendering](#) on page 6562.

NOTE The Batch Rendering dialog is for rendering different aspects of the same scene, such as views from different cameras. To batch-render a number of different scenes, use [Backburner](#) on page 6550 or [command-line rendering](#) on page 6562.

Batch Render Completed

If a problem is encountered by the Batch Renderer, you will be notified by means of the Batch Render Completed dialog. This is an error dialog that

appears and notifies you about which batch renders did not complete and, if possible, provides a description of why the failure occurred.



If the cause of the error cannot be identified, then the error entry will simply state *Failed*. The most common causes for failure are:

- Missing texture maps for materials that are assigned to objects in the scene. This shows up as *Failed. Missing External File*. Once the texture map is found or map paths are properly set, this error will not occur.
- Missing UVW coordinates for objects that have texture mapped materials assigned to them. This is reported as *Failed. Missing Map Coordinates on Object* and can be alleviated by making sure new objects are created with the Generate Mapping Coords switch turned on and by assigning a UVW Map modifier to the object that is not displaying its texture mapping.

Procedures

To use the Batch Render tool:

- 1 Open or create a MAX scene.
- 2 Choose Rendering menu > Batch Render.
The Batch Render dialog opens.
- 3 On the Batch Render dialog, click the Add button.
This adds your first rendering task to the batch render queue.
By default, the Camera parameter is set to Viewport, which means that the task will render the active viewport. To change to a set view, make

sure the scene contains at least one camera, and then choose the camera view to render from the [Camera drop-down list](#) on page 6559.

- 4 Review the Selected Batch Render Parameters settings and, if necessary, turn on Override Preset and then change the Frame Start, Frame End, Width, Height, and Pixel Aspect settings.
- 5 Click the Output Path button to set a drive location, file name and file format for the rendered image.
- 6 If you've saved any scene states with the model, you can choose which one is loaded during the rendering operation by opening the Scene State drop list.
- 7 Repeat steps 3 through 6 to continue adding rendering tasks to the batch render queue, as necessary.
- 8 When all your tasks are set, click the Render button.

To use the Batch Render tool with Backburner:

Before attempting to use the Batch Render tool with Backburner for network rendering, make sure the Backburner Manager is running on your managing workstation and that Backburner Server is running on all the other workstations that will receive the rendering assignments. For more information on setting up Backburner Network Rendering, refer to [Network Rendering](#) on page 6433.

- 1 Set up a series of rendering tasks in the Batch Render queue as documented in the previous procedure.
- 2 Turn on Net Render and then click the Render button.
The Network Job Assignment dialog opens.
- 3 Enter a subnet mask, or, with Automatic Search off, enter the Manager name or IP address, and then click Connect.
The available rendering servers show up in the list on the right side of the Network Job Assignment dialog.
- 4 Click the Submit button to send all the Batch Render camera tasks to Backburner for network rendering to all the workstations that are running Backburner Server.
If you are running the Backburner Queue Monitor, you'll see all the camera tasks listed as rendering jobs in the Job section of the Queue Monitor.

Interface

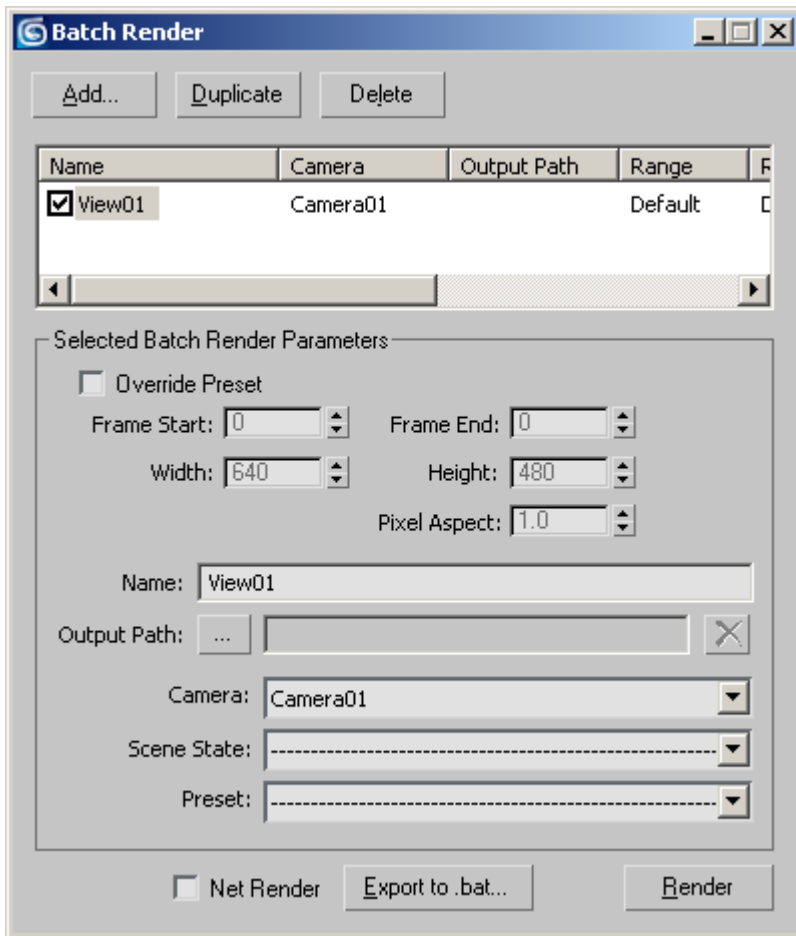

Add Adds a new rendering task to the queue, using the default settings. By default, a new task is set to render the active viewport. To set it to render a particular camera, choose the camera from the [Camera drop-down list](#) on page 6559.

Duplicate Adds a copy of the highlighted rendering task to the queue. All rendering parameters that were part of the original task are duplicated for the new task.

Delete Deletes the highlighted rendering task.

No warning appears to confirm deletion and you cannot undo a deletion.

[Task Queue] This is a listing of all the camera tasks that have been chosen for batch rendering. The task queue consists of eight columns that show all the parameters that have been set for a particular camera task. You can control which tasks are rendered by toggling the check boxes in the list.

Name	Camera	Output Path	Range	Resolution	Pixel Aspect	Scene State	Preset
<input checked="" type="checkbox"/> Camera02 View01	Camera02	hallway_wal...	0 - 5	320x240	1.000		
<input checked="" type="checkbox"/> Camera01 View03	Camera01		0 - 0	320x240	1.000	Brick Wall - ...	
<input checked="" type="checkbox"/> Camera02 View03	Camera02	hallway_wal...	Default	Default	Default		

Selected Batch Render Parameter group

By default, any tasks you've designated for batch rendering use the current Time Output and Output Size parameters from the [Render Setup dialog](#) on page 6067.

For example, if the Output Size settings on the Render Setup dialog shows that you have a Time Output settings of Single and an of 800 width and 600 height, when you add a camera, its Selected Batch Render Parameters will mimic those settings. Likewise, if the Render Setup dialog has a Time Output set to Range and frame 0 to 25, the Frame Start and Frame End settings on the Batch Render dialog will default to those Time Output settings.

This group gives you access to changing those default parameters.

Override Preset When on, you can override any of the default settings for the highlighted task via the Frame Start, Frame End, Width, Height, and Pixel Aspect settings. Default=off.

Frame Start The first frame to be rendered for the highlighted task. The default setting for this parameter matches the Time Output group settings on the Common panel of the Render Setup dialog.

Frame End The last frame to be rendered for the highlighted task. Its default state also matches the Time Output group settings on the Common panel of the Render Setup dialog.

The default Frame Start and Frame End parameters correspond to the Render Setup dialog parameters as follows:

Render Setup dialog >Time Output	Batch Render dialog Frame Start/End
Single	Defaults to the frame set by the time slider.

Render Setup dialog >Time Output	Batch Render dialog Frame Start/End
-------------------------------------	--

Active Time Segment	Defaults to 0 (zero) and the last frame of the animation as set in the Time Configuration dialog on page 7565.
---------------------	--

Range	Defaults to the range of frames specified, such as 0 (zero) To 14 or 6 To 11.
-------	---

The Frame Start and End settings also conform to the current time configuration format; i.e. Frames, SMPTE, Frame:Ticks, or MM:SS:Ticks.

Width Allows you to specify a new image width setting if Override Preset is on. If Override Preset is off, this value matches the width set on the Render Setup dialog.

Height Allows you to specify a new image height setting if the Override Preset is on. If Override Preset is off, this value matches the height set on the Render Setup dialog.

Pixel Aspect Sets the aspect ratio of the pixels for display on another device. The image might look squashed on your display but will display correctly on the device with differently shaped pixels. By default, this mimics the value set on the Render Setup dialog.

Name Lets you change the default name of the highlighted task. The default naming structure for camera tasks uses “View” plus an incremented view number, such as *View01* or *View02*. If you want, you can change the task's name to something more descriptive.

NOTE After changing the name, you must press Enter for the change to register.

NOTE If you're [rendering elements](#) on page 6336 as part of the batch, the task name is appended to each rendered element's specified file name. For example, if the task name is *View01* and the render element output file name is *Test_Diffuse.tga*, then the batch-rendered element output becomes *Test_Diffuse_View01.tga*.

If you're rendering an element without specifying a file name for the element, the batch renderer appends the element type to the batch output file name.

For example, if the batch output file name is *MyBatch.png*, and you're rendering an Atmosphere element, then the element output name becomes *MyBatch_Atmosphere.png*.

Output Path The ellipsis (...) button opens the [Render Output File dialog](#) on page 6086 where you can specify the output path, file name and file format for the rendered image of the selected camera task.

Once set, the output path and file name appears in the output path field and the file name appears in the Output Path column of the task queue.

X [Clear Output Path] Removes the output path and file name from the Output Path field and task queue.

Camera This drop-down list shows any cameras in the scene.

By default, a task is set to render the active viewport, as indicated by the "Viewport" entry in the Camera column of the task queue. You can use this list choose a camera from any in the scene for the highlighted task. The new camera is shown in the Camera column of the task queue.

To set the highlighted task to render the active viewport, choose the dashed line (-----) from the top of the drop-down list.

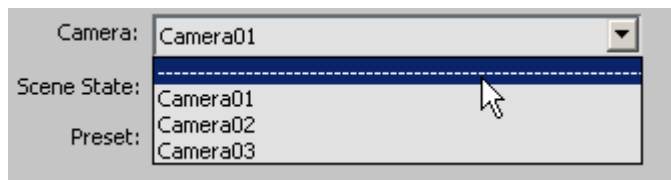

Choose the dashed line to render the active viewport.

NOTE Choosing a camera changes only the camera the task uses. It does not change the name of the task.

Scene State This drop-down list displays the [scene states](#) on page 7399, if any, that you can assign to the highlighted task. If no scene state is active then current scene settings are used.

Preset Lets you choose a render preset for the highlighted task. If no render preset is active and there is no override, then the current render settings are used.

If you choose Load Preset from the drop-down list, the Render Presets Load dialog opens.

Net Render When on, opens the [Network Job Assignment dialog](#) on page 6481 when you click the Render button.

Each camera task in the Batch Render dialog is passed to the Network Job Assignment dialog as an individual rendering job instead of a single job. By default, the Network Job Assignment dialog uses the name of the MAX file as its job name, and it then appends the name of the camera task. For example, if you have a scene named *Athena_High_Rise* and camera tasks for three cameras, the jobs will look like this in the monitor: *Athena_High_Rise Camera02 View01*, *Athena_High_Rise Camera01 View02* and *Athena_High_Rise Camera01 View03*.

Export to .bat Creates a batch file for command line rendering. This button opens the Batch Render Export To Batch File dialog where you can specify a drive location and name for the batch file that is saved.

Render Starts the batch rendering process or opens the Network Job Assignment dialog if Net Render is turned on.

Batch Render Tool - Batch Render Warning Dialog

Rendering menu > Batch Render > Click Render to render tasks that do not have an output path set.

Rendering menu > Batch Render > Click Render to render tasks that could overwrite previously saved files.

The Batch Render Warning dialog informs you of certain conditions you may have overlooked while assigning the rendering tasks. The dialog that displays is context-sensitive, meaning that the warning will indicate when either of these two conditions exist:

- When you risk overwriting an existing file or if you have not specified an output path and output file name.
- When the output path that was specified has been renamed or no longer exists.

Interface

Task Queue

Both formats of the Batch Render Warning dialog include the Task Queue columns that are shown in the in the Batch Render dialog. The key difference is the exception of the check boxes that let you specify which cameras are use in the render. This Task Queue only shows the cameras that may overwrite a

saved file, or do not have a path/file name set for output, or if they show an output path that is invalid.

Missing Output Path/File name or File Overwrite

This version of the Batch Render Warning dialog appears if you click the Render button on the Batch Render dialog and one or more of the tasks to be rendered does not include an output path/file name. The dialog also appears if there is a chance you will overwrite a previously rendered image.

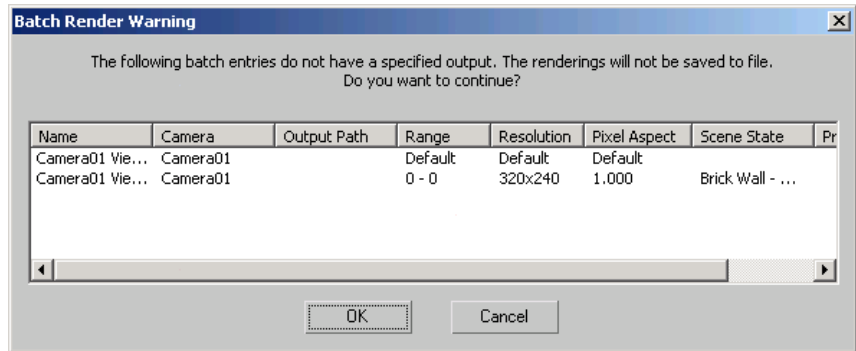

OK Allows you to continue with the batch rendering tasks even though there are some tasks without an output path/file name or some files could be overwritten. Tasks without an output path/file name are not automatically saved and only appear in the [Rendered Frame Window](#) on page 6073.

Cancel Cancels the batch rendering.

Invalid Output Path

This version of the Batch Render Warning dialog only appears if you are rendering to a file that has invalid output paths. For example, if you're rendering a client's model and they've set their own output paths.

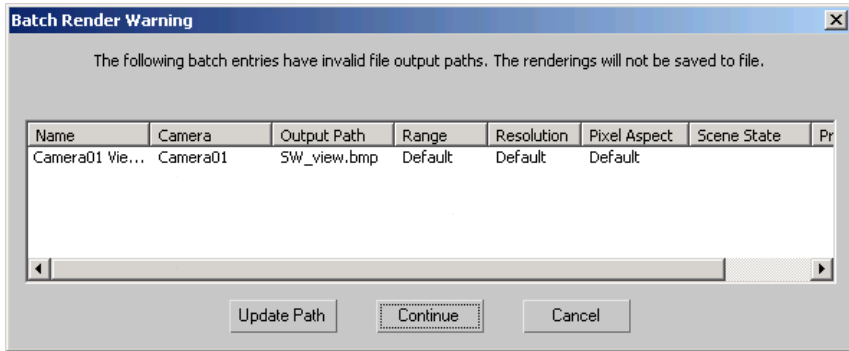

Update Path Allows you to browse to a new directory and reassign the output path for all the entries in the Task Queue. The specified output file name remains the same.

NOTE If you don't want to assign the same path to all the cameras shown in the dialog, you should Cancel and set the correct paths for each camera from the Batch Render dialog.

Continue Allows you to continue with the batch rendering tasks even though there are some tasks without an output path. Tasks without an output path are not automatically saved and only appear in the [Rendered Frame Window](#) on page 6073.

Cancel Cancels the batch rendering.

Command-Line Rendering

The command-line rendering tool lets you perform batch rendering jobs without having to manipulate parameters by hand in a MAX file. Simple, “one-shot” rendering jobs can be submitted from the Start > Run dialog. More elaborate, batched jobs can be rendered through the use of text files; for example, *MyRender.bat* or *MyRender.xml*. The ability to edit text files is what provides the power to this tool. You can quickly make changes to your rendering parameters, or output formats, simply by opening your text editor and editing the batch settings.

Command-line rendering is provided by the *3dsmaxcmd.exe* program, found in your program install folder.

You can submit command-line rendering jobs that are rendered on a single workstation, or you can take advantage of [network rendering](#) on page 6433 and let the Backburner utility manage the jobs across multiple systems.

The [Batch Render tool](#) on page 6553 is another way to quickly create BAT files that can be used with the command-line rendering. The Batch Render tool lets you create a queue of camera tasks with specific output parameters, rendering presets or automatic loading of scene states. Once your queue is complete, you can export the tasks to a BAT file that is stored in the `\scenes` folder.

WARNING Command-line rendering is a professional feature and can perform destructive operations. You will not see messages or warning dialogs informing you about potential mistakes, such as overwriting an existing frame on your drive.

See also:

- [Command-Line Rendering Switches](#) on page 6566

Procedures

To view the `3dsmaxcmd` help file:

The `3dsmaxcmd.exe` file contains a built-in help system that you can access from a command prompt.

- 1 Open a command prompt window (for example, Windows Start > Run > enter CMD).
- 2 Enter the following: `"c:\program files\autodesk\[program folder name]\3dsmaxcmd" -?` and press Enter.

The list of switches and options will scroll on to the window.

To view a list of sample command lines with descriptions of what they do:

The `3dsmaxcmd.exe` file also has an extensive list of sample text strings that describe many of the most common scenarios you'd use command-line rendering to accomplish.

- 1 Open a command prompt window.
- 2 Enter the following: `"c:\program files\autodesk\[program folder name]\3dsmaxcmd" -x` and press Enter.

Setting up the simplest rendering:

In its simplest form, just a render command using all the settings that are stored with a scene, would look like this:

- 1 Open a command prompt window.
- 2 Enter the following: `"c:\program files\autodesk\[program folder name]\3dsmaxcmd" "c:\program files\autodesk\[program folder name]\scenes\myscene.max"` and press Enter.

Example: Rendering to a JPG file at 800x600 resolution:

Perhaps the last time you rendered your scene, you had the output resolution set to 320x240 and rendered a BMP file. Re-rendering the scene using different output settings is fast and efficient with command-line rendering.

- 1 Open a command prompt window.
- 2 Enter the following:
`"c:\program files\autodesk\[program folder name]\3dsmaxcmd" -outputName:"c:\program files\autodesk\[program folder name]\renderoutput\myImage.jpg" -w 800 -h 600 "c:\program files\autodesk\[program folder name]\scenes\myscene.max"`
and press Enter.

NOTE The specified output path must already exist. If it doesn't, the image doesn't render and you get an error message.

Network rendering from the command line:

If you have your system networked and have access to other systems, you can take advantage of network rendering.

NOTE A command-line job cannot be run on a system already running the Backburner server.

- 1 Open a command prompt window.
- 2 Enter the following:
`"c:\program files\autodesk\[program folder name]\3dsmaxcmd" -submit "c:\program files\autodesk\[program folder name]\scenes\myscene.max"`
and press Enter.

Example: Rendering from a text file:

Command-line rendering gives you the ability to set a series of common switches that can be quickly re-used for rendering a single job from Start > Run, or for rendering a group of scenes specified in a BAT file. You can build your text file using any text editor.

NOTE A TXT file can specify only a single scene to render. For multiple scenes, use a BAT file.

1 Open your text editor.

2 Enter your list of commands, such as:

```
-bitmapPath=\\mapServer\maps\myMaps  
-cam=myCamera  
-width=800  
-height=600  
-vfb=true  
-frames=all  
-force2Sided=true
```

3 Once all the switches are entered, save the files as a TXT file, such as *myrender.txt*.

4 To render the scene, open the Windows Start > Run dialog.

5 Enter the following:

```
"c:\program files\autodesk\[program folder name]\3dsmaxcmd"  
@c:\myrender.txt -o="c:\program files\autodesk\[program folder  
name]\renderoutput\myImage.tga" "c:\program  
files\autodesk\[program folder name]\scenes\myscene.max"
```

and click OK.

Using a TXT file that contains your favorite settings, in conjunction with a command line that specifies the output file format and scene of your choice, gives you the flexibility to re-use the TXT file without having to edit it each time you want to render. You can create several TXT files with settings for different stages of scene development, such as *testrender.txt* or *finalrender.txt*.

Example: Rendering from a BAT file:

If you want to render several scenes in a batch process, you can create a BAT file containing all the scenes and switches needed to get the results you want. Just like a text file, you can build your BAT file using any text editor. For this

example, let's say you have three scenes, in various stages, and you want each rendered using different settings.

- 1 Open your text editor.
- 2 On the first line, enter the following text. This example assumes that the scene is far from finished, but that you want to test a chunk of animation.

```
"c:\program files\autodesk\[program folder name]\3dsmaxcmd"
-o="c:\program files\autodesk\[program folder
name]\renderoutput\scene1.jpg" -w=320 -h=240 -frame=1-33
"c:\program files\autodesk\[program folder name]\scenes\scene1.max"
```

The second scene is almost ready, but you need to test the look of some materials and do a video color check:

```
"c:\program files\autodesk\[program folder name]\3dsmaxcmd"
-o="c:\program files\autodesk\[program folder
name]\renderoutput\scene2.jpg" -w=640 -h=480 -force2Sided=true
-videoColorCheck=true "c:\program files\autodesk\[program folder
name]\scenes\scene2.max"
```

The last scene is complete, and you want to render a higher-resolution image using settings you've saved in a TXT file that you always use for final renderings:

```
"c:\program files\autodesk\[program folder name]\3dsmaxcmd"
@:c:\finalrender.txt -o="c:\program files\autodesk\[program folder
name]\renderoutput\scene3.jpg" "c:\program files\autodesk\[program
folder name]\scenes\scene3.max"
```

- 3 After entering these three command lines, save your file as a BAT file.
- 4 From the Windows Start > Run dialog, browse to the BAT file and click Open.
- 5 Click OK to start rendering.

Command-Line Rendering Switches

In order to use command-line rendering, you should be familiar with DOS and understand the structure of command lines.

Command-Line Switches

You can use the following switches after **3dsmaxcmd** on the command line of a command prompt window, or as entries in a text file. The following tables show switches and their effects.

NOTE Switches are not case sensitive.

At Verbosity level 5, the output message from command-line rendering includes both a timestamp and a date stamp. The timestamp is separated from the main message by a semicolon, and the elapsed time message is separated from the Frame Completed message by a semicolon. This lets you pipe the message to a file, and then open it in a spreadsheet program with appropriate columns by setting the delimiter character.

Separators

Many switches are displayed in the following charts with trailing colons, such as **-w:** or **-h:**. The use of a colon separator is optional, and can be replaced with a space or an equal sign (=). Therefore, command lines such as:

```
"c:\program files\autodesk\[program folder name]\3dsmaxcmd"  
-outputName:"c:\program files\autodesk\[program folder  
name]\renderoutput\myImage.jpg" -w:640 -h:480 "c:\program  
files\autodesk\[program folder name]\scenes\myscene.max"
```

```
"c:\program files\autodesk\[program folder name]\3dsmaxcmd"  
-outputName "c:\program files\autodesk\[program folder  
name]\renderoutput\myImage.jpg" -w 640 -h 480 "c:\program  
files\autodesk\[program folder name]\scenes\myscene.max"
```

```
"c:\program files\autodesk\[program folder name]\3dsmaxcmd"  
-outputName="c:\program files\autodesk\[program folder  
name]\renderoutput\myImage.jpg" -w=640 -h=480 "c:\program  
files\autodesk\[program folder name]\scenes\myscene.max"
```

will give you the same results. The use of the equal sign can give your command-line files more of an INI file appearance.

NOTE The switch **-submit:[manager_name]** is the only case where a colon is necessary.

On/Off Command-Line Switches

Many of the switches you'll use are simple on/off toggles, such as the **-rfw:** and **-renderFields:** switches. If you prefer, instead of using a **1** or **0** to designate their states, you can use **True** or **False**. For example, to render a scene to a specified file type and display the Rendered Frame Window, your command line might look like this;

```
"c:\program files\autodesk\[program folder name]\3dsmaxcmd"  
-outputName="c:\program files\autodesk\[program folder  
name]\renderoutput\myImage.jpg" -rfw=true "c:\program  
files\autodesk\[program folder name]\scenes\myscene.max"
```

Basic Options

Switch	Effect
-?	Displays a list of these switches in the DOS window.
-x	Shows a list of example command lines.
-v:#	Sets the verbosity level, where # is an integer from 0 (least verbose) to 5 (most verbose).
@ <i>command_file</i> or -cmdFile: <i>command_file</i>	Points to a separate file containing command-line options.
-preset:<file-name> or -rps:<filename>	Uses a render preset file where <filename> is the name of the preset file.
-sceneState:<scene-state-name>	Loads the specified scene state file before rendering the image.
-batchRender	Renders all enabled tasks in the Batch Render dialog.

Switch	Effect
-batchRender:<batch-render-name>	Renders batch renders in the file named <i>batch-render-name</i> .
-preRenderScript:<filename> or -script:<filename>	Uses a pre-render script where <filename> is the name of the script file.
-postRenderScript:<filename>	Uses a post-render script where <filename> is the name of the script file.
-workPath:<path-name>	Root location for job data folders.
-pathFile:<path-name>	Path configuration file (MXP format).
-bitmapPath:<path-name>	(obsolete) Provides an extra bitmap path. Multiple paths can be entered and UNC naming conventions can be used.
-xrefPath:<path-name>	(obsolete) Lets you specify extra XRef paths. Multiple paths can be entered and UNC naming conventions can be used.
-split:<strips, overlap>	Split render: number of strips, overlap amount.
-strip:<strips, overlap, strip>	Split render: number of strips, overlap amount, strip number (starting with 1). This is similar to the -split switch, but lets you render a specific, individual strip.

Switch	Effect
	<p>NOTE The strip value has no effect when submitting the job to Backburner. The job will still render all strips. Split and Stitch functionality is intended for local rendering only.</p>
-stitch:<strips, overlap>	Stitches strips (see above), combining them into a single image: number of strips, overlap amount. Stitch functionality is intended for local rendering only.
-date- Format:<date-format>	Specifies a date format to be used in message timestamp, at verbosity level 5. Defaults to locale-dependent format. For details, use the <code>3dsmaxcmd3dsvizcmd -x</code> option.
-time- Format:<time-format>	Specifies a time format to be used in message timestamp, at verbosity level 5. Defaults to locale-dependent format and 24-hour clock. For details, use the <code>3dsmaxcmd -x</code> option.

Render Parameters

NOTE Any command-line switches that are on/off toggles can be switched by entering either **1**, **0**, **on** or **off**.

Switch	Effect
-outputName:<file-name> or -o:<filename>	Sets an output file name and format.

Switch	Effect
-camera:<string> or -cam:<string>	Specifies a camera name.
-width:<integer> or -w:<integer>	Sets the output width in pixels.
-height:<integer> or -h:<integer>	Sets the output height in pixels.
-pixelAspect:<number>	Sets the pixel aspect ratio.
-start:<integer>	Sets the rendering sequence start frame.
-end<integer>	Sets the rendering sequence end frame.
-nthFrame<integer>	Sets the Every Nth Frame value.
-frames<string>	Lets you specify a frame list; for example, (1,3,5-12) or all .
-stillFrame or -sf	Indicates that this is a still-frame render; no frame suffix will be added.
-imageSequence-File:<0/1/2>	Image-sequence file creation: 0=none; 1=.imsq; 2=.iff
-gammaCorrection:<1/0>	Toggles gamma correction. "1"=On, "0"=Off.
-gammaValueIn:<number>	Sets the Input Gamma value.

Switch	Effect
-gammaValueOut:<number>	Sets the Output Gamma value.
-continueOnError	If an error is encountered, the software attempts to continue rendering.
-videopostJob:<1/0>	Turns Video Post on page 6773 on or off for the job.

Render Flags

Switch	Effect
-showRFW:<1/0> or -rfw:<1/0>	Toggles the Rendered Frame Window. "1"=On, "0"=Off.
-skipRenderedFrames:<1/0>	Toggles Skip Existing Images. "1"=On, "0"=Off.
-videoColorCheck:<1/0>	Toggles Video Color Check. "1"=On, "0"=Off.
-force2Sided:<1/0>	Toggles Force 2-Sided. "1"=On, "0"=Off.
-renderHidden:<1/0>	Toggles Render Hidden. "1"=On, "0"=Off.
-atmospherics:<1/0>	Toggles Atmospherics. "1"=On, "0"=Off.
-superBlack:<1/0>	Toggles Super Black. "1"=On, "0"=Off.

Switch	Effect
-renderFields:<1/0>	Toggles Render Fields. "1"=On, "0"=Off.
-fieldOrder: <i>even or odd</i>	Toggles Field Order. Default="Odd".
-displacements:<1/0>	Toggles Displacement Mapping. "1"=On, "0"=Off.
-effects:<1/0>	Toggles Render Effects. "1"=On, "0"=Off.
-useAreaLights:<1/0>	Toggles area lights/shadows. "1"=On, "0"=Off.
-useAdvLight:<1/0>	Toggles use advanced lighting. "1"=On, "0"=Off.
-computeAdvLight:<1/0>	Toggles compute advanced lighting. "1"=On, "0"=Off.
-ditherPaletted:<1/0>	Toggles Output Dithering (paletted). "1"=On, "0"=Off.
-ditherTrueColor:<1/0>	Toggles Output Dithering (true-color). "1"=On, "0"=Off.
-renderElements:<1/0>	Toggles render elements (true-color). "1"=On, "0"=Off.

Backburner Job Submission

These switches concern submitting a rendering job for network rendering. For further information, see [Network Rendering](#) on page 6433. Also, for a different method of network rendering via the command line, see [Backburner Command Line Control](#) on page 6579.

Switch	Effect
-submit[:manager_name] or -s[:manager_name]	Submits the scene, <filename> to a specific manager system for network rendering. NOTE This is the only switch that requires a colon separator.
-port:<integer>	Specifies a manager port number.
-netmask:<string>	Lets you specify a network mask other than 255.255.255.0.
-jobName:<string>	Lets you specify a job name to render.
-priority<integer>	Sets job priority.
-suspended:<1/0>	Toggles initially suspended. "1"=Yes, "0"=No.
-writeJobFile	Writes all job settings to an XML file. The file uses the same name as the MAX file, so, for example, <i>test.max</i> produces <i>test.xml</i> .
-readJobFile:<filename>	Reads all job settings from an XML file.
-waitLoad:<integer>	The amount of time to wait for 3ds Max to load, in minutes. Default=20.

Switch	Effect
-waitRender:<integer>	The amount of time to wait for 3ds Max to render, in minutes. Default=600.
-waitUnload:<integer>	The amount of time to wait for 3ds Max to unload, in minutes. Default=10.
-platform:32 or 64	The platform (either 32- or 64-bit) that your scene will be rendered on. Use this switch when you want to render your scene on a different platform from the platform where you created your scene.

Bitmap Parameters

Switch	Effect
-BMP_TYPE:2 or 8	Sets the type of BMP file being rendered. "2"=paletted, "8"=true 24-bit.
-JPEG_QUALITY:1 to 100	Sets the JPG quality value. Ranges from 1 to 100.
-JPEG_SMOOTHING:1 to 100	Sets the JPG smoothing value. Ranges from 1 to 100.
-TARGA_COLORDEPTH:16, 24 or 32	Sets the color depth for TGA files.
-TARGA_COMPRESSED:<1/0>	Toggles TGA Compression. "1"=On, "0"=Off.

Switch	Effect
-TARGA_ALPHASPLIT:<1/0>	Toggles TGA Alpha Split. "1"=On, "0"=Off.
-TARGA_PREMULTALPHA:<1/0>	Toggles TGA Pre-Multiplied Alpha. "1"=On, "0"=Off.
-TIF_TYPE:<0/1/2/3/4>	Sets the TIF type. "0"=mono, "1"=color, "2"=logl, "3"=logluv, "4"=16-bit color.
-TIF_ALPHA:<1/0>	Toggles TIF file alpha. "1"=On, "0"=Off.
-TIF_COMPRESSION:<1/0>	Toggles TIF Compression. "1"=On, "0"=Off.
-TIF_DPI:<number>	Sets the dots-per-inch value for TIF files.

For each of the following **-RLA_xxxx** switches, there is a corresponding **-RPF_xxxx** option.

Switch	Effect
-RLA_COLORDEPTH:8, 16 or 32	Sets the RLA color bitdepth.
-RLA_ALPHA:<1/0>:	Toggles RLA Alpha. "1"=On, "0"=Off.
-RLA_PREMULTALPHA:<1/0>	Toggles RLA Premultiplied Alpha. "1"=On, "0"=Off.
-RLA_DESCRIPTION:<string>	Lets you specify an RLA description (in quotes).

Switch	Effect
-RLA_AUTHOR:<string>	Lets you specify an RLA author name (in quotes).
-RLA_ZDEPTHCHANNEL:<1/0>	Toggles RLA Z-Depth Channel. "1"=On, "0"=Off.
-RLA_MTLIDCHANNEL:<1/0>	Toggles RLA Material Effects Channel. "1"=On, "0"=Off.
-RLA_OBJECTIDCHANNEL:<1/0>	Toggles RLA Object Channel. "1"=On, "0"=Off.
-RLA_UVCHANNEL:<1/0>	Toggles RLA UV Coordinates Channel. "1"=On, "0"=Off.
-RLA_NORMALCHANNEL:<1/0>	Toggles RLA Surface Normals Channel. "1"=On, "0"=Off.
-RLA_NONCLAMPEDCOLORCHANNEL:<1/0>	Toggles RLA Non-Clamped Color Channel. "1"=On, "0"=Off.
-RLA_COVERAGECHANNEL:<1/0>	Toggles RLA Coverage Channel. "1"=On, "0"=Off.

The following **-RPF_xxxx** switches *do not* have corresponding **-RLA_xxxx** options.

Switch	Effect
-RPF_NODERENDERID-CHANNEL	Turns on RPF Node Render ID Channel.
-RPF_COLORCHANNEL	Turns on RPF Color Channel.
-RPF_TRANSPCHANNEL	Turns on RPF Transparency Channel.
-RPF_VELOCCHANNEL	Turns on RPF Velocity Channel.
-RPF_WEIGHTCHANNEL<1/0>	Turns on RPF Sub-Pixel Weight Channel.
-RPF_MASKCHANNEL	Turns on RPF Sub-Pixel Mask Channel.
Switch	Effect
-EXR_USEEXPONENT	EXR use exponent on/off
-EXR_EXPONENT	EXR exponent value (decimal)
-EXR_PREMULTALPHA	EXR premultiplied alpha on/off
-EXR_ALPHA	EXR save alpha component on/off
-EXR_RED	EXR save red component on/off

Switch	Effect
-EXR_GREEN	EXR save green component on/off
-EXR_BLUE	EXR save blue component on/off
-EXR_BITDEPTH	EXR bit depth: 0=8-bit integers; 1=half float; 2=float
-EXR_USEFRAMENUMDIGITS	EXR use number of frame digits on/off
-EXR_FRAMENUMDIGITS	EXR number of frame digits (integer)
-EXR_COMPRESSIONTYPE	EXR compression type: 0=no compression; 1=RLE; 2=ZIP (1 scanline); 3=ZIP (16 scanlines); 4=PIZ
-EXR_USEREALPIX	EXR use RealPix RGB data on/off

Backburner Command Line Control

The Backburner command line plug-in allows you to submit batch, executable, or script files to Backburner as “custom” jobs. This *cmdjob.exe* tool, found in the Backburner program folder, provides more flexibility in running custom jobs than is offered by the 3ds Max *3dsmaxcmd.exe* plug-in.

For a list of the command-line switches that you can use with the Backburner command line plug-in, see [Command-Line Rendering Switches](#) on page 6566. Some examples of how these commands can be used with 3ds Max are listed below.

NOTE In order to use command-line rendering, you should be familiar with DOS and understand the structure of command lines.

Examples of a CmdJob Usage

Please see the online version of the *Help* for details.

See also:

- [Command-Line Rendering](#) on page 6562

Effects and Environments

21

A variety of special effects, such as film grain, depth of field, and lens simulations, are available as [rendering effects](#) on page 6583. Another set of effects, such as fog, are provided as [environment effects](#) on page 6687. Also available in the environment settings are [exposure controls](#) on page 6732, also known as tone mappers.



The fog environment effect adds atmosphere to a street scene.

In 3ds Max, rendering effects and environments are accessed from a single [Environment and Effects dialog](#) on page 6582.

Environment and Effects Dialog

Rendering menu > Environment

Rendering menu > Effects

Rendered Frame Window > Environment and Effects Dialog Toggle

You apply effects and environments by using the Environment and Effects dialog.

Interface

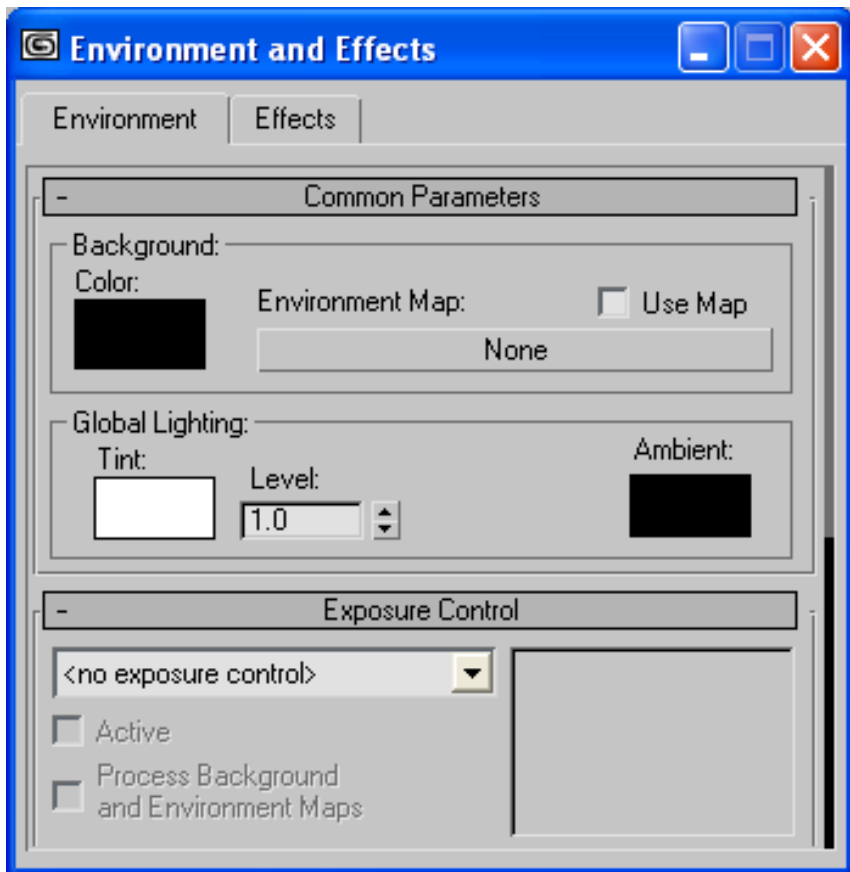

The Environment and Effects dialog has two panels, described in the following topics:

[Effects Panel and Rollout](#) on page 6585

[Environment Panel](#) on page 6689

Rendering Effects

Rendering Effects enable you to add post-production effects without having to render the scene to see the results. Through the [Effects panel](#) on page 6585 on the Environment and Effects dialog, you can add various effects and view them prior to final rendering of an image or animation.

Rendering Effects let you work interactively. As you adjust an effect's parameters, the [Rendered Frame Window](#) on page 6073 is updated with the final output image of both the scene geometry and the applied effects. You can also choose to continually work with an effect and then update the effect manually.

The following topics explain each Rendering Effect in detail.

[Hair and Fur Render Effect](#) on page 6588

[Lens Effects Rendering Effects](#) on page 6594

[Blur Rendering Effect](#) on page 6664

[Brightness and Contrast Rendering Effect](#) on page 6673

[Color Balance Rendering Effect](#) on page 6675

[Depth of Field Rendering Effect](#) on page 6683

[File Output Rendering Effect](#) on page 6676

[Film Grain Rendering Effect](#) on page 6679

[Motion Blur Rendering Effect](#) on page 6681

Rendering Effects and 32-bit Floating-Point Output

Most rendering effects in 3ds Max are not compatible with 32-bit floating-point output, such as that provided optionally by the mental ray renderer (see [Frame Buffer Type](#) on page 6277). If you render using one or more unsupported effects, the following dialog appears:

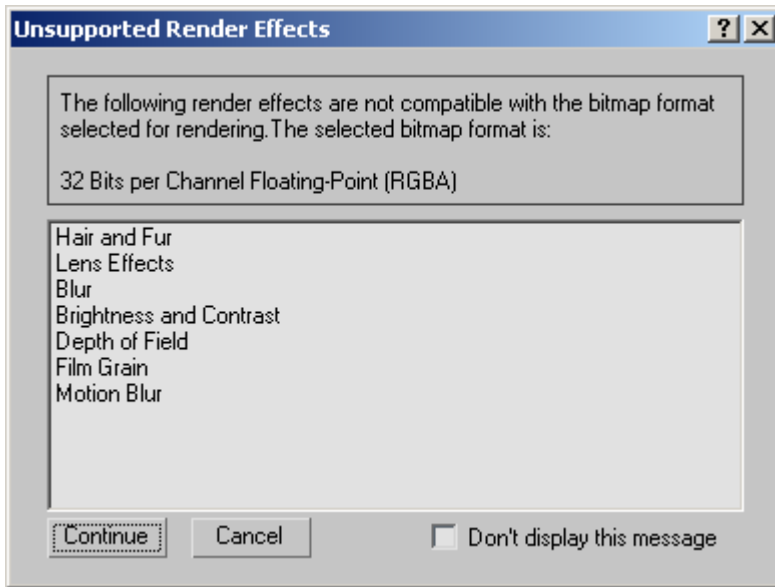

You can choose to continue rendering without the unsupported effects, or cancel the render.

The only supported effects are File Output and Color Balance; the rest (shown in the dialog above) are unsupported.

Rendering Effects Command

Rendering menu > Effects > Environment and Effects dialog > Effects panel

Effects displays the [Effects panel](#) on page 6585 on the Environment and Effects dialog, which lets you set parameters for post-rendering effects.

From this panel, you can select and assign a class of plug-in called Render Effect, which is a post-rendering image-processing effect. This lets you apply image processing without using Video Post.

Render Effects have the added advantage of allowing animated parameters and references to scene objects. You can also adjust and view the effects interactively.

Effects Panel and Rollout

Rendering menu > Effects > Environment and Effects dialog > Effects panel

Rendered Frame Window > Environment and Effects Dialog Toggle > Effects panel

You can use the Effects panel to:

- Assign a Render Effects plug-in.
- Apply image processing without using Video Post.
- Adjust and view effects interactively.
- Animate parameters and references to scene objects.

Interface

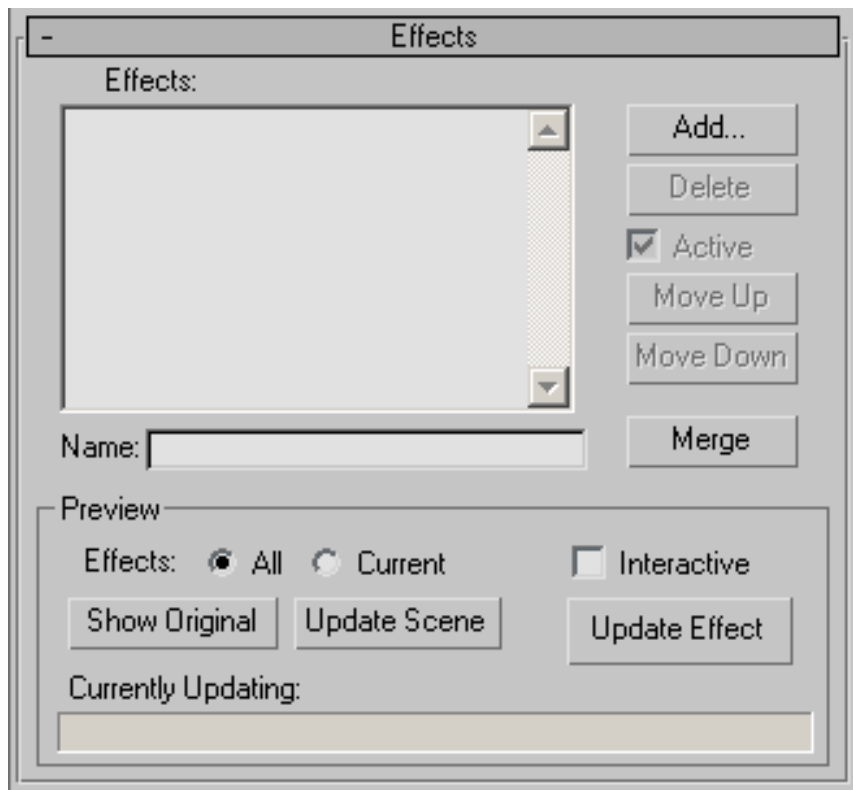

The Effects panel has one main rollout, Effects, with the following options:

Effects Displays a list of selected effects.

Name Displays the name of the selected effect. Edit this field to rename the effect.

Add Displays a dialog listing all available rendering effects. Select the effect you want added to the window list, and then click OK.

Delete Removes a highlighted effect from the window and from the scene.

Active Specifies whether the selected effect is active in the scene. On by default; you can deactivate an effect without actually removing it by selecting it in the window and turning off Active.

Move Up Moves the highlighted effect up in the window list.

Move Down Moves the highlighted effect down in the window list.

Merge Merges rendering effects from scene (.max) files. Clicking Merge displays a file dialog from which you can choose a .max file. A dialog then appears listing all rendering effects in that scene.

Preview group

Effects When **All** is chosen, all of the active effects are applied to the preview. When **Current** is chosen, only the highlighted effects are applied to the preview.

Interactive When on, changes occur interactively in the [Rendered Frame Window](#) on page 6073 as you adjust the parameters of an effect. When Interactive is not activated, you can click one of the update buttons to preview the effect.

Show Original/Show Effects toggle Click Show Original to display the original rendered image without any of the effects applied. Click Show Effects to display the rendered image with the effects.

Update Scene Updates the Rendered Frame Window with all changes made in Rendering Effects as well as any changes made to the scene itself.

Update Effect Manually updates the preview Rendered Frame Window when Interactive is not on. What is shown in the Rendered Frame Window is only an update of any changes made in Rendering Effects. Any changes made to the scene itself will not be rendered.

Merging Effects

Rendering menu > Effects > Environment and Effects dialog > Effects panel > Merge

The Merge button on the [Effects panel](#) on page 6585 lets you merge effects from other 3ds Max (.max) scene files.

See also:

- [Merge](#) on page 7058
- [Replace](#) on page 7070
- [Merge Animation](#) on page 7063

Procedures

To merge an atmospheric effect:

- 1 Choose Rendering menu > Effects to display the Effects panel.
- 2 On the Effects rollout, click Merge.
A Merge Effect dialog appears for file selection.
- 3 Choose a MAX file.
A Merge Atmospheric Effects dialog lists the effects in the specified file.
- 4 Select one or more of the effects, and then click OK to merge them into the scene.
Only atmospheric effects appear in the merge list, but when an effect is merged, any lights or gizmos bound to the effect are merged as well.

To resolve conflicts when merged effects have the same name:

- If an effect of the same type and name already exists in the scene, an alert appears. Choose from among these options:
 - **Name field** Allows you to rename the incoming effect.
 - **Merge** Results in two effects in the scene with the same name.
 - **Delete Old** Removes the existing effect in the scene.
 - **Apply To All Duplicates** Performs the same action on all subsequent matching effects.

Hair and Fur Render Effect

Rendering menu > Effects > Environment And Effects dialog > Effects panel
> Add > Add Effect dialog > Hair and Fur

Hair and Fur modifier > Tools rollout > Render Settings button

To render hair, the scene must contain a Hair And Fur render effect. The render effect is automatically added to the scene the first time you apply the Hair And Fur modifier to an object, or 3ds Max adds one (with default values) at render time if an active Hair And Fur modifier is applied to an object. If for some reason the render effect doesn't exist in the scene, you can add one by clicking the Render Settings button. This opens the Environment And Effects dialog and adds a Hair And Fur render effect. You can change the settings, or simply accept the default settings by closing the dialog after it opens.

Interface

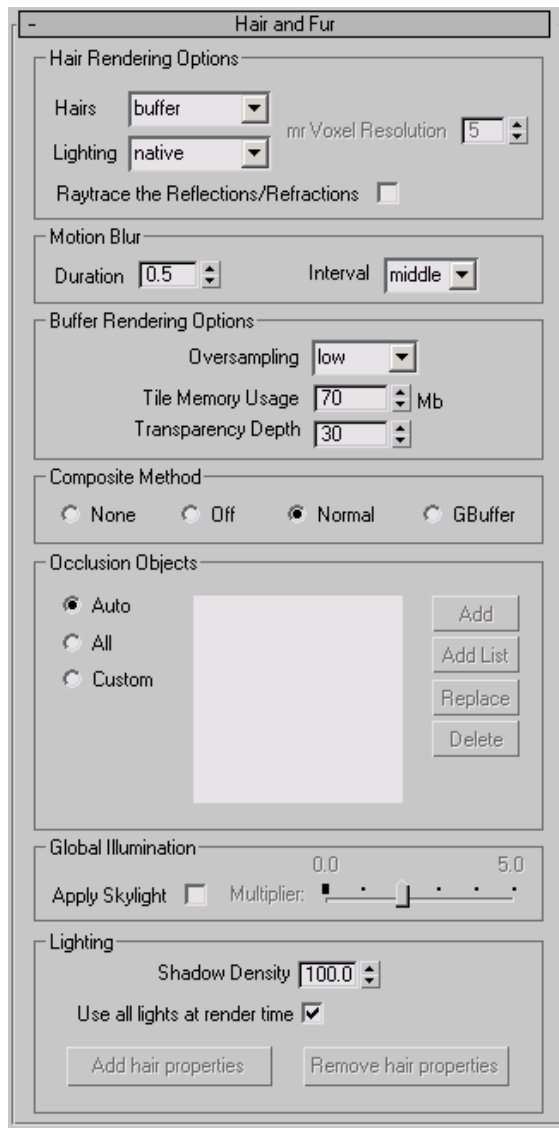

Hair Rendering Options group

Hairs Sets the method to be used for rendering hair:

- **buffer** (The default) Procedural hair generated by Hair at render time based on the modifier parameters. Buffer hair is generated by a special renderer within Hair and offers the benefit of being able to create millions of hairs with minimal memory requirements. Only one hair is in memory at a time. Also, using Buffer render offers a variety of compositing options (described below).
- **geometry** Creates actual geometry for the rendered hair at render time. This geometry is assigned the material ID set by the Hair And Fur modifier > [Geom Mat ID parameter](#) on page 1168.

NOTE “Geometry” hair derives its texture from the growth object, not from any maps applied via the Material Parameters rollout. Compositing options aren't available with “geometry” hair.

The “geometry” option works with both the default scanline renderer and the mental ray renderer.

- **mr prim** Hair is generated by a procedural mental ray shader that generates mental ray curve primitives directly into the mental ray rendering stream at render time. Choose this option *only* when you are rendering hair with the [mental ray renderer](#) on page 6230.

mr Voxel Resolution Available only for the “geometry” and “mr prim” Hairs options. At render time, hair boundaries are subdivided into volume cubes or “voxels.” 3ds Max calculates which hairs are in each voxel, and when a ray enters a voxel, it calculates for those hairs. This allows unneeded voxels to be removed from memory during calculation.

With “geometry” rendering, voxels are used only for calculating instanced hairs.

This value gives the resolution of the subdivision. For example, a value of 3 subdivides the volume into 3 x 3 x 3 voxels, for a total of 27. The higher this value, the more efficient calculations can be. Default=5.

Lighting

- **native** (The default.) Uses standard 3ds Max calculations for light falloff.
- **emulation** Performs a simpler internal calculation for light falloff within the buffer render. It applies only to the buffer hair rendering itself, not the 3ds Max scene. This mode omits features such as illumination textures on

the hair, and light falloff calculation might be slightly inaccurate, but rendering is somewhat faster.

Raytrace the Reflections/Refractions Available only for the “buffer” Hairs option. When on, reflections and refractions are ray-traced. When off, they are calculated as usual. Turning this option on can increase realism at the cost of render time. Default=off.

Motion Blur group

In order to render motion-blurred hairs, Motion Blur must be enabled for the growth object.

Duration The number of frames over which motion blur is calculated for each frame.

Interval The point in the duration at which the “snapshot” of the hair is captured, before blurring. The choices are “start”, “middle”, and “end”. The default is “middle”, which causes blurring to occur at the start and end of the duration.

Buffer Rendering Options group

This setting applies only to the [“buffer” rendering method](#) on page 6590.

Oversampling Controls the level of antialiasing applied to the Hair “buffer” render. The available choices are “draft”, “low”, “medium”, “high”, and “maximum”. The “draft” setting uses no antialiasing; “high” is suitable for most final renders; in extreme cases, use “maximum”. The higher the Oversampling level, the greater the memory requirements and render time. Default=“low.”



Tile Memory Usage Sets the maximum amount of main memory to be used by a “tile.” Hair And Fur renders hair one tile at a time. Default = 70 Megabytes.



Transparency Depth Sets a maximum depth for rendering transparent or translucent hairs. Default=30.

Composite Method group

This option lets you choose the method by which Hair composites hair with the rest of the scene. Compositing options are available only with the “buffer” rendering method.

- **None** Renders the hair only, with occlusion. The resulting image is ready to composite.
- **Off** Renders hair shadows but not the hair.
- **Normal** (The default.) Does standard rendering and composites the occluded hair with the rest of the scene in the Rendered Frame Window. Because of the occlusion, hair will not appear behind (through) transparent objects.
- **GBuffer** Buffer-rendered hair appears behind most transparent objects. Transparent refractive objects aren't supported.

Occlusion Objects group

This setting lets you choose which objects will occlude hair in the scene; that is, if the object is closer to the camera than part of the hair array, the hairs behind it won't render. By default, all objects in the scene occlude hair behind them.

- **Auto** (The default.) All renderable objects in the scene occlude hair behind them.
- **All** All objects in the scene, including non-renderable objects, occlude hair behind them.
- **Custom** Lets you specify the objects that will occlude hair. Choosing this option makes the buttons on the right side of the list available. If you choose Custom but don't specify any occlusion objects, no objects will occlude the hair; that is, the hair will appear in front of all objects, whether or not it's closer to the camera than the objects.

List The list of custom occlusion objects. To edit this list, choose Custom and then use the buttons on the right side of the list.

Add Adds a single object to the list. Click Add and then in a viewport, click the object to add.

Add List Adds multiple objects to the list. Click Add List and then in a viewport, click each object to add in turn. To finish, right-click the viewport or click Add List again to turn it off.

Replace To replace an object in the list, highlight its name in the list, click Replace, and then in a viewport click the replacement object.

Delete To remove an object from the list, highlight its name in the list and then click Delete.



Global Illumination group

Apply Skylight When on, Hair And Fur supports takes sky light into account, provided it is present in the scene. Default=off.

Multiplier Available only when Skylight is turned on. This Multiplier value lets you adjust the amount of sky light that is used when rendering hair.

Lighting group

These settings control the illumination of hair and shadow-casting from hair by supported lights in the scene.

The following light types are *not supported* when rendering hair with the “buffer” method: Skylight, mr Area Omni, mr Area Spot, IES Sun, IES Sky, mr Sky and mr Sun. However, mr Area Omni, mr Area Spot, mr Sky, and mr Sun *are supported* for hair when you use the “mr prim” method and the mental ray renderer.

NOTE For the purposes of rendering shadows in hair, Direct lights are treated as point (omni) lights.

Shadow Density Specifies the relative darkness of the shadows. At the default, highest value, 100.0, shadows are darkest. At the lowest value, 0.0, shadows are fully transparent, so they don't render. Range=0.0 to 100.0. Default=100.0.

Use all lights at render time When on, causes all supported lights in the scene to illuminate and cast shadows from hair when the scene is rendered. (Shadows are cast only from lights whose Shadows toggle is on.) When off, for a light to cast shadows from hair, you explicitly must add hair properties. In either case, shadow maps for hair use the settings from the [Hair Light Attributes](#) rollout on page 5094 Default=on.

NOTE These settings apply only to “buffer”-rendered hair (the default type, set in the Hair Rendering Options group, as described above).

Add hair properties Adds the [Hair Light Attr\(IBUTES\) rollout](#) on page 5094 to selected lights in the scene. If you want to assign hair-specific shadow properties on a per-light basis, this rollout is necessary. Available only when at least one supported light is selected.

When Use All Lights At Render Time is off, only lights with hair properties can illuminate hair.

Remove hair properties Removes the [Hair Light Attr\(IBUTES\) rollout](#) on page 5094 from selected lights in the scene. Available only when at least one light with hair properties added is selected.

Lens Effects Rendering Effects

Rendering menu > Effects > Environment and Effects dialog > Effects panel > Add > Add Effect dialog > Lens Effects

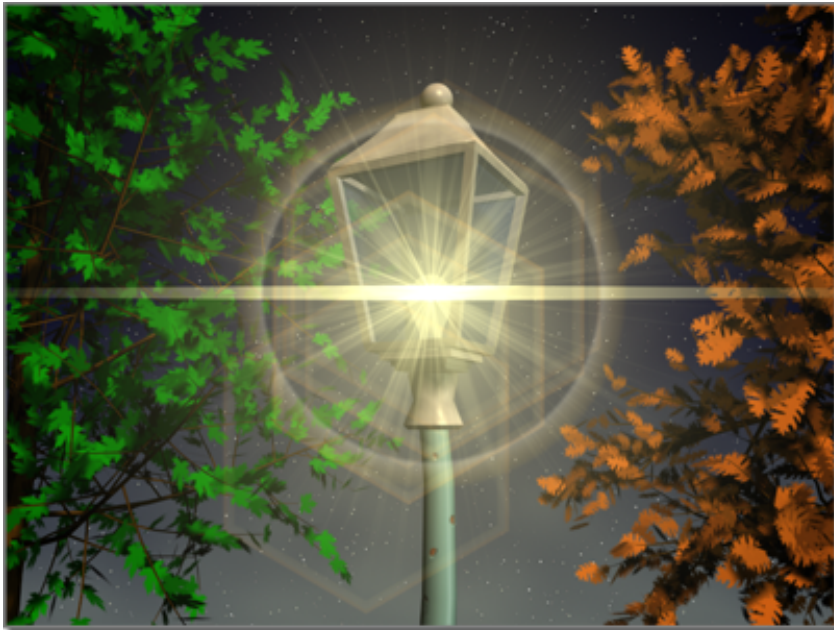

Lens flares added as lens effects

Lens Effects is a system used to create real-life effects commonly associated with a camera. These effects include [Glow](#) on page 6599, [Ring](#) on page 6606, [Ray](#)

on page 6616, [Auto Secondary](#) on page 6623, [Manual Secondary](#) on page 6631, [Star](#) on page 6638, and [Streak](#) on page 6645.

Procedures

To add an effect:

- 1 Select the desired effect from the list on the left side of the Lens Effects Parameters rollout.
- 2 Click the (>) arrow button to move it into the column on the right.

To delete an applied effect:

- 1 Select the effect from the list on the right side of the Lens Effects Parameters rollout.
- 2 Click the (<) arrow button to remove it from the list.

Interface

Lens Effects Parameters rollout

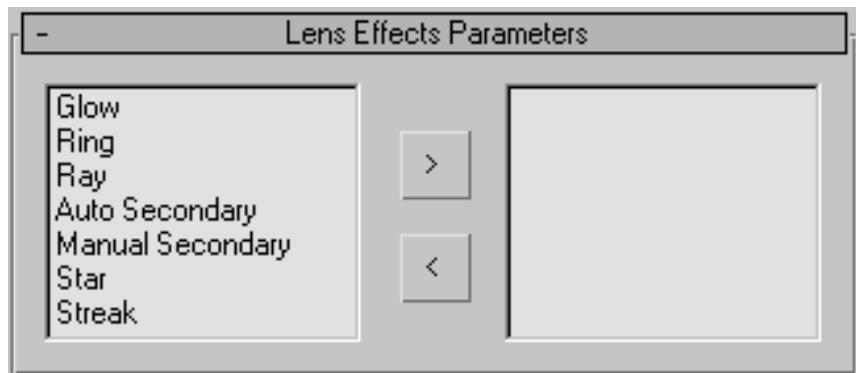

The Lens Effects system allows you to apply effects to your rendered image by choosing a particular effect from the list on the left and adding it to the list on the right. Each effect has its own rollout of parameters, but all effects share two panels of global parameters.

Lens Effects Globals rollout, Parameters panel

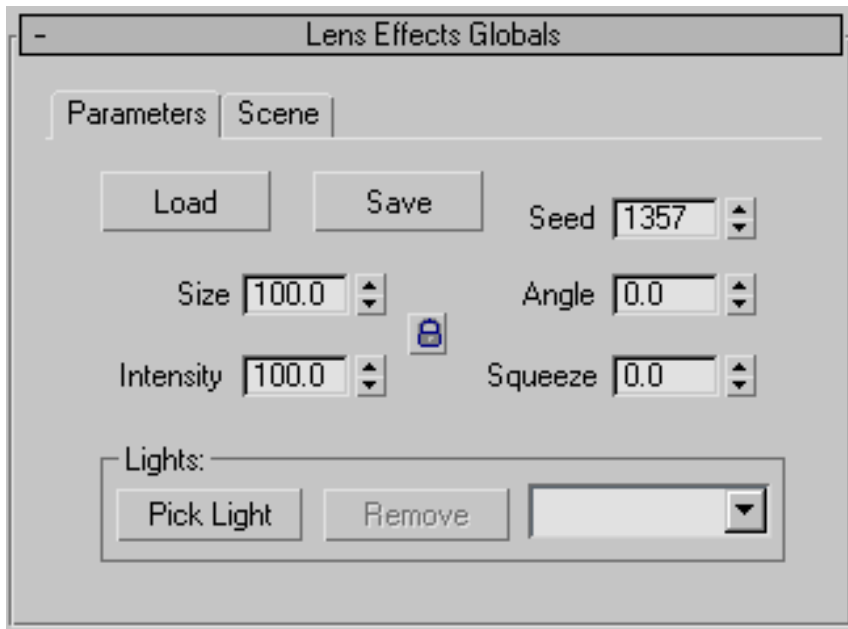

Load Displays the Load Lens Effects file dialog that enables you to open an LZV file. The LZV file format contains information saved from a previous configuration of Lens Effects. This allows you to load and use Lens Effects that have been saved from previous sessions of the software.

Save Displays the Save Lens Effects file dialog that enables you to save an LZV file. The LZV file format contains information saved from a previous configuration of Lens Effects. This allows you to save several types of Lens Effects and use them in multiple 3ds Max scenes.

NOTE Saving an effect as an LZV file will only save the attributes of the effect on the frame that it is saved at. The LZV file format doesn't save the animation keys of an animated parameter.

Size Affects the size of the overall Lens Effect. This value is a percentage of the size of the rendered frame.

Intensity Controls the overall brightness and opacity of the Lens Effect. Higher values produce a bright, more opaque effect, and lower values produces a dim, transparent effect.

Seed Gives the random number generator in Lens Effects a different starting point, which creates a slightly different Lens Effect without changing any settings. Using Seed guarantees a different Lens Effect, even if the differences are very small. For example, if you set up a Ray effect, you will get slightly different rays in the lens flare if you adjust the seed value.

Angle Affects the amount that the Lens Effect rotates from its default position, as the position of the effect changes relative to the camera.

Squeeze Squeezes the size of the overall Lens Effect, either horizontally or vertically to compensate for different frame aspect ratios. Positive values stretch the effect horizontally, and negative values stretch it vertically. The value is a percentage of the size of the flare. Range=100 to -100.

Lights group

Allows you to choose lights to apply Lens Effects to.

Pick Light Enables you to select a light directly through the viewports. You can also select a light by pressing H to open the Pick Object dialog.

Remove Light Removes a selected light.

Drop-down list Provides quick access to lights that you have added to the Lens Effect.

Lens Effects Globals rollout, Scene panel

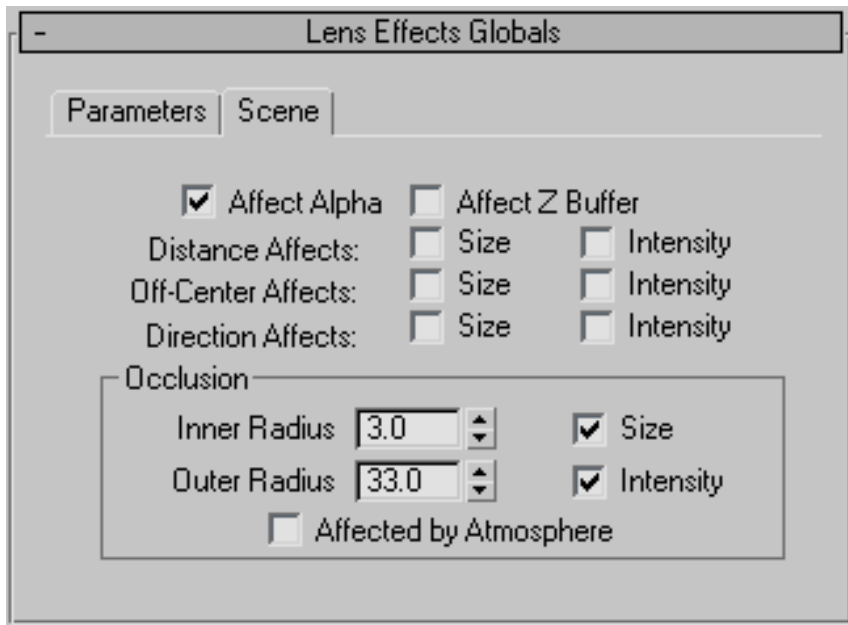

Affect Alpha Specifies whether or not the Lens Effect affects the alpha channel of an image when the image is rendered in a 32-bit file format. The alpha channel is an extra 8 bits of color (256 colors) that indicate transparency in an image. Alpha channels are used to composite one image seamlessly over the top of another. If you want to composite a Lens Effect, or an image that contains a Lens Effect, over the top of another image, enable this option. If you are not rendering to a 32-bit file, do not enable this option.

Affect Z Buffer Stores an object's distance from the camera. The Z-Buffer is useful for optical effects. When this option is enabled, the linear distance of the Lens Effect is recorded, and can be used in special effects that make use of the Z-Buffer.

Distance Affects Allows distance from the camera or viewport to affect the size and/or the intensity of the effect.

Off-Center Affects Allows an effect that is off-center from the camera or viewport to affect the size and/or the intensity of the effect.

Direction Affects Allows direction of spot lights with respect to the camera or viewport to affect the size and/or the intensity of the effect.

The size and intensity of the effect are at a maximum when the light is pointed at the camera (or viewport).

Occlusion group

Occlusion is used to determine when a Lens Effect will be affected by an object that comes between the effect and the camera. By using two spinners to determine occlusion you can have scene objects realistically affect the look of your effect. The outer radius will determine when another scene object will begin to occlude and the inner radius will determine when the scene object will cause the effect to reach maximum occlusion.

Inner Radius Sets the inner radius around the effect that another scene object must intersect in order to completely occlude the effect.

Outer Radius Sets the outer radius around the effect that another scene object must intersect in order to begin to occlude the effect.

Size Decreases the size of the effect when being occluded.

Intensity Decreases the intensity of the effect when being occluded.

Affected by Atmosphere Allows Atmospheric Effects to occlude Lens Effects.

Glow Lens Effect

Rendering menu > Effects > Environment and Effects dialog > Effects panel > Add > Add Effect dialog > Lens Effects > Choose Glow, and click the (>) arrow button.



Adding glow to the light

Glow lets you add a glowing aura around any assigned object. For example, for an exploding particle system, adding a glow to the particles makes them seem as though they are brighter and hotter.

WARNING This effect is not supported by the [mental ray renderer](#) on page 6230.

Interface

Glow Element rollout, Parameters panel

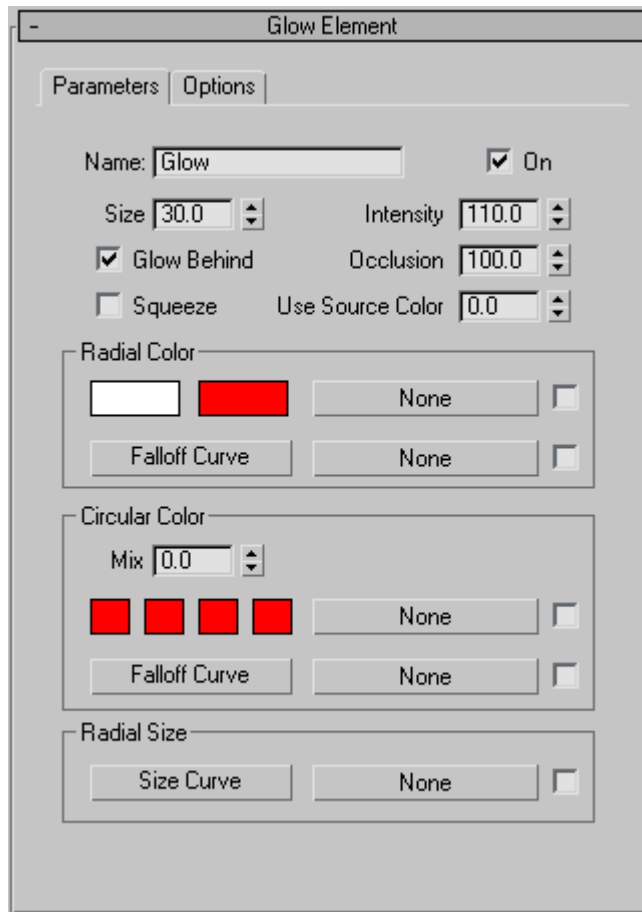

Name Displays the name of the effect. With Lens Effects you can have many different effects under one instance of Lens Effects. To keep them in order, it is often necessary to name them to make sure that when you change parameters you are changing the parameters to the correct effect.

On Applies the effect to the rendered image when activated.

Size Determines the size of the effect.

Intensity Controls the overall brightness and opacity of the individual effect. Higher values produce a bright, more opaque effect, and lower values produces a dim, transparent effect.

Glow Behind Gives the effect the ability to be displayed behind objects in your scene.

Occlusion Determines how much the Lens Effects Scene Occlusion parameters will affect the particular effect. The value entered determines what percentage of occlusion set in the Lens Effects Globals panel will be applied.

Squeeze Determines whether the effect will be squeezed. When activated the effect will be squeezed according to Lens Effects Globals under the Parameters panel in the Squeeze spinner.

Use Source Color Mixes the source color of the light or object you are applying the effect to and the color or mapping set in the Radial Color or Circular Color parameters. A value of 0 uses only the values set in the Radial Color and Circular Color parameters while a value of 100 uses only the light or objects source color. Any value between 0 and 100 will render a mix between the source color and the effect's color parameters.

Radial Color group

The Radial Color settings affect the inner and outer colors of the effect. You can set the color swatches to set the inner and outer colors of the Lens Effect. You can also use bitmaps such as Gradient or Cellular to determine the radial color.

Falloff Curve Displays the [Radial Falloff dialog](#) on page 6658 in which you can set weights for the colors used in Radial Color. By manipulating the Falloff Curve you can make the effect use more of one color or map than the other. You can also use a map to determine the falloff when a light is used as a Lens Effects source.

Circular Color group

Circular Color determines the color of the effect by using four different color swatches that are matched to the four quadrants of the effect. A map can also be used to determine circular color.

Mix Mixes colors set in Radial Color and colors set in Circular Color. Setting the spinner at 0 will only use values set in Radial Color while setting the spinner at 100 will only use values set in Circular Color. Any value between 0 and 100 will mix between the two values.

Falloff Curve Displays the [Circular Falloff dialog](#) on page 6652 in which you can set weights for the colors used in Circular Color. By manipulating the Falloff Curve you can make the effect use more of one color or map than another. You can also use a map to determine the falloff when a light is used as a Lens Effects source.

Radial Size group

Determines the radial size around the particular Lens Effect. Clicking the Size Curve button displays the [Radial Size dialog](#) on page 6661. Using the Radial Size dialog you can create points on a line and move those points along a graph to determine where the effect should be placed around the light or object. You can also use a map to determine where the effect should be placed. A check box is used to activate the map.

Glow Element rollout, Options panel

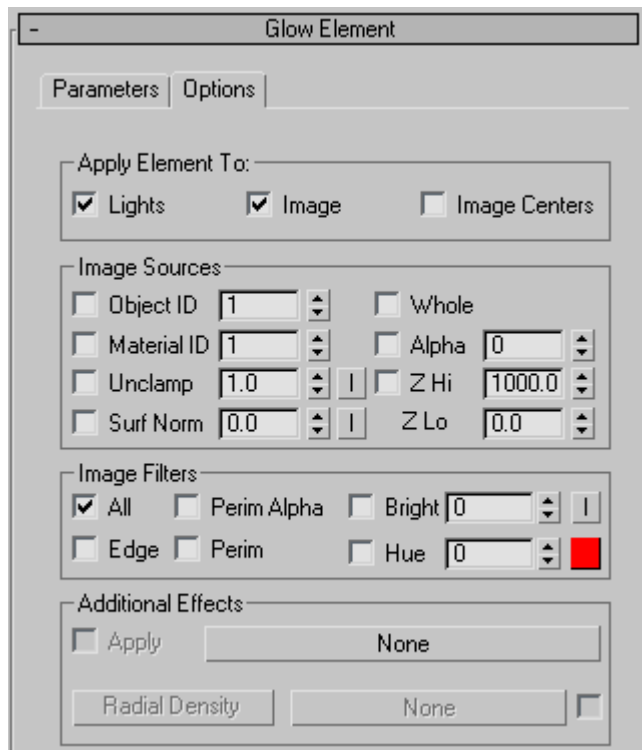

Apply Element To group

Lights Applies the effect to lights picked in Lens Effects Globals under the Parameters tab in the Lights group box.

Image Applies the effect to the rendered image using parameters set in Image Sources.

Image Centers Applies to the center of an object or to portions of an object as determined by the Image Filters.

Image Sources group

Object ID Applies the Lens Effect to particular objects in your scene that have a corresponding [G-Buffer](#) on page 7991 (or Object) ID. The G-Buffer is a geometry buffer and can be defined when you right-click any object and select Properties from the menu. Then, set the Object Channel ID under the G-Buffer ID controls.

Material ID Applies the Lens Effect to an object or part of an object with a specific [Material ID channel](#) on page 5348 assigned to it. Assign the Material ID channel in the Material Editor, using the [Material ID channel flyout](#) on page 5350. The Lens Effect will be applied only to areas of the geometry where that particular ID channel is present.

TIP In some cases you might want to apply different Lens Effects settings to different pieces of geometry or IDs. To accomplish this, add additional Lens Effects entries to the Lens Effects Parameters list. Then set each different Lens Effect entry to affect a different Material ID or Object ID and proceed.

Unclamp An unclamped color is brighter than pure white (255,255,255). The software keeps track of these "hot" areas which tend to show up when your scene contains bright metallic highlights or explosions. This spinner lets you determine the lowest pixel value that the Lens Effect is applied to. Pure white has a pixel value of 1. When this spinner is set to 1, any pixels with a value above 255 will be glowed. You can invert this value by clicking the **I** button to the right of the spinner.

Surf Norm Applies the Lens Effect to part of an object, based on the angle of the surface normal to the camera. A value of 0 is coplanar, or parallel to the screen. A value of 90 is normal, or perpendicular to the screen. If you set Surf Norm to 45, only surfaces with normal angles greater than 45 degrees will be glowed. You can invert this value by clicking the **I** button to the right of the spinner. This parameter can be animated.

Whole Applies the Lens Effect to the whole scene, not just a particular piece of geometry. This, in effect, makes each pixel in the scene a potential Lens Effect source. The areas of the scene that have the Lens Effect applied to them are determined by the settings in the Image Filters group box.

Alpha Applies the Lens Effect to the alpha channel of an image. The transparency of an alpha channel is interpreted opposite that of the Mask channel. Range=0 to 255.

Z Hi/Z Lo Highlights objects based on their distance (Z-Buffer distance) from the camera. The Hi value is the maximum distance and the Lo value is the minimum. Any objects between these two Z-Buffer distances will be highlighted.

Image Filters group

Filters the Image Sources selections to let you control how the Lens Effect is applied. For example, you can have ten spheres in your scene, each with the same Object ID, but different colors. If you set the Image Source as the Object ID of the spheres, which selects all of the spheres, these will be the only objects in the scene that Lens Effects will apply an effect to.

However, now that Lens Effects knows where the pixels are that effects *can* be applied, it needs to know which ones to actually apply the effect to. Lens Effects uses the filter controls to find out which source pixels to apply the effect to.

All Selects all source pixels in the scene and applies the Lens Effect to them.

Edge Selects all source pixels along a boundary edge and applies the Lens Effect to them. Applying a Lens Effect along the edges of objects produces a soft halo that exists on both inside and outside edges of your object.

Perim(eter) Alpha Applies the Lens Effect only to the perimeter of an object based on its alpha channel. Selecting this option applies the effect only on the outside of an object without any spill on the interior. Whereas filtering by Edge produces a spill onto the object, Perimeter Alpha keeps all of the edges clean because it relies on the scene alpha channel to derive its effect.

Perim(eter) Applies the Lens Effect only to the perimeter of an object based on Edge interference. Although not as precise as Perimeter Alpha, you might need to use the Perimeter option at times when the alpha channel is unavailable.

Bright Filters the source objects based on their brightness values. The effect is only applied to objects with a brightness above the spinner setting This option can be inverted by clicking the I button next to the spinner

Hue Filters the source objects by their hue. Select the hue by clicking the color swatch next to the spinner. You can choose hue values from 0 to 255. The spinner beside the Hue color swatch lets you enter a variance level so that the glow can find several different hues in the same range as the chosen color

Additional Effects group

Additional Effects allows you to apply maps such as Noise to your Lens Effect. You can display the Material/Map browser by clicking the long button next to the Apply check box.

Apply Applies the selected map when activated.

Radial Density Determines where and how much you would like the additional effects applied. Clicking the Radial Density button displays the [Radial Density dialog](#) on page 6655. Using the Radial Density dialog you can create points on a line and move those points along a graph to determine where the additional effect should be placed around the light. You can also use a map to determine where the additional effect should be placed.

Ring Lens Effect

Rendering menu > Effects > Environment and Effects dialog > Effects panel > Add > Add Effect dialog > Lens Effects > Choose Ring, and click the (>) arrow button.

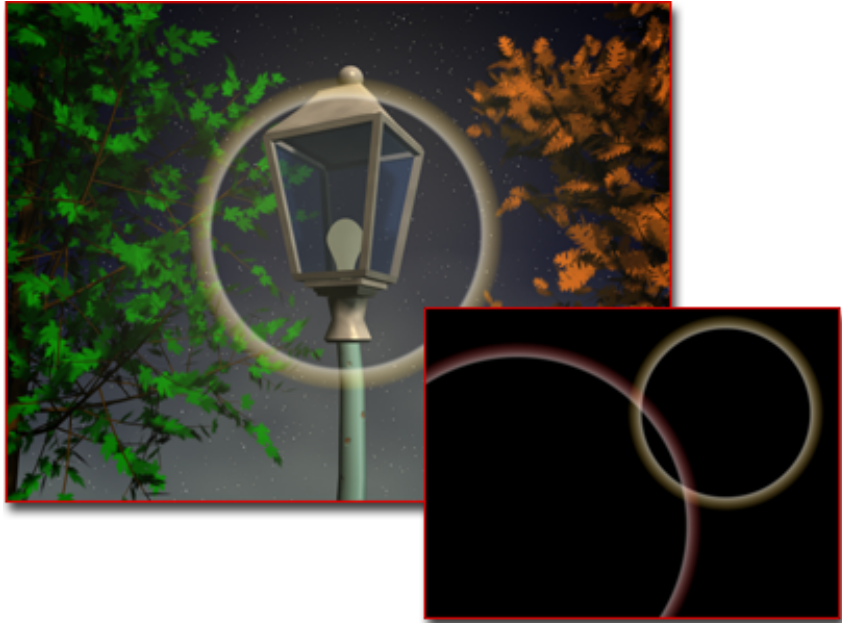

Adding a ring to the light

The ring is a circular color band that surrounds the center of the source object.

WARNING This effect is not supported by the [mental ray renderer](#) on page 6230.

Interface

Ring Element rollout, Parameters panel

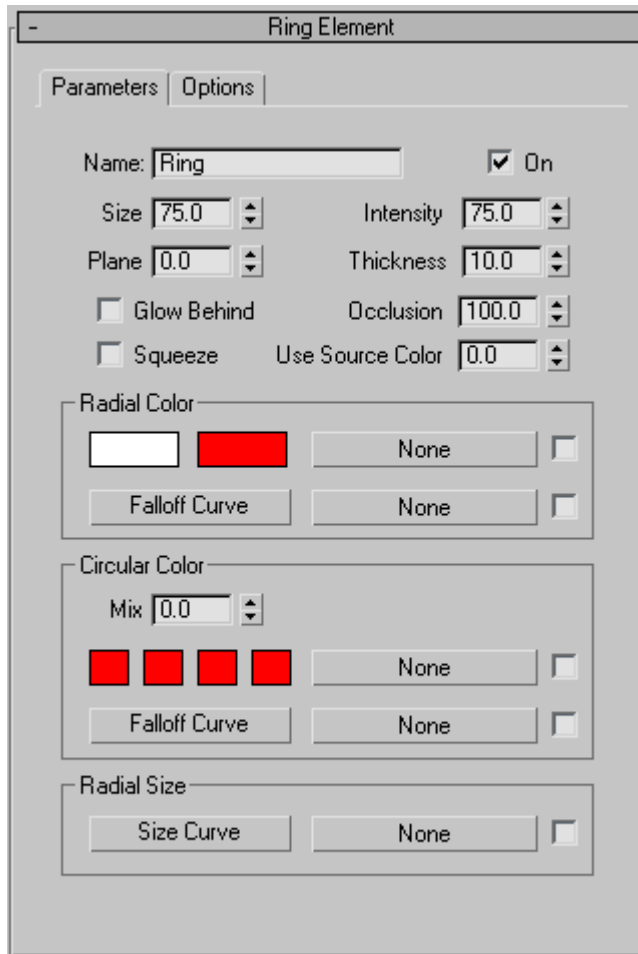

Name Displays the name of the effect. With Lens Effects you can have many different effects under one instance of Lens Effects. To keep them in order, it is often necessary to name them to make sure that when you change parameters you are changing the parameters to the correct effect.

On Applies the effect to the rendered image when activated. Default = on.

Size Determines the size of the effect.

Intensity Controls the overall brightness and opacity of the individual effect. Higher values produce a bright, more opaque effect, and lower values produces a dim, transparent effect.

Plane Sets the location of the effect along the axis of the effect which extends from the center of the effect through the center of the screen.

Thickness Determines the thickness, in pixels, of the effect.

Glow Behind Gives the effect the ability to be displayed behind objects in your 3ds Max scene.

Occlusion Determines how much the Lens Effects Scene Occlusion parameters will affect the particular effect. The value entered determines what percentage of occlusion set in the Lens Effects Globals panel will be applied.

Squeeze Determines whether the effect will be squeezed. When activated the effect will be squeezed according to Lens Effects Globals under the Parameters panel in the Squeeze spinner.

Use Source Color Mixes the source color of the light or object you are applying the effect to with the color or mapping set in the Radial Color or Circular Color parameters. A value of 0 uses only the values set in the Radial Color and Circular Color parameters while a value of 100 uses only the light or objects source color. Any value between 0 and 100 will render a mix between the source color and the effect's color parameters.

Radial Color group

The Radial Color settings affect the inner and outer colors of the effect. You can set the color swatches to set the inner and outer colors of the Lens Effect. You can also use bitmaps such as gradient or cellular to determine the radial color.

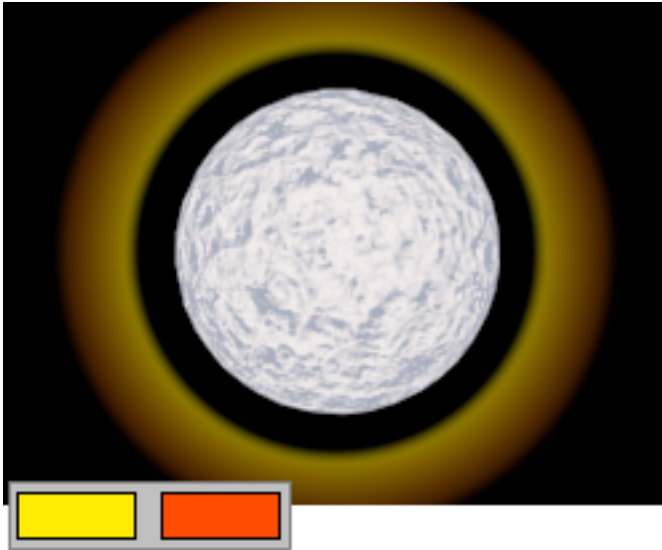

Ring using radial colors as seen in lower left inset

Falloff Curve Displays the [Radial Falloff dialog](#) on page 6658 in which you can set weights for the colors used in Radial Color. By manipulating the Falloff Curve you can make the effect use more of one color or map than the other. You can also use a map to determine the falloff.

Circular Color group

Circular Color determines the color of the effect by using four different color swatches that are matched to the four quadrants of the effect. A map can also be used to determine circular color.

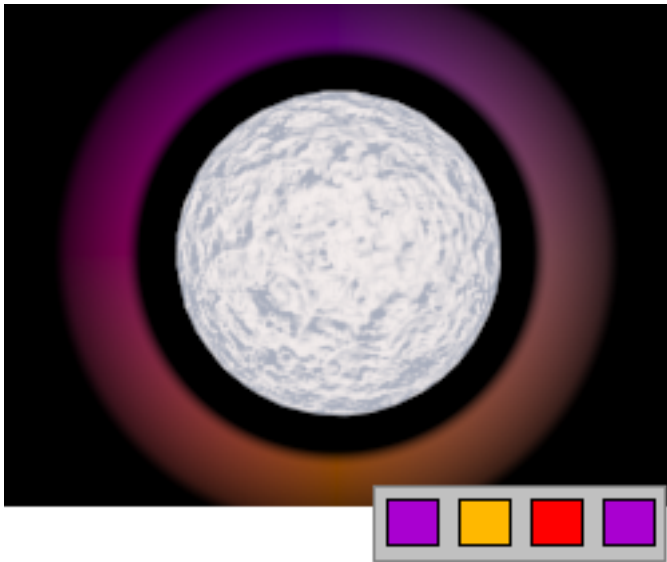

Ring using circular colors as seen in lower right inset

Mix Mixes colors set in Radial Color and colors set in Circular Color. Setting the spinner at 0 will only use values set in Radial Color while setting the spinner at 100 will only use values set in Circular Color. Any value between 0 and 100 will mix between the two values.

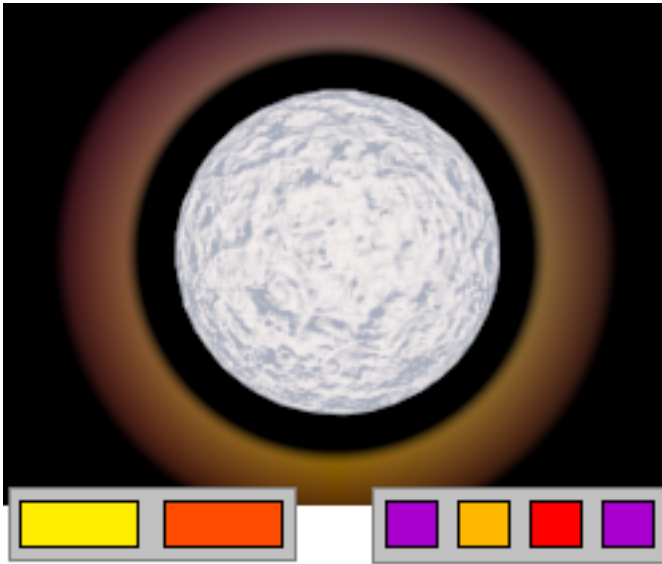

Ring using radial and circular colors mixed 50/50

Falloff Curve Displays the [Circular Falloff dialog](#) on page 6652 in which you can set weights for the colors used in Circular Color. By manipulating the Falloff Curve you can make the effect use more of one color or map than another. You can also use a map to determine the falloff when a light is used as a Lens Effects source.

Radial Size group

Determines the radial size around the particular Lens Effect. Clicking the Size Curve button displays the [Radial Size dialog](#) on page 6661. Using the Radial Size dialog you can create points on a line and move those points along a graph to determine where the effect should be placed around the light or object. You can also use a map to determine where the effect should be placed. A check box is used to activate the map.

Ring Element rollout, Options panel

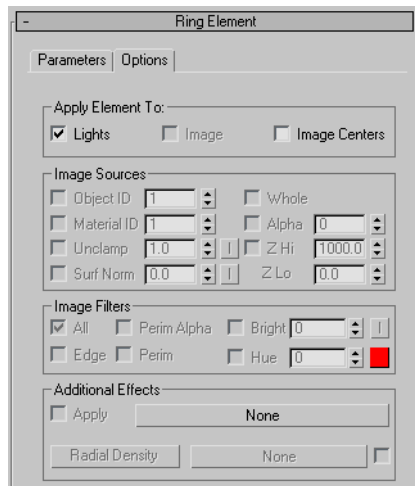

Apply Element To

Lights Applies the effect to lights picked in Lens Effects Globals under the Parameters tab in the Lights group box.

Image Applies the effect to the rendered image using parameters set in Image Sources.

Image Centers Applies to the center of an object or to portions of an object as determined by the Image Filters.

Image Sources group

Object ID Applies the Lens Effect to particular objects in your scene that have a corresponding [G-Buffer](#) on page 7991 (or Object) ID. The G-Buffer is a geometry buffer and can be defined when you right-click any object and select Properties from the menu. Then, set the Object Channel ID under the G-Buffer ID controls.

Material ID Applies the Lens Effect to an object or part of an object with a specific [Material ID channel](#) on page 5348 assigned to it. Assign the Material ID channel in the Material Editor, using the [Material ID channel flyout](#) on page 5350. The Lens Effect will be applied only to areas of the geometry where that particular ID channel is present.

TIP In some cases you might want to apply different Lens Effects settings to different pieces of geometry or IDs. To accomplish this, add additional Lens Effects entries to the Lens Effects Parameters list. Then set each different Lens Effect entry to affect a different Material ID or Object ID and proceed.

Unclamp An unclamped color is brighter than pure white (255,255,255). The software keeps track of these "hot" areas which tend to show up when your scene contains bright metallic highlights or explosions. This spinner lets you determine the lowest pixel value that the Lens Effect is applied to. Pure white has a pixel value of 1. When this spinner is set to 1, any pixels with a value above 255 will be glowed. You can invert this value by clicking the **I** button to the right of the spinner.

Surf Norm Applies the Lens Effect to part of an object, based on the angle of the surface normal to the camera. A value of 0 is coplanar, or parallel to the screen. A value of 90 is normal, or perpendicular to the screen. If you set Surf Norm to 45, only surfaces with normal angles greater than 45 degrees will be glowed. You can invert this value by clicking the **I** button to the right of the spinner.

Whole Applies the Lens Effect to the whole scene, not just a particular piece of geometry. This, in effect, makes each pixel in the scene a potential Lens Effect source. The areas of the scene that have the Lens Effect applied to them are determined by the settings in the Image Filters group box.

Alpha Applies the Lens Effect to the alpha channel of an image. The transparency of an alpha channel is interpreted opposite that of the Mask channel. Range=0 to 255.

Z Hi/Z Lo Highlights objects based on their distance (Z-Buffer distance) from the camera. The Hi value is the maximum distance and the Lo value is the minimum. Any objects between these two Z-Buffer distances will be highlighted.

Image Filters group

Filters the Image Sources selections to let you control how the Lens Effect is applied. For example, you can have ten spheres in your scene, each with the same Object ID, but different colors. If you set the Image Source as the Object ID of the spheres, which selects all of the spheres, these will be the only objects in the scene that Lens Effects will apply an effect to.

However, now that Lens Effects knows where the pixels are that effects *can* be applied, it needs to know which ones to actually apply the effect to. Lens

Effects uses the filter controls to find out which source pixels to apply the effect to.

All Selects all source pixels in the scene and applies the Lens Effect to them.

Edge Selects all source pixels along a boundary edge and applies the Lens Effect to them. Applying a Lens Effect along the edges of objects produces a soft halo that exists on both inside and outside edges of your object.

Perim(eter) Alpha Applies the Lens Effect only to the perimeter of an object based on its alpha channel. Selecting this option applies the effect only on the outside of an object without any spill on the interior. Whereas filtering by Edge produces a spill onto the object, Perimeter Alpha keeps all of the edges clean because it relies on the scene alpha channel to derive its effect.

Perim(eter) Applies the Lens Effect only to the perimeter of an object based on Edge interference. Although not as precise as Perimeter Alpha, you might need to use the Perimeter option at times when the alpha channel is unavailable.

Bright Filters the source objects based on their brightness values. The effect is only applied to objects with a brightness above the spinner setting. This option can be inverted by clicking the **I** button next to the spinner.

Hue Filters the source objects by their hue. Select the hue by clicking the color swatch next to the spinner. You can choose hue values from 0 to 255. The spinner beside the Hue color swatch lets you enter a variance level so that the glow can find several different hues in the same range as the chosen color.

Additional Effects group

Additional Effects allows you to apply maps such as Noise to your Lens Effect. You can display the Material/Map browser by clicking the long button next to the Apply check box.

Apply Applies the selected map when activated.

Radial Density Determines where and how much you would like the additional effects applied. Clicking the Radial Density button displays the [Radial Density dialog](#) on page 6655. Using the Radial Density dialog you can create points on a line and move those points along a graph to determine where the additional effect should be placed around the light. You can also use a map to determine where the additional effect should be placed.

Ray Lens Effect

Rendering menu > Effects > Environment and Effects dialog > Effects panel > Add > Add Effect dialog > Lens Effects > Choose Ray, and click the (>) arrow button.

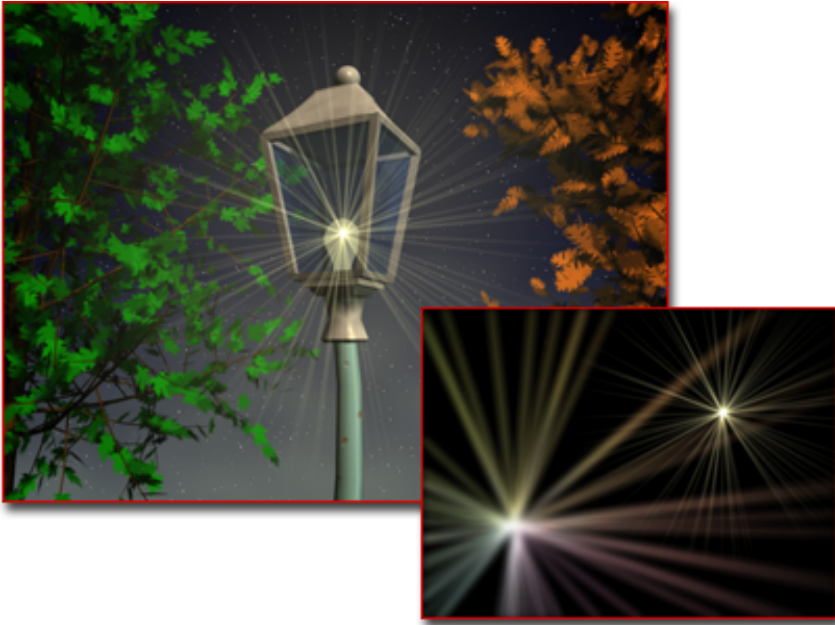

Adding rays to the light

Rays are bright lines that radiate from the center of the source object, providing the illusion of extreme brightness for the object. Rays let you emulate scratches in the lens elements of a camera.

Interface

Ray Element rollout, Parameters panel

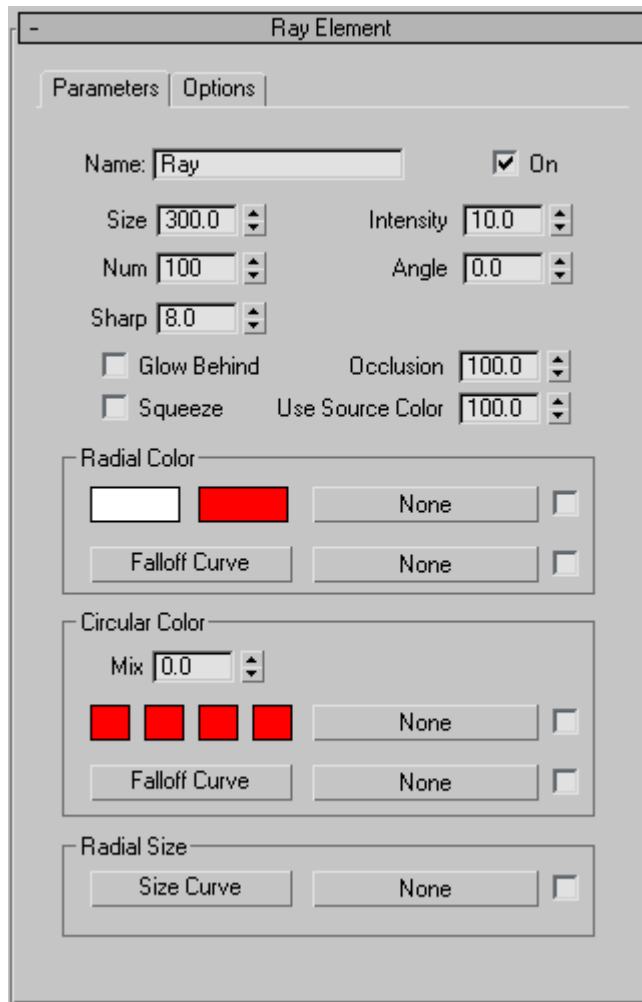

Name Displays the name of the effect. With Lens Effects you can have many different effects under one instance of Lens Effects. To keep them in order, it is often necessary to name them to make sure that when you change parameters you are changing the parameters to the correct effect.

On Applies the effect to the rendered image when activated. Default = on.

Size Determines the size of the effect.

Intensity Controls the overall brightness and opacity of the individual effect. Higher values produce a bright, more opaque effect, and lower values produces a dim, transparent effect.

Num Specifies the overall number of rays that appear in the lens flare. Rays are randomly spaced around the radius.

Angle Specifies the angle for the rays. You can enter both positive and negative values so, when animated, the rays rotate in a clockwise or counterclockwise direction.

Sharp Specifies the overall sharpness of the rays. Higher numbers produce crisp, clean, and clear rays. Lower numbers produce more of a secondary glow look. Range=0 to 10.

Glow Behind Gives the effect the ability to be displayed behind objects in your 3ds Max scene.

Occlusion Determines how much the Lens Effects Scene Occlusion parameters will affect the particular effect. The value entered determines what percentage of occlusion set in the Lens Effects Globals panel will be applied.

Squeeze Determines whether the effect will be squeezed. When activated, the effect will be squeezed according to Lens Effects Globals under the Parameters panel in the Squeeze spinner.

Use Source Color Mixes the source color of the light or object you are applying the effect to and the color or mapping set in the Radial Color or Circular Color parameters. A value of 0 uses only the values set in the Radial Color and Circular Color parameters while a value of 100 uses only the light or objects source color. Any value between 0 and 100 will render a mix between the source color and the effect's color parameters.

Radial Color group

The Radial Color settings affect the inner and outer colors of the effect. You can set the color swatches to set the inner and outer colors of the Lens Effect. You can also use bitmaps such as Gradient or Cellular to determine the radial color.

Falloff Curve Displays the [Radial Falloff dialog](#) on page 6658 in which you can set weights for the colors used in Radial Color. By manipulating the Falloff Curve you can make the effect use more of one color or map than the other. You can also use a map to determine the falloff when a light is used as a Lens Effects source.

Circular Color group

Circular Color determines the color of the effect by using four different color swatches that are matched to the four quadrants of the effect. A map can also be used to determine circular color.

Mix Allows you to mix between colors set in Radial Color and colors set in Circular Color. Setting the spinner at 0 will only use values set in Radial Color while setting the spinner at 100 will only use values set in Circular Color. Any value between 0 and 100 will mix between the two values.

Falloff Curve Displays the [Circular Falloff dialog](#) on page 6652 in which you can set weights for the colors used in Circular Color. By manipulating the Falloff Curve you can make the effect use more of one color or map than another. You can also use a map to determine the falloff when a light is used as a Lens Effects source.

Radial Size group

Determines the radial size around the particular Lens Effect. Clicking the Size Curve button displays the [Radial Size dialog](#) on page 6661. Using the Radial Size dialog you can create points on a line and move those points along a graph to determine where the effect should be placed around the light or object. You can also use a map to determine where the effect should be placed. A check box is used to activate the map.

Ray Element rollout, Options panel

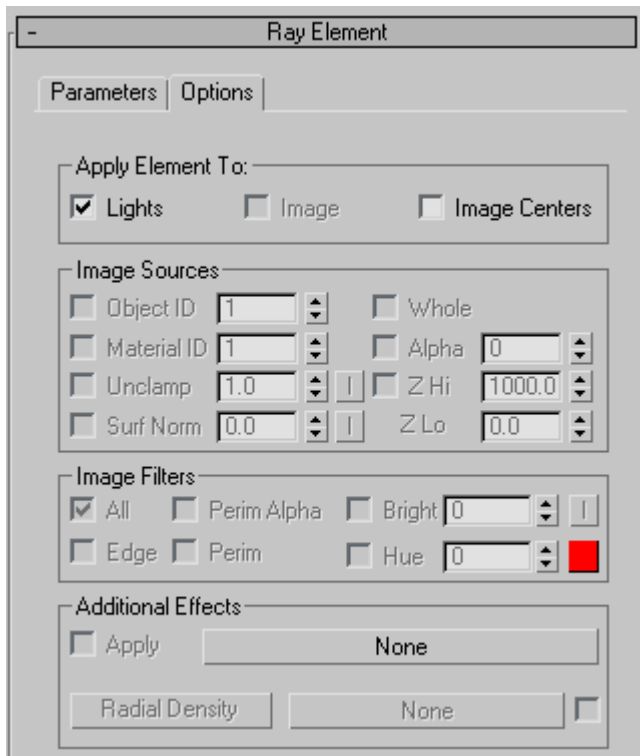

Apply Element To group

Lights Applies the effect to lights picked in Lens Effects Globals under the Parameters tab in the Lights group box.

Image Applies the effect to the rendered image using parameters set in Image Sources.

Image Centers Applies to the center of an object or to portions of an object as determined by the Image Filters.

Image Sources group

Object ID Applies the Lens Effect to particular objects in your scene that have a corresponding [G-Buffer](#) on page 7991 (or Object) ID. The G-Buffer is a geometry buffer and can be defined when you right-click any object and select Properties

from the menu. Then, set the Object Channel ID under the G-Buffer ID controls.

Material ID Applies the Lens Effect to an object or part of an object with a specific [Material ID channel](#) on page 5348 assigned to it. Assign the Material ID channel in the Material Editor, using the [Material ID channel flyout](#) on page 5350. The Lens Effect will be applied only to areas of the geometry where that particular ID channel is present.

TIP In some cases you might want to apply different Lens Effects settings to different pieces of geometry or IDs. To accomplish this, add additional Lens Effects entries to the Lens Effects Parameters list. Then set each different Lens Effect entry to affect a different Material ID or Object ID and proceed.

Unclamp An unclamped color is brighter than pure white (255,255,255). The software keeps track of these "hot" areas which tend to show up when your scene contains bright metallic highlights or explosions. This spinner lets you determine the lowest pixel value that the Lens Effect is applied to. Pure white has a pixel value of 1. When this spinner is set to 1, any pixels with a value above 255 will be glowed. You can invert this value by clicking the **I** button to the right of the spinner.

Surf Norm Applies the Lens Effect to part of an object, based on the angle of the surface normal to the camera. A value of 0 is coplanar, or parallel to the screen. A value of 90 is normal, or perpendicular to the screen. If you set Surf Norm to 45, only surfaces with normal angles greater than 45 degrees will be glowed. You can invert this value by clicking the **I** button to the right of the spinner.

Whole Applies the Lens Effect to the whole scene, not just a particular piece of geometry. This, in effect, makes each pixel in the scene a potential Lens Effect source. The areas of the scene that have the Lens Effect applied to them are determined by the settings in the Image Filters group.

Alpha Applies the Lens Effect to the alpha channel of an image. The transparency of an alpha channel is interpreted opposite that of the Mask channel. Range=0 to 255.

Z Hi/Z Lo Highlights objects based on their distance (Z-Buffer distance) from the camera. The Hi value is the maximum distance and the Lo value is the minimum. Any objects between these two Z-Buffer distances will be highlighted.

Image Filters group

Filters the Image Sources selections to let you control how the Lens Effect is applied. For example, you can have ten spheres in your scene, each with the same Object ID, but different colors. If you set the Image Source as the Object ID of the spheres, which selects all of the spheres, these will be the only objects in the scene that Lens Effects will apply an effect to.

However, now that Lens Effects knows where the pixels are that effects *can* be applied, it needs to know which ones to actually apply the effect to. Lens Effects uses the filter controls to find out which source pixels to apply the effect to.

All Selects all source pixels in the scene and applies the Lens Effect to them.

Edge Selects all source pixels along a boundary edge and applies the Lens Effect to them. Applying a Lens Effect along the edges of objects produces a soft halo that exists on both inside and outside edges of your object.



Edge filter applied to rays emanating from object

Perim(eter) Alpha Applies the Lens Effect only to the perimeter of an object based on its alpha channel. Selecting this option applies the effect only on the outside of an object without any spill on the interior. Whereas filtering by Edge produces a spill onto the object, Perimeter Alpha keeps all of the edges clean because it relies on the scene alpha channel to derive its effect.

Perim(eter) Applies the Lens Effect only to the perimeter of an object based on Edge interference. Although not as precise as Perimeter Alpha, you might need to use the Perimeter option at times when the alpha channel is unavailable.

Bright Filters the source objects based on their brightness values. The effect is only applied to objects with a brightness above the spinner setting. This option can be inverted by clicking the **I** button next to the spinner.

Hue Filters the source objects by their hue. Select the hue by clicking the color swatch next to the spinner. You can choose hue values from 0 to 255. The spinner beside the Hue color swatch lets you enter a variance level so that the glow can find several different hues in the same range as the chosen color.

Additional Effects group

Additional Effects allows you to apply maps such as Noise to your Lens Effect. You can display the Material/Map browser by clicking the long button next to the Apply check box.

Apply Applies the selected map when activated.

Radial Density Determines where and how much you would like the additional effects applied. Clicking the Radial Density button displays the [Radial Density dialog](#) on page 6655. Using the Radial Density dialog you can create points on a line and move those points along a graph to determine where the additional effect should be placed around the light. You can also use a map to determine where the additional effect should be placed.

Auto Secondary Lens Effect

Rendering menu > Effects > Environment and Effects dialog > Effects panel > Add > Add Effect dialog > Lens Effects > Choose Auto Secondary, and click the (>) arrow button.

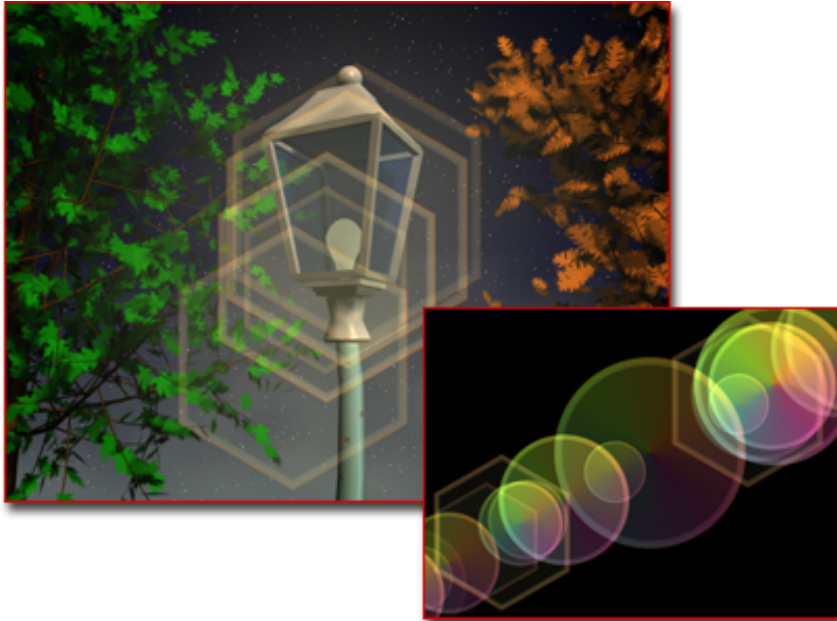

Adding secondary flares to the light

Secondary flares are the small circles you would normally see coming out from the source of the lens flare along an axis relative to the camera position. These are caused by light refracting off the different lens elements in the camera. As the camera position changes relative to the source object, the secondary flares move.

Interface

Auto Secondary Element rollout, Parameters panel

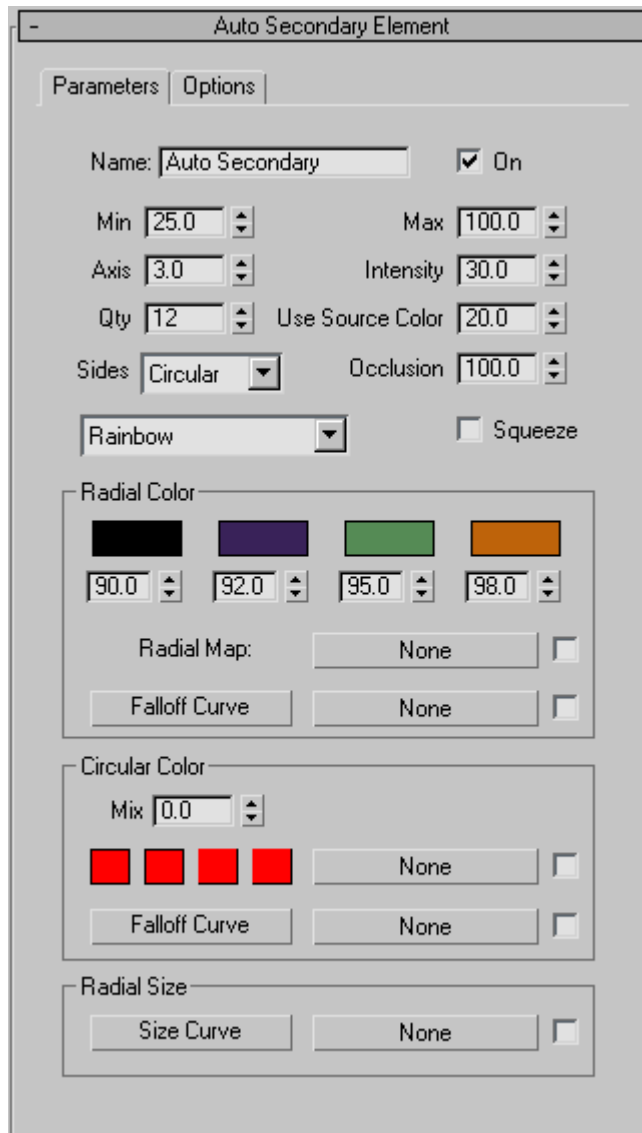

Name Displays the name of the effect. With Lens Effects you can have many different effects under one instance of Lens Effects. To keep them in order, it

is necessary to name them to make sure that when you change parameters you are changing the parameters to the correct effect.

On Applies the effect to the rendered image when activated. Default = on.

Min Controls the minimum size of secondary flares in the current set. This number is defined as a percentage of the overall image.

Max Controls the maximum size of secondary flares in the current set. This number is defined as a percentage of the overall image.

Axis Defines the overall length of the axis the automatic secondary flares will be distributed along. Increasing the value creates more space between the flares, while decreasing the value creates less space between the flares. You can set the axis from 0 to 10 degrees.

Intensity Controls the overall brightness and opacity of the individual effect. Higher values produce a bright, more opaque effect, and lower values produces a dim, transparent effect.

Qty Controls the number of secondary flares that appear in the current set of flares.

Use Source Color Mixes the source color of the light or object you are applying the effect to with the color or mapping set in the Radial Color or Circular Color parameters. A value of 0 uses only the values set in the Radial Color and Circular Color parameters while a value of 100 uses only the light or objects source color. Any value between 0 and 100 will render a mix between the source color and the effect's color parameters.

Sides Controls the shape of the secondary flares for the current set. The default is circular, but you can choose from 3- to 8-sided secondary flares.

Occlusion Determines how much the Lens Effects Scene Occlusion parameters will affect the particular effect. The value entered determines what percentage of occlusion set in the Lens Effects Globals panel will be applied.

Presets (drop-down list) Displays a list of preset values that can be selected and applied to the rendered scene.

Squeeze Determines whether the effect will be squeezed. When activated, the effect will be squeezed according to Lens Effects Globals under the Parameters panel in the Squeeze spinner.

Radial Color group

The Radial Color settings affect the inner and outer colors of the effect. You can set the color swatches to set the inner and outer colors of the Lens Effect.

Each color swatch has a percentage spinner that determines at what point that color should stop and the next should start. You can also use bitmaps such as gradient or cellular to determine the radial color.

Falloff Curve Displays the [Radial Falloff dialog](#) on page 6658 in which you can set weights for the colors used in Radial Color. By manipulating the Falloff Curve you can make the effect use more of one color or map than the other. You can also use a map to determine the falloff when a light is used as a Lens Effects source.

Circular Color group

Circular Color determines the color of the effect by using four different color swatches that are matched to the four quadrants of the effect. A map can also be used to determine circular color.

Mix Allows you to mix between colors set in Radial Color and colors set in Circular Color. Setting the spinner at 0 will only use values set in Radial Color while setting the spinner at 100 will only use values set in Circular Color. Any value between 0 and 100 will mix between the two values.

Falloff Curve Displays the [Circular Falloff dialog](#) on page 6652 in which you can set weights for the colors used in Circular Color. By manipulating the Falloff Curve you can make the effect use more of one color or map than another. You can also use a map to determine the falloff when a light is used as a Lens Effects source.

Radial Size group

Determines the radial size around the particular Lens Effect. Clicking the Size Curve button displays the [Radial Size dialog](#) on page 6661. Using the Radial Size dialog you can create points on a line and move those points along a graph to determine where the effect should be placed around the light or object. You can also use a map to determine where the effect should be placed. A check box is used to activate the map.

Auto Secondary Element rollout, Options panel

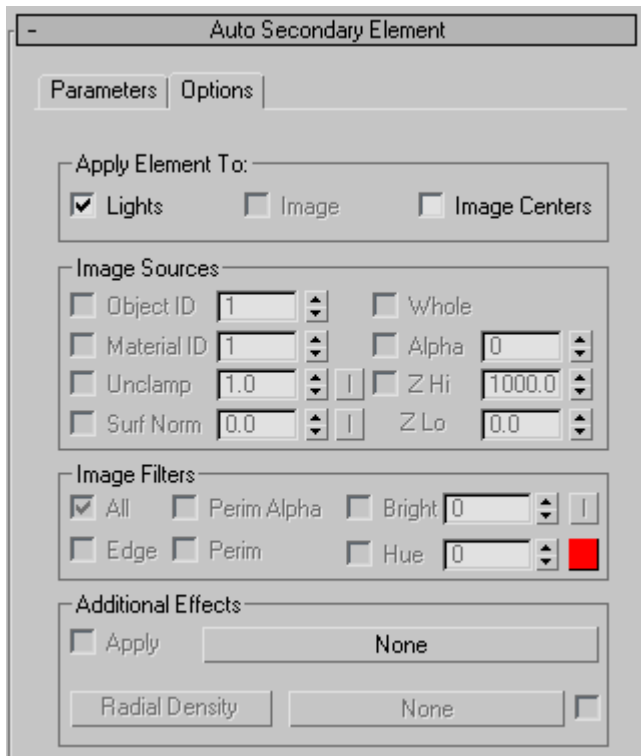

Apply Element To group

Lights Applies the effect to lights picked in Lens Effects Globals under the Parameters tab in the Lights group box.

Image Applies the effect to the rendered image using parameters set in Image Sources.

Image Centers Applies to the center of an object or to portions of an object as determined by the Image Filters.

Image Sources group

Object ID Applies the Lens Effect to particular objects in your scene that have a corresponding [G-Buffer](#) on page 7991 (or Object) ID. The G-Buffer is a geometry buffer and can be defined when you right-click any object and select Properties

from the menu. Then, set the Object Channel ID under the G-Buffer ID controls.

Material ID Applies the Lens Effect to an object or part of an object with a specific [Material ID channel](#) on page 5348 assigned to it. Assign the Material ID channel in the Material Editor, using the [Material ID channel flyout](#) on page 5350. The Lens Effect will be applied only to areas of the geometry where that particular ID channel is present.

TIP In some cases you might want to apply different Lens Effects settings to different pieces of geometry or IDs. To accomplish this, add additional Lens Effects entries to the Lens Effects Parameters list. Then set each different Lens Effect entry to affect a different Material ID or Object ID and proceed.

Unclamp An unclamped color is brighter than pure white (255,255,255). The software keeps track of these "hot" areas which tend to show up when your scene contains bright metallic highlights or explosions. This spinner lets you determine the lowest pixel value that the Lens Effect is applied to. Pure white has a pixel value of 1. When this spinner is set to 1, any pixels with a value above 255 will be glowed. You can invert this value by clicking the **I** button to the right of the spinner.

Surf Norm Applies the Lens Effect to part of an object, based on the angle of the surface normal to the camera. A value of 0 is coplanar, or parallel to the screen. A value of 90 is normal, or perpendicular to the screen. If you set Surf Norm to 45, only surfaces with normal angles greater than 45 degrees will be glowed. You can invert this value by clicking the **I** button to the right of the spinner.

Whole Applies the Lens Effect to the whole scene, not just a particular piece of geometry. This, in effect, makes each pixel in the scene a potential Lens Effect source. The areas of the scene that have the Lens Effect applied to them are determined by the settings in the Image Filters group box.

Alpha Applies the Lens Effect to the alpha channel of an image. The transparency of an alpha channel is interpreted opposite that of the Mask channel. Range=0 to 255.

Z Hi/Z Lo Highlights objects based on their distance (Z-Buffer distance) from the camera. The Hi value is the maximum distance and the Lo value is the minimum. Any objects between these two Z-Buffer distances will be highlighted.

Image Filters group

Filters the Image Sources selections to let you control how the Lens Effect is applied. For example, you can have ten spheres in your scene, each with the same Object ID, but different colors. If you set the Image Source as the Object ID of the spheres, which selects all of the spheres, these will be the only objects in the scene that Lens Effects will apply an effect to.

However, now that Lens Effects knows where the pixels are that effects *can* be applied, it needs to know which ones to actually apply the effect to. Lens Effects uses the filter controls to find out which source pixels to apply the effect to.

All Selects all source pixels in the scene and applies the Lens Effect to them.

Edge Selects all source pixels along a boundary edge and applies the Lens Effect to them. Applying a Lens Effect along the edges of objects produces a soft halo that exists on both inside and outside edges of your object.

Perim(eter) Alpha Applies the Lens Effect only to the perimeter of an object based on its alpha channel. Selecting this option applies the effect only on the outside of an object without any spill on the interior. Whereas filtering by Edge produces a spill onto the object, Perimeter Alpha keeps all of the edges clean because it relies on the scene alpha channel to derive its effect.

Perim(eter) Applies the Lens Effect only to the perimeter of an object based on Edge interference. Although not as precise as Perimeter Alpha, you might need to use the Perimeter option at times when the alpha channel is unavailable.

Bright Filters the source objects based on their brightness values. The effect is only applied to objects with a brightness above the spinner setting. This option can be inverted by clicking the **I** button next to the spinner.

Hue Filters the source objects by their hue. Select the hue by clicking the color swatch next to the spinner. You can choose hue values from 0 to 255. The spinner beside the Hue color swatch lets you enter a variance level so that the glow can find several different hues in the same range as the chosen color.

Additional Effects group

Additional Effects allows you to apply maps such as Noise to your Lens Effect. You can display the Material/Map browser by clicking the long button next to the Apply check box.

Apply Applies the selected map when activated.

Radial Density Determines where and how much you would like the additional effects applied. Clicking the Radial Density button displays the [Radial Density dialog](#) on page 6655. Using the Radial Density dialog you can create points on a line and move those points along a graph to determine where the additional effect should be placed around the light. You can also use a map to determine where the additional effect should be placed.

Manual Secondary Lens Effect

Rendering menu > Effects > Environment and Effects dialog > Effects panel > Add > Add Effect dialog > Lens Effects > Choose Manual Secondary, and click the (>) arrow button.

Manual secondary flares are additional secondary flares that are individually added to the lens flare. These can be used in addition to, or in place of [auto secondary flares](#) on page 6623.

You use Manual Secondary flares when you want to add unique flares that you don't want repeated.

Interface

Manual Secondary Element rollout, Parameters panel

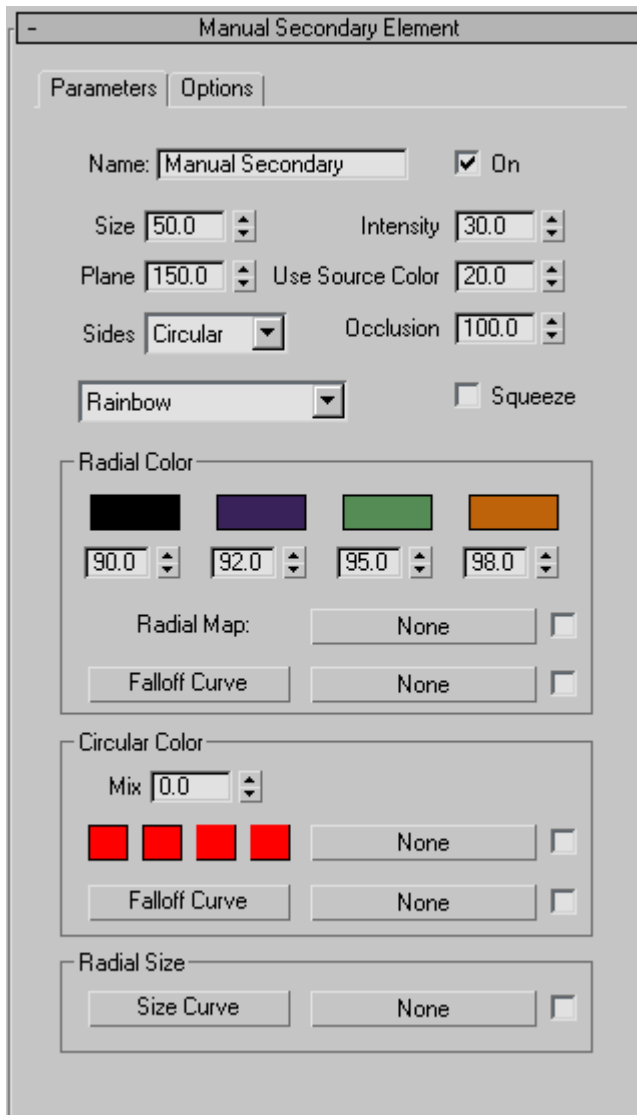

Name Displays the name of the effect. With Lens Effects you can have many different effects under one instance of Lens Effects. To keep them in order, it

is necessary to name them to make sure that when you change parameters you are changing the parameters to the correct effect.

On Applies the effect to the rendered image when activated. Default = on.

Size Determines the size of the effect.

Intensity Controls the overall brightness and opacity of the individual effect. Higher values produce a bright, more opaque effect, and lower values produces a dim, transparent effect.

Plane Controls the distance, in degrees, between the flare source and the manual secondary flare. By default, the flare plane exists at the center of the chosen node source. Positive values place the flare in front of the source, while negative values place the flare behind the flare source.

Use Source Color Mixes the source color of the light or object you are applying the effect to and the color or mapping set in the Radial Color or Circular Color parameters. A value of 0 uses only the values set in the Radial Color and Circular Color parameters while a value of 100 uses only the light or objects source color. Any value between 0 and 100 will render a mix between the source color and the effect's color parameters.

Sides Controls the shape of the secondary flares for the current set. The default is circular, but you can choose from 3- to 8-sided secondary flares.

Occlusion Determines how much the Lens Effects Scene Occlusion parameters will affect the particular effect. The value entered determines what percentage of occlusion set in the Lens Effects Globals panel will be applied.

Presets (drop-down list) Displays a list of preset values that can be selected and applied to the rendered scene.

Squeeze Determines whether the effect will be squeezed. When activated, the effect will be squeezed according to Lens Effects Globals under the Parameters panel in the Squeeze spinner.

Radial Color group

The Radial Color settings affect the inner and outer colors of the effect. You can set the color swatches to set the inner and outer colors of the Lens Effect. You can also use bitmaps such as gradient or cellular to determine the radial color.

Falloff Curve Displays the [Radial Falloff dialog](#) on page 6658 in which you can set weights for the colors used in Radial Color. By manipulating the Falloff Curve you can make the effect use more of one color or map than the other.

You can also use a map to determine the falloff when a light is used as a Lens Effects source.

Circular Color group

Circular Color determines the color of the effect by using four different color swatches that are matched to the four quadrants of the effect. A map can also be used to determine circular color.

Mix Mixes colors set in Radial Color and colors set in Circular Color. Setting the spinner at 0 will only use values set in Radial Color while setting the spinner at 100 will only use values set in Circular Color. Any value between 0 and 100 will mix between the two values.

Falloff Curve Displays the [Circular Falloff dialog](#) on page 6652 in which you can set weights for the colors used in Circular Color. By manipulating the Falloff Curve you can make the effect use more of one color or map than another. You can also use a map to determine the falloff when a light is used as a Lens Effects source.

Radial Size group

Determines the radial size around the particular Lens Effect. Clicking the Size Curve button displays the [Radial Size dialog](#) on page 6661. Using the Radial Size dialog you can create points on a line and move those points along a graph to determine where the effect should be placed around the light or object. You can also use a map to determine where the effect should be placed. A check box is used to activate the map.

Manual Secondary Element rollout, Options panel

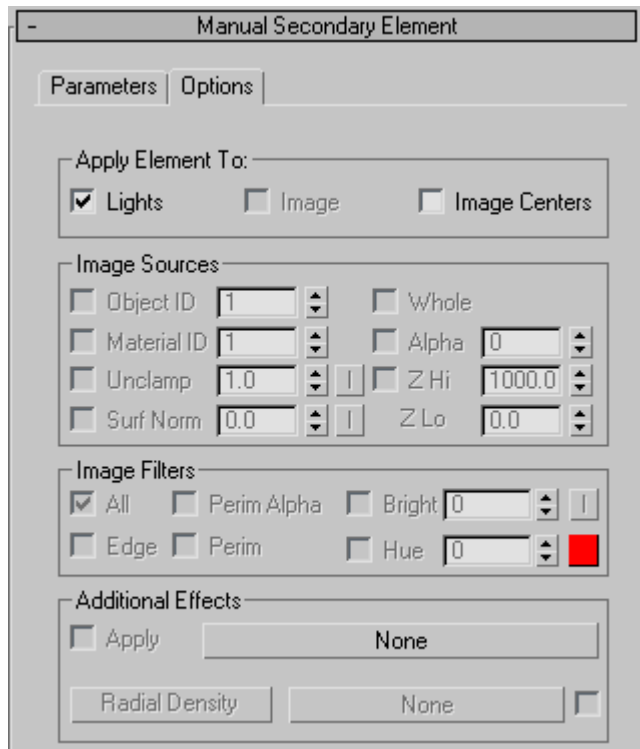

Apply Element To group

Lights Applies the effect to lights picked in Lens Effects Globals under the Parameters tab in the Lights group box.

Image Applies the effect to the rendered image using parameters set in Image Sources.

Image Centers Applies to the center of an object or to portions of an object as determined by the Image Filters.

Image Sources group

Object ID Applies the Lens Effect to particular objects in your scene that have a corresponding [G-Buffer](#) on page 7991 (or Object) ID. The G-Buffer is a geometry buffer and can be defined when you right-click any object and select Properties

from the menu. Then, set the Object Channel ID under the G-Buffer ID controls.

Material ID Applies the Lens Effect to an object or part of an object with a specific [Material ID channel](#) on page 5348 assigned to it. Assign the Material ID channel in the Material Editor, using the [Material ID channel flyout](#) on page 5350. The Lens Effect will be applied only to areas of the geometry where that particular ID channel is present.

TIP In some cases you might want to apply different Lens Effects settings to different pieces of geometry or IDs. To accomplish this, add additional Lens Effects entries to the Lens Effects Parameters list. Then set each different Lens Effect entry to affect a different Material ID or Object ID and proceed.

Unclamp An unclamped color is brighter than pure white (255,255,255). The software keeps track of these "hot" areas which tend to show up when your scene contains bright metallic highlights or explosions. This spinner lets you determine the lowest pixel value that the Lens Effect is applied to. Pure white has a pixel value of 1. When this spinner is set to 1, any pixels with a value above 255 will be glowed. You can invert this value by clicking the **I** button to the right of the spinner.

Surf Norm Applies the Lens Effect to part of an object, based on the angle of the surface normal to the camera. A value of 0 is coplanar, or parallel to the screen. A value of 90 is normal, or perpendicular to the screen. If you set Surf Norm to 45, only surfaces with normal angles greater than 45 degrees will be glowed. You can invert this value by clicking the **I** button to the right of the spinner.

Whole Applies the Lens Effect to the whole scene, not just a particular piece of geometry. This, in effect, makes each pixel in the scene a potential Lens Effect source. The areas of the scene that have the Lens Effect applied to them are determined by the settings in the Image Filters group box.

Alpha Applies the Lens Effect to the alpha channel of an image. The transparency of an alpha channel is interpreted opposite that of the Mask channel. Range=0 to 255.

Z Hi/Z Lo Highlights objects based on their distance (Z-Buffer distance) from the camera. The Hi value is the maximum distance and the Lo value is the minimum. Any objects between these two Z-Buffer distances will be highlighted.

Image Filters group

Filters the Image Sources selections to let you control how the Lens Effect is applied. For example, you can have ten spheres in your scene, each with the same Object ID, but different colors. If you set the Image Source as the Object ID of the spheres, which selects all of the spheres, these will be the only objects in the scene that Lens Effects will apply an effect to.

However, now that Lens Effects knows where the pixels are that effects *can* be applied, it needs to know which ones to actually apply the effect to. Lens Effects uses the filter controls to find out which source pixels to apply the effect to.

All Selects all source pixels in the scene and applies the Lens Effect to them.

Edge Selects all source pixels along a boundary edge and applies the Lens Effect to them. Applying a Lens Effect along the edges of objects produces a soft halo that exists on both inside and outside edges of your object.

Perim(eter) Alpha Applies the Lens Effect only to the perimeter of an object based on its alpha channel. Selecting this option applies the effect only on the outside of an object without any spill on the interior. Whereas filtering by Edge produces a spill onto the object, Perimeter Alpha keeps all of the edges clean because it relies on the scene alpha channel to derive its effect.

Perim(eter) Applies the Lens Effect only to the perimeter of an object based on Edge interference. Although not as precise as Perimeter Alpha, you might need to use the Perimeter option at times when the alpha channel is unavailable.

Bright Filters the source objects based on their brightness values. The effect is only applied to objects with a brightness above the spinner setting. This option can be inverted by clicking the **I** button next to the spinner.

Hue Filters the source objects by their hue. Select the hue by clicking the color swatch next to the spinner. You can choose hue values from 0 to 255. The spinner beside the Hue color swatch lets you enter a variance level so that the glow can find several different hues in the same range as the chosen color.

Additional Effects group

Additional Effects allows you to apply maps such as Noise to your Lens Effect. You can display the Material/Map browser by clicking the long button next to the Apply check box.

Apply Applies the selected map when activated.

Radial Density Determines where and how much you would like the additional effects applied. Clicking the Radial Density button displays the [Radial Density dialog](#) on page 6655. Using the Radial Density dialog you can create points on a line and move those points along a graph to determine where the additional effect should be placed around the light. You can also use a map to determine where the additional effect should be placed.

Star Lens Effect

Rendering menu > Effects > Environment and Effects dialog > Effects panel > Add > Add Effect dialog > Lens Effects > Choose Star, and click the (>) arrow button.

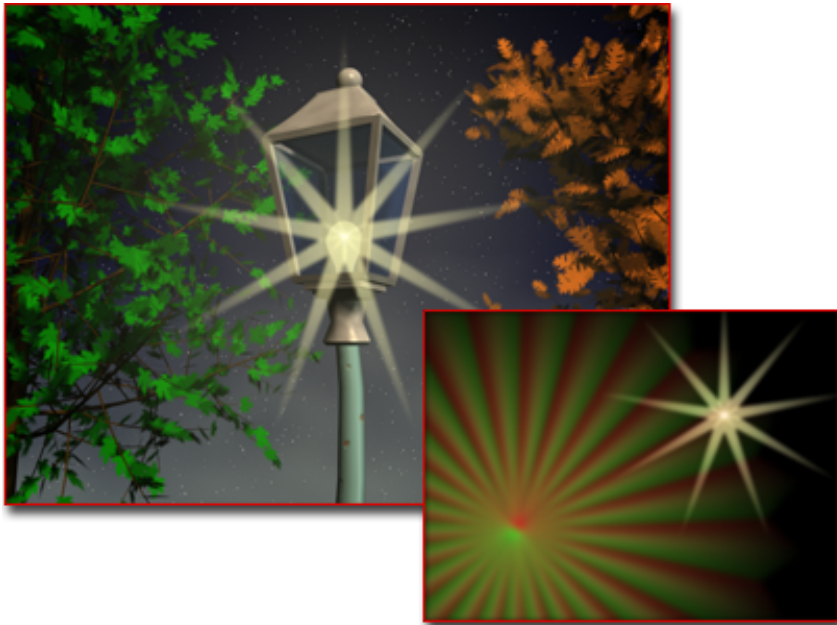

Adding a star to the light

A Star is larger than a [Ray effect](#) on page 6616 and is composed of 0 to 30 spokes, instead of hundreds like a ray.

Interface

Star Element rollout, Parameters panel

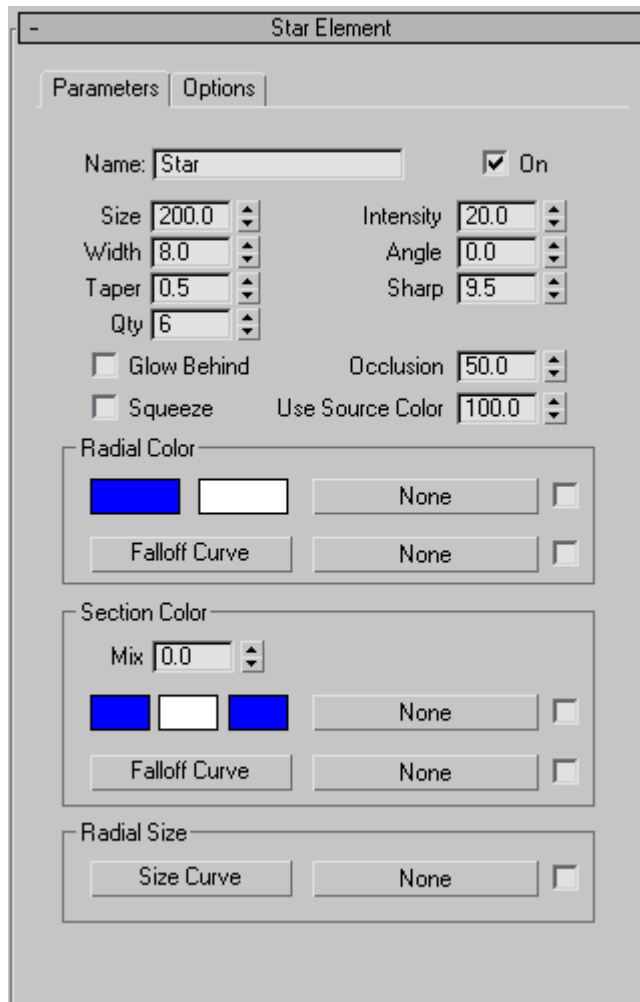

Name Displays the name of the effect. With Lens Effects, you can have many different effects under one instance of Lens Effects. To keep them in order, it is necessary to name them to make sure that when you change parameters you are changing the parameters to the correct effect.

On Applies the effect to the rendered image when activated.

Size Determines the size of the effect.

Intensity Controls the overall brightness and opacity of the individual effect. Higher values produce a bright, more opaque effect, and lower values produces a dim, transparent effect.

Width Specifies the width of the individual spokes, as a percentage of the overall frame.

Angle Sets the starting angle in degrees in which the star spokes point. You can enter both positive and negative values so, when animated, the star spokes rotate in a clockwise or counterclockwise direction.

Taper Controls the taper of the individual spokes of the star. Taper widens or narrows the tips of the individual star points. Low numbers create a sharp point, while high numbers flare the points.

Sharp Specifies the overall sharpness of the star. Higher numbers produce crisp, clean, and clear stars. Lower numbers produce more of a secondary glow look. Range=0 to 10.

Qty Specifies the number of spokes in the star effect. The default is 6. Spokes are spaced at equidistant points about the center of the flare.

Glow Behind Gives the effect the ability to be displayed behind objects in your 3ds Max scene.

Occlusion Determines how much the Lens Effects Scene Occlusion parameters will affect the particular effect. The value entered determines what percentage of occlusion set in the Lens Effects Globals panel will be applied.

Squeeze Determines whether the effect will be squeezed. When activated, the effect will be squeezed according to Lens Effects Globals under the Parameters panel in the Squeeze spinner.

Use Source Color Mixes the source color of the light or object you are applying the effect to and the color or mapping set in the Radial Color or Circular Color parameters. A value of 0 uses only the values set in the Radial Color and Circular Color parameters while a value of 100 uses only the light or objects source color. Any value between 0 and 100 will render a mix between the source color and the effect's color parameters.

Radial Color group

The Radial Color settings affect the inner and outer colors of the effect. You can set the color swatches to set the inner and outer colors of the Lens Effect.

You can also use bitmaps such as gradient or cellular to determine the radial color.

Falloff Curve Displays the [Radial Falloff dialog](#) on page 6658 in which you can set weights for the colors used in Radial Color. By manipulating the Falloff Curve you can make the effect use more of one color or map than the other. You can also use a map to determine the falloff when a light is used as a Lens Effects source.

Section Color group

Selection Color determines the color of the effect by using three different color swatches that are matched to the three sections of the effect. A map can also be used to determine section color.

Mix Mixes colors set in Radial Color and colors set in Section Color. Setting the spinner at 0 will only use values set in Radial Color while setting the spinner at 100 will only use values set in Section Color. Any value between 0 and 100 will mix between the two values.

Falloff Curve Displays the [Circular Falloff dialog](#) on page 6652 in which you can set weights for the colors used in Section Color. By manipulating the Falloff Curve you can make the effect use more of one color or map than another. You can also use a map to determine the falloff when a light is used as a Lens Effects source.

Radial Size group

Determines the radial size around the particular Lens Effect. Clicking the Size Curve button displays the [Radial Size dialog](#) on page 6661. Using the Radial Size dialog you can create points on a line and move those points along a graph to determine where the effect should be placed around the light or object. You can also use a map to determine where the effect should be placed. A check box is used to activate the map.

Star Element rollout, Options panel

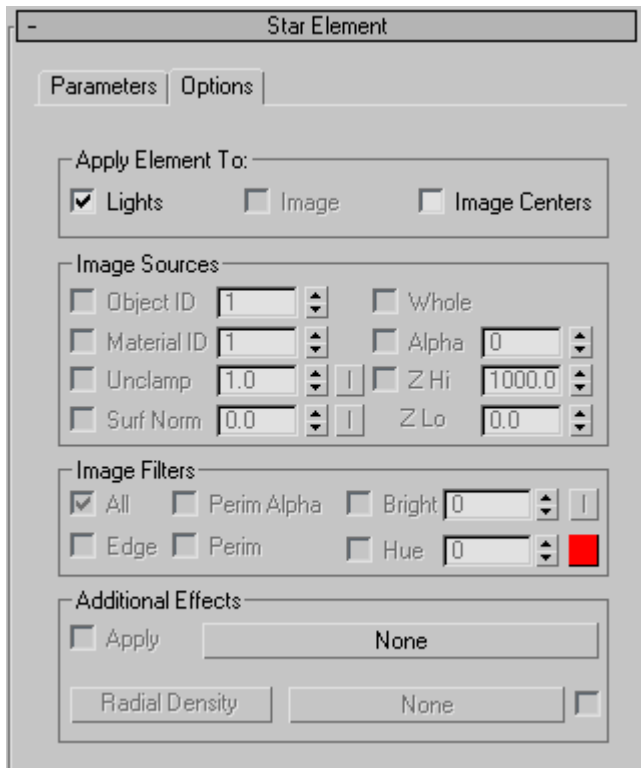

Apply Element To group

Lights Applies the effect to lights picked in Lens Effects Globals under the Parameters tab in the Lights group box.

Image Applies the effect to the rendered image using parameters set in Image Sources.

Image Centers Applies to the center of an object or to portions of an object as determined by the Image Filters.

Image Sources group

Object ID Applies the Lens Effect to particular objects in your scene that have a corresponding [G-Buffer](#) on page 7991 (or Object) ID. The G-Buffer is a geometry buffer and can be defined when you right-click any object and select Properties

from the menu. Then, set the Object Channel ID under the G-Buffer ID controls.

Material ID Applies the Lens Effect to an object or part of an object with a specific [Material ID channel](#) on page 5348 assigned to it. Assign the Material ID channel in the Material Editor, using the [Material ID channel flyout](#) on page 5350. The Lens Effect will be applied only to areas of the geometry where that particular ID channel is present.

TIP In some cases you might want to apply different Lens Effects settings to different pieces of geometry or IDs. To accomplish this, add additional Lens Effects entries to the Lens Effects Parameters list. Then set each different Lens Effect entry to affect a different Material ID or Object ID and proceed.

Unclamp An unclamped color is brighter than pure white (255,255,255). The software keeps track of these "hot" areas which tend to show up when your scene contains bright metallic highlights or explosions. This spinner lets you determine the lowest pixel value that the Lens Effect is applied to. Pure white has a pixel value of 1. When this spinner is set to 1, any pixels with a value above 255 will be glowed. You can invert this value by clicking the **I** button to the right of the spinner.

Surf Norm Applies the Lens Effect to part of an object, based on the angle of the surface normal to the camera. A value of 0 is coplanar, or parallel to the screen. A value of 90 is normal, or perpendicular to the screen. If you set Surf Norm to 45, only surfaces with normal angles greater than 45 degrees will be glowed. You can invert this value by clicking the **I** button to the right of the spinner.

Whole Applies the Lens Effect to the whole scene, not just a particular piece of geometry. This, in effect, makes each pixel in the scene a potential Lens Effect source. The areas of the scene that have the Lens Effect applied to them are determined by the settings in the Image Filters group box.

Alpha Applies the Lens Effect to the alpha channel of an image. The transparency of an alpha channel is interpreted opposite that of the Mask channel. Range=0 to 255.

Z Hi/Z Lo Highlights objects based on their distance (Z-Buffer distance) from the camera. The Hi value is the maximum distance and the Lo value is the minimum. Any objects between these two Z-Buffer distances will be highlighted.

Image Filters group

Filters the Image Sources selections to let you control how the Lens Effect is applied. For example, you can have ten spheres in your scene, each with the same Object ID, but different colors. If you set the Image Source as the Object ID of the spheres, which selects all of the spheres, these will be the only objects in the scene that Lens Effects will apply an effect to.

However, now that Lens Effects knows where the pixels are that effects *can* be applied, it needs to know which ones to actually apply the effect to. Lens Effects uses the filter controls to find out which source pixels to apply the effect to.

All Selects all source pixels in the scene and applies the Lens Effect to them.

Edge Selects all source pixels along a boundary edge and applies the Lens Effect to them. Applying a Lens Effect along the edges of objects produces a soft halo that exists on both inside and outside edges of your object.

Perim(eter) Alpha Applies the Lens Effect only to the perimeter of an object based on its alpha channel. Selecting this option applies the effect only on the outside of an object without any spill on the interior. Whereas filtering by Edge produces a spill onto the object, Perimeter Alpha keeps all of the edges clean because it relies on the alpha channel to derive its effect.

Perim(eter) Applies the Lens Effect only to the perimeter of an object based on Edge interference. Although not as precise as Perimeter Alpha, you might need to use the Perimeter option at times when the alpha channel is unavailable.

Bright Filters the source objects based on their brightness values. The effect is only applied to objects with a brightness above the spinner setting. This option can be inverted by clicking the **I** button next to the spinner.

Hue Filters the source objects by their hue. Select the hue by clicking the color swatch next to the spinner. You can choose hue values from 0 to 255. The spinner beside the Hue color swatch lets you enter a variance level so that the glow can find several different hues in the same range as the chosen color.

Additional Effects group

Additional Effects allows you to apply maps such as Noise to your Lens Effect. You can display the Material/Map browser by clicking the long button next to the Apply check box.

Apply Applies the selected map when activated.

Radial Density Determines where and how much you would like the additional effects applied. Clicking the Radial Density button displays the [Radial Density dialog](#) on page 6655. Using the Radial Density dialog you can create points on a line and move those points along a graph to determine where the additional effect should be placed around the light. You can also use a map to determine where the additional effect should be placed.

Streak Lens Effect

Rendering menu > Effects > Environment and Effects dialog > Effects panel > Add > Add Effect dialog > Lens Effects > Choose Streak, and click the (>) arrow button.

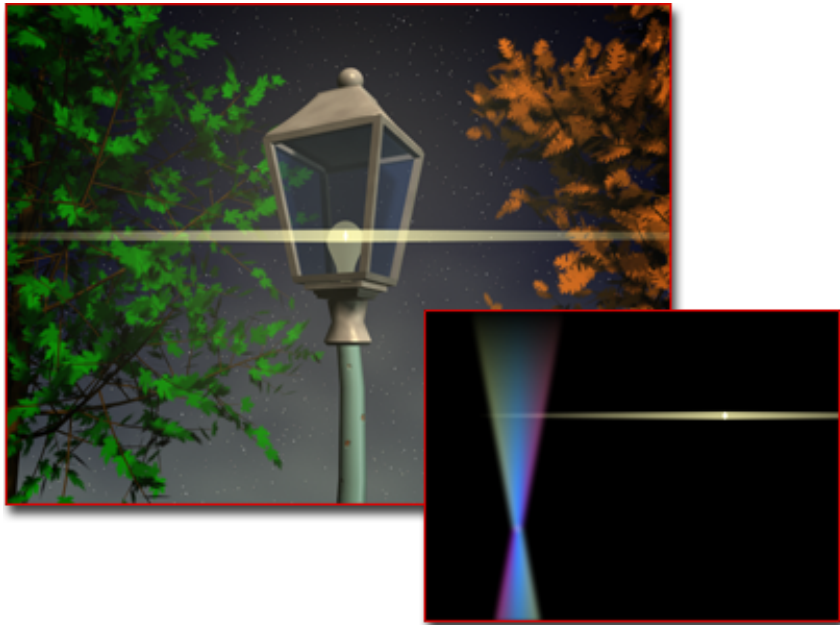

Adding a streak to the light

A streak is a wide band that runs through the center of the source object. In real camera work, it is produced when using anamorphic lenses to film a scene.

Interface

Streak Element rollout, Parameters panel

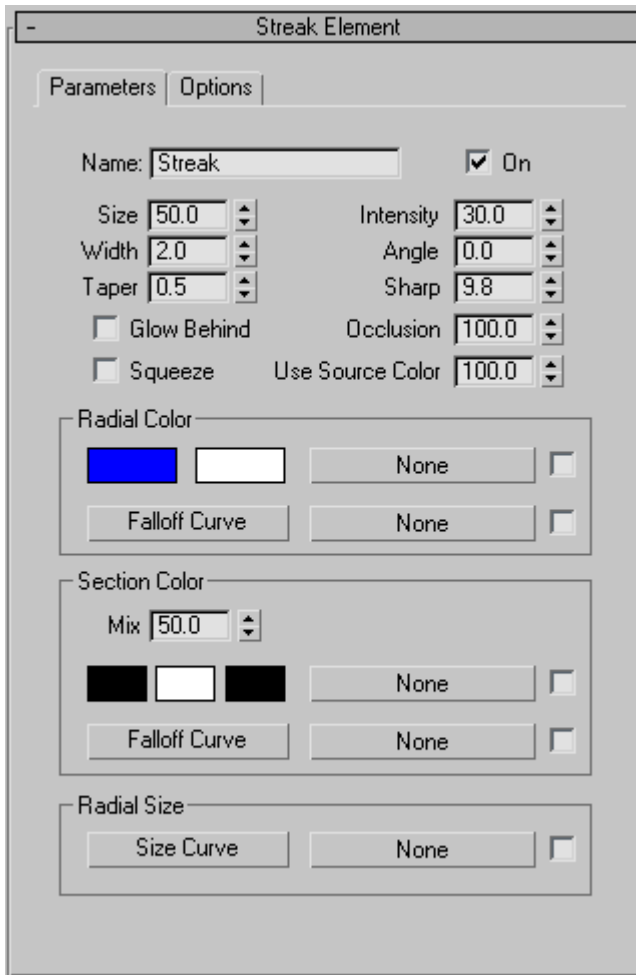

Name Displays the name of the effect. With Lens Effects, you can have many different effects under one instance of Lens Effects. To keep them in order, it is necessary to name them to make sure that when you change parameters you are changing the parameters to the correct effect.

On Applies the effect to the rendered image when activated.

Size Determines the size of the effect.

Intensity Controls the overall brightness and opacity of the individual effect. Higher values produce a bright, more opaque effect, and lower values produce a dim, transparent effect.

Width Specifies the width of the streak, as a percentage of the frame.

Angle Specifies the angle for the streak. You can enter both positive and negative values so, when animated, the streak rotates in a clockwise or counterclockwise direction.

Taper Controls the taper of the individual spokes of the streak. Taper widens or narrows the tips of the individual streak points. Low numbers create a sharp point, while high numbers flare the points.

Sharp Specifies the overall sharpness of the streak. Higher numbers produce crisp, clean, and clear streaks. Lower numbers produce more of a secondary glow look. Range=0 to 10.

Glow Behind Gives the effect the ability to be displayed behind objects in your 3ds Max scene.

Occlusion Determines how much the Lens Effects Scene Occlusion parameters will affect the particular effect. The value entered determines what percentage of occlusion set in the Lens Effects Globals panel will be applied.

Squeeze Determines whether the effect will be squeezed. When activated, the effect will be squeezed according to Lens Effects Globals under the Parameters panel in the Squeeze spinner.

Use Source Color Mixes the source color of the light or object you are applying the effect to and the color or mapping set in the Radial Color or Circular Color parameters. A value of 0 uses only the values set in the Radial Color and Circular Color parameters while a value of 100 uses only the light or objects source color. Any value between 0 and 100 will render a mix between the source color and the effect's color parameters.

Radial Color group

Falloff Curve Displays the [Radial Falloff dialog](#) on page 6658 in which you can set weights for the colors used in Radial Color. By manipulating the Falloff Curve you can make the effect use more of one color or map than the other. You can also use a map to determine the falloff when a light is used as a Lens Effects source.

Section Color group

Section Color determines the color of the effect by using three different color swatches that are matched to the three sections of the effect. A map can also be used to determine section color.

Mix Mixes colors set in Radial Color and colors set in Section Color. Setting the spinner at 0 will only use values set in Radial Color while setting the spinner at 100 will only use values set in Section Color. Any value between 0 and 100 will mix between the two values.

Falloff Curve Displays the [Circular Falloff dialog](#) on page 6652 in which you can set weights for the colors used in Section Color. By manipulating the Falloff Curve you can make the effect use more of one color or map than another. You can also use a map to determine the falloff when a light is used as a Lens Effects source.

Radial Size group

Determines the radial size around the particular Lens Effect. Clicking the Size Curve button displays the [Radial Size dialog](#) on page 6661. Using the Radial Size dialog you can create points on a line and move those points along a graph to determine where the effect should be placed around the light or object. You can also use a map to determine where the effect should be placed. A check box is used to activate the map.

Streak Element rollout, Options panel

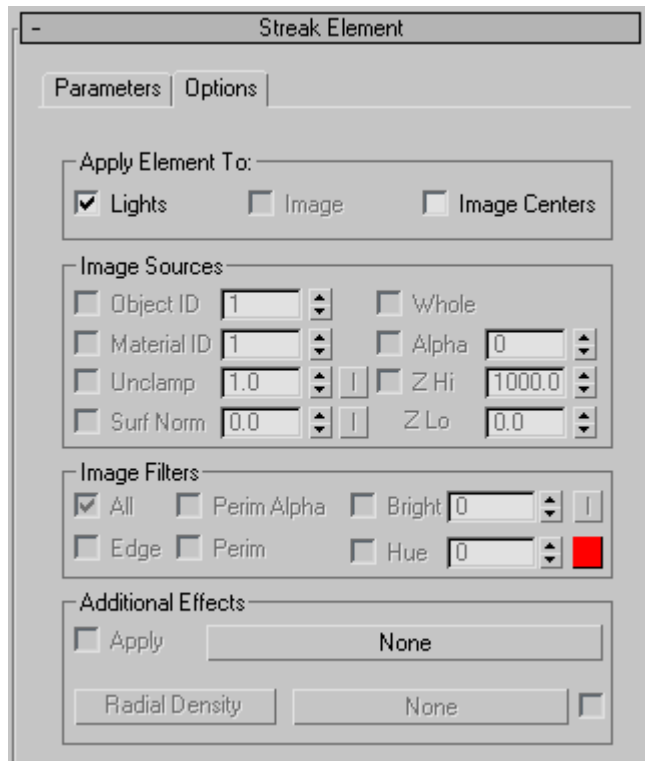

Apply Element To group

Lights Applies the effect to lights picked in Lens Effects Globals under the Parameters tab in the Lights group box.

Image Applies the effect to objects that have a corresponding Object ID channel.

Image Centers Applies to the center of an object or to portions of an object as determined by the Image Filters.

Image Sources group

Object ID Applies the Lens Effect to particular objects in your scene that have a corresponding [G-Buffer](#) on page 7991 (or Object) ID. The G-Buffer is a geometry buffer and can be defined when you right-click any object and select Properties

from the menu. Then, set the Object Channel ID under the G-Buffer ID controls.

Material ID Applies the Lens Effect to an object or part of an object with a specific [Material ID channel](#) on page 5348 assigned to it. Assign the Material ID channel in the Material Editor, using the [Material ID channel flyout](#) on page 5350. The Lens Effect will be applied only to areas of the geometry where that particular ID channel is present.

TIP In some cases you might want to apply different Lens Effects settings to different pieces of geometry or IDs. To accomplish this, add additional Lens Effects entries to the Lens Effects Parameters list. Then set each different Lens Effect entry to affect a different Material ID or Object ID and proceed.

Unclamp An unclamped color is brighter than pure white (255,255,255). The software keeps track of these "hot" areas which tend to show up when your scene contains bright metallic highlights or explosions. This spinner lets you determine the lowest pixel value that the Lens Effect is applied to. Pure white has a pixel value of 1. When this spinner is set to 1, any pixels with a value above 255 will be glowed. You can invert this value by clicking the **I** button to the right of the spinner.

Surf Norm Applies the Lens Effect to part of an object, based on the angle of the surface normal to the camera. A value of 0 is coplanar, or parallel to the screen. A value of 90 is normal, or perpendicular to the screen. If you set Surf Norm to 45, only surfaces with normal angles greater than 45 degrees will be glowed. You can invert this value by clicking the **I** button to the right of the spinner.

Whole Applies the Lens Effect to the whole scene, not just a particular piece of geometry. This, in effect, makes each pixel in the scene a potential Lens Effect source. The areas of the scene that have the Lens Effect applied to them are determined by the settings in the Image Filters group box.

Alpha Applies the Lens Effect to the alpha channel of an image. The transparency of an alpha channel is interpreted opposite that of the Mask channel. Range=0 to 255.

Z Hi/Z Lo Highlights objects based on their distance (Z-Buffer distance) from the camera. The Hi value is the maximum distance and the Lo value is the minimum. Any objects between these two Z-Buffer distances will be highlighted.

Image Filters group

Filters the Image Sources selections to let you control how the Lens Effect is applied. For example, you can have ten spheres in your scene, each with the same Object ID, but different colors. If you set the Image Source as the Object ID of the spheres, which selects all of the spheres, these will be the only objects in the scene that Lens Effects will apply an effect to.

However, now that Lens Effects knows where the pixels are that effects *can* be applied, it needs to know which ones to actually apply the effect to. Lens Effects uses the filter controls to find out which source pixels to apply the effect to.

All Selects all source pixels in the scene and applies the Lens Effect to them.

Edge Selects all source pixels along a boundary edge and applies the Lens Effect to them. Applying a Lens Effect along the edges of objects produces a soft halo that exists on both inside and outside edges of your object.

Perim(eter) Alpha Applies the Lens Effect only to the perimeter of an object based on its alpha channel. Selecting this option applies the effect only on the outside of an object without any spill on the interior. Whereas filtering by Edge produces a spill onto the object, Perimeter Alpha keeps all of the edges clean because it relies on the scene alpha channel to derive its effect.

Perim(eter) Applies the Lens Effect only to the perimeter of an object based on Edge interference. Although not as precise as Perimeter Alpha, you might need to use the Perimeter option at times when the alpha channel is unavailable.

Bright Filters the source objects based on their brightness values. The effect is only applied to objects with a brightness above the spinner setting. This option can be inverted by clicking the **I** button next to the spinner.

Hue Filters the source objects by their hue. Select the hue by clicking the color swatch next to the spinner. You can choose hue values from 0 to 255. The spinner beside the Hue color swatch lets you enter a variance level so that the glow can find several different hues in the same range as the chosen color.

Additional Effects group

Additional Effects allows you to apply maps such as Noise to your Lens Effect. You can display the Material/Map browser by clicking the long button next to the Apply check box.

Apply Applies the selected map when activated.

Radial Density Determines where and how much you would like the additional effects applied. Clicking the Radial Density button displays the [Radial Density dialog](#) on page 6655. Using the Radial Density dialog you can create points on a line and move those points along a graph to determine where the additional effect should be placed around the light. You can also use a map to determine where the additional effect should be placed.

Lens Effects Dialogs

Circular Falloff Graph (Lens Effects)

Rendering menu > Effects > Environment and Effects dialog > Effects panel > Add > Add Effect dialog > Lens Effects > Choose any effect, and click the (>) arrow button. > Parameters tab of the rollout for that effect > Falloff Curve (under the Circular or Section Color group)

The Circular Falloff graph allows you to add weight to a particular color applied to your Lens Effect. By weighting the colors that you apply you can choose to display more of one color than another. You can also make the transition of colors gradual from one color to the next or you can create a sharp edge to the transition.

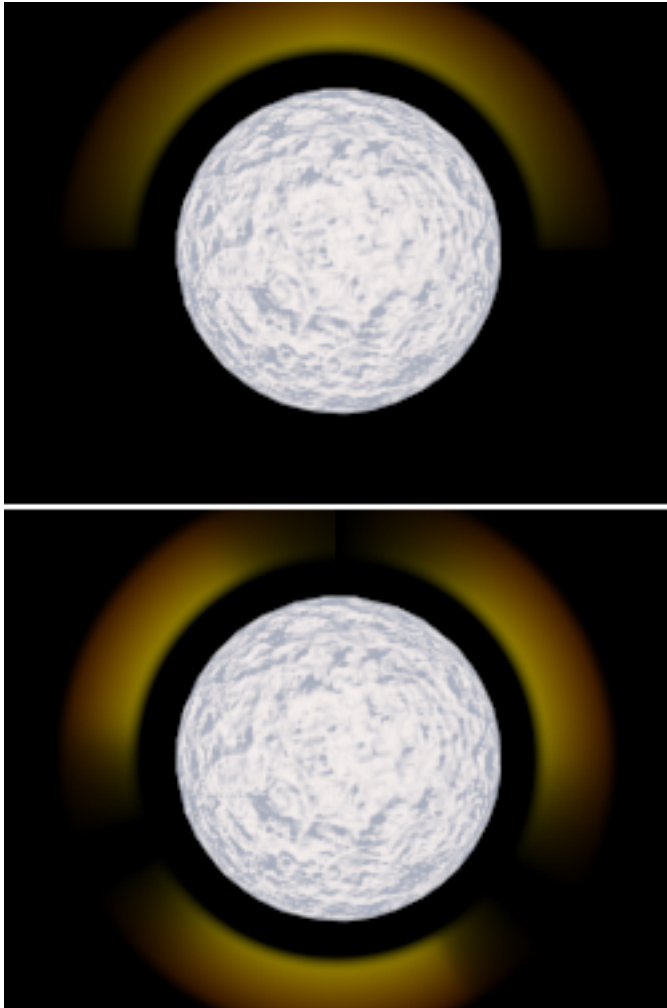

Rings with different Circular Falloff settings

The Circular Falloff graph has controls at the top for creating and moving points on a curve on the graph below. The curve represents the range of colors you have selected in the Circular Color group box to apply to the current Lens Effect. When you open the graph you will notice that there is already a line with a point on each end which represents the linear transition from one color to the next. By placing points along the curve, you can drag these points to increase or decrease a colors intensity or to eliminate it altogether.

Buttons are available at the bottom of the graph that allow you to change the display of the graph. You can also manually enter a horizontal or vertical position by entering a value into the two entry boxes.

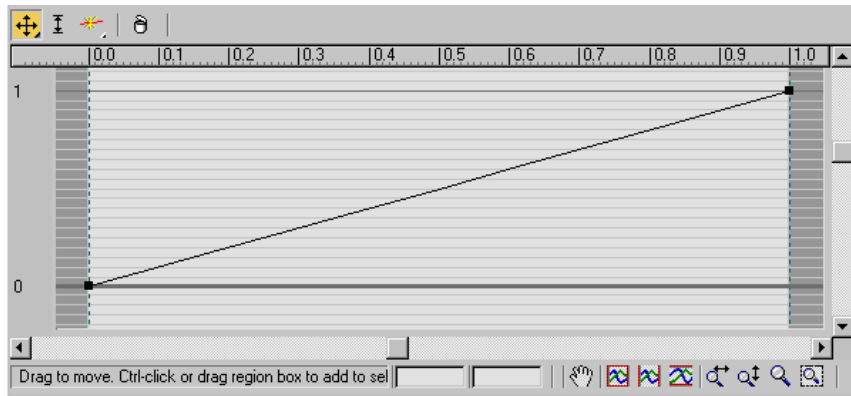

Interface

Move Moves selected points in any direction. Click and hold the Move button to display the flyout where you can select a button to move in any direction, move only in the horizontal direction, or move only in the vertical direction. The Move function remains active until you click another button. The button is yellow while it is active.

Scale Point Scales a point vertically. Click once to enable Scale Point. The Scale Point function remains active until you click another button. The button is yellow while it is active.

Add Point Allows you to add points anywhere along the Circular Falloff curve. Click and hold the Add Point button to display the flyout from which you can choose a button to add either a Corner Point or a Bezier-Smooth Point. Click once to enable Add Point. The Add Point function remains active until you click another button. The button is yellow while it is active.

Delete Point Deletes selected points.

Horizontal Position Allows you to manually enter a horizontal position value for a selected point.

Vertical Position Allows you to manually enter a vertical position value for a selected point.

Pan Allows you to click and drag the Circular Falloff graph window to move it left and right or up and down. Click once to enable panning. Pan remains active until you click another button. The button is yellow while it is active.

Zoom Extents Fits the curve within the graph window both vertically and horizontally so that the entire curve is visible.

Zoom Horizontal Extents Fits the curve horizontally within the graph window so that the full length of the curve is visible.

Zoom Vertical Extents Fits the curve vertically within the Circular Falloff graph window so that the full height of the curve is visible.

Zoom Horizontally Scales the width of the Circular Falloff graph window.

Zoom Vertically Scales the length of the Circular Falloff graph window.

Zoom Zooms in and out of the entire Circular Falloff graph window.

Zoom Region Allows you to drag a region in the Circular Falloff graph window and scale that region to fill the window.

Radial Density Dialog (Lens Effects)

Rendering menu > Effects > Environment and Effects dialog > Effects panel > Add > Add Effect dialog > Lens Effects > Choose any effect, and click the (>) arrow button. > Options tab of the rollout for that effect > Radial Density (under the Additional Effects group)

The Radial Density dialog allows you to add weight to any additional effect applied to the Lens Effect. By weighting the density of the additional effect that you apply you can choose particular areas in the effect to display more of the additional effect or to eliminate it altogether. You can also use Radial Density to gradually fade the additional effect from maximum density down to zero or you can create a sharp edge to the transition.

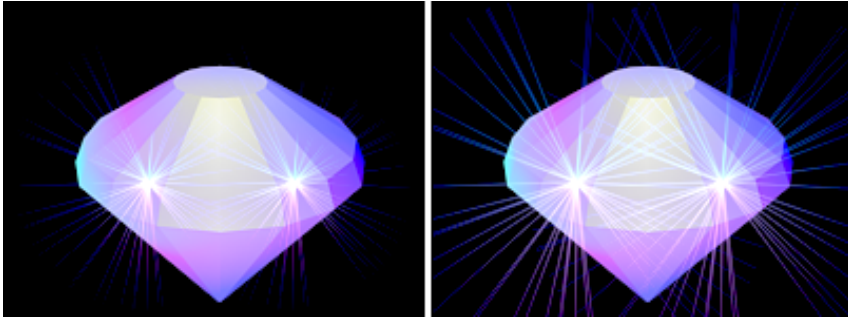

Object with different Ray effects due to different Radial Density settings

The Radial Density dialog has controls at the top for creating and moving Points on a curve on the graph below. The curve represents the density of the additional effect being applied to the Lens Effect. When you open the dialog you will notice that there is already a line with a Point on each end which represents the density of the effect. The default falloff is a fade from a density value of **1** starting from the center of the effect toward the outer edges which has a value of **0**. This produces an effect with more density being rendered at the center of the effect and a gradual fading out to no density at the edges. By placing Points along the curve, you can drag these points to increase or decrease the density of an additional effect or eliminate it in some areas altogether.

Buttons are available at the bottom of the dialog that allow you to change the display of the dialog. You can also manually enter a horizontal or vertical position by entering a value into the two entry boxes.

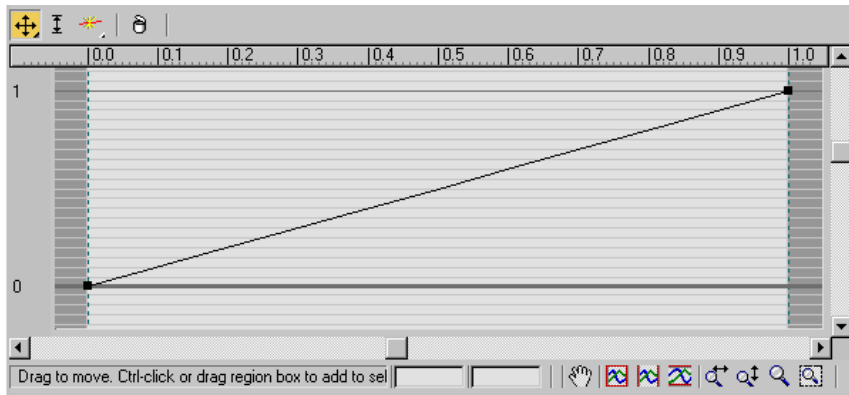

Interface

Move Moves selected points in any direction. Click and hold the Move button to display the flyout where you can select a button to move in any direction, move only in the horizontal direction, or move only in the vertical direction. The Move function remains active until you click another button. The button is yellow while it is active.

Scale Point Vertically scales a point up or down. Click once to enable Scale Point. The Scale Point function remains active until you click another button. The button is yellow while it is active.

Add Point Allows you to add points anywhere along the Radial Density curve. Click and hold the Add Point button to display the flyout where you can select a button to add either a Corner Point or a Bezier Point. Click once to enable Add Point. The Add Point function remains active until you click another button. The button is yellow while it is active.

Delete Point Deletes selected points.

Horizontal Position Allows you to manually enter a horizontal position value for a selected point.

Vertical Position Allows you to manually enter a vertical position value for a selected point.

Pan Allows you to click and drag the Radial Density dialog window to move it left and right or up and down. Click once to enable panning. Pan remains active until you click another button. The button is yellow while it is active.

Zoom Extents Fits the curve within the dialog window both vertically and horizontally so that the entire curve is visible.

Zoom Horizontal Extents Fits the curve horizontally within the dialog window so that the full length of the curve is visible.

Zoom Vertical Extents Fits the curve vertically within the Radial Density dialog window so that the full height of the curve is visible.

Zoom Horizontally Scales the width of the Radial Density dialog window.

Zoom Vertically Scales the length of the Radial Density dialog window.

Zoom Zooms in and out of the entire Radial Density dialog window.

Zoom Region Allows you to drag a region in the Radial Density dialog window and scale that region to fill the window.

Radial Falloff Dialog (Lens Effects)

Rendering menu > Effects > Environment and Effects dialog > Effects panel > Add > Add Effect dialog > Lens Effects > Choose any effect, and click the (>) arrow button. > Parameters tab of the rollout for that effect > Falloff Curve (under the Radial Color group)

The Radial Falloff dialog allows you to add weight to a particular color applied to your Lens Effect. By weighting the colors that you apply you can choose to display more of one color than another. You can also make the transition of colors gradual from one color to the next or you can create a sharp edge to the transition.

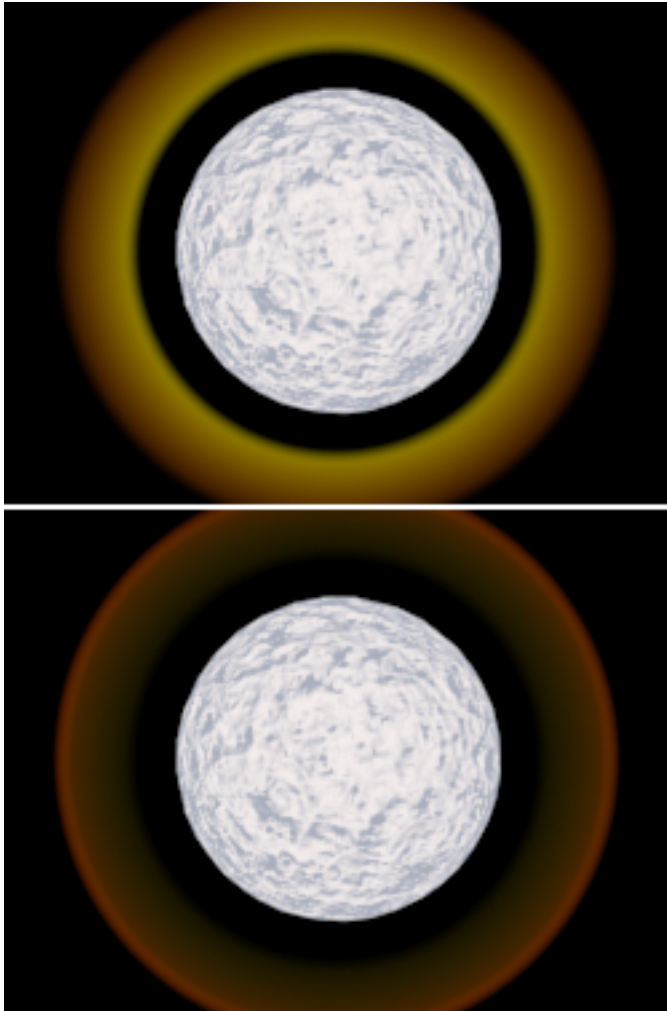

Rings with different Radial Falloff settings

The Radial Falloff graph has controls at the top for creating and moving Points on a curve on the graph below. The curve represents the range of colors you have selected in the Radial Color group box to apply to the current Lens Effect. When you open the dialog you will notice that there is already a line with a Point on each end which represents the linear transition from one color to the next. The default falloff is a fade from one color at a value of one to the other color which ends at a value of zero. This produces an effect with more intensity on the first color and a considerable fading out of the second color.

By placing Points along the curve, you can drag these points to increase or decrease a colors intensity or to eliminate it altogether.

Buttons are available at the bottom of the dialog that allow you to change the display of the dialog. You can also manually enter a horizontal or vertical position by entering a value into the two entry boxes.

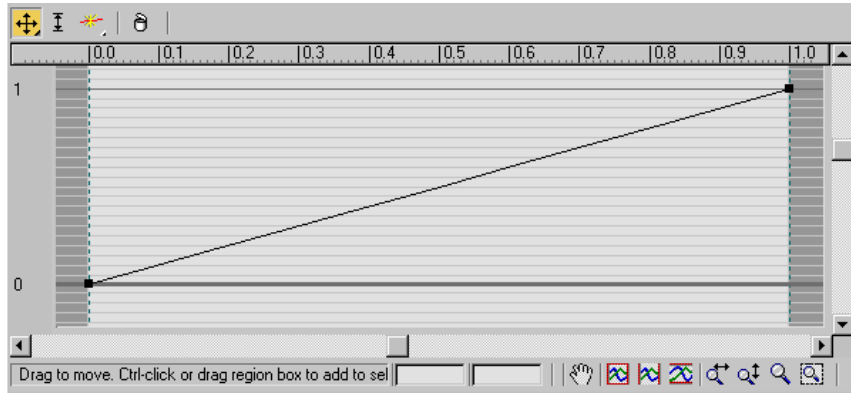

Interface

Move Moves selected points in any direction. Click and hold the Move button to display the flyout where you can select a button to move in any direction, move only in the horizontal direction, or move only in the vertical direction. The Move function remains active until you click another button. The button is yellow while it is active.

Scale Point Vertically scales a point up or down. Click once to enable Scale Point. The Scale Point function remains active until you click another button. The button is yellow while it is active.

Add Point Allows you to add points anywhere along the Circular Falloff curve. Click and hold the Add Point button to display the flyout where you can select a button to add either a Corner Point or a Bezier Point. Click once to enable Add Point. The Add Point function remains active until you click another button. The button is yellow while it is active.

Delete Point Deletes selected points.

Horizontal Position Allows you to manually enter a horizontal position value for a selected point.

Vertical Position Allows you to manually enter a vertical position value for a selected point.

Pan Allows you to click and drag the Radial Falloff graph to move it left and right or up and down. Click once to enable panning. Pan remains active until you click another button. The button is yellow while it is active.

Zoom Extents Fits the curve within the dialog window both vertically and horizontally so that the entire curve is visible.

Zoom Horizontal Extents Fits the curve horizontally within the dialog window so that the full length of the curve is visible.

Zoom Vertical Extents Fits the curve vertically within the Radial Falloff graph so that the full height of the curve is visible.

Zoom Horizontally Scales the width of the Radial Falloff graph.

Zoom Vertically Scales the length of the Radial Falloff graph.

Zoom Zooms in and out of the entire Radial Falloff graph.

Zoom Region Allows you to drag a region in the Radial Falloff graph and scale that region to fill the window.

Radial Size Dialog (Lens Effects)

Rendering menu > Effects > Environment and Effects dialog > Effects panel > Add > Add Effect dialog > Lens Effects > Choose any effect, and click the (>) arrow button. > Parameters tab of the rollout for that effect > Falloff Curve (under the Radial Size group)

The Radial Size dialog gives you the ability to determine the size of your Lens Effect. The Radial Size dialog displays a curve with a point on each end which represents the Radial Size of your Lens Effect. The default position of the curve is one which means the Lens Effect will have the same radius around the center of the effect.

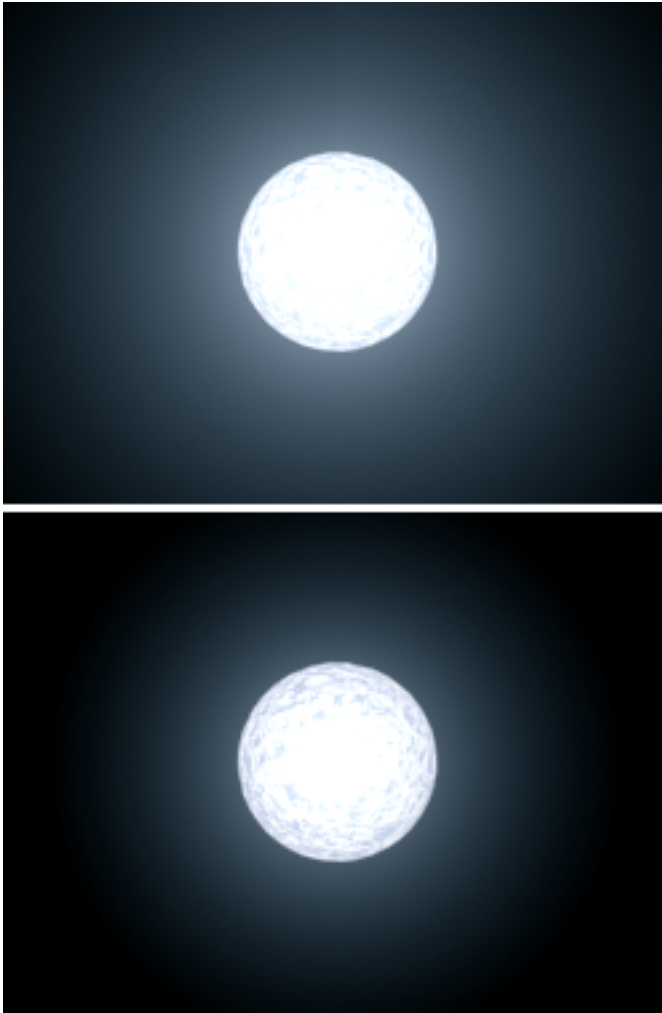

Objects with different Radial Sizes settings applied to Glow

By adding and moving points along the curve you can make areas of the effect extend further by moving a point above a value of one on the graph. You can also diminish areas of the effect by moving a point between one and zero on the graph. Finally, you can eliminate areas of the effect by moving a point below zero on the graph.

Buttons are available at the bottom of the dialog that allow you to change the display of the dialog. You can also manually enter a horizontal or vertical position by entering a value in the two entry boxes.

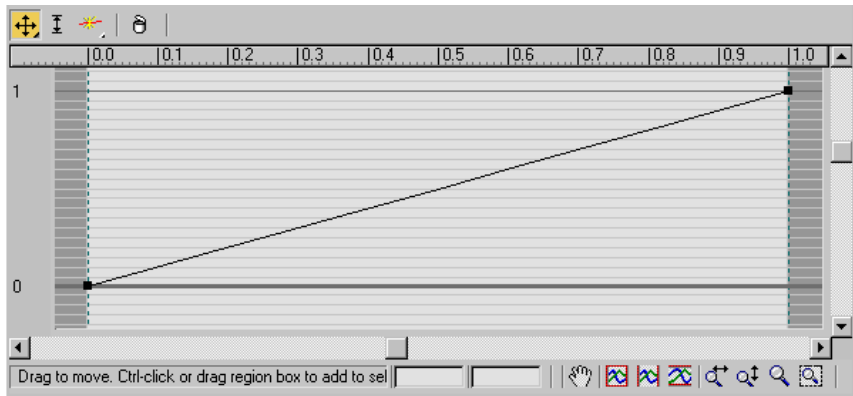

Interface

Move Moves selected points in any direction. Click and hold the Move button to display the flyout where you can select a button to move in any direction, move only in the horizontal direction, or move only in the vertical direction. The Move function remains active until you click another button. The button is yellow while it is active.

Scale Point Vertically scales a point up or down. Click once to enable Scale Point. The Scale Point function remains active until you click another button. The button is yellow while it is active.

Add Point Allows you to add points anywhere along the Radial Size curve. Click and hold the Add Point button to display the flyout where you can select a button to add either a Corner Point or a Bezier Point. Click once to enable Add Point. The Add Point function remains active until you click another button. The button is yellow while it is active.

Delete Point Deletes selected points.

Horizontal Position Allows you to manually enter a horizontal position value for a selected point.

Vertical Position Allows you to manually enter a vertical position value for a selected point.

Pan Allows you to click and drag the Radial Size graph to move it left and right or up and down. Click once to enable panning. Pan remains active until you click another button. The button is yellow while it is active.

Zoom Extents Fits the curve within the dialog window both vertically and horizontally so that the entire curve is visible.

Zoom Horizontal Extents Fits the curve horizontally within the dialog window so that the full length of the curve is visible.

Zoom Vertical Extents Fits the curve vertically within the Radial Size graph so that the full height of the curve is visible.

Zoom Horizontally Scales the width of the Radial Size graph.

Zoom Vertically Scales the length of the Radial Size graph.

Zoom Zooms in and out of the entire Radial Size graph.

Zoom Region Allows you to drag a region in the Radial Size graph and scale that region to fill the window.

Blur Rendering Effect

Rendering menu > Effects > Environment and Effects dialog > Effects panel > Add > Add Effect dialog > Blur

The Blur effect allows you to blur your image in three different methods: Uniform, Directional, and Radial. Blur works on individual pixels according to selections made in the Pixel Selections panel. You can blur an entire image, non-background scene elements, by luminance value, or by using a map mask. Blur can give your animation added realism by rendering the illusion of object or camera movement.



Object before and after adding midrange Blur effect.

Interface

Blur Parameters rollout, Blur Type panel

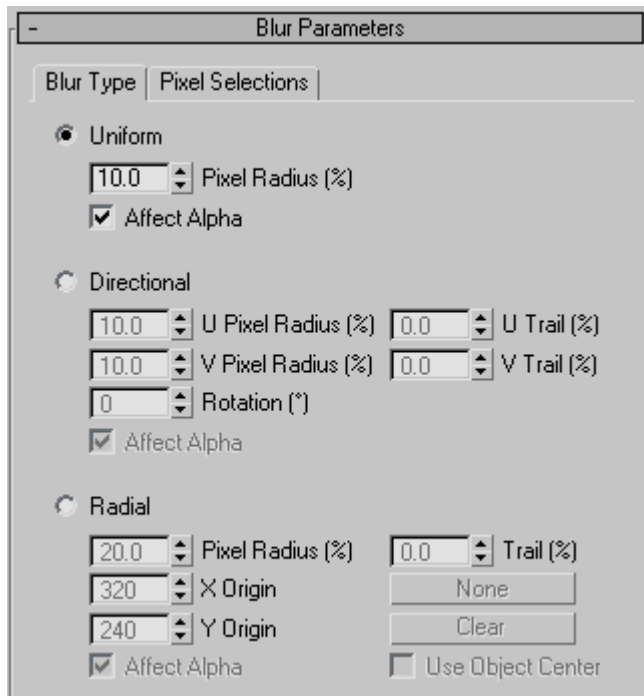

Uniform Applies the Blur effect evenly across the entire rendered image.

Pixel Radius Determines the intensity of the Blur effect. Increasing the value increases the number of surrounding pixels that each pixel will use to compute its blur. The more pixels used means a greater blur for the image.

Affect Alpha Applies the Uniform Blur effect to the alpha channel when turned on.

Directional Applies the Blur effect in any direction according to the Directional parameters. The U Pixel Radius and Trail blur the pixels horizontally while the V Pixel Radius and Trail blur the pixels vertically. Rotation is used to rotate the axis of the horizontal and vertical blurring.

U Pixel Radius Determines the horizontal intensity of the Blur effect. Increasing the value increases the number of surrounding pixels that each pixel will use to compute its blur. The more pixels used means a greater horizontal blur for the image.

U Trail Adds “direction” to your blur by weighting more blur to either side of the U axis. This adds a streaking effect and creates the illusion that your objects or your camera are rapidly moving in a particular direction.

V Pixel Radius Determines the vertical intensity of the Blur effect. Increasing the value increases the number of surrounding pixels that each pixel will use to compute its blur, and creates a greater vertical blur for the image.

V Trail Adds “direction” to your blur by weighting more blur to either side of the V axis. This adds a streaking effect and creates the illusion that your objects or your camera are rapidly moving in a particular direction.

Rotation Rotates the axis of the U and V pixels that will be blurred by the U and V Pixel Radius spinners. By using Rotation with the U and V Pixel Radius spinners you can have the Blur effect applied to any direction in your rendered image. When rotation is **0**, U corresponds to the image’s X axis and V corresponds to the image’s Y axis.

Affect Alpha Applies the Directional Blur effect to the Alpha channel when turned on.

Radial Applies the Blur effect radially. Using the Radial parameters you can define a point within your rendered image to use as the center of the Radial Blur. You can use an object as the center or an arbitrary location set by the X and Y Origin spinners. The Blur effect will apply the least amount of blur to the center origin of the effect and gradually increase the blur to the pixels further away from the center. This can be used to simulate motion blur caused by camera zoom.

Pixel Radius Determines the intensity of the Radius Blur effect. Increasing the value increases the number of surrounding pixels that each pixel will use to compute its blur. The more pixels used means a greater blur for the image.

Trail Adds “direction” to your blur by weighting more or less blur toward the center of the Blur effect. This adds a streaking effect and creates the illusion that your objects or your camera are rapidly moving in a particular direction.

X/Y Origin Specifies the center of the blur, in pixels, with respect to the dimensions of the rendered output.

None Lets you specify an object whose center serves as the center of the blur effect. Click this, select an object, and then turn on Use Object Center. The object name appears on the button.

Clear Removes the object name from the button above.

Use Object Center When on, the object specified by the None button (tooltip: Pick an object to center on.) serves as the center of the blur effect. If no object

is specified and Use Object Center is on, no blur is added to the rendered image.

Affect Alpha Applies the Radial Blur effect to the Alpha channel when turned on.

Blur Parameters rollout, Pixel Selections panel

Blur Parameters

Blur Type Pixel Selections

Whole Image
0.0 Brighten (%) 100.0 Blend (%)

Non-Background
0.0 Brighten (%) 100.0 Blend (%)
10.0 Feather Radius (%)

Luminance
0.0 Brighten (%) 100.0 Blend (%)
90.0 Min (%) 100.0 Max (%)
10.0 Feather Radius (%)

Map Mask
None Luminance Chan
0.0 Brighten (%) 100.0 Blend (%)
90.0 Min (%) 100.0 Max (%)
10.0 Feather Radius (%)

Object ID
Add 0.0 Min Lum (%)
Replace 100.0 Max Lum (%)
Delete 0.0 Brighten (%)
0 ID 100.0 Blend (%)
10.0 F. Radius (%)

Material ID
Add 0.0 Min Lum (%)
Replace 100.0 Max Lum (%)
Delete 0.0 Brighten (%)
0 ID 100.0 Blend (%)
10.0 F. Radius (%)

Whole Image Affects the entire rendered image when chosen. This is useful when the Blur effect dims your rendered image. By using Brighten and Blend you can maintain the original colors of the scene.

Brighten Brightens the entire image.

Blend Blends the Blur effect and the Whole Image parameters with the original rendered image. This can be used to create a soft-focus effect.

Non-Background Affects everything but the background image or animation when chosen. This is useful when the Blur effect has dimmed your scene objects but not the background. By Using Brighten, Blend, and Feather Radius, you can maintain the original colors of the scene.

Brighten Brightens the rendered image except for the background image or animation.

Blend Blends the Blur effect and the Non-Background parameters with the original rendered image.

Feather Radius Feathers the Blur effect applied to the Non-Background elements of your scene. When using Non-Background as a Pixel Selection you will notice that the scene objects have a hard edge to their blur since the objects are being blurred but the background is not. Use the spinner to feather the blur and eliminate the hard edge of the effect.

Luminance Affects any pixels that have luminance values that fall between it's Min and Max spinners.

Brighten Brightens pixels that fall between the Minimum and Maximum luminance values.

Blend Blends the Blur effect and the Luminance parameters with the original rendered image.

Min Sets the minimum luminance value necessary for each pixel in order for the Blur effect to be applied to the pixel.

Max Sets the maximum luminance value a pixel can have in order for the Blur effect to be applied to the pixel.

Feather Radius Feathers the Blur effect applied to pixels that fall between the Minimum and Maximum luminance values. When using Luminance as a Pixel Selection the Blur effect can create a hard edge on the effect. Use the spinner to feather the blur and eliminate the hard edge of the effect.

Map Mask Applies the Blur effect according to the channel selected and mask applied through the Material/Map Browser. After selecting a mask you must

select a channel from the Channel list. Blur then examines the mask and channel according to the values set in the Minimum and Maximum spinners. Any pixels in the mask that are of the selected channel and between the Min and Max values will have the Blur effect applied. This is useful for blurring selected portions of a scene such as a winter morning as seen through a frost covered window.

Channel Selects a channel that the Blur effect will be applied to. After selecting a particular channel, use the minimum and maximum spinners to determine the value a mask pixel must have in order to have the effect applied to it.

Brighten Brightens the portions of the image that the Blur effect is applied to.

Blend Blends the Map Mask Blur effect with the original rendered image.

Min The minimum value (RGB, Alpha, or Luminance) a pixel must have in order to have the Blur effect applied to it.

Max The maximum value (RGB, Alpha, or Luminance) a pixel can have for the Blur effect to be applied to it.

Feather Radius Feathers the Blur effect applied to pixels that fall between the Minimum and Maximum channel values. When using map mask as a Pixel Selection, the Blur effect can create a hard edge on the effect. Use the spinner to feather the blur and eliminate the hard edge of the effect.

Object ID Applies the Blur effect to an object or part of an object with a specific Object ID (in the [G-Buffer](#) on page 7991), if the object matches the Filter settings. To add or replace an Object ID, use the spinners or enter a value in the ID text box and then click the appropriate button.

Min Lum The minimum luminance value a pixel must have in order to have the Blur effect applied to it.

Max Lum The maximum luminance value a pixel can have for the Blur effect to be applied to it.

Brighten Brightens the portion of the image that the Blur effect is applied to.

Blend Blends the Object ID Blur effect with the original rendered image.

F. Radius Feathers the Blur effect applied to pixels that fall between the Minimum and Maximum luminance values. When using Luminance as a Pixel Selection, the Blur effect can create a hard edge on the effect. Use the spinner to feather the blur and eliminate the hard edge of the effect.

Material ID Applies the Blur effect to a material or part of a material with a specific [Material Effects Channel](#) on page 5348, if the material matches the Filter settings. To add or replace a Material Effects channel, use the spinners or enter a value in the ID text box and then click the appropriate button.

Min Lum The minimum luminance value a pixel must have in order to have the Blur effect applied to it.

Max Lum The maximum luminance value a pixel can have for the Blur effect to be applied to it.

Brighten Brightens the portion of the image that the Blur effect is applied to.

Blend Blends the Material Blur effect with the original rendered image.

F. Radius Feathers the Blur effect applied to pixels that fall between the Minimum and Maximum luminance values. When using Luminance as a Pixel Selection, the Blur effect can create a hard edge on the effect. Use the spinner to feather the blur and eliminate the hard edge of the effect.

General Settings group

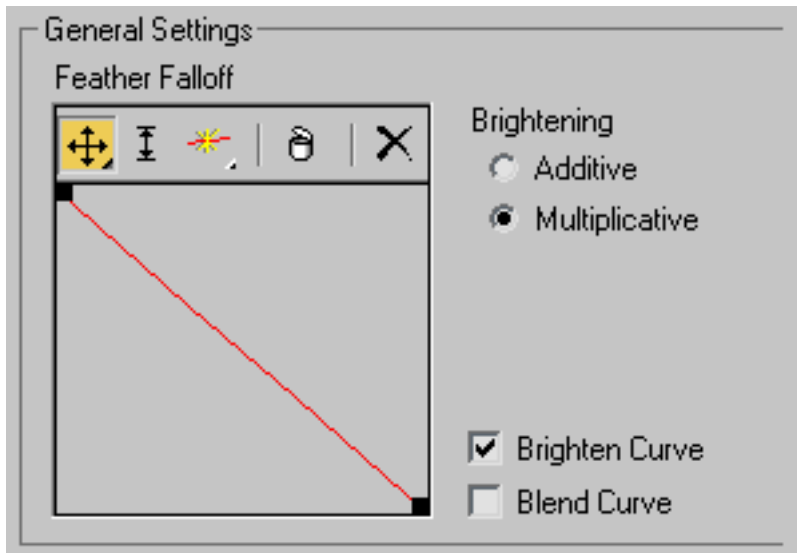

Feather Falloff control curve

The Feather falloff curve allows you to determine the feather falloff off the Blur effect based on a graph. You can add points to the graph to create a falloff curve, and adjust the interpolation in those points.

Move Lets you move the points on the graph. This button is a flyout, providing free movement (the default), horizontal, and vertical movement.

Scale Point Lets you scale the points on the graph. This moves each selected point vertically, in proportion to its previous value. Click a point to scale, or draw a selection rectangle around several contiguous points to select them, and then drag any point in the selection to scale them all.

Add Point Lets you create additional points on the falloff curve. This button is a flyout, providing linear points (the default) and Bezier points with handle.

Delete Point Removes points from the graph.

Brightening These radio buttons let you select additive or multiplicative brightening. Additive brightening is brighter and more distinct than multiplicative brightening. Additive brightening is useful when you use blur in combination with a [Glow effect](#) on page 6599. Multiplicative brightening provides a soft highlight to the Blur effect.

Brighten Curve Lets you edit the brightening curve in the Feather Falloff curve graph.

Blend Curve Lets you edit the blend curve in the Feather Falloff curve graph.

Brightness and Contrast Rendering Effect

Rendering menu > Effects > Environment and Effects dialog > Effects panel > Add > Add Effect dialog > Brightness and Contrast



Above: Original rendering is too dark.

Below: Increasing both brightness and contrast improves clarity of the rendering.

Brightness and Contrast allows you to adjust the contrast and brightness of an image. This can be used to match rendered scene objects with background images or animations.

Interface

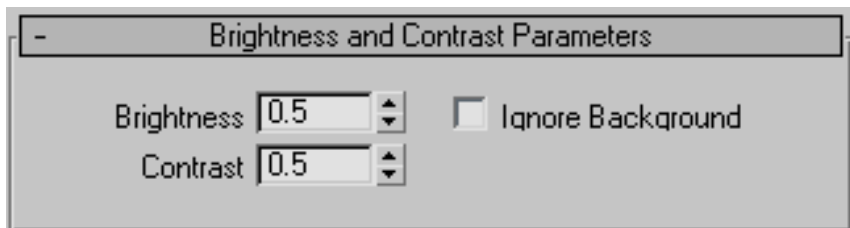

The Brightness and Contrast Parameters rollout contains the following parameters.

Brightness Increases or decreases all color components (red, green, and blue). Range=0 to 1.0.

Contrast Compresses or expands the latitude between maximum black and maximum white. Range=0 to 1.0.

Ignore Background Applies the effect to everything in your 3ds Max scene except the background.

Color Balance Rendering Effect

Rendering menu > Effects > Environment and Effects dialog > Effects panel > Add > Add Effect dialog > Color Balance

The Color Balance Effect allows you to manipulate additive/subtractive color tinting through independent control of RGB channels.

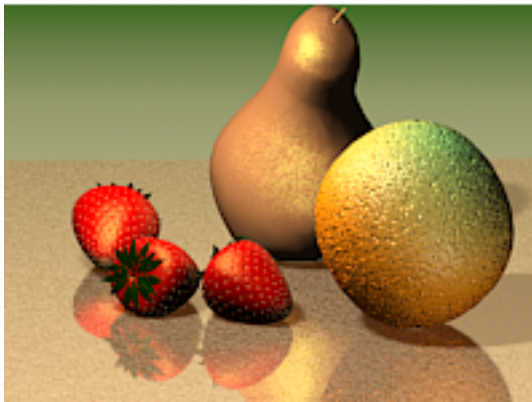
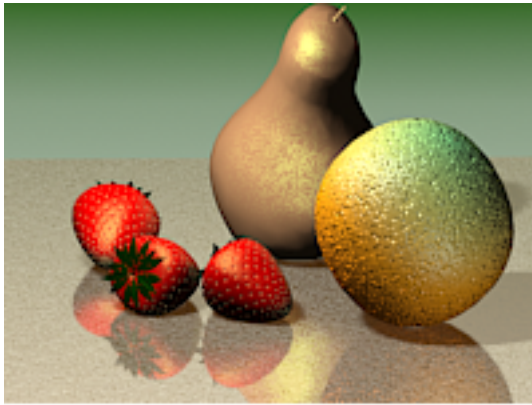

Above: Color balance effect used to correct the color cast.

Below: Original rendering has a yellow cast.

Interface

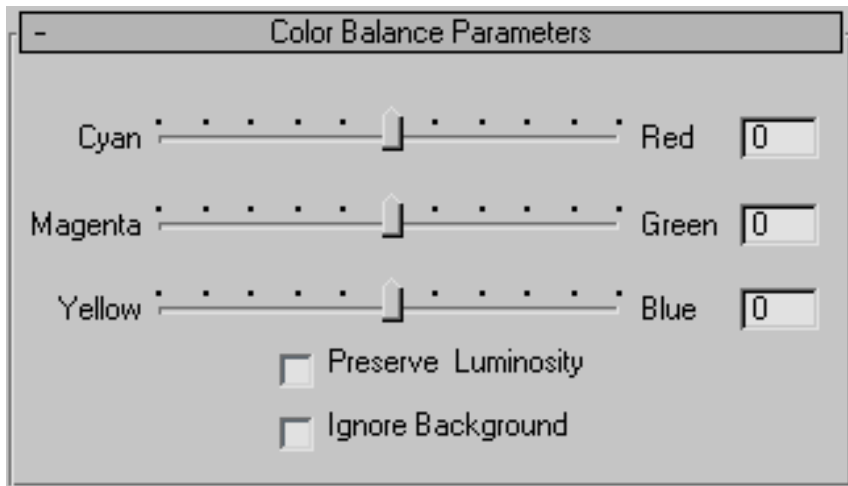

The Color Balance Parameters rollout contains the following parameters:

Cyan/Red Adjusts the red channel.

Magenta/Green Adjusts the green channel.

Yellow/Blue Adjusts the blue channel.

Preserve Luminosity When on, retains the luminosity of the image while correcting the color.

Ignore Background When on, allows you to image correct a model without affecting the background.

File Output Rendering Effect

Rendering menu > Effects > Environment and Effects dialog > Effects panel > Add > Add Effect dialog > File Output

File Output allows you to take a “snapshot” of a rendering before some or all of the other Render Effects are applied, depending on the placement of File Output in the Render Effects stack. You can save different channels such as Luminance, Depth, or Alpha to a separate file while rendering an animation.

You can also use File Output to convert an RGB image into a different channel and send that image channel back into the Render Effects stack. The rest of the effects can then be applied to that channel.

Interface

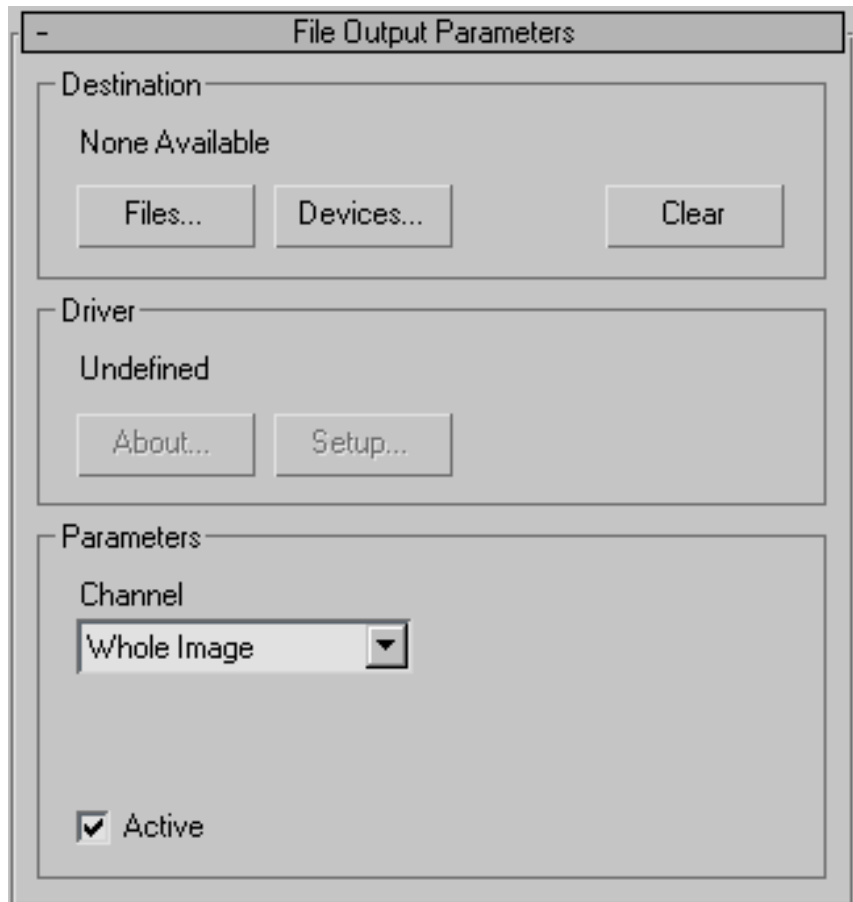

Destination group

Files Opens a dialog so you can save the rendered image or animation to disk. The rendered output can be a still image or an animation, in one of the following file formats:

[AVI File](#) on page 7326 (AVI)

[BMP Image file](#) on page 7328 (BMP)
[Encapsulated PostScript](#) on page 7332 format (EPS, PS)
[JPEG File](#) on page 7347 (JPG)
[Kodak Cineon](#) on page 7328 (CIN)
[MOV QuickTime file](#) on page 7348 (MOV)
[PNG Image File](#) on page 7360 (PNG)
[RLA Image File](#) on page 7364 (RLA)
[RPF Image File](#) on page 7366 (RPF)
[SGI Image File Format](#) on page 7369 (RGB)
[Targa Image File](#) on page 7370 (TGA, VDA, ICB, UST)
[TIF Image File](#) on page 7372 (TIF)

Devices Opens a dialog so you can send the rendered output to a device such as a video recorder.

Clear Clears any file or device selected in the Destination group box.

Driver group

These buttons are available only when you choose a device as the image source.

About Provides information on the source of the image-handler software used to bring the image into the software.

Setup Displays a setup dialog specific to the plug-in. Some plug-ins may not use this button.

Parameters group

Channel Lets you choose which channel you wish to save or send back in to the Render Effects stack. Choose Whole Image, Luminance, Depth, or Alpha to display more options in the Parameters group box.

Affect Source Bitmap When activated, this will take in an image with any effects previously applied, convert it to the channel selected, and send it back into the stack for the rest of the effects to be applied. Your rendered image will be saved in the channel selected. This parameter is not available to the Whole Image channel.

Active Turns the File Output feature on and off. Unlike the Active check box available in the Render Effects rollout, this check box is animatable allowing you to save only desired portions of a rendered scene.

Depth Parameters

When Depth is selected as a channel, new parameters are available for determining what parts of the scene should be rendered into the Depth channel image.

Copy After choosing a camera with the None button, click Copy to use the camera's clipping planes to determine which part of the scene should be rendered into the Depth channel image file.

None Enables you to select a camera to use for copying clipping planes. Click the none button to activate it. The None button will turn green until a camera has been selected in the viewport. The camera's name will then be displayed on the button instead of None.

Near Z Specifies the beginning distance from the camera that should be used in determining where to start rendering the scene's geometry in the depth channel image file.

Far Z Specifies the ending distance from the camera that should be used in determining where to stop rendering the scene's geometry in the depth channel image file.

Fit Entire Scene Makes all other Depth parameters unavailable and will render the entire viewport's scene geometry in the Depth channel image file, automatically calculating the near and far Z required.

Film Grain Rendering Effect

Rendering menu > Effects > Environment and Effects dialog > Effects panel > Add > Add Effect dialog > Film Grain

Film Grain is used to recreate the look of film grain in your rendered scene. Film Grain also allows you to match film grain from source material used as a background, such as an AVI, to the rendered scene created in the software. When applied, Film Grain automatically randomizes to create the look of moving frames.

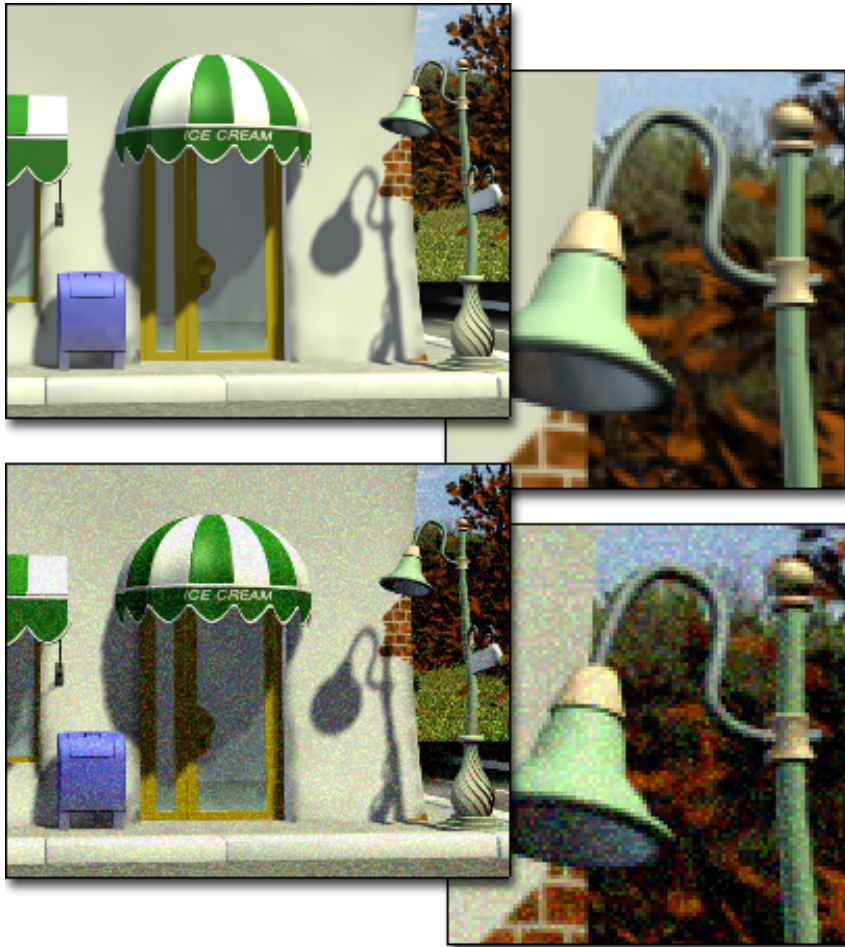

Before and after applying Film Grain to a scene

Interface

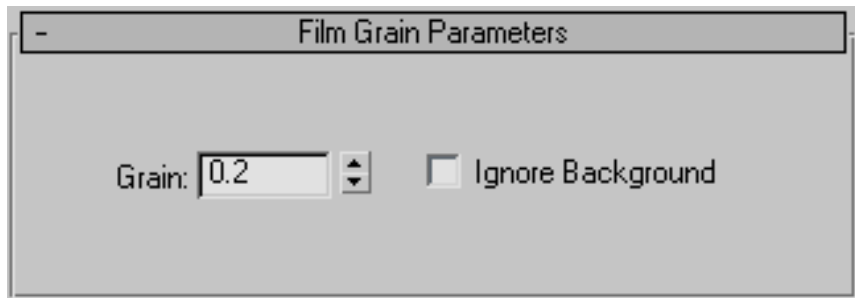

The Film Grain Parameters rollout contains the following controls.

Grain Sets the amount of grain added to your image. Range=0 to 1.0.

Ignore Background Masks the background so that grain is applied only to geometry and effects in the scene. Choose this option when you use film (which already contains grain) as the background image.

Motion Blur Rendering Effect

Rendering menu > Effects > Environment and Effects dialog > Effects panel > Add > Add Effect dialog > Motion Blur



Motion blur enhances the movement of the sword.

Motion Blur applies an [image motion blur](#) on page 8010 to your rendered scene by blurring moving objects or the entire scene. Motion blur can enhance the realism of a rendered animation by simulating the way a real-world camera works. A camera has a shutter speed, and if significant movement of objects in the scene, or of the camera itself, occurs during the time the shutter is open, the image on film is blurred.

NOTE In addition, you must set motion-blur characteristics for objects to be blurred using the [Object Properties dialog](#) on page 315.

Interface

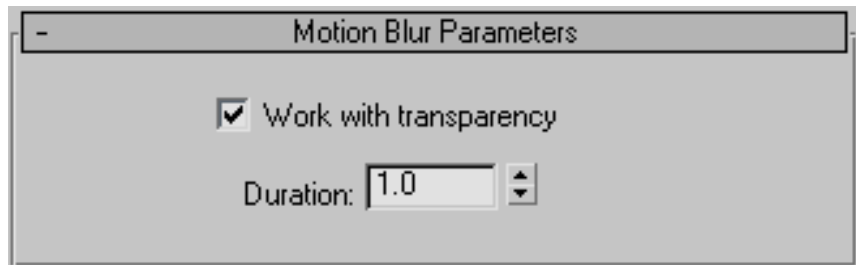

The Motion Blur Parameters rollout contains the following controls.

Work with transparency When on, motion blur is applied to objects behind transparent objects. When off, objects behind transparent objects receive no motion blur. Turning off this toggle can improve rendering speed. Default=on.

Duration Specifies how long the "virtual shutter" is open. When this is set to 1.0, the virtual shutter is open for the entire duration between one frame and the next. The higher the value, the greater the motion blur effect. Default=1.0.

Depth of Field Rendering Effect

Rendering menu > Effects > Environment and Effects dialog > Effects panel > Add > Add Effect dialog > Depth of Field



Depth of field emphasizes the scooter.

The Depth-of-Field effect simulates the natural blurring of foreground and background scene elements when viewed through a camera lens. Depth of Field works by separating the scene in Z order into foreground, background, and in-focus images. The foreground and background images are then blurred according to the values set in the Depth of Field effect parameters and the final image is composited from the processed originals.

NOTE When additional Render Effects are being applied to an image or animation, the Depth-of-Field effect should be the last effect to be rendered. The order of the rendered effects is listed in the Effects tab of the Environment and Effects dialog.

TIP To minimize sampling artifacts in out-of-focus areas with the default scanline renderer, try using the Blend filter in the [Render Setup dialog](#) on page 6067 > Renderer panel > Antialiasing group.

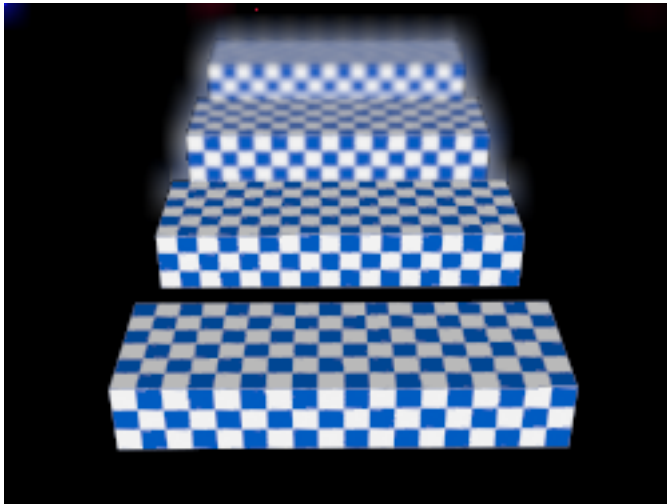
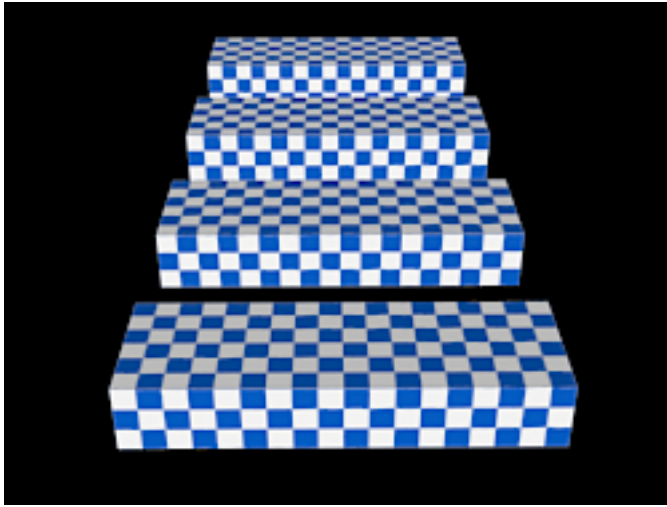

Before and after applying Depth of Field effect to scene.

Interface

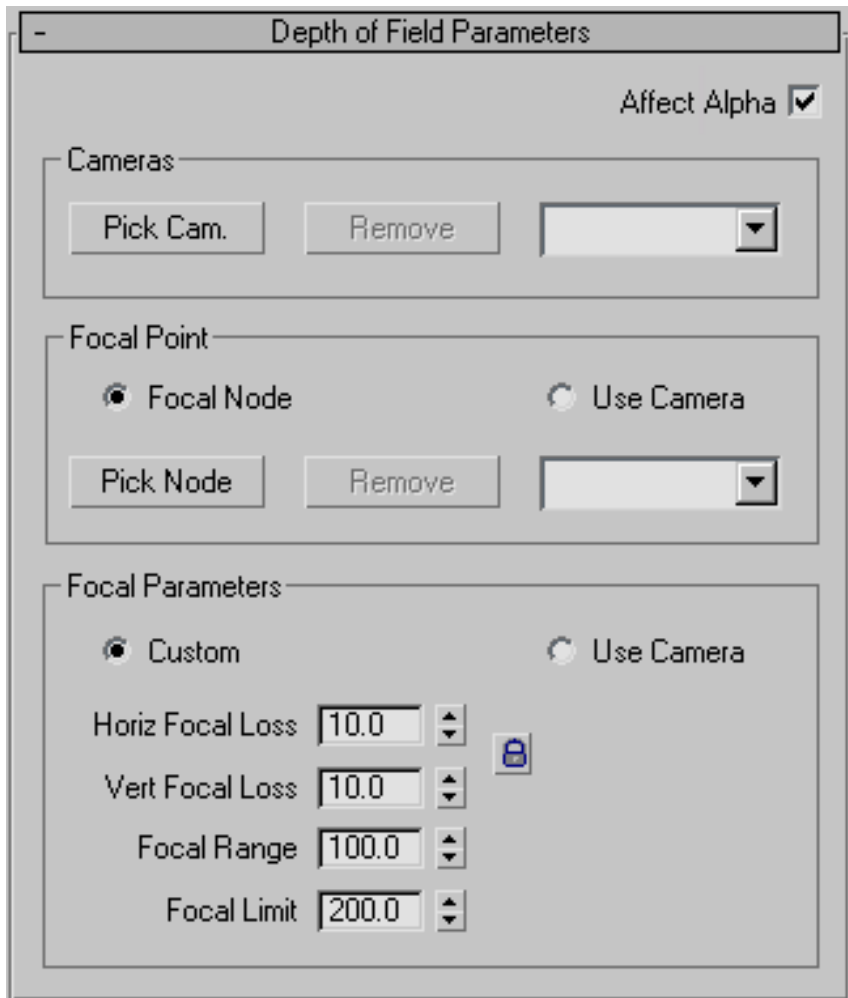

The Depth of Field Parameters rollout contains the following parameters. **Affect Alpha** Affects the alpha channel of the final rendering when on.

Cameras group

Pick Cam Enables you to interactively select from the viewport which camera you want the Depth of Field effect applied to.

Remove Deletes the camera currently selected in the drop-down list.

Camera Selection List Lists all of the cameras to be used in the effect. You can use this list to highlight a specific camera and remove it from the list using the Remove button.

Focal Point group

Pick Node Enables you to select an object to use as the focal node. When activated you can select an object directly from the viewports to use as the focal node. You can also press H to display the Pick Object dialog, which lets you select a focal node from a list of objects in the scene.

Remove Removes the object selected as the Focal Node.

Use Camera Specifies that the focal length from the camera selected in the Camera Selection list be used to determine the focal point.

Focal Parameters group

Custom Uses the values set in the Focal Parameters group box to determine the properties of the Depth of Field effect.

Use Camera Uses the values from the camera highlighted in the Camera Selection list to determine focal range, limit, and blur.

Horiz Focal Loss Determines the amount of blur along the horizontal axis when Custom has been chosen.

Vert Focal Loss Controls the amount of blur along the vertical axis when Custom has been chosen.

Focal Range Sets the Z distance, in units, to either side of the focal point in which the image will remain in focus when Custom has been chosen.

Focal Limit Sets the Z distance, in units, to either side of the focal point where blur will reach its maximum as specified by the Loss spinners when Custom has been chosen.

Environment and Atmosphere Effects

Rendering menu > Environment > Environment and Effects dialog > Environment panel

Environment displays the [Environment panel](#) on page 6689, which is used for setting up atmospheric and background effects.

You can use the environment functions to:

- Set and animate the background color.
- Use an image in the background of the rendered scene (screen environment) or use texture maps as spherical, cylindrical, or shrink-wrap environments.
- Set and animate the [ambient light](#) on page 7906.
- Use atmospheric plug-ins, such as volumetric light, in the scene.
- Apply exposure controls to renderings.

Atmospheres

Atmospheres are [plug-in](#) on page 8092 components that create lighting effects such as fog, fire, and so on.

[Fire Environment Effect](#) on page 6696

[Fog Environment Effect](#) on page 6707

[Volume Fog Environment Effect](#) on page 6713

[Volume Light Environment Effect](#) on page 6721

See [Environment dialog](#) on page 6689 for all environment parameters.

Exposure Controls

One of the limitations of rendering perceptually accurate images is the limited dynamic range of computer monitors. Dynamic range is the ratio of the highest to lowest intensity a monitor can produce. In a dark room this ratio is approximately 100 to 1. In a bright room, this drops to approximately 30 to 1. Real environments can have dynamic ranges of 10,000 to 1, or larger.

[Exposure Controls](#) on page 6732 map light-energy values to colors in a process known as *tone mapping*. They affect the brightness and contrast of both rendered images and viewport displays. They don't affect the actual lighting levels in the scene, but only how those levels are mapped to a valid display range.

- [Automatic Exposure Control](#) on page 6735
- [Logarithmic Exposure Control](#) on page 6740
- [Linear Exposure Control](#) on page 6738
- [mr Photographic Exposure Control](#) on page 6744

- [Pseudo Color Exposure Control](#) on page 6753

Environment Panel

Rendering menu > Environment > Environment and Effects dialog > Environment panel

Rendered Frame Window > Environment and Effects Dialog Toggle > Environment panel

Use the Environment panel to:

- Set and animate the background color.
- Use an image in the background of the viewport and rendered scene (screen environment) or use texture maps as spherical, cylindrical, or shrink-wrap environments.
- Set and animate the tint and [ambient light](#) on page 7906 globally.
- Use atmospheric plug-ins, such as volumetric light, in the scene. Atmospheres are [plug-in components](#) on page 8092 that create light effects such as [fire](#) on page 6696, [fog](#) on page 6707, [volume fog](#) on page 6713, and [volume light](#) on page 6721.
- Apply [exposure controls](#) on page 6732 to renderings.

Procedures

To access environment functions, do one of the following:

- 1 Choose Rendering > Environment.
- 2 On the Environment and Effects dialog, click the Environment tab.

To set the background color:

- 1 Choose Rendering > Environment.
The Environment panel appears.
- 2 In the Background group, click the color swatch.
A [Color Selector](#) on page 391 appears.
- 3 Use the Color Selector to change the background color.

The Renderer now uses this color as a background.

To choose an environment map:

- 1 Display the Material Editor.
You adjust the map's parameters with the Material Editor.
- 2 Choose Rendering > Environment.
- 3 Under Background on the Environment panel, do one of the following:
 - Click the Environment Map button. The Material/Map Browser appears. Choose a map type from the list.
 - Drag a map to the Environment Map button. You can do this from a map displayed in one of the Material Editor's sample slots, or from any map button that has been assigned, either in the Material Editor or from a projection light, and so on.
Drag a bitmap from the Material Editor's map preview to the Environment Map button.

On the Environment panel, the name of the Environment Map button changes to show the type of map you chose, and Use Map turns on.

After you have set up the map, you can later turn off Use Map to test rendering the scene without the mapped background.

You have set up the environment map, but to assign a bitmap or adjust map parameters, you need to use the Material Editor.

You can also create a standalone map in the Material Editor first, and then choose it with the Material/Map Browser.

To put the map in the Material Editor:

- Drag the Environment Map button to a sample slot.
The map is now in the Material Editor where you can adjust it by changing its parameters.

To change the color and tint of global lighting:

- 1 Choose Rendering > Environment.
- 2 Click the color swatch labeled Tint.
A [Color Selector](#) on page 391 appears.

- 3 Use the color selector to set the tint applied to all lighting except ambient light.
- 4 Use the Level spinner to multiply the overall lighting of the scene. Shaded viewports update to show global lighting changes.
- 5 Close the Environment dialog.
3ds Max uses the global lighting parameters when you render the scene.

To change the color of ambient light:

TIP You don't need to adjust ambient light if you are using [radiosity](#) on page 6168.

- 1 Choose Rendering > Environment.
- 2 Click the color swatch labeled Ambient.
A [Color Selector](#) on page 391 appears.
- 3 Use the color selector to set the ambient color.
Shaded viewports update to show ambient color changes.
3ds Max also uses the new ambient color when you render the scene.
The color of ambient light tints the scene. For most renderings, the color of ambient light should be black.
- 4 Close the Environment dialog.

To change the intensity of ambient light:

TIP You don't need to adjust ambient light if you are using [radiosity](#) on page 6168.

- 1 Choose Rendering > Environment.
- 2 Click the color swatch labeled Ambient Light.
A [Color Selector](#) on page 391 appears.
- 3 Change the Value setting (the V component of the ambient light's HSV description) to increase or decrease intensity.
Shaded viewports update to show changes in the ambient light intensity.
- 4 Close the Color Selector.
The intensity of ambient light affects contrast as well as overall illumination (the higher the intensity of ambient light, the lower the

contrast). This is because ambient light is completely diffuse, so the angle of incidence is equal for all faces. Ambient light alone cannot show depth.

NOTE 3ds Max has a default ambient light setting. You can change the default by using the Rendering panel of the Preference Settings dialog.

To add an atmospheric effect:

- 1 Choose Rendering > Environment.
The Environment and Effects dialog is displayed, with the Environment panel visible.
- 2 Under Atmosphere on the Environment panel, click Add.
The Add Atmospheric Effect dialog appears.
- 3 Choose the kind of effect you want to use, and then click OK.
The effect has now been added. Use the Atmosphere rollout to adjust parameters.

Interface

Common Parameters rollout

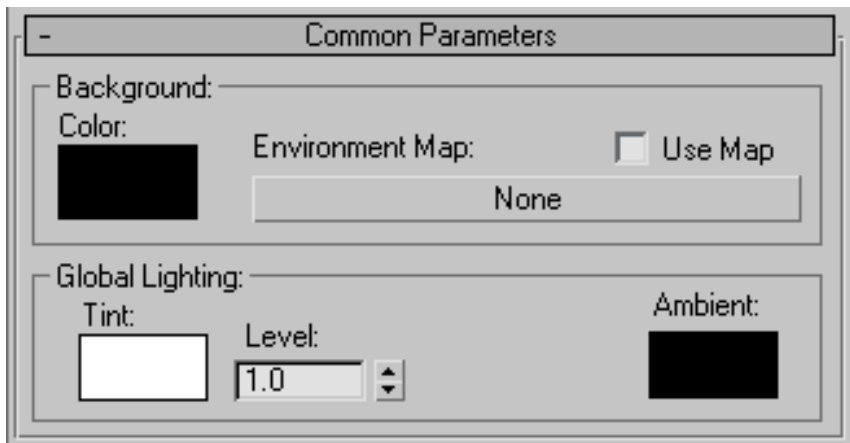

Background group

Color Sets the color for the scene background. Click the color swatch, then select the color you want in the Color Selector. You can animate the color

effect by changing the background color at a nonzero frame with the Auto Key button on.

Environment Map The button for [Environment Map](#) on page 7964 displays the name of the map, or “None” if none has been assigned. The map must use Environmental [mapping coordinates](#) on page 8034 (spherical, cylindrical, shrink wrap, and screen).

To assign an environment map, click the button and use the Material/Map Browser to choose a map, or drag a map from a sample slot or map button in the Material Editor (or anywhere else in the software; for example, a Projector Map button) and drop the map on the Environment Map button. A dialog asks if you want the environment map to be a copy (independent) or an instance of the source map.

NOTE If your scene includes animated bitmaps, including materials, projector lights, environments, and so on, the animation file is reloaded once per frame. Rendering performance slows down when your scene uses multiple animations, or the animations are themselves large files.

To adjust the environment map's parameters, for example to assign a bitmap or change the coordinate settings, open the Material Editor, drag the Environment Map button, and drop it over an unused sample window.

Use Map Uses a map for the background rather than the background color.

Global Lighting group

Tint Tints all lights in the scene (except for ambient light) if this color is anything other than white. Click the color swatch to display the Color Selector, on which you can choose the tint color. You can animate the tint color by changing it at a nonzero frame with the Auto Key button on.

Level Multiplies all lights in the scene. A Level of 1.0 preserves the original, individual light settings. Increasing the Level raises the lighting for the overall scene, and decreasing the Level lowers the overall lighting. This parameter is animatable. Default=1.0.

Ambient Sets the color for the ambient light. Click the color swatch, and choose the color you want in the Color Selector. You can animate the light effect by changing the ambient light color at a nonzero frame with the Auto Key button on.

Atmosphere rollout

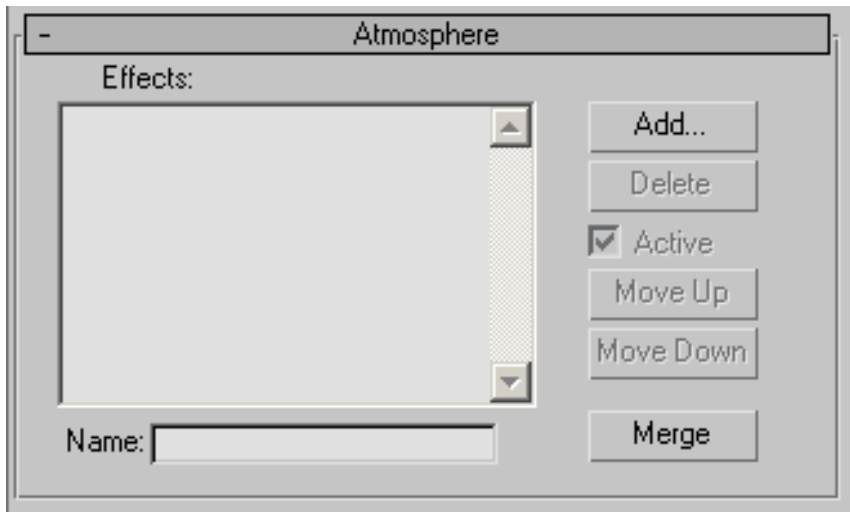

Effects Shows the queue of effects that were added. The effects are evaluated in linear order within the scene during rendering. Depending on the selected effect, the Environment dialog adds the appropriate rollout for the effect's parameters.

Name Gives a custom name to effects in the list.

For example, you might have different custom settings for different kinds of fire, that you could name Spark and Fireball.

Add Displays the Add Atmospheric Effect dialog (all currently installed atmospheric effects). Select an effect and click OK to assign an effect to the list.

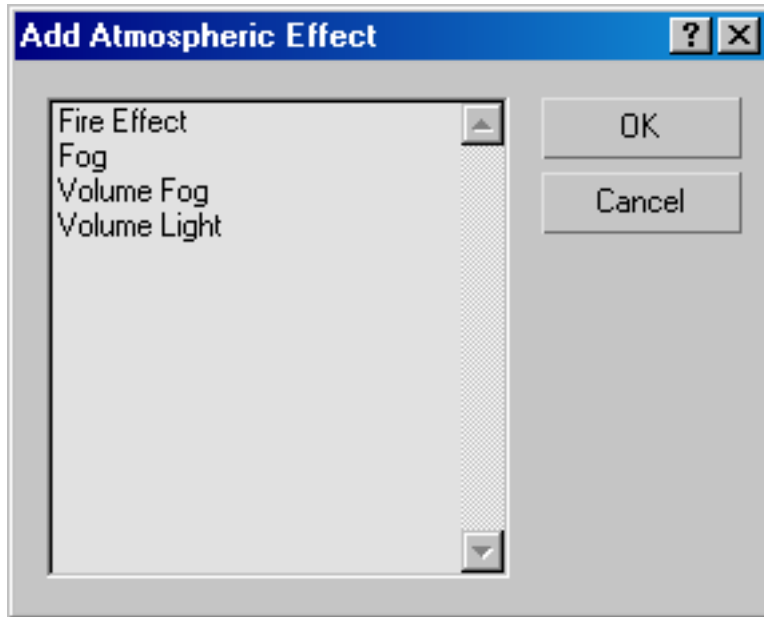

Delete Deletes a selected atmospheric effect from the list.

Active Sets the on/off state for the individual effects in the list. This is a convenient way to isolate effects within a list of complicated atmospheric functions.

Move Up / Move Down Moves the selected item in the list up or down to change the order in which the atmospheric effects are applied.

Merge Merges effects from other 3ds Max scene files.

When you click Merge, the Merge Atmospheric Effects dialog appears. Choose a 3ds Max scene, and then click Open. The Merge Atmospheric Effects dialog then lists the effects in the scene that can be merged. Select one or more of the effects, and then click OK to merge them into the scene.

The list shows the names of the atmospheric effects only, but when you merge an effect, the lights or gizmos bound to that effect are merged as well. If one of these objects you're merging has the same name as one already in the scene, an alert appears giving you the following choices:

- You can rename the incoming object by changing its name in the editable field.
- You can Merge the incoming object without renaming, resulting in two objects in the scene with the same name.

- You can delete the existing object in the scene by selecting the Delete Old button.
- You can select Apply To All Duplicates, which performs the same action to all subsequent matching objects.

NOTE To control whether or not the renderer uses the environment map's alpha channel in creating the alpha for the rendered image, choose Customize > Preferences > Rendering, and then turn on Use Environment Alpha in the Background Antialiasing group.

If Use Environment Alpha is turned off (the default) the background receives an alpha of 0 (completely transparent). If Use Environment Alpha is turned on, the alpha of the resulting image is a combination of the scene and background image's alpha. Also, when writing TGA files with Pre-Multiplied Alpha set to off, turning on Use Environment Alpha prevents incorrect results. Note that only background images with alpha channels or black backgrounds are supported when compositing in other programs such as Photoshop®.

NOTE To control whether or not a background image is affected by the renderer's antialiasing filter, choose Customize > Preferences > Rendering and then turn on Filter Background in the Background Antialiasing group. Default=off.

Fire Environment Effect

Rendering menu > Environment > Environment and Effects dialog > Environment panel > Atmosphere rollout > Add > Fire Effect



Scene using fire

Use Fire to produce animated fire, smoke, and explosion effects. Possible uses for Fire effects include campfires, torches, fireballs, clouds, and nebula.

You can add any number of fire effects to a scene. The order of effects is important because effects near the bottom of the list are layered in front of effects near the top of the list.

Each effect has its own parameters. When you select a fire effect in the Effects list, its parameters appear in the Environment dialog.

Fire renders only in Camera or Perspective views. Orthographic or User views don't render Fire effects.

TIP Fire doesn't support completely transparent objects. Set the transparency of Fire objects accordingly. Use visibility rather than transparency to make Fire objects disappear.

NOTE The Fire effect does not cast any light or shadows in the scene. To simulate illumination, you must also create lights. To cast shadows, you need to go to the [Shadows Parameters rollout](#) on page 5099 of your lights, and turn on Atmosphere Shadows.

Procedures

To create fire effects:

- 1 Create one or more atmospheric apparatus objects to locate the fire effect in your scene.
- 2 Define one or more fire atmospheric effects on the Environment panel.
- 3 Assign atmospheric apparatus objects to the fire effects.

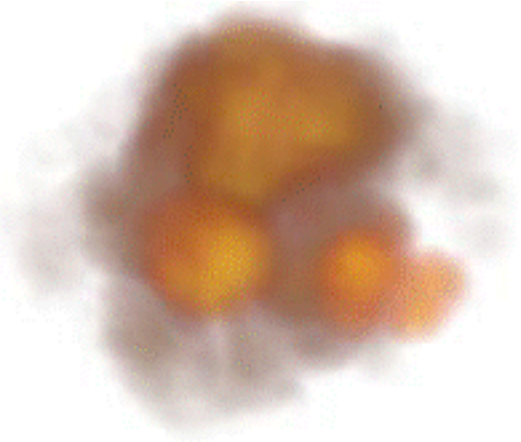

Sample fire effects

Example: To create a campfire:

- 1 Click Helpers on the Create panel and choose [Atmospheric Apparatus](#) on page 6761 from the subcategory list.
- 2 Click Sphere Gizmo. Drag the cursor in the Top viewport to define an apparatus radius of about 20 units. Turn on the Hemisphere check box in Sphere Gizmo Parameters.
- 3 Click Non-Uniform Scale. Click Yes in the Warning dialog (this warning doesn't apply to atmospheric gizmos), and scale the apparatus 250 percent along its local Z axis only. You can then model logs, embers, and rocks around the base of the apparatus.
- 4 Open the Modify panel of the Sphere Gizmo. On the Atmosphere rollout, click Add and choose Fire from the Add Atmosphere dialog.

- 5 Highlight Fire in the Atmospheres list under the Atmospheres & Effects rollout. Click Setup.
- 6 Set the following parameters under Shape and Characteristics:
 - Flame Type=**Tendrils**
 - Stretch=**0.8**
 - Flame Size=**18.0**
 - Flame Density=**30.0**
- 7 Turn on Auto Key and advance to the end of the animation.
- 8 Set the following parameters under Motion:
 - Phase=**300.0**
 - Drift=**200.0**

The Fire effect doesn't cast any light in the scene. If you want to simulate illumination from the fire effect, you must create lights as well.

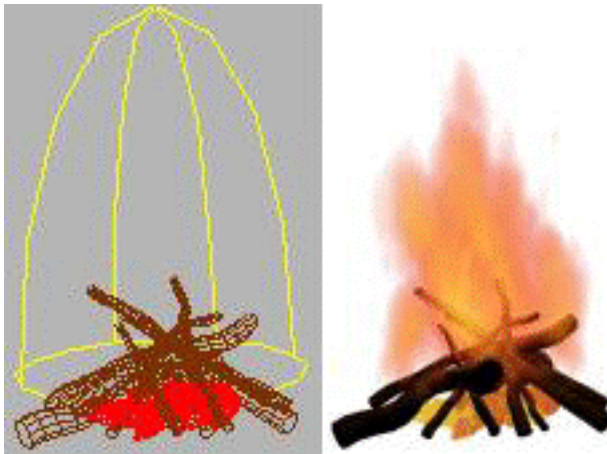

Example model with fire

Interface

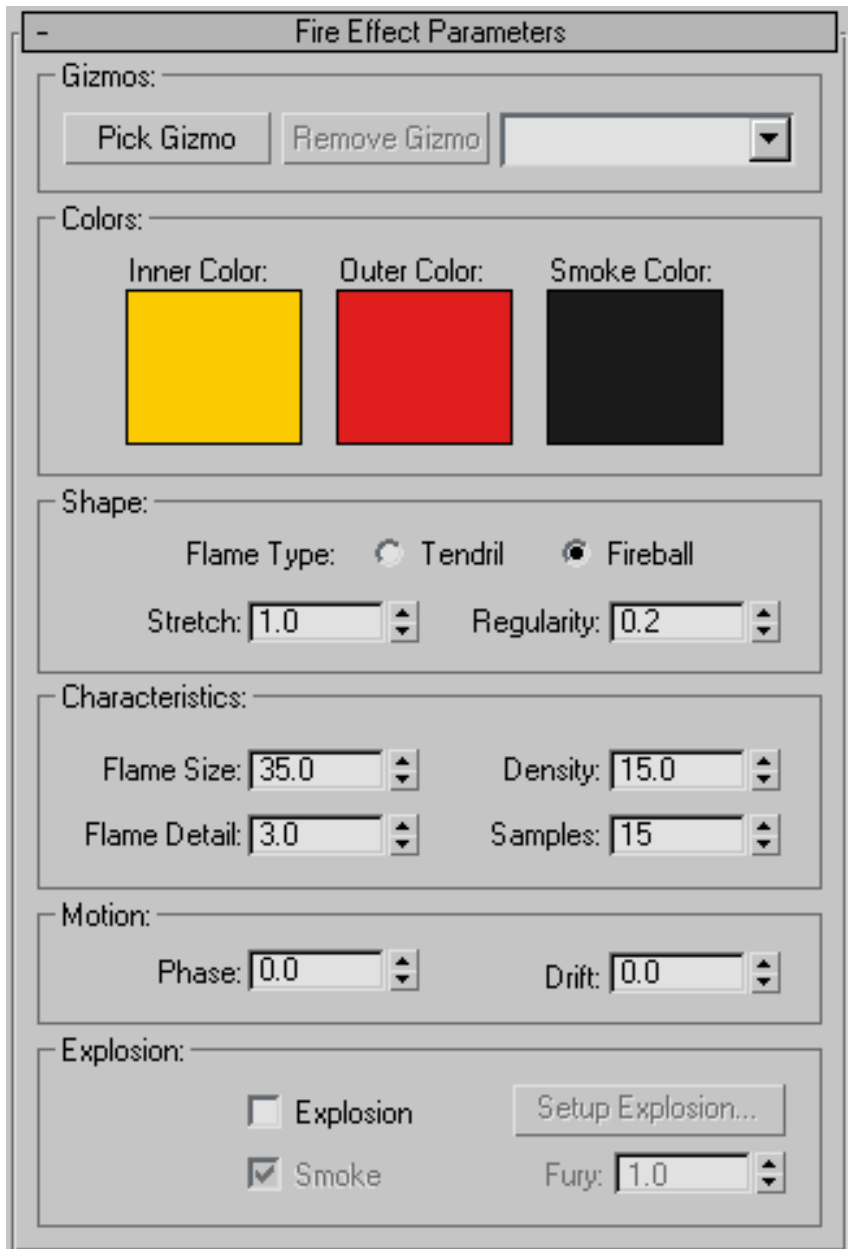

You create a fire apparatus, or "gizmo," to position the effect in your scene and to define the maximum boundaries of the effect. The apparatus is a Helper object found in the Atmospheric Apparatus subcategory.

There are three kinds of apparatus: [BoxGizmo](#) on page 6762, [SphereGizmo](#) on page 6768, and [CylGizmo](#) on page 6765.

You can move, rotate, and scale the apparatus, but you cannot apply modifiers.

Using non-uniform scale is a good way to change the shape of the apparatus for effects. (You will see a warning when you use this transform. Because you don't modify atmospheric apparatus, you can safely ignore the warning.)

Fire Parameters rollout

You must assign an atmospheric apparatus to a fire effect before you can render the effect. Use buttons in the Gizmos area to manage the list of apparatus objects.

Gizmos group

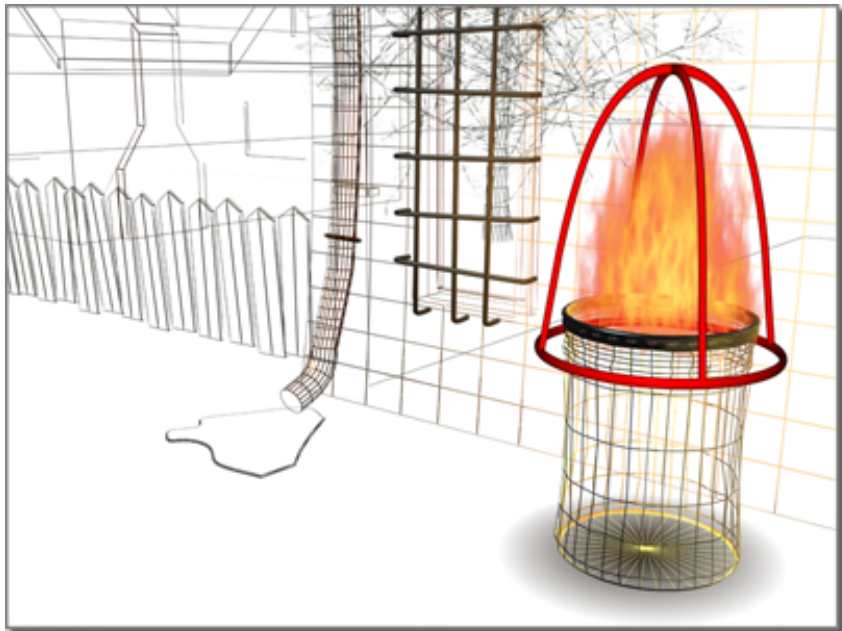

Gizmo for the fire in the scene shown at the beginning of this topic

Pick Gizmo Click to enter Pick mode and click an atmospheric apparatus in the scene. The apparatus displays the fire effect when you render. The name of the apparatus is added to the apparatus list.

Multiple apparatus objects can display the same fire effect. For example, torches on a wall can all use the same effect. Assign a different seed to each apparatus to vary the effect.

You can assign single apparatus to multiple fire effects. For example, one apparatus can display both a fireball and a tendril flame effect.

You can choose multiple gizmos. Click Pick Gizmo and press H. This opens the Pick Object dialog, which lets you choose multiple objects from the list.

Remove Gizmo Removes the gizmo selected in the gizmo list. The gizmo remains in your scene but it no longer displays the fire effect.

Gizmo List Lists apparatus objects assigned to the fire effect.

Colors group

You can set three color properties for a fire effect using the color swatches under Colors. Click a color swatch to display the software's [Color Selector](#) on page 391.

Inner Color Sets the color of the densest part of the effect. For a typical fire, this color represents the hottest part of the flame.

Outer Color Sets the color of the sparsest part of the effect. For a typical fire, this color represents the cooler, dissipating edge of the flame.

The fire effect is colored using a gradient between the inner and outer colors. The dense areas of the effect use the inner color and gradually blend to the outer color near the edges of the effect.

Smoke Color Sets the color of smoke for use with the Explosion option.

If you turn on Explosion and Smoke, the inner and outer colors animate to the smoke color. If you turn off Explosion or Smoke, the smoke color is ignored.

Shape group

You control the shape, scale, and pattern of flames within the fire effect using controls under Shape.

Two options set the direction and general shape of flames.

Tendrils Creates directional pointed flames with veins along their center. The flames orient along the local Z axis of the fire apparatus. Tendril creates campfire-like flames.

Fireball Creates round puffy flames. Fireballs are well suited for explosions.

Stretch Scales flames along the Z axis of the apparatus. Stretch works best with Tendril flames, but you can use it to give Fireballs an oval shape.

Values less than 1.0 compress flames, making them shorter and thicker.

Values greater than 1.0 stretch flames, making them long and skinny.

You can combine Stretch with non-uniform scaling of the apparatus. Use non-uniform scale to change the boundary of the effect and scale the shape of the flames.

Use the Stretch parameter to scale only the flames inside the apparatus. You can also use Stretch values to reverse the effect that scaling the apparatus had on the flames.



Effect of changing Stretch

Value=0.5, 1.0, 3.0

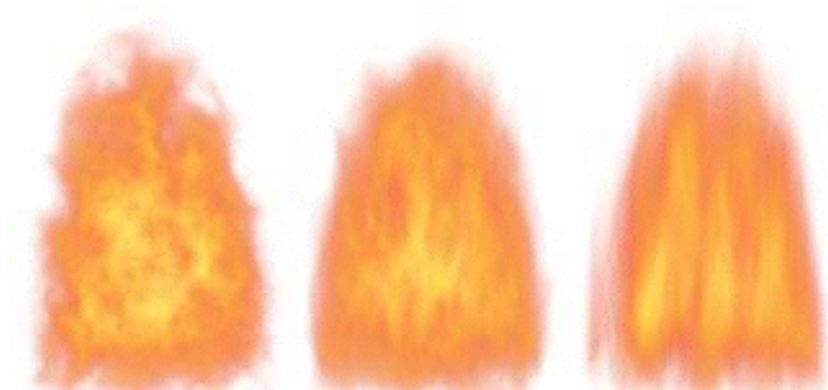

Non-uniform scaling of an apparatus

Stretch=0.5, 1.0, 3.0

Regularity Modifies how the flames fill the apparatus. Range=1.0 to 0.0.

A value of 1.0 completely fills the apparatus. The effect fades near the edges of the apparatus, but the overall shape is still very noticeable.

A value of 0.0 produces a very irregular effect that might occasionally reach the boundary of the apparatus, but usually gets trimmed back and is smaller.

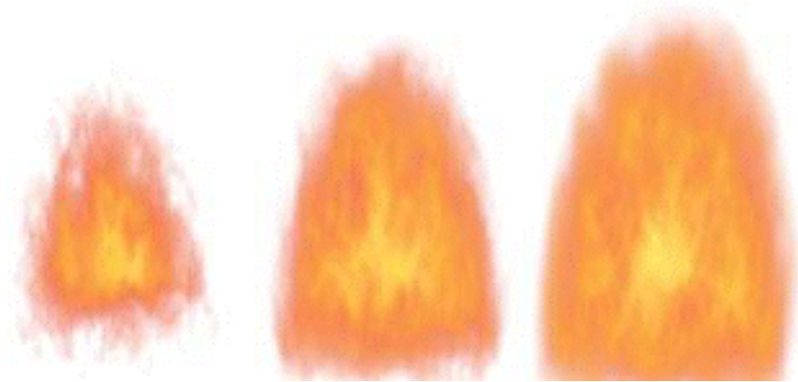

Effect of changing Regularity

Value=0.2, 0.5, 1.0

Characteristics group

You set the size and appearance of flames using parameters under Characteristics. All of these parameters depend on the apparatus size and are interdependent on each other. Changing one parameter affects the behavior of the other three.

Flame Size Sets the size of individual flames inside the apparatus. The size of the apparatus affects the flame size. A larger apparatus requires a larger flame size. Use a range from 15.0 to 30.0 for the best results.

Large values work best for Fireballs.

Small values work best for Tendrils.

If the flame size is very small, you might need to increase Samples to see individual flames.

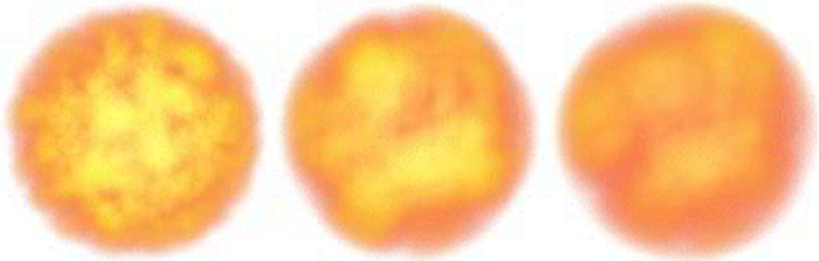

Effect of changing Flame Size

Value=15.0, 30.0, 50.0

Radius of apparatus=30.0

Flame Detail Controls the amount of color change and edge sharpness seen within each flame. Range=0.0 to 10.0.

Low values produce smooth, fuzzy flames and render faster.

High values produce patterned, sharp flames and render slower.

Use higher detail values for large flame sizes. If the detail value is greater than 4, you might need to increase Samples to capture the detail.



Effect of changing Flame Detail

Value=1.0, 2.0, 5.0

Density Sets the opacity and brightness of the fire effect. The size of the apparatus affects the density. A large apparatus with the same density as a small apparatus appears more opaque and brighter because of its larger size.

Low values make the effect less opaque and use more of the outer color. High values make the effect more opaque and brighten the effect by gradually replacing the inner color with white. The higher the value, the more white the center of the effect is.

If you turn on Explosion, Density animates from 0.0 at the start of the explosion to the set density value at the peak of the explosion.

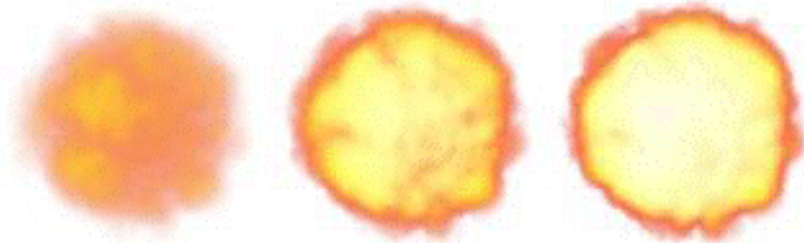

Effect of changing Flame Density

Value=10, 60, 120

Samples Sets the rate at which the effect is sampled. Higher values produce more accurate results but take longer to render.

You might consider raising the samples value under the following conditions:

- Flame Size is small.
- Flame Detail is greater than 4.
- Any time you see color banding in the effect. The chance of color banding increases if a flat surface intersects the fire effect.

NOTE 100 percent transparent objects that intersect the effect become partially visible. To use particles with Fire, consider using 3D particles instead of opacity-mapped particles.

Motion group

Use the parameters in the Motion group to animate the churning and rise of flames.

Phase Controls the rate of change for the fire effect. Turn on Auto Key and change the phase value at different times.

Drift Sets how flames are rendered along the Z axis of the fire apparatus. The value is the amount of rise in units.

Low values give a slow-burning, cool fire.

High values give a fast-burning, hot fire.

For the best fire effects, drift should be a multiple of the height of the fire apparatus.

You can also animate the location and size of the fire apparatus and most of the fire parameters. For example, a fire effect can animate color, size, and density.

Explosion group

Use the parameters in the Explosion group to automatically animate explosions.

Explosion Animates size, density, and color automatically based on the animation of the Phase value.

Smoke Controls whether or not the explosion creates smoke.

When on, fire colors change to smoke between Phase values 100 to 200. Smoke clears between Phase values 200 to 300. When off, fire colors remain at full density between Phase values 100 to 200. Fire fades away between Phase values 200 to 300.

Fury Varies the churning effect of the Phase parameter.

Values greater than 1.0 cause faster churning. Values less than 1.0 cause slower churning.

Set Up Explosion Displays the Set Up Explosion Phase Curve dialog. You enter a start time and end time, and then click OK. The Phase value animates automatically for a typical explosion effect.

Fog Environment Effect

Rendering menu > Environment > Environment and Effects dialog > Environment panel > Atmosphere rollout > Add > Fog



Fog added to a scene

This command provides fog and smoke atmospheric effects. This [plug-in](#) on page 8092 provides effects such as fog which causes objects to appear to fade as they increase in distance from the camera (standard fog), or layered fog that envelops all or parts of objects in a blanket of mist.

Fog renders only in Camera or Perspective views. Orthographic or User views don't render Fog effects.

Procedures

To use standard fog:

- 1 Create a Camera view of your scene.
- 2 In the camera's creation parameters, turn on Show in the Environment Ranges group.
Standard fog is based on the camera's environment range values.
- 3 Set Adjust Near Range and Far Range to include the objects you want to fog in your rendering.

As a general guideline, set Far Range just beyond the objects, and Near Range to intersect the object geometry closest to the camera.

- 4 Choose Rendering > Environment.
- 5 Under Atmosphere on the Environment panel, click Add.
The Add Atmospheric Effect dialog is displayed.
- 6 Choose Fog, and then click OK.
- 7 Make sure you choose Standard as the type of fog.

To use layered fog:



- 1 Create a Camera or Perspective view of your scene.
- 2 Choose Rendering > Environment.
- 3 Under Atmosphere on the Environment panel, click Add.
The Add Atmospheric Effect dialog is displayed.
- 4 Choose Fog, and then click OK.
- 5 Choose Layered as the fog type.
- 6 Set the parameters for layered fog.
You can have multiple fog layers in the scene by adding multiple Fog entries to the list and choosing Layered.

Interface

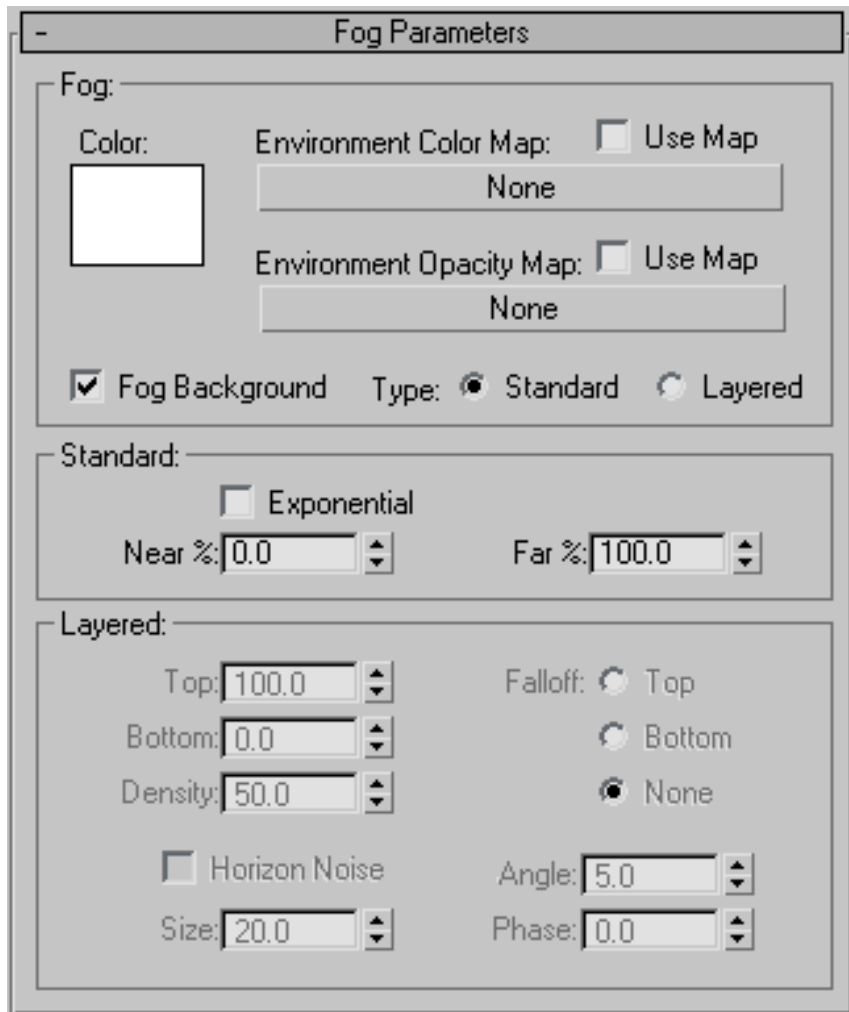

The Fog Parameters rollout appears when you select Fog under Effects in the Environment dialog. The Fog Parameters rollout has the following controls.

Fog group

Color Sets the color for the fog. Click the color swatch, and then select the color you want in the [Color Selector](#) on page 391. You can animate the color

effect by changing the fog color at a nonzero frame with the Auto Key button on.

Environment Color Map Derives the fog color from a map. You can map the background and the fog color, you can animate the procedural map parameters in Track View or Material Editor, and you can opacity-map the fog.

The large button displays the name of the color map, or None if no map is assigned. The map must use Environmental [mapping coordinates](#) on page 8034 (spherical, cylindrical, shrinkwrap, and screen).

To assign the map you can drag a map from a Sample slot or Map button in the Material Editor (or anywhere else in the software; for example, a projector map button) and drop it on the Environment Color Map button. A dialog asks if you want the environment map to be a copy (independent) or an instance of the source map.

Clicking the Environment Color Map button displays the Material/Map Browser, where you can choose a map type from the list. To adjust the environment map's parameters, open the Material Editor and drag the Environment Color Map button over an unused sample slot.

Use Map Toggles the effect of this map on or off.

Environment Opacity Map Alters the density of the fog.

You assign the opacity map, edit it, and toggle its effect in the same way as the Environment Color Map.

Fog Background Applies the fog function to the background of the scene.

Type When you choose Standard it uses the parameters in the Standard section and when you choose Layered is selected it uses the parameters in the Layered section.

Standard Enables the Standard group.

Layered Enables the Layered group.

Standard group

Thins and thickens the fog based on the distance from the camera.

Exponential Increases density exponentially with distance. When turned off, density increases linearly with distance. Activate this check box only when you want to render transparent objects in volume fog.

TIP If you turn on Exponential, this increases the Step Size value to avoid banding.

Near % Sets the density of the fog at the Near Range (Camera Environment Range parameter).

Far % Sets the density of the fog at the Far Range (Camera Environment Range parameter).

Layered group

Thins and thickens the fog between an upper and lower limit. You can have multiple layers of fog by adding multiple fog entries to the list. Because you can animate all the fog parameters, you can also animate fog rising and falling, changing density and color, and add [horizon](#) on page 8005 noise.

Top Sets the upper extent (in world units) of the fog layer.

Bottom Sets the lower extent (in world units) of the fog layer.

Density Sets the overall density of the fog.

Falloff (Top/Bottom/None) Adds an exponential falloff effect so that the density is reduced to 0 at either the Top or Bottom of the fog extent.

Horizon Noise Turns on the horizon noise system. Horizon Noise perturbs just the horizon of the fog layer to add realism.

Size Scale factor applied to the noise. Larger scale values make the fog tendrils larger. Default=20.

TIP If you want tendrils to really pop out, try making the density greater than 100.

Angle Determines the affected angle off the horizon line. For example, if the angle is set to 5 (a reasonable value), then starting at 5 degrees below the horizon, the fog will begin to break up.

This effect is mirrored above and below the horizon, which can produce strange results when the height of the fog layer traverses the horizon. Typically you'd want the fog to be either above or below the actual camera horizon. (You can use the horizon line in the camera parameters as an aid to help you position this.)

Phase Animating this parameter animates the noise. If Phase is moving in the positive direction, then the fog tendrils will drift upward (and deform at the same time). If your fog is above the horizon you may want to animate Phase in the negative direction to make the tendrils fall downward.

Volume Fog Environment Effect

Rendering menu > Environment > Environment and Effects dialog > Environment panel > Atmosphere rollout > Add > Volume Fog



Volume fog added to a scene

Volume Fog provides a fog effect in which the fog density is not constant through 3D space. This [plug-in](#) on page 8092 provides effects such as puffy, cloudy fog that appears to drift and break up in the wind.

Volume Fog renders only in Camera or Perspective views. Orthographic or User views don't render Volume Fog effects.

Procedures

To use volume fog:

- 1 Create a Camera or Perspective view of your scene.
- 2 Choose Rendering > Environment.
- 3 Under Atmosphere on the Environment panel, click Add.

The Add Atmospheric Effect dialog is displayed.

- 4 Choose Volume Fog, and then click OK.
- 5 Set the parameters for volume fog.

NOTE If there are no objects in your scene, rendering shows only a solid fog color. Also, with no objects and Fog Background turned on, volume fog obscures the background.

To create a volume fog gizmo:

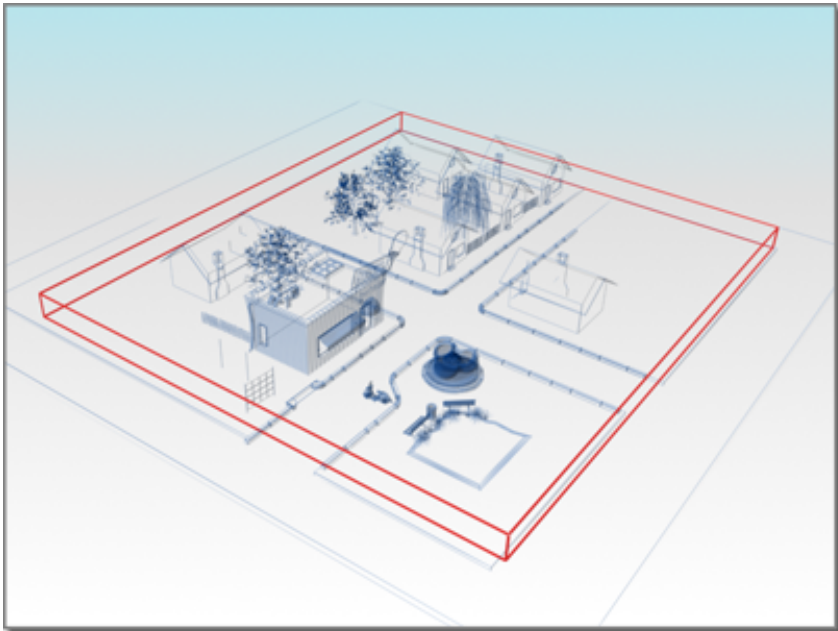

Volume fog gizmo surrounds the scene.

- 1 In the Helpers category of the Create panel, choose Atmospheric Apparatus from the pop-up menu.
- 2 Click one of the buttons to choose a gizmo shape: SphereGizmo, CylGizmo, or BoxGizmo.
- 3 Drag the mouse in the viewport to create the gizmo.
You create Gizmos in much the same way as their matching geometry types. Drag the mouse to create the initial dimensions. The Sphere gizmo

has an additional Hemisphere check box that turns the sphere into a hemisphere.

In addition, each gizmo has a Seed spinner and a New Seed button. Different seed values generate different patterns. Clicking the New Seed button randomly generates a new seed value for you.

To assign volume fog to a gizmo from an apparatus modify panel:

- 1 Open the Modify panel of an apparatus.
- 2 Open the Atmospheres & Effects rollout.
- 3 Click Add.
- 4 Select Volume Fog from the Add Atmospheres dialog and click OK.
- 5 Highlight Volume Fog from the Atmospheres list and click setup to adjust the Volume Fog parameters.

To assign a gizmo to volume fog from the Environment panel:

- 1 On the Volume Fog Parameters rollout, click the Pick Gizmo button.
- 2 Click a gizmo in the viewport.
The name of the gizmo appears in the list field at right.
When you render, the volume fog will be confined to the shape of the gizmo.

To remove an assigned gizmo:

- 1 In the Environment dialog, go to the Volume Fog Parameters rollout
- 2 Select the gizmo name from the pop-up list.
- 3 Click Remove Gizmo.
This action doesn't delete the gizmo from the scene, but simply unbinds it from the fog effect.

Interface

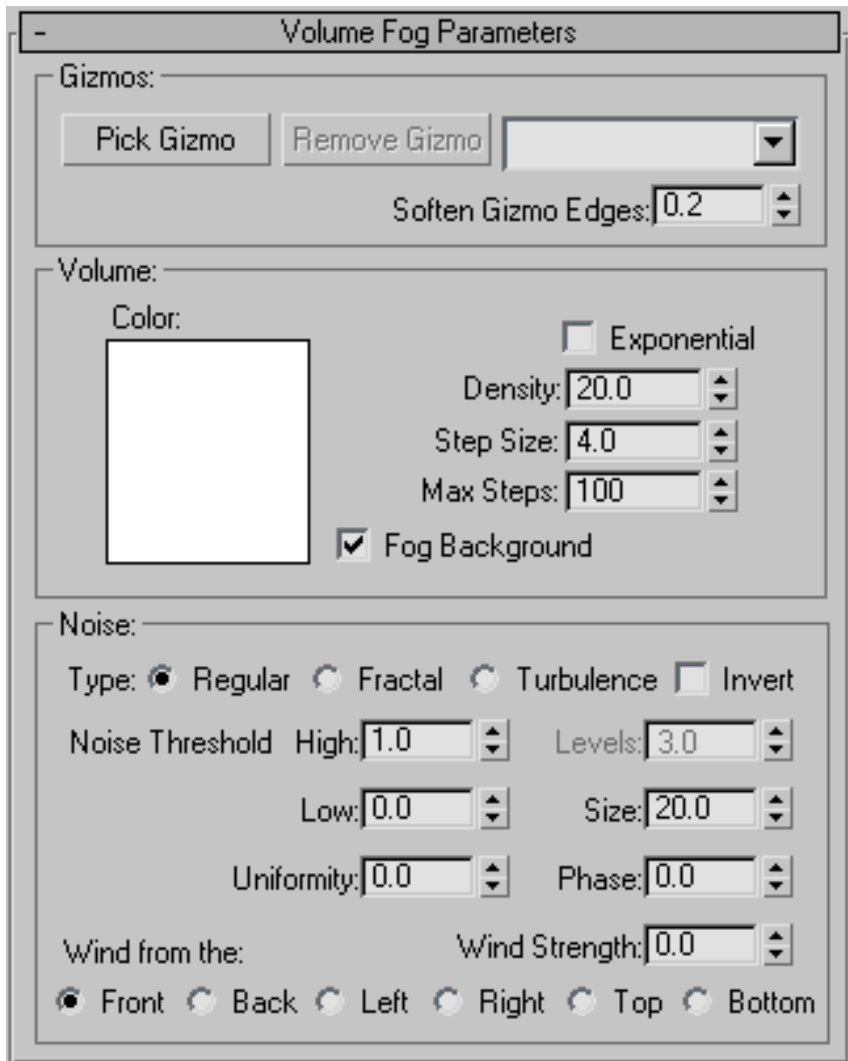

The Volume Fog Parameters rollout appears when you select Volume Fog under Effects in the Environment dialog. The Volume Fog Parameters rollout has the following controls.

Gizmos group

By default, volume fog fills the entire scene. However, you can choose a gizmo (an atmospheric apparatus) to contain the fog. The gizmo can be a sphere, a box, a cylinder, or some combination of these.

Pick Gizmo Click to enter Pick mode and click an atmospheric apparatus in the scene. The apparatus contains the volume fog when you render. The name of the apparatus is added to the apparatus list.

Multiple apparatus objects can display the same fog effect.

You can pick multiple gizmos. Click Pick Gizmo and then press H. This opens the Pick Object dialog, which lets you choose multiple objects from a list.

Changing the dimensions of a gizmo changes the region that fog affects, but doesn't change the scale of the fog and its noise. For example, reducing the radius of a spherical gizmo crops the fog, and moving the gizmo changes the fog's appearance.

Remove Gizmo Removes a gizmo from the volume fog effect. Select the gizmo in the list, and then click Remove Gizmo.

Soften Gizmo Edges Feathers the edges of the volume fog effect. The higher the value, the softer the edges. Range=0 to 1.0.

TIP Don't set this value to 0. At 0, Soften Gizmo Edges can cause aliased edges.

Volume group

Color Sets the color for the fog. Click the color swatch, and then select the color you want in the [Color Selector](#) on page 391.

You can animate the color effect by changing the fog color at a nonzero frame with Auto Key on.

Exponential Increases density exponentially with distance. When turned off, density increases linearly with distance. Activate this check box only when you want to render transparent objects in volume fog.

TIP If you turn on Exponential, increase the Step Size value to avoid banding.

Density Controls the fog density. Range=0 to 20 (anything over that tends to obliterate the scene).



Left: Original scene

Right: Increased fog density

Step Size Determines the granularity of the fog sampling; the "fineness" of the fog. A large step size creates coarse (and to some extent, aliased) fog.

Max Steps Limits the amount of sampling so that computing the fog doesn't take forever (literally). This is especially useful when the fog is of low density. When both Step Size and Max Steps have low values, aliasing results.

Fog Background Applies the fog function to the background of the scene.

Noise group



Left: Original scene

Right: Noise added to the fog

Noise options for volume fog are comparable to the noise options for materials.

Type Choose one of three types of noise to apply.

Regular The standard noise pattern.

Fractal An iterative fractal noise pattern.

Turbulence An iterative turbulence pattern.

Invert Reverses the noise effect. Dense fog becomes translucent and vice versa.

Noise Threshold Limits the noise effect. Range=0 to 1.0. When the noise value is above the Low threshold and below the High threshold, the dynamic range stretches to fill 0-1. This makes for a smaller discontinuity (First order instead of 0 order) at the threshold transition, and thus produces less potential [aliasing](#) on page 7904.

High Sets the high threshold.

Low Sets the low threshold.

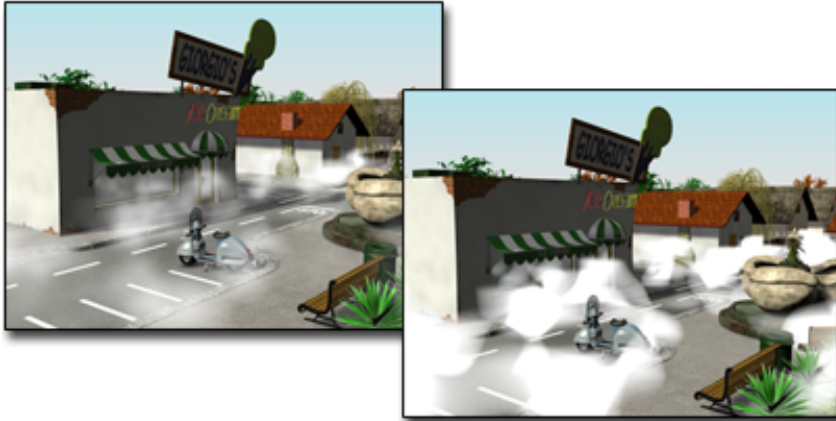

Left: Fog with noise

Right: Changing uniformity creates "blobby" fog

Uniformity Ranges from -1 to 1 and acts like a high-pass filter. The smaller the value, the more transparent the volume is with discrete blobs of smoke. Around -0.3 or so your image begins to look like specks of dust. Because the fog becomes thinner as this parameter gets smaller, you'll probably need to increase the density or the volume will start to disappear.

Levels Sets the number of times the noise is iteratively applied. Range=1 to 6, including fractional values. Enabled only for Fractal noise or Turbulence.

Size Determines the size of the tendrils of smoke or fog. Smaller values give smaller tendrils.



Left: Fog with noise

Right: Decreasing the size

Phase Controls the speed of the wind. If you have Wind Strength also set to greater than 0, the fog volume animates in accordance with the wind direction. With no Wind Strength, the fog churns in place. Because there's an animation track for phase, you can use the Function Curve editor to define precisely how you want your wind "gusts" to occur.

Wind Strength Controls how fast the smoke moves away from the wind direction, relative to phase. As mentioned above, if the phase is not animated then the smoke won't move, regardless of the wind strength. By having the phase animate slowly with a large wind strength, the fog moves more than it is churns.

Wind from the Defines the direction the wind is coming from.

Volume Light Environment Effect

Rendering menu > Environment > Environment and Effects dialog > Environment panel > Atmosphere rollout > Add > Volume Light



Volumetric light used in a complex environment with shadows and noise.

Volume Light provides light effects based on the interaction of lights with atmosphere (fog, smoke, and so on).

This [plug-in](#) on page 8092 provides effects such as radial glows for [omni lights](#) on page 8066, conical glows for spotlights, and parallel beams of fog for directional lights. Objects within the light volume can cast shadows within the spotlight's cone, if using shadow maps as a shadow generator.

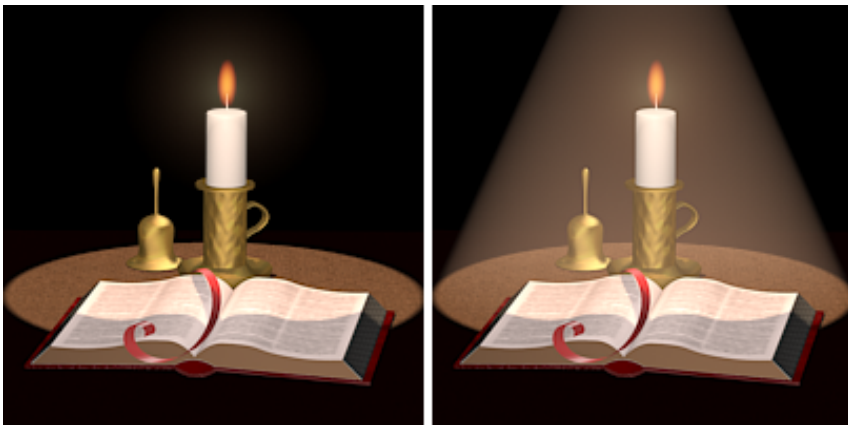

A simplified example where the light cone is clearly visible on the right.

Volume Light renders only in Camera and Perspective views. Orthographic or User views don't render Volume Light effects.

Procedures

To use Volume Light:

- 1 Create a scene with lights.
- 2 Create a Camera or Perspective view of your scene.

TIP Avoid making the view axis parallel to the cone of a spotlight. This tends to create only a washed-out scene, possibly with rendering artifacts.

- 3 Choose Rendering > Environment.
- 4 On the Environment panel, under Atmosphere , click Add.
The Add Atmospheric Effect dialog is displayed.
- 5 Choose Volume Light, and then click OK.
- 6 Click Pick Light, and then select a light in a viewport to add the light to the list of volume lights.
You can also use the Pick Object dialog to select multiple lights from a list. Click Pick Light, and then press H to open the dialog.
- 7 Set the parameters for volume light.

To add a light to the list:

- 1 Click Pick Light.
- 2 Click the light in a viewport.

To remove a light from the list:

- 1 Open the list of volume lights.
- 2 Choose the light you want to remove the volume light effect from.
- 3 Click Remove Light.

To assign volume light to a light through the Modify panel:

- 1 Open the Modify panel of a light.
- 2 Open the Atmospheres & Effects rollout.
- 3 Click Add.

- 4 Select Volume Light from the Add Atmosphere or Effect dialog and click OK.
- 5 Highlight Volume Light from the Atmospheres & Effects list and click setup to adjust the Volume Light parameters.

NOTE Volume Lights don't support negative multiplier values.

Interface

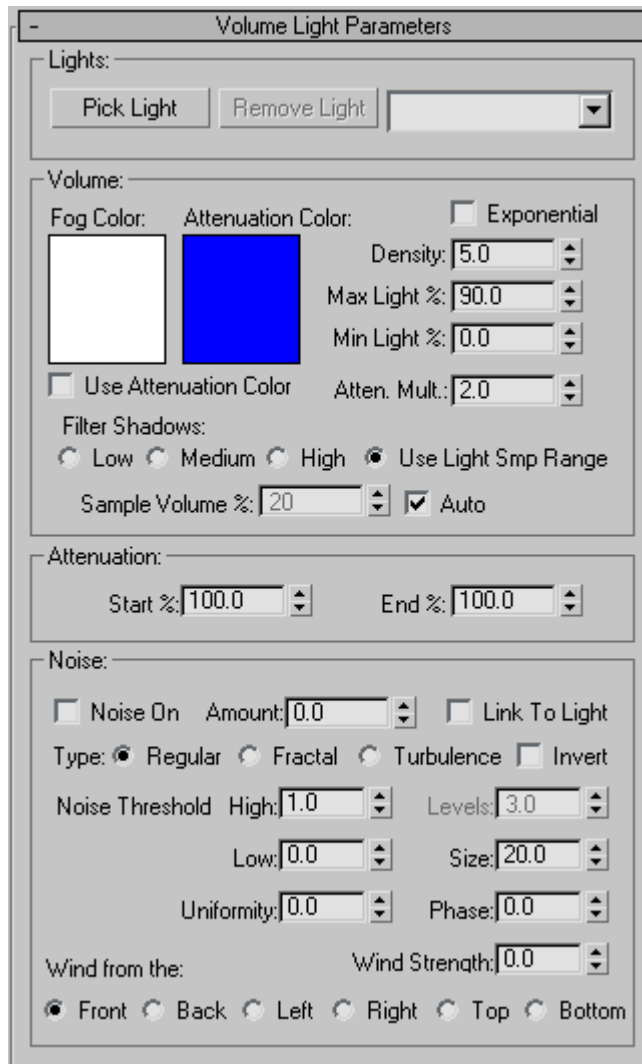

The Volume Light Parameters rollout appears when you select Volume Light under Effects in the Environment dialog. It has the following controls.

Lights group

Pick Light Click the light that you want to enable for volume light in any viewport.

You can pick multiple lights. Click Pick Light and then press H. This opens the Pick Object dialog, which lets you choose multiple lights from a list.

Remove Light Deletes a light from the list.

Volume group

Fog Color Sets the color for the fog that makes up the volume of the light. Click the color swatch, and then choose the color you want in the [Color Selector](#) on page 391.

You can animate the color effect by changing the fog color at a nonzero frame with the Auto Key button on.

Unlike the other fog effects, this fog color combines with the color of the light. Possibly the best effect is to use white fog and then color it with a colored light.

Attenuation Color Attenuates volume light over distance. The volume light ramps from the Fog Color to the Attenuation color over the light's Near and Far attenuation distances. Clicking the color swatch displays a color selector so you can change the attenuation color.

Attenuation Color interacts with Fog Color. For example, if your fog color is red and your attenuation color is green, in the rendering your fog will shade to purple. Typically the attenuation color should be very dark and neutral—black is a good choice.

Use Attenuation Color Makes attenuation color active.

Exponential Increases density exponentially with distance. When turned off, density increases linearly with distance. Activate this check box only when you want to render transparent objects in volume fog.

Density Sets the density of the fog. The denser the fog, the more the light reflects off it inside the volume. Densities of 2 to 6 percent probably make the most realistic fog volumes.

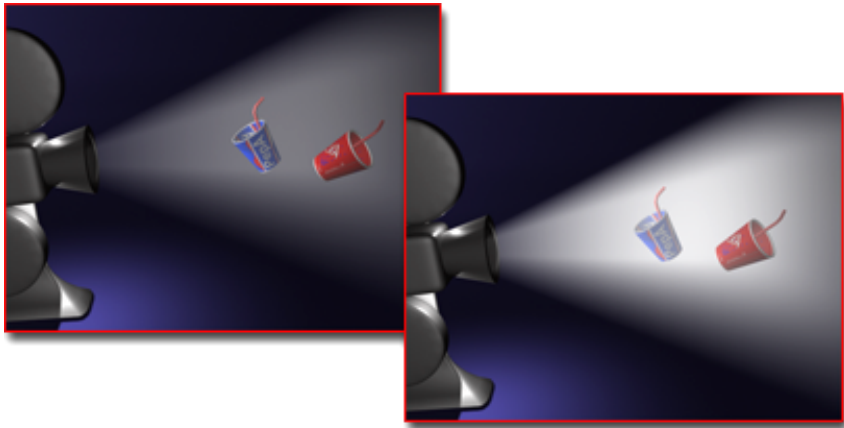

Left: Original scene

Right: Increasing the density

Max Light% Represents the maximum glow effect that you can achieve (defaults to 90 percent). By turning this down, you can limit the brightness of the glow so that it doesn't get denser and denser as it gets farther away from the light and "whites out."

NOTE When your scene includes transparent objects inside a volume light, set Max Light to 100 percent.

Min Light% Similar to an [ambient light](#) on page 7906 setting. If Min Light% is greater than 0, areas outside the light volume will glow also. Note that this means areas of open space (where the light ray can travel forever) will end up the same as the fog color (just as with normal fog).

Without objects behind the fog, the scene will always be as bright as the fog color if the Min Light% is greater than 0 (no matter what the actual value is). This is because the fog goes to infinity and is accumulated infinitely. If you're going to use min light% values greater than 0, you should make sure that you enclose your scene by geometry.

Atten. Mult. (Attenuation Multiplier) Adjusts the effect of the attenuation color.

Filter Shadows Allows you to get better quality volume-light rendering by increasing the sampling rate (at the cost of some increased rendering time). These are the options:

Low The image buffer is not filtered but directly sampled instead. This option is fine for 8-bit images, [AVI](#) on page 7326 files, and so on.

Medium Adjacent pixels are sampled and averaged. This produces a very significant improvement in cases where you're getting banding types of artifacts. It is slower than Low.

High Adjacent pixels and the diagonal pixels are sampled, and each are given different weights. This is the slowest method and provides somewhat better quality than Medium.

Use Light Smp Range Blurs the shadows cast in the volume based on the Sample Range value in the light's shadow parameters. Because increasing the Smp Range value blurs the shadow cast by the light, this makes shadows in the fog better match cast shadows, and helps prevent aliasing in the fog shadows.

TIP With the Use Light Smp Range option, the higher the light's Smp Range value, the slower the rendering. However, with this option you can usually get good results with a lower Sample Volume % setting (such as 4), which reduces rendering time.

Sample Volume % Controls the rate at which the volume is sampled. Ranges 1 through 10,000 (where 1 is the lowest quality and 10,000 is the highest quality).

Auto Controls the Sample Volume % parameter automatically and disables the spinner (this is the default). The preset sampling rates are as follows:

low=8; medium=25; high=50

Because the parameter ranges up to 100 there's still room to set it higher. Increasing the Sample Volume % parameter definitely slows things down, but in some cases you may want to increase it (for extremely high sample quality).

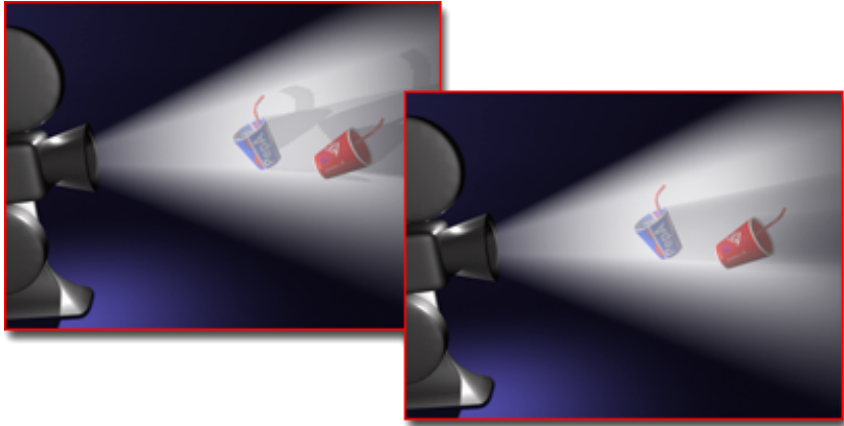

Left: Original scene

Right: Increasing sample volume to improve quality

Attenuation group

The controls in this section are contingent upon the settings of the Start Range and End Range [attenuation](#) on page 7915 parameters for the individual light.

NOTE Rendering Volume Light at some angles can introduce aliasing problems. To eliminate aliasing problems, activate the Near and Far Attenuation settings in the light object that the Volume Light applied to.

Start % Sets the start attenuation of the light effect, relative to the actual light parameter's attenuation. It defaults to 100 percent, which means that it starts attenuating at the Start Range point. When you reduce this parameter, it starts attenuating the light at a reduced percentage of the actual Start Range value that is, closer to the light itself.

Because you usually want a smooth [falloff](#) on page 8007, you can keep this value at 0, and no matter what the light's actual Start Range, you'll always get a smooth glow without [hotspots](#) on page 8007.

End % Sets the end attenuation of the lighting effect, relative to the actual light parameter's attenuation. By setting this lower than 100 percent, you can have a glowing attenuating light that casts light much farther than it actually glows. Default=100.

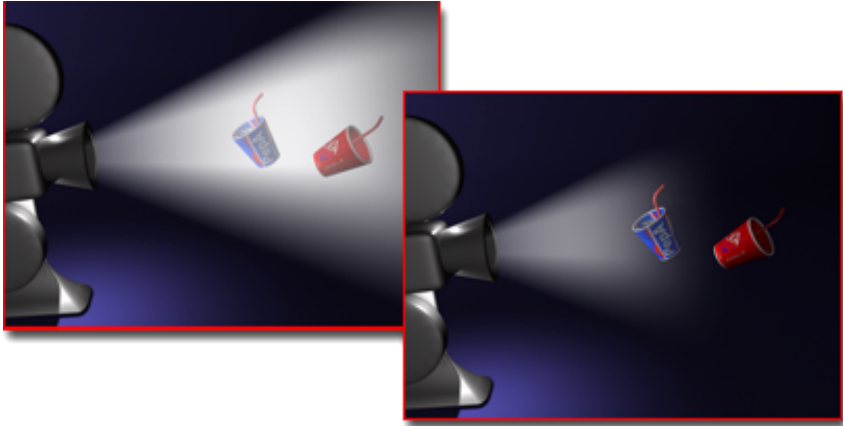

Left: Original scene

Right: Attenuation limits the range of the light.

Noise group

Noise On Turns the noise on and off. When noise is on there is a slight increase in render time.

Amount The percentage of noise applied to the fog. If the amount is 0, there is no noise. If the amount is 1, the fog becomes pure noise.

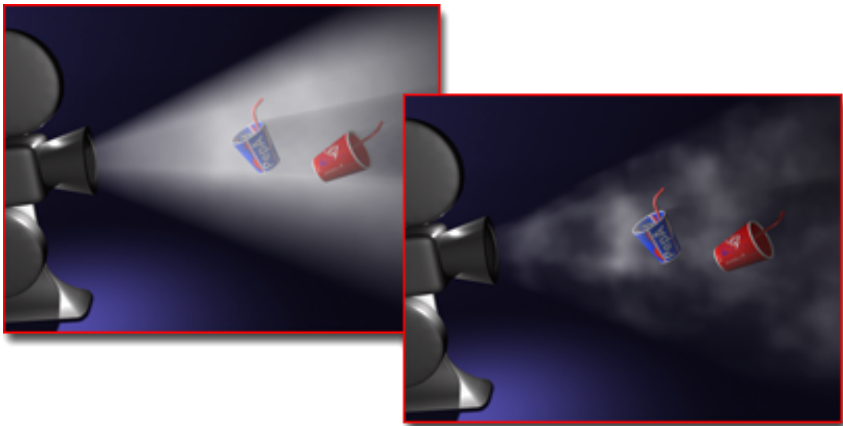

Left: Original scene

Right: Noise added

Link To Light Links the noise effect to its light object, rather than to world coordinates.

Usually you want noise to look like fog or dust motes in the atmosphere, in which case, as the light moves, the noise should remain with the world coordinates. For certain special effects, however, you might want the noise linked to the light's coordinates. In these cases, turn on Link to Light.

Type Choose one of three types of noise to apply.

- **Regular** The standard noise pattern.
- **Fractal** An iterative fractal noise pattern.
- **Turbulence** An iterative turbulence pattern.

Invert Reverses the noise effect. Dense fog becomes translucent and vice versa.

Noise Threshold Limits the noise effect. When the noise value is above the Low threshold and below the High threshold, the dynamic range stretches to fill 0-1. This makes for a smaller discontinuity (first order instead of 0 order) at the threshold transition and thus produces less potential [aliasing](#) on page 7904.

- **High** Sets the high threshold. Range=0 to 1.0.
- **Low** Sets the low threshold. Range=0 to 1.0.

Uniformity Acts like a high-pass filter: the smaller the value, the more the volume is transparent with discrete blobs of smoke. By around -0.3 or so your image begins to look like specks of dust. Because the fog becomes thinner as this parameter gets smaller, you'll probably need to increase the density or the volume will start to disappear. Range=-1 to 1

Levels Sets the number of times the noise is iteratively applied. This parameter is animatable. Enabled only for Fractal noise or Turbulence. Range=1 to 6, including fractional values.

Size Determines the size of the tendrils of smoke or fog. Smaller values give smaller tendrils.

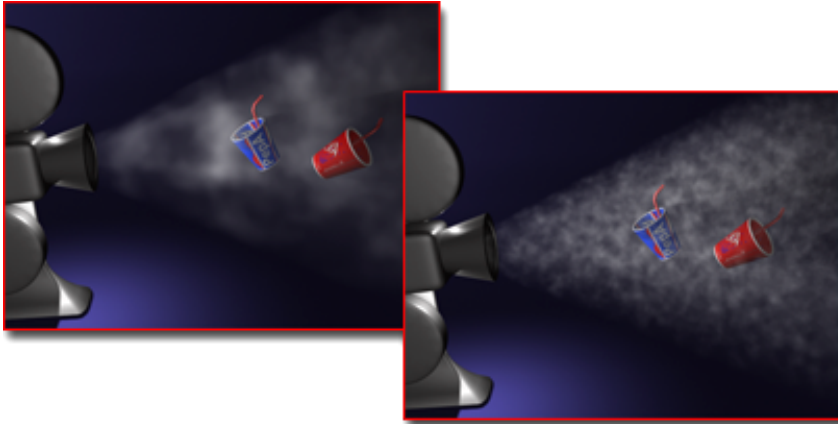

Left: Volume light with noise

Right: Reducing the size value

Phase Controls the speed of the wind. If you have Wind Strength also set to greater than 0, the fog volume animates in accordance with the wind direction. With no Wind Strength, the fog churns in place. Because there's an animation track for phase, you can use the Function Curve editor to define precisely how you want your wind "gusts" to happen.

Wind Strength Controls how fast the smoke moves away from the wind direction, relative to phase. As mentioned above, if the phase is not animated then the smoke won't move, regardless of the wind strength. By having the phase animate slowly with a large wind strength, the fog moves more than it churns.

Wind from the Defines the direction the wind is coming from.

Exposure Controls

Rendering menu > Environment > Environment and Effects dialog > Environment panel > Exposure Control rollout

Exposure controls are plug-in components that adjust the output levels and color range of a rendering, as if you were adjusting film exposure. This process is known as *tone mapping*. These controls are especially useful for renderings that use [radiosity](#) on page 6168, and when dealing with high-dynamic-range (HDR) imagery.

Exposure control compensates for the limited dynamic range of computer displays, which is typically about two orders of magnitude: The brightest color that appears on a display is about 100 times brighter than the dimmest. The eye, by comparison, can perceive a dynamic range of about 16 orders of magnitude. In other words, the brightest color we can perceive is about 10 million-billion times brighter than the dimmest. Exposure control adjusts colors so they better simulate the eye's great dynamic range, while still fitting within the color range that can be rendered.

The exposure controls included with 3ds Max are:

- [Automatic Exposure Control](#) on page 6735 samples the rendered image and builds a histogram to give good color separation across the entire dynamic range of the rendering. It can enhance some lighting effects that would otherwise be too dim to see.
- [Linear Exposure Control](#) on page 6738 samples the rendering and uses the average brightness of the scene to map physical values to RGB values. Linear Exposure Control is best for scenes with a fairly low dynamic range.
- [Logarithmic Exposure Control](#) on page 6740 uses brightness, contrast, and whether the scene is outdoors in daylight to map physical values to RGB values. Logarithmic Exposure Control is better for scenes with a very high dynamic range.
- [mr Photographic Exposure Control](#) on page 6744 gives you camera-like controls including shutter speed, aperture, and film speed, as well as image control over highlights, midtones, and shadows.
- [Pseudo Color Exposure Control](#) on page 6753 is actually a lighting analysis tool. It maps luminances to pseudo colors that show the brightness of the values being converted.

IMPORTANT The [mental ray renderer](#) on page 6230 supports only the Logarithmic, mr Photographic, and Pseudo Color exposure controls.

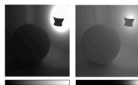

Left: Linear exposure control maps intensity evenly.

Right: Logarithmic exposure control maps most intensities to low and mid tones.

Tips:

- If the primary lighting from your scene comes from standard lights (rather than photometric lights), use the Logarithmic exposure control and turn on Affect Indirect Only.
- Use Automatic exposure control for rendering still images. This method is also useful for first-draft renderings.
- Use Logarithmic exposure control for animations with a moving camera. (Automatic and Linear exposure control with a moving camera can cause excessive flickering.)
- For rendering high-dynamic-range images with mental ray, use the mr Photographic exposure control.
- For outdoor scenes that use the Daylight system, turn on the Exterior toggle to prevent overexposure.

Exposure and Attenuation for Standard Lights

When you use standard lights that are not attenuated, renderings tend to have a low dynamic range, because light intensities don't vary greatly across the scene. In this situation, adjusting light values might be all you need to do to get a good rendering.

On the other hand, when lights are attenuated the illumination might be too bright on near surfaces or too dim on distant surfaces. In this situation, the Automatic exposure control can help, because it adjusts the larger dynamic range of the (simulated) physical scene, into the smaller dynamic range of the display.

Interface

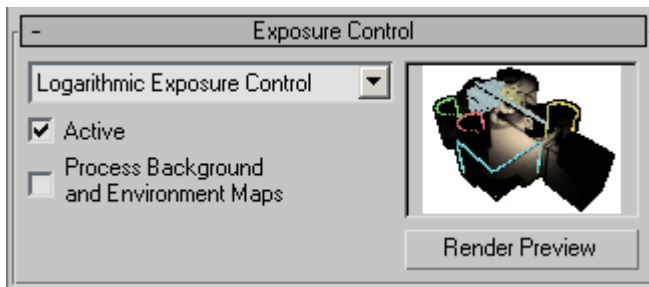

Drop-down list Choose the exposure control to use.

Active When on, the exposure control is used in rendering. When off, the exposure control is not applied.

Process Background and Environment Maps When on, the scene background and environment maps are subjected to exposure control. When off, they are not.

Preview thumbnail The thumbnail displays a preview of the rendered scene with the active exposure control applied. Once a preview has been rendered, it updates interactively when you changed exposure control settings.

Render Preview Click to render the preview thumbnail.

Automatic Exposure Control

Rendering menu > Environment > Environment and Effects dialog > Environment panel > Exposure Control rollout > Choose Automatic Exposure Control from the list. > Automatic Exposure Control rollout

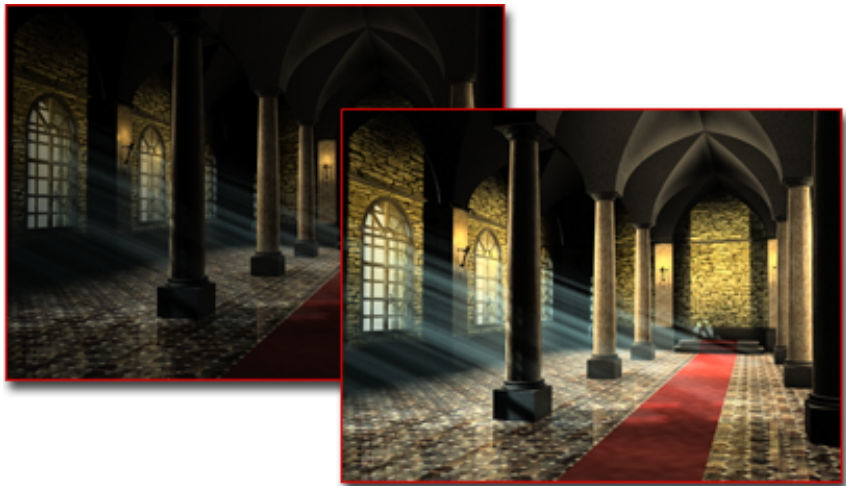

Auto exposure can affect the lighting of the whole image.

Automatic Exposure Control samples the rendered image and builds a histogram to give good color separation across the entire dynamic range of the rendering. It can enhance some lighting effects that would otherwise be too dim to see.

NOTE Automatic Exposure Control should not be used in animations, because every frame will have a different histogram, causing your animation to flicker.

IMPORTANT The [mental ray renderer](#) on page 6230 does not support the Automatic exposure control.

See also:

- [Environment Panel](#) on page 6689

Interface

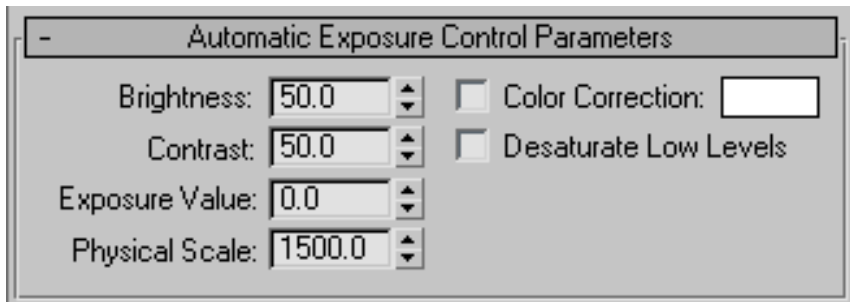

Brightness Adjusts the brightness of the converted colors. Range=0 to 200. Default=50.

This parameter is animatable.

Contrast Adjusts the contrast of the converted colors. Range=0 to 100. Default=50.

This parameter is animatable.

Exposure Value Adjusts the overall brightness of the rendering. Range=-5.0 to 5.0; Negative values make the image darker, and positive values make it brighter. Default=0.0.

The exposure value is comparable to the exposure compensation setting in cameras with automatic exposure. This parameter is animatable.

Physical Scale Sets a physical scale for exposure control to use with lights that are not physically based. The result is an adjustment of the rendering that approximates the eye's response to the scene.

Each standard light's [Multiplier](#) on page 8055 is multiplied by the Physical Scale value to give a light intensity value in candelas. For example, with the default Physical Scale of 1500, a standard omni light is treated by the renderer and

radiosity as a photometric isotropic light of 1500 candelas. Physical Scale is also factored into reflections, refractions, and self-illumination.

TIP You need to set the Physical Scale when you use ray-tracing with self illumination. Set this value to the equivalent of the brightest light source in the scene. This will set the appropriate conversion scale for reflections, self-illumination, and all other non-physically based elements a material offers. In some cases, an object might reflect or emit more light than the brightest light object in the scene; in this case, use the object's Luminance value as the Physical Scale.

Range=0.0 to 200,000.0 candelas. Default=1500.0.

A single candle is approximately 1 candela (the unit can also be called a "candle"). A 100-Watt (W) incandescent light bulb is approximately 139 candelas (cd). A 60W bulb emitting in all directions is about 70 cd, while the same bulb with a reflector is about 4500 cd because the light flux is concentrated into a narrow angle.

Photometric lights are unaffected by the Physical Scale value.

This parameter is animatable.

Color correction check box and color swatch When the check box is turned on, color correction shifts all colors so the color displayed in the color swatch appears as white. Default=off.

Clicking the color swatch displays a [Color Selector](#) on page 391 so you can choose the color to adapt to.

You can use this control to simulate how the eye adjusts to lighting. For example, even when the light in a room has a yellow hue from an incandescent light bulb, we will continue to perceive objects that we know to be white, such as printed pages, as white.

TIP For the best results, use a very pale color correction color, such as a pale blue or pale yellow.

Desaturate Low Levels When on, renders dimly lit colors as if the light were too dim for the eye to distinguish between colors. When on, renders even dimly lit colors. Default=off.

Desaturate Low Levels simulates the eye's response to dim lighting. In dim lighting, the eye does not perceive colors and sees tones of gray instead.

The effect of this setting is not apparent except at very low light levels, below 5.62 footcandles (lumens per square foot). When the illuminance is less than 0.00562 footcandles, the scene is completely gray.

NOTE 1 footcandle (fc) equals 10.76 lux (lumens per square meter).

Linear Exposure Control

Rendering menu > Environment > Environment and Effects dialog > Environment panel > Exposure Control rollout > Choose Linear Exposure Control from the list. > Linear Exposure Control rollout

Linear Exposure Control samples the rendered image and uses the average brightness of the scene to map physical values to RGB values. Linear Exposure Control is best used for scenes with a fairly low dynamic range.

NOTE Linear Exposure Control should not be used in animations, because every frame will have a different histogram, causing your animation to flicker.

IMPORTANT The [mental ray renderer](#) on page 6230 does not support the Linear exposure control.

See also:

- [Environment Panel](#) on page 6689

Interface

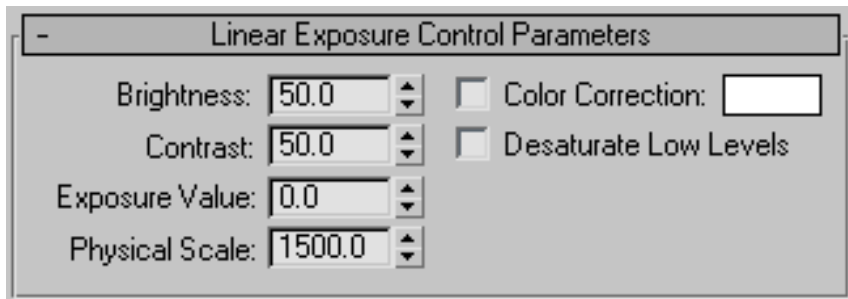

Brightness Adjusts the brightness of the converted colors. Range=0 to 200. Default=50.

This parameter is animatable.

Contrast Adjusts the contrast of the converted colors. Range=0 to 100. Default=50.

This parameter is animatable.

Exposure Value Adjusts the overall brightness of the rendering. Range= -5.0 to 5.0. Negative values make the image darker, and positive values make it brighter. Default=0.0.

The exposure value can be thought of as an exposure compensation setting in cameras with automatic exposure control.

This parameter is animatable.

Physical Scale Sets a physical scale for exposure control to use with lights that are not physically based. The result is an adjustment of the rendering that approximates the eye's response to the scene.

Each standard light's [Multiplier](#) on page 8055 is multiplied by the Physical Scale value to give a light intensity value in candelas. For example, with the default Physical Scale of 1500, a standard omni light is treated by the renderer and radiosity as a photometric isotropic light of 1500 candelas. Physical Scale is also factored into reflections, refractions, and self-illumination.

TIP You need to set the Physical Scale when you use ray-tracing with self illumination. Set this value to the equivalent of the brightest light source in the scene. This will set the appropriate conversion scale for reflections, self-illumination, and all other non-physically based elements a material offers. In some cases, an object might reflect or emit more light than the brightest light object in the scene; in this case, use the object's Luminance value as the Physical Scale.

Range=0.0 to 200,000.0 candelas. Default=1500.0.

A single candle is approximately 1 candela (the unit can also be called a "candle"). A 100-Watt (W) incandescent light bulb is approximately 139 candelas (cd). A 60W bulb emitting in all directions is about 70 cd, while the same bulb with a reflector is about 4500 cd because the light flux is concentrated into a narrow angle.

Photometric lights are unaffected by the Physical Scale value.

This parameter is animatable.

Color Correction check box and color swatch When the check box is turned on, color correction shifts all colors so the color displayed in the color swatch appears as white. Default=off.

Clicking the color swatch displays a [Color Selector](#) on page 391 so you can choose the color to adapt to.

You can use this control to simulate how the eye adjusts to lighting. For example, even when the light in a room has a yellow hue from an incandescent light bulb, we will continue to perceive objects that we know to be white, such as printed pages, as white.

TIP For the best results, use a very pale color correction color, such as a pale blue or pale yellow.

Desaturate Low Levels When on, renders dimly lit colors as if the light were too dim for the eye to distinguish between colors. When on, renders even dimly lit colors. Default=off.

Desaturate Low Levels simulates the eye's response to dim lighting. In dim lighting, the eye does not perceive colors and sees tones of gray instead.

The effect of this setting is not apparent except at very low light levels, below 5.62 footcandles (lumens per square foot). When the illuminance is less than 0.00562 footcandles, the scene is completely gray.

NOTE 1 footcandle (fc) equals 10.76 lux (lumens per square meter).

Logarithmic Exposure Control

Rendering menu > Environment > Environment and Effects dialog > Environment panel > Exposure Control rollout > Choose Logarithmic Exposure Control from the list. > Logarithmic Exposure Control rollout

Logarithmic Exposure Control uses brightness, contrast, and whether the scene is outdoors in daylight to map physical values to RGB values. You can use it with either the [default scanline renderer](#) on page 6141 and the [mental ray renderer](#) on page 6230. Logarithmic Exposure Control is best for scenes with a very high dynamic range.



Left: The intensity of an IES Sun light completely overexposes a scene.

Right: Logarithmic exposure control corrects the overexposure.

Logarithmic Exposure Control is the best type of exposure control for animations because it doesn't use histograms.

TIP If you're [rendering to texture](#) on page 6371, use the Logarithmic exposure control, not the Automatic or Linear control.

See also:

- [Environment Panel](#) on page 6689

Interface

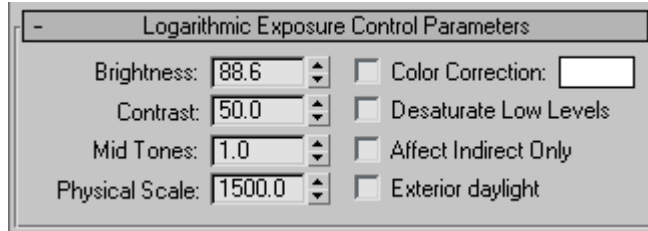

Brightness Adjusts the brightness of the converted colors. Range=0 to 200. Default=50.

This parameter is animatable.

Contrast Adjusts the contrast of the converted colors. Range=0 to 100. Default=50.

This parameter is animatable.

Mid Tones Adjusts the mid-tone values of the converted colors. Range=0.01 to 20.0. Default=1.0.

This parameter is animatable.

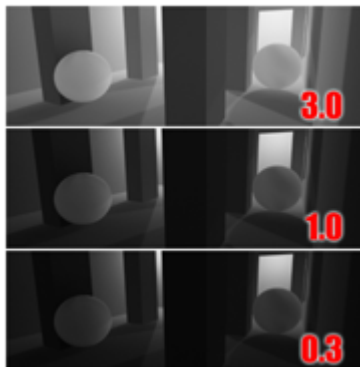

Adjusting the value of mid tones

Physical Scale Sets a physical scale for exposure control to use with lights that are not physically based. The result is an adjustment of the rendering that approximates the eye's response to the scene.

Each standard light's [Multiplier](#) on page 8055 is multiplied by the Physical Scale value to give a light intensity value in candelas. For example, with the default Physical Scale of 1500, a standard omni light is treated by the renderer and radiosity as a photometric isotropic light of 1500 candelas. Physical Scale is also factored into reflections, refractions, and self-illumination.

TIP You need to set the Physical Scale when you use ray-tracing with self illumination. Set this value to the equivalent of the brightest light source in the scene. This will set the appropriate conversion scale for reflections, self-illumination, and all other non-physically based elements a material offers. In some cases, an object might reflect or emit more light than the brightest light object in the scene; in this case, use the object's Luminance value as the Physical Scale.

NOTE The mental ray renderer treats Physical Scale in the same way the scanline renderer does in terms of its effect on reflections and refractions. Physical Scale does affect the appearance of self-illuminated materials.

Range=0.0 to 200,000.0 candelas. Default=1500.0.

A single candle is approximately 1 candela (the unit can also be called a "candle"). A 100-Watt (W) incandescent light bulb is approximately 139 candelas (cd). A 60W bulb emitting in all directions is about 70 cd, while the same bulb with a reflector is about 4500 cd because the light flux is concentrated into a narrow angle.

Photometric lights are unaffected by the Physical Scale value.

This parameter is animatable.

Color Correction check box and color swatch When the check box is turned on, color correction shifts all colors so the color displayed in the color swatch appears as white. Default=off.

Clicking the color swatch displays a [Color Selector](#) on page 391 so you can choose the color to adapt to.

You can use this control to simulate how the eye adjusts to lighting. For example, even when the light in a room has a yellow hue from an incandescent light bulb, we will continue to perceive objects that we know to be white, such as printed pages, as white.

TIP For the best results, use a very pale color correction color, such as a pale blue or pale yellow.

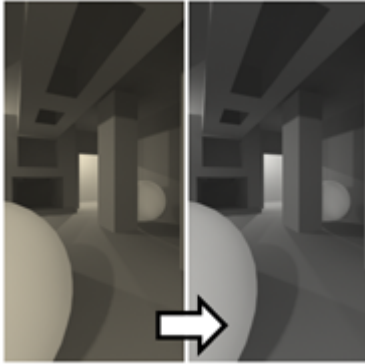

Color correction can remove the color “cast” that comes from a light source.

Desaturate Low Levels When on, renders dimly lit colors as if the light were too dim for the eye to distinguish between colors. When off, renders even dimly lit colors. Default=off.

Desaturate Low Levels simulates the eye's response to dim lighting. In dim lighting, the eye does not perceive colors and sees tones of gray instead.

The effect of this setting is not apparent except at very low light levels, below 5.62 footcandles (lumens per square foot). When the illuminance is less than 0.00562 footcandles, the scene is completely gray.

NOTE 1 footcandle (fc) equals 10.76 lux (lumens per square meter).

Affect Indirect Only When on, Logarithmic Exposure control is applied only to areas of indirect lighting. Default=off.

Turn on this toggle when the primary lighting for your scene comes from standard lights rather than photometric lights. When you use standard lights and turn on Affect Indirect Only, radiosity and exposure control yield results similar to the default scanline renderer. When you use standard lights but leave Affect Indirect Only off, radiosity and exposure control yield results that can be quite different from the default scanline renderer.

In general, you don't need to turn on Affect Indirect Only when the primary lighting for your scene comes from photometric lights.

Exterior daylight When on, converts colors for an outdoor scene. Default=off.

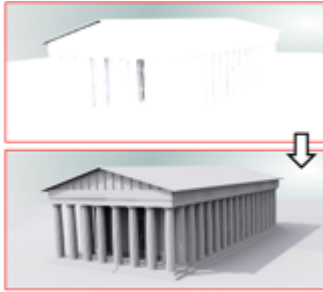

The exterior daylight setting compensates for the extreme intensity of an IES sun light.

mr Photographic Exposure Control

Set mental ray as the renderer. > Rendering menu > Environment > Environment and Effects dialog > Environment panel > Exposure Control rollout > Choose mr Photographic Exposure Control from the list. > mr Photographic Exposure Control rollout

The mr Photographic Exposure Control lets you modify rendered output with camera-like controls: either a general exposure value or specific shutter speed, aperture, and film speed settings. It also gives you image-control settings with values for highlights, midtones, and shadows. It's intended for high-dynamic-range scenes rendered with the [mental ray renderer](#) on page 6230.

NOTE The mr Photographic Exposure Control contains a built-in gamma corrector (gamma 2.2), but this correction is disabled if the 3ds Max [gamma correction](#) on page 7758 is enabled on the Preferences dialog, letting the Rendered Frame Window apply the view gamma instead.

The [Logarithmic exposure control](#) on page 6740 also has a curve similar to a gamma correction, but unlike the Photographic exposure control, it is not designed to disable its gamma correction when overall gamma correction is on. For that reason, combining gamma correction with the Logarithmic exposure control is discouraged, whereas using it together with the Photographic exposure control is encouraged.

Interface

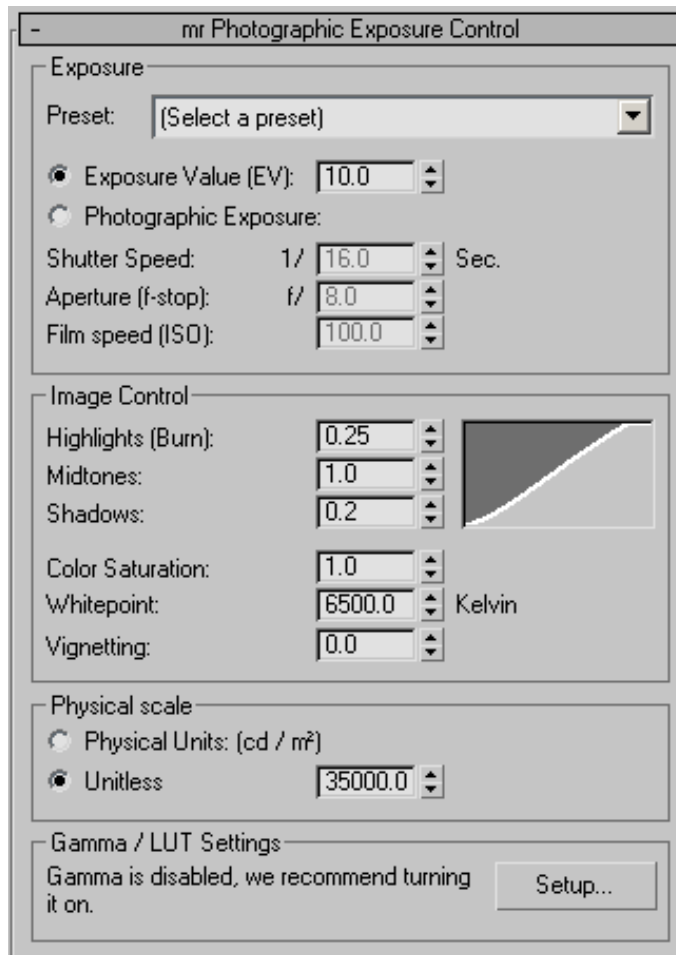

TIP To see a definition of any numeric parameter on this rollout, hover the mouse cursor over the parameter's spinner.

Exposure group

This group comprises a drop-down list of exposure presets plus a choice of Exposure Value or Photographic Exposure and associated parameters. Choosing one method makes the other's setting or settings unavailable, but they still change based on adjustments you make to the available method. For example,

when Exposure Value is active, adjusting its value also changes the Photographic Exposure > Shutter Speed setting.

Preset Choose from the available options based on setting and lighting conditions. The presets affect all of the remaining settings in this group.

Exposure Value (EV) Choose this option to specify a single Exposure Value setting that corresponds to a combination of the three Photographic Exposure values (see following). Each increment or decrement in the EV value corresponds to halving or doubling, respectively, the effective exposure, as expressed in the resultant change in the Shutter Speed value. Thus, higher values yield darker images, and lower values yield brighter images.

For example, as shown above, the combination of a shutter speed of 1/125 of a second, f/16, and ISO 100 results in an EV of 15. The same EV results from halving the shutter speed to 1/250 second and doubling the aperture size to f/11.

Photographic Exposure Lets you set the exposure using standard camera-oriented controls. These controls affect exposure only: Shutter Speed has no effect on motion blur; Aperture doesn't influence depth of field; and Film Speed has no effect on graininess.

- **Shutter Speed** The duration, in fractions of a second, that the “shutter” is open. The higher this value, the greater the exposure.
- **Aperture** The size of the opening of the “camera iris,” expressed as a ratio. The higher this value, the lower the exposure.
- **Film Speed (ISO)** The sensitivity of the “camera film,” expressed as an index. The higher this value, the greater the exposure.

Image Control group

Use these controls to adjust the relative brightness or highlights, midtones, and shadows in the rendered image. The combination of these three settings is depicted in the graph on the right side of the rollout. Additional controls available here let you adjust color saturation, whitepoint, and vignetting.



Rendering with default settings (with final gathering)

Highlights (Burn) Controls the level of the brightest areas of the image. Higher values yield brighter highlights, while lower values darken the highlights.



Darkened (burnt-in) highlights

Midtones Controls the level of the areas of the image whose brightness lies between the highlights and the shadows. Higher values yield brighter midtones, while lower values darken the midtones.



Elevated midtones

Shadows Controls the level of the darkest areas of the image. Lower values yield lighter shadows, while higher values darken the shadows.



Lightened shadows

Color Saturation Controls the intensity of colors in the rendered image. Higher values result in more intense colors.



Color Saturation=2.0

Whitepoint Specifies the main color temperature of the light sources. This is similar to white balance controls on digital cameras. For daylighting, a value of 6500 is recommended, for incandescent lighting, a value of 3700 is recommended.

For example, photographs taken indoors might be lit by incandescent lights, which are relatively orange compared to daylight. Defining "white" as daylight will give unacceptable results when attempting to color-correct a photograph taken with incandescent lighting.

Vignetting Reduces the image brightness in the image periphery compared to the image center, resulting in a circular fully exposed area in the center, with darker edges.



Vignetting=25.0

Physical Scale Determines how the software calculates pixel values when outputting HDR (high-dynamic-range) images. You can use the physical scale inherent in the scene, or set an arbitrary physical scale for non-physically-based lighting situations.

- **Physical Units: (cd/m²)** Outputs physically correct HDR pixel values in candelas per square meter. Use this option when lighting the scene with photometric light sources.

TIP When you use this option, the renderer interprets all non-physical (standard) illumination values in units of cd/m². If you use as a background image or texture map an HDR image with pixels correctly calibrated to cd/m², it will be correct in the scene. However, if you attempt to use a low-dynamic-range photo such as a JPEG photo, it will appear too dark in the rendered output. (The renderer interprets a white pixel in such an image as "1 cd/m²" by default, which is darker than the deepest dungeon.) So you need to increase the [output](#) on page 5774 of the image to match a useful cd/m² value. The sky can be around 3,000 cd/m².

- **Unitless** Lets you define how the renderer interprets the illumination from standard lights, which are not physically based. Use the numeric

setting to set the apparent illumination from these lights and the output pixel values based on the scene lighting. For example, with the default Physical Scale of 1500, a standard omni light is treated by the renderer as a photometric isotropic light of 1500 candelas. Physical Scale is also factored into the environment map and self-illumination.

NOTE This value does not affect apparent illumination of the rendered scene with photometric lights. However, it does affect the apparent illumination cast by non-physical (standard) lights. For predictable results, illuminate the scene only with photometric or standard lights (not a mix), and use Physical Units or Unitless, respectively.

Gamma/LUT Settings This group comprises text showing the status of the current Gamma/LUT settings, and a Setup button that opens the Preference Settings dialog to the [Gamma and LUT panel](#) on page 7758 so you can change the settings.

Pseudo Color Exposure Control

Rendering menu > Environment > Environment and Effects dialog > Environment panel > Exposure Control rollout > Choose Pseudo Color Exposure Control from the list. > Pseudo Color Exposure Control rollout

Pseudo Color Exposure Control is actually a lighting analysis tool that provides you with an intuitive way of visualizing and evaluating the lighting levels in your scenes. It maps [luminance](#) on page 8029 or [illuminance](#) on page 8009 values to pseudo colors that show the brightness of the values being converted. From darkest to brightest, the rendering shows blue, cyan, green, yellow, orange, and red. (Alternatively, you can choose a grayscale where the brightest values are white, and the darkest are black.) The rendering includes the colored or grayscale spectrum bar as a legend for the image.

After rendering the scene with pseudo color, 3ds Max displays a [Rendered Frame Window](#) on page 6073 labeled “Illuminance,” with a legend of illuminance values below the rendered image.

NOTE The Illuminance frame is not displayed if antialiasing is turned off.

NOTE You can use the Pseudo Color exposure control with the [mental ray renderer](#) on page 6230.

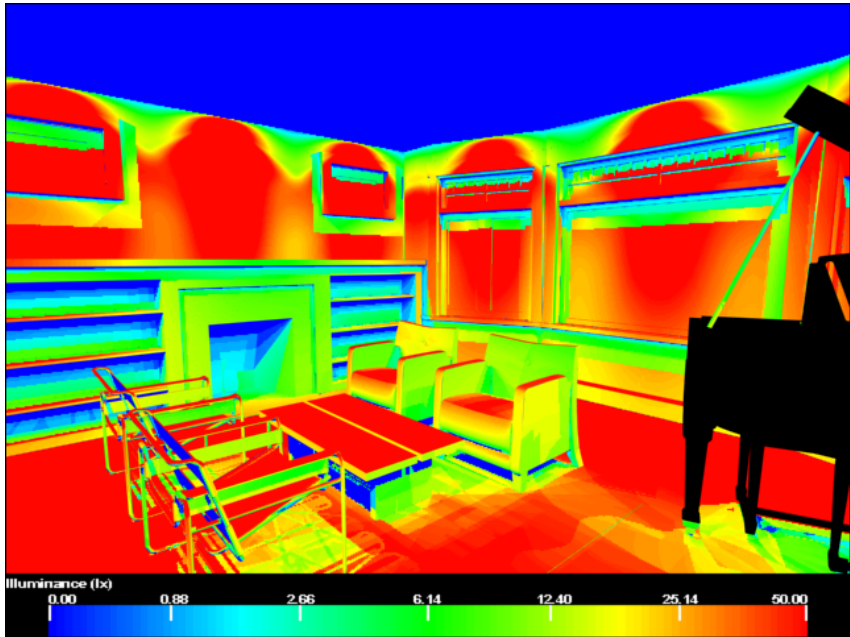

Pseudo color exposure of a scene with radiosity. Areas in red are overlit, areas in blue are underlit, and areas in green have a good lighting level.

In the Rendered Frame Window labeled “illuminance,” a legend appears below the image.

If you render a scene using this exposure control, the software creates a special [render element](#) on page 6349 named Illuminance that helps obtain accurate luminance and illuminance data.

TIP If you get a file write error when you try to render a pseudo color image, check the path and file name of the Illuminance element, or the permissions of the PNG file that saves the illuminance data.

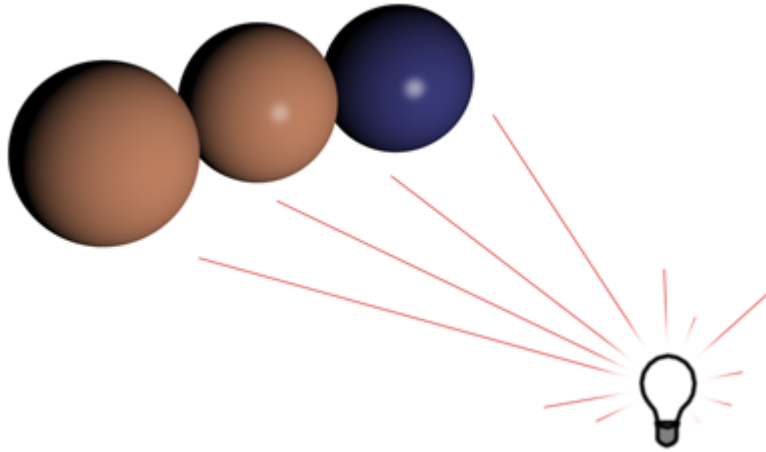

Three spheres at an equal distance from a light source. The sphere on the left has a matte material, the sphere in the middle is glossy, and the sphere on the right is glossy but has a much darker color.

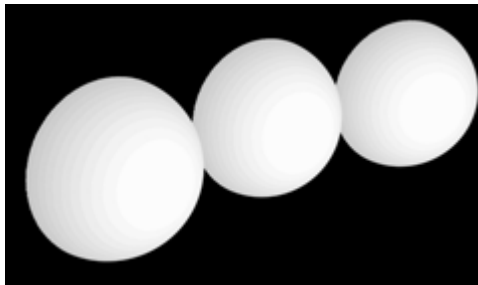

A display of illuminance shows that it is the same for all three spheres.

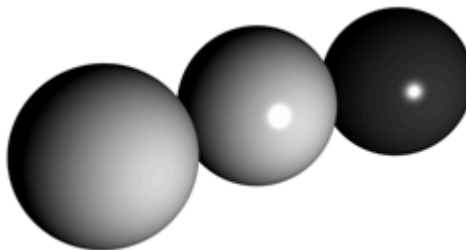

A display of luminance shows that the two spheres on the left reflect about the same amount of light, but the darker sphere on the right reflects little light except for its highlight.

See also:

- [Environment Panel](#) on page 6689

Interface

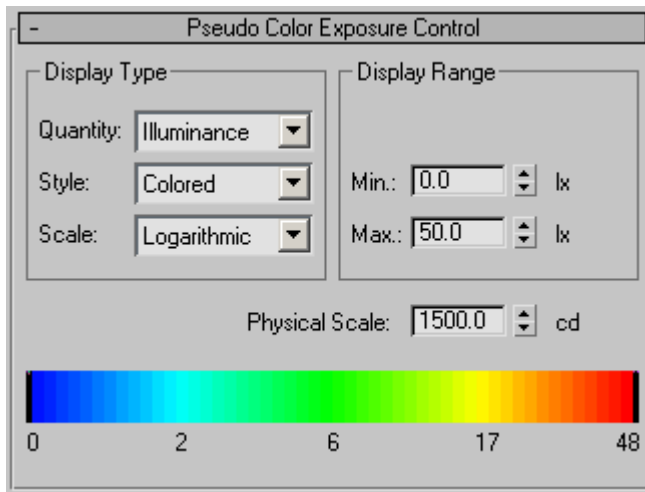

Display Type group

Quantity Chooses the value being measured.

- Illuminance (the default) displays values of light incident on surfaces.
- Luminance displays values of light reflected off surfaces.

Style Chooses the way to display values.

- Colored (the default) shows a spectrum.
- Grayscale shows gray tones that range from white to black.
The spectrum bar displays the values the rendering will use.

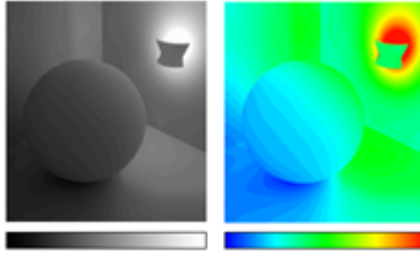

Pseudo color display style:

Left: Grayscale

Right: Colored scale

Scale Chooses the technique used to map values.

- Logarithmic (the default) uses a logarithmic scale.
- Linear uses a linear scale.

The Logarithmic scale is useful when the illumination of the surfaces of interest is low compared to the maximum illumination in the scene.

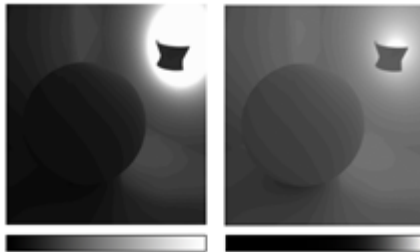

Left: Linear scale

Right: Logarithmic scale

Display Range group

Minimum (Min.) Sets the lowest value to measure and represent in the rendering. Values at this quantity or below it all map to the leftmost display color (or grayscale level).

Maximum (Max.) Sets the highest value to measure and represent in the rendering. Values at this quantity or above it all map to the rightmost display color (or grayscale value).

Physical Scale Sets a physical scale for exposure control to use with lights that are not physically based. The result is an adjustment of the rendering that approximates the eye's response to the scene.

Changing the value of Physical Scale is an optional step. Use it as a last resort when the materials or maps are not rendering correctly. Changing this setting will not affect anything in the scene unless your scene has an Ambient Color different than black. If you do adjust it, set the Physical Scale value to the equivalent of the brightest light source in the scene.

The software multiplies each standard light's [Multiplier](#) on page 8055 by the Physical Scale value to produce a light intensity value in candelas. For example, with the default Physical Scale of 1500, a standard omni light is treated by the renderer and radiosity as a photometric isotropic light of 1500 candelas. Physical Scale is also factored into reflections, refractions, and self-illumination.

TIP When you use ray-tracing with self illumination, set Physical Scale to the equivalent of the brightest light source in the scene. This sets the appropriate conversion scale for reflections, self-illumination, and all other non-physically based elements a material offers. In some cases, an object might reflect or emit more light than the brightest light object in the scene; in this case, use the object's Luminance value as the Physical Scale.

Range=0.0 to 200,000.0 candelas. Default=1500.0.

A single candle is approximately 1 candela (the unit can also be called a "candle"). A 100-Watt (W) incandescent light bulb is approximately 139 candelas (cd). A 60W bulb emitting in all directions is about 70 cd, while the same bulb with a reflector is about 4500 cd because the light flux is concentrated into a narrow angle.

Photometric lights are unaffected by the Physical Scale value.

This parameter is animatable.

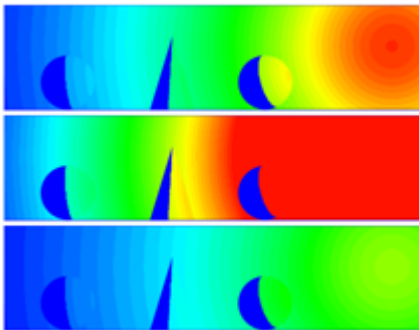

Adjusting the range to analyze:

Above: Correct range for a scene

Middle: Too narrow a range

Below: Too great a range

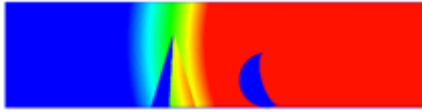

Narrowing the range to focus on a single object

General Guidelines for Physical Scale Values

- If you use only [Photometric lights](#) on page 5005, [IES Sun](#) on page 5154, and [IES Sky](#) on page 5157, the Physical Scale value is disregarded, and you don't need to change it.
- If you use [Standard lights](#) on page 5049, the Physical Scale value acts as a conversion scale that the radiosity engine uses to calculate energy. Set it to the equivalent of the brightest light source in the scene. This will set the appropriate conversion scale for reflections, self-illumination, and all other non-physically based elements a 3ds Max material offers. However, if you use the Affect Indirect Only flag in the [Logarithmic Exposure Control](#) on page 6740, you don't need to worry about the physical scale setting.

Spectrum bar Shows the spectrum-to-intensity mapping. The numbers below the spectrum range from the Minimum to the Maximum settings.

When rendering with pseudo color, the spectrum bar is displayed beneath the pseudo color image, labeled either Luminance or Illuminance.

Lighting Data Exporter Utility

Utilities panel > Utilities rollout > Lighting Data Export

The Lighting Data Exporter renders the active viewport to images that include [luminance](#) on page 8029 and [illuminance](#) on page 8009 data that can be used for lighting analysis.

The Lighting Data Exporter does not render the files unless you have applied an [exposure control](#) on page 6732 to the scene.

You can render to either the [TIFF file](#) on page 7372 format. If you export to a TIFF file, the utility renders a single image file that has separate channels for luminance and illuminance (the file is of the 32-bit SGI LogLUV image type).

You can also render to the [PIC file](#) on page 7359 format. If you export to a PIC file, the utility renders two images: one containing luminance data, and the other containing illuminance data (see the description of the File Name button, below).

Interface



File Name Click the button to specify a file name for the rendering.

When you export to the PIC format, the Lighting Data Exporter renders two files. It appends the string “_Illuminance” to the name of one file, and “_Luminance” to the other. For example, if you type **house** as the file name, the exporter renders to *house_illuminance.pic* and *house_luminance.pic*.

Image Size group

Width Sets the output width, in pixels. Default=640.

Height Sets the output height, in pixels. Default=480.

Export Click to render luminance and illuminance data.

WARNING Unlike the renderer, if you click Export more than once, this overwrites previously rendered files.

Atmospheric Apparatus

Create panel > Helpers > Atmospheric Apparatus (from drop-down list)

You can create three types of atmospheric apparatuses, or [gizmos](#) on page 7996: box, cylinder, and sphere. These gizmos contain the fog or fire effect in your scene.

[BoxGizmo Helper](#) on page 6762

[CylGizmo Helper](#) on page 6765

[SphereGizmo Helper](#) on page 6768

See also:

- [Fire Environment Effect](#) on page 6696
- [Fog Environment Effect](#) on page 6707
- [Volume Light Environment Effect](#) on page 6721

Add Atmosphere Dialog

Select Atmospheric Apparatus object. > Modify panel > Atmospheres & Effects rollout > Add button

The Add Atmosphere dialog lets you associate an atmosphere with the [Atmospheric Apparatus](#) on page 6761.

Interface

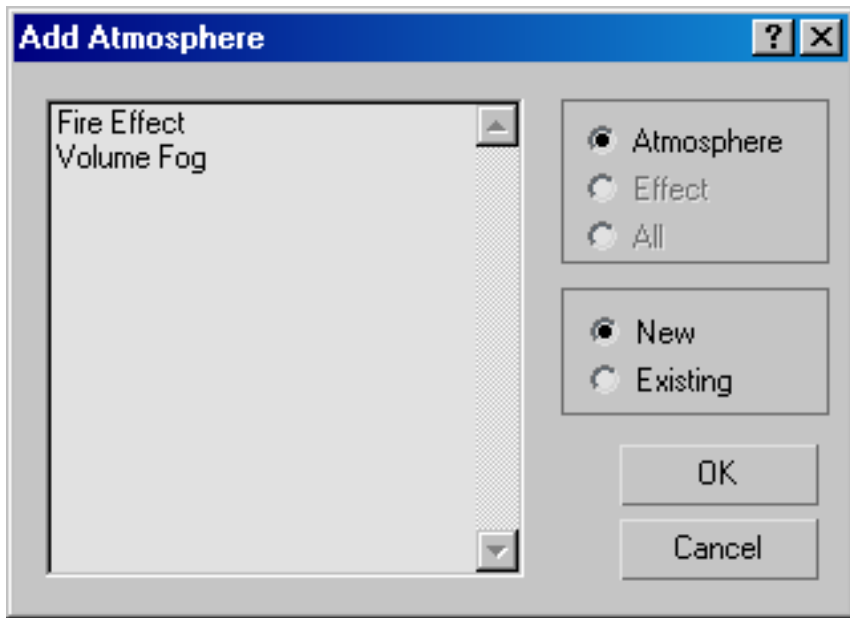

List of atmospheres Displays the atmospheres that you can associate with the apparatus.

New or existing group

These radio buttons choose between new or existing atmospheres.

New Lists only new atmospheres.

Existing Lists only atmospheres that have been already assigned to other apparatuses in the scene.

Adding an existing atmosphere creates a new atmosphere whose settings are initially identical to the previous one.

BoxGizmo Helper

Create panel > Helpers > Atmospheric Apparatus (from drop-down list) > BoxGizmo

Create menu > Helpers > Atmospherics > BoxGizmo

BoxGizmo lets you create a box-shaped gizmo in your scene. Clicking the BoxGizmo button displays the Box Gizmo Parameters rollout.

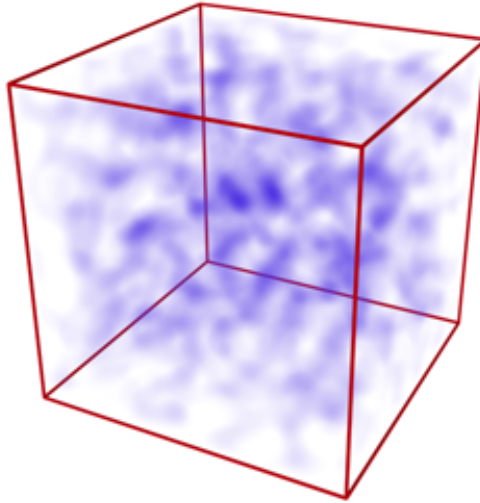

Box gizmo with volume fog

Procedures

To create the BoxGizmo:

- 1 Drag in a viewport to define the initial length and width, then release the mouse and drag vertically to set the initial height.
- 2 Click to end BoxGizmo creation.

To add a new atmosphere:

- 1 Select the apparatus gizmo.
- 2 In the Modify panel, on the Atmospheres & Effects rollout, click Add. This displays the [Add Atmosphere dialog](#) on page 6761.
- 3 Choose an atmosphere from the list.
- 4 Click OK.

This associates a new atmosphere with the apparatus.

To add an existing atmosphere:

- 1 Select the apparatus gizmo.
- 2 In the Modify panel, on the Atmospheres & Effects rollout, click Add. This displays the [Add Atmosphere dialog](#) on page 6761.
- 3 In the dialog, choose Existing.
- 4 Choose an atmosphere from the list.
- 5 Click OK.

This creates a duplicate atmosphere for the apparatus. Its settings are initially identical to the atmosphere you chose. You can adjust them using Setup.

Interface

Name and Color rollout

The [Name and Color rollout](#) on page 7631 lets you rename objects and change their wireframe color.

Box Gizmo Parameters rollout



Length, Width, and Height Set the dimensions of the box gizmo.

Seed Sets a base value used to generate the atmospheric effect. Each apparatus in the scene should have a different seed. If more than one apparatus uses the same seed and same atmospheric effect, they will produce nearly identical results.

New Seed Click to generate a random number automatically and place it in the seed field.

Atmospheres & Effects rollout



The Atmospheres & Effects rollout, available from the Modify panel, allows you to add and set up atmospheres directly to the gizmo.

Add Displays the [Add Atmosphere dialog](#) on page 6761 from which you can add an atmosphere to the BoxGizmo.

Delete Deletes a highlighted atmospheric effect.

Setup Displays the [Environment panel](#) on page 6689, where you can edit the highlighted effect.

CylGizmo Helper

Create panel > Helpers > Atmospheric Apparatus (from drop-down list) > CylGizmo

Create menu > Helpers > Atmospherics > Cylinder Gizmo

CylGizmo lets you create a cylinder-shaped gizmo in your scene. Clicking the CylGizmo button displays the Cylinder Gizmo Parameters rollout.

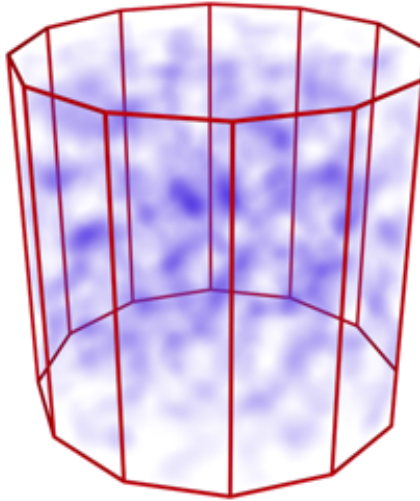

Cylinder gizmo with volume fog

Procedures

To create the CylGizmo:

- 1 Drag in a viewport to define the initial radius, then release the mouse and drag vertically to set the initial height.
- 2 Click to end CylGizmo creation.

To add a new atmosphere:

- 1 Select the apparatus gizmo.
- 2 In the Modify panel on the Atmospheres & Effects rollout, click Add. This displays the [Add Atmosphere dialog](#) on page 6761.
- 3 Choose an atmosphere from the list.
- 4 Click OK.

This associates a new atmosphere with the apparatus.

To add an existing atmosphere:

- 1 Select the apparatus gizmo.
- 2 In the Modify panel on the Atmospheres & Effects rollout, click Add. This displays the [Add Atmosphere dialog](#) on page 6761.
- 3 In the dialog, choose Existing.
- 4 Choose an atmosphere from the list.
- 5 Click OK.

This creates a duplicate atmosphere for the apparatus. Its settings are initially identical to the atmosphere you chose. You can adjust them using Setup.

Interface

Name and Color rollout

The [Name and Color rollout](#) on page 7631 lets you rename objects and change their wireframe color.

Cylinder Gizmo Parameters rollout

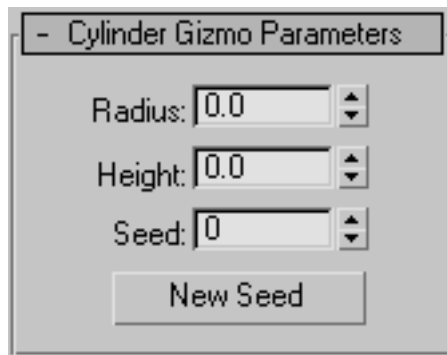

Radius and Height Set the dimensions of the cylinder gizmo.

Seed Sets a base value used to generate the atmospheric effect. Each apparatus in the scene should have a different seed. If more than one apparatus uses the

same seed and same atmospheric effect, they will produce nearly identical results.

New Seed Click to generate a random number automatically and place it in the seed field.

Atmospheres & Effects rollout



The Atmospheres & Effects rollout, available from the Modify panel, allows you to add and set up atmospheres directly to the gizmo.

Add Displays the [Add Atmosphere dialog](#) on page 6761 from which you can add an Atmosphere to the CylGizmo.

Delete Deletes a highlighted atmospheric effect.

Setup Displays the [Environment panel](#) on page 6689, where you can edit the highlighted effect.

SphereGizmo Helper

Create panel > Helpers > Atmospheric Apparatus (from drop-down list) > SphereGizmo

Create menu > Helpers > Atmospherics > Sphere Gizmo

SphereGizmo lets you create a sphere- or hemisphere-shaped gizmo in your scene. Clicking the SphereGizmo button displays the Sphere Gizmo Parameters rollout.

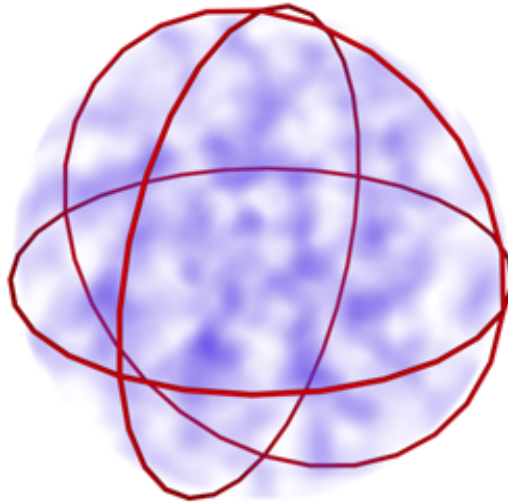

Sphere gizmo with volume fog

Procedures

To create the SphereGizmo:

- 1 Drag in any viewport to define the initial radius.
- 2 Adjust the radius with the spinner.

To add a new atmosphere:

- 1 Select the apparatus gizmo.
- 2 In the Modify panel on the Atmospheres & Effects rollout, click Add. This displays the [Add Atmosphere dialog](#) on page 6761.
- 3 Choose an atmosphere from the list.
- 4 Click OK.

This associates a new atmosphere with the apparatus.

To add an existing atmosphere:

- 1 Select the apparatus gizmo.
- 2 In the Modify panel on the Atmospheres & Effects rollout, click Add. This displays the [Add Atmosphere dialog](#) on page 6761.
- 3 In the dialog, choose Existing.
- 4 Choose an atmosphere from the list.
- 5 Click OK.

This creates a duplicate atmosphere for the apparatus. Its settings are initially identical to the atmosphere you chose. You can adjust them using Setup.

Interface

Name and Color rollout

The [Name and Color rollout](#) on page 7631 lets you rename objects and change their wireframe color.

Sphere Gizmo Parameters rollout

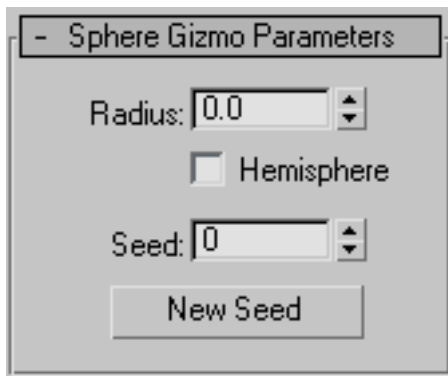

Radius Sets the radius of the default sphere.

Hemisphere When turned on, the bottom half of the SphereGizmo is discarded, creating a hemisphere.

Seed Sets a base value used to generate the atmospheric effect. Each apparatus in the scene should have a different seed. If more than one apparatus uses the same seed and same atmospheric effect, they will produce nearly identical results.

New Seed Click to generate a random number automatically and place it in the seed field.

Atmospheres & Effects rollout



The Atmospheres & Effects rollout, available from the Modify panel, allows you to add and set up atmospheres effects directly to the gizmo.

Add Displays the [Add Atmosphere dialog](#) on page 5106 from which you can add an Atmosphere to the SphereGizmo.

Delete Deletes a highlighted atmospheric effect.

Setup Displays the [Environment panel](#) on page 6689, where you can edit the highlighted effect.

Video Post

22

Video Post, available from the Rendering menu, lets you combine (composite) and render output of various types of events, including the current scene, bitmap images, image-processing functions, and so on.

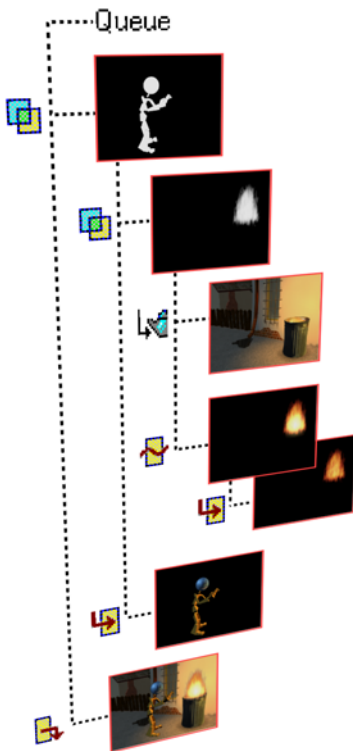

A video post queue can include scene geometry, background images, effects, and masks for compositing them.



The result of video post: a composited frame

Video Post is a self-contained, modeless dialog, similar in appearance to Track View. The edit window of the dialog shows when each event occurs in the finished video. Each event is associated with a track that has a range bar.

The Video Post dialog contains the following window components:

[Video Post Queue](#) on page 6774: Shows the sequence of post-production events.

[Video Post Status Bar/View Controls](#) on page 6776: Shows information about the active Video Post controls and lets you control the display of tracks in the event tracks area.

[Video Post Toolbar](#) on page 6797: Provides Video Post commands.

Video Post Queue

Rendering menu > Video Post > Video Post window > Video Post Queue

Video Post Queue provides a hierarchical list of the images, scenes, and events to be composited.

The Video Post queue in the Video Post dialog is similar to other hierarchical lists in the Track View and Material Editor. In Video Post, the list items are images, scenes, [animations](#) on page 7907, or external processes that together make up the queue. The items in the queue are called *events*.

The order that the events appear in the queue is the order in which they are executed, from top to bottom. Consequently, to correctly composite an image, the background bitmap must appear before, or above, the image that is to overlay it.

There is always at least one item in the queue (a placeholder labeled Queue). It is the queue's parent event.

The queue can be linear, but some kinds of events, such as Image Layer, combine other events and become their parent.

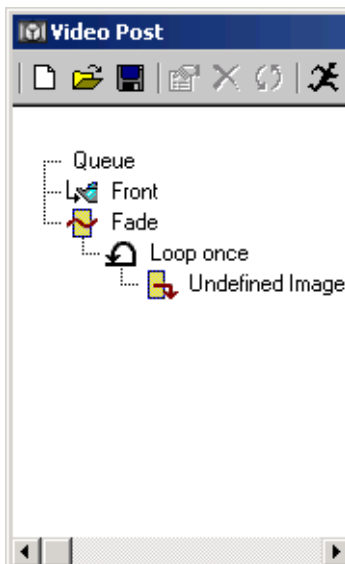

Procedures

To add an event to the queue:

- Click an event button.

When you add an event, a dialog displays where you can specify settings for that event. The settings offered on the dialog depend on the type of event; some events have different kinds of subtypes.

In general, the new event appears at the end of the queue - but some kinds of events require that you first select one or more events in the queue. An

event button is unavailable if the selection in the queue (or the absence of one) is not legal input to the button's type of event.

To highlight an event already in the queue, click its icon, label, or range-bar area.

To delete any event in the queue:

- Select the event and press the Delete key.
You can delete both enabled and disabled events, which are unavailable.

To switch the positions of two events in the queue:

- 1 Highlight both events.

- 2  Click Swap.

This operation might not be allowed if the result would be impossible to execute. At the top level of the queue, you can almost always swap events; at lower levels, an event's output must be legal input to its parent event.

To edit an event in the queue, do one of the following:

- 1 Select the event and click [Edit Current Event](#) on page 6799.
- 2 Double-click the event name.
- 3 Double-click the event's range-bar area in the edit window.
Use one of the second two methods for disabled events.

Video Post Status Bar / View Controls

Rendering menu > Video Post > Video Post Status Bar

The Video Post Status Bar contains an area for prompt and status information and for buttons to control the display of tracks in the event tracks area.

Interface

Prompt Line



Displays instructions for using the currently selected function.

Status (Start, End, Frames, Width, Height)

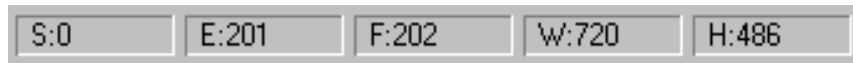

Displays the Start frame and End frame for the current event, the total number of frames and the output resolution of the entire queue.

S/E Shows start and end frames of the selected track. If no track is selected, shows the start and end frames of the entire queue.

F Shows the total frames in the selected track or for the entire queue.

W/H Shows the width and height of the image that results from the rendering of all the events in the queue.

Pan



Lets you drag horizontally in the event tracks area to shift the view left and right.

Zoom Extents



Adjusts the size of the event-track area horizontally so that all the frames of the longest track bar are visible.

Use Zoom Extents to quickly reset the display to show all frames after zooming in on a selection of frames with the Zoom Time button.

Zoom Time



Displays a greater or lesser number of frames in the event tracks area, allowing you to scale or zoom the display. The time ruler displays the current time display unit.

Drag horizontally in the event tracks area to zoom time.

Drag right to display fewer frames in the track area (zoom in).

Drag left to display more frames in the track area (zoom out).

Zoom Region



Magnifies a region that you define by dragging a rectangle in the event tracks area.

Troubleshooting Video Post

While Video Post offers many useful functions and creative effects, invariably you will set up a queue that looks like it should work or even appears to render correctly only to give you an animation that does not include the desired effect. Here are some troubleshooting tips to reference when a queue just isn't doing what you expect.

There are two key things that can cause a Video Post queue to fail. The first is incorrect ordering and nesting of events in the queue. The second is faulty positioning and/or overlapping of the range bars.

When you come up again a problem, especially if you're attempting to set up a very complex queue, the best way to diagnose the problem is to create a new queue that should only result in the effect that is failing. If you can get the simplified queue to work, you can compare it to the structure of the failing queue to see what might be out of order.

Here are two very common scenarios that look like they should work but ultimately don't give you the result you expected. These examples are shown in their simplified state, but could very easily be buried in more complex queues.

■ The object simply disappears instead of fading out.

The first example illustrates a problem where you expect the scene to render for fifteen frames before fading to black to finish the animation. However, at frame sixteen, the scene abruptly goes black.

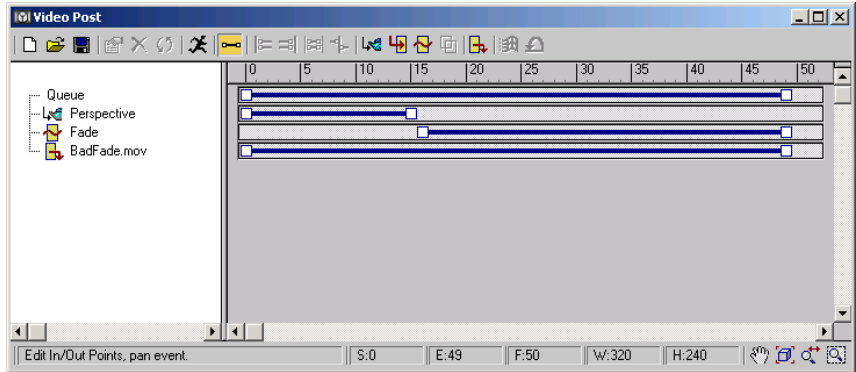

This queue shows all the correct events in the proper order in the queue. The problem is the timing and positioning of the range bars. The most likely cause of this problem is using the [Abut Selection](#) on page 6808 when it's not necessary. In order for the Fade event to work properly, it needs to overlap the animation for the amount of time you want to fade to occur. You need to take into account the number of frames where the scene actually fades.

To fix this queue, you have to decide how many frames over which the fade will occur. Let's say you want the scene to fade to black over ten frames. You would need to drag the right end of the Perspective event range bar ten frames to the right to overlap the Fade event.

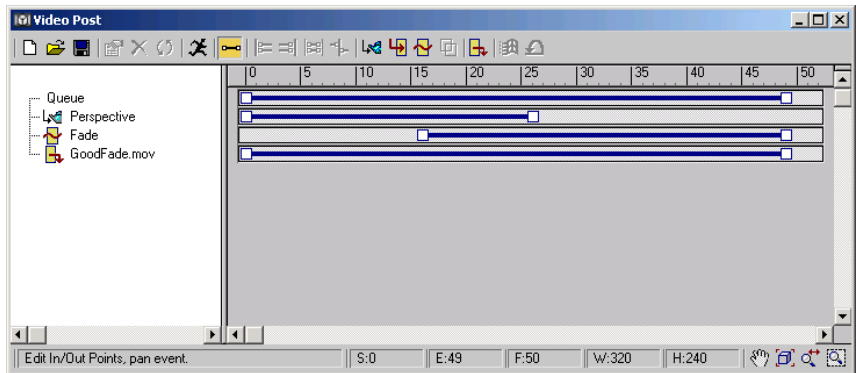

■ **The object glows during rendering, but not in the animation.**

This second example is even more misleading than the first. The infuriating thing about this problem is that while the scene is rendering, the object in the scene shows the glow effect. When the resultant animation is played back, the Glow effect is not present.

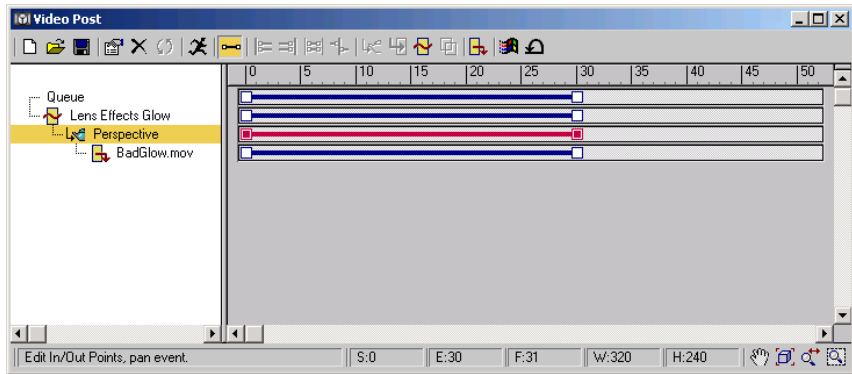

Once again, this queue shows all the correct events, but the problem here is the ordering of the events in the queue. This problem is commonly caused when an event is selected while other events are being added. In this case, the Perspective event was selected when the Lens Effects Glow and output events were added.

There are two ways to create this queue to give you the correct results. You can recreate the queue and add each event so there is no nesting, or you remove the current output event and add it again, making sure no other events are selected. The following images show the two ways this queue could be set up to successfully show the glowing object.

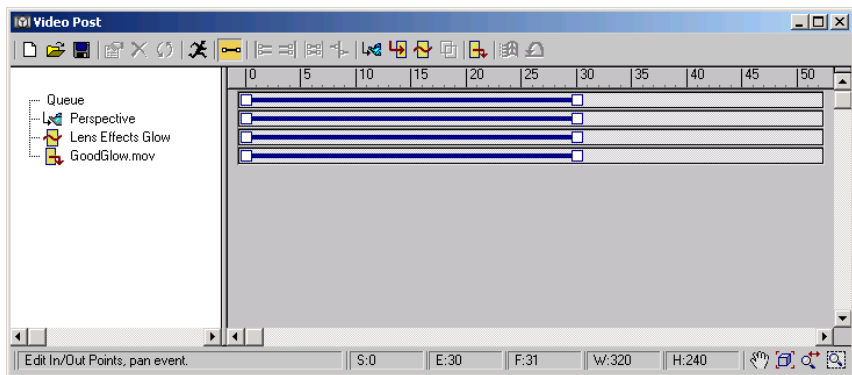

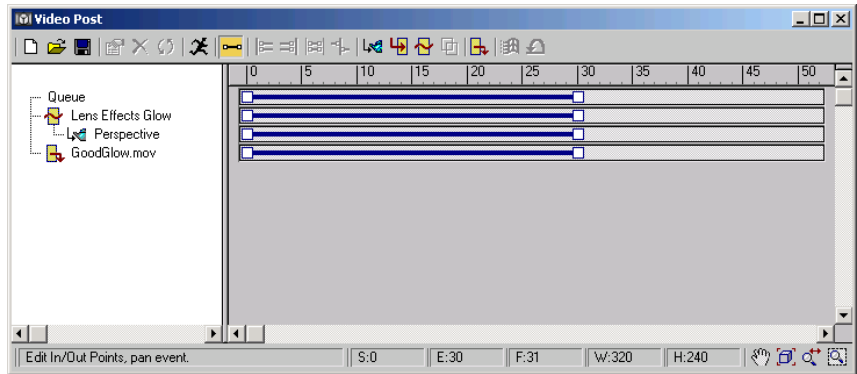

Useful Video Post Procedures

Rendering menu > Video Post

There are some tasks that you will use Video Post for more than others. This primer describes some of the more common sequences you'll find yourself using Video Post to create. The procedures are outlined in their simplest forms.





The following procedures are outlined:

- [Make an object glow](#) on page ?
- [Create an animation from a series of still images](#) on page ?
- [Render a scene with a starfield](#) on page ?
- [Set up a simple cross fade between two images](#) on page ?
- [Resize a series of images](#) on page ?
- [Composite two image sequences](#) on page ?
- [Render a scene over an image sequence or an animation](#) on page ?
- [Join two animations – end to end](#) on page ?
- [Switch between views](#) on page ?
- [Render a scene in reverse](#) on page ?

Procedures

Example: Make an object glow:

One of the most common things you'll want to do with the Glow filter is make an object glow. Here's how to do it in its simplest form.

- 1 In the Perspective viewport, create a Sphere with a radius of about 30.
- 2 Choose Rendering > Video Post.
- 3  Click [Add Scene Event](#) on page 6808 and set the view to Perspective. Click OK to close the Add Scene Event dialog.
- 4  Click [Add Image Filter Event](#) on page 6821 and choose Lens Effects Glow from the Filter Plug-In list. Click OK to close the Add Image Filter Event dialog.
- 5  Click [Add Image Output Event](#) on page 6828 and then click Files.
- 6 Set the output file format to BMP Image File and enter a filename like **MyGlow**. Click Save when you've set the name and format
- 7 Click OK to accept the default setting on the BMP configuration dialog. Then click OK to close the Add Image Output Event dialog.
- 8 Right-click the Sphere to bring up the Quad Menus and select Properties.
- 9 Set the Object Channel in the G-Buffer group to **1** and click OK.
- 10  Click the [Execute Sequence button](#) on page 6802.
- 11 Click Render on the Execute Video Post dialog. You'll see the a glowing sphere in the render window.

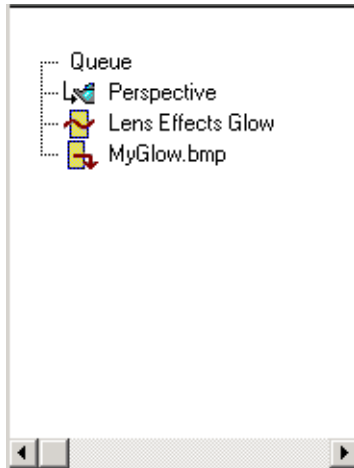

Example: Create an animation from a series of still images:

Another common process you'll use Video Post to achieve is taking a series of still images you've rendered and convert them to an animation. To accomplish this task, you need an [IFL file](#) on page 7339.

- 1 Use the [IFL Manager Utility](#) on page 7344 to create an IFL file containing the sequentially number image files you want to process.
- 2 Choose Rendering > Video Post.

- 3  Click [Add Image Input Event](#) on page 6814 and then click Files. Choose the IFL file you created at step 1 and then click Open to close the selection dialog.

- 4 Click OK to close the Add Input Image Event dialog.

- 5  Click [Add Image Output Event](#) on page 6828 and then click Files.

- 6 Set the output file format to [AVI File](#) on page 7326 and enter a filename like **MyAnimation**.

Click Save when you've set the name and format

- 7 Select a [codec](#) on page 7936 from the Video Compression dialog and click OK.



Then click OK to close the Add Image Output Event dialog.

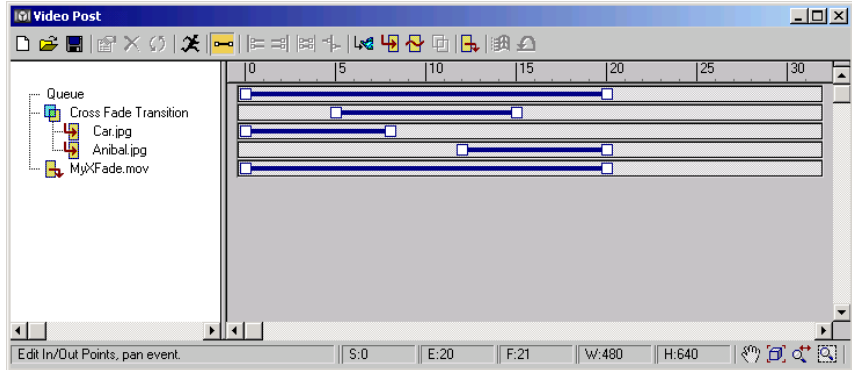

- 8  Click the [Execute Sequence button](#) on page 6802.
- 9 Click Render on the Execute Video Post dialog.
The final product is an animation.



Example: Render a scene with a starfield:

At some time, you'll want to create a night scene that requires a starry sky. The key thing to remember when creating a star field is adding a camera to the scene. The Starfield filter only works with a camera. Here are the steps to set that up.

- 1 In the Top viewport, create a Sphere with a radius of about 30 and a Target Camera.
Place the camera to one side and have it pointing at the center of the sphere.
- 2 Right-click in the Perspective viewport and press C to change the viewport display to Camera01.
- 3 Choose Rendering > Video Post.
- 4  Click [Add Scene Event](#) on page 6808 and make sure the view is set to Camera01.
Click OK to close the Add Scene Event dialog.
- 5  Click [Add Image Filter Event](#) on page 6821 and choose Starfield from the Filter Plug-In list.

- 6 Click the Setup button to open the Stars Control dialog. Make sure Source Camera (at the top) is set to Camera01, and then click OK.
- 7 Click OK to close the Add Image Filter Event dialog.
- 8  Click [Add Image Output Event](#) on page 6828 and then click Files.
- 9 Set the output file format to BMP Image File and enter a filename like **MyStarfield**.
Click Save when you've set the name and format
- 10 Click OK to accept the default setting on the BMP configuration dialog.
Then click OK to close the Add Image Output Event dialog.
- 11  Click the [Execute Sequence button](#) on page 6802.
- 12 Set the time output to Single and click Render on the Execute Video Post dialog.
The final product is a rendered image of a sphere against a starry background.

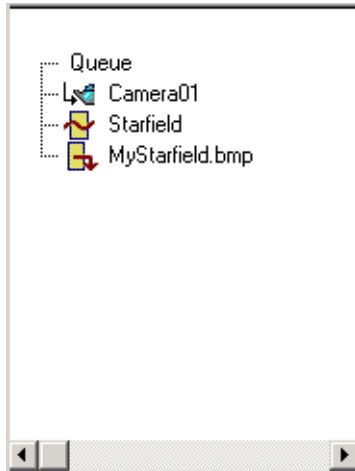

Set up a simple cross fade between two images:

Sometimes you want to transition from one view or animation to another. This set of steps will show you how to set up a cross fade from one image to another. For this example the complete cross fade will occur over 20 frames

displaying the first image for five frames, cross fade for ten frame and then display the second image for the last five frames.

The resulting animation produced by this process could be used as an Image Input Event for a different Video Post sequence.

1 Choose Rendering > Video Post.



2 Click [Add Image Input Event](#) on page 6814 and then click Files. Choose your first image and click Open and then click OK to close the Add Image Input Event dialog.



3 Click Add Image Input Event again and click Files. Choose your second image and click Open and then click OK to close the Add Image Input Event dialog.



4 Click [Add Image Output Event](#) on page 6828 and then click Files.

5 Set the output file format to MOV File and enter a filename like **MyXFade**. Click Save when you've set the name and format

6 Click OK to accept the default setting on the Compression Settings dialog. Then click OK to close the Add Image Output Event dialog.

7 Select the first Image Input Event and then hold down the Ctrl key while selecting the second Image Input Event.

Both events will highlight in gold.



8 Click [Add Image Layer Event](#) on page 6824 and choose Cross Fade Transition from the list of compositors and transitions.

Click OK to close the Add Image Layer Event dialog. Notice how the Image Layer Event becomes the parent of the two Image Input Events.



9 Click Zoom Extents to view the entire set of tracks.

10 On the Queue track bar, click and drag the right-hand end of the range-bar to frame 20.

This adjusts all the tracks.

- 11 Select the Cross Fade Transition event and drag the left-hand end of the range-bar to frame 5 and then drag the right-hand end of the range-bar to frame 15.

This sets the period in time when the cross fade occurs.

- 12 Select the track for the first Image Input Event and the right-hand end of the range-bar to frame 8.

By setting the end to frame 8 instead of 5, you'll have three frames during which the first image will fade to black.

- 13 Select the track for the second Image Input Event and the left-hand end of the range-bar to frame 12.

Similarly, setting this end to frame 12 ensures that the second image will fade in over three frames and display in full color for the last five frame of the transition.



- 14 Click the [Execute Sequence button](#) on page 6802.

- 15 Click Render on the Execute Video Post dialog.

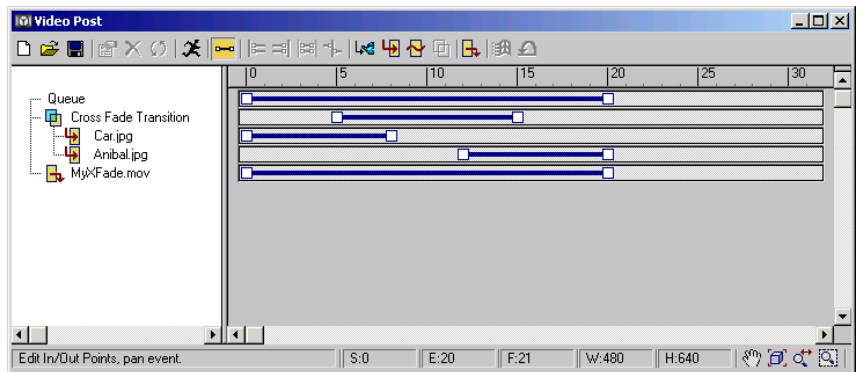

Example: Resize a series of images:

Perhaps you've rendered a series of still images but it turns out they were at the wrong resolution. You might normally think you have to re-render the entire scene again which will tie up all the systems to do the same work they just completed. Video Post can be used to resize the images without having to use all the systems.

- 1 Use the [IFL Manager Utility](#) on page 7344 to create an IFL file containing the sequentially number image files you want to resize.

2 Choose Rendering > Video Post.

3  Click [Add Image Input Event](#) on page 6814 and then click Files. Choose the IFL file you created at step 1 and then click Open to close the selection dialog.

4 Click OK to close the Add Input Image Event dialog.

5  Click [Add Image Output Event](#) on page 6828 and then click Files.

6 Set the output file format for the new set of still images to TGA and enter a filename like **MyResize**.

Click Save when you've set the name and format

7 Click OK to accept the default setting on the Targa Image Control dialog. Then click OK to close the Add Image Output Event dialog.

8  Click the [Execute Sequence button](#) on page 6802.



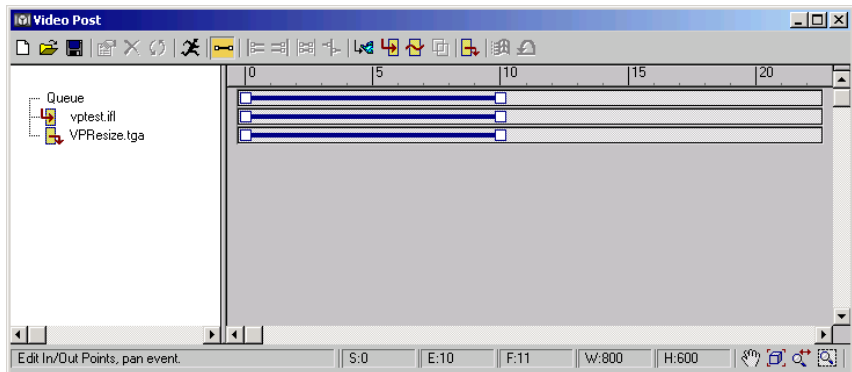

9 On the Execute Video Post dialog, set the new output resolution you want for the images and then click Render.

When the rendering is complete, you will have a new series of resized images that have a name prefix of MyResize. So, if there were ten images listed in the IFL file, there will be ten new images named *MyResize0000.tga* through *MyResize0009.tga* stored in your image folder.



Example: Composite two image sequences:

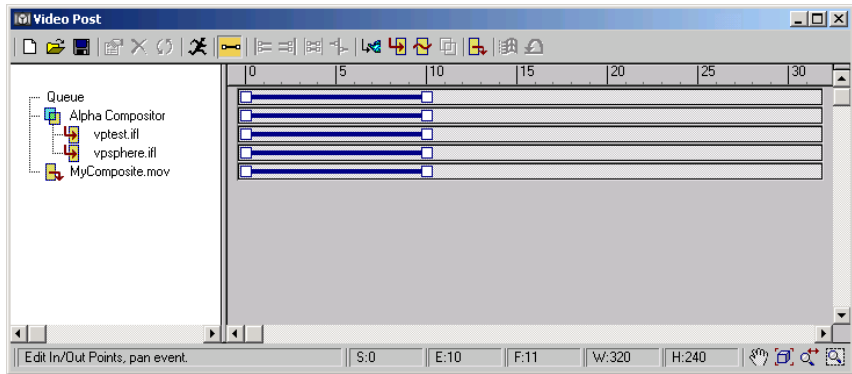

Compositing two sets of images together is one of the “workhorse” operations of Video Post. This is commonly done when a project is nearing completion and it lets you combine all the images your artists have been rendering.

- 1 Use the [IFL Manager Utility](#) on page 7344 to create an IFL file for each set of images sequences you want to composite.
- 2 Choose Rendering > Video Post.
- 3  Click [Add Image Input Event](#) on page 6814 and then click Files. Choose your first IFL file and click Open and then click OK to close the Add Image Input Event dialog.
- 4  Click Add Image Input Event again and click Files. Choose your second IFL file and click Open and then click OK to close the Add Image Input Event dialog.
- 5  Click [Add Image Output Event](#) on page 6828 and then click Files.
- 6 Set the output file format to MOV File and enter a filename like **MyComposite**. Click Save when you've set the name and format
- 7 Click OK to accept the default setting on the Compression Settings dialog. Then click OK to close the Add Image Output Event dialog.
- 8 Select the first Image Input Event and then hold down the Ctrl key while selecting the second Image Input Event. Both events will highlight in gold.
- 9  Click [Add Image Layer Event](#) on page 6824 and choose [Alpha Compositor](#) on page 6909 from the list of compositors and transitions. Click OK to close the Add Image Layer Event dialog. Notice how the Image Layer Event becomes the parent of the two Image Input Events.
- 10  Click the [Execute Sequence button](#) on page 6802.
- 11 Click Render on the Execute Video Post dialog.





Example: Render a scene over an image sequence or an animation:

This process is similar to the last one except you might have an animation or series of still images you want to use as the background for your existing scene.

- 1 Use the [IFL Manager Utility](#) on page 7344 to create an IFL file for the set of images that will be the background for your current scene.
- 2 Choose Rendering > Video Post.
- 3  Click [Add Image Input Event](#) on page 6814 and then click Files. Choose your IFL file or animation and click Open and then click OK to close the Add Image Input Event dialog.
- 4  Click [Add Scene Event](#) on page 6808 and set the view to Perspective or a Camera you have in the scene. Click OK to close the Add Scene Event dialog.
- 5  Click [Add Image Output Event](#) on page 6828 and then click Files.
- 6 Set the output file format to AVI File and enter a filename like **MyScene**. Click Save when you've set the name and format
- 7 Select a [codec](#) on page 7936 from the Video Compression dialog and click OK. Then click OK to close the Add Image Output Event dialog.



- 8 Select the first Image Input Event and then hold down the Ctrl key while selecting the Scene Event.
Both events will highlight in gold.

- 9  Click [Add Image Layer Event](#) on page 6824 and choose [Pseudo Alpha](#) on page 6911 from the list of compositors and transitions.
Click OK to close the Add Image Layer Event dialog. Notice how the Image Layer Event becomes the parent of the two Image Input Events.

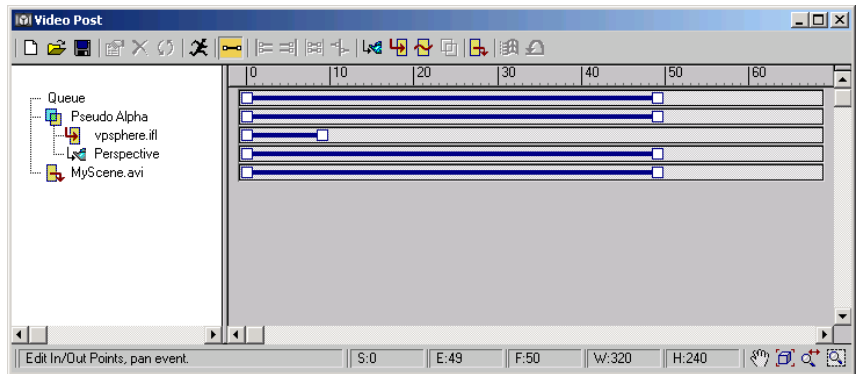
- 10  Click the [Execute Sequence button](#) on page 6802.
- 11 Click Render on the Execute Video Post dialog.



Notice that the Image Input Event in this example is only ten frames long. Normally, you'd choose a set of background images that equals the number of frames in your scene. When this sequence is executed, as is, the images in the IFL file will only appear for the first ten frames and then disappear.

- 12 Select the Image Input Event just under the Pseudo Alpha layer event.
- 13  Add a Loop Event and set the number of times to 4.
The Image Input Event becomes further nested in the queue. If you want, you can use the default Loop setting or change it to Ping Pong then click OK to close the Add Loop Event dialog.
- 14  Click the Execute Sequence button again and render the scene.

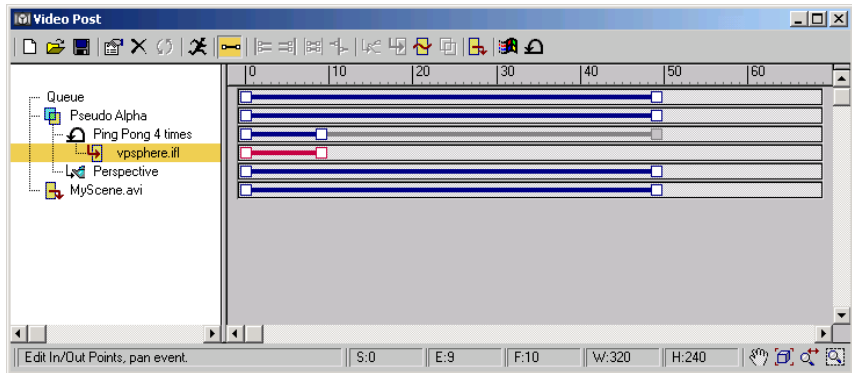

Join two animations—end to end:

If you're working in a production environment, you probably do not work on an entire animation by yourself. Instead, you might work on one part while other artists are working on other parts. At the end of the project, everyone's animations need to be joined together.

- 1 Choose Rendering > Video Post.

- 2  Click [Add Image Input Event](#) on page 6814 and then click Files. Choose your first animation file and click Open and then click OK to close the Add Image Input Event dialog.

- 3  Click Add Image Input Event again and click Files. Choose the next animation file and click Open and then click OK to close the Add Image Input Event dialog.

- 4 Repeat the last step for any other animations that need to be joined.

- 5  Click [Add Image Output Event](#) on page 6828 and then click Files.
- 6 Set the output file format to MOV File and enter a filename like **MyFinal**. Click Save when you've set the name and format
- 7 Click OK to accept the default setting on the Compression Settings dialog. Then click OK to close the Add Image Output Event dialog.

- 8 Select the first Image Input Event and then hold down the Ctrl key while selecting the second Image Input Event.
Both events will highlight in gold.

- 9  Click the [Abut Selected button](#) on page 6808.

- 10 Repeat the last two step with subsequent Image Input Events.

- 11  Click Zoom Extents to view the entire set of tracks.

- 12 Select the Image Output Event and drag the right end of the range-bar to match the total number of frames in the queue.

- 13  Click the [Execute Sequence button](#) on page 6802.



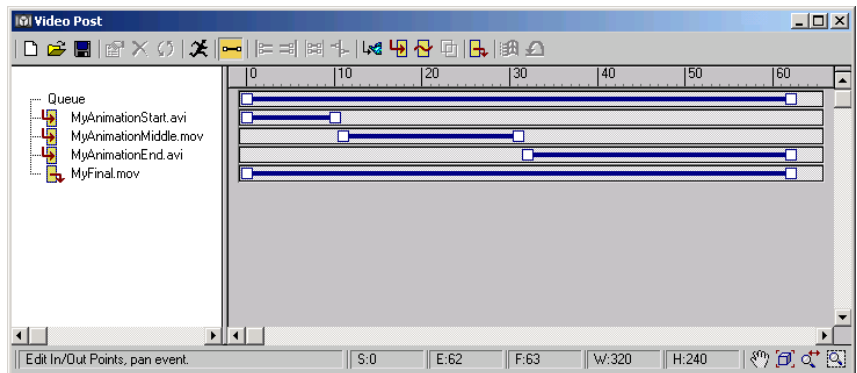

- 14 Click Render on the Execute Video Post dialog.



Switch between views:

It's not often that a final scene shows views from only one viewpoint. Either the camera moves or there are multiple cameras from which images are rendered. This sequence shows you how to switch from one camera view to another.

- 1 In the Perspective viewport, create a Box with a length of 15, a width of 30 and a height of 15.
- 2 In the Top viewport, create two Target Cameras pointing at the box from different angles.

- 3 Right-click the viewport label in the Left viewport and choose Views > Camera01.
- 4 Right-click viewport label in the Perspective viewport and choose Views > Camera02.
- 5 Choose Rendering > Video Post.
- 6  Click [Add Scene Event](#) on page 6808 and set the view to Camera01. Click OK to close the Add Scene Event dialog.
- 7  Click Add Scene Event again and set the view to Camera02. Click OK to close the Add Scene Event dialog.
- 8 Select the first Scene Event and then hold down the Ctrl key while selecting the second Scene Event. Both events will highlight in gold.
- 9  Click the [Abut Selected button](#) on page 6808.
- 10 Click in an empty part of the queue to deselect the two Scene Events.
- 11  Click [Add Image Output Event](#) on page 6828 and then click Files.
- 12 Set the output file format to MOV File and enter a filename like **MyViews**. Click Save when you've set the name and format
- 13 Click OK to accept the default setting on the Compression Settings dialog. Then click OK to close the Add Image Output Event dialog.
- 14  Click the [Execute Sequence button](#) on page 6802.
- 15 Click Render on the Execute Video Post dialog.

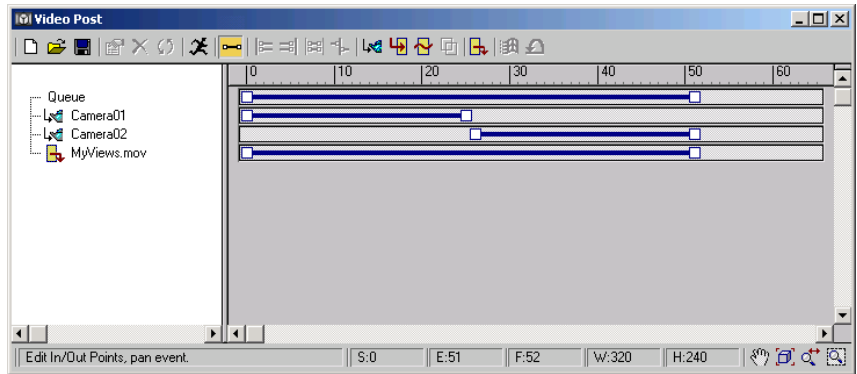

Render a scene in reverse:

It's not commonly done but when you need to render a scene in reverse you could spend hours trying to accomplish it. Video Post makes it easy.

- 1 Choose Rendering > Video Post.
- 2  Click [Add Scene Event](#) on page 6808 and set the view to Perspective or a camera in the scene.
- 3 In the Scene Range group, turn off Lock To Video Post Range and set the Scene Start value to the last frame of animation.
- 4 Turn off Lock Range Bar To Scene Range and set the Scene End value to 0.

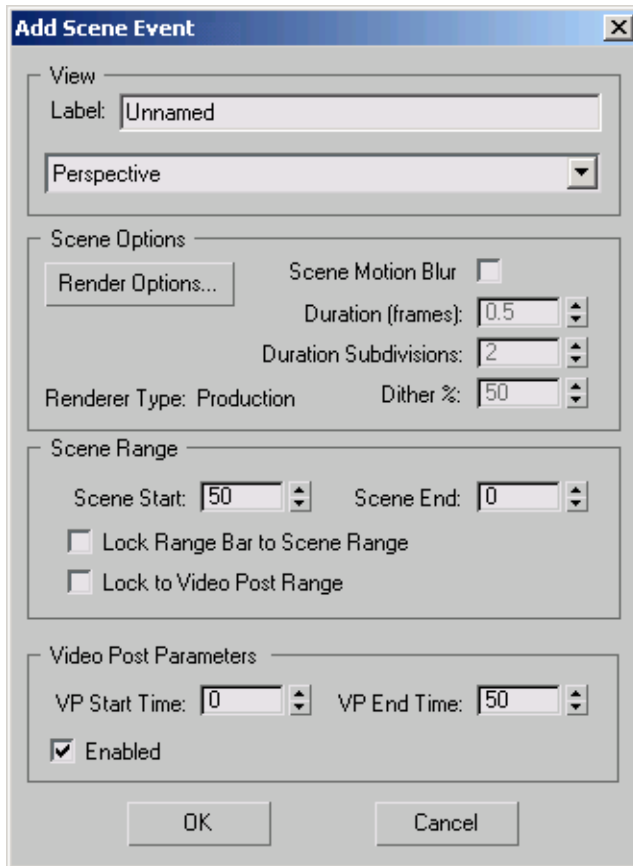

5 Click OK to close the Add Input Image Event dialog.

6  Click [Add Image Output Event](#) on page 6828 and then click Files.

7 Set the output file format to AVI File and enter a filename like **MyReverse**. Click Save when you've set the name and format

8 Select a [codec](#) on page 7936 from the Video Compression dialog and click OK.

Then click OK to close the Add Image Output Event dialog.

9  Click the [Execute Sequence button](#) on page 6802.

- 10 Click Render on the Execute Video Post dialog.

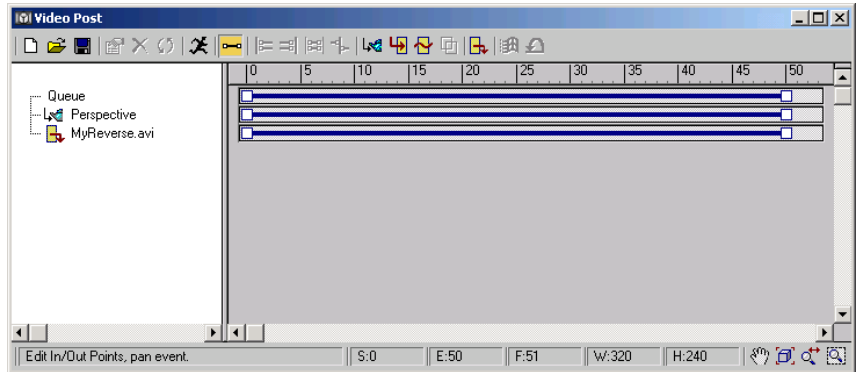

Video Post Toolbar

Rendering menu > Video Post toolbar



The Video Post Toolbar contains tools for handling Video Post files ([VPX files](#) on page 8165) and for managing the individual events displayed in the Video Post queue and event tracks area.

New Sequence

Rendering menu > Video Post > Video Post toolbar > New Sequence

The New Sequence button creates a new Video Post sequence by clearing existing events from the queue.

You'll be prompted to confirm the deletion of any entries in the current queue.

Procedures

To create a new Video Post file:

-  Click New Sequence.

WARNING This command erases all the current Video Post data.

Use New Sequence after you have saved to a different Video Post (VPX) file. Choosing Video Post from the Rendering menu displays the Video Post data (if any) saved with your 3ds Max scene.

Open Sequence

Rendering menu > Video Post > Video Post toolbar > Open Sequence

The Open Sequence button opens a Video Post sequence stored on disk.

Video Post sequences contain all the information relating to the queue and all associated settings and references. [VPX files](#) on page 8165 have the file extension *.vpx* and are stored by default in the `\3dsmax\vpst` folder.

Procedures

To open an existing Video Post file:

-  Click Open Sequence.
Use the file selection dialog that appears to choose the VPX file you want to execute or edit.

To import an existing Video Post sequence:

You can also use Open Sequence to import the Video Post queue from a 3ds Max scene (MAX file).

- 1  Click Open Sequence.
- 2 On the Open Sequence dialog, change the Files Of Type setting to All Files (*.*)
- 3 Browse to the folder where you store your MAX files.
- 4 Select the MAX file that contains the Video Post sequence you want to execute or edit and click Open.
Video Post loads only the Video Post data from the existing *.max* file, leaving your current scene unchanged.

Save Sequence

Rendering menu > Video Post > Video Post toolbar > Save Sequence

The Save Sequence button saves the current Video Post sequence to disk.

All of the Video Post configuration data, the queue events themselves, and any queue event external data are saved in the MAX file. You can also save the Video Post sequence to a separate file for sharing with other 3ds Max users.

Video Post sequence files contain all the information relating to the queue and all associated settings and references. [VPX files](#) on page 8165 have the file extension `.vpx` and are stored by default in the `\3dsmax\vpst` folder.

Procedures

To save the active Video Post data:

-  Click Save Sequence.
A file selection dialog appears to let you enter a name for the new Video Post file.
By default, Save Sequence stores the VPX file to the `\3dsmax\vpst` subdirectory. You can change the default path to another directory via the Configure User Paths dialog > [File I/O panel](#) on page 7733.

Edit Current Event

Rendering menu > Video Post > Video Post window > Select an event. > Video Post toolbar > Edit Current Event

The Edit Current Event button displays a dialog that lets you edit the properties of the selected event. The dialog depends on the type of event you've selected. The controls in the edit dialogs are the same as those in the dialog you use to add that type of event.

The top field in each event dialog is an editable label field. If the field is left blank, the event uses its assigned label. If you enter an event name, the Video Post Queue displays your event name in the field.

You can edit the following types of events:

[Add Scene Event](#) on page 6808

[Add Image Input Event](#) on page 6814

[Add Image Filter Event](#) on page 6821

[Add Image Layer Event](#) on page 6824

[Add Image Output Event](#) on page 6828

[Add External Event](#) on page 6831

[Add Loop Event](#) on page 6834

Procedures

To edit an event in the queue, do one of the following:

- 1  Select the event and then click the Edit Current Event button.
- 2 Double-click the event name.
- 3 Double-click the event's range-bar area in the edit window.

Use the second or third method above with *disabled* events.

Delete Current Event

Rendering menu > Video Post > Video Post window > Select an event. > Video Post toolbar > Delete Current Event

The Delete Current Event button deletes the selected event from the Video Post Queue.

You'll be asked to confirm event deletion.

Procedures

To delete any event in the queue:

-  Select the event and press the Delete key.
You can delete both enabled and disabled events, which are unavailable.

Swap Events

Rendering menu > Video Post > Video Post window > Select two events. > Video Post toolbar > Swap Events

The Swap Events button switches the position of two selected events in the queue.

This is useful if you have images in the wrong order for compositing. The background image has to be first and the foreground image with the [alpha channel](#) on page 7905 has to be second.

Procedures

To switch the positions of two events in the queue:

- 1 Highlight both events.
- 2  Click Swap.

Swap Events might not be allowed if the result would be impossible to execute.

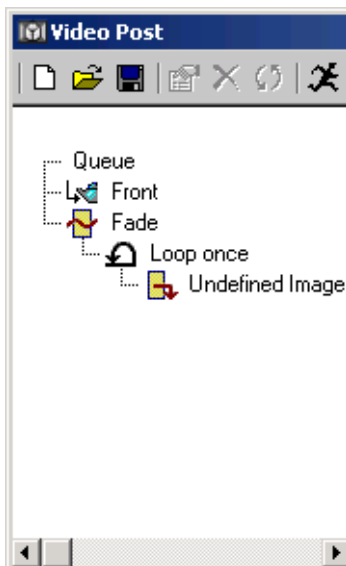

In this sample queue, the two top level events, Front and Fade, could be swapped. You can almost always swap events at the top level.

However, at lower levels, where events start getting nested, the output of a lower level event must be valid input to its parent event. In the sample queue, the output of the Loop Once event would not be recognized by the Fade event, so the Swap Events button remains inactive and you cannot swap them.

Execute Sequence

Rendering menu > Video Post > Video Post toolbar > Execute Sequence

You execute the Video Post queue as the final step in creating a post-produced video. Execution is different from rendering because rendering is done for scenes only and you can use Video Post to composite images and animations without including the current 3ds Max scene.

Although the Execute Video Post controls are similar to those of the Render Setup dialog, the settings are independent, and do not affect each other.

During execution, you can move or close the rendered frame window, but you cannot use the rest of 3ds Max until the execution is completed or cancelled.

The rendering time for the last rendered frame in the Video Post sequence is displayed in the prompt line of the main 3ds Max window.

Procedures

To execute the queue:

-  Click Execute Sequence.
An Execute Video Post dialog appears.
- Set the time range and output size, and then click Render to create the video.
- When execution is done, click Close to dismiss the Video Post progress dialog if it is still open.

Interface

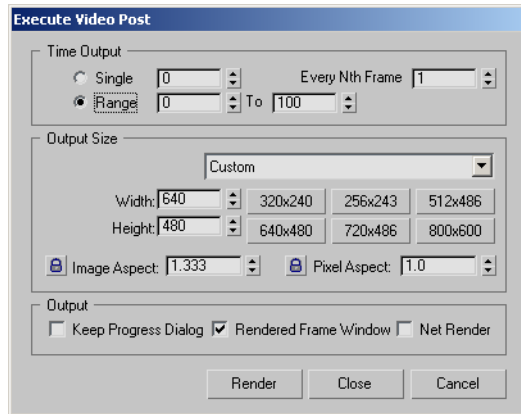

Time Output group

Select the frames to execute:

Single Current frame only.

You can execute a single frame only if it falls within the current range.

Range All the frames between and including the two numbers.

Every Nth frame Regular sample of frames. For example, enter 8 to execute every 8th frame.

Output Size group

Format Choose Custom or a standard film or video format from the list. For Custom, you can set the aperture width of the camera, the rendering output resolution, and the image aspect ratio or pixel aspect ratio. When you choose a standard format, the aperture width and aspect ratios are locked, but you can change the resolution.

Width/Height Specify the width and height of the image, in pixels. For Custom, you can set these two spinners independently. For other formats, the two spinners are locked to the specified aspect ratio, so changing one changes the other.

Resolution Buttons Specifies a preset resolution. Right-click a button to display a [subdialog](#) on page 6804 that lets you change the resolution specified by that button.

Image Aspect Sets the aspect ratio of the image. As you alter the Image Aspect, you also alter the Height value to maintain the correct aspect ratio. For standard formats, the image aspect ratio is locked, and this spinner is replaced by a text display.

If you lock the Image Aspect (by clicking the Lock button), Width and Height are locked to each other, so that changing one changes the other to maintain the image aspect ratio, and changing the Pixel Aspect value changes the Height value to maintain the image aspect ratio.

Pixel Aspect Sets the aspect ratio of the pixels of the image. For standard formats, the pixel aspect ratio is determined by the format and this spinner is replaced by a text display.

If you lock the pixel aspect ratio (by clicking the Lock button), the Pixel Aspect spinner is replaced by a text display. The Lock button is available only for the Custom format.

Output group

Keep Progress Dialog Forces the Video Post Progress dialog to remain displayed when the Video Post sequence has finished executing. By default, it closes automatically. If this option is selected, you must click the Close button to close the dialog.

Rendered Frame Window Displays the Video Post execution in a window on the screen.

Net Render Enables [network rendering](#) on page 8057. If Net Render is turned on, when you render you'll see the [Network Job Assignment dialog](#) on page 6481.

Configure Presets

Rendering menu > Video Post > Video Post toolbar > Execute Sequence > Right-click any Resolution button. > Configure Presets dialog

If you use the Custom format for [Execute Sequence](#) on page 6802, you can change the values for any preset resolution button by right-clicking the button.

If you use one of the standard formats, the Width and Height spinners are locked to the standard's image aspect ratio, and the Aspect Ratio spinner is replaced by a text display.

After you change these values and exit the Configure Presets dialog, you must click the button to apply the new values to the Execute Sequence dialog.

Interface

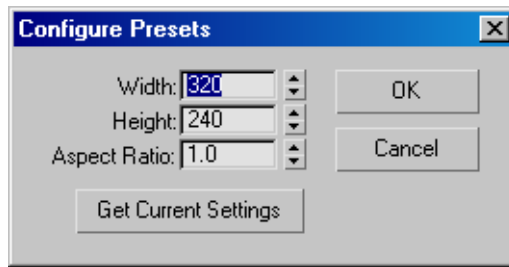

Width Specifies the width of the image, in pixels.

Height Specifies the height of the image, in pixels.

Aspect Ratio Sets the aspect ratio of the image. As you alter the Image Aspect value, you also alter the Height value so that the correct aspect ratio is maintained for the resolution.

Edit Range Bar

Rendering menu > Video Post > Video Post toolbar > Edit Range Bar

The Edit Range Bar provides editing functions for the range bars that appear in the event tracks area.

When Edit Range Bar is on, you can:

- Select any event by clicking its range bar (it turns red when selected).
- Move the range bar while maintaining its range by dragging in the middle of the bar.
- Change the start or end frame of the range by dragging either end of its bar.

Procedures

To select a range bar, do one of the following:

- 1 Click the range bar in the event tracks area.
- 2 Click the associated event name or icon in the queue.

To select multiple range bars:

- 1 Click a range bar.
- 2 Hold down Ctrl and click additional range bars.

To select multiple contiguous range bars:

- 1 Click a range bar.
- 2 Hold down Shift and click another range bar.
Both range bars you clicked and all range bars between them, if any, are selected.

NOTE In a multiple selection, the last range bar you select becomes the current event, displayed with red squares in its endpoints. The align commands use the current event.

To move a range bar:

- Click and drag the center of the range bar left or right.

To change the length of a range bar:

- Click and drag one of range bar's endpoints left or right.
If multiple range bars are selected, dragging one endpoint changes all selected range bars.

To change the number of frames in an event:

- 1 Double-click the range bar in the event tracks area or select the event and click the Edit Current Event button.
- 2 Change the VP Start Time or VP End Time values.

Align Selected Left

Rendering menu > Video Post > Video Post window > Select two or more range bars. > Video Post toolbar > Align Selected Left

The Align Selected Left button left-aligns two or more selected range bars.

When you select two or more range bars, the last one selected is the current event. The end boxes of the other events are white, while the end boxes of the current event are red. When you click Align Selected Left, the current event stays in place, and the remaining selected events are aligned to its left end.

Procedures

To change the number of frames in an event, do one of the following:

- 1 Double-click the range bar in the event tracks area.
- 2 Click the Edit Current Event button in the toolbar.

Align Selected Right

Rendering menu > Video Post > Video Post window > Select two or more range bars. > Video Post toolbar > Align Selected Right

The Align Selected Right button right-aligns two or more selected range bars.

When you select two or more range bars, the last one selected is the current event. The end boxes of the other events are white, while the end boxes of the current event are red. When you click Align Selected Right, the current event stays in place, and the remaining selected events are aligned to its right end.

Procedures

To change the number of frames in an event, do one of the following:

- 1 Double-click the range bar in the event tracks area.
- 2 Click the Edit Current Event button in the toolbar.

Make Selected Same Size

Rendering menu > Video Post > Video Post window > Select one or more events. > Video Post toolbar > Make Selected Same Size

The Make Selected Same Size button makes all selected events the same size as the current event.

When you select two or more range bars, the last one selected is the current event. The end boxes of the other events are white, while the end boxes of the current event are red. When you click Make Selected Same Size, the current event stays in place, and the remaining selected events are expand or shrink to cover the same number of frames.

Procedures

To change the number of frames in an event, do one of the following:

- 1 Double-click the range bar in the event tracks area.
- 2 Click the Edit Current Event button in the toolbar.

Abut Selected

Rendering menu > Video Post > Video Post window > Select events in the queue. > Video Post toolbar > Abut Selected

The Abut Selected button places the selected events end-to-end, so that when one ends the next one starts.

The selected events are placed end-to-end according to their order in the queue.

Add Scene Event

Rendering menu > Video Post > Video Post window > Make sure no events are selected in the queue. > Video Post toolbar > Add Scene

Rendering menu > Video Post > Video Post window > Select a scene from the Video Post Queue. > Video Post toolbar > Edit Current Event

The Add Scene Event button adds the scene in the selected camera viewport to the queue. A Scene event is a view of the current 3ds Max scene. You can choose which view to display and how to synchronize the scene with the final video. Like Image Input events, Scene events place an image in the queue, but a Scene event is the current 3ds Max scene and it must be rendered when you execute the Video Post queue. The scene is rendered exactly as it would be by

the [scanline renderer](#) on page 8116, with the additional options listed below. The resulting scene image has an [alpha channel](#) on page 7905.

You can use multiple Scene events to show two views of the same scene simultaneously or to cut from one view to another. If you have more than one Scene event in the queue, and they occupy the same time range, composite them with an [Image Layer event](#) on page 6824 such as Cross Fade or Simple Wipe. Otherwise, the second Scene Event overwrites the first even though your system has spent the time processing both events.

Procedures

To add a Scene event:

- 1 Make sure no events are selected in the queue.

- 2  Click Add Scene.

An Add Scene Event dialog appears.

- 3 Choose a view to use from the View list.
- 4 Click Render Setup to change rendering settings from the way you have set them in the Render Setup dialog.

NOTE Unlike settings in the Execute Video Post dialog, changes you make to the Scene event rendering options change the Render Setup dialog settings, and vice-versa.

- 5 Set the Scene Range options and click OK.
The Scene event appears at the end of the queue.

To match the scene's frames with Video Post frames:

- Make sure Lock To Video Post Range is selected.
Lock To Video Post Range is the default. Frames in the scene match Video Post frames and have the same frame number. That is, frame 0 in the scene is frame 0 in the Video Post dialog, frame 15 in the scene is frame 15 in Video Post, and so on. The range bar for the Scene event represents which portion of the scene is selected. If the range bar covers Video Post frames 25 to 35, executing the queue renders scene frames 25 to 35. Moving the range bar for the scene is like moving a time window within the scene. Other Scene Range options are disabled when Lock To Video Post Range is selected.

To offset the scene in time:

- Select Lock Range Bar To Scene Range.

The Scene Start control is enabled but the Scene End control remains disabled: synchronization is controlled by the Scene Start value and the length of the range bar.

The Scene Start value is the scene frame number where playback begins. If Scene Start is 0, frame 0 of the scene is the first frame played back; if Scene Start is 12, frame 12 is the first frame to play, and so on.

The range bar length determines how many frames of the scene to play. Dragging the end point of the range bar changes the length of the playback range. Although Scene End is unavailable, its value updates to show the frame number of the last scene frame that will be played.

Dragging the range bar changes where the scene is played within the final video. For example, if you set Scene Start to 5 and move the range bar to begin at Video Post frame 20, frame 5 is played at frame 20 of the final video, and so on.

To offset the scene and change scene playback rate:

- Turn off Lock Range Bar To Scene Range.

With Lock Range Bar to Scene Range off, both Scene Start and Scene End are enabled. As before, Scene Start specifies the first scene frame to play. Scene End specifies the last scene frame to play, and the length of the range bar determines playback speed.

If the range bar specifies the same number of Video Post frames as there are corresponding scene frames, then playback is at the scene's playback rate. If the range bar specifies fewer frames, the scene is sped up. If the range bar specifies more frames, the scene is slowed down. When it executes, Video Post automatically skips frames or adds frames to control the speed of scene playback.

For example, if Scene Start is frame 5 and Scene End is frame 35, the range bar represents 30 frames overall. If the range bar covers only 10 Video Post frames, scene playback is sped up to fit 30 frames into 10 of the final video. If on the other hand, the range bar covers 120 frames, scene playback is stretched to slow it down.

To render the full scene backwards:

- 1 Turn off Lock To Video Post Range.
- 2 Turn off Lock Range Bar To Scene Range.

- 3 Set Scene Start to the last frame in the scene.
- 4 Set Scene End to the first frame in the scene.
The length of the range bar also determines the playback speed of the reversed scene.

To add scene motion blur:

- 1 Select Scene Motion Blur in the Scene Event dialog.
- 2 Set the scene motion blur parameters.
The Scene event generates motion blur by simulating a camera with an open shutter. It interpolates and then renders movement within a frame, to generate a series of images of the moving object, instead of the default single image.

Interface

The Add Scene Event and Edit Scene Event dialogs have the same controls.

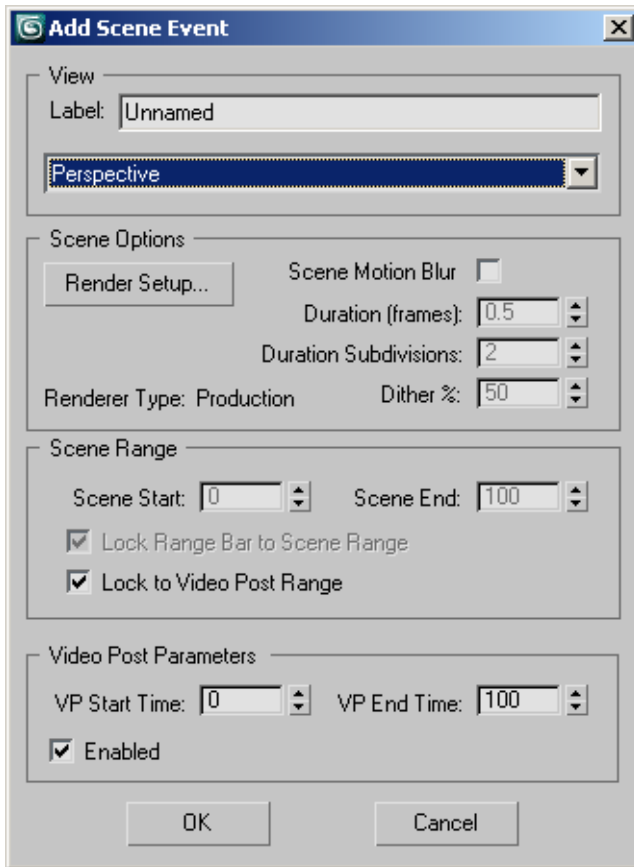

View group

Label Lets you edit the event name. A unique name can make the scene event easier to distinguish in a long list of events.

Viewport Select the viewport you want to render.

Scene Options group

Enables various rendering effects.

Render Setup Displays a subset of the [Render Setup dialog](#) on page 6067 parameters. Changes you make here affect the Render Setup dialog as well.

Scene Motion Blur Turns on the [scene motion-blur](#) on page 8117 effect for the whole scene. This is different from [object motion blur](#) on page 8063, which creates motion blur for individual objects in the scene.

When you render with Scene Motion Blur activated, the Render Progress dialog tells you which subsample is being rendered. The information appears in parentheses to the right of the "Rendering Image" text.

Duration Sets the virtual shutter speed for motion blur. When set to 1.0, the virtual shutter is open for the entire duration between one frame and the next. When set to a smaller number, such as 0.25, the number of subdivisions specified in the Duration Subdivision field will be rendered within the specified portion of the frame (in this example, in the first fourth of the duration between one frame and the next).

Duration Subdivisions Determines how many sub-frame slices are rendered within the Duration. The default is 2 slices, but you'll want at least 5 or 6 to get a decent effect.

Dither % Sets the amount of [dithering](#) on page 7956 between blurred pixels of overlapping frame slices. If Dither % is set to 0, no dithering occurs.

Scene Range group

Scene Start/End Sets the range of scene frames to be rendered.

Lock Range Bar to Scene Range Becomes available when you deselect Lock To Video Post Range. When it's available, the End spinner is disabled and locked to the Video Post range. When you change the Start spinner it automatically updates the End spinner based on the Video Post range set for this event.

If you turn off Lock Range Bar To Scene Range, you can change either Start or End spinners to whatever you want. This allows you to keep your scene range locked to its native length, and still provides flexibility for mapping an arbitrary scene range to an arbitrary Video Post range.

Lock to Video Post Range Renders the same range of scene frames as Video Post frames. You can set the Video Post range in the Execute Video Post dialog.

Video Post Parameters group

VP Start Time/End Time Sets the starting and ending frames for the selected event within the overall Video Post queue. Video Post renders the event over the number of frames specified here.

Enabled Toggles the event. When off, the event is disabled and Video Post ignores it when rendering the queue. You must disable each event individually. For example, disabling a composite layer event does not disable the composited image events. The range bars of disabled events are unavailable in the event track area.

Add Image Input Event

Rendering menu > Video Post > Video Post window > Make sure no events are selected in the queue. > Video Post toolbar > Add Image Input Event

Rendering menu > Video Post > Video Post window > Select an Image Input Event. > Video Post toolbar > Edit Current Event

The Add Image Input Event adds a still or moving image to the scene. Image Input events place an image in the queue, but unlike Scene events, the image is either a file that was saved beforehand or a device-generated image.

The image can be in one of the following file formats:

[AVI Files](#) on page 7326

[BMP Files](#) on page 7328

[CIN \(Kodak Cineon\) Files](#) on page 7328

[CWS \(Combustion Workspace\) Files](#) on page 7329

[GIF Files](#) on page 7334

[HDRI Files](#) on page 7334

[IFL Files](#) on page 7339

[MOV \(QuickTime Movie\) Files](#) on page 7348



[MPEG Files](#) on page 7348

[JPEG Files](#) on page 7347

[PNG Files](#) on page 7360

[PSD Files](#) on page 7361

[RLA Files](#) on page 7364

[RPF Files](#) on page 7366

[RGB \(SGI Image\) Files](#) on page 7369

[TGA \(Targa\) Files](#) on page 7370

[TIFF Files](#) on page 7372

[YUV Files](#) on page 7374

[DDS Files](#) on page 7330

Procedures

To add an Image Input event:

- 1 Make sure no events are selected in the queue.



- 2 Click Add Image Input Event.

An Add Image Input Event dialog appears.

- 3 Click Files to choose a bitmap or animation as the image, or click Devices to choose an image-generating device.

If you click Files, a file dialog appears to let you choose the bitmap or animation file.

If you choose Devices, a Select Image Input Device dialog appears. This dialog has a list of installed device options.

- 4 Click Options to choose the size and placement of the image in the final video frames.

An Image Input Options dialog appears.

- 5 Adjust other Image Input settings, and then click OK.

The Image Input event appears at the end of the queue.

TIP Think of images that share the same time range as layers, comparable to matted film images in a compositor. Images that share a time range must be composited with an [Image Layer event](#) on page 6824; otherwise, the second image in the queue "overwrites" the first.

To align the input image, do one of the following in the Image Input Options dialog:

- 1 Choose Presets and then click one of the preset alignment buttons.
- 2 Choose Coordinates and then enter the X,Y coordinates for the image's location.

The upper-left corner is (0,0) for both the input image and the output frame. Increasing X moves the image to the right, and increasing Y moves the image down. Negative values move the image in the opposite direction. X and Y values specify pixels.

To set the input image size, do one of the following in the Image Input Options dialog:

- 1 Choose Do Not Resize to maintain the image's original resolution.
- 2 Choose Resize To Fit to change the image size to match the output frame. This can change the image resolution, causing it to be rescaled for every frame.
- 3 Choose Custom Size and then enter the width and height of the image in the output frame.

To control playback of an animated image:

- 1 In the Frames group of the [Image Input Options dialog](#) on page 6818, set the input animation frame range and speed.
- 2 Turn on Loop At The End if you want the animation to repeat. Turn off Loop At The End if you want the animation to stop after playback. This option applies only when the input animation is shorter than the final video.

Interface

The Add Image Input Event and Edit Image Input Event dialogs have the same controls.

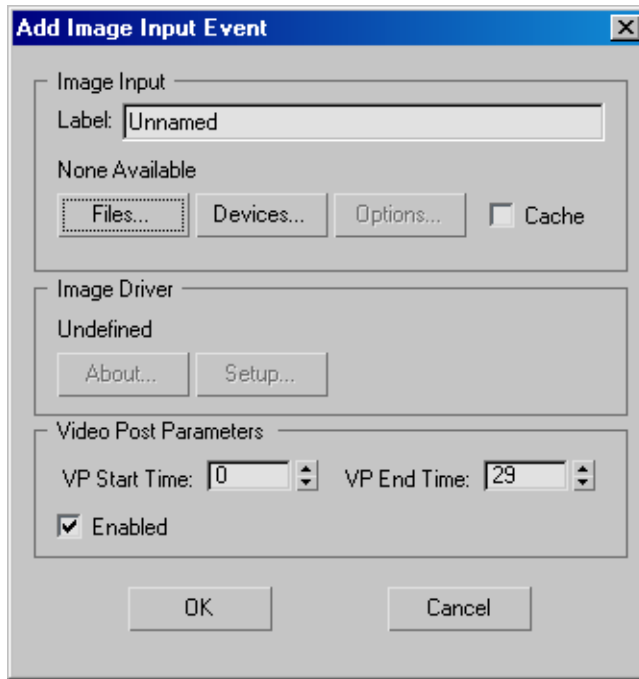

Image Input group

Label Lets you give the event a unique name. A unique name can make the image event easier to distinguish in a long list of events.

Files Lets you choose the bitmap or animation image file.

Devices Lets you choose an installed hardware input device; for example, a digital disk recorder.

Options Displays the [Image Input Options dialog](#) on page 6818 to allow you to set up alignment, size, and frame range for the input image.

Cache Stores a bitmap in memory. If you are using a single-image bitmap, you can choose this option. Video Post won't reload or scale the image for each frame.

Image Driver group

These buttons are available only when you choose a device as the image source.

About Provides information on the source of the image-handler software used to bring the image into 3ds Max.

Setup Displays a setup dialog specific to the plug-in. Some plug-ins might not use this button.

Video Post Parameters group

VP Start Time/End Time Sets the starting and ending frames for the selected event within the overall Video Post queue. Video Post renders the event over the number of frames specified here.

Enabled Enables or disables the event. When this box is off, the event is disabled and Video Post ignores it when rendering the queue. Each event must be disabled individually. For example, disabling a composite layer event does not disable the composited image events. The range bars of disabled events are unavailable in the event track area.

Image Input Options

Rendering menu > Video Post > Video Post window > Make sure no events are selected in the queue. > Video Post toolbar > Add Image Input Event > Select a file for input. > Options

The Image Input Options dialog contains controls for setting the image's size and placement relative to the frames of video output. For animated input, you also use it to synchronize the Image Input event with the frame sequence of video output. The same dialog appears when you click Options from the Mask area of the Filter Event and Layer Event dialogs.

Procedures

To align the input image, do one of the following in the Image Input Options dialog:

- 1 Choose Presets and then click one of the preset alignment buttons.
- 2 Choose Coordinates and then enter the X,Y coordinates for the image's location.

The upper-left corner is (0,0) for both the input image and the output frame. Increasing X moves the image to the right, and increasing Y moves the image down. Negative values move the image in the opposite direction. X and Y values specify pixels.

To set the input image size, do one of the following in the Image Input Options dialog:

- 1 Choose Do Not Resize to maintain the image's original resolution.
- 2 Choose Resize to Fit to change the image size to match the output frame. This can change the image resolution, causing it to be rescaled for every frame.
- 3 Choose Custom Size and then enter the width and height of the image in the output frame.

To control playback of an animated image:

- 1 In the Frames group, set the From, To and Step values.
- 2 Select Loop at the End if you want the animation to repeat. Clear Loop at the End if you want the animation to stop after playback. This option applies only when the input animation is shorter than the final video.

Interface

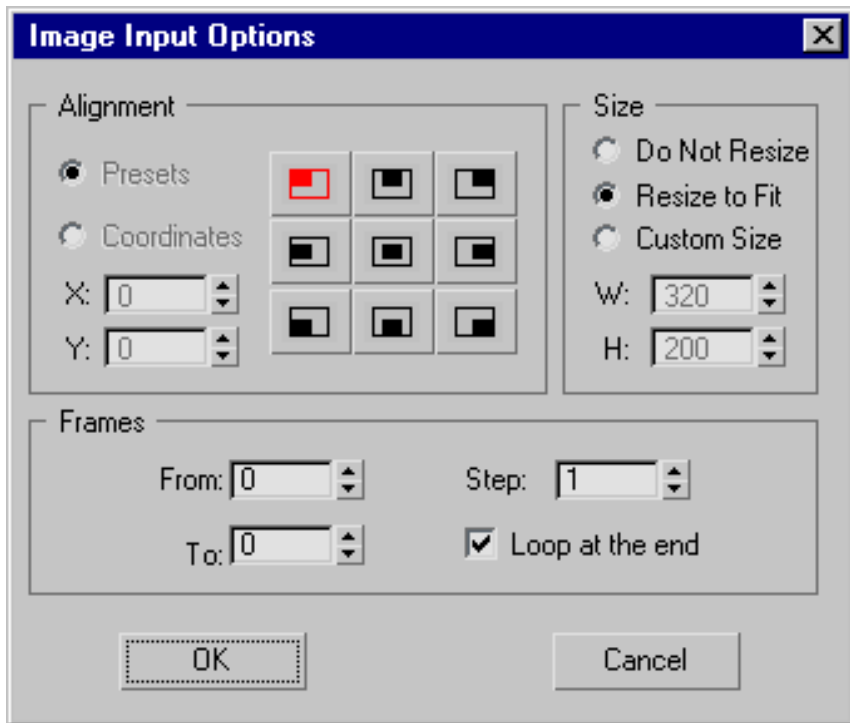

Alignment group

Presets Positions the image according to one of the preset buttons: Top-left, Center, Top-right, and so on. Mutually exclusive with Coordinates.

Coordinates Positions the image according to coordinates you enter. Mutually exclusive with Presets.

Size group

Do Not Resize Retains the image's original, stored dimensions.

Resize to Fit Resizes the image to the size of the Video Post rendered image (default).

Custom Size Resizes the image according to width and height units you enter.

Frames group

From/To Specifies the range of frames to use if the image input file is an animation or video.

Step Sets the interval between the frames you want to use. For example, if this spinner is set to 7, 3ds Max uses every seventh frame.

Loop at End Plays the frames from the beginning when the last frame is reached. This will take effect if the frame range used is less than the Video Post frame range.

Add Image Filter Event

Rendering menu > Video Post > Video Post window > Make sure no events are selected in the queue. > Video Post toolbar > Add Image Filter Event

Rendering menu > Video Post > Video Post window > Select a filter from the Video Post Queue. > Video Post toolbar > Edit Current Event

The Add Image Filter Event provides image processing for images and scenes. Several kinds of image filters are provided, see list below. For example, the Negative filter inverts the colors of an image and the Fade filter fades an image in or out over time.

An Image Filter event is usually a parent event with a single child (which can itself be a parent with children), for example, a Scene event, an Image Input event, a Layer event that contains Scene or Image Input events, or a Filter event that contains Scene or Image Input events. You can also add an Image Filter without a child event, in which case the Image Filter processes the result of the previous events in the queue.

Available Image Filters

[Contrast Filter](#) on page 6837

[Fade Filter](#) on page 6838

[Image Alpha Filter](#) on page 6839

[Lens Effects Filters](#) on page 6840

[Negative Filter](#) on page 6841

[Pseudo Alpha Filter](#) on page 6842

[Simple Wipe Filter](#) on page 6843

[Starfield Filter](#) on page 6844

Procedures

To add an image filter event:

- 1 Either select a valid child event, or make sure no event is selected in the queue.
- 2  Click Add Image Filter Event.
An Add Image Filter Event dialog appears.
- 3 Choose the kind of filter you want from the Filter Plug-In list.
- 4 If the Setup button is enabled for this kind of filter, click Setup to set the filter options.
- 5 Choose a mask if you want the filter to be masked or if the kind of filter you're using requires it.
- 6 Adjust other Image Filter settings, and then click OK.
If you selected a child event, the Image Filter event becomes its parent.
If no event was selected, the Image Filter event appears at the end of the queue.

To choose the mask file:

- 1 Click Files.
- 2 Use the file dialog to choose the mask file, and then click OK.
- 3 Choose the channel to use from the drop-down list of channels.

To position or resize the mask:

- Click Options.
An Image Input Options dialog appears, identical to the dialog you use with Image Input events.
If the mask is animated, you also use this dialog to specify its time range and playback speed.

Interface

The Add Image Filter Event and Edit Filter Event dialogs have the same controls.

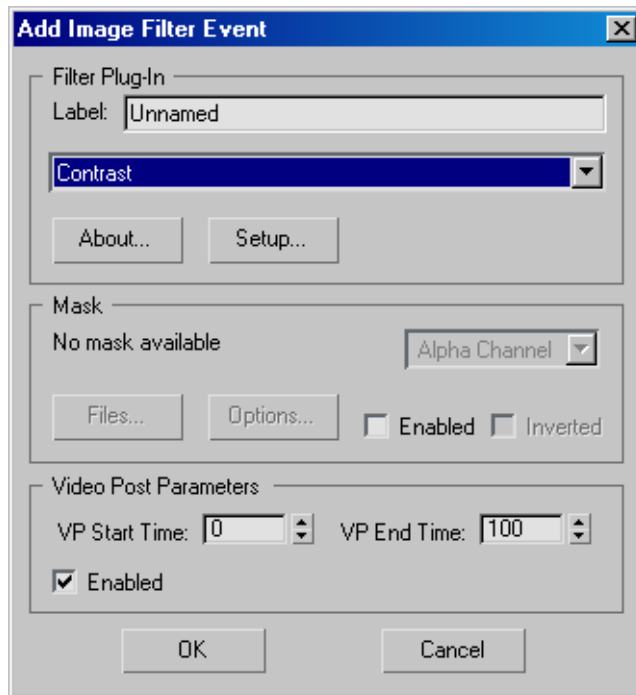

Filter Plug-In group

Label Lets you give the event a unique name. A unique name can make the filter event easier to distinguish in a long list of events.

Filter List Lists the filter [plug-ins](#) on page 8092 you have installed.

See the separate help topics for a description of the filters that come with 3ds Max by clicking any of the filters listed above.

About Provides version and source information specific to the plug-in.

Setup Displays a setup dialog specific to the plug-in. Some plug-ins might not use this button.

Mask group

Channels If you are using a bitmap as the mask file, you can use the Alpha channel, the Red, Green, or Blue channel, Luminance, Z-Buffer, Material Effects, or Object ID.

Files Select a file to use as a mask. The name of the selected file appears above the Files button.

Options Displays an [Image Input Options dialog](#) on page 6818 where you can set alignment and size, relative to the frames of video output. For animated images, you can also synchronize the mask with the frame sequence of video output. This is the same dialog used for Image Input Event options.

Enabled Enables the mask. If turned off, Video Post ignores any other mask settings.

Inverted When turned on, the mask is inverted.

Video Post Parameters group

VP Start Time/End Time Set the starting and ending frames for the selected event within the overall Video Post queue. Video Post renders the event over the number of frames specified here.

Enabled Enables or disables the event. When turned off, the event is disabled and Video Post ignores it when rendering the queue. Each event must be disabled individually. For example, disabling a composite layer event does not disable the composited image events. The range bars of disabled events are unavailable in the event track area.

Add Image Layer Event

Rendering menu > Video Post > Video Post window > Make sure the two child events are in the order you want the Image Layer event to use them. > Select the two events. > Video Post toolbar > Add Image Layer Event
Rendering menu > Video Post > Video Post window > Select a Layer Event. > Video Post toolbar > Edit Current Event

The Add Image Layer Event adds a compositing [plug-in](#) on page 8092 to layer the selected images in the queue.

Provides compositing plug-ins that use the previous event in the queue as a source, and composite the next event, using the parameters of the plug-in

compositor. The list might include plug-ins for special transformations, such as wipes, etc.

An Image layer event is always a parent event with two children. The children can themselves be parents with children. The children of an Image Layer event can be Scene events, Image Input events, Layer events that contain Scene or Image Input events, or Filter events that contain Scene or Image Input events.

Available Image Layer Event Filters

[Alpha Compositor](#) on page 6909

[Cross Fade Compositor](#) on page 6910

[Pseudo Alpha Compositor](#) on page 6911

[Simple Additive Compositor](#) on page 6912

[Simple Wipe Compositor](#) on page 6913

Procedures

To add an image layer event:

- 1 Make sure the two child events are in the order you want the Image Layer event to use them.
- 2 Select the two events.
Click to select the first event, then hold Ctrl and click to select the second.
- 3  Click Add Image Layer Event.
An Add Image Layer Event dialog appears.
- 4 Choose the kind of layer event you want from the Layer Plug-In drop-down list.
- 5 If the Setup button is enabled for this kind of layer event, click Setup to set the options.
- 6 Choose a mask if you want the layer event to be masked.
- 7 Adjust other Image Layer settings, and then click OK.
The Image Layer event becomes the parent of the two child events you selected.

To choose the mask file:

- 1 Click Files.
- 2 Use the file dialog to choose the mask file, and then click OK.
- 3 Choose the channel to use from the drop-down list of channels.

To position or resize the mask:

- Click Options.
An Image Input Options dialog appears, identical to the dialog you use with Image Input events.
If the mask is animated, you also use this dialog to specify its time range and playback speed.

Interface

The Add Layer Image Event and Edit Layer Event dialogs have the same controls.

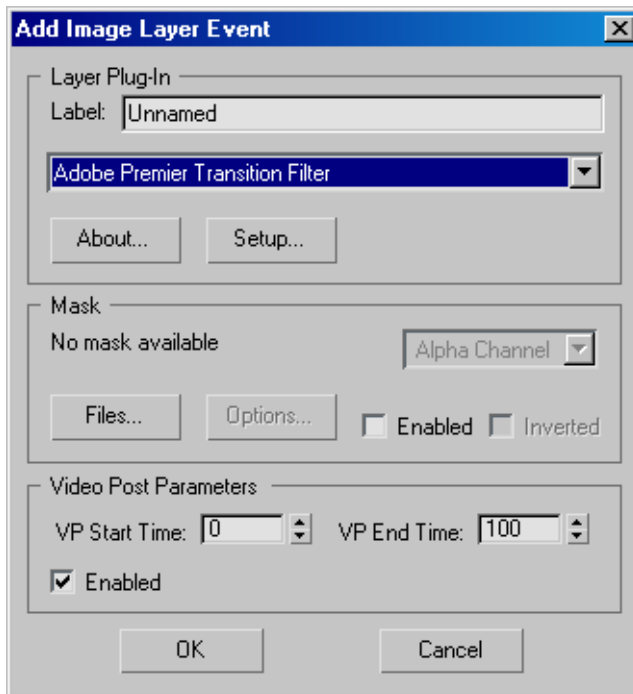

Layer Plug-In group

Label Lets you give the event a unique name. A unique name can make it easier to distinguish the layer event in a long list of events.

Layer List Selects the compositor 3ds Max uses for layering the rendered images in the queue. Alpha is the default compositor, but you can also choose from any others you have installed. See the separate help topics for descriptions of the compositors that come with 3ds Max.

About Provides version or source information specific to the [plug-in](#) on page 8092.

Setup Displays a setup dialog specific to the plug-in. Some plug-ins might not use this button.

Mask group

Channels If you are using a bitmap as the mask file, you can use the Alpha channel, the Red, Green, or Blue channel, Luminance, Z-Buffer or Material Effects channel, or Object ID.

Files Select a file to use as a mask. The name of the selected file appears above the Files button.

Options Displays the [Image Input Options dialog](#) on page 6818 where you can set alignment and size, relative to the frames of video output. For animated images, you can also synchronize the mask with the frame sequence of video output. This is the same dialog used for Image Input Event options.

Enabled Enables the mask. If turned off, Video Post ignores any other mask settings.

Inverted When turned on, the mask is inverted.

Video Post Parameters group

VP Start Time/End Time Set the starting and ending frames for the selected event within the overall Video Post queue. Video Post renders the event over the number of frames specified here.

Enabled Enables or disables the event. When turned off, the event is disabled and Video Post ignores it when rendering the queue. Each event must be disabled individually. For example, disabling a composite layer event does not disable the composited image events. The range bars of disabled events are unavailable in the event track area.

Add Image Output Event

Rendering menu > Video Post > Video Post toolbar > Add Image Output Event

Rendering menu > Video Post > Video Post window > Select an Image Output event. > Video Post toolbar > Edit Current Event

The Add Image Output Event provides controls for editing an output image event.

Image Output events send the result of executing the Video Post queue to a file or a device. You must add an Image Output event to the end of the queue if you want to save the final video. Otherwise, the results are displayed in the rendered frame window only. The Image Output event's range bar must include the entire range of frames you want to output.

The rendered output can be a still image or an animation, in one of the following file formats:

[AVI Files](#) on page 7326

[BMP Files](#) on page 7328

[CIN \(Kodak Cineon\) Files](#) on page 7328

[EPS and PS \(Encapsulated PostScript\) Files](#) on page 7332

[HDRI Files](#) on page 7334

[JPEG Files](#) on page 7347

[PNG Files](#) on page 7360

[MOV \(QuickTime Movie\) Files](#) on page 7348

[RLA Files](#) on page 7364

[RPF Files](#) on page 7366

[RGB \(SGI Image\) Files](#) on page 7369

[TGA \(Targa\) Files](#) on page 7370

[TIFF Files](#) on page 7372

You also have the option to direct the output to a VTR controller output device. If you have multiple output image events, you can output to different devices. This lets you monitor your queue with VTR output devices and view your output at any level of the Video Post queue during rendering.

Procedures

To add an image output event:



- 1 Click Add Image Output Event.

Image Output disregards whether any events in the queue are selected or not.

- 2 Click Files to save the final video in a file, or Devices to send the video to a device.

If you click Files, a file dialog appears to let you choose the bitmap or animation file.

If you choose Devices, a Select Image Output Device dialog appears. This dialog has a drop-down list of installed device options.

- 3 Adjust other parameters, and then click OK.

The Image Output Event appears at the end of the queue.

If you choose a device, its configuration controls are enabled:

Interface

The Add Image Output Event and Edit Output Image Event dialogs have the same controls.

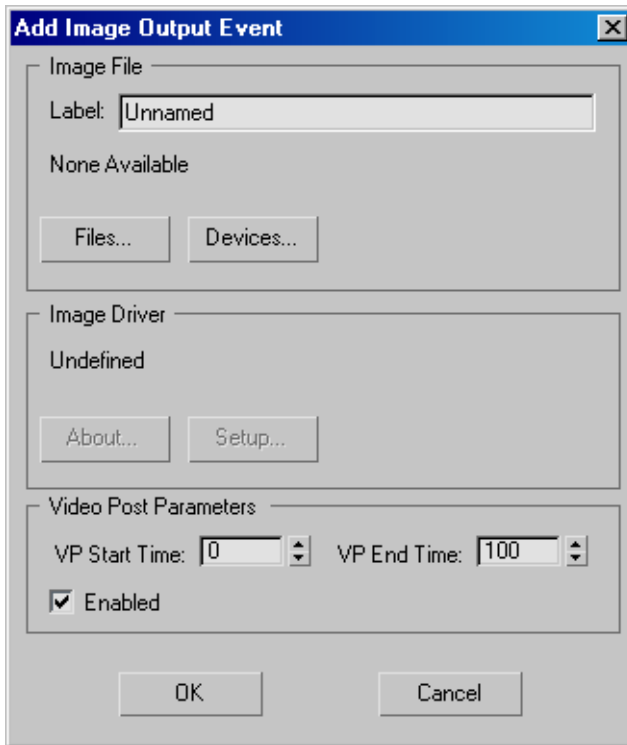

Image File group

Label Lets you give the event a unique name. A unique name can make it easier to distinguish the output event in a long list of events.

Files Lets you choose the output image file and its format.

Devices Lets you choose the hardware output device; for example, a digital video recorder. The device, its driver, and its 3ds Max plug-in must all be installed on your system to use device output.

Image Driver group

The two buttons in this area are available only when you choose a device as the image source.

About Provides information on the source of the image-handler software used to create the image from 3ds Max.

Setup Displays device-specific setup options.

Video Post Parameters group

VP Start Time/End Time Set the starting and ending frames for the selected event within the overall Video Post queue. Video Post renders the event over the number of frames specified here.

Enabled Enables or disables the event. When turned off, the event is disabled and Video Post ignores it when rendering the queue. Each event must be disabled individually. For example, disabling a composite layer event does not disable the composited image events. The range bars of disabled events are unavailable in the event track area.

Add External Event

Rendering menu > Video Post > Video Post toolbar > Add External Event

Rendering menu > Video Post > Video Post window > Select an External event.
> Video Post toolbar > Edit Current Event

An External event is typically a program that performs image processing. It can also be a batch file or utility that you want to run at a specific point in the queue, or a way to transfer images from or to the Windows clipboard.

An External event is always a child event. If you select an event in the queue before you add the External event, the External event becomes the selected event's child. Child events are evaluated before their parents.

Procedures

To add an external event:

- 1 Select an event.

- 2  Click Add External Event.

An Add External Event dialog appears.

- 3 Click Browse.
A file dialog appears.

- 4 Use the file dialog to choose the external program you want to execute, and then click OK.

- 5 If the external program accepts command-line options, enter these in the Command Line Options field.
- 6 If you want the external program to read the current Video Post image, turn on Write Image To Clipboard.
- 7 If you want Video Post to use the result of the external program, turn on Read Image From Clipboard.
- 8 Click OK.
If you selected an event, the External event becomes its child. If no event was selected, the External event appears at the end of the queue.

WARNING The image that the External event reads from the clipboard is placed in the Video Post queue. If the external program does not do what you want, this can erase or overwrite the result of all Video Post post-processing.

Interface

The Add External Event and Edit External Event dialogs have the same controls.

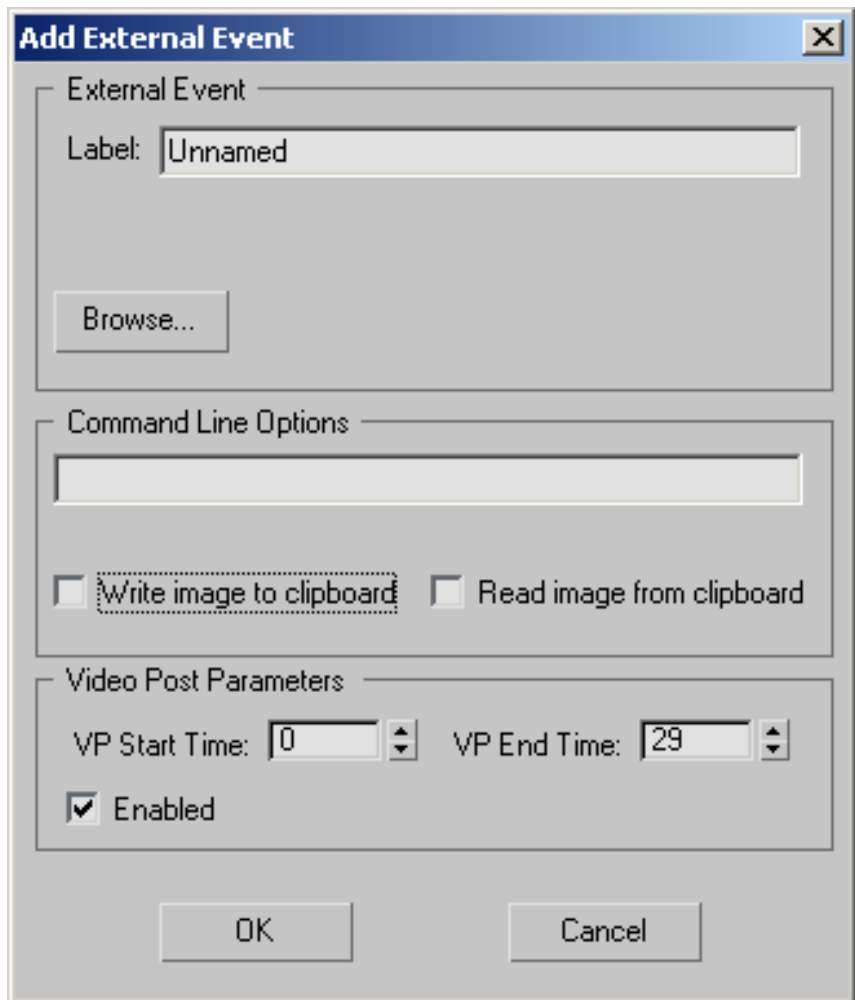

External Event group

Label Lets you give the event a unique name. A unique name can make the external event easier to distinguish in a long list of events.

Browse Lets you select an external program. For example, you can specify Adobe Photoshop™ or another image-processing application.

Command-Line Options group

For external programs that accept command-line options, lets you send real-time data to the external program. 3ds Max parses three special commands. When found in a string, these commands are replaced with real-time data, as follows:

- %f is replaced with a 4-digit frame number (for example, 0001)
- %w is replaced with a 4-digit image width (for example, 0640)
- %h is replaced with a 4-digit image height (for example, 0480)

For example, if the given command-line option is:

```
-w%w -h%h -oframe%f.tga
```

The string sent to the external program might be:

```
-w0640 -h0480 -oframe0001.tga
```

Write image to clipboard When on, writes the current rendered image to the Windows clipboard for retrieval by an external application.

Read image from clipboard When on, reads the contents of the Windows clipboard after processing by the external application. When the processed image is saved to the clipboard, it automatically appears in Video Post. With an automated script, it is possible to run the image through any external image processor and get it back automatically.

Video Post Parameters group

VP Start Time/End Time Set the starting and ending frames for the selected event within the overall Video Post queue. Video Post renders the event over the number of frames specified here.

Enabled Enables or disables the event. When turned off, the event is disabled and Video Post ignores it when rendering the queue. Each event must be disabled individually. For example, disabling a composite layer event does not disable the composited image events. The range bars of disabled events are unavailable in the event track area.

Add Loop Event

Rendering menu > Video Post > Video Post toolbar > Add Loop Event

Rendering menu > Video Post > Video Post window > Select a Loop event. > Video Post toolbar > Edit Current Event

Loop events cause other events to repeat over time in the output video. They control sequencing, but perform no image processing.

A Loop event is always a parent event with a single child. The child itself can be a parent with children. Any type of event can be the child of a Loop event, including another Loop event.

The Loop event's range bar displays the original duration of the child event's playback in color and the range of looped events in gray. You can change the duration of the child event's playback by dragging the child's frame range or the child's original range in the Loop event's track, but you can adjust the full length of the loop (the gray part of the range bar) only by changing the Number of Times parameter in the Edit Loop Event dialog.

Procedures

To add a loop event:

- 1 Select the child event.

- 2  Click Add Loop Event.

An Add Loop Event dialog appears.

- 3 Choose the loop settings, and then click OK.

The Loop event appears as the parent of the selected event.

The Loop event repeats the child event over the course of the Loop event's range.

Interface

The Add Loop Event and Edit Loop Event dialogs have the same controls.

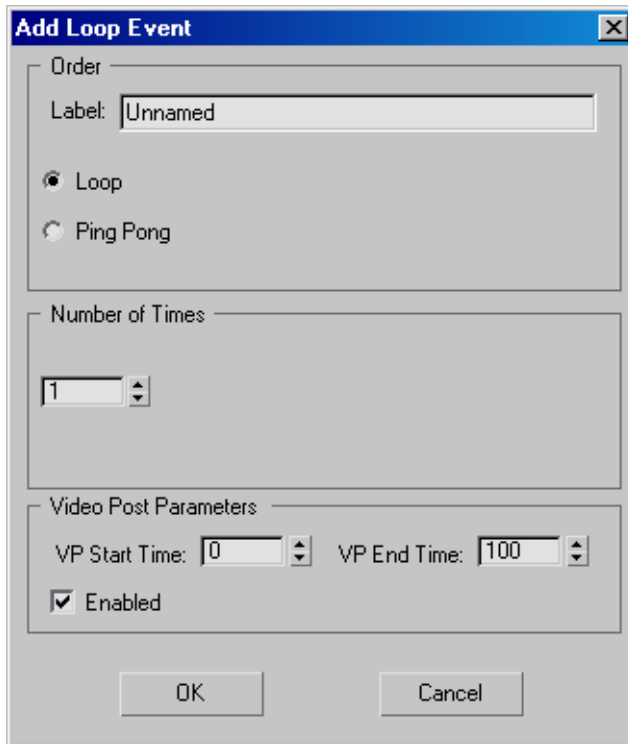

Order group

Label Lets you give the event a unique name. A unique name can make it easier to distinguish the loop event in a long list of events.

- **Loop** (The default.) Repeats the child event by starting it over when the child event reaches the end of its range.
- **Ping Pong** Repeats the child event by playing it first forward, then backward, then forward, and so on. The last frame of the child event is not repeated.

Number of Times group

Specifies the number of times to repeat the loop or ping pong, in addition to the first time that the child event is played.

Video Post Parameters group

VP Start Time/End Time Set the starting and ending frames for the selected event within the overall Video Post queue. Video Post renders the event over the number of frames specified here.

Enabled Enables or disables the event. When turned off, the event is disabled and Video Post ignores it when rendering the queue. Each event must be disabled individually. For example, disabling a composite layer event does not disable the composited image events. The range bars of disabled events are unavailable in the event track area.

Filter Events

Contrast Filter

Rendering menu > Video Post > Video Post toolbar > Add Image Filter Event > Choose Contrast Filter from the Filter Plug-In list.

Rendering menu > Video Post > Video Post window > Select a Contrast Filter. > Video Post toolbar > Edit Current Event > Setup

The Contrast filter allows you to adjust the contrast and brightness of an image.

Interface

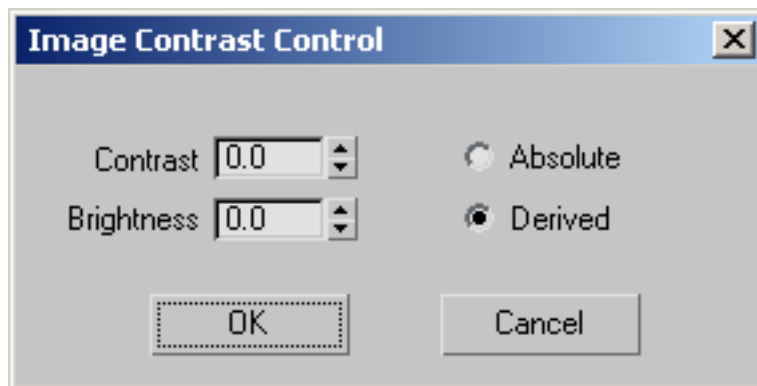

Contrast Set the spinner between 0 and 1.0. This compresses or expands the latitude between maximum black and maximum white by creating a 16-bit

look-up table for any given gray value in the image. The computation of the gray value depends on whether you select Absolute or Derived.

Brightness Set the spinner between 0 and 1.0. This increases or decreases all color components (red, green, and blue).

Absolute/Derived Determines the computation of the gray value for Contrast. Absolute uses the highest value of any of the color components. Derived uses an average of the three color components.

Fade Filter

Rendering menu > Video Post > Video Post toolbar > Add Image Filter Event > Choose Fade Filter from the Filter Plug-In list.

Rendering menu > Video Post > Video Post window > Select a Fade Filter. > Video Post toolbar > Edit Current Event > Setup

The Fade filter fades an image in or out over time. The rate of the fade is determined by the length of the Fade filter's time range.



Fade fades out to black or in from black, over time.

Interface

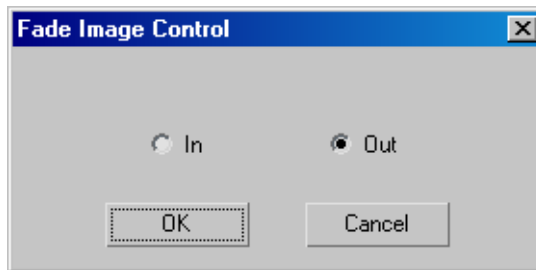

In Fade in.

Out Fade out.

Image Alpha Filter

Rendering menu > Video Post > Video Post toolbar > Add Image Filter Event
> Choose Image Alpha Filter from the Filter Plug-In list.

Rendering menu > Video Post > Video Post window > Select an Alpha Filter.
> Video Post toolbar > Edit Current Event

The Image Alpha filter replaces the image's alpha channel with the channel specified by the filter mask.

The filter takes whatever channel is selected in the channel options under Mask (including [g-buffer](#) on page 7991 channel data) and applies it to the queue's alpha channel, thereby replacing what's there.

If you don't choose a mask, this filter has no effect.

There are no setup options for this filter.

Procedures

To set an object's G-Buffer ID:

- 1 Select the object.
- 2 Right-click the object and then choose [Properties](#) on page 305 from the popup menu.
- 3 In the Object Properties dialog, set G-Buffer Object Channel to a nonzero value, and then click OK.

The G-Buffer ID can be any positive integer.

If you give the same G-Buffer ID value to more than one object, all these objects will be post-processed.

Lens Effects Filters

Rendering menu > Video Post > Video Post toolbar > Add Image Filter Event > Choose a Lens Effects Filter from the Filter Plug-In list.

The Lens Effects filters add realistic camera flares, glows, gleams, glimmers, and depth-of-field blurring to your scenes. Lens Effects can affect an entire scene or can be generated around specific objects in your scene.

Lens Effects are applied through the Video Post interface. To learn about adding scene and image filter events to the video post queue, see [Add Scene Event](#) on page 6808, and [Add Image Filter Event](#) on page 6821.

Lens Effects includes the following filters:

- [Lens Effects Flare](#) on page 6849: Creates the optical effect that occurs when a bright light reflects across the lens of a camera.
- [Lens Effects Focus](#) on page 6871: Creates a blur on objects based on their distance from the camera. tracks an object's distance from the camera using a Z-Buffer. Focus uses the Z-Buffer information from the scene to create its blurring effects.
- [Lens Effects Glow](#) on page 6875: Creates a glowing light around any assigned object, such as a laser beam or the thruster on a space ship.
- [Lens Effects Highlight](#) on page 6887: Creates a bright cross star effect on a designated object.

WARNING When you animate Lens Effects parameters, this creates pointers into the actual scene, so Lens Effects animation is lost if you save the Video Post queue in a [VPX file](#) on page 8165. To preserve the animation, save the Video Post data, including Lens Effects animation, in the MAX file.

Procedures

Len Effects like Glow and Highlight can be set to affect specific objects in your scene based on their [G-Buffer ID](#) on page 7991. This lets you apply glows and highlights to the object, or to the material, or both.

To set an object's G-Buffer ID:

- 1 Select the object.
- 2 Right-click the object and then choose Properties from the quad menu.
- 3 In the Object Properties dialog, set G-Buffer Object Channel to a non-zero value, and then click OK.

The G-Buffer ID can be any positive integer.

If you give the same G-Buffer ID value to more than one object, all these objects will be post-processed.

Negative Filter

Rendering menu > Video Post > Video Post toolbar > Add Image Filter Event > Choose Negative Filter from the Filter Plug-In list.

Rendering menu > Video Post > Video Post window > Select a Negative Filter. > Video Post toolbar > Edit Current Event > Setup

The Negative filter inverts the colors in the image, making it negative like a negative color photograph.

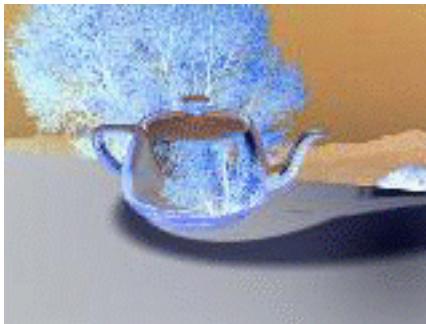

Effect of negative filter

When you click the Setup button in the Edit Filter Event dialog for the Negative filter, the Video Post dialog is replaced by a modeless Negative Filter dialog with a Blend spinner. You can turn on Auto Key, move the time slider, and change the Blend value to create keys. (You can also use other 3ds Max functions; for example, you can create objects.) When you've set all the keys you want, click the OK button to return to Video Post.

After creating keys from the Video Post filter, you'll find the track for the new keys as a child of the Video Post track in the Track View – Curve Editor. Specifically, in the above example, you'll find the following hierarchy in the Curve Editor:

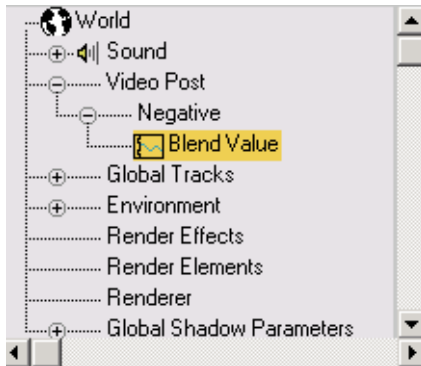

Interface

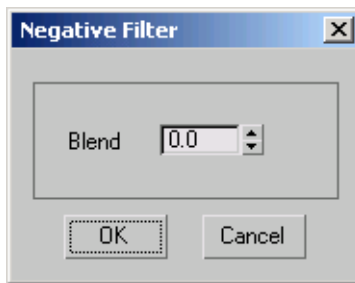

Blend Sets the amount of blending that occurs.

Pseudo Alpha Filter

Rendering menu > Video Post > Video Post toolbar > Add Image Filter Event
> Choose Pseudo Alpha Filter from the Filter Plug-In list.

Rendering menu > Video Post > Video Post window > Select a Contrast Filter.
> Video Post toolbar > Edit Current Event

The Edit Pseudo Alpha filter creates an alpha channel for the image based on the image's first pixel (the upper-left corner pixel). All pixels that have the same color as this pixel become transparent.

Because only one pixel color becomes clear, edges of the opaque areas are aliased. The main use for this filter is when you want to composite a bitmap whose format does not have an alpha channel.

There is also a layer event called the [Pseudo Alpha Compositor](#) on page 6911.

There are no setup options for this filter.

Simple Wipe Filter

Rendering menu > Video Post > Video Post toolbar > Add Image Filter Event > Choose Simple Wipe Filter from the Filter Plug-In list.

Rendering menu > Video Post > Video Post window > Select a Simple Wipe Filter. > Video Post toolbar > Edit Current Event > Setup

The Simple Wipe filter reveals or erases the foreground image with a wipe transition. Unlike the [Wipe Layer compositor](#) on page 6913, Wipe Filter wipes across a fixed image.

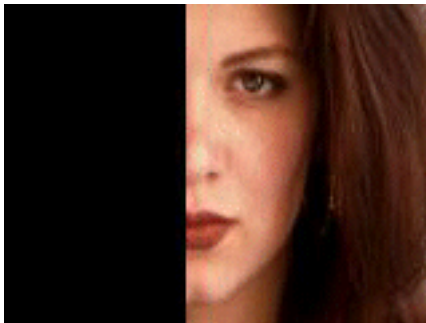

Wipe reveals an image by wiping from one side to the other, over time.

This filter wipes from image to image (or from an image to black). The filtered image stays in place, but is revealed or erased with a wipe across the image. If you're using a Wipe as a filter event, you'll usually want to use an Alpha Compositor as a layer event as well.

A typical queue sequence would be: Alpha Compositor (layer)

-->Image #1

-->Simple Wipe (filter)

----->Image #2

The rate of the wipe is determined by the length of the Wipe filter's time range. The area not covered by the image renders as black unless you use an Image Layer event to composite the Wipe filter with another image.

Interface



Direction group

Right-pointing arrow Wipes from left to right.

Left-pointing arrow Wipes from right to left.

Mode group

Push Reveals the image.

Pop Erases the image.

Starfield Filter

Rendering menu > Video Post > Video Post toolbar > Add Image Filter Event
> Choose Starfield Filter from the Filter Plug-In list.

Rendering menu > Video Post > Video Post window > Select a Starfield Filter.
> Video Post toolbar > Edit Current Event > Setup

The Starfield filter generates a realistic starfield with optional motion blur. The Starfield filter requires a camera view. Any motion of the stars is a result of camera motion.

Procedures

To use the Starfield filter:

- 1 Create a camera and (optionally) animate the camera's or target's position, field of view, and roll.
- 2 Choose Rendering > Video Post and add a Scene Event, using the camera for the view.
- 3  Select the Scene Event in the queue, click Add Image Filter, select the Starfield filter, and click the Setup button.
- 4 In the Stars Control dialog, make sure that the selected camera matches the camera used in the Scene Event.
If these don't match, the stars will not match the camera's motion. If there is only one camera in the scene, the field will default to that camera.
- 5 Set the starfield parameters, then exit the Stars Control dialog and the Edit Filter Event dialog.
- 6 Execute the Video Post sequence to see stars.

Interface

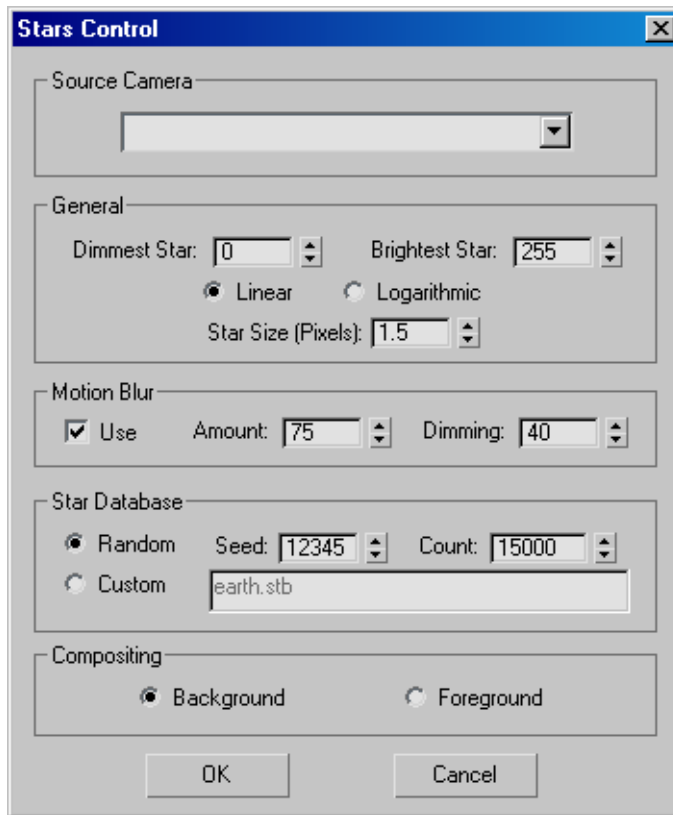

Source Camera group

Source Camera Lets you choose from a list of cameras in the scene. Choose the same camera as the one being used to render the scene.

General group

Set the brightness range and size of the stars.

Dimmest Star Specifies the dimmest star. Range = 0 to 255.

Brightest Star Specifies the brightest star. Range = 0 to 255.

Linear/Logarithmic Specifies whether the range of brightness is calculated linearly or logarithmically.

Star Size (Pixels) Specifies the size of the stars, in pixels. Range = 0.001 to 100.

Motion Blur group

These settings control the streaking effect of the stars when the camera moves.

Use When on, the starfield uses motion blur. When off, the stars appear as dots, no matter what the camera's motion.

Amount The percentage of the frame time that the camera "shutter" is open. Default = 75%.

Dimming Determines how the streaked stars will dim as their trails lengthen. The default of 40 provides a good effect for video, dimming them a bit so they don't appear to flash.

Star Database group

These settings specify the number of stars in the starfield.

■ **Random** Generates the number of stars indicated by the Count spinner, using the random number Seed to initialize the random number generator.

Seed

Initializes the random number generator. By using the same Seed value in different animations, you're guaranteed identical starfields.

Count

Specifies the number of stars generated when Random is chosen.

■ **Custom** Reads the file specified. A provided star database, *earth.stb*, contains the brightest stars in Earth's sky.

Compositing group

■ **Background** (The default.) Composites the stars in the background.

■ **Foreground** Composites the stars in the foreground.

Lens Effects Filters

Animating Lens Effects Properties

Lens Effects lets you use Track View to control parameters which can be animated while Video Post remains open. Any parameter with a green arrow button next to it can be animated.

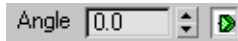

When the Auto Key button is selected, the associated spinner or variable is displayed in Track View and can be animated. If it is not selected, the green button turns gray to indicate the parameter can no longer be animated.

There are two ways to set Lens Effects parameters for use in animation:

- Enable the Auto Key button, set the frame in which you want to create a key, and set the value.
- Use Track View.

Using Track View

To use Track View with Lens Effects, one of the Lens Effects dialogs for a particular filter must be open when you start Track View.

NOTE If you open Track View without one of the Lens Effects dialogs being open, the first Lens Effects object does not appear in the Track View List. If you have more than one Lens Effects object in the scene, you will see multiple Lens Effects objects in Track View.

When Track View is open, the Lens Effects filters you have applied are listed under Video Post on the left side of the Track View interface. Under each filter are the parameters which can be animated. These are displayed individually. You can animate only the parameters you need to.

When viewing Gradients in Track View, notice that the first two flags have only a color track associated with them. This is because they are the start and end points of the gradient and never move. Any flags created after the first two will also have a position track associated with them. This means that you can animate not only the color of any flag in any gradient, but also its position over time as well.

If you disable the animation capabilities for a particular lens flare parameter, the corresponding entry in Track View immediately disappears. For more information, see [Track View](#) on page 3503.

WARNING When you animate Lens Effects parameters, this creates pointers into the actual scene, so Lens Effects animation is lost if you save the Video Post queue in a [VPX file](#) on page 8165. To preserve the animation, save the Video Post data, including Lens Effects animation, in the MAX file.

Lens Effects Flare Filter

Rendering menu > Video Post > Video Post toolbar > Add Image Filter Event > Choose Lens Effects Flare from Filter Plug-In list. > Setup

The Lens Effects Flare dialog lets you add lens flare effects as a post process to rendering. Flares are usually applied to lights in your scene. The lens flare will then be generated around that object. You can control all aspects of the lens flare in the Lens Effects Flare dialog.

Procedures

To save your flare settings, do one of the following:

You can save all of your lens flare settings to a file, so you can reload them any time. Lens Effects Flare files are saved to an [LZF file](#) on page 8029 (*.lzf*).

- 1 Click the Reset button.

This resets Lens Effects Flare to its default settings.

- 2 Click the Load button.

This displays a Windows-standard file open dialog from which you can select the settings file you want to load.

- 3 Click the Save button.

This displays a Windows-standard Save As dialog in which you specify a directory and filename.

Interface

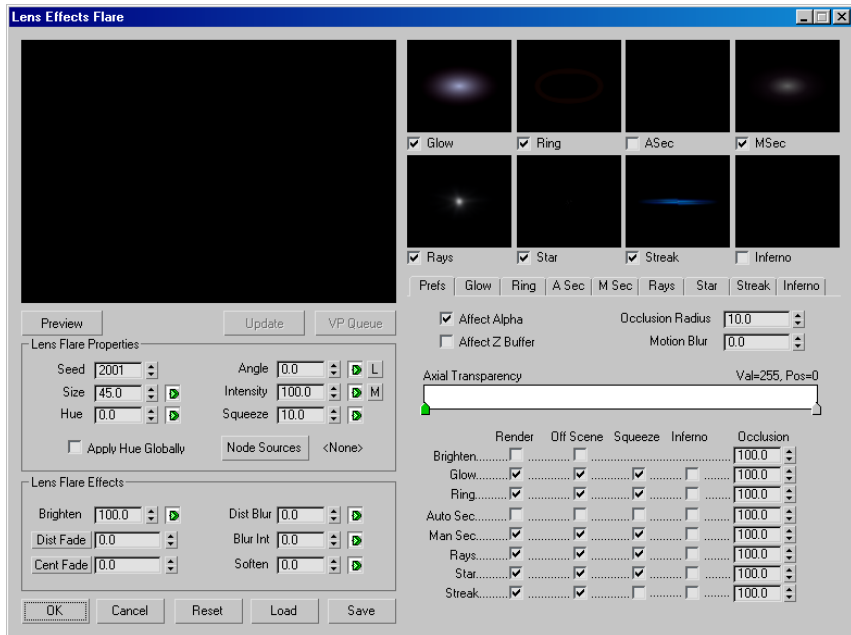

Preview group

The large black window in the left corner is the main preview window. To the right of this window are smaller preview windows for each part of the flare. You can generate continual previews by clicking the Preview button under the main preview window.

There are nine Lens Effects Flare preview windows. The main preview window in the upper left corner of the Lens Effects dialog shows you the complete scene. The eight smaller preview windows in the upper right corner show the individual parts of the lens flare. Each small preview window has a check box below the window to display the flare effect.

You might notice that an individual part of the lens flare effect might not appear as bright in the smaller preview windows, compared to the main preview. This is because the brightness of a lens flare in the main preview is a result of combining the brightness of multiple effects, the total brightness being greater than a single part.

All of the preview windows are multi-threaded to increase redraw speed and take advantage of multi-processor systems. When you make an adjustment

to a lens flare property and the preview window is active, the preview updates automatically. A white line at the bottom of the main preview window indicates that it is updating a change made within the lens flare dialog.

Preview When you click the Preview button, the window displays your flare in the upper left corner if your flare has automatic or manual secondary elements. If your flare does not contain these elements, the flare is centered in the preview window. If the VP Queue button is not on, the preview displays a generic flare to which you can make adjustments. Each time you change a setting, the preview automatically updates. A white line appears at the bottom of the preview window to indicate the preview is updating.

Update Redraws the entire Main Preview window, as well as the smaller windows each time you click this button. This function is critical when you need to view changes you have made in the Video Post queue, such as moving the Time Slider to a different frame, changing your geometry or a light, or changing another filter that precedes the current one in the Video Post queue. The VP Queue button must be on to preview the contents of the Video Post queue. In this case, clicking the Update button causes a small dialog to appear, with an indicator showing the progress of the update.

VP Queue Displays the contents of the Video Post queue in the main preview window. The Preview button must also be turned on. Rather than having to test render every time you want to see the result of the effect in the scene, VP Queue displays a final composite, combining the effect you are editing with the contents of the Video Post queue.

NOTE If you leave the Preview and VP Queue buttons active when you exit Lens Effects Flare, it will take several seconds to re-render the scene in the main preview window the next time you start Lens Effects Flare.

The view in the main preview window also depends upon which lens flare options you have set in the [Preferences panel](#) on page 6854.

Lens Flare Properties group

Specifies global settings for the flare, such as the source for the flare(s), the size, seed number, rotation, and so on.

Seed Gives the random number generator in Lens Effects a different starting point, which creates slightly different lens flares without changing any settings. Using Seed guarantees a different lens flare, even if the differences are very small. For example, if you set up a ray effect for your lens flare, you will get slightly different rays in the lens flare if you adjust the seed value.

Size Affects the size of the overall lens flare. This value is a percentage of the size of the rendered frame. Default = 30.

Other parts of the lens flare, such as glow, ring, etc., also have size adjustments, but this size setting affects the entire lens flare, including secondary flares. Adjusting individual sizes does not affect this size variable, or vice versa. This parameter can be [animated](#) on page 6848. Animating the Size parameter causes flares to grow or diminish in size over the course of your animation.

Hue If Apply Hue Globally is selected, it controls the amount of Hue applied to the Lens Flare effect. This parameter can be animated.

Apply Hue Globally Globally applies the Hue of the Node Source to the other Flare effects.

Angle Affects the amount that the flare rotates from its default position, as the position of the flare changes relative to the camera. This parameter can be animated. The lock button to the right of the Auto Key button locks the secondary flares so they do not rotate. When the button is disabled, the secondary flares will not rotate.

Animating the Angle parameter does not animate the manual and automatic secondary flares unless you turn on the L button. The default behavior mimics a camera, in which the aperture does not rotate.

Rays, stars, and streaks don't animate either unless you turn on their individual Auto Rotate toggles.

Intensity Controls the overall brightness and opacity of the flare. Higher values produce bright, more opaque flares, and lower values produce dim, transparent flares. This parameter can be animated.

Squeeze Squeezes the size of the lens flare, either horizontally or vertically to compensate for different frame aspect ratios. You can set Squeeze from 100 to -100. Positive values stretch the flare horizontally, and negative values stretch it vertically. The value is a percentage of the size of the flare. This parameter can be animated.

For example, if you convert a film for use on TV, applying Squeeze would cause the lens flare to look correct on the smaller screen, and not thin and tall, although a wide-screen 35-MM film image is much wider than a regular TV.

Although Squeeze is a global setting, you can apply this effect to selected portions of your flare through the [Preferences panel](#) on page 6854 so that only the flare elements you want are distorted. The Squeeze spinner value is given as a percentage of the size of the flare.

Node Sources Lets you select the source object for the lens flare effect. The source of the lens flare may be any object in the scene, but is generally a light, such as a target spot light, or an omni light. Clicking this button displays the Select Flare Objects dialog. You must select a source for the flare to key off.

NOTE If you select a source object, then rename the object later, you must reselect the object to ensure the correct generation of the lens flare.

Lens Flare Effects group

Controls specific effects for the flare, such as fades, brightness, softening, and so on.

Brighten Lets you set an overall brightness that affects the whole image. When a bright effect, such as a lens flare, appears in an image, the whole image should appear brighter. This effect is available only when the Brighten option is enabled under the Render section of the Preferences panel. This parameter can be [animated](#) on page 6848. Animating the Brighten spinner is an easy way to create flares that "flash" the scene as they appear.

Dist Fade Causes the effect of the lens flare to fade with its distance from the camera. This option is used only when the Dist Fade button is turned on. The values are in 3ds Max world units. This option is used when you want to create the effect of flares disappearing at a certain point away from the camera.

Cent Fade Fades the secondary flares near the center of the row of flares along the main axis of the flare. This is an effect that can be seen in many lens flares seen through a real camera lens. This value is in 3ds Max world units. This setting is only active when the **Cent Fade** button is selected.

Dist Blur Blurs the flare based on its distance from the camera. This value is in 3ds Max world units. This parameter can be animated.

Blur Int Controls the strength of the blur when it is applied to the lens flare. The value set in this spinner takes full effect as the flare reaches the Dist Blur distance in your scene. Flares closer to the camera plane get a percentage of the intensity setting. This parameter can be animated.

Soften Provides an overall softening effect for the lens flare. This parameter can be animated.

Flare Parameter tabs

Let you create and control the lens flare. Each of the nine tabs controls a specific aspect of the lens flare.

WARNING When you animate Lens Effects parameters, this creates pointers into the actual scene, so Lens Effects animation is lost if you save the Video Post queue in a [VPX file](#) on page 8165. To preserve the animation, save the Video Post data, including Lens Effects animation, in the MAX file.

A flare is composed of eight basic parts. Each part of a flare is controlled on its own panel in the Lens Effects Flare interface. Each part of the lens flare can be individually activated and deactivated to create different effects.

[Prefs](#) on page 6854: This page lets you control which parts of a lens flare are active and how they effect the overall image.

[Glow](#) on page 6857: A general glow centered around the source object of the flare. You can control the color, size, shape, and other aspects of the glow.

[Ring](#) on page 6858: A circular color band that surrounds the center of the source object. You can control the color, size, shape, and other aspects of the ring.

[A Sec](#) on page 6860: Auto Secondary Flares. The small circles you would normally see coming out from the source of the lens flare. As the camera position changes relative to the source object, the secondary flares move. The secondary flares are automatically generated when this option is active.

[M Sec](#) on page 6861: Manual Secondary Flares. Additional secondary flares added to the lens flare effect. They appear in the same axis as the automatic secondary flares and look very similar.

[Rays](#) on page 6863: Bright lines that radiate out from the center of the source object, providing the illusion of extreme brightness for the object.

[Star](#) on page 6865: Bright lines that radiate out from the center of the source object, generally composed of 6 or more spokes, (instead of hundreds, like a ray). Stars are generally thicker and extend out farther from the center of the source object than rays.

[Streak](#) on page 6867: Wide horizontal bands that run through the center of the source object.

[Inferno](#) on page 6869: Lets you add special effects, such as explosions, to your flare effect.

Flare Preferences

Rendering menu > Video Post > Video Post toolbar > Add Image Filter Event
> Choose Lens Effects Flare from Filter Plug-In list. > Setup > Prefs tab

In the Prefs panel, you can control whether or not specific parts of the lens flare, such as the rays or the star are rendered by turning them on or off. You can also control the axial transparency of the lens flare.

Interface

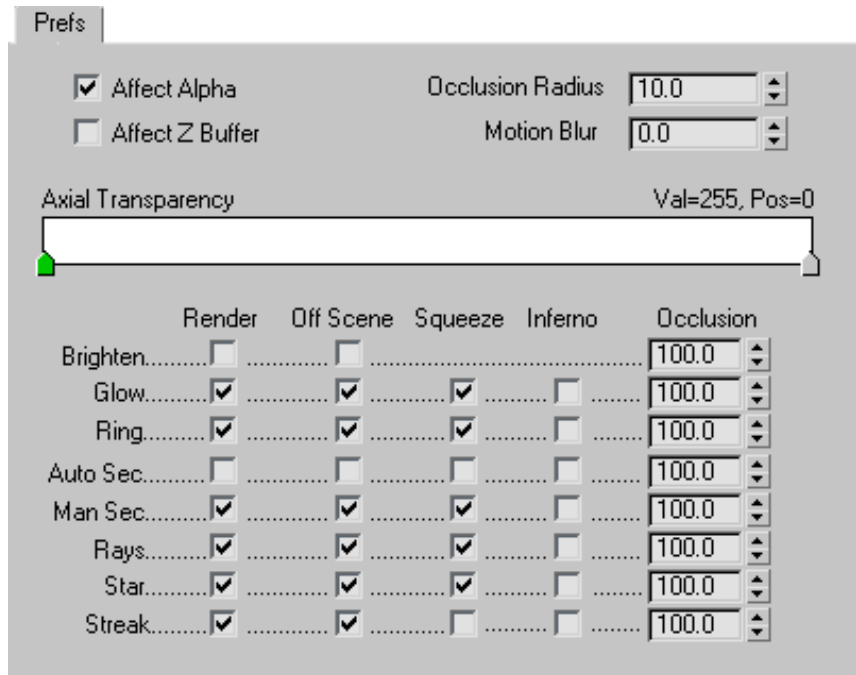

Affect Alpha Specifies whether or not the lens flare affects the alpha channel of an image, when the image is rendered in a 32-bit file format. The alpha channel is an extra 8 bits of color (256 colors) that indicate transparency in an image. Alpha channels are used to composite one image seamlessly over the top of another. If you want to composite a lens flare, or an image that contains a lens flare, over the top of another image, enable this option. If you are not rendering to a 32-bit file, do not enable this option.

Affect Z Buffer The Z-Buffer stores an object's distance from the camera. The Z-Buffer is useful for optical effects such as fog. When this option is enabled, the linear distance of the lens flare is recorded, and can be used in special effects that make use of the Z-Buffer, for example, the [Focus](#) on page 6871 effect. To use Focus with a lens flare, enable this option.

Occlusion Radius A radius around the center of the flare that determines when the lens flare effect will begin to fade as it passes behind another object. This radius is measured in pixels.

When the lens flare or scene is animated and the source of the lens flare goes behind another object, if occlusion is enabled, the flare dies down and disappears until the source object reappears on the other side of the hiding object. The radius makes the flare gently fade when it is occluded, instead of blinking out.

Motion Blur Determines whether or not an animated lens flare is rendered using Motion Blur. Motion Blur renders multiple copies in short increments to the same frame, which gives the illusion of a blurred object in motion. When an object is moving rapidly across the screen, it animates more smoothly if motion blur is turned on. Using motion blur can add considerable time to your rendering.

You can set the amount of blur with the Motion Blur spinner. Values range from 0 to 100, and are based on the number of samples the motion blur should use.

Axial Transparency A standard circular transparency gradient that affects the transparency of the lens flare secondary elements along their axis and relative to their source. This lets your secondary elements be brighter on one side than the other, adding extra realism to your flare effects.

Render Specifies whether or not each part of the lens flare is rendered in the final image. Use this set of check boxes to turn parts of the lens flare on and off.

NOTE Effects such as secondary flares are available in sets. The Render button and Off Scene determine whether the secondary flares are present in the scene. The individual secondary flare sets are controlled on their respective pages.

Off Scene Specifies whether or not lens flares that have their sources outside the scene will affect the image. For example, if a lens flare source is just off the edge of a frame, the secondary flares, and possibly the star or ring, could still be showing on the screen. Without Off Scene, the lens flare does not appear at all. You can turn this option on or off for each part of the flare.

Squeeze Specifies whether the Squeeze setting affects a particular part of the lens flare. This setting depends on the Squeeze setting in the lens flare properties.

Inferno Defines whether the [inferno](#) on page 6869 settings are active for this portion of the lens flare.

Occlusion Defines the percentage of the flare part that appears when it is occluded by another object. A value of 100 indicates that the whole object will disappear. Lower settings cause the lens flare to wrap around the occluding object, making it fade, but not disappear entirely. For example, if you look at a cylinder with a bright light behind it, the light makes the cylinder appear thinner at the brightest areas.

NOTE The Occlusion spinners work in conjunction with the Occlusion Radius spinner in the top right of the Preferences panel.

Flare Glow Parameters

Rendering menu > Video Post > Video Post toolbar > Add Image Filter Event > Choose Lens Effects Flare from Filter Plug-In list. > Setup > Glow tab

The glow of a lens flare is centered around the source object of the flare. The parameters on the Glow panel let you control each aspect of the glow.

Interface

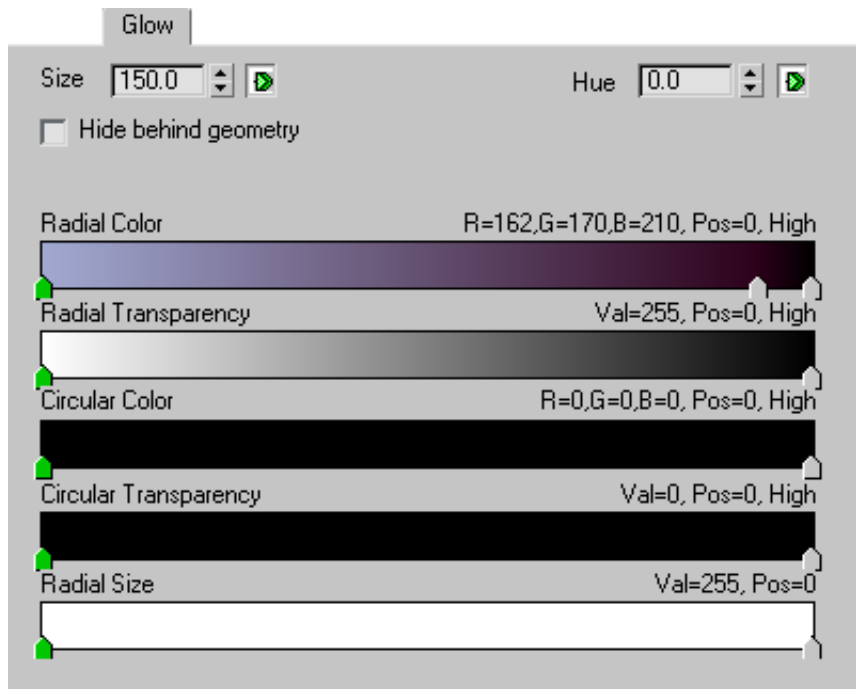

Size Specifies the diameter of the glow of the lens flare as a percentage of the overall size of the frame. This value is separate from the overall size value set in the [Flare Properties](#) on page 6849. This parameter can be [animated](#) on page 6848.

Hue Specifies the gradation of color for the glow. Clicking the green arrow button lets you animate this control. This parameter can be animated.

Hide Behind Geometry Places the glow behind the geometric forms.

Gradients Use radial, circular, transparency, and size [gradients](#) on page 6902. Glow gradients are subtler than flare gradients, because they are glowing an area larger than a pixel.

Flare Ring Parameters

Rendering menu > Video Post > Video Post toolbar > Add Image Filter Event > Choose Lens Effects Flare from Filter Plug-In list. > Setup > Ring tab

The ring is a circular color band that surrounds the center of the source object. You set ring options on the Ring panel of the Lens Effects Flare dialog.

Interface

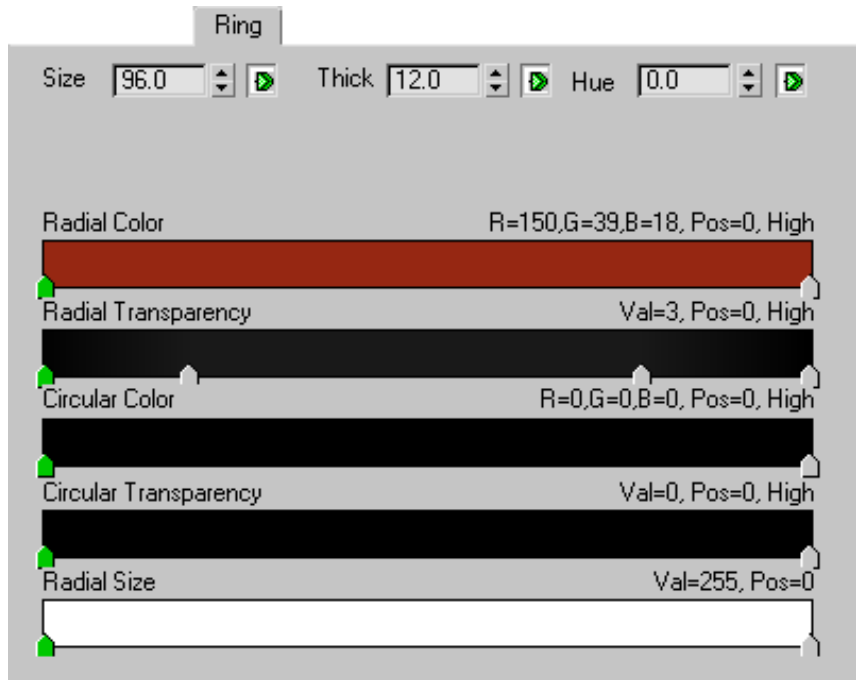

Size Specifies the overall size of the ring as a percentage of the overall frame and represents the diameter of the ring. The ring radius should be larger than the glow radius to make the lens flare look convincing. This parameter is separate from the overall size spinner in the Lens Flare Effects section of the dialog. This parameter can be [animated](#) on page 6848.

Thick Specifies the overall thickness of the ring, as a percentage of the overall size of the frame. When the ring is fairly thick, the size of the ring is measured to the inner radius. The thickness controls how thick the ring is from that point outward. This parameter can be animated.

Hue Specifies the gradation of color for the ring. This parameter can be animated.

Gradients Use radial, circular, transparency, and size [gradients](#) on page 6902.

Automatic Secondary Flare Parameters

Rendering menu > Video Post > Video Post toolbar > Add Image Filter Event
> Choose Lens Effects Flare from Filter Plug-In list. > Setup > A Sec tab

Secondary flares are the small circles you would normally see coming out from the source of the lens flare along an axis relative to the camera position. These are caused by light refracting off the different lens elements in the camera. As the camera position changes relative to the source object, the secondary flares move. These secondary flares are automatically generated when this option is selected in the Preferences section of the dialog.

You create sets of secondary elements that share common parameters instead of building them one at a time. Many of the controls on the A Sec panel are for individual sets of elements, not all sets.

Interface

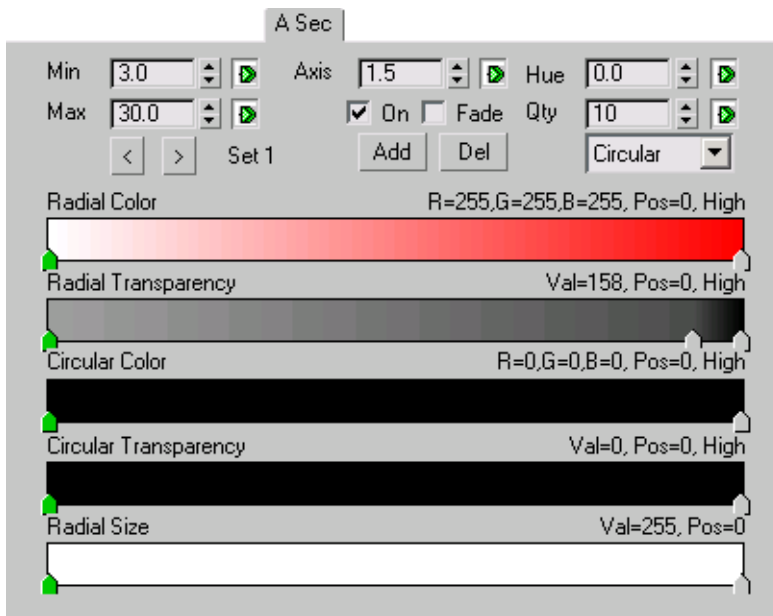

Min Controls the minimum size of secondary flares in the current set. This number is defined as a percentage of the overall image. This parameter can be [animated](#) on page 6848.

Max Controls the maximum size of secondary flares in the current set. This number is defined as a percentage of the overall image. This parameter can be [animated](#) on page 6848.

Sets Specifies which set of secondary flares you are working with. You can have as many sets of automatic secondary elements as you wish, each having their own properties. By default, seven sets are available. You can scroll through them by clicking the forward and reverse arrow icons beside the name of the set.

To add another set to your flare, click the Add button beneath the On check box. To delete a set, click the Del button.

Axis Defines the overall length of the axis the automatic secondary flares will be distributed along. Increasing the value creates more space between the flares, while decreasing the value creates less space between the flares. You can set the axis from 0 to 5 degrees. This parameter can be [animated](#) on page 6848.

On Defines whether a group or set of secondary flares is active or not.

Fade Determines whether or not axial fade is active for the current set of secondary flares.

Hue Specifies the gradation of color of the secondary flares. This parameter can be animated.

Qty Controls the number of secondary flares that appear in the current set of flares. This parameter can be animated.

Shape Controls the shape of the secondary flares for the current set. The default value is circular, but you can choose from 3 to 8 sided secondary flares.

Gradients Defines the [gradient](#) on page 6902 for the secondary flare.

Manual Secondary Flare Parameters

Rendering menu > Video Post > Video Post toolbar > Add Image Filter Event > Choose Lens Effects Flare from Filter Plug-In list. > Setup > M Sec tab

Manual secondary flares are additional secondary flares that are individually added to the lens flare. These can be used in addition to, or in place of [automatic secondary flares](#) on page 6860.

You use Manual secondary flares when you want to add unique flares that you don't want repeated.

You can have groups of secondary flares, instead of just one set. Many of the controls in this dialog are for a specific set of flares, not all sets.

Interface

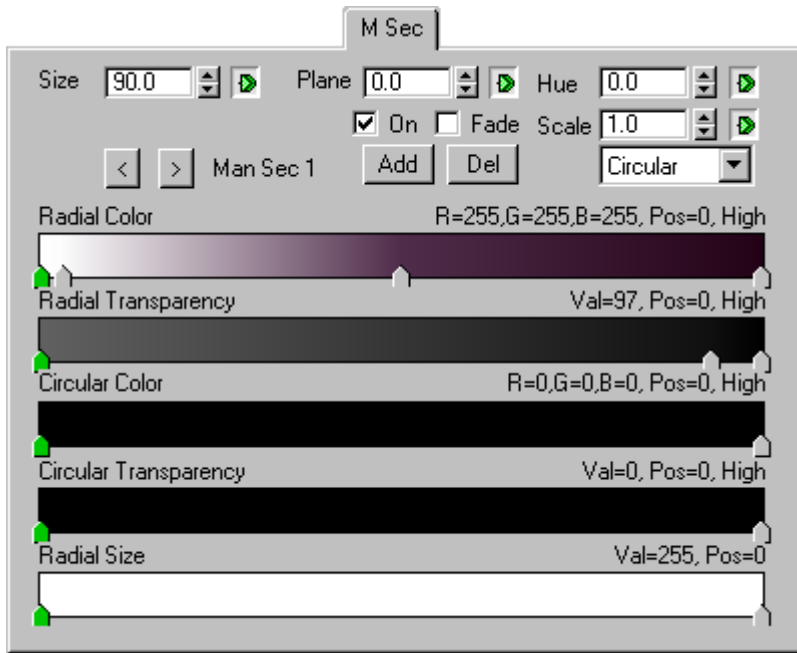

Size Controls the size, as a percentage of the overall image, of the manual secondary lens flare. This parameter can be [animated](#) on page 6848.

Plane Controls the distance, in degrees, between the flare source and the manual secondary flare. By default, the flare plane exists at the center of the chosen node source. Positive values place the flare in front of the source, while negative values place the flare behind the flare source. This parameter can be animated.

TIP In live camera work, there are often one or two secondary elements behind the light source, so you should have one or two as well.

On Turns manual secondary flares on or off. This option must be selected in both the Manual Secondary and Preferences tabs for the manual secondary flares to render.

Fade Specifies whether or not the current set of secondary flares has axial fade.

Sets Specifies which set of secondary flares you are working with. You can have as many sets of manual secondary elements as you wish, each having their own properties. By default, seven sets are available. You can scroll through them by clicking the forward and reverse arrow buttons next to the name of the set.

To add another set to your flare, click the Add button beneath the On check box. To delete a set, click the Del button.

Hue Specifies the gradation of color of secondary flares. This parameter can be animated.

Scale Specifies how to scale secondary flares. This parameter can be animated.

Shape This menu controls the overall shape of the secondary flares.

Gradients Defines the [gradient](#) on page 6902 for the secondary flare.

Flare Ray Parameters

Rendering menu > Video Post > Video Post toolbar > Add Image Filter Event > Choose Lens Effects Flare from Filter Plug-In list. > Setup > Rays tab

Rays are bright single-pixel lines that radiate from the center of the source object, providing the illusion of extreme brightness for the object. Rays let you emulate scratches in the lens elements of a camera.

You control the parameters for rays in the Rays panel of the Lens Effects Flare dialog.

Interface

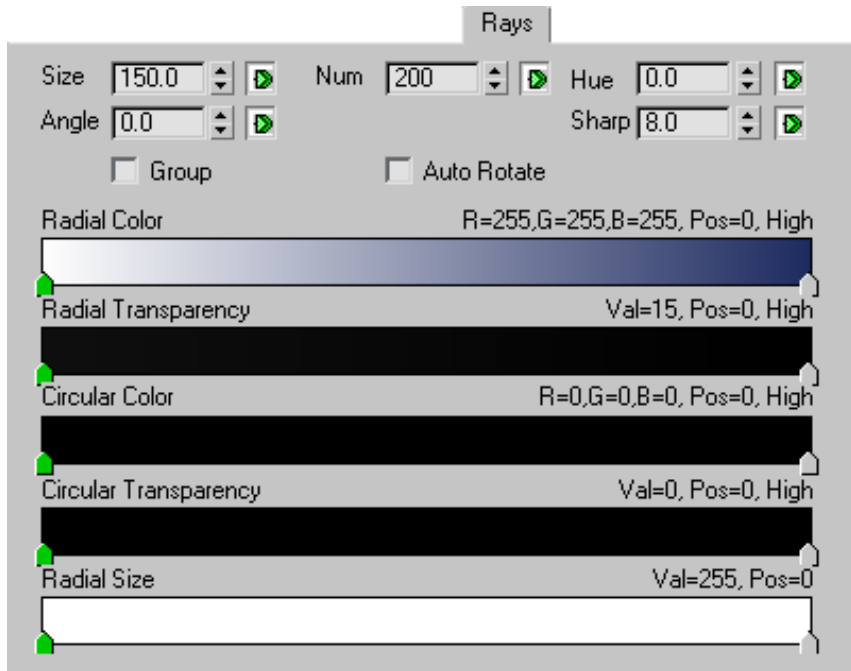

Size Specifies the overall length of the rays as they radiate from the center, as a percentage of the frame size. This parameter can be [animated](#) on page 6848.

Angle Specifies the angle for the rays. You can enter both positive and negative values so, when animated, the rays rotate in a clockwise or counterclockwise direction. This parameter can be animated.

Group Forces the grouping of rays into eight equidistant groups of equal size. Rays that are part of a group are evenly distributed within that group. Increasing the number of rays makes each grouping more dense, and therefore more bright.

Number Specifies the overall number of rays that appear in the lens flare. Rays are randomly spaced around the radius. This parameter can be animated.

Auto Rotate Adds the angle specified in the Angle spinner on the Rays panel to the angle set in the Angle spinner under Lens Flare Properties. Auto Rotate also ensures that the rays maintain their relative position to the flare as it is being animated.

Hue Specifies the gradation of the color of the rays. This parameter can be animated.

Sharp Specifies the overall sharpness of the rays. Higher numbers produce crisp, clean, and clear rays. Lower numbers produce more of a secondary glow look. Values range from 0 to 10. This parameter can be animated.

Gradients Defines the [gradient](#) on page 6902 for the rays.

Flare Star Parameters

Rendering menu > Video Post > Video Post toolbar > Add Image Filter Event > Choose Lens Effects Flare from Filter Plug-In list. > Setup > Star tab

A Star is larger than a ray effect and is composed of six or more spokes, instead of hundreds like a ray. Stars are thicker and extend out farther from the center of the source object than rays. You control the settings for stars on the Star panel of the Lens Effects Flare dialog.

Interface

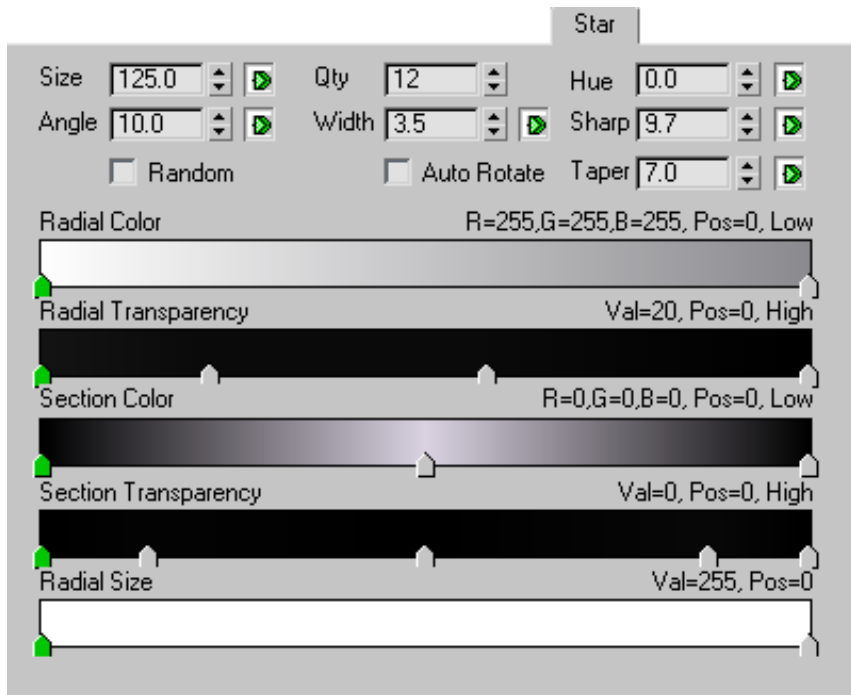

Size Specifies the overall size of the star effect, as a percentage of the overall frame. This parameter can be [animated](#) on page 6848.

Angle Sets the starting angle in degrees in which the star spokes point. You can enter both positive and negative values so, when animated, the star spokes rotate in a clockwise or counterclockwise direction. This parameter can be animated.

Random Enables random spacing of star spokes around the flare center.

Qty Specifies the number of spokes in the star effect. Default = 6.

Spokes are spaced at equidistant points about the center of the flare. This parameter can be animated.

Width Specifies the width of the individual spokes, as a percentage of the overall frame. This option can be animated.

Auto Rotate Adds the angle specified in the Angle spinner on the Rays panel to the angle set in Angle spinner under Lens Flare Properties. Auto Rotate also

ensures that the stars maintain their relative position to the flare as it is being animated.

Hue Specifies the gradation of the color of the star. This parameter can be animated.

Sharp Specifies the overall sharpness of the star. Higher numbers produce crisp, clean, and clear stars. Lower numbers produce more of a secondary glow look. This parameter can be animated. Range = 0 to 10.

Taper Controls the taper of the individual spokes of the star. Taper widens or narrows the tips of the individual star points. Low numbers create a sharp point, while high numbers flare the points. This parameter can be animated. Default = 0.

Gradients The [gradients](#) on page 6902 are the same for the Star effect as for others, except for two gradients: **Section Color** and **Section Transparency**. These options are useful when you want to create a "soft" look to the spokes. Both gradients work from the center of each spoke to the outer edge of the spoke.

Flare Streak Parameters

Rendering menu > Video Post > Video Post toolbar > Add Image Filter Event > Choose Lens Effects Flare from Filter Plug-In list. > Setup > Streak tab

A streak is a wide horizontal band that runs through the center of the source object. In real camera work, it is produced when using anamorphic lenses to film a scene. You set streak options on the Streak panel of the Lens Effects Flare dialog.

Interface

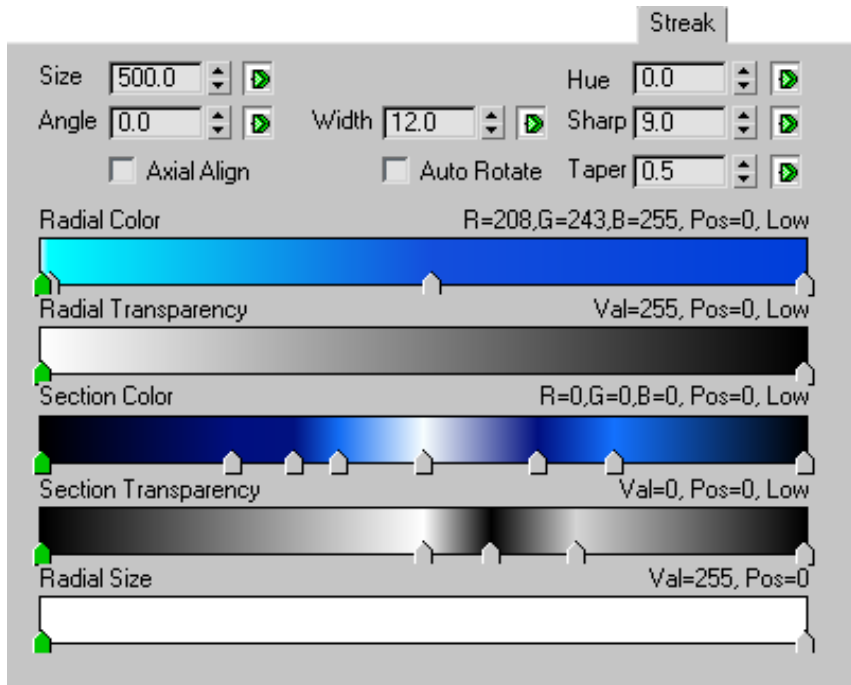

Size Specifies the overall size of the streak, as a percentage of the overall frame. This parameter can be [animated](#) on page 6848.

Angle Specifies the angle for the streak. You can enter both positive and negative values so, when animated, the streak rotates in a clockwise or counterclockwise direction. This parameter can be animated.

Axial Align Forces the streak to align itself to the axis of the secondary flares and the lens flare itself.

Width Specifies the width of the streak, as a percentage of the frame. This parameter can be animated.

Auto Rotate Adds the angle specified in the Angle spinner on the Streak panel to the angle set in Angle spinner under Lens Flare Properties. Auto Rotate also ensures that the stars maintain their relative position to the flare as it is being animated.

Hue Specifies the gradation of the color of the streak. This parameter can be animated.

Sharp Specifies the overall sharpness of the streak. Higher numbers produce crisp, clean, and clear streaks. Lower numbers produce more of a secondary glow look. Valid values are from 0 to 10. This parameter can be animated.

Taper Controls the taper of the individual spokes of the streak. Taper widens or narrows the tips of the individual streak points. Low numbers create a sharp point, while high numbers flare the points. Default = 0. This parameter can be animated.

Gradients The [gradients](#) on page 6902 are the same for the Streak effect as for others, except for two gradients: **Section Color** and **Section Transparency**. These options are useful when you want to create a "soft" look to the streak spokes. Both gradients work from the center of each spoke to the outer edge of the spoke.

Flare Inferno Parameters

Rendering menu > Video Post > Video Post toolbar > Add Image Filter Event > Choose Lens Effects Flare from Filter Plug-In list. > Setup > Inferno tab

Infernos let you use lens flare to create explosions, fire, and smoke effects and add a bit of fractal noise to any part of the lens flare. This noise comes in three types: Gaseous, Electric, and Fiery.

Interface

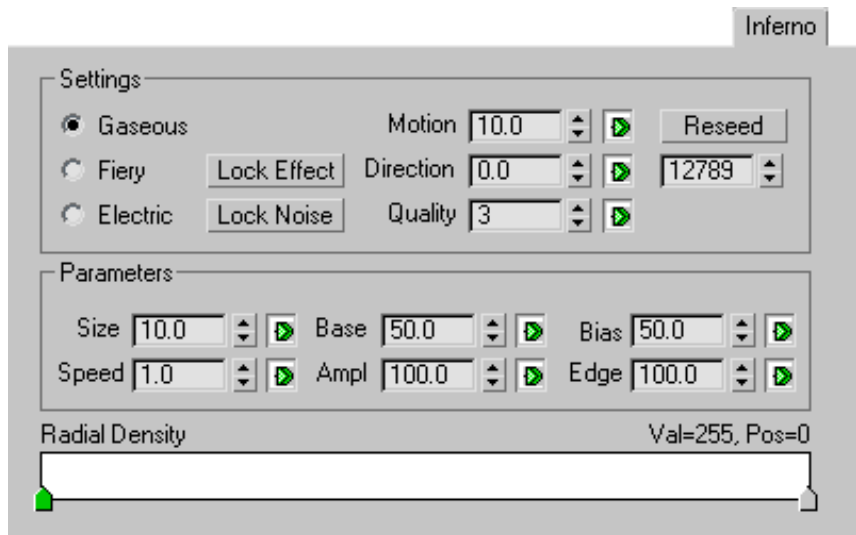

You add the Inferno effect to other lens flare effects. Inferno is selected in the Preferences panel. The lens flare effect you are adding Inferno to, such as glow, must also be selected for Inferno to work correctly. The Inferno panel is divided into two sections: Settings and Parameters.

Settings group

Gaseous A loose and soft pattern, often used for clouds and smoke.

Fiery Fractal patterns with bright, well-defined areas, often used for fires.

Electric Long, well-defined tendril pattern that can be used to produce arcing electricity, when animated. By adjusting the quality of the pattern to 0, you can create the effect of water reflection.

Lock Effect Locks the inferno effect to the lens flare. When the lens flare moves across the screen, the inferno effect moves with it. Use this option when you want the noise pattern to move with the flare for effects like torches.

Lock Noise Locks the inferno noise patterns into the screen. When the lens flare is animated and moving across the screen, the noise pattern stays in one spot and the flare moves through it. This is often used for creating plasma trails and cloud patterns.

Motion When you animate the inferno, motion specifies how fast the inferno patterns move in the direction set by the Direction spinner. For example, if you want to simulate a raging fire, you want the fractal patterns to move upward. This parameter can be [animated](#) on page 6848.

Direction Specifies the direction, in degrees, of the inferno effect motion. By default, 0 is aligned in the 12 o'clock position, and works clockwise. This parameter can be animated.

NOTE The Motion and Direction spinners control the motion of the fractal pattern in the X and Y directions. You can control the Z direction using the Speed option under Inferno Parameters.

Quality Specifies the overall quality of the fractal noise patterns in the inferno effect. Higher values result in more iterations of the fractals, more detail in the effect, and slightly longer render times. This parameter can be animated.

Reseed The number that the fractal routines use as a starting point. Set this spinner to any number to create different fractal effects. The Reseed button randomly selects a new number.

Parameters group

Size Specifies the overall size of the fractal patterns. Smaller numbers produce small, grainy fractals. Higher numbers produce larger patterns. This option can be animated.

Speed Sets the overall speed of the turbulence in the fractal patterns as they are animated. Higher numbers produce faster turbulence in the pattern. This parameter can be animated.

Base Specifies the brightness of the colors in the inferno effect. Higher values result in brighter color ranges and brighter infernos. Lower values result in dark, softer effects. The Base spinner only affects Fiery and Electric inferno types This parameter can be animated.

Amplitude With the Base spinner, controls the maximum brightness for each portion of the fractal inferno patterns. Higher values result in fractal patterns with brighter colors. Lower values result in the same patterns, with muted colors. This parameter can be animated.

Bias Shifts the colors of the effect toward one end of the color range or the other. At a setting of 50, Bias has no effect. Above 50, the colors are brighter, and below 50, they are darker and softer. This parameter can be animated.

Edge Controls the contrast between the light and dark areas of the fractal patterns. High values produce a high contrast and more well-defined fractal patterns. Low values result in less defined, subtler effects. This parameter can be animated.

Radial Density Controls the density of the inferno effect in a radial fashion from the center of the effect to the edge. Wherever there is white in the gradient, you only see inferno noise. Where the gradient is black, you can see the underlying flare. If you set the right side of the gradient to black and the left side to white, and apply the Inferno to the Glow effect of a flare, the inferno effect appears toward the outer edges of the glow, while the center of the glow is still visible.

Lens Effects Focus Filter

Video Post toolbar > Add Image Filter Event > Choose Lens Effects Focus from Filter Plug-In list. > Setup

The Lens Effects Focus dialog lets you blur objects based on their distance from the camera. Focus uses the Z-Buffer information from the scene to create

its blurring effects. You can use Focus to create effects such as foreground elements in focus and background elements out of focus.

Like Flare, Glow, and Highlight, you can load and save your focus settings for future use. Focus settings are saved to [LZO files](#) on page 8030 (.lzo).

WARNING This filter is not supported by the [mental ray renderer](#) on page 6230.

Procedures

To save your focus settings, do one of the following:

You can save all of your lens focus settings to a file, so you can reload them any time. Lens Effects Focus settings are saved as LZO files.

- 1 Click the Reset button.

This resets Lens Effects Focus to its default settings.

- 2 Click the Load button.

This displays a Windows-standard file open dialog from which you can select the settings file you want to load.

- 3 Click the Save button.

This displays a Windows-standard Save As dialog in which you specify a directory and filename.

Interface

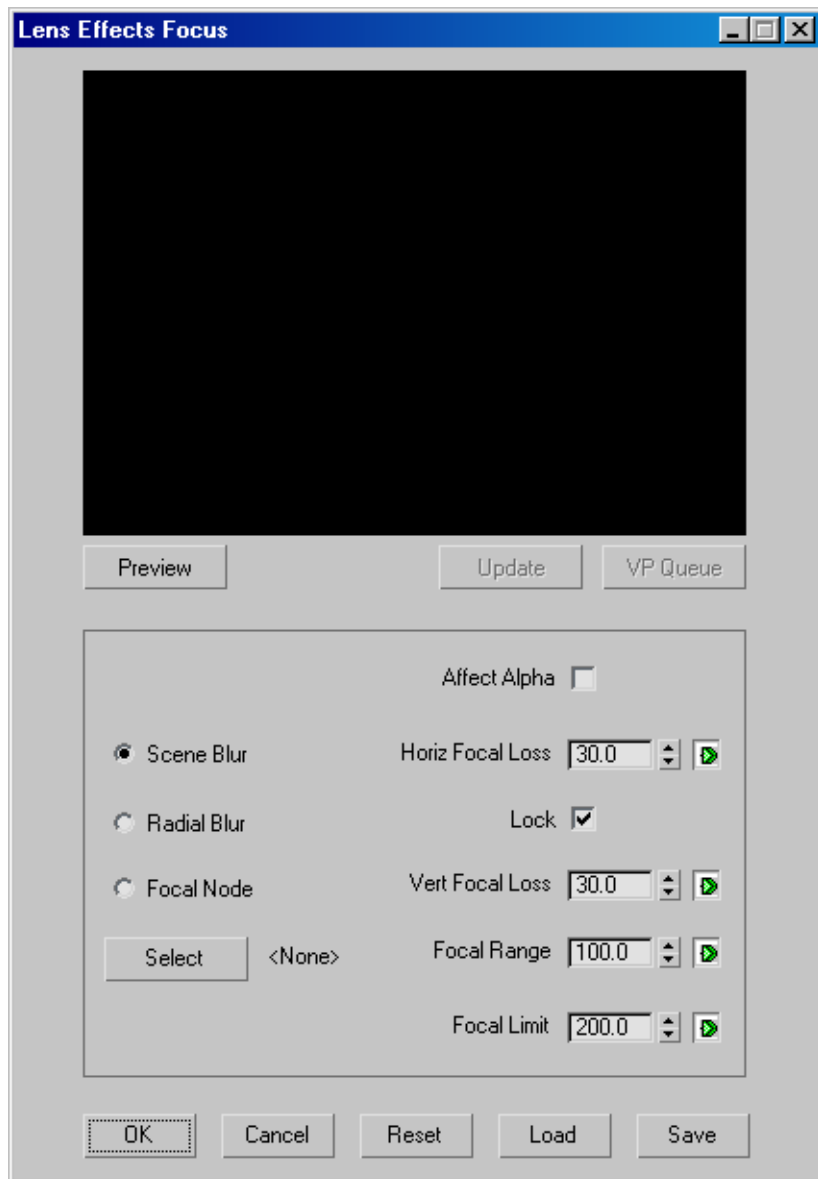

The Lens Effects Focus dialog contains a preview window, and an area below to control the parameters of Focus.

Preview group

Preview window Lets you quickly preview the Focus effect.

Preview Displays a generic scene to which you can quickly set up a Focus effect. Appears light green when selected.

VP Queue Lets you preview the scene in the Video Post queue. Preview must be selected for the VP Queue function to work.

Focus Control group

The settings on the left side of the panel let you select a method for blurring your scene. The settings on the right side of the dialog let you determine how much blurring is applied to the scene.

Scene Blur Applies the blurring effect to the entire scene, not just a portion of it.

Radial Blur Applies the blurring effect to the entire scene in a radial fashion, starting at the center of the frame. This is useful for emphasizing fish-eye lens effects and effects where the edges of the frame are blurred. This type of Focus depends on the Focal Range and Limit settings.

A scene with a radial blur is applied.

Focal Node Lets you select a specific object in the scene as the focal point for blurring. The selected objects remains in focus, while objects outside of the set **Focal Limit** are blurred.

Select Displays the Select Focal Object dialog so you can select a single 3ds Max object to use as the focal object. The object you select can be animated over time, which results in animated follow focus effects. You can also choose your camera target as the focal object so its depth in the scene determines the focus.

Affect Alpha When this option is selected, the blur effect is also applied to the Alpha channel of the image when you render to a 32-bit format. Select this option to composite the blurred image over another.

Horiz. Focal Loss Specifies the amount of blur applied to the image in the horizontal (X-axis) direction. Values range from 0 to 100% focal loss. This parameter can be [animated](#) on page 6848.

Lock Locks the horizontal and vertical loss settings together. When selected, the vertical focal loss is automatically updated to match your changes to the horizontal loss.

Vert. Focal Loss Specifies the amount of blur applied to the image in the vertical (Y-axis) direction. Values range from 0 to 100% focal loss. This parameter can be animated.

Focal Range Specifies how far away from the center of the image (Radial Blur) or from the camera (Focal Object) the blur effect begins. Increasing values move the radius of the effect farther away from the camera or the center of the image. This parameter can be animated.

Focal Limit Specifies the distance from the center of the image (Radial Blur) or the distance from the camera (Focal Object) at which the blur effect is at full strength. Setting a high Focal Limit with a low Focal Range, produces a gradual increase in the amount of blur in the scene, while setting Focal Limit and Range close together produces a rapid blur effect over a short distance. This parameter can be animated.

NOTE Do not set Focal Range and Focal Limit to the same value. This produces an abrupt change from a blur to a sharp focus, producing an undesirable visual effect.

WARNING When you animate Lens Effects parameters, this creates pointers into the actual scene, so Lens Effects animation is lost if you save the Video Post queue in a [VPX file](#) on page 8165. To preserve the animation, save the Video Post data, including Lens Effects animation, in the MAX file.

Button group

Reset Resets Lens Effects Flare to its default settings.

Load Displays a Windows-standard file open dialog from which you can select the settings file you want to load.

Save Displays a Windows-standard Save As dialog in which you specify a directory and filename. Lens Effects Focus settings are saved as LZO files.

Lens Effects Glow Filter

Video Post toolbar > Add Image Filter Event > Choose Lens Effects Glow from Filter Plug-In list. > Setup

The Lens Effects Glow dialog lets you add a glowing aura around any assigned object. For example, for an exploding particle system, adding a glow to the particles makes them seem as though they are brighter and hotter.

The Lens Effects Glow module is multi-threaded and will take advantage of multi-processing machines.

Procedures

To save your glow settings, do one of the following:

You can save all of your lens glow settings to a file, so you can reload them any time. Lens Effects Glow settings are saved to [LZG files](#) on page 8030 (.lzg).

- 1** Click the Reset button.

This resets Lens Effects Glow to its default settings.

- 2** Click the Load button.

This displays a Windows-standard file open dialog from which you can select the settings file you want to load.

- 3** Click the Save button.

This displays a Windows-standard Save As dialog in which you specify a directory and filename.

Interface

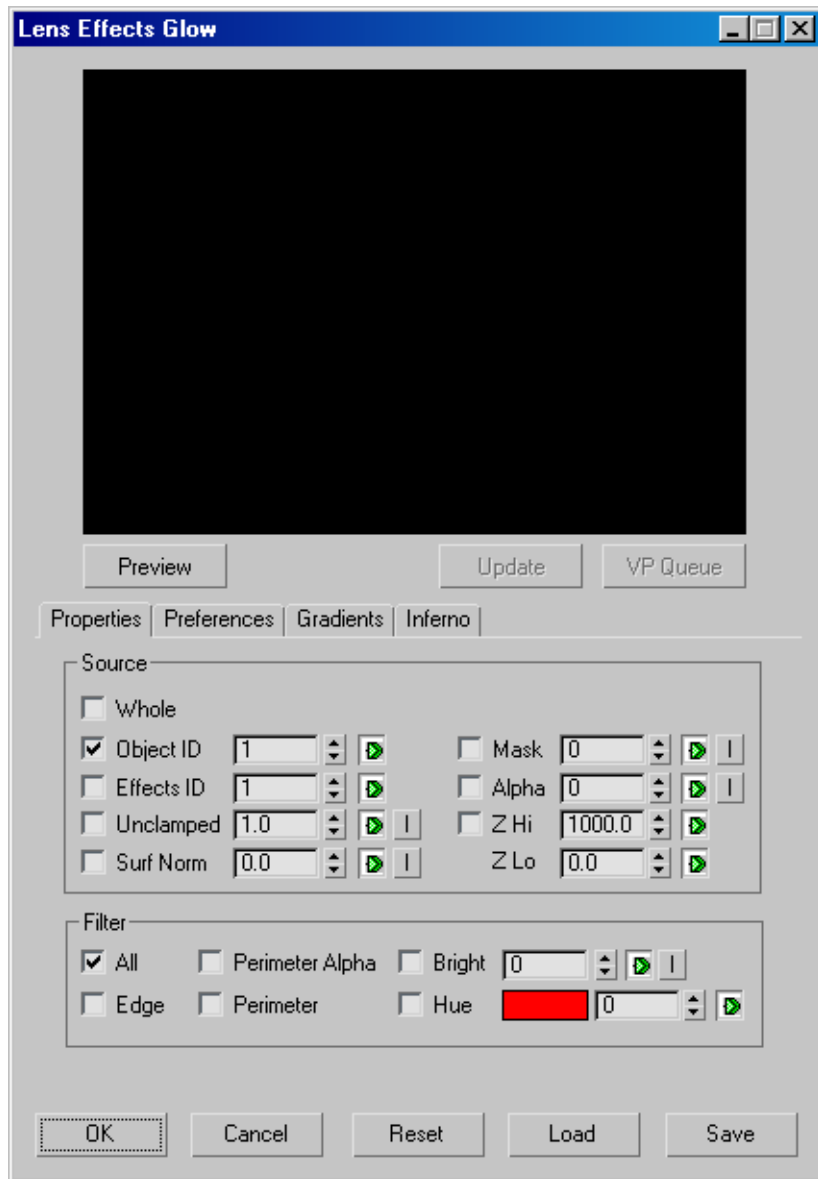

The Lens Effects Glow dialog contains a preview window, and an area below to control the parameters of Glow.

Preview group

Preview window Lets you quickly preview the glow effect. The preview window is multi-threaded to take advantage of systems with multiprocessors, and updates every time you make a change to any of the glow settings that might affect the scene.

Preview Displays a generic scene to which you can quickly set up a Glow effect. Appears light green when selected.

VP Queue Lets you preview the scene in the Video Post queue. Preview must be selected for the VP Queue function to work.

Focus Control tabs

The Lens Effect Glow dialog contains four tabs:

[Properties](#) on page 6878, [Preferences](#) on page 6882, [Gradients](#) on page 6902, and [Inferno](#) on page 6884

Button group

Reset Resets Lens Effects Glow to its default settings.

Load Displays a Windows-standard file open dialog from which you can select the settings file you want to load.

Save Displays a Windows-standard Save As dialog in which you specify a directory and filename. Lens Effects Glow settings are saved as LZG files.

Glow Properties

Video Post toolbar > Add Image Filter Event > Choose Lens Effects Glow from Filter Plug-In list. > Setup > Properties tab

The Lens Effects Glow properties let you determine which pieces of geometry in your scene will exhibit the effects of the glow filter, as well as how much of a glow is applied.

Procedures

To set a material's Effects Channel ID:

- 1 In the Material Editor, make the material you want to be post-processed the active material.

- 2 Choose a non-zero ID from the Material Effects Channel flyout.

The Effects Channel ID can range from 1 to 15.

If you give the same Effects Channel ID value to more than one material, all these materials will be post-processed.

NOTE For Multi/Sub-Object materials, post-processing applies at the sub-object/sub-material level. The Effects Channel ID of the parent Multi/Sub-Object material is ignored.

To set up an RLA file so it saves Object and Material Effects channel data:

- 1 Place an Image Output Event in the Video Post Queue.
- 2 In the Image Output Event dialog, click Files.
- 3 Choose the [.rla file type](#) on page 7364 and a file name, and then click Setup.
- 4 In the RLA Image File Format dialog, select Object, Material Effects, and then click OK.
- 5 Click OK.

When the RLA file has saved the Object and Material Effects channels, you can use the rendered scene file as an Image Input event or a Filter or Layer mask, and continue to use the Object or Material Effects Channel data.

Interface

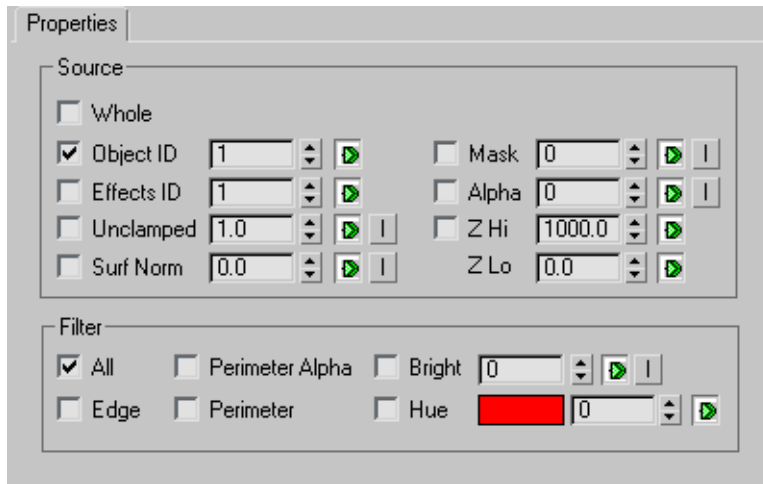

The Properties panel is divided into two sections: **Source** and **Filter**.

Source group

Specifies the objects in the scene to which a glow is applied. You can select more than one source option at a time.

Whole Applies a glow to the whole scene, not just a particular piece of geometry. This makes each pixel in the scene a potential glow source. The areas of the scene that have glow applied to them are determined by the settings in the Filter section of the dialog.

Object ID Lets you apply the glow to an object or part of an object with a specific Object ID (in the [G-buffer](#) on page 7991), if the object matches the Filter settings. To apply an Object ID glow for an object, right-click the object and select properties from the menu. Then, set the Object Channel ID. Set this field to match, and Lens Effects glow will apply the glow to that object and any other objects with the same ID. This parameter can be [animated](#) on page 6848.

Effects ID Lets you apply the glow to an object or part of an object with a specific Effects ID, if the object or part of the object matches the Filter settings. You apply a Effects ID in the Materials Editor by assigning the material to one of the available Material Effects channels. This parameter can be animated. The glow will be applied only to areas of the geometry where the ID is present.

NOTE To apply different glow settings to different pieces of geometry or IDs, add more glow entries to the video post queue. Set each glow entry to affect a different Effect or Object ID, and set the appropriate settings. This process will call the glow routine multiple times, increasing your rendering time. Try to keep the number of glow routines to a minimum per frame.

Unclamped An unclamped color is brighter than pure white (255,255,255). 3ds Max keeps track of these "hot" areas which tend to show up when your scene contains bright metallic highlights or explosions. This spinner lets you determine the lowest pixel value that is glowed. Pure white has a pixel value of 1. When this spinner is set to 1, any pixels with a value above 255 will be glowed. You can invert this value by clicking the **I** button to the right of the spinner. This parameter can be animated.

Surf Norm Glows part of an object, based on the angle of the surface normal to the camera. A value of 0 is coplanar, or parallel to the screen. A value of 90 is normal, or perpendicular to the screen. If you set Surf Norm to 45, only surfaces with normal angles greater than 45 degrees will be glowed. You can invert this value by clicking the **I** button to the right of the spinner. This parameter can be animated.

Mask Glows the mask channel of an image. The spinner value represents the level of grayscale present in a Mask. When this is set, any part of the Mask images larger than the set value will be glowed in the final image. You can invert this value by clicking the **I** button to the right of the spinner. This parameter can be animated. Range = 0 to 255.

Alpha Glows the alpha channel of an image. The transparency of an alpha channel is interpreted opposite that of the Mask channel. This parameter can be inverted, and can also be animated. Range = 0 to 255.

Z Buffer Hi and Lo Glows objects based on their distance (Z-Buffer distance) from the camera. The Hi value is the maximum distance and the Lo value is the minimum. Any objects between these two Z-Buffer distances will be glowed. These parameters can be animated.

Filter group

Filters the Source selections to let you control how the glow is applied. For example, you can have ten spheres in your scene, each with the same Object ID, but different colors. If you set the **Source** as the Object ID of the spheres, which selects all of the spheres, that is the only place in your scene that Glow applies an effect.

However, now that Glow knows where the pixels are that *can* be glowed, it needs to know which ones to actually apply the Glow to. Glow uses the filter controls to find out which source pixels to apply a glow to.

All Selects all source objects in the scene and applies a glow to them.

Edge Selects all source objects along a boundary edge and applies a glow to them. Applying a glow along the edges of objects produces a soft halo that exists on both inside and outside edges of your object.

Perimeter Alpha Applies a glow only to the perimeter of an object based on its alpha channel. Selecting this option glows only the outside of an object without any spill on the interior. Perimeter Alpha keeps all the edges clean because it relies on the scene alpha channel for its effect.

Perimeter Applies glow effect only to the perimeter of an object based on Edge inferencing. Although not as precise as Perimeter Alpha, you might need to use the Perimeter option at times when the alpha channel is unavailable.

Bright Filters the source objects based on their brightness values. Only objects with a brightness above the spinner setting are selected and glowed. This option can be inverted. This parameter can be animated.

Hue Filters the source objects by their hue. Select the hue by clicking the color swatch next to the spinner. The spinner beside the Hue color swatch lets you enter a variance level so that the glow can find several different hues in the same range as the chosen color. This parameter can be animated. Range = 0 to 255.

Glow Preferences

Video Post toolbar > Add Image Filter Event > Choose Lens Effects Glow from Filter Plug-In list. > Setup > Preferences tab

Glow Preferences define the size of the glow, its occlusion, and whether or not it affects the Z-Buffer or alpha channels.

Interface

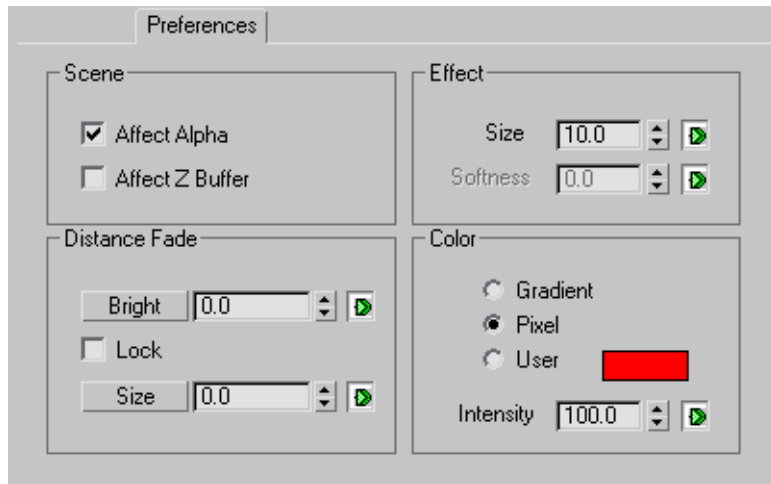

The Preferences panel is divided into four sections: Scene, Distance Fade, Effect, and Color.

Scene group

Affect Alpha Specifies whether or not the glow affects the alpha channel of the image, when rendered to a 32-bit file format.

Affect Z Buffer Specifies whether or not the glow affects the Z-Buffer of the image. When this option is enabled, the linear distance of the glow is recorded, and can be used in special effects that make use of the Z-Buffer. For example, Lens Effects Focus blurs objects based on their Z-Buffer information. To use Focus with a glow, you must enable this option.

Distance Fade group

These controls fade the glow effect, based on its distance from the camera. This is the same as distance fade for the lens flare.

Bright Lets you fade the brightness of the glow effect based on the distance from the camera. This is ideal for submarine running lights and any other effect where you want your glow to disappear into the distance. This parameter can be [animated](#) on page 6848.

Size Lets you fade the size of the glow effect based on the distance from the camera. In most circumstances, you want the overall size of the glow to

diminish as it gets farther away from the camera. This parameter can be animated.

Lock When selected, locks the Bright and Size values together, so that the size and brightness fading is synchronized.

Effect group

Size Sets the size of the overall glow effect. This parameter can be animated.

Softness Softens and blurs the glow effect. Values range from 0 to 100. This control is enabled only when you use Gradients as the color method (see the next section). Softness is only available when the Gradient option in the Color area is selected. This parameter can be animated.

Color group

Gradient Creates the glow based on the settings in the Gradients panel. When you use this method, you can use the Softness spinner in the Effect area.

Pixel Creates the glow based on the pixel color of the object. This is the default method. It is very fast.

User Lets you select a color for the glow effect. Click the color swatch to display the [Color Selector](#) on page 391 and choose a color.

Intensity Controls the intensity or brightness of the glow effect. Values range from 0 to 100. This control is enabled only when Pixel or User is the chosen color method.

Glow Inferno

Video Post toolbar > Add Image Filter Event > Choose Lens Effects Glow from Filter Plug-In list. > Setup > Inferno tab

The Inferno panel lets you create explosions, fire, and smoke effects by combining the lens flare glow with black and white fractal noise.

The Glow inferno effect is like the Inferno effect in [Lens Flare](#) on page 6869, but it is applied to the Glow through the R, G, and B color channels.

Interface

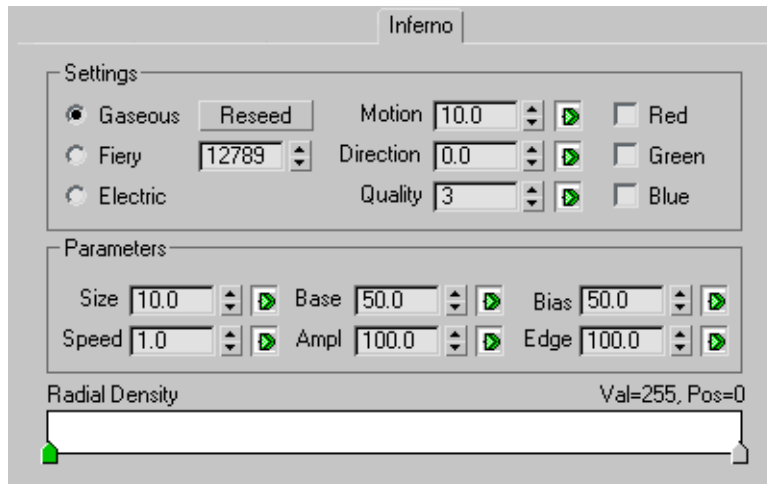

The Inferno panel is divided into two sections: Settings and Parameters.

Settings group

Gaseous A loose and soft pattern, often used for clouds and smoke.

Fiery Fractal patterns with bright, well-defined areas, often used for fires.

Electric Long, well-defined tendril pattern that can be used to produce arcing electricity, when animated. By adjusting the quality of the pattern to 0, you can create the effect of water reflection.

Reseed The number that the fractal routines use as a starting point. Set this spinner to any number to create different fractal effects. The Reseed button randomly selects a new number.

Motion When you animate the inferno, motion specifies how fast the inferno patterns move in the direction set by the Direction spinner. For example, if you want to simulate a raging fire, you want the fractal patterns to move upward. This parameter can be [animated](#) on page 6848.

Direction Specifies the direction, in degrees, of the inferno effect motion. By default, 0 is aligned in the 12 o'clock position, and works clockwise. This parameter can be animated.

NOTE The Motion and Direction spinners control the motion of the fractal pattern in the X and Y directions. You can control the Z direction using the Speed option under Inferno Parameters.

Quality Specifies the overall quality of the fractal noise patterns in the inferno effect. Higher values result in more iterations of the fractals, more detail in the effect, and slightly longer render times. This parameter can be animated.

Red/Green/Blue Selects the color channel to use for the Inferno effect.

Parameters group

Size Specifies the overall size of the fractal patterns. Smaller numbers produce small, grainy fractals. Higher numbers produce larger patterns. This option can be animated.

Speed Sets the overall speed of the turbulence in the fractal patterns as they are animated. Higher numbers produce faster turbulence in the pattern. This parameter can be animated.

Base Specifies the brightness of the colors in the inferno effect. Higher values result in brighter color ranges and brighter infernos. Lower values result in dark, softer effects. The Base spinner only affects Fiery and Electric inferno types. This parameter can be animated.

Amplitude With the Base spinner, controls the maximum brightness for each portion of the fractal inferno patterns. Higher values result in fractal patterns with brighter colors. Lower values result in the same patterns, with muted colors. This parameter can be animated.

Bias Shifts the colors of the effect toward one end of the color range or the other. At a setting of 50, Bias has no effect. Above 50, the colors are brighter, and below 50, they are darker and softer. This parameter can be animated.

Edge Controls the contrast between the light and dark areas of the fractal patterns. High values produce a high contrast and more well-defined fractal patterns. Low values result in less defined, subtler effects. This parameter can be animated.

Radial Density Controls the density of the inferno effect in a radial fashion from the center of the effect to the edge. Wherever there is white in the gradient, you only see inferno noise. Where the gradient is black, you can see the underlying glow. If you set the right side of the gradient to black and the left side to white, and apply the Inferno to the Glow effect of a flare, the inferno effect appears toward the outer edges of the glow, while the center of the glow is still visible.

Lens Effects Highlight Filter

Video Post toolbar > Add Image Filter Event > Choose Lens Effects Highlight from Filter Plug-In list. > Setup

The Lens Effects Highlight dialog lets you assign bright, star-shaped highlights. Use it on objects that have shiny materials. For example, a shiny, red car might show highlights in bright sunlight.

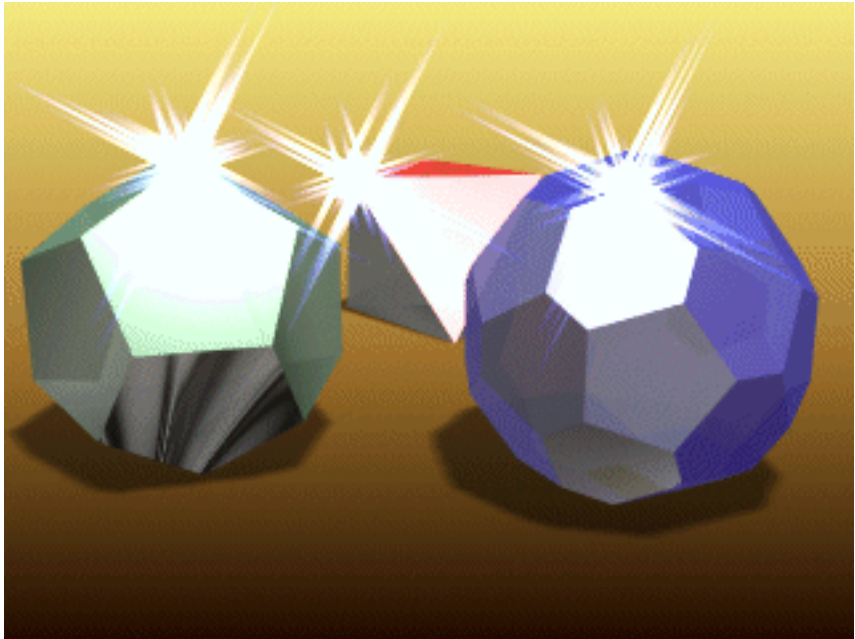

Example of highlights

Another good example of an effect perfect for Highlight is the creation of pixie dust. If you create a particle system and animate it moving in a straight line with small four-point Highlight stars applied to each pixel, it will look a lot like twinkling magic.

The Lens Effects Highlight module is multi-threaded and will take advantage of multi-processing machines, making it one of, if not the fastest highlight routines available.

Procedures

To save your highlight settings:

You can save all of your lens highlight settings to a file, so you can reload them any time. Lens Effects Highlight settings are saved as [LZH files](#) on page 8030 (*.lzh*). Do one of the following:

- 1 Click the Reset button.
This resets Lens Effects Highlight to its default settings.
- 2 Click the Load button.
This displays a Windows-standard file open dialog from which you can select the settings file you want to load.
- 3 Click the Save button.
This displays a Windows-standard Save As dialog in which you specify a directory and filename.

Interface

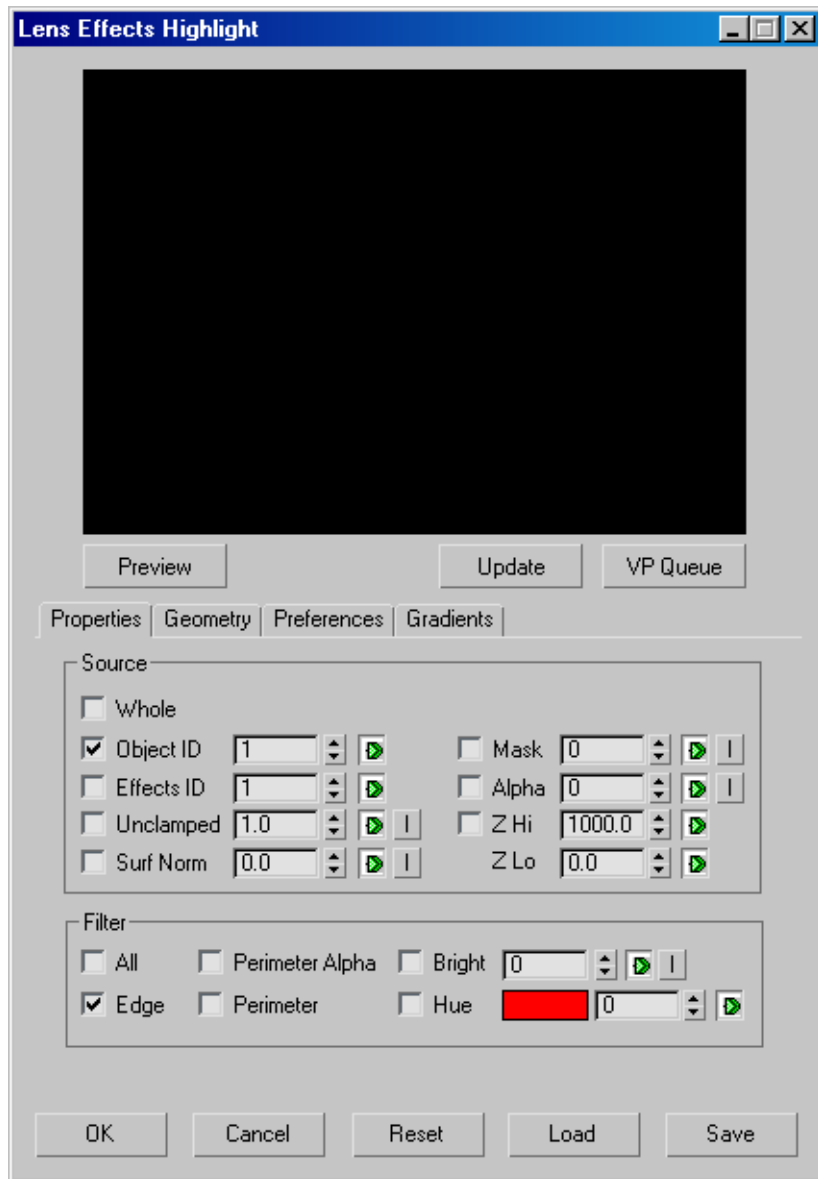

When you select Lens Effects Highlight from the Image Filter Event drop-down list and click Setup, the Highlight dialog is displayed.

The Lens Effects Highlight interface is almost identical to the Glow module, with a large preview window, and tabs to control every aspect of your highlight effects.

Preview group

Preview window Lets you quickly preview the glow effect. The preview window is multi-threaded to take advantage of systems with multiprocessors, and updates every time you make a change to any of the glow settings that might affect the scene.

Preview Activates a generic cross star filter so you can quickly set up a Highlight effect. However, as with the Glow module, it is more effective seeing your entire scene and how your effect will interact with your geometry.

VP Queue Lets you preview the scene in the Video Post queue. Preview must be selected for the VP Queue function to work.

Highlight Control tabs

Similar to the Glow settings, Highlight is also broken down into tabbed sections for fine control over each aspect of the Highlight effect. The four tabs are:

[Highlight Properties](#) on page 6890

[Highlight Geometry](#) on page 6895

[Highlight Preferences](#) on page 6900

[Lens Effects Gradients](#) on page 6902

Button group

Reset Resets Lens Effects Highlight to its default settings.

Load Displays a Windows-standard file open dialog from which you can select the settings file you want to load.

Save Displays a Windows-standard Save As dialog in which you specify a directory and filename. Lens Effects Highlight settings are saved as LZH files.

Highlight Properties

Video Post toolbar > Add Image Filter Event > Choose Lens Effects Highlight from Filter Plug-In list > Setup > Properties tab

The Lens Effects Highlight properties enable you to determine which parts of your scene will have highlights applied to them, as well as how the highlights are to be applied.

Interface

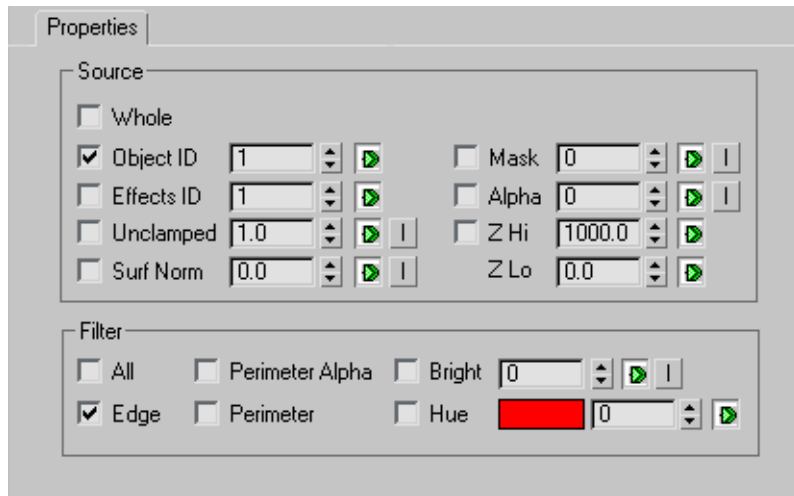

The Properties panel is broken down into two sections: Source and Filter.

Source group

The **Source** section lets you select any G-Buffer data in the scene that will have a highlight applied to it. Lens Effects Highlight will begin the process by finding the source pixels from your scene that you want to glow.

Whole Lets you apply highlights to the whole scene, not just a particular piece of geometry. This, in effect, makes each pixel in the scene a potential highlight source. The areas of the scene that have highlights applied to them are determined by the settings in the **Filter** section of the dialog.

Object ID The Object ID Lets you apply highlights to particular objects in your scene that have a corresponding G-Buffer (or Object) ID. The G-Buffer is a geometry buffer and can be defined when you right-click any 3ds Max object and select Properties from the menu. Then, set the Object Channel ID under the G-Buffer ID controls. This parameter can be [animated](#) on page 6848.

Effects ID The Effects ID lets you apply the highlight to an object or part of an object with a specific Effects ID assigned to it. Effects ID's are applied in the materials editor by assigning the material one of the eight Material Effects

channels that are available. See [G-Buffer](#) on page 7991. This parameter can be animated.

The highlights are then only applied to areas of the geometry where that particular ID is present.

NOTE In many instances, you may want to apply different highlight settings to different pieces of geometry or ID's. To accomplish this, add additional Lens Effects Highlight entries to the Video Post queue. Then set each different Highlight entry to effect a different Effect or Object ID and proceed.

Unclamped An unclamped color is brighter than pure white (255,255,255). 3ds Max keeps track of these "hot" areas which tend to show up when your scene contains bright metallic highlights or explosions. This spinner lets you determine the lowest pixel value that is highlighted. Pure white has a pixel value of 1. When this spinner is set to 1, any pixels with a value above 255 will be glowed. You can invert this value by clicking the **I** button to the right of the spinner. This parameter can be animated.

Surf Norm Highlights part of an object, based on the angle of the surface normal to the camera. A value of 0 is coplanar, or parallel to the screen. A value of 90 is normal, or perpendicular to the screen. If you set Surf Norm to 45, only surfaces with normal angles greater than 45 degrees will be glowed. You can invert this value by clicking the **I** button to the right of the spinner. This parameter can be animated.

Mask Highlights the mask channel of an image. The spinner value represents the level of grayscale present in a Mask. When this is set, any part of the Mask images larger than the set value will be glowed in the final image. You can invert this value by clicking the **I** button to the right of the spinner. This parameter can be animated. Range = 0 to 255.

Alpha Highlights the alpha channel of an image. The transparency of an alpha channel is interpreted opposite that of the Mask channel. Values range from 0 to 255. This parameter can be inverted by clicking the **I** button to the right of the spinner, and can also be animated.

Z Buffer Hi and Lo Highlights objects based on their distance (Z-Buffer distance) from the camera. The Hi value is the maximum distance and the Lo value is the minimum. Any objects between these two Z-Buffer distances will be highlighted. These parameters can be animated.

Filter group

Filters the Source selections to let you control how the highlight is applied. For example, you can have ten spheres in your scene, each with the same

Object ID, but different colors. If you set the **Source** as the Object ID of the spheres, which selects all of the spheres, that is the only place in your scene that Highlight will apply an effect.

However, now that Highlight knows where the pixels are that *can* be highlighted, it needs to know which ones to actually apply the highlights to. Highlight uses the filter controls to find out which source pixels to apply the highlight to.

All Selects all source pixels in the scene and applies a highlight to them.

Edge Selects all source pixels along a boundary edge and applies a highlight to them. Applying a highlight along the edges of objects produces a soft halo that exists on both inside and outside edges of your object.

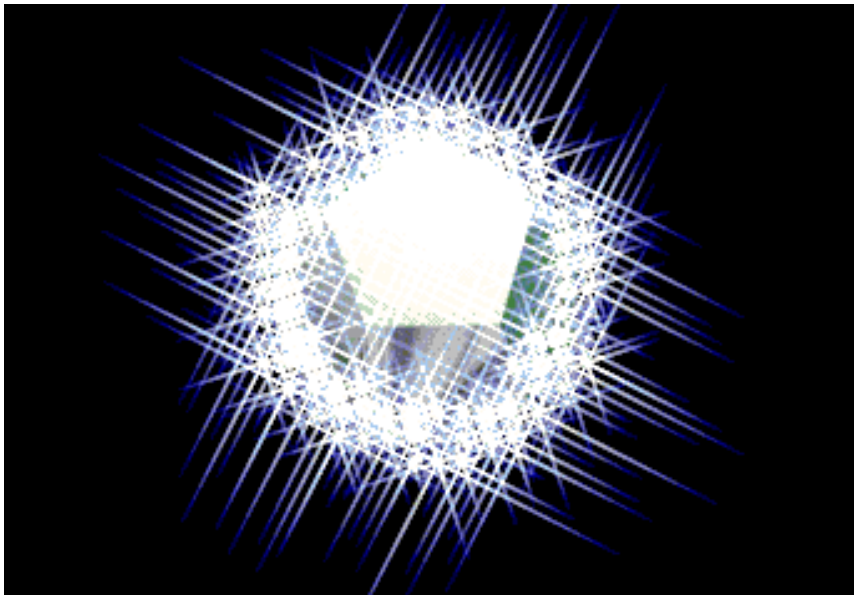

Edge highlights

Perimeter Alpha Applies a highlight only to the perimeter of an object based on its alpha channel. Selecting this option highlights only the outside of an object without any spill on the interior. Whereas highlighting by **Edge** produces a spill onto the object, Perimeter Alpha keeps all of the edges clean because it relies on the scene alpha channel to derive its effect.

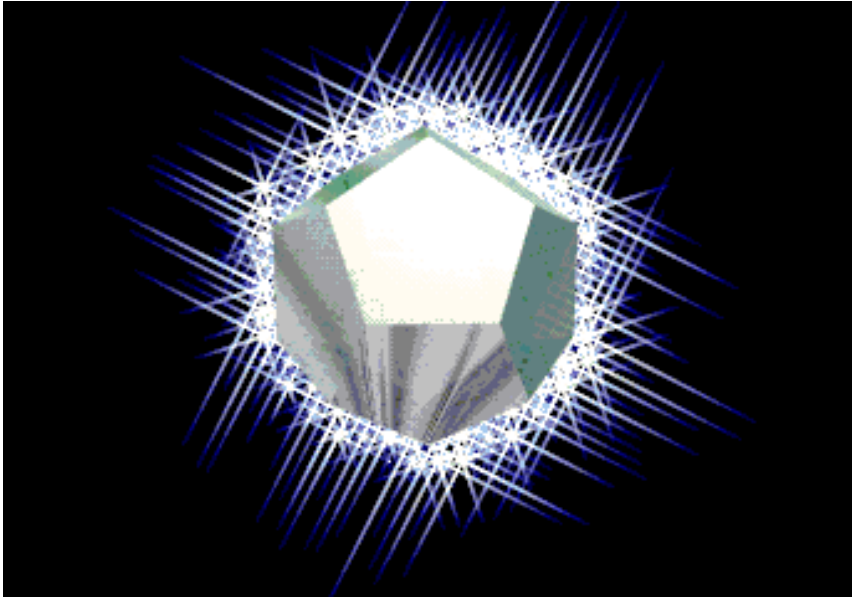

Perimeter alpha highlights

Perimeter Applies highlight effect only to the perimeter of an object based on Edge inferencing. Although not as precise as Perimeter Alpha, you might need to use the Perimeter option at times when the alpha channel is unavailable.

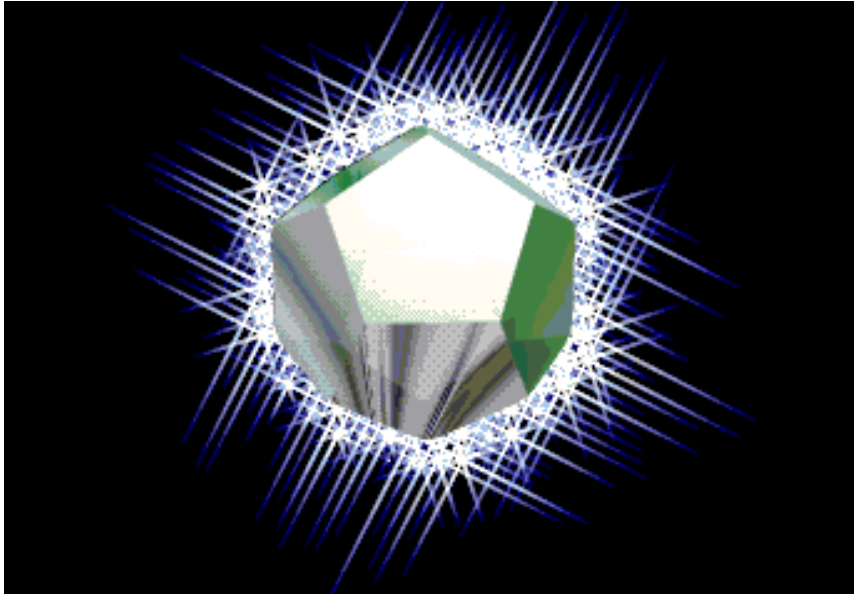

Perimeter highlights

Bright Filters the source objects based on their brightness values. Only objects with a brightness above the spinner setting are selected and highlighted. This option can be inverted by clicking the **I** button next to the spinner. This parameter can be animated.

Hue Filters the source objects by their hue. Select the hue by clicking the color swatch next to the spinner. You can choose hue values from 0 to 255. The spinner beside the Hue color swatch lets you enter a variance level so that the glow can find several different hues in the same range as the chosen color. This parameter can be animated.

Highlight Geometry

Video Post toolbar > Add Image Filter Event > Choose Lens Effects Highlight from Filter Plug-In list > Setup > Geometry tab

The Geometry panel is where you set the initial rotation of the highlights as well as how the elements are affected over time. The Geometry panel consists of three areas: Effect, Vary, and Rotate.

Interface

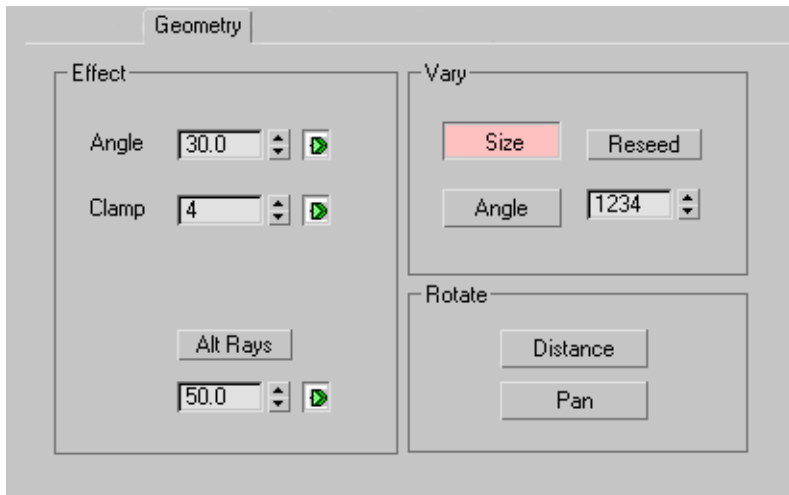

Effect group

Angle Controls the angle of the highlight points over the course of the animation. This parameter can be [animated](#) on page 6848.

Clamp Determines the number of pixels highlight must read to place a single highlight effect. In many cases, you want to key your highlight effects off of the brightness of objects that can produce a lot of pixels to generate from. The end result is something that looks like stadium lights from a Monday Night Football game, where each pixel has the highlight cross drawn on top of it, which blurs the overall effect. When you want only one or two highlights, use this spinner to adjust how highlight processes the chosen pixels. This parameter can be animated.

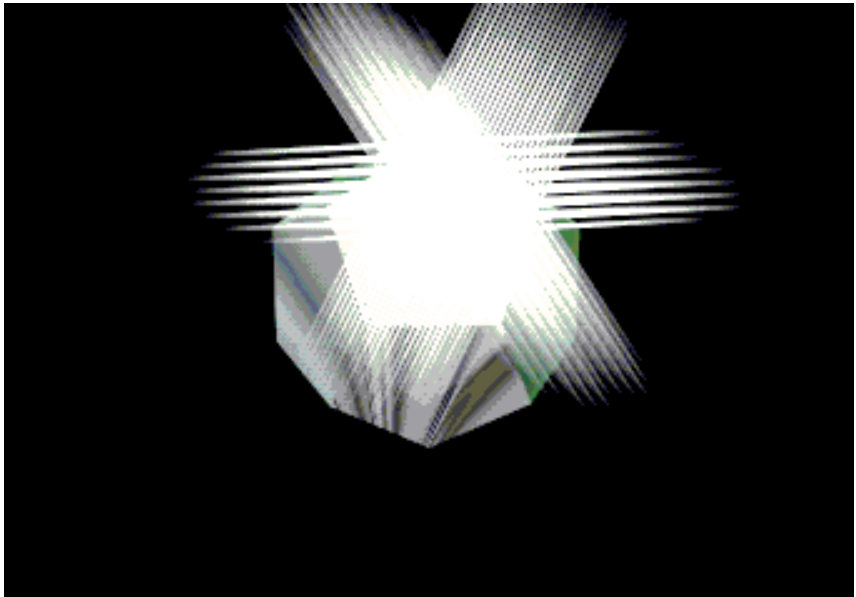

Clamp value of 5

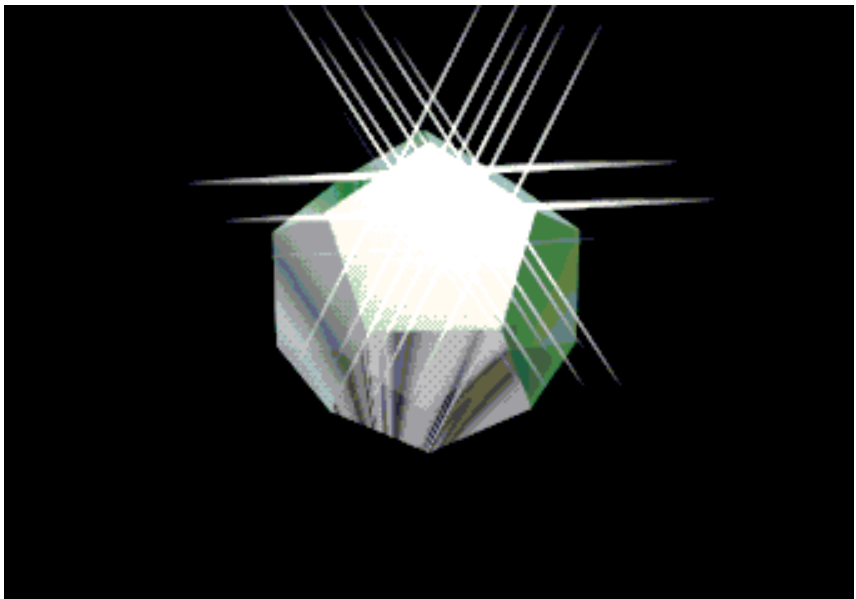

Clamp value of 15

As you can see, the Clamp value lets you maximize or minimize the overall number of highlights drawn over the same image. This can be a tremendous time saver.

Alt. Rays Alternates the lengths of points around the highlight. It works on every other ray point, changing from the ray's full length to a smaller one based on the percentage spinner beneath it. This parameter can be animated.

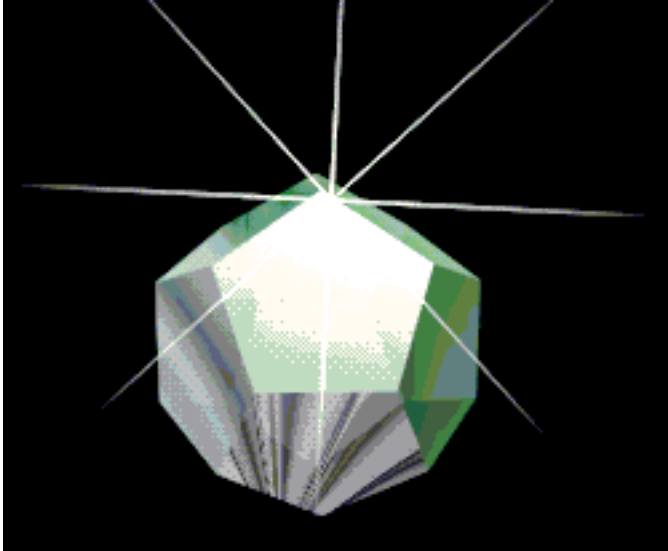

Alt. Rays turned off

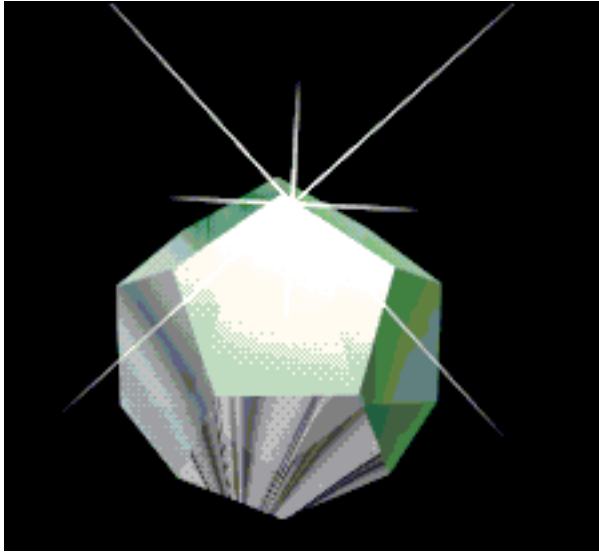

Alt. Rays turned on and set to 40%

Vary group

The Vary group of controls adds randomness to your Highlight effects. You can quickly adjust your effects so that no two look alike. In many instances, you want to avoid having your Highlights rotate in formation, and the Size and Angle buttons control that.

Size Varies the overall size of the individual Highlights.

Angle Varies the initial orientation of the individual Highlights.

Reseed Forces Highlight to use a different random number to generate parts of its effects.

Rotate group

These two buttons let you have your highlights automatically rotate based on their relative position in the scene.

Distance Automatically rotates the individual highlight elements as they recede into the distance. The faster your elements recede, the faster they will rotate.

Pan Automatically rotates the individual Highlight elements as they move laterally across the screen. If you have objects in your scene that are passing by the camera, they can be automatically rotated based on their position. The faster your elements move across the screen, the faster they will rotate.

Highlight Preferences

Video Post toolbar > Add Image Filter Event > Choose Lens Effects Highlight from Filter Plug-In list > Setup > Preferences tab

The Preferences panel defines the size and number of points on the highlight, occlusion settings, and whether or not it affects the Z-Buffer or alpha channels.

Interface

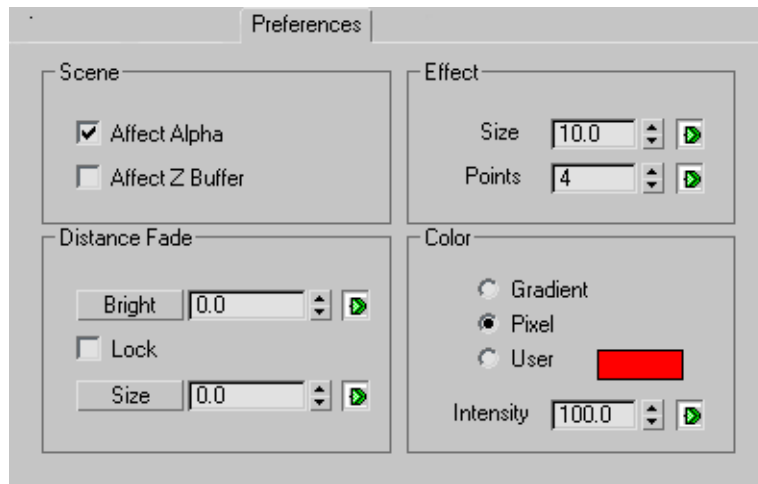

Scene group

Affect Alpha Determines whether or not the highlight settings affect the alpha channel of the image when you render to a 32-bit file format.

Affect Z Buffer Determines whether or not the highlight affects the Z-Buffer of the image. When this option is selected, the linear distance of the highlight is recorded, and can be used in special effects that make use of the Z-Buffer. For example, the Focus module that ships with Lens Effects blurs objects based on their Z-Buffer information. If you want to use Focus to blur a highlight,

you must select this option. If you are not sure about whether or not to select this option, leave it disabled, because you probably don't need it.

Distance Fade group

Bright Lets you fade the brightness of the highlight effect based on the distance away from the camera. This parameter can be [animated](#) on page 6848.

Lock Locks the Bright and Size spinner values together.

Size Lets you fade the size of the highlight effect based on the distance from the camera. In most circumstances, you want the overall size of your highlights to diminish as they get farther from the camera. This option takes care of that for you. This parameter can be animated.

Effect group

Size Lets you determine the overall size of the highlight effect, and is calculated in pixels. This parameter can be animated.

Points Controls the number of points to be generated for a highlight effect. This parameter can be animated.

Color group

Gradient Lets you create the highlight based on the settings in the Gradients panel.

Pixel Lets you create the highlight color based on the pixel color of the highlighted object. This is the default method for Lens Effects Highlight and is exceptionally fast.

User Lets you select a specific color for the highlights through the standard 3ds Max [Color Selector](#) on page 391. The color swatch shows you the currently selected color.

Intensity Lets you control the intensity or brightness of the highlights. Values range from 0 to 100. This spinner functions only when you are using either the *Pixel* or *User* color methods to control the brightness of the highlight effect. This parameter can be animated.

Lens Effects Gradients

Video Post toolbar > Add Image Filter Event > Choose Lens Effects Highlight from Filter Plug-In list > Setup > Gradients tab

A gradient is a smooth linear transition from one color or brightness to another, as shown below. Lens Effects use gradients to control aspects of the lens flares, such as colors and transparency. Lens Effects use several [gradient types](#) on page 6907.



Lens Effects Gradients are always interpreted from left to right.

Gradient Flags

Gradients use Flags to indicate points along the gradient bar where you want different colors or brightness values to be. The colors between the flags are interpolated automatically by Lens Effects. Each Gradient inside Lens Effects can contain up to 100 flags. The current flag is highlighted and green. The position number above the gradient bar indicates the position of the current flag, in relation to the overall length of the gradient.

A gradient always has non-moveable start and end flags. You can add up to 98 intermediate flags to alter the overall appearance of your gradients. You can also change the color or brightness of the end flags to suit your needs.

When you place two gradient flags on top of one another, you create a sharp break in the gradient. When a third flag is placed on top of the second flag, a sharp edge appears in the gradient.



WARNING When you animate Lens Effects parameters, this creates pointers into the actual scene, so Lens Effects animation is lost if you save the Video Post queue in a [VPX file](#) on page 8165. To preserve the animation, save the Video Post data, including Lens Effects animation, in the MAX file.

Procedures

To add an intermediate flag:

- Click the gradient bar where you want to place the new flag.
The flag uses the color of the gradient at the point where you placed it. To adjust the color, double-click to display the [Color Selector](#) on page 177.

To adjust the position of a flag:

- Drag the flag left or right.
The gradient updates to show you the changes.

To delete a flag:

- Drag the flag outside the gradient bar.
The flag turns red, and the mouse point changes to a down arrow pointing to a bucket. When you let go of the mouse button, the flag is deleted.



To change a flag's properties:

- 1 Right-click the flag to display a menu.
- 2 Click Properties and change any settings you want.

Interface

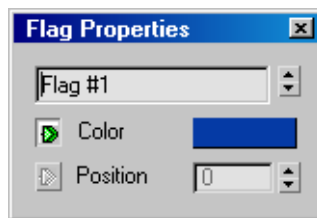

Right-clicking a gradient flag and selecting Edit Properties displays the Flag Properties dialog. To change [gradient options](#) on page 6904, right-click the gradient bar, not the flags.

The Flag Properties dialog lets you change the name of the flag, its color, and its position.

Name By default, flags are named Flag #. You can enter a different name for the current flag. The arrows to the right of the name box let you choose other flags on the same gradient.

Color The Color swatch lets you control the color or brightness component of the gradient at the position where the flag is located. Click the color swatch to display the color picker and choose a different color. The green arrow to the left of the color swatch indicates that this flag parameter can be [animated](#) on page 6848.

Position Each gradient has 100 possible positions from left to right. The number in the spinner represents the position of the flag along the gradient. Gradients are read from left to right so a value of zero aligns the flag with the left edge of the gradient. This flag parameter can be animated.

Gradient Options

Rendering menu > Video Post > Video Post toolbar > Add Image Filter Event > Choose a Lens Effects Filter from the Filter Plug-In list. > Setup > Gradient tab

Each gradient in Lens Effects has a set of common options. Right-clicking the gradient bar displays a shortcut menu with the following options.

Interface

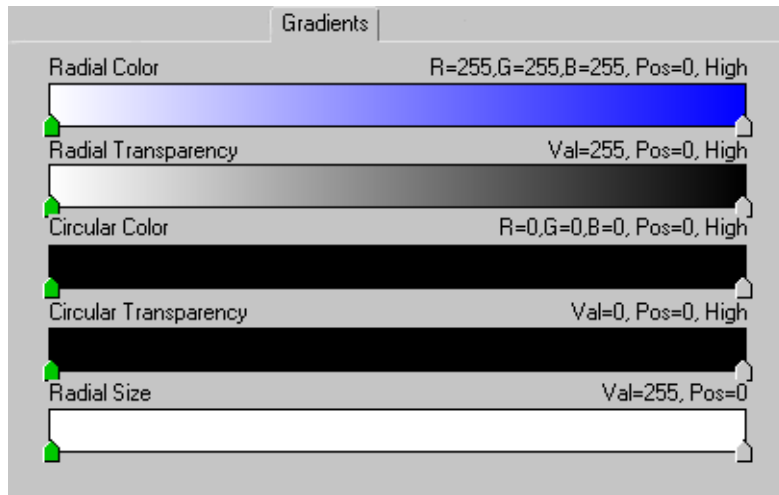

Reset Resets the gradient back to its default parameters. This action cannot be undone.

Load Gradient Displays a file open dialog in which you can load a particular gradient. Gradients are saved with a *.dgr* extension.

Save Gradient Displays a file save as dialog where you specify the path and filename for the gradient.

Load UV Map Lets you load a bitmap image and use each row of pixels of the bitmap as an animated gradient. When a bitmap is loaded into a gradient control, Lens Effects reads the first 100 pixels across the top row of the image (for the 100 divisions of its gradient controls) and makes them the gradient. With each successive frame, Lens Effects reads in the next row of pixels as the gradient. When you scrub the animation slider, you can see the gradient change over time.

NOTE If the animation is longer than the chosen bitmap is tall, then the bitmap pattern is repeated.

Load Bitmap Displays a 3ds Max file browser so you can select a bitmap to use as your gradient. Unlike UV Map, the Load Bitmap option only reads the first row of pixels for the entire animation. This is a good option when you need to have a complex but static gradient.

Flag Mode Indicates you are using flags to set the colors of your gradient instead of using a bitmap as the source. Flag Mode is selected by default.

Compositing Methods

The last five options on the shortcut menu are different types of compositing methods. When you work with Color and Transparency gradient controls in any of the Lens Effects filters, you must be aware of *both* the Radial and Circular gradients. Both Lens Effects color gradients and both Transparency gradients are "locked together" and will work together based on the compositing method you choose to create an effect.

Each compositing method works on a pixel-by-pixel basis on the positional value in both gradients. The compositing methods define how the colors and brightness values are combined to form a single color. When combining the colors, the algorithms evaluate each color channel of the color to find the end result. This lets you create five very different looking effects with the same two gradients.

High Value When this option is selected, the higher color or brightness value between the two gradients is selected. For example, if you had a color with RGB values of 255,210,255 and another with 225,240,225, the resulting color would be 255,240,255. This option generally results in a slightly brighter lens flare than the default settings.

This is the most common way of using only one gradient. Set one gradient to the color or brightness you desire, then set the other gradient to pure black. This assures that all of the values you set in one gradient are used exclusively to achieve the effect.

Average Calculates an average value between the colors. In the example above, the resulting color would be 175, 225, 225. This option is good if you want to mix gradient values and results in effects that are not as bright as High Value.

Low Value Selects the lower color values, resulting in a less intense lens flare and a more subtle overall effect. In the example above, the resulting color would be 100,210,295.

Additive Adds colors values together, pushing their composite value toward pure white, producing the brightest but most washed-out effects. Additive compositing is good when you want to burn effects out.

Subtractive Subtracts colors values from each other, resulting in slightly muted and less intense colors.

These compositing methods may be applied to all types of gradients, except size gradients. The type of compositing being used for a gradient is noted above the gradient bar.

Compositing methods are applied to every gradient. Some gradients are linked together, so if you assign a specific compositing method to one, the compositing method is automatically assigned to the other.

Types of Gradients

Rendering menu > Video Post > Video Post toolbar > Add Image Filter Event > Choose a Lens Effects Filter from the Filter Plug-In list. > Setup > Gradient tab

There are two different kinds of gradients in Lens Effects, Radial and Circular. Between the two types, you can achieve almost limitless effects.

Interface

Radial Radial gradients work from the center point to the outer edge of a Lens Effects feature, changing color or brightness in a straight line from left to right as you scan the gradient bar. The left edge of the gradient is aligned with the center of the effect and the right edge is aligned with the outer edge of the effect.

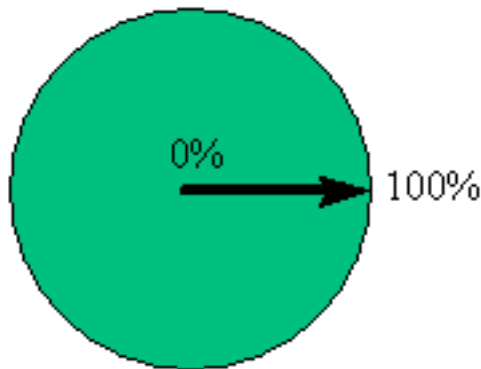

Scheme of a radial gradient

Circular Changes colors in a circular manner, working clockwise around a Lens Effects feature. If you mark North, East, South, and West on a circle, these points represent the 0%, 25%, 50%, and 75% marks of the gradient. Each parameter panel in Flare, Glow, and Highlight that utilizes gradients contain five gradient controls. The five controls are:

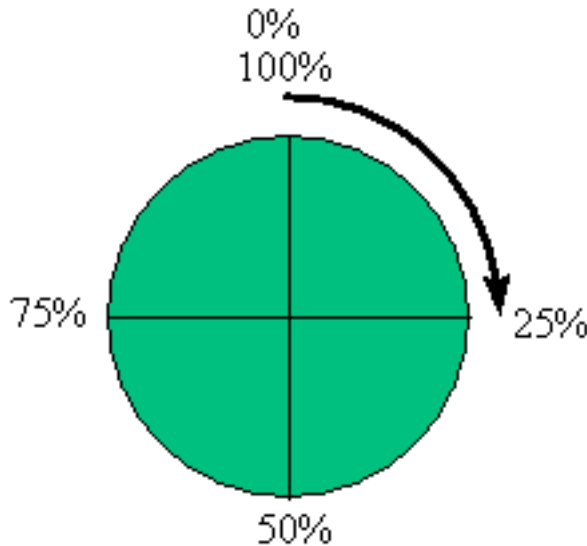

Scheme of a circular gradient

Color (Radial and Circular) Defines the [colors used](#) on page 6909 for an effect. This is based on the RGB color system, but can also be set with HSV. Within each set of gradient controls, there is a Radial and Circular Color gradient. Radial Color works with Circular Color to produce the overall color for the Lens Effects element.

Transparency (Radial and Circular) Varies the visibility of parts of the effect. The transparency gradients only make use of brightness (or luminance) values, which are essentially grayscale values. This black-to-white ramp of values provides you with 256 levels of transparency for your effects. Just like the Color gradients, both Transparency gradients are tied together to generate the overall visibility of effect. See [Gradient Options](#) on page 6904.

Size Varies the size of specific parts of the Lens Effect. Most size gradients are used to affect the radius of a lens flare part, such as a glow. Like transparency

gradients, only the brightness values are used to provide you with 256 different sizes.

The Radial Size gradient, for example, works both like a Radial and Circular gradient. This gradient is applied in a clockwise fashion, starting at 12 o'clock. The values in the gradient are applied from the center of the effect toward the outer edge, with brighter values producing bigger sizes and darker values producing shorter sizes.

Gradient Colors

Rendering menu > Video Post > Video Post toolbar > Add Image Filter Event > Choose a lens effects filter from the Filter plug-in list. > Setup > Gradient tab

Colors in 3ds Max are interpreted in two different ways: RGB and HSV. In RGB (red, green, blue), you can select one of 256 shades of red, green, and blue, giving you a palette of 16.7 million colors (24 Bit). In HSV (Hue, Saturation, Value), you can select one of 256 hues of color, then adjust the saturation or the value of the color. The saturation can also be considered the blackness of a color and value can be considered the whiteness of a color.

For transparent and size gradients, you adjust the vertical whiteness slider just to the left of the RGB and HSV sliders. The white triangle on the right side of the vertical bar is the slider. This controls the overall value of the color in terms of HSV. In RGB terms, it is the same as adjusting all three colors equally at the same time. Higher values on the whiteness scale represent more transparency, or smaller sizes.

See also:

- [Color Selector Dialog](#) on page 391

Layer Events

Alpha Compositor

Rendering menu > Video Post > Video Post window > Make sure the two child events are in the order you want the Image Layer event to use them. > Select

the two events. > Video Post toolbar > Add Image Layer Event > Choose Alpha Compositor from the Layer Plug-in list.

Rendering menu > Video Post > Video Post window > Select an Alpha Compositor > Video Post toolbar > Edit Current Event

The Alpha compositor composites the two images using the [alpha channel](#) on page 7905 of the foreground image. The background image appears in areas where the foreground image's alpha channel is transparent.

Procedures

To use the Alpha Compositor filters:

- 1 Add two Scene or Image Input events to the queue.
- 2 Select both events and assign an Image Layer event consisting of the Alpha Composite Filter.
- 3  Select the Image Layer event and click Edit Current Event.

Cross Fade Compositor

Rendering menu > Video Post > Video Post window > Make sure the two child events are in the order you want the Image Layer event to use them. > Select the two events. > Video Post toolbar > Add Image Layer Event > Choose Cross Fade Compositor from the Layer Plug-in list.

Rendering menu > Video Post > Video Post window > Select a Cross Fade Compositor. > Video Post toolbar > Edit Current Event

The Cross Fade compositor composites the two images over time, cross-fading from the background image to the foreground image. The rate of the cross fade is determined by the length of the Cross Fade Transition filter's time range.



Cross Fade fades one image into another over time.

There are no setup options for this compositor.

Procedures

To use the Cross Fade Compositor:

- 1 Add two Scene or Image Input events to the queue.
- 2 Select both events and assign an Image Layer event consisting of the Cross Fade Compositor.

Pseudo Alpha Compositor

Rendering menu > Video Post > Video Post window > Make sure the two child events are in the order you want the Image Layer event to use them. > Select the two events. > Video Post toolbar > Add Image Layer Event > Choose Pseudo-Alpha Compositor from the Layer Plug-in list.

Rendering menu > Video Post > Video Post window > Select a Pseudo-Alpha Compositor. > Video Post toolbar > Edit Current Event

The Pseudo-Alpha compositor composites a foreground image against the background by creating an alpha channel for the foreground image based on the foreground image's upper-left-corner pixel. All pixels in the foreground image that use this color become transparent.



Pseudo Alpha compositing

Because only one pixel color becomes transparent, edges of the opaque areas in the foreground image are aliased. Use this method when the foreground image is a bitmap whose format does not have an alpha channel.

There are no setup options for this compositor.

There is also a [Pseudo Alpha filter event](#) on page 6842.

Procedures

To use the Pseudo Alpha Compositor:

- 1 Add two Scene or Image Input events to the queue.
- 2 Select both events and assign an Image Layer event consisting of the Pseudo Alpha Composite Filter.

Simple Additive Compositor

Rendering menu > Video Post > Video Post window > Make sure the two child events are in the order you want the Image Layer event to use them. > Select the two events. > Video Post toolbar > Add Image Layer Event > Choose Simple Additive Compositor from the Layer Plug-in list.

Rendering menu > Video Post > Video Post window > Select a Simple Additive Compositor. > Video Post toolbar > Edit Current Event

The Simple Additive compositor composites the two images using the second image's intensity (HSV value) to determine transparency. Areas of full intensity (255) are opaque; areas of zero intensity are transparent; and areas with intermediate transparency are translucent.



Additive compositing

This layer event can be useful when the second image is a bitmap whose format does not have an alpha channel.

There are no setup options for this compositor.

Procedures

To use the Simple Additive Compositor:

- 1 Add two Scene or Image Input events to the queue.
- 2 Select both events and assign an Image Layer event consisting of the Simple Additive Compositor.

Simple Wipe Compositor

Rendering menu > Video Post > Video Post window > Make sure the two child events are in the order you want the Image Layer event to use them. > Select the two events. > Video Post toolbar > Add Image Layer Event > Choose Simple Wipe Compositor from the Layer Plug-in list.

Rendering menu > Video Post > Video Post window > Select a Simple Wipe Compositor. > Video Post toolbar > Edit Current Event

The Simple Wipe compositor reveals or erases the foreground image with a wipe transition. Unlike the [Wipe filter](#) on page 6843, the Wipe layer event moves the image, sliding it in or out.

The rate of the wipe is determined by the length of the Wipe compositor's time range.

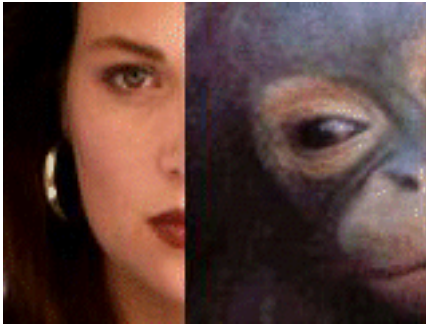

Wipe reveals an image by wiping from one side to the other, over time.

Procedures

To use the Simple Wipe compositor:

- 1 Add two Scene or Image Input events to the queue.
- 2 Select both events and assign an Image Layer event consisting of the Simple Wipe Compositor.
- 3  Select the Image Layer event and click Edit Current Event.
- 4 Click Setup to display the Simple Wipe Compositor Setup dialog.

Interface



Direction group

Right-pointing arrow Wipes from left to right.

Left-pointing arrow Wipes from right to left.

Mode group

Push Reveals the image.

Pop Erases the image.

Managing Scenes and Projects

23

These topics are concerned with managing scenes, projects, and the files that make them up.

Working with AutoCAD, Revit, and AutoCAD Architecture

3ds Max contains many features designed to streamline the design visualization workflow. See [Working with Drawing Files](#) on page 6978. The [File Link Manager](#) on page 6987 allows you to create a live link to a DWG file. You can then apply materials and animations in 3ds Max, but still update your geometry if any changes are made to the original file.

File-Handling Commands

The principal commands for [handling files](#) on page 6919 are found on the default [File menu](#) on page 7473, as in most Windows applications.

File-Handling Utilities

Several utilities help you manage files:

- The [Asset Browser](#) on page 7132 provides another way to find and preview files and use them in 3ds Max scenes
- The [Bitmap / Photometric Path Editor utility](#) on page 7141 lets you view bitmap paths or remove them from the scene file.
- The [File Finder](#) on page 7143 is another resource for finding 3ds Max scenes.
- The [Resource Collector](#) on page 7145 copies or moves a scene's bitmaps into a single directory.
- The [Fix Ambient utility](#) on page 7147 resolves lighting issues with older versions of scene files.

- The [Bitmap Pager Statistics dialog](#) on page 7150 provides information that helps you resolve issues with scenes that require large amounts of memory for texture maps.
- The [Substitute modifier](#) on page 1762 lets you replace linked AutoCAD Architecture objects with native 3ds Max geometry and objects.

Geometry File Formats

You can import a variety of [geometry file formats](#) on page 7161 into a scene.

Image File Formats

You can use [image file formats](#) on page 7324 in a variety of ways: as textures for materials, as backgrounds to viewports, as background environments, as Image Input events in Video Post, and as images projected from a light.

External References (XRefs) to Objects and Scenes

[External references](#) on page 6933 to objects and scenes are another powerful way to manage a project, especially when it involves multiple contributors.

RAM Player

You can preview images by using the [View File command](#) on page 7127, or by using the more interactive [RAM Player](#) on page 7374.

Scene Explorer

[Scene Explorer](#) on page 7379 is a powerful tool for organizing scene elements, selecting object based on various criteria, changing object display properties, and creating and modifying object hierarchies.

Scene States

The [Scene States](#) on page 7407 feature provides a fast way to save different scene conditions with various properties that can be restored at any time and rendered to produce different interpretations of a model.

Schematic View

[Schematic View](#) on page 7411 displays the scene as a graphic schema instead of as geometry. It gives you an alternate way to select or rename the objects in your scene, and to navigate among modifiers. It is especially useful for viewing objects in a hierarchy.

Layers

[Layers](#) on page 7438 are like transparent overlays on which you organize and group different kinds of scene information. The objects you create have common properties including color, renderability, and display.

File-Handling Commands

The main file-handling commands are on the default [File menu](#) on page 7473. These commands are for creating, opening, and saving scenes; importing and exporting other 3D file formats; viewing a 2D image file; displaying or changing a scene file's properties; exiting 3ds Max and other operations.

[New](#) on page 6920

[Reset](#) on page 6921

[Open](#) on page 6922

[Open Recent](#) on page 6927

[Save](#) on page 6927

[Save As](#) on page 6928

[Save Copy As](#) on page 6930

[Save Selected](#) on page 6931

[XRef Objects](#) on page 6936

[XRef Scene](#) on page 6959

[File Link Manager Utility](#) on page 6987

[Merge](#) on page 7058

[Merge Animation](#) on page 7063

[Replace](#) on page 7070

[Load Animation](#) on page 7077

[Save Animation](#) on page 7080

[Import](#) on page 7096

[Export](#) on page 7097

[Export Selected](#) on page 7099

[Asset Tracking](#) on page 7100

[Archive](#) on page 7121

[Summary Info](#) on page 7122

[File Properties](#) on page 7124

[View Image File](#) on page 7127

[Exit](#) on page 7129

See also:

- [Asset Browser Utility](#) on page 7132
- [Geometry File Formats](#) on page 7161
- [Image File Formats](#) on page 7324
- [RAM Player](#) on page 7374

New

File menu > New

Keyboard > Ctrl+N

New clears the contents of the current scene without changing system settings (viewport configuration, snap settings, Material Editor, background image, and so on). The New command also gives you the option, when you use it while a populated scene is active, to reuse objects from the current scene in the new one.

Procedures

To create a new scene:

- 1 Choose File > New or press Ctrl+N.
- 2 In the New Scene dialog, specify the types of objects to keep, if any.
- 3 Click OK.

Interface

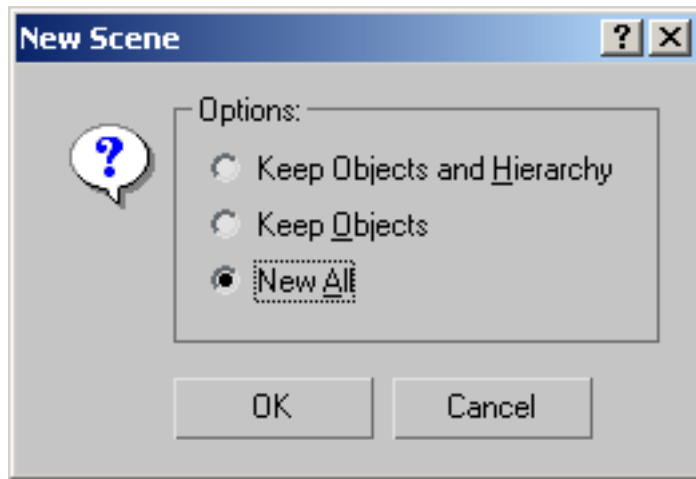

The New Scene dialog has the following controls:

Keep Objects and Hierarchy Keeps the objects and the [hierarchical links](#) on page 8002 between them, but removes any animation [keys](#) on page 8020.

NOTE If the current scene has any file links, 3ds Max performs a Bind operation on all linked files.

Keep Objects Keeps the objects in the scene, but removes any links between them and any animation keys.

WARNING This option should not be used when working with a scene containing linked or imported objects.

New All (Default) Clears the contents of the current scene.

Reset

File menu > Reset

Reset clears all data and resets the program settings (viewport configuration, snap settings, Material Editor, background image, and so on). Resetting restores the startup defaults, saved in the file *maxstart.max*, and removes any customization you might have done during the current session.

Resetting has the same effect as exiting and restarting 3ds Max.

TIP To change the startup defaults, start 3ds Max and make the adjustments you would like to see at startup. Then save the file to your *scenes/* directory as *maxstart.max*.

Procedures

If you have made changes since the last Save operation, a dialog prompts you whether you want to save your changes.

To reset 3ds Max:

- 1 Choose File > Reset.
If you have made any changes since the last Save operation, a dialog prompts you to save them. As further protection against data loss, a confirmation dialog appears.
- 2 When asked if you really want to reset, click Yes.
Clicking No on this dialog cancels the Reset operation.

Open

File menu > Open

Keyboard > Ctrl+O

Open loads a scene file (MAX file), character file (CHR file), or VIZ Render file ([DRF File](#) on page 7167) from an Open File dialog. You can also choose a previously opened file and use [command-line options](#) on page 7468.

The MAX file type is a complete scene file.

A CHR file is a character file saved with Save Character. For more information on the CHR file format, see [Character Assembly](#) on page 277 and [Save Character](#) on page 303.

A DRF file is a scene file from VIZ Render, a rendering tool included with AutoCAD Architecture (formerly Autodesk Architectural Desktop). The DRF file type is similar to MAX files from previous versions of Autodesk VIZ.

If the file you're loading was created using plug-ins that are not installed, a dialog lists them. You can still load the file, but any entities in the scene that were created by the missing plug-ins are replaced with stand-ins; non-rendering

boxes or placeholder modifiers. You can safely delete these from the scene, unless you are sharing the scene with a user who has the plug-ins installed.

If the file you are loading contains bitmaps that cannot be located, a [Missing External Files dialog](#) on page 7130 appears. This dialog lets you browse for the missing maps, or continue opening the file without loading them.

Automatic Unit Conversion

When Respect System Units In Files is turned on in the System Unit Scale group of the [System Unit Setup dialog](#) on page 7809, loaded files that have a different scene unit scale display a [File Load: Units Mismatch dialog](#) on page 7815. This dialog lets you rescale the loaded scene to the current scene unit scale, or change the current scene unit scale to match the one in the loaded file. No conversion is done when loading files created in 3ds Max 1.x.

- If you choose to match the units in the loaded file, the System Unit Scale setting in the System Unit Setup dialog is changed to the setting in the scene file.

This is the recommended choice, and it is the default in 3ds Max.

For example, if the current system unit scale is set to 1 unit = 1 inch, and the incoming file was set to 1 unit = 1 foot, a sphere with a radius of 100 feet remains 100 feet.

- If you rescale the file objects, the objects are scaled as if they had been created using the current scene unit scale.

For example, if the current system unit scale is set to 1 unit = 1 inch, and the incoming file was set to 1 unit = 1 foot, a sphere with a radius of 100 feet becomes 1200 inches in radius (assuming the unit display is set to generic units).

If Respect System Units In Files is off (which is not recommended), 3ds Max disregards the units chosen in the loaded scene file.

For example, a 100-unit radius sphere that was created in a 1 unit = 1 foot scene becomes a 100-inch sphere in a 1 unit = 1 inch scene.

Procedures

To reopen a previously opened file:

- From the bottom of the File menu, choose the file name.
You set the number of files listed by changing the [Recent Files In File Menu](#) on page 7750 field on the Files panel of the Customize > Preferences dialog.

To start 3ds Max and open a specific file:

- In a command prompt window, specify the file name after the executable name. For example:
"c:\Program Files\Autodesk\3ds Max 2009\3dsmax.exe" myproject.max

To start 3ds Max and open the last file you worked on:

- In a command prompt window, type -L after the executable name:
"c:\Program Files\Autodesk\3ds Max 2009\3dsmax.exe" -l

Interface

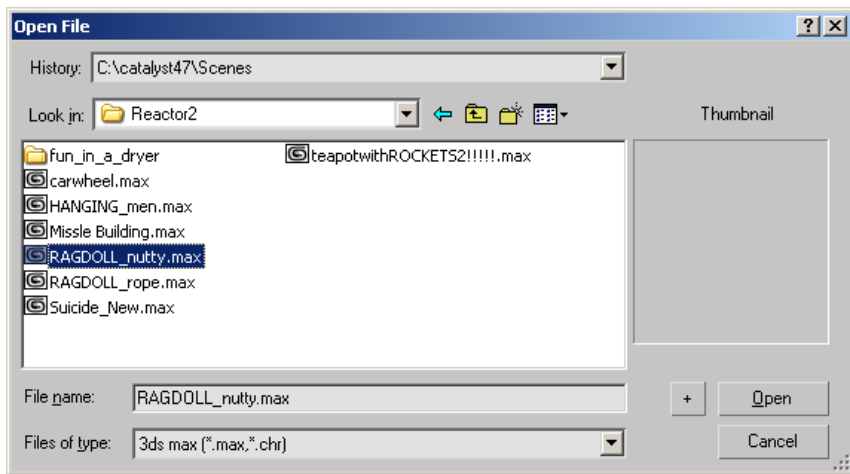

The Open File dialog has standard Windows file open controls. At the right, the Thumbnail area shows a preview of the scene whose file name is highlighted in the list on the left.

TIP You can resize the dialog by dragging an edge or a corner.



Clicking the plus button appends a sequence number to the file name you entered, or increments the sequence number if the name already has one, and then opens the file of that name, if it is present.

For example, if you have highlighted a file named *test00.max*, clicking the + button changes the name to *test01.max* and then opens that file.

Opening an Obsolete File

When opening a scene created in an earlier version of 3ds Max, you will see an Obsolete File dialog.

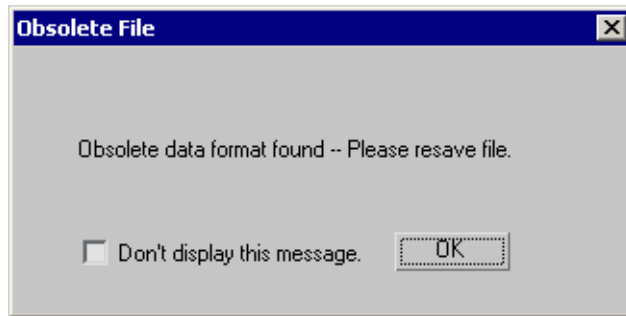

If you resave the scene, you will overwrite the file. You can still edit it using 3ds Max, but you will no longer be able to edit it in earlier versions of the software.

Don't display this message When turned on, you will not see the Obsolete File dialog. The dialog is also controlled by the Display Obsolete File Message switch on the Customize > Preferences > Files panel.

NOTE If you still need to open the scene using an earlier version of 3ds Max, use File > [Save As](#) on page 6928 and save the file using a different name. Then you will be able to open the original file with the earlier version.

Open from Vault

File menu > Open from Vault

The Open From Vault command lets you open a MAX file directly from Autodesk Vault, the data-management provider included with 3ds Max. This allows for secure control and versioning of assets used in the digital-content creation process without the need to use the Vault client.

NOTE Open from Vault appears on the File menu only if you installed the Vault plug-in, an optional part of the 3ds Max software installation

See also:

- [Asset Tracking](#) on page 7099

Procedures

To use Open From Vault:

- 1 Open the File menu and choose Open From Vault.
- 2 If you're not logged in to a provider, you're asked to log in via the [Vault Log In dialog](#) on page 7105. Fill out the form and then click OK.
- 3 Use the Open File From Vault dialog to browse the vault and choose a MAX file to open.
- 4 At this point, one of two things happens:
 - If the file is available for checkout, a dialog opens letting you know that the file is under version control and asking you if you want to check it out before making edits. Click Yes.
 - If another user has the file checked out, a dialog opens notifying you of this and telling you that you won't be able to save edits. Click OK to open the file in read-only mode. If you attempt to save this file, a dialog appears notifying you that the scene file is read-only and will not be overwritten.
- 5 If you attempt to open a different file or use the New or Reset command while the file is checked out, a dialog appears asking if you want to check the files back in. Enter a comment, if appropriate, and then click OK to check the file in.

Alternatively, if you just want to create a new version on the provider, turn on Keep Checked Out and then click OK. A new version will be created, but the file will still be checked out to you.

Interface

NOTE If you haven't set a working folder, the following dialog appears when you attempt to open a file from the vault:

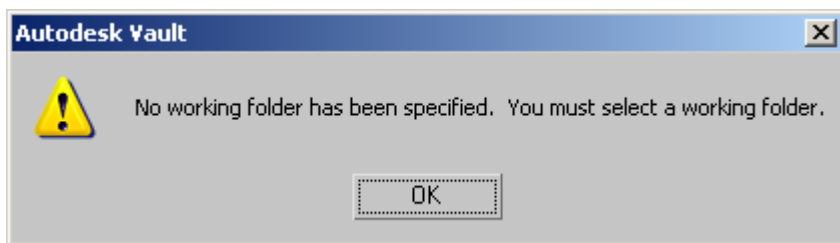

After you click OK, the Browse For Folder dialog opens, which you can use to specify a working folder.

Open Recent

File menu > Open Recent

Open recent displays a list of recently opened and saved files. The list is sorted in chronological order, with the most recent files at the top.

Procedures

To change the number of files displayed in the Open Recent list:

- 1 Choose Customize > Preferences > Files tab > File Handling.
- 2 Set a value for Recent Files In File Menu. The upper limit is 50.

Save

File menu > Save

Keyboard > Ctrl+S

Save updates the current scene by overwriting the last save of the scene. If no scene was previously saved, this command works like [Save As](#) on page 6928.

See also:

- [Save As](#) on page 6928
- [Save Copy As](#) on page 6930

Saving to an Obsolete File

When you open a file that was created with an earlier version of the software, and then attempt to save it in a current version of 3ds Max, an alert is displayed, warning you are about to overwrite the obsolete file.

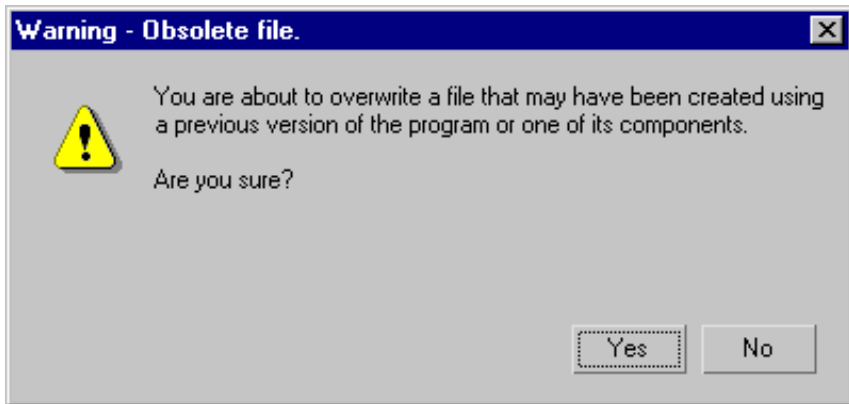

Choose Yes to go ahead and overwrite the original file, No to stop the Save. If you choose No, you can use [Save As](#) on page 6928 to save the file under a different name.

If you save to the original file name, you can still edit it using the current version of the software, but you will no longer be able to edit it in earlier versions of 3ds Max.

Interface

When you save a scene, you also save the program settings. When you open the file again, it opens with the same viewport configuration, view and zoom levels, snap and grid settings, and so on.

You can incrementally number saved files, and make automatic backup files at specified time intervals. These options, Increment On Save and Backup On Save, are on the [Files panel](#) on page 7750 of the Preference Settings dialog.

Save As

File menu > Save As

Save As lets you save the current scene file in MAX or CHR format under a different file name.

A CHR file is a character file saved with Save Character. For more information on the CHR file format, see [Character Assembly](#) on page 277 and [Save Character](#) on page 303.

NOTE 3ds Max lets you number saved files incrementally and make automatic backup files at specified time intervals. The options to set up Increment On Save and Backup On Save are on the [Files panel](#) on page 7750 of the Preference Settings dialog.

See also:

- [Save](#) on page 6927
- [Save Copy As](#) on page 6930

Procedures

To save a file to a different name:

- 1 Choose File > Save As.
- 2 Do one of the following:
 - Enter a name in the File Name field.
 - Click the Increment button.

Interface

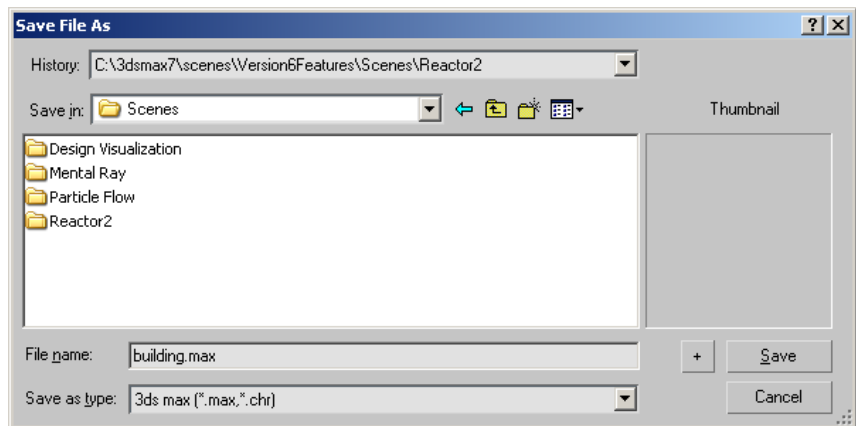

The Save File As dialog has standard Windows file save controls. At the right, the Thumbnail area shows a preview of the scene whose file name is highlighted in the list on the left.

TIP You can resize the dialog by dragging an edge or a corner.



Clicking the plus button appends a sequence number to the file name you entered, or increments the sequence number if the name already has one, and then saves the file to that name.

For example, if you have highlighted a file named *test00.max*, clicking the plus button changes the name to *test01.max* and then saves *test01.max*.

Save Copy As

File menu > Save Copy As

Save Copy As allows you to save a copy of the current scene under a different file name. It does not change the name of the file being worked on.

IMPORTANT Save Copy As does not update the original file name as Save does, and Save does not update the file you last saved using Saved Copy As. For example, if you make edits to a 3ds Max scene named *filename.max*, then use Save Copy As with the file name *filename01.max*, make additional edits, and then click Save, your second set of edits will be saved as *filename.max* but *not* as *filename01.max*.

See also:

- [Save](#) on page 6927
- [Save As](#) on page 6928
- [Auto Backup](#) on page 7750

Procedures

To save a copy of the file to a different name:

- 1 Choose File > Save Copy As.
- 2 Browse or type the name of the file you want to create or update.
- 3 Click the Save button.

Interface

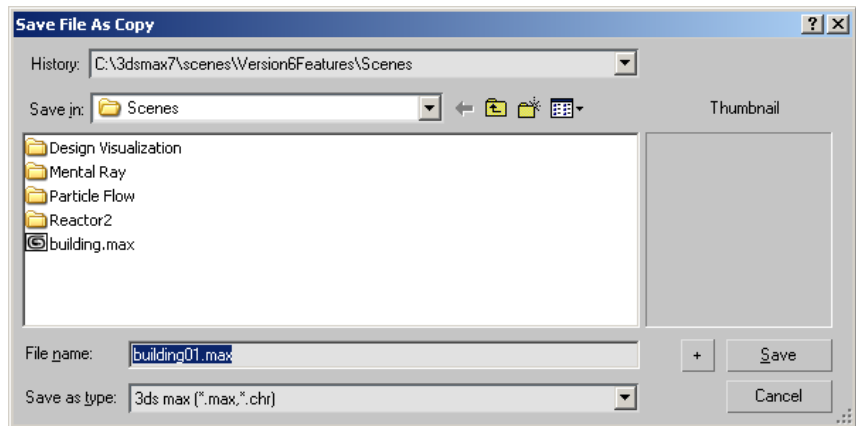

Save Copy As displays a standard Windows save dialog. Save Copy As increments the number at the end of the file name in order to propose unique but similarly-named files each time the command is used.

Clicking the Save button saves the file to the name displayed in the File Name text box.

TIP You can resize the dialog by dragging an edge or a corner.



Clicking the plus button saves the file with a name ending in a number one increment greater than that displayed in the File Name text box.

Save Selected

Select objects to save. > File menu > Save Selected

Save Selected saves the selected geometry as a scene file under a different file name.

Identically named bitmaps with different properties are stored as different files. Objects linked to a selected object are also saved. The following dependencies are preserved for a Save Selected operation:

- Ancestors of selected child objects are saved, all the way to the root of the hierarchy.

- Space Warps to which selected objects are bound are saved.
- IK follow objects to which selected objects are bound are saved.

Procedures

To save selected objects to a new file:

- 1 Select one or more objects.
- 2 Choose File > Save Selected.
- 3 Enter a name in the File Name field.
- 4 Click Save.

Set Project Folder

File menu > Set Project Folder

You can set a project folder when setting up a project, to provide a simple way of keeping all of your files organized for a particular project. When you open 3ds Max for the first time, the project folder defaults to the install folder, but you can set the folder to a different location. When you set the project folder, 3ds Max automatically creates a series of folders within it such as *scenes* and *renderOutput*. Saving or opening files from the browser defaults to this location.

Using a consistent project folder structure among team members is a useful practice for both organizing and sharing files. You can also set the project folder from the [Asset Tracking Dialog](#) on page 7100 > Paths menu.

Procedures

To set the project folder from the File menu:

- 1 Choose File > Set Project Folder.
- 2 Choose a path from the browser and click OK to set your project folder.

Interface

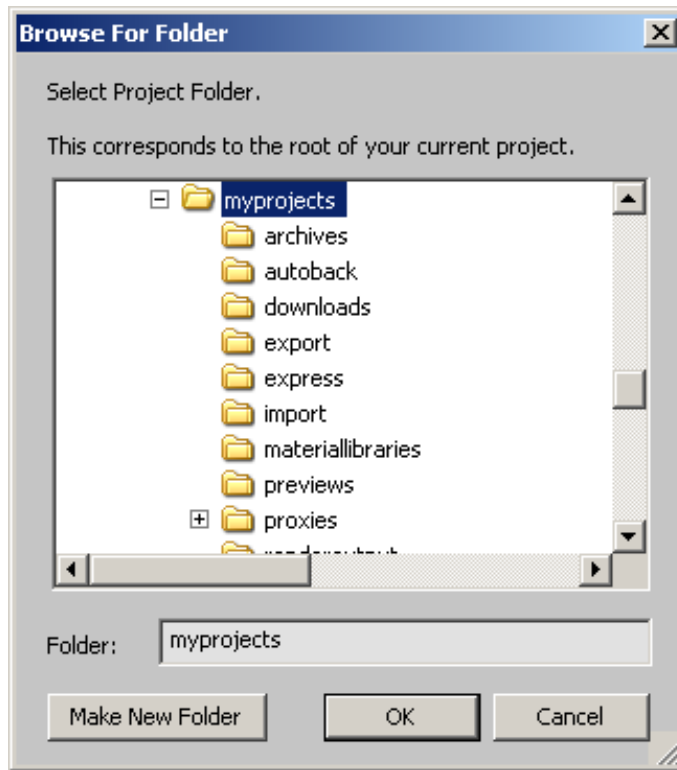

Use the browser controls to navigate the disk structure to the project folder to use, highlight the folder name, and then click OK.

Make New Folder Click this to create a folder named *New Folder* within the highlighted folder. When first created, the folder name is highlighted so that you can edit it; use the keyboard to rename the folder, or press Enter to accept the default name.

External References (XRefs)

You can use two kinds of externally referenced files (XRefs): [XRef Objects](#) on page 6936 and [XRef Scenes](#) on page 6959. Using these external references allows for a team approach to animation, where the modeling, materials, transform controllers, and animation can be handled in separate files by different artists.

It can also make large files much easier to deal with through the use of *proxy objects*.

You access the XRef Objects and XRef Scenes commands from the File menu.

The two types of references have distinct purposes:

- An externally referenced scene displays the entire contents of an external MAX file in the current scene. The objects within the external file are visible as a reference but cannot be selected. This prevents accidental changes to the referenced scene while allowing functionality such as Snap, AutoGrid, and Clone and Align to position local objects in context, as well as to pick objects as the target location for the clones. If you need to move, rotate or scale the referenced scene, you can bind it to a local object. Transforming the object the externally referenced scene was bound to will transform all objects in the externally referenced scene. Scene externally referenced objects can also be used as [reference coordinate system](#) on page 967. When changes to the externally referenced file are saved (such as objects added, edited or deleted), an Update of Xref Scene will inherit those changes locally.
- Externally referenced objects appear in the scene and can be animated. Depending on the object's XRef settings, you might or might not be able to edit the object's entities such as its transforms, materials, manipulators, or modifiers. You can add modifiers and apply transform animation to the referenced objects, but you cannot inadvertently change the model's structure. Referenced objects allow for the substitution of a proxy object, so you can animate a low-polygon version of a complex model and then render the polygon-intensive version. You can also reference transform controllers externally in addition to materials. This is part of the process of referencing objects, or you can also use the special [XRef controller](#) on page 3269 or [XRef material](#) on page 5765, respectively. By default, when referencing an object, its material and transform controller is also referenced. Alternatively, you can create an XRef controller or an XRef material that allows for referencing a transform controller or a material from an external MAX file. These external references can be assigned to any object in the scene, whether or not the object is externally referenced.

NOTE Any atmospherics applied in an XRef object's source file will be carried into the scene. Render Effects assigned to XRef objects are not externally referenced.

The use of referenced objects and scenes allows several people to work collaboratively on the same objects as the work progresses, without having to wait for the objects to be finalized. You can choose to have the objects update automatically, as soon as changes are saved to the original file, or to update manually, on demand.

There are also tools for easy conversion of scene objects into referenced objects, and a button to merge referenced objects into the scene as normal objects.

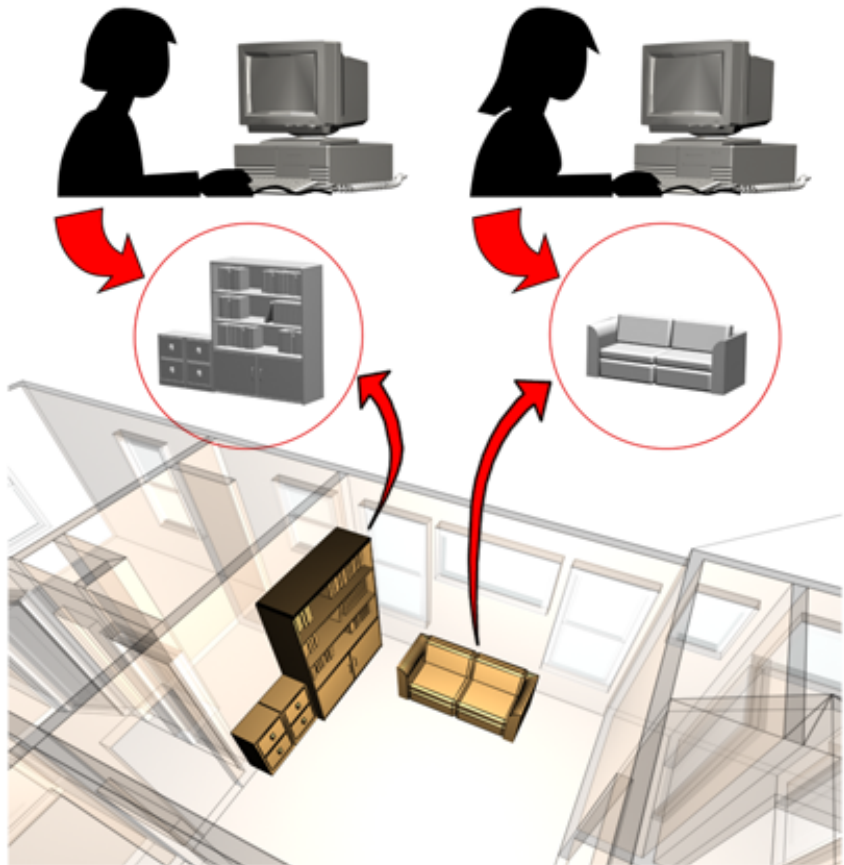

Objects in a scene can be externally referenced, created and maintained by other users.

XRef Objects

File menu > XRef Objects

Externally referenced objects, *XRef objects*, appear in your master (current) scene, but are actually referenced from external 3ds Max files. As a result, the *source* objects are protected from modifications you make to the XRef objects. Updates or changes made to the **source** objects are also updated in the master file when the source scene is reloaded. However, if an XRef object's entities are merged, the controls are local and can be modified. Therefore, they no longer reference the original attributes.

For example, if you set the [Modifiers option](#) on page 6946 of the [XRef Objects dialog](#) on page 6941 to XRef or Ignore, the only entry in the modifier stack will be "XRef Object." You can add additional modifiers to the object, but you cannot access the original ones unless you merge the XRef object into the scene. If you merge the modifiers into the master scene, you can edit them in the stack. However, changes that you make to the modifier stack in the master file have no effect in the source file.

An externally referenced object can be animated in the master file only if its transform controller has been merged. In other words, no animation can be added or blended with an XRef controller. However, an offset can be added, but it then applies to the whole animation, and the offset cannot be animated.

NOTE The XRef behavior of world-space modifiers is different than the object-space modifiers. World-space modifiers are not externally referenced. They are always merged.

Transforms and manipulators in your source file will be treated according to the Merge Transforms and Merge Manipulators setting in the XRef Objects dialog.

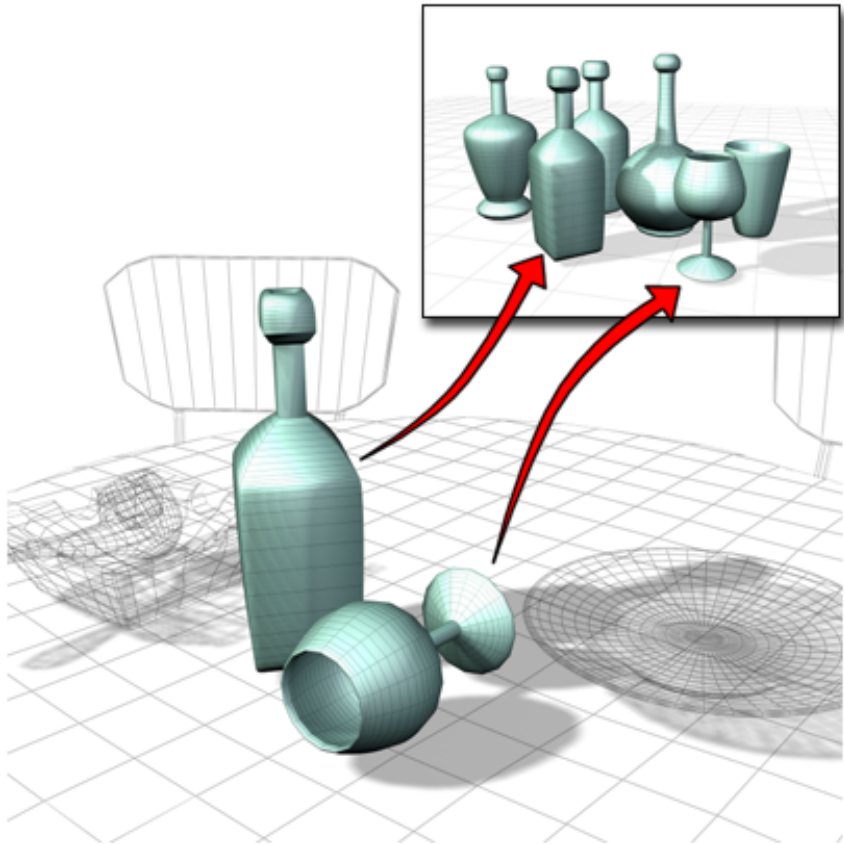

Objects in a scene can be XRefs from other scenes. They can be transformed and positioned in the scene using a local offset.

When an XRef object is loaded into the master file, it can have an [XRef material](#) on page 5765 as well as an [XRef controller](#) on page 3269 assigned to it. You can either merge the material and transform information or you can maintain it as a live connection with the source file.

XRef objects can be modified or transformed in your master scene just like any other object. XRef objects also allow the use of proxy objects to stand in or substitute for geometry. Use XRef objects to manage the complexity of your master scene during animation by substituting “lightweight” proxy objects for more complex geometry.

You can create a proxy by simplifying a clone of your existing model or you can build simple substitute objects like boxes or cylinders, or you can save a

copy of the model in the early stages of modeling before you add the detail. You can even use an object from another scene.

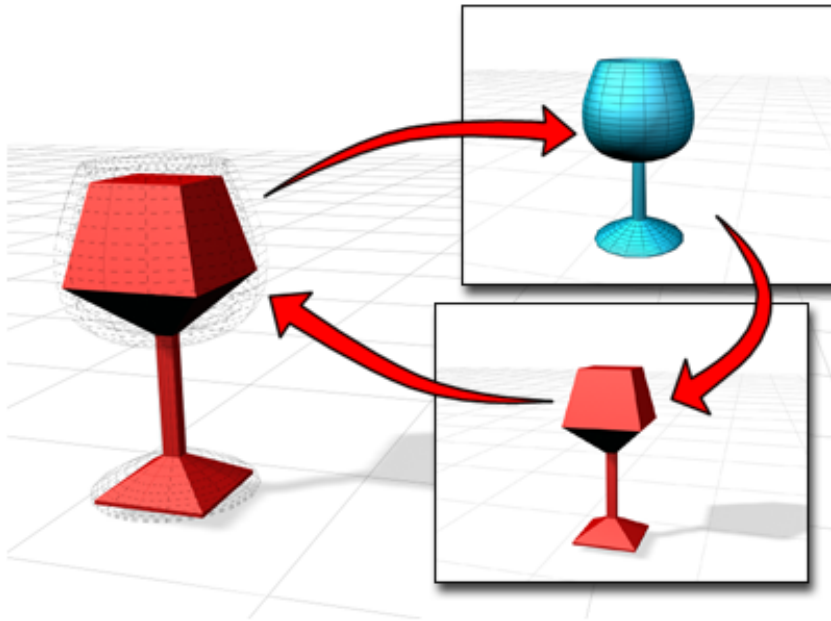

A proxy object is substituted in the scene, but the reference to the real object is always available.

Choosing XRef Objects displays the [XRef Objects dialog](#) on page 6941, where you add externally referenced objects, transforms, and materials to your master scene, and control their visibility, merge states, and other options.

If your XRef object relies on another object in the source scene, the relationship will not be automatically preserved in the destination file. Examples of this include objects with path constraints, atmospherics, particle arrays with object emitters, or space warps bound to an object. To preserve the relationship between the source objects in the master file, in the XRef Merge dialog, enable Display Influences and select the object's influences. Objects that influence each other must be referenced in the same record to maintain the relationship.

NOTE Render effects such as glow or flare are not carried in XRefs. To use render effects from the source file, merge them in using the Merge buttons found in the Environment And Effects dialog.

Procedures

To add an XRef object:

- 1 Choose File > XRef Objects.

The XRef Objects dialog enables you to choose to Merge Transforms, Merge Materials, and Merge Manipulators.

NOTE If you want to maintain externally referenced entities (transforms, materials, manipulators, or modifiers), make sure Merge Transforms, Merge Materials, and Merge Manipulators are off and the Modifiers setting is set to XRef before you proceed to the next step.

TIP To include all objects, including influences, transforms, and materials, and bypass the XRef Merge dialog, turn on Include All on the XRef Objects dialog *before* you click Create XRef Record From File.

- 2  Click the Create XRef Record From File button in the XRef Objects dialog. The Open File dialog appears. Choose the file you want by highlighting it in the list, then click Open. The [XRef Merge Dialog](#) on page 6956 appears.

If the Merge Manipulators toggle is off before you click Create XRef Record From File, manipulators applied to XRef objects are linked to the (externally referenced) source file. In a similar way, the Modifiers drop-down list gives you three alternatives for how to handle object modifiers.

If the Merge Materials toggle is off before you click Create XRef Record From File, materials applied to XRef objects are linked to the (externally referenced) source file. If Merge Materials is on, the materials are merged with the master scene.

If the Merge Transforms toggle is off before you click Create XRef Record From File, transforms applied to XRef objects are linked to the (externally referenced) source file and cannot be keyframed in the master file. If Merge Transforms is on, the transforms are merged with the master scene and can be keyframed.

- 3 Select the objects that you'd like to appear in your master scene as XRef objects.

You can choose as many as you want by holding down the Ctrl key and highlighting them in the list. If the source scene has a lot of object types you don't need to include, you can filter the list by using the List Types

radio buttons. Use the All button to select all of the entries, the None button to select no entries and the Invert button to highlight the opposite of your current selection. You can also choose to display Influences and Select Influences.

- 4 The XRef record appears in the upper list of the XRef Objects dialog and has the same name as its source file. The externally referenced entities appear in the lower list, where an entity can be either an object, a controller, or a material. Make additional choices at this time if you like. You can control how the objects will update (either automatically or on demand). Updating is done at the XRef record level: all objects, transforms, and materials from a single XRef record are updated at the same time.

To substitute an XRef object with a proxy object:

With proxy objects, you can avoid loading your detailed model in memory, and speed up the time of test renderings.

- 1 Select an XRef object.
- 2  On the Modify panel > Proxy rollout, click the Browse button, and use the File Open dialog to choose the file that contains the proxy. The XRef Merge dialog appears.
- 3 Pick the object to use as a proxy. When you have picked the proxy object, the Enable toggle should turn on.
- 4 Turn on Use In Rendering to use the proxy object in renderings.

To add objects to an XRef record:

- 1 In the XRef Objects dialog, highlight an XRef record (in the top list) that contains objects that have not already been added to the scene.
- 2  On the Entities List toolbar (the lower toolbar), click Add Objects. This button is not available if all of the objects in the source file have already been added to the XRef record. The XRef Merge dialog appears.
- 3 Highlight the objects that you want to add as XRefs, and then click OK.

The selected objects are added. Depending on the dialog settings, transforms and materials might also be added as external references.

To change an XRef object into a scene object:



- Highlight the XRef object in the Entities list (the lower list), and then click Merge In Scene. The XRef object becomes a full-fledged object in the scene, giving you access to its modifier stack.

TIP This button is also available in the upper Records list, where it merges *all* entities from the highlighted source record into the master (current) scene.

XRef Objects Dialog

File menu > XRef Objects > XRef Objects dialog

The XRef Objects dialog provides the interface for loading XRef entities into your master scene (the scene where you create the XRefs) from a source scene (the scene file that contains the entities that you want to externally reference). XRef entities can be XRef objects, transform controllers, materials, and manipulators. An XRef record can be made up of one or more XRef entities.

The XRef Objects dialog is divided into the XRef Record section at the top and the XRef Entities section at the bottom. The XRef Objects dialog provides controls to add and remove XRef objects, controllers, and materials.

When you create XRefs, the mapping between each externally referenced item and their source items is unique. This allows correct external referencing of source items with identical node names. However, if you retarget an externally referenced item by choosing a source object name that is not unique in the source scene, 3ds Max might not map the externally referenced item to the desired source object.

Interface

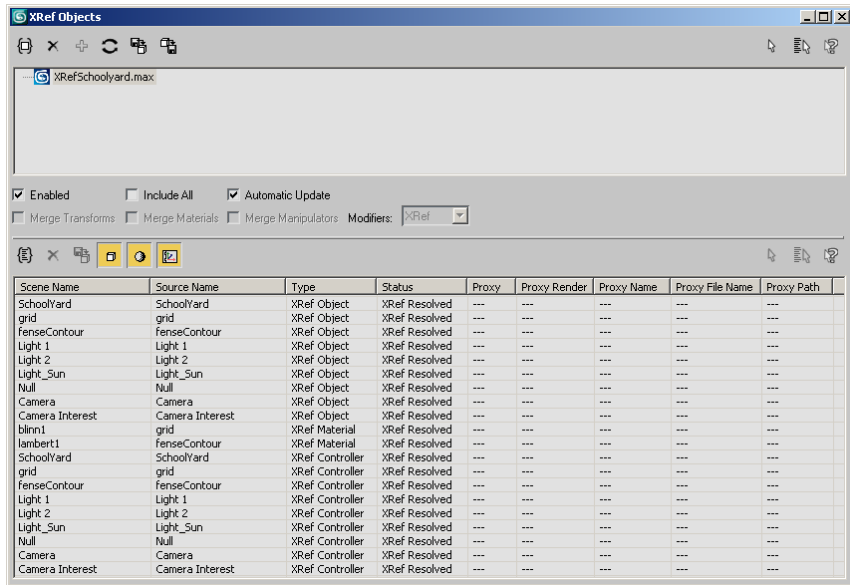

TIP You can resize the XRef Objects dialog. This can be useful if you want to see all of the columns in the XRef Entities list. You can also adjust the relative height of the two lists in the dialog: Drag the horizontal line that is just above the XRef Entities toolbar (the lower of the two toolbars).

XRef Record toolbar

Use these tools to create and update XRef records.



Create XRef Record from File Launches an Open File dialog so you can select the source file for your XRef record. When you select a file, the [XRef Merge dialog](#) on page 6956 appears.

Any *transform* animation assigned to the source objects can be merged along with the XRef object, but it will not be updated with the source object.

NOTE If you want to maintain externally referenced transforms, materials, and manipulators, make sure Merge Transforms, Merge Materials, and Merge Manipulators in the XRef Objects dialog are off before you click Create XRef Record from File.



Remove XRef Record Deletes the highlighted XRef record(s) after you confirm the action. All entities associated with the highlighted record(s) are removed from the scene.

NOTE Once you have removed an XRef record, you cannot undo this action.



Combine XRef Records Click to combine the contents of more than one XRef record from the same source file into one record. This is useful when you want to clean up the organization of your XRef records. Rather than having multiple records of the same file, you can group all of the objects, controllers, and materials from that file under the same record. This button is available only when you highlight two records that refer to the same file name and path; both records must have identical settings. XRef records must refer to the same file with the same XRef entities. Combine XRef Records only allows you to consolidate all of the entities of one file into one XRef record entry. It does not allow you to combine the contents of different files, even if the files have the same name.

NOTE Nested externally referenced records cannot be combined.



Update Refreshes the contents of the selected XRef record. If the objects, controllers, materials, or manipulators referenced have changed in the source scene, you will see these changes in your master scene.

NOTE The changes must be saved in the source file before you see them in the master file. If you remove externally referenced entities from the master file using the Delete XRef Entity button, these entities will not be externally referenced when you update the XRef record, even though they continue to exist in the source scene.

NOTE Reloading XRef items works correctly even when an object in the source scene has been renamed, or deleted and then re-created with the *exact* same name, including character case. However, if the source scene contains several nodes with the same name, an XRef item corresponding to a node whose name is not unique in the source scene might not necessarily resolve as you expect during the update process. For best results, maintain unique names for all nodes in the source scene.

WARNING If you update an XRef in a scene with [radiosity](#) on page 6168, probably this will invalidate the radiosity solution. After you update the XRef, reset the radiosity solution and then recalculate it.



Merge In Scene Converts all XRef entities of the highlighted record into native (local) entities in your master scene. The objects, controllers, materials, and manipulators are no longer referenced from the source file but become part of your master scene. A prompt appears so you can confirm the action. Since a merged XRef entity becomes part of the scene and is no longer an XRef entity, its name is removed from the XRef Entities list. This works on a XRef record basis, so all entities belonging to the highlighted XRef record are converted. The contents of the source file are not affected by this button. Merging an XRef object loads the full modifier stack of the source object into the master scene (your current scene), while maintaining any additional stack items that were added while the object was an external reference. Thus, you can use Merge In Scene to update an object that has been modified as an external reference. Similarly, merging an XRef controller into the master scene maintains any offset transformation you might have applied to the controller in the master scene.



Convert Selected Object(s) to XRefs Creates a source file for currently selected objects. This means that you can select objects in the current scene, including their transform controllers and materials, and then save them to a separate scene file. This file is then listed as an XRef record that contains the entities you selected.

NOTE This option can be used on both—native (local) objects or externally referenced objects. If you use it for an object that is already an XRef object, it creates a nested XRef. Nested XRefs still behave as you expect, but they can reduce performance when you open a scene or render it.



Select Selects all entities that belong to the currently highlighted XRef record or records. To add highlighted records' entities to the selection, hold Ctrl while clicking Select. To remove highlighted records' entities from the selection, hold Alt while clicking Select.



Select by Name Opens the [Select Objects dialog](#) on page 228, which lists all objects and highlights those belonging to the currently highlighted

XRef record, as well as objects selected in the scene. Use this dialog to select XRef objects.



Highlight Selected Objects' XRef Records Based on the object(s) selected in the scene, the corresponding record(s) that contain these objects are highlighted in the XRef Objects dialog.

XRef Record list

Displays the names of the source files that contain the source objects used as XRef objects in the current scene. These files are added using the Create XRef Record button and removed using the Remove XRef Record button.

To see the full path of the source file, move the cursor over the name of an XRef record. The full path is displayed in a tool tip.

If a source file itself contains external references, a plus/minus icon appears to the left of its name. Click the icon to expand or collapse the display of nested XRef entries. Nested XRef records that are missing and unresolved are displayed in gray.

Right-clicking the XRef Record list displays a [pop-up menu](#) on page 6951 that has additional options for managing the list and its records.

Enabled Turn off to disable all XRef objects referenced from the MAX files currently highlighted in the XRef Record list. Disabled external reference files and objects are not loaded into memory. Default=on.

Include All If you turn this on before you add an XRef record, all the objects in the source file are included as external references. This option bypasses the XRef Merge dialog. Default=off.

If you create an XRef record when Include All is turned off, only those entities selected for that XRef record (in the XRef Merge dialog) will be a part of the record: any new objects created in the source file will not be part of the record. If Include All is turned on when you create a record, any new objects created in the source file will be included in the XRef record when you reopen or Update the master file. If Include All is turned on before a record is updated (after the first XRef), all new objects will be included in the XRef, but turning it off later will not remove them from the record.

If the source scene includes nested external references, using Include All can cause some confusion if you are not careful about your tree of scenes. Consider the following arrangement:

```
master.max (Include All) --> a.max (Include All) --> b.max
```

If you later open *b.max*, create objects, and save it, then open *master.max* without first opening and saving *a.max*, you won't see the new objects created in *b.max*. The scene *master.max* is simply reading *a.max*, and since *a.max* hasn't changed, the new objects aren't present.

Automatic Update When on, changes made to externally referenced objects, controllers, materials, and manipulators in the source scene are automatically updated in the master file as soon as the source file is saved. There's no need to click Update. Default=off.

NOTE You can change the state of Enabled, Include All, and Automatic Update after a record is created.

Merge Transforms When on, combines all objects' externally referenced transform controllers from the source file into the master file. This means that the transform controllers will be loaded in the master file but will then no longer have a live connection with the source file. This is useful if you don't require the live connection, and want to alter the transform controllers in the master scene without losing your edits upon Update. Default=off.

To use Merge Transforms, you must turn on this option *before* you add the XRef record (source) file.

Merge Materials When on, combines all externally referenced materials from the source file into the master file. This means that the materials will be loaded in the master file but will then no longer have a live connection with the source file. This is useful if you don't require the live connection, and want to alter the materials in the master scene without losing your edits upon Update. Default=off.

To use Merge Materials, you must turn on this option *before* you add the XRef record (source) file.

When Merge Materials is on and there are name conflicts between materials in the target scene and materials in the XRef source scene (or between materials in two XRef records), 3ds Max displays a [Duplicate Name dialog](#) on page 5368 so you can resolve the conflicts.

Merge Manipulators When on, any [manipulator](#) on page 2636 applied to the XRef object in the source file is combined into the scene. Manipulators are applied to the XRef object and can be changed. However, these changes have no effect in the XRef source file. Default=off.

To use Merge Manipulators, you must turn on this option *before* you add the XRef record (source) file.

Modifiers Determines how modifiers from the source file will be loaded into your master file. Modifiers are not listed as XRef entities. To see an XRef

modifier on the Modify panel, you must use the Merge option. Otherwise, you have the choice of either not merging the modifier information at all (with the Ignore option) or merging the information with the object with the XRef Modifiers option.

You must choose the Modifiers option *before* you add the XRef record (source) file.

- **XRef** Modifiers are contained within the XRef object and cannot be changed in the master scene. When you load the external reference file, you will see the results of the modifier but they will not be listed separately from the object on the Modify panel. Additional modifiers can be applied to the XRef object, and will be a part of the scene; however, they will not be reflected back to the source file.

NOTE World-space modifiers remain at the top of the modifier stack and are not merged with XRef objects.

- **Merge** Modifiers assigned to the XRef object (in the source file) are merged into the master scene. When you load the external reference file, you will see the changes caused by the modifier and they will appear in the modifier stack in the Modify panel. The modifiers are copies of the original source modifiers. Although they inherit their original state, updates to the XRef will not overwrite changes made in the master scene. However, these changes are not reflected in the source file.
- **Ignore** Any modifiers assigned to the XRef object (in the source file) are disregarded and the base object is brought into the master scene as an XRef object. When you load the external reference file, the modifiers are not applied to the object so the modifications in the source file will not be reflected in the master file.

Although the Merge Transforms, Merge Materials, Merge Manipulators, and Modifiers settings are disabled after you add a record, when you highlight the record in the XRef Record list, the toggles and list field show the settings used when the record was created.

XRef Entities toolbar



Add Objects Click to add further entities to the highlighted XRef record. This button is available only when the highlighted XRef record contains objects that you have not yet referenced externally. The XRef Merge dialog

appears, with a list of the available objects. Highlight the objects to reference externally, and then click OK.

NOTE If new objects have a relationship in the source file with objects that are already in a record in the master file, update the record after Add Objects to refresh the relationship. For example, if a car is referenced in a master scene, and the car is later constrained to a new path in the source scene, adding the path with Add Objects will not put the master car on the path. To do that, update the record.



Delete XRef Entity Click to delete the highlighted XRef. An alert prompts you to confirm the action. All highlighted entities are removed from the scene. You can delete XRef objects, controllers, or materials.

NOTE Deleting XRef controllers is equivalent to merging them into the master scene. The reason for this is that nodes must have a transform controller at all times, in order to be positioned in the scene. Deleting XRef materials is equivalent to merging them into the master scene. This action could impact all objects in the master scene that use an XRef material, and could have implications difficult to be foreseen.



Merge In Scene Merges the current selection in the XRef Entities list into the master scene (the current scene). Use this button to change XRef objects, controllers, or materials into objects, controllers, or materials that are native to the current scene. The connection between the external entity from the source scene and your master scene is broken, and the object, controller, or material that you merged is no longer updated when the source scene changes.

3ds Max prompts you to confirm the merge.

Since a merged XRef object becomes part of the scene and is no longer an XRef object, its name is removed from the list.

Merging an XRef object loads the full modifier stack of the original object, while maintaining any additional stack items that were added while the object was an XRef object. Thus, you can use Merge to update an original object that has been altered as an external reference. If you do this, use Convert Selected Object(s) to XRefs to save out the “improved” original into a file, which then can be merged back into the original source.

NOTE It is also possible to merge into the master scene nested XRef entities. Once they are merged, all externally referenced nesting levels are removed and the scene entity from the lowest level source scene is merged into the master scene. In case of XRef objects, modifiers applied in a nested source file are all merged and present in the master scene.



List Objects When on, shows the XRef objects for the current XRef record in the XRef Entities list.



List Materials When on, shows the XRef materials for the current XRef record in the XRef Entities list.



List Controllers When on, shows the XRef controllers for the current XRef record in the XRef Entities list.

NOTE You can enable any combination of the List buttons to show certain types of entities and hide others.



Select Selects in the scene the XRef entities currently highlighted in the XRef Entities list. To add highlighted entities to the selection, hold Ctrl while clicking Select. To remove highlighted entities from the selection, hold Alt while clicking Select.



Select by Name Opens the [Select Objects dialog](#) on page 228, which lists all objects and highlights the XRef objects selected in the XRef Entities list, as well as any objects selected in the scene. If an XRef controller or XRef material is highlighted in the XRef Entities list, the Select Objects dialog highlights the object to which the XRef controller or material belongs to.



Highlight Selected Object's XRef Records When XRef objects are selected in the scene, the XRef record to which they belong is highlighted in the XRef Record list and the XRef objects and their XRef entities are highlighted in the XRef Entities list.

XRef Entities list

Displays the XRef objects, controllers, and materials that belong to the record that is currently highlighted in the XRef Record list. If no source file is highlighted, this list is empty.

Right-clicking the XRef Entities list displays a [pop-up menu](#) on page 6954 that has additional options for managing the list as well as the objects, controllers, and materials in it.

The XRef Entities list includes the following information for each XRef entity:

- **Scene Name** Name of the entity in the master (current) scene. By default, the name of the entity in the master scene is the same as the name of the entity in the source file. If you change the name of the entity on the [command panel](#) on page 7631, the name will update in the XRef Entities list.
- **Source Name** Name of the entity in the source file. You cannot change this name from the master file. If the name of the entity changes in the source file, the XRef in the master file will become unresolved.
- **Type** Whether the entity is an XRef object, controller, or material.
- **Status**
Usually this field displays “XRef Resolved” to indicate that the XRef is valid. When an external reference is unresolved this field displays “Unresolved XRef” An unresolved XRef indicates that there is no longer a connection between the entity in your master file and the source file. This can happen for a number of reasons. For example, the entity in the source file might have been renamed or deleted, or the file cannot be found.

NOTE If you resolve the cross reference, the XRef will be resolved again when you click Update.

- **Proxy** Whether a proxy is enabled for the entity. You enable and disable proxies for XRef entities on the Proxy Object rollout. Displays “—” when the proxy is disabled and “Enabled” when the proxy is enabled. You can assign a proxy object using the [Proxy Object rollout](#) on page 6974.
- **Proxy Render** Whether the proxy will be used in the rendering. Displays “—” when the XRef object will be rendered and “Enabled” when the proxy object will be rendered.
- **Proxy Name** Name of the proxy object that will be used as the XRef object.

- **Proxy File Name** Name of the file that contains the proxy object to use for the XRef object.
- **Proxy Path** Path of the file for the proxy object to use for the XRef object.

XRef Record List Right-Click Menu

File menu > XRef Objects > XRef Objects dialog > Right-click the list of XRef Record list.

This contextual menu appears in the [XRef Objects dialog](#) on page 6941 when you right-click the XRef Record list. It provides additional options for managing the list.

Some of the options on this menu are unavailable unless you have highlighted an XRef record.

Interface

Create XRef Record from File Launches an Open File dialog so you can select the source file for your XRef record. When you select a file, the [XRef Merge dialog](#) on page 6956 appears.

Any *transform* animation assigned to the source objects can be merged along with the XRef object, but it will not be updated with the source object.

NOTE If you want to maintain externally referenced transforms, materials, and manipulators, make sure Merge Transforms, Merge Materials, and Merge Manipulators in the XRef Objects dialog are **off** before you click Create XRef Record from File.

Remove XRef Record Deletes the highlighted XRef record(s) after you confirm the action. All entities associated with the highlighted record(s) are removed from the scene.

NOTE Once you have removed an XRef record, you cannot undo this action.

File Submenu

Open Opens the source file. If you have not saved changes to the (current) master file, 3ds Max prompts you to do so.

Browse Displays the Open File dialog that enables you to browse for a new source file. The file you choose *replaces* the highlighted XRef record in the XRef Objects dialog. Available only when a single file is highlighted.

Reveal Location in Explorer Launches Windows Explorer, open to the folder in which the highlighted source file resides with the source file highlighted. Available only when a single file is highlighted.

Strip Path Removes path information from the file name, saving only the file name. The source file location is saved relative to the master file location.

WARNING If you strip the path before you have saved the master file, the record's XRefs can become unresolved. This is because there is no location for the *Untitled*, unsaved MAX scene.

Resolve Path to UNC Location If the record's file name has had its path stripped, this option restores the full path name.

Combine XRef Records Click to combine the contents of more than one XRef record from the same source file into one record. This is useful when you want to clean up the organization of your XRef records. Rather than having multiple records of the same file, you can group all of the objects, controllers, and materials from that file under the same record. This option is available only when you highlight two records that refer to the same file name and path; both records must have identical settings. XRef records must refer to the same file with the same XRef entities. Combine XRef Records only allows you to consolidate all of the entities of one file into one XRef record entry. It does not allow you to combine the contents of different files, even if the files have the same name.

NOTE Nested externally referenced records cannot be combined.

Update Refreshes the contents of the selected XRef record. If the objects, controllers, materials, or manipulators referenced have changed in the source scene, you will see these changes in your master scene.

NOTE The changes must be saved in the source file before you see them in the master file. If you remove externally referenced entities from the master file using the Delete XRef Entity button, these entities will not be externally referenced when you update the XRef record, even though they continue to exist in the source scene.

WARNING If you update an XRef in a scene with [radiosity](#) on page 6168, probably this will invalidate the radiosity solution. After you update the XRef, reset the radiosity solution and then recalculate it.

Select Selects the entities that belong to the currently highlighted XRef record.

Select by Name Opens the [Select Objects dialog](#) on page 228, which lists all objects and highlights those belonging to the currently highlighted XRef record. Use this dialog to select XRef objects.

Highlight Selected Objects' XRefs Records Based on the object(s) selected in the scene, the corresponding record(s) that contain these objects are highlighted in the [XRef Objects dialog](#) on page 6941.

Highlight All Highlights all XRef records in the XRef Record list.

Highlight Inverse Highlights all XRef records in the XRef Record list except the currently highlighted record(s).

Highlight None Turns off highlighting for any XRef records currently highlighted in the XRef Records list.

Hide All Unresolved Hides all unresolved XRef records in the XRef Record list.

Select All Unresolved Highlights all unresolved XRef records in the XRef Record list.

Merge In Scene Converts all XRef entities of the highlighted record into native (local) entities in your master scene. The objects, controllers, materials, and manipulators are no longer referenced from the source file but become part of your master scene. A prompt appears so you can confirm the action. Since a merged XRef entity becomes part of the scene and is no longer an XRef entity, its name is removed from the XRef Entities list. This works on a XRef record basis, so all entities belonging to the highlighted XRef record are converted. The contents of the source file are not affected by this option.

Merging an XRef object loads the full modifier stack of the original object into the master scene (your current scene), while maintaining any additional stack items that were added while the object was an external reference. Thus, you can use Merge In Scene to update an object that has been modified as an external reference. Similarly, merging an XRef controller into the master scene maintains any offset transformation you might have applied to the controller in the master scene.

Convert Selected Object(s) to XRefs Creates a source file for the currently selected objects. This means that you can select objects in the current scene, including their transform controllers and materials, and then save them to a separate scene file. This file is then listed as an XRef record that contains the entities you selected.

NOTE This option can be used on both—native (local) objects or externally referenced objects. If you use it for an object that is already an XRef object, it creates a nested XRef. Nested XRefs still behave as you expect, but they can reduce performance when you open a scene or render it.

XRef Entities List Right-Click Menu

File menu > XRef Objects > XRef Objects dialog > Right-click the list of XRef entities (objects and materials).

This contextual menu appears in the [XRef Objects dialog](#) on page 6941 when you right-click the XRef Entities list. It provides additional options for managing the list.

Some of the options on this menu are unavailable unless you have highlighted an XRef entity.

Interface

Add Objects Displays the [XRef Merge dialog](#) on page 6956 so you can add entities to the XRef Entities list.

If all entities in the source scene are already externally referenced, this choice has no effect.

Delete XRef Entity Deletes the highlighted XRef entities from the scene. An alert prompts you to confirm the action.

NOTE Deleting XRef controllers is equivalent to merging them into the master scene. The reason for this is that nodes must have a transform controller at all times, in order to be positioned in the scene. Deleting XRef materials is equivalent to merging them into the master scene. This action could impact all objects in the master scene that use an XRef material, and could have implications difficult to be foreseen.

Select Selects in the scene the XRef entities currently highlighted in the XRef Entities list.

Select by Name Opens the [Select Objects dialog](#) on page 228, which lists all objects and highlights the XRef objects selected in the XRef Entities list. If an XRef controller or XRef material is selected in the XRef Entities list, the Select Objects dialog highlights the object to which the XRef controller or material belongs to.

Highlight Selected Objects' XRefs When XRef objects are selected in the scene, the XRef record to which they belong is highlighted in the XRef Record list and the XRef objects and their XRef entities are highlighted in the XRef Entities list.

Highlight All Highlights all XRef entities in the XRef Entities list.

Highlight Inverse Highlights all XRef entities in the XRef Entities list except the currently highlighted XRef entities.

Highlight None Turns off highlighting for any XRef entities currently highlighted in the XRef Entities list.

List Objects Toggles the display of XRef objects for the current XRef record in the XRef Entities list.

List Materials Toggles the display of XRef materials for the current XRef record in the XRef Entities list.

List Controllers Toggles the display of XRef controllers for the current XRef record in the XRef Entities list.

The state of List Objects, List Materials, and List Controllers is the same as the state of the toolbar buttons in the XRef Objects dialog. Changing the state in the menu changes the button state, and vice versa.

Merge In Scene Merges the current selection in the XRef Entities list into the master scene (the current scene). Use this option to change XRef objects or materials into objects that are native to the current scene. The connection between the external entity from the source scene and your master scene is broken, and the object, controller, or material that you merged is no longer updated when the source scene changes.

3ds Max prompts you to confirm the merge.

Since a merged XRef object becomes part of the scene and is no longer an XRef object, its name is removed from the list.

Merging an XRef object loads the full modifier stack of the original object, while maintaining any additional stack items that were added while the object was an XRef object. Thus, you can use Merge to update an original object that has been altered as an external reference. If you do this, use Convert Selected

Object(s) to XRefs to save out the “improved” original into a file, which then can be merged back into the original source.

NOTE It is also possible to merge into the master scene nested XRef entities. Once they are merged, all externally referenced nesting levels are removed and the scene entity from the lowest level source scene is merged into the master scene. In case of XRef objects, modifiers applied in a nested source file are all merged and present in the master scene.

Apply XRef Material(s) to Object(s) Applies the original, externally referenced material(s) to the highlighted objects. This can be useful if you have assigned a local material to the object (for example, to use in renderings of the master scene) and now want to restore the object's original material. It can also restore the externally referenced source material if the material was originally merged into the master scene.

Apply XRef Controller(s) to Object(s) Applies the original, externally referenced controller(s) to the highlighted objects. This can be useful if you have assigned a local controller to the object (for example, to use in renderings of the master scene) and now want to restore the object's original controller. It can also restore the externally referenced source controller if the controller was originally merged into the master scene.

Reset PRS Offset Sets the [PRS transformation](#) on page 3271 of the XRef object to its transformation defined in the source file.

NOTE You can undo this action.

XRef Merge Dialog

File menu > XRef Objects > XRef Objects dialog > Create XRef Record From File button > Open File > XRef Merge dialog

The XRef Merge dialog lets you choose which objects to add as XRef objects to the scene. This behaves similarly to the [Merge command](#) on page 7058. Controls on this dialog are similar to those on the [Selection Floater](#) on page 231.

The Merge dialog lets you load and save influences with or without their dependents. In many cases, objects should be referenced with their influences, but the display only makes you aware of the relationships, it does not force you to externally reference them.

When you select an item in the list window and click Influences, the object's influences are selected in the list window. When you select an item in the list window and Display Influences is on, the object's influences are shown in blue in the list window. When you select an item in the list window and Select Influences is on, the object's influences are also selected in the list window.

Procedures

To show an object's influences in the XRef Merge dialog:

- Select an object in the list window and enable Display Influences. The influences are shown in blue.

To select an object's influences in the XRef Merge dialog, do either of the following:

- Select an object in the list window and click Influences.
- Select an object in the list window and enable Select Influences.

Interface

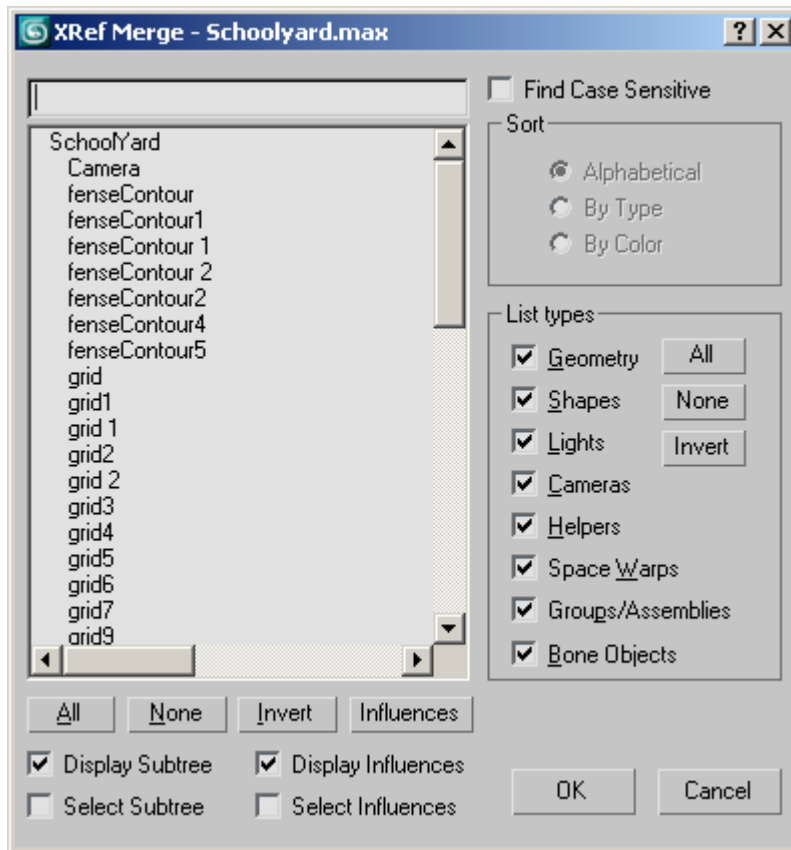

XRef Merge Objects list

Objects are listed according to the current Sort and List Types selections.

Influences When you select an object in the list window and then click the Influences button, the selected object's influences are highlighted as well.

All, None, and Invert These buttons alter the pattern of selection in the list window.

Display Influences When this is on and you select an item in the list window, all of its influences are shown in blue. If you want to highlight these influences, click Influences.

Select Influences When this is on and you select an item in the list window, all of its influences are highlighted as well.

XRef Scene

File menu > XRef Scene

An externally referenced scene, or XRef scene, appears in your current file, but is actually loaded temporarily from another MAX file. As a result, the *source* scene is protected from any modifications you might make to the XRef scene via the master scene. Updates or changes made to the source scenes are also updated in the master file once the changes are made and saved to the source file.

The XRef scene feature allows team members working on the same project to have access to each other's work without the risk of changing the files. A modeler can create a setting, while a second modeler might create a character. The animator can externally reference the setting as a scene and animate the character in the setting without being able to make changes to the setting. If the setting file is changed, those changes will be reflected in the animator's scene.

Objects loaded in the master file via XRef scenes cannot be selected nor modified, and do not appear in the Select From Scene dialog or Scene Explorer, the modifier stack, or the Track View. You can animate them in the current file only by using the Bind To Parent function in the XRef Scenes window.

You can snap to externally referenced scene entities. You can use Snap, AutoGrid, and Clone and Align to position local objects in context, as well as to pick objects as the target location for the clones. If you need to move, rotate or scale the referenced scene, you can bind it to a local object. Transforming the object the externally referenced scene was bound to transforms all objects in the externally referenced scene. You can also use externally referenced objects in the scene as the [reference coordinate system](#) on page 967. When you save changes to the externally referenced file (such as objects added, edited, or deleted), updating the XRef Scene inherits those changes locally.

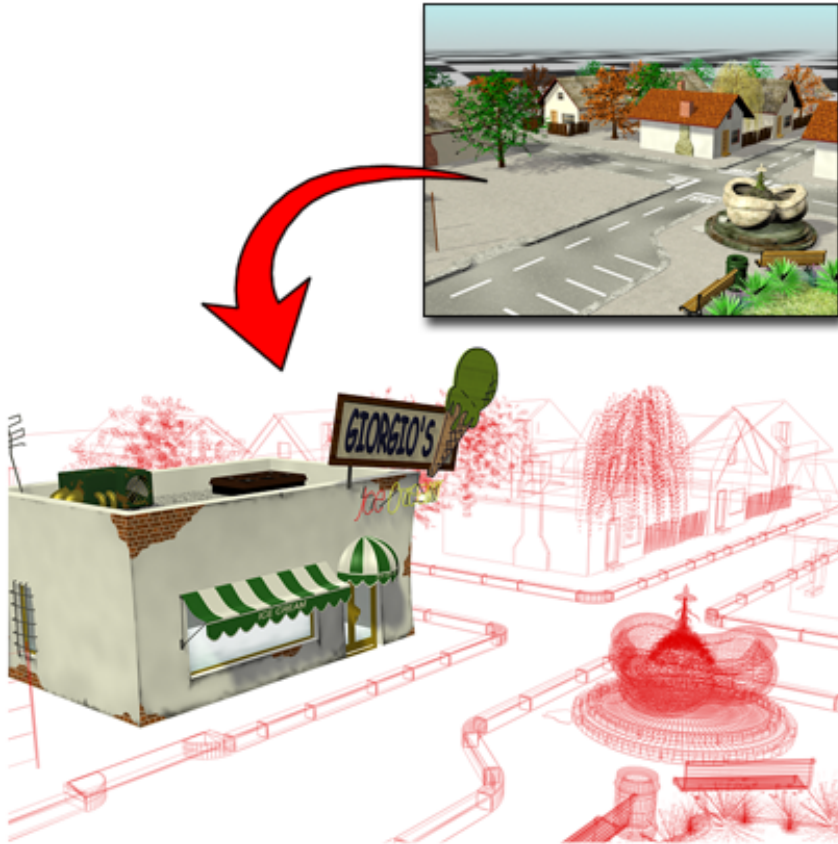

Importing the whole village model into the building model as an XRef

Radiosity solution data cannot be part of an XRef if objects have duplicate names. To solve this, change the duplicate names. Also, to reference radiosity data externally, the Save Scene Information In MAX File switch must be on in the [Radiosity panel](#) on page 7786 of the Preferences dialog. (It is on by default.)

Be aware that render effects are not carried into the master scene by XRef scenes. To use the render effects (such as glow or flare) from the XRef file, merge them in using the Merge buttons found in the Environment And Effects dialog.

NOTE Atmospheric effects assigned to objects in the source file are carried into the master file when the source file is used as an XRef scene.

Choosing XRef Scene displays the [XRef Scenes dialog](#) on page 6967.

Overlays

Overlays allow multiple scene references without the risk of creating circular dependencies. The scene XRef marked as overlay is loaded only into the master scene that references it, and is not visible in other scenes that might XRef the master file that uses the overlay. Consider two scenes that reference each other:

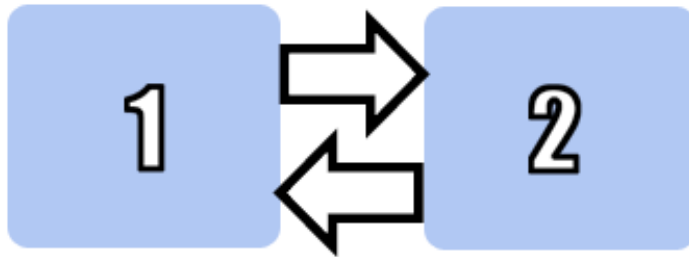

Ordinarily, 3ds Max would recognize this as a circular dependency, and disallow it. However, you can set up such a combination of XRefs by following these steps:

- 1 In scene 2, XRef scene 1 and use the toggle to flag it as an overlay.
- 2 Save scene 2.
- 3 Open scene 1, and XRef scene 2.
Scene 2 is externally referenced into scene 1, without pulling scene 1 in as a nested external reference.

The previous example is not particularly practical. But suppose you want to mask off part of your scene so other artists who XRef the scene will not see it. For example, you are working on a building and have XRefed a CAD file that lays out the plumbing of the building, as well as a scene of ground terrain that contains some XRefs to some trees. The XRef scene graph might look like this:

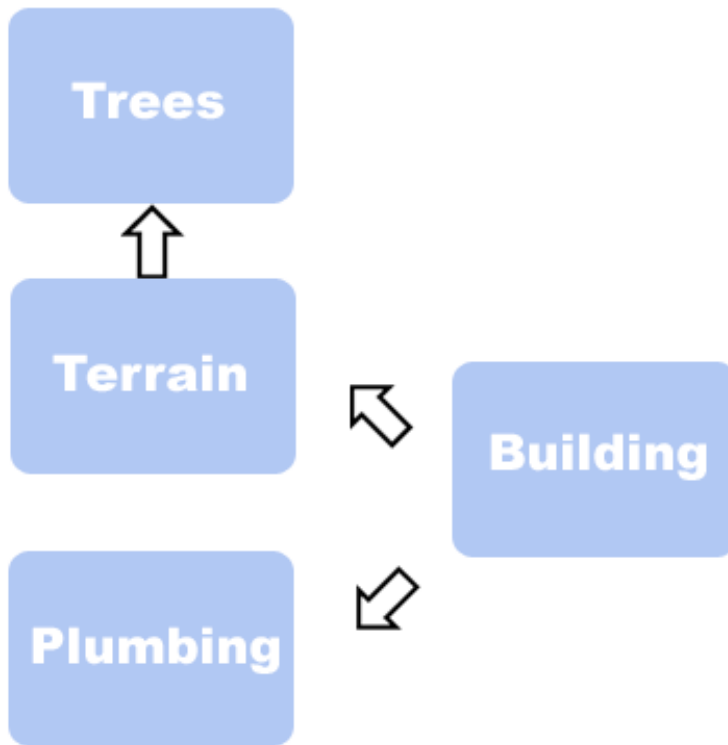

The building scene XRefs the terrain and the plumbing data. The terrain scene XRefs the trees. You decide you are the only one who needs to see the CAD plumbing data. The CAD plumbing data is needed only to line up where the sinks need to be in the building, so you set up the CAD plumbing data XRef to be an overlay. Other scenes that include the building scene won't see the plumbing. For example, another artist who is responsible for the lighting and cameras sets up an XRef to the building scene. Now the XRef graph looks like this:

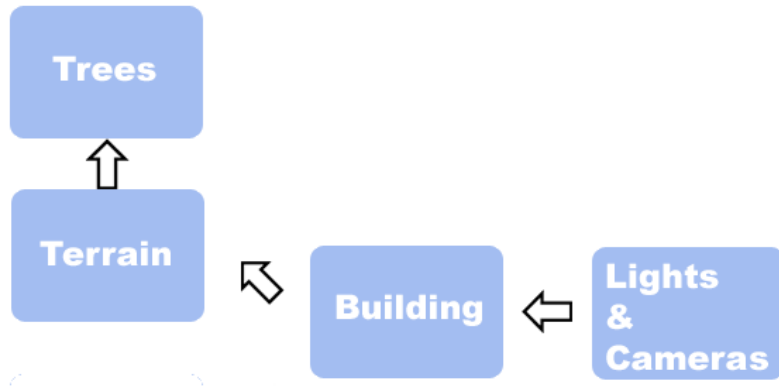

In this case, an overlay is used to simply hide data information from other master scenes. Another use of overlays is to avoid circular XRefs. For example, picture four artists working on a scene of a city block. Two of them are working on individual buildings, one is working on a sky bridge that connects the two buildings, and the fourth artist is setting up the cameras and the lights. The graph of externally referenced scenes might look like this:

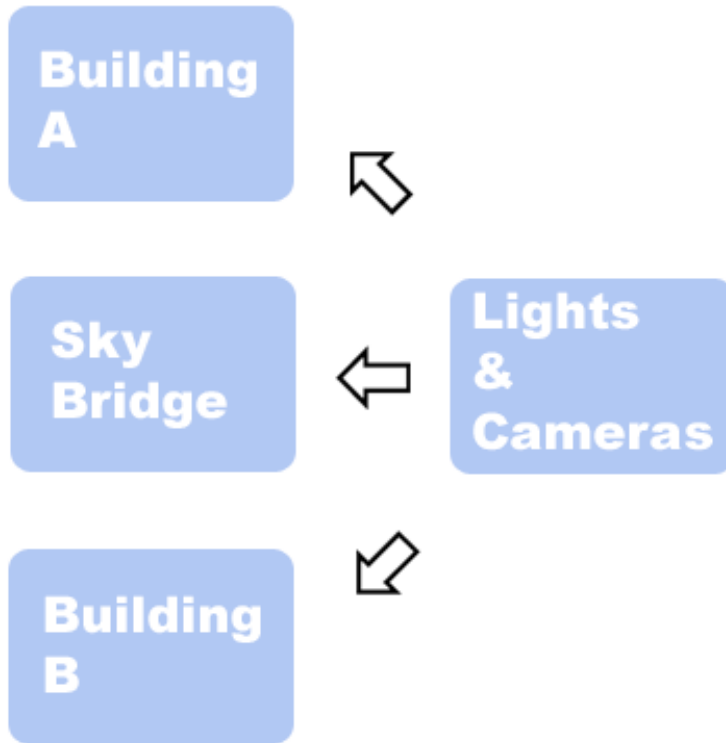

But the artists working on Building A and the artist working on the sky bridge need to see each other's work to make sure everything lines up. The obvious solution would be to externally reference each other's scene file:

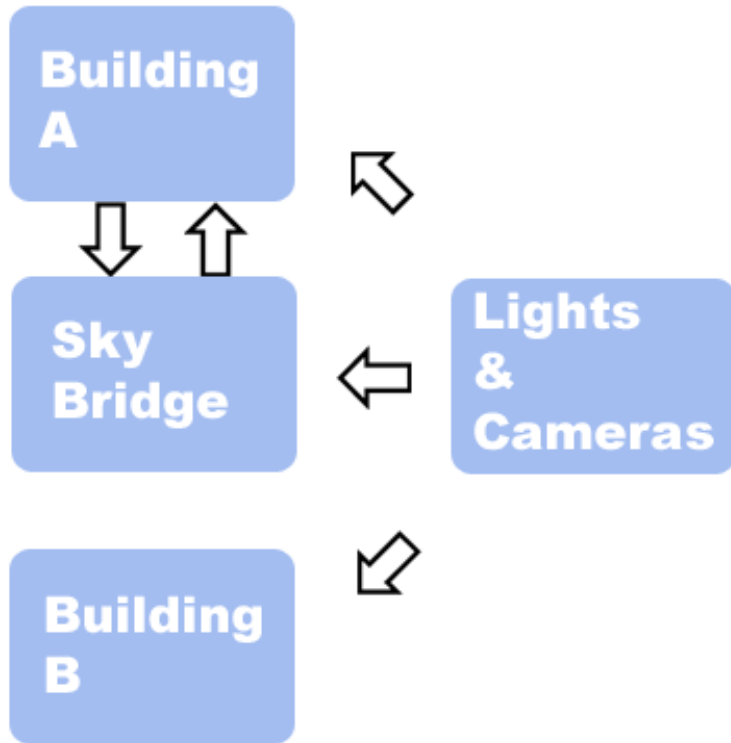

However, 3ds Max detects a circular external reference and won't allow this, unless both the Building A scene and the Sky Bridge scene flag their external reference as an Overlay.

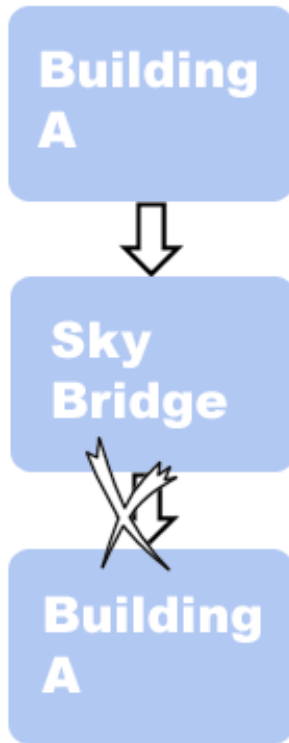

WARNING If you turn off the Overlay flag for an existing XRef scene, you can cause circular external references to occur, that aren't detected until you or another user tries to open one of the scenes in the project.

Procedures

To add an XRef scene:

- 1 Choose File > XRef Scene.
- 2 Click the Add button. An Open File dialog appears that lets you locate the MAX file you wish to reference. A thumbnail display is provided to help you identify your file.
- 3 Click Open to bring the XRef scene into the current scene.

- 4 The path and file name of the selected file appears in the XRef Files window.

You can add as many files as you like; each one appears in the XRef Files window.

- 5 Make additional choices in the XRef Scenes dialog if you want.

You can affect the display of the XRef scene, making it visible or not, or making objects in the referenced scene appear as bounding boxes. You can ignore the file's lights, cameras, shapes, helpers, or animation. You can control when the file updates, either automatically or on demand. You can have the file enabled or disabled, or you can merge it, severing the XRef relationship and inserting the scene into your current file. You can bind the scene to a Parent object to reposition or animate the XRef scene.

To scale, rotate, or reposition an XRef scene:

- 1 Create an object in your current scene to be the parent object.
- 2 Choose the XRef scene from the XRef File window.
- 3 Click Bind (in the Parent group), and then select the parent object by clicking it in the viewport.
- 4 Transform the parent object. The XRef scene will follow.

This works best if both the parent object and the XRef scene have their pivot points positioned near the scene's origin (0,0,0).

If the XRef scene was created a large distance from the origin, you can run into a problem. As you scale the parent object, the XRef scene will move away from the center. To counteract this problem, you can create a second parent object centered over the XRef scene. Then select and link the original parent object to the centered parent object. You can then scale the centered parent object and the XRef will not move toward or away from the origin and use the original parent object to move the externally referenced scene.

An alternative method for scale problems is to use the [Rescale World Units Utility](#) on page 2682 on the original file.

XRef Scenes Dialog

File menu > XRef Scene > XRef Scenes dialog

The XRef Scenes dialog lets you add and remove XRef scenes. It also gives you tools to control the display of the XRef scene, options to ignore various components of the scene, and the ability to bind to a parent object so you can scale, rotate, or move the XRef scene.

Accessing XRef Scenes

Although XRefs are inaccessible “boxes” in the scene, they can be accessed in various ways.

- Cameras and lights in the XRef scenes can be accessed in the Viewports list and assigned to viewports in the current scene.
- Objects from the XRef scenes are included in the Summary Info dialog.
- Objects can be snapped to or used for alignment purposes with AutoGrid and Align.
- AutoGrid works on XRef scene objects.
- You can use objects from XRef scenes as target for cloning or reference systems.

Nesting XRef Scenes

XRef scenes can be nested. That is, an XRef scene can contain other XRef scenes, which can in turn contain other XRef scenes.

NOTE For a nested XRef scene to update automatically, all of its parent scene files (files that include it as an XRef) must have Auto Update turned **on**.

Interface

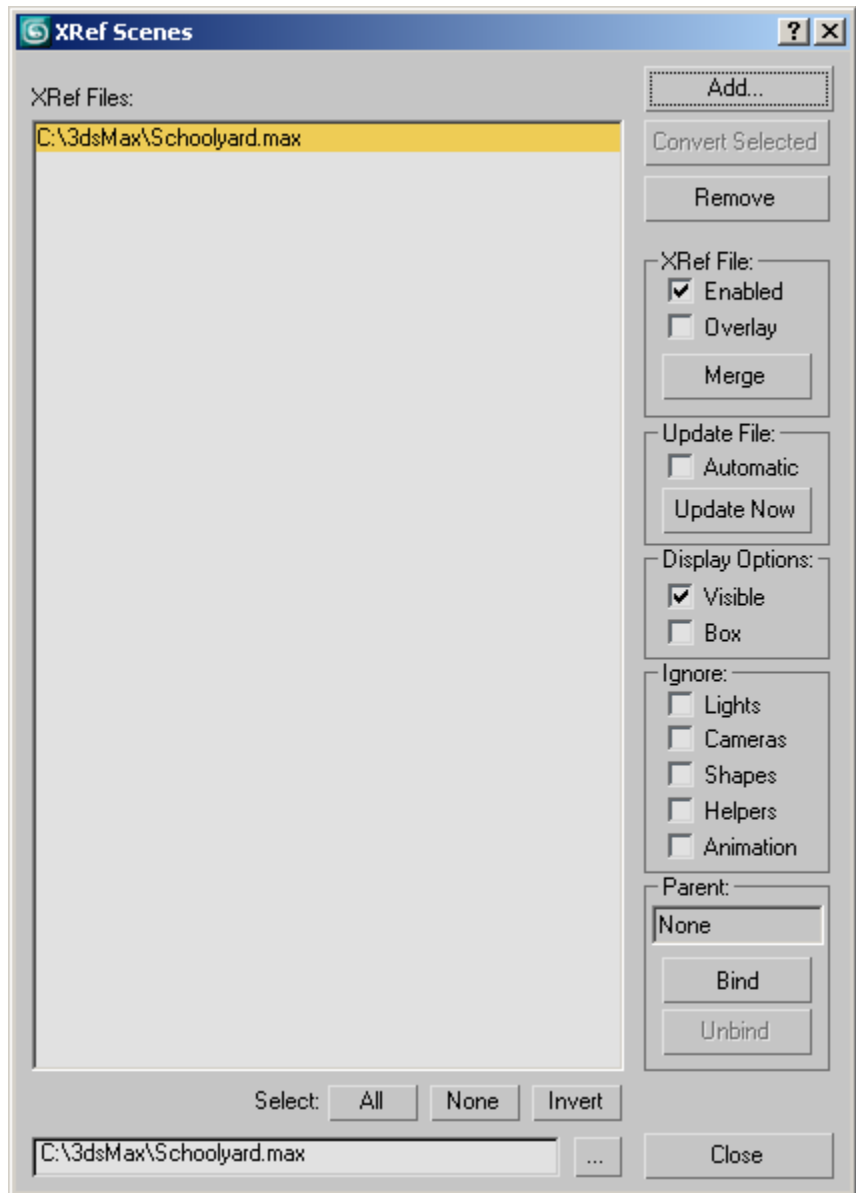

XRef File list Displays all XRef scenes in the current scene, and lets you select them for operations. XRefs that have been disabled (by turning off Enabled)

are listed in gray rather than black. If an XRef is listed in red, that means its file could not be loaded. Either the file is corrupted, or the path is not pointing to the correct directory or file name.

XRef File path field Lets you change the path or file pointed to by a selected XRef scene. To use, choose one of the XRef scenes in the list, and then change the information in the field. You can either directly enter a new file name or path, or you can click the Browse button to the right of the field, and then choose a new file from the Open File dialog. The new XRef scene that you choose replaces the one currently highlighted in the list.

Add Displays the Open File dialog from which you can choose a MAX scene file to be loaded into the current scene as an XRef. The selected scene appears in the list at left, and the geometry appears in the viewports.

You can also add a scene by dragging a MAX file from the Windows Explorer into the list, or by dragging a MAX file into a 3ds Max viewport, whereupon you're presented with a menu with the following options: Open File, Merge File, XRef File, and Cancel.

Convert Selected Lets you take any selected objects in your scene and create XRefs from them. Basically, this does a Save Selected for the objects, which are automatically cut from the MAX file and pasted into a new file. A file dialog lets you name the new file. They remain in the current scene but are now scene XRefs.

Remove Removes the XRef scene currently chosen in the list, and removes it from the current scene. To use, choose one or more XRef scenes in the list, and then click the Remove button.

Select buttons

These standard buttons change the pattern of selection in the list.

All Selects all items in the list.

None Deselects all items in the list.

Invert Inverts the current selection pattern in the list.

XRef File group

Enabled Turn this off to disable the highlighted XRef. When an XRef is disabled, it's listed in gray in the list, and it's not loaded into memory.

Overlay When on, treats the referenced source scene as an [overlay](#) on page 6961. Default=off.

Overlays allow multiple scene references without the risk of creating circular dependencies. The scene XRef marked as overlay is loaded only into the master scene that references it, and is not visible in other scenes that might XRef the master file that uses the overlay. See [Overlays](#) on page 6961 for more information.

WARNING If you turn off the Overlay flag for an existing XRef scene, you can cause circular XRefs to occur, that aren't detected until you or another user tries to open one of the scenes in the project.

Merge Click this to merge selected XRefs into the scene as real geometry. A prompt appears so you can confirm the action. Since a merged XRef becomes part of the scene and is no longer an XRef, its name is removed from the list.

Update File group

Determines how and when the XRef scenes are updated. These options are applied to the selected XRefs; for example, one XRef can have automatic updating, while another can have manual updating (using the Update Now button).

WARNING If you update an XRef in a scene with [radiosity](#) on page 6168, you will likely invalidate the radiosity solution. After you update the XRef, reset the radiosity solution and then recalculate it.

Automatic When this check box is turned on, the selected XRef scene is automatically updated when its source scene is saved.

Update Now Click this to update a selected XRef scene when you're not using Automatic (or when several XRef scenes are selected and some of them are not set to Automatic). When you click Update Now, the XRef is updated to match the latest saved version of the source scene.

Display Options group

These options let you specify how the selected XRefs are displayed in viewports. These options have no effect on the rendered scene.

Visible Turn on or off to display or hide the selected XRefs. This affects the visibility of the XRef in the viewports only (not in renderings). Note, also, that this behavior is different from the "Enabled" check box. Turning off Visible does not remove the XRef from memory.

Box Turn this on to display the selected XRefs as bounding boxes. Turn off to display the full geometry.

Ignore group

This group box lets you specify categories that you do not want included with the XRef scene. For example, if you turn on Lights, the lights in the XRef source scene are not included in the current, target scene. You can switch these categories on and off at any time, but if you Merge an XRef scene while a category is turned off, that category of objects will not be merged into the scene.

Lights Turn this on to ignore the lights.

Cameras Turn this on to ignore the cameras.

Shapes Turn this on to ignore the shapes.

Helpers Turn this on to ignore the helpers.

Animation Turn this on to ignore the animation. All animation in the scene is disabled and the scene appears as it would at frame 0 of the source scene.

WARNING Children of an ignored object are also ignored. For example, if you have mesh objects linked as children to a dummy object and ignore Helpers, then the mesh objects are ignored as well.

Parent group

These controls let you position and animate XRef scenes within the current scene by binding the XRef scene to a parent object.

Parent Name field Displays the name of the parent for the currently selected XRef.

Bind Click this, and then pick an object in the current scene to become the parent of the highlighted XRefs. Once an XRef is bound to a parent object, the transforms of the parent are inherited by the XRef. Thus, you can animate the XRef by animating the transforms of the parent.

Unbind Click to unbind the highlighted XRefs from whichever parent they'd been bound to.

Binding XRefs to objects is similar to *linking* objects, as performed with the Link/Unlink buttons on the toolbar.

If you Merge a linked XRef scene, converting it to objects in the current scene, the objects in the XRef scene become linked children of the binding parent. At this point, you could Unlink them (using the toolbar command), and they'll maintain their offset position to the parent.

Close Click to close the dialog.

XRef Object Rollout

Select an XRef object. > Modify panel > XRef Object rollout

When you've selected an XRef object in a scene, the XRef Object rollout appears along with the [Proxy Object rollout](#) on page 6974 on the Modify panel. The modifier stack for the XRef object simply displays "XRef Object."

Interface

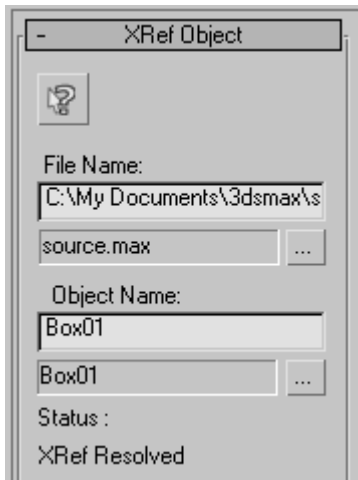

These controls let you change the file path, file name, and object name of the source of the XRef object.

IMPORTANT The specified file must contain an object of the specified name, or no XRef object will appear in your scene. Instead, a small X appears as a placeholder.



Highlight Corresponding XRef Record in the XRef Objects

Dialog Click to open the [XRef Objects dialog](#) on page 6941, with the selected object's record highlighted.

File name field Displays the path and file name of the scene file containing the source of the XRef object. You can edit this to point to a different path and file.

File name display Displays the file name only, without the path.



Path button Click to display the Open File dialog from which you can specify a different path and file name for the source file.

Object name field Displays the name of the source object pointed to in the source file. You can edit the name field to reference another object.

Object name display Displays the name of the source object.



Path button Click to display the [XRef Merge dialog](#) on page 6956 pointing to the scene in the XRef File Name field. Here, you can specify a different object to be used as the XRef object.

Proxy Object Rollout

Select an XRef object. > Modify panel > Proxy Object rollout

When you've selected an XRef object in a scene, the Proxy Object rollout appears along with the [XRef Object rollout](#) on page 6973 on the Modify panel. Use these controls to specify a low-resolution object to replace the original XRef object for easier handling in the viewports, and optionally for test rendering.

Interface

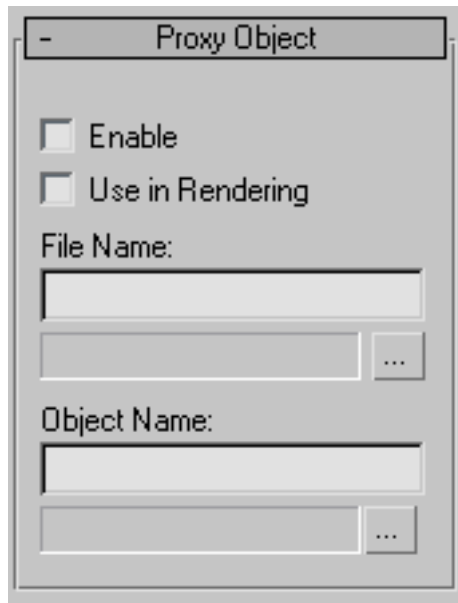

Enable When on, displays the specified proxy object in the viewports. When off, displays the original XRef object. Note: If you turn this on when no proxy object has been specified, the XRef object appears in the viewports as a small X.

Use in Rendering When on, the proxy object is also displayed in the rendering. When off, the original XRef object is rendered.

File Name field Specify the path and file name of the scene file containing the proxy object.



Path button Click to display the Open File dialog from which you can specify the scene file containing the proxy object.

Object Name field Specifies the name of the proxy object in the specified scene.



Path button Click to display the XRef Merge dialog listing the objects in the specified scene file. From here, you can select an object to be used as the proxy.

Missing XRef Paths Dialog

File menu > Open > Open a file that references other missing files.

If you load or render a scene with XRefs, but the originally specified path of the XRef object or scene can't be found, or if the XRef object name doesn't match the object name in the source file, an alert appears telling you this. The alert works in the same way as the missing bitmap dialog, and provides you with three options, described below.

Interface

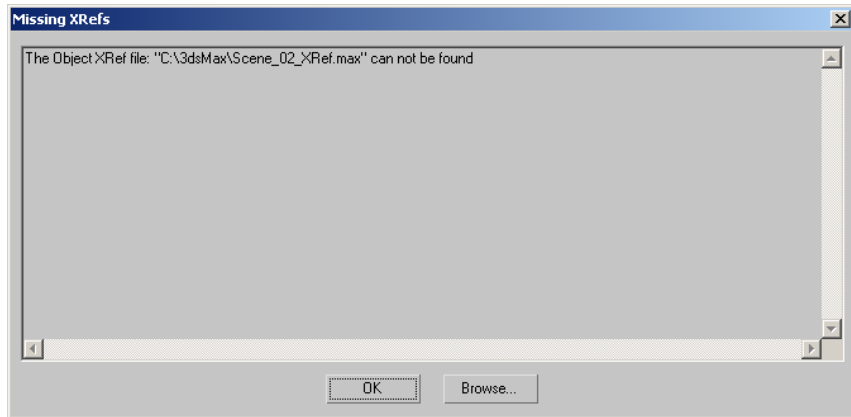

OK Lets you open the file. The referenced scene will have placeholders, but will not exist in the scene.

Browse Displays the Configure XRefs Paths dialog which you can use to specify the correct file path. This lets you modify, delete, add, and change the list position of the paths 3ds Max uses to look for missing files.

This panel is similar to the one displayed by choosing Customize > Configure User Paths > [XRefs](#) on page 7738.

If this problem occurs during network rendering, the dialog doesn't appear, but the errors are written to the network log file.

File Link

Data synchronization between drawing files created with AutoCAD, AutoCAD Architecture (ACA), or Revit and 3ds Max is implemented using the File Link

Manager, which keeps drawing data linked to the scenes. It is best understood through a few simple principles:

- **Changes in AutoCAD, AutoCAD Architecture, or Revit can change the data viewed in 3ds Max, but changes in 3ds Max never change the data in AutoCAD, AutoCAD Architecture or Revit.**

Creating a file link is a one-way process that supports the central role of AutoCAD, AutoCAD Architecture or Revit in developing and keeping a record of your core design database. Many changes made in AutoCAD, AutoCAD Architecture, or Revit will appear in 3ds Max after a file link reload. These include adding or removing objects, moving objects, changing material assignments (specific to ACA and Revit drawings), and enabling Live Section objects (specific to ACA drawings). Changes made in 3ds Max, such as moving objects, changing material assignments, and adding lights, will never appear in your AutoCAD, AutoCAD Architecture, or Revit drawing.

- **Changes you can make in AutoCAD, AutoCAD Architecture, or Revit should be made in AutoCAD, AutoCAD Architecture, or Revit.**

Changes that you make in AutoCAD, AutoCAD Architecture, or Revit become part of that database, whereas changes you make in 3ds Max appear only in the renderings you produce.

- **Changes in AutoCAD, AutoCAD Architecture, or Revit aren't reflected in 3ds Max unless you choose them to be.**

When you make changes to drawing files, those changes will not appear in 3ds Max unless you use the [Reload command](#) on page 6987 on the File Link Manager. When you reload a link in 3ds Max, you can choose to update just the geometry from AutoCAD, AutoCAD Architecture, or Revit, you can reload only specific objects, or (with AutoCAD Architecture and Revit drawings) you can choose to update both the geometry and the material assignments.

NOTE After changing your Revit project, you must export a new DWG file and then reload that file into 3ds Max. 3ds Max *cannot* link a native Revit project, RVT file, directly.

You can transform (move, rotate, or scale) AutoCAD, AutoCAD Architecture, or Revit objects and blocks that appear in 3ds Max, and these types of changes are not lost upon reload. If you have moved, rotated, or scaled linked objects and want the objects to resume the position and scale they have in the original drawing file, use the [Reset Position function](#) on page 7024.

- **3ds Max integrates linked AutoCAD, AutoCAD Architecture, or Revit data with non-AutoCAD, AutoCAD Architecture, or Revit data.**

In addition to the linked AutoCAD, AutoCAD Architecture, or Revit geometry and material assignments, 3ds Max allows you to create or merge into your scene many types of data from other sources, including:

- *Lighting objects* for simulating light fixtures and daylight conditions.
- *Entourage objects* such as surrounding buildings, terrain, trees, cars, and people.
- *Advanced rendering material effects* that simulate the rich visual variety of any imaginable material. You can take advantage of materials that appear on objects created in 3ds Max, and you can create your own material effects using the Material Editor. Materials created with the Material Editor can be assigned to any component in your scene.
- *Bitmaps* for use as environment backgrounds. You can use still images in a variety of formats, or even animated movies, as a rendering background to create stunning photomontages that appear to place your proposed design right into the actual location.

See also:

- [File Link Manager Utility](#) on page 6987
- [Working with Drawing Files](#) on page 6978
- [Resetting Transforms on Linked AutoCAD Objects](#) on page 7024

Working with Drawing Files

You can attach any [DWG file](#) on page 7958 (or [DXF file](#) on page 7958) with the [File Link Manager](#) on page 6987. This feature allows you to work in another design software's environment, such as AutoCAD®, Autodesk® AutoCAD Architecture, or Autodesk Revit® while maintaining a single design database.

NOTE For this documentation, the term “drawing” refers to DWG or DXF files created with AutoCAD and AutoCAD Architecture, or exported from Revit.

Creating Links to Files

You can establish, reload, and detach links to any number of linked files. You can also edit out unnecessary information by using layers and other filters. The File Link Manager defines which geometry is included in the scene from the linked file, how the geometry is organized, and when it's regenerated. You can also create links to files using the drag and drop feature. The objects that you bring in from linked files behave just like any other object created in 3ds Max. You can scale, rotate, and move them as well as attach modifiers and materials.

When 3ds Max stores linked file data, you'll need to decide how the objects from the linked files will be organized in the scene. For example, drawings are commonly organized by layers, blocks, and objects, and 3ds Max scenes are organized by hierarchies of objects. For translating between systems, 3ds Max includes object types called [VIZBlocks](#) on page 8165 and [Block/Style Parents](#) on page 7928.

Working with VIZBlocks and Block/Style Parents

A VIZBlock and a Block/Style Parent is like a nested block; it has an object/sub-object or parent/child hierarchy structure. In many cases, linked drawing data initially appears as a VIZBlock or Block/Style Parent (depending on the [Derive AutoCAD Primitives By options](#) on page 7004 you choose). Using VIZBlocks is helpful when you're working with layering and color schemes. You can create multiple links to the same linked file, so you can use the same geometry in different combinations.

Dynamic Blocks in 3ds Max

Dynamic Blocks give blocks flexibility and intelligence. A dynamic block reference can easily be changed in a drawing while you work. You can manipulate the geometry through custom grips or custom properties.

The File Link Manager handles dynamic blocks much the same way as any other block found in a DWG file. Dynamic block instances, even those that have been grip-edited, display certain types of instance behavior such as material propagation. For more detailed information about dynamic block handling in 3ds Max, see [Blocks](#) on page 7048.

Reloading, Binding and Detaching Links to Files

You can also reload or detach linked files. When you reload a linked file, any changes you've made to the linked file are applied to the reloaded geometry in your scene. Note, however, that 3ds Max won't edit or change your original

linked file. The integrity of your other software's design database is never compromised by the File Link Manager. Finally, if you decide to break a link to a linked file, there are two options. You can use Bind to keep the objects from the linked file in your scene, or you can use Detach to have them removed along with the link. For more information, see [File Link Tips](#) on page 6981.

NOTE Both Detach and Bind are available from the Files panel of the File Link Manager.

ObjectDBX Objects

3ds Max supports the display and use of custom AutoCAD objects. These custom objects are created using the ObjectDBX™ or ObjectARX® APIs. Applications and products that work with either of these APIs can read and write to AutoCAD drawings, and ObjectARX products can extend the available feature set of AutoCAD.

NOTE To improve file performance, some of the ObjectDBX rules have been updated. This means that some DXF files, ones built by non-Autodesk products or very old DXF files, may no longer import or file link into 3ds Max.

Object Enablers

AutoCAD and AutoCAD vertical applications, such as AutoCAD Architecture (formerly Architectural Desktop or ADT), have custom objects that are unique to the product. In order to view them in 3ds Max, you need the appropriate Object Enabler (OE). Object Enablers let you access, display, and manipulate these objects in 3ds Max, as well as the other vertical applications, including 3ds Max.

When you use the File Link Manager to Attach a DWG file to your scene, you may encounter a Proxy Objects Detected dialog. This means there are custom objects in the drawing that require special Object Enablers before you can edit the objects in 3ds Max.

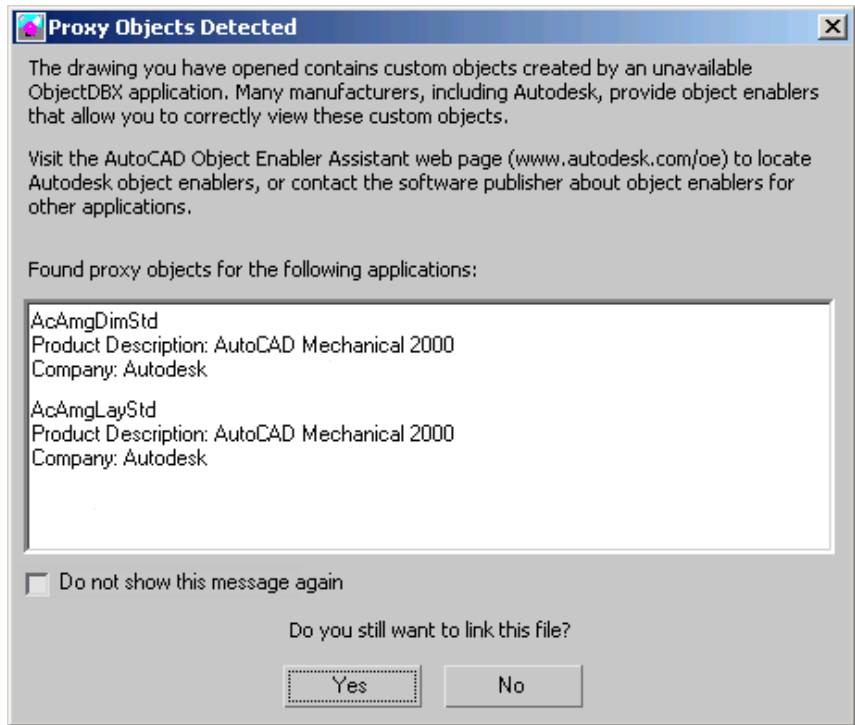

Do not show this message again Check this option to not display this message the next time proxy objects are detected.

For a list of downloadable OEs, see the <http://www.autodesk.com/autocad-object-enablers> Autodesk Web site

NOTE Drawings that are exported from Revit do not require Object Enablers.

File Link Tips

Here are some tips for choosing File Linking options and avoiding common pitfalls.

Linked Data and Face-Normal Conventions

Face normals on page 8059 can be a source of confusion when linking to AutoCAD, AutoCAD Architecture, or Revit drawing files. In 3ds Max, every face has a front and a back, corresponding to the inside or outside surface of

a solid object. In a cube, for example, there is seldom the need to view the inside surface of any of the six squares that make up the cube. So for many viewing and rendering operations, 3ds Max ignores a face if it's facing away (that is, if its face normal is directed away) from a point of view.

When you create objects in AutoCAD, AutoCAD Architecture, or Revit, 3ds Max generally understands which way faces should be oriented and manages face normals accordingly. However, occasionally you may encounter linked drawing geometry that displays correctly in AutoCAD, AutoCAD Architecture, or Revit, but doesn't strictly respect face-normal conventions. This can make it appear as though elements visible in the drawing file are missing or appear “inside-out” in 3ds Max.

If this happens, try one of these four options:

- During file link or import of the DWG file, turn on the Unify Normals switch in either the Basic panel of the File Link Settings dialog or the Geometry Options group of the AutoCAD DWG/DXF Import Options dialog.
- If the drawing is already linked or imported, assign a [Normal modifier](#) on page 1581 to the object that is not displaying properly. Turn on the Unify Normals switch to force all the normals to face the same direction. If the object then appears to be “inside-out,” turn on the Flip Normals switch as well.
- To render the faces correctly, turn on the [Render Setup dialog](#) on page 6067 > Force 2-Sided switch. Also, to display the faces correctly in the viewports, turn on Viewport Configuration dialog > [Rendering Method panel](#) on page 7818 > Force 2-Sided.
- Apply a material with the 2-Sided switch turned on.

NOTE Using the Force 2-Sided options can result in slower performance, particularly when rendering. Using either of the Unify Normals options is the preferred method of handling face normals.

If you experience a high volume of face normal problems in a particular file, verify that the [File Link Settings dialog](#) on page 6998 > Weld switch is on, and then reload the drawing. Weld forces nearby faces to share edges and vertices. Welding can still result in groups of face normals that are flipped in 3ds Max, in which case, turn on Unify Normals as well.

NOTE The disadvantage of welding is that it can be time-consuming when you attach and reload the linked file. The time penalty is much greater when 3ds Max is creating objects that have very large numbers of individual faces.

Linking Files with High Numbers of Linear Line Segments

Two-dimensional elements in drawing files, such as lines, polylines, circles, and arcs, are represented as splines in 3ds Max. These splines carry much more information at each vertex than typical AutoCAD 2D structures. Since some drawing files contain large quantities of 2D data, exercise caution when linking files containing a high number of discrete line segments. There are two ways these elements can be left out of your 3ds Max scene:

- by freezing their layers in AutoCAD, AutoCAD Architecture, or Revit before you start 3ds Max and before each subsequent reloading process.
- by excluding specific layers during the File Link Attach/Reload process or Import process so you do not have to freeze layers in the drawing. This is the preferred workflow.

If you need this type of 2D geometry in your visualization, try to use polylines instead of connected lines to get cleaner geometry in 3ds Max and to reduce the final size of your scene.

Linked 3D Solids Objects

3D Solids objects that you link from a drawing file into 3ds Max are tessellated; that is, turned into mesh objects with faces. The fineness of the tessellation is controlled by the [Maximum Surface Deviation For 3D Solids setting](#) on page 7001 on the File Link Settings dialog. A high value results in coarser tessellation. 3ds Max uses less memory in the scene, but poor approximations of curved surfaces could result. For acceptable performance, keep this value as high as possible.

TIP You can change the value of the Surface Deviation For 3D Solids control at any time by turning on [Show Reload Options](#) on page 6996 on the Files panel of the File Link Manager dialog, and then adjusting when you reload the file.

Linked Spline Objects

Splines are not rendered in 3ds Max unless they have rendering parameters applied. Normally, you have to collapse a shape to an editable spline object

in order to apply rendering parameters; however, this is not possible with spline objects from AutoCAD.

Instead, you can apply a [Renderable Spline modifier](#) on page 1652 to the spline. This lets you set rendering properties without having to collapse to an editable spline.

External References and Block Names

A linked AutoCAD or AutoCAD Architecture drawing can include xrefs that reference files but use the same block names. 3ds Max keeps the blocks distinct by prepending xref names to block names.

In Revit, a DWG, DXF or RVT file can be linked to the project. This kind of link is called a [RVT Link](#) on page 8110. When the project is exported to a DWG file, this type of link is represented in the exported drawing as an external referenced drawing. In this case, more than one drawing file may be created, with one referencing the other(s).

Circular References

An xref file that contains a sequence of nested references that refers back to the xref file is considered a circular reference. 3ds Max resolves xrefs until it detects a circular reference. For example, if you have the circular reference A|B|C|A, 3ds Max detects and breaks the circularity between C and A. This is consistent with the way AutoCAD and AutoCAD Architecture handle circular xref dependencies.

Overlay External References

3ds Max treats overlay xrefs in the same way as AutoCAD when resolving xrefs.

For more information regarding overlay xrefs, refer to your AutoCAD User Reference.

Cloning Actively Linked Objects

If you want to clone actively linked objects, you should only use the Copy option. Creating references or instances of actively linked objects is not recommended, as reliability issues can arise when the instanced or referenced object is deleted in the linked file.

When you copy actively linked objects, linked through the [File Link Manager](#) on page 6987, the copies are automatically converted to editable mesh or editable

spline objects. If your selection contains several objects which instance another object, the resulting copies also instance the same object.

Compound Objects Containing Actively Linked Objects

If you use an actively linked object as part of a compound object, you should always choose Copy when you specify how the linked object is transferred to the compound object. Choosing Reference or Instance can cause instability in the software.

Attaching Actively Linked Objects to an Editable Mesh, Poly, Patch, or Spline Object

Actively linked objects should *not* be attached to editable objects, as this introduces instability to the software. Instead, make a copy of the actively linked object, and attach the clone to the editable object.

Creating Hierarchies with Actively Linked Objects

Creating parent-child links between actively linked objects AND 3ds Max objects can cause unpredictable results. For this reason, 3ds Max does not allow you to link an actively linked object to a 3ds Max object. However, you *can* link a 3ds Max object to an actively linked object.

The existing hierarchies of linked objects cannot be broken in 3ds Max. This would compromise the structure of Blocks and Styles. Any changes must be made in the original DWG file.

Similarly, actively linked objects cannot be included in the creation of [Group](#) on page 282 or [Assembly](#) on page 287 objects in 3ds Max.

Controller Assignments

Actively linked objects should not be included in any IK animation chains, as they will cause unpredictable results. Likewise, animation controllers should not be applied to actively linked objects.

Assignments to avoid include:

- [HI IK Solver](#) on page 3392
- [IK Limb Solver](#) on page 3444
- [Spline IK Solver](#) on page 3445
- [HD IK Solver](#) on page 3422

- [Inherit Link Info](#) on page 3502
- [Link Inheritance Utility](#) on page 3372
- [Assign Controller](#) on page 3593

Interpreting Layer Data from AutoCAD, AutoCAD Architecture, and Revit

3ds Max has its own Layer system that looks and operates like a simplified version of the system you are familiar with from AutoCAD or AutoCAD Architecture (formerly Architectural Desktop). As in AutoCAD or AutoCAD Architecture, you can hide and unhide layers, freeze and unfreeze them, and change the display color for all objects on the layer.

NOTE Categories in your Revit project are similar to Layers in AutoCAD. When you export your project to a DWG, categories are mapped to AutoCAD Layers via the *Export Layers* table. For more information regarding Export Layers, refer to your *Autodesk Revit Help* file.

Layer operations are accessed through the tools on the Layers toolbar, and also on an object-by-object basis using the [quad menu](#) on page 7516.

Unlinked objects, such as 3ds Max objects or drawing geometry that has been bound into the scene using the Bind command, may be assigned to any layer you choose, including layers created by the File Link Manager.

Linked objects from AutoCAD, AutoCAD Architecture, or Revit, with some minor exceptions, will be assigned to the same layers they occupy in program where the drawing was created.

Any changes made to the layer settings in 3ds Max (hidden/unhidden, frozen/unfrozen, display color) affect linked objects just as they do unlinked objects. Also, any changes you make to the layers are *not* reset when you reload the drawing.

You can rename layers created by the File Link Manager. When the next reload occurs, the renamed layer is not affected by the File Link Manager. Objects on the renamed layer are updated; however, they remain on the same layer. The original layer is only recreated when a new object has been created in the DWG file. New objects are never placed on the renamed layer. You can also delete layers imported by the [File Link Manager](#) on page 6987; but only if they don't contain any objects.

You can move actively linked objects between layers in 3ds Max. When the next reload occurs, the objects are updated; however, they are not moved back to their original layers. You can also place non-linked objects, such as 3ds Max objects or drawing geometry that has been bound into the scene, on any of the imported layers.

Objects contained in layers that are frozen in AutoCAD or AutoCAD Architecture are not linked to 3ds Max. Objects that were originally linked to 3ds Max are removed if their layer is frozen in AutoCAD or AutoCAD Architecture and the link is reloaded, but they are added again, upon reload, after their layer is unfrozen in the program where the drawing is created.

NOTE This is only the case if Skip all Frozen Layers is active on the [Select Layers dialog](#) on page 7017. If you select the layers individually from a list, you can bring in data on frozen layers.

See also:

- [Using Layers to Organize a Scene](#) on page 7438

Scale Synchronization

3ds Max automatically manages the scale conversion on linked geometry and materials. 3ds Max has its own *system unit* for internal representation of geometrical scale.

If you find that any geometry is not shown at the size you intended it to be, it is because it was created at the improper scale in the originating program.

See also:

- [Using Units](#) on page 2588

File Link Manager Utility

Utilities panel > Utilities rollout > Click the More button. > Utilities dialog > File Link Manager

File menu > File Link Manager

The File Link Manager utility allows you to work in either another design software's environment (such as AutoCAD) or in 3ds Max while maintaining

a single design database. If you use AutoCAD drawings, this feature works with drawings from AutoCAD Release 12 through AutoCAD 2005, including the AutoCAD Mechanical/Architecture and Revit applications.

You can establish, refresh, and break links to any number of linked files. You can also edit out unnecessary information by using layers and other filters. The File Link Manager defines which geometry is included in the 3ds Max scene from the linked file, how the geometry is organized, and when it's regenerated.

The objects that you bring in from linked files behave just like any other object created in 3ds Max. You can scale, rotate, and move them, as well as attach modifiers and materials.

You can also refresh or break links to linked files. When you refresh a linked file, any changes you've made to the linked file are applied to geometry in your scene. Note, however, that 3ds Max won't edit or change your original linked file. The integrity of your other software's design database is never compromised with the File Link Manager.

Finally, if you decide to break a link to a linked file, you can either keep the objects from the linked file in your scene or have them removed along with the link.

TIP For optimal speed when bringing a DWG file that contains a lot of text into 3ds Max, use [Import](#) on page 7182 rather than File Link.

See also:

- [File Link](#) on page 6976
- [File Link Tips](#) on page 6981
- [Working with AutoCAD, AutoCAD Architecture, and Revit Files](#) on page 7021

Support of Multiple Materials on Linked ACIS Solids

3ds Max supports multiple materials per object in DWG files exported as ACIS solids from Revit Architecture/Structure/MEP 2008 and later, as well as solid primitives created in AutoCAD Architecture 2008 (formerly ADT) and later. Linked solids can have [Multi/Sub-Object materials](#) on page 5720 that you can view and manipulate in the Material Editor.

NOTE Previous versions of 3ds Max supported multiple materials for polymeshes but only one material ID for each ACIS solid when linking a DWG file, regardless of how many material IDs had been assigned to the solid.

Process

When 3ds Max links a ACIS solid DWG file from AutoCAD or Revit Architecture (version 2008 and later) with either the Layer, Blocks as Node Hierarchy, Split by Material” or the Entity, Blocks as Node Hierarchy derivation methods, multiple material IDs are read and editable as Multi/Sub-Object materials in the Material Editor.

3ds Max reads each face of a linked ACIS solid to determine if it contains any material IDs that it can read. If more than one material ID is read from a solid, each material ID is translated to a material ID on file link and re-assigned to the object.

The program creates Multi/Sub-Object materials only if more than one material ID is found; if an ACIS solid contains only one material ID, a standard architectural material is created and assigned instead.

NOTE 3ds Max first evaluates the linked file to find any Revit material IDs, and then looks for AutoCAD material IDs.

NOTE If you link a DWG file with the Layer, Blocks as Node Hierarchy, Split by Materials” derivation method, the solid is not split to reflect its materials set.

Multi/Sub-Object Material Naming

In earlier versions, 3ds Max read the material ID information from the color ID of the AutoCAD/Revit material ID’s face. Now, 3ds Max creates a Multi/Sub-Object material for every translated per face material ID each time you link a DWG file that contains an AutoCAD/Revit solid.

When the program finds multiple materials assigned to an ACIS solid and creates a Multi/Sub-Object material, it consists of instances of standard architectural scene materials.

Naming Conflicts

Material IDs are unique within one DWG file. However, the same material ID may appear in two different files, such as Basic Wall: Generic – 12” Masonry. If a naming conflict arises when two scenes are merged, the program applies the last loaded material used in the Multi/Sub-Object material.

For example, if **file1.dwg** and **file2.dwg** both contain a material named Brick, and they are both linked, the Brick material used is the one from the second file (**file2.dwg**).

Or, if **file1.dwg** contains a material named Brick that is internally stored as material ID 222 and **file2.dwg** contains a different material stored as ID 222, the material used in the scene when they are linked is **file2.dwg**'s material.

If two solids share the same material ID, they will share the same Multi/Sub-Object material.

Non-AutoCAD Materials

3ds Max does not link non-AutoCAD material IDs. The only non-AutoCAD Architecture IDs it preserves are the Color IDs.

ACIS Solids

DWG ACIS solids link as solid objects in 3ds Max. You cannot separate faces of an ACIS solid object unless you apply the [Edit Poly](#) on page 1363 or [Edit Mesh](#) on page 1353 modifier.

TIP You can access the material ID value assigned to this face with the Edit Poly modifier.

ACIS Solids and Materials

ACIS solid materials display in the Material Editor along with any other linked material.

When you apply a bitmap material to an ACIS solid, it is applied to every side of the object. For example, a brick bitmap material that you apply to a wall object appears on both sides and all edges of the wall. If you want to apply a material to each face ID, you can use a multi/sub object material so you can assign sub-materials to each face ID.

When you link ACIS solids into 3ds Max, procedural textures are not supported, only materials. For example, a brick wall in Revit may have mortar lines procedurally drawn on it in red, but if the object is an ACIS solid, the mortar lines, which are procedural hatches, are lost in 3ds Max.

When an ACIS object's materials display as Multi/Sub-Object materials in the Material Editor, each material name appears in the Material/Map Browser, for example, Default wall or Basic Wall: Generic – 12" Masonry.

Polymesh

Polymesh DWGs link as polymesh geometry in 3ds Max. Unlike ACIS solids, you can modify and edit any polymesh object's face.

Polymesh Objects and Materials

When you link a polymesh DWG file, each polymesh face is considered as a separate entity, with one material permitted per entity, which allows it to contain multiple materials

You can apply a bitmap material to the different faces of polymesh geometry, unlike ACIS solids, where you would need to use a Multi/Sub-Object material to create the same effect. For example, you can select the outside face of wall and apply a brick bitmap material and also apply a diffuse material on the inside wall to simulate white paint.

When you link a polymesh DWG file, every material used in the scene appears in the Material Editor as a separate material where you can edit it.

When a polymesh object's materials are shown in the Material Editor, each material name appears in the Material/Map Browser, for example, Default wall or Basic Wall: Generic – 12" Masonry.

Procedures

To link a drawing file:

You can link drawings in the form of DWG or DXF files. A DWG is the native file format for AutoCAD and AutoCAD Architecture, but you must first export a DWG when working from a Revit project. The File Link Manager does not recognize RVT files.

- 1 Choose File menu > File Link Manager.
- 2 On the Attach panel, click Files to select a file from the appropriate directory on either your local or network system, and click Open.
- 3 Choose a Preset from the pull-down list, if you have one defined.

TIP If this is your first File Linking, and you have not defined any presets, you may want to create one on the [Presets panel](#) on page 7013 of the dialog.

- 4 Turn on the Rescale switch and adjust the Incoming File Units, if necessary.
- 5 Click Attach This File.

To reload a drawing:

Reload is most often used when your drawing or project has been changed in AutoCAD, AutoCAD Architecture, or Revit, or if the linked drawing file has been moved and you have to tell the File Link Manager where to find the drawing.

NOTE If your Revit project has been updated, remember to export a new DWG file that can be reloaded.

- 1 On the Files panel of the File link Manager, click the file name in the Linked Files list and click Reload.

Linked files that have been changed are prefaced with the  symbol.

TIP Turn on the Show Reload Options switch if you want to make changes to the settings used to link the drawing. Otherwise, the reload process will use the same settings you originally used when creating the link.

- 2 If Show Reload Options is turned on, the [File Link Settings dialog](#) on page 6998 is displayed where you can change your settings in the Basic and Advanced panels.

NOTE You cannot change the sorting or layer options when reloading a drawing.

- 3 Click OK to reload the file.

Interface

The File Link Manager dialog contains three panels for listing linked files:

- [Attach](#) on page 6993
- [Files](#) on page 6995
- [Presets](#) on page 6997

These panels let you attach files, update attachments and settings, and change presets used by File Link. The terminology is similar to the terminology for managing AutoCAD external references, or [xrefs](#) on page 8176.

NOTE An xref is an AutoCAD external reference. This is different from a 3ds Max [Xref](#) on page 8177, which is an externally referenced file that can be a 3ds Max object or scene.

Attach panel

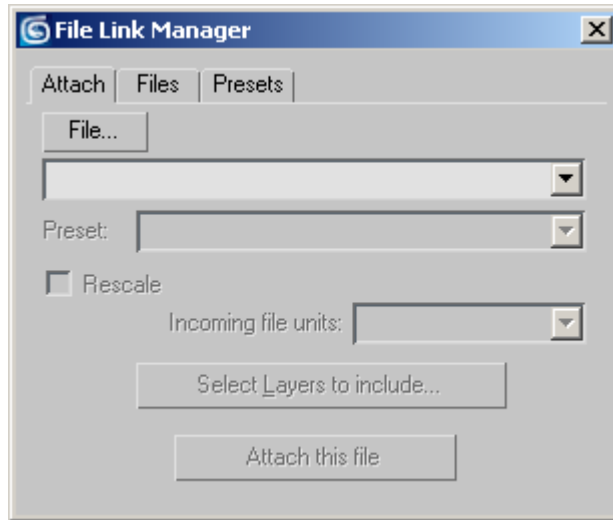

File Displays an Open dialog that you can use to browse for DWG and DXF files that you want to link. When a file is selected, its path and name appear in the File list.

File list The file to be attached to your scene. You can enter the file location, or you can expand the list to display a history of the last ten attached files.

NOTE You can resize the File Link Manager dialog by dragging any corner or edge. This is useful for viewing a file path if it's too long to fit in the file list field.

Preset Displays a list of preset settings you can choose to use when attaching the file. Each list entry in this list represents a unique collection of attach and reload settings. You can create additional presets in the Presets panel of the File Link Manager dialog.

Rescale Alters the scale of the geometry from a linked file to match the [system unit scale](#) on page 7812 in 3ds Max. When Rescale is on, you can specify what the base units should be for the geometry in the linked file. For example, if the length of a line in the linked file is 2 units, you can specify that these units

be considered as any of the units listed under File Units (below), such as inches, millimeters, or parsecs.

When Rescale is on, and the units you specify are different from the system units currently set in the 3ds Max scene, the incoming objects are scaled appropriately. For example, if a door measures 914 units in the linked file, and you specify millimeters to convert from, the door will measure 36 inches in the 3ds Max scene.

NOTE You can't change units when you reload a linked file.

NOTE By default, system units are inches in 3ds Max. Consider carefully before changing the default system units. For more information, see [Using Units](#) on page 2588.

Incoming File Units Displays the unit of measure found in the original drawing file and lists the units to which you can choose to rescale the attached file. This is only active when Rescale is on.

Select Layers to Include Displays the [Select Layers dialog](#) on page 7017, which you use to select the layers to import from the linked file.

Attach This File Attaches the selected file to your scene, using the settings selected in the Preset list, if one was selected.

To cancel the File Link operation press Esc. You can do this at any time during the process.

Cancelling the File Link operation removes every object the process has linked to the scene until the moment you press Esc.

Close Cancels all changes to settings and closes the dialog.

Files panel

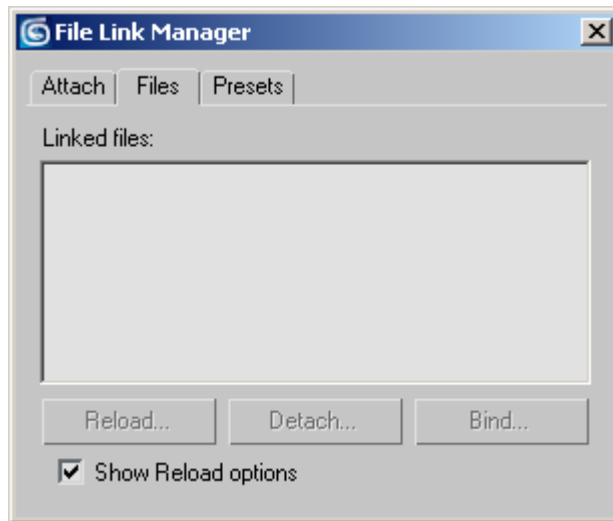

Linked Files Lists linked files. The File Link Manager displays an icon next to the path name of each linked file. The icon reflects the status of the linked file, as described below:



The linked file hasn't changed and there are no errors.



The linked file can't be found at the specified location.



The linked file has changed or another file has been selected by changing the path or using the browser from this list. If you want to update your scene with the changes in this file, you must [reload](#) on page 6995 your link.

You can change the path name by highlighting it and clicking again to enter its location. This also displays a file browser button to the right of the file name that you can use to locate a file. If the directory of a linked file is no longer valid, then you must enter a new, valid path name.

Reload Refreshes the link between the file and the 3ds Max session. This feature is useful when the file has been modified and you want to see the changes reflected in your 3ds Max scene. If you turn on Show Reload Options, the [File Link Settings dialog](#) on page 6998 displays when you click this button.

Changes that have been made to the base file will be applied to the objects at the bottom of the 3ds Max modifier stack. If you have 3ds Max materials

applied to walls in a floor plan in your scene, the same materials are applied to the walls when you reload an updated version of the linked file.

To cancel the File Link operation press Esc. You can do this at any time during the process.

Cancelling the File Link operation removes every object the process has linked to the scene until the moment you press Esc.

NOTE This option is available only when the file is highlighted in the Linked Files list.

Detach Removes an existing link to a file. Detach also removes all geometry associated with or dependent on the link.

When you click this button, you receive a warning that you're about to remove all objects associated with the linked file. You can either proceed or cancel the operation.

NOTE This option is available only when the file is highlighted in the Linked Files list.

Bind Removes the link to the file. The geometry in the scene remains unchanged, but it's no longer linked back to the original file and, if the original file changes, it can't be updated using Reload.

When you click this button, you receive a warning that you're about to break the link between the objects in the current 3ds Max scene and the file.

NOTE This option is available only when the file is highlighted in the Linked Files list.

Show Reload Options Displays the [File Link Settings dialog](#) on page 6998 when you click Reload, and uses these settings for reloading. When you turn off this option, the File Link Manager uses the reload settings stored in the current scene.

Close Cancels all changes to settings and closes the dialog.

Presets panel

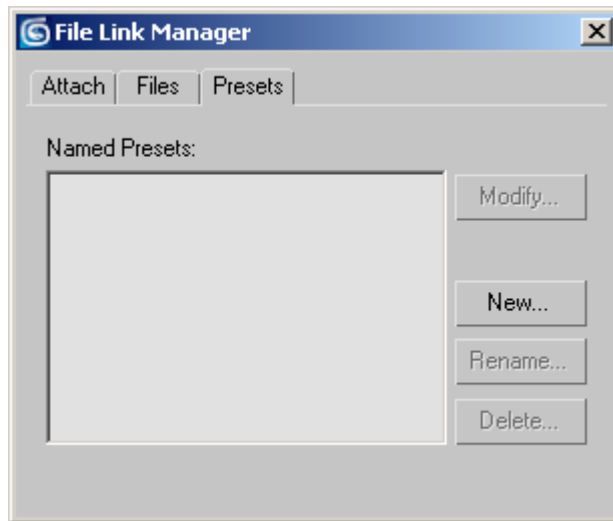

Named Presets Lists all existing presets.

Modify Opens the [File Link Settings dialog](#) on page 6998, letting you change the settings of the selected preset.

New Opens the [New Settings Preset dialog](#) on page 7013, creating a new preset with default settings.

NOTE New is only available when no preset is selected in the list. If a preset is selected, this button changes to Copy.

Copy Opens the [New Settings Preset dialog](#) on page 7013, creating a new preset with the same settings as the currently selected preset.

NOTE Copy is only available when a preset is selected in the list. If no preset is selected, this button changes to New.

Rename Opens the [Rename Settings Preset dialog](#) on page 7015, letting you change the name of the selected preset.

Delete Deletes the selected preset.

Close Cancels all changes to settings and closes the dialog.

File Link Settings Dialog

File menu > File Link Manager > Files tab > Turn on Show Reload Options. > Click Reload.

Utilities panel > Utilities rollout > More button > File Link Manager > Files tab > Turn on Show Reload Options. > Click Reload.

The File Link Settings dialog gives you control over the detailed aspects of how geometry is translated from DWG or DXF files and interpreted in 3ds Max. It also allows you to control whether only a portion of the 3ds Max objects will be affected by subsequent reloading. The File Link Settings dialog is displayed when Show Reload Options is turned on in the File Link Manager dialog, or when editing a file link Preset.

The File Link Settings dialog lets you:

- View and exclude layers in a linked file.
- Control how geometry is converted.
- Define how linked objects are converted to 3ds Max objects, referred to as *VIZBlocks*.

The selections you make in the File Link Settings dialog can affect the amount of memory used by 3ds Max to hold the linked data. Use the [Select Layers To Include option](#) on page 7007 to reduce the amount of information added to your scene.

In some cases, it might be more efficient to create multiple links to the same file, making different file link settings for each file.

See also:

- [File Link Tips](#) on page 6981

Basic File Link Settings

File Link Manager > Reload a linked file with Show Reload Options turned on. > File Link Settings dialog > Basic panel

File Link Manager > Presets panel > Highlight a preset and click Modify. > File Link Settings dialog > Basic panel

The Basic panel of the [File Link Settings dialog](#) on page 6998 defines how 3ds Max converts the linked file's objects into corresponding 3ds Max objects.

Interface

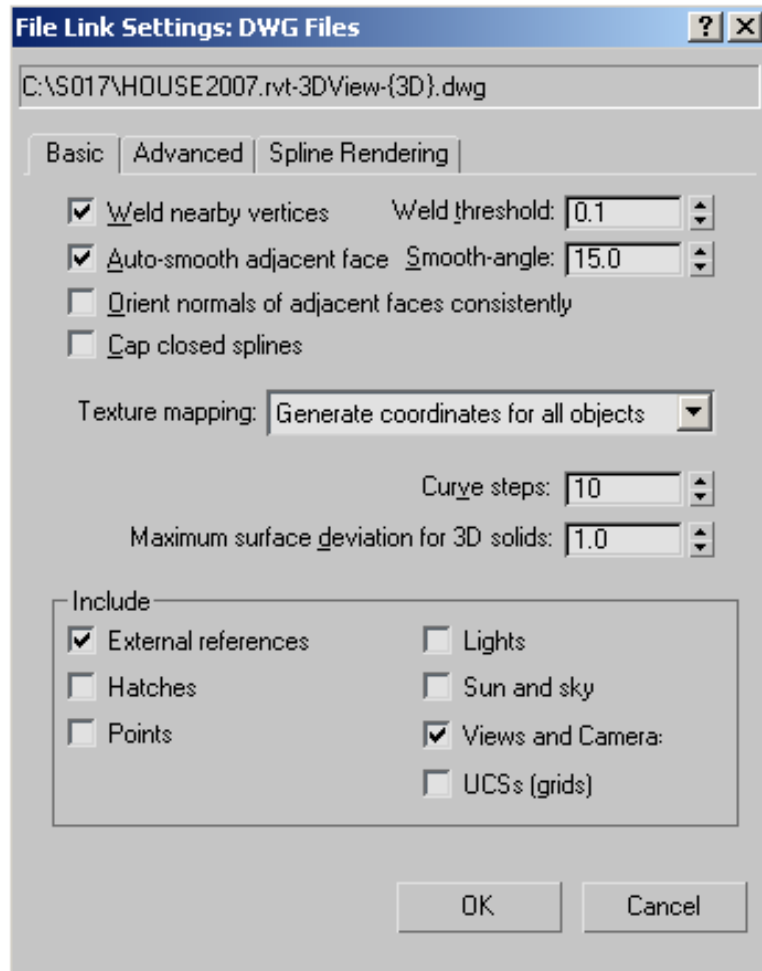

Weld nearby vertices Sets whether to weld nearby vertices of converted objects according to the Weld Threshold setting. Welding smooths across seams and unifies normals of objects with coincident vertices. Welding occurs only on vertices that are part of the same object.

Weld threshold Sets the distance that determines whether vertices are coincident. If the distance between two vertices is less than or equal to the weld threshold, the vertices are welded together. To use the Weld Threshold, turn on Weld.

Auto-smooth adjacent face Assigns [smoothing groups](#) on page 8130 according to the Smooth-angle value. Smoothing groups determine whether faces on an object render as a smooth surface or display a seam at their edges, creating a faceted appearance.

Smooth-angle Controls whether smoothing occurs between two adjacent faces. If the angle between the two face normals is less than or equal to the smooth angle, the faces are smoothed (that is, put in the same smoothing group).

Orient normals of adjacent faces consistently Analyzes the face normals of each object and flips normals where necessary, so they all point in a direction that is consistent with adjoining faces. If the imported geometry isn't properly welded, or if the AutoCAD geometry did not contain or specify normal information, normals might be oriented in the wrong direction. Use the [Edit Mesh](#) on page 1353 or [Normal](#) on page 1581 modifiers to flip normals.

When Unify Normals is off, normals are calculated according to the face vertex order in the linked file. Face normals for AutoCAD solids are already unified. Turn off Unify Normals when importing only AutoCAD solid models from AutoCAD Architecture.

Cap closed splines Applies an [Extrude modifier](#) on page 1448 to all closed objects, and selects the Cap Start and Cap End options of the modifier. The Extrude modifier Amount value for a closed object with no thickness is set to 0. Capping makes closed objects with thickness appear solid and closed objects without thickness appear flat. When Cap Closed Objects is off, the Extrude modifier Cap Start and Cap End options for closed objects with thickness are clear. No modifiers are applied to closed objects without thickness.

TIP Unless you chose the One-to-One sorting option, you won't immediately see the Extrude modifier when selecting an object. To see it, look through the modifier stack for the [VIZBlock](#) on page 8165 sub-objects. In a nested VIZBlock, the Extrude modifiers appear at the bottom of the stack. You can then edit the Extrude modifier parameters.

Texture Mapping The texture mapping setting can reduce the loading time of models that have many objects with stored UVW Coordinates for texture mapped materials.

NOTE This setting applies only to geometry that is stored as a mesh in the scene. Spline shapes marked as renderable have separate controls for UVW coordinate generation; these are found on the [Spline Rendering panel](#) on page 7010.

- **Generate Coordinates For All Objects** Automatically generates UVW coordinates for all objects when the drawing is linked.
This option tells the File Link Manager to create UVW coordinates, but loading time is increased while the coordinate generation occurs.

- **Generate Coordinates On Demand** Does not generate texture coordinates for linked mesh objects.
Actively linked objects generate UVW coordinates on demand, so if you assign a material to an object and the material requires texture coordinates, the texture coordinates are silently assigned to that object. If the material or texture map is set to display in viewport, the coordinates are assigned as soon as the material is applied; if not, the coordinates are assigned when the scene is rendered.

This option gives you faster loading speed, but no UVW coordinate generation.

NOTE Objects in drawings created in AutoCAD Architecture pass texture coordinates explicitly to 3ds Max when you attach the drawing. If you specify on-demand coordinate generation, they might not match the coordinates that were specified in the original drawing. The map scaling is the same, but the texture offsets may be altered.

Curve steps For objects such as splines, the number of knot points determines the spline's shape and curvature. The Curve steps value defines the number of segments between knot points. A low value gives you a more linear interpolation between the knot points; a higher number gives you a more accurate curve.

Maximum surface deviation for 3D solids Specifies the maximum allowable distance from the 3ds Max surface mesh to the parametric AutoCAD solid surface. Small numbers produce more accurate surfaces with a greater number of faces. Large numbers produce less accurate surfaces with fewer faces.

Include group

This group allows you to toggle the inclusion of specific parts of a DWG file during the file link process.

External references Imports xrefs attached to the DWG file.

Lights Imports lights from pre-AutoCAD 2007 DWG files.

Sun and Sky Imports Sun and Shadows position from the drawing file (AutoCAD / AutoCAD Architecture 2008 and Revit 2008 only).

NOTE You must set mental ray as the default renderer for you to see the Sun and Sky effect. To set mental ray as the default renderer, see [Choose Renderer Dialog](#) on page 6136.

Hatches Imports hatches from the DWG file.

WARNING This stores each line or dot in the hatch pattern as a separate spline that defines the hatch; this can create a very large number of objects in your scene.

Views and Camera Imports named views from the DWG file, and converts them to 3ds Max cameras.

NOTE Orthographic views do not translate correctly in imported DWG files. However, there are no problems with Perspective views.

Points Imports points from the DWG file.

NOTE The imported point objects are represented in 3ds Max as [Point Helper](#) on page 2628 objects.

UCSs (grids) Imports user coordinate systems (UCS) from the DWG file and converts them to 3ds Max grid objects.

Advanced File Link Settings

File menu > File Link Manager > Reload a linked file with Show Reload turned on. > File Link Settings dialog > Advanced panel

File menu > File Link Manager > Presets panel > Select an existing preset and click Modify. > File Link Settings dialog > Advanced panel

File menu > File Link Manager > Presets panel > Create a new preset. > Select the newly created preset and click Modify > File Link Settings dialog > Advanced panel

Utilities panel > Utilities rollout > More button > File Link Manager > Reload a linked file with Show Reload turned on. > File Link Settings dialog > Advanced panel

Utilities panel > Utilities rollout > More button > File Link Manager > Presets panel > Highlight an existing preset and click Modify. > File Link Settings dialog > Advanced panel

Utilities panel > Utilities rollout > More button > File Link Manager > Presets panel > Create a new preset. > Highlight the newly created preset and click Modify > File Link Settings dialog > Advanced panel

The Advanced panel of the [File Link Settings dialog](#) on page 6998 controls how the software derives AutoCAD primitives and whether 3ds Max uses the scene material definitions when linking to or reloading the AutoCAD drawing. It also lets you selectively reload your scene, so that you reload only specific objects, not the entire file.

Interface

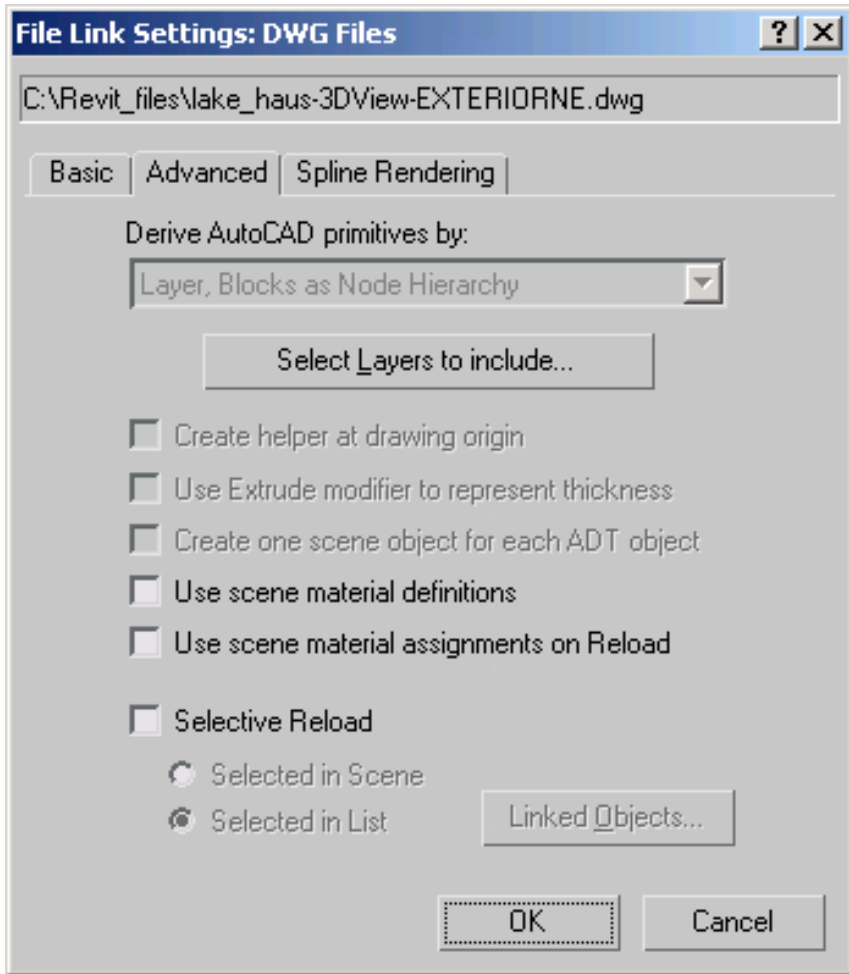

Derive AutoCAD primitives by: Lists the options for deriving objects from the linked DWG file. This setting is available only when [modifying a preset](#) on page 7016.

NOTE This applies only to standard AutoCAD primitives. Specialized objects, such as those from AutoCAD Architecture, are handled differently.

TIP For best results, use the *Layer, Blocks as Node Hierarchy* or *Entity, Blocks as Node Hierarchy* options, except in special circumstances.

There are six options to choose from:

- **Layer, Blocks as Node Hierarchy** Linked objects on a given layer in the AutoCAD drawing that aren't in blocks are combined into a single Editable Mesh or Editable Spline object in 3ds Max. The name of each linked object is based on the AutoCAD object's layer. The linked object name has a "Layer:" prefix and is followed by the layer name. For example, all AutoCAD objects residing on the layer Walls become part of the Editable Mesh named Layer:Walls after they are linked in 3ds Max. Each block is linked separately as a hierarchy, with the block itself as the parent object and its constituent parts as child objects. The child objects of the block are combined by layer.

TIP This is usually the best option for file linking. It preserves all ADT information, and generally maintains the same granularity as you would expect in AutoCAD.

- **Layer, Blocks as Node Hierarchy, Split by Material** This works the same as the Layer, Blocks as Node Hierarchy option, with the following additional functionalities: The combination of non-block objects by layer, followed by material and support for multiple materials assigned to ACIS solid and polymesh geometry.

- Non-block object layer combination:

For example, take an AutoCAD file with six objects in layer A: three have a Brick material and three have a Stone material. Using this option, this file would be linked to in the form of two objects, or nodes, one containing the Brick material and the other with the Stone material.

Each block is linked to separately as a hierarchy, with the block itself as the parent object and its constituent parts as child objects. The child objects of the block are combined by layer.

- Multiple material support

On import, ACIS solids and polymesh geometry can support multiple materials. For polymesh geometry, one material is supported per face. For an ACIS solid, if the solid has more than one material associated with it, a multi/sub object material is created that contains the materials used. If the solid has only one material associated with it, a standard/architectural material is assigned instead.

NOTE Multiple material support for ACIS solids applies to DWG files imported or file linked from Revit Architecture 2008 or AutoCAD Architecture (formerly Architectural Desktop or ADT) 2008 and later.

NOTE This derivation method is intended for use with AutoCAD 2007 (and later) format files. Using this method with DWG files created with previous versions of AutoCAD could result in data loss.

- **Entity, Blocks as Node Hierarchy** Every linked object not in a block is represented as a separate object in the 3ds Max scene, without regard to layers. The nodes are then placed on scene layers that correspond to the drawing layers. Each block is imported separately as a hierarchy, with the block itself as the parent object and its constituent parts as child objects. The child objects of the block are combined by layer.

One benefit of this option is that you can apply [instanced animation controllers](#) on page 3109 to block subcomponents and thus, by transforming a single member, transform all members at once. For example, in a scene containing a conference table with six chairs around it, you could move all of the chairs simultaneously by moving a single chair.

Another advantage is that all geometry is instanced, so edited UVs and normals and other modifications need be done only once.

NOTE This derivation method might cause unreliable material propagation when importing drawings containing dynamic blocks. Materials might propagate to some block instances and not to others.

WARNING This option has the potential to create an enormous number of objects in your scene.

Multiple materials per object are supported with this option, if needed. If the object is an ACIS solid, and has more than one material associated with it, a multi/sub object material is created containing the materials that can be edited in the Materials Editor. If the solid has only one material associated with it, a standard/architectural material is assigned instead. If the object is polymesh geometry, one material per face is supported.

NOTE Multiple material support for ACIS solids applies on the DWG files imported or file linked from Revit Architecture 2008 or AutoCAD Architecture (formerly Architectural Desktop or ADT) 2007 and later.

- **Layer** Linked objects are combined in 3ds Max according to their layer. Objects in each of the associated application's layers are combined into

one object, with the exception of blocks, each of which is represented as an individual VIZBlock (not a hierarchy). Multiple inserts of the same block are represented using instances in the scene. Material assignments are lost but material IDs are preserved.

- **Color** Linked AutoCAD objects are combined in 3ds Max according to their color. All objects of the same color are combined into one object, with the exception of blocks, each of which is represented as an individual VIZBlock (not a hierarchy). Multiple inserts of the same block are represented using instances in the scene. Material assignments are lost but material IDs are preserved.

NOTE Blocks can contain objects with different colors. However, when sorting, 3ds Max considers only the color of the block itself. Also, 3ds Max objects can only display one color, unless a material is applied.

- **Entity** Provides a one-to-one correspondence between AutoCAD objects and 3ds Max objects. For each linked object or block in the imported file, the File Link Manager creates an independent object or VIZBlock, respectively, in the scene. Material assignments are lost but material IDs are preserved.

WARNING This option has the potential to create an enormous number of objects in your scene.

NOTE When working with drawings exported from Revit, it is recommended that you do not use this setting.

- **One Object** All linked objects are combined into a single VIZBlock. Material assignments are lost but material IDs are preserved.

Select Layers to Include Displays the [Select Layers dialog](#) on page 7017, which you use to choose layers to import from the linked file. Available only when reloading a linked file.

TIP Excluding unnecessary objects from linking can improve the performance of the reload operation.

Create Helper at Drawing Origin When on, 3ds Max inserts the user coordinate system icon as an origin point helper. 3ds Max places this helper at the world origin of the linked file. It's a reference point for all the geometry of the linked file. After attaching, the helper is selected, allowing you to easily

move, rotate, or scale all the geometry that was just added to the scene. Each linked file gets a unique helper object.

This setting is available only when [modifying a preset](#) on page 7016.

Use Extrude Modifier to Represent Thickness When on, linked objects with thickness receive an Extrude modifier to represent the thickness value. You can then access the parameters of this modifier and change the height segments, capping options, and height value.

When off, objects with thickness (and closed capped objects) are converted directly to a mesh.

This setting is available only when [modifying a preset](#) on page 7016, and not using the Derive option Layer, Blocks as Node Hierarchy.

Create One Scene Object for Each ADT Object AutoCAD Architecture (formerly Architectural Desktop or ADT) objects are linked as a single object instead of being separated into their constituent components. This means that if you link an AutoCAD Architecture door object, the door is represented as one object instead of three. Turning on this switch make linking faster and the scene size is smaller.

This setting is available only when [modifying a preset](#) on page 7016.

NOTE This switch presents several modeling concerns that you need to be aware of.

- Material assignments from AutoCAD Architecture are not translated during the file link process.
- If you want to assign materials to these objects, use Multi/Sub-Object materials.
- Depending on the Texture Mapping option you choose, UVW coordinates are translated correctly.

Use Scene Material Definitions When on, 3ds Max checks the current scene for any currently used materials with the exact same name as a material name in the linked DWG file. If a match is found, File Link does not translate the drawing's material, but instead uses the material defined in the scene.

When off, the File Link Manager *always* uses the material definitions contained in the DWG file, and will overwrite scene materials with the same name, regardless of which objects the material is applied to. All material definitions stored in the DWG file are reloaded (even when using a selective reload). If you make changes to a linked material, in 3ds Max, then reload, those changes will be lost (if the switch is off).

If Use Scene Material Assignments on Reload is on at the same time as Use Scene Material Definitions, standard/architectural materials, material assignments, and face material IDs are left as they are.

If Use Scene Material Assignments on Reload is off at the same time as Use Scene Material Definitions, only the material assignments and face material IDs are updated and standard/architectural materials are not translated.

TIP When reloading a file, most of the materials from the DWG file will have already been created in the scene by 3ds Max; they may not need to be re-translated. If you want to update a scene material with the definition contained in the drawing, turn this switch off.

NOTE Material name comparison is case-sensitive.

Use Scene Material Assignments on Reload When on, linked objects with a material already assigned to them in the 3ds Max scene will not have that material assignment changed. This is the case regardless of whether the material was assigned automatically by the File Link Manager or manually by the user. When off, linked objects have their material assignment “coordinated” with the drawing, so that the two are in sync.

If Use Scene Material Definitions is on at the same time as Use Scene Material Assignments on Reload, standard/architectural materials and material assignments are left unchanged.

If Use Scene Material Definitions is off while Use Scene Material Assignments on Reload is on, only standard/architectural materials are retranslated. Any material assignments and Face Material IDs are left unchanged, so Multi/Sub object materials are not retranslated but some sub-materials may have changed.

Selective Reload Lets you perform a partial reload of your linked file. Use a partial reload when you know what has changed in the linked file, and want to speed up the time it takes to reload the geometry.

The following options are available:

- **Selected in Scene** Reloads only the objects currently selected in your scene.
- **Selected in List** Reloads only the objects that you choose from a named list. This list is defined by clicking Linked Objects.

Linked Objects Allows you to reload only objects that you choose from a named list. The list is created from the objects linked in the file. When you click Linked Objects, the [Select Linked Object dialog](#) on page 7019 is displayed.

Spline Rendering File Link Settings

File menu > File Link Manager > Reload a linked file with Show Reload turned on. > File Link Settings dialog > Spline Rendering panel

File menu > File Link Manager > Presets panel > Select an existing preset and click Modify. > File Link Settings dialog > Spline Rendering panel

File menu > File Link Manager > Presets panel > Create a new preset. > Select the newly created preset and click Modify > File Link Settings dialog > Spline Rendering panel

Utilities panel > Utilities rollout > More button > File Link Manager > Reload a linked file with Show Reload turned on. > File Link Settings dialog > Spline Rendering panel

Utilities panel > Utilities rollout > More button > File Link Manager > Presets panel > Highlight an existing preset and click Modify. > File Link Settings dialog > Spline Rendering panel

Utilities panel > Utilities rollout > More button > File Link Manager > Presets panel > Create a new preset. > Highlight the newly created preset and click Modify > File Link Settings dialog > Spline Rendering panel

The Spline Rendering panel of the [File Link Settings dialog](#) on page 6998 controls how shapes will appear in the scene once the DWG or DXF file is linked. You can control the appearance of the shape, its smoothing, mapping coordinates and if they can be rendered.

Interface

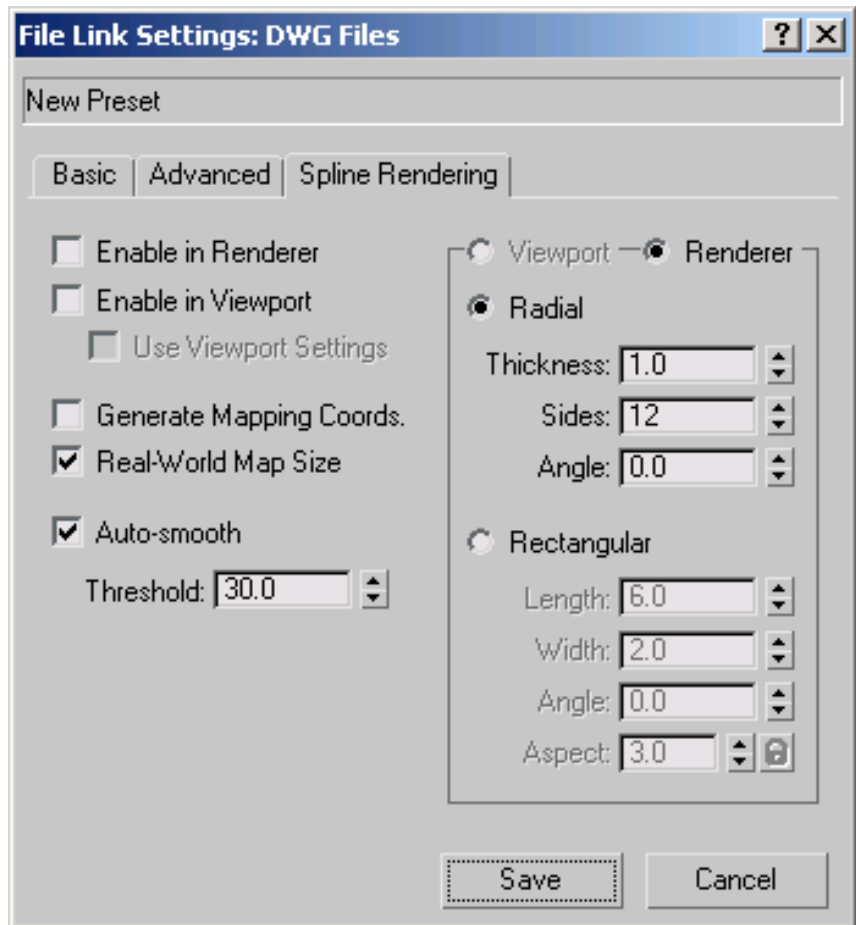

The controls on this panel are identical in name and operation to those found on the [Rendering rollout](#) on page 615 for splines. The values of these settings are set for all imported shapes. Once the import is complete, you can change the settings as necessary for each object.

Enable in Renderer When on, the shape is rendered as a 3D mesh using the Radial or Rectangular parameters set for Renderer. In previous versions of the program, the Renderable switch performed the same operation.

Enable in Viewport When on, the shape is displayed in the viewport as a 3D mesh using the Radial or Rectangular parameters set for Renderer. In previous

versions of the program, the Display Render Mesh performed the same operation.

Use Viewport settings Lets you set different rendering parameters, and displays the mesh generated by the Viewport settings. Available only when Enable In Viewport is on.

Generate Mapping Coords Turn this on to apply mapping coordinates. Default=off.

3ds Max generates the mapping coordinates in the U and V dimensions. The U coordinate wraps once around the spline; the V coordinate is mapped once along its length. Tiling is achieved using the Tiling parameters in the applied material. For more information, see [Mapping Coordinates](#) on page 5279.

Real-World Map Size Controls the scaling method used for texture mapped materials that are applied to the object. The scaling values are controlled by the Use Real-World Scale settings found in the applied material's [Coordinates rollout](#) on page 5782. Default=on.

Auto Smooth If Auto Smooth is turned on, the spline is auto-smoothed using the threshold specified by the Threshold setting below it. Auto Smooth sets the smoothing based on the angle between spline segments. Any two adjacent segments are put in the same smoothing group if the angle between them is less than the threshold angle.

Threshold Specifies the threshold angle in degrees. Any two adjacent spline segments are put in the same smoothing group if the angle between them is less than the threshold angle.

Viewport Turn this on to specify Radial or Rectangular parameters for the shape as it will display in the viewport when Enable in Viewport is turned on.

Renderer Turn this on to specify Radial or Rectangular parameters for the shape as it will display when rendered or viewed in the viewport when Enable in Viewport is turned on.

Radial Displays the 3D mesh as a cylindrical object.

Thickness Specifies the diameter of the viewport or rendered spline mesh. Default=1.0. Range=0.0 to 100,000,000.0.



Splines rendered at thickness of 1.0 and 5.0, respectively

Sides Sets the number of sides (or facets) for the spline mesh in the viewport or renderer. For example, a value of 4 results in a square cross-section.

Angle Adjusts the rotational position of the cross-section in the viewport or renderer. For example, if the spline mesh has a square cross section you can use Angle to position a "flat" side down.

Rectangular Displays the spline's mesh shape as a rectangle.

Length Specifies the size of the cross-section along the local *Y* axis.

Width Specifies the size of the cross-section along the local *X* axis.

Angle Adjusts the rotational position of the cross-section in the viewport or renderer. For example, if you have a square cross-section you can use Angle to position a "flat" side down.

Aspect Sets the aspect ratio for rectangular cross-sections. The Lock check box lets you lock the aspect ratio. When Lock is turned on, Width is locked to Length that results in a constant ratio of Width to Length.

New Settings Preset Dialog

File menu > File Link Manager > Presets panel > Copy or New

Utilities panel > Utilities rollout > More button > File Link Manager > Presets panel > Copy or New

The New Settings Preset dialog creates a new preset in the [File Link Manager](#) on page 6987. The settings of the new preset either use default values (if you clicked New), or they inherit the values of a selected preset (if you clicked Copy).

After creating the preset, you can change its settings by clicking Modify.

Procedures

To create a new preset:

- 1 On the Presets panel of the File Link Manager, click New.

NOTE New is available only if no named presets are highlighted.

- 2 On the New Settings Preset dialog, enter a name for your preset, and click OK.

A new preset is created with default settings.

To copy a preset:

- 1 On the Presets panel of the File Link Manager, choose a named preset.

- 2 Click Copy.

NOTE Copy is available only if a named preset is highlighted.

- 3 In the New Settings Preset dialog, rename the preset, and click OK.

A new preset is created with the same settings as the selected preset.

NOTE If you do not rename the preset, it will cancel the command.

Interface

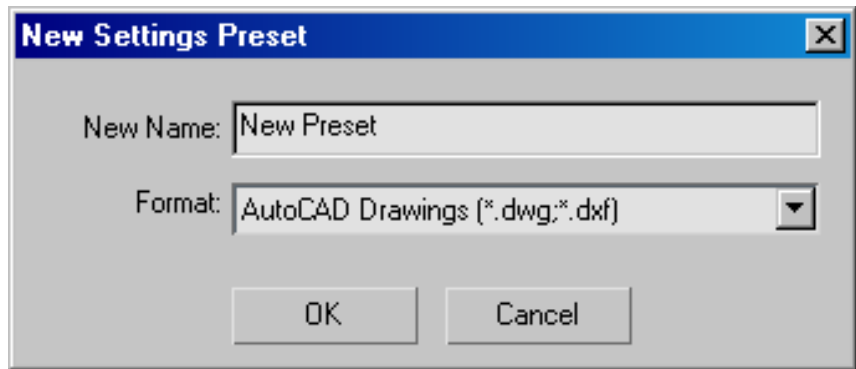

New Name The name of your preset.

Format The file type for the preset.

Rename Settings Preset Dialog

File menu > File Link Manager > Presets panel > Click a preset > Rename

Utilities panel > Utilities rollout > More button > File Link Manager > Presets panel > Click a preset > Rename

The Rename Settings Preset dialog lets you rename your preset.

NOTE You cannot use names beginning with 'Preset', so names like "Preset 1" or "Preset with Welding" are not allowed.

Interface

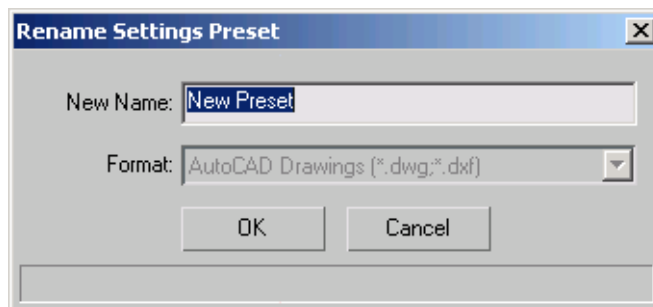

New Name The name of your preset.

Format The file type for the preset.

NOTE By default, presets can be created only for AutoCAD file types (DWG, DXF). Other file types might be available, depending on the third-party plug-ins you have installed.

Preset Editing

File menu > File Link Manager > Presets panel > Click a preset > Modify

Utilities panel > Utilities rollout > More button > File Link Manager > Presets panel > Click a preset > Modify

After you've created a preset, you can use this function to adjust its settings. For instance, you might want to make sure Weld is on, or perhaps to include lights or views (cameras).

Procedures

To edit or modify a preset:

- 1 On the Presets panel of the File Link Manager, choose a named preset.
- 2 Click Modify.
The [File Link Settings dialog](#) on page 6998 is displayed.
- 3 From the Basic, Advanced and Spline Rendering panels, make the settings you want associated with the preset and click Save.

Differences Between Layers and Blocks in AutoCAD and 3ds Max

AutoCAD has special handling for objects in the block definition that are associated with layer 0. When a block contains objects on layer 0, and those objects have a color property of "ByLayer" or "ByBlock", the color of the object is determined either by the color of the block or by the layer assigned to the [block reference](#) on page 7927 in AutoCAD. When blocks are nested, this color system can get complex.

Select Layers Dialog

File menu > File Link Manager > Files panel > Reload button > File Link Settings dialog > Advanced panel > Select Layers to Include button

Utilities panel > Utilities rollout > More button > File Link Manager > Files panel > Reload button > File Link Settings dialog > Advanced panel > Select Layers to Include button

This dialog lets you toggle a layer's include/exclude status and choose other options, as described in this topic.

NOTE You toggle the include/exclude status of a layer by clicking anywhere on a row in the list of layers. The dialog lists included layers with a check mark to the left of the layer name. This list of included layers is retained for subsequent reloads of the linked file. For informational purposes, the property icons display the state of the layers' properties, but you can't change their status in this dialog.

See also:

- [Layer Properties Dialog](#) on page 7451

Interface

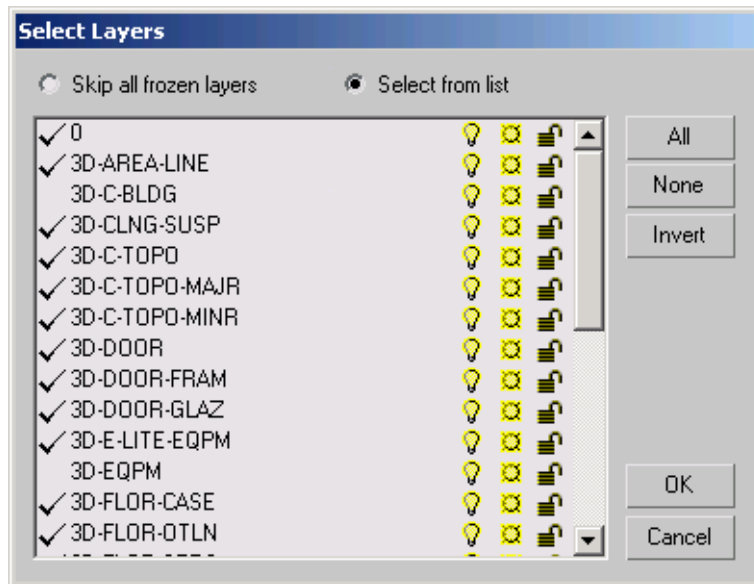

Skip all frozen layers Excludes all layers frozen in the linked file. All active files are included.

Select from list Lets you select individual active layers to include/exclude. A check mark beside the layer name indicates the layer is selected.

All Includes all layers in the linked file by selecting all of them. You can then deselect just the layers you want to exclude.

None Excludes all layers in the linked file by deselecting all of them. You can then select just the layers you want to include from importing.

Invert Reverses the current selection of layers in the linked file.

Resolve External Reference File Dialog

The Resolve External Reference File dialog is displayed when 3ds Max can't find the externally referenced files it needs in an attached DWG file.

See also:

- [File Link Tips](#) on page 6981

Interface

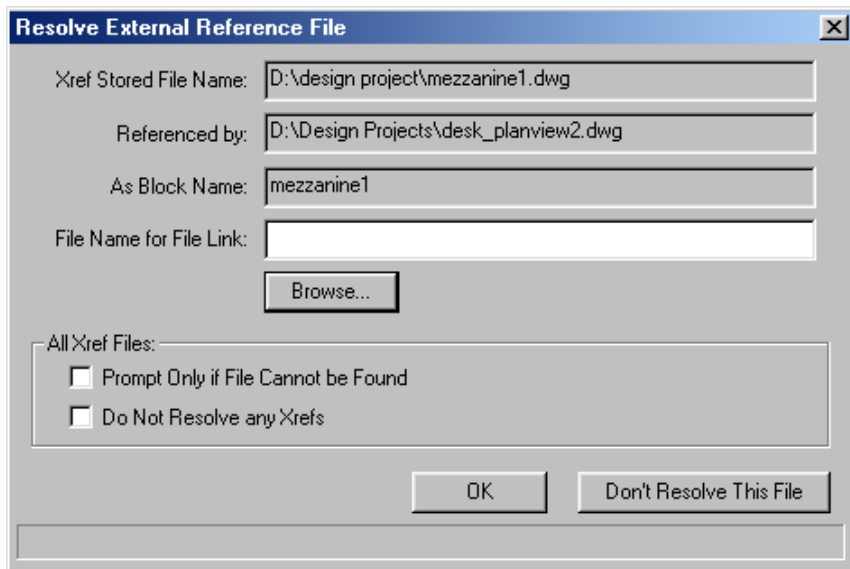

Xref Stored File Name Displays the external reference path stored in the attached drawing.

Referenced by Displays the path of the attached drawing.

As Block Name Displays the name of the block reference in the attached drawing. The block name is usually the same as the xref name, but it can be different.

File Name for File Link When 3ds Max can't locate the linked file, use this field to enter another path and file name. 3ds Max verifies that the file exists at that location and reports its status in the lower left of the dialog.

Browse Lets you use the file system to find another file for the link. Choosing a file this way enters file path and name in the File Name For File Link field.

All Xref Files group

Controls whether and how 3ds Max resolves external references from File Link.

Prompt Only if File Cannot be Found Searches for the externally referenced file and all unresolved external references from File Link in the attached drawing by using the stored file name in the locations listed in this dialog and in the order they appear.

Do Not Resolve any Xrefs Doesn't resolve this externally referenced file or any other unresolved external references from File Link in the attached drawing. However, any external references from File Link resolved before you turn on Do Not Resolve Any Xrefs will still be resolved.

OK Resolves this externally referenced file.

Don't Resolve This File Doesn't resolve this externally referenced file, but will prompt for any other external references from File Link to resolve.

Select Linked Objects Dialog

File menu > File Link Manager > Files panel > Select file to reload. > Reload button > File Link Settings dialog > Advanced panel > Turn on Selective Reload. > Linked Objects

Utilities panel > Utilities rollout > More button > File Link Manager > Files panel > Select file to reload. > Reload button > File Link Settings dialog > Advanced panel > Turn on Selective Reload. > Linked Objects

The Select Linked Objects dialog displays the linked objects associated with the selected linked file, including [VIZBlocks](#) on page 8165, lights, and cameras. You use this dialog when reloading a linked file so that you can include/exclude specific objects from the reloading process. You might want to do this in order to reload only the objects which have changed.

Interface

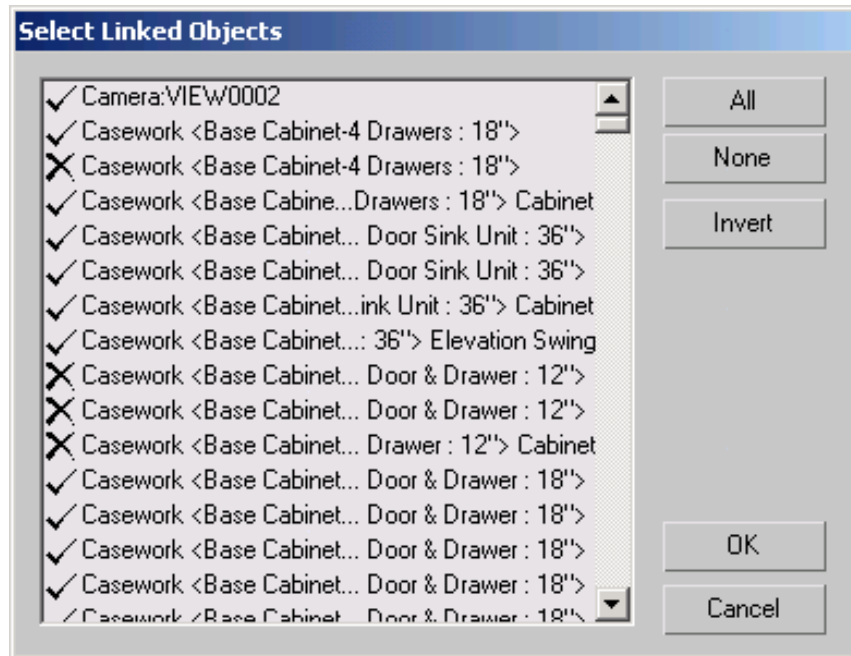

List of Objects Lists the VIZBlocks, cameras, and lights associated with the selected linked file. A check mark beside the object name indicates the object is selected; an X mark indicates the object is deselected.

All Selects all linked objects in the linked file. You can then deselect specific linked objects by clicking their rows.

None Deselects all linked objects in the linked file. You can then select specific linked objects by clicking their rows.

Invert Reverses the current selection of linked objects in the linked file.

Working with AutoCAD, AutoCAD Architecture, and Revit Files

3ds Max produces rich visualizations based on your drawing design data. In order to produce high-quality visualizations, you need to add and adjust many design variables that affect the visual impact of your design, but don't really belong in your core AutoCAD, AutoCAD Architecture, or Revit data. You may want to test your design under different lighting conditions, experiment with different texture and material effects, animate components, or move through a space. 3ds Max allows you to enhance your design with this “extra” data while maintaining the integrity of the underlying AutoCAD, AutoCAD Architecture, or Revit design.

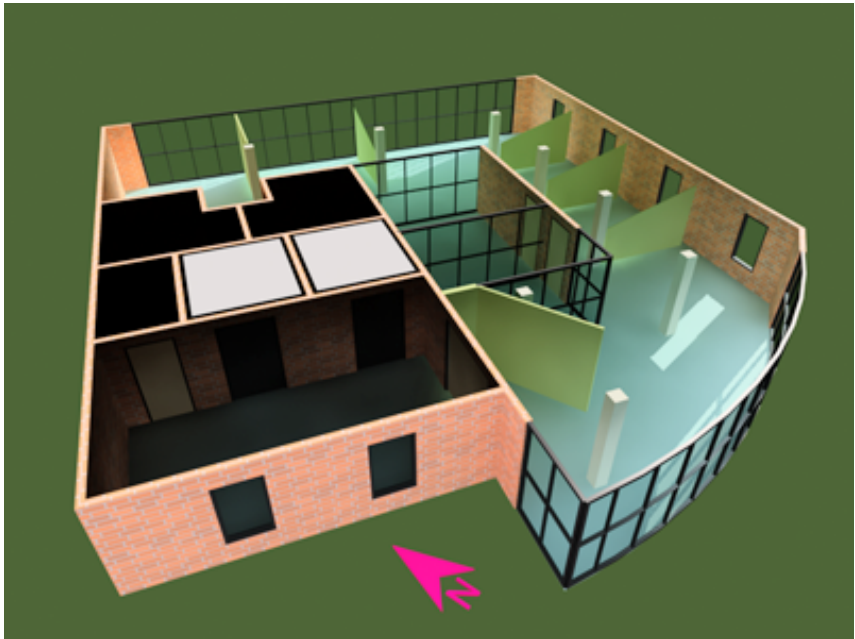

Using the [File Link Manager](#) on page 6987, 3ds Max maintains a live data link to AutoCAD, AutoCAD Architecture, or drawings exported from Revit that allows you to use the linked object data in your 3ds Max scene. You can perform various operations on this linked data in 3ds Max for visualization purposes, but nothing you do in 3ds Max will change the base data you see in the source application. The data link allows you to periodically refresh your 3ds Max scene with revised drawing data.

If a live data link is not important to you, the DWG/DXF Import functionality processes drawings, exported from Revit, in the same intelligent way as the File Link Manager. You just don't have the benefit of the live data link.

See also:

- [Using Layers to Organize a Scene](#) on page 7438
- [File Link](#) on page 6976
- [Interpreting Layer Data from AutoCAD, AutoCAD Architecture, and Revit](#) on page 6986

AutoCAD Geometry in 3ds Max

The basis of your model in 3ds Max is the geometry of the objects, blocks, and other entities that are transferred through the file linking functionality. In many cases, these objects behave just like the editable meshes and splines you create in 3ds Max. But because the link to the source drawing plays such a central role in your workflow, 3ds Max has special rules and tools for handling linked AutoCAD geometry.

When you are working with linked objects and blocks from AutoCAD, you will find that these are composed as groups of related objects in 3ds Max. These groups are organized hierarchically below a 3ds Max *VIZBlock* object. VIZBlocks are special objects created by the file linking functionality that are used to contain other file linked objects in a group. VIZBlocks don't contain any geometry directly, so for example it is meaningless to apply modifiers to them. However, they do reference the components below them so that transforms applied to a VIZBlock will be applied to all the component objects it contains.

See also:

- [Styles](#) on page 7054
- [Instanced Objects](#) on page 7047
- [Blocks](#) on page 7048

AutoCAD Entities and Blocks in 3ds Max

AutoCAD blocks in 3ds Max are treated similarly to AutoCAD objects, though the rules for propagation of transforms are slightly different to mirror the behavior of blocks in AutoCAD.

As with AutoCAD objects, linked AutoCAD blocks, of any type, and externally referenced drawings appear in 3ds Max as objects hierarchically grouped below a VIZBlock to reflect the structure of the block or xref in AutoCAD.

When non-nested blocks, of any type, are linked to a scene, the naming for the incoming block instances are based on the original block definition in the form of *Block: block_name* where *block_name* is the actual name of the block definition. For example, if you link a drawing containing a series of blocks named *office chair*, their name will show as *Block: office chair* in 3ds Max.

Nested blocks in AutoCAD will be analogously nested in 3ds Max under nested VIZBlocks. The grouping and naming follows the parent-child structure of *xref drawing name:block name:nested block name:entity*.

NOTE Entities that lie on layer 0 of an AutoCAD block definition will appear as *Layer:0* in 3ds Max, even though they may appear to reside on a different layer when they are inserted in AutoCAD.

With linked AutoCAD Architecture objects, material assignments to linked AutoCAD blocks can propagate automatically to all other instances of those block components in the 3ds Max scene, depending on how [Propagate Materials To Instances](#) on page 5328 is set. Modifiers applied to block components, however, propagate automatically to all other block instances, regardless of how Propagate Materials To Instances is set.

If you transform (move, rotate, or scale) the top-level VIZBlock that contains a block reference, all the components of that block will be transformed together and no other VIZBlocks will be affected. If, however, you transform a block *component*, including a nested VIZBlock, that transformation will automatically propagate to all other instances of that block in the scene. This mirrors the behavior of blocks in AutoCAD when reference-editing a block definition.

See also:

- [Blocks](#) on page 7048

Resetting Transforms on Linked AutoCAD Objects

Select a linked AutoCAD object. > Modify panel > Linked Geometry rollout > Reset Position

You can move, rotate, or scale linked AutoCAD objects in 3ds Max, and these transformations will remain intact even after the linked AutoCAD drawing has been reloaded. But you can choose to eliminate the transforms on an object-by-object basis using the Reset Position function, available on the Modifier panel.

NOTE The Reset Position functionality is only available for linked files. It is *not* available when you Import a DWG file, or when you have bound a linked file.

Every linked AutoCAD object and component has a Reset Position function associated with it. Clicking this button automatically resets all transformations that have been applied to this object or component in 3ds Max, so that the component resumes the location, rotation, and scale it held in the linked AutoCAD drawing when it was last reloaded.

WARNING Transforms applied to block components are applied to all instances of that component in all other linked block insertions in the 3ds Max scene. Resetting the transformation of *any* instance will reset *all* of them.

To reset the transforms applied to a linked AutoCAD object:

- 1 Select a linked object in your scene.
- 2 On the Command panel, click the Modify tab to display the Modify panel.
The name of the linked object appears at the top of the Modify panel, and the modifiers that have been added to the object (if any) are shown on the modifier stack.
- 3 At the bottom of the list of applied modifiers, click either *Linked Geometry*, *VIZBlock*, or *Block/Style Parent*, whichever appears, if it is not already highlighted.
A Linked Geometry rollout appears at the bottom of the Modify panel.
- 4 Click the Reset Position button
The linked object reverts back to its original location, rotation, and scale in the linked AutoCAD drawing.

NOTE When Reset Position is applied to a linked object that has been animated (in other words, has transform keys for different frames) only the transform for frame 0 is reset.

See also:

- [File Link](#) on page 6976

Interface

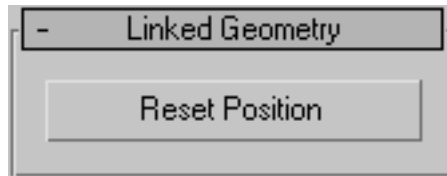

Reset Position Resets the selected object's transforms to those of the original AutoCAD object when the drawing was last reloaded.

Restrictions on Editing AutoCAD Geometry

Many operations that are allowed on mesh, spline, or shape objects in 3ds Max are not allowed on linked AutoCAD geometry, and other operations behave differently.

The following operations are not allowed on linked geometry:

- Deletion
- Altering the parent-child hierarchy
- Collapsing the linked geometry into an editable mesh or an editable spline

If you must perform any of these operations, you must either do them in AutoCAD or else bind the drawing data to 3ds Max, which breaks the link back to AutoCAD.

Applying Modifiers to Linked AutoCAD Geometry

You can apply modifiers to linked AutoCAD geometry and these modifiers will persist when you reload the geometry. This can be a very powerful way

to intelligently manage your design intent, but it can also lead to some unexpected results, especially when using *topology-dependent* modifiers.

“Topology-dependent” simply means that the modifier is relying on the particular arrangement and number of faces and vertices that comprise the mesh representation of the object. It is common, for example, for the modifier to cause an action to be performed on the *n*th element it encounters, say the “twelfth” face or the “fourth through the twentieth” vertex. It is easy to perform edits on the base object in AutoCAD that would cause the definition of the *n*th element to change, which would result in the modifier yielding unexpected results when the drawing is reloaded in 3ds Max.

Not all modifiers are topology-dependent. When you attempt to use a topology-dependent modifier on linked AutoCAD geometry, a warning dialog is displayed that gives you an opportunity to continue or abort the operation.

When you use modifiers on linked AutoCAD objects and blocks, remember that the VIZBlock object you see in 3ds Max does not contain any geometry directly; applying modifiers to VIZBlocks will never have any visible effect. Instead, apply modifiers to the component objects below the VIZBlock in the 3ds Max object hierarchy.

Copying Actively Linked Objects

You can *copy* actively linked objects in 3ds Max; the copies are automatically converted to editable mesh objects. If your selection contains several objects that instance another object, the resulting copies also instance the same object.

However, it is recommended that you do not instance or reference actively linked objects, as this can introduce instability to the scene.

See also:

- [Using Modifiers](#) on page 1085

AutoCAD Architecture Files

DWG files from AutoCAD Architecture (formerly Architectural Desktop or ADT) often contain additional information, such as special objects, material definitions, and styles. 3ds Max is thoroughly compatible with AutoCAD Architecture, and it recognizes all of these specialized objects and definitions during the file link process.

AutoCAD Architecture Objects in 3ds Max

Each instance of an AutoCAD Architecture (formerly Architectural Desktop or ADT) object is represented by multiple objects in 3ds Max. Whenever the file link process detects a useful distinction between elements of an AutoCAD Architecture object, it automatically separates, names, and groups the elements in 3ds Max to make them easier to work with. The new objects created in 3ds Max through file linking are grouped together hierarchically below a special object called a *VIZBlock*, allowing you to deal with individual objects in the hierarchy or with all of them as a group. You can view this hierarchy, but you cannot change it in 3ds Max. You can only change the hierarchy indirectly by editing the objects in AutoCAD Architecture, and then reloading them into 3ds Max using the [File Link Manager](#) on page 6987.

Criteria for Subdividing AutoCAD Architecture Objects

The File Link Manager divides an AutoCAD Architecture object into multiple objects in 3ds Max if it detects distinctions based on the following features:

- Component name
- Component subtype (for example, in sectioned bodies)
- Layer
- Material assignment

So, for example, if a window object in AutoCAD Architecture contained a mullion component, but a portion of the component had a different material assignment than the rest of it, the mullion component would appear as two separate objects when linked into 3ds Max. The objects will be linked together with all the other components of the window, but you could modify the material properties of the two mullion objects separately. If you changed the material assignments in AutoCAD Architecture so that the entire mullion component only had one material assignment, then when you reloaded the drawing in 3ds Max there would only be one mullion object present.

NOTE Material assignment and Layer are two of the properties used to separate one component from another. When these are changed in the AutoCAD Architecture drawing, new objects are created in 3ds Max, or geometry may move from one object to another. In either case, some scene properties are changed, such as assigned material or scene layer.

3ds Max organizes and names file linked objects to reflect their structure in AutoCAD Architecture, using a parent-child hierarchy. The parent object will be a VIZBlock named *object class <style>*, and this VIZBlock will have one or more child objects named *object class <style name> component1*, *object class <style name> component2*, and so forth. Objects that originate in an xref drawing in AutoCAD Architecture are grouped together under a VIZBlock that is named for the xref drawing.

The following table lists some examples of the naming conventions of AutoCAD Architecture objects that are file linked in 3ds Max.

Name in 3ds Max	Remarks
Xref:Draw- ing1XRef:5701	A VIZBlock containing one or more objects found in <i>drawing1.dwg</i> , which is an xref in the linked AutoCAD Architecture drawing.
Window <Picture- Arched>	A VIZBlock for an object of class= <i>Window</i> and style= <i>Picture-Arched</i> . There will one or more components that belong to this object instance, which will be child objects with the VIZBlock as their parent.
Window <Picture- Arched> Frame	A component to the object, named <i>Frame</i> .

NOTE It is possible for instances of the same AutoCAD Architecture object to subdivide differently into 3ds Max objects. AutoCAD Architecture objects are considered instances of the same object if their type, style name, and component name are exact matches, and this will affect their instancing behavior for 3ds Max functions such as substitution as well as material propagation.

See also:

- [Instanced Objects, Elements, Blocks and Styles](#) on page 7046
- [Styles](#) on page 7054

Materials and Linked AutoCAD Architecture Objects

Materials in 3ds Max are vital to making your visualizations compelling and realistic. The native material attributes that 3ds Max relies on are those that tell it how to render the surface of an object given certain lighting conditions. Those material properties that are so central to architectural visualization (that convey surface coloring, surface texture, transparency, and so forth) are only one of many sets of properties covered in an AutoCAD Architecture (formerly Architectural Desktop or ADT) material definition. To make your work more efficient, the rendering material properties stored and assigned in AutoCAD Architecture are designed to flow transparently to 3ds Max through the [File Link Manager](#) on page 6987.

See also:

- [Propagate Materials to Instances](#) on page 5328

Assigning Materials to Linked AutoCAD Architecture Objects

Material assignments exhibit special behavior on linked AutoCAD Architecture objects and blocks, and the behavior is controlled by the [Propagate Materials To Instances toggle](#) on page 5328.

In the default state, assigning a material to any component of any linked AutoCAD Architecture object or block is equivalent to assigning the same material to every instance of that component of that object or block throughout your scene.

As an example, let's say you have multiple instances of a block named Telephone in your AutoCAD Architecture drawing, which consists of two nested blocks named Handset and Base. If you assign a material to one Handset anywhere in your scene, all the Handsets in all the Telephones throughout the scene will receive that material.

If you want to keep materials from propagating between instances in your scene, turn off the [Propagate Materials To Instances toggle](#) on page 5328.

See also:

- [Instanced Objects](#) on page 7047
- [Blocks](#) on page 7048

Making Changes to AutoCAD Architecture Materials

AutoCAD Architecture (formerly Architectural Desktop) object components frequently appear in 3ds Max carrying rendering material assignments that were made in AutoCAD Architecture. You can use these materials, adjust them, or replace them with new rendering materials for use in 3ds Max. If you modify or replace the materials in 3ds Max, or if they change in the linked AutoCAD Architecture drawing, you can choose either to retain the current material in 3ds Max or else to revise the material assigned in 3ds Max with the current material in AutoCAD Architecture when you use the [File Link Manager](#) on page 6987 to reload the linked drawing.

NOTE When 3ds Max encounters additional material references among xref files that use a material name that is already in use, it compares the properties of the two material definitions in an attempt to determine whether they really represent identical materials. If the two materials appear to be the same material being used in different drawings, 3ds Max will use only one of the material definitions for all objects assigned either material. But if 3ds Max determines that this is merely a naming conflict between two different materials, it will slightly modify the name of one of the materials and keep the materials and their assignments distinct.

Legacy Materials in AutoCAD Architecture

Longtime users of AutoCAD may be familiar with an older form of material creation and assignment associated with the RMAT command in AutoCAD that is still present in AutoCAD Architecture. Materials developed in this way can be viewed in AutoCAD Architecture and rendered with the legacy AutoCAD renderer. Any assignments of these materials to geometry in AutoCAD Architecture that is made through the RMAT command or its Material dialog in AutoCAD Architecture will be ignored in 3ds Max.

In theory, RMAT materials could be assigned to AutoCAD Architecture objects (not AutoCAD objects) by incorporating them into AutoCAD Architecture material definitions, and using these material definitions in edits to AutoCAD Architecture styles or object overrides. Materials created and assigned in this

way would appear in 3ds Max assigned to the linked AutoCAD Architecture objects. However, this practice is not recommended because the native 3ds Max Architectural materials have more complete information on the surface characteristics of objects, and are easier to create and share. In other words, you work faster, share easier, and get better results using native 3ds Max rendering materials in both AutoCAD Architecture and 3ds Max.

See also:

- [Material Editor, Materials, and Maps](#) on page 5259

UVW Mapping in AutoCAD Architecture Objects

An important consideration in how many materials render is how they are “mapped” to the surfaces of the objects they are assigned to. This is especially important for materials that use [bitmaps](#) on page 7926 to define the diffuse color of a material, or the bump and cutout special effects. As an example, you may have scanned a picture of wood grain for use in a material, but when the material is applied to an object, how large should the image of the wood grain be? Which way do you want the grain to run, and how do you want the grain to wrap around the corners of a three-dimensional object?

How two-dimensional maps are applied to three-dimensional surfaces is represented by [mapping coordinates](#) on page 8034, which are stored as [UVW coordinates](#) on page 8161. In cases where mapping coordinates are likely to be important to the rendered appearance of an object, AutoCAD Architecture (formerly Architectural Desktop) assigns UVW coordinates to object components. 3ds Max translates these coordinates and stores them in the object mesh that is displayed and rendered in the 3ds Max scene. You can adjust these coordinates in 3ds Max using the [UVW Xform modifier](#) on page 1955, or you can redefine them all at once using the [UVW Map modifier](#) on page 1931.

IMPORTANT Make sure that Rescale is turned on in the Attach Panel of the File Link Manager dialog. Otherwise, if the units do not match, the UVW coordinates will be incorrectly scaled when linked to 3ds Max.

Drawings Exported from Revit

The Export function in Autodesk Revit lets you export models to DWG or DXF file formats. In Revit 6.1 and 7.0, the exported drawing entities contain

additional information, “*Revit data*,” such as their originating Category, Family, Type, and Material.

The [File Link Manager](#) on page 6987 and DWG/DXF Import functionality looks for and processes this additional information. When “*Revit data*” is found with an object, the object is treated differently by the import/file link process. The primary differences are:

- object naming conventions
- scene organization of incoming geometry (how the objects are combined)
- parent-child hierarchy of scene objects
- possible automatic material assignments

IMPORTANT 3ds Max cannot directly import (or link) a native Revit project (RVT). You must first export a DWG or DXF file from Revit before you can import the model into 3ds Max. The imported or linked file will contain scene objects that correspond directly to individual Revit objects. In addition, most materials are translated and assigned to the objects, giving Revit customers a head start toward better visualization and faster rendering of their models.

See also:

- [Revit Elements in CEV_ProdName_CEV](#) on page 7032
- [Materials and Linked Revit Objects](#) on page 7041

Revit Elements in 3ds Max

Whenever you use the File Link Manager or DWG/DXF Import functionality, 3ds Max detects a useful distinction between categories of a Revit elements. It automatically separates names and groups the elements in 3ds Max to make them easier to work with. The new objects created in 3ds Max through file linking are grouped together hierarchically below a special object called a [Block/Style Parent](#) on page 7928, allowing you to deal with individual objects in the hierarchy or with all of them as a group. This hierarchy is similar to the one created when AutoCAD Architecture objects are linked.

You can view this hierarchy, but you cannot change it in 3ds Max. You can change the hierarchy only indirectly by editing the elements in Revit, exporting an updated DWG, and then reloading the drawing.

Criteria for Subdividing Revit Elements

The File Link Manager organizes Revit elements into multiple 3ds Max objects based on the following classification of elements:

- **Categories** Categories are the most general class of element. They are subdivided into *model categories* and *annotation categories*. Model categories include doors, windows, walls, and furniture. Annotation categories include dimensions, grids, levels, and text notes.
- **Families** Families are classes of elements within a category that group elements with a common set of parameters (properties), identical use, and similar graphical representation. Different elements within a family may have different values of some or all properties, but the set of properties—their names and meaning—is the same. For example, six-panel colonial doors are one family, although the doors that compose the family come in different sizes and materials. Most families are component family files, which means you can load them into your project or create them from family templates. You can determine the set of properties and the graphical representation of the family. Other families are called *system families* and are not available for loading or creating in Revit. Autodesk Revit predefines the set of properties and the graphical representation of system families; they include walls, dimensions, ceilings, roofs, floors, and levels.
Besides being a class of elements, families are also a template that allows you to generate new types of items that belong to this family.
- **Types** Types, also called a family types, are a class of elements within a family that have the exact same values for all type properties. For example, all 32x78 six-panel doors belong to one type, while all 24x80 six-panel doors belong to another type. Like a family, a type is also a template that generates new instances of this type.
- **Instances** Instances are the actual items that have specific locations in the building (model instances) or on a drawing sheet (annotation instances).

3ds Max organizes and names file linked objects to reflect their structure in Revit, using a parent-child hierarchy. The parent object is a Block/Style Parent named *category <family : type>*, and the Block/Style Parent has one or more child objects named *category <family : type> subcategory1*, *category <family : type> subcategory2*, and so forth.

For example, if a single-flush door object in Revit is linked to 3ds Max, it will have a parent-child hierarchy displayed as a parent object, *Doors <Single-Flush*

: 34" x 80">, with three children, (2) Doors <Single-Flush : 34" x 80"> Frame/Mullion and a Doors <Single-Flush : 34" x 80"> Panel. The objects will be linked together with all the other components of the door, but you could modify the material properties of the two frame/mullion objects separately. If you changed the material assignments in Revit so that the entire frame/mullion component only had one material assignment, then when you reloaded the drawing in 3ds Max there would only be one frame/mullion object present.

When working in Revit, you also have the ability to link AutoCAD drawings or other Revit projects to your current project. This is comparable to using xrefs in AutoCAD. Objects that originate as a linked drawing in Revit are grouped together as Linked Geometry that is named for the linked drawing. In this case, the parent object is named *Import Symbol <drawing.dwg>* and its children are named *Import Symbol <drawing.dwg> subcategory1*, *Import Symbol <drawing.dwg> subcategory2*, etc. The subcategories are derived from the layers that the objects reside on in the drawing.

The following table lists some examples of the naming conventions of Revit objects that are imported or file linked in 3ds Max.

Imported/File Linked Name	Remarks
Door <Single-Flush : 34" x 80">	A Block/Style Parent for an object of category= <i>Door</i> , family= <i>Single-Flush</i> and type= <i>34" x 80"</i> . This parent object has one or more components, that are child objects displayed as Linked Geometry.
Window <Casement with Trim : 24" x 48"> Frame/Mullion	A component to an object named, <i>Window <Casement with Trim : 24" x 48"></i> . This is a child object and is displayed as Linked Geometry. In Revit, the Frame/Mullion is a subcategory of Windows.
Casework <Base Cabinet-4 Drawers : 18">	A Block/Style Parent object named, <i>Casework <Base Cabinet-4 Drawers : 18"></i> and the

Imported/File Linked Name	Remarks
Casework <Base Cabinet-4 Drawers : 18"> Casework <Base Cabinet-4 Drawers : 18"> Cabinet	two, child components, <i>Casework <Base Cabinet-4 Drawers : 18"></i> and <i>Casework <Base Cabinet-4 Drawers : 18"> Cabinet</i>
Import Symbol <drawing1.dwg>	This object is Linked Geometry containing one or more components found in <i>drawing1.dwg</i> , which is a drawing that is linked to the Revit drawing. This linkage is comparable to an xref in AutoCAD.

NOTE It is possible for instances of the same Revit element to subdivide differently into 3ds Max objects. Revit elements are considered instances of the same element if their category, family, and type name are exact matches, and this will affect their instancing behavior for 3ds Max functions such as material propagation.

Revit Cameras and Views

In order to navigate a Revit drawing more efficiently, you might have set up a series of 3D views by means of placing cameras at different viewpoints around the drawing. The File Link Manager and Import functions of 3ds Max allow camera views to be treated as 3ds Max cameras.

You must meet two conditions in order for 3ds Max to understand Revit camera views.

- A camera view must be active *before* you export the DWG file from Revit.

NOTE Only the active camera view is exported.

- You have to make sure you've turned on the Views (cameras) switch in the [Basic File Link Settings dialog](#) on page 6998.

When the drawing is linked to 3ds Max, that camera and its target appear in the scene named *Camera:viewname* and *Camera:viewname.Target*.

Light Sources

Drawing files, exported from Revit, can contain light sources, however, they do not export with the DWG or DXF files. What does get exported is the 3D mesh geometry representing the light fixture. Therefore, when you import or link the drawing to 3ds Max, the light object is strictly geometry, not an actual light source like a spotlight or omni light that you can adjust.

These pieces of geometry are still useful in that you can use them as reference points for placing and aligning lights you add in 3ds Max.

DXF Files

Along with the ability to export DWG files, Revit can also export to the DXF file format. The only difference is in how they handle drawings that are linked (RVT links) to the Revit drawing.

When exporting to DXF, the linked drawings are automatically bound to the drawing. Therefore, while exporting to a DWG honors the linked drawings and treats them as AutoCAD xrefs, an exported DXF file will not have xrefs. Instead, the linked drawings are converted to blocks.

The resulting scene organization will be slightly different when linking or importing a DXF as opposed to a DWG, but only when RVT links are present in the drawing.

See also:

- [Instanced Objects, Elements, Blocks and Styles](#) on page 7046
- [Styles](#) on page 7054

Suggested Settings and Workflow

Suggested Settings for Revit Projects

The File Link Manager and DWG/DXF Importer have many settings that you can adjust so you get the best results when linking or importing a drawing that you've exported from Revit. In this section, you'll find some recommended settings that you can use when linking or importing your DWG files. These settings are found on the [Basic File Link Settings dialog](#) on page 6998, the [Advanced File Link Settings dialog](#) on page 7002, the [Spline Rendering File Link](#)

[Settings dialog](#) on page 7010, and the [AutoCAD DWG/DXF Import Options dialog](#) on page 7182.

Use the Revit Preset

3ds Max includes a preset named “*Revit*” that you can use when using File Link to link a drawing that is exported from Revit. The Revit preset has many of the following suggested settings turned on by default. Or, you can use the Revit preset as a basis for your own customized Revit preset containing the settings you prefer.

The Revit preset can be assigned from the Preset list on the Attach panel of the [File Link Manager](#) on page 6987. You can [edit the preset](#) on page 7016 by choosing the Revit preset shown on the Presets panel of the File link Manager.

If you plan on creating your own presets or modifying the Revit preset, use these settings to streamline the file linking process.

Turn on Weld and set a Weld Threshold

- Weld and Weld Threshold are found on the Basic panel of the File Link Settings dialog or in the Geometry Options group of the AutoCAD DWG/DXF Import Options dialog.

When Revit exports model geometry to a DWG file, objects are translated as multiple surface meshes. For example, a single wall is made up of 6 or more AutoCAD entities; each a polyface mesh with vertices that overlap their neighbors. When the meshes get linked to 3ds Max, the File Link Manager or DWG/DXF Importer recombines them back to a single object. However, when the meshes are recombined, their vertices are not welded, so you end up with a larger and less elegant model than expected. By turning on the Weld option and setting an appropriate Weld Threshold (like 0.1" or smaller), coincident vertices are welded together and the file structure is more efficient.

NOTE This is particularly important if you plan to do radiosity rendering because gaps in the model can cause leaks that greatly increase the rendering time.

Turn on Views (cameras)

- Views (cameras) is found in the Include group on the Basic panel of the File Link Settings dialog and the AutoCAD DWG/DXF Import Options dialog.

If you've set up one or more cameras in your Revit project, the File Link Manager or DWG/DXF Importer will recognize and link a camera when the Views (cameras) option is turned on. There is, however, a catch. Before you export a DWG from Revit, the camera view must be active and *only* the active camera will be exported.

Avoid Entity and Entity, Blocks as Node Hierarchy

- On the Advanced File Link Settings dialog, when choosing a Derive AutoCAD Primitives By option, avoid Entity and Entity, Block as Node Hierarchy.

Elements are occasionally missing Revit embedded data. When this data is missing, the objects are "derived" according to the Derive AutoCAD Primitives By setting. Deriving by either of the Entity choices will not, generally, give you the end result you want and could result in a scene in 3ds Max that contains a vast number of individual objects. In particular, these settings can cause issues with railing balusters.

Use Layer, Blocks as Node Hierarchy

- On the Advanced File Link Settings dialog, use Layer, Block as Node Hierarchy, when choosing a Derive AutoCAD Primitives By option.

The Layer, Blocks as Node Hierarchy derive by option, often gives the best results for linking DWG files, especially when the Revit project has other drawings, [RVT links](#) on page 8110, linked to it. Combining by Layer (node hierarchies or not) is the preferred setting. RVT links get exported to the DWG as xrefs. If you want the File Link Manager to preserve color and material assignments of those objects, Layer, Blocks as Node Hierarchy is the setting to use.

Turn on Material Definitions and Assignments

- The Use Scene Material Definitions and Use Scene Material Assignments on Reload switches are on the Advanced File Link Settings dialog.

These two switches are quite important when you've got materials assigned in your Revit project.

When the Use Scene Material Definitions switch is turned on, 3ds Max checks the scene for any currently used materials matching the exact same name as a material name in the linked DWG file. If a match is found, File Link does

not translate the drawing's material, and instead uses the material defined in the scene.

When turned off, the File Link Manager always uses the material definitions contained in the DWG file, and will overwrite scene materials with the same name, regardless of which objects the material is applied to. In addition, material definitions are always reloaded from the DWG file, so if you make changes to a linked material, then reload, those changes will be lost.

If the Use Scene Material Assignments on Reload switch is turned on, linked objects with a material already assigned to them in the 3ds Max scene will not have that material assignment changed. When turned off, linked objects have their material assignment 'coordinated' with the drawing, so that the two are in-sync.

Determine how you want Splines Handled

- The settings on the Spline Rendering File Link Settings dialog control how shapes and splines are linked or imported into 3ds Max.

In your original project, you may have used 2D lines to represent joints between sidewalk pavers or as mullions separating sections of a curtain wall. The settings on the Spline Rendering panel let you use those lines more advantageously.

When you turn on Enable In Renderer and/or Enable In Viewport, lines are visible when you render the scene or are treated as selectable objects in the scene. You can also adjust the appearance of lines by having them display as radial or rectangular geometry.

TIP Using the [Sweep modifier](#) on page 1780 with 2D splines or shapes lets choose a cross-sectional shape that is swept along the spline resulting in much more scene detail.

Suggested Workflow for Revit to 3ds Max Projects

Most of the work you do on your Revit project will be done in Revit. The initial design, layout and modeling all occurs from within the Revit program. 3ds Max comes into play when you're ready to produce some higher end renderings and perhaps add some final details.

Following is a basic description of the expected workflow between Revit and 3ds Max:

- 1 You've completed most of the design work in Revit and you're ready to add finishing touches and create some presentation renderings.
- 2 From Revit, export a DWG file.
Exporting to a DWG file is necessary because the File Link Manager cannot accept the “native” Revit project (RVT) files.
- 3 Start 3ds Max and use the File Link Manager to link the DWG file.
Link the drawing using presets that include the linking settings you want as described in the [Suggested Settings for Revit Projects](#) on page 7036 section.
- 4 Adjust materials or make final modifications in 3ds Max in preparation for rendering.
Depending on the results at this stage, you may find that the Revit project needs to be changed and updated.
- 5 In Revit, makes changes to the project like moving walls, adding new doors and windows or adding/removing objects.
For structural changes like adjusting walls, doors, windows, etc., it's best to make these changes in Revit because those changes need to be included in the originating project. File Link is a one way link so any changes you can make in Revit, should be made in Revit. Otherwise, you'd have to remember to make the same changes in both 3ds Max and Revit.
- 6 When the changes are completed, export another DWG file with the same name as the original DWG file you exported in step 2.
If you give a new name to the exported DWG, the File Link Manager will not show that the currently linked file has been updated.
- 7 In 3ds Max, open the File Link Manager and review the Files panel. Select the updated file link and click the Reload button — Turn on Show Reload Options if you want to change link settings.
The changed model reloads to 3ds Max and changes made to the model in 3ds Max prior to the reload are retained.

The  symbol means the DWG file has been updated.

Materials and Linked Revit Objects

When you export a DWG or DXF from Revit projects, materials are translated into a format that 3ds Max can understand. Revit creates materials in the same format as used by AutoCAD Architecture, VIZ Render and 3ds Max. There are two kinds of materials associated with the Revit project; AccuRender materials and Revit materials. When a Revit material references an AccuRender material, the AccuRender material's parameters are used; otherwise, the Revit material parameters are used.

There is an important caveat to this. AccuRender materials that reference a bitmap file are translated in 3ds Max without any problems, while AccuRender materials that are considered "procedural" are only translated at the most basic level.

Therefore, an AccuRender material that uses a bitmap image in the base texture definition will provide a more accurate translation to 3ds Max.

NOTE There are some limitations on what is translated between Revit/AccuRender materials and 3ds Max materials because there is not a one-to-one correlation between the two material definitions.

Material Assignments

The Revit DWG Exporter puts embedded information on each object it exports. Amongst this information are identifiers specifying material assignments. Revit creates the same kind of material definitions used by AutoCAD Architecture, VIZ Render and 3ds Max. When imported or linked, 3ds Max uses this information to translate and maintain the material assignment to the resulting scene object.

Because the material identifier is embedded, if you opened the DWG in AutoCAD, you would not see the applied materials.

Revit offers many options for specifying a material to an object or class of objects. Likewise, there are many ways where material assignments can be overridden. The results you see in the 3ds Max scene, in terms of how the materials are applied, match what you see in the Revit model.

The exception to the rule would be if many of the materials are AccuRender procedural materials. In these cases, you will see only the diffuse color.

Texture Coordinates

Material textures on imported or linked objects have the same appearance as within Revit or AccuRender. Of course, the exception to this rule is when AccuRender procedural textures are used.

When materials from Revit are viewed in the 3ds Max Material Editor, you'll notice that some settings are not translated or they are not set as you're used to seeing in 3ds Max. For example, if the texture map of a flooring material has a rotation of 45 degrees in the Revit project, the rotation setting does not translate when the model is linked/imported to 3ds Max. The rotation for the texture map is set to zero in the 3ds Max Material Editor.

Map Scaling

The scale of material textures is of primary importance. The File Link Manager or DWG/DXF Importer attempts to read and translate the offset and tiling of the materials so the texture maps appear in 3ds Max as they do in Revit.

However, map scaling may differ because the Tile Size settings in Revit are measured in decimal feet or meters even if your Project Units are set to Decimal Inches or Millimeters. Once the model is linked or imported to 3ds Max, you can turn on Use Real-World Scale and match the Tile Size settings. The main thing is to pay attention to the Tile Size settings when you create the material in Revit.

As an example, let's say you've created a material in Revit that uses a brick texture map with an X: Tile Size set to 20 and a Y: Tile Size set to 16. If you open that material in the 3ds Max Material Editor, you will find that the Width and Height Size settings are automatically set to 20' and 16' respectively. The texture mapping will always be scaled correctly in the scene. How a material is displayed in the Material Editor depends on whether Use Real-World Scale is turned on or off.

See also:

- [Applying Materials to Linked Revit Objects](#) on page 7043
- [Editing Revit Materials in 3ds Max](#) on page 7043
- [UVW Mapping on Revit Objects](#) on page 7045
- [Propagate Materials to Instances](#) on page 5328

Applying Materials to Linked Revit Objects

As with models that are imported or linked from AutoCAD Architecture, there are special behaviors exhibited with materials assigned to linked Revit objects. The behavior is controlled by the [Propagate Materials To Instances toggle](#) on page 5328.

When applying materials to a linked drawing in 3ds Max, family and type plays an important role in material management. Assigning a material to any component of any linked Revit object is equivalent to assigning the same material to every instance of that component in every object with the same family and type throughout your scene.

As an example, say you have multiple instances of a *Doors <Single-Flush : 34" x 80">* door in your drawing, which consists of three components: two Frame/Mullion components representing the inside and outside trim and a Panel component. If you assign a material to one Panel component anywhere in your 3ds Max scene, all the Panels for all the Doors of that family and type throughout the scene will receive the new material.

If you want to keep materials from propagating between instances in your scene, turn off the [Propagate Materials To Instances toggle](#) on page 5328 from the Material Editor's Options menu.

See also:

- [Instanced Objects](#) on page 7047
- [Blocks](#) on page 7048

Editing Revit Materials in 3ds Max

Once a drawing is linked or imported to 3ds Max, you can modify or replace the materials. The File Link Manager maintains a list of materials that it links to 3ds Max. If you change the properties of an assigned material while working in 3ds Max, the new properties can get overwritten the next time you reload an updated drawing, exported from Revit.

During a File Link reload, if the Show Reload Options switch is turned on, you can control how materials are handled by using the *Use Scene Material Definitions* or *Use Scene Material Assignments on Reload* options.

AccuRender Materials

AccuRender materials consist of one or more base materials. For each base material you can set attributes such as color, reflectivity, transparency, index of refraction, bump maps, and image maps.

The Procedures list displays the simple materials that combine to form your final material definition and the rules for combining them. For simple materials, there is only one item in the list: Base. For complex materials, a tree indicates how the components combine. For example, the marble procedure consists of a Base material and a Vein material. While the Base material is considered a 'procedure', it is translated because it's at the bottom level of the material. The Vein material is ignored.

AccuRender materials that are applied to objects in the Revit drawing are translated when you link or import the drawing to 3ds Max. If the texture used for the material is a digital bitmap like a BMP or JPG file, the texture will be included with the material.

However, if the texture being used is one of the Procedures, the texture is not translated when the drawing is brought into 3ds Max. In these cases, you will see only the diffuse color.

See also:

- [Material Editor, Materials, and Maps](#) on page 5259

Procedures

To retain material settings made in 3ds Max during a reload:

- 1 On the Files panel of the File Link Manager, make sure the Show Reload Options switch is active.
- 2 Select the updated DWG file from the Linked Files list and click Reload.
- 3 Open the Advanced tab and turn on *Use Scene Material Definitions* and then click OK.

The updated DWG file is reloaded and Revit materials retain the setting changes you made in 3ds Max.

UVW Mapping on Revit Elements

An important consideration in how many materials render is how they are “mapped” to the surfaces of the objects they are assigned to. This is especially important for materials that use [bitmaps](#) on page 7926 to define the diffuse color of a material, or the bump and cutout special effects. As an example, you may have scanned a picture of wood grain for use in a material, but when the material is applied to an object, how large should the image of the wood grain be? Which way do you want the grain to run, and how do you want the grain to wrap around the corners of a three-dimensional object?

How two-dimensional maps are applied to three-dimensional surfaces is represented by [mapping coordinates](#) on page 8034, which are stored as [UVW coordinates](#) on page 8161. Revit assigns UVW coordinates to object components, so in cases where mapping coordinates are important to the rendered appearance of an object, 3ds Max translates these coordinates and stores them in the object mesh that is displayed and rendered in the 3ds Max scene.

Using Revit Materials on 3ds Max Geometry

After you've linked a DWG file that has been exported from Revit, you may find that some of the materials that were created in Revit could be used on new geometry you're adding while working on the model in 3ds Max. Reusing a material is often easier than creating a brand new one.

For example, let's say a wall element in the Revit project has a brick material that you'd like to use on an object you added to the model while working in 3ds Max. If you simply apply the material to the new object, you'll find that the texture map does not show as it does on the wall that came from Revit. This is because UVW coordinates of the new object are not set up to coordinate with the Tiling parameters of the Revit material.

When using Revit materials with objects created in 3ds Max, there are really two things to keep in mind;

- All materials from Revit use real-world scaling.
- Real-world scaling must be active for objects you've created in 3ds Max.

There are a few way to make sure your 3ds Max objects are using real-world scale.

- If you're working with a primitive object, like a box or cylinder, make sure Real-World Map Size is active.
- For more complex objects, apply a [UVW Map modifier](#) on page 1931 and make sure Real-World Map Size is active.
- Assign the object a [MapScaler modifier](#) on page 1514.

Instanced Objects, Elements, Blocks and Styles

The primary structural entities you will find in a model or project that is linked/imported to 3ds Max from AutoCAD, AutoCAD Architecture, or Revit are [style-based objects](#) on page 7054 (in ADT models), family elements (in Revit projects) or [blocks](#) on page 7048 (in both ADT and AutoCAD files). Each style-based object, family element, or block will most likely have many [instances](#) on page 7047 in the 3ds Max scene.

- *Instances* are multiple occurrences of objects such as style-based objects or blocks that are clone instances. When you link a model or drawing that contains instanced objects to 3ds Max, those objects remain instances of one another.
- *Family Elements* in a Revit project represent different items of a building and are separated into two general categories; Model and Annotation. The Model category includes such elements as walls, doors, windows and stairs while the Annotation category includes dimensions, text notes and section tags. When a DWG is exported from Revit and linked to 3ds Max, elements appear in the Modifier panel as [Block/Style Parents](#) on page 7928, meaning you've selected the element at its topmost level, or as [Linked Geometry](#) on page 8024, meaning one of the element's subcomponents.
- *Blocks* are reusable objects made in AutoCAD or Architectural Desktop. Blocks are made of one or more objects that can be inserted into a scene at different locations, scales and orientations. Blocks can also be an amalgam of other blocks. A block that is made of other blocks is referred to as a *nested block*. Once linked to 3ds Max, blocks appear in the Modifier panel as VIZBlocks, meaning you've selected the block at its topmost level, or as Linked Geometry, meaning one of the block's subcomponents.

NOTE If you use one of the “node hierarchy” Derive By settings, you will see Block/Style Parent objects in the Modifier panel and not VIZBlocks.

- AutoCAD Architecture *style-based objects* are complex objects like Doors and Windows whose components rely on style definitions to control how they appear in the scene. For example, style definitions for a door set the type of door, the door thickness, the materials assigned to the various components, and so forth. Altering the style definitions changes the appearance of the object in the scene.

See also:

- [Object Properties](#) on page 305

Instanced Objects

Instanced objects are AutoCAD, Revit, or AutoCAD Architecture objects or blocks that you can drag and drop into 3ds Max.

Modifiers and materials that are applied and assigned to an instanced object propagate throughout all instances of the object. For example, if all the doors in a scene have glass panes and you change the glass material of one door, all the doors of the same style will adopt that material. Propagation of materials can be controlled by toggling [Propagate Materials To Instances](#) on page 5328.

Once you link a model to 3ds Max, instanced objects can be transformed (moved, rotated, or scaled). If you don't like the way an object is transformed, you can use the Undo command or [Reset Transform button](#) on page 7024 on the Modify panel.

Family Elements

When modifiers and materials are assigned to family elements that are imported or linked to 3ds Max, they propagate throughout all instances of the element if their family and type match exactly. For instance, one particular part of your model shows a room with three doors. Two of the doors are *Doors <Single-Flush : 32" x 80">* and the third is a *Doors <Single-Flush : 36" x 80">*. If you change the panel material of one of the *Doors <Single-Flush : 32" x 80">* doors, the panel of the other *Doors <Single-Flush : 32" x 80">* door will also

change because their family, *Doors*, and type, *Single-Flush : 32" x 80"*, are identical.

Propagation of materials can be controlled by toggling the [Auto Material Propagation Toggle](#) on page 5328.

Blocks

The concept of *blocks* originated in AutoCAD. Blocks allow you to combine one or more objects into a single reusable object. As you work in AutoCAD or AutoCAD Architecture, you can insert blocks repeatedly in the drawing at various locations, orientations, and scales. If you change a block, the changes propagate automatically to all instances of that block throughout the drawing.

You then link the DWG file to 3ds Max, where your goal is to beautify the scene in preparation for rendering. Some of those preparations include such procedures as selecting a block instance so you can apply or adjust a material, applying texture mapping coordinates, unifying or flipping normals, and setting rendering properties. These procedures affect all other block instances in the scene.

The structure of *nested blocks*, blocks that are made from multiple sub-blocks, is maintained when you link an AutoCAD or AutoCAD Architecture drawing to 3ds Max. For example, if the block *Desk1* is made using several blocks, *Desk*, *Chair* and *Return*, you will be able to select any of *Desk1*'s sub-blocks to alter their rendering properties or materials. You can only access rendering properties for block components that appear as Linked Geometry on the Modifier panel. Blocks or sub-blocks, that appear as VIZBlocks in the Modify panel, do not have rendering properties because they are not renderable.

NOTE A change to the drawing in AutoCAD or AutoCAD Architecture is reflected in 3ds Max when you reload the linked model. Changes made in 3ds Max do not propagate back to AutoCAD or AutoCAD Architecture.

Block and Modifying Linked Geometry

Linked objects show up as *linked geometry* objects in the modifier stack. These objects don't allow access to sub-object levels where minor editing can occur at Vertex or Face levels. You must first add an Edit Mesh modifier to the object in order to access sub-object levels where you can perform operations like welding vertices or deleting faces. If you add a modifier to a block, the modifier is applied to all instances of that block. Likewise, any sub-object level editing to the originally selected block propagates to all other instances.

NOTE Any modifiers you apply to a block or block component in 3ds Max are preserved if you reload the file with the [File Link Manager](#) on page 6987.

If you move, rotate, or scale blocks or block components in 3ds Max, their new transform is preserved even if the linked model is reloaded from AutoCAD. Transforms applied to linked geometry in 3ds Max are relative to the transforms applied to the same objects in AutoCAD. Further, the transform propagates to all instances of that block or component. For example, if you move the *Chair* component of *Desk1*, the *Chair* component of all *Desk1s* in the scene will be moved. If the transform is undesirable, you can use the [Reset Transform button](#) on page 7024 on the Modify panel to put the block or component back to its original position.

When a modifier is applied to a block or block component, it propagates throughout all instances of the block or block component in the scene.

Limitations of Blocks

Blocks have some limitations when you link a drawing to 3ds Max.

- You cannot change the structure of actively linked blocks or their components in 3ds Max. In order to delete a block or component, you will have to bind the file, breaking the link.
- You cannot change the color of linked blocks or their components. Their color is set by layer when they're built in AutoCAD or AutoCAD Architecture.
- You can only access rendering properties for block components that appear as Linked Geometry on the Modifier panel. Blocks or sub-blocks, that appear as VIZBlocks in the Modify panel, do not have rendering properties because they are not renderable.
- You cannot [collapse](#) on page 1093 the modifier stack of an [actively linked](#) on page 7897 object.
- Layer assignments of linked geometry cannot be changed in 3ds Max if an object is actively linked. Layers can be reassigned if the model is bound.
- Cloning a block or block component is not possible if it is actively linked. You cannot select a block and use Shift+drag to duplicate it. This is also true for tools like Array, Mirror, and the Spacing Tool. Once a block or block component is bound, you can clone it.

Blocks and Materials

When assigning a material in 3ds Max to an instance of a block or block component, all the instances of that block or component are assigned the same material automatically. This is called *automatic material propagation*. This feature helps align 3ds Max behavior with that of AutoCAD Architecture.

If you find that a material you've assigned to a block or block component is not what you wanted, you can undo the material assignment by choosing Edit menu > Undo or pressing Ctrl+Z. If you undo a material assignment, the undo will propagate to all instances of the objects to which you assigned the material.

NOTE When assigning a material to a block or block component, you are not prompted to accept or cancel the material propagation. You can only control propagation of materials by toggling [Propagate Materials To Instances](#) on page 5328.

For more information about working with materials and assigning materials to blocks in 3ds Max, see the [Material Editor, Materials, and Maps](#) on page 5259 topic.

Multi-View Blocks (MVBlocks)

3ds Max accommodates both AutoCAD blocks and AutoCAD Architecture multi-view blocks through the file linking functionality, and for the most part the two block types behave similarly in 3ds Max with some exceptions.

The structure of AutoCAD Architecture multi-view blocks is expressed differently than AutoCAD blocks in 3ds Max. Rather than peer into the internal structures of multi-view blocks, as is done with AutoCAD blocks, 3ds Max relies on the multi-view block's own ability to draw its own 3D view, much as it does in the AutoCAD Architecture Object Viewer. Because of this, you will notice that multi-view blocks never exhibit nesting in their object structure when they are file linked into 3ds Max.

Behavior of instanced AutoCAD Architecture multi-view objects is different from that of AutoCAD blocks as well. Multiple instances of multi-view blocks require more memory in 3ds Max than do multiple instances of AutoCAD blocks. But multiple instances of multi-view blocks are better behaved when being cut by live section objects than their AutoCAD counterparts.

Dynamic Blocks

The File Link Manager handles dynamic blocks the same way as other blocks found in a DWG file. When linked to a scene, the naming for the incoming dynamic block instances are based on the original dynamic block definition in the form of *Block: block_name* where *block_name* is the actual name of the dynamic block definition.

Dynamic block instances, even those that have been grip-edited, display certain types of instance behavior such as material propagation, if the setting is activated from the [Material Editor Options menu](#) on page 5321. Below is a table showing instance behavior of dynamic blocks.

Property	Behavior
Modifiers	Modifiers applied to one component are applied to the same component in other instances, but only when those instances have the same grip property values.
Materials	When material propagation is turned on, materials are applied to all block instances. When turned off, materials are applied only to the current selection set. NOTE If you use the <i>Entity, Blocks as Node Hierarchy Derive By</i> setting for drawings containing dynamic blocks, materials may propagate to some block instances and not to others.
Node Properties	Changes to node properties are not propagated to block instances.
Transforms (on components)	Transforms, like move, rotate and scale, of one component will affect that same component in other block instance only when those instances have the same grip property values.

Keep in mind that elements of a dynamic block can be turned on and off by certain grip-edit operations depending on the way the dynamic block is defined. When one instance has a component and another doesn't, instance behaviors cannot occur between them because they are treated as instances of one another.

Modifier behavior of Dynamic Blocks during a File Link Reload

There is no change in modifier behavior for dynamic blocks that have not been grip-edited between one Reload and the next. All properties (materials, modifiers, node properties) are preserved. Dynamic blocks that have been grip-edited preserve their node name, node properties, scene-applied transform, and materials, but may lose applied modifiers and/or may inherit modifiers. This table shows the behavior of modifiers during a File Link Reload before and after dynamic block editing.

The Block Insert ...		
... has unique parameter values before it was edited.	... has unique parameter values after it was edited.	... shows this modifier behavior upon Reload.
Yes	Yes	Modifiers are preserved.
Yes	No	Applied modifiers may be lost, and it may inherit modifiers from the instance(s) it now matches.
No	Yes	Applied modifiers are lost.
No	No	Applied modifiers may be lost, and it may inherit modifiers from the instance(s) it now matches.

Blocks and Interactive Selection and Navigation

Once blocks and block components are linked to 3ds Max, you can begin adjusting their materials and properties. In a drawing for a small apartment, blocks are pretty easy to locate because the drawing is not very congested. You can simply select a block or one of its components in the viewport and alter it.

With complex drawings, finding the block or block instance you want can pose a problem. For example, a common block you might add to a drawing is a table. If you're designing a corporate headquarters that makes use of several different types of tables, finding the one you want to change becomes more difficult. There are several ways for you to find and select a block more precisely in 3ds Max.

- One way is by means of the block's name. When you link a drawing to 3ds Max, file linking creates a name such as *Block: ConferenceTable*. The first part of the name identifies the object's type, *Block*. The second part of the name indicates the block name, *ConferenceTable*. With this sort of naming breakdown, you can easily find a block using the [Select From Scene dialog](#) on page 228.
- Another selection method uses the Layer or Color setting you made for your block when you created it in AutoCAD Architecture. Because layer and color data is also linked to 3ds Max, you can select entire groupings of blocks using Select By Color or Select By Layer.
- Finally, you can select blocks by the type of material that's applied to them. Take care when selecting blocks this way because the material assigned to the block may also be assigned to other objects in the scene. Once you've selected a block or set of block instances, you can isolate them from the remainder of the model to work on them more efficiently.

To select a block by color:

- 1 Choose Edit menu > Select By > Color.
- 2 Select a block in the scene.
All blocks that share that color are selected.

To select blocks by name:

- 1 Choose Edit menu > Select By > Name, or press the H key to open the [Select From Scene dialog](#) on page 228.

- 2 While holding down the Ctrl key, select blocks with common names.
You can also enter the block name in the name field at the top of the dialog.
- 3 Click Select.
All blocks that share the specified name are selected.

To select blocks by layer:

- 1 Choose Edit menu > Select By > Layer.
- 2 Select a block in the scene.
All the blocks sharing that layer are selected.

To isolate selected objects:

- 1 Using one of the previous selection methods, select some blocks.
- 2 Choose Tools menu > Isolate Selection.
This hides all objects except for the selected blocks. A dialog is opens, indicating that isolation mode is active.

Styles

Styles are sets of parameters that you can assign to objects in AutoCAD Architecture to determine their appearance. This means an AutoCAD Architecture object references a style in order to determine certain aspects of its appearance. For example, a door style determines the type of door represented in the drawing, such as single or double hung, bifold or hinged, solid core or glass pane. You can assign one style to more than one object, and you can modify the parameters of that style to change all the objects that have the same style assigned to them.

For more information about how to work with styles in AutoCAD Architecture, refer to the *AutoCAD Architecture Reference*.

A style is made up of components. Each component defines dimensions and display properties per view. For example, the hatch pattern defined for component1 in Plan view can be different from the hatch pattern for the same component in Model view. Styles are grouped in categories that mirror the categories of AutoCAD Architecture objects. You perform model management, such as creating and deleting styles and style-components in AutoCAD

Architecture, and reload the modified scene into 3ds Max using the [File Link Manager utility](#) on page 6987.

When a model is linked to 3ds Max from AutoCAD Architecture, styles play an important role in assigning render materials and texture coordinates to AutoCAD Architecture object components described by style components. Components of an AutoCAD Architecture object often have predefined materials in their style definitions. This means that if you have many instances of an object in your drawing, you can quickly replace materials on all the objects without having to select each instance of the object.

'Style-based objects' is a more common term for AutoCAD Architecture objects that reference styles.

Limitations of Styles

Styles-based AutoCAD Architecture objects do have some limitations when a model is linked to 3ds Max.

- Changes to styles and their components performed in 3ds Max will not propagate back into AutoCAD Architecture.
- You cannot use any transform commands (Move, Rotate, or Scale) to clone an object that has an actively linked style. You have to make that type of change in AutoCAD Architecture.
- The structure of a style-based object in 3ds Max cannot be changed. You cannot add components to or delete them from a linked object.
- Objects on frozen layers in AutoCAD Architecture will not be displayed when the model is linked to 3ds Max.

NOTE This is not the case when Skip All Frozen Layers is turned off in your File Link settings.

Styles and Materials

The primary purpose of linking a model from AutoCAD Architecture to 3ds Max is preparing the scene for presentation to your clients and rendering. AEC Objects are made up of components that have default architectural materials assigned through their styles. You can select components from the [Select From Scene dialog](#) on page 228 or the [Scene Explorer](#) on page 7379 , and you can assign new materials or alter the existing material in the Material Editor.

For example, a door that is assigned the “Hinged – Single – Full Lite” style is made up of five components in AutoCAD Architecture: the Frame, Panel, Stop, Glass, and Muntins. Each component has a material assigned to it. For instance, the default material assigned to the Panel component of this type of door is “finish carpentry.wood.mahogany.” To change the Panel material in 3ds Max, you can select the Panel component and drag a new material to it from the Material Editor.

Because the Panel material is part of the door's style, your new material automatically propagates to any other door in the scene that is assigned the “Hinged – Single – Full Lite” style.

NOTE If you need to apply a material to individual objects, or object selections, rather than to all objects of the same style, you can use the command [Propagate Materials To Instances](#) on page 5328.

For more information about working with materials and assigning materials to objects in 3ds Max, see [Materials](#) on page 5259.

Styles and Interactive Selection and Navigation

Architectural drawings range from simple sketches to highly complex floor plans, so finding different components of a drawing can be difficult. Style-based objects from AutoCAD Architecture all have styles associated with them. So if you link a drawing to 3ds Max, objects with styles will be associated with them both in AutoCAD Architecture and in 3ds Max. Furthermore, in 3ds Max, the name of the object will contain the AutoCAD Architecture object category name (Door, for example), style name (Double Hinged) and component name (Panel).

You make most object and component selections in 3ds Max by selecting objects in the viewports. However, in complex models where objects and components may be spread across multiple layers or located in congested areas, style definitions help streamline the selection of reusable components in a drawing.

Once objects and components are selected, you can also isolate them from the remainder of the model to work on them more efficiently.

To select objects by style:

The Select Similar command has the same function in 3ds Max as it does in AutoCAD Architecture.

- 1 In a scene imported or linked from AutoCAD Architecture, select an object that contains the style of interest.

- 2 Choose Edit menu > Select Similar.

All objects or components that share that style, as defined in AutoCAD Architecture, are selected.

To select objects or components by color:

- 1 Choose Edit menu > Select By > Color.

- 2 Select an object in the scene.

All objects or components that share that color are selected.

To select objects or components by name:

- 1 Choose Edit menu > Select By > Name, or press the H key to open the Select From Scene dialog.

Alternatively, you could use the [Scene Explorer](#) on page 7379, accessed from the Tools menu. While functionally similar to the Select From Scene dialog, the Scene Explorer is modeless and can remain open while you're working.

- 2 While holding down the Ctrl key, select objects or components with common names.

You can also enter the object or component name in the name field at the top of the dialog.

- 3 Click Select.

All objects or components that share the specified name are selected.

To select objects or components by layer:

- 1 Choose Edit menu > Select By > Layer.

- 2 Select an object in the scene.

All objects or components that share that layer are selected.

To isolate selected objects:

- 1 Using one of the previous selection methods, select some objects.

- 2 Choose Tools menu > Isolate Selected.

All objects are hidden except for the selected objects or components. A dialog appears indicating that isolation mode is active.

Merge

File menu > Merge

Merge allows you to load objects from saved scene files into the current scene. You can also use Merge to combine an entire scene with another. This behaves similarly to the [XRef Merge dialog](#) on page 6956.

The Merge dialog lets you load and save [influences](#) on page 8012 with or without their dependents. In many cases, objects should be referenced with their influences, but the display only makes you aware of the relationships, it does not force you to externally reference them.

When you select an item in the list window and click Influences, the object's influences are selected in the list window. When you select an item in the list window and Display Influences is on, the object's influences are shown in blue in the list window. When you select an item in the list window and Select Influences is on, the object's influences are also selected in the list window.

Automatic Unit Conversion

When Respect System Units in Files is on in the [Units Setup dialog](#) on page 7809, in the System Unit Scale group, merged objects from a file with a different scene unit scale are scaled to maintain their correct size in the new scene. No conversion is done when merging files created in 3ds Max 1.x.

NOTE If Respect System Units is off (which is not recommended), a 100-foot radius sphere that was created in a 1 unit = 1 foot scene becomes a 100-inch sphere in a 1 unit = 1 inch scene.

Resolving Name Conflicts

Object Name Conflicts

When one or more incoming objects have the same name as objects in the scene, an alert gives you the following options:

Merge Merges the incoming object using the name in the field at the right. To avoid having two objects with the same name, type a new name before proceeding.

Skip Does not merge the incoming object.

Delete Old Deletes the existing object before merging the incoming one.

Apply to All Duplicates Treats all subsequent incoming objects with duplicate names the same way you specified for the current object. No further alerts will appear. This option is not available if you renamed the current object.

Cancel Cancels the merge operation.

Material Name Conflicts

When one or more materials assigned to incoming objects have the same name as materials in the scene, an alert gives you the following options:

Rename Merged Material Defines the name for incoming material.

Use Merged Material Assigns the characteristics of the incoming materials to the same-named scene materials.

Use Scene Material Assigns the characteristics of the scene materials to the same-named incoming materials.

NOTE Only top-level material names (not sub-materials) are checked for duplicates.

Auto Rename Merged Material Automatically renames the incoming materials to new names. Uses Material number names based on the next available Material number.

Apply to All Duplicates Treats all subsequent incoming Materials with duplicate names the same way you specified for the current object.

Parent Name Conflicts

When you merge an object that's linked to a parent object in a source scene, and an object of the same name as the original parent exists in the current scene, the [Merge File dialog](#) on page 7062 opens, giving you the option to re-create the same hierarchy.

See also:

■ [Merge Animation](#) on page 7063

■ [Merging Effects](#) on page 6587

■ [Open](#) on page 6922

■ [Replace](#) on page 7070

Procedures

To merge items:

This is the general procedure. Detailed steps follow.

- 1 Choose File > Merge.
- 2 Select a file from which to merge items.
- 3 Choose a group or an item to merge.

To specify object types to list, do any of the following:

- 1 Display or hide the subtree. If the subtree is not displayed, you can sort items in the list alphabetically or by type or color.
- 2 Select the object types that you want displayed in the list box.
- 3 Click All or None to select or clear all of the object types.

To select objects to merge, do any of the following:

- 1 Enter the name of an item, or use wildcard characters to specify multiple items that share a set of characters in their names.
- 2 Click to select single objects.
- 3 Press Ctrl and click to add and remove single objects from the selection.
- 4 Press Shift and click to select all objects between the previously selected object and the current object.
- 5 Click All or None to select or deselect the entire list.
- 6 Click and drag to select items to merge from the list on the left.

Interface

Use the Merge File dialog to open the scene file to merge. This opens the Merge dialog, whose controls are similar to those on the [Selection Floater](#) on page 231.

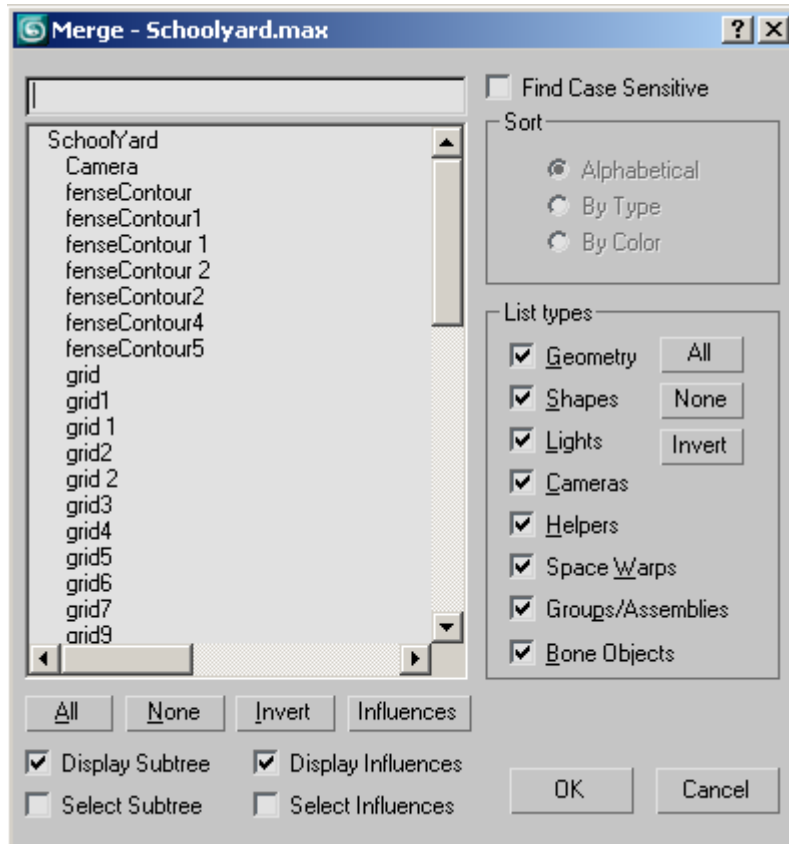

Merge Objects list

Objects are listed according to the current Sort and List Types selections.

All/None/Invert These buttons alter the pattern of selection in the list window.

Influences When you select an object in the list window and then click the Influences button, the selected object's influences are highlighted as well.

Display Influences When this is on and you select an item in the list window, all of its influences are shown in blue. If you want to highlight these influences, click Influences.

Select Influences When this is on and you select an item in the list window, all of its influences are highlighted as well.

Merge File Dialog

File menu > Merge > Choose a file to merge. > Choose objects to merge.

When you merge an object that's linked to a parent object in a source scene, and an object of the same name as the original parent exists in the current scene, you can re-create the same hierarchy using this dialog.

Interface

If you merge an object that's linked to a parent object in a source scene, and an object of the same name as the original parent exists in the current scene, a dialog appears asking if you want to link the incoming object to the existing parent object.

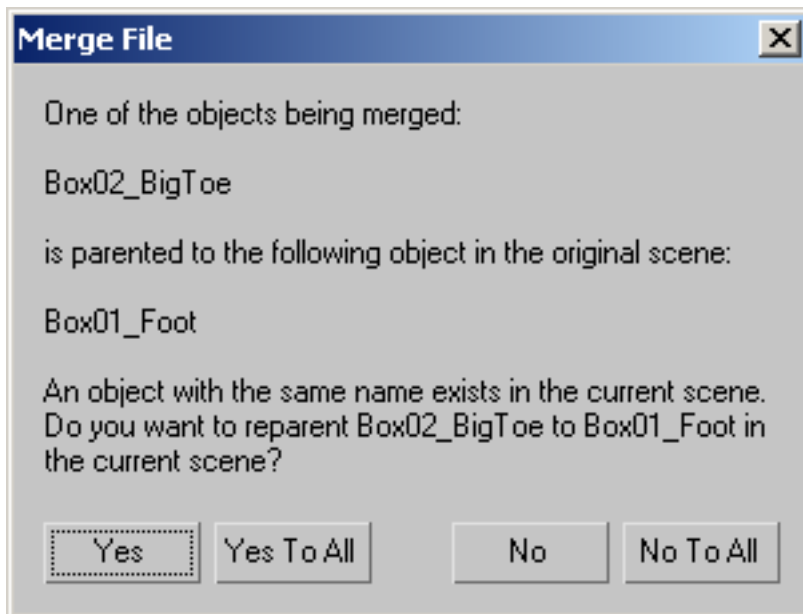

Yes Reparents the specified object and continues prompting for all subsequent merging objects that might need reparenting.

Yes To All Reparents the specified object and all subsequent merging objects that need reparenting.

No Merges the specified object without reparenting, but continues to prompt for subsequent objects.

No To All Doesn't reparent any of the incoming objects. When an object is merged without reparenting, it becomes a child of the world.

This feature can also be used to reconnect parent objects to children in the scene.

Merge Animation

[Available only as a CUI action]

Merge Animation merges (transfers) animation data from one object to another. Animation data can be transferred from one scene to another, or between objects in the same scene. Animation data from several objects can be merged at the same time.

IMPORTANT The Merge Animation command is available only as a [Customize User Interface](#) on page 7697 action; to use it you must first add it explicitly to the user interface. For transferring animation data between scenes, we highly recommend that you use, instead of Merge Animation, the Save Animation and Load Animation functions. See [Saving and Loading Animation](#) on page 7074.

Within the Merge Animation dialog, objects eligible for transferring or receiving animation data are called *nodes*. *Source nodes* refer to objects from which animation data can be transferred, while *current nodes* can receive animation data. *Merge nodes* are source nodes that have been mapped to (matched up with) current nodes in the Merge Animation dialog in preparation for merging.

In order for a particular attribute's animation data to be transferred from a merge node, the corresponding current node must have the same attribute. For example, if a merge node has an animated Bend modifier applied to it, the current node must also have a Bend modifier applied to it for the animation data to transfer successfully.

The Merge Animation feature is ideal for transferring animation data between similar hierarchies, such as character structures. In character creation, it is a common practice to name bones for different characters with the character name plus a suffix or prefix that describes the bone. For example, you might have one character called Alien with bones named Alien_Pelvis, Alien_LeftHand, etc. Another character called Chef would have bones named Chef_Pelvis, Chef_LeftHand, etc. The Merge Animation dialog can automatically filter prefixes and suffixes so you can quickly map the merge nodes for complex hierarchies.

NOTE If you plan to merge animation data to and from characters, the process will be much easier if you use the same bone-name prefixes or suffixes for each character.

See also:

- [Merge](#) on page 7058
- [Merging Effects](#) on page 6587
- [Replace](#) on page 7070

Procedures

To replace the animation in the current scene with the animation from another scene:

- 1 Load the scene that will receive the merged animation data.
- 2 Choose File menu > Merge Animation.
- 3 In the Merge Animation dialog, click Source File to choose the file from which to merge animation data. The objects appear under Source Nodes in the Object Mapping rollout.
- 4 On the Object Mapping rollout, drag and drop the source nodes to the Merge Nodes column, matching them with the appropriate current nodes.
- 5 In the Source Time Range group, choose Replace Animation.
- 6 Specify the source node attributes that will be merged.
- 7 Click Merge Animation to merge the animation data from the merge nodes to the current nodes.

To insert animation data from one character to another:

The Source Objects and Current Objects entry fields allow you to enter wildcard expressions to filter prefixes and suffixes of node names. The filtered text is ignored by the Auto Name Mapping tool, so complex structures of similarly-named nodes can be mapped quickly. This feature is handy for transferring an animation between character structures, providing the source and current nodes have been named with the same conventions.

- 1 Load the file with the character to which animation data will be merged.
- 2 Choose File menu > Merge Animation.

- 3 Click Source File and choose the animation source file.
- 4 In the Merge Animation dialog, under Source Objects, use a wildcard expression to specify multiple items that share a set of characters in their names. For example, if the character bones are named *Skater_Head*, *Skater_RFoot*, and so on, enter **Skater*** under Source Objects.
- 5 Click Refresh for Source Objects.
- 6 Under Current Objects, use a wildcard expression to filter the current nodes' prefix or suffix. Click Refresh.
- 7 Click Auto Name Mapping.
Source nodes are placed in the Merge Nodes column, corresponding with current nodes with the same prefix or suffix.
- 8 Specify whether to replace or paste animation data from the source file. If pasting animation data, the frame times for the merge nodes are added to the current nodes.
- 9 Specify the source node attributes that will be merged.
- 10 Click Merge Animation to merge animation data from merge nodes to corresponding current nodes.

To insert animation from one character assembly to another:

For [character assemblies](#) on page 277, the Insert Animation feature can be used to merge animation data.

- 1 Load the file into which the animation data will be merged.
- 2 Select the character assembly node.
- 3 On the Modify panel, click Insert Animation. Select the source file from which animation data will be merged.
- 4 Follow the previous procedure from step 4.

To merge animation data from objects in the same scene:

- 1 Choose File menu > Merge Animation.
- 2 Click Source Object, and choose the object from which animation data will be transferred. This object and its hierarchy appear under Source Nodes in the Object Mapping rollout.

- 3 On the Object Mapping rollout, drag and drop source nodes to the Merge Nodes column, matching them with the appropriate current nodes.
- 4 Specify whether to replace or paste animation data from the source file. If pasting animation data, the frame times for the merge nodes are added to the current nodes.
- 5 Specify the source node attributes that will be merged.
- 6 Click Merge Animation to merge the animation data from the merge nodes to the current nodes.

Interface

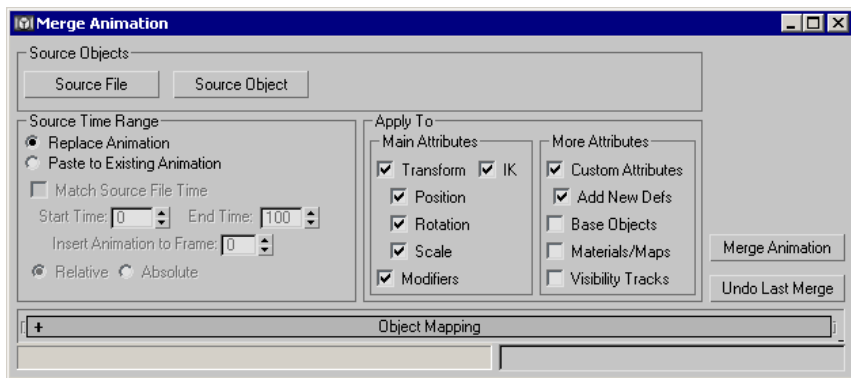

The Merge Animation dialog has the following controls.

Source Objects group

Source File Click to select a source file containing the animation data. Animation data from this file will be merged into the current scene. All objects in the scene are displayed under Source Nodes in the Object Mapping rollout.

Source Object Selects a source object from within the current scene. If a source object is selected, the Source File selection is ignored.

Merge Animation Merges the animation data based on settings on this dialog. Before animation data can be merged, Merge Nodes must be listed for their corresponding Current Nodes on the Object Mapping rollout. The progress bar at the bottom of the dialog shows the progress of the merge operation. After merging, this dialog remains on-screen so you can check whether the merge was performed properly before closing the dialog.

Undo Last Merge Undoes the last merge. If the merge was not performed properly, you can change settings and try again.

Source Time Range group

Replace Animation Completely replaces existing animation data in the current scene with the animation data from the source file.

Paste to Existing Animation Appends the source file animation data to the existing animation data based on the following time parameters.

Match Source File Time Sets the source time range to match the active time segment in the source file.

Start Time Start Time and End Time set the frame range to merge from the source file. Start Time sets the first frame in the range.

End Time Sets the end frame number to merge from the source file.

Insert Animation to Frame Sets the start time in the current scene. Animation data will be pasted into the current scene starting at this frame. Any existing animation data in the current scene prior to this frame will remain the same.

Relative Animation data pasted into the scene will change the current scene objects relative to their current status. For example, if an object in the source file is animated to move from the XYZ position 0,0,0 to 12,0,0, the object receiving the animation data in the current scene will start at its current position and move 12 units along the X axis.

Absolute Animation data pasted into the scene will replace the current animation data. For example, if an object in the source file is animated to move from the XYZ position 0,0,0 to 12,0,0, the object receiving the animation data in the current scene will start at exactly 0,0,0 and animate to 12,0,0.

Main Attributes group

Specify the source file attributes whose animation data will be merged. Current nodes must have the same attributes as merge nodes for the attribute animation data to be merged.

Transform Enables selection of Position, Rotation and Scale animation data for merging.

IK Merges animation data of IK chains created with IK solvers.

Position Merges Position transform animation data.

Rotation Merges Rotation transform animation data.

Scale Merges Scale transform animation data.

Modifiers Merges animation data of modifiers. In order for animation data of a modifier to be transferred, the current object must already have the same modifier applied to it.

More Attributes group

Selects additional attributes to be merged from the source file.

Custom Attributes Merges animation data of any custom attributes on source objects.

Add New Defs Adds custom attribute definitions to the current object if it doesn't have the same definitions as the source object.

Base Objects Merges animation data of parameters at the object base level. For example, if a sphere's Radius parameter is animated, checking this option will merge the Radius animation data. This option will also merge animation data at an object's sub-object level, such as the animation of vertices on a spline or Editable Mesh object.

Materials/Maps Merges animation data of materials and/or maps.

Visibility Tracks Merges animation data of visibility tracks.

Object Mapping rollout

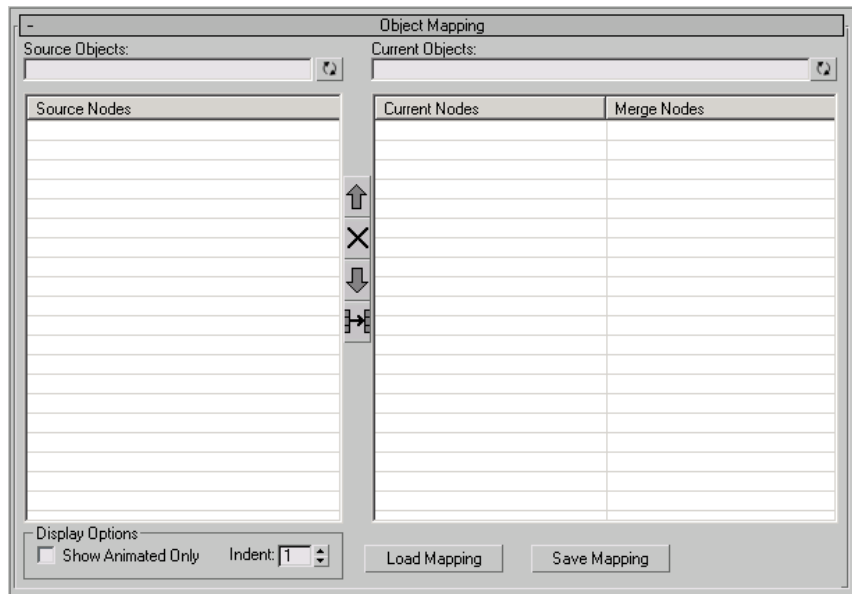

Sets up a one-to-one correspondence (mapping) between source objects and current objects. Animation data on objects in the Merge Nodes column will be merged to the corresponding object in the Current Nodes column.

To move objects to the Merge Nodes column, drag them from the Source Nodes column, or use Auto Name Mapping to automatically map objects with the same names or partial names.

Source Objects Allows you to specify wildcard expressions for filtering source objects. Click Refresh to view objects specified by the wildcard expression.

Refresh Refreshes the display based on wildcard expressions entered in the Source Objects field.

Source Nodes Displays the object selected with the Source Object option, and all its children. Objects with keyframed animation are listed in red, and objects with procedural controllers (such as a Noise or Expression controller) are listed in green. The display can be limited with wildcard expressions entered in the Source Objects field.

Current Objects Allows you to specify wildcard expressions for filtering current objects. Click Refresh to view objects selected by the wildcard expression.

Refresh Refreshes the display based on wildcard expressions entered in the Current Objects field.

Current Nodes Displays objects in the current scene. Animated objects are listed in red. Display can be limited by wildcard expressions in the Current Objects field.

Merge Nodes Lists the current objects that will receive animation data from the corresponding object under Current Nodes. To place an object in the Merge Nodes column, drag and drop the item from Source Nodes, or use Auto Name Mapping to automatically map objects with the same or similar names.

Move Up Moves the selected Merge Node up one row.

Clear Selected Clears selected entries under Merge Nodes.

Move Down Moves the selected Merge Node down one row.

Auto Name Mapping Automatically maps source objects to the Merge Nodes column, matching names with current objects. The mapping process filters any wildcard expressions entered in the Source Objects and Current Objects fields. If no wildcard expressions are entered, source objects are mapped only to current objects with identical names.

Display Options group

Show Animated Only Displays animated objects only.

Indent Sets the number of characters by which child objects are indented in the display.

Load Mapping Loads a previously saved *.mnm* file. This type of file can be loaded and saved only on the Merge Animation dialog.

Save Mapping Saves the current mapping in an *.mnm* file. The name of the source file and the mapping of source and current objects are saved. This type of file can be loaded only with the Load Mapping option on the Merge Animation dialog.

Replace

File menu > Replace

Replace lets you substitute the geometry of one or more objects in a scene by merging objects with *duplicate* names. Use Replace when you want to work

with less complex geometry to set up your scene and animation, and then replace it with more detailed geometry before rendering.

- When you replace an object in your scene, you replace its geometry, including its modifiers, but not its transforms, space warps, hierarchy, or materials.
- To replace the object with *all* its characteristics, use [Merge](#) on page 7058.
- If the object that you're replacing has instances in the scene, all of the instances are replaced with the new object.
- All objects in the scene with the same name as the incoming object are replaced by that object. If you have more than one object in the scene with the same name as the incoming object, all of those objects are replaced.

See also:

- [Merging Effects](#) on page 6587
- [Merge Animation](#) on page 7063

Procedures

To replace items:

- 1 Choose File > Replace to display the Replace File dialog.
To see more than one file type at a time, choose the All Files file type.
- 2 Select a file from which to choose replacement items.
- 3 On the Replace dialog for that file, choose a group or a replacement item. (See the following procedure.)
An alert asks if you want to replace the materials along with the objects.
 - If yes, the materials from the incoming objects replace the current materials.
 - If no, only the geometry is replaced, while the material assigned to the original object is retained.

To select objects to replace, do one of the following:

- 1 Enter the name of an item, or use wildcard characters to specify multiple items that share a set of characters in their names.
- 2 Click to select single objects.
- 3 Press Ctrl and click to add and remove single objects from the selection.
- 4 Press Shift and click to select all objects between the previously selected object and the current object.
- 5 Click All or None to select or deselect the entire list.

Interface

When you choose replace, a standard file selector dialog is displayed. Use the file selector to choose the scene file with the replacement objects. After you click Open, the Replace dialog is displayed.

TIP In the file selector, you can see more than one file type at a time by choosing the All Files file type.

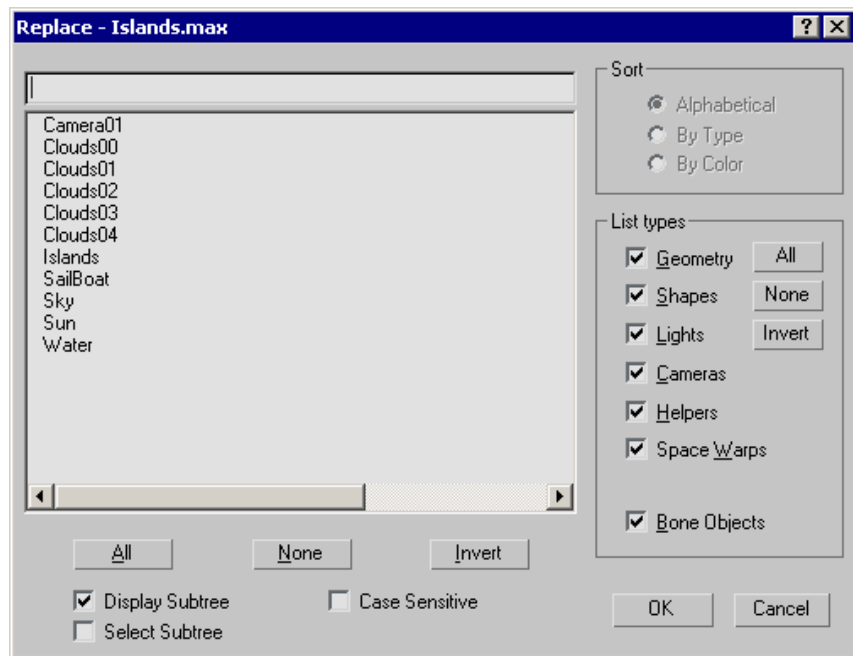

In the Replace dialog, select the objects to replace. Either enter the object name or select the object from the list.

All Selects all objects in the list.

None Deselects all objects in the list.

Invert Inverts the current list selection.

Display Subtree Displays object hierarchies in an indented format.

When this option is off, the Sort group is enabled.

Select Subtree When this option is on, all items indented below the selected one are also selected.

Case Sensitive When on, distinguishes between upper and lower case in object names.

Sort group

These are options for sorting the object list. If the Display Subtree check box is on, these options are not available.

Alphabetical Sorts from A at the top to Z at the bottom.

By Type Sorts by category, using the same order as the check boxes in List Types.

By Color Sorts by object wireframe color.

List Types group

Determines which object types are displayed in the list: geometry, shapes, lights, cameras, helpers, space warps, or bone objects.

All Turns on all check boxes in the group.

None Turns off all check boxes in the group.

Invert Inverts the current state of the check boxes.

Saving and Loading Animation

You can save and load animation data for any number of objects separately from the actual scene via Load Animation and Save Animation commands available on the File menu. These commands use two file types:

- XAF (XML Animation File) contains the animation data.
- XMM (XML Animation Map File) contains mapping information: how the incoming animation data is assigned to objects in the current scene.

Mapping is quite flexible: as long as data is comparable, it can be assigned. For example, each key for both position and rotation animation contains three numbers, so you could, if you wanted, assign incoming position data to a current object's rotation track, or vice versa.

See also:

- [Save Animation](#) on page 7080
- [Load Animation](#) on page 7077
- [Map Animation Dialog](#) on page 7083

Procedures

To use the Save Animation and Load Animation commands:

You start by saving animation data from the current scene.

- 1 Select any number of objects in your scene that contain animation. The animation can be of any type: procedural, manually keyframed, IK, and so on.

The frame range from which the animation is saved is the same for all objects, so make sure you select only objects from which you want to save the same frame range.

NOTE Using this method, you can save animation only from selected objects. Alternatively, you can save animation from specific tracks in Track View; see [Hierarchy Right-Click Menu](#) on page 3538.

- 2 From the File menu, choose [Save Animation](#) on page 7080.
- 3 Set the save parameters.

By default, the command saves all keys from animated tracks for selected objects, including motion derived from constraints. For example, if an object rotates because a LookAt constraint is applied to its Rotation track, then when you save its animation with Include Constraints on, the software generates rotation keys based on the constrained motion. It does not save the actual constraint.

If you turn on Segment, you can then set a frame range from which to save animation.

- 4 Specify a file name and then click Save, or click the + button next to Save to increment the file name and save under the new file name.

If the selected objects contain no savable animation, the message “No animation tracks to save” appears. If this happens, create animation to save or change the Save Animation parameters as needed.

Next, you load the animation data.

- 5 Set up or load a new scene and then select any objects that are to receive the loaded animation.

NOTE Using this method, you can load animation only to selected objects. Alternatively, you can load animation to specific tracks in Track View; see [Hierarchy Right-Click Menu](#) on page 3538.

- 6 From the File menu, choose [Load Animation](#) on page 7077.
- 7 Find and highlight the XAF file from which to load animation.
- 8 Click Load Motion. If the objects you're loading animation to are the same as those you saved the animation from, the animation loads and is mapped automatically. If mapping is required, you're given the opportunity to set it up. Or, if you've already set up mapping for the scene and incoming animation data, choose a mapping (XMM) file from the Motion Mapping/Retargeting drop-down list and then click Get Mapping. Otherwise, click Edit Mapping.

Clicking Edit Mapping opens the [Map Animation dialog](#) on page 7083, which contains three lists: from left to right, Current, Mapped, and Incoming. The Current list shows selected objects in the scene and their animation tracks; the Incoming list shows animation tracks in the XAF file, and the Mapped list shows, for each track in the Current list, the animation track in the Incoming list that will map to it. In certain cases, such as with objects that have the same name, some tracks are mapped automatically and appear in the Mapped column as soon as you open

the dialog. The tracks that are already mapped are shown in gray in the Current and Incoming columns.

- 9 To map a pair of tracks manually, click a track in the Current list and another in the Incoming list, and then click the left-arrow (<-) button to the left of the Incoming list.

This places the name of the incoming track in the Mapped list, opposite the Current-list track to which it is assigned.

- 10 To remove a mapping assignment, click its entry in the Mapped list, and then click the -> button.
- 11 Continue setting up the mapping assignments as needed. When you're finished, click Save Mapping or Save Mapping As, and then specify a file name to save.

After you save the mapping file, the Load Motion button becomes available, and you can proceed with loading the animation.

- 12 Click Load Motion.

The animation data is loaded and assigned to the selected objects, and any animation keys appear on the track bar.

To retarget an incoming animation:

This is a continuation of the previous procedure, and explains the basic workflow of node retargeting. *Retargeting* means to scale the animation so it matches the objects onto which you are mapping the motion. You can use this feature any time you need to transfer an animation between two objects or rigs of different sizes and proportions. For example, an animation of a cat stretching could be retargeted to a bigger dog model, resulting in a scaled animation to fit the dog's skeleton.

Once your track-mapping assignments are complete, the Retargetable Nodes list on the Retargeting rollout displays the mappings available for retargeting.

For steps that describe retargeting a character rig, see [To retarget one character onto another](#) on page ?.

- 1 First, in the Scale Origin group, choose the Incoming and Current objects to use as the origin and basis for scaling.

For example, when retargeting a rig, you would use each rig's root object.

- 2 Next, in the Derive Scale Between Chains group, choose comparable IK or FK chains from the Incoming and Current models to obtain a Scale Factor

that proportionally retargets the incoming animation onto the current model.

- 3 Click Set to apply the retargeting.
- 4 If different portions of the model are differently proportioned, you might need to repeat steps 2 and 3 for different selections of mapped tracks. You might also need to use the FK Retargeting Extent group to account for the different proportions. See [Retargeting Rollout](#) on page 7090 for more details.
- 5 When you're finished, save your mapping to preserve the retargeted data, and then click Load Motion to apply the animation to the currently selected objects.

Retargeting is essentially a “by hand” process. You might need to try different settings to get the result you need. You can remove retargeting by highlighting a mapped track in the Retargetable Nodes list, and then clicking Clear.
- 6 Close the Map Animation dialog.

Load Animation

Select one or more objects. > File menu > Load Animation

Track View > Hierarchy/Controller window > Highlight one or more tracks > Right-click. > Load Animation

Load Animation lets you load animation from an XAF (XML Animation File) file to objects in your scene. Part of the animation-loading process is mapping the animation; that is, specifying which objects in the scene are to receive the loaded animation tracks.

For a procedure that outlines the basic method of saving and loading animation, see [To use the Save Animation and Load Animation commands](#) on page ?.

See also:

- [Saving and Loading Animation](#) on page 7074
- [Save Animation](#) on page 7080
- [Map Animation Dialog](#) on page 7083

Interface

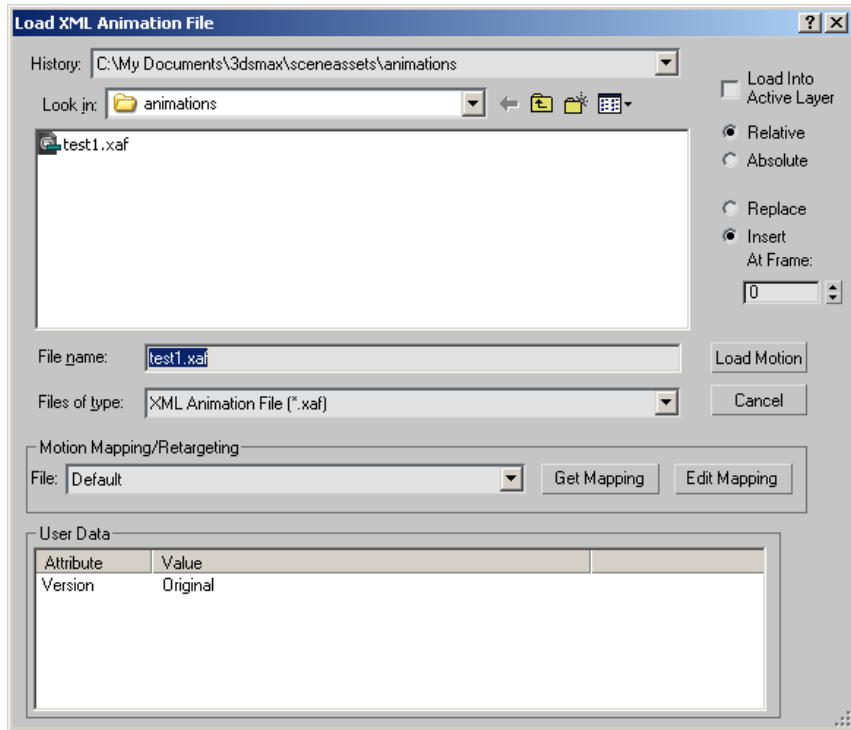

[file controls] The controls in the upper-left corner of the dialog are standard file-browsing controls.

Load Into Active Layer Loads the animation file into the active layer. Default=off.

This option makes it easier to load an animation file to an object that has had [Animation Layers](#) on page 3164 enabled (or disabled) subsequent to saving the animation files. Remapping is necessary in this case because enabling or disabling Animation Layers causes the full controller names to change. For example, if a sphere's X position track before enabling Animation Layers is Sphere01\Transform\Position\X Position, then after enabling Animation Layers it might change to Sphere01\Transform\Position\Base Layer\X Position (the layer name is inserted into the controller name).

Whether Load Into Active Layer is on or off, when you load animation to an object after changing its Animation Layers status, the software prompts you to create a map file. If Load Into Active Layer is on, when you click Yes to create the map file, the Map Animation dialog opens showing only the active

layer's tracks in the Current list, and the tracks are already mapped correctly in the Mapped list. All you need to do is save the mapping, and then load the motion.

If Load Into Active Layer is off, clicking Yes to create the map file opens the Map Animation dialog showing all animation tracks in all layers, and you need to use the Map Animation controls to map the tracks before saving the mapping and loading the motion.

Relative/Absolute Determines how incoming animation affects existing values. Relative starts the loaded motion at the current values of the selected objects in the scene. Absolute sets the values of objects in the scene to those of the motion; so, for example, it would move a character to a new location and start the animation there. Default=Relative.

Replace/Insert Determines how existing keys are treated when the animation is loaded. Replace overwrites the keys in the scene with the incoming motion, starting at the chosen frame. Insert inserts the motion at the chosen frame and moves any subsequent, existing keys to the end of the incoming motion. Default=Insert.

At Frame The frame at which the incoming animation is applied. Default=0.

Load Motion If mapping information is available, loads the animation from the file specified in the File Name field and applies it to current objects according to the mapping information. If no mapping has been specified, you're given the opportunity to create a map file. If you then click Yes, the [Map Animation dialog](#) on page 7083 opens, but if you click No, no animation is loaded.

Cancel Closes the dialog without loading any animation.

Motion Mapping/Retargeting group

File Shows the current mapping file, or "Default" if no mapping file has been chosen. Choose a mapping file from the drop-down list.

The list contains the most recently loaded mapping files. If the file you want to use isn't available in the list, use the Get Mapping button.

TIP If the paths in the drop-down list are too long to see the file name itself, you can resize the dialog to make the dialog and the list wider.

Get Mapping Lets you browse to load a mapping file. Use this if the file doesn't appear in the Use Mapping drop-down list. The file then appears in the list for easy reloading.

Edit Mapping Opens the [Map Animation dialog](#) on page 7083 for setting up animation assignments between incoming tracks and existing tracks. Available only after an animation (XAF) file has been chosen.

User Data group

The User Data list shows any user data present in the XAF file specified in the File Name field. User data can be created via the Save Animation dialog, or by editing the XAF file directly.

Save Animation

Select one or more animated objects. > File menu > Save Animation

Track View > Hierarchy/Controller window > Highlight one or more tracks > Right-click. > Save Animation

Save Animation lets you store animation from your scene to disk in the XML Animation File (XAF) format. The XAF file format lets you save and load animation for any number of objects separately from the actual scene.

For a procedure that outlines the basic method of saving and loading animation, see [To use the Save Animation and Load Animation commands](#) on page ?.

See also:

- [Saving and Loading Animation](#) on page 7074
- [Load Animation](#) on page 7077
- [Map Animation Dialog](#) on page 7083

Interface

To use Save Animation, select the objects from which to save animation data, and then choose Save Animation from the File menu. Settings in the Save XML Animation dialog apply only to objects that are selected when you save the animation.

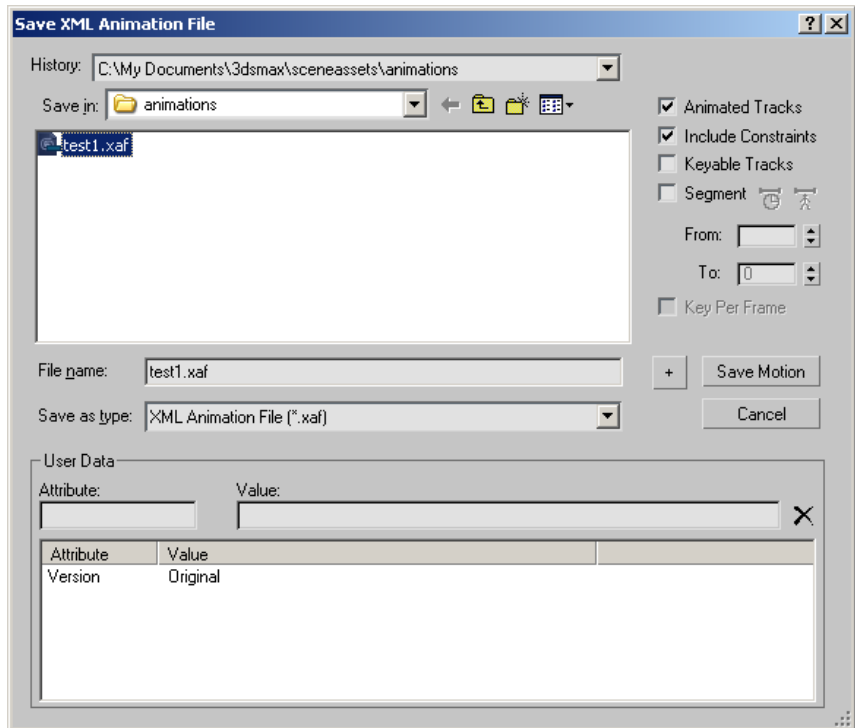

File controls The controls in the upper-left corner of the dialog are standard file-browsing controls.

Animated Tracks Saves only animated tracks. This is on by default, and should generally be left on.

- **Include Constraints** When on, includes motion derived from constraints. For example, if an object rotates because a LookAt constraint is applied to its Rotation track, then when you save its animation with Include Constraints on, the software generates rotation keys based on the constrained motion. It does not save the actual constraint. When off, animation accomplished only by constraints, such as the Link constraint, is not saved. Default=on.

NOTE This doesn't apply to constraints such as the [Path constraint](#) on page 3297. Because this constraint assigns the animation directly to the constrained object, rather than deriving it from the constraining object, Save Animation saves path-constrained animation even if Include Constraints is off.



Keyable Tracks When on, saves only [keyable](#) on page 3563 tracks with controllers, as defined in Track View. Turning this on allows keyless animation tracks to be saved. Default=off.

If both Animated Tracks and Keyable Tracks are on, any tracks that contain animation but are not keyable won't be saved. You can use this option to avoid saving tracks that aren't relevant to the scene into which you're loading the animation. For example, if you want to save constraint data, but not data from a LookAt constraint (because LookAt tends to be specific to the scene), you can turn off Keyable for the LookAt track, and then save with Keyable Tracks on.

NOTE Animated Tracks overrides Keyable Tracks. If a track is keyable but doesn't contain any animation data, and Animated Tracks is on, the track won't be saved even if Keyable Tracks is on.

NOTE Tracks without controllers, such as nonanimated creation-parameter tracks, won't be saved even if Keyable Tracks is on. To save a nonanimated creation-parameter track, add a controller, turn off Animated Tracks, and turn on Keyable Tracks.

Segment Lets you save a specific frame range, as opposed to the entire animation. Default=off.

-  **Active Time Range** Click to set the From and To fields to the currently active time range. Available only when Segment is on.
-  **Objects Time Range** Click to set the From and To fields to the time range that corresponds to the keys of the currently selected objects. Available only when Segment is on.
- **From** Sets the starting frame for the range to save. Available only when Segment is on.
- **From/To** Sets the ending frame for the range to save. Available only when Segment is on.

Key Per Frame Saves an animation key per frame, thus “baking” the animation to keyframes.

This can be useful if you are applying a procedural animation, such as a dynamics simulation, to an object that won't be participating in a dynamics simulation in the target scene.

+ Increments the number at the end of the file name and saves the animation file with the new name. If the file name doesn't currently end with a number of two or more digits, clicking + appends "01" to the file name (before the extension), and then saves the file.

Save Saves the animation using the current file name.

Cancel Closes the dialog without saving any animation.

User Data group

These controls let you enter user attributes and names. This could simply be notes about the animation file, or they could be actual data for use by custom plug-ins and utilities.

To enter user data, type a value in the Attribute field, press Tab and type a value in the Value field, and then press Enter to add the attribute and value to the list below. These values are saved with the XAF file and can be viewed with the Load Animation dialog.

Attribute Enter an attribute name.

Value Enter an attribute value. This can be any combination of alphanumeric characters. To add the attribute and value to the file, press Enter while the cursor is in this field.



Delete User Data Deletes the highlighted attribute from the list along with its corresponding value.

Attribute list Shows all attributes and values in the file. To change a value, click the corresponding attribute in the list to highlight it and place it in the Attribute and Value fields, edit the Value field, and then press Enter. You can also edit the Attribute field, but this creates a new entry.

To remove an attribute, highlight its name in the list and then click Delete User Data.

Map Animation Dialog

File menu > Load Animation > Open dialog > Edit Mapping

File menu > Load Animation > Open dialog > Load Motion > XML Animation dialog > Click Yes.

The Map Animation dialog lets you assign incoming animation tracks when using the [Load Animation](#) on page 7077 command. The dialog is resizable and contains three rollouts: for setting up basic parameters, doing the actual mapping, and doing retargeting.

For a procedure that outlines the basic method of saving and loading animation, see [To use the Save Animation and Load Animation commands](#) on page ?.

See also:

- [Saving and Loading Animation](#) on page 7074
- [Save Animation](#) on page 7080
- [Load Animation](#) on page 7077

Interface

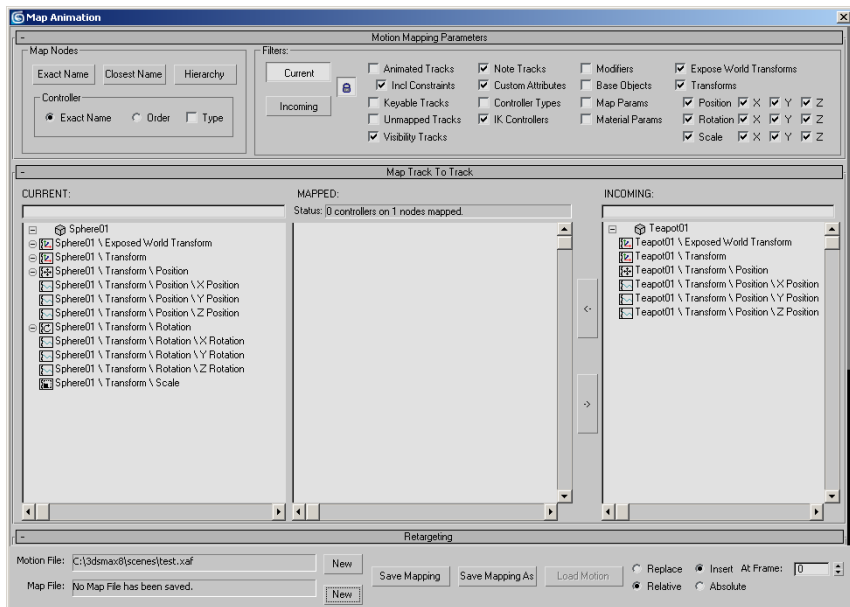

Most controls on this dialog are contained in three rollouts:

[Motion Mapping Parameters Rollout](#) on page 7086

[Map Track to Track Rollout](#) on page 7089

[Retargeting Rollout](#) on page 7090

Motion File Shows the path and name of the current animation (XAF) file.

- **New** Click to display a file dialog and specify a new animation file to load.

With this option, you don't need to return to the Load Animation dialog.

Map File Shows the path and name of the current map (XMM) file.

- **New** Click to display a file dialog and specify a new map file to load.

With this option, you don't need to return to the Load Animation dialog.

Save Mapping Click to save the current mapping assignments to an XMM file. If a file name is already displayed in the Map File field, it is overwritten; otherwise, 3ds Max displays a file dialog so you can enter a name for the new file.

Save Mapping As Click to save the current mapping assignments to an XMM file using a different file name. This displays the Save XML Animation map file dialog.

Load Motion Click to load the animation from the XAF file, and maps the animation tracks as specified.

This button is available only when the Map File field contains a valid map file name.

Replace / Insert These options determine how existing keys are treated when you load an animation. Replace overwrites the current scene's keys (if any) with the incoming motion, starting at the chosen frame. Insert inserts the motion at the chosen frame and moves any existing keys to the end of the incoming motion. Default=Insert.

- **At Frame** The frame at which the incoming animation is written (Replace) or inserted. Default=0.

Relative/Absolute These options determine how incoming animation affects existing values. Relative starts the loaded motion at the current values of the selected objects in the scene. Absolute sets the values of objects in the scene to those of the incoming motion. For example, when you load a character animation, Relative starts the animation from the character's current position, while Absolute first moves the character to the position of the character in the scene from which the animation was saved. Default=Relative.

Motion Mapping Parameters Rollout

File menu > Load Animation > Open dialog > Edit Mapping

File menu > Load Animation > Open dialog > Load Motion > XML Animation dialog > Click Yes.

This rollout provides controls for automatically mapping animation tracks and for filtering tracks to reduce clutter.

Interface

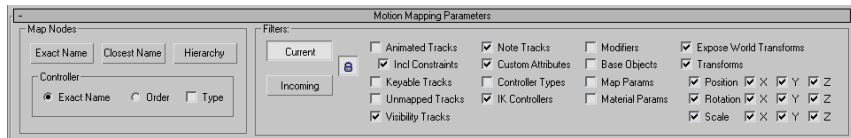

Map Nodes group

These controls let you perform automatic mapping by name or hierarchical order. Mapping is done first by node (object) name, and then within each node's hierarchy by controller (track) name.

The default method of automatic mapping is Exact Name for both nodes and controller. When you first open the Map Animation dialog, any node/controller pairs whose names match exactly are automatically mapped. To change the mapping, remove any existing assignments in the Mapped list (highlight them and then click the -> button), and then choose an alternate method.

Exact Name This maps node to node, by name. If the names do not match exactly, the tracks will not map, and the status line will report how many nodes did not map

Closest Name Finds a match in the object names, and uses the Controller options (described below) to confirm the match.

For example, if the incoming is *R Toe 01* and the choice in the Current list is between *Right Index Toe* and *R Toe Helper*, it will look at the controller structure and compare by name, or type or order, and try to determine which node is the closest to the incoming. When the choice is close like this, the status line reports that there was another close match, and highlight the close, but unmapped, nodes in the incoming list in red.

Hierarchy This option turns off the above options. It matches by node order; for example, *Bone01>Bone02>Bone03* would map to *Leg>Calf>Foot*, if Controller

is set to Order and the leg is mapped to *Bone01*. The Hierarchy option ignores the names.

Controller Determines how automatic mapping is performed within nodes:

- **Exact Name** (The default.) Matches controllers by name, regardless of order. This applies specifically to lists, morph channels, maps, custom attributes, and any other tracks that are listed by a user-defined name that might be reordered for some reason.
- **Order** This maps by controller order only, regardless of name or type, and it turns the other options off. For example, it will map the first controller in a list to the first controller in a list. If necessary, it “bakes” the animation by creating per-frame keys.
If any controllers are not mappable (for example, a Bezier controller getting mapped into a script), the status line will report the error and highlight the node that couldn’t map in the incoming list.

Type When on, allows mapping only between controllers of the same type. It prevents mapping between two controllers of different types. For example, a controller such as Noise and its parameters will map only to another Noise controller. Default=off.

Filters group

The Filters options are similar to those available in Track View: they enable viewing only certain types of tracks. Filtering is can be a help with large, complex animation setups, because it lets you focus on tracks of specific interest and ignore the rest.

The following information describes the action of filters that are on. Unless otherwise specified, when a filter is off, the track type it applies to is hidden. In some cases, a track will *not* be hidden because a different filter that is on permits display of that track.

NOTE The Incoming list contains only animation tracks that were saved in the XAF file, so it cannot display unavailable tracks. For example, if you don't animate an object's creation parameters, toggling the Base Objects switch won't change the Incoming list contents.

Current/Incoming Determines whether the filters are applied to the Current list or the Incoming list.



Lock When the Lock button is on, the filters are applied to both lists. Default=locked.



When the Lock button is off, only one of these is active at a time, and 3ds Max remembers different sets of on/off values for the filtering parameters.

Animated Tracks Displays tracks that contain animation keys.

Include Constraints Displays constraint tracks, even if they are not animated.

Keyable Tracks Displays tracks that are set to keyable, regardless of whether they contain animation.

Unmapped Tracks When on, hides mapped tracks. When off, all tracks are displayed.

Visibility Tracks Displays visibility tracks.

Note Tracks Displays note tracks. When a note track is mapped, the notes are added to an existing note track in the current scene.

Custom Attributes Displays custom attribute tracks.

Controller Types Displays controller types (names) in the list. For example, the Position X track reads “Position X: Bezier Float.”

IK Controllers Displays any IK controllers.

Modifiers Displays animatable modifier tracks.

NOTE In order for modifier tracks to display in the Current column, the Base Objects filter must also be on.

Base Objects Displays creation-parameter tracks for parametric objects such as Box and Sphere.

Map Parameters Shows map tracks, such as Tiling for Bitmaps and Mix Amount for Mix maps.

Material Parameters Shows tracks for materials; for example, animated Diffuse color values, Opacity, and so on.

Expose World Transforms Displays tracks for world transforms. These let you map all transform animation between two objects using a single track, named *Exposed World Transform*.

Transforms Enables or disables display of all transforms other than the exposed world transforms. The toggles that follow control display of individual transforms:

- **Position/X/Y/Z** The Position check box lets you toggle display of all Position tracks, while the X/Y/Z check boxes let you toggle display of the track for each axis.
- **Rotation/X/Y/Z** The Rotation check box lets you toggle display of all Rotation tracks, while the X/Y/Z check boxes let you toggle display of the track for each axis.
- **Scale/X/Y/Z** The Scale check box lets you toggle display of all Scale tracks, while the X/Y/Z check boxes let you toggle display of the track for each axis.

Map Track to Track Rollout

File menu > Load Animation > Open dialog > Edit Mapping

File menu > Load Animation > Open dialog > Load Motion > XML Animation dialog > Click Yes.

This rollout comprises three list windows. The left (Current) and right (Incoming) show node/controller hierarchies, as in Track View.

Because the Map Nodes group functions apply to highlighted tracks, you can use standard highlighting methods. Click to highlight an entry, Ctrl+click to highlight multiple entries, and Shift+click to highlight a range. Also, in the Current and Incoming windows, you can right-click to open a menu that lets you highlight all tracks (Select All), invert the current highlighting (Select Invert), and turn off highlighting for all tracks (Select None).

In addition, you can use the right-click menu to expand and collapse any track with a - or + icon next to its name.

Interface

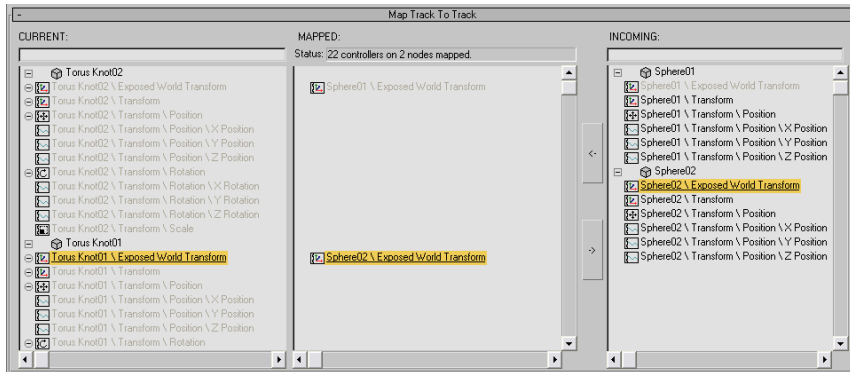

Current list Shows animation tracks for selected objects in the scene, using the same hierarchical display as Track View. Unassigned tracks use black characters, while assigned tracks use gray characters.

Status This read-only field shows the number of controllers and the number of nodes mapped.

Mapped list Shows tracks that have been mapped.

<- Assigns the highlighted animation track in the Incoming list to the highlighted animation track in the Current list. The assignment then appears in the Mapped list, opposite the corresponding Current list entry.

If the two tracks don't contain comparable data, nothing happens when you click the button.

-> Removes the highlighted Mapped list entry.

Incoming list Shows animation tracks in the loaded XAF file, using the same hierarchical display as Track View. Unassigned tracks use black characters, while assigned tracks use gray characters.

Retargeting Rollout

File menu > Load Animation > Open dialog > Edit Mapping

File menu > Load Animation > Open dialog > Load Motion > XML Animation dialog > Click Yes.

When you map an animation from one rig or object onto another, use this rollout to establish *retarget* references between the incoming nodes in regards

to their scale dependency. *Retargeting* means to scale the animation so it matches the objects onto which you are mapping the motion. You need to retarget only when the size or proportions of the incoming model differ from the size or proportions of the current model.

Retargeting applies to *any kind of animation*, from matching fight choreographies, to changing a weather balloon's fly-through trajectory over hills and valleys. The down side of this is that essentially you have to set up the scaling relationships by hand; the good news is that the steps are fairly straightforward, and that once you have retargeted, the settings are reusable for all animation mapped between the same two sets of objects.

While retargeting is a general-purpose feature, it is especially useful for transferring animation from one character to another, when the characters are of different sizes, and possibly of different proportions (for example, a human model to a gorilla, or vice versa). You can transfer IK animation onto an FK rig, or vice versa. There are some rules of thumb when you work with mapping character animation:

- In a walk cycle, the root of a character moves, and all other movement is typically rotation.
Because of this, usually you want to map the root motion and the rotation tracks, and leave the others alone.
The exception to this is when arms or other parts (tentacles?) are animated by IK. When IK is present, you need to take the additional step of mapping and retargeting the IK goals.
- The legs need to reach the “ground,” and feet should not slide.
Because of this, use the legs as the basis of recalculating the scale for the target character.
- Characters are usually symmetrical.
Because of this, usually retargeting one limb does the trick for both.
If a character's limbs are *not* symmetrical, retarget each of them individually.
If the current model uses forward kinematics, then use the FK Retargeting Extent controls as well.

Procedures

To retarget one character onto another:

This procedure is not a detailed procedure, but an overall workflow. It assumes you have already saved the incoming character's animation, then loaded it onto the current character, as described in [To use the Save Animation and Load Animation commands](#) on page ?.

NOTE If the animation you are saving is unkeyed world-space animation (as opposed to IK or FK), turn off Animated Tracks when you save.

- 1 On the [Map Track To Track rollout](#) on page 7089, map the motion tracks of the incoming character's root to the current character's root.
For example, if you are retargeting a [Biped](#) on page 4147 onto another, you would map the incoming *Biped* object's position and rotation tracks onto the current *Biped*.
- 2 Map the rotation tracks of the incoming character's limbs onto the current character's limbs.
There is one exception here: if a hand (for example) is going to use IK in the current scene, either don't map it at all, so you can animate it later, or if you are mapping from an FK model to an IK model, map the *Exposed World Transform* to transfer the incoming FK trajectories to current IK controls.
- 3 Go to the Retargeting rollout.
- 4 In the Scale Origin group, choose both the Incoming and Current root objects.
If the characters are symmetrical and have the same proportions, you can now choose all the mapped tracks in the Retargetable Nodes list. If the characters are not symmetrical, or their proportions are different, then you need to take further steps.
- 5 In the Derive Scale Between Chains group, choose the Start and End nodes of both Incoming and Current chains to correspond to either the left or right leg of the character: for example, *Thigh* to *Toe*.
Read the Scale Factor that is set on the basis of the two chains.
- 6 Click Set to retarget the highlighted mapped tracks.
If the two current legs are not the same length, repeat step 5 for the other leg, then choose that leg's *Foot* (or *Toe*) node, turn on Enabled in the FK Retargeting Extent group, and choose the top of the leg (for example, *Thigh*) as the parent to use. Click Set.
- 7 Save the retargeted mapping file.
- 8 Click Load Motion to animate the current character, and then close the Map Animation dialog.

Interface

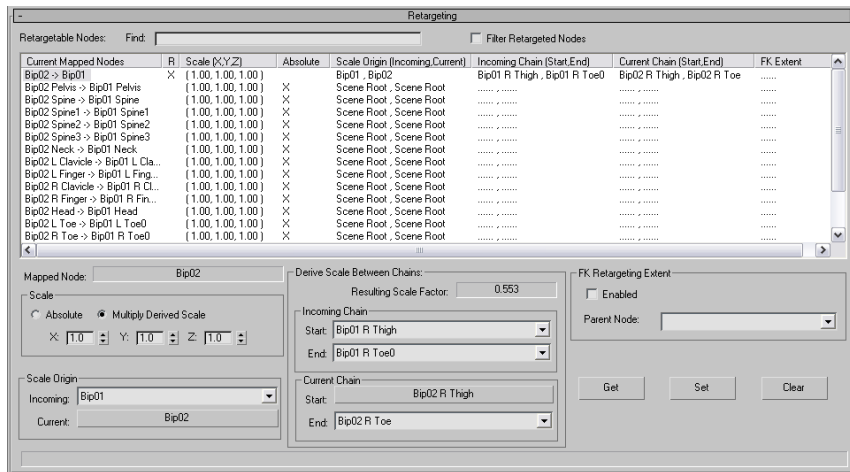

Retargetable Nodes list This list shows the tracks that have been mapped using the [Map Track To Track rollout](#) on page 7089. Each of these mappings can be retargeted.

The fields in this list are as follows:

- **Current Mapped Node** Shows the node-to-node mapping, as in “CurrentObject->IncomingObject.”
- **R** When a mapping has been retargeted, this field shows an “X.”
- **Scale (X,Y,Z)** Shows the current scaling factor for each dimension of the current node.
- **Absolute** When a mapping uses absolute scaling, this field shows an “X.”
- **Scale Origin (Incoming,Current)** Shows the incoming and current scale origins for this mapping. If the mapping hasn't been retargetted, this field shows “Scene Root , Scene Root.”
- **Incoming Chain (Start,End)** If the mapping has been retargeted, shows the incoming chain used to calculate scale.
- **Current Chain (Start,End)** If the mapping has been retargeted, shows the current chain used to calculate scale.
- **FK Extent** If a mapped track's FK extents have been recalculated, shows the parent node used in the recalculation.

Find Enter a name to search for a particular object, then press Enter. 3ds Max highlights matching entries in the list.

Filter Retargeted Nodes When on, the list shows only those mappings that have been retargeted. When off, all mappings are listed. Default=off.

Mapped Node Shows the currently highlighted mapped node. If more than one list entry is highlighted, shows “—Multiple—.”

Scale group

- **Absolute** When chosen, scaling for the currently highlighted mappings is absolute, and based on the XYZ settings in this group alone.
- **Multiply Derived Scale** (The default.) When chosen, scaling for the selected mappings is based on both the XYZ settings in this group, and calculations from the Derive Scale Between Chains group and the FK Retargeting Extent group (if that is used).

X/Y/Z You can use these fields to explicitly set the scaling factor for the currently highlighted mappings.

Scale Origin group

Incoming Choose the incoming object from which to derive the scaling origin. This is a drop-down list obtained from the list of incoming nodes.

Current Click to display a Select dialog and chose the current object from which to derive the scaling origin. The dialog shows all currently selected objects.

Typically, you set these two to be the incoming root node and current root node, whose motion tracks are already mapped.

Derive Scale Between Chains group

Resulting Scale Factor Displays the scale factor derived from the Scale Origin and Incoming/Current Chain settings. Check this value to see that it matches the apparent difference in proportion between the objects or characters you are retargeting.

Incoming Chain These controls set the incoming IK or FK chain to use in calculating the Scale Factor.

- **Start** Choose the start of the incoming chain. This is a drop-down list obtained from the list of incoming nodes.

When retargeting character animation, typically you choose the top of the incoming character's leg; for example, the thigh.

- **End** Choose the end of the incoming chain. This is a drop-down list that is restricted to children of the incoming Start object.
When retargeting character animation, typically you choose the end of the incoming character's leg; for example, the toe.

Current Chain These controls set the incoming IK or FK chain to use in calculating the Scale Factor.

- **Start** Click to display a Select dialog and choose the start of the current chain. The dialog shows all currently selected objects.
When retargeting character animation, typically you choose the top of the current character's leg (using the same side as you used for the incoming chain).
- **End** Choose the end of the current chain. This is a drop-down list that is restricted to children of the current Start object.
When retargeting character animation, typically you choose the end of the current character's leg.

If a character's legs are symmetrical, which is usually the case, you only need to calculate the retargeting scale for one leg, and then Set that value to both. If the character's legs are *not* symmetrical, you need to calculate values for both legs, and also use the FK Extents controls (described below).

FK Retargeting Extent group

When the current model uses IK, 3ds Max knows the extent to retarget because it is defined by the IK solution. But if the current model uses FK, you should specify the extent of retargeting. For example, mapping rotation animation from a long leg to a short leg with different link lengths requires that the short leg's foot be chosen to retarget so it ends up meeting the floor in the same way the long leg does. In order for 3ds Max to know how far up the chain from the foot to do the retargeting, the parent of the desired chain (for example, the thigh) must be specified. By defining the two chains to compare, 3ds Max can adjust the resulting rotations such that the feet don't slide.

When a character's limbs are not symmetrical, you can also use these controls to keep rotations proportional. First, highlight the current child (for example, a foot or toe) in the Retargetable Nodes list. Turn on Enabled, and then use the drop-down list to choose the upper parent (for example, the thigh) of the limb you are retargeting. Finally, click Set.

Enabled Turn on to enable retargeting extents. Default=off.

Parent Node Choose the current upper parent of the limb you are retargeting. This drop-down list is restricted to parents of the currently highlighted current object.

Get Click to set controls in the Scale, Derive Scale Between Chains, and FK Retargeting Extents groups based on the currently highlighted mapping in the list.

If multiple mappings are selected, Get fetches the first highlighted mapping in the list.

Set Click to apply the current Scale Factor to the mappings that are currently highlighted in the list.

Clear Click to clear retargeting values from the mappings that are currently highlighted in the list.

Import

File menu > Import

Import loads or merges geometry files that are not 3ds Max scene files. See the following procedure for a complete list of file types you can import.

Procedures

To import a file:

- 1 Choose File menu > Import.
- 2 Choose an import file type from the Files Of Type list in the file selector dialog. To see more than one file type at a time, choose the All Files file type.
 - [Autodesk \(FBX\)](#) on page 7222
 - [3D Studio Mesh \(3DS, PRJ\)](#) on page 7172
 - [Adobe Illustrator \(AI\)](#) on page 7178
 - [Autodesk Collada \(DAE\)](#) on page 7222
 - [LandXML /DEM /DDF \(DEM, XML, DDF\)](#) on page 7249
 - [AutoCAD Drawing \(DWG\)](#) on page 7182

- [Legacy AutoCAD \(DWG\)](#) on page 7201
- [Flight Studio OpenFlight \(FLT\)](#) on page 7223
- [Motion Analysis HTR File \(HTR\)](#) on page 7257
- [IGES \(IGE, IGS, IGES\)](#) on page 7226
- [Autodesk Inventor \(IPT, IAM\)](#) on page 7211
- [Lightscape \(LS, VW, LP\)](#) on page 7253
- [gw::OBJ-Importer \(OBJ\)](#) on page 7285
- [3D Studio Shape \(SHP\)](#) on page 7177
- [Stereolitho \(STL\)](#) on page 7276
- [Motion Analysis TRC File \(TRC\)](#) on page 7259
- [VRML \(WRL, WRZ\)](#) on page 7290
- [VIZ Material XML Import \(XML\)](#)

NOTE This applies the imported material directly to selected objects. See [Material XML Exporter Utility](#) on page 5281 for information on creating this file type.

- 3 Choose a file to import.
- 4 For some file types, a second dialog appears, with options specific to that file type. Choose the import options you want.

Export

File menu > Export

Export converts and exports 3ds Max scenes in various formats. See the following procedure for a complete list of file types you can export.

See also:

- [Export Selected](#) on page 7099

Procedures

To export a file:

- 1 Choose File menu > Export.
- 2 Choose an export file type from the Files Of Type list in the file selector dialog:
 - [Autodesk \(FBX\)](#) on page 7222
 - [3D Studio \(3DS\)](#) on page 7175
 - [Adobe Illustrator \(AI\)](#) on page 7179
 - [ASCII Scene Export \(ASE\)](#) on page 7180
 - [Lightscape Material \(ATR\)](#) on page 7251
 - [Lightscape Blocks \(BLK\)](#) on page 7251
 - [Autodesk Collada \(DAE\)](#) on page 7222
 - [Lightscape Parameter \(DF\)](#) on page 7251
 - [Publish to DWF \(DWF\)](#) on page 7216
 - [AutoCAD \(DWG\)](#) on page 7206
 - [AutoCAD \(DXF\)](#) on page 7209
 - [Flight Studio OpenFlight \(FLT\)](#) on page 7223
 - [Motion Analysis HTR File \(HTR\)](#) on page 7261
 - [IGES \(IGS\)](#) on page 7230
 - [Lightscape Layers \(LAY\)](#) on page 7251
 - [Lightscape Preparation \(LP\)](#) on page 7251
 - [JSR-184 \(M3G\)](#) on page 7233
 - [gw::OBJ-Exporter \(OBJ\)](#) on page 7281
 - [StereoLitho \(STL\)](#) on page 7279
 - [Lightscape View \(VW\)](#) on page 7251
 - [Shockwave 3D Scene Export \(W3D\)](#) on page 7264
 - [VRML97 \(WRL\)](#) on page 7292

- 3 Enter a name in the File Name field.
- 4 Depending on the file type you choose, you might be presented with options available for that export choice. If a second dialog appears, choose the export options you want.

Export Selected

Select one or more objects. > File menu > Export Selected

Export Selected exports selected geometry in a variety of formats. For details, see [Export](#) on page 7097.

When you choose Export Selected, a file dialog appears, from which you can choose a type of format from the Save as type list. The list of formats available with Export Selected is a subset of the Export list.

Procedures

To export selected objects to a file:

- 1 Select one or more objects.
- 2 Choose File menu > Export Selected.
- 3 Enter a name in the File Name field.
- 4 From the Save As Type drop-down list, choose a file format.
- 5 Click the Save button.

Asset Tracking

The Asset Tracking feature provides direct access within 3ds Max to asset tracking systems (ATS), also known as providers. You use asset tracking systems to share files such as scene files and bitmaps used in materials with other members of your development team.

Asset tracking provides full support for the Autodesk Vault data-management solution, and basic version-control support for other providers, such as Perforce and Microsoft SourceSafe. In general, asset tracking supports version-control providers that are capable of integrating into Microsoft Visual Studio, sometimes referred to as MSSCC support. This topic assumes usage of Autodesk

Vault. Autodesk Data Management Server and Autodesk Vault Explorer are available to subscription customers and are also shipped with certain other Autodesk softwares. See [Manage Files with Autodesk Vault](#) on page 29. The Vault Plug-ins are included with 3ds Max.

NOTE When you have Vault installed, you can open files directly from the Vault database with the File menu command [Open from Vault](#) on page 6925. This command mimics the File Open process, but browses the vault instead of the file system. In addition to opening the scene file, it downloads or updates any dependent scene files, such as bitmaps and XRefs. You see Open from Vault in the File menu only if you have installed the Vault Plug-in.

Asset Tracking with Autodesk Vault

The 3ds Max Vault Plug-in works with 3ds Max by adding data-management tools to the interface. Through the Vault Plug-in, you can add files to a vault, and check files out and in. The add-in works with many different types of files including MAX and image files. The recommended method for performing Vault operations depends upon your working environment.

When you work on a file that is checked out of the vault, you work on a local copy of the file and not the original. At no point do you ever work on the actual vaulted file. When you check a modified file back into the vault, the modifications are available as the latest version in the vault. All past versions of a file are maintained in the vault.

See also:

- [Asset Tracking Dialog](#) on page 7100
- [Open from Vault](#) on page 6925
- [Prompts Dialog](#) on page 7118
- [Asset Tracking Dialog Icons](#) on page 7119

Asset Tracking Dialog

File menu > Asset Tracking

With the Asset Tracking dialog, you can check files in and out, add files to the Asset Tracking System (ATS), get different versions of files, etc., all from 3ds Max without the need to use separate client software. Another important

function of the Asset Tracking dialog is for *repathing*; locating missing files. For example, if you move bitmap files used by materials in your scene to the same folder as the scene file, the bitmaps will be loaded when you open the scene file, but the materials will still use the original, no-longer-valid path for the bitmap files, and the Asset Tracking dialog will show the files as missing. To resolve the incorrect paths, you can use the tools available from the Paths menu.

Asset tracking provides full support for the Autodesk Vault data-management solution, and basic version-control support for other providers, such as Perforce and Microsoft SourceSafe. In general, asset tracking supports version-control providers that are capable of integrating into Microsoft Visual Studio, sometimes referred to as MSSCC support. This topic assumes usage of Autodesk Vault.

The Asset Tracking dialog provides the principal functionality for working with the Vault data-management solution from within 3ds Max, but you can also work directly with Vault using the Vault Explorer client software, which is included with 3ds Max. To run Vault Explorer, go to Windows Start menu > Autodesk > Autodesk Data Management and choose Autodesk Vault Explorer. To learn more about using Vault Explorer, open the Autodesk Vault Explorer Help menu and choose Autodesk Vault Help Topics, or simply press F1 while the Vault Explorer window is active.

See also:

- [Asset Tracking](#) on page 7099

Filtering Files

You can configure individual asset-tracking-system providers via the provider configuration file, *ATSProviders.xml*, which resides in `\plugcfg` in the program install folder. 3ds Max reads this file, but doesn't write to it.

The primary configuration function is filtering. Filters define criteria the software uses to determine whether a file should be excluded from a provider's control. If a file is determined to be excluded from a provider, the file is never sent to the provider for status check or any other action. This feature is useful when using multiple providers within the same pipeline or if your studio still uses file servers for certain file types.

When a file is excluded, its icon is grayed out and its status message indicates that it is excluded. You can also toggle the display of excluded files in the dialog window with the [Display Excluded Files option](#) on page 7113.

A example filter file, `\plugcfg\ATSProviders_Example.xml` is included with the software, in the program install folder. The file includes comments, so you can load it into a text editor to see how it works and edit it. If you're using Autodesk Vault as your provider, you can rename the provider field (in the `<Provider>` section, near the beginning of the file) to Autodesk Vault, as follows:





Change:

```
<Name>Sample Provider Name Example</Name>
```

to:

```
<Name>Autodesk Vault</Name>
```

One of the effects of the example file is to exclude FX files, as shown in the following illustration:

 Autodesk Vault		Logged In
<input checked="" type="checkbox"/>  sph_fx.max	C:\max_scene_fi...	Checked Out
 Maps / Shaders		
<input type="checkbox"/>  fur.fx	C:\max_scene_fi...	Excluded - No FX Files
<input type="checkbox"/>  test_noise.dds	C:\max_scene_fi...	Ok

Procedures

If you are using Vault as your asset management system, you will need to login into the Vault the first time you access it, otherwise you will not be able to check files in and out.

To start and login into the Vault from 3ds Max:

- 1 In 3ds Max choose File > Asset Tracking.
- 2 Select the version of Autodesk Vault that you want to login to from the Autodesk Vault Version box.

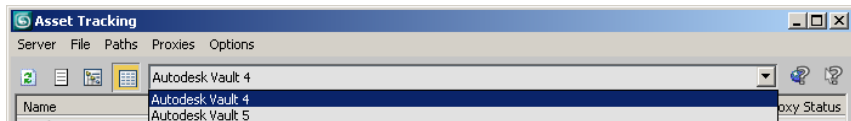

- 3 In the Asset Tracking dialog choose Server > Log in.

4 In the Log in dialog box enter the following:

User Name	The name for the vault account. Default= Administrator
-----------	--

Password	The password associated with the vault account. Default=<left blank>
----------	--

Server	The name of the computer on which the vault server is installed. Use "localhost" if the server is installed on the same machine as the client. See your system administrator if this does not work.
--------	---

Database	The name of a vault database located on the specified server. The default is "Vault". Click the browse button to select from a list of available databases on the server. Default=Vault
----------	---

NOTE Enable Use this settings next session if you want to be automatically logged in future sessions.

Click OK when you have entered values in all fields.

NOTE Your system administrator may provide you with your own account values which you will use instead of the defaults. If you are experiencing problems, speak with your system administrator.

To set up a local working folder when using Vault:

When you are working with files in Autodesk Vault you need to have a **working folder** set up. The working folder houses your files while you are working on them (between checking files out of the vault and checking them back in to the Vault). The working folder can be a folder on your local machine or a folder on the network. Typically a system administrator will set up the working folder on the network.

NOTE If your system administrator has enforced a network working folder, you may receive a message notifying you of this. You will not need to set your working folder, though you may need to map the drive location that has been set up for your working folder. For further information, speak with your system administrator.

- 1 In 3ds Max choose Server > Login and [login](#) on page 7105 to the Vault.

NOTE Make sure the version of Vault that you want to work with is selected in the Autodesk Vault Version box.

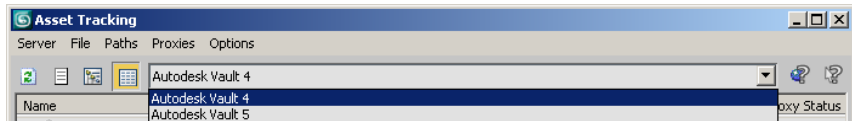

- 2 Choose Server > Options.
- 3 Browse to the folder that you want to use and click OK to confirm.

To coordinate local files with Vault files:

For optimal coordination between your files and those in the Vault, you need to maintain a one-to-one correspondence between the folder structure in the database and the structure in your *working folder* and its subdirectories.

Create a local folder structure for Vault files and then use Options to map the top of the local structure to the top of the Vault structure (i.e., *Vault(\$)*).

- 1 Create a working folder on a local drive to contain all files to be coordinated with other users via the Vault. For example, you could call the working folder **My_Vault**.
- 2 Open the Asset Tracking dialog and log in to the tracking database if necessary.
- 3 On the Asset Tracking dialog, choose Server menu > Options.
- 4 On the Vault Options dialog, click the Change button and then use the Browse For Folder dialog to choose the folder you created in step 1.

TIP You can also use the Browse For Folder dialog to create this folder.

Now, when you [open a file from the Vault](#) on page 6925, the folder structure in which the file resides in the Vault is replicated in your local folder, if necessary. Likewise, when you add a file to the Vault, the local structure

is replicated in the Vault, if necessary. For example, if you open a character mesh from *Vault(\$)\max_files\characters* and the file uses a bitmap stored in *Vault(\$)\max_files\characters\face_maps*, the character mesh is stored locally in *My_Vault\max_files\characters* and the map file is stored locally in *My_Vault\max_files\characters\face_maps*.

Interface

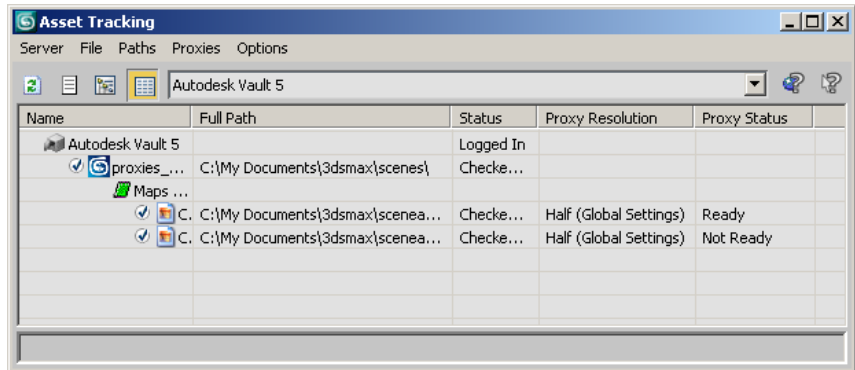

Menu bar

The menu bar provides access to most Asset Tracking functions. Most of the menu functions are also available from the right-click menu available in the dialog window.

NOTE If you highlight and then Ctrl+right-click one or more assets all of which reside in the same directory, a version of the Windows Explorer context menu opens. This lets you perform such functions as cutting or copying the file, or sending it to the desktop as a shortcut for easy access.

Server menu

Log in Displays the Vault Log In dialog. Enter your user name, password, server name, and database, and then click OK. After entering a server name, you can click the ellipsis (...) button display all available databases and choose one from the dialog.

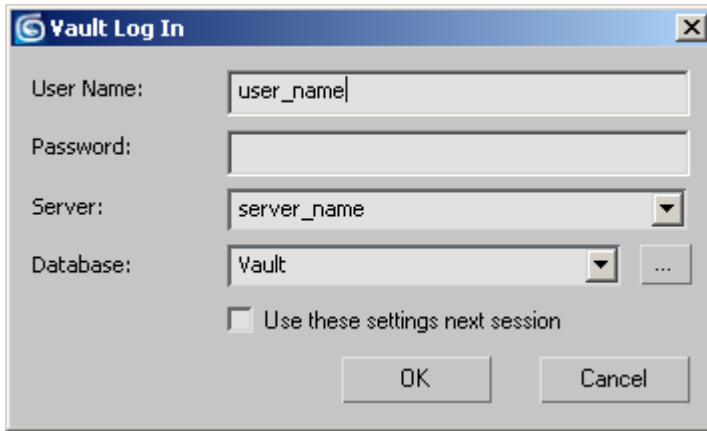

You can log in automatically in future sessions without having to use the Vault Log In dialog if you turn on “Use these settings next session.” This also turns on Options > “Log in using saved settings.”

The login settings are stored in the file *plugcfg\ATSVaultLogin.ini* in the program install folder.

Log out Logs you out of the database.

Options Opens the Vault Options dialog, where you can view the *working folder* and specify a new one (click the Change button). Available only when logged in.

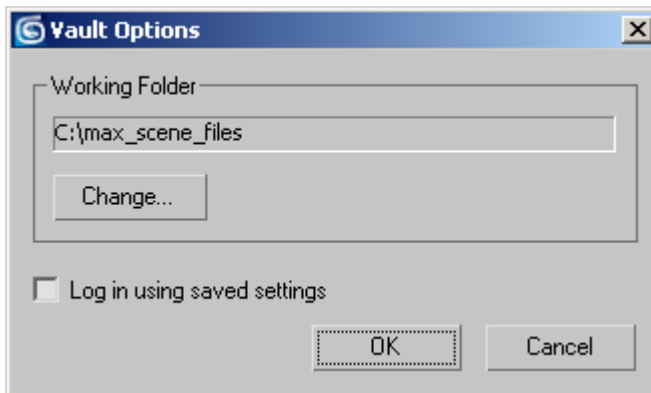

IMPORTANT The working folder is a folder on your local drive that mirrors the top-level folder of the provider database structure. For further information, see [this procedure](#) on page ?.

You can log in automatically in future sessions, bypassing the Vault Log In dialog, if you turn on “Log in using saved settings.” This also turns on Vault Log In > “Use these settings next session.”

Launch Provider Opens the database client program. This is the same as running the program from the Start menu. It doesn't necessarily open to the same database you're using in 3ds Max.

File menu

Most of the File menu commands are available only when you're logged in.

Checkout Lets you check out the highlighted assets in the Asset Tracking dialog list of assets, if the assets are available for checking out. This opens a dialog that lets you confirm the checkout, specify whether to replace the local copies with the checked-out version, and enter a comment.

If you enter a comment, it's copied to the [Working Comment dialog](#) on page 7108.

TIP Always be sure to check out an asset before modifying it, even if you have a writable version on a local drive. This prevents other users from modifying the file at the same time, and lets you maintain strict version control over the asset.

Checkin Lets you check in the highlighted assets in the Asset Tracking dialog list of assets. This opens a dialog that lets you confirm the checkin, specify whether to keep the assets checked out, and enter a comment. Also, if the assets have been edited but not saved locally, you're prompted to save first.

Checking in an asset increments the current version number of the asset as stored in the database, and saves the current Comment text along with the asset.

Undo Checkout Reverses a checkout, setting the highlighted assets' status to checked in, without saving any changes.

Add Files Lets you add files in the scene, such as bitmaps used in materials, to the provider database. To add a file, load it (such as a scene file) or add it to the scene (such as a bitmap used in a material), highlight it in the Asset Tracking dialog, and then use Add Files.

You can add multiple files at the same time.

NOTE You cannot add a file that doesn't exist on a local drive, such as an unsaved scene file. Also, you cannot add a file that's not in the working folder, as specified via [Options](#) on page 7106. For best results, before adding a file, make sure it exists in a local folder within a structure that mirrors the one in the Vault. For details, see [this procedure](#) on page ?.

Get Latest Downloads the most recent (highest-numbered) version of the highlighted asset from the database. Use this when a teammate has updated an asset such as a bitmap.

History Opens a History dialog from which you can get any version of the highlighted asset. When the dialog opens, highlight the version to get by clicking it and then click Get Version. You can also right-click the asset and choose Get Version from the context menu.

Properties Opens a read-only dialog that shows information about the highlighted asset such as vault and local locations, versions, and check-out status.

Get From Provider Lets you copy files from the database to the local working folder. Use the Get Files dialog to navigate to the folder from which to get files, highlight any number of files, and then click Open. The highlighted files and any dependent files, such as bitmaps and XRefs, are copied to the local folder, using the same folder hierarchy as that of the database.

Working Comment Opens a dialog that containing a common text buffer for the current session.

When you check out a file, any comment you enter in the Asset Tracking dialog is copied to the Working Comment dialog. You can edit this text at any point during the session. When you check a file back in, all Working Comment text appears in the Asset Tracking dialog; you can edit it as necessary without affecting the original text before completing the check in. The checked-in comments remain with that version of the file in the Vault.

Browse Lets you browse the local directories for missing files such as bitmaps. Use the Browse dialog to find the file, and then click Open.

View Image File Opens a window showing the highlighted image file. The file must be present in a local directory.

Reveal In Explorer Opens a Windows Explorer dialog showing the location of the highlighted asset.

Custom Dependencies Opens a dialog that lets you specify files to be dependents of the current scene; files that aren't necessarily present in the current scene but should be associated with it. On the Custom Dependencies

dialog, click the Add button and then use the Add Custom Dependencies file browser to open dependent files.

The Custom Dependencies function lets you associate files that aren't true scene dependencies. A true dependent file is required for rendering, animation, exporting, etc. A custom dependency might be reference art work, a text file with scene documentation or tasks to accomplish, custom scripts, etc. Basically, any collection of files that should "travel along" with the scene.

One potential use for a custom dependency is as a way to perform simple project management. For example, you could add a file called *GameTitle-A.txt* as a custom dependency to any scene file associated with GameTitle-A. You could then instruct the provider client, such as Vault Explorer, to display all files that are dependent on *GameTitle-A.txt*, which would give you a list of files associated with that project.

Refresh Reloads the asset listing from the local scene and updates the window contents.

Paths menu

The tools on this menu help you resolve file-path issues such as missing files. They include functionality also available in the [Bitmap/Photometric Path Editor Utility](#) on page 7141, but their integration into the Asset Tracking dialog helps speed the workflow of managing scene assets.

Highlight Editable Assets Highlights all assets whose paths can be affected by the remaining commands on this menu.

For example, if your scene materials use bitmaps from a number of different folders, you could copy all the bitmaps to a common directory within your working folder, use Highlight Editable Assets to highlight all the bitmap assets, and then use Set Path (see following) to designate the common directory.

Set Path Opens a dialog for editing the scene's record of the highlighted asset's or assets' path and, in the case of a single asset, the file name. Both versions of the dialog include drop-down history lists for reverting to a previous path or file name.

The primary function for this command is to change the path pointed to by 3ds Max for existing assets whose locations have changed. However, for output files such as rendered images and render elements, you can also use Set Path to create and use new output directories. If you change an output path to one that doesn't exist, you're prompted to confirm that you want to create the folder(s). If you confirm, the output paths are changed in all appropriate locations, such as the Render Setup dialog.

The version of the dialog that appears depends on the number of highlighted assets:

- If a single asset is highlighted, you can change the path and the file name. The following dialog appears.

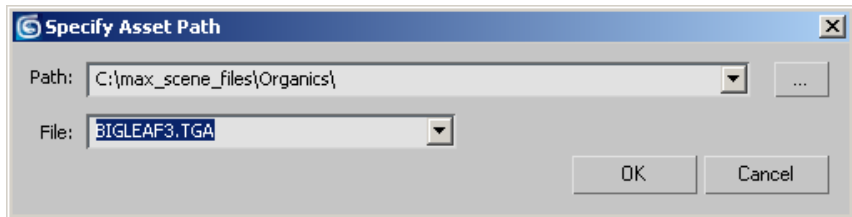

To change the path, edit the Path field or use the ellipsis [...] button to browse for a new path. This changes the path only.

To revert to a previous path, choose it from the drop-down list.

To change the file name, edit the File field or choose a name from the drop-down history list. Note that this changes only the name of the asset file as pointed to in the scene; it doesn't change the actual asset file name. Use this to update the scene if the asset file name has changed.

- If multiple assets are highlighted, you can change the path but not file names. The following dialog appears.

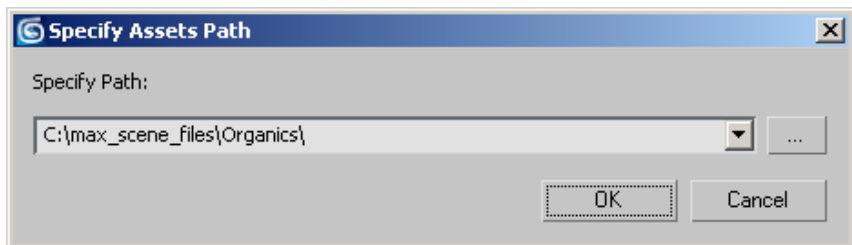

The dialog shows the portion of the current path that the highlighted assets and lets you specify a new one, either by editing the Specify Path field contents or by clicking the ellipsis [...] button and browsing to a different path.

For example, if two assets are highlighted, and one asset's path is *c:\max_files\maps1* while the other's is *c:\max_files\maps2*, the Specify Path field will show *c:\max_files*. Changing this changes the *complete* path for all highlighted assets. Of course, they must all be present there for the program to find them.

To revert to a previous path, choose it from the drop-down list.

To change only the portion of the path that all highlighted assets have in common, use Retarget Common Root (see following).

Retarget Common Root Lets you change only the part of the path that all highlighted assets have in common. This command opens a version of the Specify Assets path dialog that shows the common path prefix for the highlighted assets and lets you specify a new one, either by editing the Specify New Common Path Prefix field contents or by clicking the ellipsis [...] button and browsing to a different path. Use Retarget Common Root for repathing multiple files, particularly those in different directories within the common root.

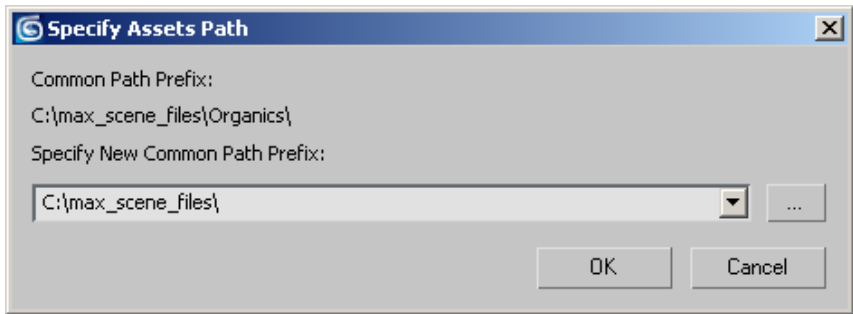

For example, if all maps were originally in various subdirectories within *c:\maps* and the entire subdirectory structure was moved to *d:\resources\maps*, you could repath all files simultaneously using Retarget Common Root.

To revert to a previous path, choose it from the drop-down list.

If you change the common root for *output* files to a path that doesn't exist, you're prompted to confirm that you want to create the folder(s). If you confirm, the output paths are changed in all appropriate locations, such as the Render Setup dialog.

Strip Path Strips all path information from the highlighted assets, leaving only the file names.

Stripped path information is saved in the Set Paths dialog drop-down list. To restore stripped paths, highlight the assets, choose Paths menu > Set Paths, and then choose the desired path to restore from the drop-down list.

Make Path Absolute Gives the complete path of the found asset file. This is useful when a relative path is displayed and you want to see the entire path.

Make Path Relative to Project Folder This takes the current path of the found asset file and makes it relative to your [project folder](#) on page 6932.

Resolve Path to UNC Location Resolves highlighted paths that point to mapped drives to [Universal Naming Convention \(UNC\) format](#) on page 8160.

Set Project Folder See [Set Project Folder](#) on page 6932.

Configure User Paths Opens the [Configure User Paths dialog](#) on page 7729, which you can use to resolve locations for support files such as bitmaps.

NOTE This option makes it simple to share files between different users, even if you are not using the same project folder. If user A loads a file from user B and they do not have the same project folder, this will not be a problem.

Preferences Use this submenu to toggle these options:

- **Convert file paths to UNC** When on, paths shown in the Asset Tracking dialog for any added assets present on a mapped drive use [Universal Naming Convention \(UNC\) format](#) on page 8160. When off, each path starts with the mapped drive letter (e.g., w:\).
This switch is linked to the [Convert file paths to UNC](#) on page 7750 switch on the Preferences dialog > Files panel. Toggling either one toggles both.

NOTE This switch affects only newly added paths. Toggling it has no effect on existing paths. For example, if you add an asset from a mapped drive with the switch on, turning it off does not change the path to the mapped version.

- **Convert local file paths to Relative** When on, converts the file paths of all newly added assets in a scene so that they are relative to the project folder. Default=off.
This switch is linked to the [Convert local paths to Relative](#) on page 7751 switch on the Preferences dialog > Files panel. Toggling either one toggles both.

Proxies menu

The Proxy system lets you determine how 3ds Max should create and use proxy versions of bitmaps incorporated in materials. Proxies are intended for use primarily in the viewports when building and editing scenes to reduce the amount of memory required by the bitmapped textures, but you can also use them at render time.

Enable Proxy System Toggles the Proxy system globally. When on, 3ds Max replaces all bitmaps used in materials with proxies as specified on the [Bitmap Proxies dialog](#) on page 7115. When off, the original bitmaps are used.

Global Settings Opens the [Bitmap Proxies dialog](#) on page 7115.

Set Proxy Resolution Opens the Per-Bitmap version of the [Bitmap Proxies dialog](#) on page 7115 for setting the resolution for proxies of only those bitmap assets highlighted in the Asset Tracking dialog. Available only when one or more bitmap assets are highlighted.

Generate Selected/Stale Proxies Generates the proxy image files as specified. When one or more image assets are highlighted in the Asset Tracking dialog list, the command is Generate Selected Proxies, and applies only to those assets. When no asset is highlighted, the command is Generate Stale Proxies, and applies to all assets whose settings, such as proxy resolution, have changed since the previous generation, as well as any assets whose proxies are missing.

Options menu

Disable Asset Tracking Turns off asset-tracking functionality. Choosing this command logs you out of the database and makes most asset-tracking functions unavailable. To restore asset tracking, turn off Disable Asset Tracking and then log back in.

Prompts Opens the [Prompts dialog](#) on page 7118, which lets you toggle two different options for each of various actions in the Asset Tracking dialog: actions and prompts.

Auto Login Logs you in to the Vault, if necessary, whenever you cause a MAX scene file to be present in memory; for example when you load or save a scene. You can bypass the Vault Log In dialog If you've turned on Options dialog > "Log in using saved settings" or Vault Log In > "Use these settings next session."

Display Excluded Files Displays files that are set to Excluded status. When off, these files aren't shown in the dialog window. For information about excluding files, see [Filtering Files](#) on page 7101. You can also set output files to Excluded status; see following.

Exclude Output Files Sets output files such as rendered images to Excluded status; you can prevent the dialog from displaying such files by turning off Display Excluded Files (see preceding).

Tree View Displays a simplified, hierarchical listing of the assets in the current scene. You can expand and collapse hierarchy branches by clicking the + and - icons to the left of the branch names.

Table View Displays listing of the assets in the current scene in tabular format along with the full path and for the local version of each asset. The branches are hierarchical, but cannot be expanded or collapsed.

Toolbar

Refresh Reloads the asset listing from the local scene and updates the window contents.

Status Log Opens a read-only window showing all status messages received from the Vault during the current session.

Tree View Displays a simplified, hierarchical listing of the assets in the current scene without path or status information. You can expand and collapse hierarchy branches by clicking the + and - icons to the left of the branch names.

Table View Displays listing of the assets in the current scene in tabular format along with the full path and status for the local version of each asset. The branches are hierarchical, but cannot be expanded or collapsed.

Folders

[**folders**] If the system administrator created files folders in Autodesk Vault, they appear in the Asset Tracking dialog and help you maintain organization of files.

[**library folders**] If your system administrator set library folders up in Autodesk Vault, they appear in the Asset Tracking dialog. The system administrator sets these folders up on the network and they can act as multiple network workspaces for a team. Your team can use them to organize different types of files. For example, you may have a library folder for materials, for maps, for animations, and so on. Since these library folders are stored on the network, files that are shared between team members can reside on the network at all times, rather than on a user's local workspace. Library folders can also be used to protect files because the system administrator can set up read/write permissions so that only certain users can make changes to files. See your system administrator for further details.

NOTE A regular folder looks the same as a library folder from the Asset Tracking dialog. Different icons distinguish the two types of folders inside Autodesk Vault.

[window]

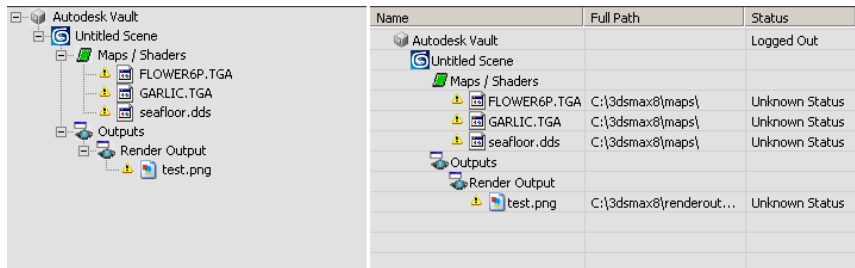

Left: Asset Tracking dialog window in Tree View

Right: Asset Tracking dialog window in Table View

The Asset Tracking dialog window lists all assets in the current scene in a tree or table view, depending on the current setting. Listed assets include the scene file, any images used by the scene in materials, etc., XRefs, and photometric files. By default, output files such as rendered images also appear in the window listing; you can [turn off](#) on page 7113 display of these if you wish.

Also shown are icons for each assets showing the type of asset (3ds Max scene file, map branch, etc.) and status, as appropriate. Most status icons are documented in the Vault Explorer Help > Autodesk Vault Explorer Icon Reference topic. For a reference to the most common icons, see [Asset Tracking Dialog Icons](#) on page 7119.

NOTE No status icons appear if you don't have any version-control provider installed.

In general, status errors can be resolved by being careful to coordinate the local folder/file structure with that of the Vault, as described in the above procedure.

You can access most dialog commands by right-clicking an asset in the window; the commands applicable to the asset are available in the context menu. These commands are the same as those documented above.

Global Settings and Defaults for Bitmap Proxies Dialog

Render Setup dialog > Common panel > Common Parameters rollout > Bitmap Proxies group > Setup

Asset Tracking dialog > Proxies menu > Global Settings

Asset Tracking dialog > Highlight bitmap asset(s). > Proxies menu > Set Proxy Resolution

Asset Tracking dialog > Right-click a bitmap asset. > Set Proxy Resolution

This dialog lets you determine how 3ds Max should create and use proxy versions of bitmaps incorporated in materials. Proxies are intended for use primarily in the viewports when building and editing scenes to reduce the amount of memory required by the bitmapped textures, but you can also use them at render time.

NOTE When you open this dialog using either of the Set Proxy Resolution commands cited at the top of this topic, the title changes to Per-Bitmap Resolution for Bitmap Proxies, the Enable Proxy System check box changes to Use Global Settings, and you can set only the [proxy resolution](#) on page 7117.

Interface

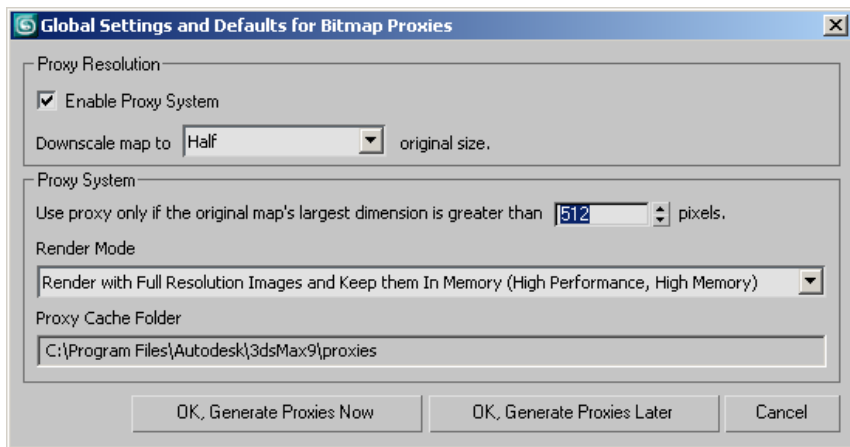

Proxy Resolution group

The label and function of the first check box on the dialog depends on whether you invoked it with Setup/Global Settings command or Set Proxy Resolution:

- **Enable Proxy System** Toggles usage of the proxy system. When off, 3ds Max uses only the original, full-resolution maps. Available only on the Global version of the dialog (see [note](#) on page 7116).

- **Use Global Settings** When on, the proxy system applies the same settings to all bitmaps subject to proxy substitution, as set via the Global version of the dialog (see [note](#) on page 7116). When off, use the Downscale Map ... setting (see following) to specify resolution only for bitmaps highlighted before invoking Set Proxy Resolution. Available only on the Per-Bitmap version of the dialog.

Downscale map to ... original size. Use the drop-down list to choose the fraction to which the proxy system reduces the bitmap(s): Full (no reduction), Half, Third, Quarter, or Eighth. The greater the reduction, the greater the memory savings and speed improvement, especially in a scene with many maps, but the less recognizable the map.

Proxy System group

These settings are available only when you open the dialog using the Setup or Global Settings commands cited at the top of this topic.

Use proxy only if the original map's largest dimension is greater than ... pixels. Lets you indicate that bitmaps smaller than the size you specify are not to be reduced. Downscaling smaller maps isn't particularly efficient or useful.

To ensure that the system creates proxies for *all* bitmaps, set this to 0.

Render Mode Lets you determine whether to use the proxies at render time. The options, available from the drop-down list, are self-descriptive:

- **Render with Proxies (High Performance, Low Memory)**
- **Render with Full Resolution Images and Keep them In Memory (High Performance, High Memory)**
- **Render with Full Resolution Images and Free them from Memory (Low Performance, Low Memory)**

Proxy Cache Folder This read-only field displays the path in which 3ds Max stores proxy bitmap files. To change the path, go to Configure User Paths > [File I/O](#) on page 7733 and edit the BitmapProxies entry.

OK, Generate Proxies Now Generates proxy bitmaps as specified by the dialog settings and closes the dialog.

OK, Generate Proxies Later Saves the dialog settings and closes the dialog but does not generate proxy bitmaps. You must generate the proxies manually

using the [Generate Selected/Stale Proxies command](#) on page 7113 from the Asset Tracking dialog.

Cancel Closes the dialog without saving any changed settings.

Prompts Dialog

File menu > Asset Tracking > Asset Tracking dialog > Options menu > Prompts

The Prompts dialog lets you specify what happens when you perform a number of different functions via the [Asset Tracking dialog](#) on page 7100. For each message, you can choose an action and toggle the prompt using a right-click menu. If you turn off the prompt, the option you set on the top part of the menu takes place automatically.

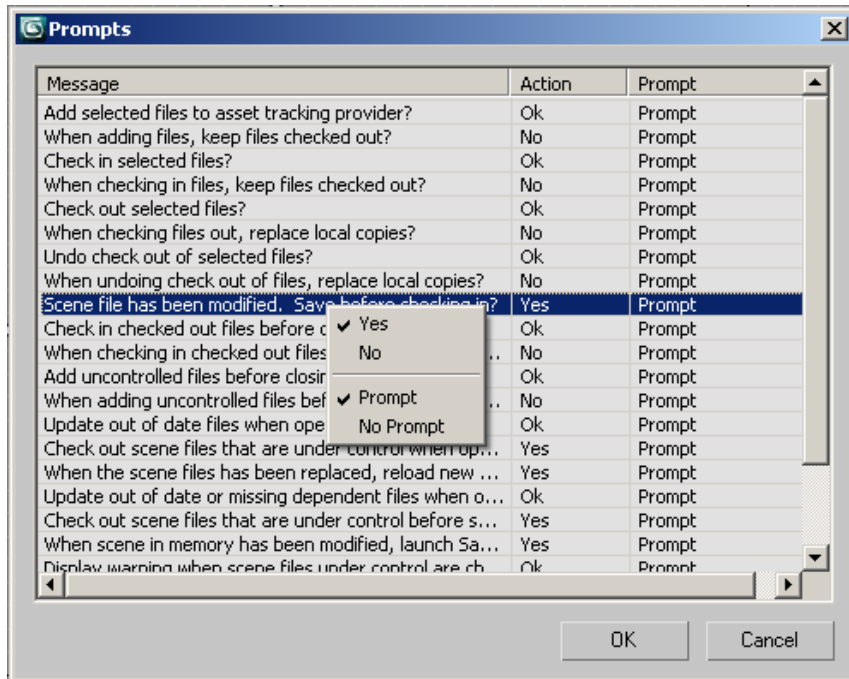

Procedures

To set prompts for asset tracking:

- 1 From the Asset Tracking dialog > Options menu, choose Prompts.

2 Right-click the message to set prompts for.

The right-click menu shows check marks next to the active settings. For each message, you have two options:

- Yes/No or Ok/Cancel
- Prompt/No Prompt



3 Change the options to suit your preferences.









For example, if you know that you always want to keep files checked out that you add to the vault, set the option “When adding files, keep files checked out?” to Yes and No Prompt.





The changed settings are saved with the program.

Asset Tracking Dialog Icons

The [Asset Tracking dialog](#) on page 7100 uses a number of icons to indicate the status of assets listed in the dialog window. The following table lists these icons and describes their functions:

Icon	Meaning
	If no icon is displayed, the file is under version control, but you do not have a local copy of the file on your computer.
	File is under version control and available to be checked out. The version in your working folder is the same as in the provider. Also referred to as the Latest Version.
	File is under version control and available to be checked out, but the local version is newer than the latest version. This typically means that your local file was changed without checking it out.
	File is under version control and available to be checked out, but the local copy is out of date.

Icon	Meaning
	File is checked out to you and the local version is the latest.
	File is checked out to you and the local copy is newer than the latest version. This typically means that you made changes to the file since it was checked out but have not checked it back in.
	File is checked out by someone else, and the local copy is the same as on the provider. Also referred to as the Latest Version.
	File is checked out to someone else, but the local copy is newer than the latest version.
	File is checked out to someone else, but the local copy is older than the latest version.
	File is checked out by someone else in a setup where the working folder is shared and the local copy is the same as on the provider.
	File is checked out by someone else in a setup where the working folder is shared on the network, but the local copy is newer than the latest version.
	File is checked out by someone else in a setup where the working folder is shared on the network, and the local copy is older than the latest version.

Icon	Meaning
	Status for the file could not be obtained. This typically means you are not logged into the provider.
	The file is not under version control.
	You are not logged in to the provider.
	You are logged in to the provider.

Archive

File menu > Archive

Archive creates a compressed archive file or a text file listing the scene bitmaps and their path names.

3ds Max automatically finds the files referenced in the scene and creates the archive file in the executables folder. During the archiving process, a log window is displayed.

Compressed archive files are created using an external program. You specify the name and location of the [archive program](#) on page 7750 you want to use in the Files tab of the Preferences dialog.

Procedures

To set up an external archive program:

- 1 Choose Customize > Preferences.
- 2 Click the Files tab to display the Files panel.

- 3 In the Archive System group, enter the full path and executable file name, and any command-line option you want for your external archive program in the Program field.

To archive a file:

- 1 Choose File > Archive > Archive.
- 2 Enter a name for the archive in the File Name field.
Include the appropriate file extension (for example *.zip*).
- 3 Choose a file type: 3ds Max Archive or List Of Files.
 - To create an archive file, choose 3ds Max Archive in the Save As Type list. The archive file contains the scene plus all bitmaps used for the scene, including Video Post bitmaps.
 - To create a text file, choose List Of Files (*.txt) in the Save As Type list. The resulting file is an ASCII list of scene files.

Summary Info

File menu > Summary Info

Summary Info displays statistics about the current scene.

Interface

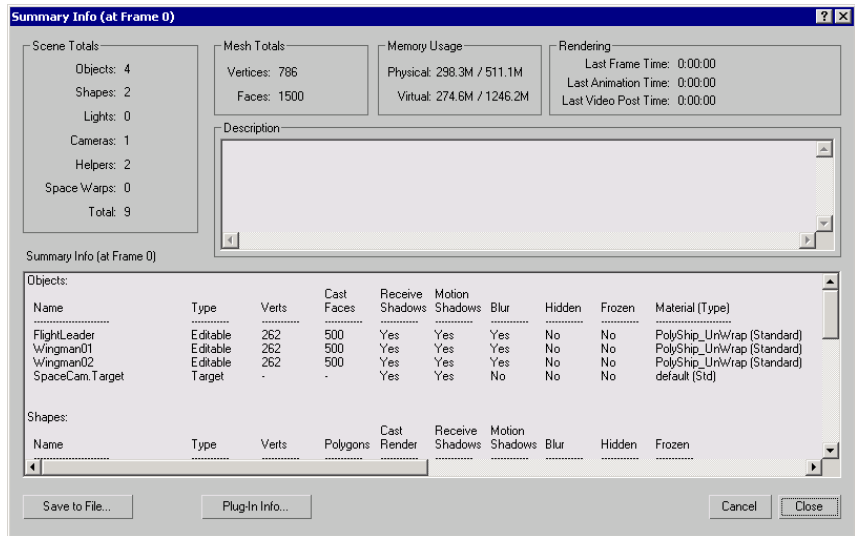

The Summary Info dialog includes the following information:

Scene Totals Number of objects in your scene listed by type.

Mesh Totals Total number of vertices and faces in the scene.

Memory Usage Physical and virtual memory used and available.

Rendering Time spent rendering the last frame, animation, and video post.

Description Lets you enter notes about the scene. Information that you add to the Comments field on the [File Properties dialog](#) on page 7124 will appear in the Description field and vice-versa.

Summary Info Lists materials in the scene. The information is sorted by category and includes object name, assigned material name, type of material, object vertex and face counts, and so on. Materials are listed at the bottom of the list. Bitmaps used by the materials are listed with the materials. Environmental and atmospheric maps are listed separately. The Other Maps category lists all other maps used in the scene, such as Displace maps, and any maps assigned by third-party plug-ins.

Video Post maps are not included.

The buttons at the bottom of the Summary Info dialog have the following functions:

Save to File Saves the contents of the dialog and descriptive text to a *.txt* (text) file.

Plug-In Info Displays a subdialog with information about the [plug-ins](#) on page 8092 used in the scene. By default, the subdialog shows the name and a brief description of each plug-in.

Show Details Shows information about all of the classes supported by each plug-in.

Show Used Only Restricts the view to only those plug-ins that have been used in the scene.

File Properties

File menu > File Properties

File Properties allows you to enter information about a scene that can later be read by Windows NT 4.0 or later and Windows 98 or later, using a program such as Windows Explorer to view the properties of the scene file.

This information can also be used to locate scene files with the [File Finder utility](#) on page 7143.

The Properties dialog comprises three tabs:

- The Summary panel displays predefined fields that are commonly used.
- The Contents panel displays scene information available after the scene had been saved.
- The Custom panel enables you to create new fields that can also be used by the File Finder utility.

Interface

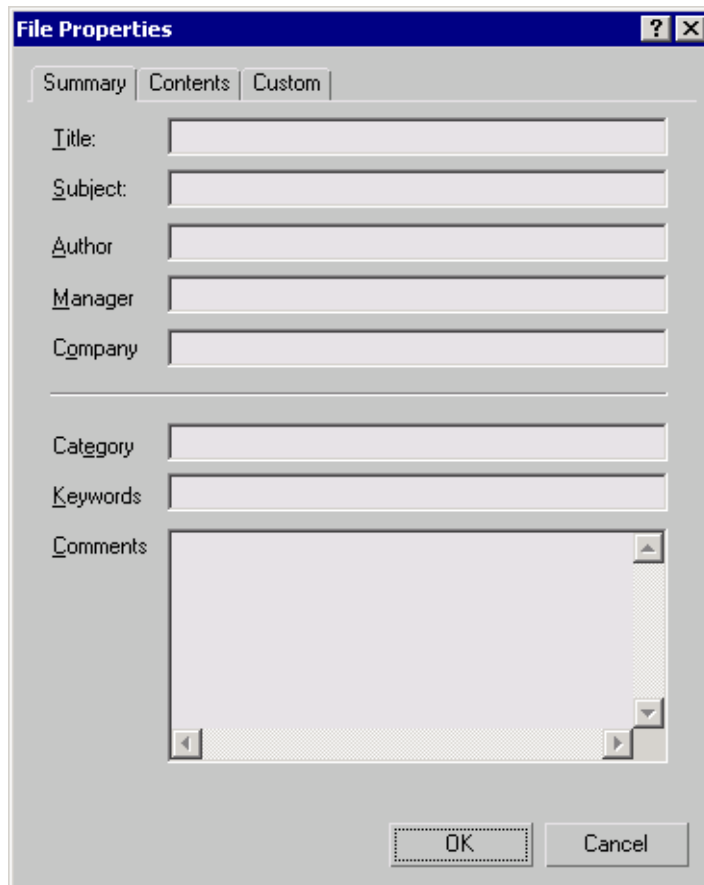

Summary panel

Summary provides fields for entering information related to the saved scene. Many commonly used fields are available from the Summary tab. If there is a field you would like that is not represented in the Summary tab you can use the Custom tab to define new fields for information.

Title Enter the title of your scene or animation here.

Subject Enter the subject of your scene or animation here.

Author Enter the author of your scene or animation here.

Manager Enter the manager of your scene or animation here.

Company Enter the name of your company here.

Category Enter the category of your scene or animation here.

Keywords Enter keywords that identify your scene here.

Comments Enter personal comments here. Information that you add to the Description field on the [Summary Info dialog](#) on page 7122 will appear in the Comments field and vice-versa.

Contents panel

When a scene is saved, a summary list of everything contained in the scene is generated and displayed in the Contents tab. If a scene has not been saved, the Contents tab remains empty.

NOTE There is currently a bug in Windows NT 4.0 that causes the information in the Contents tab to look garbled when you view a MAX file in Windows Explorer. The problem has been corrected in Windows 98. Although the information looks garbled, it is internally correct and the File Finder utility can still read it.

Custom panel

The Custom panel lets you create custom fields. Custom is useful when there is more information that needs to be entered into the properties of a scene but there is no field or no room in the Summary panel.

Name Enter the name of a custom field. You can manually enter anything you want into the Name field. A drop-down list provides commonly used field types.

Type Specifies the type of information to be entered into the Value field: choose from Text, Date, Number, and Yes or No. This dictates the type of information to be entered into the Value field.

Value Enter the data here.

Add Adds the Custom properties entered into the Name, Type, and Value fields to the Properties list.

Delete Removes a selected Custom property from the Properties list.

Properties Displays all Custom properties entered into the scene.

View Image File

File menu > View Image File

Choose and view still images, numbered image sequences, images in an [IFL file](#) on page 7339, or animation files using options in the View File dialog. Still images and numbered image sequences appear in a feature-reduced version of the [Rendered Frame Window](#) on page 6073.

If you choose an IFL file in the file dialog, the Info button displays the contents of the text file in Windows Notepad.

You can zoom in and out and pan the image. If you have a wheel mouse, you can use its wheel button to zoom and pan. See the following procedures.

If you choose an animation file ([AVI](#) on page 7326 or [QuickTime MOV](#) on page 7348), the software starts the Windows Media Player so that you can play it. The Media Player has its own Help system.

Procedures

To view a file:

- 1 Choose File > View Image File.
- 2 Choose a file type from the Files of Type list.
- 3 Choose a file to view.

NOTE The View File dialog uses the last location where a file was chosen, rather than the default Images path defined on the Configure User Paths dialog.

To zoom in the Rendered Frame Window:

- Press Ctrl and click.
- Using a wheel mouse, roll the wheel forward (away from you).

To zoom out in the Rendered Frame Window:

- Press Ctrl and right-click.
- Using a wheel mouse, roll the wheel backward (towards you).

To pan the Rendered Frame Window:

- Press Shift and drag.
- Using a wheel mouse, drag with the wheel button held down. (You can use any three-button device to pan the image.)

Interface

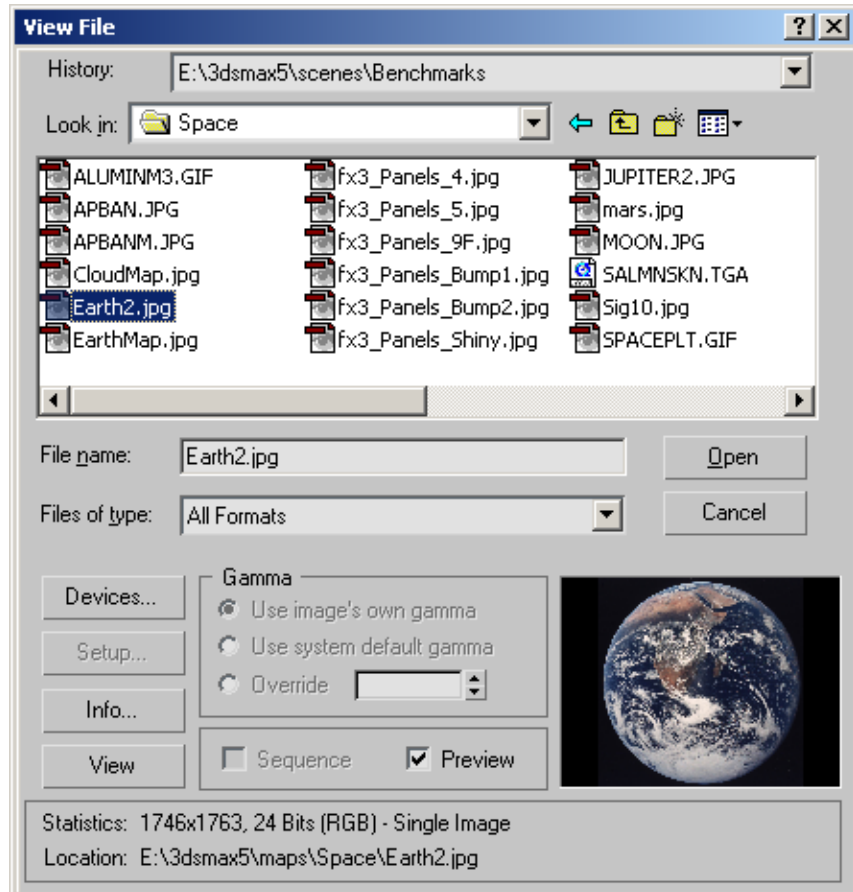

History Whenever an image is selected, the path used is added to the top of the history list as the most recently used path.

File selections from other areas of the interface, such as Views > Viewport Background, are stored here also. The history information is saved in the [3dsmax.ini](#) on page 83 file.

Look In Browses drives and directories.

File Name Displays the name of the selected file.

Files of type Selects the type of files to list in the directory window.

Devices Lets you choose the hardware output device, for example, a digital video recorder. To use the output device, the device, along with its driver, and its plug-in must all be installed on your system.

Setup This is unavailable in View Image File.

This option is available only in file dialogs like the Render Output File dialog or the Viewport Background dialog. Displays a dialog to specify image attributes for saved files or, in the Select Background Image dialog, the arguments for creating an IFL file.

Info Displays image information.

View View the selected image or animation.

Gamma group

Selects the type of gamma to be used for the selected file. Available only when Enable Gamma Selection is turned on in the [Gamma panel](#) on page 7758.

Use Image's Own Gamma Uses the gamma of the incoming bitmap.

Use System Default Gamma Ignores the image's own gamma and uses the system default gamma instead, as set in the [Gamma panel](#) on page 7758.

Override Defines a new gamma for the bitmap that is neither the image's own, nor the system default.

Sequence This is unavailable in View Image File. This option is available in the Views > Viewport Background > Files > [Select Background Image dialog](#) on page 156. It is used in conjunction with Setup to create IFL files.

Preview Toggle the image preview display.

Preview Window Displays the selected image.

Displays file statistics and the file's full directory path.

Exit

File menu > Exit

Exit closes 3ds Max. If you have unsaved work, you'll be asked if you want to save it.

Procedures

To exit the program:

- 1 Choose File > Exit.
- 2 Click the Yes, No, or Cancel button.

If you click Yes the scene is saved, if you click No the scene is not saved, if you click Cancel the Exit operation is canceled.

NOTE You can also click the Close button (the X) in the upper-right corner of the 3ds Max window to exit.

Missing External Files Dialog

This dialog appears when you attempt to open or render a scene with [bitmaps](#) on page 7926 or photometric files ([IES](#) on page 5034, [CIBSE](#) on page 7935, [LTLI](#) on page 8029) whose path is no longer current. This can happen if the bitmaps have been moved or deleted, or if the scene has been placed on a system with a different drive mapping than the system on which it was created.

See also:

- [External Path Configuration](#) on page 7735
- [Bitmap / Photometric Path Editor Dialog](#) on page 7156

Interface

Two slightly different versions of the dialog exist: One appears when you load a scene that references missing files, and the other appears when you attempt to render such a scene.

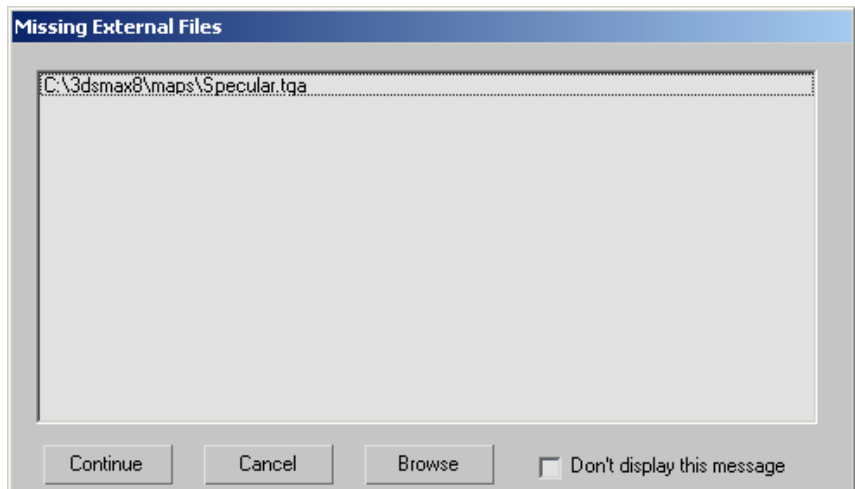
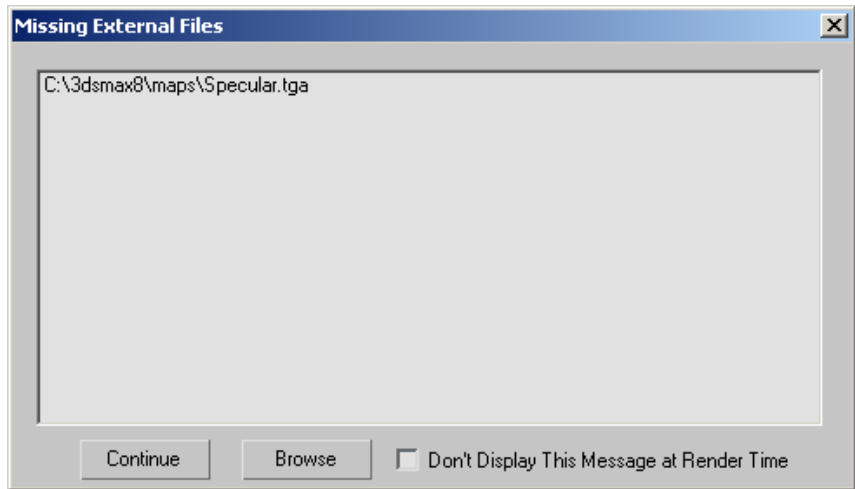

Top: This dialog appears at load time.

Bottom: This dialog appears at render time.

[List of external files] Lists the bitmaps or photometric files that cannot be located, along with their path names.

Continue Opens or renders the file anyway, without loading the missing bitmaps or photometric files.

If you continue rendering the scene, the bitmaps do not appear, or the lights assigned missing photometric files will render using the default isotropic distribution.

Cancel Cancels the render. This button appears only at render time.

Browse Displays a Configure External File Paths dialog, to let you add the missing files' paths to the search sequence. This dialog has the same controls as the Configure User Paths dialog > [Configure External Files Paths panel](#) on page 7735 .

Don't Display This Message at Render Time Appears only when loading a scene with missing files. When on, the program does not display this dialog if you render the scene without resolving the missing files.

Don't Display This Message Appears only at render time. When on, the software does not display the dialog the next time external files cannot be found.

File-Handling Utilities

Asset Browser Utility

Utilities panel > Utilities rollout > Asset Browser button

The Asset Browser provides access from your desktop to design content on the World Wide Web. From within the Browser you can browse the Internet for texture samples and product models. This includes bitmap textures (BMP, JPG, GIF, TIF, and TGA), or geometry files (MAX, DWG, and so on). You can drag these samples and models into your scene for immediate visualization and presentation. You can use the Ctrl key to drag geometry into predefined locations. You can also use the Asset Browser to browse thumbnail displays of bitmap textures and geometry files on your hard disk or shared network drives. Then you can either view them or drag them into your scene or into valid map buttons or slots.

NOTE The thumbnail display of a geometry file is a bitmap representation of a view of the geometry. Since the thumbnail display is not a vector-based representation, you can't rotate it or perform zooms on it.

You can drag most graphic images that are embedded in a Web page into your scene. The exception is images or regions of a Web page that are tagged as

hyperlinks or other HTML controls (such as when a bitmap is tagged as a button with hypertext links).

IMPORTANT Downloaded content might be subject to use restrictions or license of site owner. User is responsible for obtaining all content license rights.

Drag and Drop

You can assign files represented by the thumbnail images by dragging the thumbnails over various parts of the Asset Browser or the 3ds Max user interface. There are three basic methods of using drag in the Asset Browser :

Local Drag and Drop: You can drag thumbnails to the directory tree, and you can copy or move files from one directory to another. As the default, when you drag to a folder within the same partition or device, you perform a move. If you drag beyond the current partition or device (to another drive, for example), you perform a copy. If you hold down the Ctrl key, you perform a copy regardless of the destination. If you hold down the Shift key, you perform a move. You can manipulate bitmap, 3ds Max scene, and DWG thumbnails in this way.

Bitmap Drag and Drop: You can drag the thumbnails that represent bitmap files to any bitmap or map slot in the interface or onto any object in a viewport. You can also drag the thumbnails into the viewport background. When you drag a bitmap onto an object, the program creates a new standard material with the bitmap as the diffuse map and assigns the material to that object.

Scene Drag and Drop: You can drag the thumbnails representing *.max* scene files directly over an active viewport to merge the scene with the current scene. When you drag the thumbnail over the active viewport and release the mouse, the objects in the file appear attached to the mouse. Place them where you want them, and then click the mouse. Choose from the menu whether you want to open the file, merge the file to the current scene, or XRef the file. To cancel, you can select from the menu, or right-click. If you hold down the Ctrl key, and drag the thumbnail over the active viewport, when you release the mouse button the objects in the dragged file will snap into their old location in their original file.

TIP When you drop scene files into your current scene, you can use [AutoGrid](#) on page 2597 to position the geometry file on an object.

Procedures

To drag scene files from the World Wide Web:

- 1 In the Address bar, enter the URL of the scene files on the World Wide Web.
- 2 Select the thumbnail of the scene file with your mouse and drag it over the active viewport.
The [Internet Download dialog](#) on page 7153 appears.
- 3 If you want objects placed in the viewport automatically, then in the Options group, turn off Place Objects When Download Completes.
- 4 If you skipped step 3 (that is, if Place Objects When Download Completes is still on), then when you release the mouse, the objects in the file appear attached to the mouse. Place them where you want them, and then click the mouse. Choose from the menu whether you want to open the file, merge the file to the current scene, or XRef the file. To cancel, you can select from the menu, or right-click. If you hold down the Ctrl key when you drag the thumbnail, the objects in the file are placed at the world space origin of the current scene.

To drag thumbnails to the directory tree:

- 1 In the Asset Browser directory tree, make sure the place you want to copy or move the thumbnail to is visible.
- 2 Select the thumbnail with your mouse and drag it to the directory tree destination.
- 3 As a default, if you drag to a folder within the same partition or device, a move is performed. If you drag beyond the current partition or device (to another drive, for example), a copy is performed. If you hold the Ctrl key down, a copy is performed, regardless of the destination. If you hold the Shift key down, a move is performed.

To drag bitmaps onto a map slot in the Material Editor:

- 1 Open the Material Editor and click the Maps rollout.
- 2 Open the Asset Browser and select the thumbnail of a bitmap with your mouse.
- 3 Drag the thumbnail to the map button of your choice on the Material Editor Maps rollout.

This assigns the bitmap as a map type for use in the Material Editor.

To drag a bitmap onto an object in a viewport:

- 1 Select a thumbnail of the bitmap with your mouse and drag it onto an object in a viewport.

NOTE If you miss the object, the bitmap becomes the viewport background image.

The Bitmap Viewport Drop dialog is displayed:

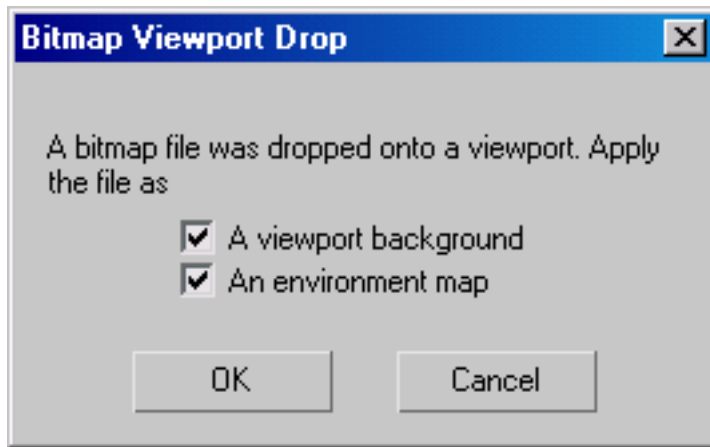

A viewport background Puts the bitmap into the viewport as a background.

An environment map Includes the bitmap when you render the viewport.

- 2 A new standard material is created. The bitmap is assigned to its diffuse component, and the new material is applied to that object.

To drag scene files from a local or shared disk:

- 1 From the Asset Browser's menu bar, choose Filter and then a geometry filter such as All Geometry, Importable Files, or 3ds Max Files.
- 2 Select the thumbnail of the geometry file with your mouse and drag it over a viewport.

- 3 When you drag the thumbnail over the active viewport and release the mouse, the merged objects appear attached to the mouse. Place them where you want them, and then click the mouse. Choose from the menu whether you want to open the file, merge the file to the current scene, or XRef the file. To cancel, you can select from the menu, or right-click. If you hold down the Ctrl key when you drag the thumbnail, the objects in the file are placed at the world space origin of the current scene.

Interface

When you first start the Asset Browser, a window appears displaying the home page that is installed locally on your computer system.

NOTE You can't change the [home page](#) on page 7140 for the Asset Browser.

Each subsequent time that you start the Asset Browser, it displays what was displayed last in the previous Asset Browser session.

The Asset Browser window contains:

- A [menu bar](#) on page 7136.
- A [toolbar](#) on page 7140.
- An [address bar](#) on page 7141.
- A pane on the left displaying your computer system's directory hierarchy.
- A pane on the right displaying a Web page, thumbnails, or an Explorer view of file names.

At the bottom of the window, there is also a tabbed [favorites bar](#) on page 7141 (by default, it first contains a Startup button) and a [status bar](#) on page 7139.

Asset Browser menu bar

Contains the menus for the Asset Browser.

File menu

Contains commands for managing files.

Preferences Displays the [Preferences dialog](#) on page 7151, with which you can manage the cache directory and control drag-and-drop operations.

Properties Displays information about the file of the selected thumbnail.

Show Image Displays the currently selected bitmap thumbnail in a [Rendered Frame Window](#) on page 6073. You can also double-click a thumbnail. This does not work for geometry thumbnails.

Print Prints the page displayed in the Web pane. Print is available only when a Web page is displayed.

Exit Closes the Asset Browser window.

Filter menu

Filters the display of thumbnails according to the category or file type you select.

All images Displays thumbnails of all supported bitmap files, such as BMP, JPG, GIF, TIF, and TGA.

All geometry Displays thumbnails of all supported geometry files, such as DWG and MAX.

All in cache Displays thumbnails of all images stored in your cache directory. When turned on, the left pane displaying the directory tree goes away, and the thumbnails you see might be in various directories. Because the thumbnails point to the correct directories, you can still use them to access the files and display or drag them to areas in the 3ds Max user interface.

IMPORTANT If a file has been subsequently renamed, deleted, or moved from the directory it was in when its thumbnail was first created, then the thumbnail represents only the thumbnail bitmap itself. If you assign that image to a map slot in the software, you'll be assigning the thumbnail bitmap rather than the original image.

All files (*.*) Displays thumbnails for all files.

See the following topics for information on the file types listed on the Filter menu:

[AutoCAD DWG Files](#) on page 7958

[IGES Files](#) on page 8008

[AVI Animation File](#) on page 7326

[BMP Image File](#) on page 7328

[Kodak Cineon](#) on page 7328

[CWS \(Combustion Workspace\) Files](#) on page 7329

[GIF Image File](#) on page 7334

[Radiance Image File \(HDRI\)](#) on page 7334

[IFL Image File](#) on page 7339
[JPEG File](#) on page 7347
[PNG Image File](#) on page 7360
[Adobe PSD File Reader](#) on page 7361
[MOV QuickTime File](#) on page 7348
[MPEG Files](#) on page 7348
[SGI's Image File Format](#) on page 7369
[RLA Image File](#) on page 7364
[RPF Image File](#) on page 7366
[Targa Image File](#) on page 7370
[TIF Image File](#) on page 7372
[YUV Image File](#) on page 7374

Thumbnails menu

Sorts and sets the size of the displayed thumbnails.

Create Thumbnails Creates thumbnails for bitmap and geometry files.

Sort by Name Sorts by file names.

Sort by Type Sorts by file extensions.

Sort by Size Sorts by file size.

Sort by Date Sorts by file creation date.

Large (200X200) Sets the size to large (200 by 200 pixels).

Medium (100X100) Sets the size to medium (100 by 100 pixels).

Small (50X50) Sets the size to small (50 by 50 pixels).

Display menu

Controls the display of:

- The left pane, where the directory tree displays your computer system's folders.
- The right pane, which can display files as thumbnails (a Thumbnail pane), or Web pages (a Web pane).
- The Favorites and status bars located at the bottom of the Asset Browser window.

- Any available manufacturer data in the Product Information dialog that appears over the right pane.

Directory Tree Turns the directory tree in the left pane on or off. The directory tree displays the available directories on your system. You can navigate and select the directories where you want to view images. When you select and enter a directory containing valid bitmaps, the Browser displays their thumbnails in the Thumbnail pane to the right. Right-clicking in the directory tree pane displays a menu allowing you to change directories, delete directories, and add a directory to your Favorites list.

TIP To refresh the contents of the directory tree, press Shift+F5.

Favorites Bar Turns the Favorites bar on or off. The Favorites bar is located at the bottom of the Asset Browser window.

Status Bar Turns the status bar on or off. The status bar is located at the bottom of the Asset Browser window.

Thumbnail Pane Displays valid bitmaps and geometry files of a selected directory as thumbnails in the right pane.

Thumbnail bitmaps for MAXScript files (*.ms*, *.mcr*, and *.mse*), dropScript files (*.ds*), and zipped script files (*.mzp*) display in the Thumbnail pane. By right-clicking the thumbnail, you can view the file, look at its properties, run the script, or open it in the Web Pane. By double-clicking the thumbnails for *.ms*, *.mcr*, and *.ds* files, you can open them in the MAXScript editor window. Double-clicking *.mzp* files will open them in the associated zip utility.

Explorer Pane Displays valid bitmaps and geometry files of a selected directory as file name icons in the right pane. This is similar to how Windows displays file name icons in the Explorer.

Web Pane If there's a file named *maxindex.htm* in the selected directory, the program displays it as a Web page in the right pane. You can use the *.htm* file to display selected bitmaps as a Web page. Also if you enter a URL in the address bar, the program displays the page in this pane.

Favorites menu

Adds and deletes Web sites and path names to the Favorites menu and the Favorites bar.

Add to Favorites Displays the [Favorite Location dialog](#) on page 7155.

Delete All Favorites Removes all Web site and path name shortcuts from the Favorites menu and the Favorites bar.

Browse menu

Allows you to refresh thumbnails and Web pages, to move forward and backward between recently viewed Web pages, to return to your home page, and to stop loading a Web page.

Refresh For a Thumbnail pane, rereads the directory and redraws the thumbnails. For a Web pane, rereads the URL and redisplay the Web page.

Forward For a Web pane, displays a Web page you viewed before clicking the Back button.

Back Returns to the last Web page viewed in the Web pane.

Home Returns to the local copy of the home page that is installed on your computer system. This is the page that displays when you first start the Asset Browser.

Stop Stops loading a Web page. Use this button when a page you're trying to view takes too long to load.

Toolbar

The buttons on the toolbar provide some of the same functions as the menu items on the menu bar.



Back to previous page Returns to the last Web page viewed in the Web pane.



Forward to next page Displays a Web page you viewed before clicking Back to previous page.



Stop Stops loading a Web page. Use this button when a page you're trying to view takes too long to load.



Refresh content For a Thumbnail pane, rereads the directory and redraws the thumbnails. For a Web pane, rereads the URL and redisplay the Web page.



Homepage Returns to local copy of the Browser home page that is installed on your computer system. This is the page that displays when you first start the Asset Browser.



Add to Favorites Bar Displays the Favorite Location dialog that allows you to add Web sites and path names to the Favorites menu and the Favorites bar. When you want to open that page or view the files from a path name, you can click the appropriate shortcut button from the Favorites bar, or click the appropriate menu item from the Favorites menu

Address Displays the current path name or URL. Clicking the history arrow at the right end of the address bar displays a list of recently viewed sites. You can select one of these to return to that site.

Favorites Bar

The Favorites bar is at the bottom of the Asset Browser window. It displays tabbed buttons for the startup page and for any shortcuts to directories and Web pages that you added to your favorites list. Right-clicking over a favorites tab that you've added displays a menu that you can use to [modify](#) on page 7155 or delete the favorites.

Startup Returns to the directory or Web page where the Asset Browser started in the current session.

Status Bar

The status bar is under the Favorites bar at the bottom of the Asset Browser window. The bar is divided into three sections. The first section displays a progress meter when the program loads thumbnails. The second section displays the current filter selection (such as "All in cache"). The third section displays messages, file names, or Web page shortcut labels when you move your cursor over such items.

Bitmap/Photometric Path Editor Utility

Utilities panel > Utilities rollout > More button > Utilities dialog > Bitmap/Photometric Path Editor

The Bitmap/Photometric Path Editor lets you change or remove the paths of [bitmaps](#) on page 7926 and photometric distribution files (IES) used in the scene. It also lets you see which objects use a resource in question.

By default, 3ds Max stores a path with the name of the files it references. This can be a problem when you share scenes among different users. Another user might have the same scene and resources, in the same directory structure, but on a different disk drive; this will cause the scene to "lose" the resources.

Removing paths from resource references eliminates this problem. When paths are not saved with the resource file, they are searched for in these directories:

- 1 The directory of the current scene.
- 2 The paths listed in the [External Files panel](#) on page 7735, starting at the top of the list.

Removing paths from bitmap and photometric references can be useful for [network rendering](#) on page 6433 as well.

See also:

- [Asset Browser Utility](#) on page 7132
- [Configure Paths](#) on page 7728
- [Resource Collector Utility](#) on page 7145

Interface

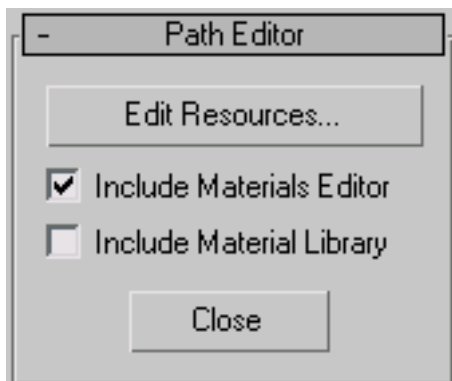

Edit Resources Click to display the [Bitmap/Photometric Path Editor dialog](#) on page 7156. Most of this utility's functionality is provided by this dialog.

Include Materials Editor When on, the Bitmap Path Editor dialog shows materials in the Material Editor, as well as those assigned to objects in the scene. Default=on.

Include Material Library When on, the Bitmap Path Editor dialog shows materials in the current material library, as well as those assigned to objects in the scene. Default=off.

Close Click to close this utility.

MAX File Finder Utility

Utilities panel > Utilities rollout > More button > Utilities dialog >MAX File Finder

Run *maxfind.exe* in the 3ds Max root directory.

The MAX File Finder utility lets you search for MAX files containing specific properties, for example:

- Search the hard drive for all MAX files containing the "Pink Carpet" material.
- Search the 3ds Max program directory and below for all MAX files using the *raymtl.dlt* plug-in.
- Search the *c:\Program Files\Autodesk\VIZ2008* directory and below for all MAX files using the *raymtl.dlt* plug-in.

The utility comes in two formats: a standard utility, and a standalone executable. Both work identically.

File Finder demonstrates how to read a MAX file's properties from an external application. These properties include predetermined data such as object and plug-in names, plus information you provide via the File menu > Properties dialog. You can also view this data from outside the software with Windows Explorer or an equivalent program by viewing a file's properties.

TIP You can combine this tool with the powers of the Properties dialogs. If you have a team of animators, you can have the individual animators use the File menu > Properties dialog to create Categories, Keywords and Comments that you can search for using the File Finder. They can also use the Contents and Custom Tabs as well. All are searchable using the Finder.

You can also create similar structures at the Object level. The [Object Properties dialog](#) on page 305 has a User Defined tab to enter any properties you like, and use that to organize your projects.

Interface

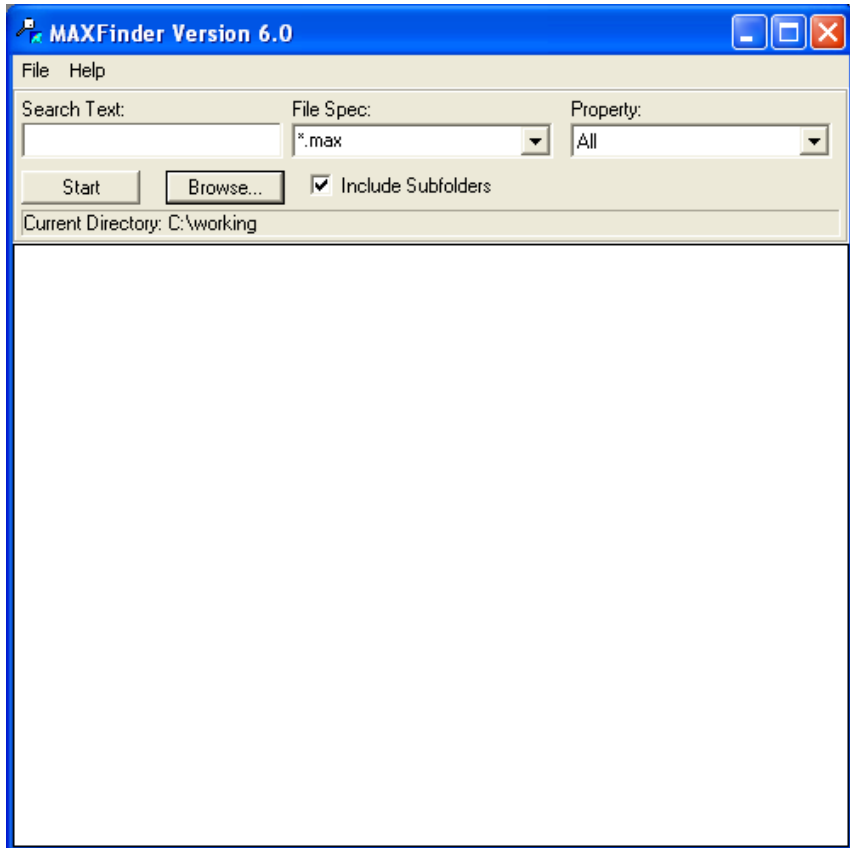

File menu

Reset Clears the list box of any files previously found.

Exit Exits the application

Help menu

About Displays something fun to play with while Finder is searching for files. The search continues in the background while this dialog is active.

Program window

Search Text Specifies the text to search for. If you leave the field empty, all files that contain the specified property will be found.

File Spec Specifies which file types to search through. The predefined file type is **.max*. You can enter a different file type, such as **.dwg*. To search through all files, use **.**.

The currently selected item in this list is restored the next time you run Finder.

Property Specifies the property you want to search for. Use All to search for any property.

Start Activates the search. During a search, the button title switches to Cancel. Click Cancel to abort the search.

Browse Specifies the directory for the search, using the standard Windows Browse for Folder dialog.

Include Subfolders When on, Finder searches the current directory and all subdirectories. When off, only the current directory is searched.

File List Lists all files that were found and match the current search criteria. Double-click a found file in this list to display the property viewer for the file. The information presented in this dialog is the same that is displayed with File menu > Properties inside the software. Use the << and >> buttons to step to the previous or the next file in the found list.

While in the property viewer, the search continues in the background.

Resource Collector Utility

Utilities panel > Utilities rollout > More button > Utilities dialog > Resource Collector

The Resource Collector gathers the resource files used by a scene ([bitmaps](#) on page 7926, photometric distribution files (IES), and optionally, the scene itself into a single directory.

WARNING The Resource Collector does not collect maps used for displacement mapping or as light projections.

See also:

- [Bitmap/Photometric Path Editor Utility](#) on page 7141

Interface

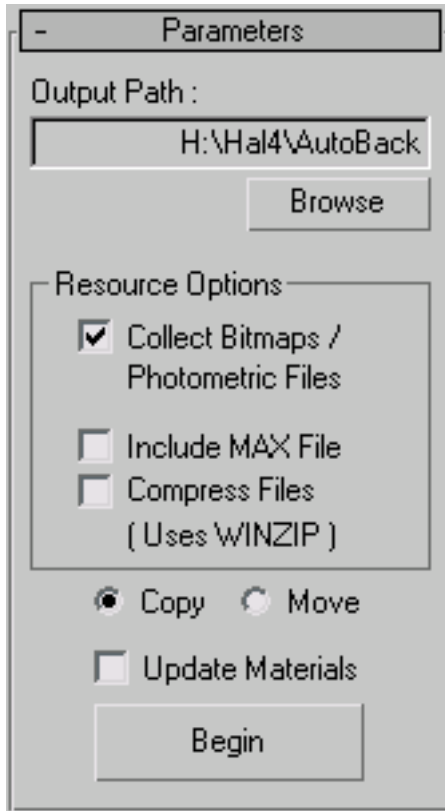

Output Path Displays the current output path. This can be changed using the Browse button.

Browse Click to display a Windows file dialog that lets you choose the output path.

Resource Options group

Collect Bitmaps/Photometric Files When on, the Resource Collector places the scene's bitmaps, and photometric files, in the output directory. Default=on.

Include MAX File When on, the Resource Collector places the scene itself (the *.max* file) in the output directory. Default=off.

Compress Files When on, compresses the files into a ZIP file, saved in the output directory. Default=off.

Copy or Move Choose Copy to make a copy of the files in the output directory. Choose Move to move the files (they are deleted from the directory in which they originally were saved). Default=Copy.

Update Materials When on, updates material paths. Default=off.

Begin Click to collect the resource files according to the settings above this button.

Fix Ambient Utility

Utilities panel > Utilities rollout > More button > Utilities dialog > Fix Ambient

The Fix Ambient utility solves a compatibility problem that sometimes occurs when you use 3ds Max to open files from earlier versions of 3ds Max or Autodesk VIZ.

In 3ds Max, the [ambient](#) on page 7906 and [diffuse](#) on page 7955 color channels are locked for standard materials. However, this was not always the case with earlier versions of 3ds Max and Autodesk VIZ. As a result, files might render differently than expected.

The Fix Ambient utility looks for standard materials in the current scene whose ambient and diffuse colors are different, presenting you with the option to copy the diffuse color to the ambient color channel. This will ensure that your renderings are consistent with earlier versions of products.

Interface

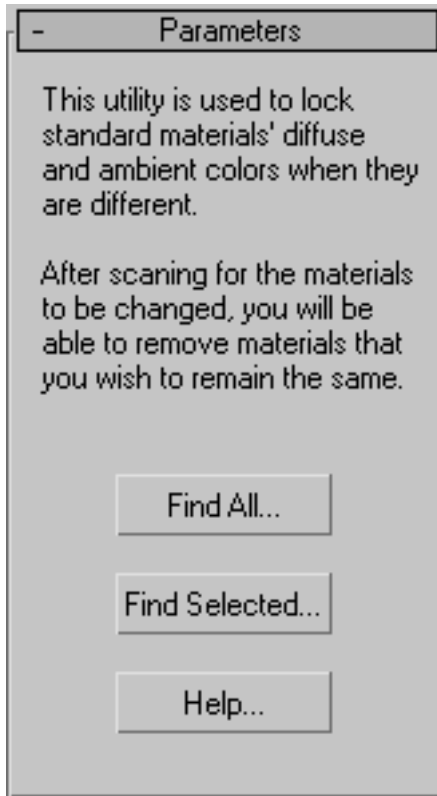

Find All The utility searches the entire scene for materials with different ambient and diffuse colors.

Find Selected The utility searches the current selection for materials with different ambient and diffuse colors.

Help Opens the help file to this topic.

Different Ambient and Diffuse Materials

This dialog appears after clicking Find All or Find Selected.

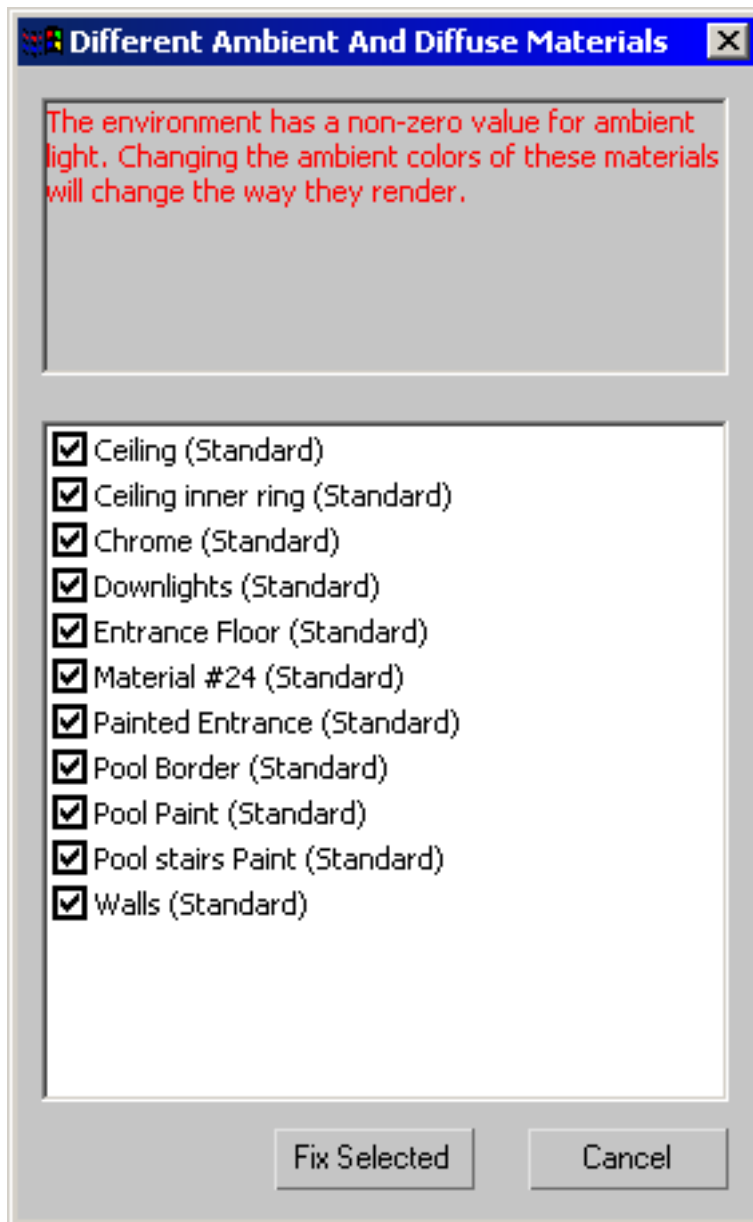

Status Message This area displays a message indicating whether your scene (or selection) has materials with different ambient and diffuse values.

Material List Lists all of the materials with different ambient and diffuse values.

Fix Selected Locks the ambient and diffuse channel for the materials selected in the dialog.

Cancel Closes the dialog without making any changes.

Bitmap Pager Statistics Dialog

Customize menu > Customize User Interface > Category: All Commands or Render > Action: Bitmap Pager Statistics Toggle > Assign to hotkey, menu, etc.

The Bitmap Pager Statistics dialog provides information to help you resolve issues with scenes that require large amounts of memory for texture maps. It is intended for advanced users to debug scenes and help shorten render times.

By default, the dialog is not available in the interface; it must be added as a hotkey, menu item, or toolbar button via [Customize User Interface](#) on page 7697 functionality.

Interface

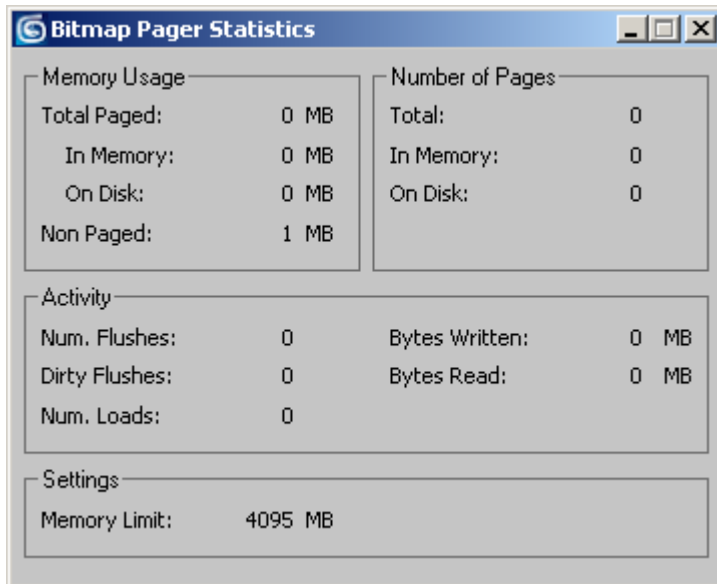

The read-only dialog shows statistics in four categories:

- Memory Usage
- Number of Pages
- Activity
- Memory Limit

Asset Browser Subdialogs

Preferences Dialog (Asset Browser)

Utilities panel > Utilities rollout > Asset Browser button > File menu > Preferences

Contains the settings with which you can manage the Asset Browser's cache directory and control drag and drop operations.

Interface

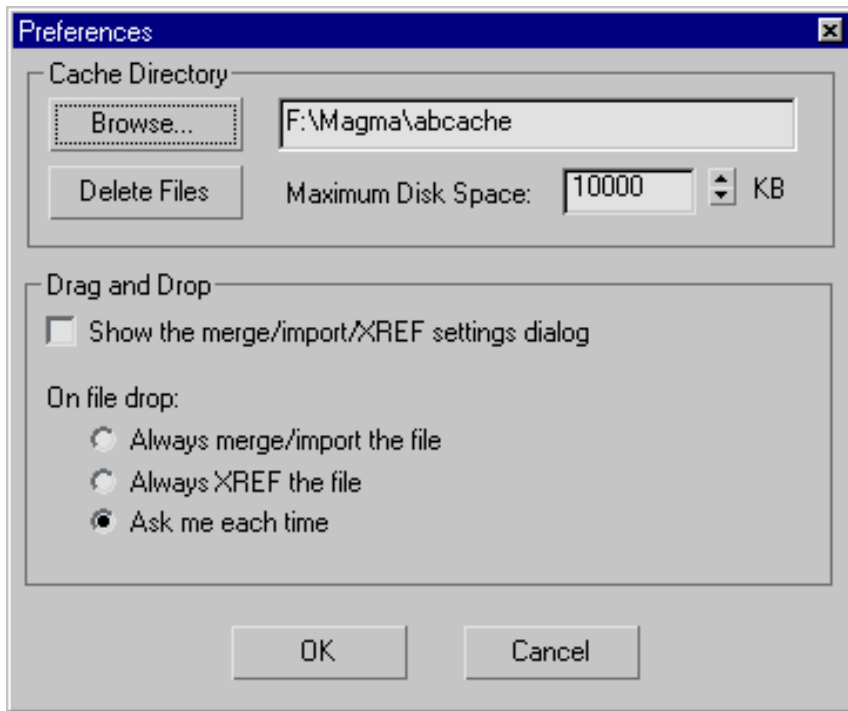

Cache Directory group

Provides settings and controls for the cache directory.

Browse Displays the Choose Cache Directory dialog where you can specify a new directory to use for your cache. The adjacent text box displays the path of the cache directory where the thumbnail images are stored. You can change the path either by editing the field or choosing a directory from the pane below the Folders field.

NOTE When you change directories, you're asked if you want to clear the cache from the previous directory. If you choose to do so, the program erases all thumbnail files from the cache directory you were using previously.

Delete Files Removes all thumbnail files from your cache directory.

Maximum Disk Space Sets the maximum size of the cache directory. When you exit Asset Browser, the program selects the size of the cache directory. If

it's over the maximum size, the program deletes the oldest thumbnail files until the total size is 50 percent of the Maximum Disk Space setting.

Drag and Drop group

Provides controls for importing or linking files after dragging and dropping them into a viewport.

Show the merge/import/XREF dialog Displays the merge/import/XREF dialog after you drop a file into a viewport.

Always merge/import the file Imports the file without prompting for confirmation after you drop it into a viewport.

Always XREF the file Links the file as an XREF without prompting for confirmation after you drop it into a viewport.

Ask me each time Displays a popup menu to confirm importing or linking after you drop a file into a viewport.

Internet Download Dialog

Utilities panel > Utilities rollout > Asset Browser button > Address bar > Enter URL of geometry files on World Wide Web. > Drag thumbnail over active viewport.

Menu bar > Tools > Asset Browser > Address bar > Enter URL of geometry files on World Wide Web. > Drag thumbnail over active viewport.

When you drag geometry files from the World Wide Web using the Asset Browser, the Internet Download dialog appears. How long this dialog remains on-screen depends on the size of the file you're downloading.

Interface

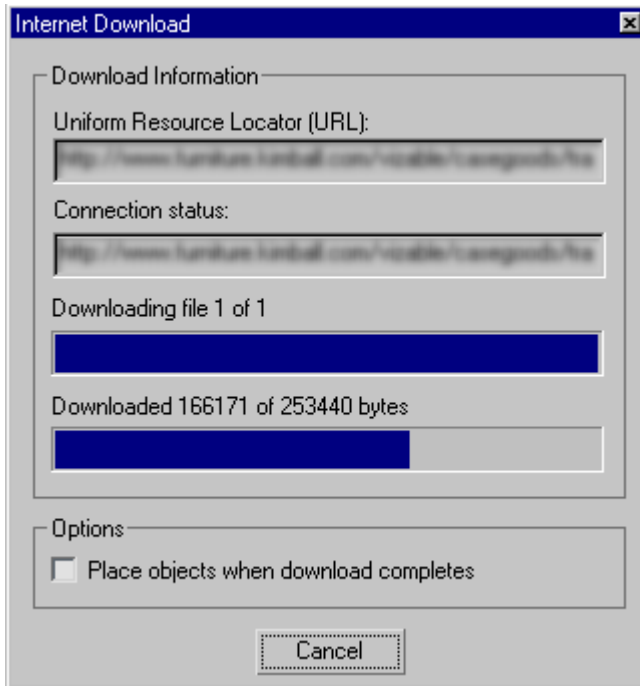

Download Information group

Displays the URL of the download, the pathname of the file being saved, and a meter indicating the bytes downloaded.

Uniform Resource Locator (URL) Displays the URL and file name that you're downloading.

Saved as Local File Displays the pathname of the file being saved as a result of the download.

Options group

Specifies whether or not to place the objects when the download is complete. If you leave this option selected, 3ds Max allows you to position the mouse at the location of your choice.

Favorite Location Dialog

Utilities panel > Utilities rollout > Asset Browser button > Favorites menu > Add to Favorites

Menu bar > Tools > Asset Browser > Favorites menu > Add to Favorites

The Favorite Location dialog allows you to add Web sites and path names to the Asset Browser Favorites menu and Favorites bar. When you want to open that page or view the files from a pathname, you can click the appropriate shortcut button from the Favorites bar, or click the appropriate menu item from the Favorites menu.

Interface

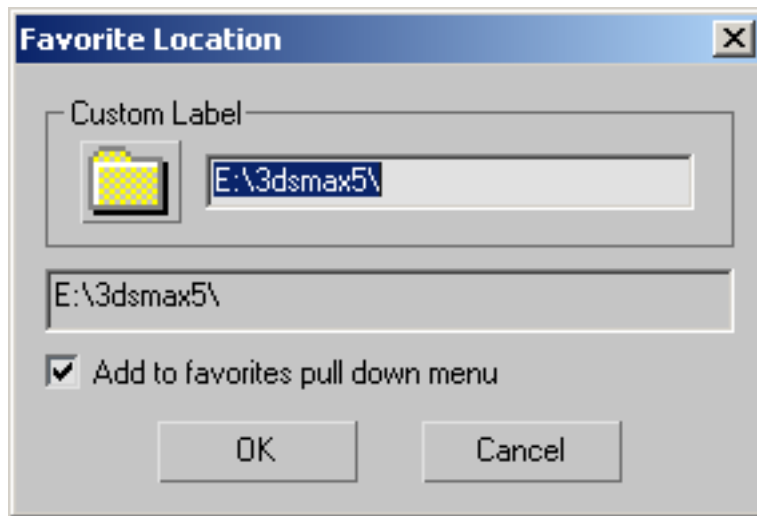

Custom Label

The button displays the Load Custom Icon dialog. Use this dialog to select an icon file to associate with the Web site or path name you're adding to the Favorites. You must use icon files that have an `.ico` extension.

The text box adjacent to the button displays the URL of the Web page, or the path name that you're adding to the Favorites. You can edit this to wording of your choice. The unedited URL or pathname displays in the label below the Custom Label group.

Add to favorites pull down menu When you turn this on, Web site or path-name shortcuts are added to the Favorites menu. When this box is not selected, the Web site or path-name shortcuts are added only to the Favorites bar.

Bitmap Path Editor Subdialogs

Bitmap / Photometric Path Editor Dialog

Utilities panel > Utilities rollout > More button > Utilities dialog > Bitmap/Photometric Paths > Edit Resources button

This dialog is the main part of the interface to the [Bitmap / Photometric Path Editor utility](#) on page 7141.

See also:

- [Asset Browser Utility](#) on page 7132
- [Missing External Files Dialog](#) on page 7130
- [Resource Collector Utility](#) on page 7145

Procedures

To correct the path name for a missing map:

You must first locate the missing bitmap or photometric files. The Windows Search program can help you with this.

- 1 On the Bitmap / Photometric Path Editor dialog, click Select Missing Files.
- 2 Click to select a single missing file in the list.
If a group of missing files are in the same directory, you can leave all of them selected.
- 3 Click Strip Selected Paths.
- 4 Click Set Path.
- 5 Enter the correct path in the New Path field, or click the "..." button to browse to the correct path in a Windows file dialog.

The Bitmap/Photometric Path Editor updates the selected maps' path to use the new path.

Interface

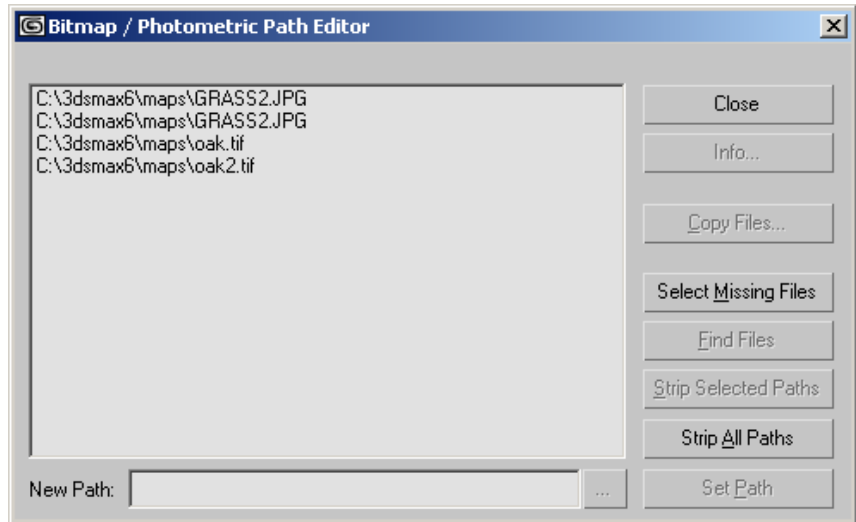

List of maps and photometric files Shows all bitmaps and photometric files ([IES](#) on page 5034, [CIBSE](#) on page 7935, [LTLI](#) on page 8029) used in the scene, along with their current path.

When no file is selected in the list, the only controls available in the dialog are Close, Select Missing Maps, and Strip All Paths.

Close Click to close the dialog.

Info Click to display a [Resource Information dialog](#) on page 7158.

This button is available only when a single file is selected in the list.

Double-clicking a name in the list is another way to display the Resource Information dialog.

Copy Files Copies the selected files to a directory you choose. This button displays a Windows file dialog that lets you choose the destination directory.

Select Missing Files Highlights the names of missing files in the list.

Find Files Click to search for the maps or photometric files in the current selection. This button displays an alert that shows how many files are findable, how many files are missing.

Strip Selected Paths Click to strip the path from the selected files. An alert appears to warn you that the scene will lose this information.

Strip All Paths Click to strip the path from all files in the list. An alert appears to warn you that the scene will lose this information.

Set Path Click to apply the New Path field to the selected files.

If the New Path field is identical to the selected file or files, clicking Set Path clears New Path.

New Path Lets you enter a path for the currently selected file or files. Default=The path of the currently selected file, or none if multiple files with differing paths are selected.

"..." button (To the right of the New Path field.) Displays a Windows file dialog to let you browse for a path.

Resource Information Dialog

Utilities panel > Utilities rollout > More button > Utilities dialog > Bitmap/Photometric Path Editor > Edit Resources button > Select a single bitmap or photometric file name. > Info button

Utilities panel > Utilities rollout > More button > Utilities dialog > Bitmap/Photometric Path Editor > Edit Resources button > Double-click a bitmap or photometric file name.

The Resource Information dialog displays information about where a bitmap is used in other materials or photometric distribution files and shows an image of the bitmap.

Interface

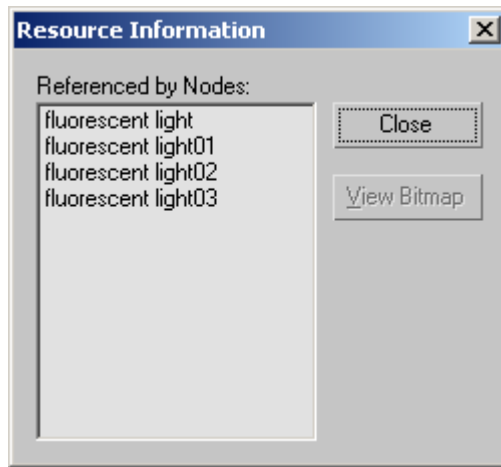

Referenced by Nodes Lists the objects ("nodes") that are assigned materials that use this bitmap or use a given [photometric distribution file](#) on page 5005.

Close Closes the dialog.

View Bitmap Displays a [Rendered Frame Window](#) on page 6073 that shows the bitmap. This button is unavailable if the file is a photometric file, and it has no effect if the map is missing.

Internet Access

The [Asset Browser](#) on page 81 can locate locally or network-stored materials, textures, geometry, and other 3D assets that can be easily dragged and dropped into the 3ds Max workspace. The Browser can also access the Internet to do the same.

The Asset Browser provides embedded Web browser functionality, so you can go directly to the Internet to capture 2D and 3D content for use in 3ds Max. For example, a visit to any of several manufacturers' sites, such as www.formica.com, can yield flooring, countertop, or other samples in bitmap form. Provided a site encourages such use of its content (and most do), these thumbnails can be dragged into 3ds Max with a single mouse movement and dropped onto objects in a scene for instantaneous "what if" visualizations of different textures and treatments. They can also be saved for later use.

2D and 3D geometry can also be captured off the Internet and put to immediate use in 3ds Max scenes. You can also use the Asset Browser with topographical maps, detailed aerial and satellite photos, and any design data in MAX or STL form. In this way, you are assured instant access to the latest design content, free from leading vendors around the world, without leaving your desktop.

For Web Content Providers

Any Web page that uses standard HTML source code can easily be enhanced so that 3ds Max users can access it for content. Making bitmap textures (.BMP, .JPG, .GIF, .TIF, etc.) available for downloading requires no special HTML coding, but there are guidelines you should follow for optimum utility to 3ds Max users. Making geometry (MAX) files (.max) available to 3ds Max users requires some simple modifications to your HTML source code.

See also:

- [i-drop Indicator](#) on page 7160

i-drop Indicator

In order to support the World Wide Web as a primary source of product information, Autodesk has introduced the i-drop™ Indicator. This enables manufacturers and design professionals to publish and acquire design data using standard Web pages.

The i-drop Indicator is used to transfer content from the World Wide Web by means of a drag-and-drop operation. The content can be any type of file (such as a geometry or a raster file) that the content producer has made available and that the application will accept.

For example, imagine that you are a lighting designer and require a specific fixture to embed within your 3ds Max scene. Now imagine that a lighting company such as ERCO has a Web site containing a library of their fixtures online. You can browse this library, then drag and drop the appropriate fixture into your scene. You don't need to download the file and then insert it. Now you can drag any MAX file from an i-drop-enabled web site and drop its geometry directly into your Autodesk product.

In addition to geometry, you can drag and drop photometric data, cost information, materials, and so on.

An i-drop object in a Web page is an open gateway between the content provider's server and the Autodesk software user's desktop. Web pages that contain i-drop objects can be designed to look and behave exactly like standard Web pages in a standard Web browser. You simply drag the i-drop object from the provider's Web page and drop it onto a desktop or into an application.

The desktop or application is the i-drop target. The i-drop target requests the data in one or more specific clipboard formats and receives the content. This is called being "i-drop aware." i-drop can also deliver data in any of the system default clipboard formats. What the application gets depends on what clipboard format it requires. For example, if the user drags to the desktop, the desktop takes a file. If the user drags to a text editor, the text editor takes textual data. What the desktop or application takes is independent of i-drop.

For more information, see <http://idrop.autodesk.com>.

Geometry File Formats

The [Import](#) on page 7096 and [Export](#) on page 7097 commands on the [File menu](#) on page 7473 let you share 3D geometry with other 3D modeling programs. The software can import and export a variety of file formats.

3ds Max can also open [DRF Files](#) on page 7167, which are created in VIZ Render, a rendering tool packaged with AutoCAD Architecture.

See also:

- [Asset Browser Utility](#) on page 7132
- [Internet Access](#) on page 7159
- [i-drop Indicator](#) on page 7160

Compatible File Formats

[MAX Files \(from Autodesk VIZ\)](#) on page 7164

[VIZ Render \(DRF\) Files](#) on page 7167

Importable File Formats

[Importing 3DS Files](#) on page 7172

[Importing PRJ Files](#) on page 7174

[Importing SHP Files](#) on page 7177
[Importing Adobe Illustrator 88 Files](#) on page 7178
[Importing AutoCAD Drawing Files](#) on page 7182
[Importing DXF Files](#) on page 7209
[FBX Files](#) on page 7222
[Flight Studio OpenFlight \(FLT\) Files](#) on page 7223
[Importing Autodesk Inventor Files](#) on page 7211
[Importing IGES Files](#) on page 7226
[Importing LandXML/DEM Models](#) on page 7247
[Importing Lightscape Files](#) on page 7253
[Importing HTR/HTR2 Files](#) on page 7257
[Importing TRC Files](#) on page 7259
[Importing STL Files](#) on page 7276
[Importing VRML Files](#) on page 7290
[Wavefront \(OBJ, MTL\) Files](#) on page 7280

Exportable File Formats

[Exporting 3D DWF Files](#) on page 7216
[Exporting to 3DS](#) on page 7175
[Exporting to Adobe Illustrator](#) on page 7179
[Exporting to ASCII](#) on page 7180
[Exporting AutoCAD DWG Files](#) on page 7206
[Exporting to DXF Files](#) on page 7209
[FBX Files](#) on page 7222
[Flight Studio OpenFlight \(FLT\) Files](#) on page 7223
[Exporting IGES Files](#) on page 7230
[JSR-184 Files](#) on page 7233
[Exporting Lightscape Files](#) on page 7251
[Exporting HTR/HTR2 Files](#) on page 7261

[Exporting to Shockwave 3D](#) on page 7264

[Exporting to STL](#) on page 7279

[Exporting to VRML97](#) on page 7292

[Exporting Wavefront Object \(OBJ\) Files](#) on page 7281

Importing Geometry

When you import geometry, using the Import command on the File menu, in most cases a dialog is displayed that asks whether you want the imported geometry to be added to the scene, or to replace the scene entirely. For example:

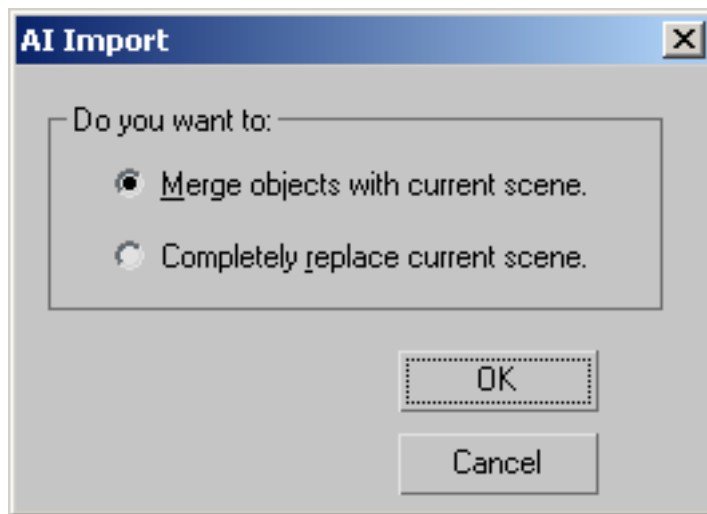

Merge objects with current scene Merges imported data with the current scene.

Completely replace current scene Completely replaces the current scene with the imported data.

In general, once you respond to this dialog, a second dialog with geometry-specific options is displayed, as described in the topics that follow. (For some geometry formats, only one dialog appears, and these options are merged with the geometry-specific options.)

Working with MAX Files from Autodesk VIZ

Although they share the same file type, 3ds Max files and Autodesk VIZ files are quite a bit different. This topic describes some of the differences, and recommends ways to obtain the desired results from your files.

See also:

- [Working with Drawing Files](#) on page 6978

Defaults

3ds Max ships with several market-specific defaults sets. If you are working on design visualization types of files, you should load the *DesignVIZ* default settings. For more information on how to do this, see [Market-Specific Defaults](#) on page 7694.

Objects

AEC objects (walls, doors, windows, etc.) in an Autodesk VIZ file retain all their original properties as AEC objects when opened in 3ds Max. Autodesk VIZ models can also contain File Link created objects that appear as VIZBlocks or Linked Geometry.

File Linked VIZBlocks in 3ds Max

A VIZBlock is a compound object similar to a nested AutoCAD or Architectural Desktop block. If a drawing containing nested blocks is file linked to Autodesk VIZ, the block objects display in the Modify panel as VIZBlocks.

3ds Max recognizes VIZBlocks when you open a MAX file created in Autodesk VIZ. You can access the sub-object hierarchy, rename sub-object components and even extract sub-objects of the VIZBlock. You are also allowed to add modifiers on top of the sub-objects. You cannot attach objects to a VIZBlock as you could in Autodesk VIZ.

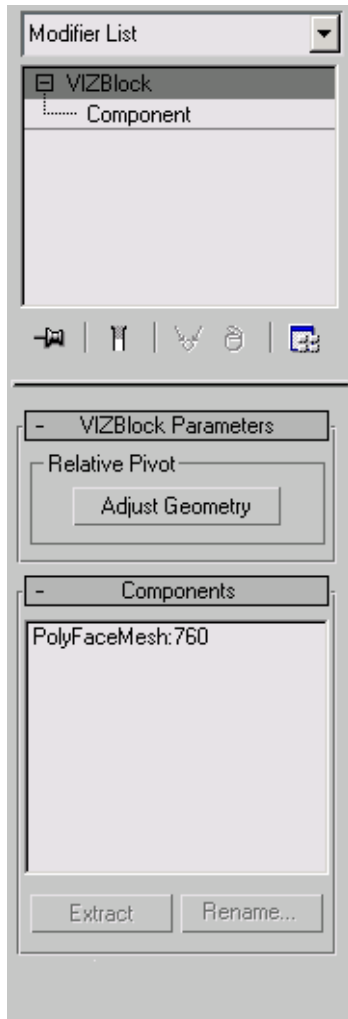

The VIZBlock user interface on the Modify panel

NOTE VIZBlocks can contain both mesh and spline geometry. This can cause some confusion when applying modifiers like Edit Mesh. If a spline component is closed, it will be converted to a mesh with no extrusion. If a spline is not closed, it will disappear and leave behind stray vertices in the mesh.

VIZBlocks are assigned a special controller called a Link™ controller. If a sub-object component is extracted and converted to an Editable Mesh or

Editable Spline, the LinkTM controller is replaced with a PRS controller. Likewise, if an entire VIZBlock is converted to an Editable Mesh or Spline, the LinkTM controller for the node is replaced with a PRS controller.

When using Track View, sub-object components of VIZBlock do not display. Data pertaining to the LinkTM controller is not displayed, however, you can access the PRS subcontroller.

While working on VIZBlocks, it is very possible that the you might lose portions of the original data organization of the scene, for example, when a sub-object component is extracted from an instanced VIZBlock, the extracted object is not instanced the same number of times.

File Linked Geometry in 3ds Max

This file linked object type appears in Autodesk VIZ when you use the Entity Combine-By option or if you extract a component from a VIZBlock. These objects display in the Modify panel as Linked Geometry. If a linked geometry object is moved, rotated, or scaled, you can use the Reset Position option.

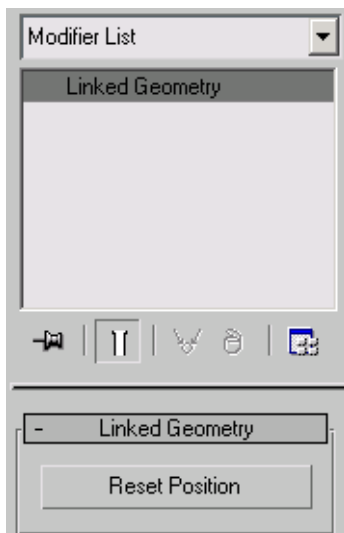

The Linked Geometry user interface on the Modify panel

3ds Max recognizes Linked Geometry objects when you open a MAX file created in Autodesk VIZ. Since Linked Geometry objects offer no parameters on the Modify panel, you have to modify these objects by converting them to Editable Mesh or Splines or applying modifiers on top of them.

Linked Geometry objects are also assigned a LinkTM controller. If the object is converted to an Editable Mesh or Editable Spline, the LinkTM controller is replaced with a PRS controller.

File Link Reloading

If you plan on working on an Autodesk VIZ scene in 3ds Max, you should download the latest service pack for the product. The latest service pack includes functionality that makes 3ds Max more compatible with Autodesk VIZ.

Materials

In 3ds Max, the [ambient](#) on page 7906 and [diffuse](#) on page 7955 color channels are locked for standard materials, however this is not the case in Autodesk VIZ. As a result, MAX files from Autodesk VIZ may render differently in 3ds Max.

To solve this issue, use the [Fix Ambient utility](#) on page 7147.

Missing Maps

Many times, when you open a MAX file from Autodesk VIZ, you will be presented with a [Missing External Files dialog](#) on page 7130. To locate the missing files, click Browse and then add the appropriate Autodesk VIZ directories to the [Configure External File Paths dialog](#) on page 7735.

VIZ Render (DRF) Files

DRF is the file format for VIZ Render, a rendering tool formerly included with AutoCAD Architecture. The DRF file type is similar to MAX files from previous versions of Autodesk VIZ.

This file format is available only when you use the File menu > [Open](#) on page 6922 command. All DRF files must be saved as MAX files in 3ds Max. Likewise, DRF files cannot be imported or merged into 3ds Max scenes.

NOTE You can open DRF files using drag-and-drop functionality.

Saving DRF Files

DRF files must be saved as MAX files in 3ds Max.

Defaults

3ds Max ships with several market-specific defaults sets. If you are working on design visualization types of files, you should load the *DesignVIZ* default settings. For more information on how to do this, see [Market-Specific Defaults](#) on page 7694.

Units

In VIZ Render, you can only use meters as your system unit. However, 3ds Max lets you define your own system unit, and how units are displayed. For more information on units, see [Using Units](#) on page 2588 and [Units Setup Dialog](#) on page 7809.

Missing Maps

Many times, when you open a DRF file, you will be presented with the [Missing External Files dialog](#) on page 7130. To locate the missing files, add the appropriate VIZ Render directories to the Configure User Paths dialog > [External Files panel](#) on page 7735.

Handling Linked Geometry in 3ds Max

Linked objects show up as Linked Geometry objects on the Modify panel. These objects don't allow access to sub-object levels where minor editing can occur. If a linked geometry object is moved, rotated or scaled you do have the option to Reset Position.

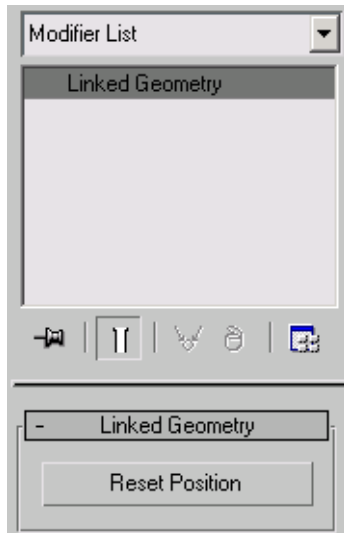

Linked Geometry user interface on the Modify panel.

3ds Max recognizes Linked Geometry objects when you open a MAX file created in VIZ Render. Since linked geometry objects offer no parameters on the Modify panel, you must first add an Edit Mesh modifier to the object or collapse the linked geometry object to an Editable Mesh in order to access sub-object levels. If you add a modifier to linked geometry, the modifier is applied to all instances of that object.

Linked Geometry objects are assigned a special LinkTM controller. If a the object is converted to an Editable Mesh, Poly, NURBS or Editable Spline, the LinkTM controller is replaced with a PRS controller.

Substituted Objects

There is no substitution modifier in 3ds Max. However, if you open a DRF file with substituted objects, 3ds Max will recognize the substitutions and will add the substituted objects into the scene.

User Interface Changes

Some of the user interface elements in 3ds Max are not where you would expect them if you are coming from VIZ Render. For example, the [viewport controls](#) on page 7572 are in the bottom-right corner, instead of the top-left.

For more information on the user interface, see [User Interface](#) on page 7465.

Render Presets

The Render Presets in 3ds Max are very different from the presets in VIZ Render. For more information on using them, see [Preset Rendering Options](#) on page 6114.

Working with DRF Files in 3ds Max

Saving DRF Files

DRF files must be saved as MAX files in 3ds Max.

IMPORTANT Once you save a DRF file in 3ds Max, it becomes a MAX file and you can no longer open it in VIZ Render.

Defaults

3ds Max ships with several market-specific defaults sets. If you are working on design visualization types of files, you should load the *DesignVIZ* default settings. For more information on how to do this, see [Market-Specific Defaults](#) on page 7694.

Units

In VIZ Render, you can only use meters as your system unit. However, 3ds Max lets you define your own system unit, and how units are displayed. For more information on units, see [Using Units](#) on page 2588 and [Units Setup Dialog](#) on page 7809.

Missing Maps

Many times, when you open a DRF file, you will be presented with the [Missing External Files dialog](#) on page 7130. To locate the missing files, add the appropriate VIZ Render directories to the Configure User Paths dialog > [External Files panel](#) on page 7735.

Handling Linked Geometry in 3ds Max

Linked objects show up as Linked Geometry objects on the Modify panel. These objects don't allow access to sub-object levels where minor editing can occur. If a linked geometry object is moved, rotated or scaled you do have the option to Reset Position.

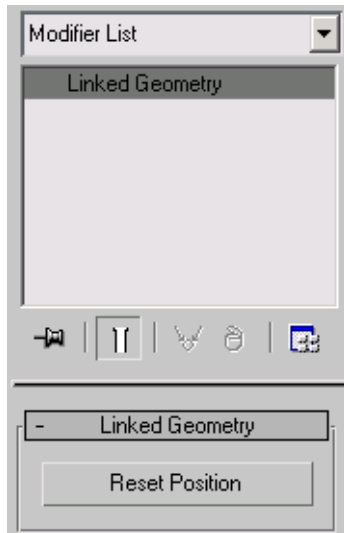

Linked Geometry user interface on the Modify panel.

3ds Max recognizes Linked Geometry objects when you open a MAX file created in VIZ Render. Since linked geometry objects offer no parameters on the Modify panel, you must first add an Edit Mesh modifier to the object or collapse the linked geometry object to an Editable Mesh in order to access sub-object levels. If you add a modifier to linked geometry, the modifier is applied to all instances of that object.

Linked Geometry objects are assigned a special LinkTM controller. If a the object is converted to an Editable Mesh, Poly, NURBS or Editable Spline, the LinkTM controller is replaced with a PRS controller.

Substituted Objects

There is no substitution modifier in 3ds Max. However, if you open a DRF file with substituted objects, 3ds Max will recognize the substitutions and will add the substituted objects into the scene.

User Interface Changes

Some of the user interface elements in 3ds Max are not where you would expect them if you are coming from VIZ Render. For example, the [viewport controls](#) on page 7572 are in the bottom-right corner, instead of the top-left.

For more information on the user interface, see [User Interface](#) on page 7465.

Render Presets

The Render Presets in 3ds Max are very different from the presets in VIZ Render. For more information on using them, see [Preset Rendering Options](#) on page 6114.

3D Studio Mesh (3DS, PRJ) Files

Importing 3DS Files

File menu > Import > Select File To Import dialog > Files Of Type > 3D Studio (*.3DS)

3DS is the 3D Studio® (DOS) mesh-file format. You can import 3DS files into 3ds Max.

When you import a 3DS file, you can merge the imported objects with the current scene or replace the current scene completely. If you choose to merge the objects with the current scene, you are asked whether you want to reset the length of the animation in the scene to the length of the imported file (if the imported file contains animation).

When you import a 3DS file, the following information is imported:

- Backgrounds (solid, gradient, and bitmap).
- Fog, Layered Fog, and Distance Cue.
- Ambient light level.
- Subtractive transparency is converted to 3ds Max "Filter" transparency and the filter color is set equal to the diffuse color.
- Transparency falloff settings.
- All map channels that are enabled. Map channels that are turned off in the 3DS file do not import into 3ds Max.
- All map parameters, including UV transforms, Negative, Mirror, and Rotation. Some Map parameters such as Blur, Luma, RGB, and Alpha work much differently in 3ds Max. These values are converted to new values that produce a similar affect.
- Mask bitmaps are imported as 3ds Max mask textures.

- When materials with both Texture 1 and Texture 2 are imported, a composite texture is created and added to the Standard material's Diffuse channel.
- Reflection maps, auto-cubics, and mirrors.
- Automatic reflection map Nth frame and Map Size settings.
- SXP translation for Marble and Noise materials.
- 3DS/DOS R4 IK joint parameters.
- 3D Surfer patch data.

When you import a PRJ file, all of the above items are imported, plus shapes.

When you import a 3DS file, the following information is *not* imported:

- Morph keys.
- Keyframer instances.
- Map channels that are turned off.
- Custom *.cub*-format cubic maps.
- Decal transparency using the RGB color of the upper-left pixel of the map.

Interface

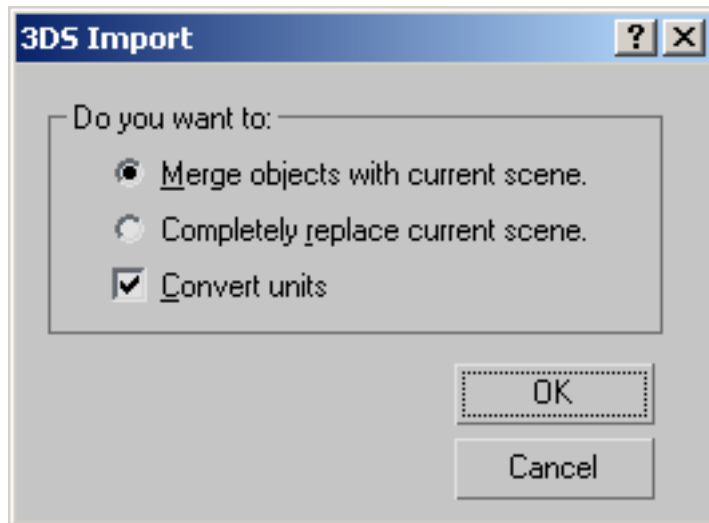

Merge objects with current scene Merges imported data with the current scene.

Completely replace current scene Completely replaces the current scene with the imported data.

Convert units When turned on, the software assumes units in the imported file to be in inches, and converts them to the current system of units. When turned off, the software assumes the units in the imported file match the current scene unit and doesn't convert the units.

Importing PRJ Files

File menu > Import > Select File To Import dialog > Files Of Type > 3D Studio Project (*.3DS,*.PRJ)

PRJ is the 3D Studio (DOS) project-file format.

When you import a PRJ file, you can merge the imported objects with the current scene or replace the current scene completely. If you choose to merge the objects with the current scene, you'll be asked whether you want to reset the length of the animation in the scene to the length of the imported file (if the imported file contains animation).

You'll also be asked how you want the software to handle [shapes](#) on page 8127 in the incoming file: to make them into a single object or multiple objects.

Interface

When you import a PRJ file, you first see a [3DS Import dialog](#) on page 7172. This is identical to the dialog you see when you import a 3DS file. When you have set the options and clicked OK in the 3DS Import dialog, you then see a Shape Import dialog.

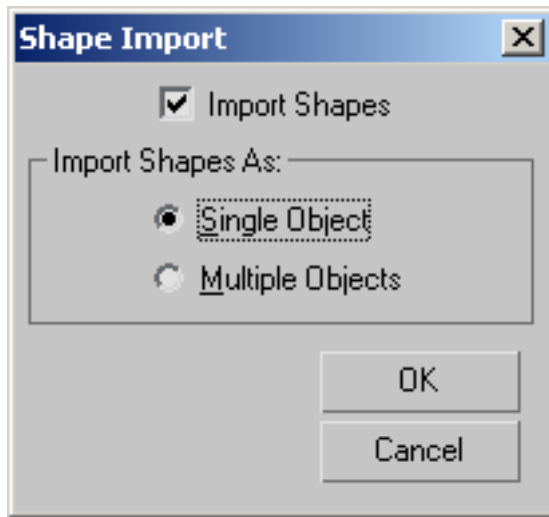

When importing PRJ files, the software converts polygons to shape objects. You choose an option in the Shape Import dialog to set how the shape objects are created:

Import Shapes Turn on this option if you don't want to import shapes from a *.prj* file.

Single Object All polygons in the *.prj* file are converted to Bezier splines and placed inside a single composite shape object.

Multiple Objects Each polygon in the *.prj* file is converted to a Bezier spline and placed inside an independent shape object.

Exporting to 3DS

File menu > Export > Select File To Export dialog > Save As Type > 3D Studio (*.3DS)

3DS is the 3D Studio (DOS) mesh file format. You can export 3ds Max files to this format.

When you export a 3DS file, the following information is exported:

- Position, Rotation and Scale animation. If the controller is a TCB controller, the TCB, Ease In, and Ease Out values are also saved. If the controller is any other type of key controller, the keys are saved but the tangent

information is lost. If the controller is not a key controller, only the object's transformation at frame 0 is saved.

- Basic material color/parameters from the Standard material.
- Single maps with their amount, offsets, scales, etc.
- Auto-cubics and Mirrors.
- Target cameras, target spotlights and omni lights.
- Most "static" parameters for cameras and lights, and animation tracks for Roll, Falloff, Hotspot, and FOV.

When you export a 3DS file, the following information is *not* exported:

- Composite and procedural maps.
- Grouped object transformations. There's no concept of group hierarchy in the 3D Editor. Groups export to the Keyframer because the Keyframer understands hierarchies.
- Global shadow parameters.

When you export a 3DS file, the following occur:

- All non-mesh geometry, such as procedural primitives and patches, is collapsed to meshes before export.
- Objects are exported as they exist on the frame 3ds Max displays at export time.
If you want to output morph targets, go to each frame and export the target to a different file name.
- Meshes are saved with edge display information and smoothing groups.
- 3ds Max instances are saved as Keyframe instances.
- Modifier and morph animation is frozen at the current frame, collapsed, and exported as a simple mesh.

Interface

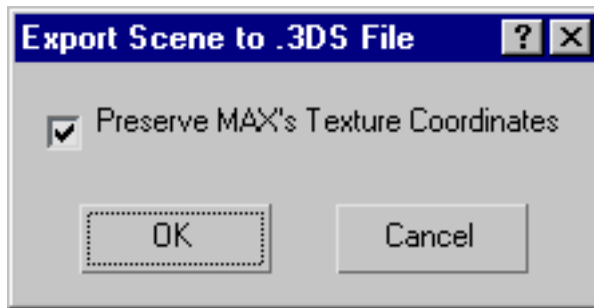

When you choose 3DS as the export file format, enter a file name, and click Save, an Export Scene To .3DS File dialog is displayed. This dialog has a single option:

Preserve MAX's Texture Coordinates When on, preserves mapping coordinates. When off, mapping information is discarded. Default=on.

Importing SHP Files

File menu > Import > Select File To Import dialog > Files Of Type > 3D Studio Shape (*.SHP)

SHP is the 3D Studio (DOS) shape file format. You can import these files into 3ds Max.

A SHP file contains polygons created in the 2D Shaper in 3D Studio.

When importing an SHP file that contains multiple shapes, the software gives you the option to either merge them all into one object or make multiple incoming objects.

The shape importer looks at the vectors on incoming splines, and if they're collinear within a couple of percentage points, it changes the angle to a smoothed Bezier (otherwise, it's a Bezier corner).

Interface

When you import an SHP file, you first see a [3DS Import dialog](#) on page 7172. This is identical to the dialog you see when you import a 3DS file. When you have set the options and clicked OK in the 3DS Import dialog, you then see a Shape Import dialog.

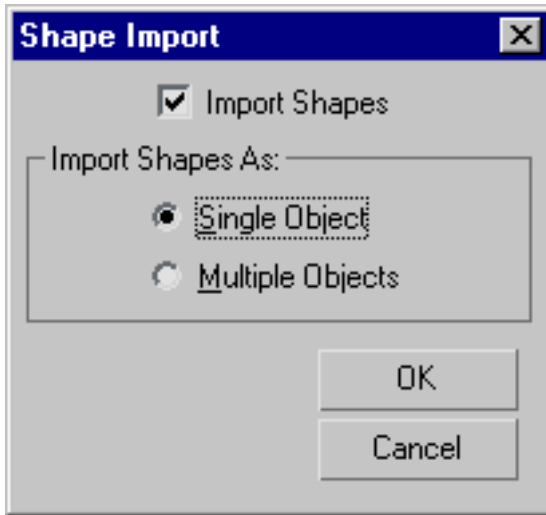

Import Shapes When on, imports the shape objects. When off, does not import them. Default=on.

Import Shapes As group

Single Object (The default.) When chosen, imports all shapes in the SHP file as a single [editable spline object](#) on page 659.

Multiple Objects When chosen, imports each shape in the SHP file as an individual editable spline object.

Adobe Illustrator Files

Importing Adobe Illustrator 88 Files

File menu > Import > Select File To Import dialog > Files Of Type > Adobe Illustrator (*.AI)

You can import Adobe Illustrator (AI88) files into 3ds Max.

Interface

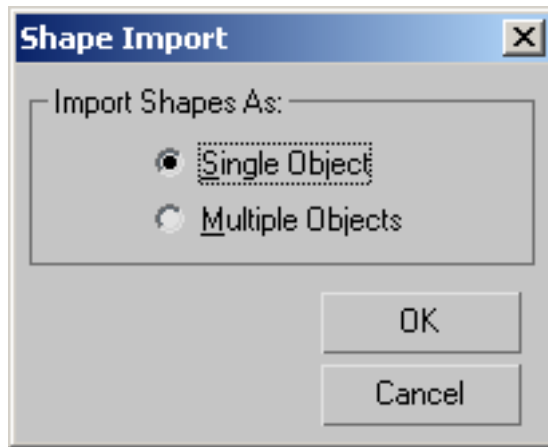

When importing AI88 files, the software converts polygons to shape objects. You choose an option in the Shape Import dialog to set how the shape objects are created:

Single Object All polygons in the *.ai* file are converted to Bezier splines and placed inside a single composite shape object.

Multiple Objects Each polygon in the *.ai* file is converted to a Bezier spline and placed inside an independent shape object.

Exporting to Adobe Illustrator

File menu > Export > Select File To Export dialog > Save As Type > Adobe Illustrator (*.AI)

You can export shapes that can be converted to [Bezier splines](#) on page 7922. The software exports these shapes in 2D only. It uses only the X and Y coordinates of the shape's local coordinate system, discarding the Z coordinates.

Procedures

To export a file to Adobe Illustrator:

- 1 Select one or more shape objects.
- 2 Choose File menu > Export.

- 3 Select Adobe Illustrator (*.AI) as the file format.
- 4 Enter a file name, and click Save.

Exporting to ASCII

File menu > Export > ASCII Scene Export (*.ASE)

When you choose ASCII Scene Export (*.ase) as the Save As type, the exported file is an ASCII representation of your scene. A dialog lets you specify which scene components are included, and how they're output. This is helpful if you are writing a program that requires you to parse the ASCII file.

Interface

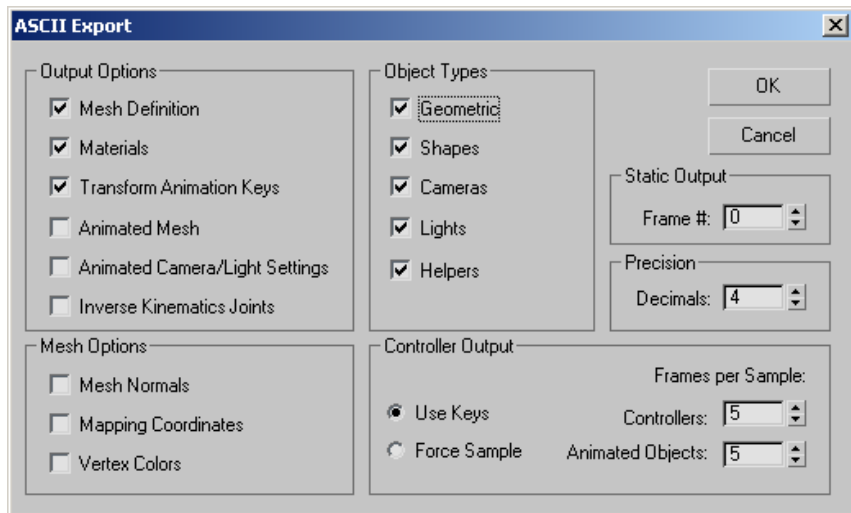

Output Options group

Provides check boxes to specify which general options are included in the ASCII file.

Mesh Definition Exports the definition of each mesh, including vertex and face information for geometric objects. In addition, turning this on enables the items in the Mesh Options group box, described below.

Materials Includes the material description. If a material is not assigned to an object, its wireframe color is exported. All levels of a material tree are included, so this can produce a lot of text.

Transform Animation Keys Includes the transform animation data for the objects. If the object is a target camera or spotlight, this will include target animation data.

Animated Mesh Exports a complete mesh definition of every n frames. The frequency is specified by the Controller Output spinner, described below. Each block contains the same information specified in the Mesh Options group box, described below. Turning this on can result in a huge file, even for small scenes.

Animated Camera/Light Settings Exports the animation data for cameras and lights, such as color, intensity, falloff, map bias, etc. Outputs a block every n frames, as specified by the Controller Output spinner.

Inverse Kinematics Joints Exports the IK joint settings in the Hierarchy branch.

Mesh Options group

These items are enabled only when Mesh Definition is turned on in the Output Options group box.

Mesh Normals Exports the face and vertex normals. The normal of the face is listed first, followed by the normals of the three vertices supporting the face. Turning this on results in a much larger file.

Mapping Coordinates Exports a list of mapping vertices and faces, according to the TVert and TVFace structures described in the 3ds Max Software Development Kit. If an object uses face mapping, a face map list is exported containing UVW coordinates for each face.

Vertex Colors Exports vertex colors.

Object Types group

The items here let you specify which category of object you want included in the output. You can include geometric objects, shapes, cameras, lights, and helper objects.

Static Output group

Frame # Lets you specify which frame of the animation will be used to export all static data, whether or not you output controller animation data.

Precision group

Decimals Lets you specify the precision (the number of digits after the decimal) of the values exported to the ASCII file.

Controller Output group

Use Keys Exports key values. If the controller doesn't use keys, then the Force Sample method is used. In the case of transform controllers, the Use Keys option works only if all of the transform controllers are either Linear/TCB or Bezier. If one of the transform tracks uses a different type of controller, then the Force Sample method is used for all transform tracks.

Force Sample Samples controller values based on the frequency specified in the Frames per Sample Controller.

Frames per Sample group

Controllers Specifies the frequency, in frames, with which to sample controller values for export.

Animated Objects Specifies the frequency, in frames, with which to output animation settings and mesh definitions.

AutoCAD (DWG) Files

Importing AutoCAD Drawing Files

File menu > Import > AutoCAD Drawing (*.DWG, *.DXF)

In most cases, when using the same data with two or more different Autodesk products, it's preferable to use the [File Link Manager](#) on page 6987 to connect to drawing files; this lets you maintain a "live" link between the applications. However, if you prefer you can also use the Import command to bind to the drawing file immediately.

When you import a drawing file, 3ds Max converts a subset of the AutoCAD, AutoCAD Architecture (formerly Architectural Desktop), or Revit objects to corresponding 3ds Max objects.

After you select a drawing file to import, the AutoCAD DWG/DXF Import Options dialog is displayed. After choosing options and proceeding with the import, you are presented with editable meshes, editable splines, and PRS controllers. Each nested block maintain its parent-child hierarchy and is imported as “Block/Style Parent”. In addition, if a single drawing object creates both mesh and spline geometry, you will find objects referred to as “Linked Geometry” in the scene. Block/Style Parent and Linked Geometry objects appear in the modifier stack on the Modify panel.

NOTE If you import multiple drawings, the importer merges the drawings together.

If you are using AutoSurf or AutoCAD Designer, use the AutoCAD command 3DSOUT to export mechanical models to 3ds Max. You can also explode the mechanical models and then import the resulting file, but some data will not appear in the AutoCAD drawing file.

IMPORTANT AutoCAD and its vertical applications, such as AutoCAD Architecture (formerly ADT), have custom objects that are unique to the product. In order to view them in 3ds Max, you need the appropriate Object Enabler (OE). Object Enablers let you access, display, and manipulate these objects in AutoCAD, as well as the other vertical applications, including 3ds Max. For a list of downloadable OEs, see the <http://www.autodesk.com/autocad-object-enablers> Autodesk Web site.

Legacy DWG Importer

The current DWG import utility contains many improvements, including enhanced DWG compatibility and greater user control and customizability; however, some features were lost from the DWG Importer found in previous versions of the software. For this reason, 3ds Max retains the [legacy DWG Import functionality](#) on page 7201.

Support of Multiple Materials on Imported ACIS Solids

3ds Max supports multiple materials per object in DWG files exported as ACIS solids from Revit Architecture/Structure/MEP 2008 and later, as well as solid primitives created in AutoCAD Architecture 2008 (formerly ADT) and later. Imported solids can have [Multi/Sub-Object materials](#) on page 5720 that you can view and manipulate in the Material Editor.

NOTE Previous versions of 3ds Max supported multiple materials for polymeshes but only one material ID for each ACIS solid when importing a DWG file, regardless of how many material IDs had been assigned to the solid.

NOTE Legacy AutoCAD DWG import does not support multiple materials on ACIS solids.

Process

When 3ds Max imports a DWG file from AutoCAD or Revit Architecture (version 2008 and later) with either the Layer, Blocks as Node Hierarchy, Split by Material” or the Entity, Blocks as Node Hierarchy derivation methods, multiple material IDs are readable and editable as Multi/Sub-Object materials in the Material Editor.

3ds Max reads each face of an imported AutoCAD/Revit solid to determine if it contains any material IDs that can be imported. If the program reads more than one material ID from a solid, it translates each material ID on import and re-assigns it to the object.

The program creates Multi/Sub-Object materials only if it finds more than one material ID; if an ACIS solid contains only one material ID, 3ds Max creates and assigns a standard/architectural material instead.

NOTE 3ds Max first evaluates the imported file to find any Revit material IDs, and then looks for AutoCAD material IDs.

NOTE If you import a DWG file with the Layer, Blocks as Node Hierarchy, Split by Materials derivation method, it does not split the solid to reflect its materials set.

Multi/Sub-Object Material Naming

In earlier versions, 3ds Max read the material ID information from the color ID of the AutoCAD/Revit material ID’s face. Now, it creates a Multi/Sub object material for every translated per face material ID each time you import a DWG file that contains an AutoCAD/Revit solid.

When the program finds multiple materials assigned to an ACIS solid and creates a Multi/Sub-Object material, the Multi/Sub-Object material consists of instances of standard architectural scene materials.

Naming Conflicts

Material IDs are unique within one DWG file. However, the same material ID may appear in two different files, such as Basic Wall: Generic – 12” Masonry. If a naming conflict arises when two scenes are merged, the program applies the last loaded material used in the Multi/Sub object material.

For example, if you import two files, **file1.dwg** and **file2.dwg**, and they both contain a material named Brick; the Brick material used is the one from the second file (**file2.dwg**).

Or, if **file1.dwg** contains a material named Brick that is internally stored as material ID 222 and **file2.dwg** contains a different material stored as ID 222, the material used in the scene when they are imported is **file2.dwg**'s material.

If two solids share the same material ID, they will share the same Multi/Sub-Object material.

Non-AutoCAD Materials

3ds Max does not import non-AutoCAD material IDs. The only non-AutoCAD Architecture IDs it preserves are Color IDs.

ACIS Solids

DWG ACIS solids import as solid objects in 3ds Max. You cannot separate faces of an ACIS solid object unless you apply the [Edit Poly](#) on page 1363 or [Edit Mesh](#) on page 1353 modifier.

TIP You can access the material ID value assigned to this face with the Edit Poly modifier.

ACIS Solids and Materials

ACIS solid materials display in the Material Editor, along with any other imported materials.

When you apply a bitmap material to an ACIS solid, it is applied to every side of the object. For example, a brick bitmap material that you apply to a wall object appears on both sides and all edges of the wall. If you want to apply a material to each face ID, you can use a Multi/Sub Object material so you can assign sub-materials to each face ID.

When you import ACIS solids into 3ds Max, procedural textures are not imported, only materials. For example, a brick wall in Revit may have mortar

lines procedurally drawn on it in red, but if the object is an ACIS solid, the mortar lines, which are procedural hatches, are lost in 3ds Max

When an ACIS object's materials are shown as a Multi/Sub-Object material in the Material Editor, each material name appears in the Material/Map Browser, for example, Default wall or Basic Wall: Generic – 12" Masonry.

Polymesh

Polymesh DWGs import as polymesh geometry in 3ds Max. Unlike ACIS solids, you can modify and edit any face of a polymesh object.

Polymesh Objects and Materials

When you import a polymesh DWG file, 3ds Max considers each polymesh face as a separate entity, with one material permitted per entity, which allows it to contain multiple materials.

You can apply a bitmap material to the different faces of polymesh geometry, unlike ACIS solids, where you would need to use a Multi/Sub-Object material to create the same effect. For example, you can select the outside face of wall and apply a brick bitmap material and also apply a diffuse material on the inside wall to simulate white paint.

When you import a polymesh DWG file, every material used in the scene appears in the Material Editor as a separate material, where you can edit it.

When the Material Editor shows a polymesh object's materials, each material name appears in the Material/Map Browser, for example, Default wall or Basic Wall: Generic – 12" Masonry.

Procedures

To import a DWG or DXF file:

- 1 Choose File menu > Import.
- 2 Choose AutoCAD Drawing (*.DWG, *.DXF) in the Files of Type list.
- 3 Specify the file to import and click Open.
- 4 Set options in the AutoCAD DWG/DXF Import Options dialog.
- 5 Click OK to perform the import.

Interface

The Import Options dialog contains three panels, documented in the following topics:

[DWG/DXF Import: Geometry Panel](#) on page 7187

[DWG/DXF Import: Layers Panel](#) on page 7196

[DWG/DXF Import: Spline Rendering Panel](#) on page 7198

A Note on Large-Scale Drawings

If you attempt to import geometry that is created very far from the origin or contains a very large bounding box in tools like AutoCAD, the 3ds Max viewports and transform tools do not respond properly. When you use them, the cursor does not move smoothly.

For example, if you have a file that is a mile wide, but your system units are millimeters, you have a scene width of 1.6 million units, which is too great a value. If you change your system unit to feet, this is less taxing on the system.

If any side of the scene's bounding box measures larger than 1,000,000 system units, you will see the following dialog:

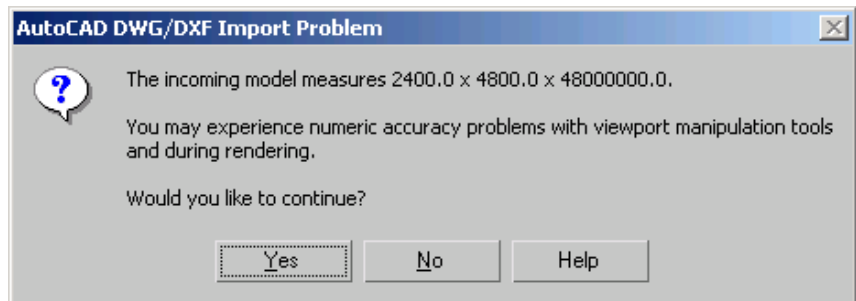

DWG/DXF Import: Geometry Panel

File menu > Import > AutoCAD Drawing (*.DWG, *.DXF) > Geometry panel

The Geometry panel of the Import Options dialog controls how the software derives AutoCAD primitives and whether 3ds Max uses the scene material definitions when linking to or reloading the AutoCAD drawing. It also presents options for geometry translation and for toggling inclusion of certain elements in the DWG or DXF file.

Interface

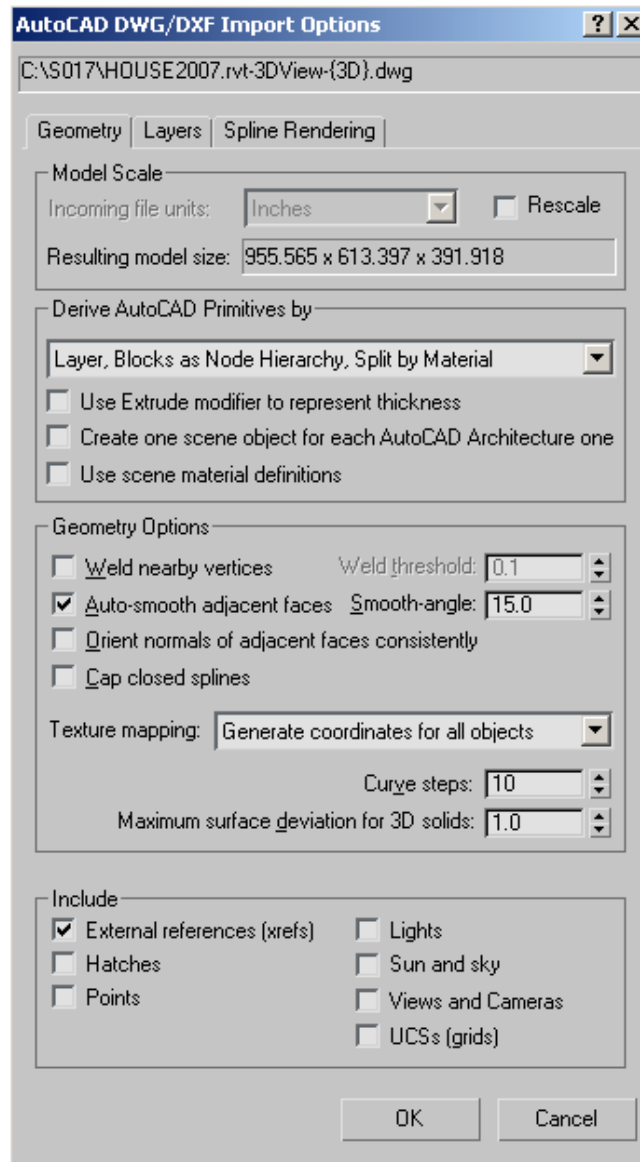

Model Scale group

Incoming file units This drop-down list lets you specify the base units in the incoming file. Available only when Rescale is on.

Rescale Allows rescaling the incoming geometry by a factor corresponding to the most common unit type used. The importer tries to detect the units of the DWG file being imported, compares those units with the 3ds Max system units, and then provides the appropriate conversion factor.

For example, if a drawing file is built in millimeters and 3ds Max has its System Units set to inches, the AutoCAD DWG/DXF Import Options dialog automatically has Rescale on and the Incoming File Units set to millimeters.

When there is a scale disparity, it's generally advisable to rescale an incoming drawing to more realistic units to account for the precision limitations of 3ds Max compared to AutoCAD. For instance, if you import an airport designed in millimeters in AutoCAD, set Incoming File Units to Feet or Meters. For further information, see [A Note on Large-Scale Drawings](#) on page 7187.

NOTE If the units are unspecified in the drawing, the drop-down list is blank. In this case, if you click OK to perform the import with Rescale on, you are prompted to select a value for Incoming File Units, and are then returned to the AutoCAD DWG/DXF Import Options dialog.

Resulting model size Incoming geometry is evaluated to determine its bounding box size. This field displays the scene extents based on three factors:

- Incoming file units
- System units in 3ds Max
- Display units in 3ds Max

NOTE If the software cannot determine the size, the field shows “(Drawing Extents Not Known)”.

Derive AutoCAD Primitives By group

This group box contains options for translating the geometry in the DWG or DXF file to 3ds Max format.

[derivation method] Choose the method for deriving imported AutoCAD primitives from this drop-down list. The options are as follows:

- **Layer, Blocks as Node Hierarchy** All objects on a given layer in the AutoCAD drawing that aren't in blocks are combined into a single Editable Mesh or Editable Spline object when imported into 3ds Max. The name

of each imported object is based on the AutoCAD object's layer. The imported object name has a "Layer:" prefix and is followed by the layer name. For example, all AutoCAD objects residing on the layer Walls become part of the Editable Mesh named Layer:Walls after they are imported to 3ds Max.

Each block is imported separately as a hierarchy, with the block itself as the parent object and its constituent parts as child objects. The child objects of the block are combined by layer.

- **Layer, Blocks as Node Hierarchy, Split by Material** This works the same as the Layer, Blocks as Node Hierarchy option, with the following additional functionalities: the combination of non-block objects by layer, followed by material and support for multiple materials assigned to ACIS solid and polymesh geometry.

- Non-block layer combination

For example, take an AutoCAD file with six objects in layer A: three have a Brick material and three have a Stone material. Using this option, this file would be imported in the form of two objects, or nodes, one containing the Brick material and the other with the Stone material.

Each block is imported separately as a hierarchy, with the block itself as the parent object and its constituent parts as child objects. The child objects of the block are combined by layer.

- Multiple material support

On import, ACIS solids and polymesh geometry can support multiple materials. For polymesh geometry, one material is supported per face. For an ACIS solid, if the solid has more than one material associated with it, a multi/sub object material is created that contains the materials used. If the solid has only one material associated with it, a standard/architectural material is assigned instead.

NOTE Multiple material support for ACIS solids applies to DWG files imported or file linked from Revit Architecture 2008 or AutoCAD Architecture (formerly Architectural Desktop or ADT) 2007 and later.

NOTE This derivation method is intended for use with AutoCAD 2007 (and later) format files. Using this method with DWG files created with previous versions of AutoCAD may result in data loss.

- **Entity, Blocks as Node Hierarchy** Every imported object not in a block is represented as a separate object in the 3ds Max scene, without regard to

layers. The nodes are then placed on scene layers that correspond to the drawing layers. Each block is imported separately as a hierarchy, with the block itself as the parent object and its constituent parts as child objects. The child objects of the block are combined by layer.

One benefit of this option is that you can apply [instanced animation controllers](#) on page 3109 to block subcomponents and thus, by transforming a single member, transform all members at once. For example, in a scene containing a conference table with six chairs around it, you could move all of the chairs simultaneously by moving a single chair.

Another advantage is that all geometry is instanced, so edited UVs and normals and other modifications need be done only once.

Multiple materials per object are supported with this option, if needed. If the object is an ACIS solid, and has more than one material associated with it, a multi/sub object material is created containing the materials that can be edited in the Materials Editor. If the solid has only one material associated with it, a standard/architectural material is assigned instead. If the object is a Polymesh, one material per face is supported.

NOTE Multiple material support for ACIS solids applies on the DWG files imported or file linked from Revit Architecture 2008 or AutoCAD Architecture (formerly Architectural Desktop or ADT) 2007 and later.

NOTE This derivation method setting might cause unreliable material propagation when importing drawings containing dynamic blocks. Materials may propagate to some block instances and not to others.

WARNING This option has the potential to create an enormous number of objects in your scene.

- **Layer** Imported objects are combined in 3ds Max according to their layer. Objects in each of the associated application's layers are combined into one object, with the exception of blocks, each of which is represented as an individual VIZBlock (not a hierarchy). Multiple inserts of the same block are represented using instances in the scene. Material assignments are lost but material IDs are preserved.
- **Color** Imported AutoCAD objects are combined in 3ds Max according to their color. All objects of the same color are combined into one object, with the exception of blocks, each of which is represented as an individual VIZBlock (not a hierarchy). Multiple inserts of the same block are represented using instances in the scene. Material assignments are lost but material IDs are preserved.

NOTE Blocks can contain objects with different colors. However, when sorting, 3ds Max considers only the color of the block itself. Also, 3ds Max objects can only display one color, unless a material is applied.

- **Entity** Provides a one-to-one correspondence between AutoCAD objects and 3ds Max objects. For each imported object or block in the imported file, the importer creates an independent object or VIZBlock, respectively, in the scene. Material assignments are lost but material IDs are preserved.

WARNING This option has the potential to create an enormous number of objects in your scene.

NOTE When working with drawings exported from Revit, it is recommended that you do not use this setting.

- **One Object** All imported objects are combined into a single VIZBlock. Material assignments are lost but material IDs are preserved.

Use Extrude modifier to represent thickness When on, objects with thickness receive an Extrude modifier to represent the thickness value. You can then access the parameters of this modifier and change the height segments, capping options, and height value. Unavailable with the Layer, Blocks As Node Hierarchy option.

When off, objects with thickness (and closed capped objects) are converted directly to mesh objects.

Create one scene object for each ADT object AutoCAD Architecture (formerly Architectural Desktop or ADT) objects are imported as a single object instead of being separated into their constituent components. This means that if you import an ADT door object, the door is represented as one object instead of three (frame, step, door). Turning on this switch makes importing faster and the scene size smaller.

NOTE This switch presents several modeling concerns that you should be aware of:

- Material assignments from ADT are not translated during the import process..
- If you want to assign materials to these objects, use Multi/Sub-Object materials. The assigned material IDs match the color indices specified in ADT (red=1, white=7, etc.).
- Depending on the Texture Mapping option you choose, UVW coordinates are translated correctly.

Use scene material definitions When on, 3ds Max checks the current scene for any currently used materials with the exact same name as a material name in the incoming DWG file. If a match is found, the importer does not translate the drawing's material, but instead uses the material defined in the scene.

When off, the File Link Manager always uses the material definitions contained in the DWG file, and will overwrite scene materials with the same name, regardless of which objects the material is applied to. All material definitions stored in the DWG file are reloaded (even when using a selective reload). If you make changes to a linked material, in Autodesk VIZ, then reload, those changes will be lost (if the switch is off).

Geometry Options group

Weld nearby vertices Sets whether coincident vertices of converted objects are welded, according to the Weld Threshold setting. Welding smoothes across seams and unifies normals of objects with coincident vertices.

Weld threshold Sets the distance that determines whether vertices are coincident. If the distance between two vertices is less than or equal to the Weld Threshold, the vertices are welded together.

Auto-smooth adjacent faces Assigns [smoothing groups](#) on page 8130 according to the Smooth Angle value. Smoothing groups determine whether faces on an object render as a smooth surface or display a seam at their edges, creating a faceted appearance.

Smooth-angle Controls whether smoothing occurs between two adjacent faces. If the angle between the two face normals is less than or equal to the smooth angle, the faces are smoothed.

Orient normals of adjacent faces consistently Analyzes the face normals of each object and flips normals to make their directions consistent. If the

imported geometry is not properly welded, or if the software can't determine the object's center, normals might be oriented in the wrong direction. Use the Edit Mesh or Normal modifiers to flip normals.

When this option is off, the software calculates normals according to the face vertex order in the drawing file. Face normals for solid objects are already unified. Make sure this option is off when importing drawings containing solid objects.

You should also make sure this option is off when working with AutoCAD Architecture files.

AutoCAD solids will never have their normals unified, regardless of the setting of this import toggle. Solids generate faces and normals correctly.

Cap closed splines Applies an Extrude modifier to all closed objects, and turns on the Cap Start and Cap End options of the modifier. The Extrude modifier Amount value for a closed entity with no thickness is set to 0. Capping makes closed entities with thickness appear solid and closed entities without thickness appear flat. When Cap Closed Objects is turned off, the Extrude modifier Cap Start and Cap End options for closed entities with thickness are turned off. No modifiers are applied to closed entities without thickness, except for Circle, Trace, and Solid.

NOTE If [Use Extrude Modifier to Represent Thickness](#) on page 7192 is off, the software does *not* apply an Extrude modifier to closed objects.

Texture mapping The texture mapping settings affect the loading time of models that have many objects with stored UVW Coordinates for texture mapped materials.

NOTE This setting only applies to geometry that is stored as a mesh in the scene. Spline shapes marked as renderable have separate controls for UVW coordinate generation on the Spline Rendering panel.

- **No mapping coordinates** When No Mapping Coordinates is used, the software not generate texture coordinates for the mesh objects that are imported.
When drawings are imported, objects are added to the scene as Editable Mesh objects that do not have UVW coordinate assignments. Before assigning materials to imported objects, you'll need to apply a [UVW Map modifier](#) on page 1931 to add texture coordinates. When you then apply the material and the material or texture map is set to Show Map in Viewport, the texture map is displayed if the viewport is set to Smooth + Highlights. If the UVW Map modifier is not applied, the object turns gray and you'll

see a [Missing Map Coordinates dialog](#) on page 5780 when you render the scene.

This option gives you faster loading speed, but no UVW coordinate generation.

- **Generate coordinates for all objects** This option forces all objects to have UVW coordinates generated when the drawing is imported. This option tells the DWG/DXF Importer to create UVW coordinates, but loading time is increased while the coordinate generation occurs.

Curve steps Adjusts how smoothly an arc or curve appears when the drawing is imported. Larger numbers result in smoother curves. Default=10.

Maximum surface deviation for 3D solids Specifies the maximum allowable distance from the 3ds Max surface mesh to the parametric 3D solid surface. Small numbers produce more accurate surfaces with a greater number of faces. Large numbers produce less accurate surfaces with fewer faces. In most cases, the default value suffices. Default=1.0.

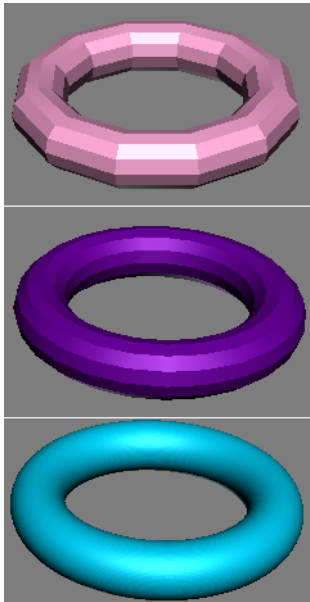

Imported 3D solid with different Surface Deviation settings

Top: Surface Deviation=10.0

Center: Surface Deviation=1.0 (the default)

Bottom: Surface Deviation=0.1

Include group

This group allows you to toggle the inclusion of specific parts of a drawing file during the import process.

External References (xrefs) Imports xrefs attached to the drawing file.

Lights Imports lights from pre-AutoCAD 2007 drawing files.

Sun and Sky Imports Sun and Shadows position from the drawing file (AutoCAD / AutoCAD Architecture 2008 and Revit 2008 only).

NOTE You must set mental ray as the default renderer for you to see the Sun and Sky effect. To set mental ray as the default renderer, see [Choose Renderer Dialog](#) on page 6136.

Hatches Imports hatches from the drawing file.

WARNING This stores each line or dot in the hatch pattern as a separate component of the VIZBlock that defines the hatch; this can create a very large number of objects in your scene.

Views and Cameras Imports named views and cameras from the drawing file, and converts named views to 3ds Max cameras.

NOTE Orthographic views do not translate correctly in imported DWG files. However, there are no problems with Perspective views.

Points Imports points from the drawing file.

NOTE The imported point objects are represented in 3ds Max as Point Helper objects.

UCSs (grids) Imports user coordinate systems (UCS) from the drawing file and converts them to 3ds Max grid objects.

DWG/DXF Import: Layers Panel

File menu > Import > AutoCAD Drawing (*.DWG, *.DXF) > Layers panel

The Layers panel of the Import Options dialog lets you choose specific layers for importing from the DWG or DXF file.

Interface

Layers panel

This interface is very similar to the [Layer Manager](#) on page 7441. Layer names remain the same as specified in the drawing file.

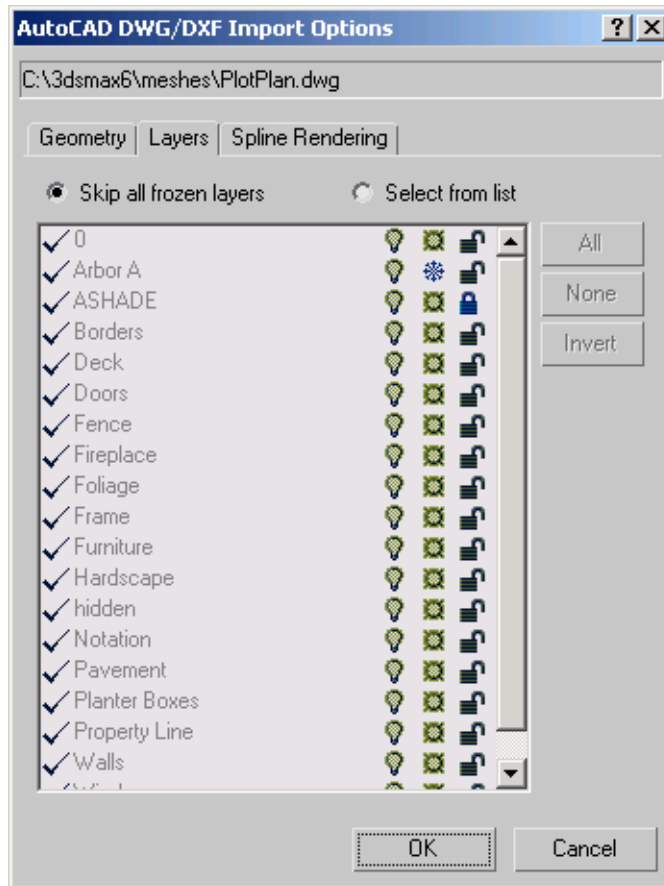

Skip all Frozen Layers Excludes the import of objects on frozen layers.

Select from List Allows you to choose specific layers to import. A check mark beside the layer name indicates the layer will be imported. Click the layer to toggle the check mark.

All The All button is only active when Select From List is turned on. It quickly lets you select all the layers in the list.

None The None button is only active when Select From List is turned on. It deselects any layers you've selected.

Invert The Invert button is only active when Select From List is turned on. Clicking this button reverses the selection set: currently selected layers are unselected and unselected layers are selected.

[**layer list**] This field displays all the layers that make up the drawing and shows their status such as hidden/displayed or frozen/unfrozen.

DWG/DXF Import: Spline Rendering Panel

File menu > Import > AutoCAD Drawing (*.DWG, *.DXF) > Spline Rendering panel

The Spline Rendering panel of the Import Options dialog lets you determine how spline objects imported from DWG and DXF files are displayed in the viewports and how they're treated by the 3ds Max renderer.

Interface

Spline Rendering panel

The controls on this panel are identical in name and operation to those found on the Rendering rollout of [editable spline](#) on page 659 and [Edit Spline](#) on page 1447 objects. The values of these settings apply to all imported shapes. Once the import is complete, you can change the settings as necessary for each object with the Modify panel controls.

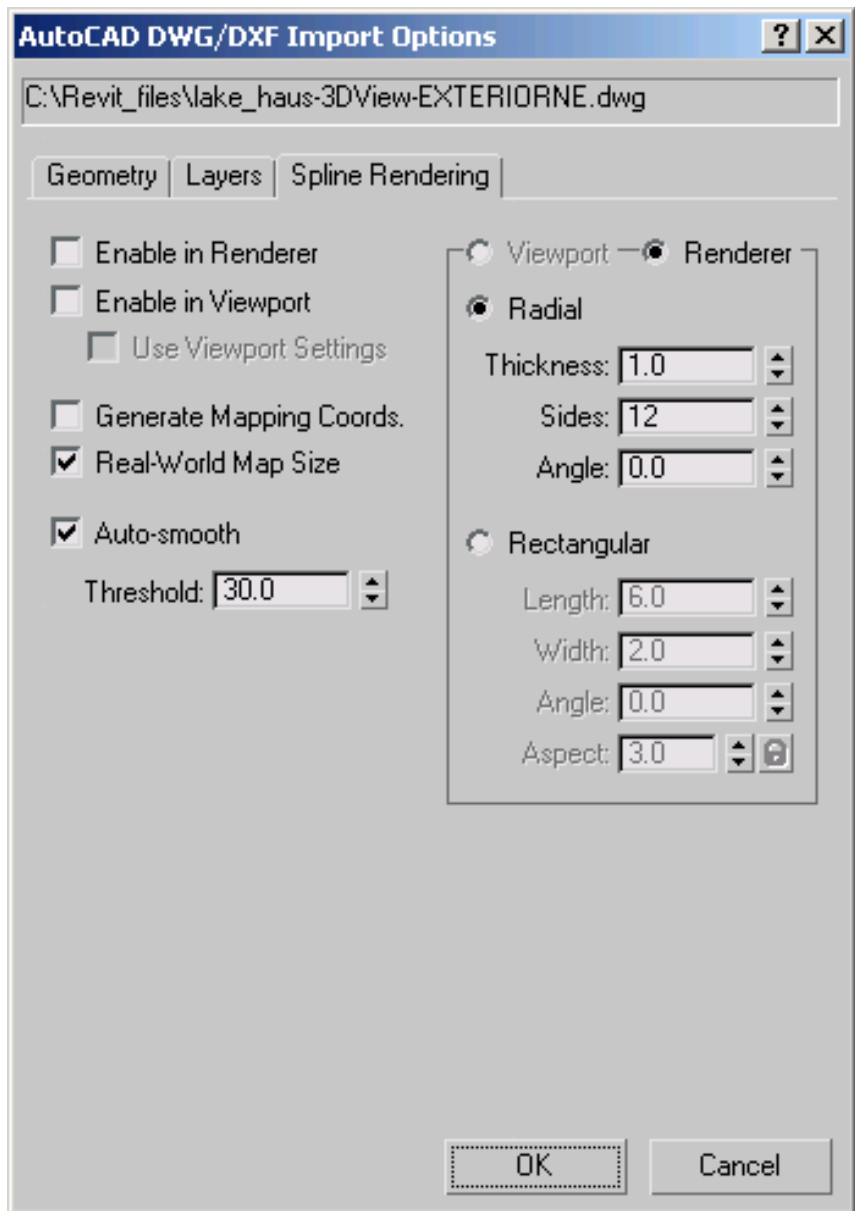

Enable In Renderer When on, the shape is rendered as a 3D mesh using the Radial or Rectangular parameters set for Render.

Enable In Viewport When on, the shape is displayed in the viewport as a 3D mesh using the Radial or Rectangular parameters set for Renderer.

Use Viewport settings Lets you set different rendering parameters, and displays the mesh generated by the Viewport settings. Available only when Enable in Viewport is turned on.

Generate Mapping Coords Turn this on to apply mapping coordinates. Default=off.

3ds Max generates the mapping coordinates in the U and V dimensions. The U coordinate wraps once around the spline; the V coordinate is mapped once along its length. Tiling is achieved using the Tiling parameters in the applied material. For more information, see [Mapping Coordinates](#) on page 5279.

Real-World Map Size Controls the scaling method used for texture mapped materials that are applied to the object. The scaling values are controlled by the Use Real-World Scale settings found in the applied material's [Coordinates rollout](#) on page 5782. Default=on.

Auto Smooth If Auto Smooth is turned on, the spline is automatically smoothed using the threshold specified by the Threshold setting below it. Auto Smooth sets the smoothing based on the angle between spline segments. Any two adjacent segments are put in the same smoothing group if the angle between them is less than the threshold angle.

Threshold Specifies the threshold angle for smoothing, in degrees. Any two adjacent spline segments are put in the same smoothing group if the angle between them is less than the threshold angle.

Viewport Choose this to specify Radial or Rectangular parameters for the shape as it will display in the viewport. Available only when Enable in Viewport and Use Viewport Settings are on.

Renderer Choose this to specify Radial or Rectangular parameters for the shape as it will display when rendered or viewed in the viewport when Enable in Viewport is turned on.

Radial Displays the 3D mesh as a cylindrical object.

Thickness Specifies the diameter of the viewport or rendered spline mesh. Default=1.0. Range=0.0 to 100,000,000.0.



Splines rendered at thickness of 1.0 and 5.0, respectively

Sides Sets the number of sides (or facets) for the spline mesh in the viewport or renderer. For example, a value of 4 results in a square cross section.

Angle Adjusts the rotational position of the cross-section in the viewport or renderer. For example, if the spline mesh has a square cross section you can use Angle to position a "flat" side down.

Rectangular Displays the spline's mesh shape as a rectangle.

Length Specifies the size of the cross-section along the local Y axis.

Width Specifies the size of the cross-section along the local X axis.

Angle Adjusts the rotational position of the cross-section in the viewport or renderer. For example, if you have a square cross-section you can use Angle to position a "flat" side down.

Aspect Sets the aspect ratio for rectangular cross-sections. The Lock check box lets you lock the aspect ratio. When Lock is turned on, Width is locked to Length that results in a constant ratio of Width to Length.

Legacy AutoCAD Import

File menu > Import > Legacy AutoCAD (*.DWG)

The new [AutoCAD DWG/DXF Import Options dialog](#) on page 7182 contains many improvements, including enhanced DWG compatibility and greater user control and customizability; however, some things were also lost from

the DWG Import found in previous versions of the software. For this reason, 3ds Max retains the legacy DWG Import functionality.

Differences Between New and Legacy DWG Import

Features Unique to the new DWG Import System

- Support for AutoCAD, AutoCAD Architecture and Revit Sun and Shadows information.
- Support for AutoCAD Architecture mapped UV textures on objects.
- Support of multiple materials on ACIS solids from files imported or linked from Revit Architecture 2008 or AutoCAD Architecture (formerly Architectural Desktop or ADT) 2007 and later.
- Support for all ObjectARX custom objects (ignored by the Legacy importer).
- Specialized support for AutoCAD Architecture and Revit objects, including style/component grouping and naming, style associations for material and modifier propagation, and material translation and assignment.
- Specialized support for AEC Civil contour objects (translated into a Terrain object).
- Support for Raster objects.
- Support for axonometric named views (translated into cameras with the Orthogonal toggle turned on). Both importers can translate perspective views.
- Support for attached drawing xrefs.
- Support for DXF files.
- Rescaling to imported drawings created with units that differ from the 3ds Max system units.
- Ability to skip frozen layers, or to select specific layers to import (or exclude) from a list.
- Ability to set shape rendering parameters before importing to 3ds Max.
- Ability to maintain layer assignments from the drawing file.

Features Unique to the Legacy DWG Import System

- AutoCAD primitives are translated into 3ds Max primitives.
- Support for Text (though not MText).
- Imported blocks are represented as groups.

Interface

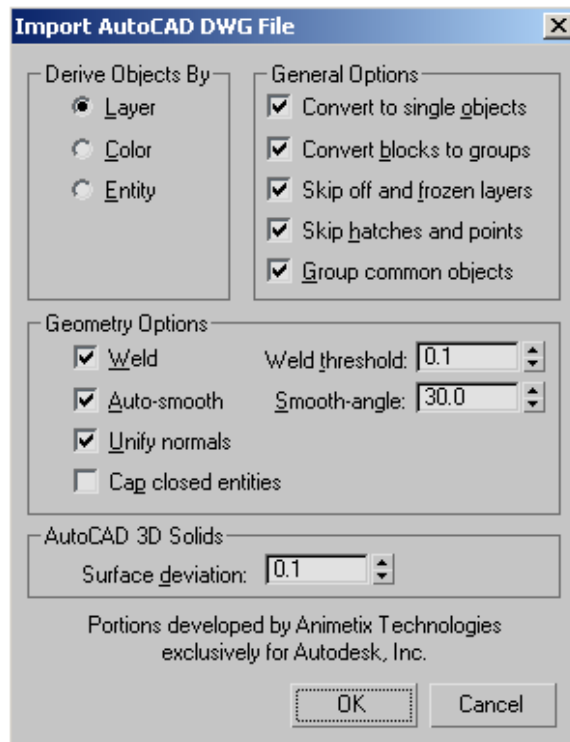

Derive Objects By group

Layer Names each 3ds Max object based on the object layers specified in the drawing file. The layer name is followed by a number for each object from that layer. For example, an object on the layer BASE becomes BASE.01. If Convert To Single Objects is turned on, objects on the same layer become a single 3ds Max object.

Color Derives the name of each 3ds Max object based on the object's layer color in the drawing. The AutoCAD color number is followed by a number for each object using that layer color. For example, objects on a layer that is set to the color red (Color number 001) become COLOR001.01. Colors assigned by object are ignored in favor of colors assigned by layer. If Convert To Single Objects is turned on, objects assigned the same layer color become a single 3ds Max object.

Entity Names each 3ds Max object based on the object type. The object type name is followed by a number for each object converted. For example, a Line object becomes Line.01. Drawings can contain thousands of entities, so deriving objects by entity can create many 3ds Max objects.

General Options group

Convert to Single Objects Combines multiple objects in the drawing file into a single 3ds Max object. Objects are combined according to the current Derive Objects By setting and their 3ds Max object type. Explicit mesh objects are combined. Shapes with no Z axis extrusion are combined, as are shapes with the same Z axis extrusion amount. Shapes with differing amounts of Z axis extrusion are assigned an Extrude modifier and are not combined.

Convert Blocks to Groups Places all objects in a block entity into a 3ds Max group that uses the name of the block entity and the number .01. For example, a block entity named CHAIR becomes a collection of 3ds Max objects inside a group named [CHAIR.01].

Multiple insertions of the block entity are converted to instances of the 3ds Max group. For example, a second insertion of the block, CHAIR, becomes an instance of [CHAIR.01] named [CHAIR.02].

When Convert Blocks To Groups is turned off, block definitions are ignored and block insertions are treated as separate objects, similar to exploding blocks in AutoCAD.

Skip Off and Frozen Layers Excludes the import of objects on layers that are hidden or frozen.

Skip Hatches and Points Excludes the import of hatch patterns and point objects.

Hatch patterns are made of many short line segments and points. Importing all the objects in hatch patterns can overload your 3ds Max scene.

NOTE Hatch patterns are stored in drawings as anonymous blocks. Skip Hatches And Points skips any other anonymous blocks in the drawing file. Hatch patterns created in AutoCAD R14 are skipped regardless of this setting.

Group Common Objects Puts imported objects into a common group, based on how they are derived. In other words, the group would include all objects on a common layer, or color, and so on.

Geometry Options group

Weld Sets whether coincident vertices of converted objects are welded according to the Weld Threshold setting. Welding smoothes across seams and unifies normals of objects with coincident vertices. To use the Weld option, first turn on Convert To Single Objects, because welding occurs only for vertices that are part of the same object.

Weld Threshold Sets the distance that determines whether vertices are coincident. If the distance between two vertices is less than or equal to the Weld Threshold setting, the vertices are welded together.

Auto-Smooth Assigns smoothing groups according to the Smooth Angle setting. Smoothing groups determine whether faces on an object render as a smooth surface or display a seam at their edges, creating a faceted appearance.

Smooth Angle Controls whether smoothing occurs between two adjacent faces. If the angle between the two face normals is less than or equal to the Smooth Angle setting, the faces are smoothed.

Unify Normals Analyzes the face normals of each object and flips normals where necessary, so they all point out from the center of an object. If the imported geometry is not properly welded, or if the software can't determine the object's center, normals might be oriented in the wrong direction. Use the Edit Mesh or Normal modifiers to flip normals.

When Unify Normals is turned off, normals are calculated according to the face vertex order in the drawing file. Face normals for 3D Solids are already unified. Turn off Unify Normals when importing 3D Solid models.

Cap Closed Entities Applies an Extrude modifier to all closed entities, and turns on the Cap Start and Cap End options of the modifier. The Extrude modifier Amount value for a closed entity with no thickness is set to 0. Capping makes closed entities with thickness appear solid and closed entities without thickness appear flat. When Cap Closed Entities is turned off, the Extrude modifier Cap Start and Cap End options for closed entities with thickness are turned off. No modifiers are applied to closed entities without thickness, except for Circle, Trace, and Solid.

AutoCAD 3D Solids Group

Surface Deviation Specifies the maximum allowable distance from the 3ds Max surface mesh to the parametric 3D solid surface. Small numbers produce more accurate surfaces with a greater number of faces. Large numbers produce less accurate surfaces with fewer faces.

Exporting AutoCAD DWG Files

File menu > Export > AutoCAD (*.DWG)

When you export an AutoCAD drawing file, you convert your 3ds Max objects into AutoCAD objects. Because AutoCAD doesn't support animation, the exporter produces objects in a static state defined by the current frame set by the time slider.

If you used layers, instances, or colors to organize objects in the scene, that structure is maintained when the model is exported.

Exported objects with modifiers assigned to them are affected by the current state of the modifier. For instance, if the Taper modifier assigned to a box is turned off, the exported scene shows a non-tapered box.

NOTE Layers created in 3ds Max are not exported to AutoCAD.

NOTE Exporting to an AutoCAD R14 drawing file is not supported. If you are working with AutoCAD R14, export to 3DS or DXF file format.

What to Expect When Opening the DWG File

When you open an exported drawing in AutoCAD, you are presented with an isometric (3/4) view looking toward the positive XY direction instead of a Front elevation view.

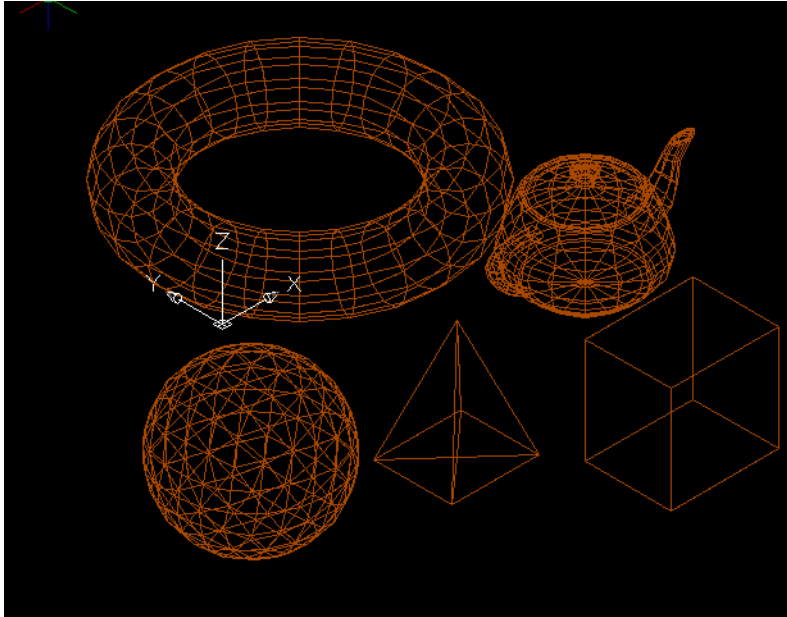

The isometric view of an exported model opened in AutoCAD

The exporter also sets two AutoCAD system variables:

- **INSUNITS**, Insert Units, sets the drawing-unit value for blocks or images inserted from AutoCAD Design Center. Therefore, if you have the units of a model in 3ds Max set to millimeters, **INSUNITS** will be set to 4.
- **MEASUREMENT** sets the drawing units either to English or Metric.

See also:

- [Exporting to DXF Files](#) on page 7209

Procedures

To export a DWG file:

- 1 Choose File menu > Export.
- 2 From the Files Of Type drop-down list, choose AutoCAD (*.DWG).
- 3 Specify a file name to export.

4 Set options in the Export to AutoCAD File dialog (described below).

Interface

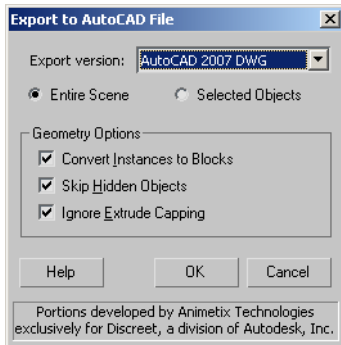

Export version

Export version 3ds Max allows you to export to AutoCAD 2007, AutoCAD 2004, or AutoCAD 2000.

The next option lets you choose to export everything in the current scene or only selected objects:

- **Entire Scene** All objects in the scene are exported. This is the default setting.
- **Selected Objects** Only selected objects are exported. Choosing this is equivalent to using File > [Export Selected](#) on page 7099.

Geometry Options group

Convert Instances To Blocks Converts instances to AutoCAD block insertions. The block definition uses the same name as the first instance converted. When turned off, each instance is converted as a separate AutoCAD object. References are always exported as separate objects.

Skip Hidden Objects Toggles export of hidden objects. When on, hidden objects are not exported.

Ignore Extrude Capping When on, exports shapes with Extrude modifiers as 2D AutoCAD objects with a thickness property, and ignores the state of the Cap Start and Cap End parameters. When off, shapes with Extrude modifiers that also have Cap Start or Cap End on are exported as polyface 3D meshes.

Extruded circles, donuts, and rectangle objects export as AutoCAD circles, donuts, and trace objects with a thickness property.

AutoCAD Interchange (DXF) Files

Importing DXF Files

File menu > Import > Select File To Import dialog > Files Of Type > AutoCAD (*.DXF)

If using a DWG file is not an option, the DXF file format is the next best method of getting design data to and from 3ds Max. Most commonly, DXF files are used to import and export modeling data to and from CAD programs that have support for DXF but not DWG files.

When you import an DXF file, the software converts a subset of AutoCAD objects to corresponding 3ds Max objects. Importing DXF files employs the same methods as importing DWG files. For more information, see [Importing AutoCAD Drawing Files](#) on page 7182.

Exporting to DXF Files

File menu > Export > Select File To Export dialog > Save As Type > AutoCAD (*.DXF)

DXF files are used to import and export objects to and from AutoCAD (and other programs that support this file format).

NOTE The DXF Exporter can export only mesh data. Therefore, all [shapes and splines](#) on page 8127 are exported as mesh objects. Consequently, any open splines (which cannot be converted to mesh objects) in your scene will not be exported.

See also:

- [Exporting AutoCAD DWG Files](#) on page 7206

Interface

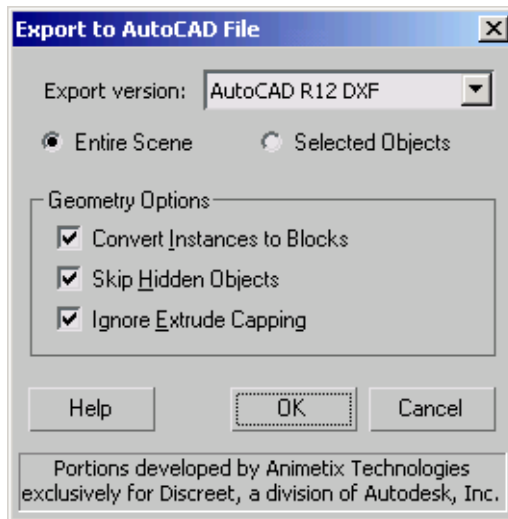

Export version

Export version list Lets you choose the AutoCAD version to export. You can export to AutoCAD 2007, AutoCAD 2004, or AutoCAD 2000, or AutoCAD R12 DXF format.

- **Entire Scene** (The default.) All objects in the scene are exported.
- **Selected Objects** When chosen, only the selected objects are exported. Choosing this option is comparable to using File > [Export Selected](#) on page 7099.

Geometry Options group

Convert Instances To Blocks Converts instances to AutoCAD block insertions. The block definition uses the same name as the first instance converted. When turned off, each instance is converted as a separate AutoCAD object. References are always exported as separate objects.

Skip Hidden Objects Exports hidden objects. When turned off, hidden objects are not exported.

Ignore Extrude Capping When turned on, exports shapes with Extrude modifiers as 2D AutoCAD objects with a thickness property, and ignores the state of the Cap Start and Cap End parameters. When turned off, shapes with

Extrude modifiers that also have Cap Start or Cap End turned on, are exported as polyface 3D meshes. Extruded Circles, Donuts, and Rectangles export as AutoCAD Circles, Donuts and Traces with a thickness property.

Importing Autodesk Inventor Files

File menu > Import > Select File To Import dialog > Files Of Type > Autodesk Inventor (*.IPT, *.IAM)

IPT and IAM are the native Autodesk Inventor® file formats for *parts* (IPT) and *assemblies* (IAM). You can now import both file formats into 3ds Max without having to copy scripts from the install CD.

The components of models that you import into 3ds Max retain their object naming as assigned in Autodesk Inventor and appear as [editable meshes](#) on page 2075. Once imported, you can edit the model just as you would any other type of object that you construct. You can apply modifiers, alter materials, add lighting and cameras, create animations, etc.

Requirements and Limitations

In order to be able to import models that originate from Autodesk Inventor, Inventor 8, or later, is required to be installed along with 3ds Max on the system.

At this time, there are some limitations to the Inventor Importer. They are as follows:

- Camera animation paths are not converted to 3ds Max cameras so any animation you've set up in Inventor is lost during import.
- Any lighting from brightness and ambience settings created in the Inventor file are not imported. You will have to relight the scene once the import is complete.
- A model that is set up with constraints to limit the movement of parts will lose those constraints upon import. You will need to use [inverse kinematics \(IK\)](#) on page 3374 to restore the constraints.
- Dragging and dropping an Inventor file into 3ds Max uses the settings last set on the Inventor File Import dialog with the except for Mesh Resolution, which always resets to 0.
- 3ds Max uses the last version of Inventor that was opened to set the Import version. For instance, let's say you have both Inventor 8 and Inventor 10

on your system. If the last version of Inventor you ran was Inventor 8, you cannot import Inventor 10 files. Inventor 8 must be closed and Inventor 10 opened, at least once, in order for you to successfully import Inventor 10 files.

Material Handling

Materials and material assignments made to the original Inventor model are retained and imported along with the geometry. Materials are imported as [Architectural materials](#) on page 5526 or if a single object has several materials assigned to it, they are imported as a [Multi/Sub-Object material](#) on page 5720.

Procedures

To import an IAM or IPT file:

- 1 Choose File menu > Import.
- 2 Choose Autodesk Inventor (*.IPT, *.IAM) in the Files of Type list.
- 3 Specify a file name to import.
- 4 Set options in the Autodesk Inventor File Import dialog.

Interface

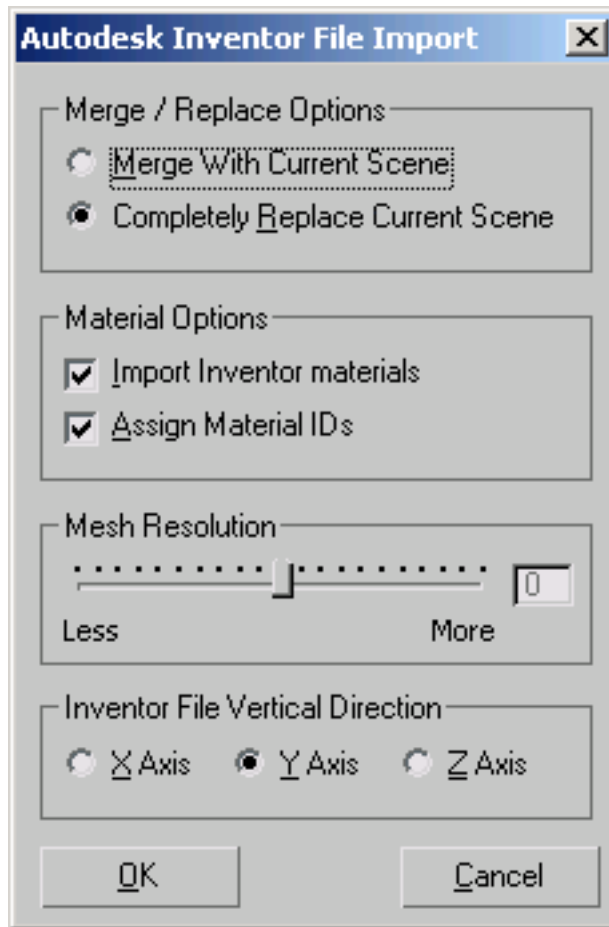

Merge / Replace Options group

Merge With Current Scene Incoming geometry is merged with any existing geometry that is already present in the scene. This setting is useful if you have several separate files that contains components that you want to combine into a single model.

Completely Replace Current Scene The file you're importing will completely replace any existing geometry that is in the current scene. If your current scene has not been saved, you are given the opportunity to save your changes to the current scene before the import process continues. Default=on.

Material Options group

Import Inventor Materials When turned on, all Inventor materials and texture maps are translated and imported into the scene. If turned off, no materials are imported with the model.

Assign Material IDs Lets you control whether material IDs are assigned to objects that are imported from Inventor. You can assign different materials to different surfaces of the same object while working in Inventor. When these objects are imported to 3ds Max, material IDs are assigned to the faces of single objects to which multiple materials are applied.

For example, you've created a single object that represents a knob that has a threaded shaft and you've applied a black, plastic material to the knob and a silver, metal material to the threaded shaft. If Assign Material IDs is turned on when you import the model into 3ds Max, the faces of the object that have the plastic material are assigned material ID #1 and the faces that have the metal material are assigned material ID #2. If you choose to try different materials while working in 3ds Max, you can quickly make [sub-object selections](#) on page 220 based on the material IDs or apply a [Multi/Sub-Object material](#) on page 5720 that contains materials that correspond to the IDs assigned to the faces.

Mesh Resolution group

Mesh Resolution This slider lets you determine the degree of refinement applied to mesh objects by the importation process. When set to 0 (zero), the geometry is imported as it appears in Autodesk Inventor. When set less than zero, the mesh is optimized with fewer faces thus reducing detail. If the mesh resolution is set higher than zero, the mesh is tessellated with more faces, giving you greater detail.

The mesh resolution slider is always set to 0 when you initiate an import.

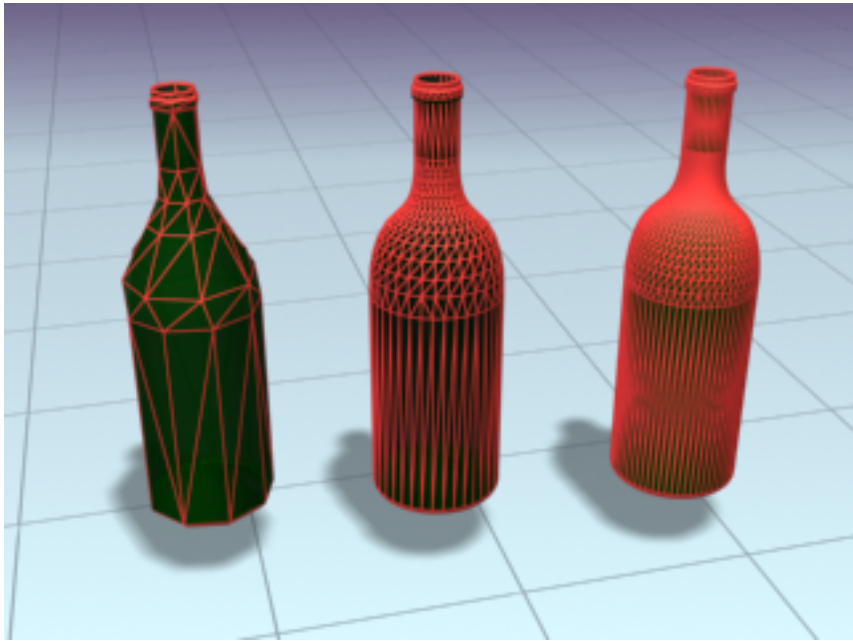

Left: Mesh Resolution=-7.

Center: Mesh Resolution=0.

Right: Mesh Resolution=+7.

NOTE The option to adjust mesh resolution is available only for models imported from Autodesk Inventor 10 or later.

Inventor File Vertical Direction group

This option determines the model's orientation upon import. You can choose which axis of the Inventor model is vertical.

X Axis The X axis of the model, as seen in Inventor, is rotated so it is vertical when the model is imported.

Y Axis The model is imported with the Y axis oriented as the vertical axis.

Z Axis The imported model is rotated so its Z axis is the vertical axis.

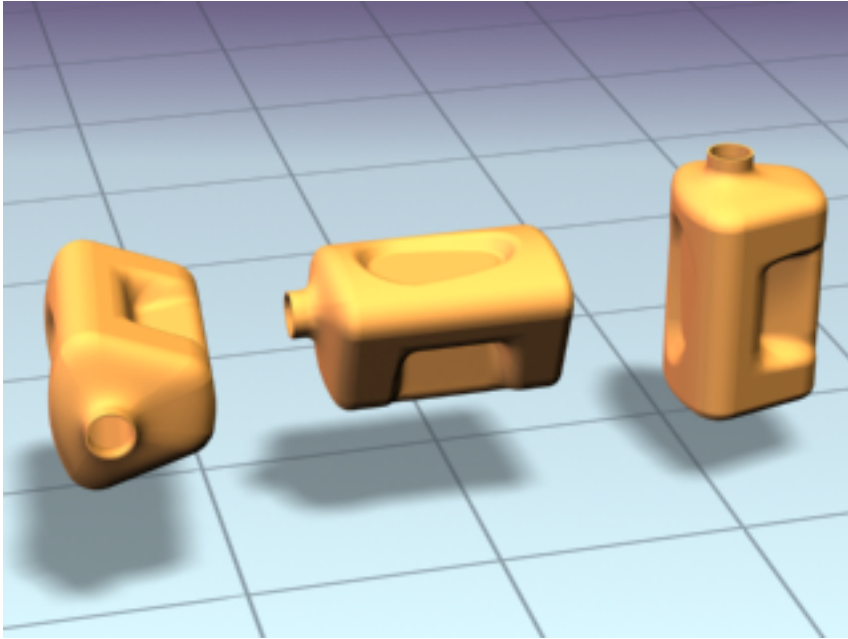

Left: Vertical axis set to X.

Center: Vertical axis set to Y.

Right: Vertical axis set to Z.

Exporting 3D DWF Files

File menu > Publish to DWF

File menu > Export > Publish to DWF

With 3D DWF publishing, you can export Design Web Format™ (.DWF™) files of your three-dimensional models with nearly the same visual fidelity as in rendered scenes. DWF files are relatively small files that you can easily share with team members who might not have 3ds Max. It also provides a fast way to view models without having to spend time animating and rendering them because you can use the Orbit feature in the viewer to fly around the model.

For example, a DWF file of your scene can allow you and others to quickly view an interactive model as well as the properties of each object.

Recipients of 3D DWF files can view and print them using Autodesk® Design Review, which is an optional part of the 3ds Max install program. For more information about using the viewer, see the Autodesk Design Review help system.

Feature Support with 3D DWF Export

- 2D and 3D splines. The Enable In Viewport setting on the [Rendering rollout](#) on page 615 does not need to be enabled in order to export splines.
- 3D geometry
- Texture-mapped materials with a diffuse map channel, UV mapping channels, and material IDs

NOTE Materials that have [Use Real-World Scale](#) on page 5771 enabled display more accurately in the Autodesk Design Review program.

- Procedural materials, but only as a rough, low-resolution approximation. Real-World Map Size should be off for objects with procedural materials.
- Materials that have transparency are correctly exported and their opacity values are recognized by the Autodesk Design Review program. Even when you orbit the view, objects that pass behind other objects with transparent materials are still visible.

Limitations of 3D DWF Export

Materials and Environments

- Environment backgrounds do not export; the Design Review program uses its own background color setting.
- Environmental effects such as fog do not export.
- Materials using reflection maps such as Flat Mirror do not produce reflections when exported.
- Two-sided materials are not supported. However, you can get around this by turning on Force 2-Sided on the Render Setup dialog.

NOTE Turning on Force 2-Sided affects the entire scene. This can slow down the performance of Design Review because it has to process the two-sided display of everything in scene.

- Materials from third-party suppliers and mental ray materials are not exported.
Objects that have unsupported materials display in their diffuse colors in the viewer. AutoCAD Architecture materials are displayed in their ambient color.
- Export doesn't support all material parameters, even with supported materials. Therefore, materials you export to Design Review might not look as they do in a rendered image.

Lights

- You cannot export scene lighting.

Cameras and Animation

- Named camera views are exported. The exporter creates a DWF view for each camera in the scene. You can choose these views from the Views panel in the Autodesk Design Review program, but the cameras are not otherwise visible as objects in the scene.
- Animations are not supported, however, the frame at the time of the export is published.

Procedures

To export a 3D DWF file:

- 1 Set up the scene in the active viewport as you want it displayed in the Autodesk Design Review program.
If you want to publish particular objects or layers, make a selection set of those objects. Hide those objects or layers you do not want published.

NOTE You can also isolate objects in the viewer you want to hide or make transparent.

TIP If you have a camera in the scene and want that view exported, make sure the Camera viewport is active when you publish the DWF file.

- 2 Choose File menu > Export.
- 3 Choose Publish To DWF (*.DWF) from the Save as type list in the file selector dialog.
- 4 Specify a file name to export.

- 5 Click Save.
- 6 Use the DWF Publish Options dialog to make the desired settings, and then click OK.
- 7 If you turn on Save Log file but do not want the existing log file to be overwritten, enter a new name or specify a different folder.

Interface

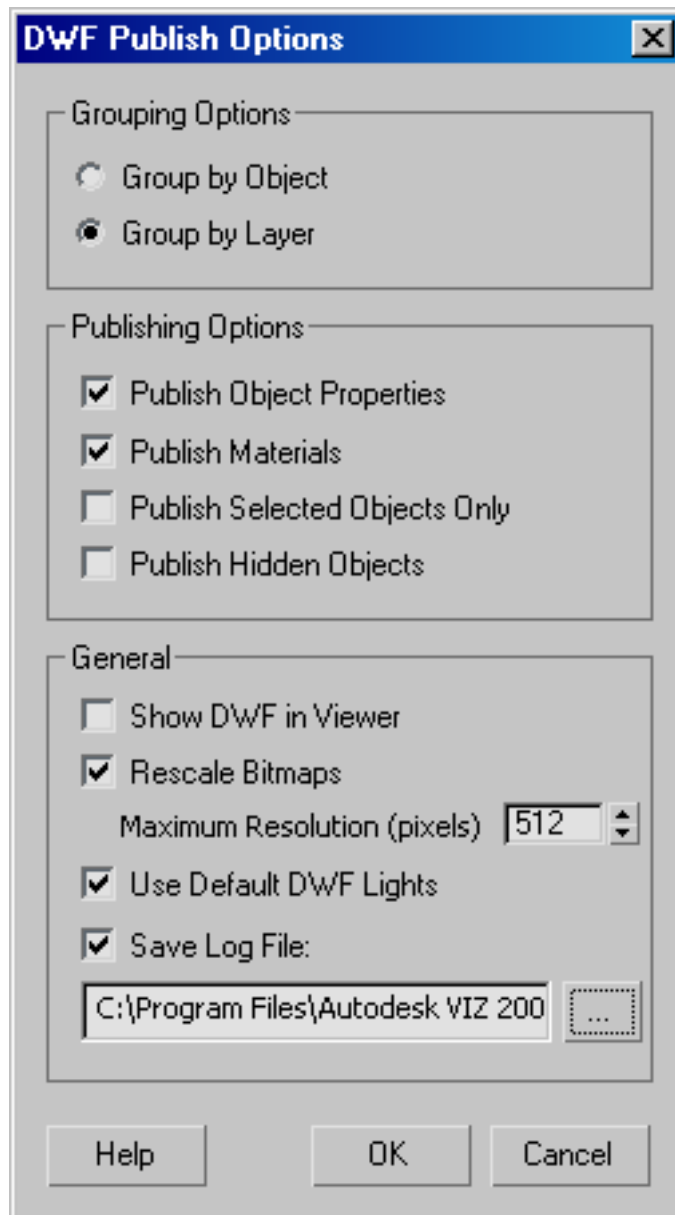

Grouping Options group

Group by Object When on, objects are listed on the Navigator Pane in Design Review by object name or group name.

Group by Layer When on, objects are grouped on the Navigator Pane of Design Review by their respective layers.

Publishing Options group

Publish Object Properties When on, object property data is exported and displayed in Design Review and reported in the log file if Save Log File is enabled. The displayed properties are name, layer name, face count, vertex count, and whether the object is frozen or hidden.

Publish Materials Exports objects with their assigned materials in Design Review. When off, exports objects in their basic object colors. Material names are not exported.

Publish Selected Objects Only Exports only objects that are selected when you export.

Publish Hidden Objects Hidden objects are exported and displayed in the viewer. When off, objects that are hidden or on layers that are hidden do not appear. Hidden objects are listed in the log file if Save Log File is enabled.

NOTE Frozen objects and frozen layers are exported.

General group

Show DWF in a Viewer When on, Autodesk Design Review automatically opens the exported DWF file. When off, you must run Design Review and open the file manually.

Rescale Bitmaps When on, bitmap textures are automatically rescaled in the DWF file to the size set for pixels for Maximum Resolution. When using large texture files, turn this on to reduce the DWF file size.

NOTE This setting has no effect when Publish Materials is off.

Maximum Resolution (pixels) Sets the maximum length, in pixels, of the longest edge of all the bitmap images that are used as textures.

NOTE All bitmap images exported to the DWF file are compressed to [JPG](#) on page 7347 format in order to create small DWF files.

Use Default DWF Lights Lets you control whether Design Review adds its own default lighting. When turned off, the scene is displayed without lights in the viewer, which can result in the scene objects being flat shaded making them appear two dimensional. Turn Use Default DWF Lights off if the scene contains lights that are already baked into textures with [Render to Texture](#) on page 6371, otherwise it is recommended that DWF lights are used. Default=on.

NOTE When exporting a scene with all the lighting baked into the texture maps after using Render to Texture, if Use Default DWF Lights is turned on the scene may actually appear darker in Design Review, and the built-in DWF lights will cause the scene lighting to change as you orbit around the objects in the scene. With it turned off, the lighting will be constant as you move through the scene.

Save Log File When enabled, 3ds Max creates a text file with the *.log* file extension that lists objects, their layers, face and vertex counts that are exported as well as the time and date of the export. Objects that were not selected or hidden are also listed as not as not being exported. The log file is overwritten each time a DWF file is created unless the log file name or file location is changed. Default=on.

FBX Files

File menu > Import/Export > [Files of type]=Autodesk (*.FBX, *.DAE)

FBX is the file format native to Autodesk MotionBuilder, a system used for the creation, editing, and blending of motion capture and keyframe animation. You can import and export files in this format with 3ds Max.

Softimage and Maya can also use the FBX format, making it a bridge among the four applications.

NOTE The FBX importer/exporter also supports the Collada (DAE) file format.

Interface

For the current version of the **3ds Max FBX Plug-in Guide**, click the ? (Help) button on the FBX Importer/Exporter dialog.

The FBX plug-in changes often, with the result that Autodesk updates it more frequently than it does this program. Be sure to check regularly for updated versions by clicking the Check For Web Updates button on the dialog.



Flight Studio OpenFlight (FLT) Files

This import/export format is commonly used in visual-simulation systems. Also included is a related utility, available from Utilities panel > More > Flight Studio.

Documentation is provided in a separate help file, available from Help menu > Additional Help > Flight Studio 2009 Reference.

IGES Files

Overview of IGES in 3ds Max

The Initial Graphics Exchange Specification (IGES) is an ANSI standard that defines a neutral form for the exchange of information among dissimilar computer-aided design (CAD), computer-aided manufacturing (CAM), and computer visualization systems. The software implements the IGES standard for translating files between 3ds Max and IGES file formats used by the mechanical engineering and entertainment industries. Using the IGES import/export feature, you can read in and write out native [NURBS](#) on page 8060 data between 3ds Max and programs such as Mechanical Desktop release 3.0, Maya™, Pro/ENGINEER®, SOFTIMAGE®, CATIA®, and others. For complete details on the IGES standard, see The Initial Graphics Exchange Specification (IGES) Version 5.3.

What IGES Translates

The ideal file translation preserves the appearance and functionality of objects (called entities in IGES) contained in a file. This process has limits. You should be aware that some 3ds Max objects are not supported or not fully supported by IGES. Similarly, be aware that some IGES entities are not supported by the software. For example, you can't translate animation data and mapping coordinates, as these elements are not supported by IGES.

As with all translations, concepts that can be expressed succinctly in one language might not have exact equivalents in another language; conversely, concepts common to two languages might be expressed differently by each.

Even when the objects you translate don't have an equivalent in the target system, a one-time translation to or from IGES might not pose a serious problem. However, data loss can become a concern if you maintain objects

that will be repeatedly translated in and out of different formats through IGES. By becoming familiar with the details of the systems and the IGES translators you use, you can learn to structure files to minimize information loss.

WARNING The conversion of objects during translation is not fully symmetrical. If you import an IGES file that you created by exporting to IGES, the resulting objects might not be identical to the original.

NURBS

When you import an IGES file into the software, IGES meshes are converted to [NURBS](#) on page 2237 surfaces, rather than to 3ds Max mesh objects. An IGES file with multiple meshes imports as a *single* NURBS model. Each IGES mesh is a surface sub-object within the model.

Each surface sub-object based on an IGES mesh is initially a [rigid surface](#) on page 2257. To edit the surface and its [CVs](#) on page 7946, you must first make the rigid surface independent. The following procedure explains how to do this.

Future Compatibility

The group that maintains and updates the IGES standard, the IGES/PDES (Product Data Exchange Standard) consortium, attempts to keep IGES upwardly compatible. It's likely that files generated by the software will be compatible with future versions of IGES.

See also:

- [3ds Max to IGES Export Table](#) on page 7231
- [Exporting IGES Files](#) on page 7230
- [IGES Log Files](#) on page 7225
- [IGES to 3ds Max Import Table](#) on page 7228
- [Importing IGES Files](#) on page 7226

Procedures

To make rigid imported NURBS surfaces independent:

- 1 Select the object.

- 2  Go to the Modify panel.
- 3 In the Modifier Stack rollout, choose Surface as the sub-object level.
- 4 Select the surface sub-object you want to edit.
- 5 In the Surface Common rollout, click Make Independent.

NOTE Making rigid imported NURBS surfaces independent can take a long time if there are complicated surfaces in the file, or if the file is large. Avoid selecting all surfaces and then clicking Make Independent. Rather, save your file immediately after successfully importing it, and then use Make Independent with care.

IGES Log Files

During the translation process, the software creates log files containing detailed information about the processing of the model. This information includes error messages and entity-mapping statistics. You can use this log file to understand what occurred during the translation.

The software places log files in the directory where the IGES file is either imported from or exported to. The log file name has the prefix name of the 3ds Max file name, with the extension of *.xli* (input) for import, and *.xlo* (output) for export.

The log file provides the following information:

- Name of the file processed.
- Number and severity of errors encountered, a description of them, and an explanation of what can be done, or what was done to the data in error. (The software attempts to fix many errors itself.)
- Summary of entities processed.
- List of the entity types encountered and those created.

See also:

- [Overview of IGES in 3ds Max](#) on page 7223
- [3ds Max to IGES Export Table](#) on page 7231

- [Exporting IGES Files](#) on page 7230
- [IGES to 3ds Max Import Table](#) on page 7228
- [Importing IGES Files](#) on page 7226

Importing IGES Files

File menu > Import > IGES (*.IGE, *.IGS, *.IGES)

IGES files are used to import and export NURBS objects to and from 3ds Max (and other programs that support this file format). For more information, see [Overview of IGES in 3ds Max](#) on page 7223.

In some cases, when you import an IGES file, the translation doesn't produce exact replicas. To understand what happens to each entity when it's translated, review the [IGES import table](#) on page 7228.

3ds Max imports an object containing multiple surfaces as a single NURBS object. To work with a single surface of the object, detach it in sub-object NURBS and work with only that object. This releases the rest of the object from memory. For more information, see [NURBS](#) on page 7224.

When you import IGES files, 3ds Max creates a log file containing detailed information about the processing of the model. The name of the file has the form of *filename.xli*. For more information, see [IGES Log files](#) on page 7225.

NOTE 3ds Max creates and uses a few temporary files during translation. Temporary files can be large. If there has been a computer or IGES translation failure and temporary files remain on your system, they might need to be removed to free up disk space. For storage of these temporary files in Windows, 3ds Max uses the directory specified by the TEMP environment variable, or the current directory if TEMP is not set.

See also:

- [3ds Max to IGES Export Table](#) on page 7231
- [Exporting IGES Files](#) on page 7230
- [IGES Log Files](#) on page 7225
- [IGES to 3ds Max Import Table](#) on page 7228
- [Importing IGES Files](#) on page 7226

Procedures

To import an IGES file:

- 1 Choose File menu > Import.
- 2 Specify the IGES file to import from the file selector dialog.
You can choose IGES (*.IGE, *.IGS, *.IGES) from the Files Of Type list to display only IGES files.
- 3 From the IGES Import dialog, select Merge Objects With Current Scene or Completely Replace Scene.
- 4 To review the translation process, read the `.xli` log file with your preferred text editor.

Interface

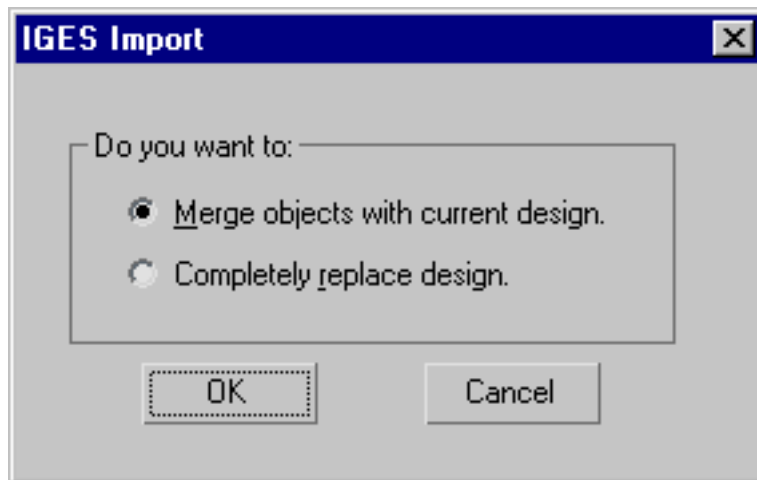

IGES Import

The IGES Import dialog has the following controls:

Merge objects with current scene Merges imported data with the current scene.

Completely replace scene Completely replaces the current scene with the imported data.

IGES to 3ds Max Import Table

The following table lists IGES entities and the 3ds Max objects they translate to when you import them. Any IGES entities not listed here do not import.

IGES entity number	IGES entity name	3ds Max
100	Circular Arc	Arc Shape
102	Composite Curve	Spline Shape
104	Conic Arc	Spline Shape
106	Copious Data	Spline Shape
108	Plane	NURBS Surface (unbounded converts to construction plane)
110	Line	Spline Shape
112	Parametric Spline Curve	NURBS Curve
114	Parametric Spline Surface	NURBS Surface
116	Point	Point Helper
118	Ruled Surface	NURBS Surface
120	Surface of Revolution	NURBS Surface
122	Tabulated Surface	NURBS Surface
126	Rational B-spline Curve	NURBS Curve
128	Rational B-spline Surface	NURBS Surface

IGES entity number	IGES entity name	3ds Max
130	Offset Curve	NURBS Curve
140	Offset Surface	NURBS Surface
141	Boundary Curve	NURBS Surface
142	Curve on Parametric Surface	NURBS Surface
144	Trimmed Parametric Surface	NURBS Surface
143	Bounded Surface	NURBS Surface
186	Solid	NURBS Surface
308	Subfigure Definition	Instance
402	Group	NURBS Object

Notes

The 3ds Max objects translated from IGES can have surface sub-objects.

IGES import supports name and color mappings to 3ds Max names and colors.

When you import IGES files, names are mapped by using the level name followed by a colon, and then the object name.

See also:

- [3ds Max to IGES Export Table](#) on page 7231
- [Exporting IGES Files](#) on page 7230
- [IGES Log Files](#) on page 7225
- [IGES to 3ds Max Import Table](#) on page 7228
- [Importing IGES Files](#) on page 7226

Exporting IGES Files

File menu > Export > IGES (*.IGS)

IGES files are used to import and export objects to and from 3ds Max (and other programs that support this file format). For more information, see [Overview of IGES in 3ds Max](#) on page 7223.

In some cases, when you export 3ds Max objects to an IGES file, the translation doesn't produce exact replicas. To understand what happens to each object when it's translated, review the [IGES export table](#) on page 7231.

When you export IGES files, 3ds Max creates a log file containing detailed information about the processing of the model. The name of the file has the form of *filename.xlo*. For more information, see [IGES Log files](#) on page 7225.

NOTE If there are modifiers applied to surfaces in your scene, it's best to collapse the stack before exporting to IGES. When 3ds Max exports to an IGES file, it skips any surface that has any modifiers applied.

See also:

- [3ds Max to IGES Export Table](#) on page 7231
- [IGES Log Files](#) on page 7225
- [IGES to 3ds Max Import Table](#) on page 7228
- [Importing IGES Files](#) on page 7226
- [Overview of IGES in 3ds Max](#) on page 7223

Procedures

To export an IGES file:

- 1 Select the objects to export.
- 2 Choose File menu > Export.
- 3 Choose IGES (*.IGS) from the Save as type list in the file selector dialog.
- 4 Specify a file name to export.
- 5 Click Save.

- 6 From the IGES Export dialog, select Export Hidden Objects or Export Selected Objects Only.
- 7 To review the translation process, read the `.xlo` log file with your preferred text editor.

Interface



IGES Export

The IGES Export dialog has the following controls:

Export Hidden Objects Exports objects that are currently hidden in the 3ds Max scene.

Export Selected Objects Only Exports only objects that are currently selected.

3ds Max to IGES Export Table

The following table lists 3ds Max objects and the IGES ID and IGES Type they translate to when you export them. Any 3ds Max objects not listed here do not export.

NOTE The convention for denoting the type of IGES entity is the numerical construction type:form. For example, 214:2 is the IGES entity number 214, form 2. Form numbers can also be signed (given a positive or negative value).

3ds Max object	IGES entity name	IGES entity number
Surface	Rational B-spline Surface	128
NURBS Surface	Bounded Surface	143
Trimmed Surface	Bounded Surface	143/144
Curve	Rational B-spline Curve	126
Point	Point	116
Group	Group	402:7
Instance	Subfigure Definition	308
Instance(s)	Subfigure Definition(s)	408

Notes

When 3ds Max exports IGES, it supports name and color mappings to IGES names and colors.

Since IGES requires unique names per element, 3ds Max will append a unique identifier to multiple objects with the same name.

See also:

- [Exporting IGES Files](#) on page 7230
- [IGES Log Files](#) on page 7225
- [IGES to 3ds Max Import Table](#) on page 7228
- [Importing IGES Files](#) on page 7226
- [Overview of IGES in 3ds Max](#) on page 7223

JSR-184 Files

File menu > Export > JSR-184 (*.M3G)

3ds Max provides support for developing mobile games using the JSR-184 format. JSR-184 is a Java standard used to create 3D applications for mobile phones. Once you have exported your scene to JSR-184 format, you can preview the animation using the [JSR-184 Standalone Player](#) on page 7245.

Procedures

To export an M3G file:

- 1 Choose File menu > Export.
- 2 Choose JSR-184 (*.M3G) in the Files Of Type list.
- 3 Specify a file name to export, and then click Save. This opens the JSR-184 dialog, displaying the scene hierarchy for your 3ds Max scene. By default, all of the elements in your scene are also listed for export in the JSR-184 scene.

NOTE If you wish to export a particular object in your scene, use File > Export

Selected, or delete the objects you do not wish to export by clicking



. If an object is a descendant within an hierarchy, it will be exported with its hierarchy. The same applies for objects in a group.

- 4 Modify the parameters of objects exported to JSR-184. See [JSR-184 Object Parameters](#) on page 7236 for more info.
- 5 Click Export.
- 6 Preview your exported JSR-184 scene in the [JSR-184 Standalone Player](#) on page 7245.

Interface

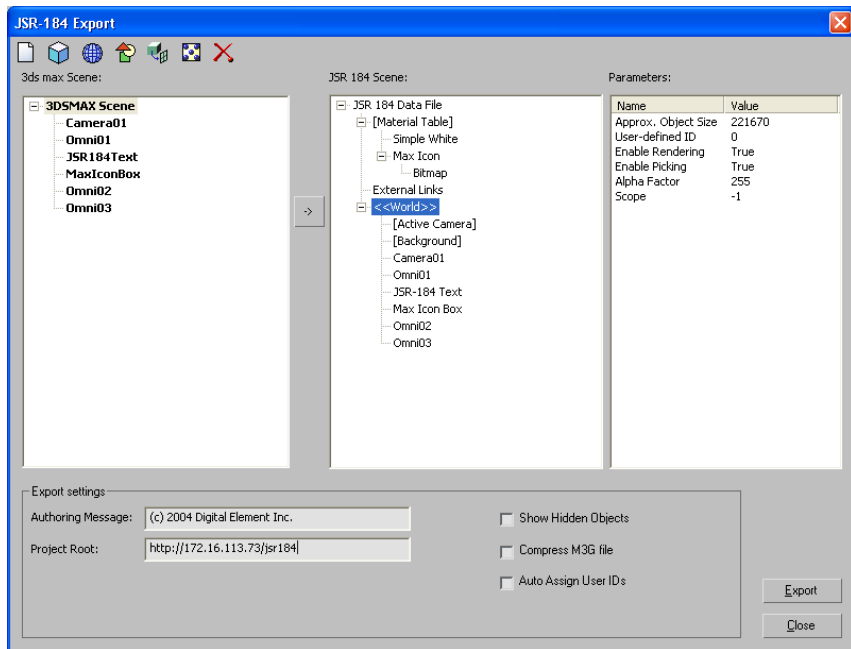

The 3ds Max scene hierarchy is shown on the left of the dialog, and the hierarchy of the JSR-184 scene to be exported is displayed on the right. Object parameters for the JSR-184 scene are displayed on the far right-hand side of the JSR-184 Export dialog. The exported m3g file contains all of the objects and parameters included in the JSR-184 scene. Many of the parameters for the objects in the JSR-184 scene can be modified prior to exporting the file. See [JSR-184 Object Parameters](#) on page 7236 for more details.

Menu options:



New JSR-184 Scene Creates an empty JSR-184 scene



Add 3ds Max Scene Adds all objects that can be converted to the JSR-184 format to the JSR-184 scene.



Add World Object Adds a World Object to the JSR-184 scene file. A World Object contains sub-object hierarchies and has two special sub-objects: Active Camera and Background.



Add Group Adds an empty Group. Use this option to group objects in your scene without the need to create a World Object.



Convert Mesh to Sprite3D Converts a selected 3ds Max plane object into a JSR-184 Sprite3D object. If you do not select this option, by default all plane objects are converted to JSR-184 mesh objects.



Texture Tool All the textures of objects in your 3ds Max scene are placed in the Material Table level of JSR184 image file. Use the [JSR-184 Texture Tool](#) on page 7241 to edit texture properties.



Remove Object Removes the selected object from the JSR-184 scene.

Export Settings:

Authoring Message This message is required by the JSR-184 file format standard and is usually reserved for entering copyright notice information. This message is stored in the header portion of the M3G file.

Project Root Sets the location of the root of the project. If you do not enter a path in this field, all external references within the M3G file are loaded from the same location as the current file.

Show Hidden Objects Shows all the hidden objects in the 3ds Max scene hierarchy.

Compress M3G File Compresses all the data in the exported M3G file.

Auto Assign User IDs Automatically assigns unique User ID values to all exported objects.

See also:

- [JSR-184 Object Parameters](#) on page 7236
- [JSR-184 Texture Tool](#) on page 7241
- [JSR-184 Log Files](#) on page 7243
- [JSR-184 Standalone Player](#) on page 7245

JSR-184 Object Parameters

File menu > Export > JSR-184 (*.M3G).

The JSR-184 data file is represented as the root object of your scene. Many of the parameters of objects in the JSR-184 data file can be adjusted to optimize the output of your scene. You can preview your exported scene using the [JSR-184 Standalone Player](#) on page 7245.

NOTE All editable parameters are displayed in *italic*.

The JSR-184 Data File

Material Table

Material Table is a special object that contains all the materials and textures used in the JSR-184 scene. The Material Table has a two-level structure: the 3ds Max material name is the first level and its associated textures comprise the second level. The Material Table is represented as [Material Table] in the JSR-184 scene tree.

The 3ds Max level displays the following parameters:

- **Approx.Object Size:** Shows the object size with sub-objects.
- **User-defined ID:** Displays the user ID for the object.
- **Layers:** Sets the rendering layer for the JSR-184 Appearance Object. When rendering a World, Group, or Mesh, submeshes and sprites are rendered in the order of ascending layers.

The texture level displays the following parameters:

- **Approx.Object Size:** Shows the object size with sub-objects.

- **User-defined ID:** Displays the user ID for the object.
- **Blending:** Specifies how to combine the filtered texture color with the incoming fragment color in a texturing unit. This is equivalent to the texture environment mode in OpenGL. Options are Add, Blend, Decal, Modulate, and Replace.
- **WrappingS and WrappingT:** The Repeat and Clamp texture wrapping modes define the treatment of coordinate values that are outside the [0,1] range.
- **Level Filter:** Sets the texture filtering. Options are Nearest, Linear, and Base Level.
- **Image Filter:** Sets the image filtering. Options are Nearest, Linear, and Base Level.

World

World is a special Group node that is a top-level container for scene graphs. A World Object is represented as <<World>> in the JSR-184 scene tree. Every world object has three sub-objects: [Background], [Active Camera], and [Ambient Light]. A World object has the following parameters:

- **Approx.Object Size:** Shows the object size with sub-objects.
- **User-defined ID:** Displays the user ID for the object.
- **Enable Rendering:** Sets the picking enable flag of this node. The effective rendering enable status for this node is the logical AND of the enable flags on this node and all of its ancestors. This means that the World node is disabled if any of its ancestors are disabled. The status of the World node has an effect only if all its ancestors are enabled. If the effective status is set to True, this node is enabled. If it is False, it is disabled.
- **Enable Picking:** Sets the picking enable flag of this node. The effective rendering enable status for this node is the logical AND of the enable flags on this node and all of its ancestors. This means that the World node is disabled if any of its ancestors are disabled. The status of the World node has an effect only if all its ancestors are enabled. Options are True and False.
- **Alpha Factor:** Allows groups of mesh objects to fade in and out conveniently, provided that certain preconditions related to their appearance are met. The Alpha Factor is defined for each node, and its value is between 0 and 255.

- **Scope:** Allows the scene graph nodes to form conceptual groups independent of the scene graph hierarchy. By default, all objects are visible to all cameras and lit by all light sources. The scope is an integer bitmask set to -1 by default.

Background

Every world object has two sub-objects: [Background] and [Active Camera]. The only parameter available for the Active Camera is selecting an active camera from sub-objects of the current World Object. Background parameters are listed below:

- **Approx.Object Size:** Shows the object size with sub-objects.
- **User-defined ID:** Displays the user ID for the object.
- **Image Mode X and Image Mode Y:** Sets the background image repeat mode for the X and Y directions. Image mode can be set to either Border or Repeat.
- **Depth Clear Enabled:** Enables or disables depth buffer clearing. If depth buffer clearing is enabled, the portion of the depth buffer that corresponds to the viewport is cleared to the maximum depth value. Set this parameter to True to enable depth buffer clearing. Set it to False to disable.
- **Color Clear Enabled:** Enables or disables color buffer clearing. If color buffer clearing is enabled, the portion of the color buffer that corresponds to the viewport is cleared with the background image and/or the background color. Set this parameter to True to enable color buffer clearing. Set it to False to disable.

Group

Group is a scene graph node that stores an unordered set of nodes as its children. A Group object is represented as <<Group>> in the JSR-184 scene tree.

NOTE Since most JSR-184 objects cannot contain any sub-objects, the JSR-184 exporter uses the Group object to represent the 3ds Max hierarchy. In this case, the Group object is assigned a name such as <<ObjectName Group>>, where ObjectName is the name of the 3ds Max object with sub-objects. Parameters available for Group objects are the same as parameters for World objects.

Camera

Camera is a scene graph node that defines the position of the viewer in the scene and the projection from 3D to 2D. A Camera object is assigned the same name as its counterpart in the original 3ds Max scene.

- **Approx.Object Size:** Shows the object size with sub-objects.
- **User-defined ID:** Displays the user ID for the object.
- **Scope:** Allows scene graph nodes to form conceptual groups independent of the scene graph hierarchy. The default scope is -1, implying that all nodes are in the same scope. By default, all objects are visible to all cameras and are lit by all light sources.
- **Projection Type:** Sets the projection mode for the Camera. Options are Parallel and Perspective.

Ambient Light

Ambient light represents the ambient light color from the 3ds Max environment setting. Ambient light parameters are the same as Light parameters.

Light

Light is a scene graph node that represents different kinds of light sources. A Light object is assigned the same name as its counterpart in the original 3ds Max scene.

- **Approx.Object Size:** Shows the object size with sub-objects.
- **User-defined ID:** Displays the user ID for the object.
- **Enable Rendering:** Sets the light to On or Off. Options are True and False.
- **Scope:** Allows scene graph nodes to form conceptual groups independent of the scene graph hierarchy. The default scope is -1, implying that all nodes are in the same scope. By default, all objects are visible to all cameras and are lit by all light sources.

Sprite3D

Sprite3D is a scene graph node that represents a 2-dimensional image with a 3D position. The only way to create a Sprite3D object is to convert a two-polygon 3ds Max mesh object. A Sprite3D object is named "Sprite,

ObjectName,” where ObjectName is the name of the corresponding 3ds Max mesh object.

- **Approx.Object Size:** Shows the object size with sub-objects.
- **User-defined ID:** Displays the user ID for the object.
- **Enable Rendering:** Sets the rendering enable flag of this node. The effective rendering enable status for this node is the logical AND of the enable flags on this node and all of its ancestors. This means that this node is disabled if any of its ancestors are disabled. The status of this node has an effect only if all its ancestors are enabled. If the effective status is set to True, this node is enabled. If it is False, it is disabled.
- **Scope:** Allows scene graph nodes to form conceptual groups independent of the scene graph hierarchy. The default scope is -1, implying that all nodes are in the same scope. By default, all objects are visible to all cameras and are lit by all light sources.

Mesh

- **Approx.Object Size:** Shows the object size with sub-objects.
- **User-defined ID:** Displays the user ID for the object.
- **Scope:** Allows scene graph nodes to form conceptual groups independent of the scene graph hierarchy. The default scope is -1, implying that all nodes are in the same scope. By default, all objects are visible to all cameras and are lit by all light sources.
- **Projection Type:** Sets the projection mode for the Camera. Options are Parallel and Perspective.

Morphing Mesh

Morphing mesh is a scene graph node that represents a vertex-morphing polygon mesh. A morphing mesh object is assigned the same name as its counterpart in the original 3ds Max scene. Morphing mesh parameters are the same as mesh object parameters.

NOTE Morphing animation is not supported. A Morphing mesh is exported with morph targets. If you wish to export a morphing mesh animation, set animated weights to morph targets during playback.

Skinned Mesh

Skinned Mesh is a scene graph node that represents a skeletally-animated polygon mesh. A skinned mesh object in the JSR-184 scene is assigned the same name as its counterpart in the original 3ds Max scene. Skinned mesh parameters are the same as Mesh Object parameters.

NOTE Biped meshes are not supported.

JSR-184 Texture Tool

File menu > Export > JSR-184 (*.M3G). > Name your file and click OK. > Select a texture in your scene. > Click the Texture Tool button to edit the texture properties.

You can edit the parameters that are exported for the textures in your JSR-184 scene. The Texture Tool dialog displays a preview of the texture with its current settings. When you select different options, the preview is updated to reflect the changes. You can modify the parameters described in this topic.

NOTE If the image is not a texture, then you can choose any palette in the Image Format group.

Interface

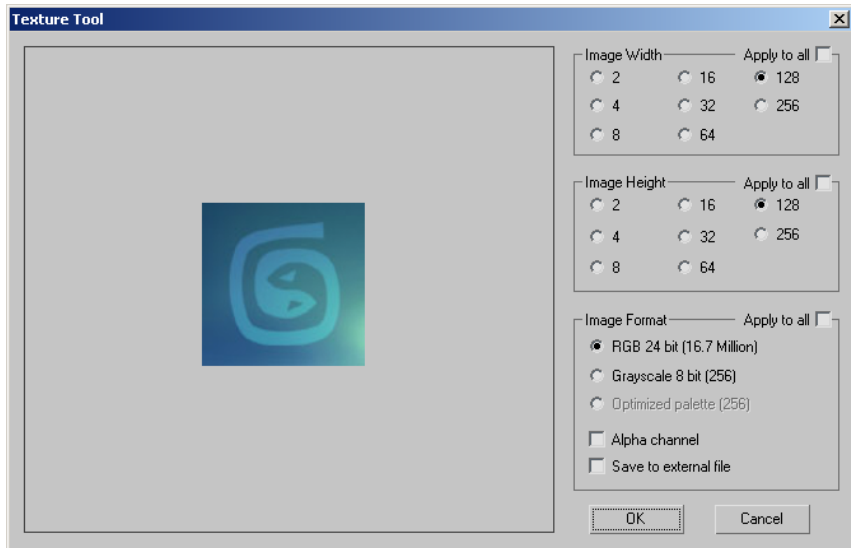

Image Width group

The JSR-184 format requires that texture sizes use the “power of two rule,” and supports texture sizes less than or equal to 2562. You can select either 2, 4, 8, 16, 32, 64, 128, or 256.

If you want to modify the image width of all of the textures in your JSR-184 scene, turn on Apply To All; otherwise, the changes affect only the selected texture.

Image Height group

These are the same options as Image Width: you can select either 2, 4, 8, 16, 32, 64, 128, or 256.

If you want to modify the image height of all of the textures in your JSR-184 scene, turn on Apply To All; otherwise, the changes affect only the selected texture.

Image Format Group

Changes the color model of all textures in your JSR-184 scene.

If you want to modify the image format of all of the textures in your JSR-184 scene, turn on Apply To All; otherwise, the changes affect only the selected texture.

- **RGB 24 bit (16.7 Million of colors)** Changes the color model to RGB color.
- **Grayscale 8 bit (256 grayscales)** Changes the color model to grayscale.
- **Optimized Palette (256 colors adaptive palette)** Changes the color model to a limited 256-color palette.
The Optimized Palette option is available only when the Save To External File option is on. This palette does not support an alpha channel.

Save to External File

When on, saves the texture as an external file (in PNG format) in the same directory as the M3G file. If you do not select this option, the texture is saved as part of the M3G file only.

Alpha Channel

When on, saves the alpha channel with the texture.

JSR-184 Log Files

File menu > Export > JSR-184 (*.M3G).

When you export an M3G file, the JSR-184 Export feature creates a log file. This log file is an HTML file, saved in the same directory as the M3G file. The table contains an entry for all the objects exported to the M3G file format.

- **Object #** Indicates the root object value. When multiple root objects exist in the M3G file, this value is used by the JSR-184 Load object to load the correct object.
 - **Object Name** Contains the name of the corresponding 3ds Max object.
 - **Object Type** Indicates the type of saved object.
 - **User ID** Displays the User ID for the object.
 - **Object Size** Shows the object size (in kilobytes) for the object.
 - **Comments** Displays additional information such as errors and warnings.

Below is a sample of a simple log file:

Object #	Object Name	Object Type	User ID	Object Size	Comments
		Vertex Array	0	161	
		Vertex Array	0	89	
		Vertex Buffer	0	48	
		Triangle Strip Array	0	213	
		Material	0	30	
		Appearance	0	33	
	Box01	Mesh	0	78	
		Group	0	66	
	Camera01	Camera	0	89	
	Omni01	Light	0	90	
		Group	0	26	
		Light	0	50	
		Background	0	40	
0		World	0	58	

JSR-184 Standalone Player

Start menu > Programs > Autodesk > Autodesk 3ds Max 2009 [installed version] > JSR184 Viewer

Once you have exported your 3ds Max scene to JSR-184 format, you can preview how the animation is displayed on various mobile screens.

Interface

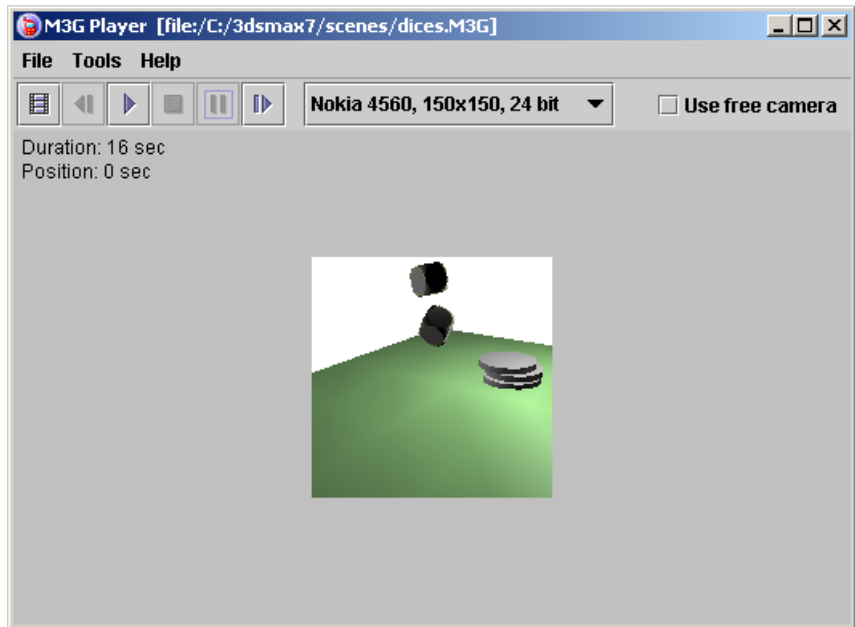

File menu

- **Open** Opens an M3G file for viewing in the JSR-184 player.
- **Reopen** Displays a list of recently opened files. The list displays the most recently opened files at the top.
- **Exit** Closes the JSR-184 viewer window.







Tools menu

- **Handsets** Allows you to add or edit phone profiles. You can modify the vendor, model, screen width, screen height, and screen color depth.

NOTE You can also modify the handset profiles directly in the **terminals.xml** file in the **c:\Program Files\Autodesk\3ds Max 9\JSR** directory.

Player controls

The player is controlled by the following buttons on the toolbar:

-  Opens the Choose Objects for Rendering dialog. This dialog allows you to select the JSR-184 world object in the scene hierarchy in the event that there are multiple world objects in the JSR-184 data file.
-  Steps one frame backward through the animation.
-  Plays the animation.
-  Stops the animation and returns to the first frame.
-  Pauses the animation.
-  Steps one frame forward in the animation.

Phone Profiles Displays the phone profiles defined in the Tools > Handsets dialog.

Use Free Camera Switches to viewing the scene from the free camera. The camera is controlled by the following keyboard shortcuts:

Left Arrow

Rotate Left

Right Arrow	Rotate Right
Up Arrow	Rotate Up
Down Arrow	Rotate Down
A	Move Left
D	Move Right
S	Move Backward
W	Move Forward
Home	Move camera to default

LandXML (XML, DEM) Files

Importing LandXML/DEM Models

LandXML/DEM Model Import lets you import land development data into 3ds Max. Civil engineering data, from XML, DEM (digital elevation model), or DDF files, is used to create a 3ds Max model.

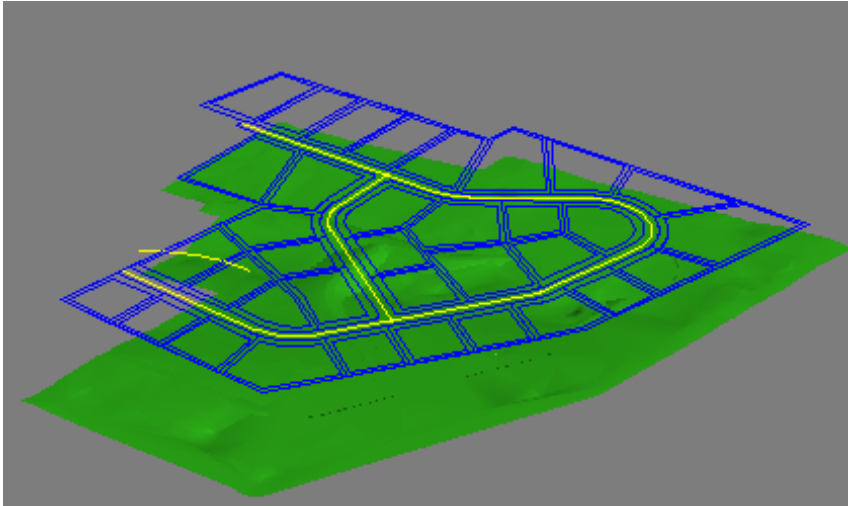

The [LandXML/DEM Model Import dialog](#) on page 7249 allows for interoperability with Autodesk products such as Land Development Desktop 3, Land Development Desktop 2005, Civil 3D™, and CAiCE Visual PE. Once imported, the models are ready for high-quality photorealistic rendering and animations.

LandXML File Types

There are three file types you can import with the LandXML/DEM Model Import dialog: XML, DEM, and DDF.

- **XML** is the most robust file type for LandXML import. In addition to surface elevation data, XML files can also contain Alignment (road) and Parcel data.
- The **DEM** (digital elevation model) file type is the most commonly available large area surface data type supplied by the USGS and other government and private organizations. DEM files contain only surface data.
- The **DDF** file type is an SDTS (spatial data transfer standard) format grid surface. DDF files are very similar to DEM files; however, DDF information is shared across multiple files.

The LandXML/DEM Model Import utility searches for the key DDF file in the selected directory, which is identified by the following pattern: `xxxxCEzz`, where `xxxx` is usually numeric and `zz` typically 'LO'.

Like DEM files, DDF files only contain surface data.

LandXML/DEM Model Import Dialog

File menu > Import > Select File to Import dialog > Files of Type > LandXML/DEM (*.DEM, *.XML, *.DDF)

In the LandXML/DEM Model Generator, you determine which parts of your land development data are imported to 3ds Max. 3ds Max then creates separate objects for each of the land features, including terrain surfaces, road alignments, and parcels.

Interface

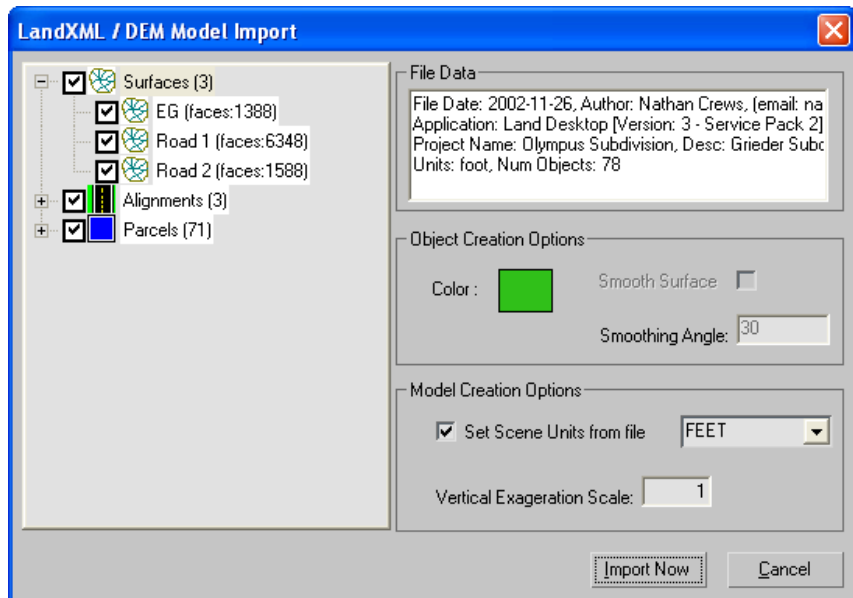

Object List Lists the terrain surfaces, alignment data, and parcel data in the file to be imported. You can toggle the import of individual objects or entire groups with their corresponding check boxes.

Three types of civil engineering data stored in LandXML files are supported:

- **Surfaces** 3D TIN ground and finished surface model. Terrain surface data is imported to 3ds Max as an editable mesh.
- **Alignments** 2D road centerlines. Alignment data is imported to 3ds Max as a Shape object.

NOTE DEM and DDF files do not contain Alignment data.

- **Parcels** 2D legal parcel or lot boundaries. Parcel data is imported to 3ds Max as a Shape object.

NOTE DEM and DDF files do not contain Parcel data.

NOTE 2D Alignment and Parcel shapes are created on top of the highest terrain surface.

File Data group

The File Data group displays information about the file to be imported, including date of creation, author, the application used to create the file, and the units.

Object Creation Options group

The Object Creation Options group lets you set the import properties for selected objects.

Color The color of the object when it is imported into 3ds Max. To change this setting, click the color swatch and select a new color from the Color Selector.

Smooth Surface Applies smoothing to the geometry, based on the Smoothing Angle setting. Edges between faces that have an angle between them that is greater than the specified smoothing angle will appear faceted in the scene. Edges between faces that are below or equal to the specified angle are smoothed.

NOTE This option is only available for terrain surface objects.

Smoothing Angle Determines the size of the smoothing angle.

NOTE This option is only available for terrain surface objects.

Model Creation Options group

Set Scene Units from file Changes the 3ds Max Scene Unit to match the units of the incoming file.

NOTE This setting is only available when the 3ds Max scene is empty. If there is geometry in your scene, this setting is not available.

The units setting of the incoming file is displayed in the drop-down list.

Vertical Exaggeration Scale Artificially exaggerates the terrain surface to enhance subtle details by applying a scale factors to the vertical dimensions.

TIP This can be useful for very flat surface models.

Exporting Lightscape Files

You can export your 3ds Max scenes to Lightscape. Lightscape is a visualization application that uses radiosity and ray tracing to create accurate lighting for 3D models.

NOTE This feature is being retired. For more detailed information about Lightscape export and import, you can refer to the 3ds Max 8 reference. You can download the v8 reference from the Autodesk Web site: go to www.autodesk.com, choose Support, pick the product Autodesk 3ds Max, and then choose Documentation.

You can export several Lightscape file formats from 3ds Max. The Lightscape Preparation (*.lp) file is the main format Lightscape uses. Other Lightscape file formats save selected portions of the information in the LP file. These are the additional Lightscape file formats:

- View file (*.vw): Exports the active view, or selected camera views.
- Block file (*.blk): Exports materials, lights, and geometry. Blocks in a block file can be selectively loaded into Lightscape.
- Material file (*.atr): Exports materials.
- Layer file (*.lay): Exports layers.
- Parameter file (*.df): Exports processing parameters.

Overall Workflow for Exporting a Lightscape Preparation (LP) File

- 1 Select the object to be exported.
- 2 Open the Export Lightscape Preparation File dialog.

- 3 If your scene uses standard lights, set the units and scale, and then set the light conversion method.
- 4 If you are exporting an animation, select the frames to be exported.
- 5 If your scene uses daylight, set the daylight parameters.
- 6 Select the cameras to be exported.
- 7 [Export the file](#) on page ?.

Procedures

To export a Lightscape file:

- 1 Choose File > Export.

The Select File To Export Dialog is displayed.

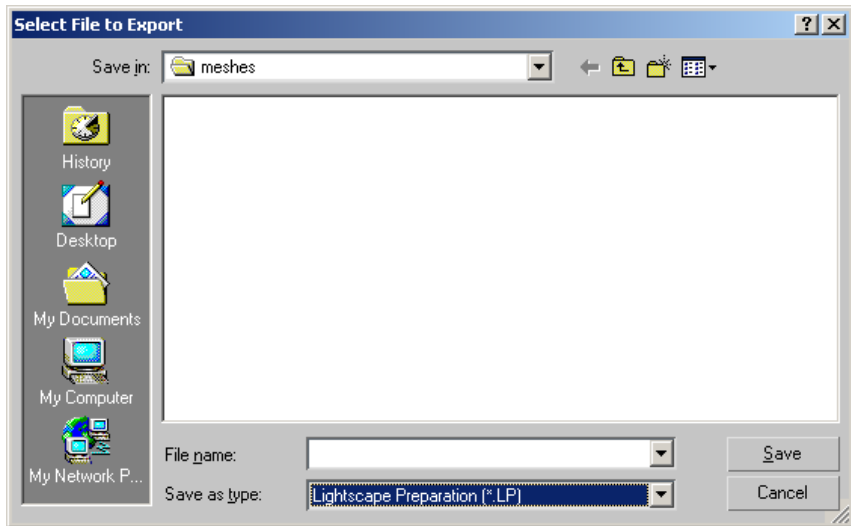

- 2 Use the Save As Type list to choose which kind of Lightscape file format you are exporting.
- 3 Use the Save In list to navigate to the appropriate directory.
- 4 In the File Name field, enter the name of the file that you want to create, and then click Save.

To get version information about the Lightscape exporter:

- 1 Export one of the Lightscape file types.
A dialog with options for that file type is displayed.
- 2 Click About.
An About dialog is displayed. The dialog shows the version of the Lightscape exporter.

Importing Lightscape Files

Just as you can export a Lightscape Preparation (LP) file, you can also import one into 3ds Max. You can also import Lightscape Solution (LS) and Lightscape View (VW) files.

NOTE This feature is being retired. For more detailed information about Lightscape export and import, you can refer to the 3ds Max 8 reference. You can download the v8 reference from the Autodesk Web site: go to www.autodesk.com, choose Support, pick the product Autodesk 3ds Max, and then choose Documentation.

The steps to import a Lightscape file include:

- Accessing the import dialog.
- Choosing to replace the current scene.
- Choosing how to group the imported objects.
- (LS files.) Specifying a prefix for imported Lightscape objects.
- (LS files.) Choosing which Lightscape objects to import.
- (LS files.) Choosing the conditions for importing Lightscape lights.
- (LS files.) Choosing the radiosity mapping settings.

NOTE The Lightscape importer does not convert Lightscape layers into 3ds Max scene layers, because it was written before that feature was implemented.

Procedures

To import a Lightscape (LS, VW, or LP) file:

- 1 Choose File > Import.

The Select File To Import dialog is displayed.

- 2 Choose Lightscape (*.LS, *.VW, *.LP) from the Files Of Type drop-down list.
- 3 Use the dialog's controls to browse to the directory that contains the file you want to use. Highlight the name of that file, and then click Open.
Depending on the type of file you chose, an Import Lightscape Preparation dialog or an Import Lightscape Solution dialog is displayed.
No dialog is displayed when you import a Lightscape view (VW) file.

To replace the current scene:

When you import a Lightscape Solution or Preparation file, you can choose to add the imported objects to the current scene, or to replace entire scene.

- 1 In the Import Lightscape Preparation dialog, turn on Replace Current Scene.
- 2 In the Import Lightscape Solution dialog, turn on Replace Scene Contents.

To group imported objects:

- In the Import Lightscape Preparation or the Import Lightscape Solution dialog, use the controls in the Entity Grouping group to choose how imported Lightscape objects are grouped.
See each dialog's description for details about these options.

To get version information about the Lightscape file importer:

- 1 Access the Import Lightscape Solution dialog.
- 2 Click About.
An About Lightscape LS File Import dialog is displayed. This shows the version of the importer that is currently installed.

Lightscape Materials Utility

Utilities panel > Click More. > Utilities dialog > Choose Lightscape Materials.
> Lightscape Materials rollout

With the Lightscape Materials utility, you can add the [Lightscape material](#) on page 5741 to multiple objects, and remove the Lightscape radiosity material from multiple objects.

Interface

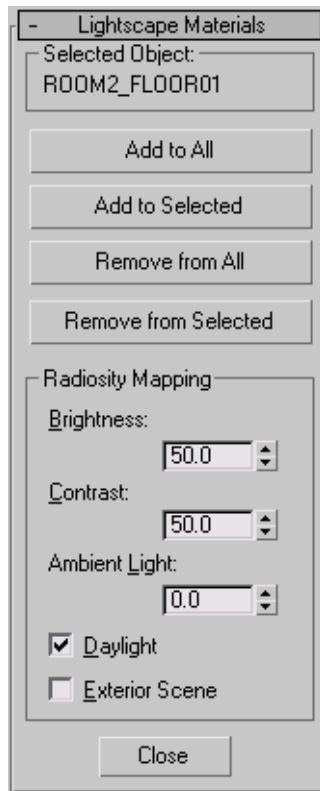

Selected Object group

Displays the name of the currently selected object. If no objects are selected, displays None Selected. If more than one object is selected, displays Multiple Selected.

Add to All Click to add a Lightscape material to all materials used by all objects in the scene.

An object's previous material, if any, becomes the Lightscape material's base material. If a material is already using a Lightscape material, it remains unchanged.

You set the new Lightscape material's values in the Radiosity Mapping group, described below.

Add to Selected Clicking to add a Lightscape material to all materials used by the current selection.

An object's previous material, if any, becomes the Lightscape material's base material. If a material is already using a Lightscape material, it remains unchanged.

You set the new Lightscape material's values in the Radiosity Mapping group, described below.

Remove from All Click to remove the Lightscape material from all materials used by all objects in the scene.

Each material's base material becomes the top-level material. If a material is not using a Lightscape material, it remains unchanged.

Remove from Selected Click to remove the Lightscape material from all materials used by the current selection.

Each material's base material becomes the top-level material. If a material is not using a Lightscape material, it remains unchanged.

These parameters are used only when you add the Lightscape materials. They set the initial values of the new Lightscape material.

Radiosity Mapping group

Brightness Controls the brightness of the displayed image on your monitor. The setting of this control does not affect the actual lighting levels in the model. Default=50.0.

Contrast Controls the contrast between light and dark regions in the model. Default=50.0.

Ambient Light Controls the amount of 3ds Max ambient light that will be mixed in with the radiosity calculations. If the value is 0.0, none of the 3ds Max ambient light is used. If the value is 1.0, the full 3ds Max ambient light is added into the radiosity calculations. Default=0.0.

Daylight Determines whether you want natural daylight to be used in the calculation. Default=on.

Exterior Scene Used for exterior daylight simulations. Default=off.

Motion Analysis Files (HTR/HTR2,TRC)

Importing HTR/HTR2 Files

File menu > Import > Motion Analysis HTR File (*.HTR)

The Motion Analysis HTR (Hierarchical Translation-Rotation) motion capture file format is an alternative to the [BVH](#) on page 7922 format because it provides flexibility in data types and ordering. It also has a complete base pose specification, which consists of indicating the starting point for both rotations and translations.

The stored data is grouped by segments; all motions from the first segment are read, then those from the next segment, and so on.

The HTR format contains four sections: Header, Segment Names & Hierarchy, Base Position, and the motion data section.

NOTE All section titles are displayed between square brackets ([]).

NOTE Comments within the HTR file are denoted by a hash mark (#).

The header section contains global parameter information:

- file type
- data type
- file version
- number of segments
- number of frames
- data frame rate
- Euler rotation order
- calibration units
- rotation units
- global axis of gravity
- bone length axis
- scale factor

HTR2 is nearly identical to HTR, except that the data from the motion section is organized differently in order to better suit a streaming data input (a sample-major ordering is used to present the motion information).

On import, 3ds Max constructs a FK hierarchy rig from the incoming data. The resulting bone skeleton is linked to a dummy object named after the HTR file.

Interface

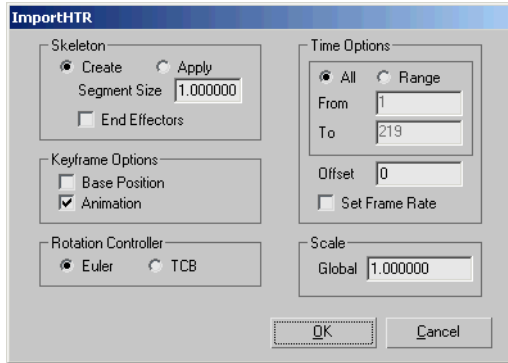

Skeleton group

Create Choose this option to build a new bone skeleton from the incoming data. Default=on.

Segment Size Set this value to modify the scale factor for the weight and height of all bones from the motion capture data. Only available if Create is active.

NOTE This does not change the skeleton's scale.

End Effectors Toggle this option to import [end effectors](#) on page 7963 from the incoming data, if they exist. Only available if Create is active.

Apply Choose this option to map the incoming data onto the children of the selected skeleton root in your scene.

Keyframe Options group

Base Position When on, imports only the keys of the base pose.

Animation When on, imports all animation keys. Default=on.

Rotation Controller group

Euler/TCB Choose one of the two [rotation controllers](#) on page 3151 to apply to the imported data.

Time Options group

These options (except Set Frame Rate) are only functional if the Animation option in the Keyframe Options group is enabled.

All/Range Choose between using the entire animation range from the motion capture file, or a defined portion.

From/To These values represent the start and end frames of the defined range. Only available if Range is active.

Offset Sets the number of inserted empty frames before the imported animation starts.

NOTE This does not affect the Base Position setting (in the Keyframe Options group), which sets a key at frame 0.

Set Frame Rate When on, the [frame rate](#) on page 7987 from the HTR file overwrites the current one in the [Time Configuration dialog](#) on page 7565.

Scale group

Global Sets the size of the resulting skeleton.

NOTE The scale value within 3ds Max remains 100.

Ok Proceeds with HTR/HTR2 import, using the current settings.

Cancel Cancels HTR/HTR2 import.

Importing TRC Files

File menu > Import > Motion Analysis TRC File (*.TRC)

The Motion Analysis TRC motion capture file format represents the raw form (in ASCII) of tracking output. It contains a header section and a motion section.

All tracking markers stored in a TRC file contain global positioning data and do not share parent-child relationships among themselves.

On import, 3ds Max converts the incoming data as either spheres or points, which are named according to the markers names.

You can [convert an imported TRC motion into CSM format](#) on page 3817 using the [MACUtilities utility](#) on page 3817 in order to map it onto a biped.

Interface

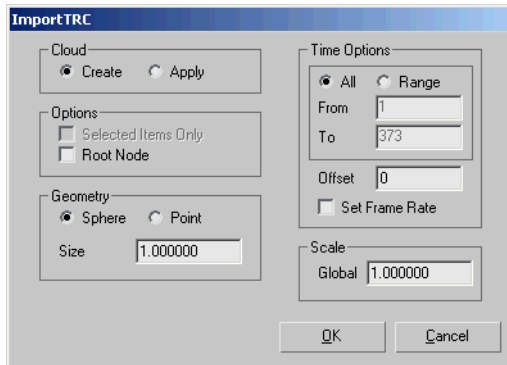

Cloud group

Create Choose this option to build a new set of marker objects. Default=on.

Apply Choose this option to map the incoming data onto the marker children of the selected root in your scene.

NOTE The marker objects must be named to match the imported data.

Options group

Selected Items Only Imports the motion data only relative to the selected objects in your scene. Available only if the Apply option (in the Cloud group) is active.

Root Node Includes a root dummy on file import. Available only if the Create option (in the Cloud group) is active.

Geometry group

These settings are available only if the Create option (in the Cloud group) is active.

Sphere/Point Choose between creating spheres or point helpers to illustrate markers.

Size Sets the sphere diameter or point size, based on your choice above.

Time Options group

All/Range Choose between using the entire animation range from the motion capture file, or a defined portion.

To/From These values represent the start and end frames of the defined range. Only available if Range is active.

Offset Sets the number of inserted empty frames before the imported animation starts.

Set Frame Rate When on, the [frame rate](#) on page 7987 from the TRC file overwrites the current one in the [Time Configuration dialog](#) on page 7565.

Scale group

Global Sets the size of the resulting skeleton.

NOTE The scale value within 3ds Max remains 100.

Ok Proceeds with TRC import, using the current settings.

Cancel Cancels TRC import.

Exporting HTR/HTR2 Files

File menu > Export > Motion Analysis HTR File (*.HTR)

The Motion Analysis HTR (Hierarchical Translation-Rotation) motion capture file format is an alternative to the [BVH](#) on page 7922 format because it provides flexibility in data types and ordering. It also has a complete base pose specification, which consists of indicating the starting point for both rotations and translations.

The stored data is grouped by segments; all motions from the first segment are read, then those from the next segment, and so on.

The HTR format contains four sections: Header, Segment Names & Hierarchy, Base Position, and the motion data section.

NOTE All section titles are displayed between square brackets ([]).

NOTE Comments within the HTR file are denoted by a hash mark (#).

The header section contains global parameter information:

- file type
- data type
- file version
- number of segments
- number of frames
- data frame rate
- Euler rotation order
- calibration units
- rotation units
- global axis of gravity
- bone length axis
- scale factor

HTR2 is nearly identical to HTR, except that the data from the motion section is organized differently in order to better suit a streaming data input (a sample-major ordering is used to present the motion information).

On export, the root object is named after your file name.

NOTE To have a successful export, you have to select the root of the desired skeleton.

NOTE You can only export one bone hierarchy at a time.

Interface

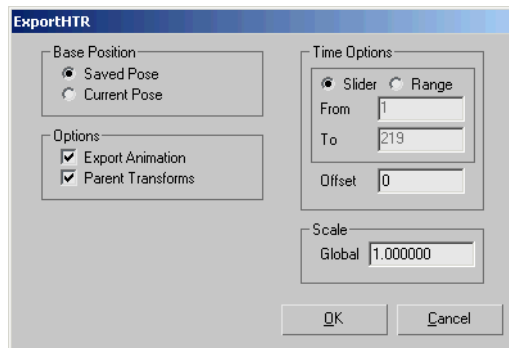

Base Position group

Saved Pose Choose this option to use the skeleton's pose at frame 0 as base position data. Default=on.

Current Pose Choose this option to use the skeleton's pose at the current frame as base position data.

Options group

Export Animation Enable to export all animation keys. Otherwise, only the base position is exported.

Parent Transforms Enable to include the root object's animation data in the export file.

Time Options group

These options are only functional if the Export Animation option in the Options group is enabled.

Slider/Range Choose between using your scene's [time slider](#) on page 7528 range or a defined portion.

From/To These values represent the start and end frames of the defined range.

Offset The exported animation starts after the number of frames set by this value.

Scale group

Global Sets the bone length scale factor in the export file.

Ok Proceeds with HTR/HTR2 export, using the current settings.

Cancel Cancels HTR/HTR2 export.

Exporting to Shockwave 3D

You can set up 3D scenes and animations in 3ds Max, and then export them in Shockwave 3D (W3D) format for use in interactive presentations in Macromedia Director. To start this process, choose File menu > Export, and choose Shockwave 3D Scene Export (*.W3D) as the file type. Choosing this format opens the [Shockwave 3D Scene Export Options dialog](#) on page 7265.

The Shockwave exporter in 3ds Max offers significant differences from the 3ds Max exporter previously available from Macromedia. When you prepare a scene for exporting to Director, please be aware of the following:

- Bones require special consideration when being exported to Shockwave 3D format. See “Exporting Bones” below.
- Hidden objects are not exported. However, bones are exported whether hidden or not.
- The exporter supports specular lighting for light sources with Specular turned on in the General Parameters rollout > Affect Surfaces group.
- Some types of mapping distort or disappear on export. Whenever possible, use Multi/Sub-Object materials rather than maps.

Exporting Bones

The exporter supports character animation using bones and the Skin modifier, or a **character studio**[®] biped with the Physique[®] modifier. Bones are exported not as geometry, but as Shockwave 3D bones.

If the bones deform a mesh with the Skin modifier, the scene must be arranged in a specific manner to cause the bones and mesh to export properly:

- All bones for each mesh object must be linked, and linked contiguously. In other words, each bone must link to another bone, with one bone acting as the root for the entire hierarchy.

- You'll get the best results if all bones are created in the same viewport, and bones are created individually (not copied or mirrored).
- All vertices in the skinned mesh must be assigned to at least one bone, even if they constitute a part of the mesh that isn't animated. Otherwise, the mesh will distort on export.
- You must group the bones and the skinned mesh with the Group menu > Group command prior to export. If you have more than one set of bones with skinned meshes, create a separate group for each.
- You can also export animation on IK chains and dummy objects. These objects must be grouped with the skin and bones to export correctly.

For more tips on working with bones animation and the Shockwave 3D Exporter, visit the

http://www.macromedia.com/support/director/work_3d/models_use_in_sw/models_use_in_sw07.html Macromedia Web site. Also, search the Macromedia site for "bones shockwave export" (without the quotes).

Shockwave 3D Scene Export Options Dialog

File menu > Export > Select File To Export dialog > Save As Type > Shockwave 3D Scene Export (*.W3D)

This dialog appears when you choose the Shockwave 3D format as the export format for your scene.

Interface

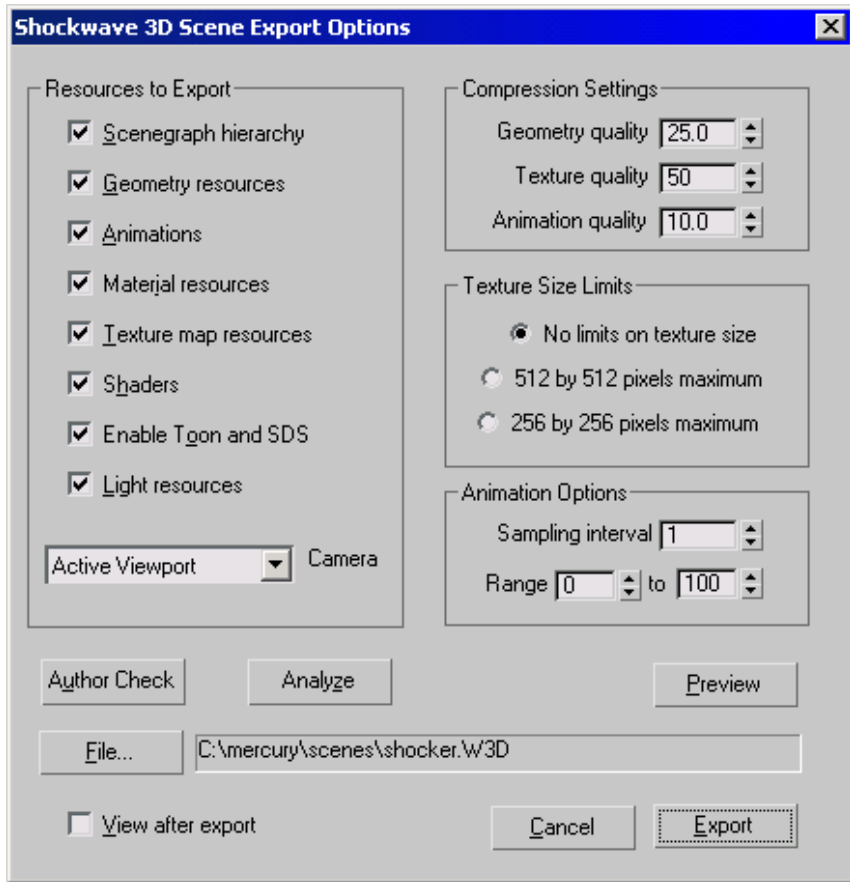

Resources to Export group

Scenegraph hierarchy Controls whether or not the parent-child hierarchy between all geometry, light, group, and camera resources is written to the Shockwave 3D file. This option should always be selected when exporting an entire scene from 3ds Max. The Shockwave 3D scenegraph contains:

- Information on parent-child relationships.
- Information about what resources each scene element uses (for example, the model resource used by a model in the scenegraph).
- Controls for any modifiers associated with the geometry resources.

- Information about any cameras, lights, and groups in the scene. Shockwave 3D treats cameras, lights, and groups as less important resources, and stores information about them only in the scenegraph.

The scenegraph hierarchy is the glue that binds most of the scene assets in the Shockwave 3D file. If this option is turned off, only shader, texture, model, and motion resources will be written to the W3D file, and all the other information that specifies how objects exist in the scene, how the scene is laid out, how the scene is lit, and how the scene is viewed will be missing. For this reason, turn this option off only when exporting libraries of animations or texture maps.

NOTE The exporter will remember this setting from one export to the next. Be sure to turn on this option again before trying to export an entire scene. If you do not, the result will be unusable (except as an object and texture library).

Geometry resources Exports all meshes and their associated bones to the Shockwave 3D file. If this option is turned off, the preview window will be completely black. All other designated resources will be written to the W3D file.

Animations Writes out the animation on all objects supported by the exporter to the Shockwave 3D file. The preview window is useful in quickly showing which animations the exporter is capturing.

By default, the Shockwave 3D Exporter captures the animation of all objects in the scene in every frame. This data is compressed into a streaming format as the file is written. There may be times, however, when you only want to capture part of an animation, or sample it more coarsely than once a frame. If this option is cleared, the full scene will be displayed in the preview window without any animations.

NOTE 3ds Max supports direct animation of cameras and lights. If you animate a camera or light, that animation will be exported, but an extra geometry node will be inserted into the scene during the export process. This geometry node has the animation of the camera or light applied to it, and the camera or light is made a child of this extra node.

The exporter does this because the Shockwave 3D runtime engine supports keyframes only on geometric nodes. The extra node that the exporter creates is named "Dummy Animation Node xyz", where xyz is the name of the animated camera or light. This dummy geometry node also has a dummy material applied to it named Dummy Material, and the geometry is invisible.

Lingo™ programmers should note that the camera or lights transform is now relative to the dummy geometry node, that is, its parent.

IMPORTANT Animation export compression collapses non-bone-based hierarchies (simple linked hierarchies in 3ds Max), so only animation assigned to the root exports properly. For example, in a simple head animation where the eyes and eyelids are linked to the skull, the skull movements export but the eye and eyelid animations do not. Because 3ds Max groups do not collapse on export, you should link each element of your chain, and then group each element with its parent starting from the bottom of the chain and working to the top. Arrange each group's pivot point, and then animate only the group objects, and not their contained elements.

Material resources Exports all basic materials associated with all objects supported by the exporter to the Shockwave 3D file. Materials represent the most basic properties that can be assigned to a surface, such as diffuse color, opacity, and specular color.

We strongly recommend that you leave this option on when exporting any geometry, shader, or texture map resources. Turn this option off only when exporting just the animation in a scene; otherwise, the W3D file will not work correctly with Director.

Texture map resources Exports all texture maps associated with all objects supported by the exporter to the Shockwave 3D file. Texture maps in Shockwave 3D are bitmap images or 2D procedural maps, such as Tile and Gradient Ramp. All bitmap images used in 3ds Max are transformed by Shockwave 3D into streaming JPEG images.

NOTE The terms "Texture," "Map," and "Texture Map" are used interchangeably. If this option is turned off, models will be untextured when first loaded into Director, because they will have no texture information (despite their being visible and fully shaded in the preview window). Once textures are assigned to the proper shaders with Lingo, the models will look properly textured.

Shaders Exports all shaders in the Shockwave 3D file. Shaders are the highest-level entities that describe surface properties. They bear no relationship to the shaders used in 3ds Max. Shockwave 3D does not distinguish among Blinn, Phong, Anisotropic, or any other shader algorithm that determines the rendered look of materials and maps. Only Gouraud shading, which is most closely emulated by the standard shaders in 3ds Max, is supported. Shockwave 3D shaders are primarily pointers to [texture map resources](#) on page 7268 and [material resources](#) on page 7268.

NOTE The Shaders option should be used in conjunction with the Texture Map Resources and Material Resources options. If this option is turned off, models will be invisible when first loaded into Director, because they will have no shading information (despite their being visible and fully shaded in the preview window). Once shaders are assigned to the models with Lingo (Director's scripting language), the models will become visible and look properly shaded.

Enable Toon and SDS When turned off, this option prevents the writing of geometry data used by some of the more advanced Shockwave 3D technologies, and thus reduces the overall file size.

If turned off, Toon and Subdivision Surfaces (SDS) data is not included in the export file, which means that the Toon and Subdivision Surfaces modifiers cannot be applied to the model in Director. A model missing this geometry data can be used with all other Shockwave 3D technologies, however. Leave this option turned on unless it is expedient to reduce the size of the W3D file.

NOTE There is no way to tell if a W3D file was exported with this option enabled or disabled until you try to apply the Toon or SDS modifiers in Director. For this reason, if you turn off this option, use a special naming convention to indicate that a model doesn't have the Toon or SDS data in it.

Light resources Exports all lights in the scene to the Shockwave 3D file.

Turning this option off doesn't do anything unless the scenegraph hierarchy option is also turned off. The only time you should turn this option off is when exporting just the animation, geometry, or texture data in a scene.

Camera Determines the viewpoint used for the scene in Director. This option defaults to Active Viewport, but if any cameras exist in the scene, you can choose one from the drop-down list.

NOTE In order to preview or export an animated camera, you must select that camera from the list. Selecting Active Viewport with an animated camera will not export that camera's animation.

Compression Settings group

The Shockwave 3D file contains all scene assets in a proprietary compressed and streaming format. You can control the order in which data streams with the user properties. The amount of compression of the scene assets is set by three controls: Geometry Quality, Texture Quality, and Animation Quality. The controls have values that range from 0.1 to 100.0, with higher values giving less compression and better quality (a more faithful representation of the original model).

A value of 100 means that the scene assets will be represented at the best quality possible, but with some degree of compression still present. It does not represent the value at which compression does not occur. Also, the compression controls do not have a linear scale, so a setting of 20.0 doesn't necessarily mean that the quality level of the resulting data is twice as good as that produced with a setting of 10.0.

Geometry quality Controls how much the scene geometry data (such as vertex positions and normals and texture coordinates) is compressed. The default of 25.0 generally produces a good compromise between data accuracy and space savings.

Texture quality Controls the compression of textures (images) in the scene.

Animation quality Controls the compression of animation data in the scene. Higher compression levels (lower quality) tend to remove the finer motions authored in the scene, especially motion-capture data, while occasionally introducing small noise artifacts.

NOTE You might need to use larger values of the [Animation Sampling Interval control](#) on page 7271 (below) along with greater values of this setting to minimize the file space consumed by animation while still maintaining acceptable motions.

Texture Size Limits group

The Texture Size Limits setting lets you reduce the size of the W3D file by limiting the size of the texture maps in the export.

The reduced size of the texture maps will usually look fine on the model, because the model's UVW texture coordinates will have already taken into account the non-square dimensions of the image. Use the smaller settings if, after tuning the compression settings and simplifying the scene in 3ds Max, the W3D file is still too large. If the scene contains no textures, or only small textures, limiting the texture size will not help to reduce the size of the W3D file.

No limits on texture size Exports all texture maps in the scene at the full resolution of the image as used in 3ds Max. For example, a 2048 X 4096-pixel image will be written to the W3D file at these dimensions (compressed, of course).

512 by 512 pixels maximum Exports the texture maps so that no image exceeds 512 X 512 pixels. A 2048 X 4096-pixel image will be scaled to a 512 X 512-pixel image; a 128 X 1024-pixel image will be scaled to a 128 X 512-pixel image.

256 by 256 pixels maximum Exports the texture maps so that no image exceeds 256 X 256 pixels. A 2048 X 4096-pixel image will be scaled to 256 X 256 pixels; a 128 X 1024-pixel image will be scaled to 128 X 256 pixels.

Animation Options group

The Animation Options group contains the controls to change how an animation is captured.

Sampling interval This setting is used to capture object animation once every specified number of frames.

Range These Start and End controls indicate which frames of the scene animations are to be captured. By default, these values are set to capture the entire animation interval specified in 3ds Max, sampling all animations in the scene every frame.

Export Controls

Author Check Opens a window displaying warning messages about possible problems found converting the scene to the W3D file format. If no errors are found, the window is blank.

These messages, which do not necessarily indicate problems with the scene, can be useful in debugging problems such as why the scene looks different in the preview window than it does in 3ds Max. If the scene uses any 3ds Max features that are not supported by the exporter, they will be listed here.

Analyze Opens the [Shockwave 3D File Analysis window](#) on page 7274, displaying a graphic breakdown of the data in the W3D file.

Preview Opens the [Shockwave 3D Export Preview window](#) on page 7272, showing the scene as it will be exported.

File Opens the Choose Export File dialog, which lets you specify the name and location of the file to be exported. When you click Save, you're returned to the Export Options dialog; the file name and path you specified appear in the field next to the File button.

NOTE Clicking the Save button does not save the W3D file; you must click the Export button to create the file.

Export Exports the Shockwave 3D file, using the path and name specified next to the File button.

View after export After you export a file, this option lets you view it in the [Preview window](#) on page 7272.

Shockwave 3D Export Preview

File menu > Export > Select File To Export dialog > Save As Type > Shockwave 3D Scene Export (*.W3D) > Preview

This window displays the scene as it has been captured by the Shockwave 3D Exporter. This view lets you quickly identify scene elements that are not supported by the Shockwave 3D Exporter.

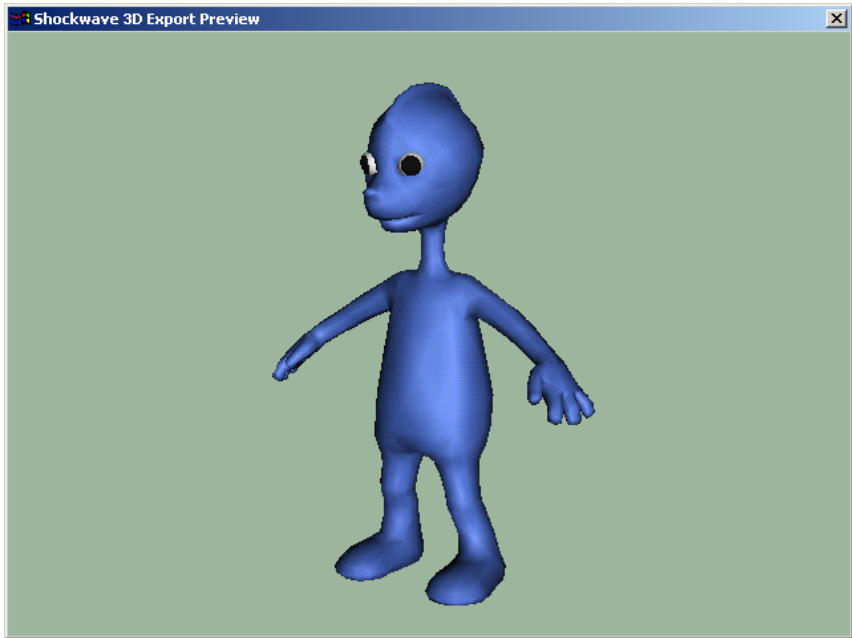

In many cases the export preview window will display scene resources you had decided not to export. Remember that this window displays the scene as captured by the exporter and not necessarily how it is written to the W3D format. Only those scene assets indicated under the export options and supported by the exporter will be written to the W3D file.

Export with a Top, Front, Right, or orthographic viewport active in 3ds Max, and the scene will be viewed through an orthographic camera. Export with a Perspective or Camera viewport active in 3ds Max, and the scene will be viewed through a perspective camera.

NOTE When navigating a scene, keep in mind that only the parts of models that are in front of the camera will be rendered. Parts of models that penetrate the camera plane and are behind the camera will not render, resulting in visual artifacts ("black holes" or "tearing") in the model. This is particularly noticeable when you dolly an orthographic camera forward, because the lack of perspective effects does not hide models as the camera passes them. Dolly the camera back, and any visual artifacts should disappear.

You can navigate the export preview window using the following controls.

Rotation

- Drag (move the mouse with the left button held down)=orbit
- Y+drag=rotating the camera with "Y-up" (particularly useful if the scene was created in the "Y-up" environment)
- Shift+drag=roll; vertical movement is ignored

Dolly

- Ctrl+drag=dolly
- Ctrl+Shift+drag=dolly faster

Pan

- Spacebar+drag=pan
- Shift+Spacebar+drag=constrain the movement to be either horizontal or vertical, depending on the initial direction when you start dragging

Shockwave 3D File Analysis Window

File menu > Export > Select File To Export dialog > Save As Type > Shockwave 3D Scene Export (*.W3D) > Analyze

This window provides a graphic breakdown of the data in the W3D file. Click OK to close the window.

Interface

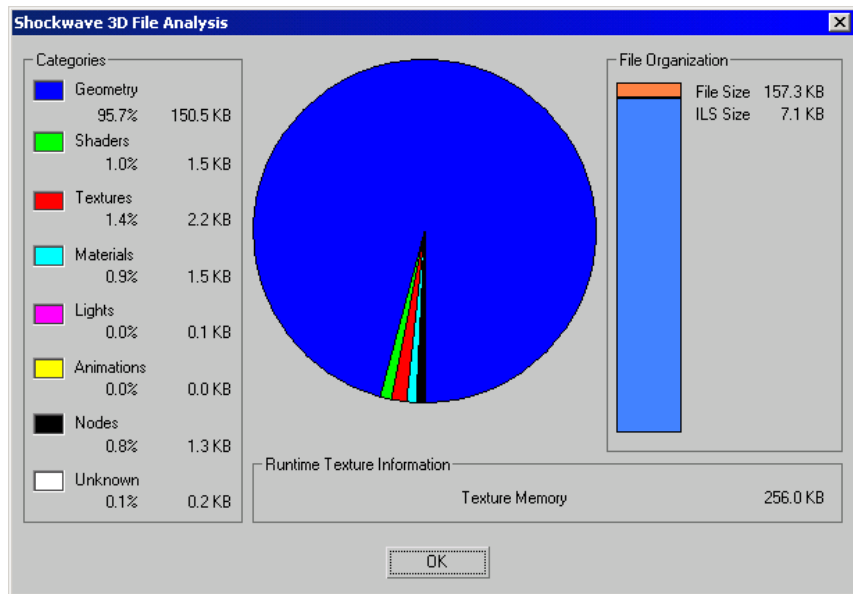

Pie Chart Graphic display of the proportion of the file used by all of the W3D file data types. Refer to the color-coded Categories list, which gives a percentage and an absolute size in kilobytes of each asset:

- **Geometry** (in the initial load segment, if a model has a zero priority in the `sw3d_stream_priority` user property, or in the streamable portion of the file, if a model has a non-zero streaming priority)
- **Shaders** (only in the initial load segment)
- **Textures** (in the initial load segment, if the model that uses the texture has a zero priority in the `sw3d_texture_stream_priority` user property, or in the streamable portion of the file, if a model has a non-zero streaming priority)
- **Materials** (only in the initial load segment)
- **Lights** (only in the initial load segment)
- **Animations** (only in the initial load segment)

NOTE Large animations can greatly lengthen the time it takes to see the start of a Shockwave 3D animation, because they must fully download before any of the scene can become visible.

- **Nodes** or scenegraph hierarchy data (only in the initial load segment)
- **Unknown** includes, for example, streaming priorities, names, and block sizes.

File Organization Graphic display of the size of the entire file and its initial load segment (ILS) portion. The ILS, in orange, consists of all the data that must be loaded before Shockwave will display the scene (scenegraph data, animations, shaders, and any textures or geometry with a streaming priority of zero). The rest of the file, in light blue, represents all of the streamable data with a non-zero streaming priority. This data will continue to load and fill out the detail of the scene as the download proceeds.

Runtime Texture Information Approximate texture memory that will be required at run time to display the textures in the scene. Scenes requiring more than a few megabytes of texture memory will require accelerated graphics cards to display textures at their full resolution.

Stereolithography (STL) Files

Importing STL Files

File menu > Import > StereoLitho (*.STL)

An STL file saves object data in a format used for stereolithography. STL files have a filename extension of *.stl*. There is an ASCII STL format as well as a binary STL format. You can choose which to create when you export a 3ds Max scene.

STL files are generally used for purposes of rapid prototyping. A variety of methods use the STL format to construct prototypes. For example, many STL machines use a liquid polymer and harden it in small slices, creating a solid plastic model. Other STL machines use metal powder to create a model in steel. Still other machines use a special wax.

You can import and export STL files. See [Exporting to STL](#) on page 7279.

Interface

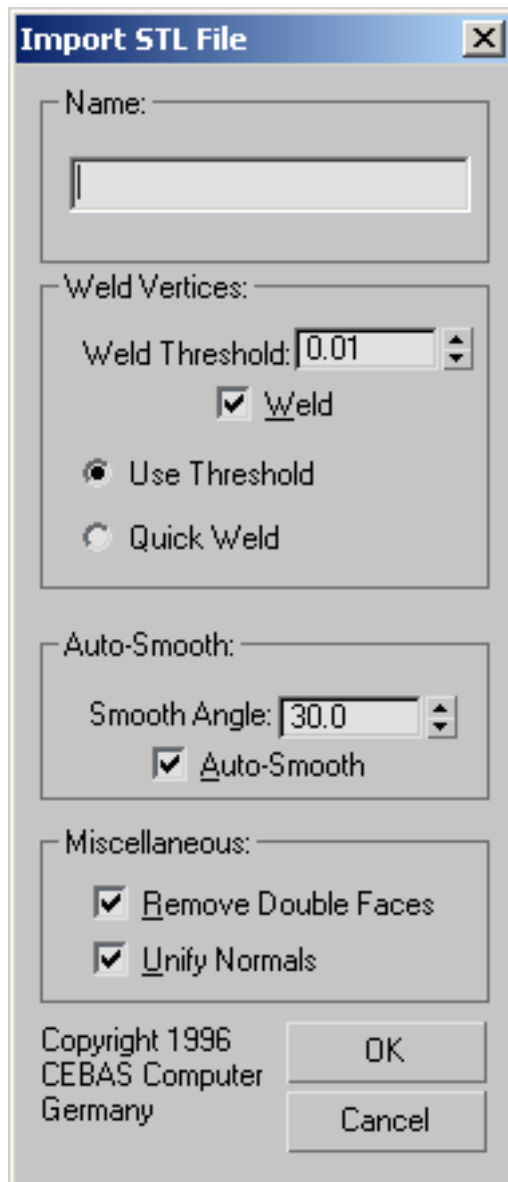

Name Enter a name for the 3D Studio object created from the STL file. Default is the file name (without extension) or the name saved internally in the STL file.

Weld Vertices group

Welds coincident vertices in the STL file into single vertices in the 3D Studio mesh.

Weld Threshold Determines the size of the area which vertices must occupy to be welded. Vertices with distances equal to or less than this value are welded into a single vertex.

Weld Turns on the Weld Vertices function. In most cases, you should leave this box turned on because unwelded objects can't be unified or smoothed.

Use Threshold If on, STL import uses the standard 3D Studio welding method. This can be a very slow process.

Quick Weld If on, STL import uses a welding algorithm optimized for the STL format. This is up to thirty times faster than standard 3D Studio welding, and is highly recommended.

Auto-Smooth group

Auto-Smooth Applies [smoothing groups](#) on page 8130 to the geometry based on the smoothing angle set by the smooth angle spinner. Edges between faces that have an angle between them that is greater than the specified smoothing angle will appear faceted in the rendered image. Edges between faces that are below the specified angle are smoothed

Smooth Angle Determines the size of the smoothing angle.

Auto-Smooth Turns on the Auto-Smooth function.

Miscellaneous group

Remove Double Faces Removes one of the pair wherever two faces are occupying the same location. Recommended.

Unify Normals Forces the [normals](#) on page 8059 of all faces on each object to face the same way (usually out). If, when you render your scene, the face normals are pointing in the wrong direction, use the Normal modifier to flip them. For best results, leave this box turned on.

Exporting to STL

File menu > Export > StereoLitho (*.STL)

An STL file saves object data in a format used for stereolithography. STL files have a file-name extension of *.stl*. There is an ASCII STL format as well as a binary STL format. You can choose which to create when you export a 3ds Max scene.

STL files are generally used for purposes of rapid prototyping. A variety of methods use the STL format to construct prototypes. For example, many STL machines use a liquid polymer and harden it in small slices, creating a solid plastic model. Other STL machines use metal powder to create a model in steel. Still other machines use a special wax.

An STL object must define a complete and closed surface. You can check whether the geometry you want to export satisfies this criterion by using the [STL Check modifier](#) on page 1749.

You can also import STL files. See [Importing STL Files](#) on page 7276.

Interface

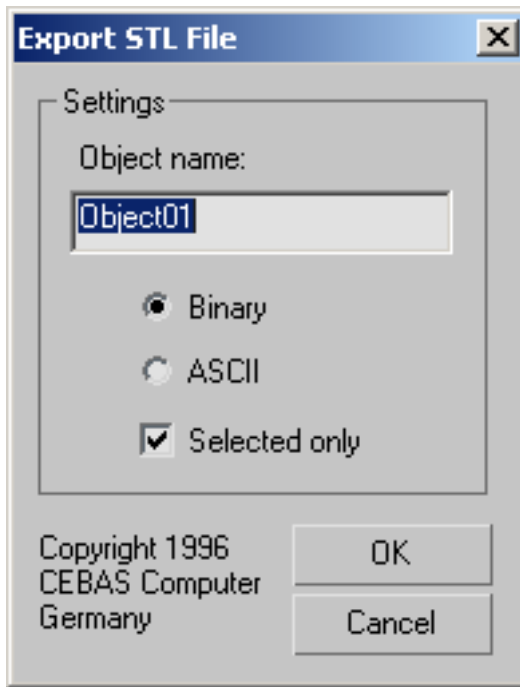

Object Name Enter a name for the object you want to save in STL format.

Binary/ASCII Choose whether the STL output file will be binary or ASCII (character) data. ASCII STL files are much larger than binary STL files.

Selected Only Exports only objects that you selected in the scene.

Wavefront (OBJ, MTL) Files

3ds Max can import and export the text-based (ASCII) Wavefront formats OBJ and MTL. An OBJ file contains geometry descriptions. A MTL file is also text based, and contains material descriptions that supplement the OBJ file. Exporting and importing MTL files is done as an adjunct to the OBJ export/import.

NOTE  In Autodesk 3ds Max 2009, the legacy OBJ/MTL export/import plug-in has been replaced by software from GuruWare. This module provides enhanced functionality and improved performance. However, as a consequence, separate MTL export is no longer available. Export and import of MTL files attached to OBJ files is fully supported.

See also:

- [Exporting Wavefront Object \(OBJ\) Files](#) on page 7281
- [Importing Wavefront Object \(OBJ\) Files](#) on page 7285
- [Map-Export Dialog \(OBJ\)](#) on page 7288

Exporting Wavefront Object (OBJ) Files

File menu > Export > Save as type > gw::OBJ-Exporter (*.OBJ)

The ASCII-based OBJ format makes it possible to exchange graphical data between many applications. Both polygons and freeform geometries such as curves are supported with this format. You can export 3ds Max files to this format.

See also:

- [Importing Wavefront Object \(OBJ\) Files](#) on page 7285
- [Map-Export Dialog \(OBJ\)](#) on page 7288

Procedure

To export scene geometry to an OBJ file:

- 1 From the File menu, choose Export. Or, to export only the current selection, choose Export Selected.
The Select File To Export dialog opens.
- 2 Enter the file name, optionally with the *.obj* file name extension. If you don't enter the extension, open the Save As Type drop-down list and choose gw::OBJ-Exporter (*.OBJ).
- 3 Click Save.
The exporter dialog opens.

- 4 Set parameters manually, or choose the name of the target program from the Preset drop-down list. Optionally click Map-Export and set map-export parameters.
- 5 Click Export.
During export, a dialog showing progress and the names of exported objects opens. When the export is finished, click DONE to return to 3ds Max.

Interface

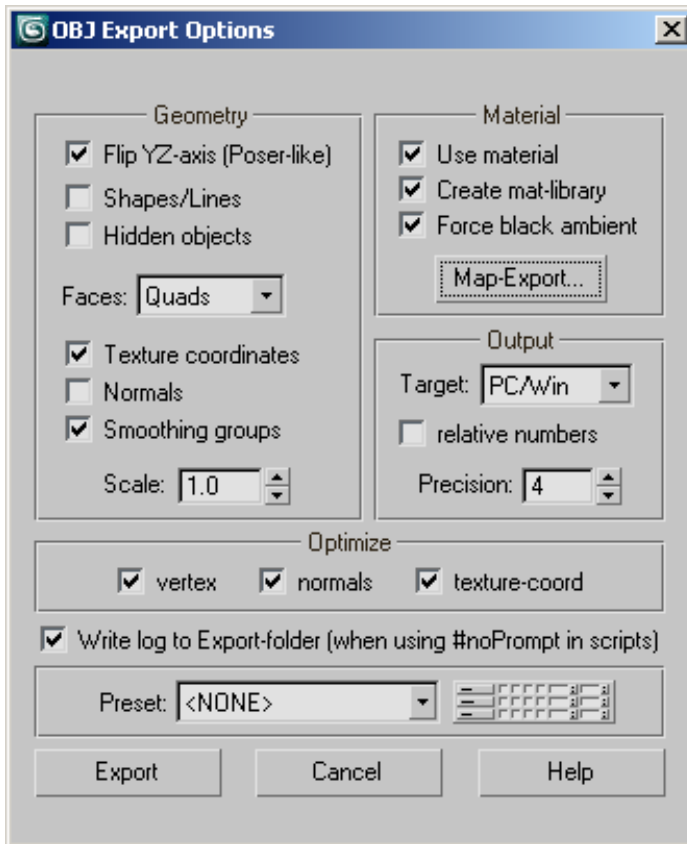

Geometry group

Flip YZ-axis When on, transfers all Y-axis values to the Z axis and vice-versa. Use this when exporting to Poser and other programs that use Y as the vertical axis and Z as the depth axis.

Shapes/Lines Enables export of splines and NURBS curves.

NOTE NURBS curves are exported as splines.

Hidden Objects When on, hidden objects are exported.

Faces Choose whether the mesh faces are stored as triangles, quadrangles, or polygons.

Texture coordinates When on, texture coordinates are stored with the exported file. When you import the file in another application you will be able to use this information if it is supported.

Normals When on, the [normal information](#) on page 8059 for the mesh is stored.

Smoothing groups When on, the information about color transition between groups is stored. See [Viewing and Changing Smoothing](#) on page 403.

Scale Determines the scaling for the contents of the OBJ file. The default value of 1.0 means no scaling is performed.

Material group

Use material Determines whether the materials associated with the scene objects are also exported to the OBJ file.

Create mat-library Determines whether the exporter creates a separate file to store information about the materials. This creates a MTL library file in the same directory as the OBJ file.

If Use Material is on but Create Mat-library is off, the OBJ file contains a reference to a like-named MTL file, but the MTL file is not saved. Use this to save time if the MTL file already exists.

Force black ambient Sets the Ambient component of exported materials to black.

Map-Export Click to open the [Map-Export dialog](#) on page 7288

Output group

Target Sets the target operating system of the computer on which the exported data is to be used. Technically, this setting determines the line-end characters for the ASCII OBJ file.

Relative numbers Causes face vertex indices in exported files to be expressed as relative (i.e., negative) numbers. This can cause compatibility issues when importing with certain programs. If you're unable to import an OBJ file, make sure this option is off and export again.

Precision The precision of the exported vertex data, as expressed by the number of decimal places.

Optimize group

Optimize Removes duplicate elements of the indicated type or types: vertices, face normals, and texture coordinates.

Write log to Export-folder Saves a log file to the same folder as the OBJ file when exporting via script.

Preset When exporting to a specific application, choose the application from the list. Presets comprise all export settings, including geometry and materials.



[edit presets] Click to open a dialog that lets you edit the presets. To change the map path for a preset, edit the map-path setting manually or click the folder button at the right end of the row and navigate to the new path.

While the Presets dialog is open, you can choose a preset by clicking its name (the row highlights) and then clicking OK.

Export Saves the exported files (OBJ + optional maps and material library) according to the current settings.

During the export, a dialog shows the progress and saved files. When it's finished, click DONE to close the dialog.

Cancel Cancels the OBJ export.

Help Opens the help file to this topic.

About Opens a small dialog with information about this plug-in. To close the dialog, click the image.

Importing Wavefront Object (OBJ) Files

File menu > Import > Files of type > gw::OBJ-Importer (*.OBJ)

Geometry imported from OBJ files appears in 3ds Max as editable mesh objects. Import of associated materials and maps is supported.

See also:

- [Exporting Wavefront Object \(OBJ\) Files](#) on page 7281
- [Map-Export Dialog \(OBJ\)](#) on page 7288

Procedure

To import an OBJ file:

- 1 From the File menu, choose Import.
The Select File To Import dialog opens.
- 2 Choose an OBJ file to open and click Open.
The importer dialog opens.
- 3 Choose the objects to import and set the import parameters. For details, see the Interface section, following.
- 4 Click Import.
During import, a dialog showing progress and the names of imported objects opens. If a name conflict occurs, a dialog opens giving you the opportunity to skip or rename the object.

Interface

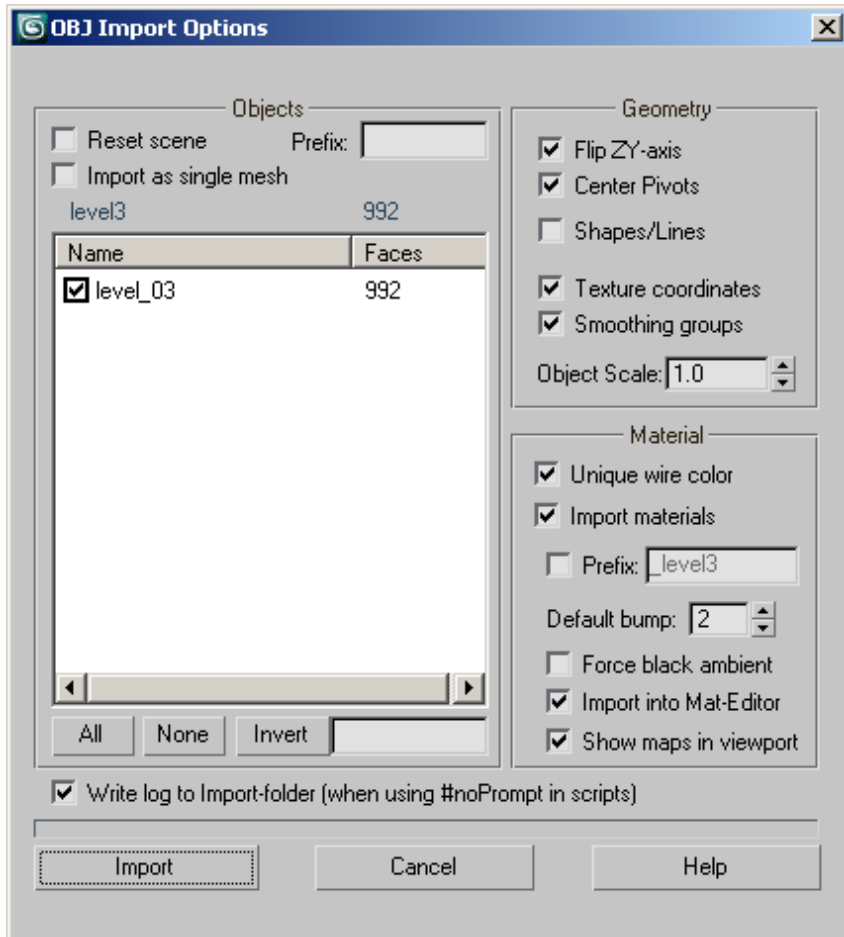

Objects group

Reset scene Deletes the current scene from memory before importing the OBJ file.

Prefix The importer prepends any text entered here to the name of each imported object.

Import as single mesh When on, the importer combines the contents of the OBJ file into a single editable mesh object, and gives the object the same name as the file (without the file name extension).

For example, if you import as a single mesh a file named *window_parts.obj*, all separate objects in the OBJ file are combined into a single editable mesh object named “window_parts”.

[file info] Just above the list of objects in the file, appearing as read-only fields, are the name of the OBJ file and the total number of faces in the file.

[object list] The objects in the imported OBJ file appear in this scrolling list. Each entry consists of an object name and the number of faces in the object, plus a check box to the left of the object name for enabling and disabling import per object.

By default, import is enabled for all objects in the file. To toggle import for an individual object, click its check box in the list. You can also use the controls at the bottom of the list to enable and disable import (see following).

All/None/Invert Use these buttons to modify the state of the import enable/disable check boxes. All enables all objects in the list; None disables all objects; Invert reverses the state of each check box.

[text field] Enter search phrases with wild cards into the editable text field to the right of the Invert button to enable only objects that satisfy the search criteria. For example, to enable all list items whose names start with “Sphere”, enter **sph***.

You can also use the standard search character **?** to represent a single character. For example, to enable all four-character names starting with “Box”, use the search string **box?**.

Geometry group

Flip ZY-axis When on, transfers all Y-axis values to the Z axis and vice-versa. Use this when importing from Poser and other programs that use Y as the vertical axis and Z as the depth axis.

Center Pivots Positions the pivot of each imported object at its center. When off, the pivots are positioned at the world center: (0,0,0).

Shapes/Lines Enables import of splines.

Texture coordinates When on, texture coordinates are loaded from the imported file, if present, and associated with the geometry.

Smoothing groups When on, the information about color transitions between groups is loaded. See [Viewing and Changing Smoothing](#) on page 403.

Object Scale Determines the scaling for the contents of the OBJ file on import. The default value of 1.0 means no scaling is performed.

Material group

Unique Wire Color Determines the wireframe colors assigned when importing multiple objects without materials. When on, each object is assigned a different wireframe color. When off, each object is assigned the same wireframe color, picked at random.

Import Materials When on, imports materials from the MTL file associated with the OBJ file.

Prefix Prepends the indicated text to the name of each imported material. Enter the prefix in the editable text field to the right of the Prefix check box.

Default bump The default amount of bump maps if the value is not specified in the MTL file.

Force black ambient Sets the Ambient component of imported materials to black.

Import into Mat-Editor Brings imported materials into the Material Editor. If this is off at import time and you later want to edit a material, you need to use [Get Material](#) on page 5341 first.

Show maps in viewport Turns on [Show Map In Viewport](#) on page 5350 for imported materials' Diffuse maps.

Write log to Import-folder Saves a log file to the same folder as the OBJ file when importing via script.

Import Loads the designated files (OBJ + materials and maps) according to the current settings.

During the import, a dialog shows the progress. If a name conflict occurs, a dialog appears giving you the option to skip the duplicate object or rename it.

Cancel Cancels the OBJ import.

Help Opens the help file to this topic.

About Opens a small dialog with information about this plug-in. To close the dialog, click the image.

Map-Export Dialog (OBJ)

File menu > Export > Save as type > gw::OBJ-Exporter (*.OBJ) > Material group > Map-Export button

The Map-Export dialog provides settings for exporting maps as part of material definitions along with exported OBJ files.

See also:

- [Exporting Wavefront Object \(OBJ\) Files](#) on page 7281
- [Importing Wavefront Object \(OBJ\) Files](#) on page 7285

Interface

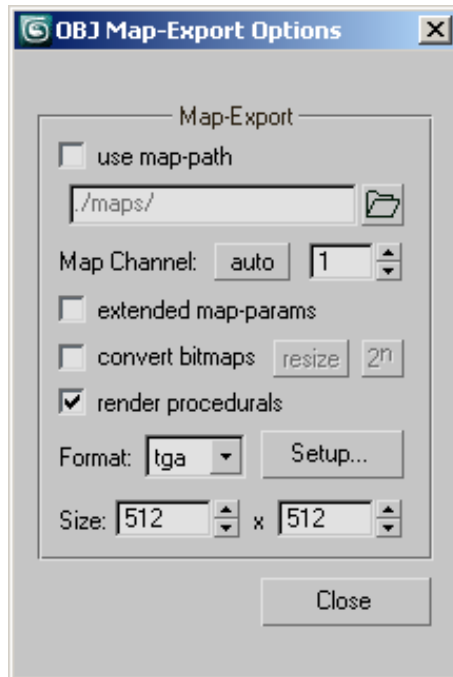

use map-path When off (the default), uses the same folder as the OBJ file for maps. When on, uses the designated folder (see following), relative to the folder containing the OBJ file, for maps.

[map path] When Use Map-Path is on, specifies the folder relative to the folder containing the OBJ file where the exporter should save maps. Edit the path from the keyboard, or click the folder button to the right of the text box and navigate to the desired folder.

Map Channel Specify a map channel using the numeric field, or, to set the channel automatically, click Auto (disables the numeric field).

extended map-params When on, stores the Bump Amount value and UVW offsets in the MTL file.

convert bitmaps When on, resaves existing bitmaps used in materials according to the Format setting and, optionally, the Size setting (see following). When off, uses the original bitmaps without resaving.

Resaved maps go in the same path as the OBJ file, or, if Use Map-Path is on (see preceding), in the designated folder.

When converting bitmaps, you can optionally turn on either of the following two options:

- **resize** When on, saves bitmaps at the resolution specified by the Size settings.
- **2n** Scales each dimension of converted bitmaps to the nearest power of two. For example, resizes a bitmap of resolution 200 x 900 to 256 x 1024. Use this option when your target is a real-time 3D graphics engine.

render procedurals Creates bitmap images of procedural textures such as [Checker](#) on page 5808, using the specified Format and Size settings. Use this option when the intended target program doesn't support 3ds Max procedural maps.

Format Choose a file format for converted bitmaps. Choices are [BMP](#) on page 7328, [JPG](#) on page 7347, [PNG](#) on page 7360, [TGA](#) on page 7370, and [TIF](#) on page 7372.

Setup Opens the setup dialog for the active file format. For details, click a link in the Format definition, preceding.

Size For converted, resized bitmaps and rendered procedurals, sets the output resolution on the horizontal and vertical dimensions.

Close Closes the dialog, saving any changes.

VRML Files

Importing VRML Files

File menu > Import > Select File To Import dialog > Files Of Type > VRML (*.WRL, *.WRZ)

You can import VRML 1.0, VRBL, and VRML 2.0/VRML 97 files into 3ds Max. 3ds Max imports geometry, materials (including diffuse texture maps), lights,

perspective cameras and viewpoints, transformations, and grouping nodes created by other VRML tools. Once they are in the scene file, you can edit, modify, and animate these objects.

3ds Max also imports basic transform animations, such as position, rotation, and scale. Also included are animated color and light. These correspond to the basic animation that is exported by the VRML 1.0/VRBL and VRML97 exporters. Helper objects are not created upon import. Lighting effects are somewhat simplified from the full VRML lighting model.

- VRML97 files don't indicate the duration of an animation. If you import animation from a VRML97 file, you might want to set the animation length in 3ds Max manually.
- More elaborate forms of animation and simulation, including Script nodes, MovieTexture nodes, and sensor nodes, are not supported.
- The VRML 1.0 WWW Inline works only if the URL refers to a local file residing in the same folder as the .WRL file. Internet URLs are not supported.

Interface

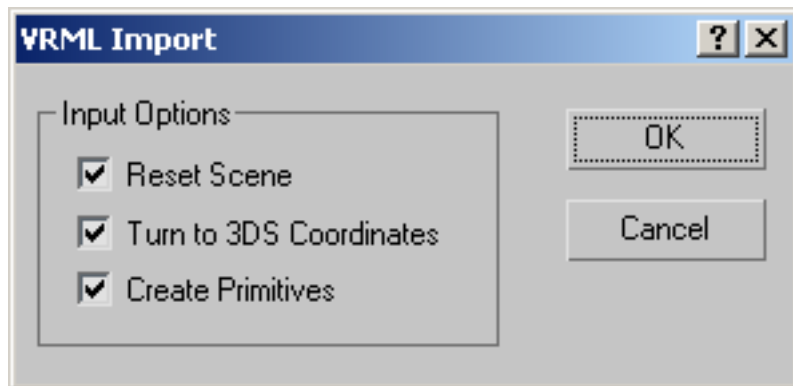

Reset Scene Deletes any existing scene upon import. If you turn off this option, the imported VRML world is merged into the 3ds Max scene.

Turn to 3DS Coordinates Rotates the imported VRML world from Y, which is "up" in VRML, to Z, which is "up" in 3ds Max. If you turn off this option, VRML X, Y, and Z coordinates are imported without change.

Create Primitives Converts the VRML Box/Cube, Cone, Cylinder, and Sphere nodes to corresponding 3ds Max primitives, if possible. If the VRML object

has a texture on it, or if only part of the VRML object is to be created, a general triangular mesh object will be created instead. If you turn off this option, 3ds Max will convert these objects to triangular mesh objects.

Exporting to VRML97

File menu > Export > Select File To Export dialog > Save As Type > VRML97 (*.WRL)

3ds Max scenes can be exported to VRML97 file format.

See also:

- [VRML97 Export](#) on page 7297

Procedures

To export a file to VRML97:

- 1 Choose File menu > Export.
- 2 Choose VRML97 (WRL) as the file format.
- 3 Enter a file name, and click Save.
- 4 In the VRML97 Exporter dialog, set options as described below.

Interface

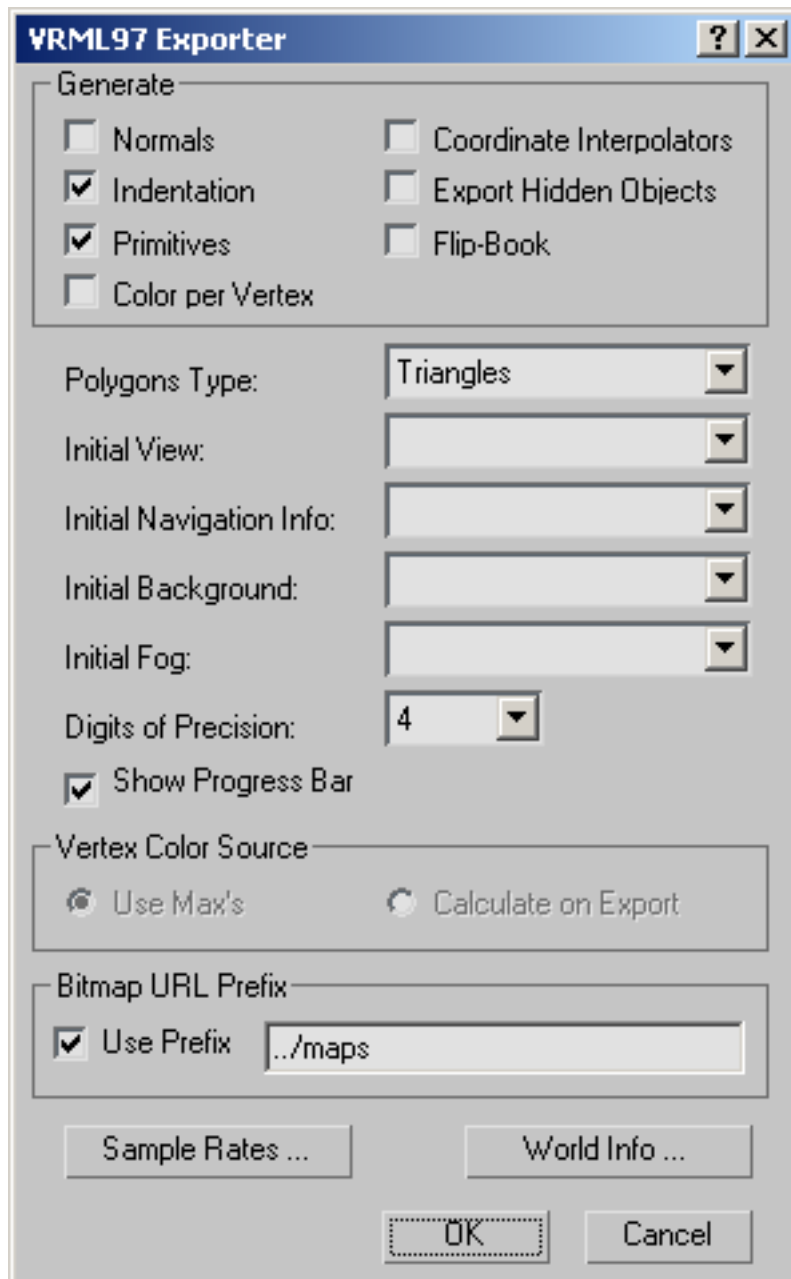

Generate group

Turning on any of these options increases the size of the VRML97 file generated by the export process.

Normals Generates real normals for objects. Some browsers need normals to do smoothing properly. Check this box if you are exporting geometry that uses smoothing groups in 3ds Max, to see the correct shading. Default=off.

Coordinate Interpolators Exports animation effects that involve actual modifications of the mesh objects, and not just move, rotate, and scale. Examples include modifiers whose parameters can be animated, the Taper, Bend, and Twist modifiers, and space warps. This option can generate large files, because the exporter has to calculate the position of every vertex for this kind of animation.

If your animations aren't exporting correctly, try exporting with this option chosen. An example of animation motion requiring Coordinate Interpolators is a stick figure made up of simple rectangular boxes that have bones Linked to the boxes as a skeleton. Even though these boxes move through space without any noticeable shape morphing, their motion will not be exported without the use of Coordinate Interpolators, because their motion isn't derived from simple transforms. Any animation achieved using the modifier stack or object parameters needs Coordinate Interpolators. This includes animated XForm modifiers.

Certain types of animations are not possible with Coordinate Interpolators; for example, when the mesh being animated changes size between frames. An example of this is animating the number of segments in a sphere. 3ds Max warns you if it detects this type of animation on export.

Indentation Indents the VRML97 source code so it is easy to read. Default=on.

Export Hidden Objects Exports hidden objects. Default=off.

Primitives Exports VRML97 primitives, which reduces the file size because these primitives are described very simply (for example, a sphere is described by its radius). To see how many polygons are in the scene, turn off this box to export 3ds Max primitives, which have an indexed face set for each object. Default=on.

Flip-Book Exports the scene to multiple files. The sample rate is set in the in the Flip-Book section of the Sample Rates dialog. The file name you specify becomes the base for the sequence of files. For example, if you specify the file name *test.wrl*, choose one file per animation frame, and have five frames, 3ds Max exports the following:

test.txt contains general info, start/stop times, and number of frames.

test0.wrl through *test4.wrl* are snapshots of the animation in frames 0 through 4.

Color Per Vertex Exports the vertex colors of geometry. If this is turned on, the Color Per Vertex Source lets you choose the source of the vertex color.

Polygons Type

Determines how geometric faces are written out as VRML97 IndexedFaceSet nodes.

Ngons Writes faces with as many edges as possible.

Quads Writes quadrilateral faces where possible (otherwise triangles).

Triangles Writes only triangular faces.

Visible Edges Breaks faces at internal edges that are marked as being visible.

Initial View

Sets the entry camera for the scene and controls what first appears in the browser. If there are no cameras in the scene, the scene appears with a default viewpoint (which may give only a partial view).

All scenes should have at least one camera, so you can control how the scene initially renders. Add more cameras to the scene than you might ordinarily use, so the viewer can switch between cameras if his VRML97 browser allows it. This lets you set up your scene with pre-installed vantage points. Otherwise, if the world is very large, it can overpower the viewer's system and make navigation difficult. Some browsers animate camera moves, so the extra cameras can make viewing the scene more pleasant.

Initial Navigation Info

Specifies the [Navigation Info helper object](#) on page 7306 to use when the world loads in the browser.

Initial Background

Specifies the [Background helper object](#) on page 7317 to use when the world loads in the browser.

Initial Fog

Specifies the [Fog helper object](#) on page 7307 to use when the world loads in the browser.

Digits of Precision

Sets the number of decimal points used for calculating dimensions. The default of 4 is usually sufficient. Set this number greater than 4 if parts of your world were created 100,000 units away from the center of the scene. Setting the value to 3 reduces the file size.

Show Progress Bar

Gives you the option to view a progress bar as the scene is exported.

Vertex Color Source group

Lets you choose the source for the vertex color when Color Per Vertex is turned on.

Use Max's Exports Exports the current vertex color of the object defined in the scene.

Calculate on Export Calculates the diffuse color at the vertices during export, based on the current lighting and the objects' materials.

Bitmap URL Prefix group

Lets you specify a URL prefix for bitmaps assigned to objects in the scene. You must keep all your texture bitmaps in either the same directory as the WRL file or in one other location, which you specify here. If your maps are stored in other locations, you will have to manually search for the map in the WRL and change its location. Not all browsers will display error messages if the maps aren't found on the WWW server.

Use Prefix Enables the prefix mechanism. If this box is turned off, image maps must be in the same location as the WRL file.

Prefix Adds the prefix you enter here to the names of all assigned bitmaps. The name can be a full URL (beginning with HTTP), or it can be a relative path (a subdirectory of the location of the VRML97 file). For example, if you enter "Maps" for the prefix, when the browser opens a VRML97 file that has a texture map assigned to it, it will look for the subdirectory "Maps." "Maps" must be a directory that is directly under the directory where the VRML97 file resides.

Use forward slashes (not backslashes) to enter longer paths; for example:
Myfiles/maps.

Sample Rate

Displays a dialog that lets you specify sample rates for controller-based and coordinate-interpolated animation, as well as the Flip-Book output rates. Setting sample rates lets you trade off between animation fidelity and file size. The default values give good results in most cases. For the greatest animation precision, use a lower number (a higher sampling rate).

World Info

Lets you enter information about the world. This has no effect on the visual appearance or behavior of the world. Some browsers can display what you enter in the Title field, for example, in the browser window's title bar. You can use the Info field to provide author, version, and copyright information.

VRML97 Export

Vrmlexp.dle is for creating and exporting scenes in the VRML97 format. VRMLEXP exports *.wrl* files, which can be viewed in any VRML97 browser.

Make sure that you have the most current version of your VRML browser and check its documentation to insure that it supports VRML97.

This documentation covers:

[VRML97 Helper Objects](#) on page 7301

[Exporting to VRML97](#) on page 7292

[VRML97 Tips](#) on page 7298

[VRML97 Specification](#) on page 7301

Procedures

To create VRML97 files:

- 1 Create the objects that make up the scene.
- 2 On the Create panel, choose Helpers.
- 3 Use the tools in the [VRML97 Helpers](#) on page 7301 to add actions and triggers and prepare the scene.

- 4 Choose File > Export and export the scene in the VRML97 format.
- 5 Open the VRML97 file in the browser and test it.

Interface

The VRML97 exporter supports the following:

Lights All VRML97 light types: direct, omni, and spot.

Cameras Free and targeted cameras.

Primitives Sphere, cone, box, and cylinder primitive objects. These objects export as VRML97 primitive objects. This helps reduce the size of VRML97 files.

Animation All position, rotation, and scale animation on objects, as well as animated hierarchies, inverse kinematics, and all controller types. Select [Coordinate Interpolators](#) on page 7292 in the Export dialog to export animated meshes, such as an animated Bend modifier or **character studio** Physique animations.

VRML97 Tips

The following tips will help you make your work look as good as possible and display and move as fast as possible.

Geometry

Use small texture maps, and use them sparingly. Keep the polygon count of your objects down to achieve good performance. A complete scene with a maximum of 5,000 to 10,000 polygons is manageable for most computers. The [Level of Detail](#) on page 7311 helper lets you manage the polygon count of objects in the scene. You can also use the software's Optimize modifier to simplify objects before exporting them to VRML97.

Use primitives whenever possible. For example, a scene containing only a sphere exports to a VRML97 file of about 400 bytes, but if you apply an edit mesh modifier and move one vertex on the sphere, the VRML97 file is about 7,400 bytes.

Use [Show Statistics](#) on page 2577 to keep track of the number of faces in your scene.

Call your VRML97 *.wrl* files from a standard HTML page and constrain the viewer to a limited window on the screen using the embed command. This decreases the number of pixels that must be rendered on every frame and makes the VRML97 environment more responsive. Many users use high resolution (800x600 or more), so the number of pixels during rendering and navigation can be large and the video display may slow down. Frames may be dropped as the browser attempts to keep up its real-time rendering, and navigating the scene will become "chunky." Use the embed command to avoid this, for example, `<embed SRC=myworld.wrl WIDTH=300 HEIGHT=200>`

Hide faces on an object in the software, then export the object. The hidden faces appear as a hole in the object. While the VRML97 plug-in can export hidden objects, it does not export hidden faces. Hide faces that you know will never be visible in the scene, such as the backs of objects or the bottom faces of objects resting on a surface.

Use instances to reduce file size for objects that have the same geometry.

Whenever you use a Mirror transform, use the Reset Transform utility immediately afterward. You can also use a Normal modifier immediately followed by Unify Normals. VRML97 does not allow mirror transforms (negative scales). The Reset Transform utility modifies the data in the actual mesh object to create the mirroring effect.

Don't change units when modeling for VRML97. To model in meters, keep the units set to the default and use one world unit as one meter.

Animation

Beware of large file sizes when you use transform animation and coordinate-interpolated animation. The VRML97 plug-in exports transform animation (move, rotate, and scale), and coordinate-interpolated animation. For example, you can animate modifiers such as Taper and Bend and you can animate changing parameters, such as increasing or decreasing the radius of a sphere.

When scenes using the Inherit Links function are exported to VRML97, child objects always inherit their parents' transforms. Inverse kinematics export correctly to VRML97 with the exception of the Inherit Links function, which determines whether child objects inherit the transforms of parent objects.

Always use TCB controllers for VRML animations. These controllers provide precise control and generate the smallest possible file size. Other kinds of controllers, such as the default Bezier controller, create larger VRML97 files that do not perform as well.

Make sure your animations never change the face or vertex count over time. VRML97 can not add or delete faces or vertices over time. CoordinateInterpolators support morphing a mesh only, not changing the number of vertices or faces.

To trigger an animation that is not on an object at the top-level of the software's linking hierarchy, use a TimeSensor helper object. If you trigger an animation directly from a TouchSensor or ProximitySensor, without a TimeSensor, you can animate only top-level objects. Animating from TimeSensors does not have this limitation.

Turn off the Generate Primitives toggle in the Export dialog if you animate the parameters of primitives (like the radius of a sphere), and want the animation exported with CoordinateInterpolators. This applies to box, sphere, cylinder and cone primitives only.

Materials

You can export only standard and multi/sub-object materials, and only the following components of the material:

- Diffuse, ambient, and specular color
- One texture map, which must be in the Diffuse channel
Use JPEG or PNG format for your maps, because they are recognized by all VRML97-compliant browsers and generally create the smallest files. (Some older browsers may recognize GIF format and not PNG.) Multi/sub-object materials export colors and textures. If an object has a multi/sub-object material with textures, it exports as separate objects in VRML97, since VRML97 does not support more than one texture map per object. Texture maps slow down the browser and increase download time. Use them sparingly.
- Shininess (but not shininess strength)
- Opacity
- Wire frame

Make sure that all large flat surfaces have enough vertices in them that a few vertices can be seen from all reasonable vantage points in your scene. Some browsers cannot display textures on an object where all of its vertices are outside the current viewport.

If you have several lights in you scene, lower the default multiplier value on all the lights in the scene. Lights can oversaturate the scene and make all your

geometry wash out toward white. Always add at least one camera and one light to a scene exported to VRML97.

Helper Objects

Insert VRML helper objects into your scene in the top viewport. You can insert VRML helper objects in any view, but if you insert them in the top viewport, they appear properly oriented in the front viewport.

VRML97 Specification

You can find the complete VRML97 specification at <http://www.web3d.org/x3d/vrml/index.html>.

This document describes the entire VRML97 language and provides technical details on the behavior of exported VRML97 worlds.

VRML97 Helper Objects

Create panel > Helpers > VRML97 > Object Type rollout

The VRML97 helpers let you create online 3D scenes and interaction using Virtual Reality Markup Language. Insert a VRML 97 Helper into the scene by clicking and dragging at the desired location.

NOTE Some helper objects (for example, Billboard and Level Of Detail) are position-sensitive, so be careful how and where you insert them. Usually, you have the most control by creating the helper object in the Top viewport.

[Anchor VRML97 Helper](#) on page 7302

[ProxSensor VRML97 Helper](#) on page 7304

[NavInfo VRML97 Helper](#) on page 7306

[Fog VRML97 Helper](#) on page 7307

[Sound VRML97 Helper](#) on page 7308

[LOD VRML97 Helper](#) on page 7311

[TouchSensor VRML97 Helper](#) on page 7313

[TimeSensor VRML97 Helper](#) on page 7315

[Background VRML97 Helper](#) on page 7317

[AudioClip VRML97 Helper](#) on page 7320

[Billboard VRML97 Helper](#) on page 7322

[Inline VRML97 Helper](#) on page 7323

Anchor VRML97 Helper

Create panel > Helpers > VRML97 > Object Type rollout > Anchor

The Anchor rollout lets you specify a click-to-play trigger in the scene. This trigger will be linked to a currently existing object in the scene. This allows you to add links to other HTML pages, VRML97 worlds, or alternate cameras in your VRML97 world.

Procedures

To set up an Anchor to jump to another VRML world:

- 1 Add an Anchor helper object by clicking the Anchor button and then dragging in the Top viewport to create its icon.
- 2 Pick a Trigger Object in the scene that will be the object the viewer clicks while browsing.
- 3 Choose Hyperlink Jump and designate a URL to jump to.
- 4 When the user clicks the Trigger Object geometry, the browser will replace the current scene with the designated URL.

Interface

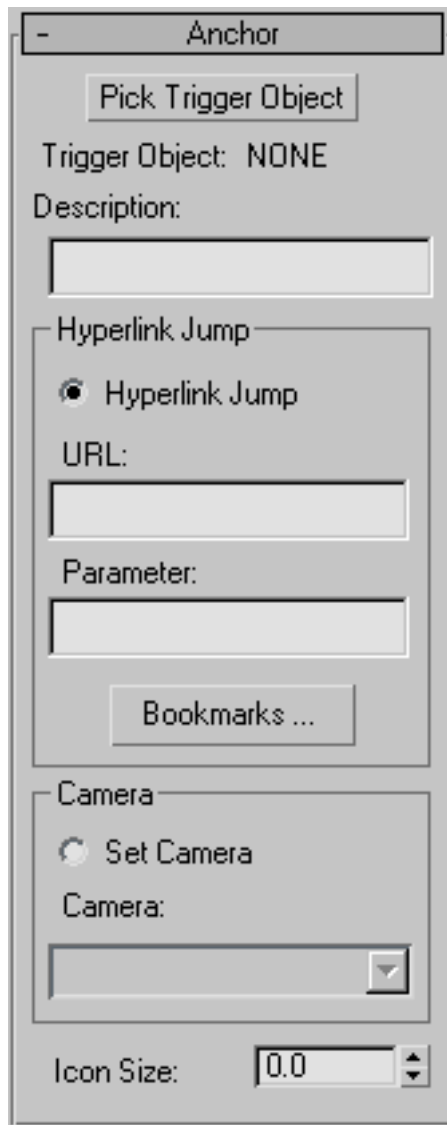

The Anchor rollout contains the following options:

Pick Trigger Object Specifies the geometry that will be the trigger for this anchor. Click this button, then select the geometry.

Description Lets you enter a text description or message that will appear in the browser's status bar when the mouse is over an object that has an Anchor action defined for it.

Hyperlink Jump Creates an Anchor that jumps to a URL.

URL Specifies the location for Hyperlink Jump. Use your Bookmarks list, or enter a location manually. If the URL points to another VRML97 world (a *.wrl* file) you can append "#CameraName" to the end of the URL to have the browser use the viewpoint named "CameraName" as the initial view.

Bookmarks Lets you select a URL location from a list of bookmarks. Click Import List to import the list of bookmarks defined in your browser, or manually enter new URLs into the list.

Parameter Lets you specify additional browser parameters for the hyperlink jump. See the [VRML97 specification](#) on page 7301 for the uses of this field.

Set Camera Creates an Anchor that jumps to a given camera in the current VRML97 world.

Camera Specifies the name of the camera for Set Camera.

Icon Size Determines the size of the helper in the scene.

ProxSensor VRML97 Helper

Create panel > Helpers > VRML97 > Object Type rollout > ProxSensor

The ProxSensor helper creates a VRML97 ProximitySensor node. This lets you set up a rectangular region in space, so that entering the region in a VRML97 browser starts a set of objects animating.

Procedures

To create a Proximity Sensor object:

- 1 Add a Proximity Sensor object by clicking the ProxSensor button and then click-dragging in the Top viewport to create its icon.
- 2 Select the geometry, camera, or sound to control.
When the user navigates inside the box, the specified objects animate or the sound plays.

Interface

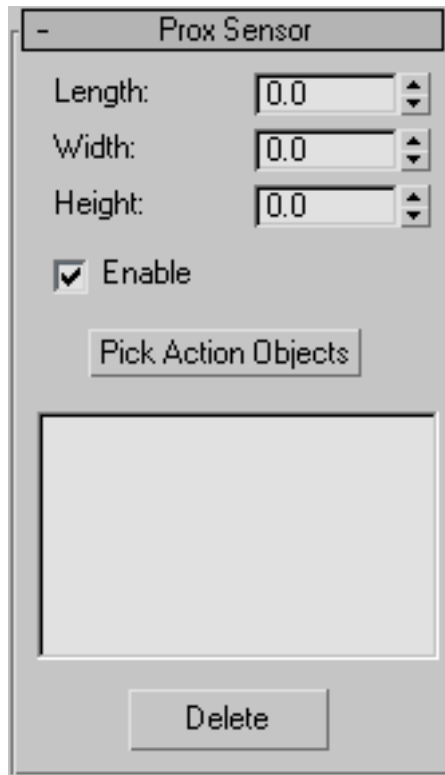

The Prox Sensor rollout contains the following options:

Length/Width/Height Specifies the dimensions of the bounding box that triggers the action.

Enable Activates the Proximity Sensor. When this check box is turned off, the sensor has no effect, even if objects have been selected.

Pick Action Objects Specifies the objects in the scene to control with this helper. The objects can be animated geometry, cameras, lights, or AudioClips. Click this button then click the objects in the viewports.

Delete Deletes an object from the list of picked objects.

NavInfo VRML97 Helper

Create panel > Helpers > VRML97 > Object Type rollout > NavInfo

The NavInfo helper lets you create a VRML97 NavigationInfo node. This tells the browser how to navigate around the VRML97 world.

Procedures

To create a NavInfo helper:

- 1 Add a NavInfo helper by clicking the NavInfo button and then click-dragging in the Top viewport to create its icon.
- 2 Use the controls to adjust the behavior of the helper.

Interface

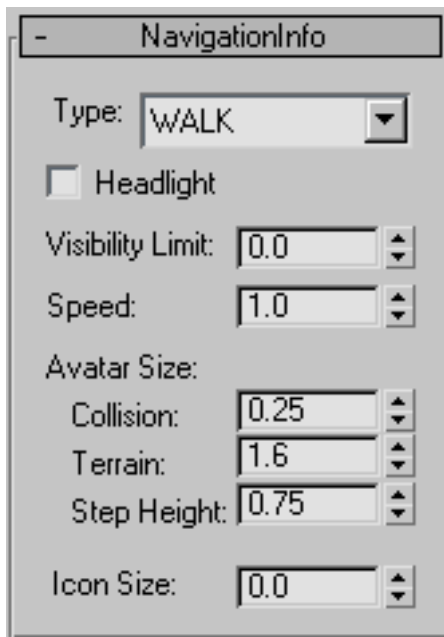

The NavigationInfo rollout contains the following options:

Type Specifies the type of movement (Walk, Examine, Fly, and None) for navigating the world. Implementation of these movement types may vary from browser to browser.

Headlight Places a directional light at the viewpoint. The light always points in the direction the user is looking.

TIP Don't use this option if you have lights in the scene.

Visibility Limit Sets the far clipping plane. Any geometry beyond this point is invisible. The smaller this value is, the closer the clipping plane is to the camera. The larger this value is, the more of your scene is visible to the camera. A value of 0 turns off the effect, making everything in the scene visible. Use this option to show just part of large scenes.

Speed Determines the speed of navigation in units per second. Use this option to allow the user to travel faster, if you're building a large world (like a cityscape), and slower, if you're building a small world (like a room).

Avatar Size Specifies the user's physical dimensions in the world, to detect collision distance and follow terrain.

Collision Specifies the allowable distance between the user's position and any collision geometry before a collision is detected. For example, you can set this so that a collision is detected one unit in front of a wall.

Terrain Specifies the height above the surface to maintain when following terrain.

Step Height Specifies the highest object that can be "stepped over." If an object like a staircase has steps that are lower than this value, the user can go up.

Icon Size Adjusts the size of the helper object in the viewports.

Fog VRML97 Helper

Create panel > Helpers > VRML97 > Object Type rollout > Fog

The Fog helper lets you specify the color and range of fog in your VRML97 world. You can simulate atmospheric effects by blending objects with a color based on the objects' distances from the viewer. For the best visual results, the background (which is unaffected by the fog) should be the same color as the fog.

Procedures

To create a VRML 97 Fog helper:

- 1 Add a Fog helper by clicking the Fog button, then click-drag in the Top viewport to create its icon.
- 2 Use the controls to adjust the type of fog in your VRML environment.

Interface

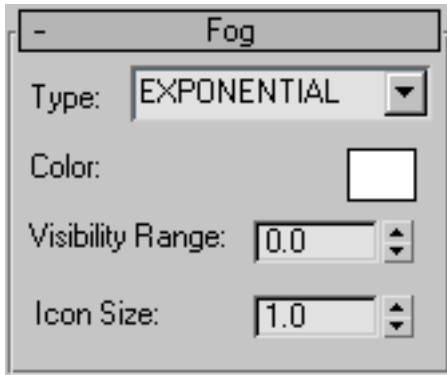

The Fog rollout contains the following options:

Type Specifies the fog type (linear or exponential). Linear means that the amount of blending is a linear function of the distance, resulting in a depth-cueing effect. Exponential uses an exponential increase in blending, resulting in a more natural fog appearance.

Color Lets you select the fog color from the Color Selector dialog.

Visibility Range Specifies the distance from the viewer at which objects are totally obscured by the fog. The smaller this value is, the closer the fog is to the camera, and the less your scene is visible. The larger this value is, the more of your scene is visible to the camera. A value of 0 turns off the effect, making everything in the scene visible. A value of 0 means that there is no fog effect.

Icon Size Adjusts the size of the helper object in the viewports.

Sound VRML97 Helper

Create panel > Helpers > VRML97 > Object Type rollout > Sound

The Sound helper lets you place 3D (spatial) or ambient sounds in a scene. The sound may be located at a point and emit sound in a spherical or ellipsoid pattern. The ellipsoid is pointed in a particular direction and may be shaped to provide more or less directional focus from the location of the sound. The sound node may also be used to describe an ambient sound that tapers off at a specified distance from the sound node.

The red ellipsoid of the helper represents the outermost range for which the sound can be heard. The blue ellipsoid represents the range of the maximum strength of the sound. The area between the red and blue ellipsoids represents a falloff area in which the volume varies in intensity. The helper's arrow points in the direction toward which the sound is emanating.

NOTE The Sound helper object must be linked to an existing audio clip in the scene. Therefore, you must have an [AudioClip](#) on page 7320 helper object in the scene in order for the Sound helper to play.

Procedures

To create a Sound helper object:

- 1** Add a Sound helper by clicking the Sound button, then click-drag in the Top viewport to create its icon.
- 2** Press Pick Audio Clip and select an AudioClip helper object in the scene.
- 3** Rotate the icon to determine the direction in which the sound is emanated.
- 4** Use the controls to adjust the range and strength of the playback sound.

Interface

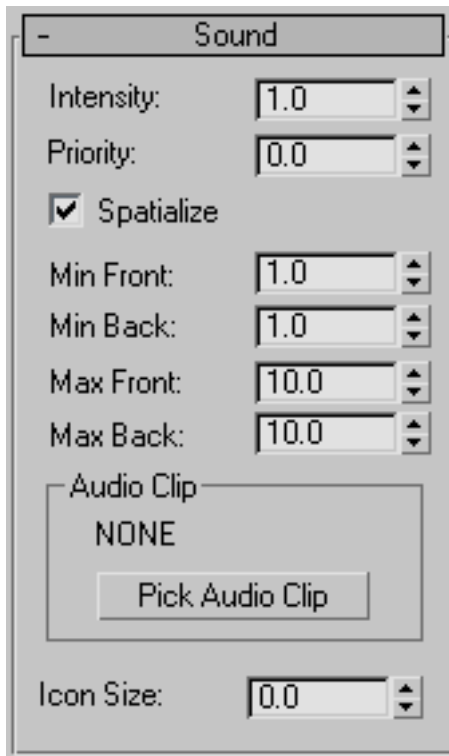

The Sound rollout contains the following options:

Intensity Sets the loudness of the sound. 1.0 is full volume.

Priority Sets the relative importance of the sound, if you have more than one sound in the scene and the browser cannot play all of them. 0 is least important. 1 is most important.

Spatialize Makes the sound 3D. A spatial sound has a particular source location in the scene. If this box is turned off, the sound is ambient.

Min Back/Front, Max Back/Front Displays red and blue ellipsoids that allow you to set the area of the sound effect. Inside the blue ellipsoid, the sound is at full volume. Outside the red ellipsoid, the sound is inaudible. Between the blue and red ellipsoids is a falloff area in which the volume varies in intensity.

Pick Audio Clip Lets you choose an audio clip. Click this button, then click an AudioClip helper object. The audio clip must already be in the scene and have a sound file associated with it.

Icon Size Determines the size of the helper in the scene.

LOD VRML97 Helper

Create panel > Helpers > VRML97 > Object Type rollout > LOD

The Level of Detail (LOD) helper lets you specify objects with varying face counts that are appropriate for different viewing distances. Browsers display the less detailed objects when the viewer is far away from them and substitute the more detailed objects at closer ranges.

Use LOD objects to speed up rendering of scenes in which highly detailed objects are often far away from the viewer.

Objects used for LOD do not have to be of the same type or size, so you can accomplish a crude form of morphing by using different objects as the LOD components. For example, a tree might seem to grow if taller trees with more limbs are substituted as the viewer gets closer.

Procedures

To create a Level of Detail helper object:

- 1 Create the objects to which you want to add level of detail.
- 2 Click the LOD button.
- 3 Click and drag in the scene to create a helper object.
- 4 Add the objects to the list with Pick Objects.
- 5 Use the Hide and Unhide commands, or the **H** key, to help pick the objects and add them to the LOD list.
- 6 Select the objects in the list and use the Distance spinner to set the distance.

To create all the objects and the LOD helper object at exactly the same coordinates:

- 1 Create the LOD helper object.

- 2 You can use Snap and create the helper object at the origin (0,0,0 coordinates), or use the Keyboard Entry rollout for a Standard Primitive to specify an exact object origin.
- 3 Create the object with the most detail at the same coordinates. Name it (for example, hicapsule).
- 4 Choose Edit/Clone.
In the Clone Options dialog, choose Copy and name the new object (for example, medcapsule).
- 5 Repeat step 3 to create the other objects (for example, locapsule).
For the medium and low resolution objects, apply an Optimize modifier to reduce the face count.
For primitives, you can reduce the face count by changing the creation parameters in the modifier stack.

Interface

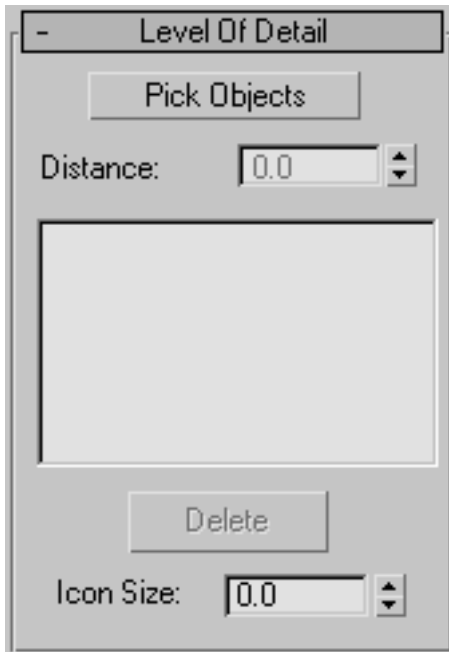

The Level of Detail rollout contains the following options:

Pick Objects Selects objects of different face counts to substitute for the LOD helper object. Create all the objects and the LOD helper object at exactly the same coordinates.

Distance Sets the distance from the camera at which the user sees the selected object. The distance specified for the object appears next to the object name.

For example:

hicapsule - 100 medcapsule - 300 locapsule – 500

Hicapsule is displayed when the distance between it and the camera is within 100 units. The lower resolution object (medcapsule) is displayed when the camera is between 100 and 300 units. The lowest resolution object (locapsule) is displayed when the camera is beyond 300 units. The greatest distance (500 in this case) is not actually used, but must be supplied.

Delete Deletes the selected object from the list.

Icon Size Sets the size of the LOD helper object.

TouchSensor VRML97 Helper

Create panel > Helpers > VRML97 > Object Type rollout > TouchSensor

The TouchSensor helper lets you set up an object so that selecting it in a VRML97 browser starts a set of objects animating.

Procedures

To set up an object as a TouchSensor trigger:

- 1 Add a Touch Sensor object by clicking the Touch Sensor button and then click-dragging in the Top viewport to create its icon.
- 2 Select the geometry to control.
When the user clicks the trigger geometry, the geometry, camera or light animates, or the sound plays.

Interface

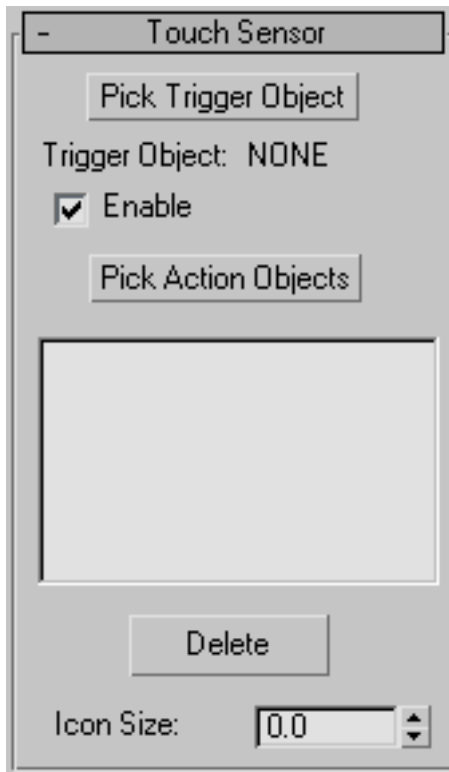

The Touch Sensor rollout contains the following options:

Pick Trigger Object Specifies the geometry that will be the trigger for this TouchSensor. Click this button, then select the geometry.

Enable Activates the Touch Sensor. When this box is turned off, the sensor has no effect, even if objects have been selected.

Pick Action Objects Specifies the objects in the scene to control with this helper.

Delete Deletes an object from the list of picked objects.

Icon Size Determines the size of the Touch Sensor helper in the scene.

TimeSensor VRML97 Helper

Create panel > Helpers > VRML97 > Object Type rollout > TimeSensor

The TimeSensor helper lets you add time-based animation controls, such as the start and end frames for a particular object's animation, and looping. Use this helper to split up an object's animation keys over several triggers, to automatically start an animation upon loading the *.wrl* file, or to make animation endlessly loop.

Procedures

To assign an object to a TimeSensor helper:

- 1 Add a Time Sensor object by clicking the Time Sensor button and then click-dragging in the Top viewport to create its icon.
- 2 Press Pick Objects and select the (animated) geometry to control.
- 3 Use the controls to adjust the start and end times of the animation, and to loop the animation.

Interface

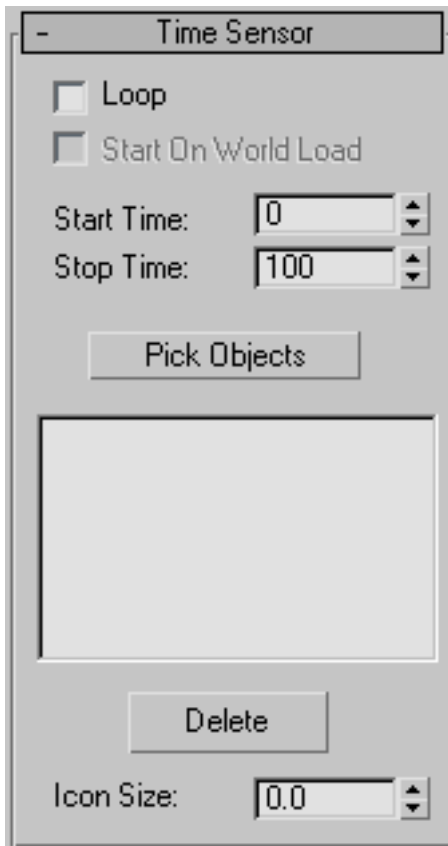

The Time Sensor rollout contains the following options:

Loop Repeats the animation from the start-time frame to the stop-time frame.

Start on World Load Starts the animation so that it will be running when the file is loaded into the browser.

NOTE This option is only available when Loop is turned on. Otherwise, the animation will start and stop at the specified times.

Start Time/Stop Time Specifies the range of frames to play.

NOTE If the start time is after the end time, the animation will play from the earliest frame to the last frame. It will not play the animation backward.

Pick Objects Lets you select the objects to control with this TimeSensor.

Delete Deletes an object from the list of picked objects.

Icon Size Adjusts the size of the helper object in the viewports.

Background VRML97 Helper

Create panel > Helpers > VRML97 > Object Type rollout > Background

The Background button displays the Sky Color, Ground Color, and Images rollouts. Use these rollouts to specify colors and images for the sky and ground in your VRML97 world.

Procedures

To create a Background helper object:

- 1** Add a Background helper object by clicking the Background button, then click-drag in the Top viewport.
- 2** Use the controls to adjust the colors and layout of the background.

Interface

Sky Colors rollout

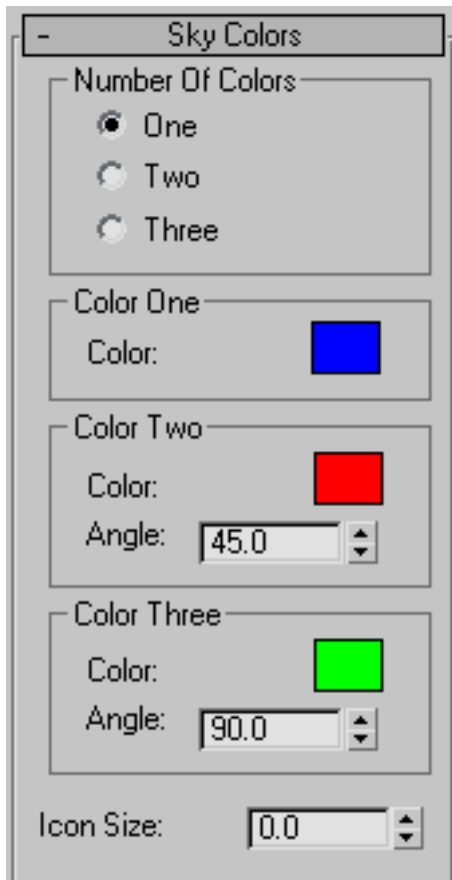

Lets you provide a colored background to the world's sky using a gradient of up to three colors. The sky is an infinite sphere that encloses the objects of the scene.

Number of Colors Specifies whether the sky is one solid color or a gradient of two or three colors.

Color One/Two/Three Lets you select the colors from the Color Selector. Color One is the base color.

Angle Specifies the angle at which Color Two and Color Three merge with the base color, in degrees from the North pole of the sky (straight up from the viewer).

Icon Size Adjusts the size of the helper object in the viewports.

Ground Colors rollout

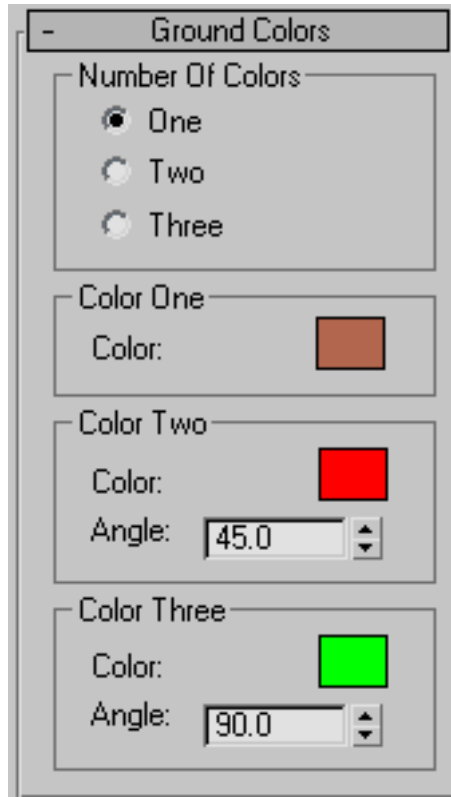

Lets you provide a colored background to the world's ground plane using a gradient of up to three colors. The ground appears inside the sky sphere and below the objects of the scene.

Number of Colors Specifies whether the ground is one solid color or a gradient of two or three colors.

Color One/Two/Three Lets you select the colors from the Color Selector. Color One is the base color.

Angle Specifies the angle at which Color Two and Color Three merge with the base color, in degrees from the South pole of the sky (straight down from the viewer).

Images rollout

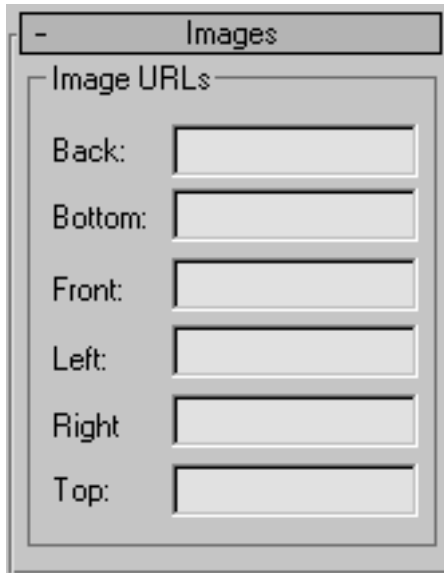

Lets you specify a set of images that define a background panorama between the ground/sky backdrop and the objects in the scene. The panorama consists of six images, each of which is mapped onto a face of an infinitely large cube centered in the local coordinate system.

Image URLs Specifies the location/file names of the images to use. The images can be JPEG files or PNG files with or without transparency. Some browsers also support GIF files.

See the [VRML97 specification](#) on page 7301 for diagrams of the typical image configuration.

AudioClip VRML97 Helper

Create panel > Helpers > VRML97 > Object Type rollout > AudioClip

The AudioClip rollout lets you specify the name and characteristics of an audio file that can be used by the Sound helper.

Procedures

To create an AudioClip helper:

- 1 Press the AudioClip button, and click-drag in the Top viewport to create the helper.
- 2 Enter the location of the sound file (*.wav* or *.mid*) you want to use in the URL text box.

Interface



The rollout contains the following options:

URL Specifies the location/file name of the sound to use. Either *.wav* (waveform) or *.mid* (MIDI) files can be used, but MIDI sound files may not be spatialized. Some browsers do not support MIDI.

Description Lets you enter a text description of the sound, which is displayed by some browsers.

Pitch Sets the relative pitch of the sound. 1.0 is normal pitch, and 0.5 is one octave lower than normal.

Loop Repeats the sound.

Start on World Load Starts playing the sound as soon as the world is loaded into the browser.

Icon Size Determines the size of the AudioClip helper in the scene.

Billboard VRML97 Helper

Create panel > Helpers > VRML97 > Object Type rollout > Billboard

The Billboard helper lets you create geometry that is camera-aligned in the VRML97 browser. The objects always align to the viewpoint in the VRML97 browser.

Any geometry linked to the Billboard helper will rotate about the local Z axis of the helper object to face the viewer. Since it rotates about the location of the Billboard, it is best to center the Billboard on the object that you will link to it.

The direction of the negative Y axis of the object, which will be its front, is aligned with the negative Y axis of the helper, and will be the Billboard surface that always faces the viewer. This is the side usually seen from the default camera position.

Procedures

To create a Billboard helper object:

- 1 Press the Billboard button and click-drag in the Top viewport to create the helper.
- 2 Link object(s) to the billboard to keep them aligned with the camera.

Interface

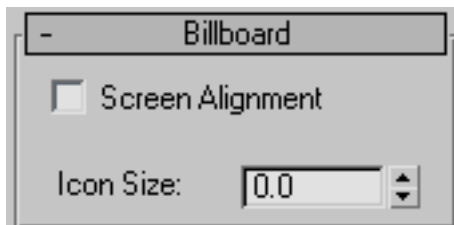

The Billboard rollout contains the following option:

Screen Alignment Keeps the geometry linked to the Billboard helper aligned, even when the viewer elevates, pitches, and rolls.

Icon Size Determines the size of the Billboard helper in the scene.

Inline VRML97 Helper

Create panel > Helpers > VRML97 > Object Type rollout > Inline

The Inline helper lets you reference another VRML97 file that is included in your world when you load it into your VRML97 browser. These inline objects are like instance objects, but they function at the browser level.

Procedures

To create an Inline helper object:

- 1 Click the Inline button.
- 2 Click and drag in one of the viewports.
You can modify the helper object with the tools in the VRML Inline rollout.

Interface

If you create the objects in the scene to be inserted off-center (away from the origin), they will appear in the browser off-center as well. Align the original scene and the scene to be inserted correctly, in relation to the origin.

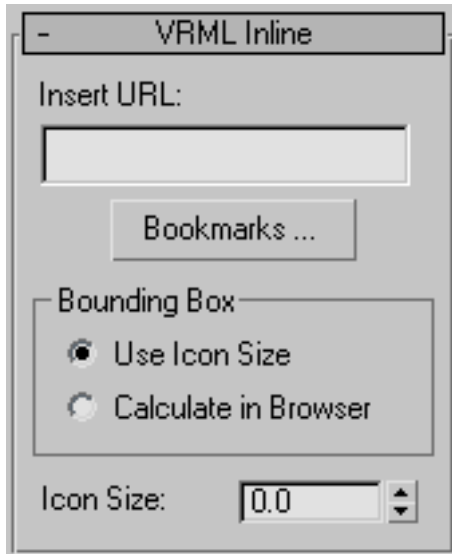

The VRML Inline rollout contains the following options:

Insert URL Specifies the URL of the *.wrl* files to insert in place of the helper object. The URL must be another VRML97 file.

Bookmarks Displays a dialog that lets you select a location from a list of bookmarks. Click Import List to import the list of bookmarks defined in your browser. Most browsers store bookmarks in a file called *bookmark.htm*.

Bounding Box Specifies whether an explicit bounding box size will be exported. If you select “Use Icon Size,” the diameter of the icon will be written into the VRML97 file for the width, length, and height of the bounding box; the actual contents of the inline file should fit within that bounding box. If you select “Calculate in Browser,” no bounding box size is exported and the VRML browser will determine the size of the inline geometry.

Icon Size Sets the size of the helper object. You can transform this object like any other object in the software. The scene that replaces the helper object will be moved, rotated, or scaled in the same manner. The size shown is the radius of the icon.

Image File Formats

Image files, also known as bitmaps, have a variety of uses in 3ds Max scenes. You can use bitmaps as textures for materials, as backgrounds to viewports,

as environment maps, as Image Input events in Video Post, or as images projected from a light.

An image file can be a single still image, or a sequence of images that form a video sequence or animation. When you assign an animation for use as a bitmap, then the image changes over time when you render the 3ds Max scene.

NOTE Bitmaps are reloaded automatically after they have been changed and resaved by a graphic editing program. See the Reload Textures On Change toggle in [File Preferences](#) on page 7750.

When you render a scene, you can render a still image or an animation. You can render to most of the formats listed below. Some of the formats support various options. If there are output options, these appear in a dialog that is described along with the image file's format.

These are the image file formats supported by 3ds Max:

[AVI Files](#) on page 7326

[BMP Files](#) on page 7328

[CIN \(Kodak Cineon\) Files](#) on page 7328

[CWS \(Combustion Workspace\) Files](#) on page 7329

[DDS Files](#) on page 7330

[EPS and PS \(Encapsulated PostScript\) Files](#) on page 7332

[GIF Files](#) on page 7334

[HDRI Files](#) on page 7334

[IFL Files](#) on page 7339

[IMSQ Files](#) on page 7346

[JPEG Files](#) on page 7347

[MOV \(QuickTime Movie\) Files](#) on page 7348

[MPEG Files](#) on page 7348

[OpenEXR Files](#) on page 7349

[PIC Files](#) on page 7359

[PNG Files](#) on page 7360

[PSD Files](#) on page 7361

[RLA Files](#) on page 7364

[RPF Files](#) on page 7366

[RGB \(SGI Image\) Files](#) on page 7369

[TGA \(Targa\) Files](#) on page 7370

[TIFF Files](#) on page 7372

[YUV Files](#) on page 7374

NOTE To save loading time, if a map with the same name is in two different locations (in two different paths), it is loaded only once. This poses a problem only if your scene includes two maps that have different content but the same name. In this case, only the first map encountered will appear in the scene.

AVI Files

The AVI (Audio-Video Interleaved) format is the Windows standard for movie files. The *.avi* file-name extension indicates a Windows AVI movie file.

3ds Max creates an AVI created when you [make a preview animation](#) on page 6422. You can also render your final output to an AVI file. Although 3ds Max produces its highest-quality output by rendering single-frame TGA files or rendering directly to a digital disk recorder, you can still get good results rendering AVI files.

AVI files can be used as input to 3ds Max in several ways, for example:

- As animated materials in the Material Editor
- As viewport backgrounds for rotoscoping
- As input images for compositing in Video Post

Interface

When AVI is the chosen output format, clicking Render or Setup on the [Render Output File dialog](#) on page 6086 displays the Video Compression dialog.

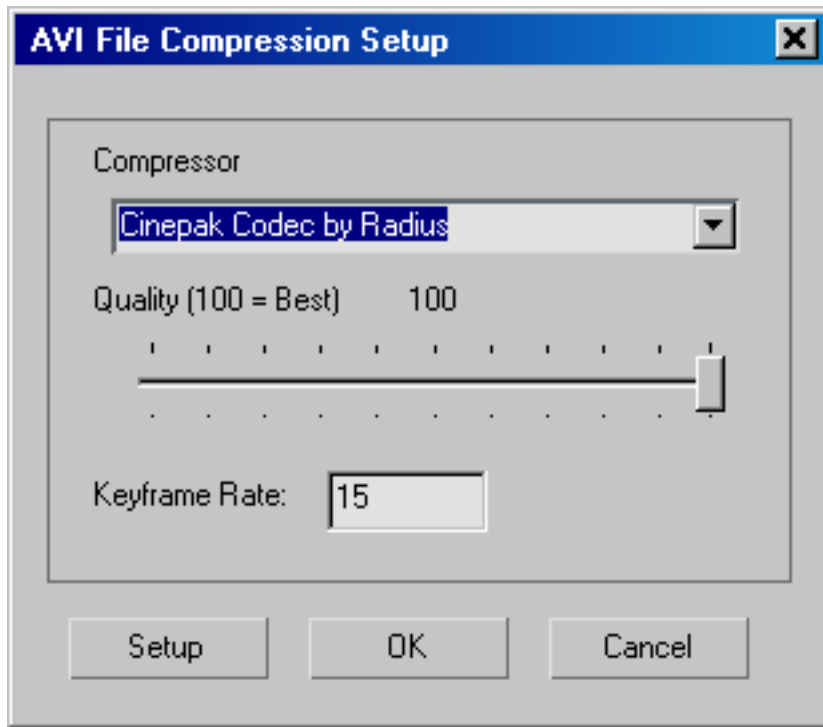

Compressor Use the drop-down list to choose the [codec](#) on page 7936 (compressor/decompressor) you want to use to compress the file. You can use any codec that's installed on your system.

Alternatively, you can render uncompressed frames and then use an external application to compress the animation. Video-file compression is a complex subject, with many aspects to consider.

Compression Quality Available only for certain codecs. When available, use the slider to specify the quality you want. The higher you set the quality, the larger the file size will be.

Keyframe Rate Available only for certain codecs. When available, use this setting to specify the interval between the delta keyframes used to compare one frame with another and generate in-between frames. Too large an interval will create loss of quality in the AVI file as a whole.

Setup Available only for certain codecs. Click this button to see any additional options that are specific to the codec. These are vendor specific and vary from codec to codec.

BMP Files

BMP files are still-image bitmap files in the Windows bitmap (.*bmp*) format.

Interface

When BMP is chosen as the output format, clicking Render or Setup on the [Render Output File dialog](#) on page 6086 displays the BMP Compression dialog.

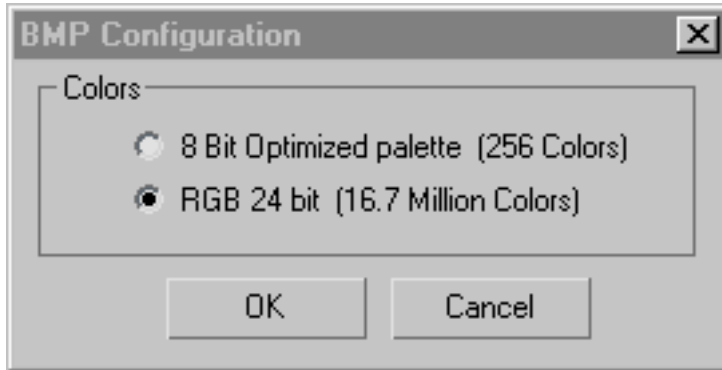

8 Bit Optimized palette (256 Colors) Choose to render a smaller, 8-bit color file.

RGB 24 bit (16.7 Million Colors) Choose to render a larger, true color (24-bit) file.

CIN (Kodak Cineon) Files

A file format that stores a single frame of a motion picture or video data stream. Each frame is saved as cineon version 4.5 with a CIN file-name extension. The file contains no user-defined data such as a thumbnail, and supports 10-bit log, and three colors per pixel. Alpha channels are not supported.

Interface

When CIN is chosen as the output format, clicking Render or Setup on the [Render Output File dialog](#) on page 6086 displays the Cineon Image File Format dialog.

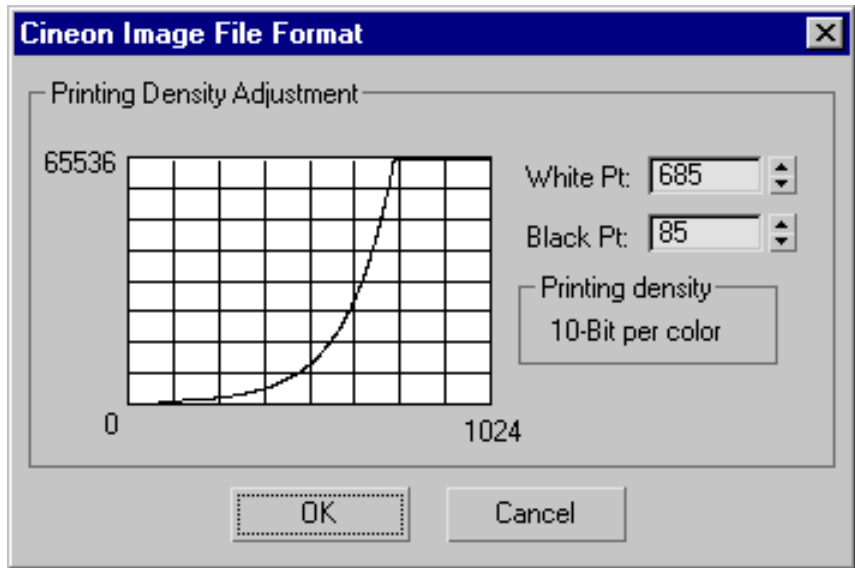

Printing Density Adjustment Represents the transfer function from printing density (10-bit log) to 16-bit linear with the white point mapped to a maximum code value of 65535.

Conversion of logarithmic printing density to a linear representation requires both a scaling and an anti-log operation. With 16-bits linear, it is possible to maintain the full printing density range. The 90% white card at code value 685 is mapped to maximum code value of 65535.

The **White Pt** and **Black Pt** spinners let you adjust the 90% white code and the 2% black code.

CWS (Combustion Workspace) Files

The file format for the Combustion™ software from Autodesk. CWS is a resolution-independent, vector/raster file format.

You can use CWS files in conjunction with the [Combustion map](#) on page 5811. You can't use a CWS file as a general-purpose bitmap. You can also generate a CWS file by using the [Render Elements option](#) on page 6336 when you render a scene.

IMPORTANT Only Combustion 2.1 and later formats are supported. Maps in the Combustion 1 format are not supported in 3ds Max.

DDS Files

The DirectDraw® Surface (DDS) file format is used to store textures and cubic environment maps, both with and without mipmap levels. This format can store uncompressed and compressed pixel formats, and is the preferred file format for storing DXTn compressed data. Microsoft® is the developer of this file format.

You can use DDS files as texture maps.

With Direct3D 9, you can render to the DDS format. (With DX8 or DX9, DDS files can be rendered using the [Metal Bump shader](#) on page 5761, as well.) If your system does not support DX9, you can use DDS files as textures, but you can't render them.

Interface

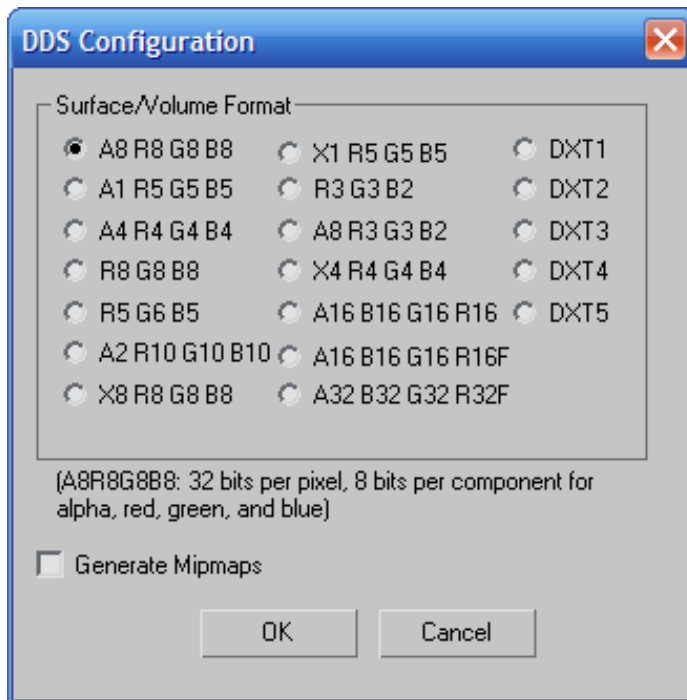

Surface/Volume Format group

DDS supports a variety of output formats, which vary in the number of pixels allocated to the red, green, and blue (RGB) channels, to the optional alpha channel (transparency), and to possible unused bits. There is also a set of compressed formats.

- **A8 R8 G8 B8** 32 bits per pixel: 8 bits each for the RGB and alpha channels.
- **A1 R5 G5 B5** 16 bits per pixel: 5 bits each for the RGB channels, and one bit for the alpha channel.
- **A4 R4 G4 B4** 16 bits per pixel: 4 bits each for the RGB and alpha channels.
- **R8 G8 B8** 24 bits per pixel: 8 bits each for the RGB channels; no alpha.
- **R5 G6 B5** 16 bits per pixel: 5 bits each for the R and B channels, 6 bits for the G channel; no alpha.
- **A2 R10 G10 B10** 32 bits per pixel: 10 bits each for the RGB channels; 2 bits for the alpha channel.
- **X8 R8 G8 B8** 32 bits per pixel: 8 bits each for the RGB channels; 8 bits unused; no alpha.
- **X1 R5 G5 B5** 16 bits per pixel: 5 bits each for the RGB channels; 1 bit unused; no alpha.
- **R3 G3 B2** 8 bits per pixel: 3 each for the R and G channels, 2 bits for the B channel; no alpha.
- **A8 R3 G3 B2** 16 bits per pixel: 3 each for the R and G channels, 2 bits for the B channel; 8 bits for the alpha channel
- **X4 R4 G4 B4** 16 bits per pixel: 4 each for the RGB channels and 4 unused bits.
- **A16 B16 G16 R16** 64 bits per pixel: 16 bits each for the RGB and alpha channels.
- **A16 B16 G16 R16F** 64-bit floating-point format using 16 bits each for each channel: alpha, blue, green, red.
- **A32 B32 G32 R32F** 128-bit floating-point format using 32 bits each for each channel: alpha, blue, green, red.
- **DXT1** Compressed format with 1-bit alpha.
- **DXT2** Compressed format with 4-bit [premultiplied alpha](#) on page 8096.

- **DXT3** Compressed format with 4-bit alpha, no premultiplication.
- **DXT4** Compressed format with interpolated premultiplied alpha.
- **DXT5** Compressed format with interpolated alpha but no premultiplication.

Generate Mipmaps When on, mipmaps are generated for the image. Default=off.

Mipmaps are a set of lower-detail bitmaps. The first is half the size of the original image, the next is half the size of that, and so on down to a single pixel. (You can think of them as being arranged like a pyramid.) They are used to optimize display time and reduce [aliasing](#) on page 7904 when the texture is to be displayed at less than full size. For example, if your original DDS image is 512 x 512 pixels, but the area in which it would be displayed is only 100 pixels square, the display device would interpolate between the 128 x 128 mipmap and the 64 x 64 mipmap.

EPS and PS (Encapsulated PostScript) Files

3ds Max can render images to Encapsulated PostScript format files, which have the *.eps* or *.ps* extension.

PostScript is an Adobe page-description language for encoding graphics images. It is supported by many printing devices and is widely used in desktop publishing and graphic design as a means of porting images from one platform to another. You can not view PostScript files with 3ds Max or use them as bitmaps in materials or environments.

Interface

When PostScript is the chosen output format, clicking Render or Setup on the [Render Output File dialog](#) on page 6086 displays the EPS File Output Options dialog.

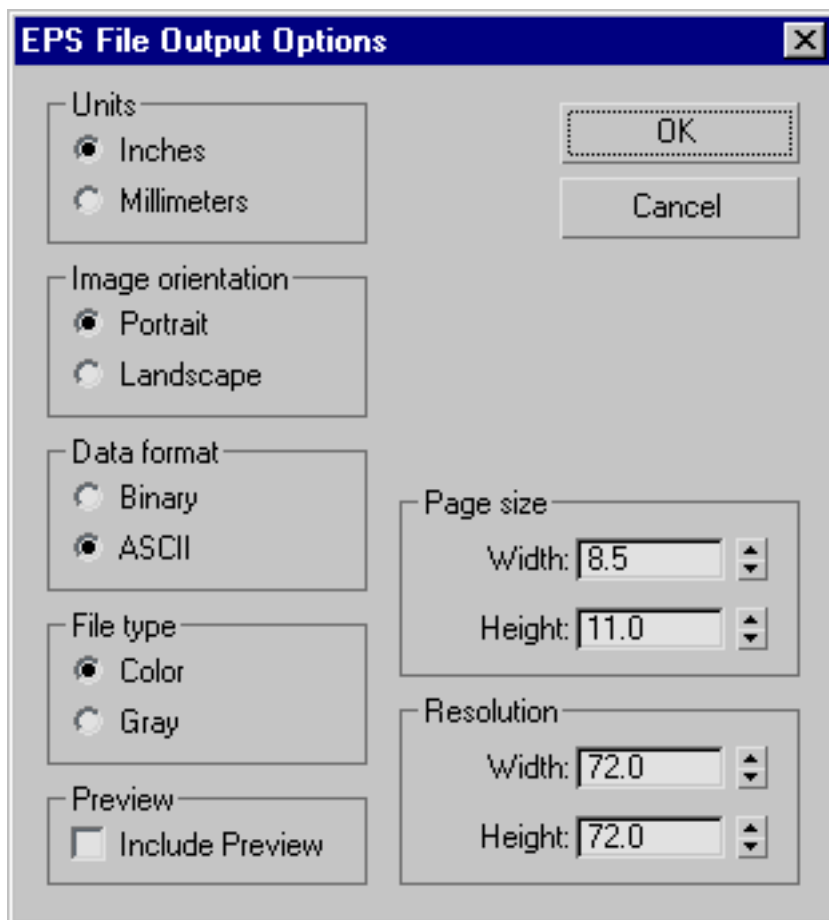

Units Select inches or millimeters.

Image Orientation Select portrait (tall) or landscape (wide).

Data Format Select binary or ASCII.

File Type Select color or grayscale.

Preview Check to generate a thumbnail image so that file browsers can preview the contents of the PostScript file.

Page Size Set width and height measurements.

Resolution Set width and height resolution in dots per inch (dpi).

GIF Files

GIF is an 8-bit (256-color) format developed by Informix for the CompuServe® information service. It was originally designed to minimize file transfer times over telephone lines.

GIF is supported only as an input file format. You can use GIF files as general-purpose bitmaps, but you can't render to a GIF file.

HDRI Files

HDRI is a file format used for high-dynamic-range images. Most cameras don't have the capability to capture the dynamic range (the gamut of luminances between dark and bright regions) that is present in the real world. However, the range can be recovered by taking a series of pictures of the same subject with different exposure settings, and combining them into one image file.

This type of image is called a *high dynamic range image* (HDRI) or *radiance map*. HDRI files have an *.hdr* extension and radiance maps have a *.pic* extension. The file actually contains all the data from all the pictures, so a wide luminance range is present, from bright, white highlights to the darkest black.

HDR files are particularly useful as backgrounds for compositing, and as reflection maps on composited objects. When using a HDR image as a skylight, use the parameters in the Exposure group to control the brightness of the scene.

Procedures

To use a HDR image as a background, or as a diffuse or reflection map:

- 1 In the Material Editor, choose Bitmap as the map type.
- 2 On the Select Bitmap Image File dialog, under Files Of Type, choose Radiance Image File (HDRI). Open the HDR file you would want to use. The HDRI Load Settings dialog appears, with the image displayed in its preview window.
- 3 On the HDRI Load Settings dialog, look at the Measured Min/Max values to see the luminance range for the image.
- 4 Turn on Black Point.

- 5 Adjust the Black Point and White Point values until the red lines on the histogram encompass the majority of the graph, and the preview image is satisfactory.

TIP For the Internal Storage option, use the default choice of 16 bit/chan Linear (48bpp) unless you have a specific reason for doing otherwise.

- 6 When you have finished adjusting values, note the Linear White Point value, and click OK to accept the settings.
- 7 In the Material Editor, expand the Output rollout. Set the RGB Level to the same value as the Linear White Point value on the HDRI Load Settings dialog.

The result is a map with a wide range of deep blacks and very white highlights. If such an image is used as both a background in the rendering and a reflection map on an object, the object will appear to be extremely shiny and reflective.

Interface

HDR Load Settings dialog

When you open a HDR file as a bitmap, the HDR Load Settings dialog appears. This dialog allows you to specify the luminance range to use from the image, and the method for storing the data.

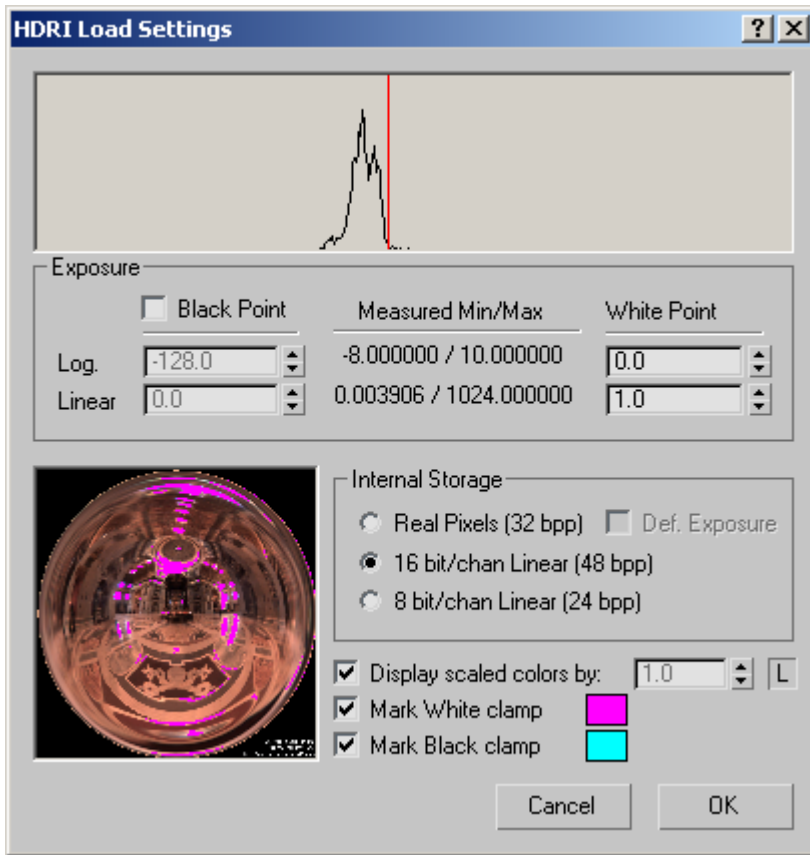

Histogram This graph shows the image's luminance values in a logarithmic scale. The red lines indicate the current Black Point and White Point values. The graph is visible only for luminance levels with substantial representation in the image. In other words, if a luminance level only applies to one or two pixels in the image, there will be no corresponding graph line on the histogram. Compare with Measured Min/Max, which gives the entire range of luminance levels in the image.

In general, the resulting image will have the most dramatic effect when the histogram is used to set the Black Point and White Point range values, rather than using the full range expressed by Measured Min/Max.

Exposure group

Black Point When this option is turned on, you can set the luminance value that you would like to be treated as the darkest color, or “black”. The value can be set as a logarithm (Log) or as a linear value (Linear). All values below this value will be clamped to black. When this option is turned off, the lowest possible value is used as the Black Point.

Measured Min/Max Displays the actual minimum and maximum luminance values in the image, expressed as both the logarithmic and linear values. Using these values for the Black Point and White Point will result in the image's full luminance range being used. However, the histogram might show that the majority of the luminance levels fall into a much smaller range.

White Point Sets the luminance value that you would like to be considered the brightest color, or “white”, either as a logarithm (Log) or linear value (Linear). All luminance values in the image that are above this value will be clamped to white. White pixel values inside HDR files can be much larger than a Linear value of 1.

The image's extended luminance range is used only when the White Point's Linear value is set above 1.0. In other words, setting White Point at or below a Linear value of 1.0 will not use any of the HDR image's special luminance properties, and will give results similar to other bitmap formats such as TIF and JPG.

Log Sets the Black Point or White Point as a logarithmic value ranging from -128 to 127. Changing this value changes the Linear parameter to the corresponding value.

Linear Sets the Black Point or White Point as a linear value ranging from 0 to over 1 trillion. Changing this value changes the Log parameter to the corresponding value.

Preview window Displays the selected HDR image.

Internal Storage group

Real Pixels (32 bpp) Compresses the luminance selections into a color space with 32 bits per pixel. Premultiplied Alpha and Motion Blur do not work with this option.

Def Exposure When on, the image will load as is without applying any changes to the colors. When off, you can use the parameters in the Exposure group to remap colors. Available only with the Real Pixels option.

16 bit/chan Linear (48 bpp) Compresses the luminance selections into 16-bit color space, at 48 bits per pixel. This is the recommended setting. To decompress the luminance for use in the scene, set the RGB Level on the image's **Output rollout** on page 5774 to the same value as the linear white value on this dialog.

8 bit/chan Linear (24 bpp) Compresses the luminance selections into 8-bit color space, at 24 bits per pixel. This compression method uses less memory than other methods, but it is generally not adequate to display the range of luminance in a HDR image, and can result in banding or other artifacts.

Display scaled colors by When on, this value scales the preview image's luminance value by the specified amount.

L Locks the preview luminance scale to the white linear value. When off, you can change the value manually. Default=on.

Mark White clamp Masks the white-clamped values in the preview window with the color indicated by the color swatch. Click the color swatch to change this color.

Mark Black clamp When Black Point is on, this option masks the black-clamped values in the preview window with the color indicated by the color swatch. Click the color swatch to change this color.

HDRI Save Settings dialog

3ds Max can render and save images with 32-bit floating-point channels. Among the useful applications for this type of imagery are:

- **Compositing:** Using 16-bit images in a compositing pipeline can quickly become a problem as colors are manipulated. For example, banding may appear.
- HDR images are not bound to a specific range (e.g., 0-255 or 0-65535); they have a dynamic range. As such, high-contrast and physically accurate values can be stored in 32-bit floating-point pixels.
- Because of their large range of values, HDR images can easily be modified, and effects can be reapplied long after rendering, without affecting the quality of the image. For example, changing the contrast/brightness/exposure of a 16-bit image could cause banding, which would require re-rendering the image. However, the same operation on an HDR image should not affect its quality.

Clicking Save or Setup in the [Render Output File dialog](#) on page 6086 displays the HDR Save Settings dialog.

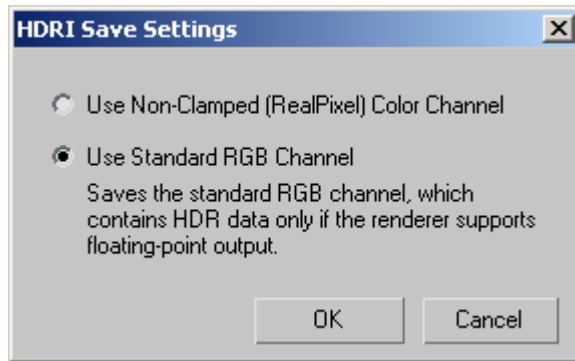

The dialog lets you choose the source of the values used for output:

- Higher dynamic range and color precision than existing 8- and 10-bit image file formats.
- Support for 16-bit floating-point pixels. The pixel format, called "half," is compatible with the half data type in NVIDIA's Cg graphics language and is supported natively on their new GeForce FX and Quadro FX 3D graphics solutions.
- Multiple lossless image compression algorithms. Some of the included codecs can achieve 2:1 lossless compression ratios on images with film grain.
- Extensibility. New compression codecs and image types can easily be added by extending the C++ classes included in the OpenEXR software distribution. New image attributes (strings, vectors, integers, etc.) can be added to OpenEXR image headers without affecting backward compatibility with existing OpenEXR applications.

IFL Files

An IFL (Image File List) file is an ASCII file that constructs an animation by listing single-frame bitmap files to be used for each rendered frame. When you assign an IFL file as a bitmap, rendering steps through each specified frame, resulting in an animated map.

(In a similar way, if you assign an AVI file or MOV file as a bitmap, rendering steps through each frame of the animation.)

For example, if you assign a 10-frame animation of a blinking red "Danger" sign to a material's diffuse component, apply the material to a cube, and then render a 30-frame animation, the cube displays the blinking red Danger animation three times.

The *.ifl* file lists the bitmap files to be used with each frame. You can append an optional numeric argument to each file name to specify the number of frames of rendered animation on which it is used. For example:

```
; Anything after a semicolon is a comment, and is ignored.  
sand.tga 20  
pebble.tga 40  
stone.tif 20  
boulder.tif 20
```

The IFL file listed above specifies *sand.tga* to be used for the first 20 frames, *pebble.tga* to be used for the next 40 frames, *stone.tif* to be used for 20 frames, and *boulder.tif* to be used for 20 frames.

TIP Specify only the file names in your IFL files. The file paths can be derived from the map paths established in your preferences. See [External Path Configuration](#) on page 7735. IFL files with path names can be used only on the system on which you create them.

See also:

- [Image File List Control Dialog](#) on page 7342
- [IFL Manager Utility](#) on page 7344

Sequentially Numbered Files

You can use incrementally numbered bitmap files (for example, *frame001.bmp*, *frame002.bmp*, and so on) to construct an IFL file. Either use the [IFL Manager Utility](#) on page 7344, or use the Sequence check box in a file selector dialog, as described in the following procedures.

Notes

- If the IFL generator has a name conflict with an existing IFL file, it will increment the new file's name to avoid overwriting the existing file.
- If the IFL generator has any problems with write access while trying to create the IFL file, the process will fail and the IFL file won't be created.

Therefore, automatic IFL generation won't work when reading bitmaps from a CD-ROM. You need to copy them to a directory on your hard disk first. Likewise, automatic IFL generation won't work on network drives to which you don't have write access.

Procedures

To construct an IFL file from sequentially numbered files:

- 1 In the file selector dialog, navigate to a directory that has a sequence of incrementally numbered bitmaps.
- 2 Choose the name of one of the sequential files (for example, *image01.bmp*). The Sequence check box becomes available.
- 3 Turn on the Sequence check box. The Setup button becomes available.
- 4 Click Setup to display the [Image File List Control dialog](#) on page 7342.
- 5 In the Image File List Control dialog, choose the options you want, and then click OK.

TIP Use the Browse button to set the Target Path to a directory on your hard disk. Do not set this path to a CD-ROM drive, because you cannot save the file there.

The Image File List (IFL) file is saved to the target directory.

- 6 In the file selector dialog, click OK. This assigns the newly created IFL file as the bitmap.

Example: To select a set of still images as a viewport background:

- 1 Activate the viewport where you want the animated background.
- 2 Choose Views menu > Viewport Background.
- 3 In the Background Source group, click Files. A Viewport Background dialog is displayed.
- 4 On Select Background Image dialog, use the Look In field to navigate to the directory containing the files you want to use for the sequence. If necessary, change the file type to match the file name extension of the sequence, or choose All Formats.

NOTE The Select Background Image File dialog uses the last location where a bitmap was chosen, rather than the default bitmap path defined in Customize menu > Configure User Paths.

- 5 Construct an IFL file as described in the previous procedure.
- 6 On the Select Background Image dialog, click OK.
The IFL file now provides the background for the viewport.

TIP The viewport background does not render. To render the IFL file's animation, assign the IFL file as a rendering environment. (See the following procedure.)

To render the frames in an IFL file as a movie (AVI or MOV format):

- 1 Choose Rendering > Environment.
- 2 On the Environment dialog, click Environment Map.
- 3 On the Material/Map Browser, choose Bitmap, and then click OK.
- 4 On the Select Bitmap Image File dialog, choose the IFL file, and then click OK.
- 5  Click Time Configuration, and use the Time Configuration dialog to make the animation length match the number of frames specified in the IFL file.
- 6 Render a viewport to a movie-format file.

TIP The aspect ratio of the rendered movie should match the aspect ratio of the frames in the IFL file.

Image File List Control Dialog

Views menu > Viewport Background > Select Background Image dialog > Choose a directory with sequentially numbered files. > Sequence > Setup > Image File List Control dialog

The Image File List Control dialog provides controls for creating an [Image File List \(IFL file\)](#) on page 7339, which lists sequential still image files for rendering

into backgrounds or materials. It is particularly useful if you are choosing a sequence of files that are on a CD-ROM, because you can redirect the IFL file to a different directory on your hard disk.

This dialog duplicates the functionality found in the [IFL Manager utility](#) on page 7344.

Interface

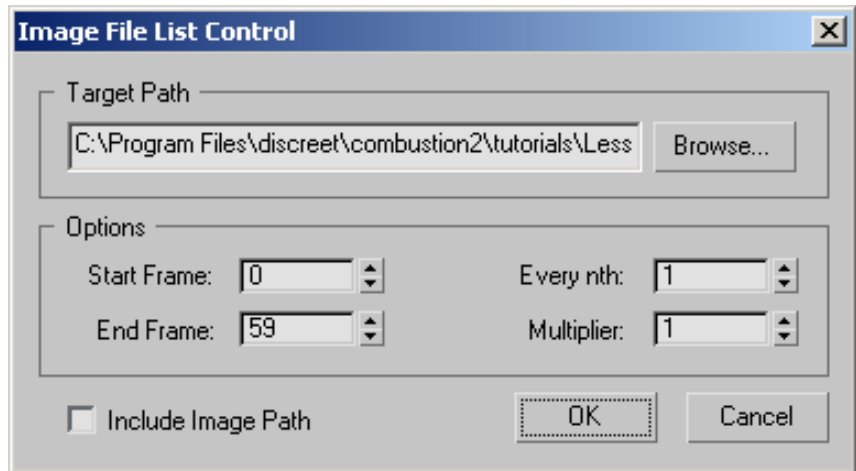

Target Path Sets the directory where the IFL file is saved.

Browse Use this to navigate to the correct directory.

Options Sets additional options for creating the IFL file.

Start Frame Determines which file in the sequence will be the first frame. Use this when you have a sequence but you don't want to start with the first image in the sequence.

End Frame Determines which file will be the last frame listed in the IFL list.

Nth Frame Skips frames in the image file list. Use this to match the length of the sequence to the length of the animation.

Multiplier Increases the frames in the image file list. Each frame in the file list can be repeated by this value to stretch out the length of the sequence.

Include Image Path Includes the path in the image file list.

IFL Manager Utility

Utilities panel > Utilities rollout > More button > Utilities dialog > IFL Manager

The IFL Manager utility generates an [image file list \(IFL\) file](#) on page 7339 from an image file you choose from a numbered file sequence.

NOTE You can also generate an IFL file in a file selector dialog by selecting a numbered bitmap, turning on Sequence, and then clicking Setup to display an [Image File List Control dialog](#) on page 7342.

See also:

- [Image File List Control Dialog](#) on page 7342

Procedures

To use the IFL Manager utility:

- 1 Open the IFL Manager.
- 2 Click the Select button to display a file selector.
- 3 Select any of the sequentially numbered image files that you want included in the list, and click Open.
The prefix name of the file appears in the Working File Prefix group box, and the spinners in the IFL Manager panel become enabled.
- 4 Set the Start spinner to specify the first numbered file in the sequence. For example, set this to 5 to begin with file *tree0005.jpg*.
- 5 Set the End spinner to specify the last numbered file in the sequence. The Start and End spinners default to the first and last number in the existing numbered files.

NOTE You can invert the Start and End values (setting the greater value in Start and the lesser in End) to create a reversed list in the *.ifl* file.

- 6 Click Create to display a file dialog where you can name and then save your IFL file.
- 7 Click the Edit button to display a file dialog where you can choose an IFL file, which then appears in the Windows Notepad.

Interface

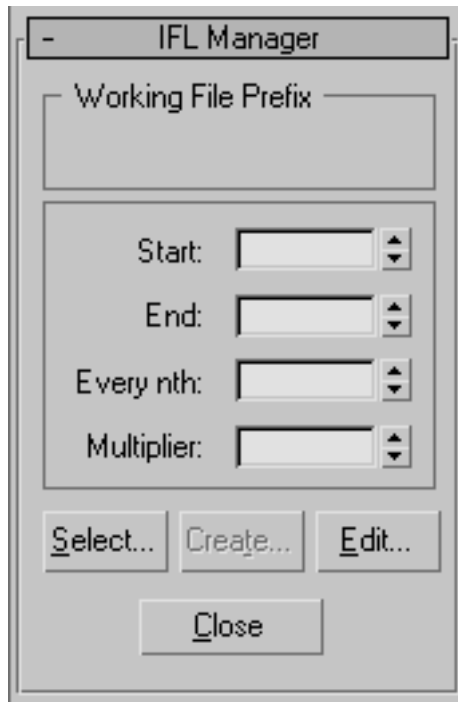

Working File Prefix group

After you use the Select button to select a sequentially numbered file, the prefix name of the file appears here. For example, if the files are *tree0000.jpg*, *tree0001.jpg*, *tree0002.jpg*, and so on, the title in this group box would be **tree**.

Spinners group

Start Displays the number of the first image file in the selected sequence. Increase to specify a different starting image for the IFL file.

End Displays the number of the last image file in the selected sequence. Decrease to specify a lower ending image for the IFL file.

Every nth Set to a number greater than 1 to skip a specified number of images in the list.

Multiplier Adds a multiplier after each file in the IFL list. If you set to 3, each image is used three times before the next image in the list is used.

Button set

Select Displays a file dialog that lets you select a file in a sequential list. The number appended to the file doesn't matter, as long as the prefix and file name extension are the same. After selecting the file, the spinners in the IFL Manager are enabled.

Create Displays a file dialog where you can name and save your IFL file.

Edit Displays a file dialog where you can select an IFL file. The selected file is then displayed in the Windows Notepad editor.

Close Closes the utility.

IMSQ Files

The Autodesk ME Image Sequence (IMSQ) format is an XML file used by the Autodesk products Cleaner and Toxik. You generate IMSQ files in the Render Output group of the Render Setup dialog > [Common Parameters rollout](#) on page 6121 by turning on Put Image File List(s) In Output Path(s) and then clicking Create Now. The IMSQ file stores information about the rendering, including:

- The name of the rendering file
- The format of the rendering file
- The range of frames
(Nonsequential frame sequences, such as 1, 7, 12–19, are not supported.)
- The frame rate
- The pixel aspect ratio
- The output type, aperture width, and resolution (width x height)
- The render element type and name
- The camera name (when rendering a Camera view)

3ds Max generates a separate IMSQ file for each render element.

JPEG Files

JPEG (.jpeg or .jpg) files follow the standards set by the Joint Photography Experts Group. These files use a variable compression method that is called lossy compression because of the loss of image quality as you increase the compression. However, the JPEG compression scheme is extremely good and you can sometimes compress the file up to 200:1 without severe loss of image quality. JPEG is consequently a popular format for posting image files on the Internet for minimum file size and fast download time.

Interface

When JPEG is the chosen output format, clicking Render or Setup in the [Render Output File dialog](#) on page 6086 displays the JPEG Image Control dialog.

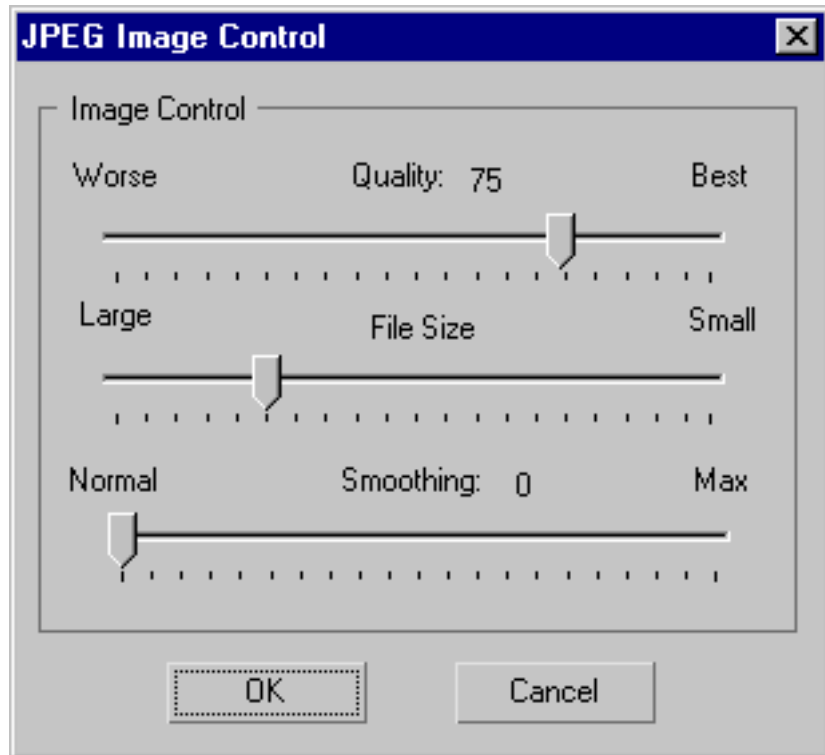

Quality Move the slider to the level of quality you want: the higher the quality, the larger the file size. In general, files compressed with the slider set to Best have compression ratios between 5:1 and 15:1.

File Size Move the slider to the size of file you want: the larger the file, the higher the quality.

Smoothing Move the slider to the level of smoothing you want: the higher the level of smoothing, the larger the file size.

MOV (QuickTime Movie) Files

QuickTime® is a standard file format created by Apple® for storing common digital media types such as audio and video. When you choose QuickTime (*.mov) as the Save as Type, your animation is saved as a .mov file.

You can export animations to .mov for both rendering and previews. You can also export audio if an audio track is present in Track View. To preview an existing .mov file, you must have *movieplayer.exe* included in your environment path. You can download the QuickTime movie player from <http://www.apple.com/quicktime/download>.

NOTE The plug-in does not allow for the direct import of audio from a QuickTime file.

Interface

When you create a new QuickTime file or choose Setup for an existing one, you see a dialog that is typically titled Compression Settings. This dialog is provided by the QuickTime [codec](#) on page 7936 installed with your system, and can change depending on the version of QuickTime you've installed.

MPEG Files

The MPEG format is a standard for movie files. MPEG stands for Moving Picture Experts Group. MPEG files can have a .mpg or .mpeg file name extension.

MPEG is supported only as an input file format. You can use MPEG files as texture maps.

OpenEXR Files

3ds Max can both [read](#) on page 7355 and [write](#) on page 7350 image files in the OpenEXR format. OpenEXR is both an image file format and a general open-source API for reading and writing such files.

The best place to look for information on OpenEXR itself is [http://www.openexr.com/the official Website](http://www.openexr.com/the_official_Website). The following is taken directly from the OpenEXR home page:

OpenEXR is a high dynamic-range (HDR) image file format developed by Industrial Light & Magic for use in computer imaging applications.

OpenEXR is used by ILM on all motion pictures currently in production. The first movies to employ OpenEXR were Harry Potter and the Sorcerer's Stone, Men in Black II, Gangs of New York, and Signs. Since then, OpenEXR has become ILM's main image file format.

OpenEXR's features include:

- Higher dynamic range and color precision than existing 8- and 10-bit image file formats.
- Support for 16-bit floating-point, 32-bit floating-point, and 32-bit integer pixels. The 16-bit floating-point format, called "half," is compatible with the half data type in NVIDIA's Cg graphics language and is supported natively on their new GeForce FX and Quadro FX 3D graphics solutions.
- Multiple lossless image compression algorithms. Some of the included codecs can achieve 2:1 lossless compression ratios on images with film grain.
- Extensibility. New compression codecs and image types can easily be added by extending the C++ classes included in the OpenEXR software distribution. New image attributes (strings, vectors, integers, etc.) can be added to OpenEXR image headers without affecting backward compatibility with existing OpenEXR applications.

The OpenEXR Bitmap I/O software goes beyond the "standard" OpenEXR format, taking advantage of the flexibility of the format itself. It can write channels and attributes as well as general RGBA data in formats that many OpenEXR file importers cannot understand, due to implementation limits as well as limits to the current set of standards. The full-latitude 32-bit floating point RGBA files that the output function can write is one example. While the OpenEXR API itself fully supports this capability, and these files are written

using the standard set of OpenEXR libraries, most software only reads the 16-bit “half” floating point RGBA files that are considered standard EXR files.

TIP To take best advantage of the OpenEXR format’s 32-bit support, use the mental ray renderer and set [Frame Buffer Type](#) on page 6277 to Floating-Point (32 bits per channel).

Configuration File Usage

Most bitmap I/O plug-ins, including those integrated into 3ds Max, store their configuration information in a binary CFG file that cannot be edited. To allow external scripting support as well as ordinary preferences, the OpenEXR software uses a standard INI file format to store its configuration data. The file is named *openexr.ini* and is found in the *plugcfg* folder in the program directory. The file is generated automatically the first time you edit the OpenEXR configuration settings, and is updated each time you modify an EXR loader. It is a standard text file and can be modified with any text editor.

When the INI file is written, it automatically generates a companion “help” text file named *openexr_ini_help.txt*. This file contains the valid ranges for various INI settings, as well as the various text strings used to specify compression type and bit depth. This file is just a guide; editing it has no effect, and it is overwritten whenever the INI file is updated.

To restore the default settings after editing the INI file, simply delete the *openexr.ini* file and a new one with the original defaults will be generated the next time you edit the configuration settings.

See also:

- [Saving OpenEXR Files](#) on page 7350
- [Opening OpenEXR Files](#) on page 7355

Saving OpenEXR Files

Render Setup dialog > Common panel > Common Parameters rollout > Render Output group > Click Files. > Enter file name and set type to OpenEXR Image File > Click Save. > OpenEXR Configuration dialog

Rendered Frame Window > Click Save Bitmap. > Enter file name and set type to OpenEXR Image File > Click Save. > OpenEXR Configuration dialog

Use the OpenEXR Configuration dialog to set output parameters for OpenEXR files. You can specify the format for saving the RGBA data as well as which of the four standard channels should be saved. An option is available to use RealPixel unclamped color information for Render Output saving. Also available are color transforms to be applied, file compression type, and additional attributes.

Interface

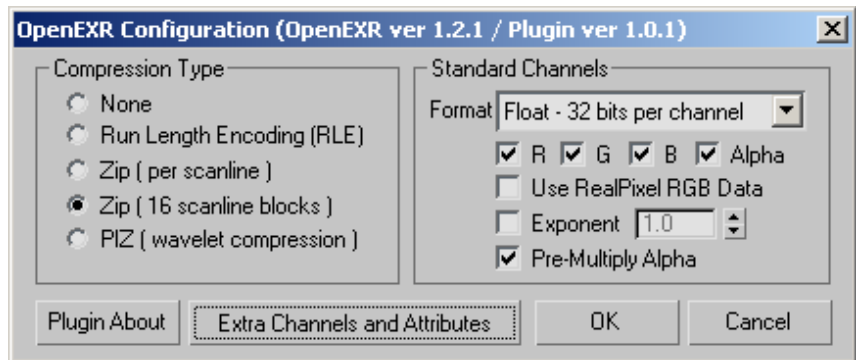

Compression Type Lets you choose the method of file compression. The OpenEXR API provides for three general types of lossless compression, including two different methods of Zip compression. For most images without a lot of grain, the two Zip compression methods seem to work best, while the PIZ compression algorithm is better suited to grainy images. The following options are available:

- **None** Disables all compression.
- **Run Length Encoding (RLE)** A basic form of compression comparable to that used by standard Targa files.
- **Zip (per scanline)** Zip-style compression applied to individual scanlines.
- **Zip (16 scanline blocks)** Zip-style compression applied to blocks of 16 scanlines at a time. This tends to be the most effective style of compression to use with rendered images that do not have film grain applied.
- **PIZ (wavelet compression)** Uses a combined wavelet/Huffman compression. This form of compression is best for grainy images.

Standard Channels group

The standard channels in an image are: red, green, blue, and alpha (transparency). This group lets you choose the general type of OpenEXR file to save, as well as which of the four channels to save with the file. The most widely supported format is Half Float - 64 bpp format. This stores each channel of the image in a separate slice in the file using half-type 16-bit floating-point data. The OpenEXR distribution has features that allow easy implementation of reading and writing this type of file, and it is considered a standard OpenEXR file.

Format Choose one of the following from the drop-down list:

- **Integer - 32 bpp** This non-standard OpenEXR format contains only a single 32-bit integer channel. It uses a packedIntRGBA image type in order to support old-style bit depths, such as 32-bit Targa files. Only this plug-in can read this format.
- **Half Float - 64 bpp** This 16-bit-per-channel “half-float” format is standard OpenEXR. Any software that supports OpenEXR can use this format.
- **Float - 128 bpp** The 32-bit-per-channel “full-float” format is encoded using standard OpenEXR channel tags. Most OpenEXR implementations will have no problems reading this format.

R/G/B/Alpha Let you specify the channels to save: red, green, blue, and alpha.

Use RealPixel RGB Data When on, compresses the essential data of floating-point color into 32 bits. For technical information, see the RealPixel Struct Reference topic in the 3ds Max SDK Help.

NOTE Image motion blur is not applied to the RealPixel RGBA data by the renderer. If you are using Image motion blur, you will not be able to save RealPixel unclamped color data.

Exponent Enables and sets the power function exponent to use. This is effectively a gamma curve, but the exponent is presented in an inverse manner from typical gamma. The default value is what exrdisplay expects for input.

Pre-Multiply Alpha When on, the software uses [premultiplied alpha](#) on page 8096 when saving the file. Pre-multiplying saves computation time if you later use this image in compositing.

Plugin About Opens a dialog that shows information about the OpenEXR plug-in.

Extra Channels and Attributes Opens a [sub-dialog](#) on page 7353 that lets you specify additional information to save with the OpenEXR image file.

OK Accepts any changes and closes the dialog.

Cancel Discards any changes and closes the dialog.

Extra Channels and Attributes

To specify an extra attribute or channel to be included in the saved OpenEXR file, click the corresponding + button and then choose the attribute or channel from the list. To delete an attribute or channel, highlight it in the list and then click the corresponding X button.

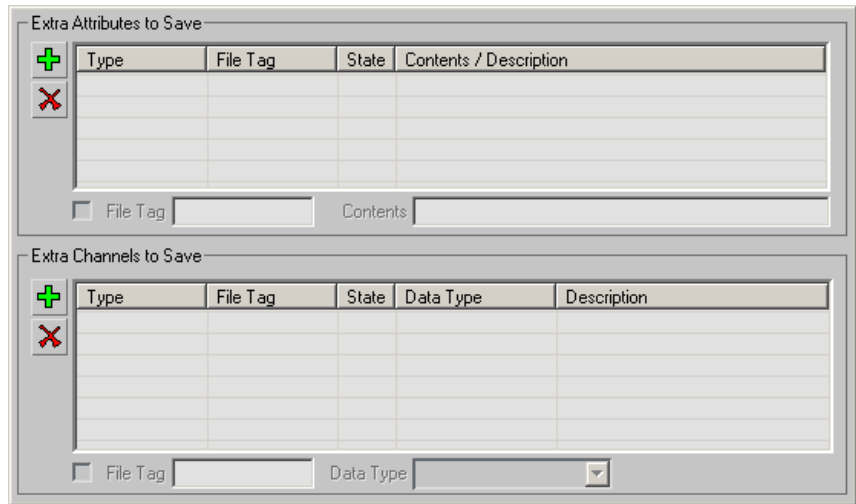

General Notes on Extended Attributes and Channels

Please note the following:

- You can view the extended information via the [File Info button](#) on page 7358 on the input dialog.
- A default File Tag string is provided when you add an attribute/channel. You can change the file tag by highlighting the entry in the list and then editing the File Tag field immediately below the list. You can also enable and disable the attribute/channel with the check box to the left of the File Tag field.

NOTE Each saved attribute or channel must have a unique file tag. If you specify multiple instances of a file tag, only the first attribute or channel with that file tag is used.

- All the current attributes are String type attributes that are stored in the header for the file, and can be read in plain text via the *exrheader.exe* utility (available from [http://www.openexr.com/the official Website](http://www.openexr.com/the_official_Website) > Downloads page).
- Attributes and channels are stored in the file in alphabetical order according to the ASCII file tag.
- While this plug-in can write most of the 3ds Max [G-Buffer](#) on page 7991 channels, there is no software that can utilize them yet.
- Attributes and channels are identified by plain-text (ASCII) strings. There can be only one instance of a string tag in any file. Attributes are data that is stored per frame, not per pixel, and they are embedded in the file's header. Channels are data that is stored per pixel. In order to maximize flexibility with other software, this plug-in lets you edit the file tags. You should only do this if you know the tag required by some other software; otherwise it is best to leave the file tags at their default values.
- Channels that create multiple “slices” in the EXR file require multiple file tags. In this case, the file tag in the user interface comprises several sub-tags denoted by square brackets. For example, the Normal channel generates three slices in the EXR file: one for the Normal vector x data, 1 for y, and 1 for z. In this instance, the tag string in the user interface would read [NX][NY][NZ], and generate slices with the file tags "NX", "NY", and "NZ". The file tag is used by software that is reading the EXR file to identify the intended use of the channel data. Even standard image channels are encoded this way, with the tags "R", "G", "B", and "A" used to denote red, green, blue, and alpha channels respectively.

Extended Attributes

Comment A general-purpose comment string defined by the user. To define the comment, highlight the Comment entry in the list and then edit the Comments field immediately below the list.

Computer Name The name of the computer the image was saved from. In the case of standard render output during a net render, this is the machine that rendered the frame.

System Time The UTC (GMT) system time and date when the file was written.

Local Time The local time and date (corrected for the time zone) when the file was written.

Version OpenEXR The plug-in version, OpenEXR API version, and ZLib version in plain text form.

Version 3dsMax The release version of 3ds Max itself, the API number, and the SDK revision used when the build of 3ds Max was compiled. This also reports whether the file was generated using 3ds Max or Autodesk VIZ.

Extended Channels

Z-Buffer The standard buffer depth channel. (16-bit or 32-bit floating point)

Object ID The object ID from the [Object Properties dialog](#) on page 305. (32-bit unsigned integer)

Material ID The [material effects channel number](#) on page 5348. (32-bit unsigned integer)

Node Render ID A unique object ID set by the renderer. All objects in the scene have a unique Render ID, though the value stored varies from renderer to renderer. (32-bit unsigned integer)

UV Coords The UV coordinates for the object. Only one UV channel is stored. (two slices, 16-bit or 32-bit floating point)

Velocity The 2D velocity vector for the pixel in screen space. (two slices, 16-bit or 32-bit floating point)

Normal The surface normal. (three slices, 16-bit or 32-bit floating point)

Coverage The pixel coverage of the foremost object in the pixel. (32-bit unsigned integer, 16-bit floating point, or 32-bit floating point)

Opening OpenEXR Files

Any command that opens an image file, such as View Image File > Specify an EXR file. > Click Open. > OpenEXR Configuration dialog

This version of the OpenEXR Configuration dialog appears whenever you open an EXR file. It lets you specify various color transformations to be applied to the loaded image, designate the internal storage format to use, and preview the loaded image with the color transforms applied. There is also a histogram for viewing the brightness distribution in the image and adjusting the white and black points interactively.

Interface

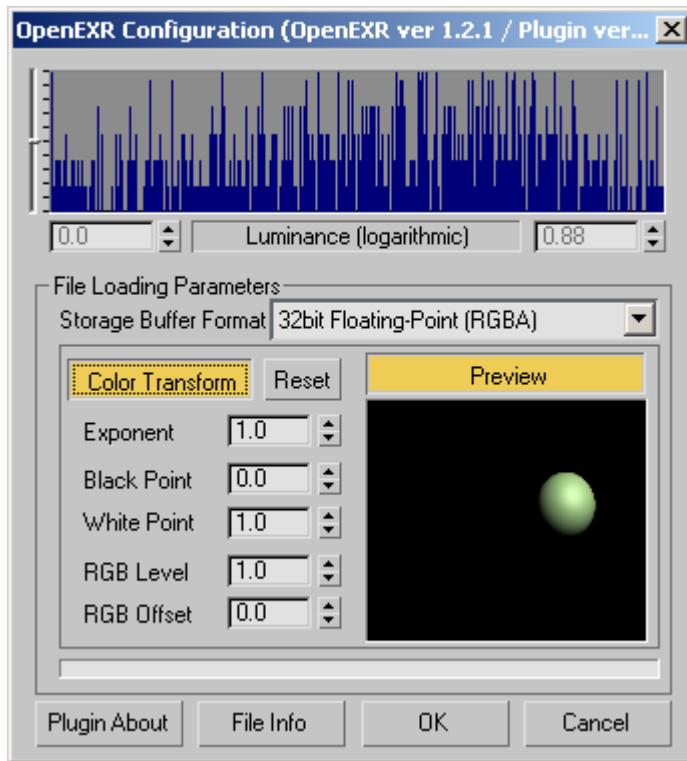

Histogram

To view the histogram, click the Preview button. The histogram displays a detailed bar graph of the distribution of brightness throughout the image. The horizontal axis of the histogram defines the luminance value, and the vertical axis indicates the percentage of the image covered by pixels of that brightness. Histogram features are:

- The histogram supports several display modes, which you can choose by right-clicking the histogram display window. The menu lets you choose between linear and logarithmic display, automatic or manual x-axis scaling, y-axis scale options, and which channel is graphed: luminance, red, green, or blue. The menu entries X-Axis Scale and Y-Axis Scale are simply labels, and are thus unavailable for choosing.

- The vertical scale slider on the left side of the histogram lets you adjust the automatically computed vertical scale.
- To modify the luminance “window,” set X-Axis Scale to Manual and adjust the minimum and maximum values in the numeric fields below either end of the graph.
- The background coloration indicates several pieces of information:
 - The area between the black and white points is shaded gray.
 - The area below 1.0 (low dynamic range) is a lighter shade of gray than the area with luminance greater than 1.0, the high dynamic range region.
 - The background of the region outside the currently selected blackpoint/whitepoint region is tinted pink.
 - The vertical dotted lines indicate integer spacing (for example, 1...2...3...4). To see these, the maximum luminance value must be greater than 1.0.
- You can drag whitepoint/blackpoint markers in the histogram to place them visually. The hot-spot is two pixels to either side of the marker line. White point selection is tested first, so if the two lines are right next to each other, the white point will be selected.
- You can set the display itself to linear or logarithmic mode. Logarithmic display remaps all values greater than 1.0 to a logarithmic curve. The dotted spacing indicators are supplemented by heavier dotted lines that indicate when the scale has changed by a factor of 10. This is useful for most HDR images, as the HDR data is usually spread out over a wide range.
- Setting X-Axis Scale to Auto mode causes the histogram to encompass the entire spectrum of the image. If you switch back and forth, previous manually set values are preserved and restored.

File Loading Parameters group

Storage Buffer Format Specifies the format in which the image data is stored within 3ds Max. The base types are variations on 8-bits-per-channel and 16-bits-per-channel integer formats. There are two forms of each: one with alpha (RGBA) and one without alpha (RGB). If you are loading an image with

an alpha channel but don't require the alpha data, choose the RGB version to save some memory. If you choose a storage type that supports alpha, but load an image without alpha, no memory is allocated for the alpha channel; the loader detects the situation and reverts to the alpha channel-free storage option with equivalent RGB bit depth.

The options supports the HDR bitmap storage options. This allows storage of the high-dynamic-range data within 3ds Max in three different HDR formats: 24- and 32-bit LogLUV formats and 32-bit RealPixel format.

EXR files loaded using these storage modes are suitable for use as environment maps for reflections and skylight.

Color Transform Because EXR images often contain values brighter than “white,” it is often desirable to change the luminance range in the source image over which black to white occurs; that is, to remap the color data. When Color Transform is on, you can adjust these luminance and general brightness controls:

Exponent The exponent to apply when loading the file

Black Point Where black should be in the luminance range of the image

White Point The white point

RGB Level A standard multiplier for the RGB data

RGB Offset An additive offset for the RGB data

Preview The Preview window provides for interactive previewing of color-transform options for loading EXR files. After choosing an EXR file to open, click Preview to enable the preview window. The image file is loaded into the preview window, and from then on any changes to the Color Transform options update the thumbnail in real time.

The preview window ignores the aspect ratio of the image to make the most of the small screen space available.

Plugin About Opens a dialog that shows information about the OpenEXR plug-in.

File Info Opens the [File Information dialog](#) on page 7359, which lets you view file statistics plus any attributes and channels stored in the file.

OK Accepts any changes, closes the dialog, and opens the image file.

Cancel Discards any changes and closes the dialog without loading the image file.

File Information dialog

This read-only dialog displays basic file statistics including date, time, size, and resolution, plus any attributes and channel information stored with the file. See [Extra Channels and Attributes](#) on page 7353.

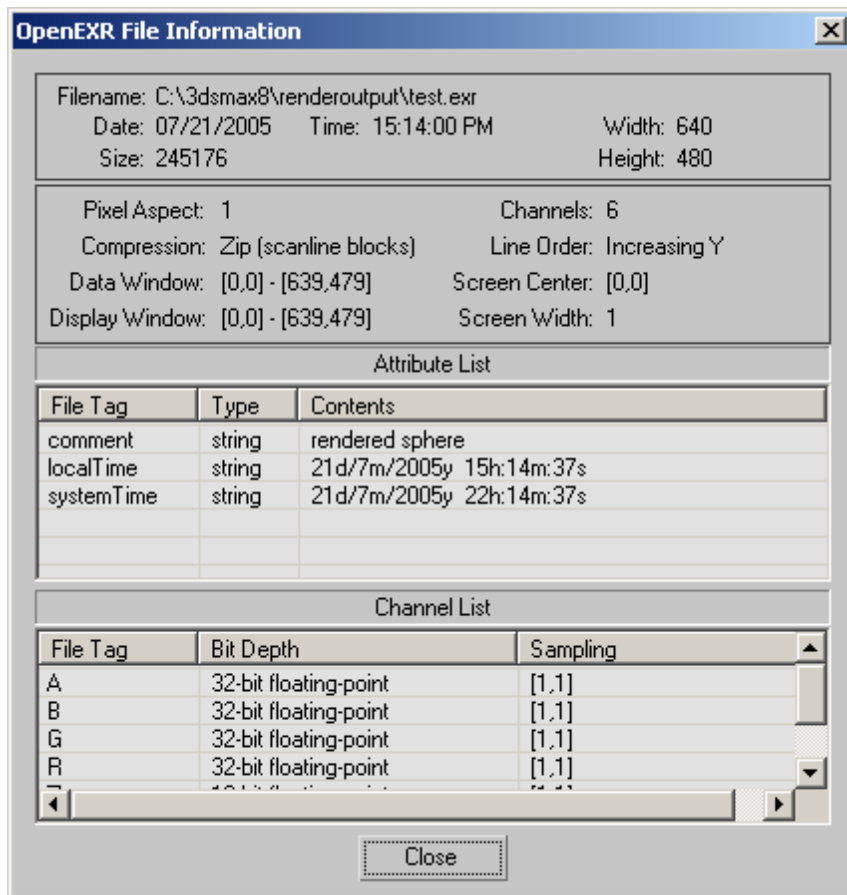

PIC Files

3ds Max can import and export Radiance Picture (PIC) files. The PIC file is a lighting-analysis format used for the same purpose as LogLUV [TIFF files](#) on page 7372. The PIC format differs from the LogLUV TIFF format by creating

separate files for [luminance](#) on page 8029 and [illumination](#) on page 8009 channel data (the LogLUV TIFF format creates one file containing *both* channels).

One way to create PIC files is with the [Lighting Data Exporter utility](#) on page 6759. You specify a file name by clicking the File Name button. When you click Export, the Lighting Data Exporter renders two files. The string “_illumination” is appended to the name of one file, and “_luminance” is appended to the other. For example, if you type **house** as the file name, the exporter renders to *house_illumination.pic* and *house_luminance.pic*.

You can also open and save high-dynamic-range images in the PIC format using the Radiance Image File format in input and output file browsers in 3ds Max. For further information, see [HDRI Files](#) on page 7334.

See also:

- [Radiosity Workflows](#) on page 6181

PNG Files

PNG (Portable Network Graphics) is a still-image file format developed for use with the Internet and World Wide Web.

Interface

Clicking Render or Setup in the [Render Output File dialog](#) on page 6086 displays the PNG Configuration dialog.

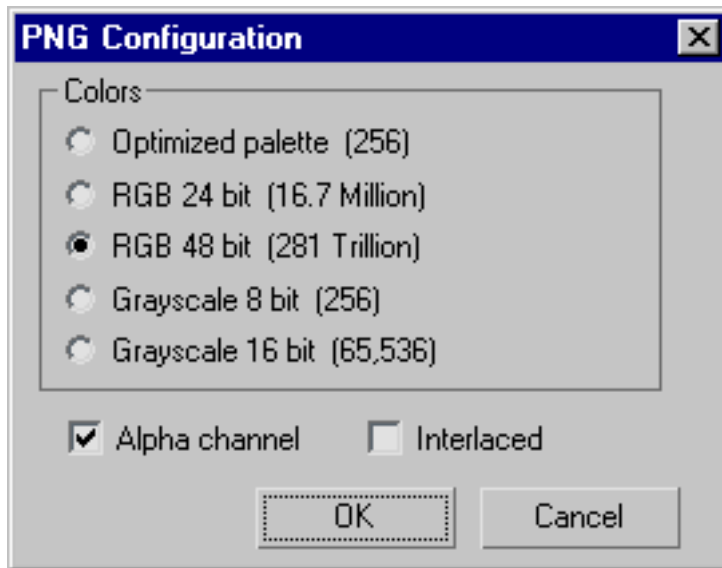

Optimized palette (256) Choose to render a smaller, 8-bit color file.

RGB 24 bit (16.7 Million) Choose to render a true color (24-bit) file.

RGB 48 bit (281 Trillion) Choose to render a 48-bit color file.

Grayscale 8 bit (256) Choose to render a grayscale image with 256 shades.

Grayscale 16 bit (65,536) Choose to render a grayscale image with 65,536 shades.

Alpha Channel Turn on to save the alpha channel with the file.

Interlaced Turn on to make the file interlaced for faster display in Web browsers.

PSD Files

PSD is the file-name extension for graphics files native to Adobe Photoshop. This image format supports multiple layers of images superimposed to get the final image. Each layer can have any number of channels (R, G, B, Mask, and so on). It is a powerful file format because multiple layers can contribute to a variety of special effects.

Adobe provides many different modes of superimposing layers, including normal, darken, lighten, difference, multiply, screen, dissolve, hard light, hue, saturation, color, luminosity, overlay, and soft light.

You can use PSD files as bitmaps, viewport backgrounds, and so on. You can't render to a PSD file.

3ds Max supports Photoshop 6.0 format, and allows you to use image layers as bitmaps, as well as the entire composited graphic.

Limitations

Bits Per Channel Photoshop supports images with 1, 8, and 16 bits per channel (1-, 24-, and 48-bit RGB images, respectively). 3ds Max supports PSD images with 8 or 16 bits per channel. (In practice, there are very few images with 1 bit per channel.) While Photoshop can load images with 16 bits per channel, layers are always 8 bits per channel.

Modes 3ds Max supports *.psd* files saved in the following modes:

- RGB
- Grayscale

3ds Max doesn't support the following Photoshop modes:

- Indexed Color
- Bitmap
- Duotone
- CMYK Color
- Lab Color
- Multichannel

Non-Image Layers Layers other than image layers (for example, text layers) are not supported. In Photoshop, you can “rasterize” a non-image layer to make it an image.

Compositing Options Compositing options between image layers, which require processing by Photoshop, are not supported.

Interface

When you open a PSD file as a bitmap, a dialog appears that lets you choose how to use the image.

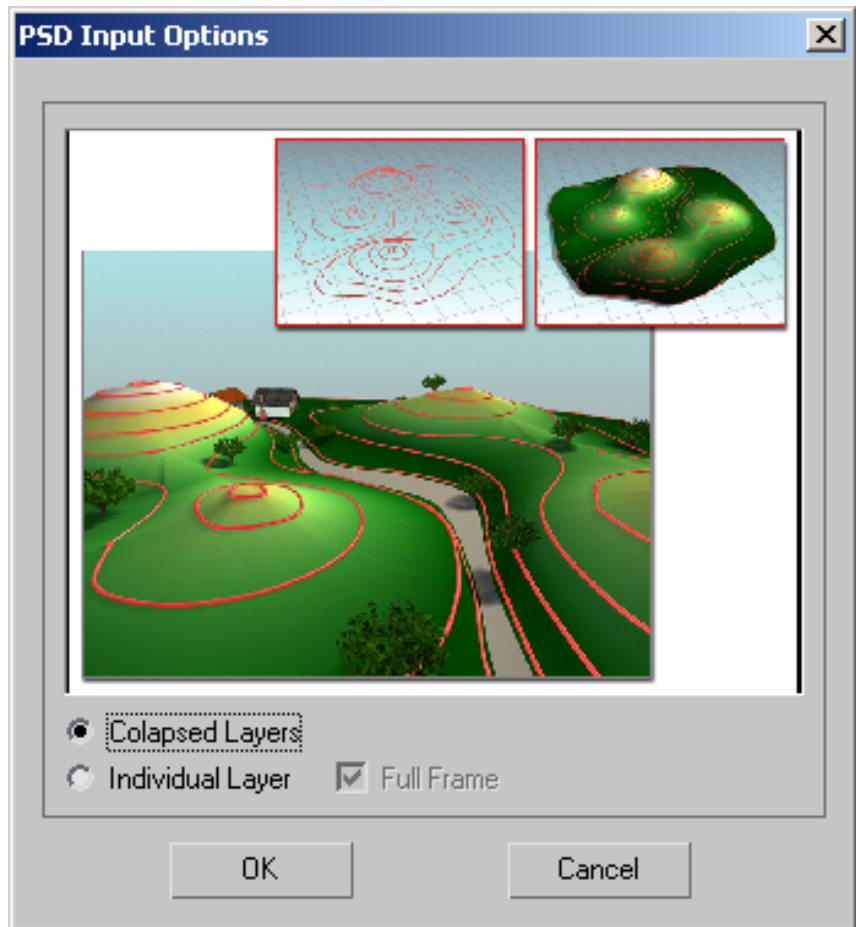

Collapsed Layers displays the entire image.

Collapsed Layers (The default.) Uses the entire composited image.

Individual Layer Uses a single layer of the image. When you choose this, the dialog shows a list of the layers, with a thumbnail of each, and the layer names. Click a layer to choose it, then click OK.

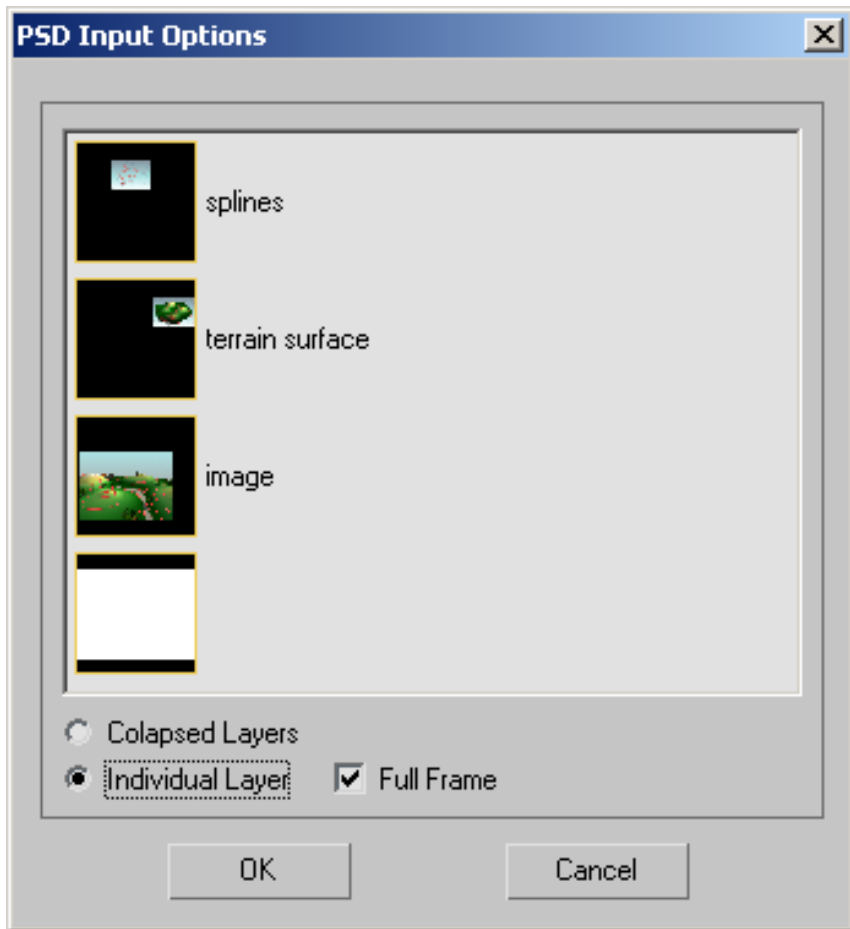

Individual Layer displays list of layers to choose from.

Full Frame When on, uses the entire layer as the bitmap. When off, uses only that portion of the layer occupied by image data. Default=on.

RLA Files

The RLA format is a popular SGI format that supports the ability to include arbitrary image channels. While setting up a file for output, if you select RLA Image File from the list and click the Setup button, you'll go to the RLA setup

dialog. Once there, you can specify what channels (and what format) you want to write out to the file.

See also:

- [RPF Files](#) on page 7366

Interface

When RLA is the chosen output format, clicking Render or Setup on the [Render Output File dialog](#) on page 6086 displays the RLA Image File Format dialog.

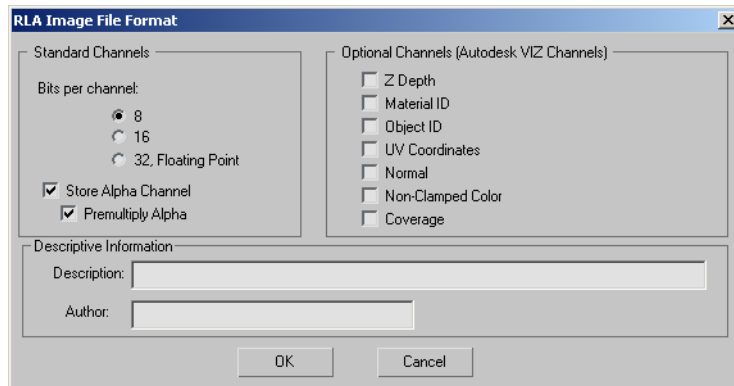

Standard Channels group

The standard channels are RGB color and the alpha (transparency) channel.

Bits per Channel Choose 8, 16, or 32 Floating Point as the number of bits per channel. Default=8.

Store Alpha Channel Choose whether to save the alpha channel. Default=on.

Premultiply Alpha When on, premultiplies the alpha channel. Default=on. Premultiplying saves computation time if you later use this image in compositing. For more information, see [Premultiplied Alpha](#) on page 8096.

Optional Channels group

For output RLA files, there are eight additional channels that you can generate (and view in the Rendered Frame Window):

Z Depth Displays Z-Buffer information in repeating gradients from white to black. The gradients indicate relative depth of the object in the scene.

Material ID Displays the Effects channel used by materials assigned to objects in the scene. The Effects channel is a material property set in the Material Editor and used during Video Post compositing. Each Effects Channel ID is displayed using a different random color.

Object ID Displays the [G-Buffer](#) on page 7991 Object Channel ID assigned to objects using the Object Properties dialog. The G-Buffer ID is used during Video Post compositing. Each G-Buffer ID is displayed using a different random color.

UV Coordinates Displays the range of UV mapping coordinates as a color gradient. This channel shows where mapping seams might occur.

NOTE UV Coordinates will not be displayed on objects that have the UVW Map Modifier applied unless a map has been applied that uses the coordinates.

Normal Displays the orientation of normal vectors as a grayscale gradient. Light gray surfaces have normals pointing toward the view. Dark gray surfaces have normals pointing away from the view.

Non-Clamped Color Displays areas in the image where colors exceeded the valid color range and were corrected. The areas appear as bright saturated colors usually around specular highlights.

Coverage This saves the coverage of the surface fragment from which other G-buffer values (Z-Depth, Normal, and so on) are obtained. Z-Coverage values range from 0 to 255. To see Z Coverage, render to an RLA file after first checking Z Coverage in the Setup subdialog, then choose Z-Coverage in the Rendered Frame Window's Viewing Channel drop-down list.

The Z-Coverage feature is provided primarily for developers, and should aid in the antialiasing of Z-buffers.

Descriptive Information group

This information is saved with the file.

Description You can enter descriptive text here.

Author You can enter your name here.

RPF Files

RPF (Rich Pixel Format) is the format that supports the ability to include arbitrary image channels. While setting up a file for output, if you select RPF

Image File from the list, you'll go to the RPF setup dialog. Once there, you can specify what channels you want to write out to the file.

RPF files replace RLA files as the format of choice for rendering animations requiring further post-production or effects work. Many channels available in RPF files are exclusive to this format.

TIP When you create a scene you plan to render as an RPF file for use with the Autodesk Combustion™ product, turn on Render Occluded Objects (on the [Object Properties dialog](#) on page 305) for objects in the scene. This is important if you want to use the Combustion G-Buffer Extract feature. When Render Occluded Objects is enabled and you extract an object in Combustion, the objects behind it are drawn correctly. If Render Occluded Objects is disabled (the default), objects behind the extracted object appear with black holes where they were occluded.

Interface

When RPF is the chosen output format, clicking Render or Setup on the [Render Output File dialog](#) on page 6086 displays the RPF Image File Format dialog.

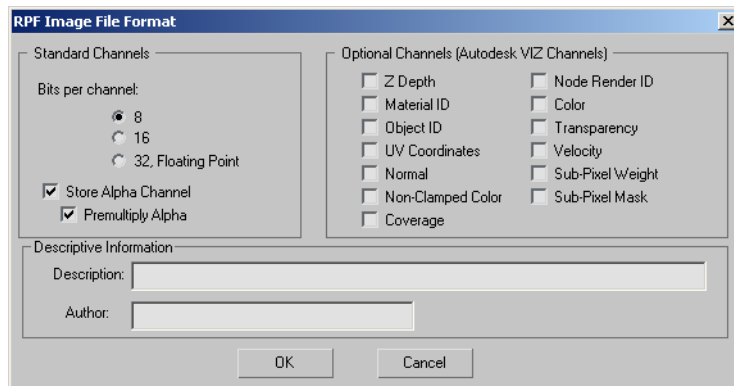

Standard Channels group

The standard channels are RGB color and the alpha (transparency) channel.

Bits per Channel Choose 8, 16, or 32 Floating Point as the number of bits per channel. Default=8.

Store Alpha Channel Choose whether to save the alpha channel. Default=on.

Premultiply Alpha When on, premultiplies the alpha channel. Default=on.

Premultiplying saves computation time if you later use this image in compositing. See [Premultiplied Alpha](#) on page 8096 for more information.

Optional Channels group

For output RPF files, there are additional channels that you can generate (and view in the Rendered Frame Window):

Z Depth Saves Z-Buffer information in repeating gradients from white to black. The gradients indicate relative depth of the object in the scene.

Material ID Displays the Effects channel used by materials assigned to objects in the scene. The Effects channel is a material property set in the Material Editor and used during Video Post compositing. Each Effects Channel ID is displayed using a different random color.

Object ID Displays the [G-Buffer](#) on page 7991 Object Channel ID assigned to objects using the Object Properties dialog. The G-Buffer ID is used during Video Post compositing. Each G-Buffer ID is displayed using a different random color.

UV Coordinates Saves the range of UV mapping coordinates as a color gradient. This channel shows where mapping seams might occur.

NOTE UV Coordinates will not be displayed on objects that have the UVW Map Modifier applied unless a map has been applied that uses the coordinates.

Normal Saves the orientation of normal vectors as a grayscale gradient. Light gray surfaces have normals pointing toward the view. Dark gray surfaces have normals pointing away from the view.

Non-Clamped Color Saves areas in the image where colors exceeded the valid color range and were corrected. The areas appear as bright saturated colors usually around specular highlights.

Coverage Saves the coverage of the surface fragment from which other G-buffer values (Z Depth, Normal, and so on) are obtained. Z-Coverage values range from 0 to 255. To see Z Coverage, render to an RLA file after first checking Z Coverage in the Setup subdialog, then choose Z-Coverage in the Rendered Frame Window's Viewing Channel drop-down list.

The Z-Coverage feature is provided primarily for developers, and should aid in the antialiasing of Z-buffers.

Node Render ID Saves each object as a solid color according to its G-Buffer Object channel (found under Object Properties).

Color Saves the color returned by the material shader for the fragment. This channel displays any transparent fragment as a solid color.

Transparency Saves transparency returned by the material shader for the fragment. Any fragment with any degree of transparency will be rendered as a solid gray object.

Velocity Saves the velocity vector of the fragment relative to the screen in screen coordinates.

Sub-Pixel weight Saves the sub-pixel weight of a fragment. The channel contains the fractions of the total pixel color contributed by the fragment. The sum of all the fragments gives the final pixel color. The weight for a given fragment takes into account the coverage of the fragment and the transparency of any fragments that are in front of a given fragment.

Sub-Pixel Mask Saves the sub-pixel alpha mask. This channel provides a mask of 16 bits (4x4) per pixel, used in antialiased alpha compositing. This mask is especially useful with the Combustion compositing product.

Descriptive Information group

This information is saved with the file.

Description You can enter descriptive text here.

Author You can enter your name here.

RGB (SGI Image) Files

The SGI™ Image File format is a bitmap file type created by Silicon Graphics®. SGI Image File support in 3ds Max lets you load and save files in both 8- and 16-bit color depth, with alpha channels, and RLE Compression.

Interface

Clicking Render or Setup in the [Render Output File dialog](#) on page 6086 displays the RGB Image File Format dialog.

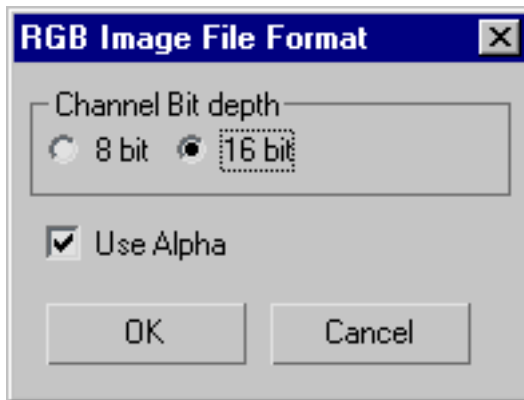

Channel Bit Depth group

8 Bit Saves the RGB file as 8-bit color.

16 Bit Saves the RGB file as 16-bit color.

Use Alpha toggle

Use Alpha Saves Alpha channels with the RGB file.

TGA (Targa) Files

The Targa (TGA) format was developed by Truevision for their video boards. The format supports 32-bit true color; that is, 24-bit color plus an alpha channel, and is typically used as a true color format.

Targa files are widely used to render still images and to render sequences of still images to video tape.

Some Targa files created by other applications have different file-name extensions. 3ds Max can render the *.vda*, *.icb*, and *.vst* variants as well as *.tga*.

Interface

Clicking Render or Setup in the [Render Output File dialog](#) on page 6086 displays the Targa Image Control dialog.

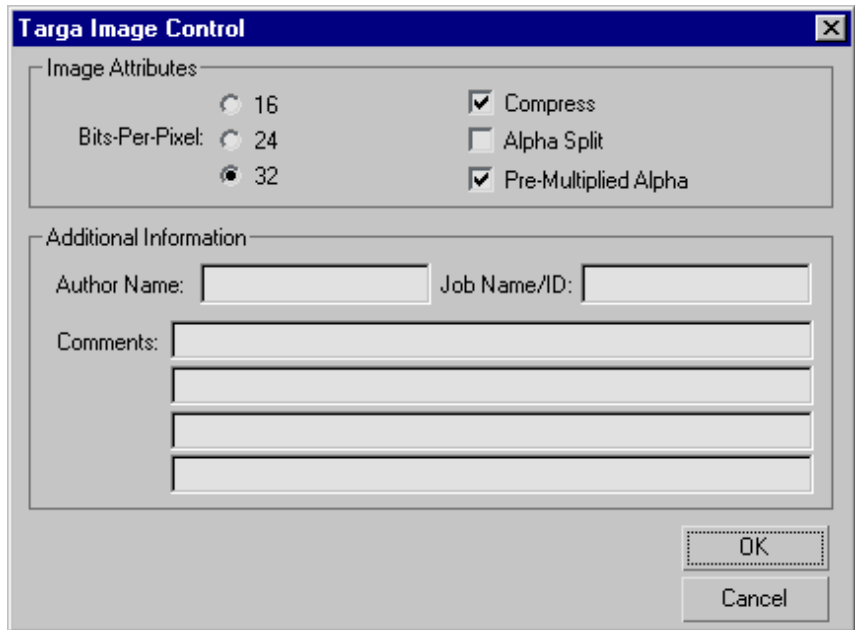

When you render to a Targa file, you have the following options:

Image Attributes group

Bits-Per-Pixel Choose the color depth: 16-bit, 24-bit, or 32-bit.

Compress Applies lossless compression to the file.

Alpha Split Creates a separate file for the alpha channel. The file name created for the alpha-channel file starts with `a_` and then appends the full file name. For example, if you check this box and render the file `greek004.tga`, 3ds Max creates the file `a_greek004.tga` for the alpha channel. (Sometimes the name will be longer than 8 characters.)

Pre-Multiplied Alpha When on, pre-multiplies the alpha channel. Pre-multiplying saves computation time if you later use this image in compositing. See [Premultiplied Alpha](#) on page 8096.

Additional Information group

Author Name, Job Name/ID, Comments These fields are available for you to add information about the file.

NOTE To control whether or not the renderer uses the environment map's alpha channel in creating the alpha for the rendered image, choose [Customize > Preferences > Rendering](#), and then turn on [Use Environment Alpha](#) in the [Background Antialiasing](#) group.

If [Use Environment Alpha](#) is turned off (the default) the background receives an alpha of 0 (completely transparent). If [Use Environment Alpha](#) is turned on, the alpha of the resulting image is a combination of the scene and background image's alpha. Also, when writing TGA files with [Pre-Multiplied Alpha](#) set to off, turning on [Use Environment Alpha](#) prevents incorrect results. Note that only background images with alpha channels or black backgrounds are supported when compositing in other programs such as Photoshop.

TIFF Files

TIFF (Tagged Image File Format) is a multiplatform [bitmap](#) on page 7926 format originating on the Macintosh® and in desktop-publishing applications. TIFF is a common choice if you plan to send your output to a print service bureau or import the image into a page-layout program.

There are several classes of TIFF files, each varying in the color depth and color palette that they support.

You can render TIFF files with alpha, [luminance](#) on page 8029, and UV color coordinate information, which describes [illuminance](#) on page 8009. You also have the option to render a compressed image. Luminance and illuminance data are rendered by the [Lighting Data Exporter utility](#) on page 6759.

Interface

To open the TIF Image Control dialog, click [Save or Setup](#) on the [Render Output File dialog](#) on page 6086.

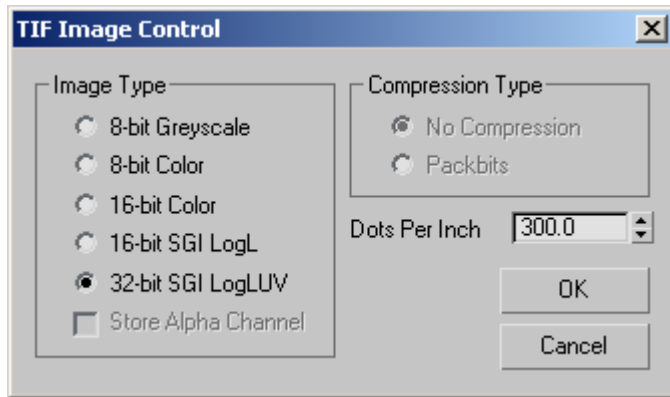

When you render to a TIFF file, you have the following options:

Monochrome Creates an 8-bit grayscale image.

Color Creates a 24-bit color image (no alpha channel).

Image Type group

Lets you choose the method for saving image information:

- **8-bit Greyscale** Creates an 8-bit grayscale image.
- **8-bit Color** Creates an 8-bit color image.
- **16-bit Color** Creates a 16-bit color image.
- **16-bit SGI LogL** Creates a color image that includes a logarithmic encoding of the luminance channel.
- **32-bit SGI LogLUV** Creates a color image that includes a logarithmic encoding of the luminance channel and UV color coordinate information.

Store Alpha Channel When on, stores the alpha channel along with other image data. Alpha data adds 8 bits per pixel to the image type you selected.

Compression Type group

Lets you render a compressed TIFF file. Default=No Compression.

- **No Compression** Does not compress the rendered image.

- **Packbits** Uses the TIFF Packbits algorithm to compress the file.

Dots Per Inch Sets the dots per inch (dpi) for the saved image. This setting does not change the resolution of the final image, but can affect the way it prints in documents.

YUV Files

YUV files are still-image graphics files in the Abekas Digital Disk format.

YUV is supported only as an input file format. You can use YUV files as general-purpose bitmaps, but you can't render to a YUV file.

RAM Player

Rendering menu > RAM Player

The RAM Player loads a frame sequence into RAM and plays it back at selected frame rates. The RAM Player has a channel A and a channel B. Two different sequences can be loaded into the channels to play back together, giving you the ability to compare them.

Clicking and dragging in the channel display window allows you to set the A/B divider between the two channels. The right mouse button “scrubs” the animation through all of its frames. Hold the right mouse button and move the mouse left to move the animation back to the first frame. Move the mouse right to advance the animation to its end.

For best RAM Player performance, Gamma should not be enabled in Customize > Preferences > Gamma.

Interface

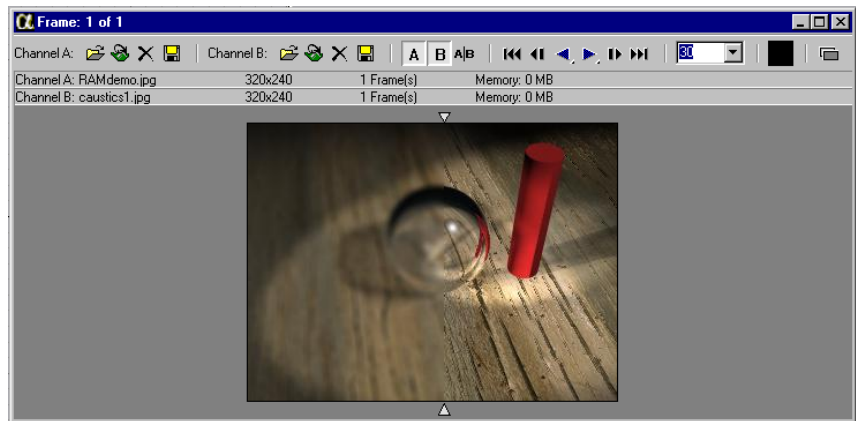

Channel A/B

Open Channel Displays an Open File dialog that lets you select a file to load into the channel. After you have selected a file, the [RAM Player Configuration dialog](#) on page 7378 appears that allows you to set height, width, and memory usage for that channel.

Open Last Rendered Image Loads the last rendered image into the channel. Nothing is displayed if there is no last rendered image available.

Close Channel Unloads the image in the channel and frees up your memory.

Save Channel Displays a Save File dialog that lets you save the animation or image from the respective channel. You can save the animation as a .avi file or a numbered sequence of images.

NOTE The RAM Players converts everything it loads into 24-bit RGB which means that some information may be lost when it is loaded. This may affect a file saved in the RAM Player.

Channel A When selected, this button will show the file loaded into channel A. Split screen markers are displayed if both channels are enabled. The split screen markers are represented by two triangles. These markers indicate where channel A ends and channel B begins. You can move the divider using the left mouse button.

Channel B When selected, this button will show the file loaded into channel B. Split screen markers are displayed if both channels are enabled. The split

screen markers are represented by two triangles. These markers indicate where channel A ends and channel B begins. You can move the divider using the left mouse button.

Horizontal/Vertical Split Screen Toggles between the view of the two channels side-by-side or one on top of the other.

Frame Controls

First Frame Automatically returns the RAM Player to the first frame of the animation. If the RAM Player is at the first frame, First Frame returns the animation to the last frame.

Previous Frame Backs up the RAM Player to the previous frame in the animation. If the RAM Player is at the last frame, Previous Frame returns the animation to the first frame.

Playback Reverse Plays the frames in the animation in reverse order. The flyout contains an option to play the animation once and then stop.

Playback Forward Plays the frames in the animation in rendered order. The flyout contains an option to play the animation once and then stop.

Next Frame Advances the RAM Player to the next frame in the animation.

Last Frame Automatically places the RAM Player at the last frame of the animation.

Frame Rate Control Sets the desired frame rate in frames per second. When playing back a movie, you see the frame rate displayed in the title bar of the RAM Player. You can select a predefined frame rate or type in your own frame rate value.

Color Selector Ctrl+right-clicking the mouse in the display window displays the color of the pixel in the color selector swatch. Stop the animation to get a correct pixel reading. The RGB of the pixel is also displayed in the title bar of the RAM player.

Double Buffer Selecting Double Buffer ensures that the two frames in channels A and B are synchronized. Enabling this function has a substantial impact on the maximum frame rate.

RAM Player Keyboard Shortcuts

The following keyboard shortcuts are available for the RAM Player.

RAM Player Function	Keyboard Shortcut
Go To Start Frame	Home
Go To End Frame	End
Go To Previous Frame	Left Arrow
Go To Next Frame	Right Arrow
Playback Reverse	Up Arrow
Playback Forward	Down Arrow
Stop Playback	Esc or Ctrl+C
Toggle Playback or Stop	Spacebar
Toggle Channel A On/Off	A
Toggle Channel B On/Off	B
Open File in Channel A	Ctrl+A
Open File in Channel B	Ctrl+B
Open Last Rendered Image in Channel A	Alt+A
Open Last Rendered Image in Channel B	Alt+B
Scrub Animation	Ctrl+left mouse button or right mouse button

RAM Player Configuration Dialog

Rendering menu > RAM Player > Load a file into either channel. > RAM Player Configuration dialog

The RAM Player Configuration dialog contains controls for resolution, frames, memory usage, and alpha channel for playing back animations.

Interface

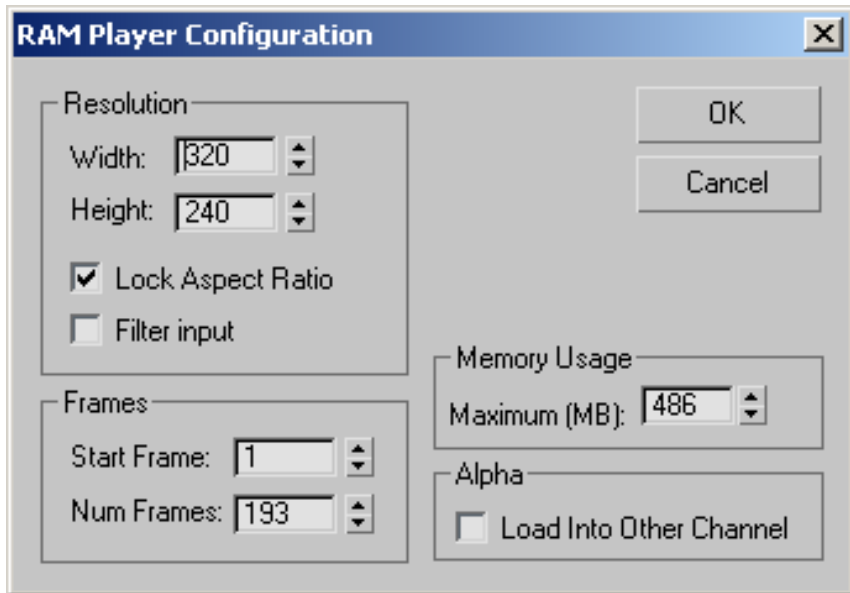

Resolution group

Width Defines the width at which the file is loaded.

Height Defines the height at which the file is loaded.

Lock Aspect Ratio When turned on, Lock Aspect Ratio forces the file to load at the same aspect ratio, regardless of the Width and Height values you enter. If you change the Width of the file, the Height adjusts according to the file's original aspect ratio. Adjusting the Height does the same to the Width value.

Filter Input When turned on, Filter Input filters the image or animation so that it best maintains the quality of the original file. When turned off, filtering does not occur, and the image or animation could be distorted.

Frames group

Start Frame Specifies a certain frame in an animation where you want the RAM Player to begin loading. A value of 1 would start the animation at its rendered beginning. A value of 5 would start the animation on frame five and any frame before that would not be loaded.

Num Frames Specifies the total number of frames to be loaded into the RAM Player.

Memory Usage group

Maximum Lets you configure the maximum amount of memory to use for the RAM player. This value includes both channels.

Alpha group

Load Into Other Channels When turned on, this option loads a grayscale alpha channel into the other channel. This allows you to wipe between an RGB channel of the animation and the alpha channel of the animation.

Scene Explorer

Menu bar > Tools > New Scene Explorer

Menu bar > Tools > Open Explorer: [name of most recently used explorer]

Menu bar > Tools > Saved Scene Explorers > Choose a saved scene explorer.

Scene Explorer provides a modeless dialog for viewing, sorting, filtering and selecting objects in 3ds Max, as well as additional functionality for renaming, deleting, hiding, and freezing objects, creating and modifying object hierarchies, and editing object properties en masse.

When working on a new scene, you open the Scene Explorer dialog with the Tools menu > New Scene Explorer command. Each subsequent invocation of this command opens a separate, additional Scene Explorer dialog. All scene explorers persist in the scene, even if closed. You can open the most recently used scene explorer with the Tools menu > Open Explorer command, or any scene explorer with the Tools menu > Saved Explorer submenu.

TIP In a new scene, the keyboard shortcut Alt+Ctrl+O (letter O) creates a new scene explorer. But when one or more scene explorers exist in the scene, the same shortcut opens the most recently used explorer.

All active scene explorers are saved and loaded with the scene. To save and load scene explorers separately, and delete and rename them, use the [Manage Scene Explorer dialog](#) on page 7393.

The Scene Explorer interface consists of a menu bar, two toolbars, and a table view of objects in the scene, with a row for each object and a column for each displayed object property. The default layout displays object name, color, number of faces, and certain display properties, but you can easily customize it to show only the properties you want. You can save customized Scene Explorer setups, and set any custom setup to be the default view.

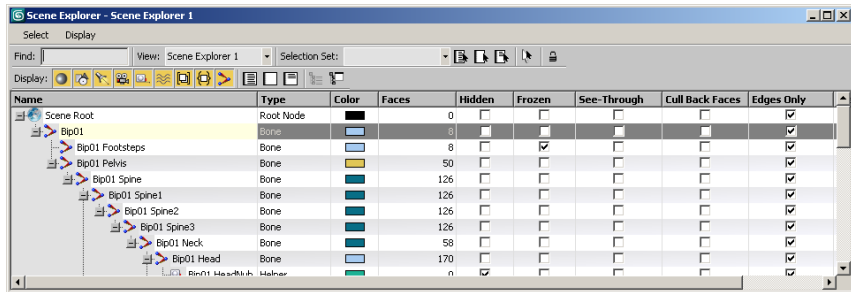

Scene Explorer Features

Following are some of the notable features of Scene Explorer:

- Customize the dialog by setting any configuration of columns, hidden and displayed categories, etc.
- Open as many separate instances of the dialog as you like, each with a different configuration.
- Synchronize selection between Scene Explorer and the scene.
- Save and load different configurations.
- Set any configuration as the default.
- Scene Explorer setup saved with your MAX scene file.
- Use scripting to create custom columns such as an [editable Radius field](#) on page ?.
- Create and edit object hierarchies by dragging and dropping.
- Sort on single or multiple columns.
- Change object settings singly or *en masse*.

- Powerful, sophisticated search and filtration features.

See also:

- [Using Scene Explorer](#) on page 7381
- [Scene Explorer Columns](#) on page 7385
- [Scene Explorer Menus](#) on page 7389
- [Scene Explorer Toolbars](#) on page 7391
- [Manage Scene Explorer](#) on page 7393
- [Advanced Search Dialog](#) on page 7395
- [Advanced Filter Dialog](#) on page 7397

Using Scene Explorer

This topic includes procedures for using general functionality in the [Scene Explorer window](#) on page 7379. You can find additional procedures for specific Scene Explorer features in [Scene Explorer Columns](#) on page 7385, [Advanced Search Dialog](#) on page 7395, and [Advanced Filter Dialog](#) on page 7397.

To highlight objects in Scene Explorer:

- Optionally, set the filters on the Display toolbar to show only object types you're interested in. Next, do any of the following:
 - Click in the Find field, if necessary, and then, on the keyboard, enter enough characters to distinguish the object or objects you want to select from the rest. For example, if the scene contains several spheres and several boxes, you can highlight all the spheres simply by typing **S** (assuming the spheres still have their default names).

TIP The Scene Explorer dialog always opens with the keyboard focus in the Find field, so in general you don't need to click the field before entering a search phrase.

- Use the mouse:
 - To highlight a single item, click its name.

- To highlight multiple contiguous list entries, drag vertically in any column. Alternatively, click the first item and then Shift+click the last.
- To highlight non-contiguous items, hold down the Ctrl key as you click.
To remove highlighting from an item, Ctrl+click it.
- On the upper toolbar, click Select All, Select None, or (after making a selection), Select Invert.
- If any [named selection sets](#) on page 239 exist, choose one from the Selection Set drop-down list on the upper toolbar.
- Use the [Advanced Search function](#) on page 7395: From the Scene Explorer > Select Menu, choose Search, set any number of Boolean search terms, and then click Select.

To edit properties for multiple objects:

- 1 Highlight several objects, as described in the preceding procedure.
- 2 Change a property for any of the highlighted objects. For example, turn on Hidden, or change an object name.
All highlighted objects receive the changed value or property.

TIP You can toggle an on/off-type property, such as Hidden, by clicking anywhere in the cell, not just in the check box.

NOTE Clicking a highlighted item's row doesn't remove highlighting from other highlighted rows.

To synchronize selection between the scene and Scene Explorer:

Do any of the following:

- Make a selection in Scene Explorer, and then right-click a selected item in the list and choose Select In Scene.
- On the Scene Explorer > Select menu, turn on Sync Selection. When this is on, selecting an object in the viewport highlights it in Scene Explorer and vice-versa.

- Make a selection in the viewport, and then right-click any cell in Scene Explorer and choose Pull Selection from Scene.

To delete objects from the scene:

- Highlight one or more items in Scene Explorer, and then right-click a highlighted item in the list and choose Delete From Scene. The objects are deleted from Scene Explorer and the scene.

TIP To undo such a deletion with the keyboard shortcut Ctrl+Z, first change the focus from Scene Explorer to the main application by activating a viewport or clicking the command panel.

To edit hierarchies with Scene Explorer:

- To link one object to another (child to parent), drag an object's icon (to the left of its name) to another object. The first object will become a child of the second object. When a yellow arrow appears to the left of the target object, release the mouse button.
- To unlink a child object from its parent, drag the object's icon to the Scene Root node at the top of the list.

To remove a column from the table:

- 1 Drag the column heading downward until the mouse cursor changes to an X icon.
- 2 Release the mouse button.

To edit multiple items:

- 1 Make sure the value or values you want to change are exposed in the Scene Explorer interface. If not, add them with the [Column Chooser](#) on page ?.
- 2 Highlight multiple list entries.
- 3 Change a value for one of the entries. Scene Explorer sets the same value for all of the highlighted entries.

To rename an object:

This method applies to editing any text field, such as the custom Radius field demonstrated in the next procedure.

- 1 Select the object in the list by clicking its name (or the field you want to edit). Alternatively, select multiple list entries. The editing is applied to all highlighted entries.
 - 2 Do any of the following:
 - Press F2.
This highlights the object name.
 - Double-click an entry.
This places an insert cursor where you double-click.
-
- NOTE** You need not double-click a highlighted entry. If you double-click a non-highlighted entry, you can edit it immediately, and the edit affects only that entry. If you double-click a highlighted entry and edit it, the edit affects all highlighted entries.
-
- Wait a moment and then drag over the part of the name you want to replace.
This highlights only the text over which you drag.
- 3 Edit the name using the keyboard. When finished, press Enter or Tab, or click a different part of the dialog.

Example: To customize Scene Explorer:

With some knowledge of MAXScript, you can add custom fields to Scene Explorer that lets you view and edit object properties of your choice. In this example, you'll add an editable Radius column that applies to object primitives such as Sphere, Cylinder, and Teapot.

- 1 Open a text editor and enter the following (you can copy and paste this listing):

```
showinterface sceneexplorermanager
function getter node=(return getuserprop node "user")
function setter node value=(setuserprop node "user" value)
sceneexplorermanager.addProperty "User" getter setter
function getrad node=(if isProperty node "radius" then return
node.radius)
function setrad node value=(if isProperty node "radius" then
node.radius=value as float)
```

```
sceneexplorermanager.addproperty "Radius" getrad setrad
```

- 2 Save the file in text format in the *Scripts* folder in your program installation. Use the file name **radius.ms**.
- 3 In 3ds Max, create some teapots and spheres.
- 4 From the MAXScript menu, choose Run Script, and then find and highlight the script file from step 2 and open it.
This adds a new item to the Column Chooser.
- 5 Open a new Scene Explorer window, right-click a column heading, and choose Column Chooser.
- 6 Scroll down to the bottom of the Column Chooser dialog, and then drag the Radius item to one of the current column headings.
The new Radius column shows and lets you edit the Radius values for the teapots and spheres. You can now, for example, highlight several of the objects by dragging in the Radius column, press F2 to edit the first item you clicked on, and enter a new value; this sets all highlighted items to the new Radius value.

Using groups with Scene Explorer

- By default, [group](#) on page 282 members do not appear in the Scene Explorer list. To show group members, [open](#) on page 283 the group. When the group is closed, only the group itself appears in the list.
- Scene Explorer does not support grouping functionality. In other words, you cannot add members to groups or remove members by dragging and dropping items in Scene Explorer.

Scene Explorer Columns

[Scene Explorer](#) on page 7379 > Column headings

The Scene Explorer columns provide information on and means to edit various properties of scene contents in 3ds Max. These include text strings, check boxes, numeric quantities, and more. You can also sort the Scene Explorer listing by clicking a column heading (a second click reverses the sort). Additional methods for using columns are available; see the Procedures section (following).

Procedures

To add columns to the table:

- 1 Right-click a column heading and then choose Column Chooser from the context menu.

This opens the Column Chooser dialog.

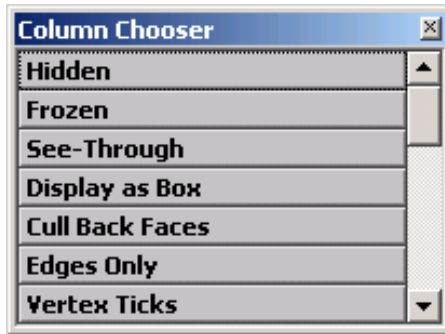

TIP Another way to access Column Chooser is from the Display menu.

- 2 Drag a column heading from the Chooser dialog to one of the Scene Explorer column headings.
The new column is inserted to the left of the existing column.
- 3 Continue adding columns as desired. When finished, close the Column Chooser.

To sort the list based on a column or columns:

- 1 Click a column heading.

This performs a single-level sort based on the column contents, in ascending order, as indicated by up arrow on the right side of the heading. For example, clicking the Name column sorts the table in ASCII order, starting with punctuation, then numbers, then letters.

NOTE Object hierarchies remain together when the list is sorted. Child objects at the same level are sorted only with respect to one another, not objects on other hierarchical levels.

- 2 To reverse the sort order, click the same column heading again.

Alternatively, right-click a column heading and choose Sort Ascending or Sort Descending. You can sort any number of different columns this way to perform a multi-level sort. For example, you could sort by type, and then, within that sort, by whether the objects are hidden.

To rearrange columns:

- Drag a column heading on top of another one. This moves the column to the left of the target column.

To resize a column:

- Drag the divider on the right side of the column heading.
Alternatively, to auto-resize a column, double-click the divider on the right side of the heading.

Interface

This section lists the available columns, briefly describes each column's function, and notes whether the column appears by default in Scene Explorer.

Name The [name](#) on page 7631 of the object.

Default column.

Type The type of object, such as Geometry, Shape, Light, and so on.

Default column.

Color The [wireframe color](#) on page 7631 of the object.

Default column.

Faces The number of faces in the object. By default, this is the number of triangular faces, but with polygon-type objects such as editable poly, it's the number of polygons. For example, the default box primitive has 12 faces, but if you convert it to editable poly, the Faces column value changes to 6. Other modifiers can also change this value.

Default column.

Hidden Shows whether the object is hidden (quad menu, Display panel, or Display floater).

Frozen Shows whether the object is frozen (quad menu, Display panel, or Display floater).

See-Through Shows whether the object is see-through (Object Properties).

Display as Box Shows whether the object has box display (Object Properties).

Cull Back Faces Shows whether the object has culled backfaces (Object Properties).

Edges Only Shows whether the object is set to display only edges (Object Properties).

Vertex Ticks Shows whether the object displays vertex ticks (Object Properties).

Trajectory Shows whether the object has trajectory display (Object Properties).

Ignore Extents Shows whether the object's extents are ignored when zooming (Object Properties).

Show Frozen in Gray Shows whether the object is shown as gray when it is frozen (Object Properties).

Display Vertex Channel Shows whether vertex channel display is active for editable mesh, poly, and patch objects (Object Properties).

Viewport Lighting Shows whether viewport lighting and shading is active for the object (quad menu).

Viewport Locked Lighting For a light, shows whether viewport lighting is locked (quad menu).

Viewport Shadows For a light, shows whether viewport shadows are active (quad menu).

Light Color Shows the color that a light casts (Modify panel).

Light Intensity For a light, shows the intensity (Multiplier) value (Modify panel).

Light On Shows whether the light is turned on (Modify panel)

Shadow On Shows whether the light casts shadows (Modify panel).

Has Material Shows whether the object has a material (Material Editor).



Revit Category If the object is imported from Revit, shows its user-defined Category tag.



Revit Family If the object is imported from Revit, shows its user-defined Family tag.



Revit Level If the object is imported from Revit, shows its user-defined Level tag.



Revit Type If the object is imported from Revit, shows its user-defined Type tag.



Application Origin If the object is imported from an application other than 3ds Max, shows the originating application.

Scene Explorer Menus

[Scene Explorer](#) on page 7379 > Menu bar

The principal Scene Explorer menus are available on the dialog menu bar. In addition, several context menus are available by right-clicking different user-interface elements on the dialog.

Interface

Select menu

Select All Highlights all objects in the list.

Select None Removes highlighting from all objects in the list.

Select Invert Highlights objects that weren't highlighted and vice-versa.

Select Children When on, highlighting a parent object also highlights its children.

Select Influences When on and you highlight an object with [influences](#) on page 8012, the influencing objects also highlight.

Choosing this command turns off Select Dependents, if on.

Select Dependents When on and you highlight an object that influences another, the object's [dependents](#) on page 7951 also highlight.

Choosing this command turns off Select Influences, if on.

Find Case Sensitive When on, searching with the Find field results in only exact matches with the case in the search phrase.

Find Using Wildcards When on, searching with the Find field lets you use standard wildcards: ? stands in for a single character, while * stands in for

multiple characters. For example, if you have objects named Set11, Set21, Set31, and Set34, using the search phrase “Set?1” with Find Using Wildcards on will highlight the first three but not the fourth. Searching for “Set*” will highlight all four.

Find Using Regular Expressions When on, you can use regular expressions in the Find field.

For example, to highlight all items that *do not* start with upper-case “A”, turn on Find Case Sensitive and Find Using Regular Expressions, and use this search term: [^A]. Or to highlight all items that start with “sph” and end with “1”, turn on Find Using Regular Expressions, and use this search term: **sph.*1**. Similarly, to find all light targets, use **.*Target**.

Sync Selection When on, selecting an object in the viewport highlights it in Scene Explorer and vice-versa.

Search Opens the [Advanced Search dialog](#) on page 7395, which lets you set up and use complex Boolean search terms.

Display menu

Object Types The submenu choices are All, None, and Invert; these are the same as the buttons at the right end of the [Display toolbar](#) on page 7392. Also available on the submenu is the Hide Toolbar command, which toggles display of the Display toolbar.

Children Displays linked objects as parent-child hierarchies, with the children as expandable branches below their parent objects. When off, lists all objects in the specified sort order with no regard to hierarchies.

Influences When on and you highlight an object with [influences](#) on page 8012, contents of any text-based fields of the influential objects appear in blue.

Column Chooser Opens the Column Chooser dialog, which lets you add columns by dragging new column headings to the existing column headings.



Configure Advanced Filter Opens the [Advanced Filter dialog](#) on page 7397, which lets you set up and use complex Boolean filter terms.



Enable Advanced Filter Activates the filter specified with the [Advanced Filter dialog](#) on page 7397.

Scene Explorer Toolbars

[Scene Explorer](#) on page 7379 > Upper (main) and lower (Display) toolbars

Interface

main toolbar



Find Entering a search phrase here highlights search results in the list in real time. By default, Scene Explorer uses a simple text-search method, but you can alternatively use regular expressions by turning on [Select Menu > Find Using Regular Expressions](#).

View Use the drop-down list to choose a different scene explorer, or click in the text field to edit the name of the current explorer.

Selection Set If any object-level [named selection sets](#) on page 206 exist in the scene, use this list to choose one. This selects all objects in the set.



Select All Highlights all objects.



Select None Removes highlighting from all objects.



Select Invert Toggles all highlighting; highlights non-highlighted objects and vice-versa.



Sync Selection When on, selecting an object in the viewport highlights it in Scene Explorer and vice-versa.





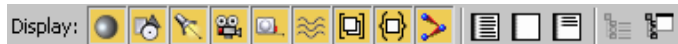





Lock Cell Editing When on, prevents you from changing any names, settings, etc. All selection functionality remains intact.





Display toolbar

Use these controls to determine the type of objects that are displayed in the dialog list.

The first part of the Display toolbar consists of a row of buttons that toggle display of the different list types. When on (pushed in, orange background), a button enables display of its list type; when off (pulled out, gray background), Scene Explorer doesn't list that type of object. The list types are:

-  Display Geometry
-  Display Shapes
-  Display Lights
-  Display Cameras
-  Display Helpers
-  Display Space Warps
-  Display Groups
-  Display Object XRefs

-  **Display Bones**

 **Display All** Turns on all display filters; that is, display of all object types is enabled.

 **Display None** Turns off all display filters; that is, display of all object types is disabled.

 **Invert Display** Toggles display of all object types; those that were enabled are disabled, and vice-versa.

 **Toggle Advanced Filter** Activates the filter specified with the [Advanced Filter dialog](#) on page 7397.

 **Advanced Filter Setup** Opens the [Advanced Filter dialog](#) on page 7397, which lets you set up and use complex Boolean filter terms.

Manage Scene Explorer

Tools menu > Manage Scene Explorer

Use the Manage Scene Explorer dialog to save and load custom scene explorers, delete and rename existing instances, and set your favorite scene explorer as the default.

Interface

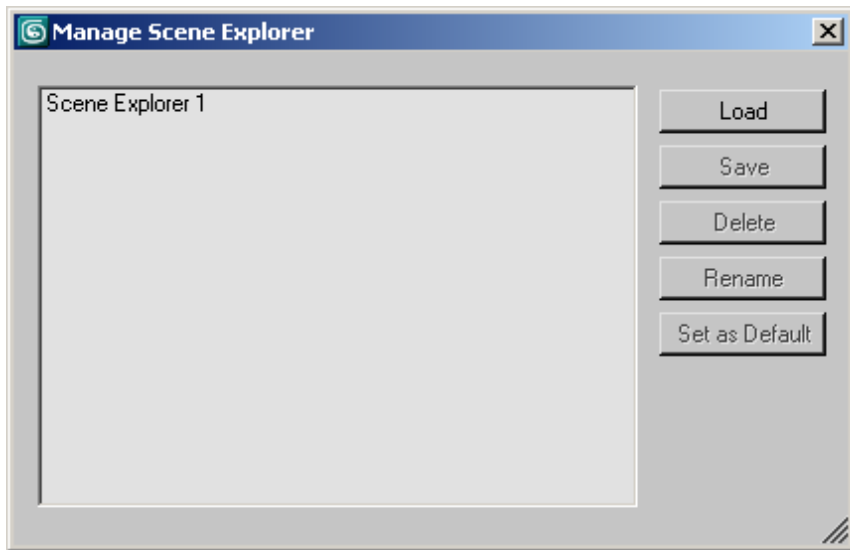

When you first open the Manage Scene Explorer dialog, it lists all current scene explorers. To highlight one or more list items, use standard mouse-based methods, including clicking, dragging, and Ctrl-clicking.

Load Opens a file dialog named Load Scene Explorer. Highlight an INI file and then click Open.

If the file isn't a valid saved Scene Explorer file, you receive an error message and nothing is loaded.

Save Lets you save the highlighted scene explorer as an INI file. Available only when a single scene explorer is highlighted.

TIP The default folder for saving scene explorers is the `\plugcfg` folder, but because it already contains a number of INI files, if you use this feature much you might want to create a dedicated folder for saving scene explorers.

Delete Eliminates all highlighted Scene Explorer instances from memory. This is not undoable.

Rename Opens a small Rename Scene Explorer dialog, with the name highlighted in an editable field. Available only when a single scene explorer is highlighted.

Set as Default Makes the configuration of the highlighted scene explorer the default configuration, so when you add a new scene explorer the software uses this configuration. Available only when a single scene explorer is highlighted.

Advanced Search Dialog

[Scene Explorer](#) on page 7379 > Select menu > Search

The Advanced Search dialog lets you highlight objects in the Scene Explorer list using combinations of search phrases to specify Boolean searches. For example, you can use Advanced Search to show only hidden non-geometry objects of a specific color whose name begins with “S”.

Procedure

To use the Advanced Search dialog in Scene Explorer:

- 1** From the Property drop-down list, choose a property for your search.
This choice determines the available options in the Condition and Reference Value lists.
- 2** Choose the Condition.
For example, if you set Property=Name, then you could choose Condition=Contains String to be able to search for a text string anywhere in the object names.
- 3** Set the Reference Value. With some properties, such as Name, you enter the value from the keyboard. With others, such as Type and Color, you use the mouse to choose the Reference Value from a list.
- 4** Click Add.
This adds the search term to the dialog list.
- 5** Add enough search terms to create the search you want to perform.
For example, if you want to find all objects other than Helper objects whose name begins with “House”, your search would look like this:

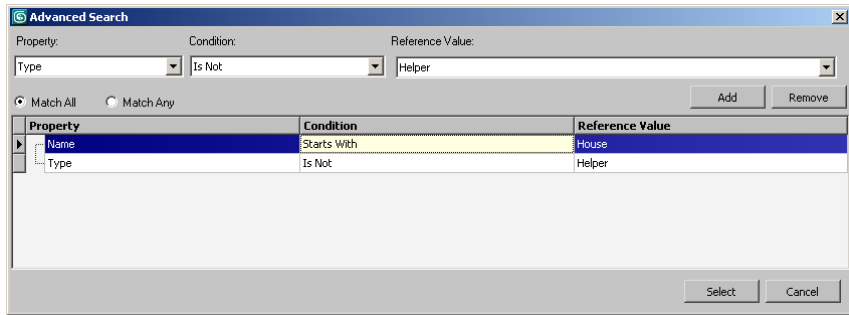

TIP

If you add a search term and then later decide you don't want to use it, highlight it in the list and then click Remove.

6 When you've set up the search you want, click OK.

This closes the Advanced Search dialog and highlights items that meet the search criteria.

Interface

Use the dialog controls to specify one or more search phrases and then initiate the search. Successful search results can meet all or any specified criteria.

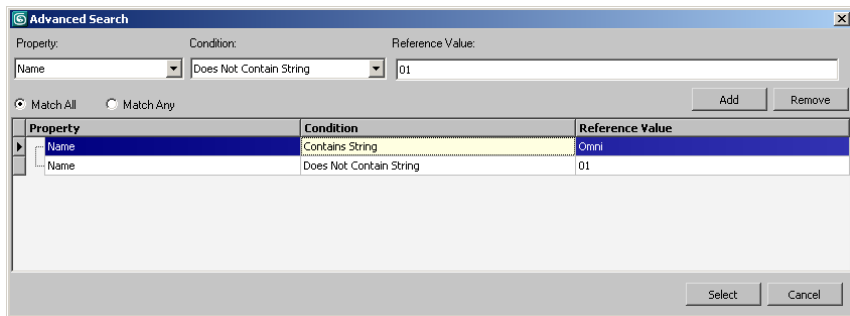

Property Choose the desired property to search for from the drop-down list.

Condition Based on the Property choice, choose an available condition.

Reference Value Enter a search term or choose one from the drop-down list, depending on the Property choice.

Match All/Match Any To use all terms for the search, choose Match All. To highlight items that match any of the search terms, choose Match Any. In Boolean terms, Match All is an AND search and Match Any is an OR search.

Add Click to add the search phrase to the list.

Remove Deletes the highlighted search phrase from the list.

[list of search phrases] When you click Add, the current combination of search conditions (the *search phrase*) is added to this list.

Select Closes the dialog and performs the search, highlighting all objects in the Scene Explorer list that satisfy the combination of search conditions.

Cancel Closes the dialog without performing a search.



Advanced Filter Dialog



[Scene Explorer](#) on page 7379 > Display toolbar > Advanced Filter Setup button

[Scene Explorer](#) on page 7379 > Display menu > Configure Advanced Filter

The Advanced Filter dialog lets you limit object display in Scene Explorer based on combinations of filter conditions (*filter phrases*). For example, you can use Advanced Filter to list only hidden non-geometry objects of a specific color whose name begins with “S”.

Procedure

To use the Advanced Filter dialog in Scene Explorer:

- 1 From the Property drop-down list, choose a property for your filter.
This choice determines the available options in the Condition and Reference Value lists.
- 2 Choose the Condition.
For example, if you set Property=Name, then you could choose Condition=Contains String to be able to filter for a text string anywhere in the object names.
- 3 Set the Reference Value. With some properties, such as Name, you enter the value from the keyboard. With others, such as Type and Color, you use the mouse to choose the Reference Value from a list.

- 4 Click Add.

This adds the filter phrase to the dialog list.

- 5 Add enough terms to create the filter you want to perform.

For example, if you want to show only objects other than Helper objects whose name begins with “House”, your setup would look like this:

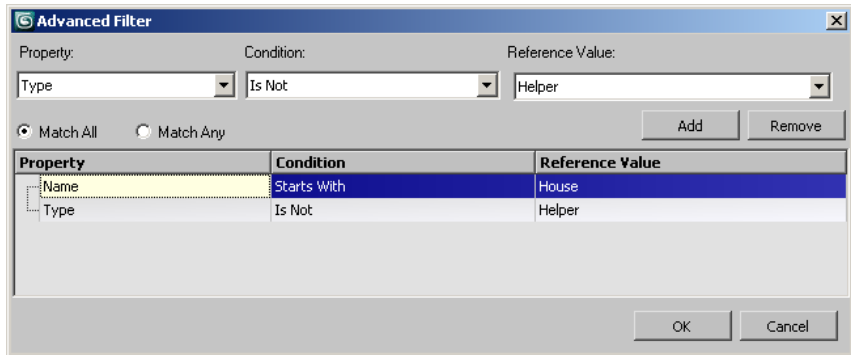

TIP

If you add a phrase and then later decide you don't want to use it, highlight it in the list and then click Remove.

- 6 When you've set up the filter you want, click OK.

This closes the Advanced Search dialog and activates the filter, with the result that only items that meet the criteria you specified appear in the Scene Explorer list.

- 7 One way that you can tell the filter is active is that the Toggle Advanced Filter button on the Display toolbar is on:

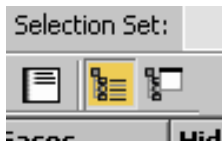

To return to displaying the full list, turn off Toggle Advanced Filter.

Interface

Use the dialog controls to specify one or more filter phrases and then initiate the search. Successful search results can meet all or any specified criteria.

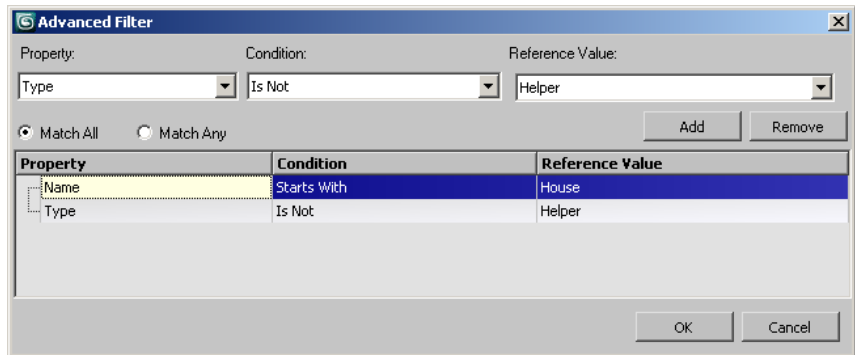

Property Choose the desired property to filter for from the drop-down list.

Condition Based on the Property choice, choose an available condition.

Reference Value Enter a term or choose one from the drop-down list, depending on the Property choice.

Match All/Match Any To use all phrases for the filter, choose Match All. To filter for items that match any of the search phrases, choose Match Any. In Boolean terms, Match All is an AND search and Match Any is an OR search.

Add Click to add the filter phrase to the list.

Remove Deletes the highlighted filter phrase from the list.

[list of filter phrases] Shows all active filter phrases. When you click Add, the current combination of filter conditions is added to this list.

OK Closes the dialog and activates the filter, displaying only objects in the Scene Explorer list that satisfy the combination of filter conditions.

Cancel Closes the dialog without activating the filter.

Scene States

Tools menu > Manage Scene States

Right-click to open the quad menu. > Display (upper-right) quadrant > Manage Scene States

The Scene States feature provides a fast way to save different scene conditions with various lighting, camera, material, environment, and object properties that can be restored at any time and rendered to produce numerous interpretations of a model. You save and restore scene states with the [Manage](#)

[Scene States dialog](#) on page 7402, which makes it a convenient way to quickly compare how different parameter settings affect how each scene looks. Because scene states are saved with the MAX file, they are easily accessible to everyone on a design team.

Scene states also allow you to experiment with different scene setups without having to save the entire MAX file each time a change is made. This means you don't need to open and close files in order to render different conditions of the same model. As well, scene states do not add to the size of the file.

When you save a scene state, you can choose which aspects of the scene to record:

- **Light Properties** Light parameters such as color, intensity, and shadow settings are recorded with the scene for each light or luminaire.
- **Light Transforms** Transforms such as position, orientation, and scale are recorded for each light.
- **Object Properties** Current Object Properties values are recorded for each object. This includes settings for Advanced Lighting and mental ray.
- **Camera Transforms** Camera transform modes such as position, orientation and scale are recorded for each camera.
- **Camera Properties** Camera parameters such as FOV and depth of field, including any corrections made by the [Camera Correction modifier](#) on page 5247 are recorded for each camera.
- **Layer Properties** Records the settings for each layer in the Layer Properties dialog at the time the scene state is saved.
- **Layer Assignment** Records each object's layer assignment.
- **Materials** All materials and material assignments used in the scene are recorded.
- **Environment** Records these [Environment and Atmosphere Effects](#) on page 6687 settings: Background, Ambient, and Tint colors; Global Lighting > Level; Environment Map; Environment Map on/off state; Exposure Control rollout settings.

Tips for Managing Scene States

- When first becoming familiar with scene states, minimize changes to make it easier to keep track of what each scene state contains.

- Saving all scene aspects in a scene state allows you more flexibility when restoring. When you include all the parts of the scene, you can choose to restore all or just a few of the aspects that were originally saved.
- Additions made to a scene after a scene state has been saved affect how the restored scene will render. For example, say you already have a scene state named *Omni* that contains omni lights. You then decide to save another scene state named *Free Spot* that contains a free spot light. When you restore the *Omni* scene state, the scene will contain both the omni lights and the free spot light.
If you decide to add other lights to the scene that you don't want to render with the existing lights, you need to remember to turn off the new lights and overwrite any existing scenes that have Light Properties saved. See [Saving Changes to an Existing Scene State](#) on page ? on how to overwrite an existing scene state.
- Use descriptive names for scene states. If scene state names are too long to see in the dialog, resize the Manage Scene States dialog or use the scroll bar at the bottom of the dialog.
If you select individual parts to be saved with a scene state, it is useful to note in the scene state name which parts are recorded.
- If the scene contains more than one camera, restore the desired scene state first, then change the viewport to the desired camera view.

Scene State Limitations

- Even though you can select multiple scene states from the Manage Scene State dialog, only one scene state can be restored at a time.
- The currently restored scene state name is not displayed in the user interface. It's helpful to save rendered scenes by their scene state name as a reference.
- Materials must be reopened in the Material Editor after a scene state containing objects with material assignments is restored.
- If part of a scene state is later deleted or hidden, a warning does not display when the scene state is restored indicating that there are missing parts or that the scene will not be restored as it was when originally recorded.
- Likewise, if you delete one or more scene states from the Manage Scene States dialog, you are not presented with a warning that you are about to delete them. However, you can restore deleted scene states with Undo.

- Viewport configurations are not saved as part of the scene state. Therefore, you cannot use scene states to control which viewport is active or whether viewports are minimized or maximized.

Scene States and Batch Render

Scene states do not store viewport layouts, such as which camera view is active, so you can use the [Batch Render tool](#) on page 6553 to coordinate rendering from any camera that is saved with the model. With each camera task that you assign to the batch render tool, you can specify a saved scene state that will be automatically loaded and rendered.

See also:

- [Manage Scene States Dialog](#) on page 7402
- [Batch Rendering](#) on page 6548
- [Batch Rendering - Batch Render Dialog](#) on page 6553

Manage Scene States Dialog

Tools menu > Manage Scene States

Right-click to open the quad menu. > Display (upper-right quadrant) > Manage Scene States

The Manage Scene States dialog is a modeless dialog where you can select, save, rename, and delete [scene states](#) on page 7399.

Procedures

To save a scene state:

- 1 Set up the scene in the viewport.

TIP It is best to first render the scene to see if it is set up the way you want before saving it. If it isn't, make the desired changes and render again before proceeding to the next step.

- 2 Right-click in a viewport and choose Save Scene State from the quad menu.

- 3 In the Save Scene State dialog, highlight the parts you want saved in the scene state, then enter a descriptive name. For descriptions of these parts, see [Managing Scene States](#) on page 7399.
- 4 Click the Save button. This saves the scene state to the MAX file.

To restore a scene state:

- 1 Right-click in a viewport and choose Restore Scene State from the quad menu.
- 2 Choose the scene state to restore from the flyout list.
- 3 Highlight the parts you want restored with the scene state. Only the parts that were originally saved with the scene state are listed.
- 4 Click Restore.
The scene state is restored in the viewport.

To rename a scene state:

- 1 Right-click in a viewport and choose Manage Scene States from the quad menu.
- 2 In the scene state list, highlight the scene state you want to rename.
- 3 Click the Rename button.
- 4 In the Rename Scene State dialog, enter a new name for the scene state.
- 5 Click OK. The new name is displayed in the scene state list.

To delete a scene state:

- 1 Right click in a viewport and choose Manage Scene States from the quad menu.
- 2 In the scene state list, highlight the scene state you want to delete.
- 3 Click the Delete button. The scene state is deleted from the MAX file.

NOTE You can undo to restore the deleted scene state.

To save changes to an existing scene state:

- 1 In the Manage Scene States dialog, highlight the scene state you want to overwrite.
- 2 Click the Save button.
The Scene State Manager displays a message confirming if you want to overwrite the scene state.
- 3 Click OK.

Interface

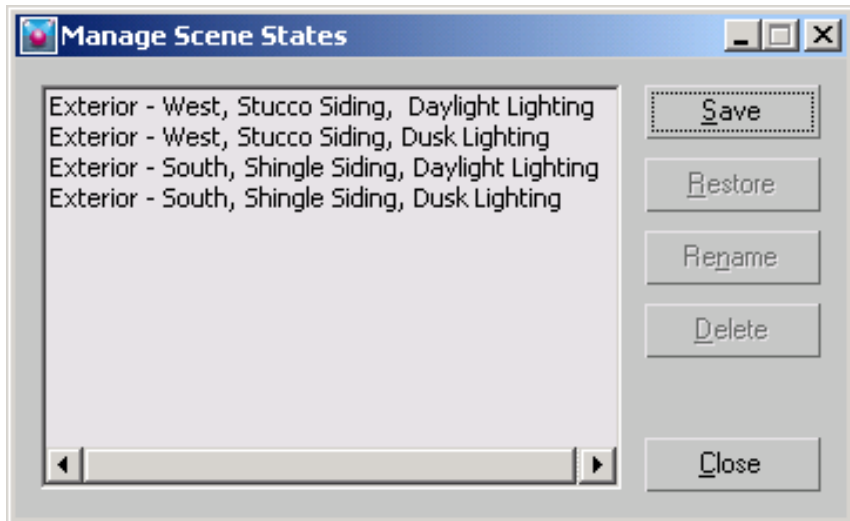

The dialog lists all the scene states that are saved in the MAX file.

Save Opens the [Save Scene State dialog](#) on page 7405 where you enter a name for the current scene state. To select a continuous range of parts, drag or Shift+click. To make a noncontinuous selection, use Ctrl+click.

Restore Opens the [Restore Scene State dialog](#) on page 7406 for the selected scene state.

Rename Opens the [Rename Scene State dialog](#) on page 7407 for the selected scene.

Delete Deletes the highlighted scene state(s) without first warning you if you are sure you want to delete the scene. To select a continuous range of entries, drag or Shift+click. To select noncontinuous entries, use Ctrl+click.

Close Closes the Manage Scene States dialog.

Save Scene State

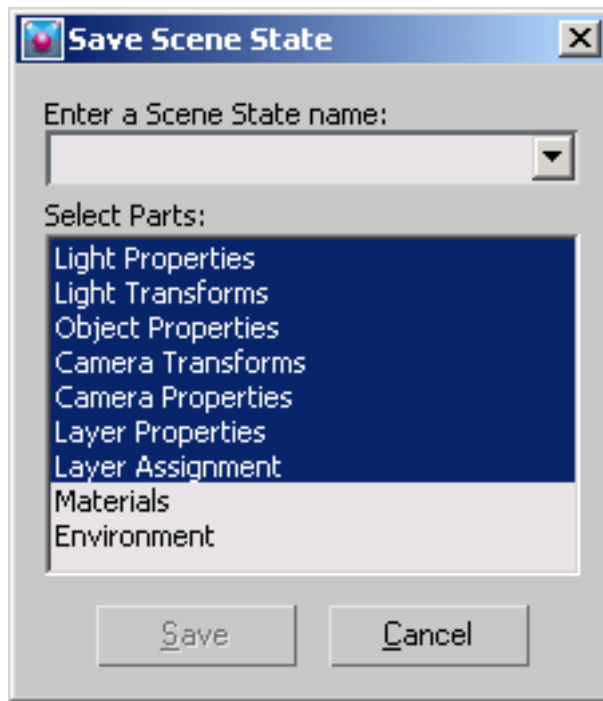

Enter a Scene State name A text field where you enter a descriptive name for the scene state.

Select Parts Lists the parts you can save in the scene state. By default, all parts are highlighted except for Materials and Environment. When you make a different selection set, it is “sticky,” which means the next time the dialog is displayed, the parts you highlighted previously are highlighted.

Save Saves the scene state with the name you supplied and the parts you selected. The scene state is saved in the MAX file.

Cancel Closes the dialog without saving the scene state.

Restore Scene State

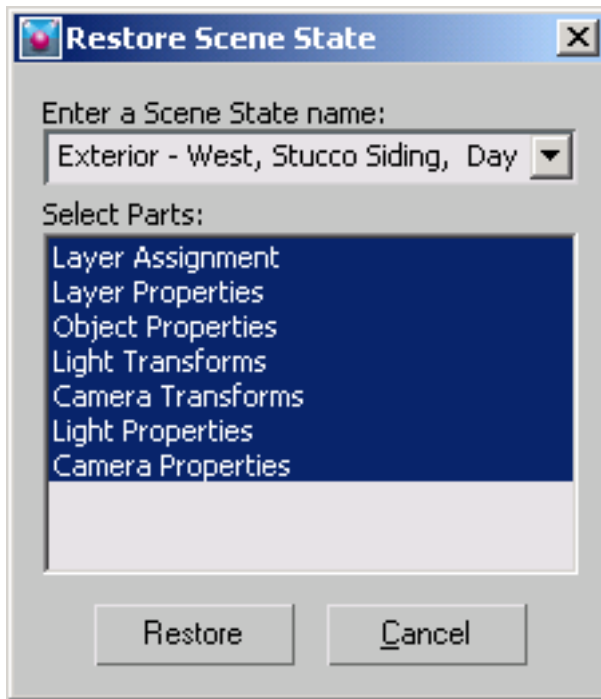

Enter a Scene State name Displays the scene name that was selected in the Manage Scene States dialog. Use the drop-down list to select a different scene state to restore.

Select Parts Displays a list of scene parts from which you can restore for the scene state. To highlight a continuous range of parts, drag or Shift+click. To highlight noncontinuous items, use Ctrl+click.

Restore Click to restore the scene state in the active viewport.

Cancel Closes the dialog without restoring the selected scene state.

Rename Scene State

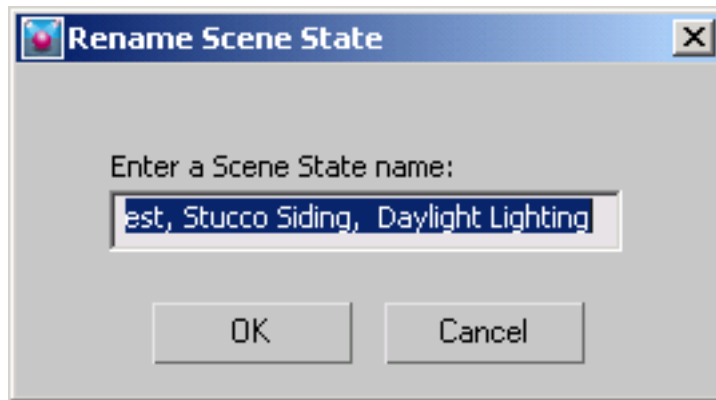

Enter a Scene State Name Enter a new name in the Name field for the highlighted scene state. Click OK to accept the change or Cancel to close the dialog without renaming the scene state.

Schematic View

Menu bar > Graph Editors > New Schematic View

Menu bar > Graph Editors > Saved Schematic Views > Choose a saved schematic view.

Main toolbar > Schematic View button

The Schematic View is a node-based scene graph that gives you access to object properties, materials, controllers, modifiers, hierarchy, and non-visible scene relationships such as wired parameters and instancing.

Here, you can view, create, and edit relationships between objects. You can create hierarchies, assign controllers, materials, modifiers, or constraints.

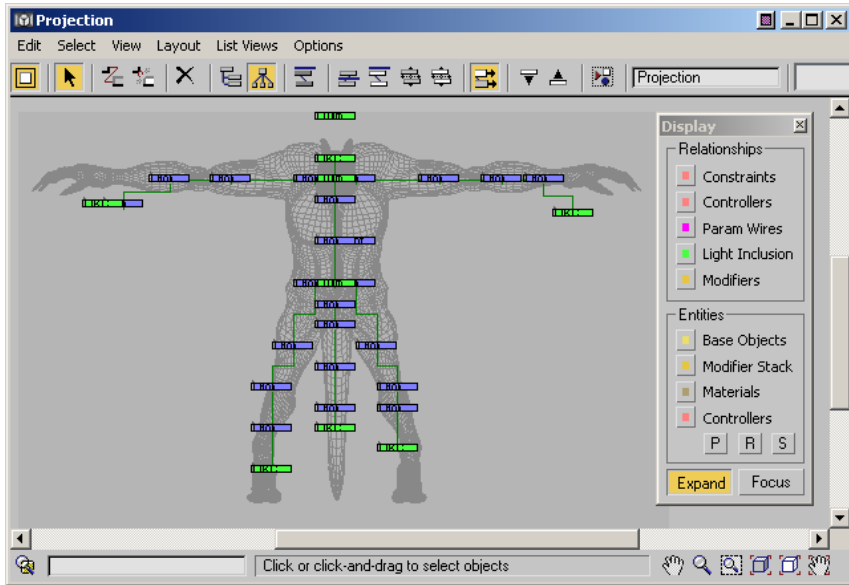

You can use the Schematic View Display floater to control what entities and relationships you want to see and work with. Use Schematic View to navigate complex hierarchies or scenes with large numbers of objects. Use Schematic View to understand and explore the structure of files you didn't create yourself.

One powerful feature is the list view. You can see the nodes in a text list which you can sort by criteria. The list views can be used to navigate extremely complex scenes quickly. You can use the relationship or instance viewer within Schematic View to see light inclusions or parameter wirings within the scene. You can control the display of instances or see a list of object occurrences.

Schematic View also allows for background image or grid, and automatic arrangement of nodes based on physical scene placement. This makes arranging nodes for character rigs easier.

Choose between a variety of arrangement selections so you can auto-arrange, or work in a free mode. The layout of the nodes is saved with the named Schematic View window. You can load a background image as a template for laying out the nodes in the window.

Schematic View Features

Here are some of the notable features of Schematic View:

- Layouts are saved with the named Schematic View file.

- Text remains readable during window navigation.
- Schematic View includes tools for displaying and arranging nodes including a free mode.
- You can use a background image or grid in the Schematic View window.
- You can see and edit wired parameters.
- A modeless display floater lets you turn on and off node display by category.
- The Relationship List Viewer enables quick navigation and selection of nodes. Relationships displayed includes Lights inclusion/exclusion, all parameter wires, constraints, controllers, and modifier relationships such as path deform paths and morph targets
- You can copy and instance controllers.
- You can assign controller types.
- Schematic View offers extensive MAXScript exposure.
- Ability to drill down to more properties (such as static values and custom attributes).

How the Components of Schematic View Behave

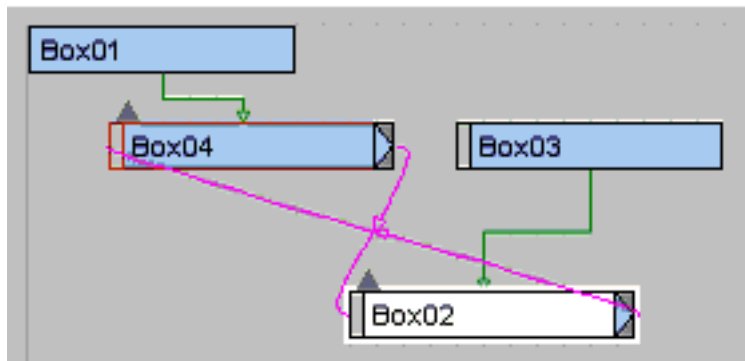

Everything displayed in the Schematic View window is shown as a box with a name. There are various conventions to indicate different states regarding these objects.



Solid End Signifies that the entity is arranged.

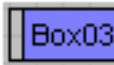

Open end Signifies that the entity is free.



Red Border Signifies that the entity is animated.



End Arrow Signifies that the entity shares a relationship with another entity.

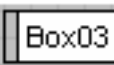

White Fill Signifies that the entity is selected in the Schematic View window.



White Border Signifies that the entity is selected in the viewport.



Up Arrow Collapses the entity it springs from and all child entities thereof up into the parent entity



Down Arrow Expands the next child entity down from the entity that the arrow springs from.



Overlap Schematic View will prevent newly visible nodes from overlapping with existing nodes. This applies to free mode: make an object, free it, make another object and it will fall on top but to the right of the original object so both can be accessed and moved.

Instances Schematic View will bold the text of instanced entities, for nodes this will show up on the base object entity. In the example illustrated, *Box02* and *Box03* are instances.

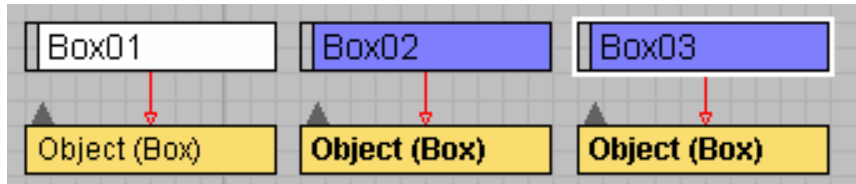

See also:

- [New Schematic View](#) on page 7433
- [Delete Schematic View](#) on page 7434
- [Saved Schematic Views](#) on page 7434
- [Schematic View Selection Right-Click Menu](#) on page 7434

Procedures

See [Using Schematic View](#) on page 7411

Interface

See the following topics describing the Schematic View user interface.

[Schematic View Menus](#) on page 7415

[Schematic View List Views](#) on page 7419

[Schematic View Preferences Dialog](#) on page 7421

[Schematic View Toolbars](#) on page 7427

[Schematic View Display Floater](#) on page 7431

Using Schematic View

This topic includes procedures for using functionality in the [Schematic View window](#) on page 7407.

To create hierarchies with Schematic View:

- 1 Select the objects you want to work with in the viewport.
- 2 Use Zoom Extents Selected to display these objects in the Schematic View window.

-  On the Schematic View toolbar, click the Connect button.
- In the Schematic View window, drag from the child object to the parent. A dotted line follows your cursor. Click to set the linkage.



If you are in Hierarchy mode, the children will arrange themselves into an indented list under the parent as you create linkages.

To assign controllers with Schematic View:

- On the Schematic View toolbar, click Display.
The Display floater appears. It lets you control what you see in the Schematic View window.
- On the Display floater, in the Relationships group, click Controllers. In the Entities group, click Controllers as well.
The buttons indent to show they are active. The Transforms now appear in the Schematic View window.
- In the Schematic View window, select the transform of the object you want to assign a controller to.
- Right-click the transform, from on the Tools quad, choose Assign Controller.
- Choose the controller you want to apply from the list, then click OK.

To wire parameters with Schematic View:

- Using the Display Floater, turn on Param Wires in the Relationships group.
- In the Schematic View window, select one of the objects you want to wire.
- Right-click the selected object and choose Wire Parameters.
- In the pop up that appears select the component you want to wire, either a Transform or an Object parameter, for instance.
- Drag to the other object you want to wire to.
- Again in the pop up that appears, select the component you need to wire to.

- 7 The Wire Parameters dialog appears. Make the necessary selections and connect the wires.
- 8 Once the wiring is established you can edit the wiring by double-clicking *the wire* in Schematic View.

To save a Schematic View layout:

- 1 When you have a layout you like, name the layout using the Schematic View name field in the toolbar, just to the right of the Preferences button.
- 2 Close the Schematic View window.
- 3 To load the saved view, go to Graph Editors > Saved Schematic View and choose the schematic view from the history list.

To add a background image:

- 1 On the Schematic View Options menu, choose Preferences.
- 2 In the Background Image group, click the File: button to launch the File Browser.
- 3 In the Browse Images for Input dialog, find and highlight the bitmap you want to use, then click Open.
- 4 On the Schematic View Preferences dialog, in the Background group, turn on Show Image.

The Background bitmap show up in the Schematic View window.

TIP Turn on Lock Zoom Pan, if you want to zoom in or pan the background image.

To navigate complex scenes:

Complex scenes can be navigated quickly by using the list viewer combined with the pan or zoom to selected option. For example suppose you need to locate all the bones within a certain character.

- 1 Open Schematic View
- 2 Press **H** on the keyboard and enter the name of the object you're looking for in the Select Objects field. Press Enter to select the object by name.



- 3 In the window navigation tools group, click Zoom Selected.

The Schematic View window now clearly shows the object node.

- 4 On the List Views menu, choose Show Occurrences.

The List viewer displays the Object Occurrences dialog.

This is a sortable list. You can click the header title to sort by it.

NOTE Object Occurrence is being used as an example here. You can use any of the List View menu choices to display a list of objects based on a certain relationship.

- 5  On the Options menu choose Pan to Selected. Now click through the nodes in the list.

The Schematic View window updates to display each node as you click.

This method makes navigation of very complex scenes much more convenient. Also when working with lists such as relationships or instances you have the additional ability to detach the relationship or make the instance unique.

To arrange the nodes in Schematic View to match the viewport:

It can be useful sometimes to arrange the nodes in the Schematic View the same as in the viewport. There is a script that can do this for you. In this example we'll use the bones of a character rig.

- 1 Using Windows Explorer, copy
`\3dsmax\scripts\maxscripttools\macro_schematicviewtools.mcr` into
`\3dsmax\ui\macroscripts`.
- 2 Restart 3ds Max.
- 3 On the Customize menu, choose Customize User Interface.
- 4 Click the Quads tab, then choose the Schematic View category from the drop-down list on the right
- 5 Drag the action named Project into Schematic View in the Schematic View quad menu (any quad you like).
- 6 Drag the Spacing Tool item into Schematic View's quad menu.
- 7 On the Graph Editors menu, choose New Schematic View.
- 8 In any viewport (other than Perspective or User), select the bones of the rig that you want to arrange.

- 9 In the Schematic View window, right-click and choose Project Into Schematic View from the quad menu.

A new Schematic View named Projection shows the selected bones arranged as in the viewport.

TIP If the components appear on top of one another, right-click again and choose Spacing Tool from the quad menu. Drag the spacing slider to the right to add space between the objects. If necessary manually reposition components as needed.

Schematic View Menus

Menu bar > Graph Editors > New Schematic View > Menu bar

Menu bar > Graph Editors > Saved Schematic Views > Choose a saved schematic view. > Menu bar

Main toolbar > Schematic View button > Menu bar

Edit menu

Connect Activates the connect tool. The connect tool in Schematic View can be used to create any relationship or constraint, are can be used to assign modifiers.

Unlink Selected Disconnects the selected entities.

Delete Removes entities from Schematic View and from the scene. Disconnects selected relationships.

Assign Controller Lets you assign controllers to transform nodes. Only available when controller entities are selected. Opens the standard assign controller dialog.

Wire Parameters Lets you wire parameters using Schematic View. This is active only when entities are selected. This launches the standard Wire Parameters dialog.

Object Properties Displays the [Object Properties dialog](#) on page 305 for the selected nodes. Has no effect when no node is selected.

Select menu

Select Tool Activates the Select tool when in Always Arrange mode and Select and Move tool when not.

Select All Selects all entities in the current Schematic View.

Select None Deselects all entities in the current Schematic View.

Select Invert Deselects selected entities and selects unselected entities in the current Schematic View.

Select Children Selects all children of currently selected entities.

Deselect Children Deselects children of all selected entities. Parent and child must be selected for child to become unselected.

Select to Scene Selects in viewport all nodes that are selected in Schematic View.

Select from Scene Selects in Schematic View all nodes that are selected in viewport.

Sync Selection When on, selecting objects in Schematic View also selects them in the viewport, and vice-versa.

List Views menu

See [Schematic View List Views](#) on page 7419.

Layout menu

Align Lets you define the following alignment options for selected entities in the Schematic View window:

- **Left** Aligns selected entities to the left edge of the selection, leaving vertical positioning intact.
- **Right** Aligns selected entities to the right edge of the selection, leaving vertical positioning intact.
- **Top** Aligns selected entities to the top edge of the selection, leaving horizontal positioning intact.
- **Bottom** Aligns selected entities to the bottom edge of the selection, leaving horizontal positioning intact.
- **Center Horizontal** Aligns selected entities to the horizontal center of the selection, leaving vertical positioning intact.

- **Center Vertical** Aligns selected entities to the vertical center of the selection, leaving horizontal positioning intact.

Arrange Children Arranges the display of children based on set arrangement rules (align options) below the selected parent.

Arrange Selected Arranges the display of children based on set arrangement rules (align options) below the selected parent.

Free Selected Frees all selected entities from arrangement rules, tags them with a hole icon on their left end and leaves them in place. Use this to freely arrange selected objects.

Free All Frees all entities from arrangement rules, tags them with a hole icon on their left end and leaves them in place. Use this to freely arrange all objects.

Shrink Selected Hides all selected entities' boxes, keeping arrangement and relationships visible.

UnShrink Selected Makes all selected shrunk entities visible.

UnShrink All Makes all shrunk entities visible.

Toggle Shrink When on, shrinking entities works normally. When off, shrunk entities are fully visible, but not unshrunk. Default=on.

Options Menu

Always Arrange Causes Schematic View always to arrange all entities based on the chosen arrangement preference. Displays a pop-up warning before doing so. Choosing this activates the toolbar button.

Hierarchy Mode Sets Schematic View to display entities as a hierarchy instead of reference graph. Children appear indented below the parent. Switching between Hierarchy and Reference mode is nondestructive.



Reference Mode Sets Schematic View to display entities as a reference graph instead of hierarchy. Switching between Hierarchy and Reference mode is nondestructive.

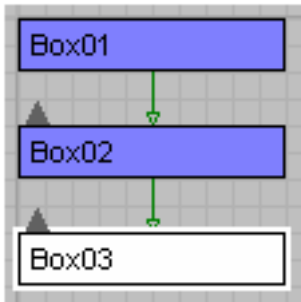

Move Children Sets Schematic View to move all children of parent being moved. When this mode is on, the toolbar button is activated.

Preferences Opens the [Schematic View Preferences Dialog](#) on page 7421, which lets you control what displays in the window by filtering for categories and setting display options.

Display menu

Display Floater Displays or hides the Display Floater which controls what is displayed in the Schematic View window.

Hide Selected Performs the action of hiding whatever is selected in the Schematic View window.

Unhide All Reveals any hidden items.

Expand Selected Displays all child entities of selected entity.

Collapse Selected Hides all children of selected entity, leaving the selected entity visible.

View Menu

Pan Activates the Pan tool, which lets you move horizontally and vertically in the window by dragging the mouse.

Pan to Selected Centers selected entities in the window. If no entity is selected, centers all entities in the window.

Zoom Activates the zoom tool. Lets you move closer to or further from the Schematic display by dragging the mouse.

Zoom Region Lets you zoom to a specific area by dragging a rectangle in the window.

Zoom Extents Zooms the window so all the nodes in the Schematic View are visible.

Zoom Extents Selected Zooms the window so that all selected nodes are visible in the display.

Show Grid Displays a grid in the background of the Schematic View window. Default=on.

Show Background Displays an image in the background of the Schematic View window. Set the image via [Preferences](#) on page 7421.

Refresh View Redraws the contents of the Schematic View window with all changes made to it or with changes made in the scene.

Schematic View List Views

Menu bar > Graph Editors > New Schematic View > Menu bar

Menu bar > Graph Editors > Saved Schematic Views > Choose a saved schematic view. > Menu bar

Main toolbar > Schematic View button > Menu bar

Schematic View supports several list views that display objects and their relationships in a list. These include list views for instances, object occurrences, and relationships. Use these lists to quickly edit your parameter wiring, detach relationships, or make instances unique. Use the List options to synchronize the list with the viewport or the node display in the Schematic View window.

Interface

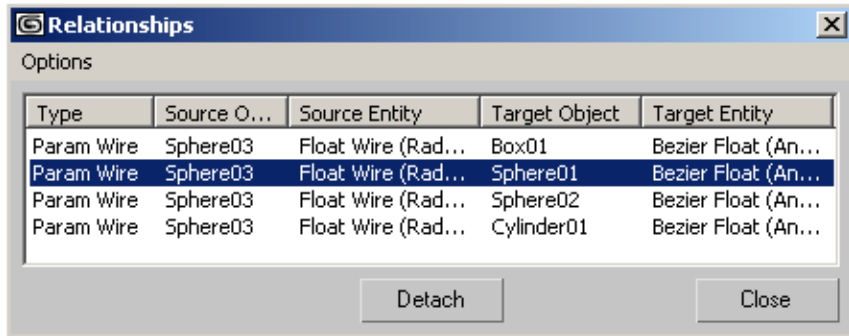

List view displaying relationships

All Relationships Opens or redraws List View with all relationships of currently displayed Schematic View entities.

Selected Relationships Opens or redraws List View with all relationships of currently selected Schematic View entities.

All Instances Opens or redraws List View with all instances of currently displayed Schematic View entities.

Selected Instances Opens or redraws List View with all instances of currently selected Schematic View entities.

Show Occurrences Opens or redraws List View with all entities that share a property or relationship type with currently selected entities

All Animated Controllers Opens or redraws List View with all entities that have or share animated controllers.

Make Unique In the All Instances and Selected Instances views, this makes the selected entity a copy and takes it out of the list.

Detach In the All Relationships and Selected Relationships views, eliminates the selected relationship and takes it out of the list.

Options Menu in the List View Dialogs

Options for list view let you synchronize the list selection with the viewport and the Schematic View window.

Sync selection When this is turned on, Schematic View selection corresponds to selections made in the list.

Pan to Selected When this is turned on, Schematic View pans to put the entity selected in the list into the center of the Schematic View within the existing zoom factor. For Instances and Occurrences this will be single entities, for Relationships it will be two entities.

Zoom to Selected When this is turned on, Schematic View zooms extents around the entity selected in the list. For Instances and Occurrences this will be single entities, for Relationships it will be two entities

Respect display When this is turned on, the List View will only show entities turned on for display by the Display Floater.

Schematic View Preferences Dialog

[Schematic View](#) on page 7407 > toolbar > Preferences button

[Schematic View](#) on page 7407 > Options menu > Preferences

The Schematic View Preferences dialog controls what is shown and what is hidden based on categories. You can filter the objects appearing in the Schematic View window, so you see only what you need to.

You can add a grid or background image into your Schematic View window. Here you can also choose the arrangement method and determine the synchronization between viewport selection and Schematic view window selection. You can also set the style for the node connections. By selecting the appropriate filters in this dialog you can make working with Schematic View more controllable.

Interface

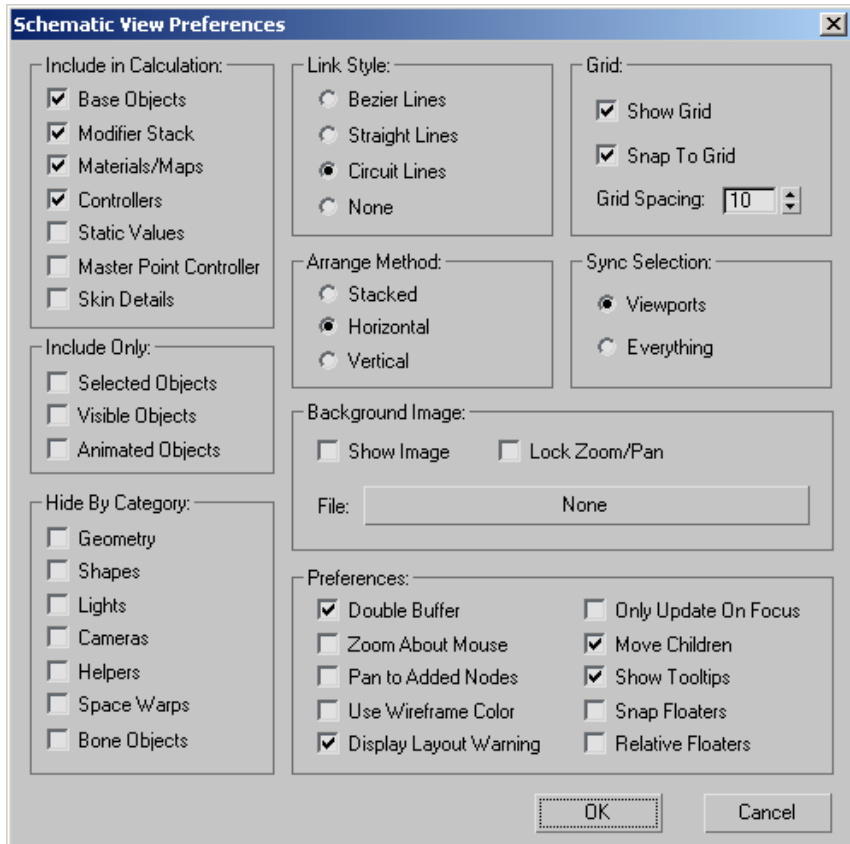

Include in Calculation group

Schematic View can traverse the entire scene, including materials, maps, controllers, and so on. The Include In Calculation settings control which scene components Schematic View will know about. The Display Floater then controls what is displayed. So, if you don't Include Materials, you can't display materials. If you don't include controllers, you can't display controllers, constraints, or parameter-wiring relationships.

If you have a huge scene and are interested only in using Schematic View for selection, you can turn everything off except Base Objects. If you are interested only in materials, you can turn off controllers, modifiers, and so on.

Base Objects Turns on and off the display of the base objects. Use this to remove clutter in the Schematic View window.

Modifier Stack Turns on and off the display of modifier nodes.

Materials/Maps Turns on and off the display of material nodes in the Schematic View window. Hide the materials when you are animating and don't need to see them, display them when you want to select materials or make changes to the material of various objects.

NOTE Schematic View does not support the ability to manipulate maps. You can not paste a map from one material to another.

Controllers When this is turned on, controller data is included in the display. When this is turned off Controllers, Constraints and Param Wires relationship and entity buttons are unavailable in the Display floater. When this is on, you can assign controllers or wire parameters using the tools quad of the Schematic View right-click menu.

Static Values When this is turned on, unanimated scene parameters are included in the Schematic View display. Turn this off to prevent the window from filling up with everything seen in Track View.

Master Point Controller When this is on, sub-object animation controllers are included in the Schematic View display. This button prevents the window from filling up with too many controllers in cases in which sub-object animation is present.

Skin Details When this is turned on four controllers for each bone in the Skin modifier are included in the Schematic View display (when Modifiers and Controllers are also included). This button prevents the window from stretching out around too many Skin controllers with normal use of the Skin modifier.

Include Only group

Selected Objects Filters the display of selected objects. Check this box if you have a lot of objects and only want Schematic View to display the viewport selection.

Visible Objects Limits the display in Schematic View to the visible objects. Hide objects you don't need to display, then check this box to contain clutter in Schematic View.

Animated Objects When this is turned on, then only objects that have keys and their parents will be included in the Schematic View display.

Hide By Category group

These toggles control the display of objects and their children, by category. The categories are:

- **Geometry** Hides or displays geometric objects and their children.
- **Shapes** Hides or displays shape objects and their children.
- **Lights** Hides or displays lights and their children.
- **Cameras** Hides or displays cameras and their children.
- **Helpers** Hides or displays helper objects and their children.
- **Space Warps** Hides or displays space warp objects and their children.
- **Bone Objects** Hides or displays bone objects and their children.

Be aware that if you have a hierarchy linked to a helper such as a dummy, and you hide the dummy, you'll also hide the children.

Link Style group

Bezier Lines Displays the reference lines with arrowheads as Bezier curves.



Straight Lines Displays the reference lines as straight lines instead of Bezier curves.

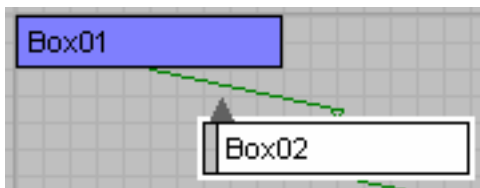

Circuit Lines Displays the reference lines as orthogonal lines instead of curves.

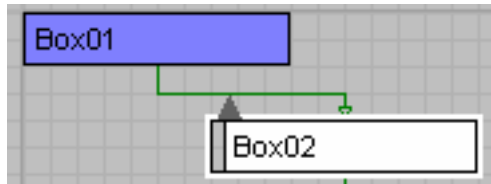

None When this is chosen, link relationships will not appear in the Schematic View display.

Grid group

This group controls the display and use of a grid in the Schematic View.

Show Grid Displays a grid in the background of the Schematic View window.

Snap to Grid When this is on, all moved entities and children of those entities will snap their upper left corners to the nearest grid point. Entities not snapped to a grid point when snap is enabled will not snap until they are subsequently moved.

Grid Spacing: Sets the spacing units of the Schematic View grid. This uses the standard that entities are 20 grid units high and 100 grid units long.

Arrange Method group

Arranging always takes place within the confines of the positive X and negative Y space which is delineated by the darker grid lines.

Stacked When this is turned on, arranging via Always Arrange, Arrange Children or Arrange Selected will result in the hierarchies being stacked below a width that is determined by the extents of the highest entities in the view.

Horizontal When this is turned on arranging using Always Arrange, Arrange Children or Arrange Selected will result in the hierarchies being distributed along and below the $y=0$ line. Arranging always takes place within the confines of the positive X and negative Y space.

Vertical When this is turned on arranging using Always Arrange, Arrange Children or Arrange Selected will result in the hierarchies being distributed along and to the right of the $x=0$ line. Arranging always takes place within the confines of the positive X and negative Y space.

Sync Selection group

Viewports When this is chosen, node entities selected in Schematic View will have their corresponding nodes selected in the viewports. Likewise, nodes selected in the viewports will have their corresponding entities selected in Schematic View.

Everything When this is chosen, all entities selected in Schematic View will have their corresponding entities selected in the appropriate places in the interface, given that those places are open. For instance, selecting a material in Schematic View will select it in the material editor if it is open and the material is present, selecting a modifier in Schematic View will select it in the stack if the Modify panel is open. Likewise, entities selected in the scene will have their corresponding entities selected in Schematic View.

None When this is chosen, changes in the viewport selection do not affect the Schematic View display, and selection changes in the Schematic View display do not affect the viewport selection.

Background Image group

Show Image When on, the background bitmap (if one is chosen) is displayed. When off, it is not displayed.

By default, the background image displays at screen resolution at the current zoom factor of Schematic View.

Lock Zoom/Pan When this is turned on, zooming and panning resizes the background image accordingly. When turned off, the bitmap will remain or revert to actual pixels at screen resolution.

File button Click to choose an image file for the background of Schematic View.

When no background image has been chosen, this button displays “None.” If an image has been chosen, it shows the name of the bitmap file.

Preferences group

Double Buffer Allows for double buffer display to control viewport performance.

Zoom About Mouse Pointer When this is turned on you can zoom into wherever you place your cursor. You can also zoom with the zoom wheel, or hold Ctrl and press the middle mouse button.

Pan to Added Nodes When this is turned on the Schematic View window will alter itself to accommodate new objects or nodes as they are added to the scene. When this is turned off the view is unchanged. Leave this off and turn off Auto arrange, and Schematic view will not disturb the layout of the nodes.

Use Wireframe Color Uses the wireframe color to shade the node in the Schematic View window.

Display Layout Warning When this is on, Schematic View will show a layout warning when Always Arrange is first turned on.

Only Update On Focus When this is turned on, Schematic View only updates with additions or changes to the scene when it is given focus. This lets you avoid constant redraws when making changes in the viewport to the scene objects.

Move Children When this is turned off you can move the parent without affecting the children. When this is turned on, moving a parent also moves the children.

Show Tooltips Toggles the display of tooltips when the cursor is over the node in the Schematic View window.

Snap Floaters Enables floating dialogs (Display and List) to snap to the edges of the Schematic View window.

Relative Floaters Enables floating dialogs to move and resize as the Schematic View window is moved and resized.

Schematic View Toolbars

Menu bar > Graph Editors > New Schematic View > Top and bottom toolbars

Menu bar > Graph Editors > Saved Schematic Views > Choose a saved schematic view. > Top and bottom toolbars

Main toolbar > Schematic View button > Top and bottom toolbars

The Schematic View toolbar at the top of the window contains the following buttons:



Display Floater Displays or hides the Display Floater. Active button means floater is open, inactive button means it's hidden.



Select Lets you select objects in the Schematic View window and in the viewport. Selecting objects in the Schematic View window turns the node yellow. Selecting the objects in the viewport, outlines their Schematic View representation box in white, but doesn't select it in the Schematic view window. If you want to the selection in Schematic view passed into the viewport use the Sync Selection button. Whatever is selected in Schematic view will become selected in the viewport as well.



Connect Lets you create hierarchies. Just as you link objects in the viewports, you can create linkages in Schematic View. Click the child and connect to the parent. You also use this to add modifiers to objects, and to wire parameters.



Unlink Selected Unlinks whatever is selected in the Schematic View window.



Delete Objects Deletes whatever is selected in Schematic View. The deleted selection disappears in the viewport and the Schematic View window.



Hierarchy Mode Shows the parent/child relationships in a cascading display. The parents are to the left and up, the children are indented toward the right and down.



References Mode Shows relationships based on instances and references rather than hierarchy. Use this to view materials and modifiers.



Always Arrange Sets Schematic View to always arrange all entities based on arrangement preference (alignment options). Displays a pop-up warning before doing so. When this mode is on it activates the toolbar button.



Arrange Children Arranges the display of children based on set arrangement rules (align options) below the selected parent.



Arrange Selected Arranges the display of children based on set arrangement rules (align options) below the selected parent.



Free All Frees all entities from arrangement rules, tags them with a hole icon on their left end and leaves them in place. Use this to freely arrange all objects.



Free Selected Frees all selected entities from arrangement rules, tags them with a hole icon on their left end and leaves them in place. Use this to freely arrange selected objects.



Move Children Sets Schematic View to move all children of parent being moved. When this mode is on, the toolbar button is activated.



Expand Selected Reveals the display of all child entities of selected entity.



Collapse Selected Hides the display of all children of selected entity, leaving the selected entity visible.



Preferences Displays the Schematic View Preferences dialog. This lets you control what is displayed and hidden in the Schematic View window by category. Various options are here to filter and control the display within the Schematic View window. See [Schematic View Preferences Dialog](#) on page 7421.

Schematic View Name field Use this field to give the particular configuration of Schematic View a name. Simply typing the name and hitting enter will add the named view to the list of Saved Schematic View windows available from the Graph Editors menu.

Bookmark Name field Let's you define a selection of entities in the Schematic View window as a bookmark, so you can easier return to them in a complex scene with many objects.



Go to Bookmark Zooms and pans the Schematic View window so the bookmarked selection is displayed.



Delete Bookmark Removes the bookmark name that is displayed in the Bookmark name field.

Buttons on the Lower Toolbar



Zoom Selected Viewport Object Zooms in on whatever is selected in the viewport. You can also type in the name in the text field next to this button.

Selected Object text entry window Lets you type in the name of the object you are looking for. Then click the Zoom Selected Viewport Objects button and that object will appear in the Schematic View window selected.

Prompt Area Provides a one-line instruction to tell you how to use the highlighted tool or button or provides you with details such as how many objects are currently selected.



Pan Lets you move horizontally or vertically in the window. You can also achieve the same effect by using the scroll bars at the right and bottom of the Schematic View window, or by using the middle mouse button.



Zoom Lets you move closer to or further from the Schematic display. When you first open your Schematic View window you will spend a moment zooming and panning to gain the appropriate view of the objects in the display. The display of the nodes changes as you move in or out.

You can also zoom by holding Ctrl and pressing the middle mouse button. To zoom at the cursor, turn on Zoom About Mouse Point in the Schematic View Settings dialog, accessed by click the Preferences button.



Zoom Region Lets you draw a zoom window on the area of the Schematic view you want to see up close.



Zoom Extents Zooms the window back so all the nodes in the Schematic View are visible.



Zoom Extents Selected Zooms the window back so that all the selected nodes are visible in the display.



Pan to Selected Pans the window to include the selected objects, within the same zoom factor, so that all selected entities are visible within current extents of the window.

Schematic View Display Floater

The Display Floater controls by category what is displayed in the Schematic View window. The Schematic View Preferences dialog also filters that display of the window. Use these to manage the clutter of the window, and the performance speed. Note that unless you display the correct entity and relationship, you will not be able to perform certain operations. If you want to wire parameters, for instance, you must have Param Wires turned on. If you want to wire the parameters of a material, you must also have Materials chosen.

Interface

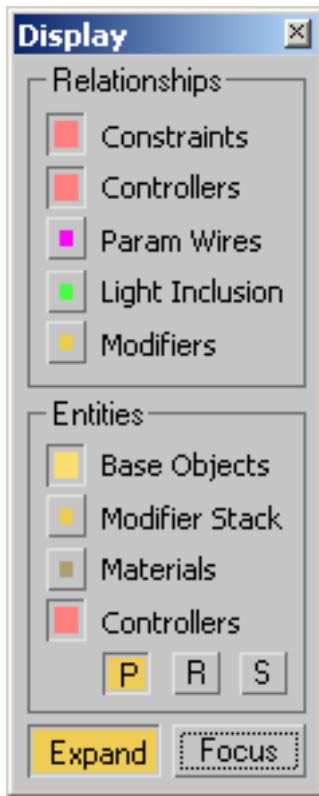

Relationships group

Lets you choose which of the following relationships you want to display or create: Constraints, Controllers, Parameter wiring, Light inclusion and Modifiers.

Entities group

Selects which types of entities are displayed or edited:

Base Objects When active, all base object entities will display as children of the node entities. When Sync Selection is on and the Modifier stack is open, clicking on a base object will activate that level of the object's stack.

Modifier Stack When active, all modifiers in the object's stack will display as children, beginning with the Modified Object base entity. Modifiers can be copied, instanced or moved between objects by using the Connect tool. For example, connecting *XForm* to *Box01*, will display the Attach Modifier dialog where you can choose between Copy, Move or Instance. Deleting the modifier from the Schematic View will also remove it from the object's stack in the Modify panel.

Materials When active, all materials and maps assigned to the objects will display as children of the objects. Materials can be instanced between objects by using the Connect tool on the Schematic View toolbar. For example, drag material *Default1* to *Box01*. Double clicking on a material will bring up the Material editor if the Material is already in a sample material slot.

Controllers When this is active, all controllers other than position, rotation and scale will display as children of the objects' transform controller, which also displays. Controllers can be added to objects only when this is active. Controllers can be copied or instanced between objects by using the Connect tool. For example dragging *PositionXYZ* from *Box01* to *Position List* for *Box02*, for instance, will open the Attach Controller dialog, where you can choose to Copy, Move or Instance this controller.

PRS Lets you choose to display any combination of the three transform types (position, rotation or scale).

Expand When turned on, entities that are activated will be displayed in Schematic View. When turned off, only the triangle child indicator on the bottom of the nodes will display. This toggle only applies at activation time, it will not expand or contract entities that are already displayed.

Focus When this is turned on, only those entities that are related to others and have their relationships displayed will be filled with their color, all others will be displayed unshaded.

Schematic View Commands

New Schematic View

Menu bar > Graph Editors > New Schematic View

New Schematic View creates a new [Schematic View window](#) on page 7407. You might want to create multiple Schematic view windows filtered in different

ways that you recall for quick access to multiple objects. Name the new schematic view using the Schematic View name field.

Delete Schematic View

Select a schematic view. > Menu bar > Graph Editors > Schematic View > Delete Schematic View

Delete Schematic View opens the Delete Schematic View dialog. This dialog displays all saved schematic views. Choose the view to be deleted from the list, and then click the OK button.

For information on the Schematic View buttons and controls, see [Schematic View](#) on page 7407.

Saved Schematic Views

Graph Editors menu > Saved Schematic Views > Schematic views by name

Saved Schematic Views displays a list of schematic views by name that were previously created by [New Schematic View](#) on page 7433.

Schematic View Selection Right-Click Menu

[Schematic View](#) on page 7407 > Select any node. > Right-click.

The Schematic View right-click menu contains controls for selecting, displaying, and manipulating selections of nodes. It gives you quick access to List Views, Display Floater and lets you switch between Reference and Hierarchy Mode quickly.

Interface

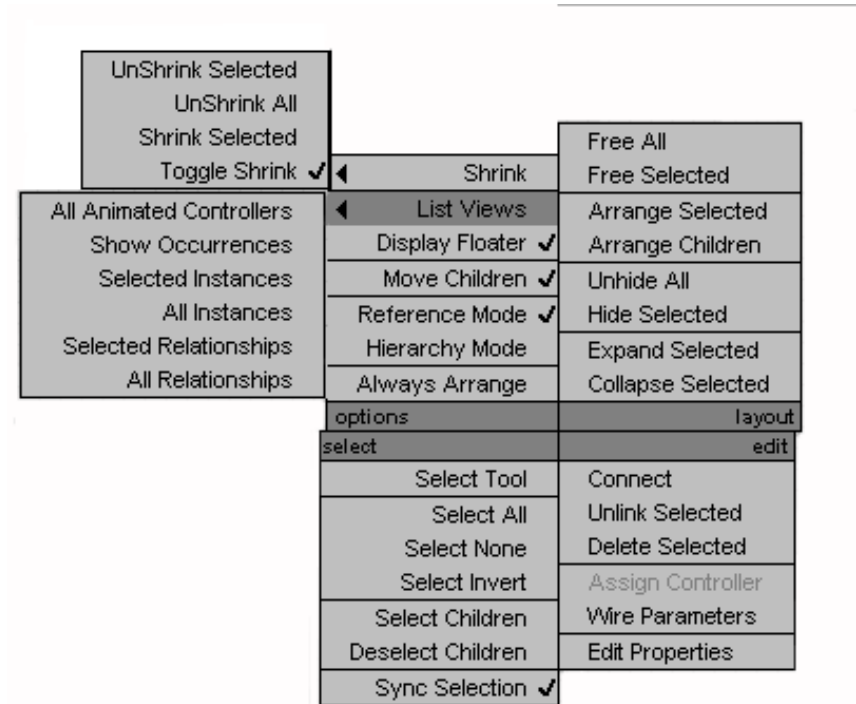

Select quadrant

Select Tool Activates the Select tool when Always Arrange is turned on. Activates the Select and Move tool when Always Arrange is off.

Select All Choose Select All to select everything in the window.

TIP Hold down the Ctrl key to add to selections, and the Alt key to subtract from them.

Select None Choose Select None to deselect everything.

Select Invert Deselects selected entities and selects all other entities in the current Schematic View.

Select Children Selects all children of the current selection.

Deselect Children Deselects children of all selected entities. Parent and child must be selected for child to become unselected.

Sync Selection Synchronizes the selection in the Schematic View window with the viewport. Whatever you have selected in the Schematic View window becomes selected in the viewport. Whatever you select in the viewport becomes selected in Schematic View. It's a two-way street.

Layout quadrant

Free All Frees all entities from arrangement rules, tags them with a hole icon on their left end and leaves them in place. Use this to freely arrange all objects.

Free Selected Frees all selected entities from arrangement rules, tags them with a hole icon on their left end and leaves them in place. Use this to freely arrange selected objects.

Arrange Selected Arranges the display of the selection based on the arrangement preferences.

Arrange Children Arranges the display of children based on set arrangement rules (align options) below the selected parent.

Unhide All Displays all the nodes in the scene. If the resulting Schematic View is too cluttered to work with, try using Preferences to remove what you don't need to see. Or make individual selections and hide upstream or downstream to unclutter the display.

Hide Selected Hides the selection in the Schematic View window.

Expand Selected Reveals the display of all child entities of selected entity.

Contract Selected Hides the display of all children of selected entity, leaving the selected entity visible.

Edit quadrant

Connect Tool Activates the connect tool. This tool in Schematic View can be used to create many Schematic View relationships such as parent, constraint, copy modifier, copy controller, or copy material.

Unlink Selected Disconnects the selected entities

Delete Selected Deletes entities from Schematic View and from the scene. This also can be used to disconnect selected relationships.

Assign Controller Displays the Assign controller dialog. This is available only when controller entities are selected.

Wire Parameters Let's you wire parameters using Schematic View. This is active only when entities are selected. This launches the standard Wire Parameters dialog.

Edit Properties Displays the Object Properties dialog for the selected objects.

Options quadrant

Shrink Hides all selected entities' boxes, keeps arrangement and relationships visible.

Toggle Shrink Changes the state of entity shrinkage. Shrunken entities become unshrunken, and the other way around.

Unshrink All Makes all shrunken entities visible.

Unshrink Selected Makes all selected shrunken entities visible.

Shrink Selected Hides all selected entities' boxes, keeps arrangement and relationships visible.

List Views

Selected Occurrences Opens or redraws List View with all entities that share a property or relationship type with currently selected entities

Selected Instances Opens or redraws List View with all instances of currently selected Schematic View entities.

All Instances Opens or redraws List View with all instances of currently displayed Schematic View entities.

Selected Relationships Opens or redraws List View with all relationships of currently selected Schematic Vie entities.

All Relationships Opens or redraws List View with all relationships of currently displayed Schematic View entities.

Display Floater Opens the Display floater and activates the corresponding toolbar button.

Move Children Sets Schematic View to move all children of parent being moved. When this mode is on, the toolbar button is activated.

Reference Mode Sets Schematic View to display entities as a reference graph instead of hierarchy. Switching between Hierarchy and Reference mode is nondestructive.

Hierarchy Mode Sets Schematic View to display entities as a hierarchy instead of reference graph. Children appear indented below the parent. Switching between Hierarchy and Reference mode is nondestructive.

Always Arrange Sets Schematic View to always arrange all entities based on the chosen arrangement preference. Displays a pop-up warning before doing so. Choosing this activates the toolbar button.

Using Layers to Organize a Scene

Layers are like transparent overlays on which you organize and group different kinds of scene information. The objects you create have common properties including color, renderability, and display. An object can assume these properties from the layer on which you create it. Using layers makes it easier to manage the information in your scenes. Layers are used primarily to control the visibility of objects in your scene, however they also controls the color of objects' wireframe and the [frozen](#) on page 212 and hidden state of objects, as well as their radiosity properties.

For example, you might want to set up a layer that will contain detailed, custom furniture. To do this, you create a layer and set Viewport Display to Bounding Box. Then you set the object's display properties to ByLayer (in the [Object Properties dialog](#) on page 305). This will keep the viewport display quick. Then, whenever you want to import new furniture, switch to this layer. You don't need to set up your viewport display every time you import new furniture. Also, if you don't want to render the furniture, you can turn off that layer's Renderable property.

NOTE When you link an AutoCAD file into 3ds Max, any layers that are frozen (and all objects that reside on these layers) are not imported.

NOTE Objects can be hidden and frozen on a per-object basis; however, an object residing on a hidden or frozen layer will *always* adopt the hide/freeze state of its layer.

TIP If you set lights' render control to ByLayer (in the General panel of the Preferences dialog), you can use the Render column in the Layer Manager to quickly turn lights on or off in your scene.

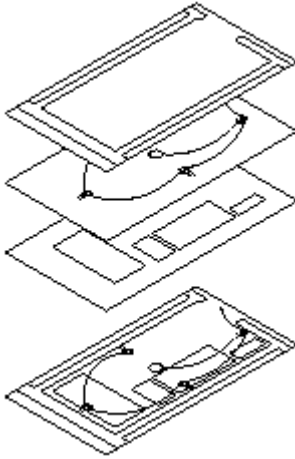

Layers can help organize the contents of a scene.

Layer-Object Relationships

The [Layer Manager](#) on page 7441 displays layers, as well as their associated objects. This makes it very easy to organize, and make changes to objects in a scene. With the Layer Manager, you can adjust property settings at either the layer level, or individually for each object. Each property can be toggled between various states, including the [ByLayer state](#) on page 7933. When an object's property is set to ByLayer, the object inherits that setting from the layer it is associated with.

NOTE The Hide and Freeze states of an object cannot be set to ByObject. Objects *can* be hidden or frozen on a per-object basis; however, they will *always* follow the behavior of their layer when it is hidden or frozen.

Special Layer 0

When you begin a new scene, 3ds Max creates a special layer named *0 (default)*. By default, objects on layer 0 have their visibility settings on, renderability is on, and viewport display is set. You can't delete or rename layer 0.

If you haven't created any layers, 3ds Max places objects you create on layer 0 by default. After you create objects, you can reassign them to different layers, including those residing on layer 0.

Display Properties

In the [Layer Properties dialog](#) on page 7451, you can specify layer visibility individually for each viewport. If you don't want to display a certain layer, you can hide that layer. 3ds Max hides the layer in the viewport, but not in any output rendered image of the scene.

NOTE For hidden geometry to render, Render Hidden Geometry must be on on the Render Setup dialog > [Common Parameters rollout](#) on page 6121.

You can specify layers to display objects [shaded](#) on page 7576, in [wireframe mode](#) on page 8172, as a [bounding box](#) on page 7932, or as whatever is set on the [Viewport Properties menu](#) on page 7576. Using this method, you can have different objects displayed differently in the same scene.

You can display layers in [See-Through mode](#) on page 7454. See-Through mode temporarily displays selected objects in translucent form so you can see through them without applying special materials. You can toggle See-Through mode for all objects per layer.

NOTE You can control whether newly created objects adopt the default layer settings on a per-object basis by using Default To By Layer For New Nodes in the [General Preferences panel](#) on page 7743.

You can also Freeze, Hide, or Isolate the layer of a selected object using the corresponding command in the display quadrant of the quad menu.

Layer Names

You can create and name a layer for each conceptual grouping (such as walls or terrain) and assign common properties to those layers. By grouping objects into layers, you can control their display and make changes quickly and efficiently. When you name layers, you can use names of variable length up to 255 characters. These names can contain letters, digits, blank spaces, and the special characters dollar sign (\$), hyphen (-), and underscore (_).

NOTE Any layers from a linked AutoCAD file are automatically imported to 3ds Max. 3ds Max names the converted layers based on the layer names from the AutoCAD drawing.

See also:

- [Layer List](#) on page 7459
- [Layer Manager](#) on page 7441

- [Layer Properties Dialog](#) on page 7451

Layer Manager



Main toolbar > Layer Manager



Layers toolbar > Layer Manager

Tools menu > Layer Manager

The Layer Manager, available from the main toolbar, is a modeless dialog where you can create and delete layers. You can also view and edit the settings for all of the layers in your scene, as well as the objects associated with them. You can specify the name, visibility, renderability, color, and objects' and layers' inclusion in the radiosity solution from this dialog.

Objects are organized by layer in the dialog, in an expandable list. By clicking '+' or '-', you can expand or collapse (respectively) the object list for each layer. You can also sort the layers by clicking any of the column heads.

  Another useful tool is the ability to open the [Object Properties dialog](#) on page 305 and [Layer Properties dialog](#) on page 7451 for one or more highlighted objects or layers directly from the Layer Manager by clicking the corresponding icon.



NOTE You can change the property settings for each layer or object by clicking the corresponding icon in the dialog. With each click, the icons cycle through the various states of the property, including Off () and [By Layer](#) on page 7933 (), and, in the Render, Color, and Radiosity columns, By Object. When a property is set to By Layer, the object inherits the property setting from its associated layer.

Procedures

To create a new layer:

When you create new layers, 3ds Max names them sequentially by default: Layer01, Layer02, and so on. After creating a layer, you can rename it. 3ds

Max assigns a random color to all new layers. You can accept the default settings or specify other colors.

- 1  On the main toolbar, click Layer Manager.
- 2  In the Layer Manager, click Create New Layer.
3ds Max displays a new layer in the list with the temporary name Layer01.
- 3 Click the Layer to enter a new name.
- 4 To create more than one layer, click New again and enter the new layer name.

TIP If an existing layer is highlighted when you create a new layer, the new layer inherits the properties of the highlighted layer. You can modify the properties of the new layer, if necessary, as illustrated in the following procedures.

To make a layer current:

- 1  On the main toolbar, click Layer Manager.
- 2 In the Layer Manager dialog, click the second column next to the layer name.
 A check box appears indicating that the layer is current.

NOTE The current layer is also displayed in the title bar of the Layer Manager.

To make a layer current (alternate method):

- On the Layers toolbar > Layer List, select a layer.
The highlighted layer becomes the current layer.

To hide a layer:

- 1  On the Layers toolbar, click Layer Manager.
- 2 In the Layer Manager, select the layers you want to hide.



- 3  In the Hide column, click Off to turn Hide on for the highlighted layer(s).

 The hide icon displays.

TIP  You can hide *all* layers by clicking Hide/Unhide All Layers on the Layer Manager toolbar.

To freeze a layer:

Freezing layers is useful when you want to edit objects associated with particular layers but also want to view, without editing, objects on other layers. You can't edit or select objects on a frozen layer; however, the objects are still visible if the layer is on. You can make a frozen layer current, and you can add new objects to the frozen layer.

- 1  On the main toolbar, click Layer Manager.
- 2 In the Layer Manager, highlight the layers you want to freeze.
- 3  In the Freeze column, click Off to turn Freeze on for the highlighted layer(s).

 The Freeze icon displays.

TIP  You can freeze *all* layers by clicking Freeze/Unfreeze All Layers on the Layer Manager toolbar.

To assign a color to a layer:

You can assign a color to a layer using the Layer Manager dialog. For example, you can assign the color red to a layer named HVAC to help you identify the mechanical equipment in your scene.

- 1  On the main toolbar, click Layer Manager.
- 2 In the Layer Manager, select a layer and click the Color icon.
- 3 In the Layer Color dialog, select a color, and then click OK.

To rename a layer:

You might want to rename a layer to better define how it's used in your scene. You can rename a layer at any time during a 3ds Max session. However, you can't rename Layer 0.



- 1 On the main toolbar, click Layer Manager.
- 2 In the Layer Manager, select a layer to rename.
- 3 Click the layer's name again and enter a new name.

To delete a layer:

You can delete an empty layer at any time during a 3ds Max session. However, you can't delete the current layer, Layer 0, or a layer that contains objects.



- 1 On the main toolbar, click Layer Manager.



- 2 In the Layer Manager, select one or more layers, and then click Delete Empty Layer.

To open the Object Properties dialog for an object selection:



- 1 On the main toolbar, click Layer Manager.
- 2 Highlight one or more objects in the Layer Manager.
- 3  Click the Object Properties icon to open the [Object Properties dialog](#) on page 305 for the highlighted objects.

To open the Layer Properties dialog for a layer selection:



- 1 On the main toolbar, click Layer Manager.
- 2 Highlight one or more layers in the Layer Manager.
- 3  Click the Layer Properties icon to open the [Layer Properties dialog](#) on page 7451 for the highlighted layers.

Interface

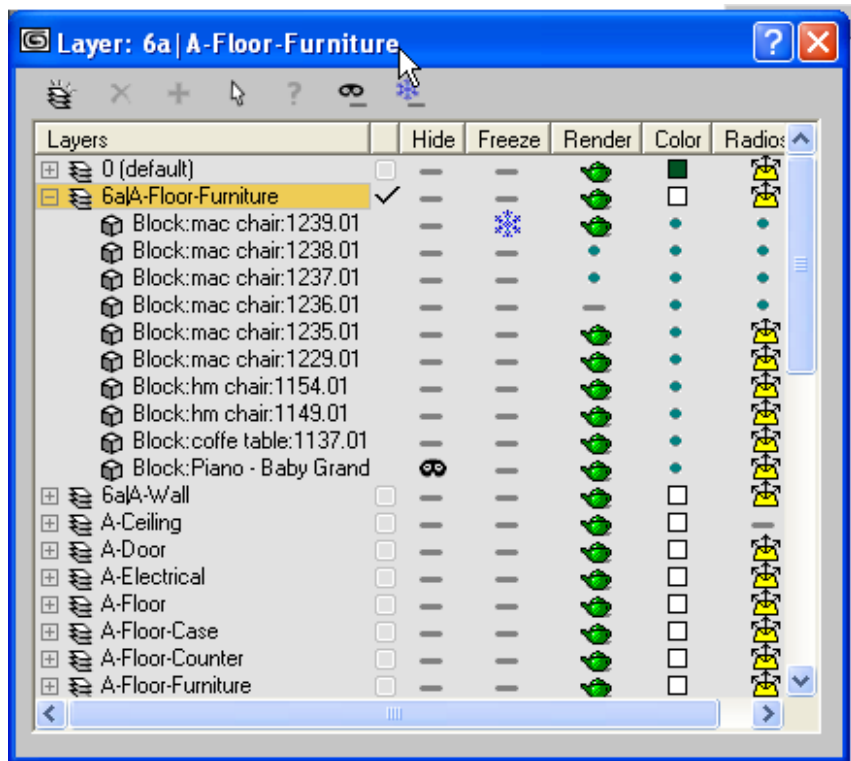

Title Bar

The title bar displays the word “Layer” followed by the name of the active Layer. For example, if *Layer02* is the active layer, the title bar will read *Layer: Layer02*.

Layer Manager toolbar



Create New Layer Creates a new layer containing any selected objects. The new layer's name is generated automatically ("Layer01", "Layer02", etc.) but you can change it by clicking the label.

NOTE The new layer becomes the current layer.



Delete Highlighted Empty Layers Deletes highlighted layers if they are empty.

NOTE This button is not available if any of the following items are in your selection set: nothing, the current layer, objects, Layer 0, or non-empty layers.



Add Selected Objects to Highlighted Layer Moves currently selected objects into the highlighted layer.

NOTE This button is not available if nothing is selected or if more than one layer is highlighted.



Select Highlighted Objects and Layers Selects all of highlighted objects, as well as all objects contained in any highlighted layers.

NOTE This button is not available if nothing is highlighted.



Highlight Selected Objects' Layers Highlights layers containing the currently selected objects and automatically scrolls so that highlighted layers are visible in the layer manager.

NOTE This button is not available if nothing is highlighted.



Hide/Unhide All Layers Toggles the display of all layers.

TIP This is most useful if you hide all layers and then display only the layers you want to work on.





Freeze/Unfreeze All Layers Toggles the frozen state of all layers.

TIP This is most useful if you freeze all layers and then unfreeze only the layers you want to work on.

List of layers

Displays layers, their associated objects, and their properties. To expand or collapse the object list for each layer, click '+' or '-', respectively. To modify a

property, click its icon. To select all layers quickly, right-click and choose Highlight All. To open the Object/Layer Properties dialog, click on the icon next to the layer or object.

Each property has a unique icon to indicate that it is turned on, while all properties share the same icon for the off () and By Layer () states.

NOTE By Layer is available only at the object level, in the Render, Color, and Radiosity columns.

TIP You can sort the layers by any of their properties by clicking the column name.

Layers Displays the names of the layers/objects. Click a name to select the layer, or to rename the layer.

NOTE  Clicking the layer icon opens the [Layer Properties dialog](#) on page 7451 for all highlighted layers.

 Clicking the object icon opens the [Object Properties dialog](#) on page 305 for all highlighted objects.

 **Current Layer Toggle** The unlabeled column to the right of the layer name indicates the current layer and lets you make a different layer current.

 A check mark appears next to the current layer. Click the check box next to another layer name to make it current.

 **Hide** Hides and unhides layers. When a layer is hidden, it's invisible. You might want to hide layers that contain construction or reference information.

 **Freeze** Freezes layers. You can't select or edit objects on a frozen layer. Freezing a layer is useful if you want to view information on a layer for reference but don't want to edit objects on that layer.

 **Render** When on, objects appear in the rendered scene. Non-rendering objects don't cast shadows or affect the visual component of the rendered scene. Like dummy objects, non-rendering objects can manipulate other objects in the scene.

[Shape objects](#) on page 606 have the Render option turned on by default. In addition, they have a Renderable check box in their creation parameters. When both check boxes are on, the shape is renderable. If either check boxes are off, the shape isn't renderable. If you apply a modifier that converts the shape into a mesh object, such as a [Lathe](#) on page 1501 or [Extrude](#) on page 1448

modifier, the shape automatically becomes renderable regardless of the state of its local Renderable check box.

For shapes, the Renderable toggle in the [Object Properties dialog](#) on page 305 affects the main object, so it also affects all instances of and references to the shape.

Color Changes the color associated with the highlighted layers. You can select another color by clicking the color swatch to display either the [Object Color dialog](#) on page 387 (for objects), or the Layer Color dialog (for layers).

You can set an object's color independently, or turn on ByLayer in the Object Color dialog to use the associated layer's color.



Radiosity When on, objects are included in the [radiosity solution](#) on page 6168. Objects *not* included in the radiosity solution do not contribute to indirect illumination. If these objects are lights, only their direct contribution will be used for rendering.

NOTE Removing objects from the radiosity solution can significantly decrease radiosity processing and rendering time, however it does sacrifice some accuracy in the solution. It can be useful for creating quick test renders.

Layer Manager Right-Click Menu

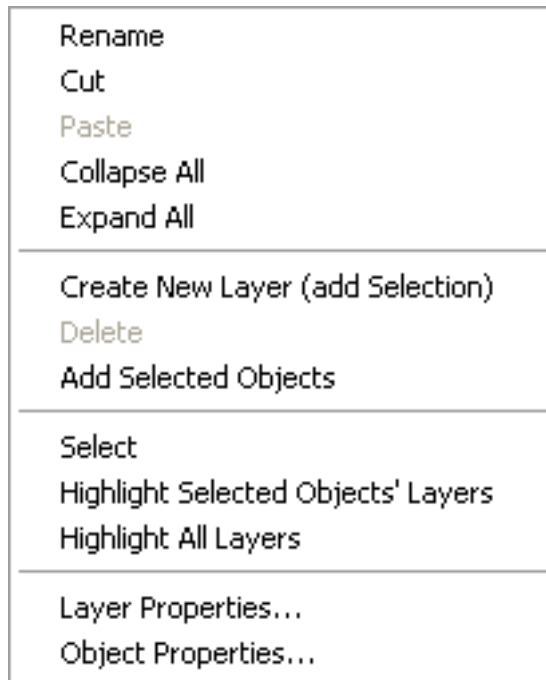

A standard popup menu is displayed over the Layer Manager by right-clicking anywhere in the Layer Manager dialog. The menu contains a variety of layer management and focus operations.

Some of the operations involve highlighted items or selected objects in your scene. If the right-click is on a non-highlighted row, the highlight switches to that row and the subsequent operation applies to the newly highlighted item. If the right-click is on a highlighted row (or a group of highlighted rows), all of the highlights are preserved and the subsequent operation applies to all of the highlighted items.

NOTE To apply an operation to a group of objects or layers, you must hold Ctrl when you right-click. If you have highlighted a group of objects and right-click on one of them (without holding Ctrl), the selection group is cleared and only that object will be highlighted.

Rename Initiates text editing mode for the highlighted layer's name. Unique names are enforced. If a non-unique name is typed in, a modal dialog pops up, stating "Invalid Layer Name. Layer names must be unique."

NOTE Rename is available only for layers; objects cannot be renamed in the Layer Manager. Likewise, Rename is only available when a single layer is highlighted.

Cut Stores references to highlighted objects in memory so they can be pasted into another layer.

Cut is only available when objects are highlighted; if there are no objects highlighted or if a layer is part of a multiple selection, it is not available.

NOTE Objects are not actually cut from their assigned layer until they are pasted to another one.

TIP If you cut a layer, 3ds Max cuts all objects in the layer.

Paste Moves cut objects into the highlighted layer.

Paste is available only when a single layer is highlighted and one or more objects have been cut.

Collapse All Closes all expanded layers, hiding the object lists.

Expand All Expands all layers, displaying the objects within each.

Create New Layer Creates a new layer containing any currently selected objects.

The new layer becomes the current layer. Its name is generated automatically ("Layer01", "Layer02", etc.) but can be changed by clicking its label.

Delete Deletes any empty highlighted layer.

NOTE This does not delete objects. Likewise, this command is not available when your selection includes Layer0, any objects, or any layer containing objects.

Add Selected Objects Places objects currently selected in your scene into the highlighted layer.

NOTE This command is available only when a single layer is highlighted.

Select Selects all of the currently highlighted objects or layers in the Layer Manager.

NOTE If you use this command on a layer, all objects in that layer are selected.

Highlight Selected Objects' Layers Highlights all layers that contain objects in the current scene selection.

Highlight All Layers Highlights all of the layers in your scene.

NOTE This command does not highlight any objects.

Layer Properties Opens the [Layer Properties dialog](#) on page 7451 for the currently highlighted layers.

Object Properties Opens the [Object Properties dialog](#) on page 305 for the currently highlighted objects.

Layer Properties Dialog

Main toolbar > Layer Manager > Select one or more layers. > Click Layer icon.



Layer Manager > Right-click a layer. > Layer Properties

The Layer Properties dialog is similar to the [Object Properties dialog](#) on page 305. Here, you can change the rendering, motion blur, and display settings of one or more selected layers. In addition, you can also change the advanced lighting settings or hide/freeze one or more selected layers.

Interface

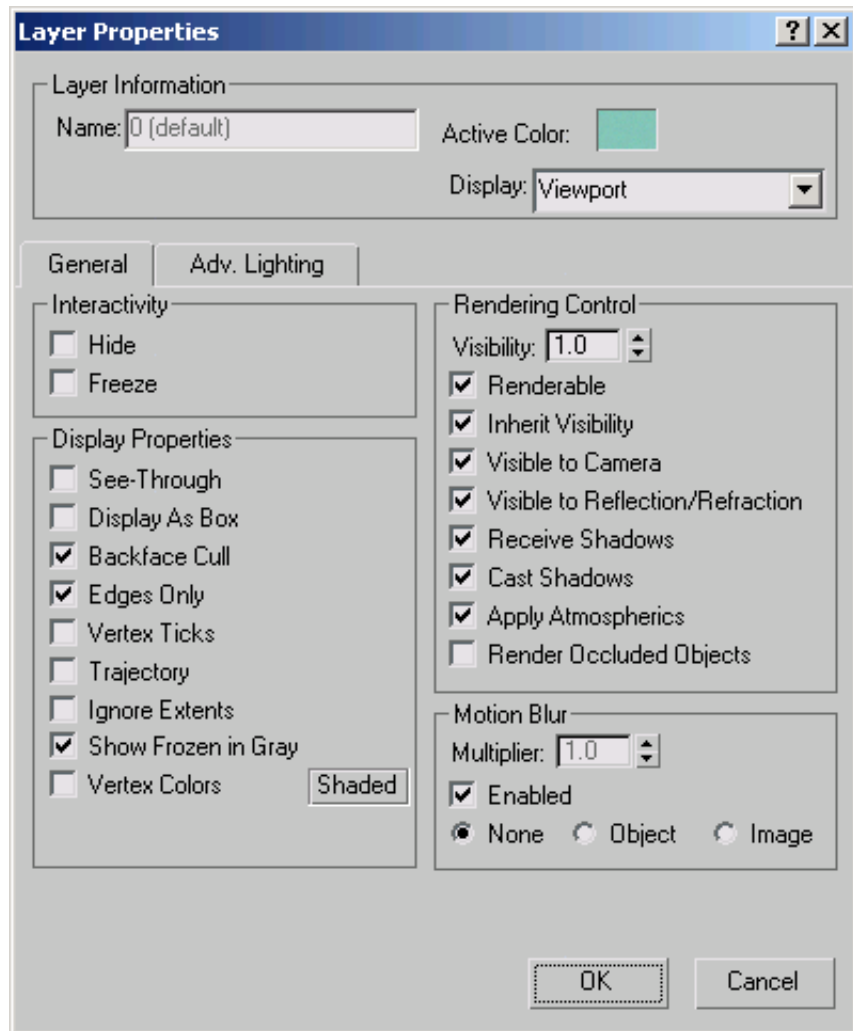

Layer Information group

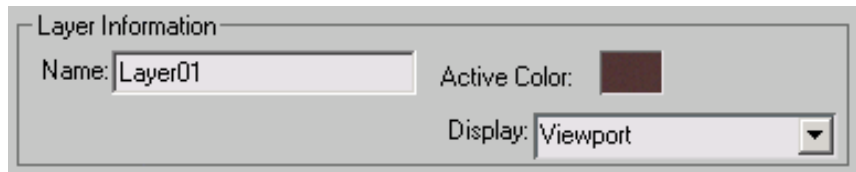

Controls layer information for objects on the selected layer.

Name Displays the selected layer name, which you can edit. The name can contain up to 255 characters, including letters, digits, blank spaces, and the special characters dollar sign (\$), hyphen (-), and underscore (_).

Active Color Displays the color of the selected layer. You can select another color by clicking the color to display the Layer Color dialog, which is identical to the [Object Color dialog](#) on page 387, except that it doesn't have the By Layer/By Object toggle.

Display Controls the display of the objects on the selected layer.

Viewport Displays the objects on the selected layer using the current settings under Views on the [viewport right-click menu](#) on page 7576.

Bounding Box Displays the objects on the selected layer as a [bounding box](#) on page 7932.

Wireframe Displays the objects on the selected layer in [wireframe mode](#) on page 8172.

Shaded Displays the objects on the selected layer in [Smooth+Highlight mode](#) on page 7576.

General panel

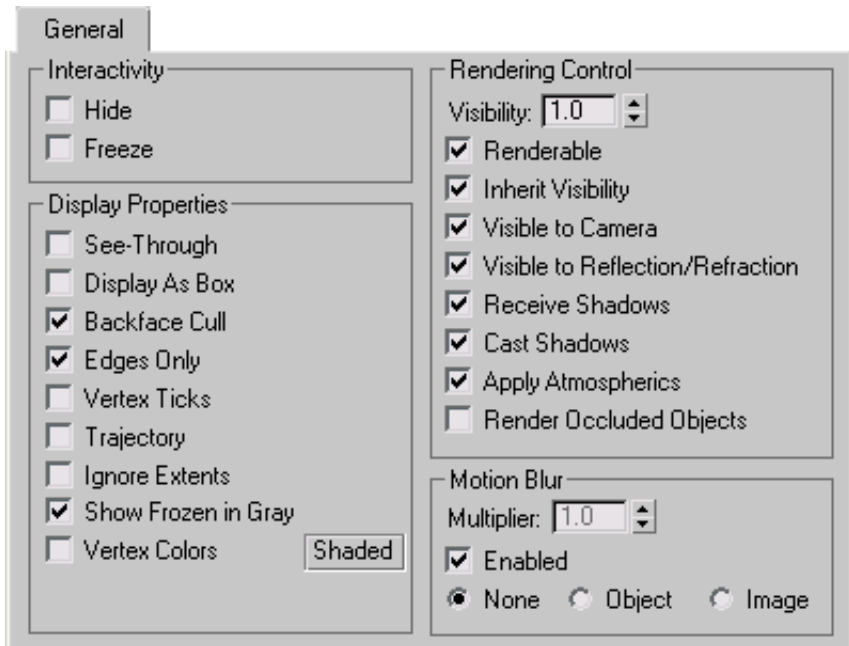

Interactivity group

Hide Hides the selected layer.

Freeze Freezes the selected layer.

Display Properties group

Provides controls that alter the display of objects on the selected layer.

See-Through Makes objects on the selected layer translucent in viewports. This setting has no effect on rendering, it simply lets you see what's behind an object in a crowded scene, and especially to adjust the position of objects behind or inside the See-Through object.

Display As Box Toggles the display of objects on the selected layers, including 3D objects and 2D shapes as [bounding boxes](#) on page 7932. Produces minimum geometric complexity.

Backface Cull For objects on the selected layer, toggles the display of faces with [normals](#) on page 8059 pointing away from view. When on, you see through the wireframe to the back faces. Applies only to Wireframe viewport display.

Edges Only For objects on the selected layer, toggles the display of face edges. When set, only faces appear. When off, all mesh geometry appears. Applies only to Wireframe viewport display.

Vertex Ticks Displays the vertices in objects on the selected layer as tick marks. If the current selection has no displayed tick marks, the check box is clear. If *some* of the vertices in the current selection display tick marks, the check box contains a gray X. If all vertices in the current selection display tick marks, the check box contains a black X.

Trajectory Toggles [trajectory](#) on page 8154 display for objects on the selected layer. You can display an object's trajectory wherever you are in 3ds Max.

Ignore Extents When turned on, objects on the selected layer are ignored when you use the display control [Zoom Extents](#) on page 7594.

Show Frozen in Gray When on, the object turns gray in viewports when you freeze it. When off, viewports display the object with its usual color or texture even when it is frozen.

Vertex Colors Affects [editable mesh objects](#) on page 2075 on the selected layer. Displays the assigned [vertex colors](#) on page 305 in the viewport. You assign vertex colors at the vertex or face sub-object levels.

Shaded Affects [editable mesh objects](#) on page 2075 on the selected layer. When on, if the editable mesh has vertex colors, shaded viewports use vertex colors to shade the mesh. When off, colors are unshaded.

Rendering Control group

Controls rendering settings for objects on the selected layer.

Visibility Controls the rendered visibility of the object. At 1.0, the object is fully visible. At 0.0, the object is completely invisible when rendered. Default=1.0.

Renderable Makes objects on the selected layer appear or disappear from the rendered scene. For more information, see [Renderable](#) on page 7447.

NOTE This has the same functionality as the Render toggle in the [layer list](#) on page 7459.

Inherit Visibility Causes objects on the selected layer to inherit the visibility of their parents (as determined by the parent's Visibility track in Track View). When a group parent is assigned a visibility track, Inherit Visibility is automatically turned on for all children in the group. Transparent materials and hidden objects have no effect on this function.

Visible to Camera When on, the object is visible to cameras in the scene. When off, cameras do not view this object.

Visible to Reflection/Refraction When on, the object is used in calculating reflections and refractions. When off, the object does not appear in reflections or refractions.

Receive Shadows When on, objects on the selected layer can receive shadows.

Cast Shadows When on, objects on the selected layer can cast shadows.

Apply Atmospheric When on, atmospheric effects are applied to the object. When off atmospheric effects do not change the rendered appearance of this object.

Render Ocluded Objects Allows special effects to affect objects in the scene that are occluded by this object. The special effects, typically applied by [plug-ins](#) on page 8092 such as [Glow](#) on page 6599, use [G-Buffer](#) on page 7991 layers to access occluded objects. Turning on this control makes the object transparent for the purposes of special effects. This makes no difference when you render to most image files. When you render to either the [RLA](#) on page 7364 or [RPF](#) on page 7366 file format, however, occluded objects appear with the effect applied on their designated G-buffer layer.

Motion Blur group

Controls motion blur for objects on the selected layer.

Multiplier Affects the length of the motion blur streak.

Enabled When on, enables motion blur for this object. When off, motion blur is disabled regardless of the other blur settings. Default=on.

None Turns off the state of motion blur for objects on the selected layer.

Object [Object motion blur](#) on page 8063 provides a time-slice blur effect for objects on the selected layer.

Image [Image motion blur](#) on page 8010 blurs the image of each object on the selected layer, based on the velocity of each pixel.

Adv. Lighting panel

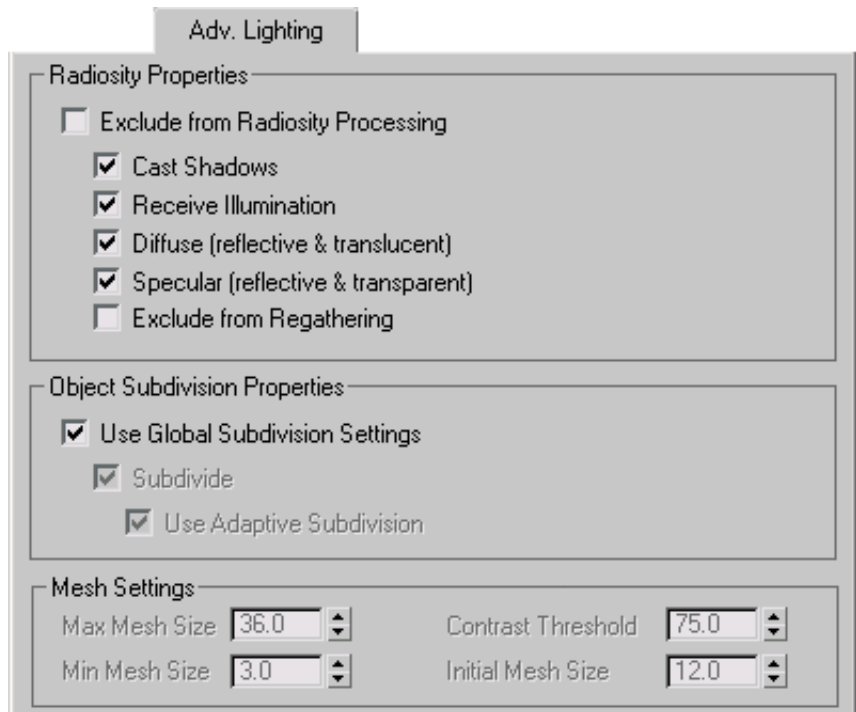

Radiosity Properties group

Exclude from Radiosity Processing When on, objects on a selected layer are included in the radiosity solution. Objects *not* included in the radiosity solution do not contribute to indirect illumination. If these objects are lights, their direct contribution will only be used for rendering.

NOTE This has the same functionality as the Radiosity toggle in the Layer List.

Cast Shadows Determines whether objects on the selected layer will cast shadows.

Receive Illumination Determines whether objects on the selected layer will receive illumination.

Diffuse (reflective & translucent) When on, objects on the selected layer are treated as diffuse (rough) in the radiosity process.

Specular (reflective & transparent) When on, objects on a selected layer are treated as specular (smooth) in the radiosity process.

Exclude from Regathering When on, objects on a selected layer are excluded from the regathering process of the radiosity solution.

For more information on the Radiosity Properties group, see [Radiosity Control Panel](#) on page 6188.

Object Subdivision Properties group

Use Global Subdivision Settings When on, the object's meshing settings correspond to the global subdivision settings on the Radiosity Control Panel. When off, you can change the meshing settings for each object. Default=on.

- **Subdivide** When on, a radiosity mesh is created for the objects regardless of the global meshing state. The subdivision that is performed is determined by the Use Adaptive Subdivision switch. When off, the settings in the Mesh Settings group are unavailable. Default=on.
- **Use Adaptive Subdivision** Turns adaptive subdivision on and off. Default=on.

NOTE The Mesh Settings group parameters Contrast Threshold, Min Mesh Size, and Initial Mesh Size are available only when Use Adaptive Subdivision is turned on.

Mesh Settings group

Max Mesh Size The size of the largest faces after adaptive subdivision. Default=36" for imperial units and 100cm for metric units.

When Use Adaptive Subdivision is turned off, Max Mesh Size sets the size of the radiosity mesh in world units.

Min Mesh Size Faces are not divided smaller than the minimum mesh size. Default=3" for imperial units and 10cm for metric units.

Contrast Threshold Faces that have vertex illuminations that differ by more than the Contrast Threshold settings are subdivided. Default=75.0.

Initial Mesh Size When improving the face shape, faces that are smaller than the Initial Mesh Size are not subdivided. The threshold for deciding whether a face is poorly shaped also gets larger as the face size is closer to the Initial Mesh Size. Default=12" for imperial units and 30cm for metric units.

Layer List

Layers toolbar > Layer List

The Layer List, available from the [Layers toolbar](#) on page 7504, displays layer names and their properties. You can control the properties of layers by clicking the property icons. You can make a layer current by simply selecting it from the list.

The controls available in the Layer List are a subset of the controls available in the Layer Manager. For more information, see [Layer Manager](#) on page 7441.

TIP The Layer List is most useful in conjunction with the other tools available on the [Layers toolbar](#) on page 7504.

See also:

- [Using Layers to Organize a Scene](#) on page 7438

Procedures

To make a layer current:

- 1 Click Layers toolbar > Layer List to display the list.
- 2 Click in the first (left) column next to the layer you want to make current. A check mark appears next to the current layer.
- 3 Click the layer list again to collapse it.
- 4 Select the layer you want to make current from the list. It is now the current layer.

To change the layer of a selected object:

- 1 Click Layers toolbar > Layer List to display the list.
- 2 Select the desired destination layer to make it current.
- 3  On the Layers toolbar, click Add Selected Objects to Current Layer.

To change a layer's properties:

- 1 Click Layers toolbar > Layer List to display the list.

- 2 Click the layer property icon that you want to set.
You can change the following properties from the layer list: hide/unhide, freeze/unfreeze, renderable/non-renderable, and color.
- 3 Click the Layer List again to collapse it.

Interface

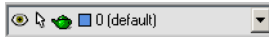

You can change the following properties from the layer list: hide/unhide, freeze/unfreeze, renderable/non-renderable, and color.

Unlike the Layer Manager, where one icon is used for all Off states, the 'Off' icons for each property on the Layer List are unique.

The following are the On and Off icons for each toggled property in the Layer List:

Property	On	Off
Hide/Unhide	 (Hidden)	 (Visible)
Freeze/Unfreeze	 (Frozen)	 (Editable)
Renderable/Non-Renderable	 (Renderable)	 (Non-renderable)

Create New Layer

Layers toolbar > Create New Layer

Layers toolbar > Layer Manager > Create New Layer

Create New Layer creates a new layer the layer containing the currently selected objects. The new layer's name is automatically generated ("Layer01", "Layer02", etc.) but may be changed in the [Layer Manager](#) on page 7441.

Add Selection to Current Layer

Layers toolbar > Add Selection to Current Layer

Add Selection to Current Layer moves the current object selection to the current layer.

Select Objects in Current Layer

Layers toolbar > Select Objects in Current Layer

Select Objects in Current Layer selects all of the objects contained in the current layer.

Set Current Layer to Selection's Layer

Layers toolbar > Set Current Layer to Selection's Layer

Set Current Layer to Selection's Layer changes the current layer to the layer which contains the currently selected objects.

NOTE This button is not available if your selection includes objects that reside on different layers.

List of Available Utilities

The table of contents for this reference lists utilities alongside the features they support. Here is a consolidated, alphabetical list.

[Asset Browser Utility](#) on page 7132

[Assign Vertex Colors Utility](#) on page 6038

[Bitmap/Photometric Path Editor Utility](#) on page 7141

[Camera Match Utility](#) on page 5249

[Camera Tracker Utility](#) on page 3819

[Channel Info Utility](#) on page 6047

[Clean MultiMaterial Utility](#) on page 6052

[Collapse Utility](#) on page 2016

[Color Clipboard Utility](#) on page 397

[COM/DCOM Server Control Utility](#) on page 7696

[Dynamics Utility](#) on page 3852

[File Link Manager Utility](#) on page 6987

[Fix Ambient Utility](#) on page 7147

[Flight Studio](#) on page 7223

[Follow/Bank Utility](#) on page 3796

[IFL Manager Utility](#) on page 7344

[Instance Duplicate Maps Utility](#) on page 6058
[Level of Detail Utility](#) on page 2579
[Lighting Data Exporter Utility](#) on page 6759
[Lightscape Materials Utility](#) on page 7254
[Link Inheritance \(Selected\) Utility](#) on page 3372
[MACUtilities Utility](#) on page 3817
[Material XML Exporter Utility](#) on page 5281
[MAX File Finder Utility](#) on page 7143
[MAXScript Utility](#) on page 11
[Measure Utility](#) on page 2680
[Motion Capture Utility](#) on page 3798
[Panorama Exporter Utility](#) on page 6426
[reactor Utility](#) on page 3881
[Rescale World Units Utility](#) on page 2682
[Reset XForm Utility](#) on page 957
[Resource Collector Utility](#) on page 7145
[Shape Check Utility](#) on page 707
[Skin Utilities](#) on page 3875
[Strokes Utility](#) on page 7854
[Surface Approximation Utility](#) on page 2565
[UVW Remove Utility](#) on page 5284
[Visual MAXScript Utility \(See MAXScript Reference\)](#) on page 7679

See also:

- [Track View Utilities](#) on page 3619

The 3ds Max user interface provides multiple ways to achieve the same goals. You can hide, [float](#) on page 7957 or [dock](#) on page 7957, resize and rearrange the user interface elements into your own personal design. For more information, see [Customizing the User Interface](#) on page 7683.

See the topics referenced below for detailed information on the major elements of the user interface.

See also:

- [Menu Bar](#) on page 7471
- [Toolbars](#) on page 7498
- [Quad Menu](#) on page 7516
- [Status Bar Controls](#) on page 7524
- [Animation and Time Controls](#) on page 7548
- [Viewport Controls](#) on page 7572
- [Viewport Navigation](#) on page 7585
- [Command Panel](#) on page 7630
- [MAXScript Interface](#) on page 7496

Additional Keyboard Commands

This topic describes some commands that are provided only as customizable actions. You can assign them to a keyboard shortcut, a menu, or a button by using the [Customize User Interface dialog](#) on page 7697.

See also:

- [Keyboard Shortcuts](#) on page 7857
- [Unwrap UVW Shortcuts](#) on page 1878

Keyable Property

Keyable Property Toggle

Default key: None

In Track View, if you select any track or group of tracks, this command turns the [keyable property](#) on page 3563 on or off. If a selected track is not keyable, its children (sub-animations), if any, are toggled. For example, if you select a transform controller track, this command toggles the keyable property of all position, rotation, and scale tracks. If you select an object's track, its transform, parameter, and material tracks are all toggled. If the object is part of a hierarchy, all its child objects' tracks are also toggled.

This action can be undone.

Set Key

Clear Set Key Mode Buffer

Default key: None

While in Set Key mode, if you transform an object but haven't yet clicked Set Key, this shortcut undoes the transformation and restores the viewport to show the animation that existed before the change.

Another way to accomplish this is to move the time slider or to turn on Play.

Transforms

Create Position Lock Key and Create Rotation Lock Key

Default keys: None

A lock key is a key with Linear interpolation. If you create the lock key while an existing key is selected, it changes that key's interpolation from Smooth to Linear. (Different types of interpolation are described in [Bezier Controllers](#) on page 3138.) You can create a lock key for position or for rotation.

Lock keys are useful when you want an object to be stationary, but smooth interpolation is causing it to "wobble" on its stationary spot.

Position to Zero

Default key: None

Like its counterparts on the [Animation quad menu](#) on page 7522, this shortcut restores the object's position to the initial "frozen" pose (0,0,0).

NOTE Position To Zero works only if you have previously invoked Freeze Transform or Freeze Rotation from the Animation quad menu.

Viewport Navigation

Pan Viewport

Default key: I (the letter "i")

Pans the active viewport, centering it on the current location of the cursor.

You can use this shortcut while another command, such as Move, is active.

This action can be undone, using Shift+Z.

Toggling Dialogs

In most cases, you can close a dialog with the same command used to open it. This applies to any combination of input methods, including menu, toolbar button, and keyboard shortcuts. For example, you can open the Render Setup dialog by choosing Rendering > Render Setup, and then close it by pressing F10 (default keyboard shortcut). If a dialog is available from a menu, a check mark appears next to the respective command while it's open.

If a dialog is minimized, invoking its command opens the dialog, and invoking it a second time closes the dialog.

In addition, the keyboard shortcut Ctrl+~ (tilde) toggles display of any open dialogs, in most cases.

The dialogs affected by this functionality are:

- Asset Browser
- Bone Tools

- Channel Info Editor
- Clone and Align dialog
- Display Floater
- Environment and Effects dialog
- Grid and Snap Settings dialog
- Layer Manager
- Light Lister
- Material Editor
- Material/Map Browser (modeless version)
- mental ray Messages Window
- Parameter Collector
- Parameter Editor
- Rename Objects
- Render dialog
- Render to Texture
- Rigid Body Property editor
- Selection Floater
- Spacing Tool
- Transform Type-In
- Video Post

The one exception is Particle View, which is toggled by its keyboard shortcut (6), but is not toggled by the Modify panel > Particle View button.

Starting 3ds Max from the Command Line

You can start the program from the command line in a Command Prompt window, or include the command line in a batch file. There are a number of switches that you can use on the command line.

To start 3ds Max from the command line:

- 1 Open a Command Prompt window.
- 2 Change directory to the 3ds Max root directory, if this directory is not in your PATH statement.
- 3 Type **3dsmax** to start the program. Optionally, add a command-line switch (see below).

Command-Line Switches

You can use the following switches after **3dsmax** on the command line.

Switch	Effect
-c other-cui	Starts program using <i>othercui.cui</i> instead of <i>maxstart.cui</i> .
-d	Causes Track View to use a double-buffered display, which is smoother than the single-buffered display but uses more system resources.
-g	Makes background white (instead of gray) in the following dialogs: Track View, RAM Player, Video Post, Loft, and Falloff Curve. Useful for screen captures when using a display mode less than 24 bits deep, for avoiding background patterns.
-h	Allows choice of graphics drivers: Software, Open GL, Direct3D, and Custom.
-i other-file	Starts program using <i>otherfile.ini</i> instead of <i>3dsmax.ini</i> .
-l	Loads the last <i>.max</i> file automatically.
-ma	Open maximized.

Switch	Effect
-mi	Open minimized.
-n	Disables network mode.
-p otherfile	Starts program using <i>otherfile.ini</i> instead of <i>plugin.ini</i> .
-q	Starts program "quietly," without the splash screen.
-s	Starts program in server mode.
-u	Opens utility.
-v	Loads a display driver. See details following, under "Using the -V Option." NOTE It is not possible to select which version of Direct3D you will use with this switch.
-z	Writes version number to file. See details following, under "Using the -Z Option."
any-scene	Starts the program and opens a file called <i>anyscene.max</i> .

A space must separate the program executable name and the command-line switch.

Examples:

3dsmax -l

3dsmax -i otherfile

3dsmax anyscene

3dsmax -c MaxCustom

See also:

- [Startup Files and Defaults](#) on page 82
- [Saving and Loading Custom User Interfaces](#) on page 7722
- [Graphics Driver Setup Dialog](#) on page 7790
- [Running Scripts from the Command Line](#) on page 7680

Using the -V Option

You use the -V option to load a different display driver at startup. This option overrides the setting in *3dsmax.ini*.

Follow the -V with one of these letters for the driver you want to use:

s: Loads the software driver.

o: Loads the OpenGL driver.

d: Loads the Direct3D driver.

n: Loads a null driver.

For example, if you ordinarily run OpenGL and want to switch to the software driver for a session, you would type: **3dsmax -vs**

Using the -Z Option

If you call product support, the representative might ask you to run this option to determine the exact version of your software. This option only writes to a file; it does not start 3ds Max.

Follow the -Z with a file name:

3dsmax -z id.txt

The file (in this example, *id.txt*) is written to the 3ds Max root directory.

Menu Bar



File Edit Tools Group Views Create Modifiers Animation Graph Editors Rendering Lighting Analysis Customize MAXScript Help

The menu bar is located directly under the main window's title bar. The title of each menu indicates the purpose of the commands on the menu. Each menu uses standard Microsoft Windows conventions.

[File Menu](#) on page 7473
[Edit Menu](#) on page 7474
[Tools Menu](#) on page 7475
[Group Menu](#) on page 7477
[Views Menu](#) on page 7477
[Create Menu](#) on page 7478
[Modifiers Menu](#) on page 7485
[Animation Menu](#) on page 7490
[Graph Editors Menu](#) on page 7493
[Rendering Menu](#) on page 7493
[Customize Menu](#) on page 7494
[MAXScript Interface](#) on page 7496
[Help Menu](#) on page 7496

Interface

When you click a menu name, a number of commands are listed below it.

As an alternative to using your mouse (or other pointing device), each menu name includes an underlined character. Pressing that character key while holding down the Alt key opens the menu, unless that particular key combination is assigned to a keyboard shortcut. Some commands and subheadings in the open menu have an underlined character as well. While the menu is open, pressing that character key invokes the command. While navigating menus with the keyboard, you can also use the arrow keys to move the highlighting and the Enter key to activate a command or open a submenu.

An ellipsis (...) after a command name indicates a dialog will appear.

A right-pointing triangle after a command name indicates that a submenu will appear.

If a command has a keyboard shortcut, the menu displays it to the right of the command name.

If a menu command is an on/off toggle, a check mark indicates its status: If a check mark is present, the command is active.

File Menu

Menu bar > File

The File menu contains commands for managing files.

[New](#) on page 6920

[Reset](#) on page 6921

[Open](#) on page 6922

[Open from Vault](#) on page 6925

[Open Recent](#) on page 6927

[Save](#) on page 6927

[Save As](#) on page 6928

[Save Copy As](#) on page 6930

[Save Selected](#) on page 6931

[Set Project Folder](#) on page 6932

[XRef Objects](#) on page 6936

[XRef Scene](#) on page 6959

[File Link Manager Utility](#) on page 6987

[Merge](#) on page 7058

[Merge Animation](#) on page 7063

[Replace](#) on page 7070

[Load Animation](#) on page 7077

[Save Animation](#) on page 7080

[Import](#) on page 7096

[Export](#) on page 7097

[Export Selected](#) on page 7099

[Publish to DWF](#) on page 7216

[Asset Tracking](#) on page 7100

[Archive](#) on page 7121

[Summary Info](#) on page 7122

[File Properties](#) on page 7124

[View Image File](#) on page 7127

[Exit](#) on page 7129

File dialogs (such as Open, Save, Save As) uniformly remember the previous path you used, and default to that location.

Edit Menu

Menu bar > Edit

The Edit menu contains commands for selecting and editing objects in a scene.

[Undo/Redo](#) on page 262

[Hold/Fetch](#) on page 264

[Delete](#) on page 265

[Clone](#) on page 1034

[Move](#) on page 959

[Rotate](#) on page 960

[Scale](#) on page 962

[Transform Type-In](#) on page 944

[Select All](#) on page 249

[Select None](#) on page 249

[Select Invert](#) on page 250

[Select Similar](#) on page 250

Select Instances Selects all [instances](#) on page 8014 of the selected object. Unavailable if the object has no instances, or if multiple objects are selected.

[Select By](#) on page 251

[Selection Region](#) on page 252

[Manage Selection Sets](#) on page 246

[Object Properties](#) on page 305

Tools Menu

Menu bar > Tools

The Tools menu displays dialogs that help you change or manage objects, especially collections of objects, in your 3ds Max scene.

[Open Scene Explorer](#) on page 7379 (Opens the most recently accessed scene explorer)

[New Scene Explorer](#) on page 7379

[Manage Scene Explorer](#) on page 7393

[Saved Scene Explorers](#) on page 7379 (when one or more scene explorers exist)

[Isolate Selection](#) on page 219

[Display Floater](#) on page 7666

[Manage Layers](#) on page 7441

[Light Lister](#) on page 5000

[Manage Scene States](#) on page 7399

[Mirror](#) on page 982

[Array](#) on page 986

[Align](#) on page 7476

[Snapshot](#) on page 992

[Rename Objects](#) on page 328

[Assign Vertex Colors](#) on page 6038

[Color Clipboard](#) on page 397

[Camera Match](#) on page 5249

[Grab Viewport](#) on page 145

[Grids and Snaps](#) on page 7476

[Measure Distance](#) on page 2613

[Channel Info](#) on page 6047

Align Submenu

Menu bar > Tools > Align

The Align submenu contains functions for aligning objects in the scene, as well as for creating aligned objects.

[Align](#) on page 1009

[Quick Align](#) on page 1015

[Spacing Tool](#) on page 996

[Clone and Align](#) on page 1004

[Align to View](#) on page 1021

[Normal Align](#) on page 1015

[Align Camera](#) on page 1020

[Place Highlight](#) on page 1018

Grids and Snaps Submenu

Menu bar > Tools > Grids and Snaps

The Grid And Snaps submenu contains commands for using grids and snapping tools to help lay out scenes precisely. The submenu contains the following commands:

[Grid and Snap Settings](#) on page 2661

[Show Home Grid](#) on page 2648

[Activate Home Grid](#) on page 2649

[Activate Grid Object](#) on page 2650

[Align Grid to View](#) on page 2650

[Snaps Toggle](#) on page 2652

[Angle Snap Toggle](#) on page 2654

[Percent Snap Toggle](#) on page 2655

[Snaps Use Axis Constraints](#) on page 2675

Group Menu

Menu bar > Group

The Group menu contains functions for grouping and ungrouping objects in the scene.

[Group](#) on page 282

[Ungroup](#) on page 284

[Open](#) on page 283

[Close](#) on page 283

[Attach](#) on page 286

[Detach](#) on page 285

[Explode](#) on page 285

[Assembly](#) on page 286

See also:

■ [Using Groups](#) on page 266

■ [Using Assemblies](#) on page 269

Views Menu

Menu bar > Views

This menu contains commands for setting up and controlling viewports. Some of the commands found on this menu can also be accessed when you right-click a viewport label.

[Undo View Change/Redo View Change](#) on page 146

[Viewport Configuration](#) on page 7817

[Redraw All Views](#) on page 172

[Set Active Viewport](#) on page 7580

[Save Active View](#) on page 147

[Restore Active View](#) on page 147

[ViewCube](#) on page 109 (also see [ViewCube configuration](#) on page 7837)

[SteeringWheels](#) on page 117

[Create Camera From View](#) on page 168

[Show Materials in Viewport As](#) on page 5350

[Viewport Lighting and Shadows](#) on page 4991

Viewport Background >

- [Viewport Background](#) on page 148
- [Update Background Image](#) on page 161
- [Reset Background Transform](#) on page 162

[Show Transform Gizmo](#) on page 162

[Show Ghosting](#) on page 163

[Show Key Times](#) on page 164

[Shade Selected](#) on page 166

[Show Dependencies](#) on page 167

[Update During Spinner Drag](#) on page 174

[Adaptive Degradation](#) on page 143

[Expert Mode](#) on page 175

NOTE The following commands, also influencing viewport behavior, are accessed from a different menu:

[Units Setup Dialog](#) on page 7809

[Grid and Snap Settings](#) on page 2661

Create Menu

Menu bar > Create

The Create menu provides a way to create geometry, lights, cameras, and [helper objects](#) on page 2614. It is organized into various submenus.

See also:

- [Create Panel](#) on page 7631

Interface

Standard Primitives

- [Box](#) on page 410
- [Cone](#) on page 413
- [Sphere](#) on page 416
- [GeoSphere](#) on page 421
- [Cylinder](#) on page 424
- [Tube](#) on page 427
- [Torus](#) on page 430
- [Pyramid](#) on page 434
- [Teapot](#) on page 437
- [Plane](#) on page 440

Extended Primitives

- [Hedra](#) on page 445
- [Torus Knot](#) on page 448
- [Chamfer Box](#) on page 452
- [Chamfer Cylinder](#) on page 456
- [Oil Tank](#) on page 459
- [Capsule](#) on page 462
- [Spindle](#) on page 465
- [L-Extrusion](#) on page 469
- [Gengon](#) on page 471
- [C-Extrusion](#) on page 474
- [RingWave](#) on page 477
- [Hose](#) on page 485

[Prism](#) on page 483

AEC Objects

[Foliage](#) on page 499

[Railing](#) on page 507

[Wall](#) on page 516

[Pivot Door](#) on page 571

[Sliding Door](#) on page 573

[BiFold Door](#) on page 575

[Straight Stair](#) on page 549

[L-Type Stair](#) on page 534

[U-Type Stair](#) on page 555

[Spiral Stair](#) on page 540

[Awning Window](#) on page 584

[Casement Window](#) on page 587

[Fixed Window](#) on page 589

[Pivoted Window](#) on page 591

[Sliding Window](#) on page 595

[Projected Window](#) on page 593

Compound

[Morph](#) on page 709

[Scatter](#) on page 717

[Conform](#) on page 731

[Connect](#) on page 739

[BlobMesh](#) on page 745

[ShapeMerge](#) on page 752

[Boolean](#) on page 757

[Terrain](#) on page 774

[Loft](#) on page 786

[Mesher](#) on page 837

[ProBoolean](#) on page 844

[ProCutter](#) on page 862

Particles

[Particle Flow Source](#) on page 2829

[Spray](#) on page 3016

[Snow](#) on page 3020

[Blizzard](#) on page 3029

[PArray](#) on page 3042

[PCloud](#) on page 3034

[Super Spray](#) on page 3025

Patch Grids

[Quad Patch](#) on page 2069

[Tri Patch](#) on page 2072

NURBS

[CV Surface](#) on page 2280

[Point Surface](#) on page 2276

[CV Curve](#) on page 2293

[Point Curve](#) on page 2286

Dynamics

[Damper](#) on page 881

[Spring](#) on page 890

Shapes

[Line](#) on page 620

[Rectangle](#) on page 624

[Circle](#) on page 626

[Ellipse](#) on page 628

[Arc](#) on page 629

[Donut](#) on page 633

[NGon](#) on page 634

[Star](#) on page 636

[Text](#) on page 638

[Helix](#) on page 643

[Section](#) on page 645

Extended Shapes

[WRectangle](#) on page 649

[Channel](#) on page 652

[Angle](#) on page 654

[Tee](#) on page 656

[Wide Flange](#) on page 657

Lights

Photometric Lights >

[Target Light](#) on page 5009

[Free Light](#) on page 5011

[mr Sky Portal](#) on page 5186

Standard Lights >

[Target Spotlight](#) on page 5051

[Free Spotlight](#) on page 5054

[Target Directional](#) on page 5057

[Directional](#) on page 5060

[Omni](#) on page 5063

[Skylight](#) on page 5065

[mr Area Spot](#) on page 5073
[mr Area Omni](#) on page 5070
[Daylight System](#) on page 5139

Cameras

[Free Camera](#) on page 5203
[Target Camera](#) on page 5205
[Create Camera From View](#) on page 168

Helpers

[Dummy](#) on page 2615
[Expose Transform](#) on page 2616
[Grid](#) on page 2622
[Point](#) on page 2628
[Tape Measure](#) on page 2630
[Protractor](#) on page 2633
[Compass](#) on page 2635
Light Meter
[Camera Point](#) on page 5255
[Delegate](#) on page 4811
[Crowd](#) on page 4819
Atmospherics >
[Box Gizmo](#) on page 6762
[Cylinder Gizmo](#) on page 6765
[Sphere Gizmo](#) on page 6768
Manipulators >
[Slider](#) on page 2643
[Plane Angle](#) on page 2640
[Cone Angle](#) on page 2636

Particle Flow >

[Speed by Icon](#) on page 2876

[Find Target](#) on page 2970

Space Warps

Forces >

[Motor](#) on page 2696

[Push](#) on page 2691

[Drag](#) on page 2706

[Vortex](#) on page 2701

[Path Follow](#) on page 2717

[PBomb](#) on page 2712

[Displace](#) on page 2727

[Gravity](#) on page 2721

[Wind](#) on page 2724

Deflectors >

[PDynaFlect](#) on page 2738

[POmniFlect](#) on page 2732

[SDynaFlect](#) on page 2745

[SOMniFlect](#) on page 2743

[SDeflector](#) on page 2751

[UDynaFlect](#) on page 2748

[UOmniFlect](#) on page 2746

[UDeflector](#) on page 2754

[Deflector](#) on page 2757

Geometric/Deformable >

[FFD \(Box\)](#) on page 2760

[FFD \(Cyl\)](#) on page 2767

[Wave](#) on page 2777

[Ripple](#) on page 2781

[Displace](#) on page 2727

[Conform](#) on page 2785

[Bomb](#) on page 2789

Modifier-Based >

[Bend](#) on page 2793

[Noise](#) on page 2793

[Skew](#) on page 2793

[Taper](#) on page 2793

[Twist](#) on page 2793

[Stretch](#) on page 2793

Particles and Dynamics >

[Vector Field](#) on page 4917

Systems

[Bones IK Chain](#) on page 901

[Biped](#) on page 4147

[Daylight System](#) on page 5139

Modifiers Menu

Menu bar > Modifiers

The Modifiers menu provides a way to apply frequently used modifiers quickly. It is organized into submenus. The availability of items on this menu depends on the current selection. If a modifier doesn't apply to currently selected objects, it is unavailable in the menu.

See also:

- [Modify Panel](#) on page 7633
- [Modifier Stack Controls](#) on page 7635
- [List of Available Modifiers](#) on page 1081

Interface

Selection Modifiers

[FFD Select](#) on page 1466

[Mesh Select](#) on page 1527

[Patch Select](#) on page 1592

[Poly Select](#) on page 1613

[Select by Channel](#) on page 1659

[Spline Select](#) on page 1744

[Volume Select](#) on page 1992

Patch/Spline Editing

[Cross Section](#) on page 1329

[Delete Patch](#) on page 1337

[Delete Spline](#) on page 1339

[Edit Patch](#) on page 1360

[Edit Spline](#) on page 1447

[Fillet/Chamfer](#) on page 1467

[Lathe](#) on page 1501

[Normalize Spline](#) on page 1583

[Renderable Spline](#) on page 1652

[Surface](#) on page 1766

[Sweep](#) on page 1780

[Trim/Extend](#) on page 1818

Mesh Editing

[Cap Holes](#) on page 1228

[Delete Mesh](#) on page 1336

[Edit Mesh](#) on page 1353

[Edit Normals](#) on page 1354

[Edit Poly](#) on page 1363

[Extrude](#) on page 1448
[Face Extrude](#) on page 1452
[MultiRes](#) on page 1565
[Normal Modifier](#) on page 1581
[Optimize](#) on page 1587
[Smooth](#) on page 1736
[STL Check](#) on page 1749
[Symmetry](#) on page 1807
[Tessellate](#) on page 1815
[Vertex Paint](#) on page 1959
[Vertex Weld](#) on page 1957

Conversion

[Turn to Mesh](#) on page 1828
[Turn to Patch](#) on page 1830
[Turn to Poly](#) on page 1833

Animation Modifiers

[Attribute Holder](#) on page 1206
[Flex](#) on page 1471
[Linked XForm](#) on page 1511
[Melt](#) on page 1523
[Morpher](#) on page 1545
[PatchDeform](#) on page 1597
[PatchDeform \(WSM\)](#) on page 1193
[PathDeform](#) on page 1600
[PathDeform \(WSM\)](#) on page 1193
[Skin](#) on page 1672
[Skin Morph](#) on page 1708
[Skin Wrap](#) on page 1719
[Skin Wrap Patch](#) on page 1728

[SplineIK Control](#) on page 1741

[SurfDeform](#) on page 1778

[SurfDeform \(WSM\)](#) on page 1202

Cloth

[Cloth](#) on page 1247

[Garment Maker](#) on page 1297

Hair and Fur

[Hair and Fur \(WSM\)](#) on page 1119

UV Coordinates

[Camera Map](#) on page 1223

[Camera Map \(WSM\)](#) on page 1113

[Map Scaler \(WSM\)](#) on page 1190

[Projection](#) on page 1628

[Unwrap UVW](#) on page 1841

[UVW Map](#) on page 1931

[UVW Mapping Add](#) on page 1954

[UVW Mapping Clear](#) on page 1954

[UVW XForm](#) on page 1955

Cache Tools

[Point Cache](#) on page 1604

[Point Cache \(WSM\)](#) on page 1199

Subdivision Surfaces

[HSDS Modifier](#) on page 1491

[MeshSmooth](#) on page 1532

[TurboSmooth](#) on page 1822

Free Form Deformers

[FFD 2x2x2](#) on page 1454

[FFD 3x3x3](#) on page 1454

[FFD 4x4x4](#) on page 1454

[FFD Box](#) on page 1460

[FFD Cylinder](#) on page 1460

Parametric Deformers

[Affect Region](#) on page 1203

[Bend](#) on page 1208

[Displace](#) on page 1344

[Lattice](#) on page 1506

[Mirror](#) on page 1543

[Noise](#) on page 1573

[Physique](#) on page 4670

[Push](#) on page 1646

[Preserve](#) on page 1622

[Relax](#) on page 1647

[Ripple](#) on page 1655

[Shell](#) on page 1660

[Slice](#) on page 1729

[Skew](#) on page 1668

[Stretch](#) on page 1752

[Spherify](#) on page 1739

[Squeeze](#) on page 1747

[Twist](#) on page 1837

[Taper](#) on page 1811

[Substitute](#) on page 1762

[XForm](#) on page 2004

[Wave](#) on page 2000

Surface

[Disp Approx](#) on page 1340

[Displace Mesh \(WSM\)](#) on page 1115

[Material](#) on page 1517

[Material by Element](#) on page 1519

NURBS Editing

[DispApprox](#) on page 1340

[SurfDeform](#) on page 1778

[Surface Select](#) on page 1585

Radiosity Modifiers

[Subdivide](#) on page 1759

[Subdivide \(WSM\)](#) on page 1199

Cameras

[Camera Correction](#) on page 5247

Animation Menu

Menu bar > Animation

The Animation menu provides a set of commands related to animation, constraints and controllers, and inverse-kinematics solvers.

Also present here are controls for custom attributes and parameter wiring, as well as for creating, viewing, and renaming animation previews.

Interface

IK Solvers

[HI Solver](#) on page 3392

[HD Solver](#) on page 3422

[IK Limb Solver](#) on page 3444

[Spline IK Solver](#) on page 3445

Constraints

[Attachment Constraint](#) on page 3288

[Surface Constraint](#) on page 3293

[Path Constraint](#) on page 3297

[Position Constraint](#) on page 3303

[Link Constraint](#) on page 3308

[LookAt Constraint](#) on page 3312

[Orientation Constraint](#) on page 3319

Transform Controllers

[Link Constraint](#) on page 3308

[Position/Rotation/Scale](#) on page 3220

[Script](#) on page 3261

Position Controllers

[Audio](#) on page 3135

[Bezier](#) on page 3138

[Expression](#) on page 3154

[Linear](#) on page 3193

[Motion Capture](#) on page 3203

[Noise](#) on page 1573

[Quaternion \(TCB\)](#) on page 3258

[Reaction](#) on page 3222

[Spring](#) on page 3253

[Script](#) on page 3248

[XYZ](#) on page 3219

[Attachment Constraint](#) on page 3288

[Path Constraint](#) on page 3297

[Position Constraint](#) on page 3303

[Surface Constraint](#) on page 3293

Rotation Controllers

[Audio](#) on page 3135

[Euler XYZ](#) on page 3151

[Linear](#) on page 3193

[Motion Capture](#) on page 3203

[Noise](#) on page 3214

[Quaternion \(TCB\)](#) on page 3258
[Reaction](#) on page 3222
[Script](#) on page 3248
[Smooth](#) on page 3253
[LookAt Constraint](#) on page 3312
[Orientation Constraint](#) on page 3319

Scale Controllers

[Audio](#) on page 3135
[Bezier](#) on page 3138
[Expression](#) on page 3154
[Linear](#) on page 3193
[Motion Capture](#) on page 3203
[Noise](#) on page 3214
[Quaternion \(TCB\)](#) on page 3258
[Reaction](#) on page 3222
[Script](#) on page 3248
[XYZ](#) on page 3246
[Parameter Editor](#) on page 329
[Parameter Collector](#) on page 347
Wire Parameters >
[Wire Parameters](#) on page 3322
[Parameter Wire Dialog](#) on page 3324
[Animation Layers](#) on page 3164
[Reaction Manager](#) on page 3228
[Bone Tools](#) on page 915
[Set as Skin Pose](#) on page 304
[Assume Skin Pose](#) on page 304
[Skin Pose Mode](#) on page 304
[Make Preview](#) on page 6422

[View Preview](#) on page 6425

[Rename Preview](#) on page 6425

Toggle Limits Toggles all [Limit controllers](#) on page 3181 in the current scene. If all Limit controllers are off, Toggle Limits turns them on, and if all are on, it turns them off. If some are on and the rest are off, Toggle Limits turns them all on.

[Delete Selected Animation](#) on page 7523

[Walkthrough Assistant](#) on page 5239

[reactor](#) on page 3887

Graph Editors Menu

Menu bar > Graph Editors

The Graph Editors menu gives you access to graphic sub-windows for managing a scene and its hierarchies and animation.

Interface

[Track View – Curve Editor](#) on page 3518

[Track View – Dope Sheet](#) on page 3519

[New Track View](#) on page 3686

[Delete Track View](#) on page 3686

[Saved Track Views](#) on page 3688

[New Schematic View](#) on page 7433

[Delete Schematic View](#) on page 7434

[Saved Schematic Views](#) on page 7434

[Particle View](#) on page 2811

[Motion Mixer...](#) on page 3699

Rendering Menu

Menu bar > Rendering

The Rendering menu contains commands for rendering scenes, setting up environmental and render effects, compositing scenes with Video Post, and accessing the RAM Player.

NOTE The presence on the menu of certain commands depends on which renderer is currently active, as noted here.

[Render](#) on page 6100

[Render Setup](#) on page 6067

[Rendered Frame Window](#) on page 6073

[Indirect Illumination](#) on page 6295 (mental ray Renderer)

[Radiosity](#) on page 6188 (Default Scanline Renderer)

[Light Tracer](#) on page 6154 (Default Scanline Renderer)

[Exposure Control](#) on page 6732

[Environment](#) on page 6687

[Effects](#) on page 6585

[Raytracer Settings](#) on page 6221 (Default Scanline Renderer)

[Raytrace Global Include/Exclude](#) on page 5519 (Default Scanline Renderer)

[Render to Texture](#) on page 6371

[Material Editor](#) on page 5284

[Material/Map Browser](#) on page 5290

[Video Post](#) on page 6773

[Panorama Exporter](#) on page 6426

[Batch Render](#) on page 6553

[Print Size Assistant](#) on page 6117

[mental ray Message Window](#) on page 6244 (mental ray Renderer)

[RAM Player](#) on page 7374

Customize Menu

Menu bar > Customize

The Customize menu contains commands for customizing the 3ds Max user interface (UI).

[Customize User Interface](#) on page 7697

[Load Custom UI Scheme](#) on page 7724

[Save Custom UI Scheme](#) on page 7725

[Revert to Startup Layout](#) on page 7728

[Lock UI Layout](#) on page 7690

[Show UI](#) on page 7689

[Custom UI and Defaults Switcher](#) on page 7692

[Configure User Paths](#) on page 7729

[Configure System Paths](#) on page 7732

[Units Setup](#) on page 7809

[Plug-In Manager](#) on page 7690

[Preferences](#) on page 7743

You can create a custom user interface layout, including custom keyboard shortcuts, colors, menus, and quad menus. You can load or save all of these things individually in the Customize User Interface dialog, or you can load or save all of them at once, using *schemes*. Schemes allow you to load all customized features of the UI at one time.

You can hide, [float or dock](#) on page 7957, resize, and rearrange some UI elements into your own personal design. You can also lock the UI once you've got it set. Tools are provided in the Customize menu to load and save these custom UI files, or to revert to the startup user interface.

System preferences such as keyboard shortcuts, viewport configuration, units setup, grid and snap settings, and many important default settings, are also on the Customize menu.

TIP You can access many of these commands with keyboard shortcuts or right-click options. For example, you can display the Grid and Snap Settings dialog by right-clicking the Snaps buttons on the main toolbar; you can display the Viewport Configuration dialog by right-clicking the viewport label, and then choosing Configure.

MAXScript Interface

Menu bar > MAXScript

Utilities panel > MAXScript

[MAXScript](#) on page 11 is the software's built-in scripting language. Its main interface, the MAXScript menu, contains the following commands for creating and working with scripts:

[New Script](#) on page 7676

[Open Script](#) on page 7677

[Run Script](#) on page 7677

[MAXScript Listener](#) on page 7677

MAXScript Editor Toggles the MAXScript Editor window. For details, see the *MAXScript Help*, available from Help menu > MAXScript Help.

[Macro Recorder](#) on page 7678

[Visual MAXScript Editor](#) on page 7679

[MAXScript Debugger Dialog](#) on page 7680

In addition, the [status bar](#) on page 7524 contains a [MAXScript Mini Listener](#) on page 7525, and MAXScript functionality is also available from the [Utilities panel](#) on page 7671.

For detailed information about MAXScript, open the *MAXScript Help*, available from Help menu > MAXScript Help.

Help Menu

Menu bar > Help

The Help menu provides access to the 3ds Max online help systems.

Autodesk 3ds Max Help Opens the 3ds Max Help.

Learning Movies Opens a dialog that provides access to movies for learning the essentials of using 3ds Max.

Learning Path Opens your Web browser to a page of resources for learning how to use 3ds Max.

Tutorials Displays the online tutorials for 3ds Max.

What's New Opens the 3ds Max to the new features section.

MAXScript Help Displays the MAXScript Help online. See [About MAXScript](#) on page 11.

Additional Help Opens a dialog that lets you choose to display the help for installed third-party plug-ins and for add-on products from Autodesk.

By default, this command looks for additional help files in the `\help` subdirectory. That location might have changed if you've edited plug-in path settings. See [3rd Party Plug-Ins Path Configuration](#) on page 7740.

Keyboard Shortcut Map Opens a page showing keyboard shortcuts.

Data Exchange Solutions Opens your Web browser to a page about software for exchanging data among applications.

Customer Involvement Program When activated, lets Autodesk collect anonymous information about your usage of 3ds Max to help us improve the software. No personal information is collected. Choose whether or not to participate, and then click OK.

Subscription e-Learning Catalog Opens your Web browser to a page about electronic learning content for subscribers.

Edit Subscription Center Profile Opens your Web browser to a page that lets you edit your subscription profile.

Create Support Request Opens your Web browser to a page about obtaining technical support.

View Support Requests Opens your Web browser to a page about existing requests for technical support.

3ds Max on the Web Displays a submenu whose options display a Web page with additional information.

Activate 3ds Max Starts the 3ds Max registration wizard, which lets you enter a new license authorization code. For example, you need to reauthorize 3ds Max if you're changing from a trial license to a permanent license.

License Borrowing If you are using a network-licensed version of 3ds Max, use this choice to borrow or return a license. For details, see the AutoCAD License Borrowing help, which is available as the file `acad_brw.chm`, installed in the `\program files\common files\autodesk shared\enu` folder on your local drive (typically, drive C:).

Diagnose Video Hardware Lets you determine whether your system supports certain display-related features. See [Diagnose Video Hardware](#) on page 174.

About 3ds Max Displays copyright and license information about your copy of 3ds Max.

See also:

- [Using the 3ds Max Help](#) on page 33
- Copyrights and Trademarks

Toolbars

Many of the commands in 3ds Max are available as buttons on various toolbars. By default, only the [main toolbar](#) on page 7499 is open, docked at the top of the interface. You can open and close toolbars and place them wherever you want. For more information, see [Customizing the User Interface](#) on page 7683.

Several additional toolbars are hidden by default, including [Axis Constraints](#) on page 7503, [Layers](#) on page 7504, [Extras](#) on page 7506, [Render Shortcuts](#) on page 7506, [Brush Presets](#) on page 7509, and [Snaps](#) on page 7508. To toggle a toolbar, right-click a blank area of the main toolbar and choose the toolbar's name from the list.

See [Customize Display Right-Click Menu](#) on page 7687 for more information.

See also:

- [Main Toolbar](#) on page 7499
-  [InfoCenter Toolbar](#) on page 7503
- [Axis Constraints Toolbar](#) on page 7503
- [Layers Toolbar](#) on page 7504
- [reactor Toolbar](#) on page 7505
- [Extras Toolbar](#) on page 7506
- [Render Shortcuts Toolbar](#) on page 7506
- [Snaps Toolbar](#) on page 7508
- [Animation Layers Toolbar](#) on page 7508
- [Brush Presets Toolbar](#) on page 7509

Main Toolbar

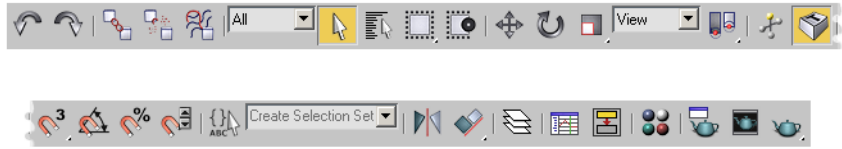

The main toolbar, split in two for this illustration

The main toolbar provides quick access to tools and dialogs for many of the most common tasks in 3ds Max.

NOTE Right-clicking the move, rotate, or scale button opens the [Transform Type-In dialog](#) on page 944.



[Undo/Redo](#) on page 262



[Select and Link](#) on page 3343



[Unlink Selection](#) on page 3344



[Bind to Space Warp](#) on page 2691



[Selection Filter List](#) on page 235



[Select Object](#) on page 227



[Select From Scene](#) on page 228

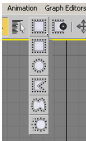

[Selection Region Flyout](#) on page 234



[Window/Crossing Selection Toggle](#) on page 261



[Select and Move](#) on page 959



[Select and Rotate](#) on page 960



[Select and Scale](#) on page 962

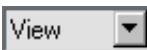

[Reference Coordinate System](#) on page 967



[Use Center Flyout](#) on page 975



[Select And Manipulate](#) on page 2613



[Keyboard Shortcut Override Toggle](#) on page 7858



[2D Snap, 2.5D Snap, 3D Snap](#) on page 2652



[Angle Snap Toggle](#) on page 2654



[Percent Snap Toggle](#) on page 2655



[Spinner Snap Toggle](#) on page 2656



[Edit Named Selection Sets](#) on page 246

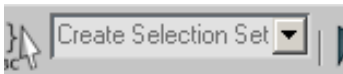

[Named Selection Sets](#) on page 239



[Mirror](#) on page 982

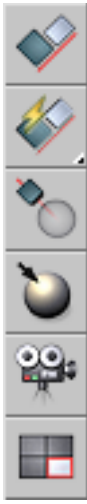

[Align Flyout](#) on page 1009



[Layer Manager](#) on page 7441



[Curve Editor \(Open\)](#) on page 3518



[Schematic View \(Open\)](#) on page 7407



[Material Editor](#) on page 5284



[Render Setup](#) on page 6067





[Rendered Frame Window](#) on page 6073

Render flyout:



■ [Render Production](#) on page 6101

-  [Render Iterative](#) on page 6101
-  [ActiveShade](#) on page 6102

InfoCenter Toolbar

Right-click unused area of any toolbar > InfoCenter

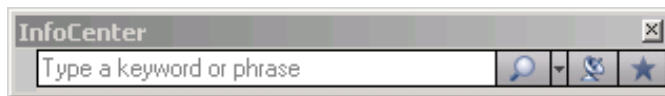

The InfoCenter toolbar is displayed by default. For instructions on how to use it, see [Search For and Receive Information](#) on page 13 and the topics that follow that topic.

Axis Constraints Toolbar

Right-click unused area of any toolbar > Axis Constraints

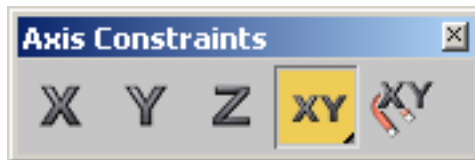

The axis constraint buttons and flyouts appear on the Axis Constraints toolbar. See [Using the Axis Constraints](#) on page 955.

NOTE The default UI does not display this toolbar: to see it, right-click an empty portion of any toolbar, and choose Axis Constraints from the menu.





Restrict to Y



Restrict to Z

Restrict to Plane flyout



Restrict to XY Plane



Restrict to YZ Plane



Restrict to ZX Plane



[Snaps Use Axis Constraints Toggle](#) on page 2675

Layers Toolbar

Right-click any toolbar > Layers



The Layers toolbar simplifies interaction with the layer system in 3ds Max, allowing you to easily organize the layers in your scene. Most of these operations are available from the [Layer Manager](#) on page 7441, however the Layers toolbar provides shortcuts to several common actions, as well as the advantage of being able to work directly in the viewports.

NOTE The default UI does not display this toolbar; to see it, right-click an empty portion of any toolbar, and choose Layers from the menu.

The Layers toolbar provides the following controls:



[Layer Manager](#) on page 7441



[Layer List](#) on page 7459



[Create New Layer](#) on page 7460



[Add Selection to Current Layer](#) on page 7461



[Select Objects in Current Layer](#) on page 7461



[Set Current Layer to Selection's Layer](#) on page 7461

See also:

- [Using Layers to Organize a Scene](#) on page 7438

reactor Toolbar



The reactor toolbar provides quick access to many of the objects and commands for the reactor dynamics toolset. For more information, see [reactor](#) on page 3881.

NOTE The default UI does not display this toolbar; to see it, right-click an empty part of any toolbar, and then choose reactor from the menu. When activated, the reactor toolbar is docked on the left side of your interface by default.

For more information, see [Customize Display Right-Click Menu](#) on page 7687 and [Customizing the User Interface](#) on page 7683.

Extras Toolbar



The Extras toolbar contains several miscellaneous tools for working with your 3ds Max scene.

NOTE The default UI does not display this toolbar; to open it, right-click an empty portion of any toolbar, and choose Extras from the menu.



[AutoGrid](#) on page 2597

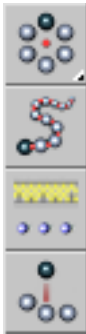

[Array Flyout](#) on page 981

[Preset Rendering Options](#) on page 6114

Render Shortcuts Toolbar

Right-click the unused (gray) portion of the main toolbar or another toolbar.
> Render Shortcuts

The Render Shortcuts toolbar lets you assign settings to three custom preset buttons. You can then use these buttons to switch among various render presets.

Procedures

To define the presets for a button:

- 1 Choose one of the default shortcuts from the Presets drop-down list, or use Load to load the presets from an RPS file.

The Select Preset Categories dialog appears. See [Preset Rendering Options](#) on page 6114.

- 2 Choose the categories you want, and then click Save.

The preset render settings are now active.

- 3 Shift+click the button you want to define.

3ds Max assigns the presets to the file that corresponds to the button: *a.rps*, *b.rps*, or *c.rps*.

To use a saved preset:

- 1 Click one of the buttons you defined.

The button's name appears in the field above the drop-down list: "a," "b," or "c."

If the button has not yet been defined, clicking it has no effect, and no name appears in the preset field.

- 2  On the main toolbar, click Render.

The scene is rendered using the presets you chose.

Interface

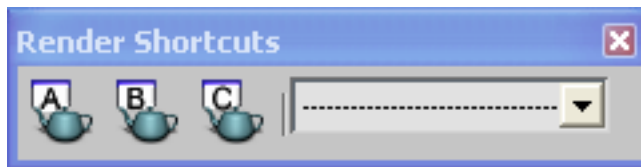

Render Preset Slot A, B, and C Click a button to make its presets active.

If you haven't assigned presets to a button, clicking it has no effect. If presets are assigned, then after you click the button, its name appears in the field above the drop-down list: "a," "b," or "c."

After assignment, each button has its own render preset (RPS) file: *a.rps*, *b.rps*, and *c.rps*. These are saved in the `\renderpresets` folder in the 3ds Max root directory. The active preset status is not saved with the MAX scene, but it is saved in the [3dsmax.ini](#) on page 83 file.

Render Presets drop-down list Lets you choose from among a set of preset rendering parameters, or load or save rendering parameter settings. See [Preset Rendering Options](#) on page 6114.

This list is the same as the one that appears at the bottom of the [Render Setup dialog](#) on page 6067.

Snaps Toolbar

Right-click unused area of any toolbar. > Snaps

The Snaps toolbar provides access to the most common Snaps settings.



To toggle display of the Snaps toolbar, right-click an empty area of the main toolbar, such as the section under the Reference Coordinate System drop-down, and choose Snaps. For details on the button functions, see [Standard Snaps](#) on page 2666 and [Snap Options](#) on page 2671.

Animation Layers Toolbar

Right-click unused area of any toolbar. > Animation Layers

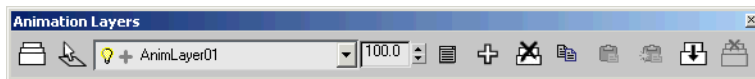

The animation layers toolbar provides quick access to commands related to the Layer controller, such as enabling, adding, and collapsing layers. Some of these commands are also accessible through the [Layer Controller dialog](#) on page 3162. For more information, see [Animation Layers](#) on page 3164.

Brush Presets Toolbar

Right-click unused area of any toolbar. > Brush Presets

The Brush Presets toolbar gives you quick access to up to 50 different brush settings for use with the following paint-oriented tools:

- [Paint Deformation](#) on page 2210 (Edit/Editable Poly)
- [Paint Soft Selection](#) on page 2015 (Edit/Editable Poly)
- [VertexPaint modifier](#) on page 1959
- [Skin modifier](#) on page 1672

You can also use the toolbar to create new presets and to open the [Brush Preset Manager](#) on page 7511, which lets you edit presets, and save and load groups of presets. The current group of presets is saved when you quit 3ds Max and is restored the next time you start the program.

NOTE Only one set of presets is available at a time. The Brush Presets feature stores context-specific features, such as the VertexPaint color, but a given preset has the same size (or size range) in *every* context. Other context-independent settings are Strength and Mirror options (set via the [Painter Options dialog](#) on page 1989).

Procedures

To use the Brush Presets toolbar:

- 1 Access any of the brush tools listed above.
The tool starts with a default brush.
- 2 Right-click an empty area on a toolbar, such as the main toolbar below the Named Selection Sets drop-down list, and choose Brush Presets.

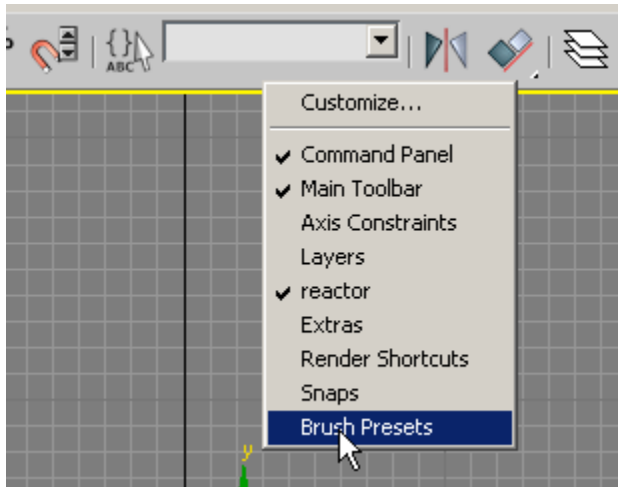

This opens the Brush Presets toolbar.

3 Do either of the following:

- Click any of the presets to use it instead of the default brush.

-  Change brush settings and click Add New Preset to add a new button with the current settings.

4 Paint with the brush.

5 If you change brush settings with a preset brush active, the preset will remember the changes between sessions. Common setting changes such as Size will apply to use of the brush with any tool.

- 6  To change a preset's name, copy it, delete it from the toolbar, or save or load all brush presets, click [Brush Preset Manager](#) on page 7511.

Interface

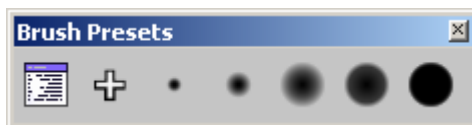

The Brush Preset toolbar controls are available only when a brush tool such as [Paint Deformation](#) on page 2210 is active.



Brush Preset Manager Opens the [Brush Preset Manager](#) on page 7511 dialog, which lets you add, duplicate, rename, delete, save, and load brush presets.



Add New Preset Adds a new preset with the current brush settings to the toolbar, first prompting you for a name for the brush. If you attempt to exceed the maximum number of brush presets (50), a dialog alerts you.

[brush presets] Each preset is available on a button with a grayscale bitmap showing its shape and relative size. Click a preset to activate it and use its settings. Each preset contains all settings pertinent to the current tool, such as Mode for Paint Deformation brushes. You can see a preset name by hovering the mouse cursor over it; the tooltip that appears shows its name.

To deactivate a preset, click its preset again on the toolbar. Its settings remain active, but changing the settings no longer modify the preset.

By default, the toolbar contains five brush presets, but you can add up to a total of 50. To activate and use a preset, click its button on the toolbar. The program remembers any changes you make to the brush settings while a preset is active and automatically restores these at the start of the following session.

The button image updates automatically to reflect changes to the size (by default, up to 40.0) and the falloff, which is depicted as a gradient on the button image. Set the falloff with the [Painter Options dialog](#) on page 1989.

NOTE Changing a value for a setting the preset has in common with other contexts, such as Size, changes it for all contexts. For example, if you set a preset brush's size to 11.6, the brush will be that size when used with any other tool.

Brush Preset Manager

[Brush Presets toolbar](#) on page 7509 > Activate a brush tool. > Brush Preset Manager

The Brush Preset Manager lists all brush presets, showing the context-specific settings and lets you change contexts. It also lets you rename, add, copy, and delete presets, and set the range for the depiction of brush sizes on the toolbar. Lastly, it lets you save and load custom collections of brush presets using the BPR file format.

The Brush Presets feature recognizes four contexts:

- [VertexPaint modifier](#) on page 1959
- [Paint Deformation](#) on page 2210 (Edit/Editable Poly)
- [Paint Soft Selection](#) on page 2015 (Edit/Editable Poly)
- [Skin modifier](#) on page 1672

Procedures

To use the Brush Preset Manager:

- 1 Access any of the brush tools listed above.
The tool starts with a default brush.
- 2 Right-click an empty area on a toolbar, such as the main toolbar below the Named Selection Sets drop-down list, and choose Brush Presets.

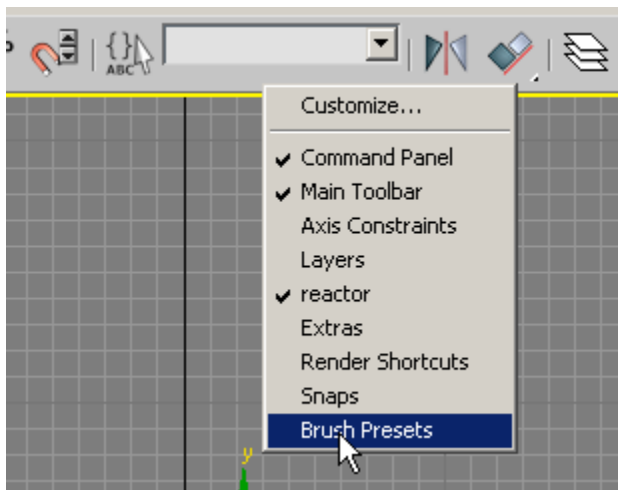

This opens the Brush Presets toolbar.

- 3  On the toolbar, click Brush Preset Manager.

Interface

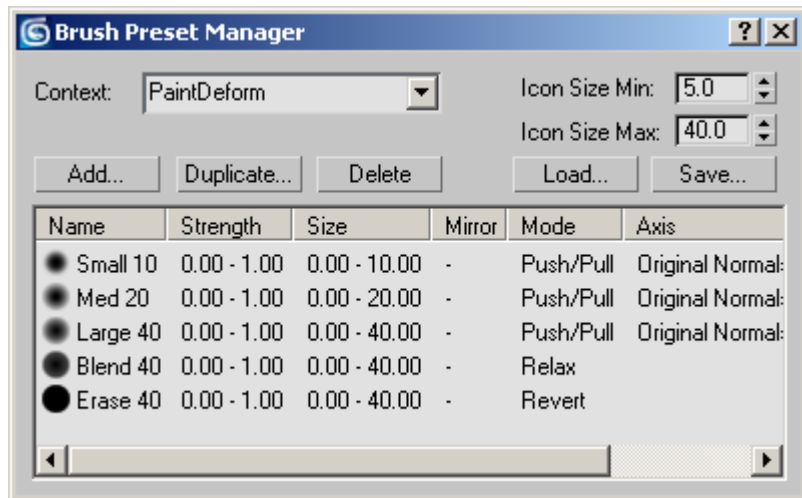

Context Choose the context for the settings in the list window. The Brush Presets feature recognizes four contexts and shows the current context as active:

- [VertexPaint \(modifier\)](#) on page 1959
- [PaintDeform \(Paint Deformation; Edit/Editable Poly\)](#) on page 2210
- [PaintSoftSel \(Paint Soft Selection; Edit/Editable Poly\)](#) on page 2015
- [Paint Skin Weights \(Skin modifier\)](#) on page 1672

Icon Size Min/Max Sets the range of the brush size depicted on the toolbar. Changing the actual brush size between the minimum and maximum settings changes the image of the brush as depicted on its button to show its size relative to the other presets. Changes to the brush size outside these limits are not reflected on the toolbar buttons.

Add Adds a new preset to the list, using the current brush settings. When you click Add, you're prompted to enter a name for the new preset. Edit the name and then click OK to create the new preset. The new preset appears highlighted at the end of the list and the toolbar.

NOTE If 50 presets already exist, you won't be able to add any new ones.

Duplicate Adds a copy of the highlighted preset to the list. When you click Duplicate, you're prompted to enter a name for the new preset. Edit the name

and then click OK to create the new, duplicate preset. The preset appears highlighted at the end of the list and the toolbar.

NOTE If 50 presets already exist, you won't be able to add any new ones via duplication.

Delete Deletes the brush preset highlighted in the list from both the list and the toolbar.

Load Lets you load a saved Preset (BPR) file. Click Load to open the Load Brush Preset File dialog, click a BPR file to load, and then click Open. The loaded Preset file replaces the current presets.

Save Lets you save a custom Preset (BPR) file, containing all current brush presets. Click Save to open the Save Brush Preset File dialog, specify a BPR file to save, and then click Save. You can then load the Preset file into 3ds Max at any time.

[presets list] Shows all presets in a scrollable list. Each list entry shows a small version of the button image, the preset name, ranges for Strength and Size, Mirror and Mode settings, and other settings depending on the context.

To rename a button preset, double-click its name and then edit or enter a new one. Other settings are available from the applicable rollout and the [Painter Options dialog](#) on page 1989. For example, you can set the brush strength and size on the applicable rollout, but to set the range, which is used by a pressure-sensitive input device such as a pen and tablet, you must use the Painter Options dialog. Mirror options are also available only from this dialog.

The list shows the following general and contextual information:

- General (all contexts):
 - **Strength** (with range)

 - **Size** (with range)

 - **Mirror** on/off (with axis and offset, if on)

 - **Falloff** values (set via the Painter Options graph, displayed as a gradient in the button image)

- [VertexPaint](#) on page 1959
 - **Mode** (brush state: Paint, Erase, Blur Brush)

 - **Color**

- **Opacity**
- **BlurStrength** (if Mode=Blur Brush)

- **PaintDeform** on page 2210
 - **Mode** (brush state: Push/Pull, Relax, Revert)
 - **Axis** (if brush is Push/Pull)
 - **Push/Pull Value** (if brush is Push/Pull)

- **PaintSoftSel** on page 2015
 - **Mode** (brush state: Paint, Blur, Revert)
 - **Selection Value**

- **Paint Skin Weights (Skin modifier)** on page 1672
 - **Mode** (Paint, Blend [Paint Blend Weights=on])

Right-Click Menu for Scripted Toolbar Buttons

Any toolbar > Right-click a button that is implemented by a script. > Pop-up button menu

When you right-click a toolbar button that is implemented by a macro script, a pop-up menu appears.

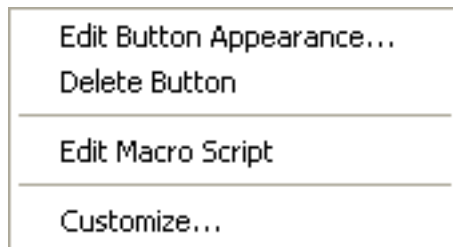

Edit Button Appearance Displays the Edit Macro Button dialog, which lets you change the button's appearance and its tooltip. This is documented in the *MAXScript Reference: see Customizing MacroScript Buttons*.

Delete Button Deletes the button from the toolbar.

NOTE There is no Undo for Delete Button, although Customize > Revert To Startup Layout will restore the toolbar to its original appearance.

Edit Macro Script Opens a MAXScript Editor window, which lets you edit the button's script.

Customize Opens the [Toolbars panel](#) on page 7700 of the Customize User Interface dialog, which lets you customize the contents of the current toolbar (or any other toolbar).

Quad Menu

When you click the right mouse button anywhere in an active viewport, except on the viewport label (see [Viewport Right-Click Menu](#) on page 7576), a *quad menu* is displayed at the location of the mouse cursor. The quad menu can display up to four quadrant areas with various commands. These commands can be customized on the [Quads panel](#) on page 7704 of the [Customize User Interface dialog](#) on page 7697.

The quad menu allows you to find and activate most commands without having to travel back and forth between the viewport and rollouts on the command panel.

The two right quadrants of the default quad menu display generic commands, which are shared between all objects. The two left quadrants contain context-specific commands, such as mesh tools and light commands. Each of these menus provides convenient access to functions found in the command panel. You can also repeat your last quad menu command by clicking the title of the quadrant.

The quad menu contents depend on what is selected, as well as any customization options you may have selected in the Quads panel of the Customize UI dialog. The menus are set up to display only the commands that are available for the current selection; therefore, selecting different types of objects displays different commands in the quadrants. Consequently, if no object is selected, all of the object-specific commands will be hidden. If all of the commands for one quadrant are hidden, the quadrant will not be displayed.

Cascading menus display submenus in the same manner as a right-click menu. The menu item that contains submenus is highlighted when expanded. The submenus are highlighted when you move the mouse cursor over them.

Some of the selections in the quad menu have a small icon next to them in the quad menu. Clicking this icon opens a dialog where you can set parameters for the command.

To close the menu, right-click anywhere on the screen or move the mouse cursor away from the menu and click the left mouse button. To reselect the last selected command, click in the title of the quadrant of the last menu item. The last menu item selected is highlighted when the quadrant is displayed.

Additional, specialized quad menus become available when you are working in [ActiveShade](#) on page 6102, the [Edit UVWs dialog](#) on page 1859, or when you press any combination of Shift, Ctrl, or Alt while right-clicking in any standard viewport. For more information, see [Additional Quad Menus](#) on page 7520.

Interface

The following are the default commands for the right-click menu. You can add, edit, or remove any of these commands in the [Quads panel](#) on page 7704 of the Customize User Interface dialog.

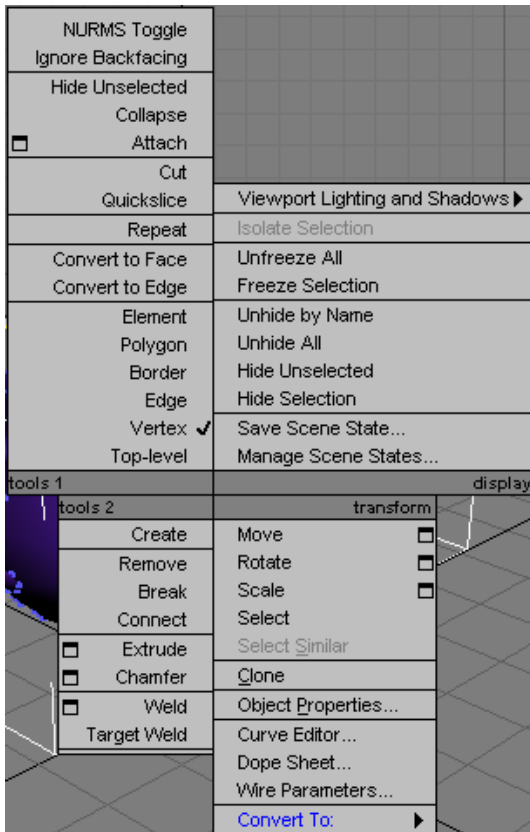

Default quad menu for an editable poly object at the Vertex sub-object level

Transform quadrant

These options are available from the Transform quadrant:

Move Lets you move objects. This is the same as clicking [Select And Move](#) on page 959 on the main toolbar.

You can open the [Transform Type-In](#) on page 944 by clicking the icon to the right of Move on this menu.

Rotate Lets you rotate objects. This is the same as clicking [Select And Rotate](#) on page 960 on the main toolbar.

You can open the [Transform Type-In](#) on page 944 by clicking the icon to the right of Rotate on this menu.

Scale Lets you scale objects. This is the same as clicking [Select And Scale](#) on page 963 on the main toolbar. If one of the other [Select And Scale flyout](#) on page 962 buttons is active on the maintoolbar, that tool becomes active when you click Scale on the quad menu.

You can open the [Transform Type-In](#) on page 944 by clicking the icon to the right of Scale on this menu.

Select Lets you select objects.

Select Similar Automatically selects objects similar to the current selection. See [Select Similar](#) on page 250

Clone Lets you clone objects. This is the same as choosing [Clone](#) on page 1034 from the Edit menu.

Object Properties Opens the [Object Properties dialog](#) on page 305 for a selected object. This command is available only if an object is selected when you open the quad menu.

Curve Editor Opens and displays the selected object at the top of the Track View Hierarchy. This command is visible only if an object is selected when you open the quad menu.

Dope Sheet Opens and displays the [Dope Sheet](#) on page 3519.

Wire Parameters Starts a [wire parameter](#) on page 3322 from the selected object. This command is available only if an object is selected when you open the quad menu.

Convert To This submenu lets you convert the selected object to an [editable mesh](#) on page 2075, an [editable patch](#) on page 2019, an [editable spline](#) on page 659, a [NURBS surface](#) on page 2275, or an [editable poly](#) on page 2123. This command is available only if an object is selected when you open the quad menu.

Display quadrant

These options are available from the Display quadrant:

Viewport Lighting and Shadows This submenu provides commands for displaying shadows and accurate lighting in viewports. See [Previewing Shadows in Viewports](#) on page 4991.

Isolate Selection The [Isolate Selection tool](#) on page 219 lets you edit your selection while hiding the rest of the scene.

TIP You can use this iteratively to delve into a large selection set.

Isolate Selection's Layer Isolates the layer of the selected object.

Unfreeze All Unfreezes all frozen objects.

Freeze Selection Freezes the selected objects. Frozen objects are visible in the viewports, but cannot be manipulated.

Freeze Selection's Layer Freezes the layer of the selected object.

Unhide by Name Displays a version of the [Select From Scene dialog](#) on page 228 you can use to choose objects from a list to unhide.

NOTE You cannot unhide an object on a hidden layer. If you select an object on a hidden layer, a dialog will prompt you to unhide the layer first.

Unhide All Unhides all hidden objects.

Hide Unselected Hides all visible objects that are not selected. Hidden objects still exist in the scene, but do not appear in the viewports or in rendered images.

Hide Selection Hides the selected objects.

Hide Selection's Layer Hides the layer of the selected object.

Save Scene State Opens the Save Scene State dialog where you enter a name for the current scene and select the options you want saved with the scene.

Manage Scene States Opens the Manage Scene States dialog. This is a modeless dialog where you can select, save, restore, rename, and delete scene states. See [Manage Scene States Dialog](#) on page 7402.

Tools quadrants

The two quadrants on the left side of the default quad menu are called Tools 1 and Tools 2. These quadrants contain commands specific to various geometries and modifiers such as: lights, editable geometries, and cameras. These quadrants appear only if one of the corresponding geometries or modifiers is selected when you open the quad menu.

Additional Quad Menus

Several specialized quad menus are available when you are working in certain modes, such as [ActiveShade](#) on page 6102, [Edit UVWs](#) on page 1859, [Track View](#) on page 3503, or when you press any combination of Shift, Ctrl, or Alt while right-clicking any standard viewport.

The ActiveShade quad menu provides many useful commands such as Render, Draw Region, Update, as well as access to the [Material Editor](#) on page 5284. Similarly, the Unwrap UVW quad menu contains many common UVW commands.

You can create or edit any of these menus from the quad set list in the [Quads panel](#) on page 7704, on the Customize User Interface dialog; however, they cannot be deleted.

These are the additional quad menus and their default settings:

Biped Appears when you right-click any selected [biped](#) on page 4147 part. The two left-hand quadrants, Tools 1 and Tools 2, provide quick access to many commonly used biped tools, including Track Selection rollout commands and Layers rollout commands.

ActiveShade Appears when you right-click an [ActiveShade viewport or window](#) on page 6102. This menu provides quick access to many of the commonly used actions in ActiveShade, including Draw Region, Initialize, and Update, as well as access to the Material Editor.

Unwrap UVW Appears when you right-click an Edit UVWs dialog. This menu provides quick access to many of the commonly used UVW actions.

Track View Key Appears when you right-click any Track View dialog. This menu provides quick access to common key actions, such as Move, Add, Scale, and Reduce Keys.

Shift+right-click Provides access to snap options and settings. See [Grid and Snap Settings dialog](#) on page 2662.

Alt+right-click Provides several animation tools, letting you set the coordinate system, set and assume skin poses, and set key frames.

Ctrl+right-click Provides several modeling tools that let you create and edit many geometries, including standard primitives and editable geometries.

Shift+Alt+right-click Contains many reactor commands. For more information, see [reactor](#) on page 3881.

Shift+Ctrl+right-click Available for assignment. Use the Quads panel to customize it.

Ctrl+Alt+right-click Provides several lighting and rendering commands. The default actions let you render your scene, access render effects and environmental effects, and toggle object properties for the current selection.

Shift+Ctrl+Alt+right-click Available for assignment. Use the Customize menu > Customize User Interface > Quads panel to customize this menu.

There is also a [Track View quad menu](#) on page 3569 that appears only while you are using Track View.

Animation Quad Menu

Alt+right-click a viewport. > Animation quad menu

The Alt+right-click quad menu has commands to assist in animation.

See also:

- [Additional Keyboard Commands](#) on page 7465

Interface

Freeze Transform Freeze Rotation	World View Screen
Transform To Zero Rotation To Zero	Parent Local
transform	coordinates
pose	set
Set Pref Angles Assume Pref Angles	Keyframe Show Trajectories Toggle
Set as Skin Pose Assume Skin Pose	Reaction Manager Delete Selected Animation

Coordinates quadrant

Lets you change the active [reference coordinate system](#) on page 967.

Set quadrant

Keyframe Sets a key at the current frame. Set Key or Auto Key do not need to be on.

Show Trajectories Toggle Toggles the display of [trajectories](#) on page 3121.

Reaction Manager Opens the [Reaction Manager dialog](#) on page 3228.

Delete Selected Animation Deletes any existing animation keys for all selected objects, as well as any sub-object animation. Each object remains in its state at the frame in which you use this command.

Pose quadrant

Set Pref Angles For a hierarchy with history-independent (HI) IK applied to it, sets the preferred angle for each bone in the chain.

Assume Pref Angles For a hierarchy with history-independent (HI) IK applied to it, copies the X, Y, and Z preferred angle channels of each bone and places them into its FK rotation subcontroller.

Set as Skin Pose Stores the selected objects' current position, rotation, and scale as the skin pose. See [Skin Pose Commands](#) on page 304.

Assume Skin Pose Causes the selected objects to take on the stored skin pose. See [Skin Pose Commands](#) on page 304.

Transform quadrant

Commands in this quadrant are meant primarily as aids to character animation. Use the Freeze commands to set the character's initial pose. Then you can later use the “to Zero” options to return to that initial pose.

Freeze Transform Sets the object's transform values to zero without actually moving the object.

Freeze Rotation Sets the object's rotation value to zero without actually moving the object.

Transform to Zero Transforms the object back to the zero pose established by Freeze Transform.

Transform To Zero works only if you have previously invoked Freeze Transform or Freeze Rotation.

NOTE There is also a Position To Zero command, which returns the object to the zero position only (no rotation). You can use Position To Zero by creating a keyboard shortcut for it. See [Additional Keyboard Commands](#) on page 7465.

Rotation to Zero Transforms the object back to the zero rotation established by Freeze Rotation.

Rotation To Zero works only if you have previously invoked Freeze Transform or Freeze Rotation.

Status Bar Controls

The 3ds Max window contains an area at the bottom for prompt and status information about your scene and the active command. There is a coordinate display area in which you can type transform values, and on the left, a two-line interface to the MAXScript Listener.

See also

[Animation and Time Controls](#) on page 7548

[Viewport Navigation](#) on page 7585

Time Slider and Track Bar

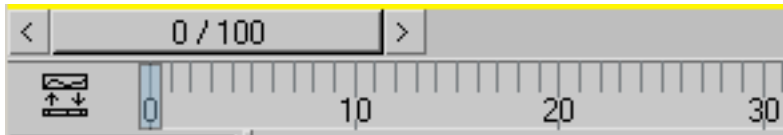

[Time Slider](#) on page 7528



Show Curves Click to display a version of the [Track View Curve Editor](#) on page 3518 in place of the time slider and track bar.

When curves are displayed, you can click the Close button at upper left to return to a view of the time slider and track bar.

[Track Bar](#) on page 7531

Status Bar

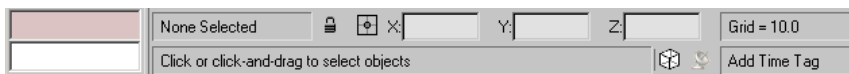

[MAXScript Mini Listener](#) on page 7525

[Status Line](#) on page 7528



Selection Lock Toggle on page 7539



Relative/Absolute Transform Type-In on page 944

[Coordinate Display](#) on page 7541

[Grid Setting Display](#) on page 7543

[Prompt Line](#) on page 7525

[Time Tag](#) on page 7544

Prompt Line

Status bar > Prompt line

The prompt line, located at the bottom of the window under the status line, provides ongoing feedback, based on the current cursor position and the current program activity. When you don't know what to do next, look down here for instructions.



Click and drag to begin creation process

Depending on what you are doing, the prompt line displays instructions that tell you what the program expects or what you can do next. For example, when you click the Move button, the prompt line reads "Click and drag to select and move objects."

Tooltips are also displayed on the prompt line as your cursor passes over icons in any toolbar and the status bar.

MAXScript Mini Listener

Click the tag bar, to the left of the status and prompt lines, and drag it to the right to display the MAXScript Mini Listener.

The MAXScript Mini Listener is a single-line view of the contents of the [MAXScript Listener window](#) on page 7677.

The MAXScript Listener window is divided into two panes: one pink, and one white. The pink pane is the MacroRecorder pane. When the MacroRecorder is enabled, everything that is recorded is displayed in the pink pane. The pink line in the Mini Listener shows the latest entry into the MacroRecorder pane.

The white pane is the Scripter window where you can create scripts. The last line you type in the white area of the Listener will appear in the white area of the Mini Listener. Use the arrow keys to scroll the display in the Mini Listener.

You can type directly into the white area of the Mini Listener, and the command executes in the viewports.

Right-click either of the Mini Listener lines to open the floating MAXScript Listener window. It will also display a list of the last 20 commands recorded. You can choose any of these commands and press Enter to execute them.

For more information about the MAXScript Listener window, as well as about creating scripts, see the MAXScript Reference: choose Help > MAXScript Reference.

Procedures

Example: To create a sphere using the Mini Listener:

- 1 Click the tag bar at the left end of the status bar, and drag it to the right to expand the Mini Listener.
- 2 In the Scripiter (white, lower) line, type **sphere radius: 50** and press Enter. A sphere appears in the viewports.

Example: To redo a command using the Mini Listener:

- 1 Click the tag bar at the left side of the status bar, and drag it to the right to expand the Mini Listener.
- 2 Right-click the Mini Listener and choose Open Listener Window.
- 3 From the MacroRecorder menu, choose Enable.
- 4 Using the command panel, create a sphere in the perspective viewport.
- 5 Convert the sphere to an Editable Mesh.
- 6 Delete the sphere.
- 7 Make a box.
- 8 Right-click the MacroRecorder (pink, upper) line and choose *macros.run "Modifier Stack" "Convert_to_Mesh"* from the list. The box has been collapsed to an editable mesh.

Example: To make a script and add it to a toolbar:

For this very simple example, you'll make a script that collapses an object to an editable mesh, and then create a toolbar icon to run the script.

- 1 Right-click the Mini Listener, and choose Open Listener Window.

- 2 From the MacroRecorder menu, choose Enable. Close the listener window.
- 3 Create a box in the Perspective viewport.
- 4 Right-click the box and choose Convert to: > Editable Mesh from the quad menu.
- 5 Left-click in the MacroRecorder line.
The MacroRecorder line goes blank because the cursor goes to the last line.
- 6 Press the upper-arrow key on the keyboard to move up the list of recorded command scripts.
- 7 Click and highlight the *macros.run "Modifier Stack" "Convert_to_Mesh"* line.
Highlight the command script as you would highlight a line of text in a text editor by clicking at the start of the line and dragging along the entire length.
- 8 Click and drag the highlighted script from the Mini Listener to a toolbar.

Interface



MacroRecorder Line The pink, upper line displays the last thing recorded by the MacroRecorder. If the MacroRecorder is not enabled, nothing will appear in this line.

Scripter Line The white, lower line displays the last entry typed into the Scripter window. You can type directly into this line and execute the commands in the viewports

History List Right-clicking either of the Mini Listener lines displays a history of the last twenty commands recorded by the Macro Recorder (provided it has been enabled). Click any of these commands to execute them in the viewports.

Open Listener Window Right-clicking either of the Mini Listener lines displays a dialog that allows you to open the MAXScript Listener window. You can also open the Listener using the Utilities panel > MAXScript rollout. You can display the Listener window in a viewport by right-clicking the viewport label, then choosing Views > Extended > MAXScript Listener.

Status Line

Status bar > Status line

The status line displays the number and type of object or objects selected. The status line is located at the bottom of the screen, just above the [prompt line](#) on page 7525.

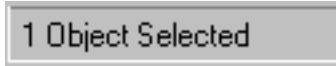

If multiple objects are selected and all are of the same type, the number and type of the objects are displayed: "2 cameras, 3 lights" for example. If multiple objects of different types are selected, the status line displays the number plus the word "objects": "6 objects" for example.

Time Slider

Status line > Time Slider

The time slider shows the current frame and lets you move to any frame in the [active time segment](#) on page 7898. Right-clicking the slider bar opens the [Create Key dialog](#) on page 3093, which lets you create position, rotation, or scale keys without using the Auto Key button.



When you are in [Auto Key](#) on page 7549 mode, you can right-click and drag the time slider to create a key that has the source at the initial time slider position, and the destination at the subsequent time slider position.

In [Set Key mode](#) on page 7552, holding down the right mouse button and dragging the time slider allows you to move a pose in time without losing it in the viewport.

To move one frame back or forward, click the arrow on the left or right side of the time slider, respectively. Or simply place your cursor anywhere on the time line, click and the time slider will jump to your cursor position. In [Key Mode](#) on page 7564, clicking an arrow jumps to the adjacent key.

The Track View Key window displays a time slider as well. The movement of the two time slider is synchronized. Moving the time slider in the Track View window also moves the time slider below the viewports, and vice-versa.

Procedures

To move to a specific frame in the animation, do one of the following:

- 1 Drag (scrub) the time slider right or left until the frame number is displayed on the time slider.

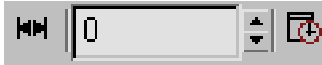

- 2 Type the frame number into the current frame field in the time controls, and then press Enter.

To move ahead or back a frame or a key at a time, do one of the following:

By default, [Key Mode](#) on page 7564 is off, and these controls move a frame at a time. To move by keys, click the Key Mode Toggle button; this turns on Key Mode. When Key Mode is on, the button looks like this:



- 1 Click the < or > button at either end of the time slider.
- 2 Press the < or > key on the keyboard.

- 3  When Key Mode is off, click the Next Frame or Previous Frame button in the time controls.

- 4  When Key Mode is on, click the Next Key or Previous Key button in the time controls.

To move ahead or back many frames at a time:

- Click in the empty track to either side of the time slider. The time slider will jump to your cursor position. This is a faster way of moving in time than dragging the time slider.

To move to the first or last frame of the active time segment:

-  Use the time control buttons Go To Start or Go To End.

To display SMPTE time code on the time slider:

-  Click Time Configuration in the time controls, and then under Time Display, choose SMPTE.

To display subframes on the time slider:

-  Click Time Configuration in the time controls, and then under Time Display choose Frames:TICKS or MM:SS:TICKS. Each frame is divided into subframes.

To use the time slider to adjust animation, do one of the following:

- 1 To copy a pose from one frame to another, with Auto Key on or off, and Set Key off, right-click the time slider and drag to a new location.
The Create Key dialog appears with Source Time set to the frame you were on when you right-clicked, and Destination Time set to the frame to which you moved the time slider. Toggle the Position, Rotation, and Scale check boxes as necessary and then click OK to create a key at the destination frame for the pose at the source frame.
- 2 In Set Key mode, if you have posed your character on the wrong frame, right-click and drag the time slider. The pose is moved in time to the new time slider position. Click the Set Key button to set the keys.

To scrub the animation with the mouse but without dragging:

- 1 Go to Customize > Customize User Interface. On the Keyboard panel, click in the Action list and then press T to jump to the T section. Scroll down to find Time Slider Capture Toggle and click it.
- 2 Click the Hotkey field and then press a keyboard combination to assign as a keyboard shortcut; for instance, Ctrl+T. Click the Assign button.
- 3 Close the Customize User Interface dialog and then press your hotkey for Time Slider Capture Toggle.
- 4 Move the mouse left and right without pressing any buttons.
The time slider moves in tandem with the mouse.
- 5 To exit this mode, press the hotkey again or click any mouse button.

Interface

By default, the active time segment is from frame 0 to frame 100. The slider displays time in frames, [SMPTE numbers](#) on page 8131, or other measurements, depending on the current setting in the [Time Configuration dialog](#) on page 7565.

The slider bar displays the current frame, followed by a slash (/), followed by the total frames in the active time segment. For example 25/100 means frame 25 of 100 frames. The current frame also appears in the current frame field. If [animation](#) on page 7907 exists in the scene, it's played back as you drag the time slider.

The buttons on either side of the time slider bar move one frame to the left and one frame to the right, like the Previous Frame and Next Frame buttons in the time controls. If [Key Mode](#) on page 7564 is on, these buttons duplicate the Previous Key and Next Key buttons.

Key Mode can jump to all the keys or only the transform keys, depending on the Key steps setting in the Time Configuration dialog.

TIP Right-click the slider bar to open the Create Key dialog. This lets you create Position, Rotation, or Scale keys without using the Auto Key button. It also lets you copy keys easily from one frame to another.

Track Bar

The track bar is located below the viewports, between the time slider and the status bar.

The track bar provides a timeline showing the frame numbers (or appropriate display units). It provides a quick alternative to Track View for moving, copying, and deleting keys, and changing key properties. Select an object to view its animation keys on the track bar. The track bar also displays keys for multiple selected objects.

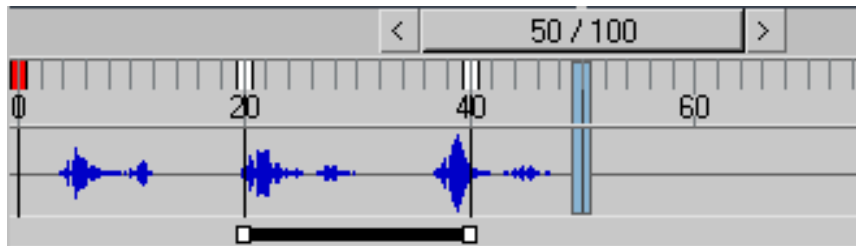

The displayed keys use color coding, so you can easily determine what kind of key exists at that frame. Position, rotation and scale keys are red, green, and blue, respectively, and non-transformational keys such as modifier parameters are gray. You can customize the colors in the [Customize User Interface dialog](#) on page 7697, and depends on the selected/unselected state of the key. The frame indicator is a similar bar displayed in blue.

A key on the track bar can represent any number of animated parameters for the selected objects. Transformations, modifiers, and animated material parameters can all have keys at a particular frame.

To display a list of all keyed values for a key on the track bar, right-click the key. Choose a key type from the right-click menu to display its key properties dialog. Delete keys and filter the track bar display using options on the right-click menu.

The track bar right-click menu contains a submenu that lists any procedural controllers (list controllers, expression, reactors, springs, noise, and so on) assigned to the current object selection. If you select one of the controllers from the submenu, the properties dialog for that controller displays in a modeless dialog.

The track bar can display a waveform (.wav file) that has already been assigned to the sound object in Track View. To display this feature, right-click the track bar and choose **Configure > Show Sound Track**. If no waveform is currently assigned to the sound object or if you are using a third-party sound object plug-in that is not compatible with the waveform display, this part of the track bar is unavailable.

You can modify the [active time segment](#) on page 7898 by pressing Ctrl and Alt while dragging the track bar. Hold the left mouse button to slide the start of the range, the right mouse button to slide the end of the range, and the middle mouse button to change both the start and end frames together. A tooltip at the cursor and a status bar message will indicate the range you are setting.

NOTE While the Auto Key button is depressed, the time slider background is highlighted red, to indicate that 3ds Max is in automatic keyframing mode.



You can expand the track bar to show curves. Click the Open Mini-Curve Editor button at the left end of the track bar. The time slider and track bar are replaced with the controller and key windows, and Track View toolbars. You can resize the track bar window by dragging the border between the menu bar and the toolbars (do this in an empty toolbar area).

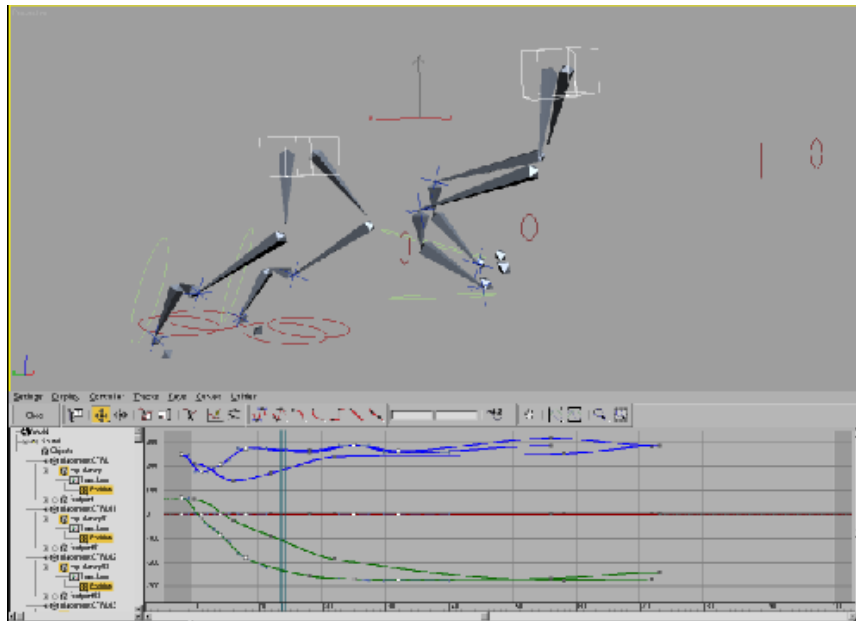

Track bar displaying curves

Procedures

To select keys on the track bar:

- 1 Click a key to select it.
- 2 Drag a window around a selection of keys to region-select multiple keys. If the track bar right-click menu > Configure > Show Selection Range option is on, when you select multiple keys, the range of the selected keys is shown in the selection range bar at the bottom of the track bar. You can then scale the selected keys proportionally by dragging either end of the selection range bar, or move the keys by dragging the center of the bar.

To move or clone keys on the track bar:

While keys are moved or cloned, small lines on the track bar mark the original position of the keys. All keys at a particular frame are moved simultaneously using the following procedures.

- 1 Drag a key selection to move it in time.

- 2 Hold down Shift, then drag a key(s) to clone keys.
- 3 Right-click to abort a move or clone operation.

To move a single key from a frame with multiple keys:

If, for example, a frame has both a transform key and a material key for the selected object, and only the transform key must move, display the Transform Properties dialog and use the Time parameter to move the transform key.

- 1 Right-click a key on the track bar and choose a key on the pop-up window key list.
A Key Properties dialog is displayed.
- 2 Change the Time parameter in the Key Properties dialog.
The key slides along the track bar to a new location.

To delete keys on the track bar:

- 1 Make a key selection on the track bar and press Delete.
All selected keys are deleted.
- 2 Make a key selection on the track bar, right-click anywhere on the track bar to display the track bar menu, and then choose Delete Selected Keys on the pop-up window.
All selected keys are deleted.

To delete a single key type on a frame with multiple keys:

An object can have many keys for different animated parameters at a particular frame. Use this procedure to delete a key for a single parameter.

- 1 Right-click over a selected or unselected key on the track bar.
A pop-up window displays.
- 2 Move the mouse over Delete Key, then choose a key to delete in the submenu.

To change the length of the active time segment:

You can change the animation length using track bar.

- Hold Ctrl+Alt and drag on the track bar:
 - *With the left mouse button* to change the active time segment's start frame.
 - *With the right mouse button* to change the active time segment end frame.
 - *With the center mouse button* to change the active time segment start and end frames simultaneously.

To hide or show the track bar:

- Choose Customize > Show UI > Show Track Bar.
This menu item is a toggle: a check mark shows that the track bar is currently displayed.

To show curves on the track bar:

-  Click the Open Mini Curve Editor button at the left hand side of the track bar.
The track bar keys are replaced with a menu bar, toolbars and the controller and key windows.

Interface

Track Bar

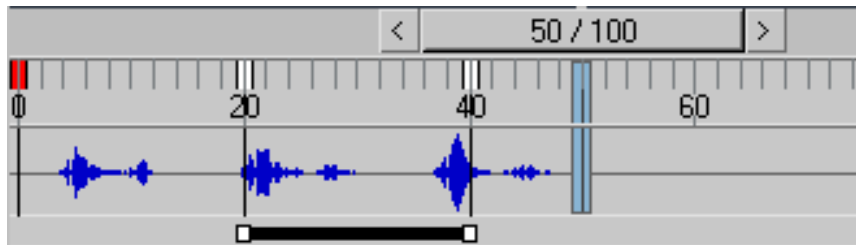

- Make an object selection in the viewports to display the object's keys on the track bar.

- Selected transformation keys are white; unselected keys are other colors.
- Drag from an empty area of the track bar to region-select keys.
- Drag a key to move it in time.
- Hold Shift and drag a key to clone it.
- Hold Ctrl+Alt and drag the track bar to change the active time segment, that is, the animation range displayed on the track bar.
 Dragging with the left mouse button will change the start of the range, dragging with the right mouse button will change the end of the range, and dragging with the middle mouse button will change both the start and the end of the range.
- Right-click to abort a move or clone operation.
- During a move or clone operation, short, vertical, gray lines represent the original key locations.
- The cursor changes to a cross when over unselected keys.
- The cursor changes to a two-sided arrow over selected keys, signifying a move operation is possible.
- Right-click anywhere on the track bar to display the track bar right-click menu. Right-click over a key to access its keyed values from the right-click menu, as well as other track bar-related commands.
-  Click the Open Mini Curve Editor button to expand the track bar. When the track bar is expanded it displays the Track View menu, toolbars, controller and key windows. You can hide or unhide UI Elements such as scroll bars as well when this is expanded.

Track bar menu

Right-click a key on the track bar to display the track bar menu.



List Displays the object name and key type for all keys at the current position. Choose any of the keys in the list at the top of the track bar menu to display a key properties dialog. For more information on this dialog, see [Key Info \(Basic\)](#) on page 3127 and [Key Info \(Advanced\)](#) on page 3131.

- A key with a check next to the name indicates the key is shared with other instances in the list. Two selected objects might share the same Twist modifier, for example.
- The list displays keys for all selected objects. If there are more than 10 keys, then the list turns to a submenu under Key Properties in the track bar menu.
- If there is no key properties dialog for a key type, the key is unavailable.

Controller Properties Displays a submenu that contains a list of all of the procedural controllers (list controllers, expression controllers, reactors, springs, noise, and so on) assigned to the object selection.

Delete Key Displays a submenu identical to the key properties list at the top of the track bar menu. Choose a key type or choose All to delete one or all of the keys.

All Deletes all keys at the current position.

Keys do *not* need to be selected on the track bar in order to use Delete Key. Keys are deleted from the track bar key over which you right-clicked.

Delete selected keys Deletes the keys selected on the track bar. If no keys are selected, this option is unavailable.

Filter

Filter Displays a Filter submenu. Choose a filter to filter the track bar display; showing only transformation keys, for example.

Right-click anywhere on the track bar, place the cursor over Filter in the track bar menu to display the Filter submenu, then choose filter settings. The settings determine which keys appear on the track bar.

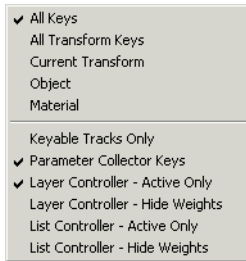

The upper section of the Filter submenu lets you choose one of the following:

- **All Keys** Displays all keys.
- **All Transform Keys** Displays only keys for position, rotation and scale.
- **Current Transform** Displays only keys that use the currently selected transform: position, rotation or scale.
- **Object** Displays object modifier keys. Excludes transformation and material keys.
- **Material** Displays material keys for the material assigned to the selected objects.

The lower section of the Filter submenu lets you toggle each of the following, for any combination of these filter options:

Keyable Tracks Only Controls the display of keyable tracks on the track bar.

Parameter Collector Keys Filters keys related to the [Parameter Collector](#) on page 347.

List Controller – Active Only This filter lets you see only the keys on the active control in a List Controller. Otherwise, you see all the keys on all the controls.

List Controller – Hide Weights This filter hides the weight parameter keys of a List Controller from the track bar.

Layer Controller – Active Only This filter lets you see only the keys of the active [Layer controller](#) on page 3164. Otherwise, you see all the keys of all Layer controllers.

Layer Controller – Hide Weights This filter hides the weight parameter keys of a [Layer controller](#) on page 3164 from the track bar.

Configure

Configure Displays a submenu that lets you change the track bar display and behavior.

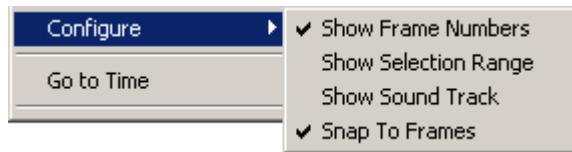

The Configure options are:

- **Show Frame Numbers** Displays frame numbers in the track bar.
- **Show Selection Range** Displays a selection range bar below the track bar, whenever multiple keys are selected.
You can scale all selected keys by dragging either end of the selection range. This lets you change the length of an animation segment while maintaining the relative distance between animation keys. You can also move the selected keys in time by dragging the selection range bar.
- **Show Sound Track** Displays the waveform (.wav file) that is assigned to the sound object in Track View.
- **Snap to Frames** Keys snap to frame numbers when moved. If turned off, you can place keys between frames.

Go to Time Moves the time slider to the cursor position.

Right-click anywhere on the track bar, and then click Go To Time.

Selection Lock Toggle



Status bar > Selection Lock Toggle

Keyboard > **SPACEBAR**

Selection Lock Toggle toggles selection locking on and off. Lock selections so you don't inadvertently select something else in a complex scene.

When your selection is locked, you can drag the mouse anywhere on screen without losing your selection. The cursor displays the current selection icon. When you want to deselect or alter your selection, click Lock Selection again to turn off locked selection mode.

When you want to select something and you can't, it's frequently because you have locked your selection.

This button is off by default.



Click to turn it on (it turns yellow). When Lock Selection is on, you can click anywhere in a viewport and the program interprets it as clicking the selected object(s). This is useful when you want to keep objects selected while you make a different viewport active or when the selection is tiny, or crowded and difficult to select.

Procedures

To transform an object without touching it:

- 1 Use the Selection Floater from the Tools menu, the Select By Name button on the main toolbar or press the H key to select the object by name.
- 2 Click the transform button (move, rotate, or scale) from the main toolbar.



- 3 On the status bar, turn on the Selection Lock toggle or press the Spacebar to lock the selection set.
- 4 Press and drag anywhere in the viewport.
The object transforms even though you are not touching it.

To avoid accidentally canceling a selection:

- 1 Make your object selection.
- 2 Click the Selection Lock toggle on the status line, or press Spacebar to turn on Locked Selection mode.

To exit sub-object selection mode, do one of the following:

- 1 In the Modifier Stack display, choose the object level.

- 2 Open another command panel. This turns off Sub-Object selection.
If you've turned off Sub-Object selection and object selection is still not restored, one of the following may be true:
- 3 Your selection is locked. Turn off the Selection Lock toggle on the status line.
- 4 You've set the Selection Filter in the toolbar to a specific category of object, so you can't select any of the other categories. To fix this, choose All in the Selection Filter list.

Coordinate Display

Status bar > Coordinate Display area

The Coordinate Display area shows the position of the cursor or the status of a transform, and allows entry of new transform values.

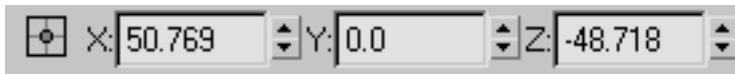

The information in these fields varies, depending on what you are doing:

- When you are simply moving the mouse in a viewport, these fields show the current cursor location in absolute [world coordinates](#) on page 8174.
- While you are creating an object, these fields also show the current cursor location in absolute world coordinates.
- While you are transforming an object by dragging in a viewport, these fields always show coordinates relative to the object's coordinates before the transformation was started.
While you are transforming an object, these fields change to [spinners](#) on page 73, and you can type values directly in them, as described below in “Using the Coordinate Display for Transform Type-In.” This is an easy alternative to using the [Transform Type-In dialog](#) on page 944.
- While a transform button is active and a single object is selected, but you are not dragging the object, these fields show the absolute coordinates for the current transform. See “Interface,” below.
- While a transform button is active and multiple objects are selected, these fields are blank.

- When no object is selected and the cursor is not over the active viewport, these fields are blank.

See also:

- [Units Setup Dialog](#) on page 7809

Procedures

To display the position of the mouse in feet or metric units:

- 1 Choose Customize > Units Setup.
- 2 Turn on one of the main categories (Metric, US Standard, Custom, or Generic Units) and choose from the drop-down list.
The coordinate display is now in labeled units.

Example: To position an object in the center of the world:

- 1 Select an object in the viewport.
- 2 Right-click and choose Move from the quad menu
- 3 Select the value in the x coordinate field, then enter **0**. Press Tab.
- 4 Type **0** in the Y coordinate field, and press Tab.
- 5 Type **0** in the Z coordinate field.

TIP Right-clicking the spinner arrows for a coordinate sets the value to zero.

Interface



When you are transforming an object, you can type coordinates directly in the Coordinate Display fields. You can do this in two modes, Absolute or Offset.

-  Absolute sets the exact coordinates of the object in world space.



- Offset transforms the object relative to its existing coordinates.

Click the Absolute or Offset button to toggle between the modes:

While you are typing in the Coordinate Display fields (X,Y,Z), you can use the Tab key to move from one coordinate field to another.

When you transform an object, the information shown by these fields depends on the type of transform:

- **Move** displays the offset XYZ coordinates based on the current coordinate system. For example, if you're moving an object and you're constrained to the X axis, only the X readout will change, displaying the offset of the move along the local X axis.
- **Rotate** displays the offset angle in degrees about the axis or axes the rotation is performed around. This is dependent on both the axis coordinate system, and the local/center toggle button.
- **Scale** displays the offset XYZ scale in percentages.

You can get the absolute as well as offset information through the [Transform Type-In dialog](#) on page 944 available from the Tools menu or by right-clicking a transform button that has been selected on the toolbar.

Grid Setting Display

Status bar > Grid Setting Display

The grid setting display shows the size of one grid square.

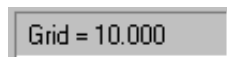

This value is constant in the active viewport. It does not change if you zoom in very close or zoom out very far.

Procedures

To change the size of one grid square:

- 1 Right-click the Snap Toggle on the main toolbar to display the Grid and Snap Settings dialog. Alternately, you can choose Customize menu > Grid and Snap Settings.

- 2 On the Home Grid tab, in the Grid Dimensions group, change the Grid Spacing value.
The new value is displayed in the grid setting display.
- 3 Close the dialog by clicking the X at the upper right corner of the Grid and Snap Setting dialog.

Time Tag

Status bar > Add Time Tag

Time tags are text labels that you can assign to any point in time in your animation.



They let you easily jump to any point in your animation by selecting its tag name. The tags can be locked to be relative to other time tags so that the movement of one time tag will update the time position of another.

The time tags are not attached to keyframes. They are simply a way to name events that occur in your animation and navigate to them. If you move your keyframes, you will need to update your time tags accordingly.

Interface

Left-click or right-click the Time Tag box to display a menu with the following items:

Add Tag Displays the [Add Time Tag dialog](#) on page 7544 that lets you define a tag name for the current location in time.

Edit Tag Displays the [Edit Time Tag dialog](#) on page 7546 that lets you rename, delete, or edit any defined tag.

The remainder of the menu displays frame numbers and their tag names. Choose a tag name to jump to the spot in time defined by the tag.

Add Time Tag Dialog



Status bar > Click in the Time Tag box. > Add Tag

Use the Add Time Tag dialog to define a [time tag](#) on page 7544 for the current spot in time.

Procedures

To use time tags:

- 1 Move to the spot in time where you want to add a tag.
- 2 Click in the Time Tag box, and choose Add Tag from the menu.
- 3 In the Add Time Tag dialog, enter the name of the tag. Choose whether to lock it to time and whether to make it relative to another tag, and click OK.

The name of the tag appears in the tag slot, and will reappear whenever you go to that spot in time.

To jump to a defined tag, click the Time Tag slot and choose the tag name from the list.

To rename, delete, or change the properties of a tag, click the Time Tag field and choose [Edit Tag](#) on page 7546.

Interface

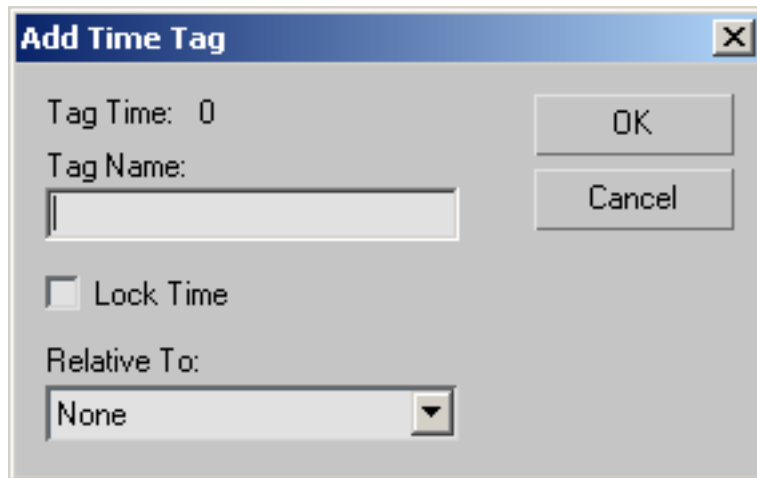

Tag Time Displays the current frame, to which the tag will be assigned.

Tag Name Enter the name of the tag. You can create a long tag name in this field, but the tag slot will display only 15 characters.

Lock Time Locks the tag to the current frame, regardless of subsequent scaling of time.

For example, with Lock Time off, if you have a tag named "Forty" at frame 40, and you scale time up 200 percent, the Forty tag will be at frame 80. If Lock Time is on, the Forty tag remains at frame 40.

Relative To Lets you assign another tag to which the current tag will maintain a relative offset.

For example, if you have a tag at frame 10 called First and you create a second tag at frame 30 called Second, if you move the position of First to frame 25, Second will move to frame 45 to maintain the 20-frame offset between the two tags.

This is a one-way offset. If you change the time position of the second tag in the example, the first tag is not affected. Circular dependencies are not allowed: you can't have First relative to Second and Second relative to First.

Edit Time Tag Dialog



Status bar > Click in the Time Tag box > Edit Tag

Use the Edit Time Tag dialog to alter the properties of any of the defined [time tags](#) on page 7544.

Procedures

To edit a time tag:

- 1 Click in the Time Tag box and choose Edit Tag from the menu.
- 2 Choose the time tag you want to edit from the list.
- 3 Use controls in the Edit Time Tag dialog to rename it, or move it in time relative to another time tag.

Interface

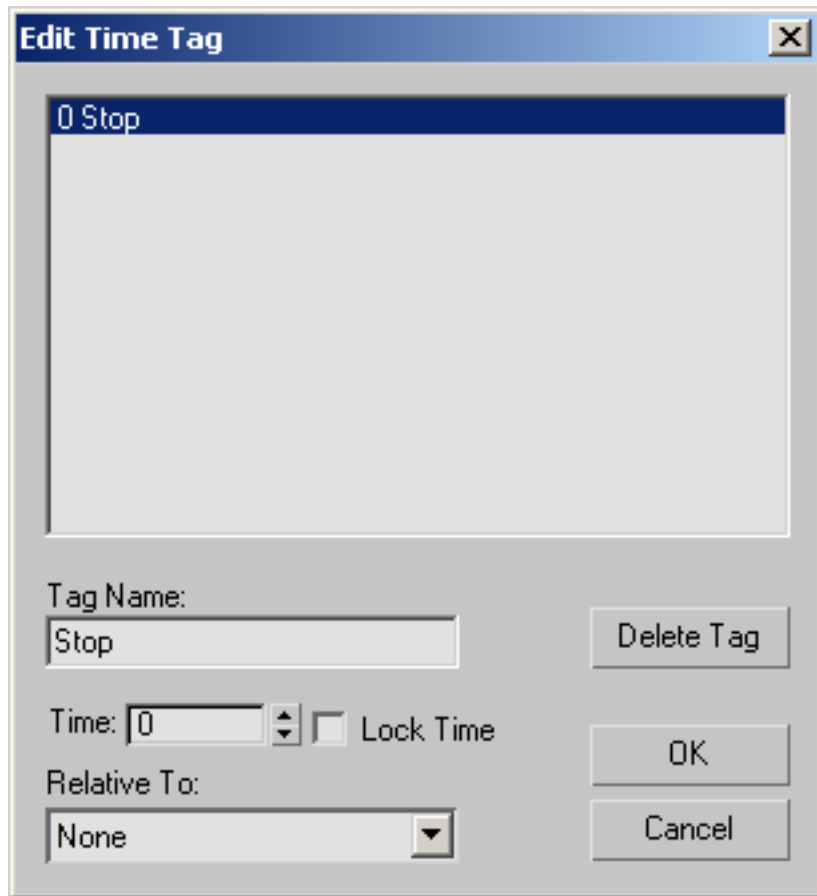

All of the current tags, along with their associated frame numbers, appear in the window at the top of the Edit Time dialog. Select the tag to edit, then adjust the controls below the window.

Tag Name Use this field to rename the selected tag. You can create a long tag name in this field, but the tag slot will display only 15 characters.

Time Lets you change the time where the tag is assigned.

Lock Time Locks the tag to the current frame, regardless of subsequent scaling of time. For example, with Lock Time off, if you have a tag named Forty at frame 40, and you scale time up 200 percent, the Forty tag will be at frame 80. If Lock Time is on, the Forty tag remains at frame 40.

Relative To Lets you assign another tag to which the current tag will maintain a relative offset. For example, if you have a tag at frame 10 called First and you create a second tag at frame 30 called Second, if you move the position of First to frame 25, Second will be moved to frame 45 to maintain the 20-frame offset between the two tags.

This is a one-way offset. If you changed the time position of the second tag in the previous example, the first tag is not affected. In addition, circular dependencies are not allowed. You can't have First relative to Second and Second relative to First.

Delete Tag Deletes the selected tag.

Animation and Time Controls

Between the status bar and the viewport navigation controls are the animation controls, along with the time controls for animation playback within viewports.



Animation Controls



[Auto Key Animation Mode](#) on page 7549 and [Set Key Animation Mode](#) on page 7552



[Default In/Out Tangents For New Keys](#) on page 7557



[Go To Start](#) on page 7560



[Previous Frame/Key](#) on page 7560



[Play/Stop](#) on page 7561



[Next Frame/Key](#) on page 7563



[Go To End](#) on page 7563

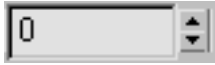

[Current Frame \(Go To Frame\)](#) on page 7563

Time Controls



[Key Mode](#) on page 7564



[Time Configuration](#) on page 7565

Auto Key Animation Mode

Status bar > Time controls > Auto Key (Toggle Auto Key Mode)

Keyboard > N

The Auto Key button turns the [keyframing mode](#) on page 8020 called Auto Key on or off. All movement, rotation, and scale changes are keyframed while the Auto key button is on. When it's off, these changes are applied to frame 0.

You can also keyframe by using [Set Key mode](#) on page 7552, which allows you to selectively add keyframes using the Set Keys button.



The Auto Key button is red when it's on. The active viewport is also outlined in red when the Auto Key mode is on; the time slider turns red as well. This serves to remind you that you are in Animate mode, and that you are setting keyframes with your actions.

WARNING Be sure to turn off Auto Key after keyframing, or you will inadvertently create unwanted animation. Use Undo to remove the unwanted animation. Be careful; it's easy to forget.

Within an existing animation, you can create keyframes for transforms without the use of the Auto Key button by right-clicking the time slider and then setting the source and destination time. For example, you can use this function to copy an existing Move key to a later frame, so an object pauses its motion momentarily (to keep the object still, you must use linear or step interpolation). You can also set keyframes for other animatable parameters in Track View and the Motion panel without using Auto Key.

See also:

- [Using Auto Key Mode](#) on page 3083
- [Set Key Animation](#) on page 7552
- [Using Set Key Mode](#) on page 3086

Procedures





To animate an object using Auto Key:

- 1  Turn on the Auto Key button.
The Auto Key button, the time slider, and the highlight border around the active viewport all turn red.
- 2 Drag the time slider to a time other than 0.
- 3 Do one of the following:
 - Move, scale, or rotate an object.
 - Change an animatable parameter.

For example, assume you start with a cylinder that has not been animated yet and therefore has no keys. You turn on Auto Key, go to frame 20, and rotate the cylinder 90 degrees about its Y axis. This action creates rotation keys at frames 0 and 20. The key at frame 0 stores the original orientation of the cylinder, while the key at frame 20 stores the animated rotation of 90 degrees. When you play the animation in the viewport, the cylinder rotates 90 degrees about its Y axis over 20 frames.

- 4  Turn off the Auto Key button when you are done.

Example: To animate an object between three points using Auto Key:

- 1  Turn on the Auto Key button.
- 2 Drag the time slider (to frame 25, for example).
- 3 Move the object from point A to point B.
A Move key is created at frames 0 and 25. The establishing key at frame 0 describes the object's position at point A. The key at frame 25 describes the object's position at point B.
- 4 Drag the time slider (to frame 50, for example).
- 5 Move the object from point B to point C.
A Move key is created at frame 50 that describes the object's position at point C.
- 6  Click the Playback button.
The object moves from point A to point B over frames 0 to 25, then proceeds to point C over frames 26 to 50.
- 7  The Playback button turns into a Stop button. Click it to stop playback.
The position of the object in between the keyframes is determined by the interpolation type used by the controller. Right-click the keys in the track bar and select the transform key to see the controls for adjusting the timing of the in-betweens.
- 8  Turn off the Auto Key button.

To remove the animation from a scene and start again:

- 1 Choose File menu > New.
If the scene has been modified, you are asked if you want to save it. After you make that decision, a New Scene dialog is displayed.
- 2 In the New Scene dialog, turn on Keep Objects And Hierarchy and click OK.
All the objects remain in the scene but all keyframes have been removed.

- 3 To remove the animation from just certain objects, delete their keys in Track View.

Example: To animate a deformation curve of a loft object:

- 1  Turn on the Auto Key button.
- 2 Set a current frame with the time slider.
- 3 Select one or more control points in the deformation curve of a loft object.
- 4 Use the Move Control Point or Scale Control Point buttons to transform the control points.

To animate a hierarchy with IK interactively:

- 1 Select any hierarchy that does not already have an IK Solver applied.
- 2 Click IK on the Hierarchy panel.
- 3  Turn on the Auto Key button.
- 4 On the Inverse Kinematics rollout, turn on Interactive IK.
- 5 Select and move objects in the IK structure on different frames.

NOTE This will work on linked hierarchies and bones that do not already have an HI, HD, or Limb Solver applied. This technique allows you to animate hierarchies using [IK methods](#) on page 3374 without applying any [IK solver](#) on page 3382.

Set Key Animation Mode

Set Key Animation mode allows you to create keys for selected objects individual tracks using a combination of the Set Keys button and Key Filters. Unlike the traditional method of 3ds Max animation, Set Key mode gives you control over what you key and when. It allows you to pose a character (or transform any object) and then if you like it, use that pose to create keys. If you move to another point in time without keying, your pose is discarded. It also works with object parameters.

You can try out different values and then when you have what you like use it to create keys. Combine this with keyable tracks in the Curve Editor to create keys on just the object parameters you want to key.

Set Key Workflow

To animate something using Set Key mode, you first turn on Set Key Mode. You can then select the object you want to animate and use the Key Filters button to set which tracks you want to keyframe. You can also use Show Keyable icons in Track View edit windows to make individual tracks keyable or not. With all this setup work completed, you can create keys by clicking the Set Key button (the large button with the key icon) or using Keyboard shortcut (K). Move ahead in time, then make changes to your character or object (transforms or parameter changes) and click Set Keys to use those changes to create keys.

If you do not click the Set Keys button and move to another frame the object changes will be lost, as if you had never made them. This is fundamentally different behavior from Auto Key mode, where you would need to use undo to lose the changes you made. Use the right mouse button on the time slider to drag a pose or transform to a different point in time.

For faster workflow you can define keyboard shortcuts for the Key Filters and Show Keyable tools by going to Customize menu > Customize User Interface and assigning keystroke combinations in the Main UI group.

Procedures

To animate using Set Key mode:

- 1  Turn on Set Key mode.
- 2 Select the objects you want to keyframe, and then right-click and choose Curve Editor.

- 3  On the Track View toolbar, click Show Keyable Icons, then use the keyable icons in the controller window to define which tracks will be keyed.

 A red key means the track will be keyed. Click a key to toggle keyable status.

4  Click Key Filters and then turn on the tracks you want to keyframe. By default, Position Rotation, Scale, and IK Parameters are on. For this example, turn off Rotation and Scale.

5 Go to a frame at which you want to set a key.

6 Move an object.

7  Click the Set Keys button.

 The Set Key button flashes red to show that it has set a key, and a key appears on the track bar.

Repeat this process, moving the time slider and setting keys.

To keyframe all parameters using Set Key mode:

1  Turn on Set Key mode.

2 In the viewport, select the objects to which you want to add keyframes.

3  Click Key Filters and then turn on the Key All.

4 Move the time slider to the frame where you wish to set keys

5  Click the Set Keys button.

Keys will be added to all keyable parameters.

To move a pose or position in time without update:

- 1 Turn on Set Key.
- 2 Move to a particular frame (let's say frame 20).
- 3 Pose your character or position your object(s).
- 4 Move your cursor over the time slider, then press the right mouse button down and drag.

The time slider moves, but the position does not change. The pose or position is maintained and transferred to the new point in time.

- 5 When you are at the appropriate frame, set the pose or position keys by clicking Set Keys.

Interface

 **Set Key** Toggles Set Key mode.

 **Set Keys** Click this to set a key. This button will create a key on tracks for the selection set. It checks that the tracks are keyable, and that Key filters allow the tracks to be keyed. If both these are satisfied, a key is set. Set Keys also sets keys in Auto Key mode, and in Layout mode (the mode when neither Auto Key nor Set Key is turned on). Keyboard shortcut default for this command is **K**.

 **Key Filters** Displays the Set Key Filters dialog where you can define which type of tracks will be allowed or disallowed keys.

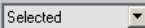

Selection List Gives quick access to [named selection sets](#) on page 239 and [track sets](#) on page 3672 while working with Set Key. Lets you easily swap among different selection sets and track sets.

NOTE Choosing a selection set from the list does not select objects in the viewports. To accomplish this, use the [Named Selection Sets](#) on page 239 feature.

NOTE Selection set names appear between braces (example: {Biped Arms}) while track set names appear between square brackets (example: [Throw Baseball]).

Set Key Filters dialog Turn on the tracks you want to key. Default=Position, Rotation, Scale and IK Parameters.

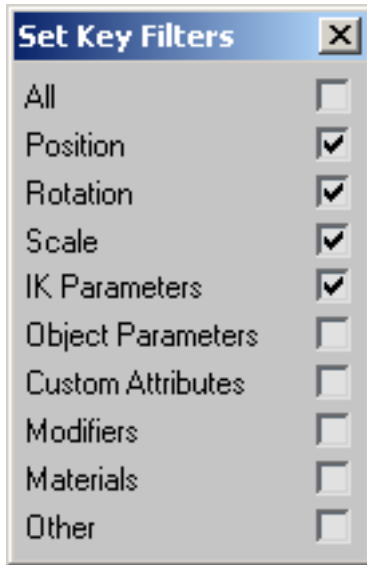

The following options are available:

- **All** allows for a quick way to key all tracks. When All is turned on, the other toggles are unavailable. Clicking Set Keys with the All filter turned on will result in a key placed on all keyable tracks.
- **Position** allows for position keys to be created.
- **Rotation** allows for rotation keys to be created.
- **Scale** allows scale keys to be created.
- **IK Parameters** allows inverse kinematic parameters to be keyframed.
- **Object Parameters** allows object parameters to be keyframed.
- **Custom Attributes** allows custom attributes to be keyframed.
- **Modifiers** allows modifiers to be keyframed. Note that you should turn on Object parameters when you turn on modifiers, so you can keyframe gizmos.
- **Materials** allows material properties to be keyframed.
- **Other** allows for other parameters that don't fall in the above categories to be keyframed using the Set Key technique. This includes such things as helper properties and look-at controller tracks for target cameras and lights.

WARNING If you turn on Object Parameters, all the object parameters of an object will then receive keys, unless you have turned off the tracks using Keyable on the Controller menu of Track View – Curve Editor. The same advice applies to Materials.

TIP You can also set keys on spinners by holding down the Shift key and right-clicking a spinner.

Default In/Out Tangents For New Keys

Status bar > Animation controls > Default In/Out Tangents For New Keys flyout



This flyout provides a quick way to set a [default tangent type](#) on page 3129 for new animation keys created with [Set Key Mode](#) on page 7552 or [Auto Key Mode](#) on page 7549. You can also access the [tangent types](#) on page 3129 from the [Key Info \(Basic\) rollout](#) on page 3127 and the Curve Editor's [Key Tangency toolbar](#) on page 3572.

NOTE Changing tangent types does not affect existing keyframes, only new ones.

On each new set keyframe, the Key Tangent flyouts on the Key Info (Basic) rollout updates with the current default tangent type.

When you set a default tangent type, both the in and out tangents are set to match that type. If you set different in and out tangents via the Controller Defaults group of the [Animation Preferences panel](#) on page 7772, the current flyout icon changes to a question mark.

NOTE Setting a default tangent type stores it in the [3dsmax.ini](#) on page 83 file, from which it is restored after a scene reset or session change.

See also:

- [Specifying Default Controllers](#) on page 3110

Procedures

Example: To set a default tangent type:

- 1 Create a sphere.
- 2  Turn on Auto Key, go to frame 10, and move the sphere on all three axes.
- 3 Right-click the sphere. From the quad menu, choose Curve Editor.

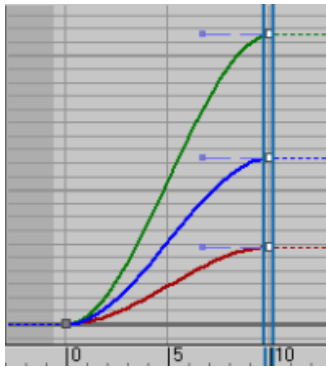

The position curve with Flat tangent.

- 4 Choose the Linear tangent type (second icon from the top) from the Default In/Out Tangents For New Keys flyout.

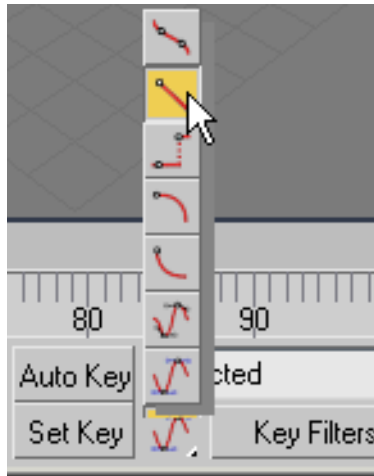

- 5 Go to frame 20 and move the sphere elsewhere in your scene.
The curve starts curvy at frame 10 but straightens out near frame 20. Its interpolation transitions from an Flat out tangent to a Linear in tangent.

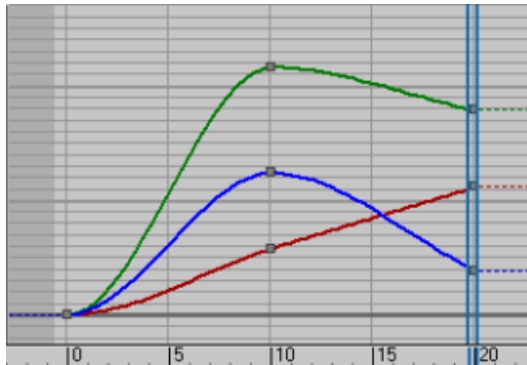

The position curve going from Flat to Linear tangents

- 6 Go to frame 30 and move the sphere again.
The curve interpolation from frame 20 to 30 is straight because both keys have tangents set to Linear.

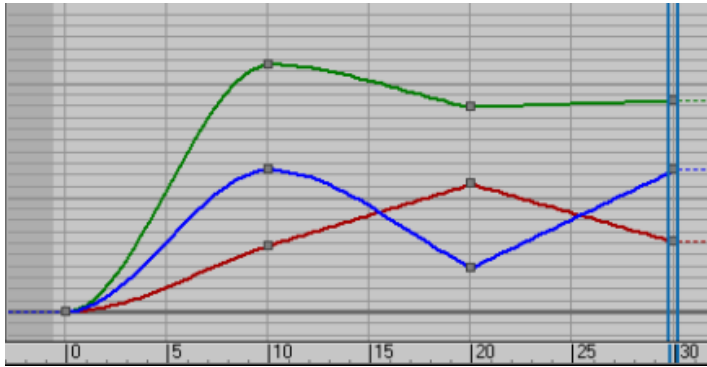

The position curve going from Flat to Linear to Linear tangents

Go To Start

Status bar > Time controls > Go To Start

Keyboard > Home

Go To Start moves the time slider to the first frame of the [active time segment](#) on page 7898. The active time segment is set in the Start Time and End Time fields of the [Time Configuration dialog](#) on page 7565.

Previous Frame/Key

Status bar > Time controls > Previous Frame

Keyboard > , (comma)

Previous Frame moves the [time slider](#) on page 7528 back one frame.

 If [Key Mode](#) on page 7564 is on, the time slider moves to the previous [keyframe](#) on page 8020. Keyframe options are set in the Key Steps group of the [Time Configuration dialog](#) on page 7565.

If Time Configuration dialog > Use TrackBar is on, Previous Key jumps to the previous key of any kind. If Use TrackBar is off, Previous Key jumps to the previous transform key, ignoring any other type of keys.

Play/Stop

Status bar > Time controls > Play

Status bar > Time controls > Stop

Keyboard > / (to play); Esc (to stop)

The Play button plays the animation in the active viewport. If you click another viewport to make it active, the animation continues playing in that viewport. When the animation is playing, the Play button becomes a Stop button. The Play button is a flyout for playing only the animation of selected objects.

TIP You can play the animation in all the viewports simultaneously by turning off Active Viewport Only in the [Time Configuration dialog](#) on page 7565.

Procedures

To play the animation in the viewport:

- 1 Activate the viewport where you want to play the animation.

- 2  Click the Play button.

The animation plays in the viewport. The Play button becomes a Stop button.

- 3  Click Stop to end the playback.

The speed of the animation playback is determined by the settings in the Time Configuration dialog, the complexity of the scene and the speed of the graphics card and processor.

To play the animation looped backward:

- 1  Click the Time Configuration button on the status bar.

- 2 In Time Configuration dialog > Playback group, turn off Real Time. The Direction buttons are now available.
- 3 Turn on Reverse and click OK.
- 4 . Click the Play button. The animation plays backward.
- 5 To play the animation front-to-back and then back-to-front in a continuous loop, turn on Ping-Pong as the Direction.

To play the animation of a selected object only:

- 1 In a viewport, select a single animated object or a set of animated objects.
- 2 . Click Play Selected on the Play/Stop flyout. Only the selection is animated in the viewport.
- 3 To end playback, click the Stop button or press Esc.

Interface

The Play/Stop flyout contains two buttons. Both buttons become a Stop button when in use.



Play Plays the animation in the currently active viewport.



Play Selected Plays the animation for selected objects only in the currently active viewport.



Stop Animation Replaces the Play button when an animation is playing. Click to stop the playback.



Stop Animation (Selected) Replaces the Play Selected button when an animation is playing. Click to stop the playback.

Next Frame/Key

Status bar > Time controls > Next Frame

Keyboard > . (period)

Next Frame moves the [time slider](#) on page 7528 ahead one frame.



If [Key Mode](#) on page 7564 is on, the time slider moves to the next [keyframe](#) on page 8020. Keyframe options are set in the Key Steps group of the [Time Configuration dialog](#) on page 7565.

If Time Configuration dialog > Use TrackBar is on, Next Key jumps to the next key of any kind. If Use TrackBar is off, Next Key jumps to the next transform key, ignoring any other type of keys.

Go To End

Status bar > Time controls > Go To End

Keyboard > END

Go To End moves the [time slider](#) on page 7528 to the last frame of the [active time segment](#) on page 7898. The active time segment is set in the Start Time and End Time fields of the [Time Configuration dialog](#) on page 7565.

Current Frame (Go To Frame)

Status bar > Time controls > Current Frame (and Go To Frame)

Current Frame displays the current frame number, indicating the position of the [time slider](#) on page 7528. You can also enter a frame number in this field to go to that frame.

Procedures

To move to a particular frame, do one of the following:

- 1 To go to the specified frame, type the frame number and press Enter.

- 2 Move the time slider and observe the frame number updating on the time slider.
- 3 To change the value in the frame number field, click or drag the spinner.

Key Mode

Status bar > Time controls > Key Mode





Key Mode lets you jump directly between [keyframes](#) on page 8020 in your animation. By default, Key Mode uses the keys visible in the track bar below the time slider. Other options are available on the [Time Configuration dialog](#) on page 7565 in the Key Steps group.

When the Auto Key button on and you change an object's creation parameters or performed a [transform](#) on page 8157, or change a material or modifier applied to that object, the software automatically creates a keyframe.

Key Mode can respect all keyframes, or you can restrict it to move only to transform keys via the Key Steps options on the Time Configuration dialog. When Key Steps > Use TrackBar is on, Key Mode jumps to keyframes of any type. When Use TrackBar is off, Key Mode respects only transform keys.

Procedures

To use Key Mode:

- 1  Turn on Key Mode.
 The button turns blue when key mode is active.
- 2   Use the [Previous Key](#) on page 7560 and [Next Key](#) on page 7563 buttons to move from one keyframe to the next.
If you are not jumping to the keys, be sure the object is selected in the viewport.
If you are still not jumping to the keys, configure Key Mode to Use TrackBar, as described in the following procedure.

To configure Key Mode:

- 1  Click Time Configuration, or right-click any animation-control button, including Key Mode.
The Time Configuration dialog opens.
- 2 Choose options in the Key Steps group.
If you turn on Use TrackBar and turn Key Mode on, then clicking Next Key advances to the next key for the selected object. This will respect every type of key that appears in the track bar. If you turn Use TrackBar off, only transform keys are used by key mode.

Time Configuration

Status bar > Time controls > Time Configuration > Time Configuration dialog

The Time Configuration dialog provides settings for frame rate, time display, playback, and [animation](#) on page 7907. You use this dialog to change the length of your animation, or stretch or rescale it. You also use it to set the start and end frames of the [active time segment](#) on page 7898 and your animation.

See also:

- [Setting Time Segments](#) on page 3097

Procedures

To define the active time segment:

- 1  Click Time Configuration.
- 2 In the Time Configuration dialog > Animation group, set Start Time to specify the beginning of your active time segment.
- 3 Do one of the following:
 - Set End Time to specify the end of your active time segment.
 - Set Length to specify the amount of time in the active time segment and automatically set the correct End Time.

You can enter positive or negative values in any spinner, but you must use the same format used by the time display.

You can change the active time segment without affecting the keys you've created. For example, if you have keys scattered over a range of 1000 frames, you can narrow your active time segment to work on only frames 150 to 300. You can only work on the 150 frames in the active segment, but the remainder of the animation stays intact. Returning the active segment from 0 to 1000 restores access and playback of all the keys.

Changing the active time segment has the following effects: it restricts the range of time you can use with the time slider, and it restricts the range of time displayed when using the animation playback buttons.

The default setting for the active time segment runs from frames 0 to 100, but you can set it to any range.

To stretch out your existing animation over a longer time:

- 1 In the Time Configuration dialog > Animation group, click Re-scale Time.
- 2 Change the value in Length to be the number of frames you want the action to fill.
- 3 Click OK.

The animation is rescaled to the new number of frames.

This also works to compress animations into a shorter space of time. To avoid losing frames during the rescaling, see "To use sub-frame animation" in this set of procedures.

To add frames onto your existing animation:

This procedure adds new frames to the end of your animation, without affecting your existing work.

- 1 In the Time Configuration dialog > Animation group > End Time field, enter the number of the last frame of the animation.
For example, if your existing animation is 100 frames long and you want to add 50 frames, enter **150**.
- 2 Click OK.
The number you entered is now the new length of the animation, shown on the time slider.

To move to an exact time in your animation:

- In the Time Configuration dialog > Animation group, enter the frame number in the Current Time field, and press Enter.
The viewport updates to this frame.

To set the frame rate of your animation:

In the Time Configuration dialog > Frame Rate group, do one of the following:

- 1 Choose one of the standard frame rates such as PAL or NTSC.
- 2 Choose Custom, and specify a frame rate in the FPS (frames-per-second) field.

To configure viewport playback:

- In the Time Configuration > Playback group, turn on or off the Real Time and Active Viewport Only boxes.

To play your animation in reverse or back and forth:

- 1 In the Time Configuration > Playback group, turn off the Real Time.
- 2 Choose the direction of the animation playback by selecting Forward, Reverse, or Ping-Pong.
- 3 Play the animation in the viewport using the Play button or the / key.

To play your animation only once:

- 1 In the Time Configuration > Playback group, turn off Loop.
- 2 Choose the direction of the animation playback by selecting Forward, Reverse or Ping-Pong.
- 3 Play the animation in the viewport using the Play button or the / key.
The animation will play once and stop.

To play your animation in multiple viewports:

- 1 In the Time Configuration > Playback group, turn off Active Viewport Only. Click OK.
- 2 Play your animation.
The animation now plays in all four viewports.

To use sub-frame animation:

- 1 In the Time Configuration > Time Display group, turn on FRAME:TICKS or MM:SS:TICKS. Click OK.
- 2 Move the time slider to set keyframes in between keys.

TIP Use this when you scale an animation down from a longer length to insure that you won't lose any keys. You can then move the keys to frames and revert to frames without ticks.

To play an animation with sound:

- In the Time Configuration > Playback group, be sure you have Real Time turned on. If Real Time is not on, the sound will not play back during the animation.

Interface

These are the controls for the Time Configuration dialog. You can display this dialog by right-clicking any of the time control buttons to the right of the Auto Key button.

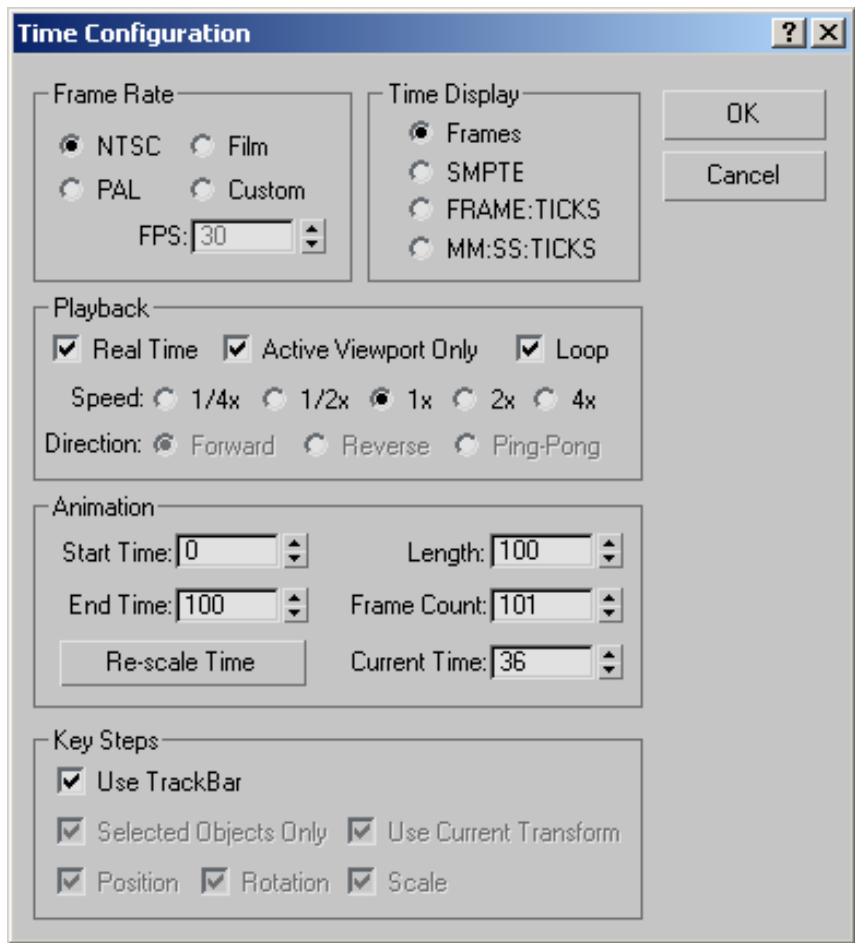

Frame Rate group

These four option buttons, labeled [NTSC](#) on page 8059, [Film](#), [PAL](#) on page 8078, and [Custom](#) let you set the [frame rate](#) on page 7987 in frames-per-second (FPS). The first three buttons force the standard FPS for that choice. The Custom button lets you specify your own FPS by adjusting the spinner.

FPS (Frames Per Second) Sets the frame rate of your animation in Frames per Second. Use frame rates of 30 fps for video, 24 for film, and lower rates for web and media animations.

Time Display group

Specifies the method for displaying time in the time slider and throughout the program. Choices are Frames or in minutes, seconds and ticks.

Specifies the method for displaying time in the time slider and throughout the program (in frames, in SMPTE, in frames and [ticks](#) on page 8147, or in minutes, seconds, and ticks).

For example, if the time slider is at frame 35, and the Frame Rate is set to 30 fps, the time slider would display the following numbers for the different Time Display settings:

- Frames: 35
- SMPTE: 0:1:5
- FRAME: TICKS: 35:0
- MM:SS: TICKS: 0:1:800

SMPTE is the *Society of Motion Picture Technical Engineers* standard used to measure time for video and television production.

Playback group

Real Time [Real Time](#) on page 8104 causes viewport playback to skip frames to keep up with the current Frame Rate setting. A choice of five playback speeds is available: 1x is normal speed, 1/2x is half speed, and so on. The speed settings affect only the playback in the viewports.

These speed settings can also be used with the [Motion Capture utility](#) on page 3798.

When Real Time is off, viewport playback occurs as rapidly as possible and displays all frames.

Active Viewport Only Causes playback to occur only in the active viewport. When off, all viewports display animation.

Loop Controls whether the animation playback occurs only once, or repeatedly. When on, playback repeats until you stop it by clicking an animation control button or the time slider channel. When off, the animation plays once and then stops. Clicking Play rewinds to the first frame and plays again.

Direction Set the animation to play forward, reverse, or ping-pong (forward and then reverse, repeating). This affects only the playback in the interactive

renderer. It does not apply when rendering to any image output file. These options are available only when Real Time is off.

You can recall these settings automatically upon startup or reset by saving a *maxstart.max* file. See [Startup Files and Defaults](#) on page 82.

Animation group

Start Time/End Time Sets the [active time segment](#) on page 7898 displayed in the time slider. Choose any time segment before or after frame 0. For example, you can set an active time segment from -50 to 250.

Length Displays the number of frames in the active time segment. If you make this greater than the total frames in the active segment, the End Time field increases accordingly.

Frame Count The number of frames that will render. Always the length plus one.

Current Time Specifies the current frame for the time slider. As you adjust this, the time slider moves accordingly and the viewport updates.

Re-scale Time Stretches or shrinks the animation for the active time segment to fit into the new time segment you specify. Relocates the position of all [keys](#) on page 8020 in all tracks. As a result, the animation plays over a greater or lesser number of frames, making it faster or slower.

Key Steps group

Controls in this group let you configure the method used when you turn on [Key Mode](#) on page 7564.

Use TrackBar Allows key mode to honor all keys in the track bar. This includes any parameter animation in addition to transform keys.

To make the following controls available, turn off Use TrackBar.

Selected Objects Only Considers only the [transforms](#) on page 8157 of selected objects when you use Key Steps mode. If you turn this off, the transforms of all (unhidden) objects in the scene are considered. Default=on.

Use Current Transform Disables Position, Rotation, and Scale and uses the current transform in Key Mode. For example, if the Rotate button is selected in the toolbar, you stop at each rotation key. If none of the three transform buttons are on, Key Mode considers all transforms.

To make the following control available, turn off Use Current Transform.

Position, Rotation, Scale Specifies which transforms are used by Key Mode.

Clear Use Current Transform to make the Position, Rotation, and Scale check boxes available.

Viewport Controls

You can choose different views to display in these four viewports as well as different layouts from the [viewport right-click menu](#) on page 7576.

See also:

- [Viewport Configuration](#) on page 7817
- [Viewport Right-Click Menu](#) on page 7576

Viewport Layouts

You can choose from other layouts different from the default configuration. To choose a different layout, right-click the viewport label and choose Configure. Click the Layout tab of the Viewport Configuration dialog to see and choose the alternative layouts.

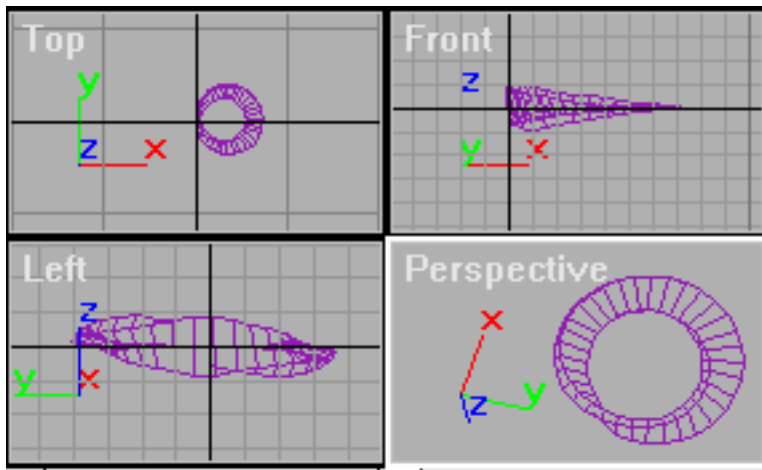

Typical viewport layout

NOTE The viewport layout is saved with your MAX file.

TIP You can change the default viewport layout by saving a *maxstart.max* file with the desired viewport configuration and placing it in the [\defaults folder](#) on page 7694.

Active Viewport Borders

When four viewports are visible, one viewport, marked with a highlighted border, is always active. This is where commands and other actions take effect. Only one viewport at a time can be active. Other viewports are for observation only; unless disabled, they simultaneously track actions taken in the active viewport. When Auto Key or Set Key is on, the active viewport border changes from yellow to red.

In general, a viewport becomes active as you work in it. You can move an object in one viewport, and then drag the same object in another viewport to continue the move. To activate a viewport without changing the selection, right-click it. If you left-click a viewport, the viewport is activated and whatever you click is selected, or, if you click an empty area, everything is deselected. You can restore previous selections with Undo.

Viewport Labels

Viewports are labeled in the upper-left corner. You can control many aspects of a viewport by right-clicking the viewport label to display the [viewport right-click menu](#) on page 7576.

Dynamic Resizing of Viewports

You can resize the four viewports so they are of unequal proportions. To do so, drag the intersection of two, three, or four viewports, on the splitter bars. To return to the original layout, right-click an intersection of the dividing lines and choose Reset Layout from the right-click menu.

The new viewport proportions are saved in the scene. However, changing the [viewport layout](#) on page 7824 always resets them.

World-Space Tripod

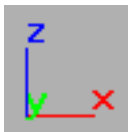

The three-color world-space tripod is visible in the lower-left corner of each viewport. The colors correspond to the three axes of world space: red=X, green=Y, and blue=Z. The axes are labeled in these same colors. The tripod always refers to world space, regardless of the current reference coordinate system.

The world-space tripod is on by default. To turn off this feature, see “To turn off the world-space tripod in all viewports” in the following procedures.

Viewport Tooltips for Object Names

When you’re working with objects in a viewport and pause the cursor over any unselected object, a tooltip appears with the name of that object. If you need to select something or link to something, wait until you see the tooltip to be sure you have selected the object you want. These tooltips are disabled when you work in sub-object mode.

[Tooltips](#) on page 7744 are on by default. To turn off this feature, see [To turn off object name tooltips](#) on page ?, below.

See also:

- [Viewport Navigation](#) on page 7585
- [The 3ds Max Window](#) on page 67

Procedures

To make a viewport active, do one of the following:

- 1 Click any viewport.
If you click an object in the viewport, it is selected. If you click a space where there are no objects, any selected objects are deselected.
- 2 Right-click any viewport.
Right-click activates a viewport without changing the selection state of objects. (You can also do this by left-clicking the viewport label.)

To switch between single and multiple viewports:

Activate the viewport you want to minimize or maximize, and do one of the following:

- 1 On the keyboard, press the W key.

- 2 On the keyboard, press Alt+W.



- 3 Click the Maximize Viewport Toggle button in the lower-right corner of the 3ds Max window.

To resize the viewports:

- 1 Drag the intersection of two, three, or four viewports to move the horizontal and vertical splitter bars.
- 2 Move the intersection to any new location.
If you don't drag a corner, you can move the borders horizontally or vertically only.
- 3 To reset the viewports, right-click an intersection and choose Reset Layout from the right-click menu.

To change the number of viewports and their arrangement:

- 1 Right-click any viewport label. Choose Configure from the right-click menu.
- 2 On the Viewport Configuration dialog, click the Layout tab.
- 3 Choose a layout from the choices at the top of the dialog.
- 4 Assign what each viewport will display in the lower window of the dialog by right-clicking a viewport representation and choosing from the right-click menu.
- 5 Click OK to make the change.

To turn off the world-space tripod in all viewports:

- 1 Choose Customize menu > Preferences to display the Preferences dialog.
- 2 Click the Viewports tab.
- 3 In the Viewport Parameters group, turn off Display World Axis.
- 4 Click OK to make the change.

To turn off object-name tooltips:

- 1 Choose Customize menu > Preferences to display the Preferences dialog.

- 2 Click the General tab.
- 3 In the UI Display group, turn off Enable Viewport Tooltips.
- 4 Click OK to make the change.

Viewport Right-Click Menu

Right-click any viewport label. > Viewport right-click menu

The viewport right-click menu, also referred to as the Viewport Properties menu, contains commands that let you change what is shown in the active viewport. This is a shortcut menu. Some of the options are also available on the [Configuration dialog](#) on page 7817.

The functions available on this menu include:

- Change the view to any available viewport type (for example, Perspective, Top, Bottom, User, Light, Camera, Grid, or Shape).
When your scene contains cameras or lights with targets, the viewport right-click menu gives you selection options for the components. For example, when you right-click the label of a target camera viewport, you see two new commands, Select Camera and Select Camera Target, that let you select the camera or target used by that view.
- Set the type of shading displayed in the viewport (for example, Wireframe, Smooth, or Edged Faces).
- Set how transparency is displayed in the viewport.
- Undo or redo a view change.
- Enable texture correction if your display is not configured for OpenGL or Direct3D.
- Disable a viewport so it doesn't update when you work in other viewports.
- Toggle the display of the grids, safe frame, and viewport background.

NOTE A grid object must be active before you can select it from its viewport.

- Display the Asset Browser, Schematic View or MAXScript Listener in a viewport.

- Turn on Viewport Clipping. This interactively sets a near and far range for the viewport. Geometry within the viewport clipping range is displayed. Faces outside the range are not displayed.

TIP If the viewport right-click menu becomes disabled, you can restore it by refreshing the UI scheme. Use Customize menu > [Load Custom UI Scheme](#) on page 7724 to load a different CUI file, then reload the original CUI file again. The right-click viewport menu will become available after either the new or original UI scheme is loaded.

Procedures

To toggle display of the home grid in the active viewport, do one of the following:

- 1 Choose Views menu > Grids, and click Show Home Grid.
- 2 Right-click a viewport label (this activates the viewport and opens a menu), and then click Show Grid.
- 3 Press G.

To change a viewport to Camera view:

This procedure requires at least one camera object in your scene. As an alternative, to create a camera and set it to a viewport at the same time, activate a Perspective viewport and then press Ctrl+C.

- 1 Right-click a viewport label.
- 2 Click Views.
- 3 Choose one of the cameras in the Views list.

This assigns the camera to the viewport and changes the label to the camera name.

A camera viewport tracks the view through the perspective of that camera. As you move the camera (or target) in another viewport, you see the scene swing accordingly. If you alter the camera's [field of view](#) on page 7596, you see the changes as they are applied.

TIP You can also press C as a shortcut to change any active viewport to an existing camera view.

To change a viewport to a shape view:

This procedure requires at least one shape object in your scene.

- 1 Right-click a viewport label.
- 2 Choose Views > Shape from the menu.

To use viewport clipping:

- 1 Right-click a viewport label.
- 2 Choose [Viewport Clipping](#) on page 7818.
The viewport displays the viewport clipping controls.
- 3 Move the lower slider up until the geometry is clipped in the viewport by the near clipping plane.
- 4 Adjust the upper slider to clip the geometry with the far clipping plane.

To display Schematic View in a viewport:

- 1 Right-click a viewport label to access the Viewport Properties menu.
- 2 Click Views > Schematic > New, or choose the name of the Schematic View to display.

To display Track View in a viewport:

- 1 Right-click a viewport label to access the Viewport Properties menu.
- 2 Click Views > Track > New, or choose the name of the Schematic View to display.

To display the Asset Browser or MAXScript Listener in a viewport:

- 1 Right-click a viewport label and then, from the right-click menu, choose Views > Extended.
- 2 From the sub-menu, choose Asset Browser or MAXScript Listener.
The feature you choose is displayed in a dedicated viewport.
To return the viewport to normal usage, right-click the viewport toolbar and choose the type of viewport.

To access the Layout panel, do one of the following:

- Choose Customize menu > Viewport Configuration, then click the Layout tab.
- Right-click a viewport label, and choose Configure, then click the Layout tab.

To turn on safe frame display, do one of the following:

- Right-click a viewport label, and then choose Show Safe Frame.
- Press Shift+F.
- Choose Customize menu > Viewport Configuration > Safe Frames panel, and turn on Show Safe Frames In Active View.
See [Safe Frames](#) on page 7825.

To fix texture display problems in a viewport:

- Right-click a viewport label, and then choose Texture Correction. This applies only to the software display driver; OpenGL and Direct3D displays automatically correct the display of textures.

TIP If you have materials with texture maps that are not displaying in the viewport, you need to turn on Show Map In Viewport in the Material Editor for each material that has this problem.

To change quickly between snapping options:

- 1 With nothing selected, hold Shift and right-click anywhere in the viewport.
The Snaps shortcut menu is displayed.
- 2 Choose any of the Standard or NURBS snap options. You can also toggle whether snaps use transform constraints.

Interface

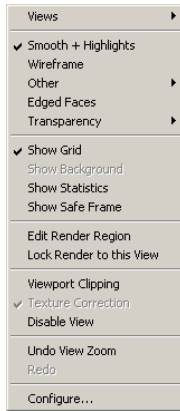

Views Displays a secondary menu that allows you to choose another view to display in the viewport (Front, Top, Back, etc.).

TIP Another method for switching views is the [ViewCube](#) on page 107.

Available views are:

- [Camera views](#) on page 7604 (if the scene contains cameras)
- [Light views](#) on page 7614 (if the scene contains spotlights or directional lights)
- [Perspective](#) on page 7591
- Orthographic
- Front
- Back
- Top
- Bottom
- Left
- Right
- [Rendering with ActiveShade](#) on page 6102

- **Track:** Choose an existing [Track view](#) on page 3503, if any, from the submenu, or choose New to create a new one. To change a viewport when it contains a Track view, right-click the menu bar and choose a different view.
- **Schematic:** Choose an existing [Schematic view](#) on page 7407, if any, from the submenu, or choose New to create a new one. To change a viewport when it contains a Schematic view, right-click the menu bar and choose a different view.
- **Grid** on page 2622: Choose Front, Back, Top, Bottom, Right, Left, or Display Planes. For details, see [Viewing Grid Objects](#) on page 2595.
- **Extended**
 - [Asset Browser](#) on page 7132
 - [Biped AnimationWorkbench](#) on page 4483
 - [Motion Mixer](#) on page 3699
 - [MAXScript Listener](#) on page 7677
 - HW Standard Material
- **Shape:** Automatically aligns view to the extents of a selected shape and its local XY axes

The fastest way to change the viewport display is with keyboard shortcuts. Press V to open the Viewports quad menu at the mouse position. You can then choose from this menu with the mouse or use the first letter of the viewport label as the keyboard shortcut (F for Front, for example. The exception is K for back).

NOTE This menu appears at the mouse cursor, but it controls the view for the active viewport, even if the mouse cursor is over a different viewport.

Smooth+Highlights Displays the smoothness and lighting of objects. You can also display maps on the surface of objects. See [Show Standard/Hardware Map in Viewport](#) on page 5350. This happens on a map-by-map basis, but you can display as many maps as you want simultaneously in the viewport. Maps display only on objects that have mapping coordinates. Also, Show Map In Viewport must be turned on for each map individually in the Material Editor,

or globally using the Views menu > [Global Viewport Rendering Setting commands](#) on page 173.

NOTE This and other shaded viewport options support self-illuminated materials and 32 lights (depending on display mode and graphics card).

Wireframe Displays objects as edges only, as if they were made from wire. Wire color is determined by object color (default).

Other Displays a cascading menu of other shading modes. These include:

- **Smooth** Displays smoothing, but doesn't show highlights.
- **Facets+Highlights** Displays highlights, but doesn't show smoothing.
- **Facets** Shades faces, but doesn't display smoothing or highlights.
- **Flat** Renders each polygon in its raw, unshaded diffuse color, disregarding any contribution from ambient lighting or light sources. This rendering method is useful when it's more important to see each polygon than to see its shading. It's also a good way to check the results of bitmaps created with [Render to Texture](#) on page 6371.
- **Hidden Line** A wireframe mode that hides faces and vertices with [normals](#) on page 8059 pointing away from the viewpoint, as well as any parts of objects that are obscured by closer objects. In this display mode only, the wireframe color is determined by the Viewports > Hidden Line Unselected color, not the object or material color. See [Colors Panel](#) on page 7712.
- **Lit Wireframes** Displays edges as wireframe, but shows lighting.
- **Bounding Box** Displays objects as a [bounding box](#) on page 7932 only.

Edged Faces Available only when the current viewport is in a shaded mode. Displays the wireframe edges of objects along with the shaded surfaces. This is helpful for when you want to edit meshes in a shaded display.

Edges are displayed using the object wireframe color, while surfaces use material colors (if assigned). This lets you create contrasting colors between the shaded surfaces and the wireframe edges. You can switch these assignments on the [Display Color rollout](#) on page 177.

Transparency Sets the quality of transparency display in the selected viewport:

- **Best** Highest quality transparency display; longer redraw time.
- **Simple** Less accurate transparency display, however viewport redraw is considerably faster with Simple.

- **None** Transparency is not displayed in the viewport.

NOTE The Transparency setting only affects viewport display, and does not affect renderings.

Show Grid Turns on and off the display of the home grid. Does not affect other grid display.

Keyboard > G

Show Background Turns on and off the display of any viewport background image (or animation). To specify an image, choose Views menu > Viewport Background.

TIP The keyboard shortcut for the Viewport Background dialog is Alt+B.

Show Safe Frame Turns on and off the display of [safe frames](#) on page 8110. You define the safe frames in the Viewport Configuration dialog (see Configure, below). The safe frame proportions conform to the Width and Height of the output size of your rendering image output.



Edit Render Region When on, you can edit a region for restricting the render to a specific rectangular area within the viewport. Available only when the Rendered Frame Window > [Area To Render](#) on page 6075 drop-down list is set to Region, Crop, or Blowup. This command is linked directly to the Rendered Frame Window > [Edit Region](#) on page 6075 command. The main difference is that you can edit the region for Crop or Blowup in the viewport, but not in the Rendered Frame Window. You can edit the region for Region in both.

While Edit Render Region is active, the only thing you can do in the viewport is edit the region. To finish editing the region while keeping the same viewport active, close the region window by clicking the X button in the upper-right corner, or turn off the command on the viewport right-click menu.

NOTE Activating a different viewport while editing a render region turns off the command and remembers the edited region. Also, 3ds Max uses two different regions: one for Region and Crop, and a separate one for Blowup.



Lock Render to this View When on, 3ds Max always renders the viewport that was active when you locked the render, even if the active

viewport changes. You can change which viewport renders by using either of these methods:

- Turn off Lock Render To This View and activate a different viewport.
- Choose a different viewport from the Viewport drop-down list on the [Rendered Frame Window](#) on page 6076 or on the [Render Setup dialog](#) on page 6071.

This toggle is also available from the Rendered Frame Window as the [Lock To Viewport button](#) on page 6077.

Show Statistics Toggles the viewport display of the [statistics](#) on page 2577 for the entire scene and your current selection.

Viewport Clipping Lets you set a near and far visibility range for the viewport interactively. Geometry within the viewport clipping range is displayed. Faces outside the range are not displayed. This is useful in complex scenes where you want to work on details that are obscured from view.

Turning on Viewport Clipping displays two yellow slider arrows on the right side of the viewport. Adjusting the lower arrow sets the near end of the range, and the upper arrow sets the far end. Tick marks on the range slider indicate the extents of the viewport.

You can also toggle Viewport Clipping on the [Viewport Configuration dialog](#) on page 7817.

Texture Correction Redraws the viewport using pixel-interpolation (perspective corrected).

NOTE This applies only to the software display driver. If you are using the OpenGL or Direct3D display mode, texture correction is automatic.

Disable View Prevents the viewport from updating with changes made in other viewports. While the disabled viewport is active, it behaves normally. However, when you change the scene in another viewport, the view in the disabled viewport does not change until you activate it. Use this function to speed up screen redraws when you are working on complex geometry.

While active, the text “/Disabled” is appended to the viewport label.

Keyboard > D

Select Camera/Select Light Selects the camera or light to which the viewport is set. Available only when the viewport is a camera or light viewport.

Select Camera Target/Select Light Target Selects the target of the camera or light to which the viewport is set. Available only when the viewport is a camera or light viewport.

Undo Undoes the last viewport change.

Redo Cancels the last viewport undo.

Configure Displays the [Viewport Configuration dialog](#) on page 7817, which contains many options for further control of the viewports.

Viewport Navigation

At the right end of the status bar are the buttons that control the display and navigation of the viewports.



Some of the buttons change for camera and light viewports. The Field Of View button changes for Perspective viewports.

The state of the navigation-button flyouts for all viewport types is saved in the [Performance] section of the [3dsmax.ini](#) on page 83 file.

Viewport Navigation Controls

The navigation controls depend on the active viewport. Perspective, orthographic, camera, and light viewports all have specialized controls. The term “orthographic” refers to User viewports as well as viewports like Top, Front, and so on. The Zoom Extents All flyout and Maximize Viewport Toggle, available in all viewports, are included with the Perspective and orthographic viewport controls.

Many of these controls are [modal](#) on page 8045, meaning they stay on for repeated use. The buttons highlights when on. To turn them off, press Esc, right-click in a viewport, or choose another tool.

Controls Available in All Viewports



[Zoom Extents All](#), [Zoom Extents All Selected](#) on page 7588



[Maximize Viewport Toggle](#) on page 7589

Perspective and Orthographic Viewport Controls



[Perspective and Orthographic Viewport Controls](#) on page 7591



[Zoom Viewport](#) on page 7592



[Zoom All](#) on page 7593



[Zoom Extents/Zoom Extents Selected](#) on page 7594



[Field-of-View Button](#) on page 7596 (Perspective) or [Zoom Region](#) on page

7599 



[Pan View](#) on page 7600



[Walk Through](#) on page 135



[Orbit, Orbit Selected, Orbit Sub-Object](#) on page 7602

Camera Viewport Controls



[Camera Viewport Controls](#) on page 7604



[Dolly Camera, Target, or Both](#) on page 7605



[Perspective](#) on page 7607



[Roll Camera](#) on page 7608



[Field-of-View Button](#) on page 7596



[Truck Camera](#) on page 7610



[Walk Through](#) on page 135



[Orbit/Pan Camera](#) on page 7611

Light Viewport Controls



[Light Viewport Controls](#) on page 7614



[Dolly Light, Target, or Both](#) on page 7616



[Light Hotspot](#) on page 7618



[Roll Light](#) on page 7620



[Light Falloff](#) on page 7622



[Truck Light](#) on page 7624



[Orbit/Pan Light](#) on page 7626

Controls Available in All Viewports





Zoom Extents All, Zoom Extents All Selected

Activate any viewport. > Viewport Navigation controls > Zoom Extents All flyout

Keyboard > Shift+Ctrl+Z

The Zoom Extents All flyout is available in all viewports. The flyout has two options:

-  **Zoom Extents All** centers all visible objects in all viewports. This control is useful when you want to see every object in a scene in every available viewport.
-  **Zoom Extents All Selected** centers a selected object, or set of objects, in all viewports. This control is useful when you want to navigate to small objects lost in a complex scene.

Procedures

To zoom all objects in a scene:

- 1 Activate any viewport.

- 2  Click Zoom Extents All.

The viewports display all objects in the scene.

To zoom to a specific object:

- 1 In any viewport, select the object by clicking it, or press H to select it by name.



- 2 Click Zoom Extents All Selected.
The viewports display the selected object.

Interface



Zoom Extents All Centers and magnifies views so all the visible objects in the scene are shown in all viewports.



Zoom Extents All Selected Centers and magnifies views so just the selected objects or sub-object selections in the scene are shown in all viewports. If no objects are selected, the effect is the same as Zoom Extents All.

Maximize Viewport Toggle

Activate any viewport. > Viewport navigation controls> Maximize Viewport Toggle

Keyboard > Alt+W

Maximize Viewport Toggle switches any active viewport between its normal size and full-screen size.



TIP The keyboard shortcut Alt+W is especially useful for quick toggles.

Walkthrough Controls for Perspective and Camera Viewports

Pan/Truck and Walkthrough Flyout



In Perspective and Camera viewports, this flyout offers two separate buttons:

-  Walk Through
-  Pan or Truck

The [Walk Through button](#) on page 7590 is one way to turn on [walkthrough navigation](#) on page 135.

The use of the Pan or Truck button depends on which kind of viewport you are in:

- [Perspective viewports \(Pan\)](#) on page 7600
- [Camera viewports \(Truck Camera\)](#) on page 7610

This flyout doesn't appear for orthographic viewports or spotlight viewports. These viewports don't provide walkthrough navigation.

Walk Through Button

The Walk Through button is one way to begin [walkthrough navigation](#) on page 135. (The other is to press Up Arrow.) It is available on the [Pan/Truck And Walkthrough flyout](#) on page 7590.

The flyout and button don't appear for orthographic viewports or for spotlight viewports. These don't provide walkthrough navigation.

Perspective and Orthographic Viewport Controls

Right-click any viewport label. > Views > Choose a perspective or orthographic view.

Right-click any viewport label. > Views > Grid > Choose any grid view.

Select a shape. > Right-click any viewport label. > Views > Shape

Keyboard > V (to open the Viewports quad menu), then P (Perspective), U (User), F (Front), K (Back), T (Top), B (Bottom), L (Left)

Perspective, orthographic, user, grid, and shape viewports all share the same viewport controls.



Perspective and orthographic viewport controls include the following. Two of these controls are available in all viewports.

[Zoom Viewport](#) on page 7592

[Zoom All](#) on page 7593

[Zoom Extents/Zoom Extents Selected](#) on page 7594 (available in all viewports)

[Field-of-View Button](#) on page 7596

[Zoom Region](#) on page 7599

[Pan View](#) on page 7600

[Orbit, Orbit Selected, Orbit Sub-Object](#) on page 7602

[Maximize Viewport Toggle](#) on page 7589 (available in all viewports)

Procedures

To undo changes to a Perspective or orthographic viewport, do one of the following:

- Right-click the viewport label and choose Undo. The type of Undo is specifically named on the menu (for example, Undo Zoom Extents).
- Press Shift+Z.

NOTE This differs from camera and light viewports, which require the use of the standard Undo function.

Zoom Viewport

Activate a Perspective or orthographic viewport. > Viewport Navigation controls
> Zoom

Keyboard > Alt+Z turns on Zoom ; [zooms in;] zooms out

Keyboard > Ctrl+Alt+middle mouse button (drag)

Roll your mouse scroll wheel.

When Zoom is active, you can adjust the view magnification by dragging in a Perspective or orthographic viewport. By default, zooming occurs from the center of the viewport.

TIP If you use a wheel mouse, you can turn the wheel to zoom the active viewport in and out without first activating Zoom. The zoom center is the center of the viewport.

Zooming takes place incrementally, based on the distance between the viewpoint and its “virtual target,” an inaccessible hidden target used for calculation purposes only. Use the Ctrl and Alt keys, respectively, to increase or decrease the increments. You can move the virtual target by holding down the Shift key during a zoom operation. Otherwise you will zoom increasingly closer to the target, which does not move.

Procedures

To zoom a view:

- 1 Activate a Perspective or orthographic viewport.

- 2  Click Zoom.

The button highlights when it is on.

- 3 Drag in a viewport to change magnification:
 - Drag upward to increase magnification.
 - Drag downward to decrease magnification.
- 4 To exit Zoom mode, press Esc or right-click in a viewport.

To increase zoom speed:

- Hold down Ctrl as you drag in a viewport.

To decrease zoom speed:

- Hold down Alt as you drag in a viewport.

To turn on an automatic zoom mode:

- On the keyboard, hold down Ctrl+Alt, then hold down the middle mouse button and drag in a viewport. This does not activate the Zoom button.

To zoom from the keyboard:

- On the keyboard, press [(left bracket) to zoom in, and] (right bracket) to zoom out.

Zoom All

Activate a Perspective or orthographic viewport. > Viewport Navigation controls
> Zoom All

Zoom All lets you adjust view magnification in all Perspective and orthographic viewports at the same time.

By default, Zoom All zooms in and out of the center of the viewports.

Procedures

To zoom all views:

- 1 Activate a Perspective or orthographic viewport.

- 2  Click Zoom All.
The button highlights when it is on.
- 3 Drag in a viewport to change magnification in all viewports.
 - Drag upward to increase magnification.
 - Drag downward to decrease magnification.
- 4 Press Esc or right-click to turn off the button.

To zoom all viewports except the Perspective viewport:

- 1 Click Zoom All.
- 2 Hold down Shift and drag in a viewport to zoom all the viewports except the Perspective.

NOTE You can drag in a Perspective viewport, but you only see the zoom in orthographic viewports.

Zoom Extents/Zoom Extents Selected

Activate a Perspective or orthographic viewport. > Viewport Navigation controls
> Zoom Extents flyout



The Zoom Extents flyout displays the Zoom Extents button and the Zoom Extents Selected button.



Zoom Extents centers all visible objects in an active Perspective or orthographic viewport. This control is useful when you want to see every object in a scene in a single viewport.



Zoom Extents Selected centers a selected object, or set of objects, in an active Perspective and orthographic viewport. This control is useful when you want to navigate to small objects lost in a complex scene.

Procedures

To zoom all objects in one viewport:

- 1 Activate the Perspective or orthographic viewport you want to zoom.

- 2  Click Zoom Extents.

The viewport displays all objects in the scene.

To zoom on a specific object:

- 1 Activate the Perspective or orthographic viewport you want to zoom.
- 2 Select the object by clicking it, or press H to select it by name.

- 3  Click Zoom Extents Selected.

The viewport displays the selected object.

To exclude an object from Zoom Extents:

Use this procedure, for example, to ignore lights that are far away from the other objects in the scene.

- 1 Click an object to select it.
- 2 Right-click the object and choose Properties.
- 3 In the Display Properties group, make sure properties are set to By Object.
- 4 Turn on Ignore Extents.

The object will now be excluded by Zoom Extents and Zoom Extents Selected.

Interface



Zoom Extents Centers and magnifies views so all the visible objects in the scene are shown in a single viewport.

Objects can be excluded from zoom extents all if the Ignore Extents box is turned on under Object Properties.





Zoom Extents Selected Centers and magnifies views so just the selected objects or sub-object selections in the scene are shown in a single viewport. If no objects are selected, the effect is the same as Zoom Extents.

Field of View Flyout

Activate Perspective viewport. > Status bar > Viewport controls > Field of View flyout

The Field of View flyout is available only for Perspective viewports. The flyout has two options:

-  **Field of View (FOV)** on page 7596: Adjusts the amount of the scene that is visible in a viewport and the amount of perspective flare.
-  **Zoom Region** on page 7599: Magnifies a rectangular area you drag within a viewport.

Field-of-View Button

Activate a Camera viewport. > Viewport controls > Field-of-View

Activate a Perspective viewport. > Viewport controls > Field-of-View (on Field-of-View flyout)

Field-of-View (FOV) adjusts the amount of the scene that is visible in a viewport and the amount of perspective flare. The effect of changing FOV is similar to changing the lens on a camera:

- As the FOV gets larger, you see more of your scene and the perspective becomes distorted, similar to using a wide-angle lens.
- As the FOV gets smaller, you see less of your scene and the perspective flattens, similar to using a telephoto lens.

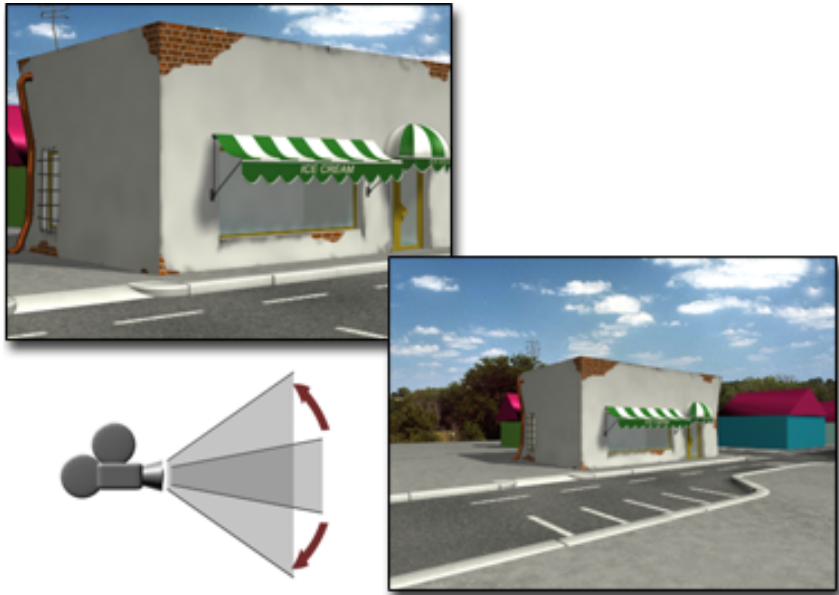

Above: Narrow field of view

Below: Wide field of view

Although the effect of Field-of-View appears similar to a zoom, the perspective is actually changing, resulting in increased or decreased distortion in the viewport.

In a Perspective viewport, Field-of-View defines the width of your view as an angle with its apex at your viewpoint and the ends at the sides of the view.

In a Camera viewport, Field-of-View controls the width of the area a camera views, and represents the arc of the camera's horizon in degrees. For a selected camera, you can adjust its [FOV and Lens parameters](#) on page 5210 directly to

fine-tune the FOV you set in the viewport. See “To use FOV with Camera parameters” in the following procedures.

Procedures

To adjust the field of view in a viewport:

- 1 Activate a Perspective or Camera viewport.
- 2  Click Field-of-View.
The button highlights in gold when it is on.
- 3 Drag in the viewport to adjust the FOV angle.
 - Dragging down widens (increases) the FOV angle, reduces lens length, displays more of your scene, and exaggerates perspective.
 - Dragging up narrows (decreases) the FOV angle, increases lens length, displays less of your scene, and flattens perspective.
- 4 To turn off the button, press Esc or right-click.

To enter an FOV value in a Perspective view:

- 1 Activate a Perspective viewport.
- 2  Right-click Field-of-View to display the Viewport Configuration dialog.
- 3 Click the Rendering Method tab.
- 4 In the Perspective User View group, enter an angle in the FOV field.
- 5 Click OK to make the change.

To use FOV with Camera parameters:

- 1 Activate a Camera viewport.
- 2 Press H and select the viewport’s camera in the [Select From Scene dialog](#) on page 228.
- 3 Open the Modify panel to view the camera’s Parameters rollout.

- 4 As you drag Field-of-View in the viewport, the FOV and Lens parameters update interactively.
- 5 Set the FOV and Lens parameters directly, or click a button in the Stock Lenses group.

NOTE Only the FOV value is saved with the camera. The Lens value (focal length) is another way to express and select the FOV.

See [Common Camera Parameters](#) on page 5210.

NOTE Using the [Perspective button](#) on page 7607 in a Camera viewport also changes the FOV in concert with dollying the camera.

Zoom Region

Activate an orthographic viewport. > Viewport navigation controls > Zoom Region

Activate a Perspective viewport. > Viewport navigation controls > Zoom Region (from Field of View flyout)

Keyboard > Ctrl+W

Zoom Region magnifies a rectangular area you drag within a viewport. This control is available only when the active viewport is an [orthographic](#) on page 8073, [Perspective](#) on page 8087 or [User-Axonometric view](#) on page 7918. It is not available for Camera viewports.

Zoom Region stays active until you right-click or select another command.

Procedures

To zoom a region:

- 1 Activate an orthographic or Perspective viewport.

- 2  Click Zoom Region or press Ctrl+W.

When you zoom a region in a perspective viewport, select Zoom Region from the Field of View flyout.

- 3 Drag a rectangular region in any viewport displaying a non-camera view. When you release, the region is magnified to fill the viewport.

NOTE When using the Zoom Region in Perspective view, the zoom rectangle is at a fixed distance from the camera. For this reason, if you draw the rectangle large enough, you can zoom out from the scene.

Pan View



Activate a Perspective or orthographic viewport. > Viewport Navigation controls > Pan View

Keyboard > Ctrl+P; I pans so the cursor location becomes the center of the viewport.

Middle mouse button > Drag in the viewport with the middle mouse button for instant access to pan the viewport.

Pan moves the view parallel to the current viewport plane.

Pan is [modal](#) on page 8045: it stays active until you right-click or select another command.

To constrain panning of any viewport to a single axis, hold down the Shift key. The pan is constrained to the axis you first move while the Shift key is down.

To accelerate panning, hold down the Ctrl key.

You can also pan by dragging in a viewport while pressing the middle button of a three-button mouse. This lets you pan without turning on the Pan button.

Procedures

To pan a viewport:



- 1 Activate a Perspective or orthographic viewport, and then click Pan View.
- 2 Drag in the viewport in the direction you want to move.
- 3 To turn off the button, press Esc or right-click.

To pan a non-Camera viewport:

- 1 Activate a Perspective or orthographic viewport.
- 2 Do one of the following:
 -  Click Pan View.
 - Press Ctrl+P.
 - Press the middle mouse button.
- 3 Drag in the viewport in the direction you want to move, or use the arrow keys.

To accelerate panning:

- Hold down the Ctrl key as you pan.

To constrain panning to a single axis:

- Hold down the Shift key as you pan.
The pan is constrained to the first axis you use.
If you drag vertically at first, the pan or orbit is constrained to be vertical;
if you drag horizontally at first, the constraint is horizontal.

Orbit Flyout

Activate a Perspective or orthographic viewport. > Viewport Navigation controls
> Orbit flyout

Keyboard > Alt+middle mouse button



The Orbit flyout contains the Orbit, Orbit Selected, and Orbit Sub-Object buttons. Use these to rotate your viewpoint around the view.

For more information on these tools, see [Orbit](#), [Orbit Selected](#), [Orbit Sub-Object](#) on page 7602.

Orbit, Orbit Selected, Orbit Sub-Object

Activate a Perspective or orthographic viewport. > Viewport Navigation controls
> Orbit flyout

Keyboard > Alt+middle mouse button

The Orbit buttons, on the [Orbit flyout](#) on page 7601, spin the viewpoint freely around a center.

Three variants are available: Orbit, Orbit Selected, and Orbit Sub-Object.

The Orbit function is [modal](#) on page 8045: It remains active until you right-click or choose another command.



Orbit respects [Angle Snap](#) on page 2654. If you turn on Angle Snap, the Orbit mouse pointer displays a magnet, and the rotation snaps by the [Viewport Orbit Snap Angle setting](#) on page 7782.

Orbiting uses a hidden “virtual target” as center of rotation. Holding down the Ctrl key in Orbit mode has a special behavior: It performs a rotation of the scene around the screen’s X and Y axis (at the position of the virtual target). Moving the mouse horizontally yields rotation around *world*-coordinates referential Z axis. Moving the mouse vertically yields rotation around world-coordinates referential X axis. This differs from standard Orbit, in which horizontal mouse movement rotates around *screen*-coordinates referential Y axis.

TIP An alternative method for orbiting the viewport is the [ViewCube](#) on page 107

Procedures

To use Orbit:

- 1 Activate a Perspective or orthographic viewport.
- 2 Click any of the three Orbit buttons.

A view-rotation “trackball” is displayed as a yellow circle with handles placed at the quadrant points.

- 3 Drag the mouse on and around the trackball to produce different types of view rotations. The cursor changes to indicate the type of rotation in effect:
 - To rotate the view freely within the viewport, drag inside the trackball. The free rotation continues while dragging even if the cursor crosses outside the trackball.
 - To constrain the rotation to the horizontal or vertical axis, drag the trackball handles. Drag horizontally on the side handles, or vertically on the top or bottom handle.
 - To rotate the view about the depth axis that is perpendicular to the screen, drag outside the trackball. When the cursor crosses inside the trackball during dragging, free rotation occurs. When the cursor crosses back outside the trackball, spinning rotation is again in effect.
- 4 To exit the Orbit function, press Esc or right-click within the viewport.

To constrain rotation to a single axis:

- Hold down the Shift key as you rotate.
The rotation is constrained to the first axis you use.

To rotate with keyboard and mouse:

- Hold down the Shift key as you rotate.
The rotation is constrained to the first axis you use.

Interface



Orbit Uses the view center as the center of rotation. If objects are near the edges of the viewport, they might rotate out of view.



Orbit Selected Uses the center of the current selection as the center of rotation. The selected object remains at the same position in the viewport while the view rotates around their center.



Orbit SubObject Uses the center of the current sub-object selection as the center of rotation. The selection remains at the same position in the viewport while the view rotates around its center.

Camera Viewport Controls

Right-click any viewport label. > Views > Choose a camera.

Keyboard > C

A Camera viewport shows the view from a camera, looking in the direction it's aimed.



Camera viewport controls include the following. Two of these controls are available in all viewports.

[Dolly Camera, Target, or Both](#) on page 7605

[Perspective](#) on page 7607

[Roll Camera](#) on page 7608

[Zoom Extents All, Zoom Extents All Selected](#) on page 7588 (available in all viewports)

[Field-of-View Button](#) on page 7596

[Truck Camera](#) on page 7610

[Orbit/Pan Camera](#) on page 7611

[Maximize Viewport Toggle](#) on page 7589 (available in all viewports)

Activate a Camera view from the viewport right-click menu, under Views. If the scene contains more than 10 cameras, the last entry in the list is "More Cameras." Choose this to display the Choose A View dialog, which shows the complete list.

If a single camera is selected and you press C, the active viewport switches to the view from that camera. If, when you press C, the scene contains more than one camera and no camera or multiple cameras are selected, the Select Camera dialog appears; choose a camera from the list.

Procedures

To undo changes to a Camera viewport, do one of the following:

-  Click Undo on the main toolbar.

- Press Ctrl+Z.

NOTE This behavior differs from that of orthographic viewports, which require the use of Views menu > Undo, or Shift+Z.

Dolly Camera, Target, or Both



Activate a Camera viewport. > Viewport navigation controls > Dolly Camera or Dolly Target or Dolly Camera + Target

The buttons on this flyout replace the Zoom button when a Camera viewport is active. Use them to move the camera and/or its target along the camera's main axis, toward or away from what the camera is pointing at.

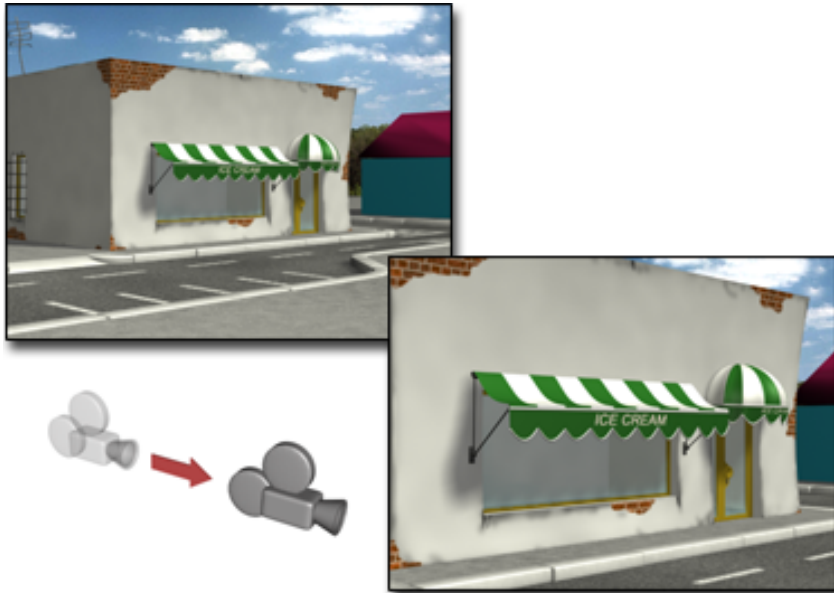

Dollying a camera

A free camera moves along its depth axis in the direction its lens is pointing. Unlike a target camera, its target distance remains fixed, no matter how far you dolly.

NOTE The three buttons of the Dolly Camera flyout are available when a target camera viewport is active. When a free camera viewport is active, the button appears as a flyout, but only Dolly Camera is available for this type of camera. If you activate a target camera viewport, the three buttons are again available.

See also:

- [Dolly Light, Target, or Both](#) on page 7616

Procedures

To dolly a camera:

- 1 Activate a Camera viewport.
- 2 Click one of the buttons on the Dolly Camera flyout.
- 3 Drag to move the camera.
 - Drag up to move the camera forward along its line of sight.
 - Drag down to move the camera backward along its line of sight.
- 4 Press Esc or right-click to turn off the button.

Interface



The Dolly Camera flyout consists of the following individual buttons:



Dolly Camera Moves only the camera to and from its target. If you go past the target, the camera flips 180 degrees and moves away from its target.



Dolly Target Moves only the target to and from the camera. You see no visual change in the camera viewport, unless you dolly the target to where it passes through the camera to the other side, at which point the camera view is reversed. However, changing the relative position of the target to the camera

affects other adjustments, such as Orbit Camera, which uses the target as its rotational pivot.

This option is available only if the viewport's camera is a target camera.



Dolly Camera + Target Moves both the target and the camera to and from the camera.

This option is available only if the viewport's camera is a target camera.

Perspective

Activate a Camera viewport. > Viewport navigation controls > Perspective

Perspective performs a combination of [FOV](#) on page 7972 and [Dolly](#) on page 7605 for target cameras and free cameras. It increases the amount of perspective flare, while maintaining the composition of the scene.

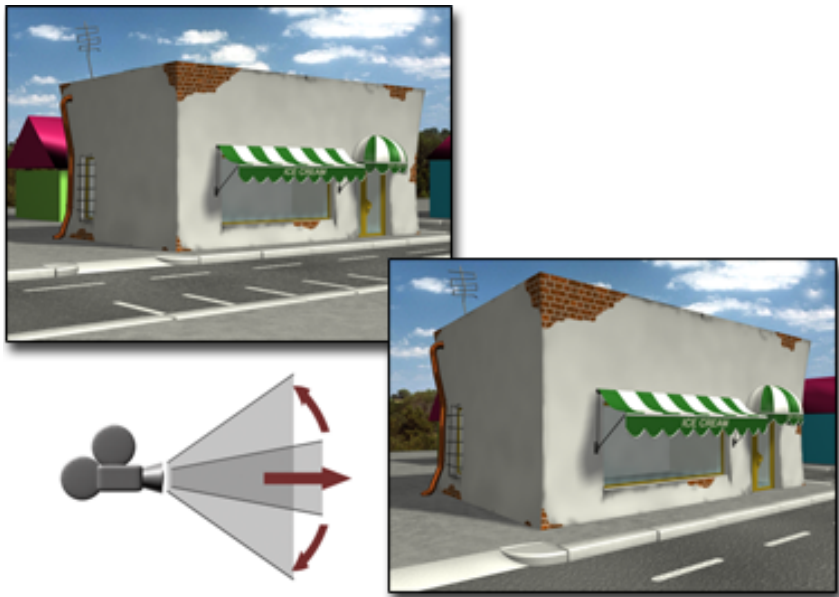

Adjusting perspective

NOTE This button replaces the Zoom All button when a Camera viewport is active.

TIP Hold down the Ctrl key to magnify the effect of the mouse on perspective adjustment.

A target camera can pass through its target object while you are using Perspective. When this happens, the FOV reaches its maximum angle of 180 degrees at the target location and cursor motion is reversed until you release the drag.

A free camera continues moving along an infinite path but uses an implied target position to control the FOV change rate. This implied target is defined as a point specified by the Target Distance field in the Parameters rollout for the free camera.

Procedures

To change perspective for a camera:

- 1 Activate a Camera viewport.



- 2 Click Perspective.

The button turns yellow when it is on.

- 3 Drag to change FOV and dolly simultaneously.

- Drag up to move the camera closer to its target, widen the FOV, and increase perspective flare.
- Drag down to move the camera away from its target, narrow the FOV, and decrease perspective flare.

- 4 Press Esc or right-click to turn off the button.

Roll Camera

Activate a Camera viewport. > Viewport navigation controls > Roll Camera

Roll Camera rotates a target camera about its line of sight, and rotates a free camera about its local Z axis.

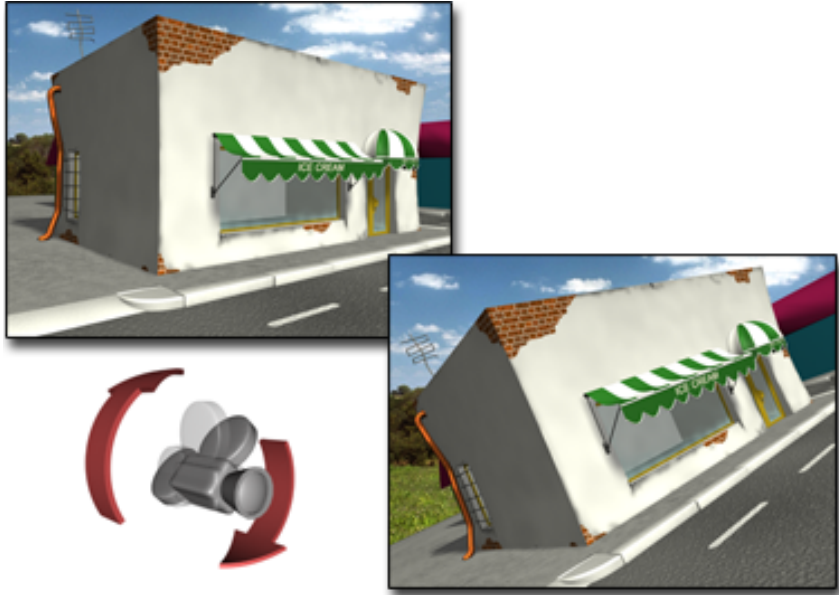

Rolling a camera

NOTE This button replaces the Zoom Extents button when a Camera viewport is active.

Procedures

To roll a camera:

- 1 Activate a Camera viewport.
- 2  Click Roll Camera.
The button highlights when it is on.
- 3 Drag horizontally to roll the view.
- 4 Press Esc or right-click to turn off the button.

Truck Camera



Activate a Camera viewport. > Viewport navigation controls > Truck Camera

Truck Camera moves the camera parallel to the view plane.

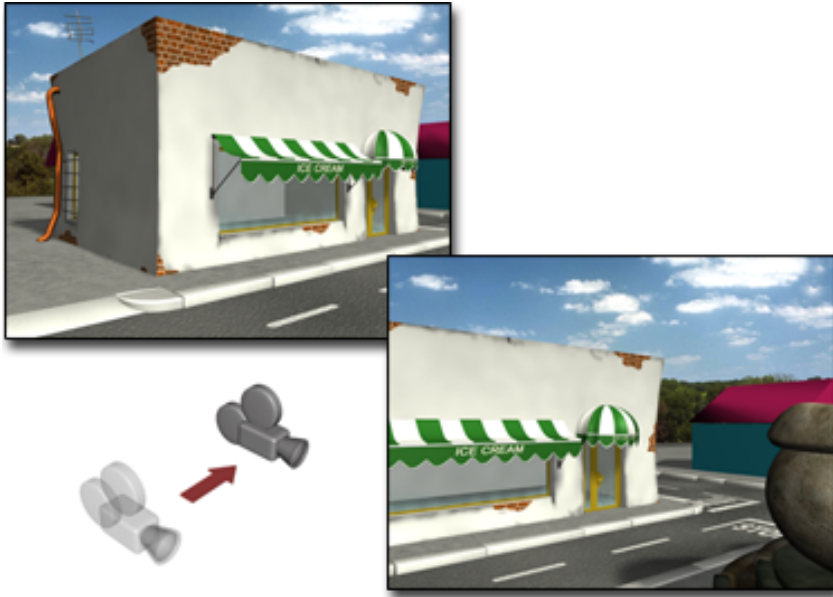

Trucking a camera

For a target camera, dragging the mouse moves both the camera and its target parallel to the Camera view.

This button replaces the Pan button when a Camera viewport is active.

Procedures

To truck a camera:

- 1 Activate a Camera viewport.

- 2  Click Truck Camera.

The button highlights when it is on.

- 3 Drag to move the camera and its target.
The camera and its target move parallel to the view plane, which is perpendicular to the camera's line of sight.
- 4 Press Esc or right-click to turn off the button.

To truck with the middle mouse button:

- Hold down the middle mouse button and drag.

To constrain trucking to a single axis:

- Hold down the Shift key.
The truck is constrained to the first axis you move while the Shift key is down.

To accelerate trucking:

- Hold down the Ctrl key.



Orbit/Pan Camera

Activate a Camera viewport. > Viewport navigation controls > Orbit Camera

Orbit Camera rotates a camera about the target. Pan Camera rotates the target about the camera.



Orbiting a camera



Panning a camera

NOTE This button replaces the Orbit button when a Camera viewport is active.

You can constrain the rotation to a single axis by first pressing Shift before beginning the rotation. The rotation is constrained to the axis you begin rotating about.

To accelerate panning, hold down the Ctrl key before you pan.

Procedures

To pan a camera:

- 1 Activate a Camera viewport.



- 2 Click Pan Camera.

The button highlights when it is on.

- 3 Drag to rotate the view about the camera.

- Dragging rotates the view freely using the world X and Y axes.
- Press Shift and drag horizontally to lock view rotation about the world Y axis. This produces a horizontal pan.
- Press Shift and drag vertically to lock rotation about the world X axis. This produces a vertical pan.

- 4 Press Esc or right-click to turn off the button.

To orbit a camera:

- 1 Activate a Camera viewport.



- 2 Click Orbit Camera.

- 3 Drag to rotate the view around the target.

- Dragging rotates the view freely using the world X and Y axes.
- Press Shift and drag horizontally to lock view rotation about the world Y axis. This produces a horizontal orbit.
- Press Shift and drag vertically to lock rotation about the world X axis. This produces a vertical orbit.

- 4 Press Esc or right-click to turn off the button.

Interface



Orbit Camera Rotates a target camera about its target. Free cameras use the invisible target, set to the target distance specified in the camera Parameters rollout.



Pan Camera Rotates the target about a target camera. For a free camera, rotates the camera about its local axes.

Light Viewport Controls

Right-click any viewport label. > Views > Choose a light.

Keyboard > \$

A Light viewport shows the view from a spotlight or directional light, looking at its target.



Light viewport controls include the following. Two of these controls are available in all viewports.

[Dolly Light, Target, or Both](#) on page 7616

[Light Hotspot](#) on page 7618

[Roll Light](#) on page 7620

[Zoom Extents All, Zoom Extents All Selected](#) on page 7588 (available in all viewports)

[Light Falloff](#) on page 7622

[Truck Light](#) on page 7624

[Orbit/Pan Light](#) on page 7626

[Maximize Viewport Toggle](#) on page 7589 (available in all viewports)

For [photometric lights](#) on page 5005, the Light Hotspot control actually adjusts the beam angle. At the beam angle, the light is 50 per cent of the maximum intensity.

Targeted photometric lights can be used as views only when the light's distribution is set to spotlight.

WARNING Switching to or from a light view clears the Undo/Redo lists.

Procedures

To set a Light viewport:

- 1 Activate the viewport you want to show the view from a spotlight or directional light in the scene.
- 2 Do one of the following:
 - Press the keyboard shortcut `$`.
 - Right-click the Viewport label. Choose Views and then choose the light from the Views submenu.
- 3 If you have more than one spotlight or directional light in the scene (and none is selected), the Select Light dialog is displayed: choose the light you want.
- 4 If there are more than 10 lights listed, the last entry is "More Lights." Choose this to display the Choose a View dialog, which shows the complete list.

To undo changes to a Light viewport, do one of the following:

- 1  Click Undo on the main toolbar.
- 2 Press `Ctrl+Z`.

NOTE This is different from orthographic viewports, which require the use of Views menu > Undo, or `Shift+Z`.

Dolly Light, Target, or Both

Activate a Light viewport. > Viewport navigation controls > Dolly Light

Dolly Light, on the Dolly Light flyout (see below) moves the light or its target or both along the light's main axis, toward or away from what the light is pointing at. A free light moves along its depth axis in the direction its lens is pointing. On a target light, the target distance remains fixed, no matter how far you dolly.

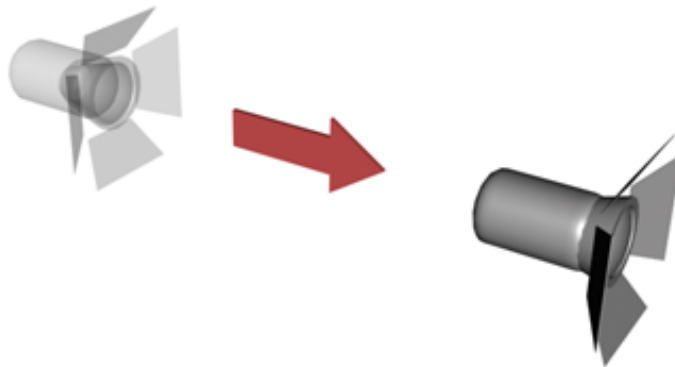

Dollying a light

When you dolly a light, the light source moves closer to and away from its target. Because spotlights have conical beams, dollying a spotlight closer to its target shrinks the area illuminated at the target. Similarly, dollying a spotlight away from its target expands the area illuminated at the target.

The three buttons of the Dolly Light flyout are available when a target light viewport is active. When a free light viewport is active, the button appears as a flyout, but only Dolly Light is available for this type of light. If you activate a target light viewport, the three buttons are again available.

The buttons on this flyout replace the Zoom button when a Light viewport is active.

See also:

- [Dolly Camera, Target, or Both](#) on page 7605

Procedures

To dolly a light:

- 1 Activate a Light viewport.



- 2 Click Dolly Light.

The button highlights when it is on.

- 3 Drag to move the light.

- Drag up to move the light forward along its line of sight.
- Drag down to move the light backward along its line of sight.

- 4 Press Esc or right-click to turn off the button.

Interface



The Dolly Light flyout consists of the following buttons:



Dolly Light Moves only the light to and from its target. If you go past the target, the light flips 180 degrees and moves away from its target.



Dolly Target Moves only the target to and from the light. You see no visual change in the light viewport, unless you dolly the target to where it passes through the light to the other side, at which point the light view is reversed. However, changing the relative position of the target to the light

affects other adjustments, such as Orbit Light, which uses the target as its rotational pivot.

This option is available only if the viewport's light is a target light.



Dolly Light + Target Moves both the target and the light to and from the light.

This option is available only if the viewport's light is a target light.

Light Hotspot

Activate a Light viewport. > Viewport navigation controls > Light Hotspot

Light Hotspot lets you adjust the angle of a light's [hotspot](#) on page 8007. This button replaces the Zoom All button when a light viewport is active.

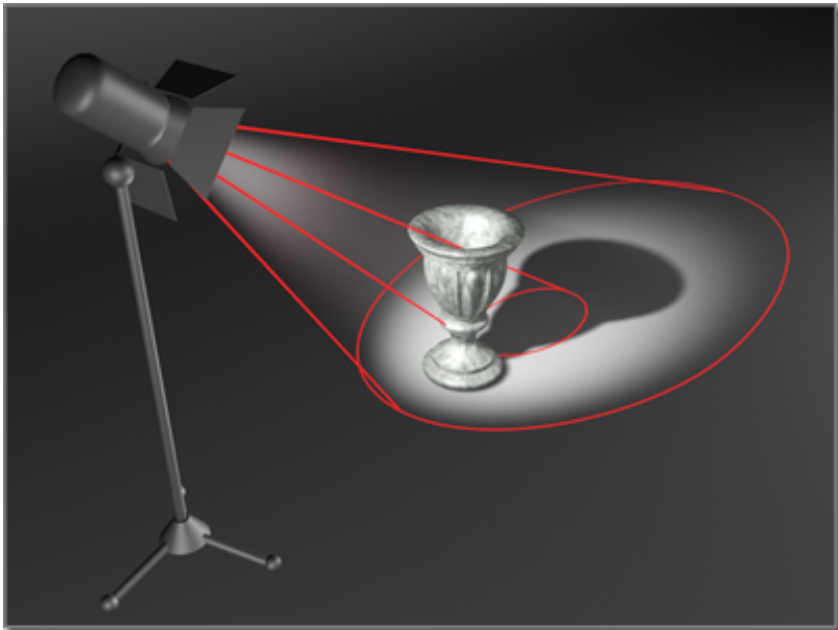

The floodlight has a narrow hotspot but a wide falloff area.

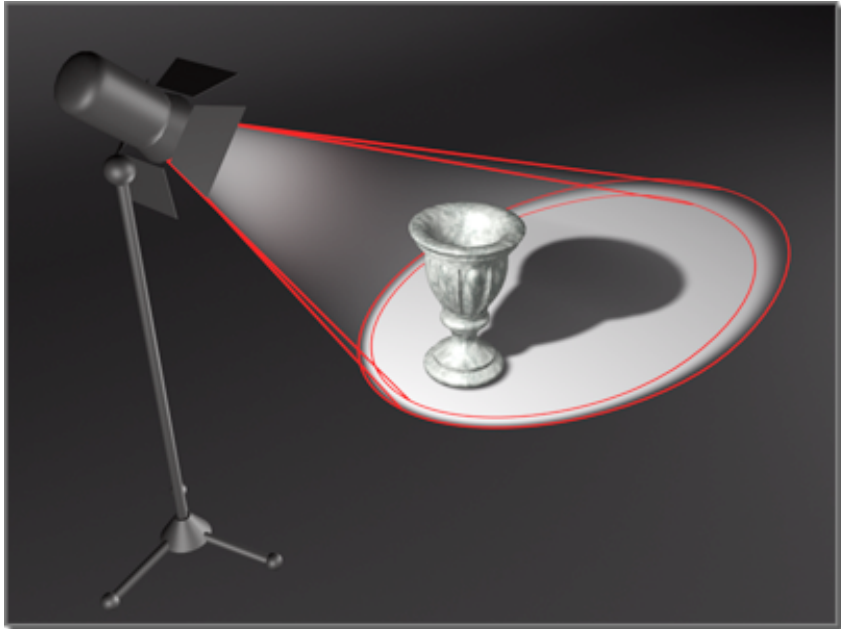

Widening the hotspot creates a brighter light.

Click this button, then move the mouse in the light viewport to make the cone of the hotspot narrower or wider (the hotspot cone is shown in blue, the [falloff](#) on page 8007 cone is in gray).

Hold down the Ctrl key while moving the mouse to lock the initial angle separation of the hotspot and falloff cones.

You can't adjust the hotspot larger than the falloff, because that would change the falloff value. Likewise, when you reduce the falloff, it stops at the hotspot size (in both cases, separated by the [Angle Separation](#) on page 7768, specified on the Rendering page of the Preferences dialog).

To override the separation of the hotspot and falloff parameters and cause the parameters to affect each other, hold down the Shift key.

For more information on the hotspot and falloff parameters, see [Spotlight Parameters](#) on page 5090 and [Directional Parameters](#) on page 5088.

NOTE If the light is a [photometric light](#) on page 5005 with spotlight distribution, this button controls the light's beam angle. At the beam angle, the light's intensity has fallen to 50 per cent (rather than 100 per cent at the hotspot angle for a standard light).

Procedures

To change a light's hotspot:

- 1 Set up a Perspective viewport so you can see the light in 3D space.
- 2 Activate a Light viewport.
- 3 Press H to display the [Select From Scene dialog](#) on page 228. Select the light.
The light and its cones should be visible in the Perspective viewport.



- 4 Click Light Hotspot.

The button highlights when it is on.

- 5 Drag in the Light viewport to change the hotspot angle.
The blue hotspot cone expands and contracts as you drag.
 - Drag down to widen (increase) the hotspot angle and illuminate more of the scene. The hotspot grows inside the falloff as its angle increases. By default, the hotspot can be no larger than the falloff cone.
 - Hold down Shift as you drag to override the default. This lets the falloff cone increase in size as you increase the size of the hotspot cone.
 - Drag up to narrow (decrease) the hotspot angle and illuminate less of the scene.
 - Hold down Ctrl as you drag to lock the initial angle separation of the hotspot and falloff cones.
- 6 Press Esc or right-click to turn off the button.

Roll Light



Activate a light viewport. > Viewport navigation controls > Roll Light

Roll Light rotates the light about its own line of sight (the light's local Z axis).

Although Roll does change the light view, it affects the light object only if the light casts a rectangular beam or is a [projector](#) on page 8099.

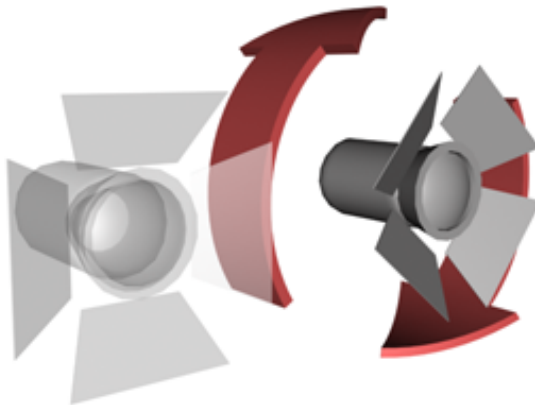

Rolling a light

Drag the mouse horizontally to roll a target light or rotate a free light about its local Z axis.

This button replaces the Zoom Extents button when a light viewport is active.

Procedures

To roll a light:

- 1 Activate a Light viewport.
- 2  Click Roll Light.
The button highlights when it is on.
- 3 Drag horizontally to roll the view.
- 4 Press Esc or right-click to turn off the button.

Light Falloff

Activate a Light viewport. > Viewport navigation controls > Light Falloff

Light Falloff adjusts the angle of a light's [falloff](#) on page 8007. This button replaces the Zoom Region button when a light viewport is active.

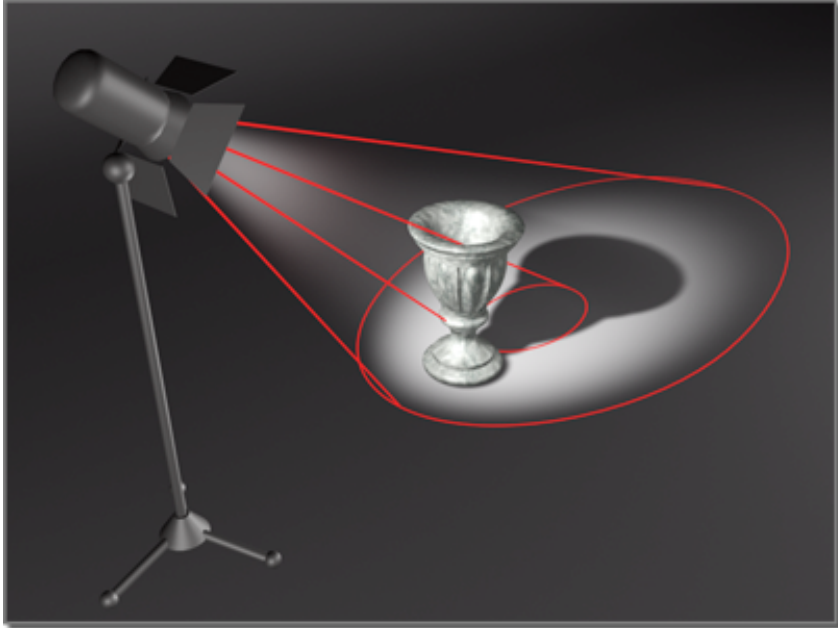

The light has a narrow hotspot but a wide falloff area.

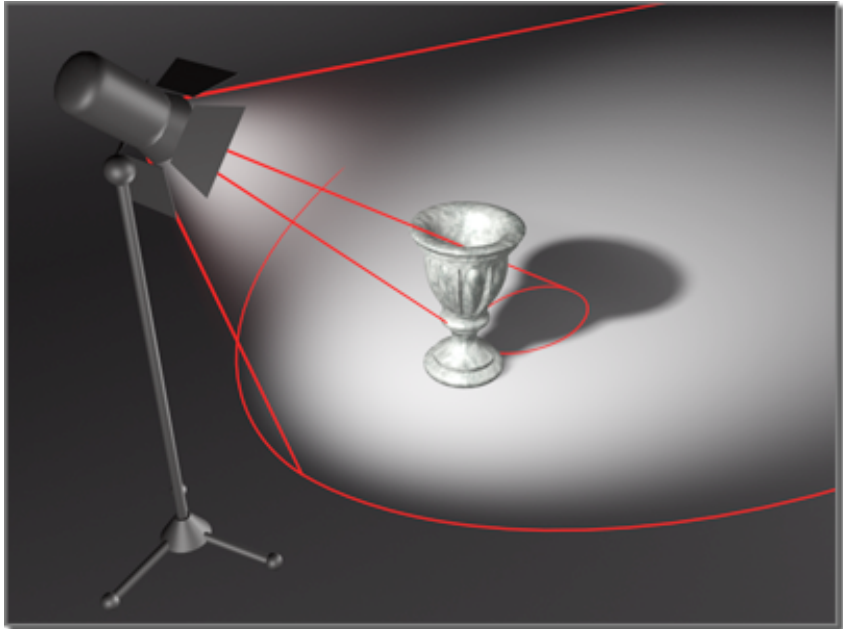

Making the falloff even wider illuminates a larger area.

Click Light Falloff, then move the mouse in the light viewport to make the falloff narrower or wider (the falloff extents are shown in gray, the [hotspot](#) on page 8007 is in blue).

Hold down the Ctrl key while moving the mouse to lock the initial angle separation of the hotspot and falloff cones.

You can't adjust the hotspot larger than the falloff, because that would change the falloff value. Likewise, when you reduce the falloff, it stops at the hotspot size (in both cases, separated by the [angle separation](#) on page 7768, specified on the Rendering page of the Preferences dialog).

To override the separation of the hotspot and falloff parameters and cause the parameters to affect each other, hold down the Shift key.

For more information on the hotspot and falloff parameters, see [Spotlight Parameters](#) on page 5090 and [Directional Parameters](#) on page 5088.

Procedures

To change a light's falloff:

- 1 Set up a Perspective viewport so you can see the light in 3D space.
- 2 Activate a Light viewport.
- 3 Press H to display the Select Object dialog. Select the light.
The light and its cones should be visible in the Perspective viewport.



- 4 Click Light Falloff.

The button highlights when it is on.

- 5 Drag in the Light viewport to change the falloff angle.

The gray falloff cone expands and contracts as you drag.

- Drag down to widen (increase) the falloff angle and illuminate more of the scene.
- Drag up to narrow (decrease) the falloff angle and illuminate less of the scene. As its angle decreases, the falloff shrinks around the hotspot. By default, the falloff cone can be no smaller than the hotspot cone.
- Hold down Shift as you drag to override the default. This lets the hotspot cone decrease in size as you decrease the size of the falloff cone.
- Hold down Ctrl as you drag to lock the initial angle separation of the hotspot and falloff cones.

- 6 Press Esc or right-click to turn off the button.

Truck Light



Activate a light viewport. > Viewport navigation controls > Truck Light

Truck Light moves a target light and its target parallel to the light view, and moves a free light along its XY axis.

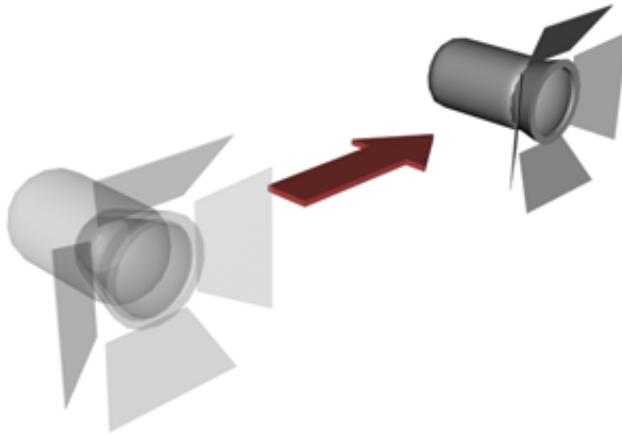

Trucking a light

To constrain trucking of any viewport to a single axis, hold down the Shift key. The truck is constrained to the first axis you move while the Shift key is down.

To accelerate trucking, hold down the Ctrl key.

NOTE This button replaces the Pan button when a light viewport is active.

Procedures

To truck a light:

- 1 Activate a Light viewport.
- 2  Click Truck Light.
The button highlights when it is on.
- 3 Drag to move the light and its target.

The camera and its target move parallel to the view plane, which is perpendicular to the camera's line of sight.

- 4 Press Esc or right-click to turn off the button.

To truck with the middle mouse button:

- Hold down the middle mouse button and drag.

To constrain trucking to a single axis:

- Hold down the Shift key.
The truck is constrained to the first axis you use.



Orbit/Pan Light

Activate a light viewport. > Viewport navigation controls > Orbit/Pan Light flyout

Orbit rotates a light about the target. Pan rotates the target about the light.

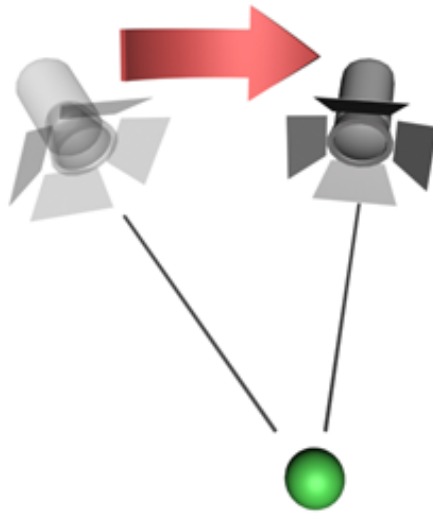

Orbiting a light

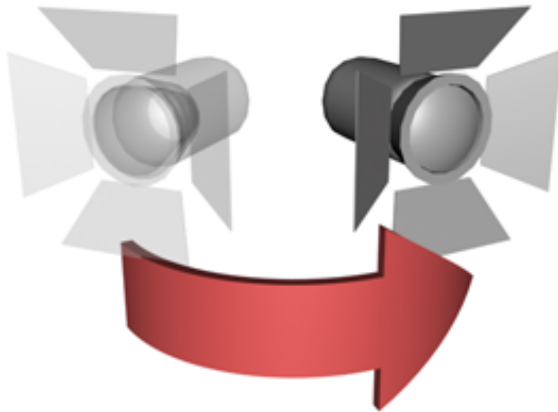

Panning a light

To constrain panning or orbiting to a single axis, hold down the Shift key. The pan or orbit is constrained to the axis you first move while the Shift key is down.

To accelerate panning or orbiting, hold down the Ctrl key before you pan or orbit.

NOTE This button replaces the Orbit button when a light viewport is active.

Procedures

To orbit a light:

- 1 Activate a Light viewport.

- 2  Click Orbit Light.

The button highlights when it is on.

- 3 Drag to rotate the view around the target.
 - Dragging rotates the view freely using the world X and Y axes.
 - Press Shift and drag horizontally to lock view rotation about the world Y axis. This produces a horizontal orbit.
 - Press Shift and drag vertically to lock rotation about the world X axis. This produces a vertical orbit.
- 4 Press Esc or right-click to turn off the button.

To pan a light:

- 1 Activate a Camera or Light viewport.



- 2 Click Pan Light.

The button highlights when it is on.

- 3 Drag to rotate the view about the camera or light.
 - Dragging rotates the view freely using the world X and Y axes.
 - Press Shift and drag horizontally to lock view rotation about the world Y axis. This produces a horizontal pan.
 - Press Shift and drag vertically to lock rotation about the world X axis. This produces a vertical pan.
- 4 Press Esc or right-click to turn off the button.

Interface



Orbit Light Rotates the light about its target. Free lights use the invisible target, set to the target distance specified in the Modify panel > Spotlight Parameters or Directional Parameters rollout.









Pan Light For a target light, rotates the target about the light. For a free light, rotates the light about its local axes.

Command Panel

The command panel comprises six user-interface panels that give you access to most of the modeling features of 3ds Max, as well as some animation features, display choices, and miscellaneous utilities. Only one panel is visible at a time. To display a different panel, you click its tab at the top of the command panel.

These are the panels:

-  [Create panel](#) on page 7631
Contains controls for creating objects: geometry, cameras, lights, and so on.
-  [Modify panel](#) on page 7633
Contains controls for applying [modifiers](#) on page 8048 to objects and editing editable objects such as meshes and patches.
-  [Hierarchy panel](#) on page 7661
Contains controls for managing links in a hierarchy, joints, and inverse kinematics.
-  [Motion panel](#) on page 7663
Contains controls for animation controllers and trajectories.
-  [Display panel](#) on page 7665
Contains controls that let you hide and unhide objects, along with other display options
-  [Utilities panel](#) on page 7671
Contains miscellaneous utility programs.

By default, the command panel appears at the right of the 3ds Max window. You can "dock" it along other edges of the program window, or make it a floating panel. See [Customizing the User Interface](#) on page 7683.

Object Name and Wireframe Color

Create panel > Any object category > Name And Color rollout

Modify, Hierarchy, Motion, Display, or Utilities panel > Name field and color swatch

The name and color fields appear at the top of all command panels other than the Create panel. On the Create panel, the fields are contained in a rollout. You can change an object's name or color from any of these locations.

Interface



Name (text field) Displays the name of the selected object and lets you enter a new name from the keyboard. Available only when a single object is selected.

Color (swatch) Displays the selected object's wireframe color and lets you select a new one. The wireframe color is the one used to display the object in viewports. Click the color swatch to display the [Object Color dialog](#) on page 387.

Create Panel

Command panels > Create panel

The Create panel provides the controls for creating objects. This is the first step in building a new scene in 3ds Max. Most likely, you will continue to add objects throughout an entire project. For example, when it is time to render a scene you might need to add more lights.







The Create panel groups the kinds of objects you create into seven categories. Each category has its own button. Within each category there can be several different subcategories of objects. A drop-down list lets you choose among object subcategories, and each kind of object has its own button, which you click to begin creation.

These are the categories of objects that the Create panel provides:



- [Geometry](#) on page 377

Geometry is the renderable geometry of the scene. There are geometry primitives such as Box, Sphere, Pyramid, and more advanced geometry such as Booleans, Lofts, and particle systems, as well as Doors and Stairs, AEC Extended objects such as Terrain and Railing.

-  [Shapes](#) on page 606
Shapes are splines or NURBS curves. They have only one local dimension, although they can exist in 2D space, such as a Rectangle shape, or 3D space, such as a Helix.
You can give shapes a thickness so they will render, but primarily you use them for constructing other objects such as Lofts, or for motion trajectories.
-  [Lights](#) on page 4970
Lights illuminate the scene and improve its realism. There are several kinds of lights, each of which models different types of lighting in the real world.
-  [Cameras](#) on page 5194
Camera objects provide a view of the scene. The advantages of cameras over the views in the standard viewports are that cameras have controls similar to real-world cameras, and that you can animate a camera's position.
-  [Helpers](#) on page 2587
Helper objects are aids to constructing a scene. They help you position, measure, and animate the scene's renderable geometry.
-  [Space Warps](#) on page 2685
Space warps produce various kinds of distortions in the space surrounding other objects. Some space warps are meant especially for use with particle systems.
-  [Systems](#) on page 899
Systems combine objects, controllers, and hierarchies to provide geometry associated with some kind of behavior. Also contains Sunlight and Daylight systems that simulate sunlight in your scenes.

Modify Panel

Command panels > Modify panel

From the Create panel of 3ds Max, you place basic objects in your scene, including 3D geometry, 2D shapes, lights and cameras, space warps, and helpers. As you do this, you give each object its own set of creation parameters, which define its geometry and other characteristics depending on the type of object. Once placed in a scene, objects carry their creation parameters with them. You can change these parameters on the Modify panel.

You also use the Modify panel to assign [modifiers](#) on page 8048. Modifiers are tools for reshaping an object. While they mold the final appearance of the object, modifiers do not change its underlying creation parameters. See the [list of available modifiers](#) on page 1081.

You use the Modify panel to:

- Change the creation parameters for existing objects.
- Apply modifiers to adjust the geometry of an object or a set of objects.
- Change the parameters of modifiers and select their components.
- Delete modifiers.
- Convert a parametric object to an editable object; see [Modifier Stack Controls](#) on page 7635.

NOTE Some space warps can be created as modifiers. See [World Space Modifiers \(WSMs\)](#) on page 1113.

The Modify panel stays in view until you dismiss it by clicking the tab of another command panel. The contents of the panel with its options and controls update when you select an object, giving you access only to what you can modify about that object.

What you can modify depends on whether an object is classed as a geometric primitive like a sphere, or as another kind of object, such as a light or a space warp. Each category has its own range of possibilities. The contents of the Modify panel are always specific to the category as well as to the selected object. When you make a change from the Modify panel, you immediately see the results transferred to the object.

You can change or delete modifiers by using the [Modifier Stack Controls](#) on page 7635.

See also:

- [List of Available Modifiers](#) on page 1081

Procedures

To use the Modify panel:

- 1 Select an object.



- 2 On the Command panel, click the Modify tab to display the Modify panel.

The name of the object appears at the top of the Modify panel, and the remainder of the panel displays settings for the object or the modifier at the top of its stack.

- 3 You can now do any of the following:

- Change the parameters for the object. As you change these parameters, the object updates in the viewports.
- Apply a modifier to the object.
- Change the parameters for a modifier. As you change these parameters, the object updates into the viewports.
- Collapse the stack to create an editable surface such as an [editable mesh](#) on page 2075.

To apply a modifier from the Modify panel:

- 1 Select an object.



- 2 On the Command panel, click the Modify tab to display the Modify panel. On the Modify panel, click the Modifier List items to open the drop-down list of modifiers.

- 3 Scroll the list to find the modifier you want. You can use any standard method to scroll the list:
 - From the keyboard, press Up Arrow or Down Arrow to scroll one item at a time, or press Page Up or Page Down to scroll in screen-height increments, or use Home or End to jump to the top or bottom of the list. The name of the chosen modifier is highlighted, and the name appears at the top of the list.

TIP If you know the modifier name, you can jump to its section by pressing the keyboard key corresponding to first letter of the name. To cycle through all modifiers starting with that letter, press the key repeatedly.

 - With the mouse, slide the scroll bar on the right side of the list, or turn the mouse wheel.
- 4 Apply the modifier. If using the keyboard, press Enter to apply the highlighted modifier. If using the mouse, simply click the modifier name to apply it.

Modifier Stack Controls

Make selection. > Modify panel

*see*The modifier stack controls appear near the top of the Modify panel, just below the name and color fields. The modifier stack ("stack" for short) contains the accumulated history of an object, including its creation parameters and the modifiers applied to it. At the bottom of the stack is the original object. Above the object are the modifiers, in order from bottom to top. This is the order in which modifiers are applied to the object's geometry.

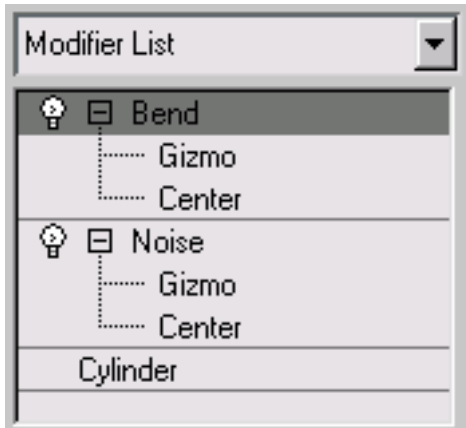

Object with two modifiers applied to it in the stack

See also:

- [Applying Modifiers](#) on page ?
- [Using the Modify Panel](#) on page 1086
- [Using the Modifier Stack](#) on page 1090
- [List of Available Modifiers](#) on page 1081
- [World-Space Modifiers \(WSMs\)](#) on page 1113
- [Object-Space Modifiers](#) on page 1202

Instances and References in the Modifier Stack Display

In the modifier stack display, objects and modifiers appear in normal type unless they are an instance or a reference. Here is how instances and references appear in the stack display:

- The name of an instanced object appears in boldface.
- The name of a modifier appears in boldface if it is part of an instanced pipeline.



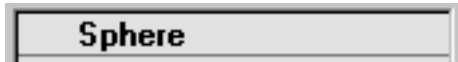

Top: Plain object displayed in plain text

Bottom: Object instance displayed in boldface

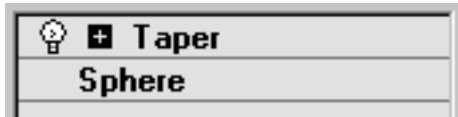
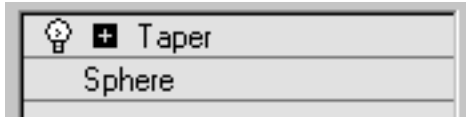

Top: Pipeline displayed in plain text

Bottom: Pipeline instance displayed in boldface

- If a modifier is applied to two or more pipelines, it is called an instanced modifier. Its name appears in italic.
- If a modifier is instanced *and* part of an instanced pipeline, its name appears in boldface and italic.

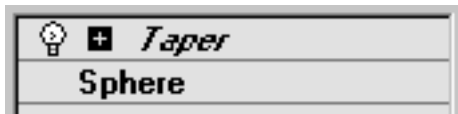
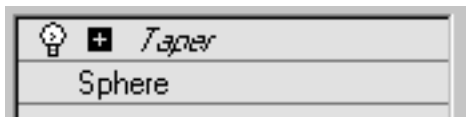

Top: Instanced modifier displayed in italic
(modifier applied to two objects)

Bottom: Instanced modifier in an instanced
pipeline displayed in italic and boldface

- A referenced object appears with a dark bar above it. Modifiers below the bar are part of the current pipeline. Modifiers above the bar are unique to the reference object.

NOTE You can also create instances of a reference. In this case, the modifier above the reference bar apply to the reference and to its instances.

- A modifier above the reference object bar can itself be an instance and appear in other pipelines, in which case its name would be italic (either plain or boldface).



Top: Object reference shows a bar in the pipe

Bottom: Modifier applied to reference is not bold, as it is unique to this reference



The [Make Unique button](#) on page 7654 makes a pipeline or a modifier instance unique. When you highlight the base object and then click Make Unique, the whole pipeline becomes unique. When you highlight a bold modifier and then click Make Unique, this also makes the pipeline unique. If the modifier is an instanced modifier that belongs to an instanced pipeline (it appears in boldface *and* italic), clicking Make Unique makes the modifier unique but not the entire pipeline (the modifier's name is no longer italic, but it is still bold).

See also:

- [How Instanced Modifiers Work](#) on page 1110
- [Transforms, Modifiers, and Object Data Flow](#) on page 1074

Most-Recently-Used Modifiers

3ds Max caches the results of evaluating most-recently-used modifiers. This means that in general, you can see results more quickly as you move among modifiers on the stack.

To conserve memory use, the list of most-recently-used modifiers has a fixed length. Once the list is full, adding a new modifier removes the oldest modifier in the list. By default, the list length is 1. You can increase it by adding an

MRUModSize entry to the [Performance] section of the [3dsmax.ini](#) on page 83 file. For example:

```
MRUModSize=10
```

A good rule of thumb for this value is 10, but results will vary depending on how much main memory your system has.

Procedures

To adjust an object's creation parameters:

- 1 Choose the object by clicking its name in the stack.
Primitive objects have a Parameters rollout. Other kinds of objects (such as meshes or NURBS) have a variety of rollouts.
- 2 Use the controls in the rollouts to adjust the object.

To apply a modifier to an object:

- 1 Select the object.
- 2 Do one of the following:
 - Choose a modifier from the Modifier List. This is a drop-down list at the top of the Modify panel.

TIP

In many cases, multiple modifiers' names start with the same letter. You can go directly to a particular modifier if you type the first few letters (enough for a unique combination) in the desired modifier's name quickly. For example, say you want to assign the Mirror modifier to an object. Pressing M goes to Mesh Select, which isn't anywhere near Mirror in the Modifier list, but typing Ml goes directly to Mirror.

- Choose a modifier from the Modifiers menu. This menu is organized into sets by functionality.
Not all modifiers appear on the Modifiers menu.
- If the modifier buttons are visible on the Modify panel and the modifier you want is one of them, click the button.



If the buttons are not visible but you want to use them, click the [Configure Modifier Sets button](#) on page 7658 (below the modifier stack display) and choose Show Buttons. A set of buttons with the

names of modifiers appears between the modifier list and the stack display. Click Configure Modifier Sets again, choose the set of modifiers you want to use (for example, Free-Form Deformations), and then click the button for the modifier you want to apply.

Rollouts are now displayed below the modifier stack display, showing settings for the modifier. As you change these settings, the object updates in viewports.

To remove a modifier:

- Do one of the following:

-  Choose the modifier by clicking its name in the stack, and then click Remove Modifier From The Stack. This button is one of the tools beneath the display of the modifier stack.
- Right-click the modifier's name in the stack and then choose Delete.

To turn the effect of a modifier off, do one of the following:

- 1  Click the light-bulb icon to the left of the modifier's name in the stack to turn it off.
When you apply a modifier, the light-bulb icon is on by default.
- 2 Right-click the modifier in the stack display, and choose Off.

To turn the effect of a modifier back on, do one of the following:

- 1  Click the light-bulb icon to the left of the modifier's name in the stack to turn it on.
- 2 Right-click the modifier in the stack display, and choose On.

To change the size of the modifier stack display:

- 1 Position the cursor over the shaded bar below the tool buttons beneath the stack list.
The cursor changes to an up-and-down resize arrow (as it does on the horizontal edges of a resizable window).

- 2 Drag the bar up or down to change the size of the stack display in the Modify panel.

To change a modifier's position in the stack:

- 1 Right-click the modifier's name in the stack, and choose Cut.
- 2 Right-click the name of the modifier you want the modifier to appear *before* (that is, *above*), and choose Paste.
You can also drag-and-drop the modifier to a different location in the stack.

NOTE The original object is always at the bottom of the stack, and world-space modifiers are always at the top.

To use the modifier buttons:

-  Click Configure Modifier Sets, and choose Show Buttons.
This menu item is a toggle. It is either on or off. When you turn on Show Buttons, the current button set appears between the drop-down modifier list and the stack display.
See [Configure Modifier Sets Dialog](#) on page 7658 for more information.

To turn the modified object into an editable mesh, do one of the following:

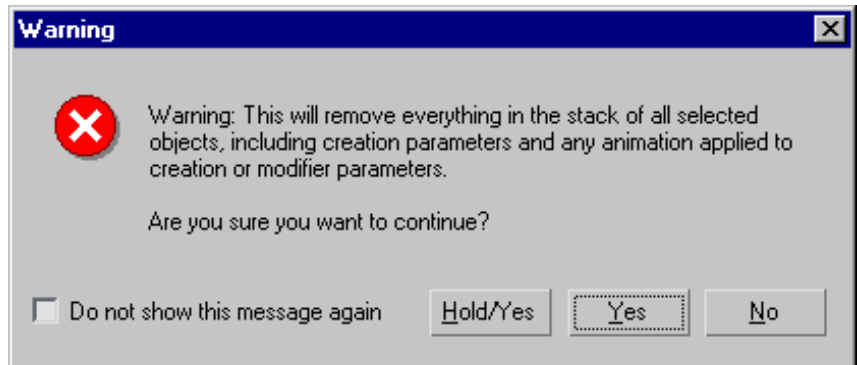

- 1 Right-click the modifier stack, and choose Collapse All.
A warning dialog is displayed that reminds you that the collapse operation cannot be undone, and gives you the option of performing a [Hold](#) on page 264 before creating the mesh.



- 2 Right-click the object in a viewport, and choose Convert To > Convert to Editable Mesh in the quad menu.

TIP You can also convert a modified object to an editable patch or editable polygon surface. Use the quad menu to do this.

To adjust a modifier's component such as its gizmo or center point:

- 1  Click the plus-sign icon to display the modifier's hierarchy.
- 2 Choose the component you want to adjust, such as the Gizmo. The component highlights to show it is active.
- 3 Adjust the component. For example, you might use transforms to move a gizmo or a center point.
- 4  When done, you can click the minus-sign icon to hide the hierarchy display. The modifier itself is highlighted again.

TIP You can also right-click the stack and use Show All Subtrees to view the entire hierarchy, and Hide All Subtrees to view only objects and modifiers.

To go to a sub-object level for complex objects:

- 1  Click the plus-sign icon to display the object's hierarchy.
- 2 Choose the sub-object level you want to adjust. The sub-object level highlights to show it is active. Keyboard shortcut: Insert cycles through the different sub-object levels.
- 3 Adjust sub-objects. When you add a new sub-object type, the modifier stack updates to show the new sub-object levels. For example, when you add a point curve sub-object to a NURBS surface, the Point and Curve sub-object levels appear in the stack.
- 4 To leave the sub-object level, click to select the name of the top-level object or a different top-level object.

TIP You can also right-click the stack and use Show All Subtrees to view the entire hierarchy, and Hide All Subtrees to view only objects and modifiers.

Interface

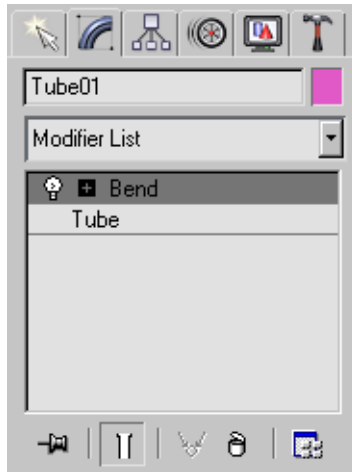

The Modifier Stack

Modifier List

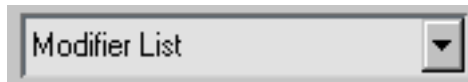

The modifier list is a drop-down list that lets you choose a modifier to add to the stack. When you choose an [object-space modifier](#) on page 1202 from this list, it appears above the object, or above the modifier that was currently selected in the stack. When you choose a [world-space modifier](#) on page 1113 from this list, it appears at the top of the stack.

Use Pivot Points The first item in the modifier list is the Use Pivot Points toggle. It is unavailable unless multiple objects are selected.

When Use Pivot Points is turned on, 3ds Max uses the pivot point of each object as the center of a modifier's operation. For example, if you bend a line of trees around the Z axis, they all bend along their trunks.

When Use Pivot Points is turned off, 3ds Max calculates a central pivot point for the entire selection set and modifies the selection as a whole. For example, if you bend a line of trees around the Z axis, trees at the end of the line deform more than those at the center where the pivot is located.

NOTE You must turn on Use Pivot Points before you apply the modifier to multiple objects. You can't change the setting afterward, although you can delete the modifier and start over without deselecting the selection set.

Modifier Buttons

Between the modifier list and the stack display, you can display up to 32 buttons. The buttons are a shortcut way to add modifiers to the stack.



To display the modifier buttons, click Configure Modifier Sets (below the stack display) and choose Show Buttons.



To customize the button set, click Configure Modifier Sets (below the stack display) and choose [Configure Modifier Sets](#) on page 7658.

When a modifier's button is visible, clicking the button adds the modifier to the stack. Object modifiers are applied immediately above the currently selected object or modifier. World space modifiers are applied at the top of the stack.

Stack Display

The modifier stack is organized as follows:

- At the bottom of the stack, the first entry always lists the object type. Click this entry to display the object's creation parameters so you can adjust them.

When you click to choose an entry in the modifier stack, its background highlights to show that the entry is current, and that the object's or modifier's parameters are available for adjusting, in rollouts that appear beneath the stack display.

- Above the object itself are entries for object modifiers. Click a modifier entry to display the modifier's parameters so you can adjust them. This section lets you go back to any modifier you've applied and rework its effect on the object. You can also delete the modifier from the stack, canceling its effect.

Reminder:3ds Max applies transforms *after* it applies object modifiers but *before* it applies space warps or world-space modifiers.

- The top of the stack shows which space warps and world-space modifiers the object uses. For example, if the object were bound to a Ripple space warp, an entry in the top section would read Ripple Binding.



To the left of each modifier in the stack is a light-bulb icon. When the bulb appears white, the modifier is applied to the stack below it. When the bulb appears gray, the modifier is turned off. Click to toggle the on/off state of the modifier.

NOTE You can also turn off the effect of modifiers in viewports but not in renderings, or vice versa. The light-bulb icon changes to show these states as well. See [Modifier Stack Right-Click Menu](#) on page 7648.



If the modifier has sub-controls such as a center or a gizmo, the stack also shows a small plus/minus icon. Click this icon to open or close the hierarchy.

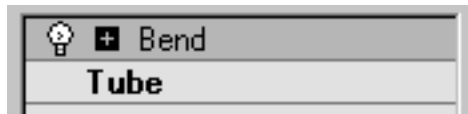

Opening a modifier's hierarchy to access sub-controls

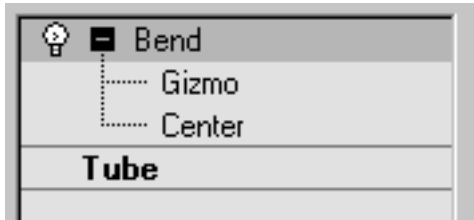

Opening a modifier's hierarchy to access sub-controls

When the hierarchy is open, you can select a sub-control, such as a gizmo, and then adjust it. The available sub-controls vary from modifier to modifier.

Objects that have a sub-object hierarchy, such as [editable meshes](#) on page 2075 and [NURBS](#) on page 2237, also show a collapsible hierarchy in the modifier stack.

To work at a sub-object level, click to open the hierarchy, then click to select the sub-object level. Controls for that particular level or type of sub-object appear in rollouts below the stack display.

(Certain types of sub-objects display an icon at the right of the stack, to help you see which sub-object type you are adjusting.)



Opening an object's hierarchy to access sub-object levels

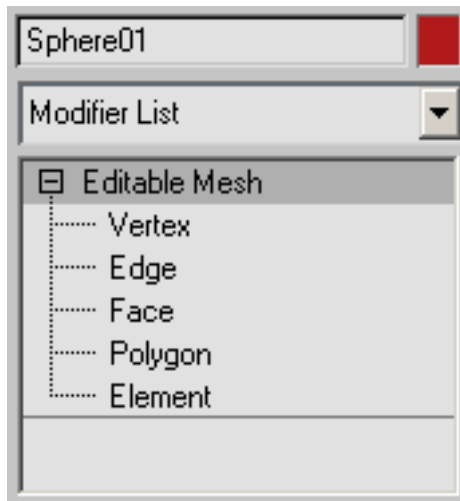

Opening an object's hierarchy to access sub-object levels

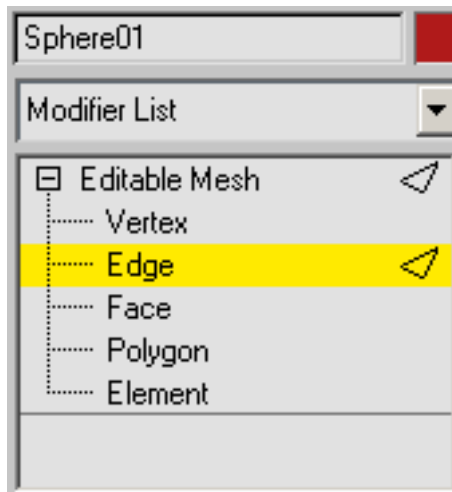

Opening an object's hierarchy to access sub-object levels

Tool Buttons

Below the stack display is a row of buttons for managing the stack.



Pin Stack Locks the stack to the currently selected object so it remains with that object regardless of subsequent changes in selection. The entire Modify panel is locked to the current object as well.

Pin Stack is useful for transforming another object while keeping your place in the modified object's stack.



Show End Result Shows the selected object as it will appear after all modifications in the stack have taken place, regardless of your current position in the stack. When this toggle is turned off, the object appears as modified up to the current modifier in the stack.



Make Unique Converts an instanced modifier to a copy that's unique to the current object. See [Make Unique](#) on page 7654.



Remove Modifier Deletes the current modifier or unbinds the current space warp.



Configure Modifier Sets Click to display the pop-up [Modifier Sets menu](#) on page 7657.

Modifier Stack Right-Click Menu

Modify panel > Modifier stack display > Right-click a modifier or object.

Some commands for managing modifiers are available by right-clicking the modifier stack display. Some options are unavailable if they don't apply to the current modifier. For example, Make Unique is available only if you select an instanced modifier.

The main uses of the right-click menu for the modifier stack are:

- Renaming modifiers
- Rearranging modifiers with the cut, copy, and paste functions

You can cut, copy, and paste multiple modifiers at one time. You can also cut and copy discontinuous selections of modifiers.

- Creating instances of modifiers

- Collapsing the stack into a surface object such as an editable mesh
- Controlling whether modifiers are on or off, off in viewports, or off in renderings

Collapsing the Stack

Collapsing the stack removes modifiers from the object. Collapsing a stack typically converts an object into an editable version of the original object (unless the object was editable to begin with, such as a NURBS model). Collapse To is unavailable unless you select one or more modifiers in the stack. Using Collapse To removes all stack items from the creation parameters to and including the uppermost selected stack item.

NOTE You can [preserve custom attributes](#) on page 7653 when collapsing the stack.

Following are suitable reasons to collapse a stack:

- To simplify the scene geometry.
- To discard applied modifiers, and convert the object to an editable object while retaining the results of any applied modifiers.
- To conserve memory.

After you collapse an object's stack, you can no longer parametrically adjust either its creation parameters or its individual modifiers. Animation tracks that were assigned to such parameters also disappear.

Procedures

To move one or more modifiers:

- 1 Select one or more modifiers in the modifier stack display.
To select multiple modifiers, click to select one modifier, then hold down Ctrl and click to select the others. Holding down Shift selects the two modifiers you click and all modifiers in between them.
- 2 Right-click and choose Cut.
- 3 Select a modifier above which to paste the cut modifiers. (This can also be the object at the bottom of the stack.)
- 4 Right-click and choose Paste. The modifiers are pasted above the current selection.

To copy one or more modifiers:

- 1 Select one or more modifiers in the modifier stack display.
To select multiple modifiers, click to select one modifier, then hold down Ctrl and click to select the others. Holding down Shift selects the two modifiers you click and all modifiers in between them.
- 2 Right-click and choose Copy.
- 3 Select an item above which to paste the cut modifiers.
- 4 Right-click and choose Paste. The copied modifiers are pasted above the current selection. Choose Paste Instanced to make the pasted modifiers instances of those you copied.

To copy modifiers from one object to another:

- 1 Select one or more modifiers in the modifier stack display of the first object.
To select multiple modifiers, click to select one modifier, then hold down Ctrl and click to select the others. Holding down Shift selects the two modifiers you click and all modifiers in between them.
- 2 Right-click and choose Copy.
- 3 Select the second object.
- 4 In the second object's modifier stack display, select an item above which to paste the copied modifiers.
- 5 Right-click and choose Paste.
The modifiers from the first object are pasted above the current selection in the second object. Choose Paste Instanced to make the pasted modifiers instances of those you copied.

Interface

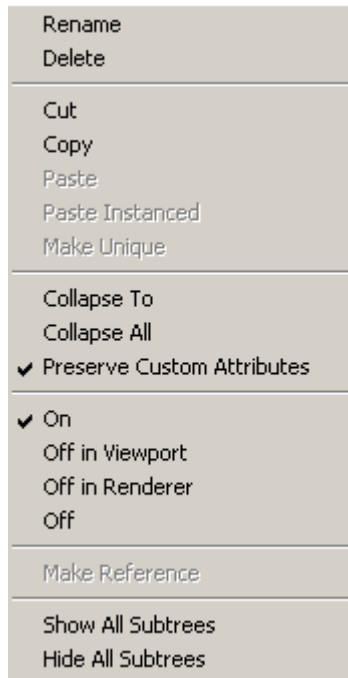

Rename Lets you change the name of the modifier. For example, you might change the name Bend to the more specific "First 45-degree bend." After choosing Rename, enter the new name in the stack display, and then press Enter. Pressing Esc cancels the name change.

Delete Deletes the modifier from the stack. The modifier is not available for pasting.

Cut Cuts the modifier from the stack. The modifier is removed, but is available for pasting.

Copy Makes a copy of the modifier that is available for pasting.

Paste Pastes the modifier into the stack. The modifier appears above the currently selected object or modifier, unless it is a world space modifier, in which case it is pasted at the top of the stack.

You can paste a modifier from one object into the stack of a different object. Paste is unavailable when more than one modifier is selected in the stack.

Paste Instanced Pastes an instance of the modifier into the stack. The modifier instance appears above the currently selected object or modifier, unless it is a world space modifier, in which case it is pasted at the top of the stack.

You can paste a modifier instance from one object into the stack of a different object.

Paste Instanced is unavailable when more than one modifier is selected in the stack.

Make Unique Converts an instanced modifier to a copy that's unique to the current object. This button is unavailable unless the modifier you right-clicked is instanced. See [Make Unique](#) on page 7654.

Collapse To Collapses a portion of the stack. Collapse To is unavailable unless you select one or more modifiers in the stack. Using Collapse To collapses all stack items from the object itself, up to and including the uppermost selected stack item. If there are modifiers above the uppermost selection, they are not changed.

The resultant object type depends on the uppermost modifier that outputs a specific geometry type, if any. If the stack contains no such modifier, the result is an [editable mesh](#) on page 2075. If the collapsed portion of the stack contains a modifier that outputs a specific geometry type, and no other such modifier is above it, the result is that type of object. For example, if the topmost such collapsed modifier is Edit Poly, the resultant object is Editable Poly.

Collapse All Collapses the entire stack.

The resulting stack list shows a single entry: Editable Mesh, unless any modifiers on the stack output a different type of geometry. For example, if the topmost such modifier is Edit Poly, the resultant object is Editable Poly.

NOTE [World-space modifiers](#) on page 1113 don't collapse along with the rest of the stack.

Convert To This menu item appears if no modifiers are applied to the object. Choose one of the Convert To options:

- Editable Mesh
- Editable Spline
- Editable Patch
- Editable Poly
- NURBS

NOTE Depending on the object type, not all Convert To options might be available.

Preserve Custom Attributes When on, collapsing an object's modifier stack or converting it a different format such as Editable Poly preserves any [custom attributes](#) on page 329 present in the stack.

On Turns on the effect of modifiers in both viewports and the renderer.



The light-bulb icon to the left of the modifier name shows "on."

Off in Viewport Turns off the currently selected modifiers in viewports only. Allows you to work in the viewport without the effects of the modifiers. You see the effects when you render.



The light-bulb icon to the left of the modifier name shows "off in viewports."

Off in Renderer Turns off the currently selected modifiers in renderings only. The effect of the modifiers is visible in viewports but not in renderings.



The light-bulb icon to the left of the modifier name shows "off in Renderer."

Off Turns off the currently selected modifiers without deleting them. This can help you see the object without the effect of its modifiers.



The light-bulb icon to the left of the modifier name shows "off."

Make Reference If the object is an instance, converts it to a reference. This option is available only when the base object is selected, and only when the base object is a reference.

When you make an instanced object into a reference, a heavy, "derived object" bar appears at the top of the stack. You can select this bar and apply modifiers above it. Modifiers applied above the bar affect the reference object only, and not its parent object.

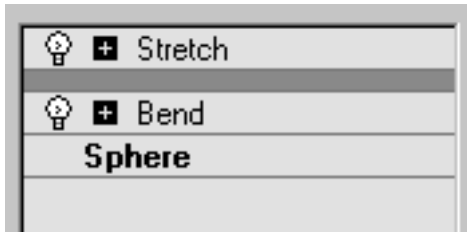

Gray bar denotes a reference object at the base of the stack

Show All Subtrees Expands the display of every hierarchical item in the stack display, so that all items in the stack are visible, including sub-objects.

Hide All Subtrees Hides the subtree of every hierarchical item in the stack display, so that only objects, modifiers, and space warp bindings are visible.

Make Unique

Modify panel > Tool buttons > Make Unique

Modify panel > Right-click an instanced modifier in the stack display. > Make Unique

Right-click an instanced object. > Make Unique

Make Unique lets you convert an instanced object to a copy that's unique. A object is instanced when it is cloned (Shift+Move or Shift+Rotate). If you make changes to an instanced object the changes are also reflected in the other instances in your scene. Making objects unique lets you adjust or change those objects independently without affecting any other objects in the scene.

TIP If you drag a material to a unique object and see the other instanced object updating as well, turn off Automatic Material Propagation. Go to Customize menu > Customize UI and choose Category: Instance Manager, then drag Automatic Material Propagation to a toolbar or assign a keyboard shortcut to it. Using this tool will allow the unique object to act uniquely.

Procedures

Example: To use the Make Unique options with an instanced modifier:

- 1 Create a cylinder with some height segments, and then use Shift+Move to create three copies, resulting in four identical cylinders.
- 2 Select all four cylinders, apply the Bend modifier, and adjust the Angle setting just enough to see the results of the bend.

You now have four cylinders with a single instance of a Bend modifier applied to them.

- 3 Choose Edit menu > Hold.

This lets you return to the current state of the scene at any time without using Undo.

- 4  Select two of the cylinders and click Make Unique.

- 5 Choose Yes in the resulting dialog.

At this point, the two selected cylinders each have unique Bend modifiers, while the remaining two cylinders share the original Bend. You can see this by selecting each cylinder and changing the Bend Angle setting.

- 6 Choose Edit menu > Fetch, and answer Yes.

- 7 Select two cylinders again, and click Make Unique.

- 8 Choose No in the resulting dialog.

The two selected cylinders now share an instance of a Bend modifier, but it's a different instance than that shared by the other two cylinders. Again, you can see this by selecting each of the cylinders and changing the Bend Angle spinner. You can also turn on [Show Dependencies](#) on page 167 in the Views menu to see the relationship between the four cylinders and the Bend modifier.

Example: To use Make Unique with an instanced object/modifier combination:

- 1 Create a cylinder with some height segments.
- 2 Apply a Bend modifier and adjust the Angle just enough to see the results of the bend.
- 3 Use Shift+Move with the Instance option to create an instanced object/modifier combination.

4 Change the Bend Angle setting on one of the instances to demonstrate that the cylinders and modifiers are truly instanced.
Both cylinders bend.

5 Select one of the instances, and then, in the modifier stack choose either the Bend modifier or the cylinder itself.

6  Click Make Unique.

When you change the Bend Angle setting or cylinder base parameters for one of the objects, the other doesn't change.

NOTE When you instance an object/modifier combination, all duplicates are instances of a *single* master node containing the original object and modifier. In such cases, you cannot selectively make the object or its modifier unique. Clicking Make Unique for one or the other, makes both unique.

Interface



Make Unique Detaches objects and modifiers (and combinations) logically from the master node of which they're instances or references.

Go to the object or modifier level in the stack for an instanced or referenced object or modifier (respectively), and click Make Unique.

For instanced object/modifier combinations, in the modifier stack, choose either the modifier or the object itself.

Making New Instances

When you click Make Unique for a selection of two or more objects, a dialog appears that asks: Do you want to make the selected items unique with respect to each other? This gives you a choice of how you want to make the objects unique.

- **Yes** Makes the instanced modifiers assigned to the objects in the selection unique for each object in the selection.
- **No** All instanced modifiers assigned to the objects in the selection remain instanced across the selected objects, but become unique from other objects not in the selection.

Modifier Sets Menu

Modify panel > Configure Modifier Sets button

The button sets menu gives you options for managing and customizing shortcut buttons for applying modifiers.

Procedures

To display the current button set on the Modify panel:

-  Click Configure Modifier Sets, and then choose Show Buttons to turn on this item.
This item is a toggle. Choosing Show Buttons a second time turns off the button display, and so on.

To configure a new modifier set:

-  Click Configure Modifier Sets, and then choose [Configure Modifier Sets](#) on page 7658.

To change from one button set to another:

- Click Configure Modifier Sets, and then choose the modifier set name from the lower part of the menu.

Interface

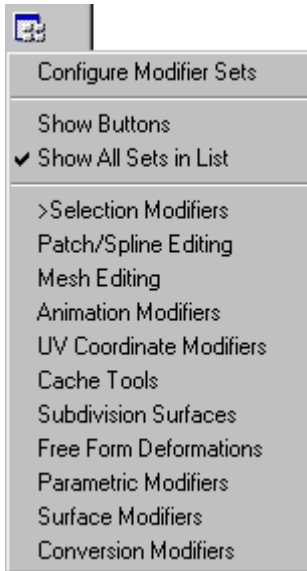

Configure Modifier Sets Displays the [Configure Modifier Sets dialog](#) on page 7658 to let you create a new, customized button set.

Show Buttons When on, buttons for the current modifier set are displayed between the modifier list and the stack display. Default=off.

Show All Sets in List When on, the Modifier List is organized by sets. When off, the Modifier List is organized simply into World-Space Modifiers and Object-Space Modifiers, and is otherwise alphabetical except that the current set appears at the top of the list. Default=off.

Saved button sets The bottom part of the Button Sets menu lists the names of saved button sets. Choose one of these sets to make it the current button set. The current set is displayed as buttons when Show Buttons is on. The Modifier List drop-down is organized by sets when Show All Sets In List is on.

Configure Modifier Sets Dialog

Modify panel > Configure Modifier Sets button > Configure Modifier Sets

This dialog lets you create custom modifier and button sets for the Modify panel.

Procedures

To choose a modifier and button set to edit:

- Choose a button set from the Sets drop-down list.

To create a new modifier and button set:

- 1 Create a custom button set in the Modifiers group box. You use these controls:
 - Use Total Buttons to change the number of buttons.
 - Drag a modifier from the Modifiers list to a button.
 - Highlight a button, and then double-click a modifier in the Modifiers list. (When you assign a button by double-clicking, the highlight moves to the next button in the Modifiers group.)
- 2 Enter the new set's name in the Sets edit field.
- 3 Click Save.
- 4 Click OK to leave the Configure Modifier Sets dialog.

To customize the current modifier and button set:

- 1 Use Total Buttons to choose the number of buttons in the set.
- 2 Assign buttons by dragging the names of modifiers in the dialog's Modifiers list to buttons in the Modifiers group box.
- 3 Click OK.
3ds Max updates the Modifiers list. You can customize the set without saving it, but if you save a new set under a new name, you can use it later.

Interface

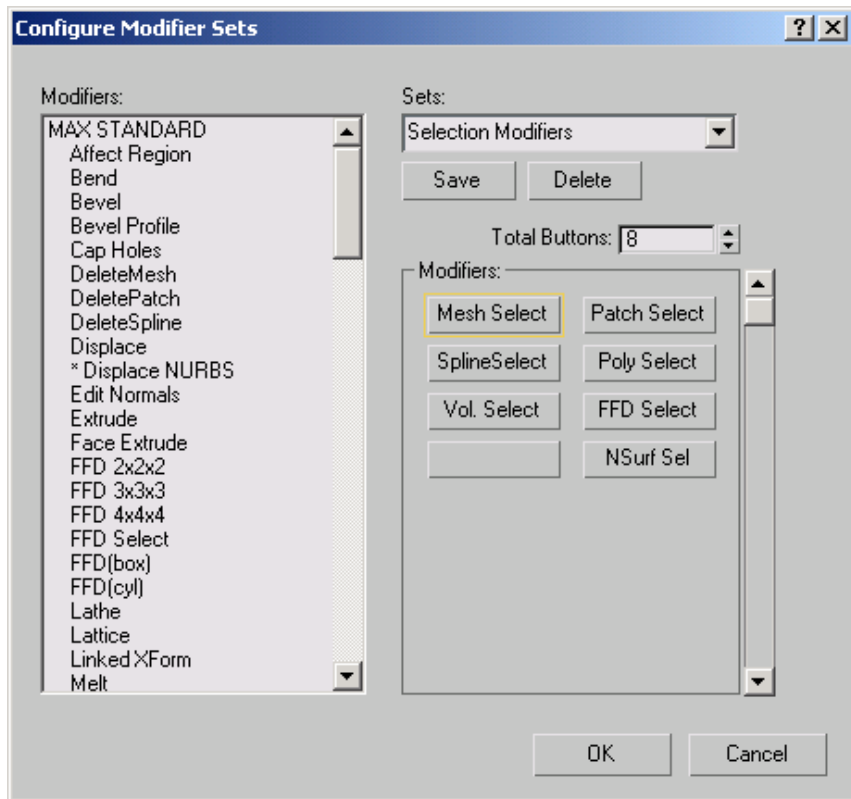

Modifiers Lists all modifiers currently available. It's organized into these categories: Channel Info, Max Edit, Max Standard, Deformations, Max Surface, Surface Tools, Modifiers, Radiosity, LIGHT, Max Additional, Shell, Spline Edits, World Space Modifiers, and others. To add a modifier to the current button set, drag the modifier's name from this list onto a button in the Modifiers group box.

Sets This edit field and drop-down list lets you choose the modifier set to edit. To create a new button set, enter the name in the edit field, and then click Save.

Save Saves the current button set.

Delete Deletes the current button set.

IMPORTANT You can't undo deleting a button set.

Total Buttons Sets the number of buttons in the button set. A button set can have up to 32 buttons.

Modifiers group

Previews how the button set will appear on the Modify panel. Because the box shows only 16 buttons at a time, a scroll bar on the right lets you see any remaining buttons.

To change a button, drag the name of a modifier from the Modifiers list to a button in this group box, or click the button (its border highlights) and then double-click the modifier name.

Hierarchy Panel

Command panels > Hierarchy panel

The Hierarchy panel provides access to tools to adjust the hierarchical linkage between objects.

By linking one object to another, you create a parent-child relationship. Transformations applied to the parent are also transmitted to the child. By linking more objects to both parent and child objects you can create complex hierarchies.



Gyroscope assembled as a hierarchy.
The parent is the outer ring with handle.
The flywheel is the lowest child.

Common uses of linking are:

- Creating complex motions.
- Simulating jointed structures.
- Providing the basis for inverse kinematics.
- Setting rotational and sliding parameters for Bones.

The Hierarchy panel is divided into three areas:

[Pivot](#) on page 3475

[IK](#) on page 3485

[Link Info](#) on page 3500

NOTE For important background information on hierarchies and kinematics, see [Animating with Forward Kinematics](#) on page 3354 and [Inverse Kinematics \(IK\)](#) on page 3374.

Motion Panel

Select an object. > Command panels > Motion panel

The Motion panel provides tools to adjust the motion of the selected object. Key timing and easing in and out of a key are parameters that you can adjust with tools on the Motion panel, for example. The Motion panel also provides an alternative to Track View for assigning animation controllers.

Additional rollouts display in the Motion panel if an assigned animation controller has parameters. If a Path constraint is assigned to the position track of an object, then a Path Parameters rollout is added to the Motion panel. A Link constraint displays a Link Parameters rollout, a Position XYZ controller displays a Position XYZ Parameters rollout, and so on.

Trajectories

Click Trajectories to chart a path that an object will travel along in the viewports. Yellow dots along the path represent frames, giving you an idea of velocity and easing. By turning on Sub-Object Keys, keys can be moved in space, key properties can be changed, the trajectories will reflect all the adjustments you make. You can also convert to and from splines and collapse transforms using trajectories.

Interface

Parameters

Provides an alternative to [Track View](#) on page 3503 for adjusting transform controllers and key information.

[Assign Controller Rollout](#) on page 7664

[PRS Parameters Rollout](#) on page 3126

[Key Info \(Basic\) Rollout/Dialog](#) on page 3127

[Key Info \(Advanced\) Rollout/Dialog](#) on page 3131

Trajectories

Provides tools for working with objects' trajectories.

[Trajectories](#) on page 3121

Assign Controller Rollout

Select an object. > Motion panel > Parameters > Assign Controller rollout

The Assign Controller rollout assigns and appends different transform controllers to individual objects. You can also assign controllers in Track View.

[Animation controllers](#) on page 3133 are plug-ins that handle all of the animation tasks in 3ds Max. For a complete list of available animation controllers, see [Assign Controller \(Track View\)](#) on page 3593.

Procedures

Example: To assign a TCB Rotation controller:

- 1 Select an object.
- 2 On the Motion panel, click Parameters, and open the Assign Controller rollout.
- 3 Highlight the Rotation track in the Assign Controller list.
- 4  Click the Assign Controller button, choose TCB Rotation from the Assign Rotation Controller dialog, and then click OK to close the dialog and accept the change.

The default Euler XYZ Rotation controller is replaced with the TCB Rotation controller.

Interface

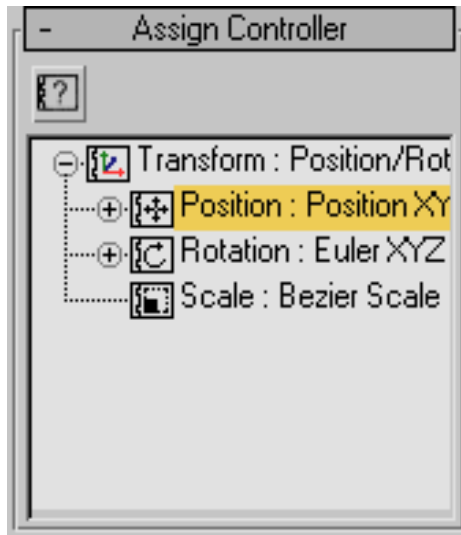

Assign Controller Displays the Assign Controller dialog. If no track is highlighted, the Assign Controller button is unavailable.

Assign Controller dialog Choose a controller from a list of available controllers in this dialog.

Depending on the type of track you've selected, the Choose Controller dialog displays a subset of the different types of controllers. Rotation controllers, for example, are available only for rotation tracks.

Display Panel

Command panels > Display panel

The Display panel provides access to tools that control the display of objects in the scene.

Use the Display panel to [hide and unhide](#) on page 8002, [freeze and unfreeze](#) on page 7989 objects, alter their display characteristics, speed up viewport displays, and simplify your modeling procedures.

NOTE A target is considered part of its light or camera for purposes of hiding and un hiding.

Display Panel Rollouts

[Display Color Rollout](#) on page 177

[Hide By Category Rollout](#) on page 178

[Hide Rollout](#) on page 179

[Freeze Rollout](#) on page 181

[Display Properties Rollout](#) on page 183

[Link Display Rollout](#) on page 188

Display Floater

Tools menu > Display Floater

This modeless dialog contains most of the functions on the Display panel. You can leave the Display floater up while you work in your scene, making it easier to change viewport displays without changing the current command panel.

Interface

The Display floater has two panels: Hide/Freeze and Object Level.

Hide/Freeze panel

NOTE These functions are also available on the [Display panel](#) on page 7665 and from the [Display quadrant](#) on page 7519 of the default quad menu.



Hide group

Selected Hides the selected object(s).

Unselected Hides all visible objects except the selected ones. Use this to hide all the objects except the one you are working on.

By Name Lets you select the objects to hide by name.

By Hit Causes any object you click in the viewport to be hidden. If you hold the Ctrl key while selecting an object, that object and all of its children are hidden. To exit Hide by Hit mode, right-click, press Esc, or select a different function. This mode is automatically turned off if you hide all objects in the scene.

Unhide group

All Unhides all hidden objects. The unhide buttons are only available when you have specifically hidden one or more objects. They won't unhide objects hidden by category.

By Name Displays a dialog in which you can unhide objects you select from a list.

NOTE You cannot unhide objects on a hidden layer. If you select an object on a hidden layer, you will be prompted to unhide the object's layer.

Freeze group

Selected Freezes the selected object(s) so they cannot move in the viewport.

Unselected Freezes all visible objects except the selected ones. Use this to quickly freeze all the objects except the one you're working on.

By Name Lets you select the objects to freeze by name.

By Hit Causes any object you click in the viewport to be frozen. If you hold the Ctrl key while selecting an object, that object and all of its children are frozen. To exit Freeze By Hit mode, right-click, press Esc, or choose a different function. This mode is automatically turned off if you freeze all objects in the scene.

Unfreeze group

All Unfreezes all frozen objects.

By Name Displays a dialog in which you can unfreeze objects you select from a list.

By Hit Causes any object you click in the viewport to be unfrozen. If you hold the Ctrl key while selecting an object, that object and all of its children are unfrozen.

NOTE You cannot unfreeze objects on a frozen layer. If you select an object on a frozen layer, you will be prompted to unfreeze the object's layer.

Hide Frozen Objects Toggles display of frozen objects on and off. You don't have to unfreeze objects to hide them; you can use Hide Frozen Objects instead to hide or unhide frozen objects in a single step.

Object Level panel

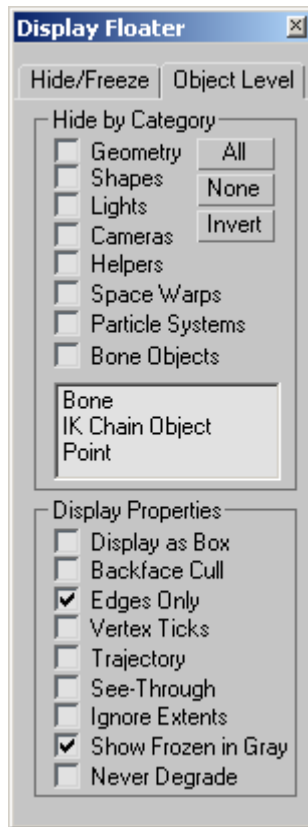

Hide by Category group

Toggles the display of objects by their category (objects, cameras, lights, and so on). Choose the check boxes to hide objects of that category. Use the All, None, and Invert buttons to change the settings of the check boxes.

NOTE These functions are also available on the [Display panel](#) on page 7665.

Display Properties group

Provides controls that alter the display of selected objects.

NOTE These options are also available on the [Display panel](#) on page 7665 and in the [Display Properties group](#) on page 309 of the Object Properties dialog.

Display as Box Toggles the display of selected objects, including 3D objects, 2D shapes, and particle systems, as [bounding boxes](#) on page 7932. Produces minimum geometric complexity.

Particle systems appear as bounding boxes when adaptive degradation takes effect. Since particle systems naturally exist in world space, their bounding box is always oriented parallel to the world planes.

Backface Cull Toggles the display of faces with [normals](#) on page 8059 pointing away from view. When selected, you see through the wireframe to the back faces.

Edges Only Toggles the display of hidden edges and polygon [diagonals](#) on page 7953. When on, only outside edges appear. When off, all mesh geometry appears. Applies to Wireframe viewport display mode, as well as other modes with Edged Faces turned on.

Vertex Ticks Displays the vertices in the selected geometry as tick marks.

If the current selection has no displayed tick marks, the check box is clear. If *some* of the vertices in the current selection display tick marks, the check box contains a gray X. If all vertices in the current selection display tick marks, the check box contains a black X.

Trajectory Toggles [trajectory display](#) on page 8154 for the selected object so you can display its trajectory wherever you are in the software.

See-Through When on, makes the object or selection translucent in viewports. This setting has no effect on rendering: it simply lets you see what's behind or inside an object in a crowded scene, and especially to adjust the position of objects behind or inside the see-through object. Use this when you need to see inside an object, such as a character with bones inside. Default=off.

You can customize the color of see-through objects by using the [Colors panel](#) on page 7712 of the Customize > [Customize User Interface dialog](#) on page 7697. Choose Geometry from the Elements list, and then choose See-Through.

Keyboard shortcut (default): Alt+X

Ignore Extents Allows an object to be excluded from a zoom extents operation. Choose this when you have lights or other distant objects that you don't want to use when you do a [Zoom Extents](#) on page 7594.

Show Frozen in Gray When on, the object turns gray in viewports when you freeze it. When off, viewports display the object with its usual color or texture even when it is frozen. Default=on.

Never Degrade When on, the object is not subject to [adaptive degradation](#) on page 7900.

Utilities Panel

Command panels > Utilities panel

The Utilities panel gives you access to a variety of utility programs. 3ds Max utilities are provided as [plug-ins](#) on page 8092. 3ds Max ships with the utilities listed below. Some utilities are available from third-party developers, so your setup of 3ds Max might include utilities not described here. Look for documentation describing these additional plug-ins by choosing Help > Additional Help.

NOTE Documentation for MAXScript and Visual MAXScript is provided in a separate help system. To access the MAXScript Reference, choose Help > MAXScript Help. See [About MAXScript](#) on page 11.

See also:

- [List of Available Utilities](#) on page 7463

Interface

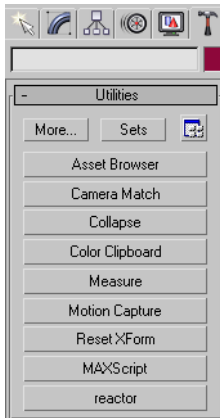

The Utilities panel contains one rollout for managing and invoking utilities. While a utility is running, additional rollouts can appear. Some utilities use a dialog rather than rollouts.

The Utilities rollout contains the following controls at the top:

More Displays a Utilities dialog that lists all utilities not already displayed in buttons on the Utilities panel. Highlight a utility in the list and then click OK to display its controls in the Utilities panel. (You can also double-click the utility's name.)

Sets Displays a list of button sets to choose from. By default, there is only one button set, called MAX Default. You can create custom button sets by clicking Configure Button Sets.

Configure Button Sets Displays the [Configure Button Sets dialog](#) on page 7673, where you can create custom button sets of up to 32 buttons.

Named utility buttons These buttons show a selection of utilities. Click one of these buttons to run a utility. The utility's parameters can appear in rollouts below the Utilities rollout. Some utilities use a dialog rather than rollouts.

While a utility is running, its button remains active until you click it again to turn it off and close the utility, or when you click a different utility's button.

Many utilities have a Close button that appears at the bottom of their rollout. This is another way to close a utility. If the utility controls appear in a dialog rather than a rollout, closing the dialog closes the utility.

Utilities Dialog

Utilities panel > Utilities rollout > More... button

This dialog lists all utilities that are not already displayed in current button set of the Utility rollout.

Procedures

To run a utility shown in the Utilities dialog, do one of the following:

- 1 Choose a utility in the list and then click OK.
- 2 Double-click the utility's name.

Interface

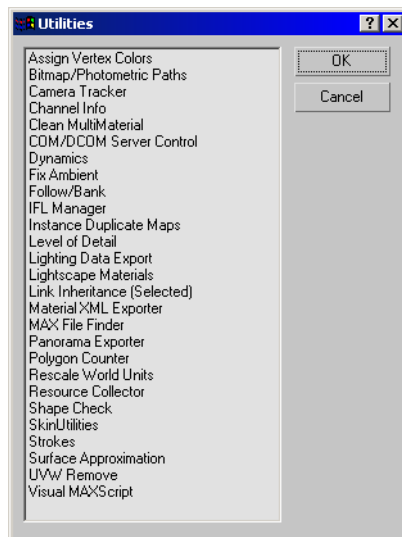

Configure Button Sets Dialog

Utilities panel > Utilities rollout > Configure Button Sets button

This dialog lets you create custom button sets for the Utilities panel. Once created, these utility sets are available from the Sets button on the Utilities panel.

Procedures

To customize the current button set:

- 1 Use Total Buttons to choose the number of buttons in the set.
- 2 Assign buttons by dragging the names of utilities in the Utilities list to buttons in the Utilities group box.
- 3 Clear buttons by dragging them to the Utilities list on the left.
- 4 Click OK.
3ds Max updates the Utilities rollout. You can customize the button set without saving it, but if you save a new button set under a new name, you will be able to use it later.

TIP Don't alter the Default button set. Create a new one instead.

To create a new button set:

- 1 Create a custom button set as described in the previous procedure.
- 2 Enter a new button set name in the Sets edit field.
- 3 Click Save.

To choose a button set to modify:

- Choose a button set from the Sets drop-down list.

Interface

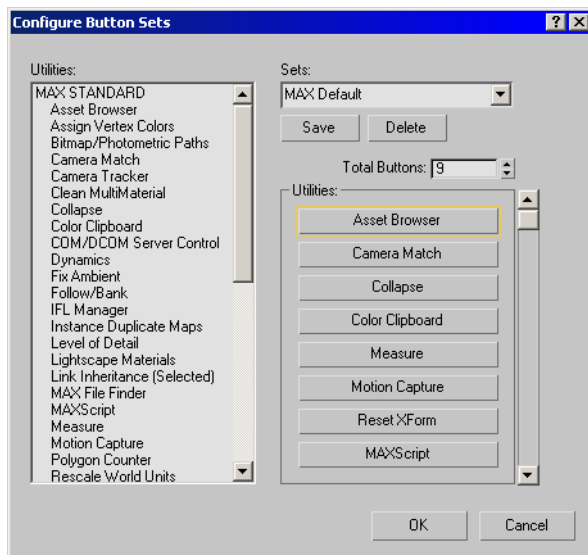

Utilities List This lists all the utilities currently available to 3ds Max. It is organized into a number of categories, including MAX STANDARD, Channel Info, NURBS, Radiosity, Skin Tools, Strokes, MAXScript Tools, Internet Extensions, Realviz Products, and reactor. To add a utility to the current button set, drag the utility's name from this list to the Utilities group box.

Sets edit field and drop-down list Lets you choose the button set to modify. By default, there is a single button set called MAX Default.

TIP Don't alter the Default button set. Create new sets as the need arises.

Save Saves the current button set.

Delete Deletes the current button set.

WARNING You can't undo the deletion of a button set.

Total Buttons Sets the number of buttons in the button set. A button set can have up to 32 buttons.

Utilities group

This group previews how the button set will appear in the Utilities rollout. A scroll bar on the right lets you see other buttons when the set has more than eight.

To change a button, drag the name of a utility from the Utilities list to a button in this group.

MAXScript Interface

Menu bar > MAXScript

Utilities panel > MAXScript

[MAXScript](#) on page 11 is the software's built-in scripting language. Its main interface, the MAXScript menu, contains the following commands for creating and working with scripts:

[New Script](#) on page 7676

[Open Script](#) on page 7677

[Run Script](#) on page 7677

[MAXScript Listener](#) on page 7677

[Macro Recorder](#) on page 7678

[Visual MAXScript Editor](#) on page 7679

[MAXScript Debugger Dialog](#) on page 7680

In addition, the [status bar](#) on page 7524 contains a [MAXScript Mini Listener](#) on page 7525, and MAXScript functionality is also available from the [Utilities panel](#) on page 7671.

For detailed information about MAXScript, open the MAXScript Reference, available from Help menu > MAXScript Reference.

New Script

MAXScript menu > New Script

Utilities panel > Click MAXScript. > MAXScript rollout > New Script

New Script opens a new MAXScript Editor window. Use this window for writing a new script.

For detailed information about the MAXScript utility, open the *MAXScript Reference*, available from Help menu > MAXScript Reference.

Open Script

MAXScript menu > Open Script

Utilities panel > Click MAXScript. > MAXScript rollout > Open Script

Open Script opens a common file open dialog for choosing an existing script. A new MAXScript Editor window then displays the selected script.

For detailed information about the MAXScript utility, open the *MAXScript Reference*, available from Help menu > MAXScript Reference.

Run Script

MAXScript menu > Run Script

Utilities panel > Click MAXScript. > MAXScript rollout > Run Script

Run Script opens a common file open dialog for choosing an existing script. MAXScript then reads and executes the selected script. Any output is printed to the Listener window.

For detailed information about the MAXScript utility, open the *MAXScript Reference*, available from Help menu > MAXScript Reference.

MAXScript Listener

MAXScript menu > MAXScript Listener

Mini Listener > Right-click menu > Open Listener Window

Utilities panel > Click MAXScript. > MAXScript rollout > Open Listener

Keyboard > F11

The MAXScript Listener window is an interactive interpreter for the MAXScript language and works similar to a DOS command prompt window. You enter

MAXScript commands in this window, and when you press Enter they are executed immediately.

The Listener window is appropriate for performing interactive work and developing small code fragments. Each command you execute in the Listener is actually an expression with a result that the Listener prints out after each execution. You can enter any MAXScript expression or sub-expression in the Listener for evaluation, and the Listener prints out its result.

The Listener is divided into two panes. The top (pink) pane is the Macro Recorder pane, and the bottom (white) pane is the output pane. When the Macro Recorder is enabled, everything recorded is displayed in the Macro Recorder pane. The output of results from scripts are displayed in the output pane. The output of code executed in the Macro Recorder pane is always directed to the output pane so as not to clutter the recordings. Both panes allow you to cut-and-paste, drag-and-drop, edit, select, and execute code. You can resize the panes by dragging the split bar between them.

The left-end of the status bar contains a resizable Mini Listener. If the Mini Listener is not visible, drag on the vertical split bar at the left end of the status bar to reveal the Mini Listener. The Mini Listener panes act as single-line sliding windows for the current line in the corresponding Listener panes. The Mini Listener panes always show what you are typing or where the edit cursor is placed in the Listener panes. Conversely, anything you type into a Mini Listener pane is entered into the corresponding Listener pane at the current edit cursor position.



The MAXScript Mini Listener on the Status Bar

You can install the Listener into any viewport by right-clicking the viewport label, choose Views > Extended, and then MAXScript Listener.

For detailed information about the MAXScript utility, open the *MAXScript Reference*, available from Help menu > MAXScript Reference.

Macro Recorder

MAXScript menu > Macro Recorder

The MAXScript Macro Recorder captures many of the actions performed by the user, and generates the MAXScript commands that correspond to those actions. Output from Macro Recorder is displayed in the Macro Recorder pane of the MAXScript Listener window. Several filtering options are available that control what types of user actions are recorded, whether the generated MAXScript commands contain explicit object references or are selection-relative, and whether the generated MAXScript commands contain absolute or relative transforms and coordinates. These options are set using the MacroRecorder menu in the Listener window. The default option settings are specified in the MAXScript page of the 3ds Max Preferences dialog, as described in [MAXScript Preferences](#) on page 7782. You can also make and change these settings by editing the [MAXScript] section of the [3dsmax.ini on page 83](#) file.

While many areas in the software generate Macro Recorder output, there are also many areas that do not. In general, most of the buttons on the software's menu bar, toolbars, status bar, Create panel, and Modify panel will generate Macro Recorder output. If the button invokes a secondary dialog, changing settings or performing actions in the secondary dialog typically do not generate Macro Recorder output. In the Create and Modify panels, Macro Recorder output is typically generated if the object or modifier can be created by MAXScript. In rare cases, the plug-ins implementing an object or modifier have not been updated to support Macro Recorder, so that object or modifier does not generate Macro Recorder output.

MAXScript supports text drag-and-drop onto toolbars to create Macro Script buttons. You can select and drag text from any text window, such as the Listener window panes or Editor window, onto any visible toolbar. The cursor changes to an arrow with a + sign when it is permissible to drop the text. Dropping it at that point adds a Macro Script button to the toolbar with the dropped text as the body of the Macro Script. A typical usage of this would be to drag text from the Macro Recorder pane onto a toolbar to make a button that does the sequence of events just recorded.

For detailed information about the MAXScript utility, consult the *MAXScript Reference*, available from Help menu > MAXScript Reference.

Visual MAXScript Utility (See MAXScript Reference)

Utilities panel > Utilities rollout > More button > Visual MAXScript

Visual MAXScript is a powerful interface to the 3ds Max scripting language, making the MAXScript feature easier to learn and use. With Visual MAXScript, you can quickly create UI elements and layouts for scripting.

For detailed information about Visual MAXScript, open the *MAXScript Reference*, available from Help menu > MAXScript Reference.

MAXScript Debugger Dialog

MAXScript menu > Debugger Dialog

MAXScript Listener > Debugger menu > Debugger Dialog

MAXScript Editor > Debugger menu > Debugger Dialog

The MAXScript debugger implements the first half of a script development and debugging environment. It allows the main thread of 3ds Max to be suspended, the values of global and local variables to be examined and altered while the thread is not running, MAXScript commands to be executed from a command line, and the execution to be suspended using method calls from inside the MAXScript code. The debugger also lets you stop or continue the execution of the suspended code.

For detailed information about the MAXScript debugger, consult the MAXScript Reference, available from Help menu > MAXScript Reference.

Running Scripts from the Command Line

3ds Max allows you to enter MAXScript commands directly on the command line. When you launch 3ds Max from a DOS command line, you can have it run a specified launch script. This can be useful for tasks such as unattended batch-rendering. This capability uses the existing -U command line switch that names a utility to be run when 3ds Max is started. The -U switch allows an optional extra argument which, for MAXScript, is taken to be the name of the launch script to run. The case (capitalization) of MAXScript must be as shown in the following example (entered after you CD to the program directory):

See the online *Help* to view this code sample.

This example command line would launch the 3ds Max executable , start MAXScript, and then have it run the launch script *rendercams.ms*.

The following example launch script loads two scenes, renders frames from each of the cameras in them, and then quits 3ds Max:

See the online *Help* to view this code sample.

This example makes use of the `quitMax()` method to exit 3ds Max when the script is finished. Launch scripts need not be batch scripts as in this example, but may be used to condition 3ds Max for interactive use, for example by loading a scene file and setting some user-interface options.

The normal startup scripts, *startup.ms* and those in the `\scripts\startup` directory, are run before the launch script. It is also possible to install scripts into individual scene files that run automatically when that scene is open or closed or at certain other events.

NOTE Command line `-U MAXScript` startup scripts are run *after* 3ds Max has completely booted and the standard scripts and startup scripts have been run.

MAXScript Command-Line Switches

The following switches work specifically with MAXScript files and functions.

Switch	Effect
-mip	Starts 3ds Max in a minimized mode – but never allows you to open the window for interactive usage.
-mxs	This switch is essentially the same as <code>-U MAXScript file.ms</code> , but avoids the need for the <code>.ms</code> file. You can follow the switch with MAXScript commands.
-silent	Comparable to the MAXScript command, <code>setSilentMode</code> , this switch suppresses all MAXScript and 3ds Max UI dialogs so that batch scripts specified by the <code>-U</code> command do not get interrupted.
-u MAX-Script <file-name>	Opens a specified MAXScript file.

Examples of desired syntax usage:

See the online *Help* to view these code samples

Customizing the User Interface

26

You can rearrange the components of the 3ds Max user interface, including the menu bar, toolbars, and command panel. You can also dynamically resize the viewport windows. You can specify which toolbars should appear and which should not, and create your own keyboard shortcuts, custom toolbars, and quad menus. You can also customize the colors used in the User Interface.

For procedures that tell how to rearrange and resize UI components, see [Useful Customization Techniques](#) on page 7683. Various other customization options are available from the [Customize menu](#) on page 7494.

See also:



- [Customize Display Right-Click Menu](#) on page 7687
- [Customize User Interface Dialog](#) on page 7697
- [Saving and Loading Custom User Interfaces](#) on page 7722
- [Revert to Startup Layout](#) on page 7728
- [Configure Paths](#) on page 7728
- [Preferences](#) on page 7743

Useful Customization Techniques

This topic offers procedures for customizing the 3ds Max user interface, including methods for rearranging and resizing UI components. Various other customization options are available from the [Customize menu](#) on page 7494.

Procedures

To switch between a single-viewport and multi-viewport layout:

-  1 By default, 3ds Max starts with a multi-viewport. To switch to a single-viewport layout, activate a viewport and click the [Min/Max Toggle](#) on page 7589.
-  2 By default, 3ds Max starts with a single viewport. To switch to a multi-viewport layout, click the [Min/Max Toggle](#) on page 7589.

To resize the windows in a multi-viewport layout:

- With your cursor, click the splitter bar between any two viewports, or at the intersection of all four viewports, and drag to a new location. When you release the mouse, the new viewport layout is defined. The dividers are saved in the scene, but are reset when you change the layout. This feature does not allow you to define new layouts, only to adjust the proportions of the currently existing ones.

To reset the viewport windows to the default layout:

- 1 Right-click the splitter bar between the viewports. The Reset Layout button is displayed.
- 2 Click this button to restore the viewports to the default multi-viewport layout.

To rearrange the order of rollouts in the command panel:

- Click the rollout title bar, and drag to another location on the command panel. A thick line indicates where the rollout will be placed. When you release the mouse button, the rollout is moved to the indicated location, and the other rollouts are shifted appropriately. The order of rollouts is saved in the text file *rolluporder.cfg*, which is located in the `\ui` subdirectory.

To float a toolbar, do one of the following:

- 1 Click the tag bar of the docked toolbar (a narrow line displayed when the toolbar is docked) and drag it away from its location. The toolbar is now floating; you can reposition, resize, or dock it.
- 2 Right-click the tag bar of the docked toolbar (a narrow line displayed when the toolbar is docked), and then choose Float.

To float the command panel, do one of the following:

- 1 Right-click the blank area at the upper-right corner of the command panel, and then choose Float.
- 2 Click a corner of the upper portion of the command panel and drag it into the viewport.

TIP If you find you tend to float the command panel accidentally, use [Lock UI Layout](#) on page 7690.

To resize the docked command panel horizontally:

- Move the cursor over the edge of the docked command panel that is nearest the viewports. The cursor changes to a double arrow. Drag the cursor to increase or decrease the width of the command panel. The command panel grows or shrinks in column increments. Unless the command panel is hidden, there is always at least one column. When the command panel is docked, the columns must fit within the main 3ds Max window.

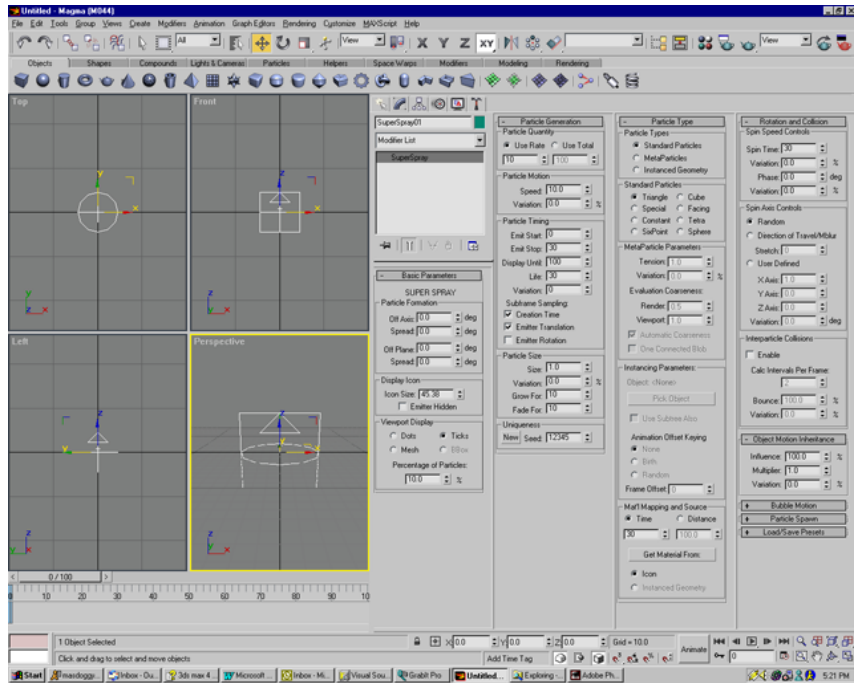

Multiple command panels are useful when working with objects such as particle systems, which have many controls.

To resize the floating command panel horizontally:

- Move the cursor over the left or right edge of the floating command panel. The cursor changes to a double arrow. Drag the cursor to increase or decrease the width of the command panel. The command panel grows or shrinks in column increments. Unless the command panel is hidden, there is always at least one column. When the command panel is floating, you can display as many columns as you want.

To resize the floating command panel vertically:

- Move the cursor over the top or bottom edge of the floating command panel. The cursor changes to a double arrow. Drag the cursor to increase or decrease the height of the command panel as you do for other windows on the desktop.

To dock a floating UI element, do one of the following:

- 1 Drag the panel by its title bar to the top, bottom, left, or right edge of the program window. The mouse cursor and the panel outline change shape at a docking location. Release the mouse.
- 2 Right-click the title bar, choose Dock from the pop-up menu, and then choose Top, Bottom, Left, or Right.
- 3 Double-click the handle or title bar.

A UI element docks automatically when it approaches a "dockable" location. The toolbars and menu bar can dock at the top or bottom, left or right of the viewports. They can also dock on either side of the Command panel.

To hide a panel or toolbar, do one of the following:

- When a panel or toolbar is floating, you can hide it by clicking the X control in the upper-right corner.

Customize Display Right-Click Menu

The Customize Display right-click menu displays when you right-click over a blank area of a toolbar (not when the cursor is over a button). It is also available when the cursor is immediately above, below, or to the right of the command panel tabs: in these locations, the cursor changes to look like a stack of two sheets of paper. In addition, the menu displays when you right-click at the right edge of the command panel when docked, or, when floating, at the right or left edge.

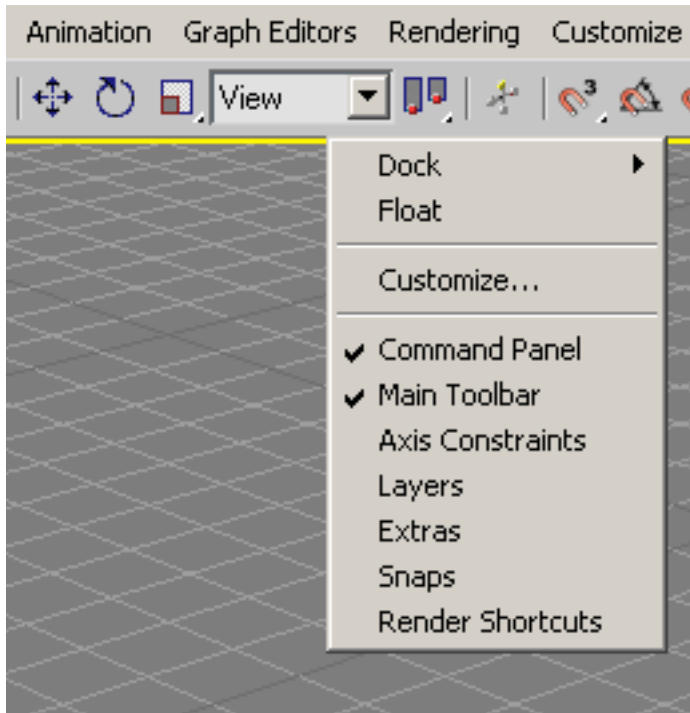

Right-click a blank area of a toolbar to open the **Customize Display** right-click menu.

Use this menu to toggle the display of various user-interface elements, customize the display of toolbars, and dock or float items such as the command panel.

Interface

The following options are displayed in all cases:

Customize Opens the [Customize User Interface dialog](#) on page 7697, which lets add commands and macro scripts to new and existing toolbars.

Command Panel Toggles the command panel display. Default=on.

Main Toolbar Toggles the [main toolbar](#) on page 7499. Default=on.

Axis Constraints Toggles the [Axis Constraints toolbar](#) on page 7503. Default=off.

Layers Toggles the [Layers toolbar](#) on page 7504. Default=on.

Reactor Toggles the [reactor toolbar](#) on page 7505. Default=off.

Extras Toggles the [Extras toolbar](#) on page 7506. Default=off.

Render Shortcuts Toggles the [Render Shortcuts toolbar](#) on page 7506. Default=off.

Snaps Toggles the [Snaps toolbar](#) on page 7508. Default=off.

Additional Options: Docking and Floating

Depending on the cursor location when you right-click, the menu can also display these options:

Dock Docks the active item to the specified location: Top, Bottom, Left, or Right.

NOTE For more information on docking toolbars, see [Customizing the User Interface](#) on page 7683.

Float Floats the active item.

NOTE This option is available only for docked items.

Show UI

Customize menu > Show UI

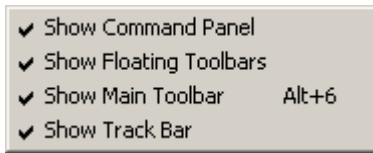

The Show UI submenu lets you add or remove UI (user interface) elements from the workspace, so that you can customize your screen as you work. You can turn these elements on and off as you need by selecting them from the menu, maximizing the efficiency of your workspace. The settings are stored in the *maxstart.cui* file, so they will remain after you shut down and restart 3ds Max.

Choosing a UI element from the Show UI submenu toggles the display of that element. The submenu displays a check mark next to the UI element when it is currently being displayed.

Keyboard shortcuts for turning on and off UI elements are displayed next to their corresponding UI elements in the Show UI menu.

You can use the Show UI menu to hide or display the following UI elements:

[Command Panel](#) on page 7630

Floating Toolbars (toggles all toolbars other than the main toolbar, including the [Axis Constraints Toolbar](#) on page 7503, [Layers Toolbar](#) on page 7504, and [Extras Toolbar](#) on page 7506)

[Main Toolbar](#) on page 7499

[Track Bar](#) on page 7531

Lock UI Layout

Customize menu > Lock UI Layout

When the Lock UI Layout toggle is active, you cannot modify the user interface layout by dragging interface elements. (You can still use the right-click menu to do so, however.) Use this command to prevent user interface changes or inadvertent actions, such as floating toolbars, from happening due to mouse clicks.

TIP Use this command if you find you are inadvertently selecting and [floating](#) on page 7957 UI elements such as the Command panel.

Procedures

To lock the UI layout:

- Choose Lock UI Layout from the Customize menu.
You can no longer move or resize the UI elements. Use this command to prevent user interface changes or if you find yourself accidentally floating toolbars or the command panels on mouse clicks.

Plug-In Manager

Customize menu > Plug-in Manager

The Plug-in Manager lets you manage plug-ins dynamically without any initialization required. The Plug-in Manager provides a list of all plug-ins found in the 3ds Max plug-in directories, including the plug-in description, type (object, helper, modifier, and so on), status (loaded or deferred), size, and path. The Plug-in Manager provides options to load any plug-in, regardless

where it resides on disk. The Plug-in Manager is similar to [Summary Info](#) on page 7122, but with more options.

See also:

- [3rd Party Plug-Ins Path Configuration](#) on page 7740

Interface

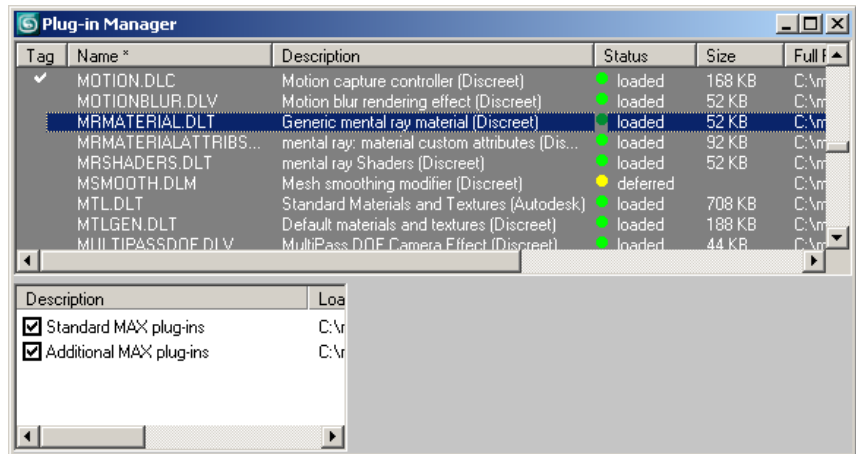

When you start the Plug-in Manager, it scans through all the plug-in paths specified in the *plugin.ini* file and lists them in the Plug-in Manager dialog. The information is divided up into columns as described following.

Tag Use the right-click menu and select Tag Selected to add a check mark for selected plug-ins. Tagging plug-ins lets you perform right-click menu actions on them. Thus you can tag multiple plug-ins and perform a single operation on all of them.

Name The filename of the plug-in.

Description A description of the plug-in.

Status Indicates whether the plug-in is loaded (green) or deferred (yellow).

Size File size of the plug-in.

Full Path The disk location of the plug-in file.

Plug-in Directories

3ds Max uses the plug-in directories listed in *plugin.ini*. You can also configure these paths with the [3rd Party Plug-Ins panel](#) on page 7740 of the Configure User Paths dialog. You can display or hide all the plug-ins in a directory by toggling the check box.

Description Shows directory description from *plugin.ini* file.

Load Path The path of the plug-in directory.

Right-Click Menu

The right-click menu for the Plug-in Manager works in the list of plug-ins, and in the blank area beneath the list. It does not work in the list of plug-in directories. The commands apply to two possible states for the listed plug-ins: selected (that is, highlighted) and tagged (a check mark appears to the left of the plug-in name).

Selected Plug-ins To load plug-ins, highlight one or more plug-ins, choose this item, and then choose Load.

Clear Selection Removes highlighting from all items in the list.

Tagged Plug-ins To load tagged plug-ins, choose this item, and then choose Load.

Tag Selected Tags all highlighted plug-ins.

Clear Tags Clears all tags.

Load New Plug-in Loads a plug-in from the hard drive. Use the file dialog to locate the plug-in, and then click Open.

Refresh View Refreshes the list of plug-ins.

Custom UI and Defaults Switcher

Customize menu > Custom UI and Defaults Switcher

Artists and designers in different industries use 3ds Max in different ways. The Custom UI and Defaults Switcher lets you quickly change your program defaults and UI scheme to more closely match the type of work you are doing.

The *Initial settings for tool options* control the default settings for various features in 3ds Max, while the UI Schemes control how the 3ds Max interface looks.

The dialog displays a detailed explanation for each of the four default sets and two UI Schemes that ship with 3ds Max. If you create your own defaults or UI Scheme, they also appear in the list. However, you cannot edit the general description of custom default sets or UI schemes.

See also:

- [Market-Specific Defaults](#) on page 7694

Interface

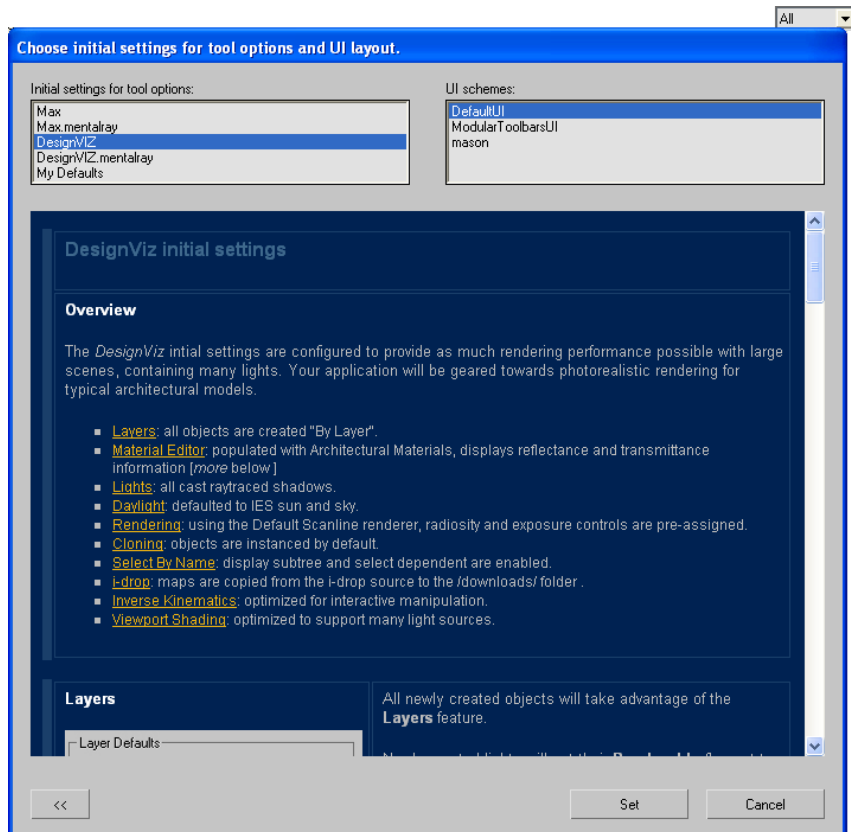

Initial settings for tool options This list contains different sets of default settings for various tools in 3ds Max. Highlight the set that corresponds to the tools you are using.

3ds Max ships with four default sets:

- **Max** contains the set of default settings for general animation use without the [mental ray renderer](#) on page 6230.
- **Max.mentalray** contains the set for general animation use with the mental ray renderer.
- **DesignVIZ** contains the set for design visualization use without the mental ray renderer.
- **DesignVIZ.mentalray** contains the set for design visualization use with the mental ray renderer.

Highlight any of these sets to see detailed explanations of the affected settings. For information on creating or editing defaults sets, see [Market-Specific Defaults](#) on page 7694.

NOTE To apply new defaults, restart 3ds Max.

UI Schemes This list contains all of the UI schemes defined in the `\UI` folder. 3ds Max ships with two UI schemes: *DefaultUI*, and *ModularToolbarsUI*, which has the [main toolbar](#) on page 7499 broken up into smaller toolbars. Highlight the name of the UI scheme in the list to see a description (and image) of the interface.

This list also contains any UI schemes you have saved with the [Save Custom UI Scheme dialog](#) on page 7725. However, no description or image is displayed for these schemes.

Set Applies the selected default settings and UI scheme to 3ds Max.

NOTE To apply new defaults, restart 3ds Max.

Cancel Closes the dialog without applying any changes.

Market-Specific Defaults

3ds Max is used in many different professional markets, including film, design, and visualization, and games. The workflow and performance requirements for users from these markets vary tremendously. As a result, different default settings are ideal for different types of scenes.

For example, a typical animation scene has a small number of lights; [shadow maps](#) on page 8125 provide a fast, accurate solution to generating shadows. On

the other hand, a typical design visualization scene can contain hundreds of lights, in which case shadow maps can cause memory issues. For this type of scene, [ray-traced shadows](#) on page 8103 are much more appropriate.

In order to provide an efficient working environment for both project types, 3ds Max offers four sets of market-specific defaults, tailored specifically for general animation scenes and for design visualization projects (both with and without the use of the [mental ray renderer](#) on page 6230). The sets are each located in their own subdirectories of the `\defaults` directory. These subdirectories each contain an INI file (*currentdefaults.ini*), which contains the global parameter defaults, a default material library (*medit.mat*), which populates the Material Editor at startup, and a startup file (*maxstart.max*), which is the file that opens when 3ds Max is started or when you reset. You can edit any of these files, and you can also create your own sets, however each set must be in a separate subdirectory of `\defaults`. In addition, each file in the directory should have the same names (*currentdefaults.ini*, *medit.mat*, and *maxstart.max*). If one of these files is not present in a custom defaults directory that you have created, 3ds Max uses the corresponding file from the `\defaults\max` directory in its place.

NOTE For your protection, both of the preset default directories have a subdirectory named `\factorydefaults`, which contains the original files for each set. You can use these files in the event that you have changed your defaults and are unhappy with the results. They are also a useful starting point for creating your own set; copy them to a new directory and edit them. It is highly recommended that you *do not edit* the files in the `\factorydefaults` directories.

Default sets are assigned through the [Custom UI and Defaults Switcher](#) on page 7692.

Procedures

To change the current set of defaults:

- 1 Choose Customize menu > Customize UI And Defaults Switcher.
- 2 Select one of the default sets from the *Initial settings for tool options* list and click Set.
- 3 Restart 3ds Max to load the new default parameters.

Interface

Include the following files in your default directory. If one or more of these files is not present in the current *Defaults* directory, 3ds Max uses the corresponding file from *\defaults\max* in its place.

currentdefaults.ini

The following table describes all of the sections that can be set in a default INI file. Any parameter with a blank or invalid value uses the hard-coded default.

NOTE See the online *User Reference* to view this table.

medit.mat

medit.mat is the default material library in your scene.

maxstart.max

The *maxstart.max* file is loaded when you start or reset 3ds Max.

COM/DCOM Server Control Utility

Utilities panel > Utilities rollout > More button > COM/DCOM Server Control

The COM/DCOM Server Control utility supports plug-ins and third-party programs that use the COM (Component Object Model). The idea behind the COM is to expose the core of 3ds Max so applications can invoke 3ds Max to generate images.

The COM facility is intended for application developers. For more information about applications development with 3ds Max, see the description of the COM object interface in the help file (*3dsMaxSDKFull.chm*) for the 3ds Max Plug-In Software Development Kit (SDK).

Procedures

To register 3ds Max as a DCOM server:

- 1 Start 3ds Max and go the Utilities panel. Click More, choose COM/DCOM Server Control, and then click OK.

- 2 If the button in the COM/DCOM Server Control rollout says Register, then click it. If it says Unregister, then do nothing, as 3ds Max is already registered.

Now 3ds Max is registered as a DCOM server and an instance of it can be created from any COM client.

NOTE Not all products include this utility. You can build it from the source located in `\maxsdk\samples\utility\comsrv\`. Copy the resulting `comsrvui.dlu` to the 3ds Max `\plugins` directory.

It is also possible to register and unregister from the command line. There are two command-line options that can be passed to 3ds Max:

```
3DSMAX -RegisterMAXRenderer
```

```
3DSMAX -UnregisterMAXRenderer
```

Customize User Interface Dialog

Customize menu > Customize User Interface

The Customize User Interface dialog lets you create an entirely customized user interface, including shortcuts, quad menus, menus, toolbars, and colors. You can also add commands and macro scripts by selecting either a text or icon button to represent the command or script on the toolbar.

Most commands in the 3ds Max interface appear in this dialog as *action items*. An action item is simply a command that you can assign to a keyboard shortcut, toolbar, quad menu, or menu. The Keyboard, Toolbars, Quads, and Menus panels of this dialog show tables of action items that you can assign. (Tables in the Colors panel list UI elements, instead.)

NOTE A few action items do not correspond to any elements in the default user interface. See [Additional Keyboard Commands](#) on page 7465.

[Keyboard Panel](#) on page 7698

[Toolbars Panel](#) on page 7700

[Quads Panel](#) on page 7704

[Menus Panel](#) on page 7709

[Colors Panel](#) on page 7712

See also:

- [Customizing the User Interface](#) on page 7683
- [Saving and Loading Custom User Interfaces](#) on page 7722

Keyboard Panel

Customize menu > Customize User Interface > Keyboard tab

The Keyboard panel lets you create your own keyboard shortcuts. You can assign shortcuts to most commands available in the software.

The same shortcuts can be assigned to multiple commands, as long as they occur in different contexts. For example, in Video Post, the shortcut Ctrl+S is assigned to Add Scene Event; however, in the Main UI, it is assigned to Save File.

When you use a keyboard shortcut, the software looks for a context-specific shortcut first. If none is found it then looks for the appropriate command in the Main UI shortcuts.

for the context-specific shortcuts to work properly, the [Keyboard Shortcut Override toggle](#) on page 7858 must be on (the default). If it is off, only the Main UI keyboard shortcuts are available.

See also:

- [Keyboard Shortcuts](#) on page 7857

Procedures

To create a keyboard shortcut:

- 1 Choose Customize menu > Customize User Interface > Keyboard panel.
- 2 Use the Group and Category lists to find the action for which you want to create a shortcut.
- 3 Click action in the Action list to highlight it.
- 4 In the Hotkey field, enter the keyboard shortcut you want to assign to the action.

NOTE If the keyboard shortcut you enter is already assigned to an action, that action name appears in the Assigned To field.

5 Click Assign.

Interface

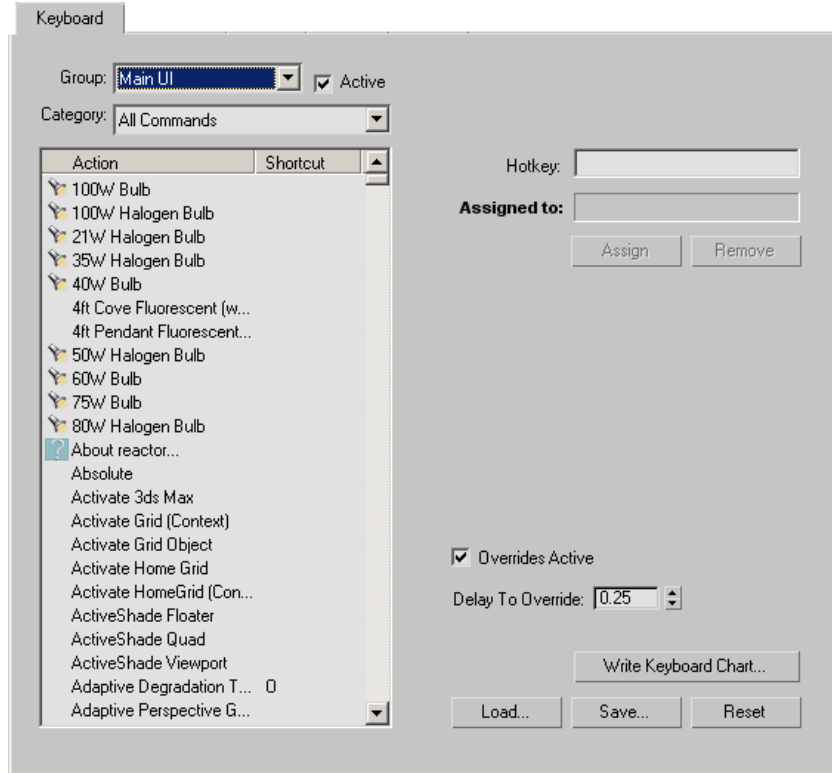

Group Displays a drop-down list that lets you select the context you want to customize, such as Main UI, Track View, Material Editor, and so on.

Active Toggles availability of context-specific keyboard shortcuts. When on, you can use duplicate shortcut keys between contexts within the overall user interface. For example, A can be the shortcut for Angle Snap toggle within the Main UI, and also a shortcut for Assign Material to Selection when you are working in the Material Editor. When Active is off, the shortcuts defined for the appropriate context are not available. Default=on.

Category Displays a drop-down list of all the available categories of user interface actions for the selected context.

Action list Displays all the available actions and shortcuts, if defined, for the selected group (context) and category.

Hotkey Allows you to enter a keyboard shortcut. Once the shortcut is entered, the Assign Button is active.

Assigned To Displays the action a shortcut is assigned to if the shortcut you entered is already assigned.

Assign Activates when you enter a keyboard shortcut in the Hotkey field. When you click Assign, it transfers the shortcut information to the Action list on the left side of the dialog.

Remove Removes all shortcuts for the selected action in the Action list on the left side of the dialog.

Write Keyboard Chart Opens the Save File As dialog, where you can save changes you made to keyboard shortcuts in a TXT file that you can print.

Overrides Active When on, holding keys for boldface shortcuts in the Edit Poly and Editable Poly groups overrides standard functionality. For example, while editing an Editable Poly object at the Polygon sub-object level, pressing and holding Shift+Ctrl+B activates the Bevel tool temporarily, overriding the current operation.

Delay To Override The delay before which the active keyboard shortcut overrides the current operation (see Overrides Active, preceding).

Load Displays the Load Shortcut File dialog. Allows you to load custom shortcuts, from a KBD file into your scene.

Save Displays the Save Shortcut File As dialog. Allows you to save any changes you've made to the shortcuts to a KBD file.

Reset Restores the shortcuts to the default setup (*defaultui.kbd*).

Toolbars Panel

Customize menu > Customize User Interface > Toolbars tab

The Toolbars panel lets you edit existing toolbars and create your own custom toolbars. You can add, remove, and edit buttons on existing toolbars, or you can delete the toolbars entirely. You can also create custom toolbars with both 3ds Max commands and scripts.

Procedures

To create and populate a toolbar:

- 1 Choose Customize menu > Customize User Interface > Toolbars tab.
- 2 Click New.
The New Toolbar dialog appears.
- 3 Enter the name of the toolbar and click OK.
The new toolbar appears as a small floater. Like any floating toolbar, you can resize it and change proportions by dragging the corners and edges.
- 4 Use any of these three methods to add commands to the toolbar:
 - Drag a command to the toolbar from the Customize User Interface dialog > Action list. If the action has a default icon assigned to it (it appears next to the command in the action list), the icon will appear as a button on your toolbar. If no icon is assigned to the command, the name of the command will appear as a button on the toolbar.
 - To copy an existing button, Ctrl+drag the button from any toolbar onto your toolbar.
 - To move an existing button, Alt+drag the button from any toolbar onto your toolbar.
- 5 If you don't want the new toolbar to appear in the interface by default, choose it from the drop-down list on the right side of the Customize User Interface dialog, and then turn on the Hide check box. Thereafter you can toggle the custom toolbar by right-clicking a blank area of any toolbar and choosing the toolbar name from the context menu.

To add commands to a toolbar:

- 1 Choose Customize menu > Customize User Interface > Toolbars panel.
Alternatively, right-click the label of a toolbar and then choose Customize.
- 2 If necessary, open the toolbar to customize using either of the following methods:
 - Right-click a blank area of any toolbar and choose the toolbar name from the context menu.
 - Choose the toolbar name from the toolbars drop-down list on the right side of the dialog and then turn off the Hide check box.

- 3 Use any of these three methods to add commands to the toolbar:
 - Drag a command to the toolbar from the Customize User Interface dialog > Action list. If the action has a default icon assigned to it (it appears next to the command in the action list), the icon will appear as a button on your toolbar. If no icon is assigned to the command, the name of the command will appear as a button on the toolbar.
 - To copy an existing button, Ctrl+drag the button from any toolbar onto your toolbar.
 - To move an existing button, Alt+drag the button from any toolbar onto your toolbar.

To record a script and add it to a toolbar:

Use this method to record a series of commands into a MAXScript command sequence and then turn the script into a toolbar button. You can then re-invoke that sequence at any time. No scripting knowledge is necessary.

- 1 Choose Customize menu > Customize User Interface > Toolbars panel. Alternatively, right-click the label of a toolbar and then choose Customize.
- 2 Open a MAXScript Listener window by any of the following methods:
 - Press F11.
 - Choose MAXScript menu > MAXScript Listener.
 - Choose Utilities panel > MAXScript > MAXScript rollout > Open Listener.
 - Right-click a viewport label, and then choose Views > Extended > MAXScript Listener.
- 3 Choose MAXScript menu > Macro Recorder, or, from on the Listener dialog, choose MacroRecorder > Enable.
- 4 Perform the actions you want to record.

The Macro Recorder records the actions you perform as a script in the upper portion of the Listener dialog (pink background).
- 5 Highlight the lines you want in the recorded script, and then drag those lines directly onto a toolbar.

NOTE Your macro might require some minor editing to remove extraneous steps or to refine the procedure.

You can edit the appearance of the text or icons on your toolbars with the [Edit Button Appearance](#) on page 7720 command, which is available when you right-click the toolbar button.

Interface

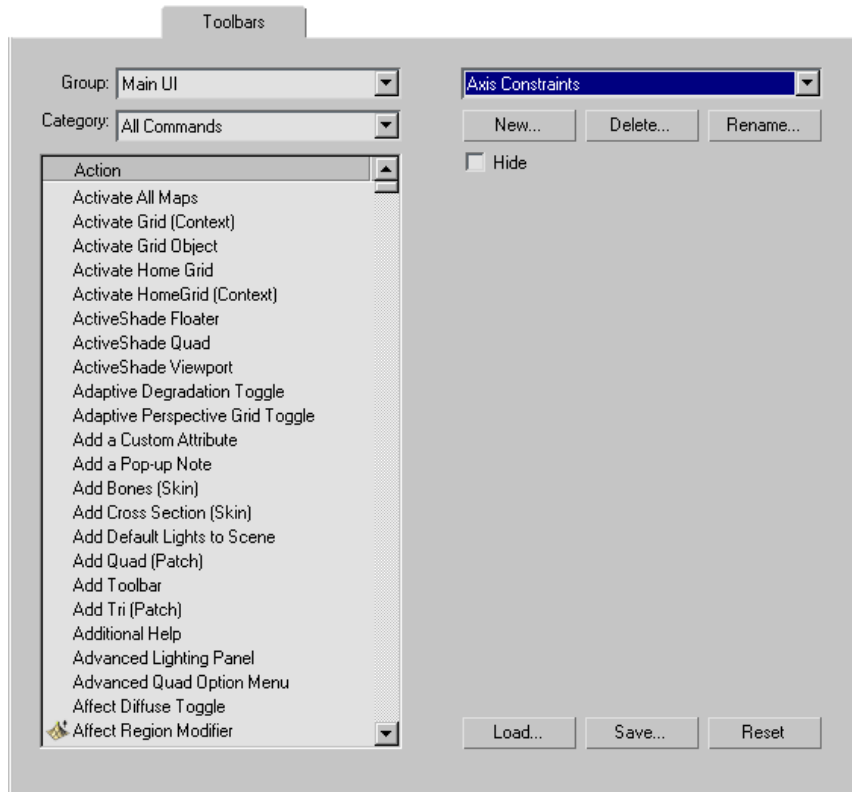

Group Displays a drop-down list that lets you choose the functional context you want to customize. Contexts include Main UI (user interface), Track View, and Material Editor.

Category Displays a drop-down list of available categories of user-interface actions for the chosen group.

Action list Displays all available actions for the chosen group and category.

[toolbars drop-down list] Displays all existing toolbars.

New Opens the New Toolbar dialog. Enter the name of the toolbar you want to create and click OK. The new toolbar appears as a small floater.

Once you've created a toolbar, there are three ways to add commands:

- Drag actions from the Action Window in the Toolbars panel of the Customize User Interface dialog onto your toolbar.
- Ctrl+drag buttons from any toolbar onto your toolbar. This action creates a copy of the button on your toolbar.
- Alt+drag buttons from any toolbar onto your toolbar. This action moves the button from the original toolbar onto your toolbar.

Delete Deletes the toolbar item displayed in the Toolbars list.

Rename Displays the Rename Toolbar dialog. Select a toolbar from the Toolbars list to activate the Rename button. Click Rename, change the name of the toolbar, and click OK. The toolbar name changes in the toolbar floater.

Hide Toggles the display of the chosen toolbar in the toolbars list.

Load Displays the Load UI File dialog. Allows you to load custom user interface files into your scene.

Save Displays the Save UI File As dialog. Allows you to save any changes to the user interface in a CUI file.

Reset Restores the default setup (*defaultUI.cui*).

Quads Panel

Customize menu > Customize User Interface > Quads tab

The Quads panel lets you customize the [quad menus](#) on page 7516. You can create your own quad menu sets, or you can edit existing sets. In the Quads panel, you can customize menu labels, functionality, layout, and shortcuts. The [advanced quad menu options](#) on page 7716 let you modify the color and behavior of the quad menu system. You can also save and load custom menu sets.

See also:

- [Additional Quad Menus](#) on page 7520

Procedures

To create a quad set:

- 1 Choose Customize menu > Customize User Interface > Quads tab.
- 2 Click New.
The New Quad Set dialog appears.
- 3 Enter the name of the quad set and click OK.
The new set appears in the Quad set list.

To add a command to a quad set:

- 1 Choose Customize menu > Customize User Interface > Quads tab.
- 2 Choose the quad set you want to edit from the upper-right drop-down list.
If you want to change the name of the quad set, click Rename and enter a new name in the Rename Quad Set dialog.
- 3 Select the quadrant where you want to place the command.
You can edit the name of the quadrant by changing the text in the Label area.
- 4 Choose the appropriate Group and Category from the respective drop-down lists.
- 5 Choose a command from the action list and drag it into the Quad Menu window.
Use the same procedure to add menus and separators to your quad set.

To delete a quad set:

NOTE You cannot delete any of the default quad sets.

- 1 Choose Customize menu > Customize User Interface > Quads tab.
- 2 Choose the quad set you want to delete from the upper-right drop-down list.
- 3 Click Delete.

To remove a command from a quad set:

- 1 Choose Customize menu > Customize User Interface > Quads tab.
- 2 Choose the quad set you want to edit from the upper-right drop-down list.
- 3 Choose the command you want to remove.
- 4 Press the Delete button.
Use the same procedure to remove menus and separators from your quad set.

To move a command in a quad set:

- Choose the command in the quad set list and drag it to a new position in the list.

Interface

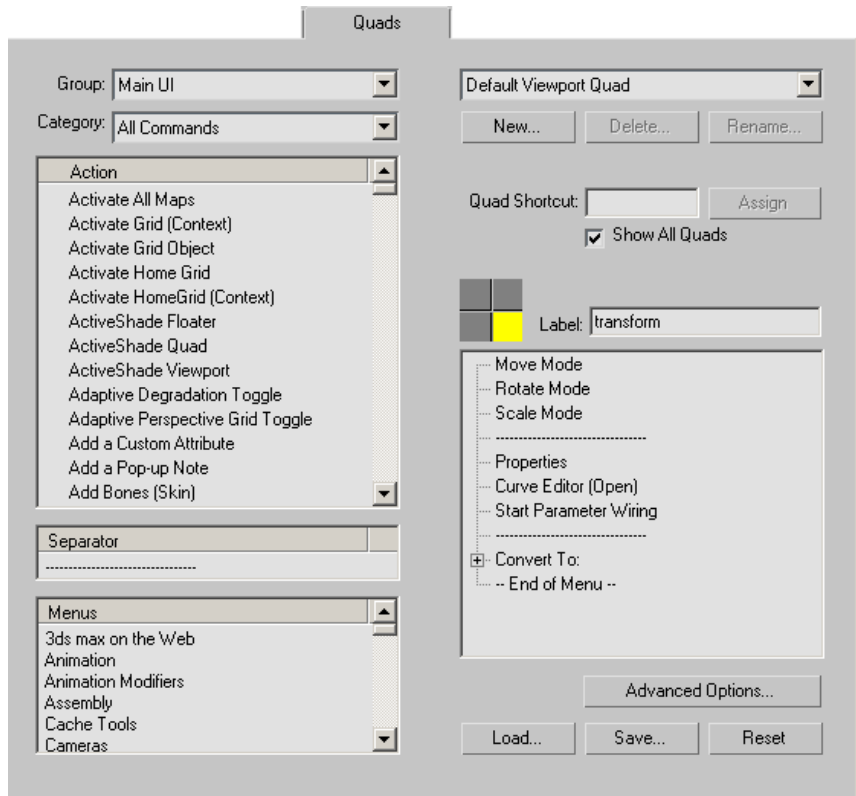

Group Displays a drop-down list that lets you select the context you want to customize, such as Main UI, Track View, Material Editor, and so on.

Category Displays a drop-down list of the available categories of user interface actions for the selected context.

Action list Displays all the available actions for the selected group and category. To add an action to a specific quad set, select it and drag it to the quad menu window on the right side of this dialog. Right-click an action in this window to edit the macro script that defines the action (if there is one).

Separator list Displays a separator line that you can use to separate groups of menu items in a quadrant. To add a separator line to a specific quad set, select it and drag it to the quad menu window on the right side of this dialog.

Menus list Displays the names of all 3ds Max menus. To add a menu to a specific quad set, select it and drag it to the quad menu window on the right side of this dialog. Right-click a menu in this window to delete the menu, rename it, or create a new, empty menu.

Quad set list Displays the available quad sets.

Additional quad menus on page 7520 appear in this list. They can be edited, renamed, and reorganized; however, they cannot be deleted.

New Opens the New Quad Set dialog. Enter the name of the quad set you want to create and click OK. The new quad set appears in the Quad set list.

Delete Deletes the item displayed in the Quad set list. Available only for user-generated quad sets.

Rename Opens the Rename Quad Set dialog. To activate the Rename button, choose a quad set from the list. To change the name, click Rename, edit the name of the quad set, and then click OK.

Quad Shortcut Allows you to define a keyboard shortcut for displaying the quad set. Enter the shortcut and click Assign to make the change.

Show All Quads When on, a viewport right-click shows all four quad menus. When off, a viewport right-click shows only one quad at a time.

Label Displays the label for the highlighted quadrant (shown in yellow to the left of the Label).

Quad Menu Window Displays the menu options for the currently selected quad menu and quad set. To add menus and commands, drag options from the Action and Menus windows to this window.

Items included in the quad menu are displayed only when they are available. For example, if your quad menu contains Track View Selected, the command will display only if a selection exists when you open the quad menu. If none of the commands are available when you open the quad menu, the quadrant does not appear.

When you right-click an item in the quad menu window, several actions become available:

Delete Menu Item Removes the highlighted action, separator, or menu from the quad menu.

Edit Menu Item Name Opens the Edit Menu Item Name dialog. To edit the name, the Customize Name check box must be on. Enter the desired name in the name text field and click OK. The item name is changed in the quad menu, but not in the quad menu window.

Flatten Sub-Menu Displays contents of selected submenu on top level of quad. If you choose this item, the menu name is followed by the string: [FLAT].

Edit MacroScript Opens the macro script for the selected action in a MAXScript editor window.

Advanced Options Opens the [Advanced Quad Menu Options dialog](#) on page 7716.

Load Displays the Load Menu File dialog. Allows you to load custom menu files into your scene.

Save Displays the Save Menu File As dialog. Allows you to save changes to the quad menus in a MNU file.

Reset Restores the default setup (*defaultui.mnu*).

Menus Panel

Customize menu > Customize User Interface > Menus tab

The Menus panel lets you customize the menus in the software. You can edit existing menus or create your own. You can customize menu labels, functionality, and layout.

Procedures

To create a menu:

- 1 Choose Customize menu > Customize User Interface > Menus tab.
- 2 Click New.
The New Menu dialog appears.
- 3 Enter the name of the menu, and click OK.
The new menu appears in the menu list.

To add a command to a menu:

- 1 Choose Customize menu > Customize User Interface > Menus tab.
- 2 Choose the menu you want to edit from the drop-down list.
If you want to change the name of the menu, click Rename, and enter a new name in the Rename Menu dialog.

- 3 Choose the appropriate Group and Category from the respective drop-down lists.
- 4 Choose a command from the action list and drag it into the Menu window.
Use the same procedure to add menus and separators to your menu.

To delete a menu:

- 1 Choose Customize menu > Customize User Interface > Menus tab
- 2 Choose the menu you want to delete from the drop-down list.
- 3 Click Delete.

To remove a command from a menu:

- 1 Choose Customize menu > Customize User Interface > Menus tab.
- 2 Choose the menu you want to edit from the drop-down list.
- 3 Choose the command you want to remove.
- 4 Press the Delete key.
Use the same procedure to remove menus and separators from your menus.

To move a command in a menu:

- Choose the command in the menu window and drag it to a new position in the window.

Interface

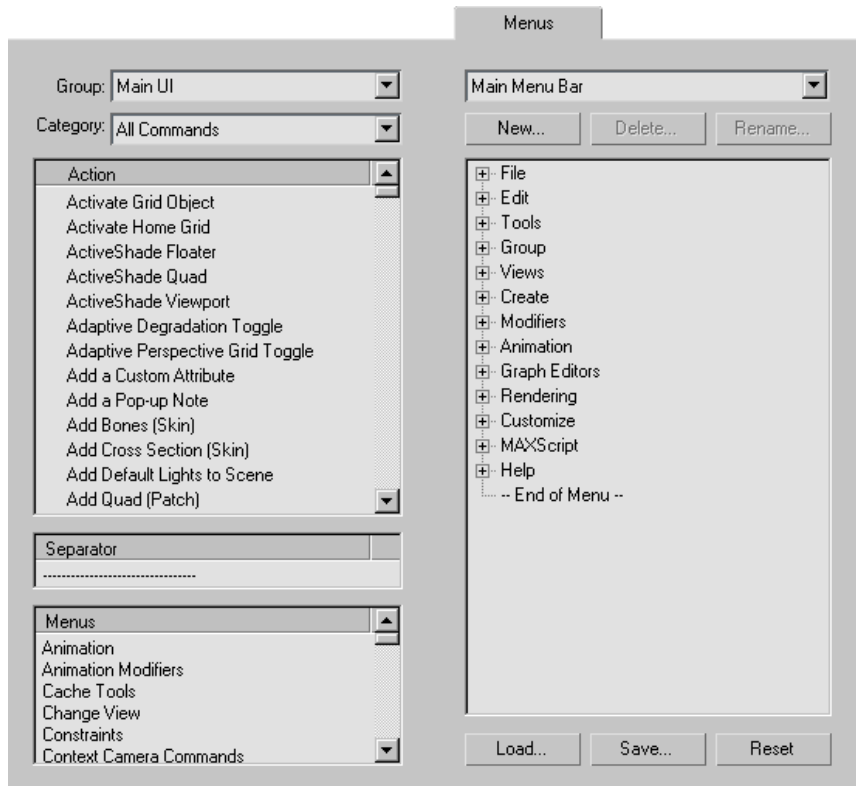

Group Displays a drop-down list that lets you select the context you want to customize, such as: Main UI, Track View, Material Editor, and so on.

Category Displays a drop-down list of the available categories of user interface actions for the selected context.

Action Window Displays all the available actions for the selected group and category. To add an action to a specific menu, select it and drag it to the menu window on the right side of this dialog. Right-click an action in this window to edit the macro script that defines this action (if there is one).

Separator Window Displays a separator line that can be used to separate groups of menu items. To add a separator to a specific menu, select it and drag it to the menu window on the right side of this dialog.

Menu Window Displays the names of all menus. To add a menu to another menu (shown in the Menu List), select and drag it to the menu window on

the right side of this dialog. Right-click a menu in this window to delete the menu, rename it, or create a new, empty menu.

Menu List Displays the default menus as well as any new ones you create or load.

New Displays the New Menu dialog. Enter the name of the menu you want to create and click OK. The new menu appears in the menu window on the left side of the dialog as well as in the Menu List.

Delete Deletes the item displayed in the menu list window.

Rename Displays the Edit Menu Item Name dialog. Select a command in the menu list window and click Rename. This dialog lets you specify a custom name to be displayed in the menu. If you precede a letter in the custom name with the “&” (ampersand) character, that letter is used as a menu accelerator.

Menu Window Displays the menu options for the menu currently selected in the menu list. To add menus and commands (actions), simply select and drag the options from the Action and Menus windows to this window.

There are several actions available when you right-click any item in the menu window:

Delete Menu Item Removes the selected action, separator, or menu from the menu.

Edit Menu Item Name Opens the Edit Menu Item Name dialog. The Customize Name check box must be on to edit the name. Enter the desired name in the name text field and press OK. The item name is changed in the menu, but not in the menu window. If you precede a letter in the custom name with the “&” (ampersand) character, that letter is used as a menu accelerator.

Edit MacroScript Opens the script for the selected action in a MAXScript editor window.

Load Displays the Load Menu File dialog. Allows you to load custom menu files into your scene.

Save Displays the Save Menu File As dialog. Allows you to save changes to the menus in an MNU file.

Reset Restores the default setup (*defaultui.mnu*).

Colors Panel

Customize menu > Customize User Interface > Colors tab

The Colors panel of the Customize User Interface dialog allows you to customize the look of the software interface. You can adjust the colors for almost every element in the interface, giving you the freedom to design your own unique style.

The quad menu colors cannot be customized from the Color panel. To customize quad menu colors, use the [Advanced Quad Menu Options dialog](#) on page 7716.

Procedures

To change an interface element color:

- 1 From the Elements drop-down list, choose the category of the interface element whose color you intend to change.
- 2 In the list below the Elements field, highlight the element whose color you intend to change.
The Color swatch shows the current color of the element.
- 3 Click the Color swatch and then use the Color Selector dialog to choose a new color. Click the Close button to set the color.
To restore the color that was active at the time that you opened the dialog, highlight the element and click Reset.
- 4 Continue choosing elements and changing colors as necessary.
- 5 To finish and apply the color changes to the interface, close the dialog by clicking the X button in the upper-right corner.

TIP If you change several colors and then want to restore all colors to the default values, click the Load button and open *DefaultUI.clr*.

Interface

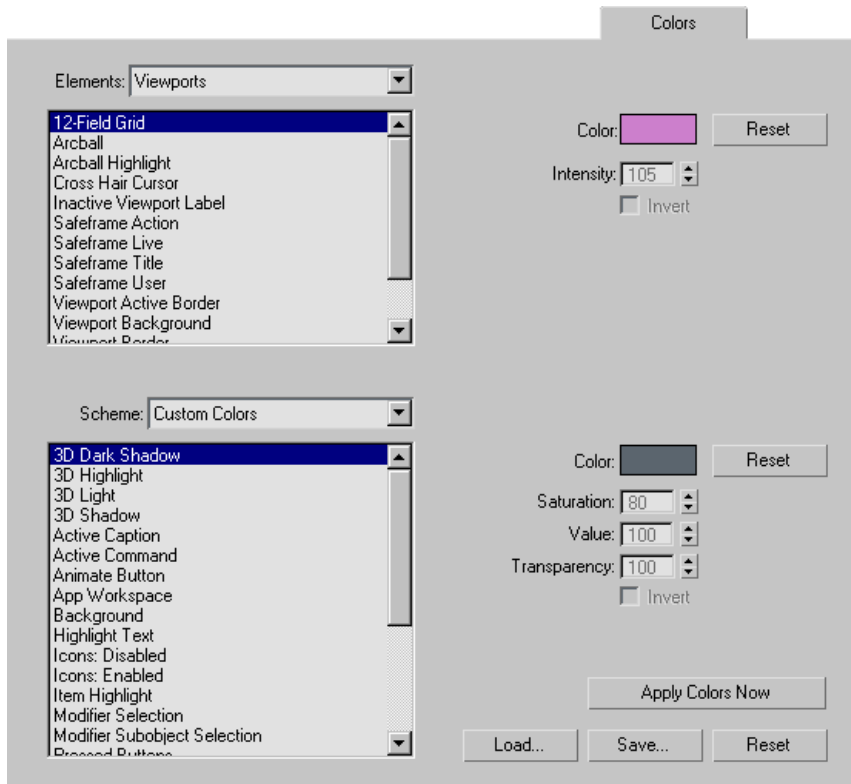

Elements Displays a drop-down list that lets you select from the various high-level groupings: Character, Geometry, Gizmos, Viewports, and more.

[UI elements list] Displays a list of the available elements in the active category.

Color Displays the color for the selected category and element. Click to display the Color Selector, where you can change the color. After choosing a new color, click Apply Colors Now to make the change in the interface.

Reset Resets the color of the highlighted element to the value that was active when you opened the dialog.

Intensity Sets a grayscale value for the display of the grid lines. 0 is black and 255 is white.

This control is available only when you choose the Set By Intensity option from the Grids element, and affects the intensity of the grid lines in the viewports.

Invert Inverts the grayscale value for the display of grid lines. Dark gray becomes light gray and vice-versa.

This control is available only when you choose the Set By Intensity option from the Grids element.

Scheme Allows you to choose whether the main UI colors are set to the default Windows colors or whether they can be customized. If Use Standard Windows Colors is active, all of the elements in the UI Appearance list are disabled, and you are unable to customize the UI colors.

[UI appearance list] Displays all the elements in the user interface that can be changed.

Color Displays the color for the selected UI appearance item. Click to display the Color Selector dialog, where you can change the color. After choosing a new color, click Apply to make the change in the interface.

Reset Restores the highlighted UI appearance item to its color when you first opened the dialog.

Saturation Sets a saturation scale of enabled or disabled icons in the UI. The higher the saturation, the less gray the color. See [Red, Green, Blue / Hue, Saturation, Value](#) on page 8105.

This control is only available when Icons: Enabled or Icons: Disabled is highlighted in the UI Appearance list.

Value Sets the value scale of enabled or disabled icons in the UI. The higher the value, the brighter the color. See [Red, Green, Blue / Hue, Saturation, Value](#) on page 8105.

This control is available only when Icons: Enabled or Icons: Disabled is highlighted in the UI Appearance list.

Transparency Sets the transparency value scale of enabled or disabled icons in the UI. The higher the value, the more opaque the icon.

This control is only available when Icons: Enabled or Icons: Disabled is highlighted in the UI Appearance list.

Invert Inverts the RGB value for the display of enabled or disabled icons in the UI.

This control is only available when Icons: Enabled or Icons: Disabled is highlighted in the UI Appearance list.

Apply Colors Now Activates any changes in the user interface.

Load Displays the Load Color File dialog. Allows you to load custom color files into your scene.

Save Displays the Save Color File As dialog. Lets you save changes to the user interface colors in a CLR file.

Reset Restores the default setup (*defaultui.clr*).

Advanced Quad Menu Options

Customize menu > Customize User Interface > Quads panel > Advanced Options

The Advanced Quad Menu Options dialog lets you customize the size and colors of your quad menus. You can also customize other quad menu behaviors such as repositioning, type font, and cursor behavior.

Interface

Save group

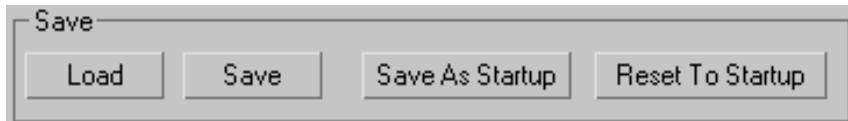

Load Lets you load a quad options (*.qop*) file.

Save Saves your settings to a *.qop* file.

Save as Startup Saves your current settings as the startup settings.

Reset to Startup Resets options to default settings (*defaultui.qop*).

Colors group

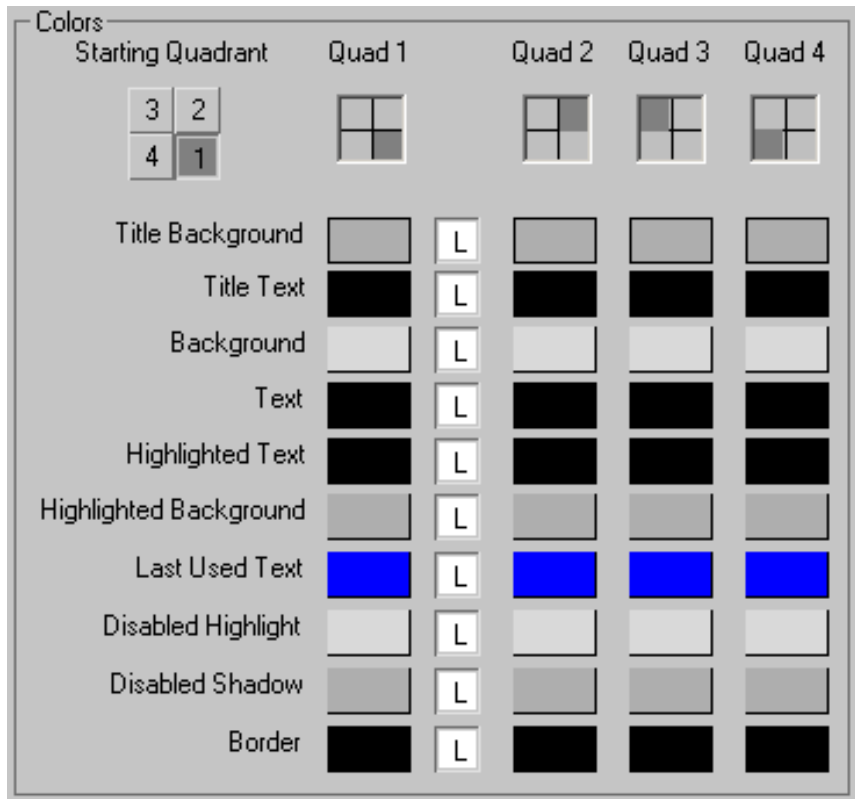

The colors group allows you to customize the colors of your quad menus.

Starting Quadrant Lets you select which quadrant your cursor starts in when you open the quad menu.

Color list Lists customizable elements of the quad menu and separates them by quadrant. Click the color swatch to open a color selection dialog.

If the colors for a quad menu element are locked (indicated by a pressed "L" button), each of the separate quadrants share the same color; when you change the color in one quadrant, it changes all of the quadrants' colors.

You can customize each quadrant separately by turning off the lock button for the selected quad menu element.

Display group

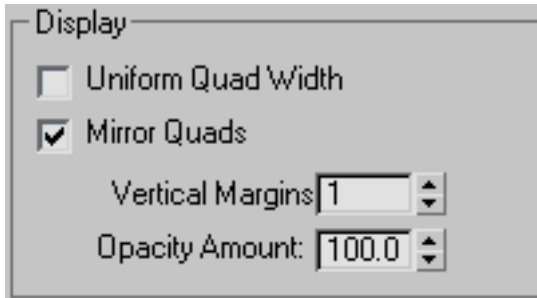

Uniform Quad Width When on, all displayed quadrants are the same width. The widest quadrant determines the width.

Mirror Quads When on, text in the quad menus is justified to the inside edge of the menu: The text in the right quadrants is left-justified, and text in the left quadrants is right-justified.

When off, all text in the quad menus is left-justified.

Vertical Margins Sets the vertical spacing between commands in the quad menu.

Opacity Amount Sets the opacity of the quad menu.

Opacity is not available in systems running on Windows NT.

Positioning group

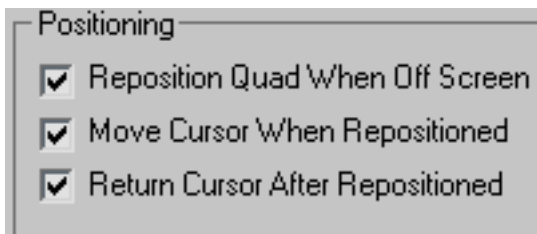

Reposition Quad When Off Screen Automatically repositions the quad menu when you open it with part of the menu off the edge of the screen. The menu is moved so that the entire menu is displayed on the screen.

Move Cursor When Repositioned Moves your cursor to the new location of the quad menu when it is repositioned.

When off, hold down the mouse button when you right-click to display the quad menu. After you move the cursor over the menu, release the mouse button.

Return Cursor After Repositioned After you have selected an action from the quad menu, the cursor is returned to the location on the screen where the original right-click was made.

Fonts group

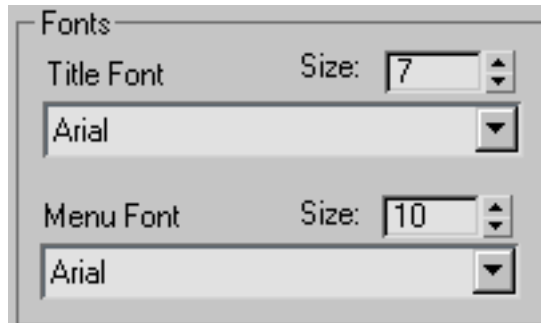

Title Font Sets the font of the quadrant titles.

Size Sets the font size of the quadrant titles.

Menu Font Sets the font of the text inside the quadrants.

Size Sets the font size of the text inside the quadrants.

Animation group

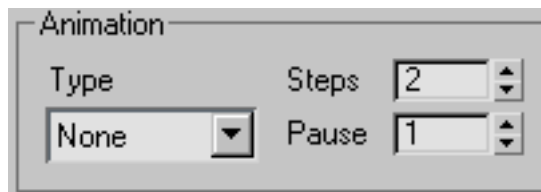

Type Sets the animation type for the quad menu from the following options:

- **None** Quad menus display immediately upon right-clicking.
- **Stretch** Quad menus open by expanding one quadrant at a time, in a clockwise manner. They close similarly; contracting one quadrant at a time, in a counterclockwise manner.

- **Fade** Quad menus open by fading in from transparent to opaque, and close by fading out from opaque to transparent.

Steps The number of frames used to complete the animated display of the quad menu.

As this value becomes larger, the transition (small to large, transparent to opaque, and so on) becomes more gradual.

Pause The time between frames during the animated display of the quad menu.

As this value becomes larger, the animated display of the quad menu slows down.

Edit Button Appearance Dialog

Right-click any button on a custom toolbar. > Edit Button Appearance

Use this dialog to change the appearance of the selected button. You can substitute a different icon for the button, or change to a text button instead. You can also customize the tooltip.

Custom Icons

To make a custom icons, you need a series of four files, each beginning with the same prefix which designates the icon group. You can create these images in any paint program.

- A 24x24 image for use when large icons are displayed. Suffix: *_24i.bmp*.
- A 24x24 grayscale image showing the transparency of the 24x24 image, with black pixels indicating see-through areas where the gray button background shows through. Suffix: *_24a.bmp*.
- A 16x15 image for use when small icons are displayed. Suffix: *_16i.bmp*.
- A 16x15 grayscale image showing transparency of the 16x16 image. Suffix: *_16a.bmp*

To use a file with multiple icons, arrange the icons in series, one after the other. For example, if you want three icons to appear, the file that ends in *_24i.bmp* would be 72 pixels wide and 24 pixels high, and contain the three icons arranged in a row with no space between them.

After you create the icon files, copy them to the *UI/icons* folder and restart 3ds Max. This lets the software find and display the group when you access the Edit Button Appearance dialog.

TIP For examples of how to arrange custom icons in image files, look at some of the existing BMP files in the *UI/icons* folder.

Interface

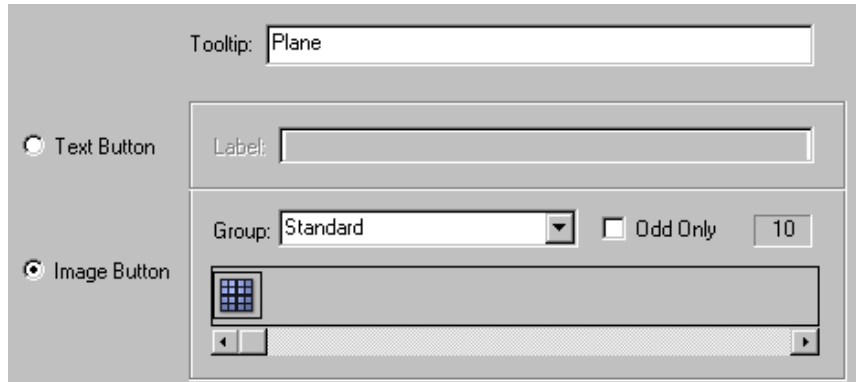

Tooltip You can add your own tooltips to the buttons. The tooltip displays when the mouse is over the tool button. You can edit this text to describe the tool.

Text Button Lets you assign text to the button. You can enter whatever text you like for the button.

Image Button Lets you assign an image (icon) to the button. You can use any predefined icon that you want by selecting it from the display on the right.

Group Displays a list of button categories. The groups of icons change with each category selection.

Odd Only Certain icon sets, including Internal, Classic, Main toolbar, and others, are designed in pairs. In each pair, one icon depicts the button when enabled, and the other shows how it looks when disabled. When Odd Only is on, the interface displays only the odd-numbered icons (enabled), when Odd Only is off, all of the icons, enabled and disabled, are displayed.

Saving and Loading Custom User Interfaces

You can customize your workspace by saving and loading custom user interface (UI) schemes.

A custom UI scheme is saved as a set of six files:

- **.cui:** Stores toolbar and panel layouts.
- **.clr:** Stores all color settings (except quad menu colors).
- **.mnu:** Stores menu bar and quad menu contents.
- **.qop:** Stores quad menu colors, layout, and behavior.
- **.kbd:** Stores keyboard shortcut assignments.
- **.ui:** Stores the icon scheme (Classic or 2D Black and White).

You can load and save each of these files individually from their respective panels in the [Customize User Interface dialog](#) on page 7697. You can also load an entire set of UI scheme files at once with the [Load Custom UI Scheme dialog](#) on page 7724, and you can save the current UI scheme as a complete set with the [Save Custom UI Scheme dialog](#) on page 7725.

By default, two sets of UI schemes are present in the `3dsmax\UI\` folder: *maxstart* and *defaultUI*. Upon startup, 3ds Max uses the *maxstart* file series if it exists; if not, it uses the *defaultui* series.

WARNING Do not save over any files that begin with *defaultUI*, as doing so permanently overwrites the default UI scheme.

Procedures

To load a custom UI scheme:

- 1 Set up the custom UI scheme within 3ds Max using the options on the Customize menu > [Customize User Interface dialog](#) on page 7697.
- 2 Save the custom UI scheme with Customize menu > Save Custom UI Scheme.
- 3 During your current 3ds Max session or any later session, choose Customize menu > Load Custom UI Scheme.
- 4 In the Load Custom UI Scheme dialog, select a type of customization file (*.cui*, *.mnu*, *.clr*, *.kbd*, *.qmo*, or *.ui*) from the Files of Type drop-down list.

- 5 Choose any file with the appropriate extension. The software will search for (and load) any other type of UI scheme file with the same base file name.

If you choose a UI scheme for which one of the six file types is not present, the part of the user interface for which there is no file will not be changed.

To return to the default UI scheme:

If you start 3ds Max and its user interface has an unfamiliar layout, you can always return to the default UI scheme.

- 1 Choose Customize > Load Custom UI Scheme.
- 2 From the Load UI File dialog that displays, choose *defaultui.cui*, and click Open.

All the default UI files begin with the base file name *defaultui*. When you choose *defaultui.cui*, the software loads all default UI scheme files.

To start the software with a custom user interface:

- 1 Arrange the user interface as you would like it to appear when you start 3ds Max.
- 2 Choose Customize menu > Save Custom UI Scheme, and save your custom UI scheme with the base file name *maxstart*.

The next time you start 3ds Max, the software uses the current UI scheme.

NOTE If the Save UI Configuration On Exit option on the Customize menu > Preferences > [General tab](#) on page 7744 is on (which it is by default), the state of the user interface when you close the program overwrites the *maxstart* UI scheme files.

To start the software with a custom user interface from the command line:

- 1 Save your custom UI scheme with a descriptive base file name with the [Save Custom UI Scheme dialog](#) on page 7725.
- 2 Right-click the 3ds Max icon on the Windows desktop, and choose Properties.
- 3 In the Target field, change **3dsmax.exe** to **3dsmax.exe -c**, followed by the name of your *.cui* file.

Example: **3dsmax.exe -c myfile.cui**. Be sure to leave a space both before and after the **-c**.

If you want to move the UI scheme to a different computer, copy all the files in the *3dsmax\UI* folder that start with the custom UI scheme base name to the new *3dsmax\UI* folder. Alternately, you can add the path name to the command line.

To save a single UI scheme file:

- 1 Choose Customize menu > [Customize User Interface](#) on page 7697.
- 2 Access the panel for the type of user interface item you want to save.
- 3 On the panel, click Save.

To change the icon display from Classic to 2D Black and White:

- 1 Choose Customize menu > Save Custom UI Scheme, enter a filename, and click Save.
- 2 On the Custom Scheme dialog, next to Icon Type, choose the type of icon you want to display.
- 3 Click OK to close the dialog and save the scheme.
- 4 Choose Customize menu > Load Custom UI Scheme and then open the UI scheme you saved.

Load Custom UI Scheme

Customize menu > Load Custom UI Scheme

On the Load Custom UI Scheme dialog, you specify the base file name of the custom UI scheme you want to load. You can select any type of UI scheme file from the dialog, and the software will load any other type of UI scheme files with the same base file name.

To save a custom UI scheme, use the [Save Custom UI Scheme dialog](#) on page 7725.

For more information on saving and loading custom user interfaces, see [Saving and Loading Custom User Interfaces](#) on page 7722.

You can also load a custom UI scheme with the [Custom UI and Defaults Switcher](#) on page 7692.

Interface

TIP You can resize the dialog by dragging an edge or a corner.

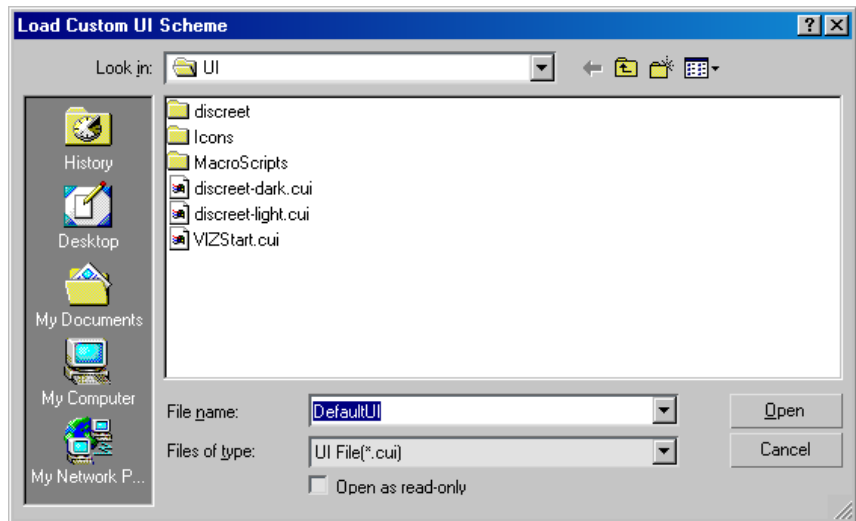

Use the Look In field to navigate to other directories. Click the folder to choose it. The files display in the window.

Use the Files of type drop-down list to search for other types of customization files. The default is `.cui`, but you can also search for `.clr`, `.mnu`, `.kbd`, `.qop`, and `.ui` files. When you choose a filename, all files with that base file name are loaded.

Save Custom UI Scheme

Customize menu > Save Custom UI Scheme

This standard Windows file save dialog lets you save your customized UI scheme.

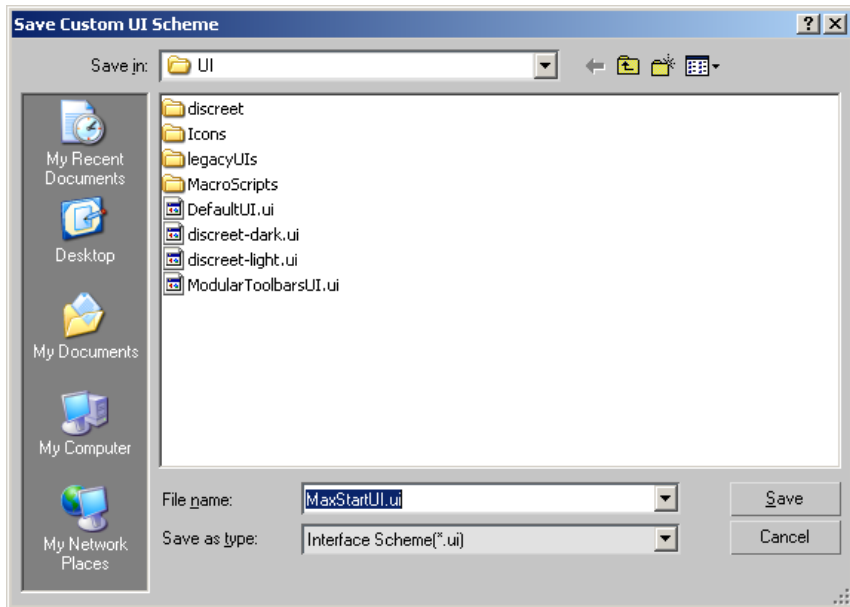

This dialog works differently from other dialogs that save files. In this dialog, after you enter a base file name and click Save, the Custom Scheme dialog appears. On the Custom Scheme dialog, you set the types of user interface schemes to save. A file is saved for each type of scheme you select, each with a specific extension for that type of scheme. When you load any one of the custom UI scheme files with the [Load Custom UI Scheme dialog](#) on page 7724, the entire set of files with the same base file name are loaded.

On the Save Custom UI Scheme dialog, the base name of the current UI scheme is filled in by default. You can enter the name of the base file name in the File Name field, or click in the list to choose an existing base file name. You can click a file with any UI scheme extension to save to the base file name from that file.

If you want the current UI to load automatically every time you load 3ds Max, you can save to the base file name *maxstart*. Alternately, you can turn on the Save UI Configuration On Exit option on the Customize menu > Preferences > [General tab](#) on page 7744. This causes the UI scheme that is current at the time you close 3ds Max to be saved to the base file name *maxstart*. This option is on by default.

WARNING Do not save over the base file name *defaultUI*, as doing so permanently overwrites the default UI scheme files.

For more information on saving and loading custom user interfaces, see [Saving and Loading Custom User Interfaces](#) on page 7722.

Interface

After you enter a file name and click Save, the Custom Scheme dialog opens, letting you define which parts of the UI scheme will be saved.

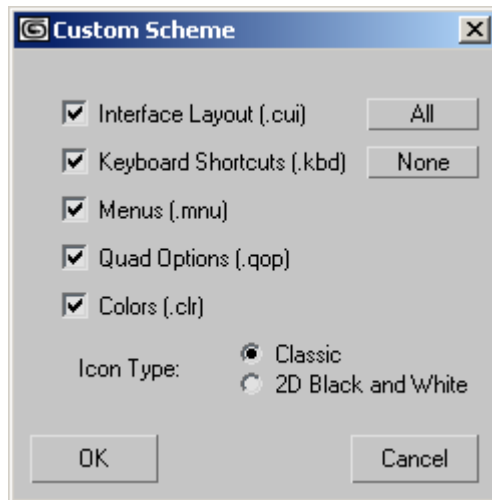

TIP You can resize the dialog by dragging an edge or a corner.

Interface Layout (.cui) When on, saves the current toolbar and panel layout to a CUI file with the UI Scheme base file name.

Keyboard Shortcuts (.kbd) When on, saves the current keyboard shortcuts to a KBD file with the UI Scheme base file name.

Menus (.mnu) When on, saves the menu layout to an MNU file with the UI Scheme base file name.

Quad Options (.qop) When on, saves the quad menus to a QOP file with the UI Scheme base file name.

Colors (.clr) When on, saves the current color definitions to a CLR file with the UI Scheme base file name.

Icon Type Selects the icon scheme for all toolbars, and saves this information in a file with the extension *.ui* after the UI Scheme base file name.

NOTE The icon scheme you choose *is* saved as part of the file set, regardless of whether the chosen icon scheme matches the current scheme displayed on your screen.

All Turns on all of the controls described preceding.

None Turns off all of the controls described preceding.

OK Closes the dialog, and saves all of the selected UI Scheme files.

Cancel Closes the dialog without saving any UI Scheme files.

Revert to Startup Layout

Customize menu > Revert to Startup Layout

Revert to Startup layout automatically loads `_startup.ui`, which returns the user interface to its startup settings. This temporary system file is created automatically when you start the program. Use this option to return the UI to startup settings.

For information on how to load different UI schemes on startup, see [Load Custom UI Scheme](#) on page 7724.

If the Preferences dialog > [General panel](#) on page 7744 > Save UI Configuration On Exit switch is on when you exit the program, the current UI file is overwritten.

Procedures

To revert to the startup UI:

- Choose Customize > Revert To Startup UI Layout. UI elements are rearranged to look as they did when you started the program.

Configure Paths

Customize menu > Configure User Paths

Customize menu > Configure System Paths

Configure Paths functionality is available in two dialogs:

- Paths that *you* use to specify locations for bitmaps, scenes, and so on, are found on the [Configure User Paths dialog](#) on page 7729. In addition, the latter dialog now lets you save, load, and merge path-configuration files, which makes it easier for content-creation teams to set up the same folders for all team members to use.
- Paths used by 3ds Max for purposes such as loading fonts and defaults are accessible on the [Configure System Paths dialog](#) on page 7732.

See also:

- [Asset Tracking dialog > Paths menu](#) on page 7109

Configure User Paths

Customize menu > Configure User Paths

3ds Max uses stored paths to locate different kinds of user files, including scenes, images, DX9 effects (FX), photometric, and MAXScript files. You use the Configure User Paths command to display the Configure User Paths dialog and customize these paths. This command is useful when you add new folders to help you organize your scenes, images, plug-ins, backups, and so on.

You can save, load, and merge the paths that the Configure User Paths dialog manages in MXP (max path) files. This capability makes it easy for all members of content-creation teams to keep projects organized and work efficiently by using the same paths.

See also:

- [Configure System Paths](#) on page 7732

Procedures

In general, these procedures are common to all panels on the Configure User Paths dialog. When you change a setting, it is written to the [3dsmax.ini](#) on page 83 file, and is effective immediately.

To modify a path:

- 1 Click a path entry to highlight it.

- 2 Click Modify.
- 3 Use the Choose Directory dialog to do one of the following:
 - Enter a path in the Path field.
 - Navigate to locate a path.
- 4 Optional step (3rd Party Plug-Ins panel only): Edit the description of the path in the Label field.
This description then appears in the path list.
- 5 Click Use Path.
The new path takes effect immediately.

To share User paths with team members:

- 1 Use the Configure User Paths dialog to set up all necessary user paths.
- 2 Click the Save As button and then use the Save Paths To File dialog to save the path configuration as an MXP file.
- 3 Make the path configuration file available to other team members.
- 4 Each team member then opens the Configure User Paths dialog and uses Load or Merge to open the path configuration file.
The new path configuration is now the same on each team member's machine.

NOTE Using Load eliminates the existing path configuration; using Merge overwrites only paths that exist in both the current configuration and the new one.

To share files with team members using relative paths:

- 1 Ensure the Convert local file paths to Relative preference is enabled.
- 2 As you work, all files are saved relative to your project folder.
- 3 Give your scene to another user.
- 4 The second user opens the scene on a machine with a different project folder and now 3ds Max searches for all files related to the scene file in the second user's project folder.

NOTE The Convert local file path to Relative preference is set when you create the file. For example, if I load a material into my scene with this preference on, this material is always treated as relative to the project folder.

Interface

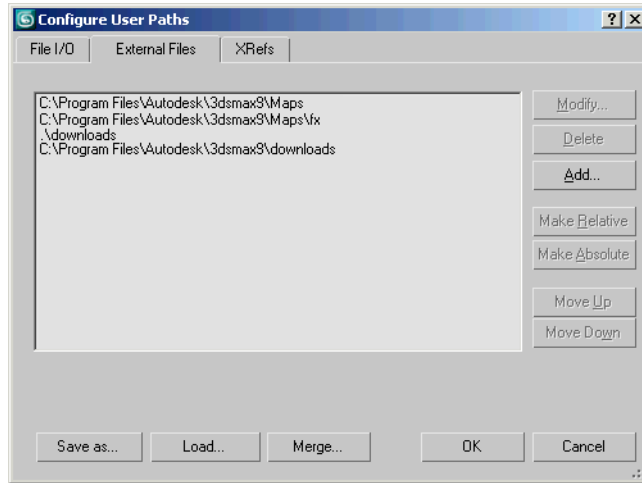

The Configure User Paths dialog comprises three panels:

- [External Files](#) on page 7735
- [File I/O](#) on page 7733
- [XRefs](#) on page 7738

In addition, the dialog provides command buttons on the right side and across the bottom:

Project Folder Lets you set the [project folder](#) on page 6932.

Modify Lets you change the highlighted path.

Make Relative Lets you change an absolute or complete file path into a path relative to the [project folder](#) on page 6932.

NOTE For relative paths within the project folder, a leading “.” represents the project folder path. On the other hand, one or more instances of “..” preceding the path indicates that the path is in a sibling folder to the project folder, as opposed to a subfolder. For example, if your project folder is `c:\MyProject\Project1` and the asset location is `c:\Resources\myresource.jpg`, then the relative path from the project folder to the resource is `..\..\Resources\myresource.jpg`. If the asset was in `c:\MyProject\Resources\myresource.jpg`, then the relative path would be `..\Resources\myresource.jpg`.

Make Absolute Lets you make the path absolute, where a relative path is currently being used. For example, if “.” represents your project folder in the path name, then when you make the path absolute the full name is used instead.

Move Up/Down Lets you change the position of the highlighted path in the list to alter its search priority. Available only on the External Files and XRefs panels.

Save as Lets you save the path configuration as an MXP file for sharing with team members.

Load Loads a path configuration from an MXP file. The loaded configuration completely replaces the existing one.

Merge Merges a path configuration from an MXP file. The merged configuration adds paths that exist only in the new file and replaces any existing paths.

For example, if your File I/O panel > Scenes path is set to `.\scenes` (relative path) and you merge a path configuration file in which the Scenes path is set to the UNC path `\\scene_server\max\scenes`, the former path is replaced by the latter one.

OK Exits the dialog and saves any changes.

Cancel Exits the dialog without saving changes.

Configure System Paths

Customize menu > Configure System Paths

The 3ds Max system uses paths to locate different kinds of files, including defaults, fonts, and startup MAXScript files. You use the Configure System Paths command to open the Configure System Paths dialog and customize these paths.

3ds Max saves the paths that the Configure System Paths command manages in the [3dsmax.ini](#) on page 83 file.

See also:

- [Configure User Paths](#) on page 7729

Interface

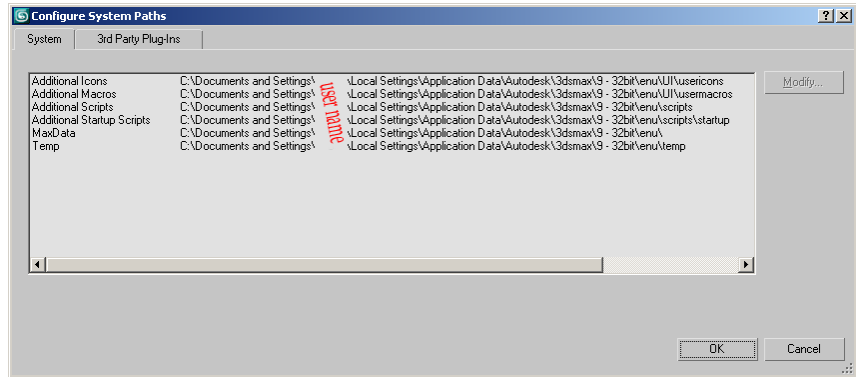

The Configure System Paths dialog comprises two panels:

- [System Paths](#) on page 7739
- [3rd Party Plug-ins](#) on page 7740

File I/O Path Configuration

Customize menu > Configure User Paths > Configure User Paths dialog > File I/O panel

The File I/O panel of the Configure User Paths dialog contains most of the file directories in which users store files.

For descriptions of the general dialog controls, see [Configure User Paths](#) on page 7729.

NOTE By default these paths are relative to the [project folder](#) on page 6932.

Procedures

To modify a file path:

- 1 On the Configure User Paths dialog, click File I/O, and then choose a path entry.
- 2 Click Modify.
- 3 In the Choose Directory dialog, do one of the following:
 - Enter a path in the Path field.
 - Navigate to locate a path.
- 4 Optional step: Enter a description of the path in the Label field.
This description later appears in the path list.
- 5 Click Use Path.
The new path takes effect immediately.

Interface

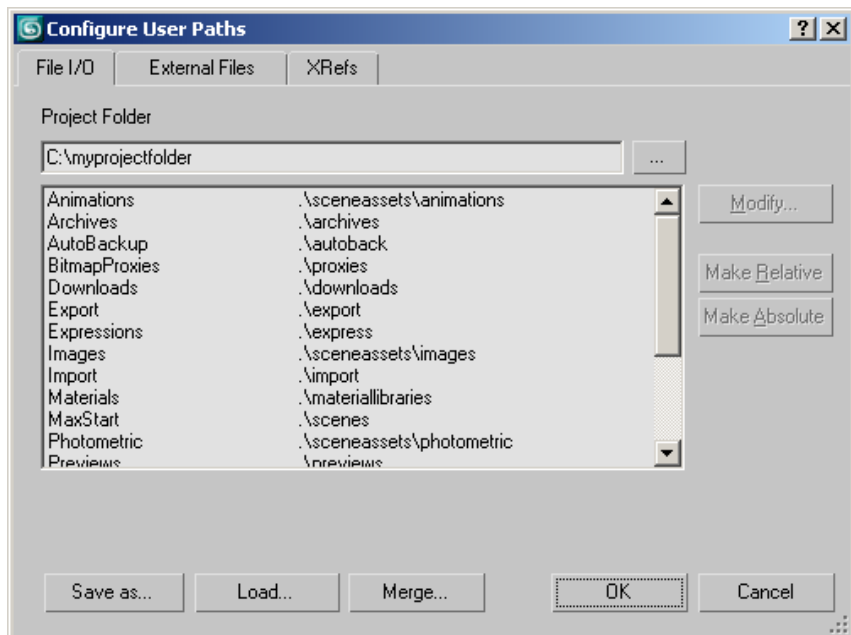

Animations Path for animation files, including XAF, XMM, BIP, FIG, MFE, and so on.

Archives Path for archive files.

AutoBackup Sets the default path for automatic backup files. If you use the [Auto Backup feature](#) on page 7750, use either the `\autoback` directory, which is specific to each running version of the software, or a directory not shared by any other machine.

BitmapProxies Path for proxy bitmaps. See [Global Settings and Defaults for Bitmap Proxies Dialog](#) on page 7115.

Downloads Path for [i-drop](#) on page 7160 files.

Export Path for exported files.

Expressions Path for text files used by expression controllers.

Images Path for image files.

Import Path for imported files.

Materials Path for material library (MAT) files.

MaxStart Path for `maxstart.max`, which provides initial 3ds Max scene settings.

Photometric Path for photometric files, which define various characteristics of [Photometric lights](#) on page 5005

Previews Path for preview renders.

RenderAssets Path for mental ray and other rendering asset files, including shadow maps, photon maps, final gather maps, MI files, and render passes.

RenderOutput Path for rendered output.

RenderPresets Path for Render Preset files.

Scenes Path for MAX scene files.

Sounds Loads sound files.

VideoPost Loads and saves Video Post queues.

External Path Configuration

Customize menu > Configure User Paths > Configure User Paths dialog > External Files panel

On the External Files panel of the Configure Paths dialog, you can add or modify path directories for [bitmaps](#) on page 7926, [DX9 effects \(FX\) files](#), on page 7990, and downloads; that is, files transferred from the Internet with [i-drop](#) on page 7160. Bitmaps are used for background images and [mapped materials](#) on page 8036 (textures, bump maps, displacement maps, and so on). FX files are used by the [DirectX 9 Shader material](#) on page 5758.

NOTE By default the paths for `\Maps\fx`, `\Maps`, and the root folder are all relative to the root directory of 3ds Max whereas the `\downloads` folder is relative to the project folder by default.

3ds Max stores the path of any file you load. When the file is reloaded, the search order is as follows:

- 1 The path saved with the file.
- 2 The directory of the current scene.
- 3 The paths listed in the External Files panel, starting at the top of the list.

NOTE To save loading time, if a map with the same name exists in two different locations (paths), the software loads it only once. This can cause a problem only if your scene includes two different maps with the same name. In this case, only the first map encountered will appear in the scene.

- 4 Every subdirectory under the directory of the current scene.

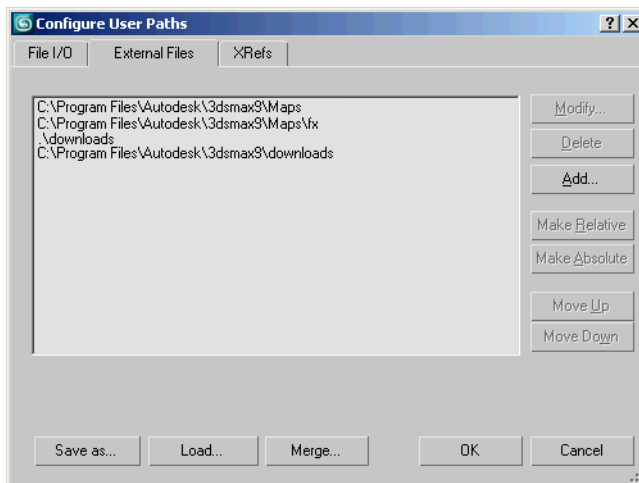

For descriptions of the general dialog controls, see [Configure User Paths](#) on page 7729.

Procedures

To modify a file path:

- 1 On the External Files panel, choose a path entry.
- 2 Click Modify.
- 3 In the Choose Directory dialog, do one of the following:
 - Enter a path in the Path field.
 - Navigate to locate a path.
- 4 Click Use Path.
The new path takes effect immediately.

To add a path for a file:

- 1 On the External Files panel, click Add.
- 2 On the Choose New Bitmap Path dialog, do one of the following:
 - Enter a path in the Path field.
 - Navigate to locate a path.
- 3 If you want to include subdirectories in this path, turn on Add Subpaths.
- 4 Click Use Path.
The new path takes effect immediately.

To delete a path for a file:

- 1 On the External Files panel, choose a path entry.
- 2 Click Delete.
The path location is removed.
- 3 Click Cancel to restore the path.
This closes the Configure Path dialog without saving any path changes.

To move a path up or down in the list:

- 1 On the External Files panel, choose a path entry.
- 2 Do one of the following:
 - Click Move Up to move the entry closer to the top of the list, giving it a higher priority in the search process.
 - Click Move Down to move the entry closer to the bottom of the list, giving it a lower priority in the search process.

XRefs Path Configuration

Customize menu > Configure User Paths > Configure User Paths dialog > XRefs panel

On the XRefs panel of the Configure User Paths dialog, you can modify, delete, or add to the directory locations 3ds Max searches for XRef objects and XRef scenes. You can also use either relative or absolute paths.

You expand the default locations of external reference files by adding paths to this panel. Use this technique to identify the directories most often used in your scenes.

3ds Max stores the path of any external reference file you load. When the external reference file is reloaded, the search order is as follows:

- 1 The path saved with the external reference file.
- 2 The directory of the current scene.
- 3 The paths listed in the Configure User Paths dialog > XRefs panel, starting at the top of the list.

NOTE By default, this path is relative to the project folder.

For descriptions of the general dialog controls, see [Configure User Paths](#) on page 7729.

Procedures

To modify an external reference file path:

- 1 On the XRefs panel, choose a path entry.

- 2 Click Modify.
- 3 On the Choose Directory dialog, do one of the following:
 - Enter a path in the Path field.
 - Navigate to locate a path, and click Use Path.

To add an XRef path:

- 1 On the XRefs panel, click Add.
- 2 On the Choose New XRef Path dialog, do one of the following:
 - Enter a path in the Path field.
 - Navigate to locate a path.
- 3 Click Use Path.
The new path takes effect immediately.

To delete an external reference file path:

- 1 On the XRefs panel, choose a path entry.
- 2 Click Delete.
The path location is removed.
- 3 Click Cancel to restore the path.
This closes the Configure User Paths dialog without saving any path changes.

To move a path up or down in the list:

- 1 On the XRefs panel, choose a path entry.
- 2 Do one of the following:
 - Click Move Up to move the entry closer to the top of the list.
 - Click Move Down to move the entry closer to the bottom of the list.

System Paths

Customize menu > Configure System Paths > System panel

This dialog is especially useful if you are programming your own scripts for 3ds Max. When you start 3ds Max, it checks these folders and runs or otherwise uses the corresponding files:

File Type	Function
Additional Icons	Path for additional icons
Additional Macros	Path for additional macros
Additional Scripts	Path for additional scripts
Additional Startup Scripts	Path for additional startup scripts
MaxData	Path for data files related to 3ds Max
Temp	Path for temporary files

Procedures

To modify a path:

- 1 Click a path entry to highlight it.
- 2 Click Modify.
- 3 Use the Choose Directory dialog to do one of the following:
 - Enter a path in the Path field.
 - Navigate to locate a path.
- 4 Click Use Path.
The new path takes effect immediately.

3rd Party Plug-Ins Path Configuration

Customize menu > Configure System Paths > Configure System Paths dialog
> 3rd Party Plug-Ins panel

On the 3rd Party Plug-Ins panel of the Configure System Paths dialog, you can add or modify the directory paths of [plug-ins](#) on page 8092 supplied by third parties and independent software developers. You can also store plug-ins in separate directories and use this panel to add the paths of those directories. Changing the list order specifies the search order. Put the most frequently used plug-ins at the top.

Path information is stored in the *plugin.ini* file.

NOTE To change the path for standard plug-ins included with 3ds Max, use the [Configure System Paths](#) on page 7732 function.

For descriptions of the general dialog controls, see [Configure User Paths](#) on page 7729.

Procedures

To modify a plug-in path:

- 1 On the 3rd Party Plug-Ins panel, choose a path entry.
- 2 Click Modify.
- 3 On the Choose Directory dialog, do one of the following:
 - Enter a path in the Path field.
 - Navigate to locate a path.
- 4 Click Use Path.
The new path takes effect immediately.

To add a plug-in path:

- 1 On the 3rd Party Plug-Ins panel, click Add.
- 2 On the Choose Directory dialog, do one of the following:
 - Enter a path in the Path field.
 - Navigate to locate a path.
- 3 Type a description in the Label field.
- 4 If you want to include subdirectories in this path, turn on Add Subpaths.
- 5 Click Use Path.
The new path takes effect immediately.

To delete a path:

- 1 On the 3rd Party Plug-Ins panel, choose a path entry.
- 2 Click Delete.
The path location is removed.

Network Plug-In Configuration

You can include paths to additional INI files within the local *plugin.ini* file; the software processes these files as if they were part of the original *plugin.ini*. This capability is helpful in settings where several systems on a network are using the same plug-ins. The network administrator maintains only a single remote INI file, rather than having to update each machine individually.

Procedures

Example: To add remote INI files to your local *plugin.ini*:

- 1 Open your local copy of *plugin.ini* with your preferred text editor.
- 2 At the bottom of the file, type **[Include]** and press Enter.
- 3 After [Include], type these *two* lines:
myremote=\\remote_dir\remote_plugin.ini
anotherdir=d:\test\extra_plugin.ini

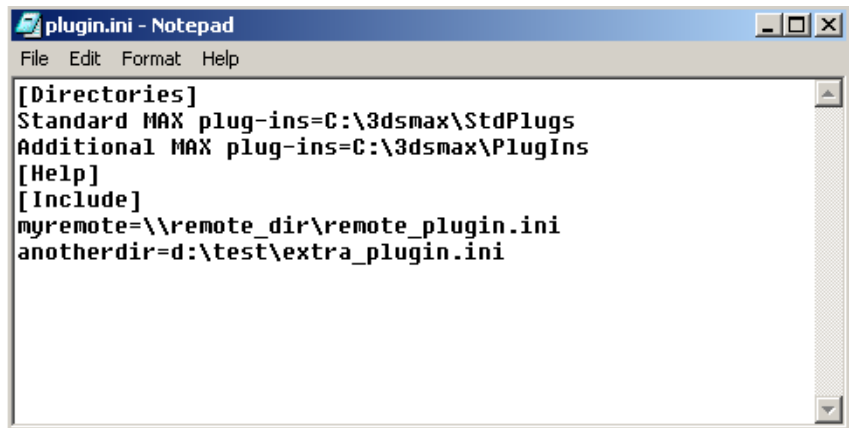

```
plugin.ini - Notepad
File Edit Format Help
[Directories]
Standard MAX plug-ins=C:\3dsmax\StdPlugs
Additional MAX plug-ins=C:\3dsmax\PlugIns
[Help]
[Include]
myremote=\\remote_dir\remote_plugin.ini
anotherdir=d:\test\extra_plugin.ini
```

NOTE You can give any title to the directory (in this case, *myremote* or *anotherdir*), and the directory can be any local or remote directory. In addition, the INI file can have any name.

- 4 Save *plugin.ini* and exit the text editor.

The next time you start the software, it will load plug-ins from the directories defined in *plugin.ini*, as well as plug-ins in any remote INI file specified in *plugin.ini*.

You can add as many remote INI files as you need, making it easy to organize groups of plug-ins.

Preferences

Customize menu > Preferences

3ds Max offers many options for its display and operation. These options are available on the Preference Settings dialog in a series of tabbed panels.

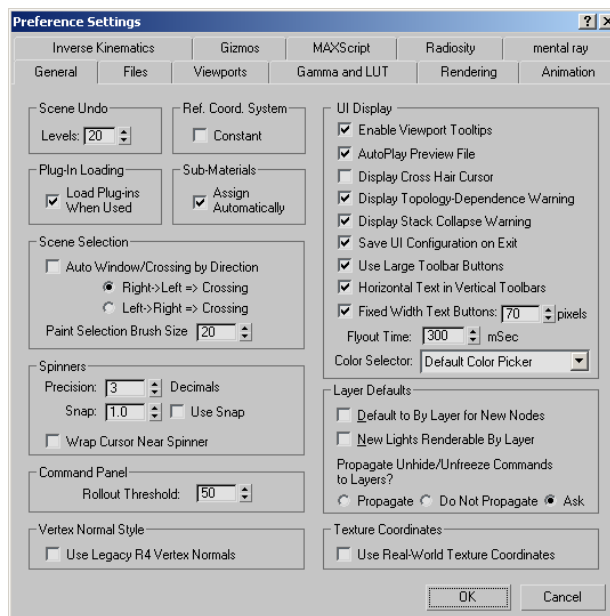

The Preference Settings dialog contains the following panels:

[General Preferences](#) on page 7744

[File Preferences](#) on page 7750

[Viewport Preferences](#) on page 7753

[Gamma and LUT Preferences](#) on page 7758

[Rendering Preferences](#) on page 7768

[Animation Preferences](#) on page 7772

[Inverse Kinematics Preferences](#) on page 7776

[Gizmos Preferences](#) on page 7778

[MAXScript Preferences](#) on page 7782

[Radiosity Preferences](#) on page 7786

[mental ray Preferences](#) on page 7787

General Preferences

Customize menu > Preferences > Preferences dialog > General tab

On the General panel of the Preference Settings dialog, you set options for the user interface and for interactivity.

[Interface](#) on page 7745

Procedures

To set and toggle spinner snap:

- 1 Do one of the following:
 - Choose Customize menu > Preferences > Preference Settings dialog > General tab.



- Right-click the Spinner Snap button on the main toolbar.

Either method brings up the General tab. The two controls for spinner snap are in the Spinners area of this panel.

- 2 Enter a value in the Spinner Snap field.
- 3 Turn on Use Spinner Snap.
When you exit the dialog, Spinner Snap is on.

- 4 As you work, use the Spinner Snap button to toggle the use of this setting.

To set the Undo level:

- 1 Choose Customize menu > Preferences > Preference Settings dialog > General panel.
- 2 Change the value of Scene Undo Levels.
The higher the value of Undo Levels, the more system resources are required. The default value is 20.

Interface

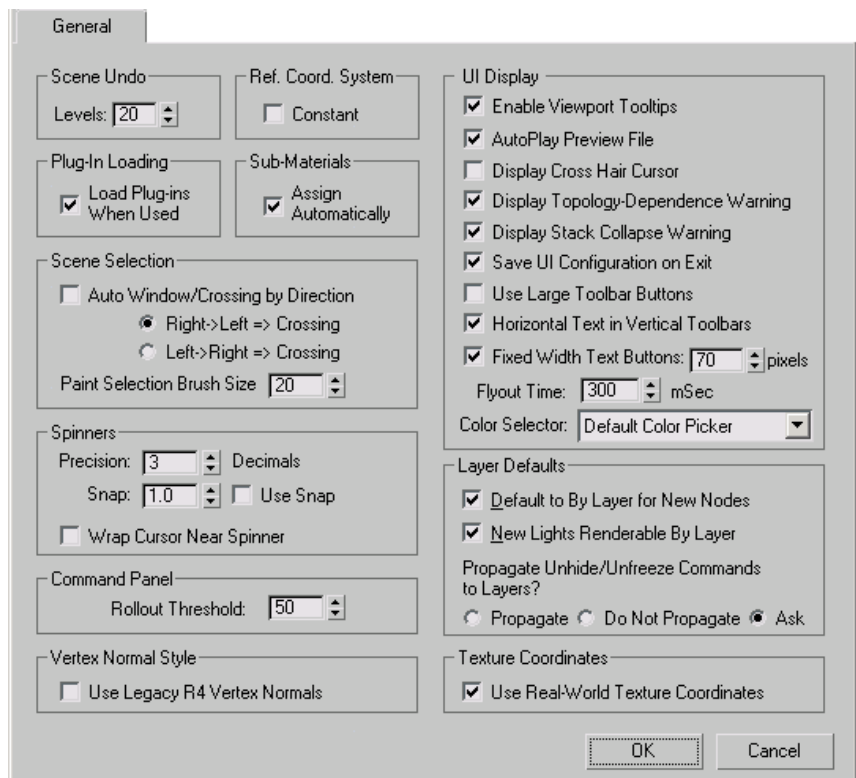

Scene Undo group

Levels Sets the number of operations you can undo.

Reference Coordinate System group

Constant Sets one coordinate system and transform center for Move, Rotate, and Scale on the Main toolbar. The coordinate system displayed in the [coordinate dropdown list](#) on page 967, and the transform center selected from the [Use Center flyout](#) on page 975, are used for all transforms.

Normally, each transform switches to the coordinate system and transform center used the last time the transform was active.

UI Display group

Enable Viewport Tooltips When on, and not at a sub-object level, this function displays a tooltip when the cursor pauses over a non-selected object in the viewport.

AutoPlay Preview File Starts the Media Player automatically at the end of a [Make Preview](#) on page 6422.

Display Cross Hair Cursor Displays the mouse cursor as full-viewport cross hairs, vertical and horizontal lines extending the full extent of the active viewport.

Each movement of the mouse is redrawn, so the cross hairs are relatively slow. If you want to create a keyboard shortcut, find *Cross Hair Cursor toggle* in Customize menu > Customize User Interface > Keyboard panel and specify the keys to use for the shortcut. To change the color of the cross-hairs cursor, go to Customize menu > Customize User Interface > Colors panel > Viewports > Cross Hair Cursor and use the color selector to change the cursor color.

Display Topology Dependence Warning Toggles the topology dependence warning. This warning appears when you choose to edit a modifier or the base object at the bottom of the modifier stack of an object with modifiers and sub-object selections. The warning occurs because this action can affect the object topology adversely. You can also turn off the warning on the warning dialog. Default=on.

Display Stack Collapse Warning Toggles the stack collapse warning, which appears if you choose to collapse the modifier stack. You can also turn off the warning on the warning dialog. Default=on.

Save UI Configuration on Exit Restores panels and toolbars to the positions they were in the last time you used the software. Turn off this switch to restore panels to the state they were in before turning on this option.

Use Large Toolbar Buttons Toggles between large and small toolbar buttons.

Horizontal Text in Vertical Toolbar Ensures that text buttons are displayed horizontally.

If you create a vertical custom toolbar that uses text rather than image buttons, you can use this option to display either horizontal or vertical text.

Fixed Width Text Button Specifies the maximum width of text buttons.

To use this feature, turn on the Horizontal Text In Vertical Toolbar switch, turn on this option, and then set a maximum display size for the text button in pixels. For custom vertical toolbars with text buttons, this option limits the size of the text display.

Flyout Time Sets the pause, in milliseconds, between the mouse click and the flyout popping up from the button. Increase this setting only if you need an extra-long delay. Don't decrease the setting much or you might not be able to execute button commands before the flyout takes over.

Color Selector Choose the default [color selector](#) on page 391, or a third-party plug-in color selector in the list. The color selector you choose here is used throughout 3ds Max whenever you specify a color.

Plug-In Loading group

Load Plug-Ins When Used When on, loads plug-ins on demand, as they are needed.

Sub-Materials group

Assign Automatically Enables the automatic creation of a Multi/Sub-Object material when you assign a material to a selection of face sub-objects in an editable object. Default=on.

When on, the assigned material becomes part of the new Multi/Sub-Object material, and is assigned to the face selection. When off, the assigned material is assigned to the entire object.

NOTE If the face selection comprises faces with different material IDs, assigning a material to the selection with Assign Automatically enabled results in the software assigning the first unused material ID to all selected faces, thus changing their IDs.

See also [Drag and Drop Sub-Object Material Assignment](#) on page 5312.

Scene Selection group

Auto Window/Crossing by Direction When on, the direction that you drag a selection area determines whether it is a [window or crossing selection](#) on page 260. This works for any selection area (rectangle, circle, fence, or lasso).

You can select which direction causes a window selection and which causes a crossing selection in the Scene Selection group. When you drag a window selection, the selection region is displayed with a solid line; when you drag a crossing selection, the selection region is displayed with dashed lines.

Right-> Left => Crossing When you drag a selection region from right to left, it is a crossing selection. Conversely, when you drag left to right, it is a window selection.

Left-> Right => Crossing When you drag a selection region from left to right, it is a crossing selection. Conversely, when you drag right to left, it is a window selection.

Paint Selection Brush Size Sets the size of the brush used by [Paint Selection Region](#) on page 256.

Spinners group

Precision Sets the number of decimal places displayed in a spinner edit field. Range=0 - 10 (where 0 is no decimal places).

Snap Sets the click increment and decrement values for all of the spinners in 3ds Max.

Use Snap Toggles spinner snap on and off.

Wrap Cursor Near Spinner Limits cursor wrapping to an area close to the spinner when you drag to adjust spinner value.

Command Panel group

Rollout Threshold The number of pixels in a rollout that should be scrollable in the command panel before the rollout is shifted into a separate command panel column.

This option is applicable only when the command panel displays multiple columns.

Layer Defaults group

Default to By Layer for New Nodes When on, the software sets rendering, motion blur, display, and advanced lighting properties for all new objects to [By Layer](#) on page 7933.

New Lights Renderable By Layer When on and you create a light, the software gets its [Object Properties](#) on page 305 > Renderable setting from the properties of the active layer.

Propagate Unhide/Unfreeze Commands to Layers? When you unhide or unfreeze an object on a hidden or frozen layer, this choice determines whether the command affects the object or its layer.

- **Propagate** Unhiding or unfreezing an object in a layer unhides or unfreezes the layer.
- **Do Not Propagate** Unhiding or unfreezing an object in a hidden or frozen layer affects only the object.
- **Ask** When this option is active and you unhide or unfreeze objects, a dialog appears asking if you want to apply the operation to the associated layers. If you do, the associated layers are unhidden or unfrozen. Otherwise the operation is applied only to the specified objects.

Vertex Normal Style group

Use Legacy R4 Vertex Normals By default, 3ds Max uses a new, more accurate method for computing vertex normals from smoothing groups, which improves the way geometry displays in viewports and in rendered output. To use the method from older versions of the software, for compatibility, turn on this check box.

Texture Coordinates group

Use Real-World Texture Coordinates Controls whether real-world texture coordinates are active or if the legacy method of applying texture coordinates is in use. When off, texture-coordinate behavior reverts to the legacy method and texture tile values have a default value of 1, and *Real-World Map Size* for primitives is off. Default=off.

When Use Real-World Texture Coordinates is on, the Use Real-World Scale and Real-World Map Size options are also on. Use Real-World Scale is present in the Material Editor, on the Coordinates rollout for 2D maps. Real-World Map Size is available for objects such as primitives and modifiers such as UVW Map.

File Preferences

Customize menu > Preferences > Preference Settings dialog > Files tab

On the Files panel of the Preference Settings dialog, you set options relating to file handling. You can choose the program used for archiving and control the options for log file maintenance. And the Auto Backup function lets you save your work automatically at defined intervals.

Interface

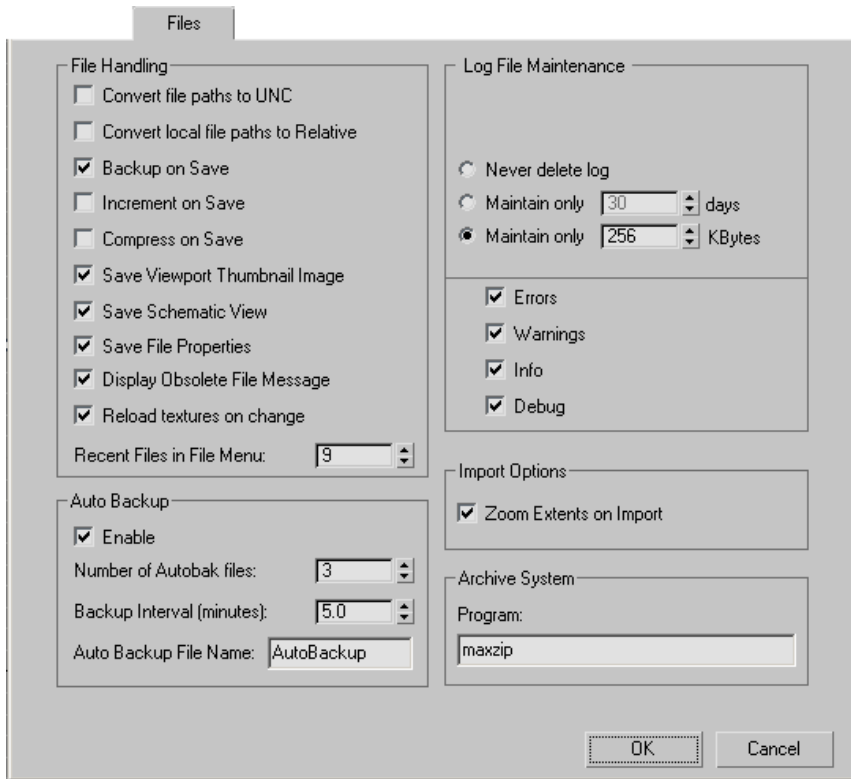

File Handling group

Convert file paths to UNC When on, paths shown in the user interface for any files present on a mapped drive use [Universal Naming Convention \(UNC\) format](#) on page 8160. When off, each path starts with the mapped drive letter (for example, *w:*).

This check box is linked to the [Convert file paths to UNC](#) on page 7750 switch on the Asset Tracking dialog > Paths menu. Toggling either one toggles both.

NOTE This switch affects only newly added paths. Toggling it has no effect on existing paths. For example, if you load an image file into a [Bitmap map](#) on page 5795 from a mapped drive with the switch on, turning it off does not change the file path to the mapped version.

Convert local paths to Relative Converts the file paths of all newly added assets in a scene so that they are relative to the [project folder](#) on page 6932. Default=off.

NOTE This is a system setting and is not saved with the scene file.

Backup on Save Creates a backup file if a file of the same name already exists. The existing file is renamed *maxback.bak* and placed in the *autoback* directory before the save occurs. You can edit the automatic backup settings in the [Auto Backup group](#) on page 7752. Default=on.

Increment on Save Creates a new copy of the file in the same directory whenever you save the file. The name of the new file is incremented by 1 (*filename01.max*, *filename02.max*, and so on). Default=off.

Compress on Save Saves the 3ds Max file in a compressed format. Depending on the details of the file, the compressed file can be as small as one-fifth the size of its uncompressed equivalent. Default=off.

You can determine whether a 3ds Max file is compressed or not by bringing up Properties for the file in Windows Explorer. On the Contents panel, under General, you'll see whether the file is compressed or uncompressed.

Save Viewport Thumbnail Image Saves a 64-pixel thumbnail of the active viewport when you save each MAX file. The Asset Browser reads thumbnails. Saving thumbnails adds about 9K to each MAX file. Default=on.

Save Schematic View When on, the active schematic view is saved with the MAX file. Default=on.

Save File Properties When on, any data entered in the [File Properties dialog](#) on page 7124 is saved with the scene file and can be accessed with Windows Explorer and [File Finder](#) on page 7143. When off, the file properties information is not stored with the file. Default=on.

Display Obsolete File Message Turns off the "Obsolete data format found - Please resave file" alert that is displayed when you load a MAX file created in an earlier version of 3ds Max. Default=on.

There is a matching "Do not display this message" check box in the alert itself, and you can also turn off the alert from there.

Reload textures on change When on, reloads bitmapped textures if the date of the bitmap file has been updated. Default=on.

Recent Files in File Menu Sets the maximum number of recently edited MAX files to display in the list File > Open Recent. Range=0 to 50. Default=9.

Auto Backup group

Auto Backup saves your work periodically. In the event of a power failure, if you have not saved your work, you can load in an auto backup (autoback) file from the *autoback* subdirectory in the program directory (or under *\My Documents\3dsmax*) and continue working with little lost work.

Auto Backup creates auto backup files based on a time interval. The name of an auto backup file is *AutoBackupN.max*, where *AutoBackup* is the main part of the name (*AutoBackup* is the default), and *N* is an integer from 1 to 99.

For example, if you've set Auto Backup to create three auto backup files at one-minute intervals, Auto Backup will create *AutoBackup1.max*, and then a minute later *AutoBackup2.max*, and then *AutoBackup3.max*. At the fourth minute, the system overwrites *AutoBackup1.max*, and so on.

Enable Toggles Auto Backup.

Number of Autobak Files The number of backup files to write before overwriting the first one. Range=1 to 99. Default=3.

Backup Interval (minutes) The number of minutes between backup file generation. Default=5.0.

NOTE This interval takes effect only when the scene changes; for example, if you move an object or apply a modifier. If nothing changes, for example, if you leave your computer for a while, then no backups are created. Also, if you save the scene file manually, Auto Backup resets the Backup Interval timer.

Auto Backup File Name Lets you enter an alternative name for the auto backup file. Auto backup files with a different name still have the filename extension *.max*. Default=AutoBackup.

Log File Maintenance group

The following controls affect the *max.log* file.

Never Delete Log Determines how long the log file is maintained. When you choose Never Delete, the *max.log* file remains on the hard disk and continues to grow.

Maintain Only...Days Resets the file to zero bytes after it reaches the number of days specified in this field.

Maintain Only... Kbytes Resets the file to zero bytes after it reaches the number of kilobytes specified in this field.

Errors Writes fatal errors to the *max.log* file instead of generating Alert dialogs. Alerts halt network rendering for one or more servers.

Warnings Writes warning messages to the *max.log* file instead of generating Alert dialogs.

Info Writes general information to the *max.log* file instead of generating Alert dialogs.

Debug Writes debug messages to the *max.log* file instead of generating Alert dialogs.

The type of errors covered by these four categories include maps that can't be found, missing UV coordinates, missing output directories, full disks, missing DLLs, disks to which you don't have access, invalid meshes, and obsolete MAX files

Import Options group

Zoom Extents on Import Automatically zooms all viewports to scene extents after importing a file.

Archive System group

Program Specifies the name and location of the program to use for archiving. The program must be independently installed on your system. You can add command-line arguments to follow the executable file name. For example, for the PKZIP program, the arguments might be:

```
project1.zip c:proj0?.max -o
```

Viewport Preferences

Customize menu > Preferences > Preference Settings dialog > Viewports tab

On the Viewports panel of the Preference Settings dialog, you set options for viewport display and behavior.

You can also set the current Display Driver.

See also:

- [Strokes](#) on page 7842
- [Graphics Driver Setup Dialog](#) on page 7790
- [Configure Driver](#) on page 7793

Interface

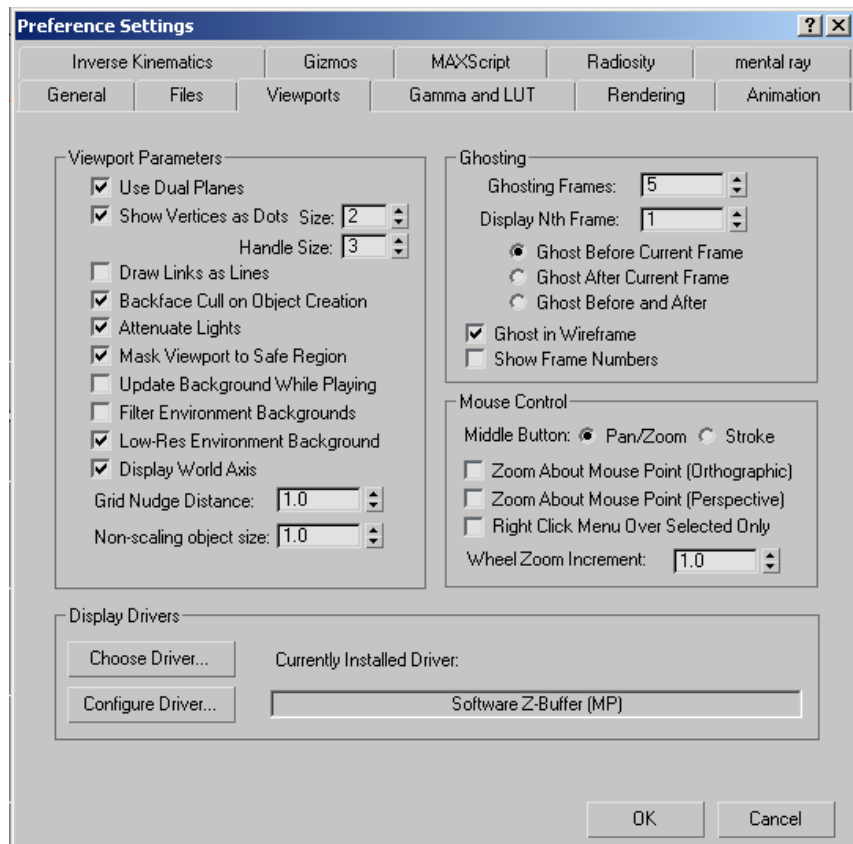

Viewport Parameters group

Use Dual Planes Uses the front/back plane system when redrawing the viewport. The selected object is manipulated in the front plane and is redrawn, while other objects remain on the back plane and are not redrawn. This default setting provides the fastest redraws under normal circumstances. If your assigned display driver doesn't support dual planes, this option is not available. Turn off this setting to improve redraw speed if you are rotating the whole scene or moving a camera through the scene (usually situations in which the whole viewport needs to be redrawn anyway).

Show Vertices As Dots When on, the software displays vertices in mesh and patch objects as small, solid-color squares, whose size you can set with the Size parameter. When off, the vertex display is a tick mark.

Size Lets you specify the vertex size displayed in the viewports. Range=2 to 7. Default=2.

Handle Size Lets you specify the display size for handles attached to patch vertices and spline vertices. Range=2 to 7. Default=3.

Draw Links as Lines Displays the [hierarchical links](#) on page 8002 between parent and child objects as plain lines, rather than shapes when Display panel > Link Display rollout > Display Link is on. Show Links is enabled in the Object Properties dialog.

Backface Cull on Object Creation Determines whether to display faces with [normals](#) on page 8059 pointing away from view. When on, you see through the wireframe to the backfaces. This option applies to wireframe viewport displays only. In most cases, keep this switch enabled. However, when modeling with NURBS surfaces, which consist of single-sided planes, it's easier to view the geometry from all angles when backface culling is off.

- This control affects only the created objects, and you can reverse the effect on each object by changing the Backface Cull setting in the Object Properties dialog for that object. You might turn off Backface Cull On Object Creation before creating your NURBS, and then turn it on again when your finished.
- You can globally change the display of backface culling in the viewports by turning on [Force 2-Sided](#) on page 7817 on the Rendering Method panel of the Viewport Configuration dialog.

Attenuate Lights Turns the display of [attenuation effects](#) on page 7915 on or off from start to end in the interactive viewport renderer. When off, attenuated lights behave as though unattenuated. Default=off.

Mask Viewport to Safe Region By default, the viewport area outside the outermost safe frame displays the contents of the viewport. When this switch is on, that area is left blank.

Update Background While Playing Turns on the updating of bitmaps in the viewport background when you play an animation. This capability lets you check your action against a 2D [rotoscoped](#) on page 8109 background, even if your animation plays at 1 frame per second. When on, an [IFL file](#) on page 7339, [AVI file](#) on page 7326, or [MOV file](#) on page 7348 updates on each frame when you click the Play button. To use this feature, turn off the [real-time](#) on page 8104 switch on the [Time Configuration dialog](#) on page 7565.

The viewport updates not only when you click Play, but also when you drag the time slider.

Filter Environment Backgrounds Affects the background displayed in the viewport only when the Viewport Background dialog > [Use Environment Background switch](#) on page 154 is on.

When you turn on Filter Environment Backgrounds, the environment background is filtered in the viewport, resulting in an antialiased image. When you turn it off, the background image is not filtered, resulting in an aliased, pixelated image.

Note the following:

- Filtering slows down the recalculation of the viewport background image about 30 to 40 percent. Unless you really need that smooth display, it's best to leave the option off.
- This option doesn't affect the rendered background image, and doesn't effect the viewport backgrounds when you turn on Use Environment Background.

Low Res Environment Background Reduces the size of the environment background map by half, and then magnifies it to the size needed for the viewport. This results in a chunkier, pixelated appearance, but speeds the rendering in the viewport by four times (because it halves the width and the height of the original image).

TIP Unless you need fine detail in your environment background, keep this switch enabled.

Display World Axis When on, displays a world axis in the lower-left corner of all viewports. Default=on.

Grid Nudge Distance Sets the nudge distance for the Nudge Grid Down and Nudge Grid Up functions, which you can use to move an active grid helper object into position. See [To nudge a grid object up or down:](#) on page 2626.

Non Scaling Object Size Sets the display size of cameras, lights, and other nonscaling objects. Default=1.

Display Drivers group

Currently Installed Driver Displays the name of the currently installed driver.

Choose Driver Displays the [Display Driver Setup dialog](#) on page 7790. Use this dialog to select a different software display driver, or to switch drivers if you installed a hardware accelerator card.

Configure Driver Displays the [Configure Driver dialog](#) on page 7793, where you can change the driver options for your currently selected driver.

Ghosting group

Ghosting Frames Specifies the number of ghost images that appear before and after the current frame when you choose Show Ghosting from the Views menu. If you display ghosts both before and after the current frame, the total number of ghosts is twice this number.

Display Nth Frame Specifies the number of frames between the appearance of each ghost. The smaller this number, the closer the ghost images appear to each other.

Ghost Before Current Frame Displays only ghost images that occur before the current frame. This makes the ghosts trail the object.

Ghost After Current Frame Displays only ghost images that occur after the current frame.

Ghost Before and After Displays ghosts both before and after the current frame.

Ghost in Wireframe Displays ghosts in black wireframe in shaded viewports. When off, the ghosts appear as shaded objects, using the same colors as the wireframe ghosts.

Show Frame Numbers Displays a frame number in the upper-left corner of each frame.

Mouse Control group

Middle Button Pan/Zoom Sets the middle mouse button to pan in the viewport if you have a three-button mouse. If you have a Microsoft Intellimouse, you can also roll the middle wheel to zoom the viewport. To Zoom with a three button mouse, press Ctrl+Alt and drag the center button.

NOTE By default, the Intellimouse slows the speed of the mouse when you hold down the wheel button. You can increase the mouse speed in the Mouse Properties dialog in the Windows Control Panel. Choose the Wheel tab, click the Settings button in the Wheel Button group, and turn the slider up to Fast.

Stroke Assigns command shortcuts to stroke patterns applied by dragging with the middle mouse button. See [Strokes](#) on page 7842.

Zoom About Mouse Point (Orthographic) When on, viewports zoom about the point where you click the mouse. When off, viewports zoom about the center of the view. Applies to orthographic viewports only.

Zoom About Mouse Point (Perspective) When on, viewports zoom about the point where you click the mouse. When off, viewports zoom about the center of the view. Applies to perspective viewports only.

Right Click Menu Over Selected Only Limits the right-click menu display over a selected object. Default=off.

When this option is off, you can right-click anywhere in the viewports to display a menu.

Wheel Zoom Increment Determines the sensitivity of the zoom when you use the wheel on the mouse. Increase sensitivity up to a maximum value of 100 or reduce it to a minimum of 0.01. Default=1.0.

Gamma and LUT Preferences

Customize menu > Preferences > Preference Settings dialog > Gamma and LUT tab

On the Gamma And LUT panel of the Preference Settings dialog, you set options to adjust the [Gamma](#) on page 7994 and lookup-table (LUT) values for input and output images and for the monitor display.

Lookup-table (LUT) Correction

Lookup-table (LUT) correction provides compatibility with the same feature used in other Autodesk Media & Entertainment products such as Combustion and the systems suite: Inferno, Flint, Smoke, and so on. This feature allows studios to implement a consistent way of displaying colors, assuming that their monitors are calibrated to the same reference. Thus 3D artists can produce results that are closer to what the compositor expects by eliminating a variable in the equation: the way colors are displayed on screen.

NOTE The lookup table controls available here do not affect exposure control or lighting of the scene. While they do affect the colors of the final image, this is with regard to the display only. By having a reference across a studio (with calibrated monitors), using standardized lookup tables minimizes variability in rendered output.

Also, please note that the LUT system of the systems suite is complex and offers a variety of controls and flavors of lookup tables. This feature integrates the View LUTs only, such as that found in Combustion, where only the displayed images are modified.

Gamma Correction

Gamma correction compensates for the differences in color display on different output devices, so that images look the same when viewed on different monitors, or are used as bitmaps or in printed matter.

The calculation of “gamma” is $output_intensity = input_intensity(1/gamma)$. That is, the result is the original value raised to the power of the inverse of the gamma value. One result of this calculation is that a gamma value of 1.0 does not adjust the image at all.

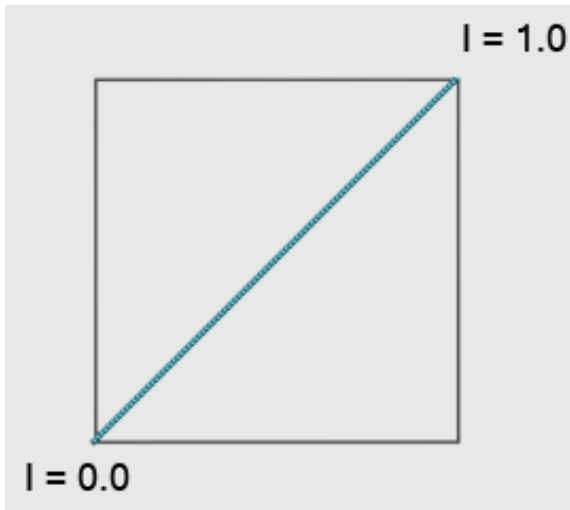

Gamma = 1.0: no correction

I stands for *Intensity*.

Another result of the gamma calculation is that black is not affected by the adjustment, and neither is white (or any fully saturated color). Gamma adjustment affects only the midtones of an image.

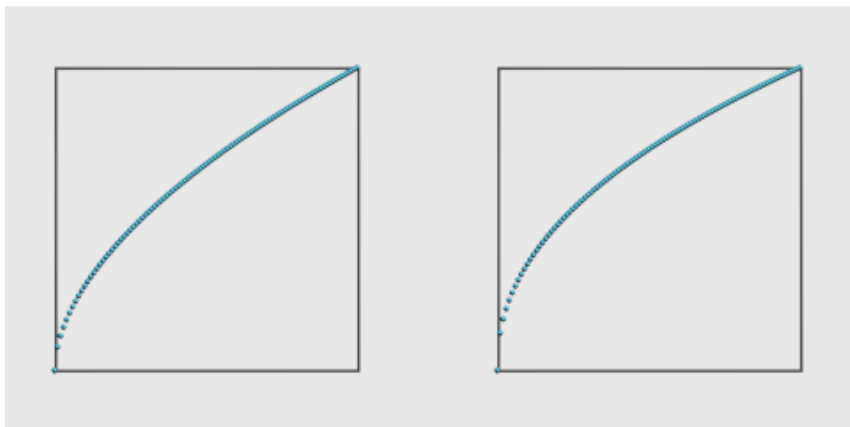

Left: gamma = 1.8

Right: gamma = 2.2, the standard for video

The horizontal axis represents input (the original value) and the vertical axis represents output (the gamma-corrected value).

Computer monitors and videos don't display color in a linear way (as in the first illustration). Also, the brightness of a monitor tends to make an image seem brighter than its intensity values really specify. Gamma correction fixes this problem, and can ensure consistency between different applications or different monitors. When you set gamma, find a value that makes middle gray on your own monitor match a true middle (50 percent) gray.

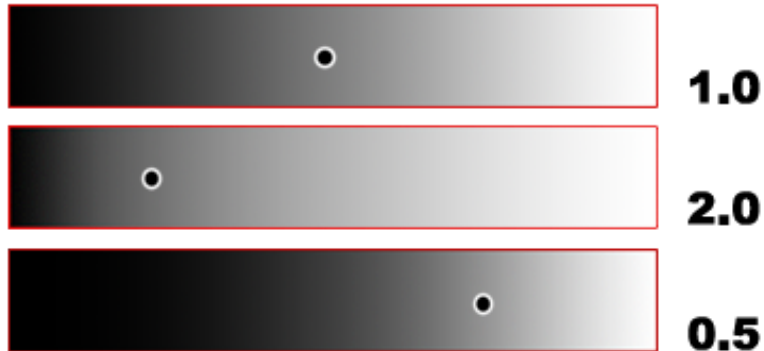

Changing gamma value to match a monitor's middle gray

The standard gamma value for video is 2.2. This is the theoretically correct value, making the linear color space stored in the bitmap and used by the renderer appear to be linear on screen.

However, because the response of photographic film isn't linear either, users find that this theoretically correct value looks too bright and washed out. A common compromise is to render to a gamma of 1.7 or 1.8, making things look more photographic; that is, as if the image had been shot on photographic film and then developed.

We recommend that you *always* turn on gamma correction when you share bitmaps between different computers, between different applications on the same computer, or create renderings to use in printed matter.

NOTE

If the only other applications that use your renderings are also Autodesk Media & Entertainment products, you might want to use LUT correction instead of gamma correction.

Two common mistakes have to do with gamma correction:

- Not applying gamma correction when it should be used. This results in renderings or bitmaps that are too dark.
- Inadvertently applying gamma correction twice. This results in renderings or bitmaps that are too bright.

See the Procedures section below for more detailed instructions.

Procedures

To set the gamma for renderings you will use as bitmaps or in printed matter:

- 1 Choose Customize > Preferences.
- 2 Turn on Enable Gamma/LUT Correction.
- 3 Turn on Load Enable State With MAX Files.
This step is optional but recommended. It ensures that the gamma settings are used with all your scenes.
- 4 In the Display group at the left-hand side of the panel, choose Gamma.
- 5 Use the Gamma spinner to adjust the Gamma value until the gray square in the center of the display shows no contrast with the surrounding border.

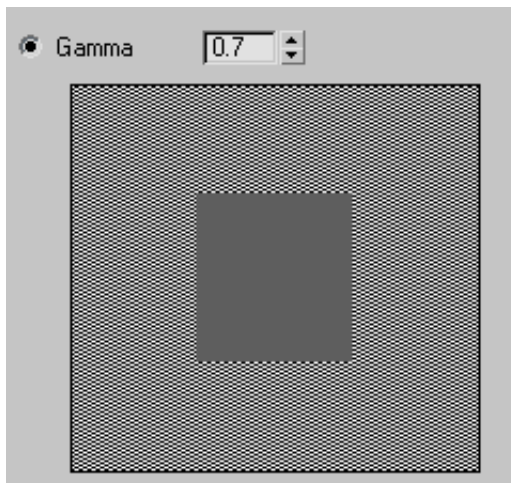

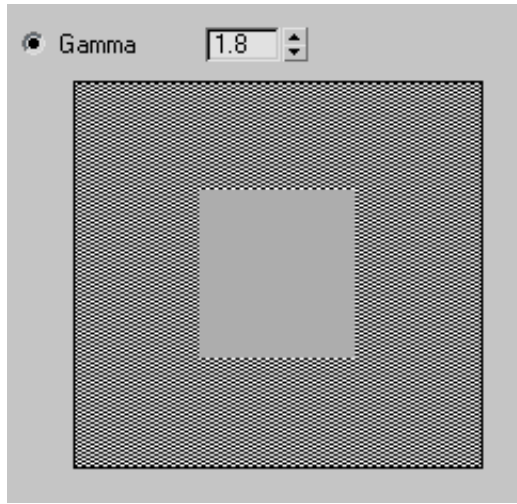

Above: A bad gamma value

Below: A good gamma value

The value you choose can vary, depending on your system's monitor.

- 6 Once you have a good gamma value, change Output Gamma in the Bitmap Files group on the right-hand side of the tab to the same value as Display gamma.
- 7 Click OK.

To set the gamma for incoming bitmaps generated (or edited) by other applications:

- 1 Find out whether the other application has its own gamma correction.
- 2 If it does, choose Customize > Preferences > Gamma And LUT. Turn on Enable Gamma/LUT Correction, and choose an Input Gamma value that matches the application's.

If the file type (for example, Targa) has an embedded gamma value, you might need to set Input Gamma to the *inverse* ($1/\text{gamma}$) of the file's embedded gamma, to avoid applying gamma correction twice.

- 3 If it does not, choose Customize > Preferences > Gamma And LUT. Turn on Enable Gamma/LUT Correction, then in the Bitmap Files group, change the Input Gamma to a suitable value.

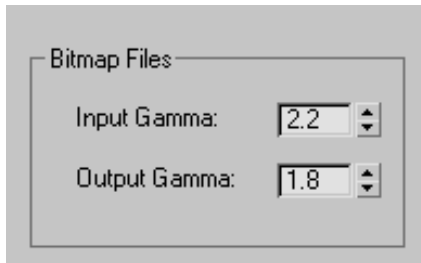

Input gamma set to a value suitable for a different application

It might take some experimentation to find the gamma value that best adjusts the bitmaps created by the other application. The bitmap should appear the way it does in the other application: if it appears too light or too dark in 3ds Max, try a different Input Gamma value.

IMPORTANT If you use bitmaps from multiple applications, and these different applications have different ideal Input Gamma values, then turn on gamma correction, but leave Input Gamma set to 1.0. Instead, for each bitmap you read, use the individual Select Bitmap Image File dialog to set the gamma value appropriate to the program that created the bitmap.

Example: To use gamma correction with Adobe Photoshop:

- 1 In Photoshop, make sure Edit > Color Settings is set to “North America General Purpose Defaults”, with Working Space > RGB set to “sRGB IEC61966-2.1”.
This is the default color correction in Photoshop.
- 2 Also in the Photoshop Color Settings dialog, change Color Management Policies > RGB to “Convert To Working RGB”.
- 3 In Photoshop, click OK and then save the bitmap file.
- 4 In 3ds Max, choose Customize > Preferences > Gamma And LUT.
- 5 On the Gamma And LUT tab, turn on Enable Gamma/LUT Correction. In the Display group, choose Gamma, then set the gamma value to **2.2**.
- 6 In the Materials And Colors group, turn on both Affect Color Selectors and Affect Material Editor.
- 7 In the Bitmap Files group, set both Input Gamma and Output Gamma to **2.2**.

- 8 Click OK to close the Preferences dialog.

Now when you use a bitmap saved by Photoshop, the colors in 3ds Max should preserve the bitmap's original colors.

To use gamma with video hardware:

Video devices such as video tape recorders usually have their own hardware gamma-correction circuitry.

- If your video device has its own hardware gamma correction, do not turn on gamma correction in 3ds Max.
- If your video device does *not* perform gamma correction automatically, follow the preceding steps for setting Input Gamma and Output Gamma, using values appropriate to your video device. Typically these will be Input Gamma = 0.45 and Output Gamma = 2.2.

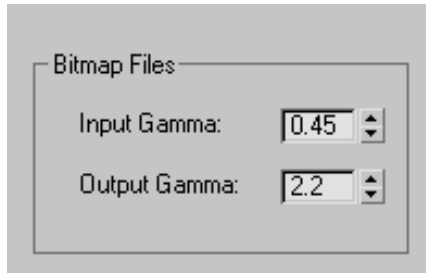

Typical input and output gamma settings for video that has no hardware gamma correction

Interface

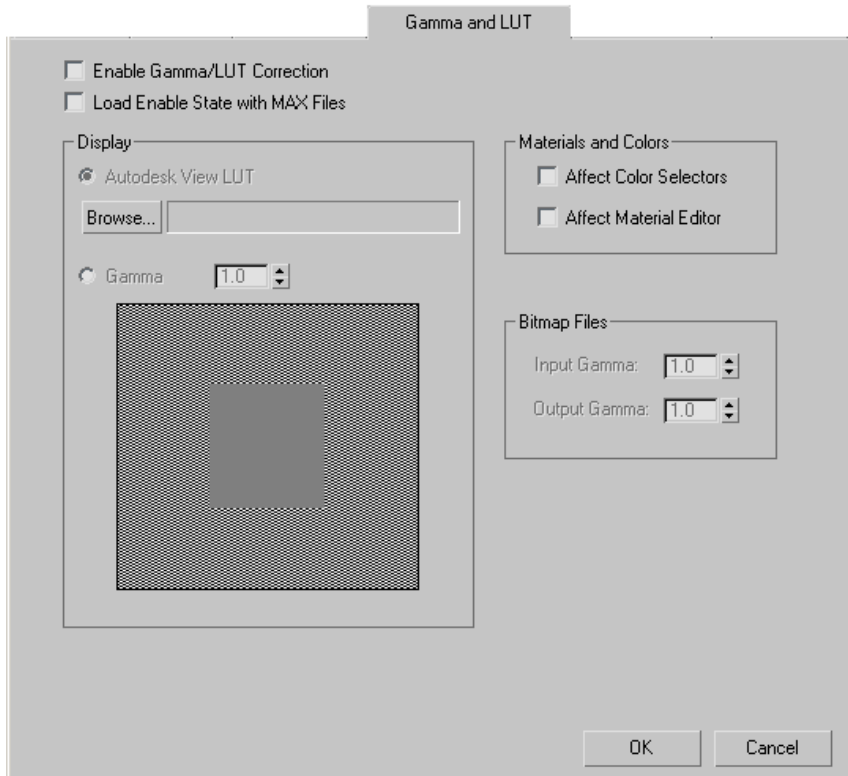

Enable Gamma/LUT Correction Makes available the controls for adjusting gamma or LUT correction. Turn off to disable gamma/LUT correction. Default=off.

Load Enable State with MAX Files Loads the state of Enable Gamma/LUT Correction with each 3ds Max file. Default=off.

When you choose Load Enable State, and load a scene file whose Enable Gamma/LUT Correction state differs from the current state, you can make the correction correspond with the setting in the current file or leave the setting as is.

If you have a *maxstart.max* file and you choose this option, new sessions of 3ds Max use the Enable Gamma/LUT Correction state in the file. If you turn this option, off, the file doesn't affect the state of Enable Gamma/LUT Correction.

Display group

Display gamma correction or lookup tables applies to viewports and the [Rendered Frame Window](#) on page 6073. Use the controls in this group to load an Autodesk View LUT or adjust gamma numerically.

Autodesk View LUT Click the Browse button and then use the Load LUT File dialog to find and open a LUT file. Thereafter the LUT file name appears in the text field to the right of the button.

NOTE 3ds Max does not support generation of LUT files, and no LUT files are included with the software. To create a LUT file, use a program such as Combustion.

Gamma Adjusts the gamma display for 3ds Max. The spinner value increases or decreases the value (lightness or darkness) of the solid gray center square. Adjust the value until the center square is as close as possible in value to the surrounding checkered border. Range = 0.1 to 5.0.

If you're creating bitmaps or renderings that will be sent to someone else, set Output Gamma to match the correct Display Gamma value. This ensures that the image will look correct at the destination site.

You can also display these gamma settings from the Gamma button in the File Browser dialog; for example, when you are rendering a scene to an image file.

Materials and Colors group

By default, the Gamma setting affects the viewport display and rendered frames, but not the Color Selector or the Material Editor. These switches can enable gamma correction for either or both of these dialogs.

Affect Color Selectors When on, the Gamma setting affects the display of colors on the standard 3ds Max Color Selector. This setting has no effect on the Object Color dialog.

Affect Material Editor When on, the Gamma setting affects the display of colors on the Material Editor dialog.

Bitmap Files group

Input Gamma Adjusts bitmaps that you load (for example, texture maps), provided that the bitmap type doesn't override the gamma with its own gamma value. Range = 0.1 to 5.0.

In the case of Targa files, for example, the file's inherent gamma will override the 3ds Max Input Gamma. In this case, set Input Gamma to the *inverse*

(1/gamma) of the incoming gamma correction. This avoids applying gamma correction twice, which will make the bitmap too bright.

Output Gamma The gamma correction applied to bitmaps that you render. Set this to match the correct Display Gamma value. Range = 0.1 to 5.0.

Rendering Preferences

Customize menu > Preferences > Preference Settings dialog > Rendering tab

On the Rendering panel of the Preference Settings dialog, you set options for rendering, such as the default color of ambient light in rendered scenes. The many choices available enable you to reassign the renderers used for production and draft rendering.

Interface

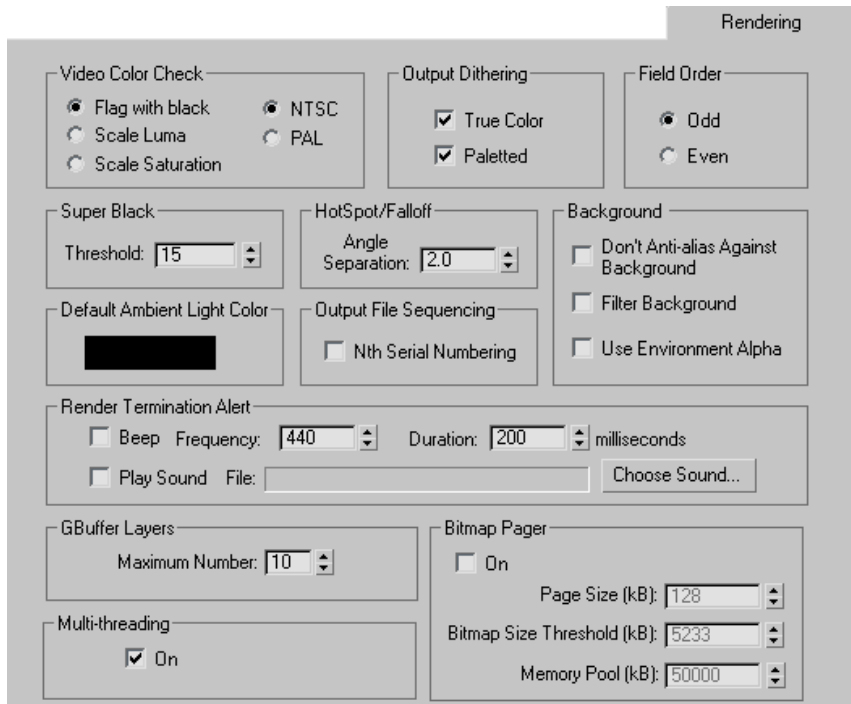

Video Color Check group

Some pixel colors are beyond the safe [NTSC](#) on page 8059 or [PAL](#) on page 8078 threshold. You can choose to flag or modify them to acceptable values.

Flag with Black Flags all illegal pixels with black to show you the illegality of your image. This mode teaches you how to make correct colors, instead of depending on Scale options. Scale options force a natural discontinuity in the color values. In some cases, that discontinuity can cause visible [aliasing](#) on page 7904.

Scale Luma Scales the luminance to bring the color into range, and maintains saturation. This generally makes the illegal areas appear darker than they should be.

Scale Saturation Scales the chroma to bring the color into range, and maintains saturation. Because this option keeps the brightness levels of the pixels fairly equal to the unscaled ones, this is the more useful of the two scale methods.

NTSC/PAL Determines the standard for the video color check. See [NTSC \(Glossary\)](#) on page 8059 and [PAL \(Glossary\)](#) on page 8078.

Output Dithering group

Sets output [dithering](#) on page 7956 for all file types.

True Color Toggles dithering for any true color output device. For 24-bit work, turn on True Color. For paletted work, turn it off.

Paletted Turns dithering on or off for any 8-bit paletted device.

Field Order group

Odd/Even Selects the field order of rendered images when the Render To Fields option is enabled on the Render Setup dialog. Some video devices require that the even field be first, other video devices require that the odd field be first. Determine the correct field order for your video device. If the video output of your device is strobing or appears jittery, it may be due to incorrect [field](#) on page 7973 order, try changing this parameter and re-rendering your animation.

Super Black group

Threshold Keeps the [super black](#) on page 8141 threshold above a certain level primarily for luminance keying.

HotSpot/Falloff group

Angle Separation Locks the spotlight [hotspot](#) on page 8007 and [falloff](#) on page 8007 cones at the angle separation defined by the spinner (degrees). This option constrains the hotspot angle so that it can't equal the falloff and cause aliasing artifacts.

Background group

Don't Antialias Against Background Ensures that the edges of rendered geometry are not antialiased against the background. The inside of the geometry is still antialiased. Keep this control off unless you're creating sprites for game development, or require special compositing techniques because the background will not be rendered. In these cases, turning on this option helps avoid generating alpha antialiasing on the outlines of the geometry.
Default=off.

NOTE When Don't Antialias Against Background is on, render *only* against a black background.

Filter Background Controls whether the antialiasing filter of the renderer affects the background image. See Plate Match /MAX R2.5/VIZ R2 Filter Types in [Default Scanline Renderer Rollout](#) on page 6141 for detailed information of filtering background and antialiasing.

Use Environment Alpha Controls whether or not the renderer uses the environment map's alpha channel in creating the alpha for the rendered image. When off, the background is transparent. When on, the alpha of the resulting image is a combination of the scene and image alpha.

NOTE Only background images with alpha channels or black backgrounds are supported when compositing in other programs such as Photoshop.

Default Ambient Light Color group

Click the color swatch to change the default [ambient light](#) on page 7906 color for renderings. This setting defines the darkest color for rendered shadows in the scene.

Output File Sequencing group

Nth Serial Numbering Specifies whether output frame files generated using a frame-step value other than 1 are numbered sequentially (on) or according to their true frame numbers (off).

Render Termination Alert group

Beep Beeps when the rendering has finished. You can set the frequency and the duration.

Play Sound Plays a sound file when the rendering has finished.

Choose Sound Opens the Open Sound browser dialog, select a sound file using the browser. You can test sound files with the Play button in the Open Sound dialog. Press ESC to turn off the sound.

GBuffer Layers group

Maximum Number Limits the number of layers that are stored in the G-buffer during rendering. Default=10; Range=1 to 999.

Memory requirements might dictate that you limit the number of G-buffer layers. The RLA and RLF image formats, used for compositing, can store many G-buffers for object Z buffer information, material ID, transparency, and so on.

Multi-threading group

On Causes the software to treat the rendering task as separate threads. This option works with multiprocessor systems. Each processor in your computer handles a different thread, which makes full use of available processing power and speeds up rendering to its maximum level. When off, 3ds Max treats a rendering task as a single processing task and doesn't divide it up.

Bitmap Pager group

The Bitmap Pager can help with the rendering of scenes that have very large textures, a large number of textures, or when rendering a high-resolution image.

TIP You can access a [Bitmap Pager Statistics dialog](#) on page 7150 with useful pager information such as memory usage: Go to Customize menu > Customize User Interface, find the Bitmap Pager Statistics Toggle item in the Main UI list, and then assign it as a keyboard shortcut or other UI element.

On When on, the software creates a series of temporary “page” files on the drive where it is installed for use in rendering bitmaps.

Page Size (kB) Sets the size of the bitmap page. If textures are smaller than the page size, the system allocates only the memory required.

Bitmap Size Threshold (kB) Sets the minimum size (in kilobytes) that a bitmap must be in order to be paged.

Memory Pool (kB) Controls the amount of memory used by the pager. All pages remain in memory until this limit is reached. When the limit is reached, the pager begins saving pages to disk. Pages that are not frequently used are paged out; more frequently used pages are kept in memory.

Animation Preferences

Customize menu > Preferences > Preference Settings dialog > Animation tab

On the Animation panel of the Preference Settings dialog, you set options relating to [animation](#) on page 7907. Options include displaying animated objects in wireframe viewports, the assignment of sound plug-ins, and controller defaults.

Procedures

To change the default transform center:

- 1 Choose Customize menu > Preferences > Preference Settings dialog > Animation tab.
- 2 Turn off Local Center During Animate in the Animate group.
This changes the default and activates all the transform center buttons. You can now move about the selection, coordinate center, or local pivot.

To set the key bracket display:

- 1 Choose Customize menu > Preferences > Preference Settings dialog > Animation tab.
- 2 Use the controls in the Key Bracket Display group to specify how you want key brackets displayed in wireframe viewports.

To specify default controller settings:

- 1 Choose Customize menu > Preferences > Preference Settings dialog > Animation tab.
- 2 Click Set Defaults in the Controller Defaults group.
The Set Controller Defaults dialog appears.

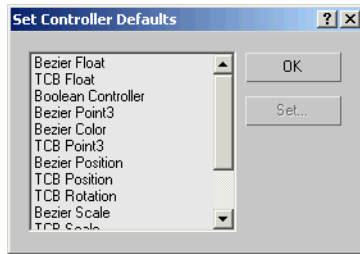

- 3 Choose a controller type from the list of available controllers and click the Set button.

A dialog containing the default settings supported by the selected controller type appears in, for example, the In and Out tangents for a Bezier controller.

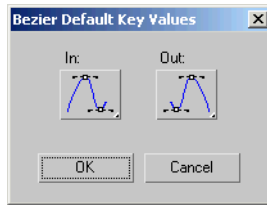

- 4 Make changes to the controller settings.

Once you click OK in the Set Controller Defaults dialog, the controller defaults are changed.

Changes to the controller default settings are written to your *3dsmax.ini* file and become the defaults for all newly assigned controllers and all new scenes.

If you decide that you want to revert to the original 3ds Max defaults for all controllers, you can click Restore To Factory Settings.

Interface

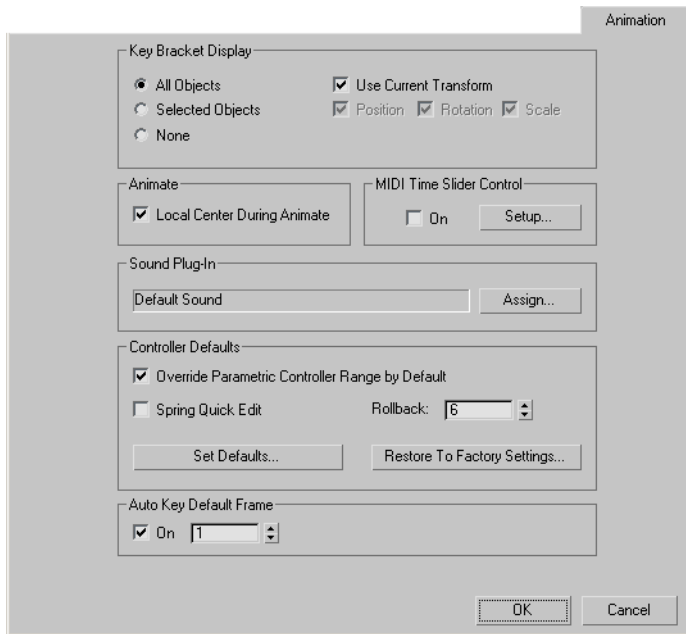

Key Bracket Display group

When you move to a frame, the software displays white brackets around objects that have transform **keys** on page 8020 at that frame, including cameras and lights. These *key brackets* appear only in wireframe viewports.

All Objects/Selected Objects/None Specifies which objects display key brackets.

Use Current Transform Displays brackets only on those frames containing keys for the active **transform tool** on page 8157 (Move, Rotate, or Scale).

If no transform tool is active, brackets appear in frames containing any of the three transforms.

To define which types of transform display brackets, turn off Use Current Transform and use the Position/Rotation/Scale switches (see following) .

NOTE When actively scrubbing the frame slider, brackets always appear for all transforms.

Position/Rotation/Scale Specifies which types of transform display brackets. For example, if only Rotation is on, brackets appear only on those frames containing Rotation keys. These check boxes become available when Use Current Transform is off.

Animate group

Local Center During Animate Locks the center method to [local](#) on page 8026. Turn off if you want to animate around a non-local center such as world or selection.

MIDI Time Slider Control group

Enables use of a MIDI device to control the time slider. Choose On to use the MIDI device specified in the [MIDI Time Slider Control Setup dialog](#) on page 7807, which is displayed with the Setup button.

Sound Plug-In group

Assign Displays a dialog listing all sound plug-ins installed in the system. Select a new plug-in to replace the current one.

Controller Defaults group

Sets the default values for animation controllers capable of supporting default settings. For example, set the default values for tension, continuity and bias in the TCB float controller.

Override Parametric Controller Range By Default When on, new parametric controllers are active throughout the timeline, independent of their animation range. Otherwise, they respect it and are only active within their range. Refer to [Ignore Animation Range](#) on page 3598 and [Respect Animation Range](#) on page 3599 for more details. Default=on.

Spring Quick Edit Toggle to increase the accuracy of all spring controllers in the scene. To be used with the Rollback input field. Default=off.

NOTE This option is saved in the *3dsmax.ini* file as *SpringsQuickEdit*.

NOTE Turning on this option can impact scene performance.

Rollback Sets the number of the frames a spring controller goes back before becoming invalid. Default=6.

NOTE This option is saved in the *3dsmax.ini* file as *SpringsRollingStart*.

NOTE Setting a high number can impact scene performance.

Set Defaults Displays a dialog listing all controllers that can have their default values changed. The Set button becomes available when you choose a controller class from the list. Highlight a controller class, click Set, edit the default key values, and then click OK.

Restore To Factory Settings Prompts you to verify if you want to reset all controllers to the program's default settings. If you choose Yes, the defaults are reset for all controllers currently in the system.

Auto Key Default Frame group

On When on, using Auto Key mode to set a key at a frame other than the start frame (0 or 1) also creates a key at the start frame. When off, no key is created at the start frame.

[default frame] When Auto Key Default Frame is on, this setting specifies the start frame at which 3ds Max sets a key when you use Auto Key to set a key at a frame other than the start of the animation.

The available settings are 0 and 1. When you set the default frame to 1, 3ds Max uses the equivalent in the current time display system, set via the [Time Display setting](#) on page 7570 on the Time Configuration dialog. For instance, if Time Display is set to MM:SS:TICKS, the equivalent to frame 1 is 0:0:160.

Inverse Kinematics Preferences

Customize menu > Preferences > Preference Settings dialog > Inverse Kinematics tab

On the Inverse Kinematics panel of the Preference Settings dialog, you set options for both applied and interactive [inverse kinematics](#) on page 8016.

Procedures

To prevent transforming unlinked objects while working in IK mode:

- 1 Choose Customize menu > Preferences > Preference Settings dialog > Inverse Kinematics tab.

- 2 On the Inverse Kinematics panel, turn off the option labeled Always Transform Children Of The World.

Single, unlinked objects are hierarchies of one object. An unlinked object is its own root and also a child of the world, so turning off Always Transform Children Of The World prevents you from transforming single objects in IK mode.

Interface

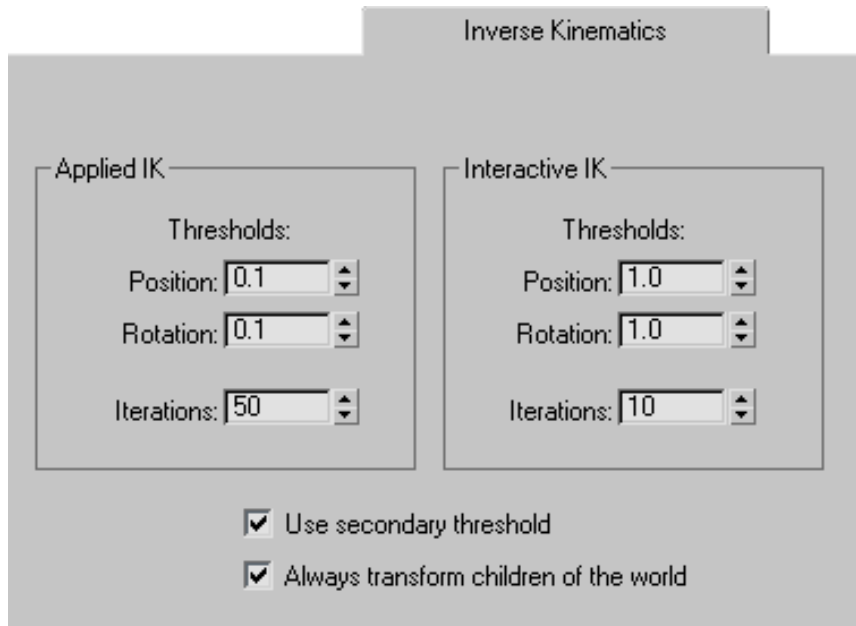

Applied IK/Interactive IK group

The threshold and iterations settings are a trade-off between accuracy and speed. With the two groups of settings you can individually tune the behavior of Interactive IK and Applied IK. Interactive IK provides fast, real-time response, so you should set Interactive IK preferences for speed. Applied IK provides the [IK solution](#) on page 8009 to match the [follow objects](#) on page 7985 very closely. You should set applied IK preferences for accuracy.

Position Sets how close the end effector has to get to the follow object or cursor position for the object to be considered a valid solution. The value represents a distance in the current display unit system. Small values increase accuracy but take longer to solve.

Rotation Sets how accurately the end effector has to match the orientation of the follow object to be considered a valid solution. The value represents a rotation angle in degrees. Small values increase accuracy but take longer to solve.

Iterations Sets the maximum number of times 3ds Max repeats the IK calculations to find a valid solution. A high iterations value increases the chance that 3ds Max can calculate a valid IK solution, but the calculation takes longer to complete.

Ungrouped controls

Use Secondary Threshold Compares the second derivative of the [end effector](#) on page 7963 to a very small threshold. If the derivative is within the threshold, IK is terminated.

Always Transform Children Of The World Applies in both move and rotate modes when IK is on. It affects only an object that is a direct child of the world when the object is selected.

For example, if the root of an IK chain is a child of the world, and you're manipulating an object at the end of the chain (the root object itself isn't selected), the software observes any constraints set for the root object. However, if you select the root object and try to move it, its constraints will be ignored.

Gizmos Preferences

Customize menu > Preferences > Preference Settings dialog > Gizmos tab

You set the display and behavior of the [Transform gizmos](#) on page 934 on the Gizmos panel of the Preference Settings dialog.

Interface

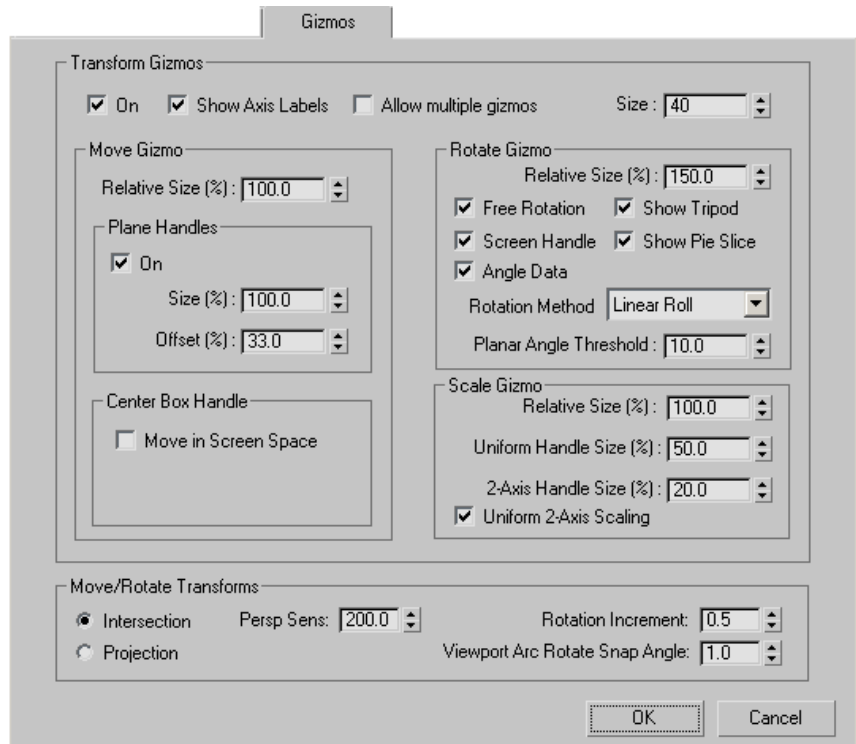

Transform Gizmos group

On When on, 3ds Max uses the Transform gizmo to enable more powerful move, rotate, and scale options. When off, a basic tripod is displayed, with no axis specificity.

Show Axis Labels Toggles the display of the axis labels on the Transform gizmo.

NOTE Functionality is maintained when Show Axis Labels is off.

Allow Multiple Gizmos Toggles the display of more than one gizmo at a time.

When off, a transform gizmo is displayed for only one object at a time in a selection set.

When on and the Use Center flyout > [Use Pivot Point Center](#) on page 976 setting is active, each object in a selection set has its own transform gizmo.

Size Sets the size of the Transform gizmo as a percentage of the viewport size. Range=1 to 100.

Move Gizmo group

Relative Size (%) Sets the size of the Move gizmo, relative to the Size value of the Transform gizmo. Range= 0.0 to 500.0.

Plane Handles group

The plane handles let you constrain object movement along combinations of any two axes.

On Toggles the use of plane handles on the Transform gizmo.

Size Sets the size of the plane handles, as a percent of the distance from the Offset to the tripod axis. Range=0.0 to 100.0.

Offset The percentage of the distance from the gizmo's tripod axis to the outer extent of the Primary axis handles.

For example, 0 = no plane handles; 100 = plane handles extend as far as the Primary axis handles.

Center Box Handle group

The center box can be used as a handle for translations constrained parallel to a viewport.

Move in Screen Space Toggles the use of the center box handle.

Rotate Gizmo group

Relative Size (%) Sets the size of the Rotate gizmo, relative to the Size value of the Transform gizmo. Range= 0.0 to 500.0.

Free Rotation Toggles the ability to rotate about any combination of axes.

When off, you can rotate only about a specific axis, or, if Screen Handle is on (see following), parallel to the screen.

Show Tripod Toggles display of an axis tripod at the pivot point. This tripod also highlights the selected axis while rotating.

Screen Handle Toggles display of the screen orbit, which lets you rotate an object parallel to a viewport.

Show Pie Slice When on, a shaded pie slice acts as a visual indicator of the direction and amount of rotation.

NOTE If you rotate more than 360°, the slice overlaps and the shading becomes increasingly intense.

Angle Data When on, numerical feedback appears in the viewport during single-axis rotation, indicating the amount of rotation around the X, Y, or Z axis.

Rotation Method Sets the rotation method for the gizmo:

- **Linear Roll:** Rotate the virtual trackball by dragging in a single direction, tangent to the Rotate gizmo.

NOTE A tangent handle appears to show the best direction to drag the mouse.

- **Circular Crank:** Rotate the virtual trackball by dragging around the Rotate gizmo, in a circular manner.
- **Legacy R4:** Turns off virtual trackball behavior, and uses the rotation method from 3ds Max 4.

Planar Angle Threshold Determines when the Circular Crank rotation method automatically switches to Linear Roll to prevent loss of control over the gizmo. This occurs when a Primary axis is nearly 90 degrees to the view plane, making it difficult to circle around. Any angle to the view plane that is higher than this setting will use Crank mode, but any angle equal to or less than this setting will always function as a Linear Roll.

Scale Gizmo group

Relative Size (%) Sets the size of the Move gizmo, relative to the Size value of the Transform gizmo. Range= 0.0 to 500.0.

Uniform Handle Size (%) Sets the size of the handle for uniform scaling (the distance from the transform center to the edge of the uniform handle), as a percentage of the scale gizmo size.

2-Axis Handle Size (%) Sets the size of the handle for non-uniform scaling along 2-axes (the distance from the edge of the uniform handle to the edge of the 2-axis handle), as a percentage of the scale gizmo size.

Uniform 2-Axis Scaling Forces scaling using a 2-axis plane handle to be uniform.

Move/Rotate Transforms group

Controls the way you can move selected objects with the mouse in a non-[orthographic](#) on page 8073 view such as [Perspective](#) on page 8087.

Intersection Shoots a ray from the mouse point into the screen. This makes moving objects easier, but as you move toward the [horizon](#) on page 8005, the object moves great distances.

Projection Projects the motion of the mouse onto the plane. This ensures that there are no singularities at the horizon, and that motion is always smooth and stable. However, it can become difficult to move objects when the plane is not parallel to the screen.

Persp Sens Sets mouse sensitivity for projection transforms.

Rotation Increment Specifies the amount of rotation generated by moving the mouse 1 pixel. Lower this value for angular rotations smaller than the default .5 degrees. The lower this value, the more mouse movement is needed to rotate objects.

Viewport Orbit Snap Angle Sets the viewport rotation increment in degrees.



Turn on Angle Snap on the main toolbar, and then use [Orbit](#) on page 7602 to rotate a viewport. The viewport rotation snaps by the value set here. The Orbit cursor displays a small magnet in the upper left to indicate that Angle Snap is on.

MAXScript Preferences

Customize menu > Preferences > Preference Settings dialog > MAXScript tab

On the MAXScript panel of the Preference Settings dialog, you set MAXScript and Macro Recorder preferences, enable or disable auto-loading of scripts, set the initial heap size, change font style and size used in the MAXScript editor, and manage all the settings for the Macro Recorder.

You can also change these settings by editing the [MAXScript] section of the *3dsmax.ini* file.

NOTE Two paths to support auto-startup scripts are on the [Configure User Paths dialog](#) on page 7729 and [Configure System Paths dialog](#) on page 7732: `..\scripts` and `..\scripts\startup`. If you prefer to start scripts from a different directory, you can change these default directories with the corresponding Customize menu commands.

Choose Help > MAXScript Reference for details on MAXScript.

Interface

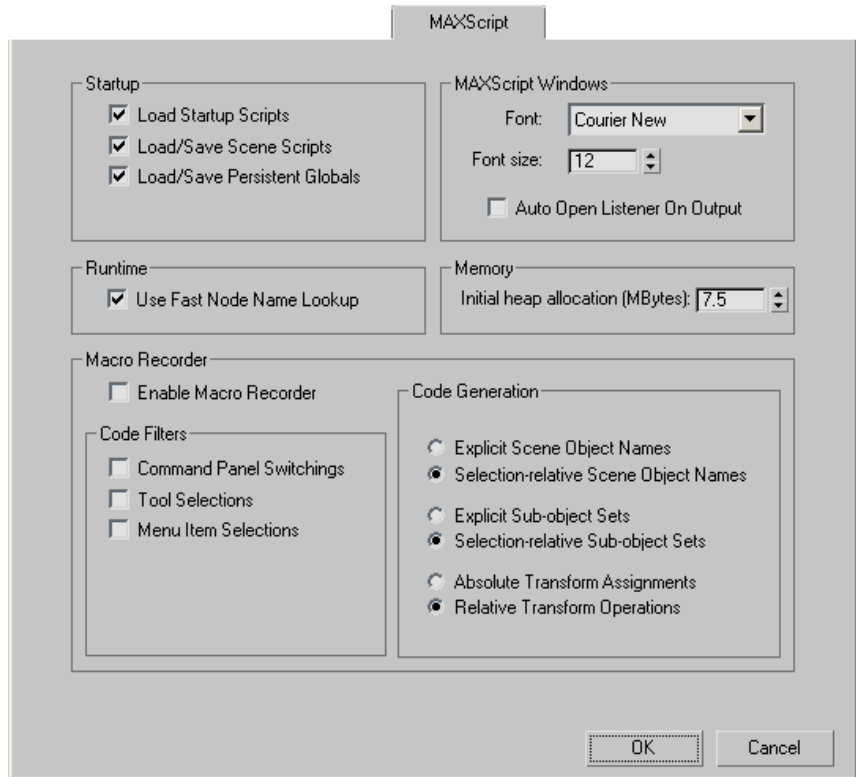

Startup group

You can start scripts automatically in two ways. You can create a file named `startup.ms` that contains your startup code. MAXScript searches for this file in the scripts directory first, then the 3ds Max root directory, and finally the directories specified in the Windows PATH environment variable. MAXScript stops searching after it finds the first occurrence of `startup.ms`.

You can also place the script files you want auto-loaded into the `\startup` directory inside the `\scripts` directory. MAXScript loads any script file with the file name extension `.ms` or any encrypted script file with file name extension `.mse`.

If you have both a `startup.ms` file and auto-load files in the `\startup` directory, MAXScript always loads `startup.ms` first.

Load Startup Scripts Loads scripts automatically when 3ds Max starts.

Load/Save Scene Scripts Enables Scene Script loading and saving.

Load/Save Persistent Globals Enables load and save Persistent Globals.

MAXScript supports a limited form of variables. You declare that a particular global is persistent and the value it contains is always saved to and restored from scene files as they are opened and closed. In this way you can, for example, keep direct references to objects in the scene in variables. Those references will move across scene save and reload.

MAXScript Windows group

Font Choose a font for the MAXScript editor

Font size Choose a font size for the MAXScript editor.

Auto Open Listener On Output Opens the Listener if a script sends output to a `WindowStream` value with no associated window. This would require a MAXScript extension.

Runtime group

Use Fast Node Name Lookup When on, MAXScript indexes scene node names in a cache, resulting in significantly faster resolution of non-wildcard pathname values (for example, `$box01`) to node values. When off, the scene nodes are enumerated as MAXScript looks for a scene node name that matches the pathname, resulting in slower lookups.

Turn this off if you encounter an incompatibility with an existing script.

Memory group

Initial Heap Allocation (Mbytes) Sets the initial heap allocation.

MAXScript carves its own working memory (called a heap) out of the memory that the software allocates. You can add to the heap at any time by increasing the value here.

Macro Recorder Group

Enable Macro Recorder Enables the Macro Recorder.

3ds Max starts with the macro recorder disabled and a minimized Macro-Recorder pane in the MAXScript listener window.

You can also enable the Macro Recorder by turning on MAXScript > Macro Recorder or by turning on Enable in the Macro Recorder menu on the MAXScript Listener toolbar.

This state is stored in the *3dsmax.ini* file. Turning it on once keeps it enabled across restarts of the program.

Code Filters group

Command Panel Switchings Displays command panel switchings in the code.

Tool Selections Displays tool selection in the code.

Menu Item Selections Displays menu selection in the code.

Code Generation group

The Code Generation parameters refer to whether or not the script emitted is made selection-relative, if possible, or if it contains object references. By making the script selection-relative, you can apply the recorded script to a different selection, thereby making it more general. Absolute mode always works on the same objects regardless of the current selection.

Explicit Scene Object Names Uses scene object names in the code.

Selection-relative Scene Object Names Makes Scene Object Names relative in the code. Default=on.

Explicit Sub-object Sets Uses explicit sub-object sets in the code.

Selection-relative Sub-object Sets Uses selection relative sub-object sets in the code. Default=on.

Absolute Transform Assignments Uses absolute transforms in the code.

Relative Transform Operations Uses selection relative transform operations in the code.

Radiosity Preferences

Customize menu > Preferences > Preference Settings dialog > Radiosity tab

On the Radiosity panel of the Preference Settings dialog, you set options for the [radiosity solution](#) on page 6168.

See also:

- [Modeling Global Illumination with Radiosity](#) on page 6168
- [Radiosity Controls](#) on page 6188

Interface

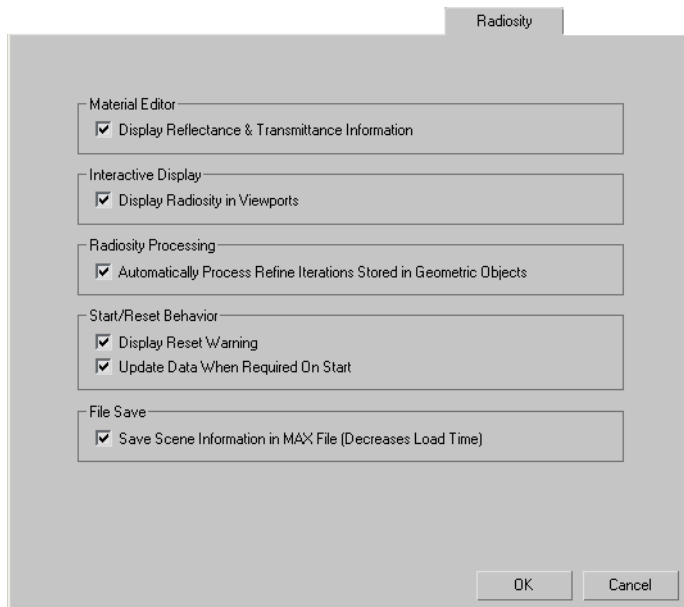

Material Editor group

Display Reflectance & Transmittance Information When on, [reflectance and transmittance values](#) on page 5324 are displayed in the Material Editor.

NOTE In order to make this change effective, you need to close and restart the Material Editor.

Interactive Display group

Display Radiosity in Viewports When on, radiosity effects are displayed in the viewports.

Radiosity Processing group

Automatically Process Refine Iterations Stored in Geometric Objects When on, all refine iterations stored in geometric objects are automatically processed.

Start/Reset Behavior

Display Reset Warning When on, a warning message is displayed whenever you reset the radiosity solution in your scene.

Update Data When Required on Start When on, the radiosity engine must be reset and then recalculated if the solution is invalidated. In this case, the Start button changes to read Update & Start. When this is pressed, the radiosity solution is reset and the calculation starts over again.

When this toggle is off, the radiosity solution does *not* need to be reset if it is invalidated. You can continue processing your scene with the invalid solution.

NOTE The radiosity solution is invalidated any time an object or light is added, removed, moved, or altered in any way.

File Save group

Save Scene Information in MAX file (Decreases Load Time) The light levels from the radiosity solution are always saved with the file, however when this is on, some additional radiosity information is saved with your scene.

mental ray Preferences

Customize menu > Preferences > mental ray panel

Interface

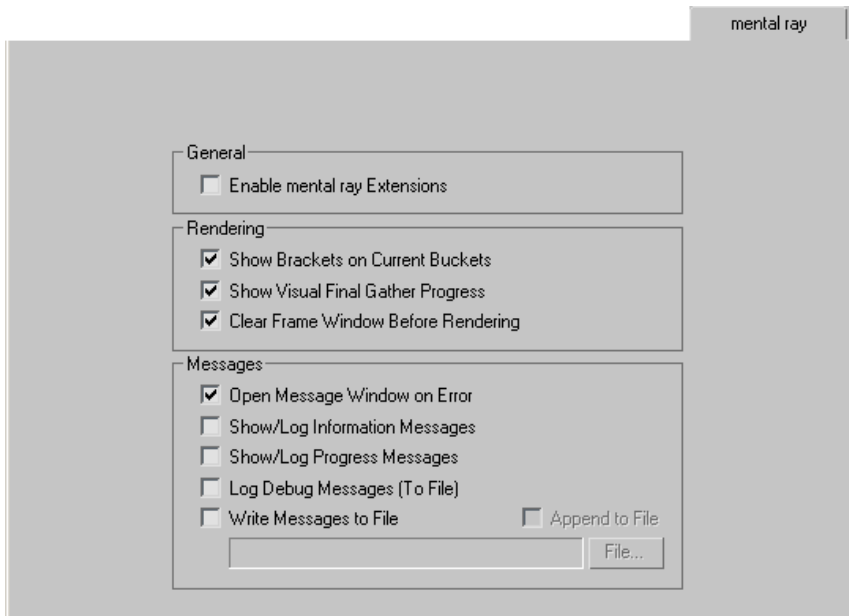

General group

Enable mental ray Extensions When on, enables certain features that provide additional support for the mental ray renderer. When off, these features do not appear in the interface. Default=off.

These are the features enabled as mental ray extensions to 3ds Max:

- [mental ray Connection rollout](#) on page 5385 for materials (Material Editor)
- [mental ray Light Shader rollout](#) on page 5115 (Modify panel for lights)

WARNING If you have assigned shaders and adjusted their settings using the mental ray Connection rollout, turning off Enable mental ray Extensions will *lose all these assignments and settings*. The same applies to light shader assignments.

Rendering group

Show Brackets on Current Buckets Displays white selection brackets at the corners of the bucket currently being rendered. Default=on.

Show Visual Final Gather Progress When on, the [Rendered Frame Window](#) on page 6073 displays a coarse image of the final gather points as those points are being calculated. This provides visual feedback of the final gather solution in progress. Default=on.

If you prefer that the final render directly overwrite the previous one in the Rendered Frame Window for comparison purposes, turn this off.

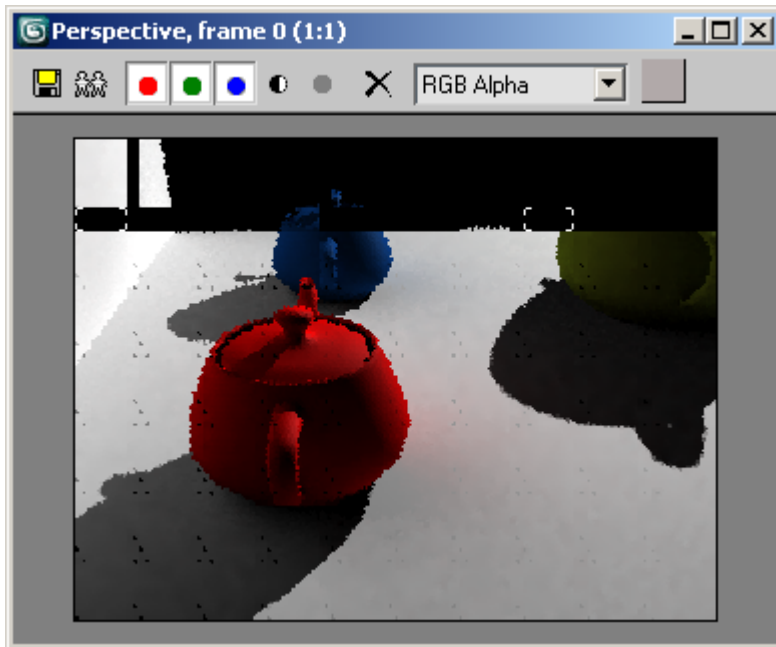

Visual display of final gather calculation in progress

Clear Frame Window Before Rendering When on, before rendering the [Rendered Frame Window](#) on page 6073 turns to a gray shade by clearing every other scanline. This makes it easier to see the progress of rendering. On the other hand, it can make it more difficult to see the effect of small changes to the model or the view. Default=on.

Messages group

Open Message Window on Error Whenever the mental ray renderer detects an error, it generates an error message. When this option is on, the Messages Window is displayed and the error message appears in it. Default=on.

Show/Log Information Messages When on, displays informational messages in the Messages Window. Default=off.

Show/Log Progress Messages When on, displays progress messages in the Messages Window. Default=off.

Log Debug Messages (to file) When on, writes debug messages to the log file, if one has been specified. Default=off.

Debug messages are never displayed in the Messages Window. The mental ray renderer generates a large number of them, which would make the window hard to read.

Write Messages to File When on, generates a mental ray [log file](#) on page 8028. Default=off.

The other log file options are unavailable unless you turn on Write Messages To File:

- **Append to File** When on, appends messages to the existing file. When off (or if the named file is not found), only new messages are written to the file. Default=off.
- **File** Click to display a file dialog that lets you choose the name and location of the *.log* file.
- **File name field** When you have specified a log file, this field shows its name and its path.

Graphics Driver Setup Dialog

Customize menu > Preferences > Preference Settings dialog > Viewports tab > Display Drivers group > Choose Driver button

(With Direct3D active) Customize menu > Preferences > Preference Settings dialog > Viewports tab > Display Drivers group > Choose Driver button > Direct3D Driver Setup dialog > Revert From Direct3D button

You choose and configure graphic display drivers on the Viewports panel of the Preference Settings dialog. This topic explains driver options available on the Display Driver Setup dialog and analyzes tradeoffs in performance.

You can also change the graphics driver when you start 3ds Max by going to the Start menu and choosing Programs > Autodesk > Autodesk 3ds Max 2009 [installed version] > Change Graphics Mode.

See also:

- [Configure Driver](#) on page 7793
- [Configure Software Display Driver Dialog](#) on page 7794
- [Configure OpenGL Dialog](#) on page 7796
- [Configure Direct3D Dialog](#) on page 7802
- [Direct3D Driver Setup Dialog](#) on page 7800

Custom

Choose this if you have a custom driver installed on your system. Such custom drivers don't use the software display driver (Heidi), OpenGL, or Direct3D. If you don't have such a driver installed, this option is not available.

Interface

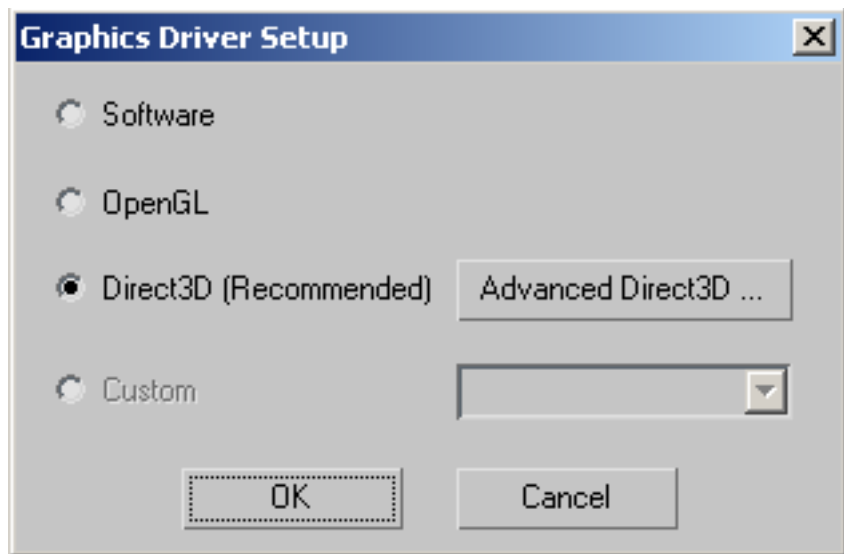

On the Display Driver Setup dialog, some options are unavailable if the corresponding driver is not installed in the system. The currently installed driver is listed in the Display Driver group.

NOTE The first time you launch 3ds Max Direct3D is selected by default.

Software Display Driver

Choose this if you're using software rather than hardware acceleration. This choice is always available.

OpenGL

Choose this option if you're using any form of hardware acceleration. The software will use whatever driver has been installed in your operating system.

The OpenGL driver supports geometry acceleration as well as rasterization acceleration. It offers the optimum display performance for animated deforming meshes. It's tightly integrated into Windows NT and Windows 2000, and many 3D display cards were specifically designed to accelerate OpenGL operations. OpenGL implementations have all of the scene data necessary to optimize the entire 3D display process.

Because OpenGL is most efficient when run on systems with at least rasterization acceleration, the software display driver/SZB option may work best on systems with an ordinary 2D display card. However, with a 3D-enabled card, you may see dramatic acceleration using the OpenGL driver.

The disadvantages of the Open GL driver are as follows:

- All potentially visible scene data must be transferred to the driver, and this can cause a communication bottleneck across the system bus. In particular, this slows down the display of individual primitives (as opposed to strips or polylines, like wireframe displays).
- Because the OpenGL design supports a wide variety of display systems, there is no guarantee that either incremental scene update methods (partial window *blits* (Block Image Transfers) or dual planes) will work with a particular implementation of OpenGL.
- Because lighting and texturing are restricted to OpenGL-specified semantics, mismatches between 3ds Max scene lighting and texturing and what appears in an OpenGL viewport can occur. This applies especially to attenuated lights and non-tiled texture display.)

Direct 3D

Choose this if you have a Direct3D (D3D) driver installed on your system. If you don't have DirectX 8.1 or above installed, this option is unavailable.

To configure the Direct3D driver, click the Advanced Direct3D button. This button, which is available only when Direct3D is the active option, opens the [Configure Direct3D dialog](#) on page 7802.

To switch to a different display driver when Direct3D is the active driver, click the Choose Driver button on the Viewports tab of the Preference Settings dialog to open the [Direct3D Driver Setup dialog](#) on page 7800, click Revert From Direct3D, and then choose the new driver from the Graphics Driver Setup dialog.

The Microsoft Direct3D API supports both rasterization and 3D scene-level calls. It offers the optimum display performance for large modeling tasks, and pixel and vertex shading. (3ds Max supports only D3D Version 8 or above, which is included in DirectX 8.1.) D3D calls are accelerated if the display hardware supports this.

Many inexpensive 3D display cards can use this driver efficiently. This driver supports scene data culling efficiently, accelerates texture display (depending on the specific display card), and performs perspective correction.

The driver works with high-color displays, which provide a good trade-off between display quality and memory overhead. Incremental display update works efficiently.

The disadvantages of the Direct3D driver are as follows:

- The driver currently runs only under Windows 98, Windows Millennium, Windows 2000, and Windows XP. (There is no multi-processor Windows NT support.)
- Dual-plane operations are slow (if available), and there can be some additional overhead in minimizing/maximizing viewports due to the way D3D allocates video memory.

You can download D3D drivers from this location:

<http://www.microsoft.com/windows/directx/>.

Configure Driver

Customize menu > Preferences > Preference Settings dialog > Viewports tab > Display Drivers group > Configure Driver button

You configure the current display driver using the Viewports panel of the Preference Settings dialog.

Changes to a driver's configuration take effect immediately, and the configuration persists between sessions. However, data downloaded to the graphics card is not regenerated. For example, if you change the texture resolution, the hardware continues to use the previous resolution until you use the Material Editor to reload the texture.

The options in the driver configuration dialog vary, depending on which driver is in use. This reference describes the options for the [software display driver](#) on page 7794, [Direct3D driver](#) on page 7802, and [Open GL driver](#) on page 7796.

If you use a custom driver, the options depend on what the driver's manufacturer provides. See the manufacturer's documentation for further information.

See also:

- [Graphics Driver Setup Dialog](#) on page 7790
- [Configure Software Display Driver Dialog](#) on page 7794
- [Configure OpenGL Dialog](#) on page 7796
- [Configure Direct3D Dialog](#) on page 7802

Configure Software Display Driver Dialog

Customize menu > Preferences > Preference Settings dialog > Viewports tab > Display Drivers group > Configure Driver button (when Software Display Driver is the current driver)

The software display driver does not require hardware acceleration.

Interface

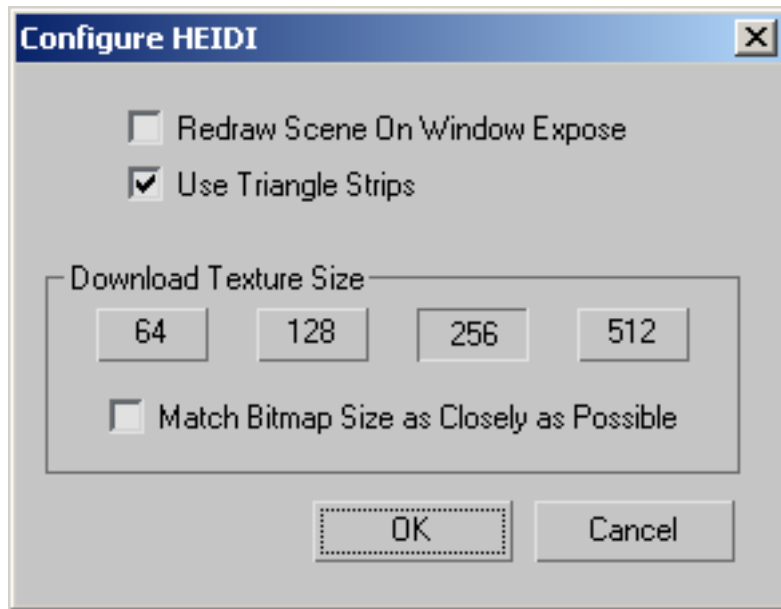

Redraw Scene On Window Expose Redraws the whole scene when a dialog over the viewports is moved, resulting in smoother dragging of dialogs such as the Material Editor or Track View.

If your 3ds Max display easily becomes messy or "corrupted," turn this option on and then redraw viewports by choosing Views > Redraw All Views (the default keyboard shortcut for this is the ` (accent grave) key, on the left side of the "1" key).

Use Triangle Strips Strips the geometry, which can more than double the display speed. In some cases, such as when topology is constantly changed, the time taken to strip the geometry can cause a slowdown instead. In such cases, turn off this option. Otherwise, leave it on for speed.

Download Texture Size group

64, 128, 256, 512 These buttons specify the size of the bitmaps used to map surfaces in the viewports. The larger the size, the better the resolution but the slower the speed. High speed produces jagged maps and slower speeds produce smooth maps.

NOTE When Match Bitmap Size As Closely as Possible is on, these buttons are overridden, however they are still available. The value is still used when procedural textures are converted to bitmaps for viewport texture display.

Match Bitmap Size as Closely as Possible To allow the viewport to show actual texture resolutions, bitmaps are individually resized in the display. This means that small bitmaps don't get overexpanded and large bitmaps retain their resolution (but potentially use a lot more video RAM).

NOTE Bitmaps can be no larger than 4000 x 4000 pixels (or they will be scaled down to this size) and no smaller than 32 x 32 (or they will be scaled up to this size). Default=off.

Configure OpenGL Dialog

Customize menu > Preferences > Preference Settings dialog > Viewports tab > Display Drivers group > Configure Driver button (when OpenGL is the current driver)

The OpenGL display driver provides options that support hardware acceleration.

Interface

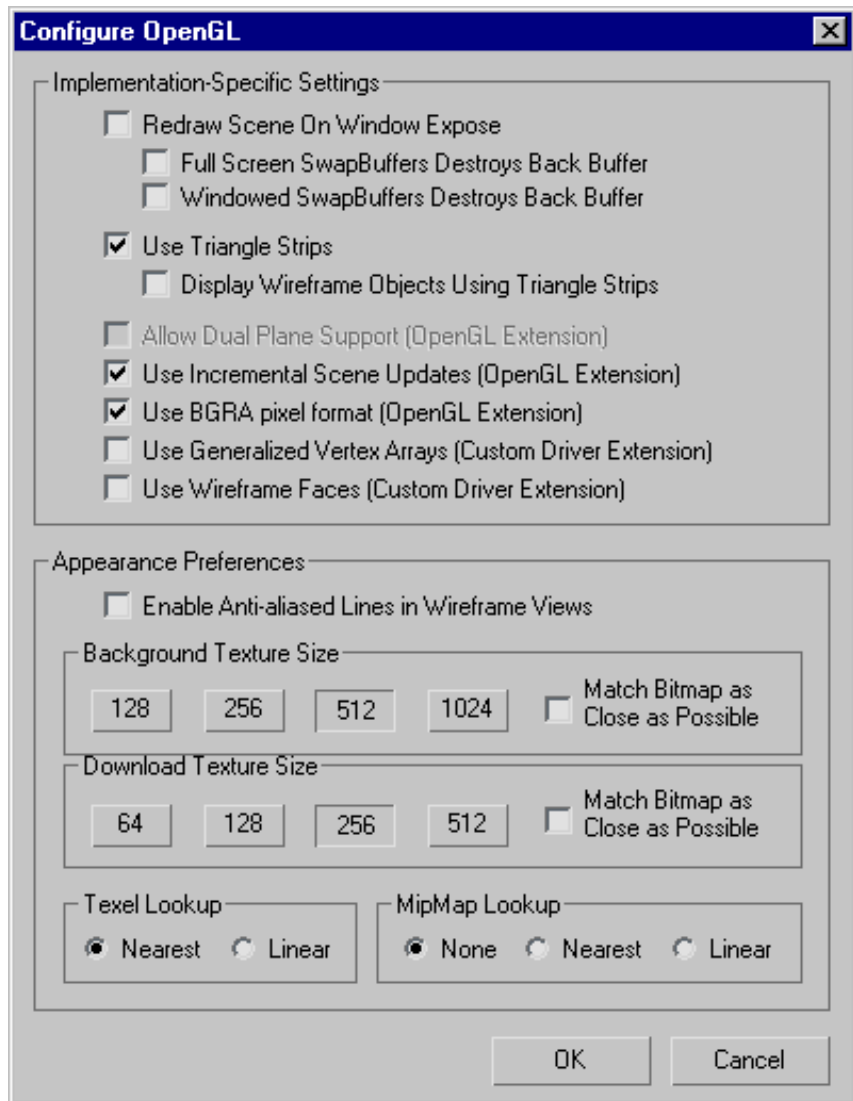

Implementation-Specific Settings group

Redraw Scene On Window Expose Redraws the whole scene when a dialog over the viewports is moved, resulting in smoother dragging of dialogs such

as the Material Editor or Track View. However, redrawing takes some time. Default=on.

If your 3ds Max display easily becomes messy or "corrupted," turn this option on and then redraw viewports by choosing Views > Redraw All Views (the default keyboard shortcut for this is the "1" key).

This option has two subordinate options. How you should set them depends on how the display card handles its back buffer, which is used for refreshing the screen. Turn on one or the other, as appropriate.

Full Screen SwapBuffers Destroys Back Buffer If, after updating the screen, the display card destroys the back buffer *only* when there's a single viewport, turn on this sub-option. The OpenGL driver redraws the scene when a single viewport is visible, but doesn't have to redraw when multiple viewports are visible. Default=off.

Windowed SwapBuffers Destroys Back Buffer If, after updating the screen, the display card destroys the back buffer when multiple viewports are visible, turn on this sub-option. Default=off.

Use Triangle Strips Strips all geometric data before sending it to the driver. In some cases, such as when topology is constantly changed, the time taken to strip the geometry can cause a slowdown instead. In such cases, turn off this option. Otherwise, leave it on for speed. Default=on.

This option has one subordinate option:

Display Wireframe Objects Using Triangle Strips Default=off.

Allow Dual Plane Support Uses the front/back plane system when redrawing the viewport. The selected object is manipulated in the front plane and is redrawn, while other objects remain on the back plane and are not redrawn. This default setting provides the fastest redraws under normal circumstances. If your assigned display driver doesn't support dual planes, this option is not available.

Turn off this setting to improve redraw speed if you are rotating the whole scene or moving a camera through the scene (usually situations in which the whole viewport needs to be redrawn anyway).

Use Incremental Scene Updates Redraws only those scene objects that have changed, or that intersect a region changed by another moving object. When off, the entire scene is redrawn for each new frame. Default=on.

If the display becomes messy or "corrupted" as a result of incremental updates, turn this option off and then redraw viewports by choosing Views > Redraw All Views (the default keyboard shortcut for this is the ` [accent grave] key).

Use BGRA Pixel Format When on, sends bitmaps using BGRA (blue-green-red-alpha) ordering for pixels. This is the default order for Windows. By default, OpenGL expects RGBA ordering. Because of this, under default conditions, loading textures or backgrounds requires the pixels to be reordered. OpenGL supports an extension that allows it to receive pixels in BGRA order. This means that bitmaps can be displayed directly, without reordering each pixel. Thus, assuming the OpenGL driver has efficient hardware support for BGRA pixels, turning on this option makes loading textures and background images much faster. Default=on.

Use Generalized Vertex Arrays When on, enables 3ds Max to use custom driver code to render smoothly shaded objects. Typically this is much faster than using standard OpenGL code, but has an effect only when the driver has hardware-specific custom code. Default=on.

Use Wireframe Faces When on, makes wireframe display accessible to hardware acceleration. Default=on.

This option is intended to allow display-card manufacturers to accelerate 3ds Max wireframe displays in a way that is specific to the underlying display hardware. Check with your display-card manufacturer to see if enabling this option will yield faster wireframe rendering with your display card.

Appearance Preferences group

Enable Anti-Aliased Lines in Wireframe Views Draws lines slightly thicker and much smoother. This is best used for wireframe-only views, and especially if you're making a preview of wireframe objects.

Background Texture Size Unlike the Software Display driver, which uses bitmaps to display viewport backgrounds directly, the OpenGL driver uses a texture-mapped background rectangle. This allows for smoother zooms and pans in orthographic views and can take less memory than the direct bitmap method. However, background bitmap resolution may be lost. Increase the resolution if you're using a maximized viewport to digitize.

Download Texture Size Lets you choose the size of the texture map that's downloaded to the driver for texture-mapped scene objects. Larger maps look better, but use more display card memory.

NOTE When Match Bitmap Size As Closely as Possible is on, these buttons are overridden, however they are still available. The value is still used when procedural textures are converted to bitmaps for viewport texture display.

Match Bitmap Size as Closely as Possible To allow the viewport to show actual texture resolutions, bitmaps are individually resized before they are

downloaded to the driver. This means that small bitmaps don't get overexpanded and large bitmaps retain their resolution (but potentially use a lot more video RAM).

NOTE Bitmaps can be no larger than 4000 x 4000 pixels (or they will be scaled down to this size) and no smaller than 32 x 32 (or they will be scaled up to this size). Default=off.

Texel Lookup Specifies whether to use the nearest [pixel](#) on page 8092 or to linearly interpolate the pixel value from the four closest [texels](#) on page 8147. Using the nearest pixel is faster, but using texels produces a higher-quality display. Default=Nearest.

MipMap Lookup Specifies whether to use one version of the texture map (None) or to interpolate between a pyramid of progressively smaller maps. With Nearest chosen, the texel lookup is done on the map level nearest the ideal one, and with Linear, the texel values from the two closest map levels are interpolated. Default=None.

NOTE When both Texel and MipMap lookup are set to Linear, a true trilinear weighting of 8 texel values is used for a single pixel display. This is very accurate and helps eliminate aliasing, but it is time consuming if the texture-mapping hardware is not accelerated.

Direct3D Driver Setup Dialog

Customize menu > Preferences > Preference Settings dialog > Viewports tab > Display Drivers group > Choose Driver button (if Direct3D is the active driver)

Customize menu > Preferences > Preference Settings dialog > Viewports tab > Display Drivers group > Choose Driver button > Graphics Driver Setup dialog > Choose Direct3D. > Advanced Direct3D button

When using the Direct3D display driver with 3ds Max, this dialog lets you make some basic choices for setting up the driver. Further Direct3D configuration options are available from the [Configure Direct3D dialog](#) on page 7802.

To switch to a different display driver when Direct3D is the active driver, click the Choose Driver button on the Viewports tab of the Preference Settings dialog, click Revert From Direct3D, and then choose the new driver from the Graphics Driver Setup dialog.

Interface

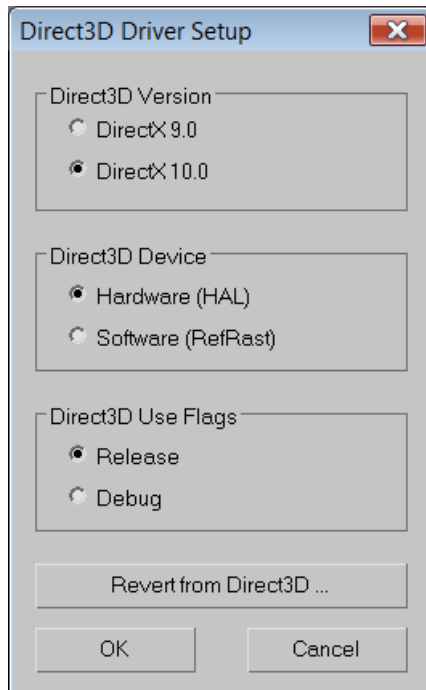

Direct3D Version The available option is whichever version is currently active in your system.

Direct3D Device The default option is Hardware (HAL). The Software (RefRast) option is for use by software developers, and is unavailable unless the debug version of DirectX is installed in your system.

Direct3D Use Flags The default option is Release. The Debug option is for use by software developers, and is unavailable unless the debug version of DirectX is installed in your system.

Revert from Direct3D Click this button to display the [Graphics Driver Setup dialog](#) on page 7790, which lets you choose a different driver.

Configure Direct3D Dialog

Customize menu > Preferences > Preference Settings dialog > Viewports tab > Display Drivers group > Configure Driver button (when Direct3D is the current driver)

The Direct3D display driver provides options that support DirectX drivers. You can download D3D drivers from this location:
<http://www.microsoft.com/windows/directx/>.

DirectX 10 Version

When DirectX 10 is active on your system, the dialog uses a simpler, more straightforward interface:

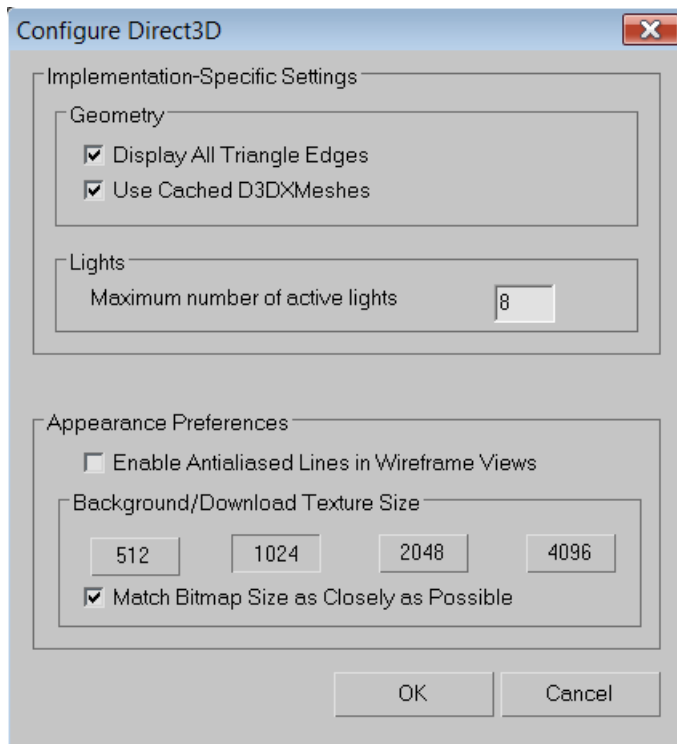

The parameters are identical to those with the same names listed previously in this topic, and one setting has been added:

Maximum number of active lights Lets you define the number of active lights used in the lighting calculations. Setting this too high can affect performance.

Interface

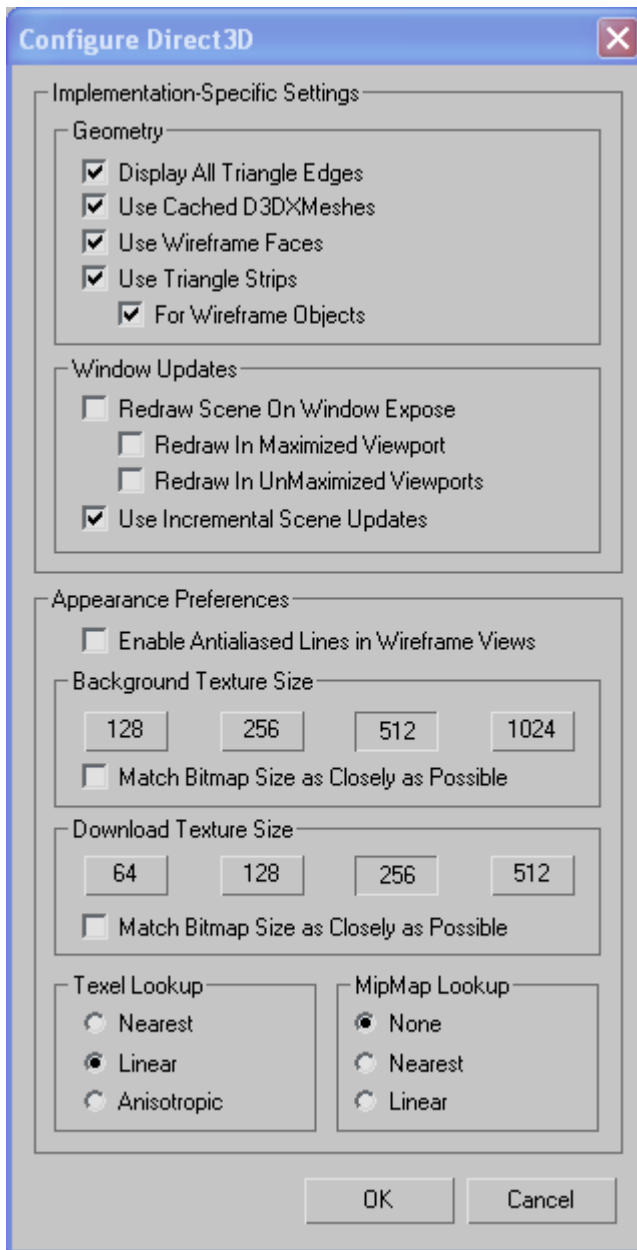

Implementation-Specific Settings: Geometry group

Display All Triangle Edges When on, all triangle edges are displayed in shaded viewports. When off, triangle edges are not displayed. Default=on.

Turning off this option can improve viewport appearance, but at a cost of display performance.

Use Cached D3DXMeshes When on, enables 3ds Max to use custom driver code to render smoothly shaded objects. Typically this is much faster than using standard Direct3D code, but has an effect only when the driver has hardware-specific custom code. Default=on.

Use Wireframe Faces When on, makes wireframe display accessible to hardware acceleration. Default=on.

This option is intended to allow display-card manufacturers to accelerate 3ds Max wireframe displays in a way that is specific to the underlying display hardware. Check with your display-card manufacturer to see if enabling this option will yield faster wireframe rendering with your display card.

Use Triangle Strips Strips all geometric data out before sending it to the driver. In some cases, such as when topology is constantly changed, the time taken to strip the geometry can cause a slowdown instead. In such cases, turn off this option. Otherwise, leave it on for speed. Default=on.

This option has one subordinate option:

- **For Wireframe Objects** When on, uses triangle strips for wireframe objects. Default=off.

Implementation-Specific Settings: Window Updates group

Redraw Scene On Window Expose Redraws the whole scene when a dialog over the viewports is moved, resulting in smoother dragging of dialogs such as the Material Editor or Track View. However, redrawing takes some time. Default=on.

If the display becomes messy or "corrupted," turn this option on and then redraw viewports by choosing Views > Redraw All Views (the default keyboard shortcut for this is 1 on the numeric keypad).

This option has two subordinate options. How you should set them depends on how the display card handles its back buffer, which is used for refreshing the screen. Turn on one or the other, as appropriate.

- **Redraw In Maximized Viewport** If, after updating the screen, the display card destroys the back buffer *only* when there's a single viewport, turn on this sub-option. The Direct3D driver redraws the scene when a single

viewport is visible, but doesn't have to redraw when multiple viewports are visible. Default=off.

- **Redraw In UnMaximized Viewports** If, after updating the screen, the display card destroys the back buffer when multiple viewports are visible, turn on this sub-option. Default=off.

Allow Dual Plane Support Uses the front/back plane system when redrawing the viewport. The selected object is manipulated in the front plane and is redrawn, while other objects remain on the back plane and are not redrawn. This default setting provides the fastest redraws under normal circumstances. If your assigned display driver doesn't support dual planes, this option is not available.

Turn off this setting to improve redraw speed if you are rotating the whole scene or moving a camera through the scene (usually situations in which the whole viewport needs to be redrawn anyway).

Use Incremental Scene Updates Redraws only those scene objects that have changed, or that intersect a region changed by another moving object. When off, the entire scene is redrawn for each new frame. Default=on.

If the display becomes messy or "corrupted" as a result of incremental updates, turn this option off and then redraw viewports by choosing Views > Redraw All Views (the default keyboard shortcut for this is 1 on the numeric keypad).

Appearance Preferences group

Enable Antialiased Lines in Wireframe Views Draws lines slightly thicker and much smoother. This is best used for wireframe-only views, especially if you're making a preview of wireframe objects.

Background Texture Size Unlike the software display driver, which uses bitmaps to display viewport backgrounds directly, the Direct3D driver uses a texture-mapped background rectangle. This allows for smoother zooms and pans in orthographic views and can take less memory than the direct bitmap method. However, background bitmap resolution may be lost. Increase the resolution if you're using a maximized viewport to digitize.

Match Bitmap Size as Closely as Possible Displays background at full resolution. This allows the viewport to behave like the [Rendered Frame Window](#) on page 6073, in regards to zoom and pan. Default=off.

Download Texture Size Lets you choose the size of the texture map that's downloaded to the driver for texture-mapped scene objects. Larger maps look better, but use more display card memory.

NOTE When Match Bitmap Size As Closely as Possible is on, these buttons are overridden, however they are still available. The value is still used when procedural textures are converted to bitmaps for viewport texture display.

Match Bitmap Size as Closely as Possible To allow the viewport to show actual texture resolutions, bitmaps are individually resized before they are downloaded to the driver. This means that small bitmaps don't get overexpanded and large bitmaps retain their resolution (but potentially use a lot more video RAM).

NOTE Bitmaps can be no larger than 4000 x 4000 pixels (or they will be scaled down to this size) and no smaller than 32 x 32 (or they will be scaled up to this size). Default=off.

Texel Lookup Specifies whether to use the nearest [pixel](#) on page 8092, to linearly interpolate the pixel value from the four closest [texels](#) on page 8147, or to use anisotropic filtering. Using the nearest pixel is faster, but using texels produces a higher-quality display. The Anisotropic filter compensates for the distortion caused by the difference in angle between the texture polygon and the plane of the screen. Default=Nearest.

MipMap Lookup Specifies whether to use one version of the texture map (None) or to interpolate between a pyramid of progressively smaller maps. With Nearest chosen, the texel lookup is done on the map level nearest the ideal one, and with Linear, the texel values from the two closest map levels are interpolated. Default=None.

NOTE When both Texel and MipMap lookup are set to Linear, a true trilinear weighting of 8 texel values is used for a single pixel display. This is very accurate and helps eliminate aliasing, but it is time consuming if the texture-mapping hardware is not accelerated.

MIDI Time Slider Control Setup Dialog

Customize menu > Preferences > Preference Settings dialog > Animation tab > MIDI Time Slider Control group > Setup button

With the MIDI Time Slider Control Setup dialog you can specify and set up a MIDI device to control animation playback.

Procedures

To use a MIDI device to control the animation time slider:

- 1 Choose Customize menu > Preferences > Preference Settings dialog > Animation tab.
- 2 In the MIDI Time Slider Control group, choose On.
- 3 Click Setup.
- 4 Set the MIDI device options and click OK.

Interface

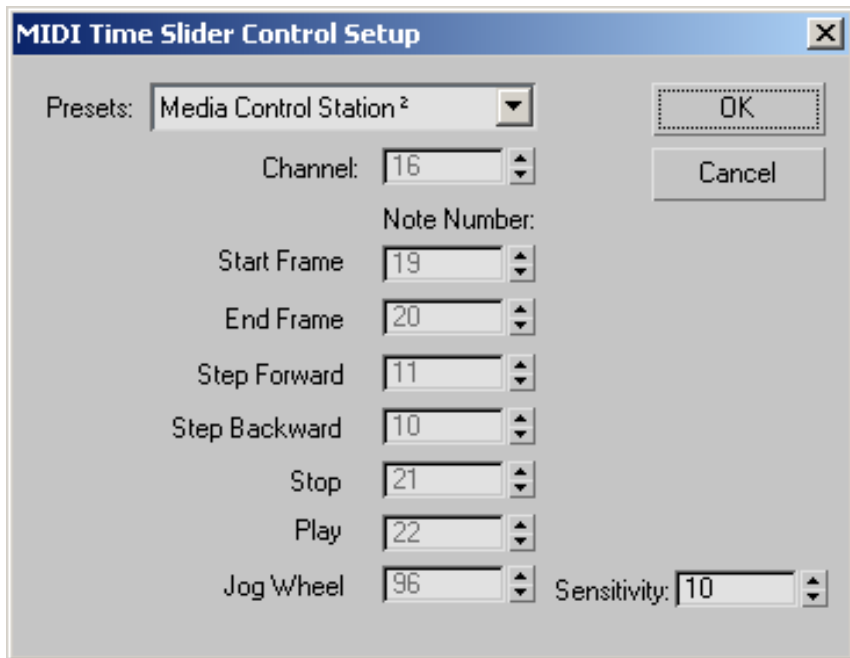

Presets Specifies the type of MIDI device used. You can choose the Media Control Station 2, which is a MIDI device containing standard VCR-style playback buttons along with a jog wheel, or you can choose Custom, which specifies note events in the spinners. You can also use Custom to customize the buttons used by the Media Control Station.

Channel Specifies the channel to which your MIDI device is assigned.

Note Number group

With the controls in this group you can specify which note event triggers which function.

Start Frame Goes to the start frame (the Rewind button in the Media Control Station).

End Frame Goes to the end frame (the Fast-Forward button in the Media Control Station).

Step Forward Moves one frame forward (the Fast-Forward button and Option button in the Media Control Station).

Step Backward Moves one frame back (the Rewind button and Option button in the Media Control Station).

Stop Stops playback (the square button).

Play Plays the animation (the arrow button).

Jog Wheel Controls the time slider with the jog wheel.

Sensitivity Controls the number of ticks that the time slider moves in response to one unit of movement from the jog wheel. A lower value provides more precise positioning of the time slider, while a higher value makes the time slider move faster. If you set your time display to show ticks and set the sensitivity to 1, you can move one tick at a time with the jog wheel.

Units Setup Dialog

Customize menu > Units Setup > Units Setup dialog

The Units Setup dialog establishes the unit display method, giving you the choice between generic units and standard units (feet and inches, or metric). You can also create custom units, which are used whenever you create an object.

The units that you set up are used to measure geometry in your scene. In addition to these units, the software also uses system units as an internal mechanism. System units should only be changed *before* you create your scene or import a unitless file. Do not change the system unit in an existing scene.

You can also set the lighting units using this dialog.

System vs. Display Units

It is important to note the distinction between System and Display units. Display units only affect how geometry is displayed in the viewports. System units determine the actual scale of geometry. For example, if you import a DXF file (unitless) containing a 1 x 1 x 1 Box, 3ds Max could import the box's dimensions in inches or miles, depending on the System unit. This can have a significant impact on your scene, which is why you should always set up the system unit *before* you import or create geometry.

Procedures

To change units to feet and inches:

- 1 On the Units Setup dialog, choose US Standard.
- 2 Choose from among the display options on the drop-down list.
 - If you want to display measurements as feet with inches, choose how inches should appear: fractional or decimal. Also choose, for Default Units, Feet or Inches
 - If you choose one of the Fractional display options, choose the fraction on the drop-down list to the right.

To enter fractions in numeric fields:

- When you enter fractions in numeric fields, they are converted to the correct units. For example, if units are set to Feet w/ Decimal Inches, and Default Units is set to Feet, type **37/45** and press Enter for the result 0'9.867", or 37/45'.

To enter a fraction and a units specifier, place the specifier after the divisor. For example, type **17/5'**, but not **17'/5**.

To convert between unit types:

- You can convert between unit types by entering any valid unit specifier, along with the number, and then pressing Enter. The number is converted to the current unit display type. For example, if units are set to Meters, type **1/2** to get the result 0.5M. However, if you type **1/2'** or **6"** the result is 0.152M.

Interface

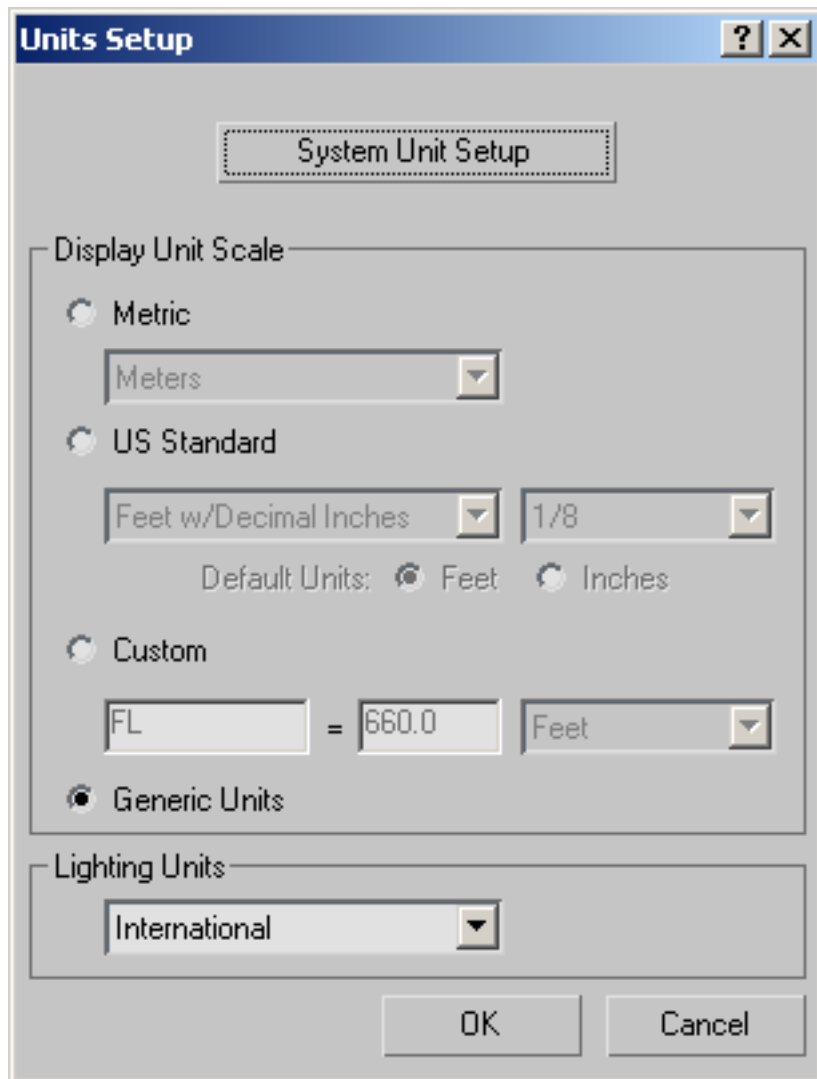

System Unit Setup Click to display the [System Unit Setup dialog](#) on page 7812 and change the system unit scale.

WARNING Change the system unit value only *before* importing or creating geometry. Do not change the system unit in an existing scene.

Display Unit Scale group

Choose a unit scale option (Metric, US Standard, Custom, or Generic Units) to activate its settings.

Metric Choose this option and then choose a metric unit: Millimeters, Centimeters, Meters, or Kilometers

US Standard Choose this option and then choose a US Standard unit. If you choose a fractional unit, the adjoining list activates to let you select the fractional component. The decimal units require no additional specification. The US Standards are as follows:

- Fractional Inches
- Decimal Inches
- Fractional Feet
- Decimal Feet
- Feet w/ Fractional Inches
- Feet w/ Decimal Inches

For the last two items, you can specify which unit is assumed when you enter a value in a numeric field and press Enter without including a units specifier, such as ' for feet or " for inches.

For example, if Feet is the default, typing **5** followed by Enter results in 5 feet. Typing **5"** followed by Enter results in 0'5". If Inches is the default, typing **5** followed by Enter results in 0'5". Typing **5'** followed by Enter results in 5 feet.

Custom Fill in the fields to define a custom unit of measurement.

Generic Units This is the default option (one inch) and is equal to the system unit used by the software.

Lighting Units group

The Lighting Units group lets you choose whether light values are displayed in American or International units.

System Unit Setup Dialog

Customize > Units Setup > Click System Unit Setup.

This dialog appears when you click System Unit Setup in the [Units Setup dialog](#) on page 7809.

WARNING You should only change the system unit value *before* importing or creating geometry. Do not change the system unit in an existing scene.

Because of the nature of digital floating-point calculations, distances that are extremely large or extremely small can cause round-off error. Symptoms of round-off error include trouble navigating (zooming and panning become too fast or too slow), unwanted viewport clipping, and unexpected flipping of normals. Here are some general guidelines to avoid these problems:

- Make sure your scene is roughly centered around the origin (0,0,0). Round-off error increases at large distances from the origin.
- Make sure no significant detail in the scene is smaller than one generic 3ds Max unit.

NOTE The [Rescale World Units utility](#) on page 2682 alters the scale of world units throughout the entire scene, or selected objects.

Procedures

To change the system unit:

- 1 Choose Customize menu > Units Setup.
- 2 Click System Unit Setup.
- 3 Change the System Unit Scale value, and click OK.
The system unit is immediately reset. This setting remains in effect until you change it.

Interface

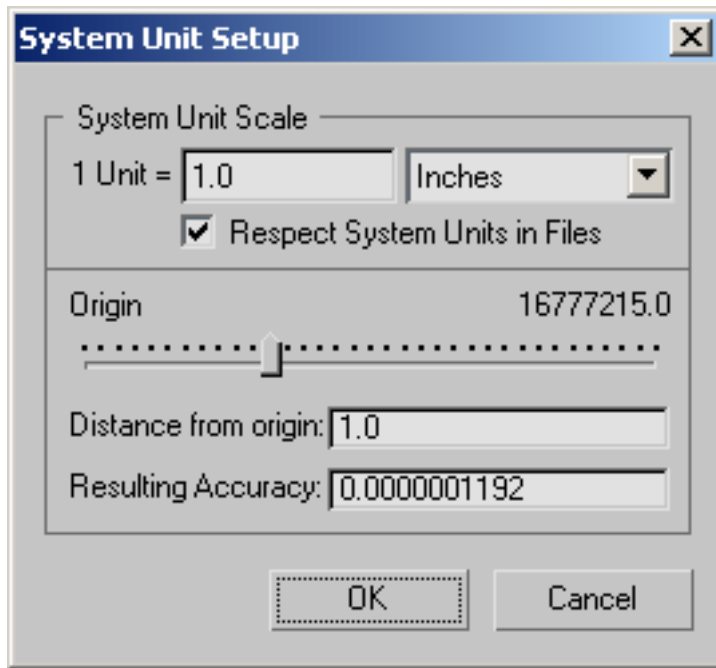

Unit and Measurement fields Change the scale of the 3ds Max unit. The system unit is the standard measurement throughout 3ds Max. You should only change the system unit value *before* importing or creating geometry.

Respect System Units in Files When on, if you open, merge, XRef, or drag and drop geometry from file that has different system unit settings, a [File Load: Units Mismatch dialog](#) on page 7815 is displayed. This dialog gives you the choice of rescaling the geometry to match the current system units, or adopting the units used in the file. When off, the dialog is not displayed, and the file is assumed to have the same units as the current 3ds Max session. Default=on.

Origin Slider, Distance from Origin, Accuracy

These controls provide a system unit calculator to help you determine the unit scale for your project. The resolution of measurement diminishes as the distance to the origin of space increases, so you need to consider space granularity when you choose a scale for your project. If you're modeling an island, for example, this calculator can help you determine the smallest object

you should model on the island. In other words, don't use a unit scale of millimeters if you plan on modeling an island that's many miles across.

When you use the slider or the text field to enter a distance from the origin, the Resulting Accuracy changes to show what the round-off error will be at that distance.

These controls don't change the unit settings in 3ds Max. They don't reflect the extents of the current scene, either.

Origin Slider Move the slider for interactive feedback of distance and accuracy. Right-click the scale to reset the slider to 0. Dragging the slider displays the last slider position as a small square on the scale markings.

The slider covers distances from 0 to the maximum distance that's accurate to one system unit.

Distance from Origin Enter the maximum distance you want to use in your project to determine the maximum accuracy, which is displayed in the Accuracy field. Values consider current settings for system scale and unit.

NOTE When you type a distance, you must press ENTER to update the Resulting Accuracy field. Pressing TAB simply moves focus to Resulting Accuracy, without doing the calculation.

Resulting Accuracy Enter the minimum resolution you will use to determine the maximum size or distance that is most practical. Values consider current settings for system scale and unit.

For example, if units are in feet and decimal inches in Customize menu > Units Setup, and you type (1', 1 foot) in the Accuracy field, a value of 22369620'0.0" is displayed in the Distance From Origin field. If you move an object that's one foot across, at this distance away from the origin of space, a round-off error will occur, and the shape of the object will be compromised.

File Load: Units Mismatch Dialog

Change the system unit scale. > Open, Merge, XRef, or drag geometry from a file with a different unit scale.

This dialog appears when you open or merge a file that has been saved with *system unit settings* that are different from those of your current 3ds Max session. The default system unit setting is Inches.

If you open a file with the system unit set to meters, for example, you will see this dialog.

When this happens, you have two options:

- **Rescale the File Objects to the System Unit Scale:** You can choose to rescale the objects from the incoming file to match the current system unit. This changes the size of the incoming geometry
- **Adopt the File's Unit Scale:** This changes the system unit in your 3ds Max installation to match that of the incoming file. This setting will persist between the current and future 3ds Max sessions until you [reset your system unit](#) on page 7812. This is the default option. Choosing File > Reset will not reset your system unit. You must either change it using Customize > Units Setup > System Unit Setup, or manually edit your *3dsmax.ini* file.

NOTE This dialog appears only if Respect System Units In Files is enabled on the [System Unit Setup dialog](#) on page 7812.

Interface

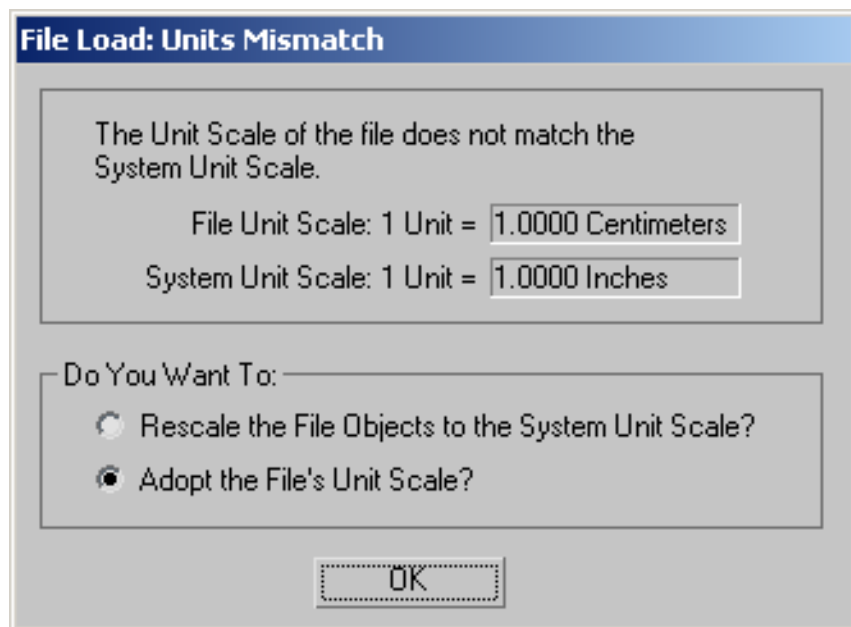

Rescale the File Objects to the System Unit Scale Objects from the file are rescaled to the current session's system unit scale.

NOTE Many features depend on the scale of the scene, so choosing to rescale the file objects can have unpredictable results, particularly in scenes using radiosity. Reset and recalculate radiosity if you have rescaled the file objects.

TIP Use the Zoom Extents All button if the geometry is no longer visible in the viewport after rescaling.

Adopt the File's Unit Scale The system unit scale is changed to match that of the other file. This is the default option.

Choosing Adopt The File's Unit Scale adds two settings to your *3dsmax.ini* file: UnitType= and UnitScale=. For this reason, this change is persistent between sessions until you reset it manually.

To get back the default System Unit Scale, you can edit your *3dsmax.ini* file and remove those settings; or go to Customize > Units Setup > System Unit Setup and change the units back to the default scale, Inches.

TIP Objects with a UVW Unwrap may lose their texture coordinate information when you choose this option. If this occurs, choose the Rescale option rather than the Adopt option.

Viewport Configuration

Views menu > Viewport Configuration

Right-click any viewport label. > Configure

The Viewport Configuration command displays the Viewport Configuration dialog. You use controls on this dialog to set options for viewport control.

All the configuration options are saved with the MAX scene file. To configure startup settings for your file, you can save a *maxstart.max* file. If this file exists, 3ds Max uses it to determine the viewport configuration and settings when the software is loaded or reset.

Interface

Viewport configuration options are available in a series of tabbed panels on the Viewport Configuration dialog:

[Rendering Method](#) on page 7818

[Viewport Layout](#) on page 7824

[Safe Frames](#) on page 7825

[Adaptive Degradation Options](#) on page 7828

[Regions](#) on page 7832

[Statistics](#) on page 7834

[Lighting and Shadows](#) on page 7836

[Lighting and Shadows](#) on page 7836

[SteeringWheels](#) on page 7839

Rendering Method

Views menu > Viewport Configuration > Viewport Configuration dialog > Rendering Method tab

Right-click a viewport label. > Configure > Viewport Configuration dialog > Rendering Method tab

You set the rendering method for either the current viewport or all viewports on the Rendering Method panel of the Viewport Configuration dialog.

NOTE These controls operate on all objects depicted in the viewports; you can also control display properties on a per-object basis.

Procedures

To set the viewport rendering method:

- 1 Choose Views menu > Configure > Viewport Configuration dialog > Rendering Method tab.
- 2 In the Rendering Level group, choose the desired rendering level and any options available for that level.
- 3 In the Apply To group, choose how to apply the rendering level to viewports:
 - **Active Viewport Only** applies the rendering method to the active viewport. This choice is the default.
 - **All Viewports** applies the rendering method to all configured viewports.
 - **All But Active** applies the rendering method to all viewports except the active one.

TIP This option lets you work in full detail in the current view and easily set other views to Wireframe or Bounding Box for quicker interactive display.

To enter an FOV value in a Perspective viewport:

- 1 Right-click a Perspective viewport label and choose Configure. It isn't necessary to activate the viewport first.

This opens the Viewport Configuration dialog. If necessary, click the Rendering Method tab.

- 2 In the Perspective User View group > Field Of View field, enter an angle.

Interface

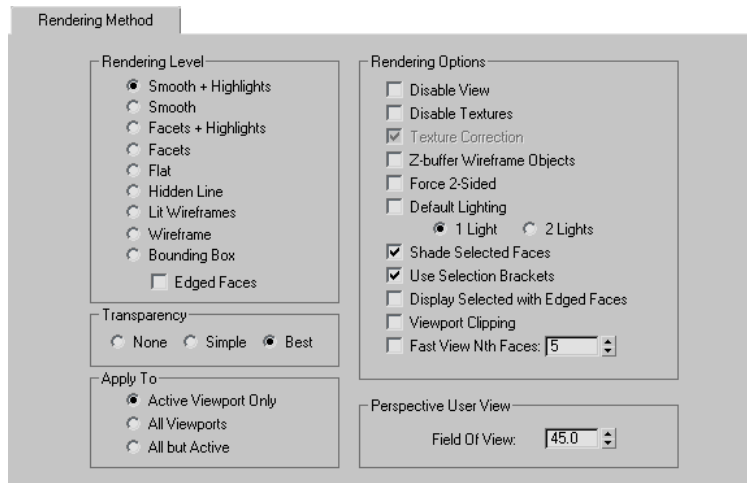

When you open this dialog, the settings reflect the current viewport settings.

Rendering Level group

Determines how the software displays objects.

Smooth+Highlights Renders objects with smooth shading and displays specular highlights. To toggle quickly between Smooth+Highlights and Wireframe, press F3.

Smooth Renders objects with smooth shading only.

Facets+Highlights Renders objects with flat shading and displays specular highlights.

Facets Renders polygons as flat surfaces, shaded but with no smoothing or highlights.

Flat Renders each polygon in its raw, unshaded diffuse color, disregarding any contribution from ambient lighting or light sources. This rendering method is useful when it's more important to see each polygon than to see its shading. It's also a good way to check the results of bitmaps created with [Render to Texture](#) on page 6371.

Hidden Line A wireframe mode that hides faces and vertices with [normals](#) on page 8059 pointing away from the viewpoint, as well as any parts of objects that are obscured by closer objects. In this display mode only, the wireframe color is determined by the Viewports > Hidden Line Unselected color, not the object or material color. See [Colors Panel](#) on page 7712.

Lit Wireframes Renders objects as wireframes with flat shading.

Wireframe Draws objects as wireframes with no shading applied. To toggle quickly between Wireframe and Smooth+Highlights, press F3.

Bounding Box Draws objects as bounding boxes with no shading applied. A [bounding box](#) on page 7932 is defined as the smallest box that completely encloses an object.

Edged Faces Available only when the current viewport is in a shaded mode, such as Smooth, Smooth+Highlights, Facets+Highlights, or Facets. When Edged Faces is on in these modes, the wireframe edges of objects appear along with the shaded surfaces. This is helpful for editing meshes in a shaded display. Press F4 to toggle Edged Faces display.

Edges are displayed using the object wireframe color, while surfaces use material colors (if a material is assigned). This lets you create contrasting colors between the shaded surfaces and the wireframe edges. You can switch these around in the [Display Color rollout](#) on page 177 in the Display panel.

Transparency group

None Objects with transparency assigned appear completely opaque, regardless of the transparency settings.

Simple Objects with transparency assigned are displayed with a “screen door” transparency effect.

Best Objects with transparency assigned are displayed with a two-pass transparency effect.

This option is smoother and closer to rendered transparency effects.

Apply To group

Applies the current settings to the active viewport only, to all viewports, or to all the viewports except the active one.

NOTE This applies to the currently active viewport only; it is not a dynamic function.

Rendering Options group

These check boxes modify either the shading modes or the wireframe modes. They refer to the [viewport renderer](#) on page 8164 only, not to the [scanline renderer](#) on page 8116 or any other renderer.

Disable View Disables the Apply To viewport selection. A disabled viewport behaves like any other viewport while active. However, when you change the scene in another viewport, the view in the disabled viewport does not change until you next activate it. Use this function to speed up screen redraws when you are working on complex geometry.

Disable Textures Select to turn off display of texture [maps](#) on page 8036 assigned to objects. Turn off to show the maps assigned to objects.

Texture Correction Redraws the viewport using pixel interpolation (perspective-corrected). The redrawn image remains until you force the viewport to redraw for any reason. This command has an effect only when the viewport is shaded and at least one object's map is displayed.

Z-Buffer Wireframe Objects Draws the wires ordered according to depth in the scene. Otherwise wires may be drawn out of order to speed the viewport display. This option is generally needed only when sub-object selections are "hidden" by lines drawn out of order. For example, you select the front edges of a box, but they don't appear highlighted in red, because the white lines from the rear may get drawn last. Activate this only if you find that selections are obscured or if you need the viewport redrawn from back to front.

Force 2-Sided Set to render both sides of faces. See [2-Sided](#) on page 7893. Turn off to render only faces with [normals](#) on page 8059 toward the viewer. Usually, you'll want to keep this option off to speed redraw time. You might want to turn it on if you need to see the inside as well as the outside of objects, or if you've imported complex geometry in which the face normals are not properly unified.

NOTE This switch has no effect when the Direct3D [graphics driver](#) on page 7790 is active. In this case, to control the visibility of backfacing faces in the viewports, use the Display Properties > [Backface Cull](#) on page 185 switch.

Default Lighting Turn on to use default lighting. Turn off to use the lights created in the scene. If no lights exist in the scene, the default lighting is used automatically, even when this check box is off. Default=on.

Sometimes the lighting you create in the scene makes the objects difficult to see in the viewport. The default lighting displays the objects with even illumination. You can use either one or two lights. By default, 3ds Max uses one default light.

- **1 Light** Provides an over-the-shoulder light with 20% faster redraws at the expense of less natural illumination.

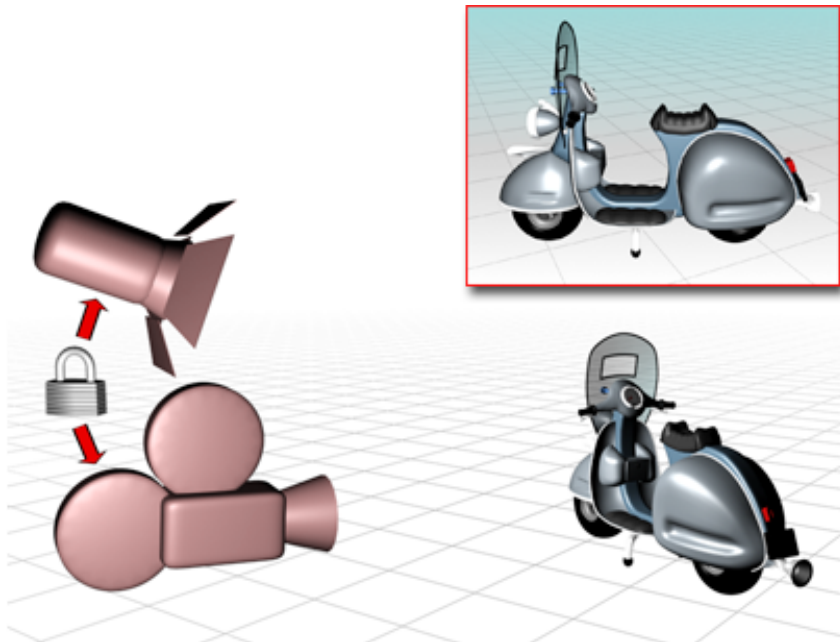

A single default light is linked to the camera and moves when you change your viewport point of view.

- **2 Lights** Provides more natural illumination, but slower viewport performance.

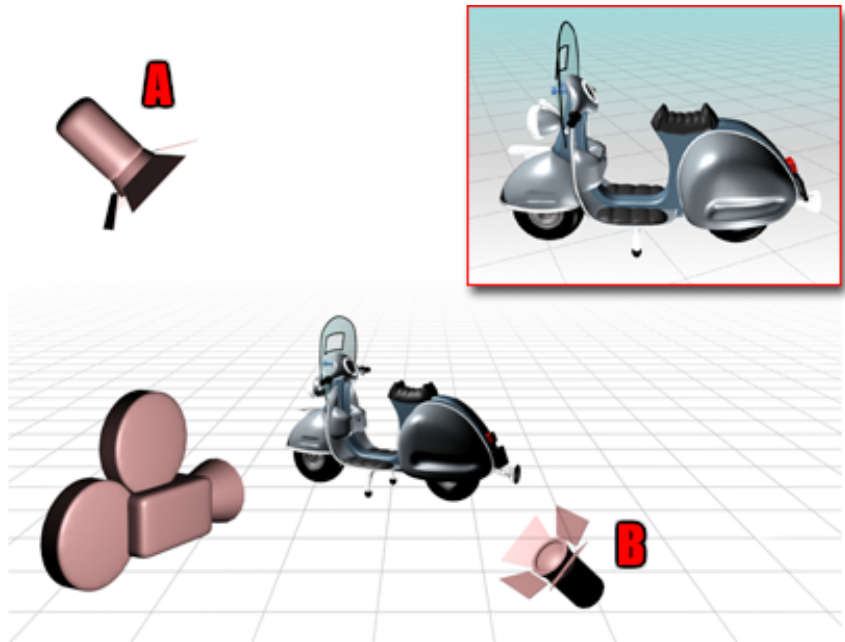

Two default lights are placed opposite to each other.

The key light, A, is in front of the object, on the upper-left side, while the fill light, B, is behind on the lower-right side.

Shade Selected Faces When on, selected faces viewport display in a red semitransparent state. This makes it easier to see selected faces in shaded viewports. Keyboard shortcut=F2.

Use Selection Brackets Toggles the display of white selection brackets in the viewport display. Turn this off in complex scenes when the display of multiple selection brackets obscures the required view of selected objects.

Display Selected with Edged Faces Toggles the display of highlighted edges for selected objects when the viewport is in a shaded mode, such as Smooth, Smooth+Highlights, Facets+Highlights, or Facets. When on in these modes, the wireframe edges of selected objects appear along with the shaded surfaces. This is helpful when selecting multiple objects or small objects.

Viewport Clipping When on, interactively sets a near and far range for viewport display. Two arrows at the edge of the viewport allow you to

determine where the clipping occurs. Tick marks correspond to the extents of the viewport, the lower tick is the near clipping plane, and the upper tick sets the far clipping plane. This does not affect the rendering to output, only the viewport display.

Fast View Nth Faces When on, speeds screen redraw by displaying fewer faces. The Nth Faces spinner sets the number of faces that are displayed when the Fast View mode is active. For example, a setting of 3 displays every third face.

Perspective User View group

Field Of View Sets the field of view angle for a Perspective viewport. This spinner is not available when any other viewport type is active. You can change the Camera field of view in the Modify panel.

Viewport Layout

Views menu > Viewport Configuration > Viewport Configuration dialog > Layout tab

Right-click a viewport label. > Configure > Viewport Configuration dialog > Layout tab

You specify the division method of viewports, and assign specific types of views to each viewport on the Layout panel of the Viewport Configuration dialog.

The layout is saved with the MAX scene file, so you can store different layouts in separate scene files. Load the file you want, then merge in the contents of other files to maintain the layout.

TIP Through MAXScript, there are commands to set the current layout to any of the 14 available setups. You can also activate any viewport and set the view type. This enables you to create macros and custom user interface buttons to set any layout you choose.

Interface

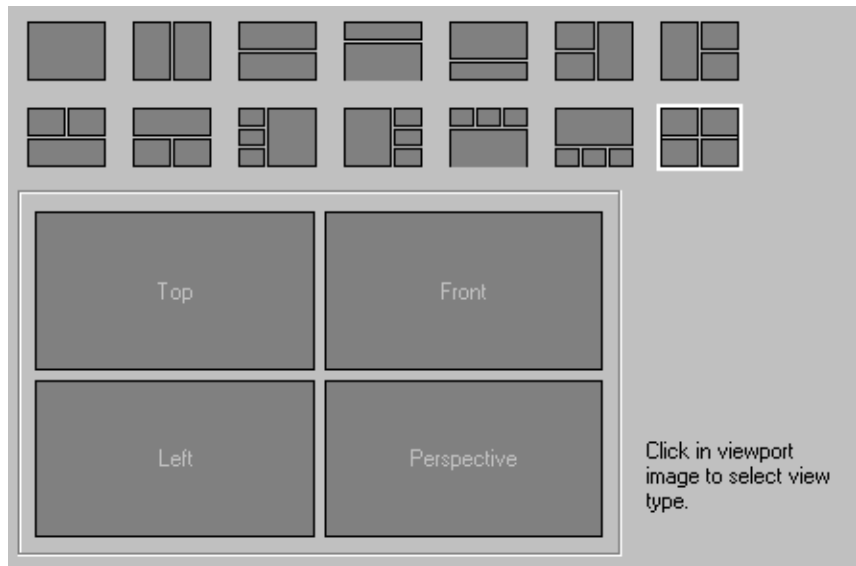

The Layout panel is arranged in two general areas. At the top are icons representing the possible division methods. Below these is a screen representation of the currently selected layout. Click an icon to select the division method, which appears in the larger screen representation.

To assign specific views, click the viewport in the screen representation. Choose a viewport type from the menu that appears.

Safe Frames

Views menu > Viewport Configuration > Viewport Configuration dialog > Safe Frames tab

Right-click a viewport label. > Configure > Viewport Configuration dialog > Safe Frames tab

Keyboard > Shift+F



Safe frame borders show which portions of a viewport will be visible when rendered to video.

You toggle the status of the [video safe frame](#) on page 8110 for the current viewport and adjust its parameters on the Safe Frames panel of the Viewport Configuration dialog.

Video Safe Frame displays a series of concentric rectangular frames in the viewport. Use Safe Frame to see the proportions of your rendered output within the viewport. This is particularly useful when you are rendering to output that doesn't match the viewport's aspect ratio.

The primary purpose of Safe Frames is to suggest safe areas for work intended for display on TV monitors. It is likely that the bezel will cover about 10% of the image so you don't want important objects or action to fall outside the Action Safe area. High contrast titles falling outside the Title Safe area are likely to bleed or be obstructed by the bezel of the TV screen.

When Safe Frames are displayed in the viewport and a bitmap image is assigned as a [viewport background](#) on page 148 using either the Match Viewport or Match Rendering Output options, the image is confined to the Live area of the safe frames and matches the rendered background. This assumes that the same bitmap is assigned to the Environment background using Environment/Screen coordinates.

You can toggle the status of [safe frames](#) on page 8110 on or off for the current viewport, and use the Safe Frames panel of the Viewport Configuration dialog to adjust the parameters.

When Safe Frame is displayed in the viewport and a bitmap image is assigned as a background, and Show Background is on, the image is confined to the Live area of the safe frame. If you are using a background image in your rendering, make sure that your rendering output size matches the background image size. This avoids distortion.

Interface

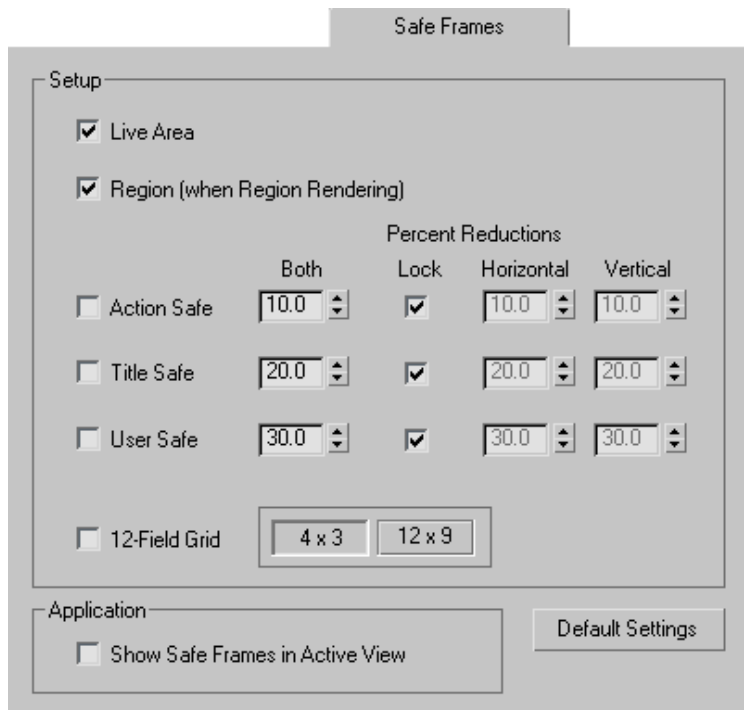

Setup group

The Safe Frames panel contains settings for the following frame types:

Live Area (yellow) The area that will actually be rendered, regardless of the size or aspect ratio of the viewport.

Action Safe (green) The area in which it's safe to include your rendered action. The Lock check box lets you lock the aspect ratio of the Action frame. When

Lock is on, use the Both spinner to set the percentage of the live area that's trimmed within the safe frame. When Lock is off, you can use the Horizontal and Vertical spinners to set these parameters independently. Default=10%.

Title Safe (cyan) The area where it's safe to include titles or other information. When used correctly, this is smaller than the Action frame. The Lock check box lets you lock the aspect ratio of the Title frame. When Lock is on, use the Both spinner to set the percentage size of the title frame relative to the action area. When Lock is off, you can use the Horizontal and Vertical spinners to set these parameters independently. Default=20% of Live Area.

User Safe Displays an additional safe frame that you can use for any custom requirements. The Lock check box lets you lock the aspect ratio of the User frame. When Lock is on, use the Both spinner to set the percentage size of the user frame relative to the action area. When Lock off, you can use the Horizontal and Vertical spinners to set these parameters independently. Default=20% of Live Area.

12-Field Grid Displays a grid of cells (or fields) in the viewport. In this case, "fields" are cells in the grid, and not scanline fields.

The "12-field grid" is a method used by video directors to refer to specific areas of the screen. A director might ask you to move an object two fields to the left and four fields down. The 12-field grid is a reference for this type of placement.

4 x 3/12 x 9 Lets you choose between two matrices of either 12 or 108 cells.

Application group

Show Safe Frames in Active View Toggles the frame displays on or off for the current viewport. This option is duplicated by the Show Safe Frame item in the viewport right-click menu.

Ungrouped

Default Settings Resets all values to the default values.

Adaptive Degradation Options



Status bar > Right-click the Adaptive Degradation button.

Views menu > Viewport Configuration > Viewport Configuration dialog > Adaptive Degradation tab

Right-click a viewport label. > Configure > Viewport Configuration dialog > Adaptive Degradation tab

You adjust the adaptive viewport redraw methods on the Adaptive Degradation panel of the Viewport Configuration dialog. The [adaptive degradation](#) on page 7900 settings are saved with your MAX scene file.

To toggle adaptive degradation, click the Adaptive Degradation button on the prompt line, or press O .

This is handy when you're adjusting lights and want to see their effect, real time, in a shaded viewport. Or you might be adjusting the camera and need to see complex geometry exactly as it is.

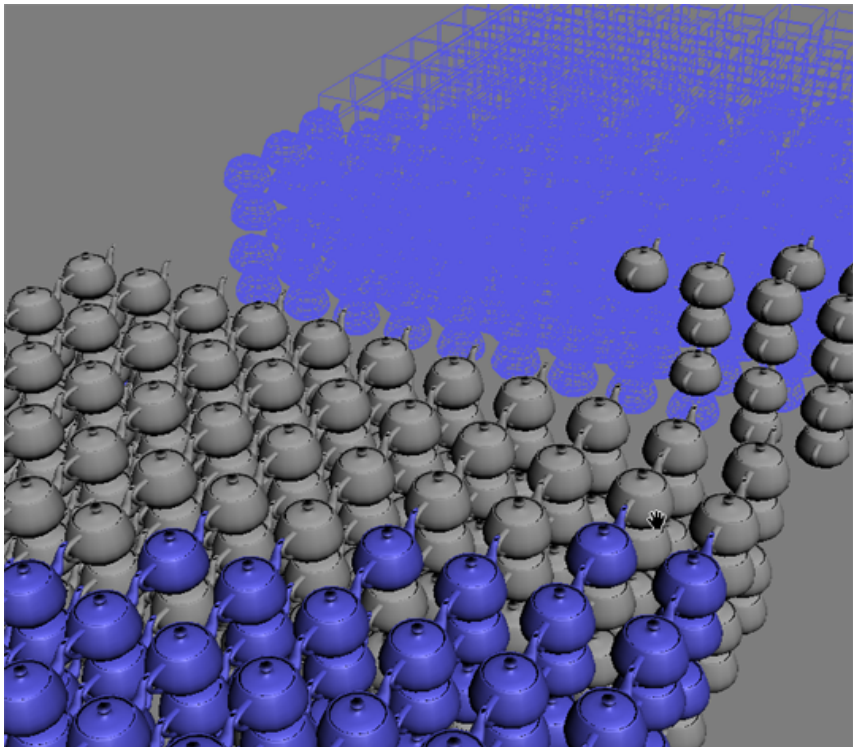

Example showing four degrees of adaptive degradation, depending on distance from camera

Interface

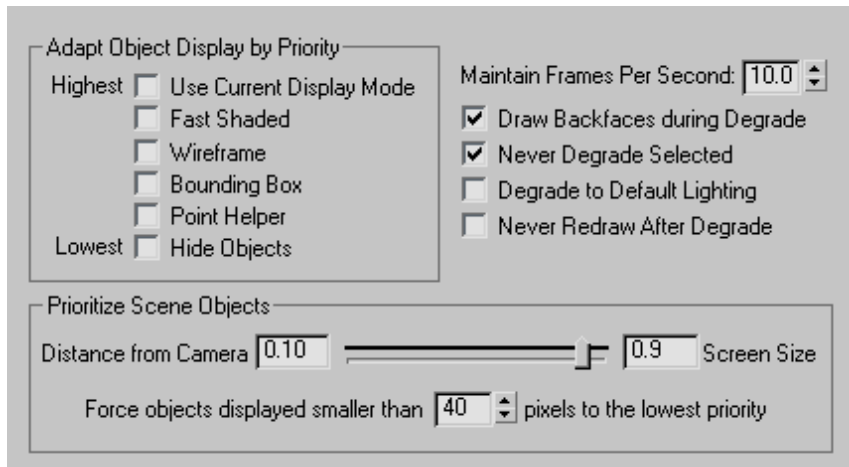

Adapt Object Display by Priority group

Turn on check boxes to indicate the rendering modes to step through during necessary degradation. As the viewport redraw demands increase, the amount of degradation increases through the active options from highest to lowest. Objects with higher priority (based on the Prioritize Scene Objects settings) will use the higher, more faithful display settings, while lower-priority objects, typically smaller and/or farther from the point of view, will use the lower display settings.

Maintain Frames Per Second Lets you set the [frame rate](#) on page 7987 in frames per second that adaptive display will attempt to maintain. If the frame rate drops below this, the software will increase the amount of degradation based on the other settings on this panel.

Draw Backfaces during Degrade When on, forces the software to draw polygons facing away from the point of view during degradation. Applies only to wireframe views. When off, can improve performance by culling backfaces during degradation.

Never Degrade Selected When on, selected objects are not subject to degradation.

TIP You can use the [Never Degrade object property](#) on page 312 to specify that 3ds Max should not subject an object to degradation, regardless of its selection status.

Degrade to Default Lighting When on, improves performance by turning off all viewport lights and enabling default lighting during degradation.

Never Redraw After Degrade When off, viewport display will restore as frame rate improves, redrawing all degraded objects. If this takes too long, turn it on. When on, objects will degrade but never redraw on mouse up, always displaying at the most recent level of degradation.



NOTE As viewport degradation occurs, the Adaptive Degradation button on the status bar turns aqua, as shown here. Normally, when the degradation stops, the color returns to gold, but when Never Redraw After Degrade is on, the background remains aqua, even when active degradation is not happening. To resolve this, either turn off Adaptive Degradation or turn off Never Redraw After Degrade. Then, to redraw the screen, press ~.

Prioritize Scene Objects group

Distance from Camera/Screen Size Use this slider to specify whether the software gives higher priority to objects based on their distance from the camera or their screen size, regardless of distance from the camera. The two criteria, represented by either end of the scale, are defined as follows:

- **Distance from Camera** This sets the priority for each object based on its distance from the camera or screen. The farther the object, the lower its priority and the faster it will degrade. Higher values display closer objects regardless of their size.
- **Screen Size** The size of the bounding box in pixels. The smaller the object, the lower its priority and the faster it will degrade. Higher values degrade smaller objects regardless of their distance.

If you move the slider all the way to either end of the scale, the software sets priorities based exclusively on that criterion. However, because it's a sliding scale, you can use both criteria on a weighted basis. For example, if you set one end to 0.66, the other is set to 0.34, meaning that the software takes both criteria into account in determining priorities, but gives the criterion set to 0.66 about twice as much weight as the other.

To return this parameter to its default setting (0.10/0.9), indicated by the tick mark on the scale, right-click the slider.

Force objects displayed smaller than ... pixels to the lowest priority Objects smaller than the specified size on the screen, in pixels, always use the lowest

available priority setting (in the Adapt Object Display By Priority group) during degradation.

Regions

Views menu > Viewport Configuration > Viewport Configuration dialog > Regions tab

Right-click a viewport label. > Configure > Viewport Configuration dialog > Regions tab

On the Regions panel of the Viewport Configuration dialog, you specify default selection rectangle sizes for the Blowup Region and the Sub Region, and the parameters for setting up a virtual viewport.

The rectangular selection region appears when you render with either Blowup or Region selected in the [Render Type List](#) on page 6095. You can change the size of the region by dragging its handles.

The Virtual Viewport options let you zoom in on a sub-region of the current viewport, creating a “virtual viewport” where you can perform any standard navigation, but in a zoomed-in area. This function works only when you're using an OpenGL driver. If you're using the software driver, these controls are disabled.

You can use the virtual viewport on any type of viewport, but it's primarily designed for zooming in on camera views. This lets you perform close-up work, such as tracing, without distorting the relationship between the geometry and a bitmap background. (See Lock Zoom/Pan in [Viewport Background](#) on page 148 for similar functionality in orthographic views.)

Because you're actually zooming the viewport image itself, the viewport label might be hidden from display, but you can still right-click in the upper-left area of the viewport to display the menu. This takes advantage of zooming features in the Open GL driver so that the software does not compute the display change internally.

Procedures

To use the virtual viewport:

- 1 Make sure you're using an [OpenGL driver](#) on page 7790 for your display.
- 2 Activate the viewport to convert to a virtual viewport (typically a camera viewport that is displaying a bitmap background).

- 3 Choose Views menu > Viewport Configuration and click the Regions tab.
- 4 Click Use Virtual Viewport. A reduced image of the viewport displays in the dialog, along with a white zoom rectangle representing the virtual viewport.
- 5 Use the Zoom, X Offset, and Y Offset spinners to adjust the size and position of the virtual window, or drag the white window anywhere within the image.
- 6 Click OK.
The viewport is converted to a virtual viewport and displays the area of viewport represented by the white rectangle. All viewport navigation methods work the same, except that you're seeing only the zoomed portion of the viewport.
- 7 To close the virtual viewport, go to Viewport Configuration > Region Tab and turn off virtual viewport. You can get to the Viewport configuration menu by right-clicking any of the viewport navigation tools or by going to Views menu > Viewport Configuration.

Interface

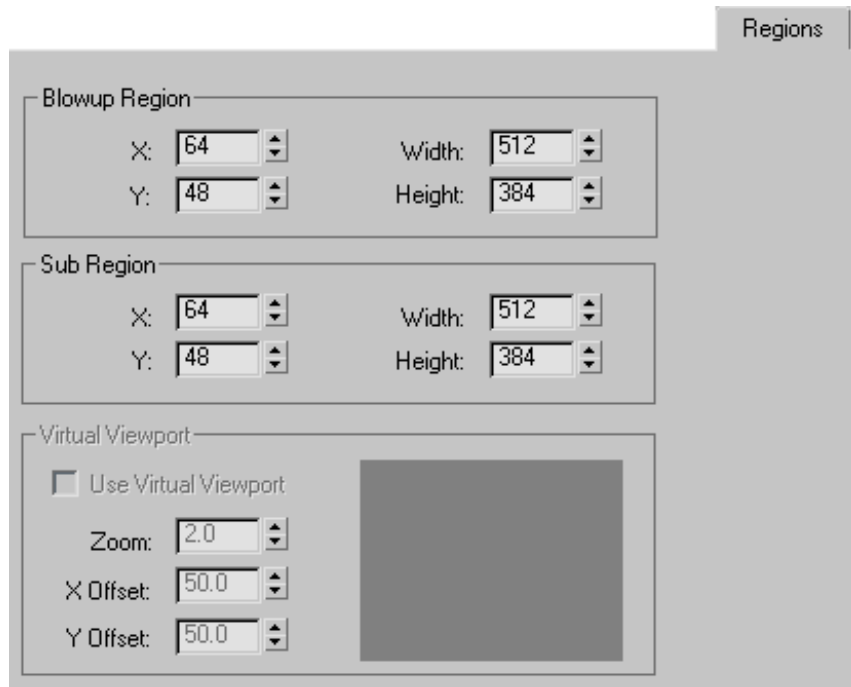

The Regions panel contains spinners for setting the four corners of the region (in pixels), and the following options.

Virtual Viewport

Use Virtual Viewport Enables the virtual viewport. A reduced image of the viewport appears in the dialog, along with a white zoom rectangle representing the virtual viewport.

Zoom, X Offset, and Y Offset Adjusts the size and position of the virtual window. You can also drag the white window anywhere within the image.

Statistics

Views menu > Viewport Configuration > Viewport Configuration dialog > Statistics tab

Right-click a viewport label. > Configure > Viewport Configuration dialog > Statistics tab

Use these controls to display statistics in the viewports concerning the number of vertices, polygons, etc., in the scene and/or the active selection, as well as a real-time count of the number of frames per second displayed. To toggle display of the statistics in a viewport on the fly, right-click the viewport label (for example, Perspective) and choose Show Statistics.

Interface

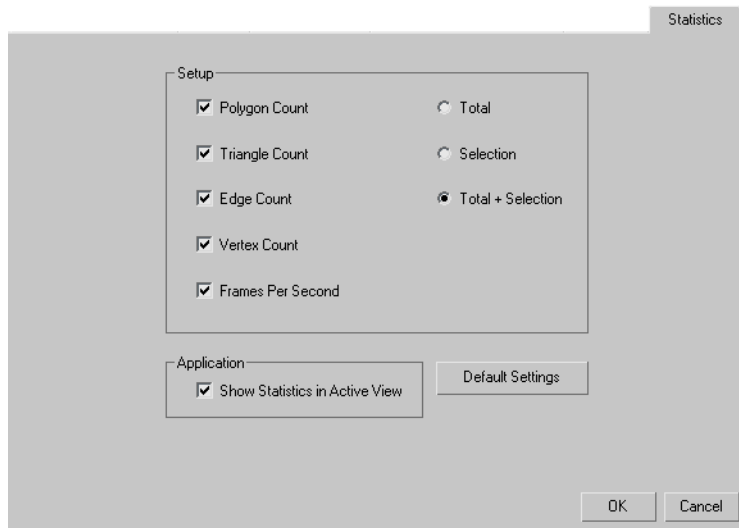

Setup group

Polygon Count Enables the polygon count display.

Triangle Count Enables the triangle count display.

Edge Count Enables the edge count display.

Vertex Count Enables the vertex count display.

Frames Per Second Enables the FPS count display.

Total Displays only the statistics for the entire scene.

Selection Displays only the statistics for the current selection.

Total + Selection Displays the statistics for the entire scene and current selection.

Application group

Show Statistics In Active View Enables the statistics display.

Default Settings Returns all options to the original settings.

Lighting and Shadows

Views menu > Viewport Configuration > Viewport Configuration dialog > Lighting And Shadows tab

Right-click a viewport label. > Configure > Viewport Configuration dialog > Lighting and Shadows tab

The Lighting And Shadows tab sets preferences for lighting and shadow display in shaded viewports. See [Previewing Shadows in Viewports](#) on page 4991.

Interface

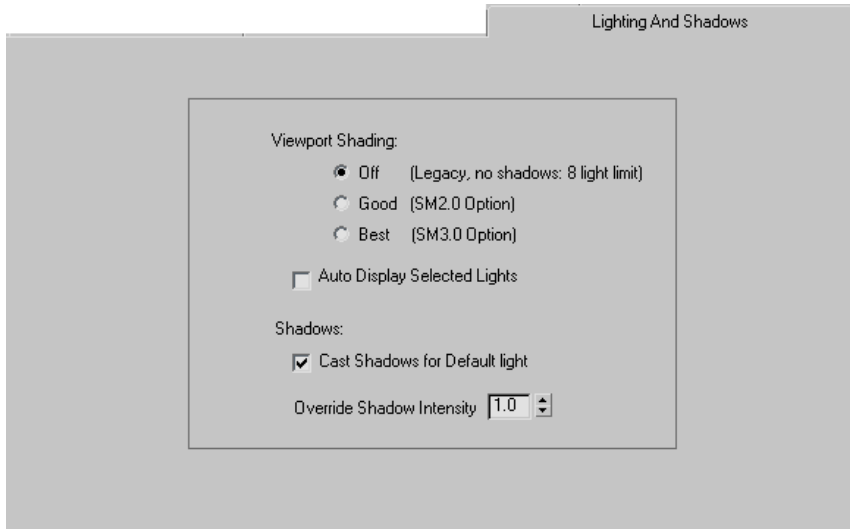

Viewport Shading Chooses the level of viewport shading. These options are equivalent to the same options on the Display quadrant of the quad menu for supported lights (Viewport Lighting And Shadows > Viewport Shading >

Off, Good, or Best): changing the setting here changes the active setting on the quad menu, and vice versa.

- **Off (Legacy, no shadows, 8 light limit)** Lights viewports as in versions of 3ds Max prior to v10. No shadows appear.
- **Good (SM2.0 Option)** Displays shadows at the SM2.0 level.
- **Best (SM 3.0 Option)** Displays shadows at the SM3.0 level, with opacity mapping.

Auto Display Selected Lights When on, light from selected lights is automatically displayed in shaded viewports. Default=off.

Cast Shadows for Default light When on, default lights display shadows (that is, when no other light object is present in the scene). Default=on.

Override Shadow Intensity Use this to lighten (greater than 1.0) or darken (less than 1.0) shadows in viewports. This is simply an aid to previewing shadows: it does not affect ambient light, or any light and shadow settings that are used when you render. Default=1.0.

ViewCube

Views menu > ViewCube > Configure

Right-click the ViewCube. > Configure

Views menu > Viewport Configuration > Viewport Configuration dialog > ViewCube tab

Right-click a viewport label. > Configure > Viewport Configuration dialog > ViewCube tab

These controls affect interaction with the [ViewCube feature](#) on page 107. Any changes in settings persist between sessions.

Interface

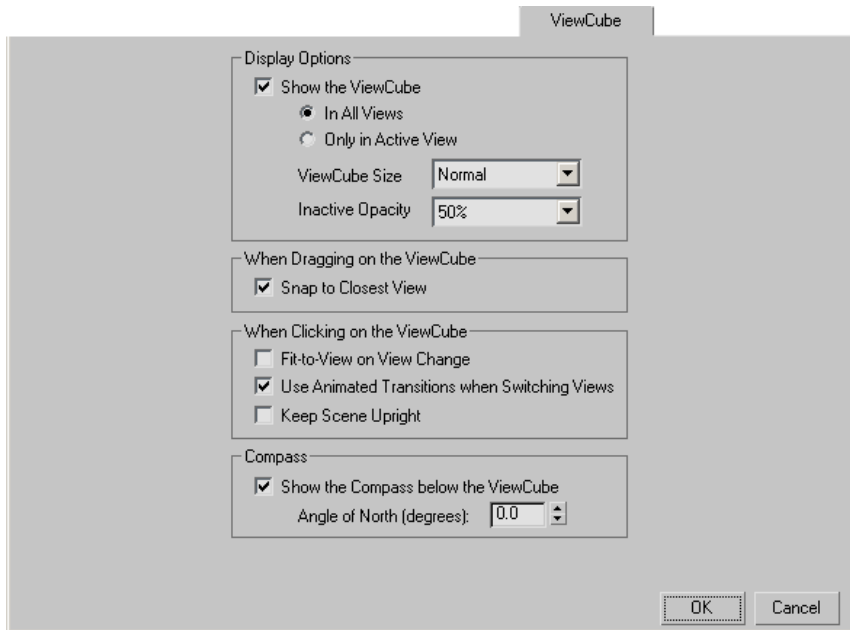

Display Options group

Show the ViewCube Lets you choose whether to display the ViewCube in all visible viewports, or only in the active viewport.

- **In All Views**
- **Only in Active View**

ViewCube Size Choose a size from the drop-down list. The choices are Tiny, Small, Normal (the default), and Large. At Tiny, the cube does not contain labels.

Inactive Opacity Sets the opacity of the ViewCube when not in use. Choose an opacity value from the drop-down list. The choices are 0%, 25%, 50%, 75%, and 100%. At 0%, the ViewCube is visible only when the mouse cursor is over its location. At 100%, the ViewCube is solid at all times. At lower opacities, the ViewCube obscures the viewport contents to a lesser extent.

When Dragging on the ViewCube group

Snap to closest view When on and you drag the ViewCube to rotate the view, the viewpoint will snap to one of the fixed views when its angle is close to that of one of the fixed views.

When Clicking on the ViewCube group

These settings apply specifically to clicking the ViewCube, not dragging it.

Fit-to-View on View Change When on, clicking the cube (face, corner, or edge) automatically zooms the view to fit the current selection. When off, no zooming is performed when clicking the cube.

Use Animated Transitions when Switching Views When on, and you change the view by clicking the cube, the new view rotates into place. When off, the new orientation snaps into view instantly. The latter mode is faster and is recommended for experienced users, but new users should keep this switch on to stay better oriented within the scene.

Keep Scene Upright Prevents the scene from appearing to flip over partially or fully. For example, with this off, going to the Top view and then clicking the upper edge of the ViewCube causes the scene to appear to rotate 45 degrees upside-down. But with Keep Scene Upright on, doing so simply rotates to an angled-down view.

Compass group

Show the Compass below the ViewCube When on, displays a compass below the ViewCube for determining the view orientation in a geographic context.

Angle of North (degrees) Lets you specify the compass orientation. For example, to rotate the compass a quarter-turn clockwise, set Angle of North to **90.0**.

SteeringWheels

Views menu > SteeringWheels > Configure

Click the Wheel menu button at the lower-right corner of the SteeringWheels.
> Configure

Views menu > Viewport Configuration > Viewport Configuration dialog > SteeringWheels tab

Right-click a viewport label. > Configure > Viewport Configuration dialog > SteeringWheels tab

These controls affect interaction with the [SteeringWheels feature](#) on page 114. Any changes in settings persist between sessions.

Interface

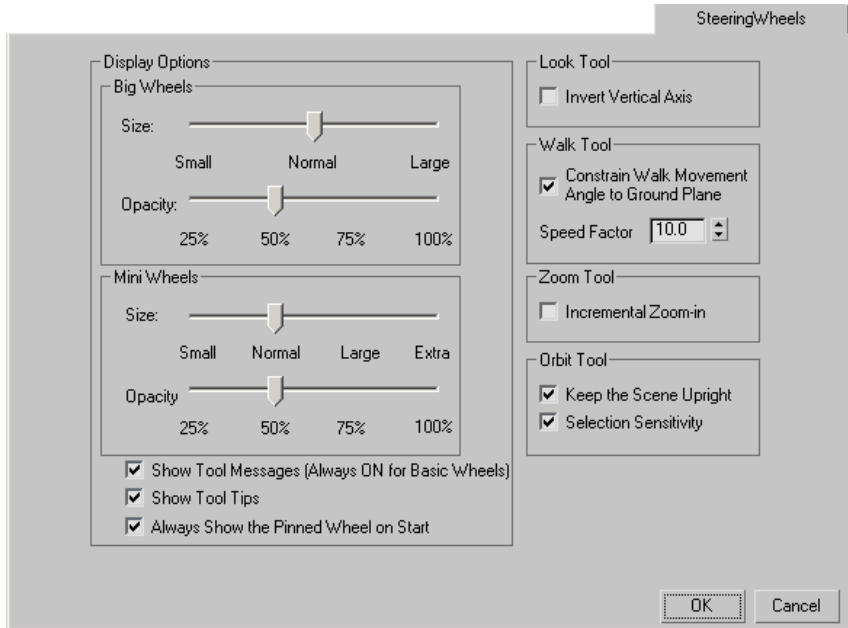

Display Options group

Big Wheels Use the sliders to specify the size and opacity of the standard-size wheels. The changes take place when you click OK.

- **Size** Sets the size of the Full Navigation Wheel, View Object Wheel, and Tour Building Wheel.
- **Opacity** Sets the opacity of the Full Navigation Wheel, View Object Wheel, and Tour Building Wheel.

Mini Wheels Use the sliders to specify the size and opacity of the small wheels. The changes take place when you click OK.

- **Size** Sets the size of the Mini Navigation Wheel, Mini View Object Wheel, and Mini Tour Building Wheel.

- **Opacity** Sets the opacity of the Mini Navigation Wheel, Mini View Object Wheel, and Mini Tour Building Wheel.

Show Tool Messages Toggles the display of tool messages such as “Press the arrow keys to move” for the Look tool.

NOTE Not all tools have tool messages.

Show Tool Tips Toggles the display of the tool tips that display when you hover the mouse cursor over a control.

Always Show the Pinned Wheel on Start When on, and you first start the program, the SteeringWheels automatically appear at the mouse cursor position. When off, the SteeringWheels must be activated manually.

Look Tool group

Invert Vertical Axis Affects how vertical mouse dragging controls view movement with the Look tool. When on, dragging upward moves the viewpoint upward, and dragging downward moves the viewpoint downward. When off, dragging upward moves the viewpoint downward, and dragging downward moves the viewpoint upward. Default=off.

Walk Tool group

Constrain Walk Movement Angle to Ground Plane When on, constrains Walk motion (Forward, Backward, Left, Right, Up, and Down) relative to the world XY plane regardless of the current Look Direction. When off, Walk motion occurs perpendicular to the view plane. Default=on.

Speed Factor Sets the relative rate of Walk motion. Range=0.1 to 10.0. Default=10.0.

Zoom Tool group

Incremental Zoom-in When on, and you’re using the [Zoom tool](#) on page 133 on the [Full Navigation wheel](#) on page 121, you can zoom in by a factor of 25 percent by clicking. When off, you must drag to zoom using the Zoom tool on the Full Navigation wheel.

Orbit Tool group

Keep the Scene Upright Prevents the scene from rotating so that it appears to be upside down when using the [Orbit tool](#) on page 127.

Selection Sensitivity When on, using the [Orbit tool](#) on page 127 rotates the view around the current selection, rather than a predefined center.

Strokes

Customize menu > Preferences > Preference Settings dialog > Viewports tab > Mouse Control group > Stroke

Strokes are a way to assign command shortcuts to mouse or tablet drag patterns. For many operations, strokes are more convenient than keyboard shortcuts because they can select an object and apply a command to it.

For example, you can assign Orbit to a downward stroke. When you draw this stroke, the software changes to Orbit mode. You can assign a circular stroke to the Hide Selected command so that it both selects the objects and then hides all the objects in the bounding extents of the stroke pattern.

You can use strokes in two ways:

- If you have a middle mouse button, you can define and use strokes by specifying the Stroke option for the middle mouse button in the [Viewports tab](#) on page 7753 of the Customize menu > Preferences dialog.
- To define and use strokes with the left mouse button, use the [Strokes utility](#) on page 7854 and turn on Draw Strokes.

Using the Keyboard with Strokes

The same stroke pattern can perform four different functions by holding Shift, Alt, or Shift+Alt when drawing the stroke:

- Drawing a vertical line is one type of stroke.
- Holding Shift while drawing the same line is another type.
- Holding Alt while drawing it is a third type.
- Holding both Shift and Alt while drawing the line is a fourth type. Holding Ctrl while drawing a stroke indicates that you want to define a new stroke, rather than use an existing stroke.

NOTE Changes you make to the set of strokes are saved with 3ds Max and persist from session to session.

See also:

- [Defining Strokes](#) on page 7845
- [Reviewing and Editing Strokes](#) on page 7849
- [Stroke Preferences Dialog](#) on page 7851
- [Strokes Utility](#) on page 7854

Procedures

To define and use strokes with the middle mouse button:

- 1 Choose Customize menu > Preferences > Preference Settings dialog > Viewports tab.
- 2 In the Mouse Control group, turn on Stroke.
You must turn on this option for all Stroke functions to work with the middle mouse button.
- 3 Hold the middle mouse button and drag in a viewport to make a stroke. If the stroke hasn't been defined, a dialog appears where you can click Define to define the stroke. If the stroke has already been defined, the corresponding function is executed.
See [Defining Strokes](#) on page 7845 for information on defining and editing strokes.

To define and use strokes with the left mouse button:

- 1 Choose Utilities panel > Utilities rollout > More button > Utilities dialog > Strokes.
- 2 Turn on Draw Strokes.
- 3 Hold the left mouse button and drag in a viewport to make a stroke. If the stroke hasn't been defined, a dialog appears where you can click Define to define the stroke. If the stroke has already been defined, the corresponding function is executed.
See [Defining Strokes](#) on page 7845 for information on defining and editing strokes.

Example: To assign Object Properties to a stroke:

- 1 Use one of the first two procedures to activate strokes.

- 2 Hold down Ctrl, and drag from top to bottom and then back up to the starting point.
- 3 The Define Stroke dialog appears, and the name of the stroke is "HKKH."

NOTE Depending on how you drew your stroke sequence, it might be defined by different letters. This is fine, as long as you use the same sequence to enact the stroke after you have finished defining it.

If an alert appears, you've either drawn the stroke incorrectly, or this stroke has already been assigned. Continue with the following steps to replace the defined stroke.

- 4 Choose the Properties command from the Command To Execute list.
- 5 The option enabled is Single Object At Start Of Stroke, because that's the logical choice for the Object Properties command.
- 6 Click OK.
- 7 Drag vertically down and back up over any object in the scene to display the Object Properties dialog for that object.

Example: To assign Hide Selection to a stroke:

- 1 Use one of the first two procedures to activate strokes.
- 2 Hold down Ctrl, and drag vertically from top to bottom.
- 3 In the alert that appears, click Yes to redefine the stroke and display the Define Stroke dialog.

The name of this stroke is HK.

NOTE Depending on how you drew your stroke sequence, it might be defined by different letters. This is fine, as long as you use the same sequence to enact the stroke after you have finished defining it.

- 4 Choose Hide Selection from the list.
- 5 Choose All Objects in the Selection Set.
- 6 Click OK.
- 7 Load a scene containing several objects, and select two or more objects.
- 8 Drag vertically from top to bottom in the viewport.
The selected objects are all hidden.

Defining Strokes

Hold down Ctrl and the middle mouse button and drag in a viewport to create the shape of an unused stroke. > Define Strokes dialog

Hold down the middle mouse button alone or with Shift, Alt, or both, and drag in a viewport to create the shape of an unused stroke. > Define > Define Strokes dialog

Utilities panel > Utilities rollout > More button > Utilities dialog > Strokes > Draw Strokes > Hold down the left mouse button alone or with Shift, Alt, or both, and drag in a viewport to create the shape of an unused stroke. > Define > Define Strokes dialog

You define a stroke by creating the stroke in a viewport, then choosing the command that the stroke defines. The next time you perform the stroke, the command will be executed. You can define strokes to work in conjunction with the Shift key, the Alt key, or both Shift and Alt.

You can define strokes with either the left or middle mouse button. If you want to use your middle mouse button to define and use strokes, you must first turn on Customize menu > Preferences > Preference Settings dialog > [Viewports tab](#) on page 7753 > Mouse Control group > Stroke. To define and use strokes with the left mouse button, choose Utilities panel > Utilities rollout > More button > Utilities dialog > [Strokes](#) on page 7854 > Draw Strokes, then draw the strokes.

In the Define Stroke dialog, you can see how the strokes are analyzed by examining the grid under Stroke to Define. When you complete the drawing of a stroke, a nine-square grid is centered around the stroke and fit to its extents. The inner segments of the grid are assigned unique letters. Where the stroke crosses a segment, the letter associated with that segment is added to the stroke name. Thus, the direction and the shape of the stroke matter, but the size of the stroke has no effect.

The stroke is always centered within the grid. If you draw a stroke vertically from top to bottom, the stroke is named HK because it crossed the segments labeled H and K, in that order. Had you drawn the stroke from bottom to top, it would have been named KH.

TIP You can define more than one stroke for the same command. For example, you might assign a U-shape stroke to Undo, but find that you sometimes draw a J shape when attempting the U. By assigning both the U and the J strokes to Undo, you don't have to worry about missing that stroke.

The Command Should Operate On group of options is important. If the command applies to selections, leave this option set to Single Object at Start of Stroke, or change it to All Objects in the Selection Set. However, if the command doesn't apply to selections, such as Orbit or Activate Grid Object, change it to No Objects Just Execute the Command.

See also:

- [Reviewing and Editing Strokes](#) on page 7849
- [Stroke Preferences Dialog](#) on page 7851
- [Viewport Preferences](#) on page 7753
- [Strokes Utility](#) on page 7854

Procedures

To define a stroke using the Ctrl key:

- 1 Hold down the Ctrl key while drawing a stroke.
- 2 If the stroke already exists, a message asks you if you want to replace the old stroke. Click Yes.
- 3 on the Define Stroke dialog that appears, assign the stroke.

To define a stroke by example:

- 1 Draw a stroke that doesn't exist.
- 2 A Stroke Not Found message appears. Click Define.
- 3 In the Define Stroke dialog that appears, assign the stroke.

Interface

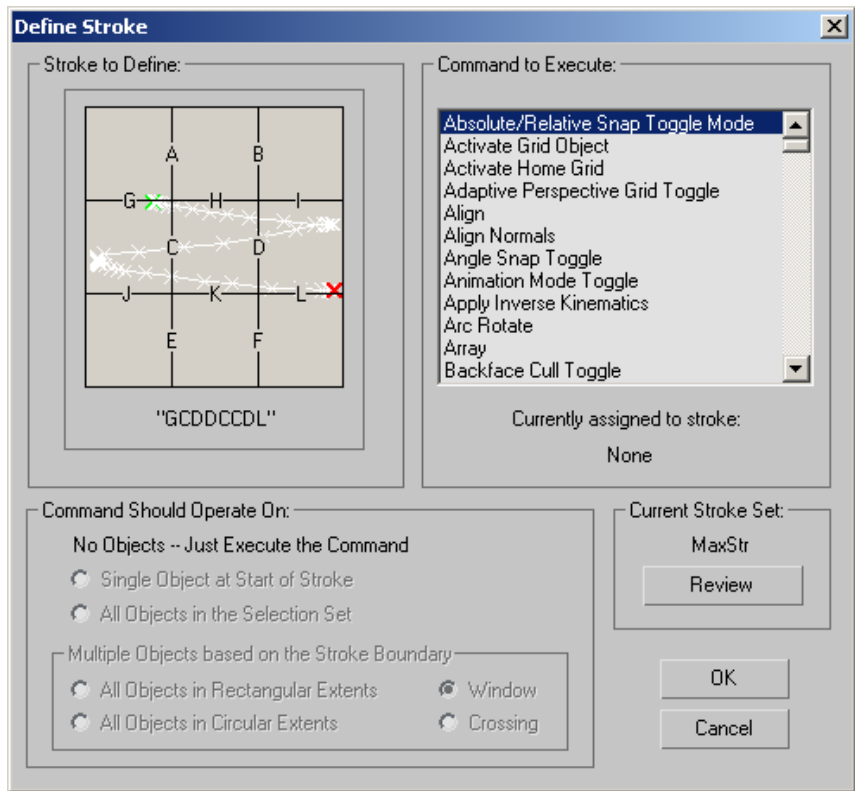

Stroke to Define group

Displays the name of the stroke and displays the stroke you just drew as a series of white Xs connected by white lines. A green X represents the start of the stroke and a red X represents the end. The labeled grid shows you how it recognizes the stroke. Where the stroke crosses the labeled segments in the grid, a letter is added to the name of the stroke.

Command to Execute group

Lists all commands to which you can assign a stroke. Select a command and click OK to assign the stroke displayed in the grid to the selected command. Depending on the type of command you choose in this list, various options become available in the Command Should Operate On group.

Currently assigned to stroke Displays the name of the stroke currently assigned to the selected command. If you pressed Shift or Alt when the stroke was drawn, they're added to the name. For example: "Shift + HK" or "Alt + HK."

Command Should Operate On group

Provides a number of options that specify which objects (if any) are affected by the command. These options are enabled or disabled depending on the type of command you've selected in the list window.

No Objects Just Execute the Command This text is displayed when you choose a command that's not specific to selected objects, such as Orbit. When you select a command that can be applied to selected objects, the following options become enabled:

Single Object at Start of Stroke Causes the command to act on the object beneath the first stroke point in the active viewport.

All Objects in the Selection Set Causes the command to act on all objects in the current selection set.

Multiple Objects Based On The Stroke Boundary group

Choosing one of the options in this group lets you use the stroke itself to select multiple objects and then apply the command.

All Objects in Rectangle Extents Selects all objects defined by the rectangular bounding of the stroke.

All Objects in Circular Extents Selects all objects defined by the largest circle that fits within the rectangular bounding of the stroke.

Window/Crossing When you choose either of the previous two options, these two options become available. Window selects only those objects entirely within the rectangular or circular region. Crossing selects all objects within or crossing the region.

Current Stroke Set group Displays the name of the current stroke set, so you can review the strokes defined in that set. You can create and save a number of different stroke sets. See [Stroke Preferences](#) on page 7851.

Review Click to display the [Review Strokes dialog](#) on page 7849, in which you can choose from a list of defined strokes and then see the stroke itself. You cannot edit strokes this way. To view, change, and delete strokes, draw the Review Strokes stroke (by default, a horizontal line from left to right).

Reviewing and Editing Strokes

Define Strokes dialog > Click Review.

Draw the Review Strokes stroke. By default, this is a horizontal line from left to right.

You can view defined strokes in the Review Strokes dialog. Depending on how you display this dialog, you can also change or delete defined strokes:

- Click the Review button in the [Define Strokes dialog](#) on page 7845 to view strokes, but not change or delete them.
- Draw the Review Strokes stroke (by default, a horizontal line from left to right) to view, change, and delete strokes. You can redefine the Review Strokes stroke in the Review Strokes dialog.

Procedures

To change the command assigned to a stroke (or vice versa):

- 1 Select a command (or stroke) from the list.
- 2 Click Change. The Define Strokes dialog appears.
- 3 Select the new stroke to assign.
- 4 Click OK in the Define Strokes dialog to assign the selected stroke to the command currently highlighted in the Review Strokes dialog.

Interface

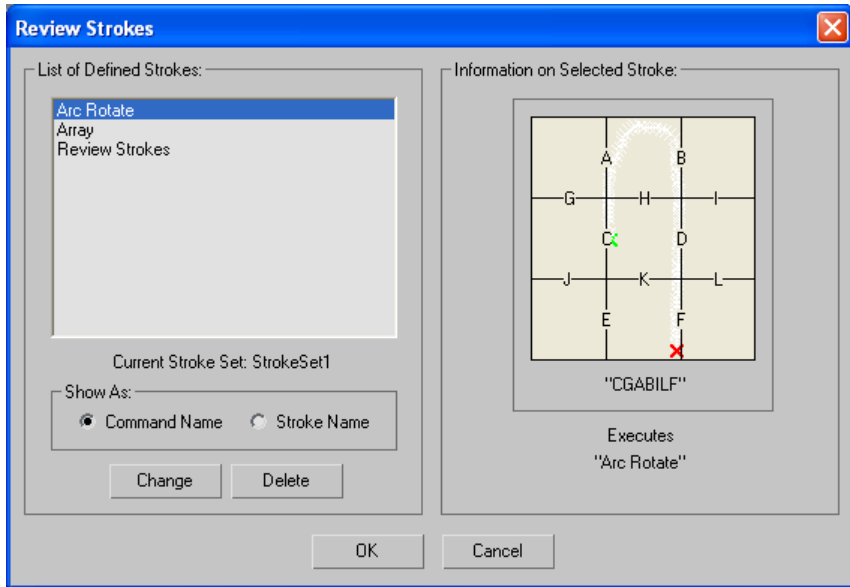

Defined Strokes

Displays a list of commands that currently have strokes assigned to them and the name of the current stroke set.

Make Camera Active Point at a single camera (not the target), draw the stroke, and that camera becomes active in the viewport in which you draw the stroke.

Change Light Color You can stroke this command over one or more lights. The color selector appears, so you can change the color of the selected lights.

Light On/Off Toggle Stroke over a light to toggle it on and off. If you stroke over two or more lights, all the lights are set to a common state, either all on or all off.

Set Constraints Displays a small dialog with the available axis constraints. Double-click to change the axis constraints for the current transform mode.

Move Mode (Set Constraints) Switches to Move transform mode and displays a small dialog with the available axis constraints. Double-click to change the axis constraints for the current transform mode.

Rotate Mode (Set Constraints) Switches to Select and Rotate mode and displays a small dialog with the available axis constraints. Double-click to change the axis constraints for the current transform mode.

Scale Mode (Set Constraints) Switches to Select and Scale mode and displays a small dialog with the available axis constraints. Double-click to change the axis constraints for the current transform mode.

Review Strokes Displays the Review Strokes dialog.

Stroke Preferences Displays the [Stroke Preferences dialog](#) on page 7851.

Show As

Provides two options that specify how commands are displayed in the list.

Command Name Displays the assigned strokes by command name (for example, Play Animation).

Stroke Name Displays the assigned strokes by their stroke name (for example, HK).

Change Assigns a different stroke to the command, or vice versa, depending on whether commands or strokes are displayed in the list.

NOTE This command is only available when the dialog is accessed by drawing the Review Strokes stroke.

Delete Removes the selected command (or stroke) from the list, and the command is no longer assigned to the stroke.

NOTE This command is only available when the dialog is accessed by drawing the Review Strokes stroke.

Information on Selected Stroke

Displays the name and shape of the stroke selected in the list window.

Stroke Preferences Dialog

Draw the Stroke Preferences stroke. By default, this is an inverse L, drawn vertically from bottom to top, and then horizontally from left to right.

Set up a stroke to access the Stroke Preferences dialog > Use the stroke

With the Stroke Preferences dialog you can save sets of strokes and set other stroke properties.

NOTE This dialog is available only by drawing its stroke (by default, an inverse L, drawn vertically from bottom to top, and then horizontally from left to right). You can redefine the Stroke Preferences stroke in the [Review Strokes dialog](#) on page 7849.

NOTE By default, the Strokes Preferences dialog is available only if you assign a stroke to it, then use the stroke to access the dialog. See the following procedure.

Procedures

To access the Strokes Preferences dialog:

- 1 Set up strokes for your left or middle mouse button. See [Strokes](#) on page 7842 for information how to do this.
- 2 To define the stroke, hold down Ctrl and drag an inverted L shape (drag vertically from bottom to top, and continue from left to right).
The name of this stroke is JGAB.
- 3 On the Define Strokes dialog, choose Stroke Preferences from the list.
- 4 Click OK to close the dialog.
- 5 Drag an inverted L shape to access the Strokes Preferences dialog.

Interface

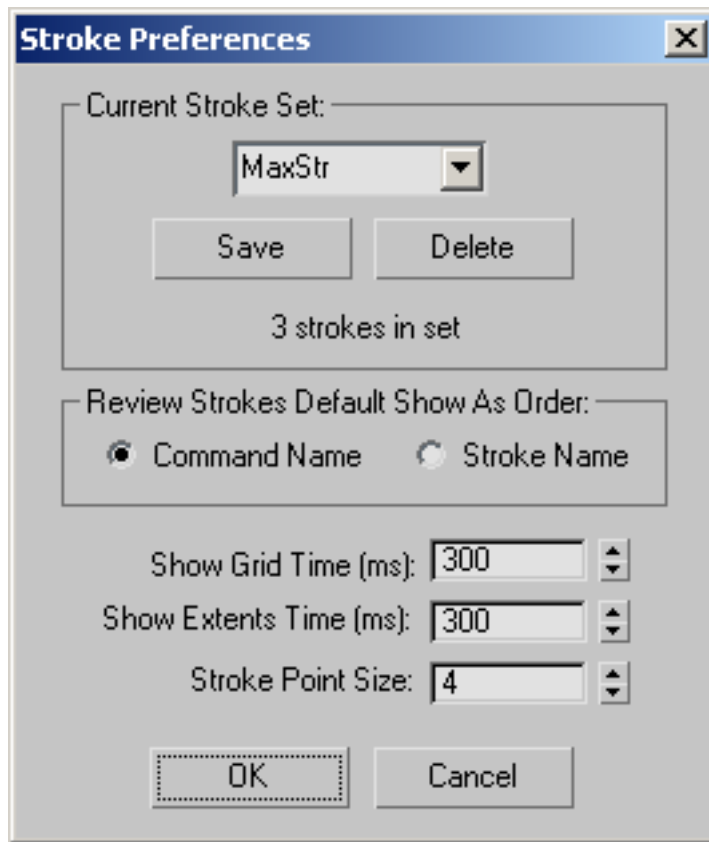

Current Stroke Set group

Displays the name and number of strokes in the current set.

- To create a new set, enter a new name in the field and click Save.
- To choose a different set, choose it from the list and click OK.

Save Saves the set displayed in the list.

Delete Deletes the set displayed in the list.

Review Strokes Default Show As Order group

Specifies whether commands or strokes are initially listed in the Review Strokes dialog.

Show Grid Time (ms)

The time it takes, in milliseconds, for the stroke analysis grid to appear in the viewports when you complete a stroke. Set it to 0 to hide the grid. Default=300 (about 1/3 of a second); Range=0 to 2000.

Show Extents Time (ms)

The time it takes, in milliseconds, for the extents of the stroke to appear in the viewports. Range=0 to 2000. Set it to 0 to disable this feature. Default=300 (about 1/3 of a second).

Strokes that operate on the First Point display a small X. Strokes that operate on items in the bounding box of the stroke display the bounding box. Strokes that operate on the circular extents display a circle that fits inside the square bounding box of the stroke. Window selections appear solid. Crossing selections appear dotted.

Stroke Point Size

The size, in pixels, of Xs drawn in the viewports that allow you to visualize the stroke shape. Default=4; Range=3 to 20.

Strokes Utility

Utilities panel > Utilities rollout > More button > Utilities dialog > Strokes

The Strokes utility lets you launch commands by dragging left-button mouse patterns in a viewport. When you launch the Strokes utility, a modeless dialog appears containing a single Draw Strokes button. When the Draw Strokes button is active, you can define and use strokes with the left mouse button.

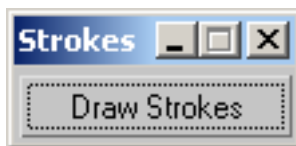

The Strokes system is also available as an option for the middle mouse button that doesn't require the utility or the modeless dialog. This option can be found on the [Viewports tab](#) on page 7753 of the Preferences dialog. For details, see [Strokes](#) on page 7842.

Procedures

Example: To define a stroke pattern for Orbit:

- 1 On the Utilities panel, click the More button, and choose Strokes from the list.
- 2 On the modeless dialog, click Draw Strokes.
- 3 Hold down the left mouse button and drag the mouse straight down from top to bottom, then release the mouse button. The length of the stroke doesn't matter, but the direction does.
A dialog appears asking you to define the pattern or continue.
- 4 Click Define to display the Define Stroke dialog.
- 5 Choose Orbit from the Command To Execute list and then click OK.
The pattern is now defined for Orbit.

Example: To turn on Orbit using the Strokes utility:

- 1 Turn on Draw Strokes in the modeless dialog.
- 2 In any viewport, hold down the left mouse button and drag the mouse straight down from top to bottom. The length of the stroke doesn't matter, but the direction does.
As you drag the mouse, small X's appear, displaying your stroke. When you release the mouse, a 3x3 grid appears briefly, and then the program switches to Orbit mode.
If a Stroke Not Found message appears, click Continue, and then repeat step 2.

Keyboard Shortcuts

27

Keyboard shortcuts are keyboard alternatives you can use to initiate actions (commands or tools) normally accessed with the mouse. For example, to open the Select From Scene dialog, you can press the H key, or you can change the active viewport to a view from the bottom by pressing B. Keyboard shortcuts let you work faster and more efficiently.

Many keyboard shortcuts are already set for most commonly used actions. Throughout this reference, command descriptions include the default shortcut, if there is one: look for the path annotation (with a gray background) at the top of the page.

To modify or add new shortcuts, use the [Keyboard panel](#) on page 7698 of the [Customize User Interface dialog](#) on page 7697. Keyboard shortcuts are separated by *Groups* or *Categories* of groups and they organize *Actions*.

Groups organize the Actions for which you can set shortcuts. Default=Main UI.

Categories offer a further breakdown of the Actions in a Group to specific categories. This lets you quickly find an Action so you can assign or adjust a shortcut.

Actions are commands or tools.

In most cases you can close a dialog with the same command used to open it. In general this applies to any combination of input methods, including menu, toolbar button, and keyboard shortcuts. For more information, see [Toggling Dialogs](#) on page 7467.

Viewing the Assigned Shortcuts

To see the currently assigned keyboard shortcuts, you can create a text (TXT) file of all the actions and their shortcuts. Go to the [Keyboard panel](#) on page 7698 of the [Customize User Interface dialog](#) on page 7697, and then click Write Keyboard Chart. All actions that can have a shortcut assigned to them are listed. For actions with no default shortcut assigned, the Shortcut column entry is blank.

If you click Reset on the Keyboard panel before you click Write Keyboard Chart, the text files shows the default keyboard shortcut assignments. However, this loses any custom shortcuts you might have created before.

See also:

- [Biped Shortcuts](#) on page 4471
- [Crowd Shortcuts](#) on page 4811
- [Physique Shortcuts](#) on page 4679
- [Track View Shortcuts](#) on page 3524
- [Unwrap UVW Shortcuts](#) on page 1878

Keyboard Shortcut Override Toggle



Main toolbar > Keyboard Shortcut Override Toggle

The Keyboard Shortcut Override Toggle lets you toggle between using only the "Main User Interface" shortcut keys and using both the main shortcuts and shortcut keys for groups such as Edit/Editable Mesh, Track View, NURBS, and so on.

When the Override toggle is off, only the Main User Interface shortcuts are recognized. When Override is on, both Main UI and functional area shortcuts are recognized; however, if there is a conflict between a shortcut assigned to a feature and one assigned to the Main UI, when Override is on, the feature's shortcut takes precedence.

You can customize keyboard shortcuts on the [Keyboard panel](#) on page 7698 of the [Customize User Interface dialog](#) on page 7697. The lists in the keyboard panel show which shortcuts have been assigned to which command or feature.

See also:

- [Keyboard Shortcuts](#) on page 7857

This section describes a collection of problematic situations and what you can do to diagnose and fix them. These include many common problems that are reported to Autodesk Product Support, and the things you can try in order to resolve the problems yourself.

When starting to diagnose a problem, by yourself or with the intent of contacting Product Support, you should take stock of the situation by answering the following questions.

- What's changed since the last time I ran 3ds Max?
- Has the 3ds Max display configuration been changed?
- Was an updated video driver or new operating system service pack installed recently?
- Has 3ds Max been running successfully without lockups or crashes?

Handling File Corruptions

Few things are more aggravating when attempting to open a scene than encountering an Assertion Failed error, File Open Failed error, or perhaps no error at all. The file just does not load. This typically occurs when the file is corrupt. A number of factors can cause file corruption, including the following:

- Some component built in another program has been imported or referenced with an XRef.
- The scene failed to save properly due to a power failure or system crash.
- A poorly coded plug-in corrupted an object in the scene.

Problems and Resolutions

Assertion Failed Errors

The assertion failed error occurs commonly when you try to load a corrupt file. The error gives you a line number and file name where the corruption occurred. You are then left with the options to retry or cancel.

Unfortunately, the line number and file often don't help because that isn't necessarily where the error is actually occurring. Most people click the Retry option a couple of times then give up, fearing they've lost many hours of work. Don't panic yet. There are a number of things you can try before you have to start rebuilding.

The first thing to try is keep clicking the Retry button. If there is a corruption to the vertices of an object, you might have to parse through each vertex until you bypass the object completely. For example, Autodesk Product Support once received a file that returned an Assertion Failed error referencing a *tab.h* file. The scene recently had an AutoCAD component imported that 3ds Max couldn't understand. However, after the support technician clicked the Retry button 88 times, the scene finally opened. After resaving the scene, it opened without incident.

Merging Corrupt Files

If normal attempts to open a scene fail, another thing you can try is merging the scene. If the file is not too corrupted, you would be able to access the Merge dialog which shows a list of the components in the scene. This is a good sign because, with a little effort, you can fix the file yourself. You now need to narrow down which object, or objects, are causing the load failure.

- 1 Start 3ds Max.
- 2 Choose File menu > Merge.
- 3 Browse to the folder containing the model, select the model and click the Open button.

The Merge dialog is displayed, showing all the components in the scene.

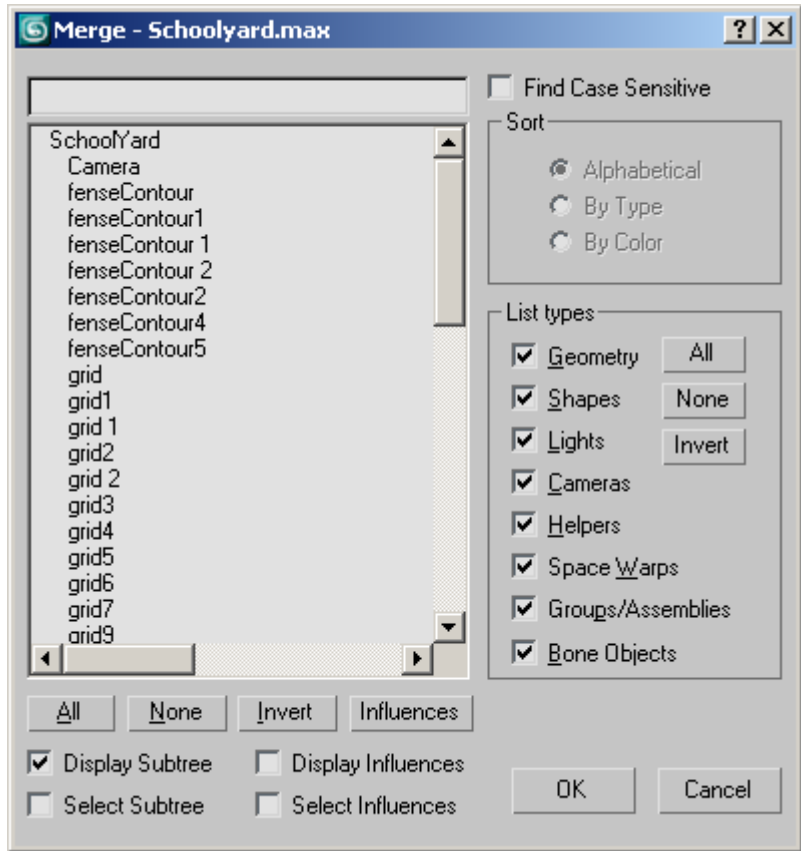

You'll start by seeing if any of the objects or shapes in the scene are corrupt.

- 4 In the List Types group, on the right, turn off everything except Geometry, Shapes, and Groups/Assemblies.
- 5 Click the All button at the lower left, and then click OK.
If the objects appear in the viewports, you know the scene components are fine and you'll have to repeat these steps with other List Types turned on.

If the objects merge successfully, and you have to try merging in other objects, be sure to first save what you've just merged as a basis for rebuilding the scene.

If you receive an error message, you know one of the objects is the offending item. Then, do as follows.

- 1 Reset 3ds Max.
You now have to narrow down exactly which object in the previous list is corrupt.
- 2 Once again, choose File > Merge and turn off everything except Geometry, Shapes, and Groups/Assemblies.
- 3 Select the first 10 objects in the list of components and click OK.
If those objects merge successfully, save the scene and repeat the Merge operation with the next set of 10 objects. Eventually, one of the sets of objects you try to merge will report the error message.
- 4 Keep refining the number of objects you are merging until you have singled out the object that reports the error.
- 5 Once you've found the corrupt object, reset 3ds Max and merge all the objects and components except for the object you've singled out.
- 6 After everything is merged, save the scene and rebuild the object that was corrupt.

Granted, this can be a long process, but it's well worth it if you can salvage most of your previous work.

Remember Backup Files

By default, the 3ds Max [automatic backup](#) on page 7752 feature is active, and writes a backup file every five minutes while you're editing the scene for a total of three files. The files are stored in the `\autoback` folder. By default, this folder is stored in `\My Documents\3dsmax\`. Using backup files is especially helpful if your file became corrupt due to a system crash or power outage.

- 1 Start 3ds Max and verify that you cannot load the scene.
- 2 Open Windows Explorer and browse to the `\autoback` folder.
- 3 Start by highlighting `AutoBackup01.max` and then copy the file (Edit > Copy or Ctrl+C).
- 4 Browse to the `\scenes` folder, found in `\My Documents\3dsmax\` or in the program install folder, and paste the file.
If you want, you can rename it.

- 5 In 3ds Max, choose File > Open and try loading the file you just copied from the `\autoback` folder.
If it opens, save the scene and rebuild what you lost in the last five minutes.

If you'd like to adjust the Auto Backup settings, you'll find them on the [Files panel](#) on page 7750 of the Preference Settings dialog, available via the Preferences command on the Customize menu.

Fixing Boolean Problems

Boolean operations are a powerful addition to your modeling toolbox; however, they can sometimes give strange or unexpected results. The Boolean button is found on the Create panel in the Compound Objects list; it allows you to join, subtract, intersect, and cut objects. Following is a list of problem scenarios and steps you can follow to fix them.

TIP The [ProBoolean compound object](#) on page 844 represents a significant improvement over the legacy Boolean compound object in a number of ways. In most cases, it's highly recommended that you use ProBoolean rather than Boolean.

TIP Before performing a Boolean operation, you should save your scene or use Edit > Hold. That way, you can quickly recover should anything not appear as expected.

Problems and Resolutions

Boolean Objects Disappear

If you mistakenly perform an Intersection Boolean operation on two objects that look like they intersect, but actually don't, you can end up in a situation where the object completely disappears. In the Operands group, you see both your objects listed but nothing on-screen.

- 1 Click the Undo button to retract the Operand B selection.
- 2 Right-click to exit the Boolean operation.
- 3 Verify that the objects intersect by checking them in two viewports, like the Top and Left.
- 4 Click Boolean to turn on the operation, and click Pick Operand B.

- 5 Click the intersecting object.

Creases or Ridges Show in Boolean Objects

Creases or ridges might be caused by a Boolean operation between an object that has very few faces and an object that has considerably more faces, for example, when you subtract a complex freeform object from a simple box.

3ds Max tessellates the surface of the box so there are additional faces for the subtraction. Unfortunately, the faces are usually generated as long, slivered faces that sometimes overlap and form creases or ridges in the resulting scene, when rendered.

Before attempting the Boolean operation, try these steps.

- 1 Select the object that has the lower face count.
In this example, it would be the box.
- 2 Change the Length, Width or Height Segments of the surfaces where the subtraction will occur.
- 3 From the Compound Objects buttons, click Boolean.
- 4 Perform the subtraction as you originally wanted.

By subdividing the surface with more faces, the Boolean operation has more faces and edges to work with. This results in fewer long, sliver-like faces that can produce creases or ridges.

Consecutive Booleans Results in Disappearing Components

Booleans are programmed to work with two operands, Operand A and Operand B. If you plan to join or subtract many objects from the object that you've selected as Operand A, you must click the Boolean button after each Operand B selection. If you don't, and simply click the Pick Operand B button and pick the next object, the previous operation is negated and the previous Operand B disappears.

The most efficient means to use when joining or subtracting a large number of objects to or from a single object is to attach all the objects before attempting the Boolean operation.

As an example, let's say you're building a metal plate that has a circle of bolt holes. So far, you have a flat box, Operand A, and ten cylinders, Operand B, passing through it.

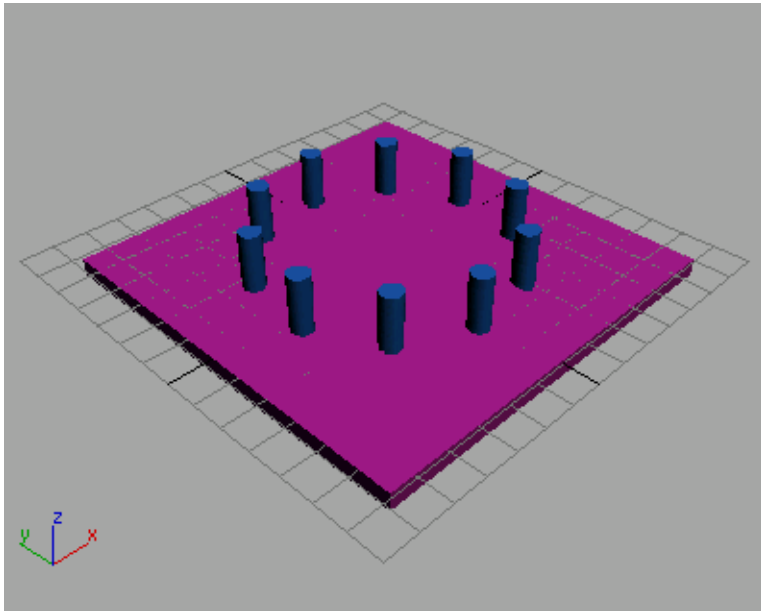

The future metal plate with circle of bolts

- 1 Select one of the cylinders.

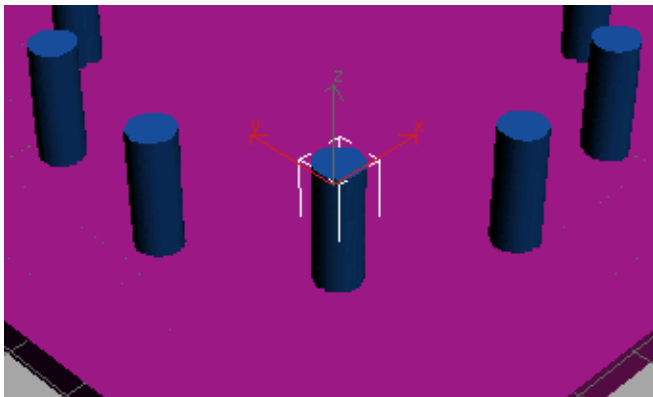

- 2 Right-click and convert it to an Editable Poly.
This automatically opens the Modify panel.
- 3  From the Edit Geometry rollout, click Attach List.

This is the little button next to Attach.

- 4 From the Attach List dialog, select all the other Cylinders and click the Attach button.

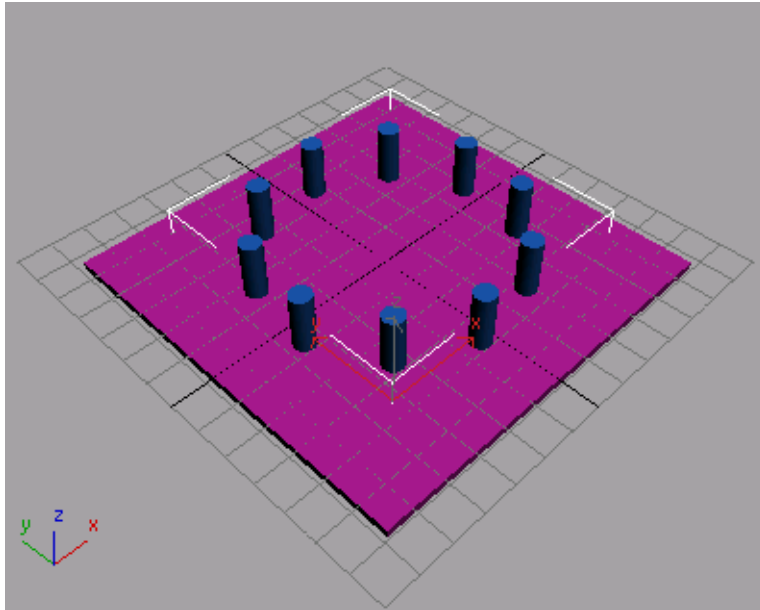

All the cylinders are a single object.

- 5 Select the Box and make sure it has Length, Width, or Height Segs values that are greater than 1.
See [Creases or ridges show in Boolean objects](#) on page 7864.
- 6 Open the Create panel and from the drop-down menu that shows Standard Primitives, choose Compound Objects.
- 7 Click the Boolean button and in the Parameters rollout > Operations group, make sure Subtraction (A-B) is turned on.
- 8 On the Pick Boolean rollout, click Pick Operand B, and select the Cylinders.

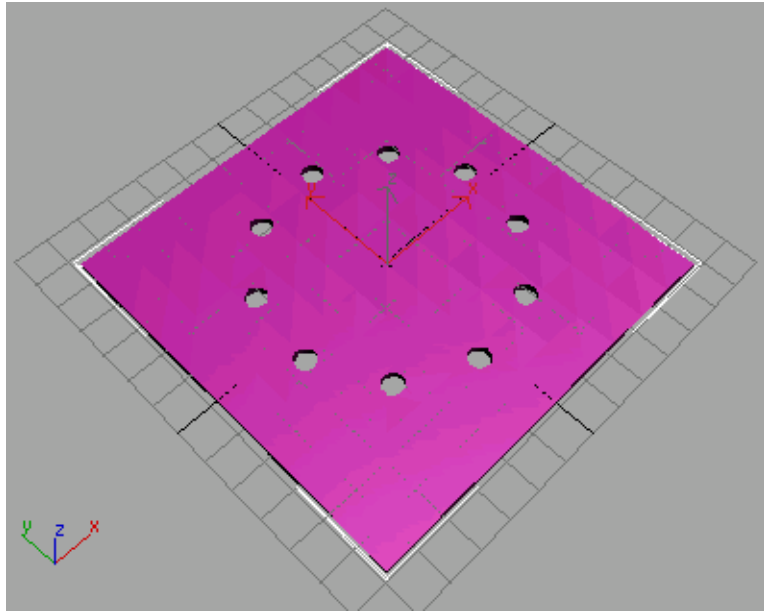

The cylinders are subtracted to form holes in the box.

You only have to perform Boolean operations once instead of several times. This method is far more efficient and less prone to errors. It is also very useful for cutting rough openings for doors and windows into a wall if you're already working with 3D geometry. Next, you'll find an example for working with 2D spline objects.

Splines and Boolean Operations

Performing Boolean operations on splines made from the Create panel > Shapes menu can be confusing. 2D spline shapes do not use the Boolean operation you'd use for 3D geometry. Shapes, converted to Editable Splines, offer Boolean functionality from the Modify panel > Geometry rollout. Unlike Boolean operations performed on two separate pieces of 3D geometry, Boolean operations can only be performed on single splines.

Therefore, one of two things must be done before you can perform Boolean operations to spline shapes.

- When originally creating the shapes, make sure Start New Shape is turned off on the Create panel > Shapes > Object Type rollout. When turned off,

you can create several overlapping shapes that are treated as a single shape made up of several splines.



Start New Shape in the OFF state (it is on, by default.)

- If you didn't turn off Start New Shape, you'll have to attach all the spline shapes to create a single shape comprised of multiple splines.

To illustrate the most common situation, let's say you've got three overlapping rectangles and you want to subtract the two outer rectangles from the central rectangle. You also forgot to turn off Start New Shape.

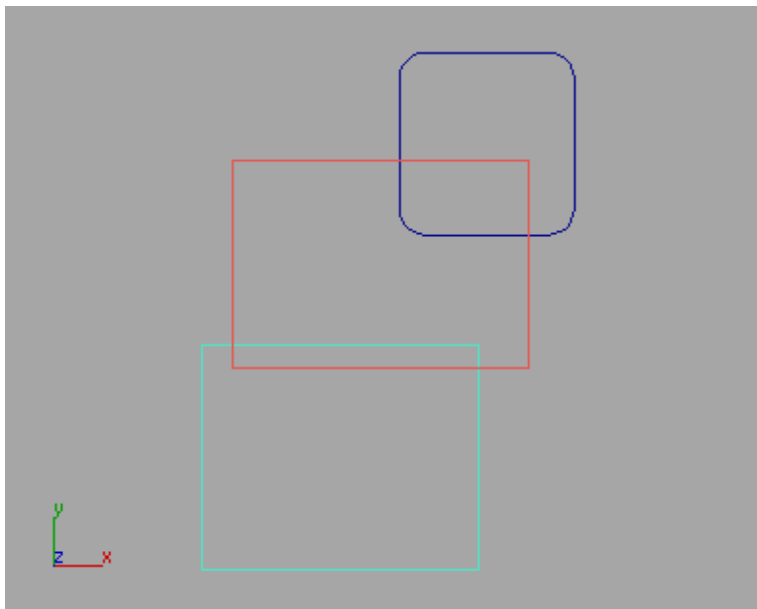

- 1 Start by selecting the central rectangle.

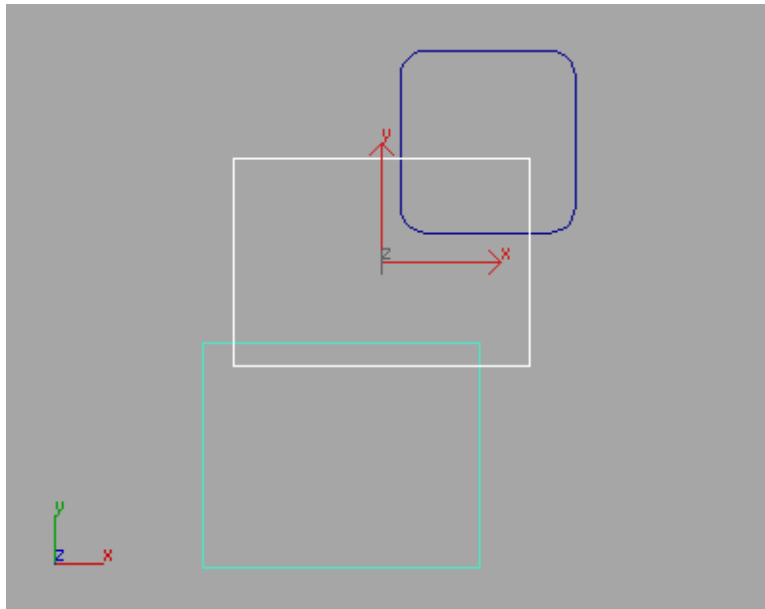

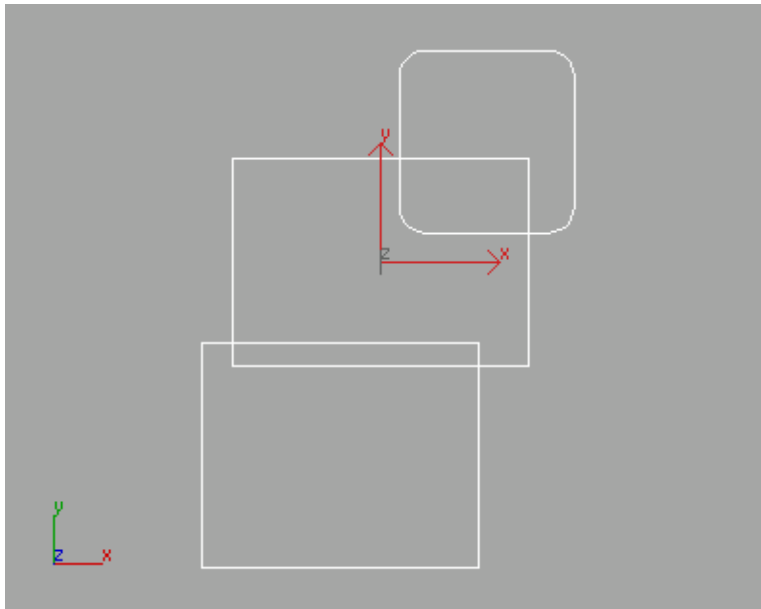

- 2 Right-click and choose Convert To > Convert to Editable Spline from the quad menu.
The Modify panel automatically opens.
- 3 In the Geometry rollout, click the Attach button and pick the two outer rectangles.
Now, you've got a single shape made up of three sub-object splines.

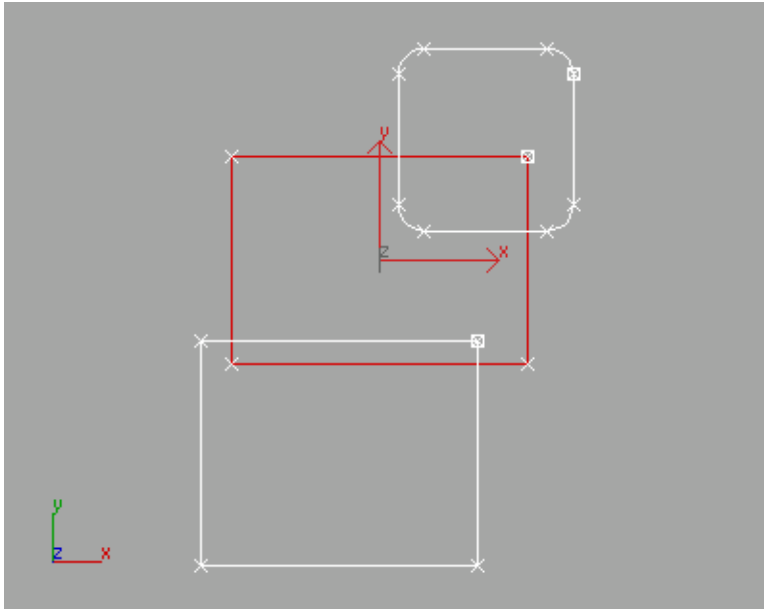

4 Turn off Attach and scroll up to the Selection rollout.

5  Turn on the sub-object Spline mode, and select the central rectangle.



- 6  Scroll down the Geometry rollout and click the Boolean button. Also click the Subtraction button to the right.
- 7 Pick the two outer rectangles.

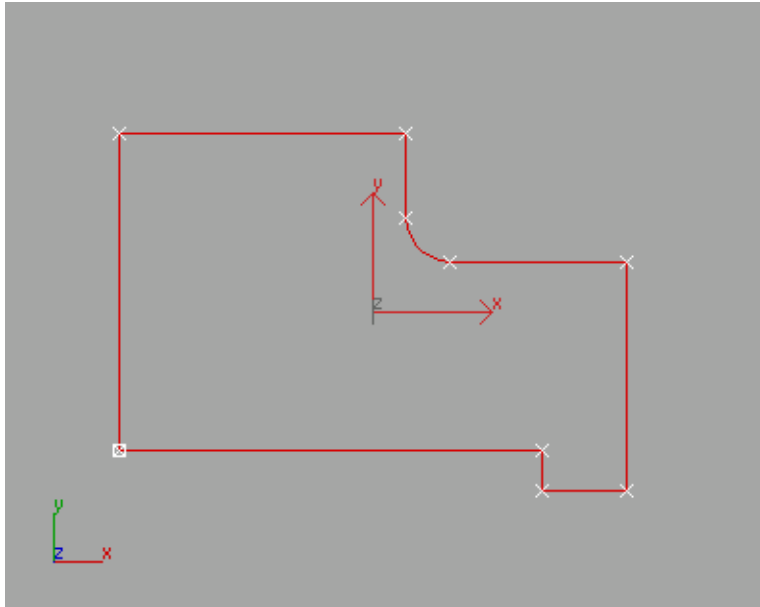

The final shape after subtracting the two outer rectangles

Tips for Successful Boolean Operations

Here, you'll find some general tips that will ensure that you're Boolean operations work the first time.

- Add a modifier and collapse the stack.
If a set of operands never seems to produce desired results, try adding a modifier and collapsing the stack to create an Editable Mesh or Editable Poly. You can also collapse objects to editable meshes and polys without first applying modifiers. If you do this, use Edit > Hold or File > Save As on the scene; you will not be able to adjust the parameters of the existing modifiers in the stack.
- Create objects with more faces.
In general, create objects that have more faces than you might normally use. For instance, increase the Height, Width, and Length segments of a Box, especially if the other object is more complex. Try to make the face count of both operands similar in number. With a larger number of faces, the edges created by the Boolean operation tend to be smoother and more

refined. Once the Boolean operation gives you the results you want, apply the Optimize modifier to reduce the number of faces on the object.

- Apply the STL-Check modifier.
One way to check the validity of objects that you intend to use as operands is by applying the STL-Check modifier. This modifier is primarily used to verify that an object is a complete and closed surface in preparation for exporting to STL files. Because Boolean operations work best with objects that meet the same criteria, use STL-Check on your operands. After applying the STL-Check to an object, turn on Check. The Status group tells you if errors are present.

Performance Issues While Running 3ds Max

Slow or sluggish performance while running 3ds Max can usually be attributed to either a video configuration conflict or a memory allocation problem. The hard thing about performance problems is narrowing down the culprit. Here are some common situations that can hamper operation of 3ds Max and steps to take to rectify them.

Problems and Resolutions

3ds Max Doesn't Start Quickly

Autodesk Product Support often encounters an increase of this situation around the time a new version or upgrade of the software is released. The question usually posed by the customer is, "Why does the new version take longer to start than the last version?" There are several reasons.

- The size of the executable that starts 3ds Max and the additional overhead needed to load the new features of a new release can cause a slowdown. Code in a new executable may use the system processors in a different way than the last version so a slowdown may be noticed. The important thing is how 3ds Max performs once it is running.
- Each version of 3ds Max is programmed and optimized to use newer video technology than what was previously available. If you haven't upgraded your video card in the last year, or at least updated video drivers, there is a very good chance 3ds Max will not start as quickly as in previous versions. You can also try a different 3ds Max video configuration.

- If you have not defragmented your system recently, 3ds Max could exhibit a slower start time. Defragmenting the system can also streamline the loading of large files that tend to swap to virtual memory.

Files Take a Long Time to Open

The size of a file often defines how quickly it loads into 3ds Max. However, if you notice an increase in load time from one design session to another, it could be an indication that 3ds Max is not finding enough memory to operate efficiently or that the file needs to be optimized.

The first thing to check is your system memory allocation. Per the 3ds Max system requirements, you should have a minimum of 256 MB of physical memory (RAM) and 300 MB of swap space. Recommended RAM is 1 GB with a 2 GB swap file. Here's how to check your memory and swap-file allocations.

To check RAM and swap-file allocation on Windows 2000:

- 1 Right-click the My Computer icon on your desktop and choose Properties from the menu.

This opens the System Properties dialog.

On the General panel, you should see information about your computer. The amount of RAM should be listed on this panel.

NOTE The RAM may be displayed in kilobytes (KB) instead of megabytes (MB).

- 2 Open the Advanced panel, and click the Performance Options button. The Performance Options dialog is displayed.
- 3 Check the "Total Paging File Size For All Drives" setting in the Virtual Memory group.

If you have 256 MB of RAM, you should set the Virtual Memory to approximately three times the RAM, or 768 MB.

To check RAM and swap-file allocation on Windows XP:

- 1 Right-click the My Computer icon on your desktop and choose Properties from the menu.

This opens the System Properties dialog.

On the General tab, you should see information about your computer. The amount of RAM should be listed on this panel.

- 2 Open the Advanced tab and click the Performance Settings button. The Performance Options dialog is displayed.
- 3 Click the Advanced tab, and check the “Total Paging File Size For All Drives” setting in the Virtual Memory group.

If the physical and virtual memory are set appropriately, then you'll have to check the model. If the model does eventually open, do the following:

- From the File menu, choose Save As and save the scene under a different name. Then try opening the new file to see if it loads faster.
- Review some of the objects you know have large modifier stacks. Performance can be improved if you collapse the stacks of objects that you've completed.
- If the model uses XRefs, make sure the XRefs are locally accessible. If they're located on a network server, the long load time could be due to high network traffic.

Slow Response to Open or Drag Dialogs

This situation is exhibited when you click a command that opens a dialog, like the Material Editor or graph window, like Track View. After you click, you notice an appreciable time lag until the dialog or window opens. If you then attempt to drag it to a new location, the dialog or window does not smoothly follow your cursor.

The usual cause for this is a video driver conflict or display configuration issue because opening or dragging a dialog causes your graphic card to refresh the screen. Try these steps to diagnose the problem.

- 1 Start 3ds Max.
- 2 From the Customize menu, choose Preferences.
- 3 Open the Viewports panel and check the Current Installed Driver. Most likely, it will be set to OpenGL or Direct3D.
- 4 If set to OpenGL or Direct3D, click the Choose Driver button and choose Software.
The Software setting is a generic driver that works for all video cards. It doesn't have any video enhancements but it's a good place to begin diagnostics.

NOTE If you're switching from Direct3D, you first have to use Revert From Direct3D before choosing the Software configuration.

- 5 Click OK to close the Graphic Driver Setup dialog.
You will be informed that you have to restart 3ds Max for the change to take affect.
- 6 Close the Preferences dialog and exit 3ds Max.
- 7 Restart 3ds Max.

Try opening or dragging dialogs around to see if performance has improved. If it has, do the following:

- If the software was originally configured for OpenGL, try configuring 3ds Max for Direct3D and see if performance is improved. Or vice-versa.
- Verify that your graphic card supports your preferred display configuration choice. Some cards do not fully support OpenGL or Direct3D.
- Visit the Web site of your graphic card manufacturer and see if they have any newer video drivers that you can download and install.

Sluggish Command Response

Sluggish command response is closely related to the previous situation. If you create an object such as a Box, you might notice that the cursor suddenly slows down when you drag it into a viewport. Clicking the corners to set the length, width and height is equally time-consuming. Once again, the likely cause is video-related.

- 1 Start 3ds Max.
- 2 From the Customize menu, choose Preferences.
- 3 Open the Viewports panel and check the Current Installed Driver.
- 4 Make sure you have 3ds Max configured for the software display driver.
- 5 Click OK to close the Graphic Driver Setup dialog.
You will be informed that you have to restart 3ds Max for the change to take effect.
- 6 Close the Preferences dialog and exit 3ds Max.
- 7 Restart 3ds Max.

Try using the command that was giving you trouble and see if it works correctly now.

Problems Caused by Unit Settings

The unit settings of a model can often get you into trouble. Understanding some of the common problems can help you avoid them.

This section addresses the two most common problems that modelers encounter.

Problems and Resolutions

Objects Disappear When the Camera Gets Close

This situation can happen when you model things on a very tiny scale and then have to get very close to them in a Camera or Perspective viewport. Architectural walkthrough animations are notorious for this kind of behavior. You've got a camera moving along a path and at some point it gets too close to a wall and you're suddenly able to see through to a room on the other side.

NOTE This problem is quite common for designers working with the metric system when you want to use real world metric units and you change the System Unit Scale to 1 unit=1 meter. You don't have to change the System Unit Scale to metric to work in Metric units; just change the units.

There are two solutions that often fix this problem.

Turn on the manual viewport clipping:

You can turn on the manual viewport clipping and adjust it to see the entire object. Viewport clipping has a Near and Far range setting, if a camera gets closer to an object than the Near Clip value, you will see through that object. Likewise, objects that are located beyond the Far Clip value, will be invisible to the camera.

- 1 Open the problematic scene and select the camera.
- 2 In the Parameters rollout > Clipping Planes group, turn on Clip Manually.
- 3 Adjust the Near or Far Clip value, or both.
When you can see the object again, your clipping plane is set properly.

Scale the entire scene:

If it doesn't matter what units you work in, scale the entire scene so objects are not affected by viewport clipping.

- 1 Open the problematic scene and select everything.



- 2 On the toolbar, click Select And Uniform Scale.

- 3 Enlarge the entire scene.

Not only do the objects in the scene get larger but the distance between objects increases. So, the larger you scale the scene, the further your camera is located from the surrounding objects.

If you need to work in real world units, such as inches or meters, you should set the scale of the scene before you begin modeling by changing the System Unit Scale value from the default of 1 unit=1 inch to something like 1 unit=0.1 inch or even 0.01 inch.

If you change the System Unit Scale after you have begun modeling, you will need to use the Rescale World Units utility to rescale the scene.

Zooming and Panning Are Too Fast or Slow

If zooming and panning are too fast or too slow, the most likely cause is the System Unit Scale. 3ds Max can exhibit round-off errors when dealing with extremely large or small distances. These round-off errors can also cause normals to be flipped or strange viewport clipping. 3ds Max does not have the numerical resolution to zoom infinitely from the some remote corner of the solar system down to an ant on your doorstep.

If you're going to change the System Unit Scale, you should change it before beginning any modeling. If you do have to set it later, it's best to rescale the entire scene with Rescale World Units. For example, if working on a tiny scale, like modeling coins, you might change the System Unit Scale from the default of 1 unit=1 inch to something like 1 unit=0.1 or 0.01 inch. For larger scaled scenes, like an airport, increase the System Unit Scale.

As a rule of thumb, keep the scale such that the smallest detail is not less than one generic unit. If this makes the scene too big to work with comfortably and efficiently, you can create separate scenes for models that include cameras for "close" and "far" shots.

User Interface Problems and Recovery

It can be frustrating when you can't find something on the user interface, especially when you saw it a few minutes ago and now it's gone missing. Of course, you've been so engrossed in your modeling that you forget what you might have done to cause the button, element or dialog to disappear.

This section addresses several common user-interface situations and how you can fix them.

Problems and Resolutions

Large Fonts and 3ds Max

While some users like to configure their systems to use large fonts, this setting is not recommended with 3ds Max. The 3ds Max user interface was designed to operate with your system set to small fonts. Small fonts are the default setting for both Windows 2000 and Windows XP.

If you have your system set to use large fonts, some of the most common anomalies you can expect while running 3ds Max are as follows:

- Buttons might be missing from the command panels.
- Some text-entry fields may not allow you to type in them.
- Garbled text appears in some dialogs.
- Text labels in dialogs and rollouts might be cut off or overlap other fields.
- Dialogs show cascading text fields and spinners.

To remedy these problems, set your system font back to small fonts.

- 1 Exit 3ds Max.
- 2 Go to Start > Settings > Control Panel, and click Display.
You can also right-click anywhere in the open desktop and choose Properties.
- 3 Open the Settings panel and click the Advanced button.

- 4 In the Display group of the General panel, click the arrow to open the Font Size list and choose:
 - Small Fonts, if running Windows 2000
 - Normal Size, if running Windows XP
- 5 Click OK to exit the Display Properties dialog.

You will most likely have to reboot the system for these changes to take effect.

Lost Dialogs and Windows

3ds Max has many dialogs or windows that float when you open them. This feature allows you to drag them anywhere on your desktop. You can greatly improve your design efficiency by positioning dialogs out of the way of the main 3ds Max interface, such as on a second monitor if you have dual-monitor functionality.

However, there are times when a dialog gets lost. Either you drag it someplace and inadvertently let go of it, or some data is written incorrectly to an initialization file and you end up with a lost dialog.

There are a couple of ways to recover a lost dialog; both entail working with the *3dsmax.ini* file found in the location indicated by the MaxData setting on the [Configure System Paths dialog](#) on page 7732.

Thorough Method

In this example, let's say you've got a single monitor that's configured for 1280x1024 resolution and you've lost your Rendering Progress dialog.

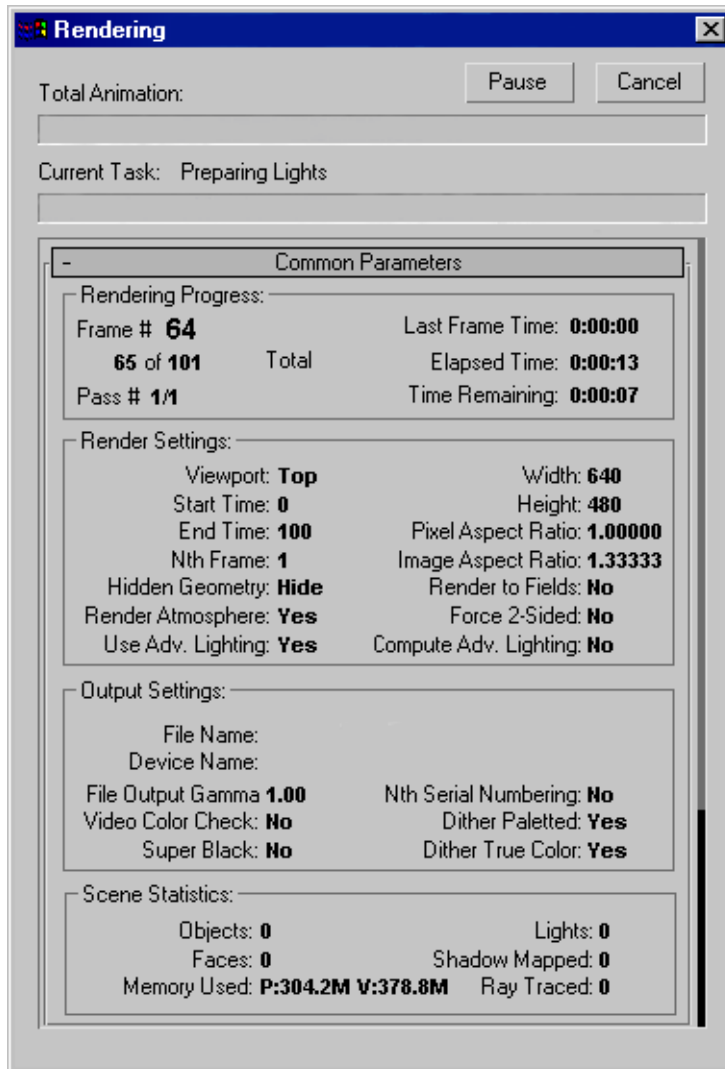

It was visible the last time you rendered, but that was awhile ago and someone else has been using the system.

- 1 Open Windows Explorer and browse to the location indicated by the MaxData setting on the [Configure System Paths dialog](#) on page 7732.
- 2 Make sure 3ds Max is not running.
The *3dsmax.ini* file is constantly being updated while 3ds Max is running.

- 3 Open a text editor and load *3dsmax.ini*.
- 4 Scroll down the list of entries until you find the data block:

```
[RenderProgressDialogPosition]  
Dimension=-425 152 379 866
```

A dialog's position is based off the location of the upper-left corner, anchored by the first pair of digits. Therefore, in this example, the upper-left corner of the dialog is -425 pixels from the left edge of the screen and 152 pixels from the top. The second pair of digits describe the horizontal and vertical size of the dialog, so this dialog is 379 pixels wide and 866 pixels tall.

Since this example assumes a single monitor, configured for 1280x1024 resolution, this dialog is off-screen to the left. If the first number were greater than 1280, the dialog would be off-screen to the right.

- 5 Place your cursor on the "Dimension" line and scroll over to the problem number.

The problem number is usually the first or second, since the last two set the width and height of the dialog.

- 6 Change the problem number to a value that is positive and within 1280x1024.
- 7 Save the *3dsmax.ini* file and start 3ds Max.

The next time you render, the Rendering Progress dialog appears on-screen.

This is the preferred method, because it causes no loss to other custom configuration settings that are stored in the *3dsmax.ini* file.

Quick Method

There are really only two reasons you'd use this method:

- 1 You've just installed 3ds Max and haven't made any customized settings that get stored in the *3dsmax.ini* file.
- 2 You're in a hurry and don't care about the customized settings that you have stored in the *3dsmax.ini* file.
- 3 Make sure 3ds Max is not running.
- 4 Open Windows Explorer and browse to the location indicated by the MaxData setting on the [Configure System Paths dialog](#) on page 7732.

5 Delete the *3dsmax.ini* file.

6 Restart 3ds Max.

A new *3dsmax.ini* file is automatically created using default settings.

You need to be careful when using this method, because you don't necessarily know what custom settings are saved in the *3dsmax.ini* file. Perhaps you have 3ds Max set to display the command panel on the left and you've changed the viewport background color. Furthermore, if you have third-party plug-ins installed, they sometimes write information to the *3dsmax.ini* file. If you delete the file, you will lose all those settings.

If you're not sure about customized settings that are stored in the *3dsmax.ini* file, you can rename the file to something like *old3ds.ini*. When you restart 3ds Max, you can continue working and, at a later time, compare the two files and copy the data you need from the old one to the new one.

Material Editor Defaults to Architectural Materials

When you open the Material Editor, you encounter Architectural Materials instead of original Autodesk VIZ Standard materials.

3ds Max allows you to set default user interfaces. If you build architectural models or require photorealistic rendering, you can set the user interface to default to features more relevant to the way you work. This is a new feature that is set from the Customize menu > [Custom UI and Defaults Switcher dialog](#) on page 7692

The program saves this setting to the *3dsmax.ini* file and you have to restart 3ds Max after using the defaults switcher.

Missing Command Panel

The command panel normally appears along the right side on the user interface. If you start 3ds Max and notice that the command panel is missing, there are usually three causes.

- The command panel is turned off.
- You floated the command panel to another monitor and attempted to drag it to a new location. When you released the mouse button, the command panel disappeared.
- A custom user interface is active that places the command panel off-screen.

All of these situations can be quickly fixed by using the following steps.

- 1 Start 3ds Max.
- 2 From the main menu, choose Customize > Revert To Startup Layout.
You're warned that all UI settings you've made during the current session of 3ds Max will be reset.
- 3 Click Yes.
The original user interface is restored.

Missing Transform Gizmos

Whenever you move, rotate or scale an object, the standard, red axis tripod is replaced by a special purpose transform gizmo. It's possible to lose the transform gizmo, but it's easy to get it back. If you find you've lost your transform gizmo, try these steps.

- 1 Start 3ds Max.
- 2 Press the X key.
This is the keyboard shortcut that toggles the transform gizmo on and off.
- 3 Press the = key.
This keyboard shortcut increases the size of the transform gizmo. The – key reduces the size.
- 4 Open the Customize > Preferences > Gizmos panel, and match your setting to the default settings shown in the following image.

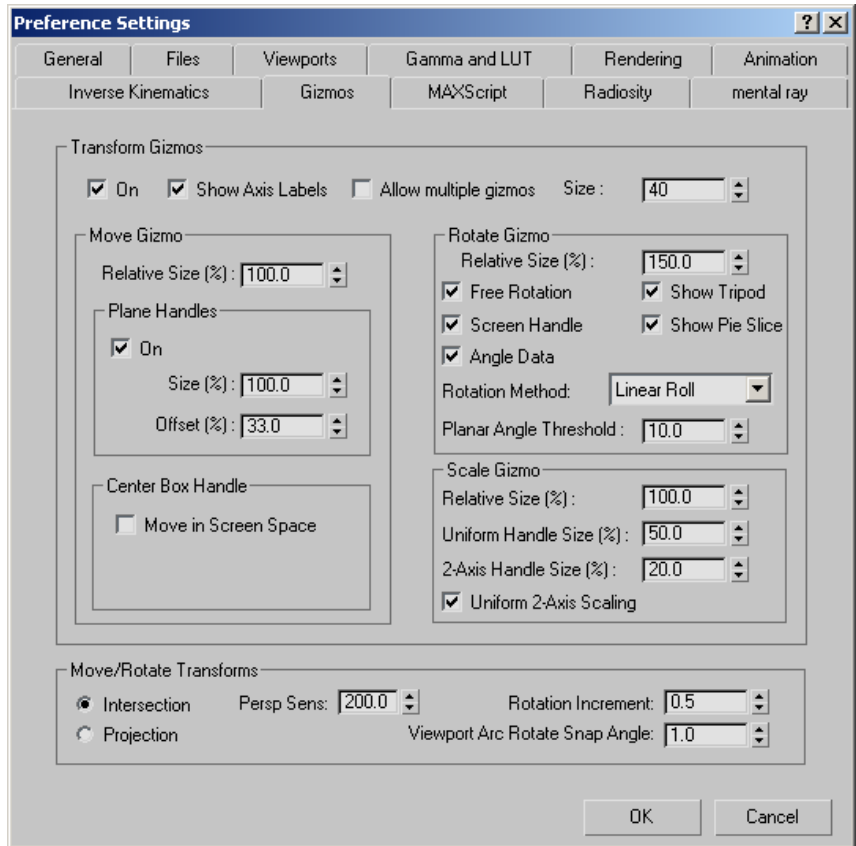

Multiple or Missing Buttons on the Toolbars

This is another tricky situation. You open a toolbar and find that there are duplicate buttons present or the button you expect to find is no longer there.

NOTE This is generally caused by holding the Ctrl key and dragging a button on the toolbar.



Three Select And Move buttons.

This is clearly a user-interface problem, so reverting to the startup layout will fix this problem.

- 1 Start 3ds Max.
- 2 From the Customize menu, choose Revert To Startup Layout, and confirm the change.

If you have multiple buttons and don't want to reset the entire UI, you can remove duplicate buttons manually by doing the following:

- Hold down the Alt key and drag the duplicate button out of the toolbar. Click Yes when asked to confirm the deletion of the button.

If buttons are missing, use Revert To Startup Layout.

Video Driver and Display Problems

Because 3ds Max heavily relies upon the graphics card in your system, many problems that you may encounter while using the program can be attributed to the video. Such problems could be slow performance, refresh delays, user interface discrepancies, and so forth.

Problems and Resolutions

Basic Troubleshooting Start Point

As a rule of thumb, before attempting to diagnose any problem with 3ds Max, you can be more efficient in your diagnostics by resetting the display configuration to its default value. After you first install and start 3ds Max, it runs by default in Direct3D mode, but if you use the Start menu > Change Graphics Mode command, you're presented with the Graphics Driver Setup dialog:

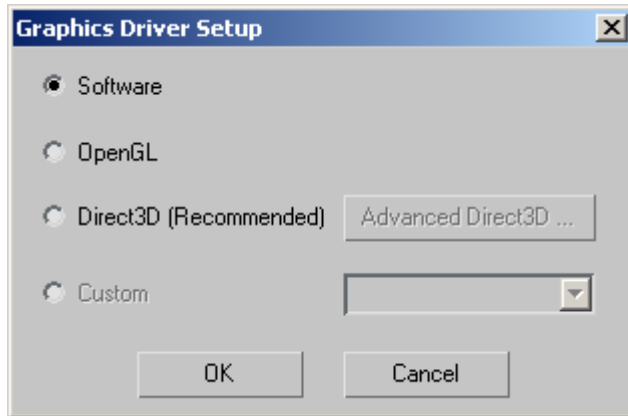

If you're configured for OpenGL, Direct3D, or Custom, choose the Software driver. By configuring for the Software driver, you can disqualify the video card or drivers if the problem you're encountering persists while running 3ds Max.

- Resetting the configuration from within 3ds Max.
 - Choose Customize menu > Preferences.
 - Open the Viewport panel and check your currently installed driver. If it's not the Software driver, proceed. Otherwise, you can cancel and begin the diagnostics elsewhere.
 - If set to OpenGL, Direct3D, or a custom driver, click the Choose Driver button. The Graphics Driver Setup dialog is displayed.
 - Choose Software and click OK. You'll see a message that the changes will take effect the next time you start 3ds Max.
 - Exit 3ds Max and restart the program.
 - Try performing the task that was giving you problems.

- Resetting the configuration before starting 3ds Max.
 - 1 From the Windows Start menu, navigate to the 3ds Max submenu and choose Change Graphics Mode.
3ds Max starts up and displays the Graphics Driver Setup dialog.
 - 2 Choose the Software driver and try performing the task that was giving you problems once the program opens.

If the problem does not persist, you know that you've encountered a display problem. If this is the case, check the following with regards to your video card:

- Verify that the video card supports the driver you attempted to use. Some cards don't fully support OpenGL or Direct3D.
- You might not have the latest video drivers for the card. Contact the board manufacturer for updated drivers.
- If you were originally configured for OpenGL, try Direct3D, or vice versa.
The driver for the graphics card may have better support for one driver than other.

Direct3D Failed to Initialize Message

You may need to update your video card drivers. Refer to your video card vendor's website or contact your vendor directly for further information about the DirectX support of your video card.

Receive DirectX Message Listing Missing dlls or Other Components

When configuring the display settings, you choose DirectX 9 or 10 (depending on your system) and start 3ds Max only to receive a message that lists missing dlls or other components.

Since certain components for DirectX are missing you should reinstall DirectX. Refer to the *Installation Guide* for complete information about downloading the correct version of DirectX.

Direct3D Reports a Memory Warning

You may encounter a memory warning when starting 3ds Max if you've configured the program to use the Direct3D driver.



This warning dialog usually appears if you have several programs, that heavily impact the video memory of your graphics card, running and you have the 3ds Max interface maximized or stretched to cover most of the display.

Your quickest options for bypassing this warning are as follows:

- Shut down some of the other programs that are concurrently running with 3ds Max.
- Reduce the size of the 3ds Max interface.
- Reconfigure 3ds Max to use a different display driver.

Dual-Monitor Configuration

Many board manufacturers are building graphic cards that support multi-monitor configurations. The cards might advertise hardware features like "Dual Head" or "Multi-Head" that have two monitor ports built into them. Other manufacturers choose to handle dual configuration through video drivers that let you configure your system display in "Wide" mode. Here are the details of what you need to watch out for when configuring a multi-monitor system.

- **Hardware "Dual Head" Solution**

Many newer video cards offer this hardware solution for setting up a dual-monitor system.

After installing the card and drivers, you want to follow the manufacturer's instructions for configuring your system. Configuration is done through your system's Display Properties dialog > Settings panel.

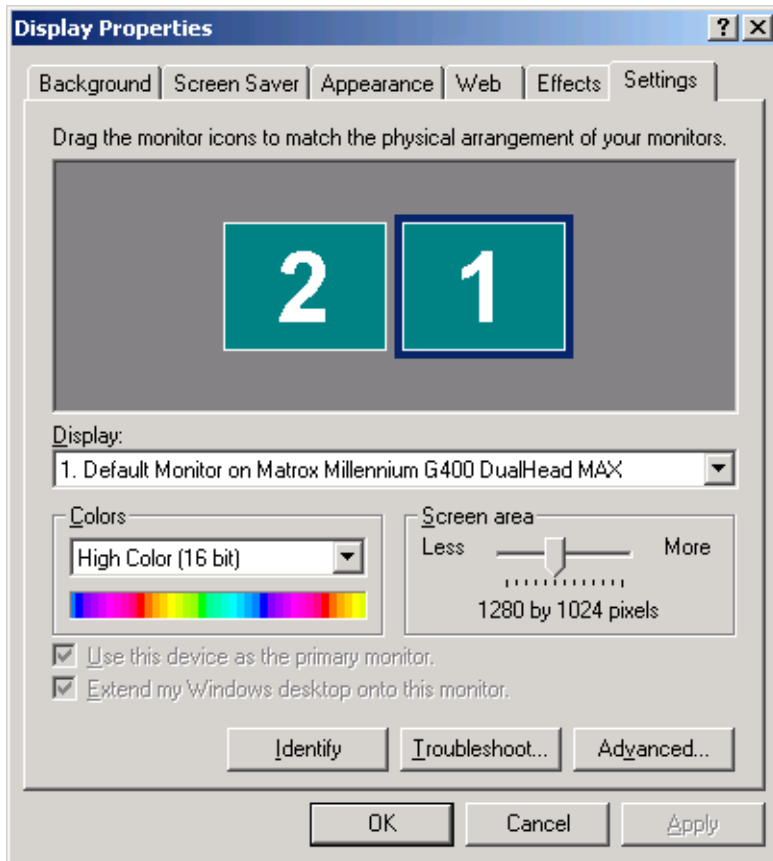

You are presented with a diagram for each monitor and you can set the resolutions independently by selecting a monitor and adjusting the screen Area slider. You will also often find utilities included with the drivers that enable special features for the graphics card.

The disadvantage to this configuration is that one monitor is a primary while the other secondary, so performing some tasks can only be done on applications positioned on the primary monitor. For instance, if you use screen-capture software, you can have that program open on the secondary monitor, but if you want to capture an image, you can only capture images of applications that are located on the primary monitor.

- **Software Driver Solution**

The software solution to multi-monitor configuration is often found in older graphic cards that fit into your PCI slots. Each board has a single port

to accept a monitor and the video drivers give you the option to configure a single display in “Wide” mode to encompass multiple displays. Also, because you have four PCI slots in your system, you could theoretically drive four monitors. However, in order for these cards to operate at the best resolutions, each card needs to have the same amount of video RAM (vRAM) installed. So, if you had two cards and one had 32 MB of vRAM and the other only had 8 MB, you can only configure to the highest resolution supported by the 8 MB card.

Display configuration is normally done through the video drivers so you have the option to configure wider screen areas. For example, instead of configuring each display individually to 1280x1024, as described above, you would treat both monitors as a single display and configure the screen area to 2560x1024 pixels.

Spanning Across Monitors

Whenever, you start 3ds Max, the user interface spans across both monitors. You find yourself constantly resizing the program to fit on one screen so you can see the programs located on the other screen.

This is usually a problem on systems that let you configure both monitors as one, in “Wide” mode. The utility software that loads with the graphic card manufacturer's drivers probably has a feature that forces programs to open across the entire expanse of the display. You can turn off this feature and programs will open in the last position and size you gave them.

Viewport Transparency

After starting 3ds Max, the user interface appears but you can see the system desktop through each of the viewports. This problem normally occurs if you have the display configuration set to either OpenGL or Direct3D and your graphics card does not completely support OpenGL or Direct3D.

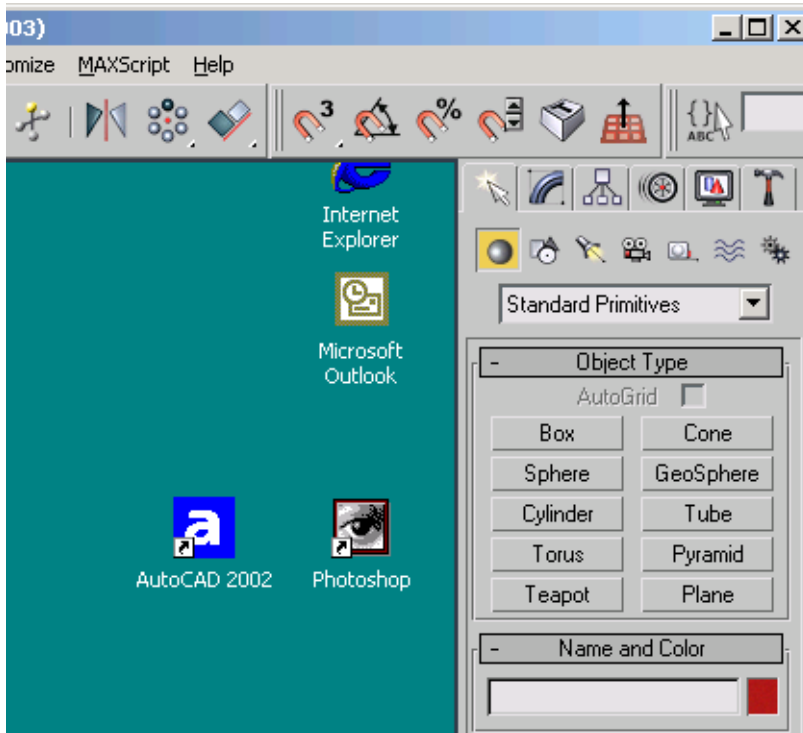

If configured for Direct3D, you might also see this problem coupled with the “Direct3D initialization failed” message.

To remedy this problem, follow the steps outlined in [Basic troubleshooting start point](#) on page 7886 and configure for Software. If 3ds Max opens correctly in this mode, check the video card manufacturers for updated drivers for the display mode you'd prefer to use.

Glossary

This section of the Help system contains explanations of concepts and terms used in the reference, arranged alphabetically.

2-Sided (Double Sided)

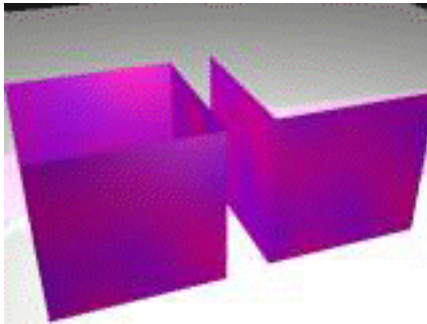

Rendering of a box with a double-sided material, and same box with a single-sided material

In 3ds Max, faces are one-sided. The front is the side with the surface [normal](#) on page 8059. The back side of the face is invisible to the Renderer; meaning the face appears to be missing when viewed from the back. Objects are usually created with the surface normals facing outward, but it is possible to create objects with the faces flipped or to import complex geometry in which the face normals are not properly unified.

There are two ways to render both sides of a face. Either turn on the Force Two Sided option in the Render dialog, or apply a two-sided material to the geometry.

Usually, you want two sided rendering turned off since it slows rendering time. However, if you want to render the inside as well as the outside of objects, or if you've imported complex geometry (for example, from AutoCAD) in which the face normals are not properly unified, you can use one of the

methods above to render each face regardless of its normal's orientation. You can also unify normals explicitly by using the [Normal modifier](#) on page 1581.

2D Map

A two-dimensional image or pattern. A 2D map requires mapping coordinates to render and appear in viewports. See [2D Maps](#) on page 5782.

3D DWF

From *Design Web Format*. A highly compressed file format that is created from a MAX file. DWF files are easy to publish and view on the Web using the Autodesk Design Review program, included with 3ds Max.

3D Map

A pattern generated procedurally in three dimensions. A 3D map does not require mapping coordinates in order to render. However, a 3D map will appear in viewports only if the object to which it is applied has mapping coordinates. See [3D Maps](#) on page 5860

3DS and PRJ Files

3DS is the 3D Studio R4 mesh-file format and PRJ is the 3D Studio R4 (for DOS) project-file format. You can import both these types of files into the software, as well as DXF and SHP files. You can export 3DS files and DXF files.

See also:

- [Importing 3DS Files](#) on page 7172
- [Importing PRJ Files](#) on page 7174
- [Exporting to 3DS](#) on page 7175

Importing PRJ and 3DS Files

When you import a 3DS file, you get the following:

- Backgrounds (solid, gradient, and bitmap).
- Fog, Layered Fog, and Distance Cue.
- Ambient light level.
- Subtractive transparency is converted to "Filter" transparency, and the filter color is set equal to the diffuse color.
- Transparency falloff settings.
- All map channels that are enabled. Map channels that are turned off in the *.3ds* file do not import.
- All map parameters, including UV transforms, Negative, Mirror, and Rotation. Some Map Parameters such as Blur, Luma, and RGB and Alpha work much differently. These values are converted to new values that produce a similar effect.
- Mask bitmaps are imported as a mask texture.
- When materials with both Texture 1 and Texture 2 are imported, a composite texture is created and added to the Standard material's Diffuse channel.
- Reflection maps, auto-cubics and mirrors.
- Automatic reflection map Nth frame and Map Size settings.
- SXP translation for Marble and Noise materials.
- 3DS/DOS IK joint parameters.
- 3DSurfer patch data.

The following information is **not** imported from a 3DS file:

- Morph keys
- Keyframer instances
- Map channels that are turned off
- Custom *.CUB*-format cubic maps
- Decal transparency using the RGB color of the upper-left pixel of the map

When you import a PRJ file, you get all of the above, plus Shapes.

Exporting to 3DS Files

The following rules determine what is exported to the 3DS format:

- Position, Rotation, and Scale animation. If the controller is a TCB controller, the TCB, Ease In, and Ease Out values are also saved. If the controller is any other type of key controller, the keys are saved but the tangent information is lost. If the controller is not a key controller, only the object's transformation at frame 0 is saved.
- Basic material color/parameters from the Standard material.
- Single maps with their amount, offsets, scales, etc.
- Composite and procedural maps don't export.
- Auto-cubics and Mirrors export.
- UV mapping coordinates can be exported.
UV mapping coordinates are exported if the toggle Preserve MAX's Texture Coordinates is turned on in the Export Scene to .3DS File dialog. See [Exporting to 3DS](#) on page 7175.
A vertex in a 3DS file can have only one texture coordinate. If a vertex in the 3ds Max file has multiple mapping coordinates, it is split into multiple 3DS vertices on export, to preserve the mapping.
- Grouped object transformations don't export to the 3D Editor because there's no concept of group hierarchy in the 3D Editor. Groups do export to the Keyframer because the Keyframer understands hierarchies.
- Target cameras, target spotlights and omni lights.
- Most "static" parameters for cameras and lights, and animation tracks for Roll, Falloff, Hotspot, and FOV are exported. Global shadow parameters are not exported.
- All non-mesh geometry, such as procedural primitives and patches, are collapsed to meshes before export.
- Objects are exported as they exist on the frame that displays at export time.
- Objects are exported as they exist on the frame that displays at export time. If you want to output morph targets, go to each frame and export the target to a different file name.

- Meshes are saved with edge display information and smoothing groups.
- Instances are saved as Keyframer instances.

Modifier and morph animation is frozen at the current frame, collapsed, and exported as a simple mesh.

Action

[Operators](#) on page 8069 and [tests](#) on page 8147 in Particle Flow are known collectively as *actions*.

Active Link

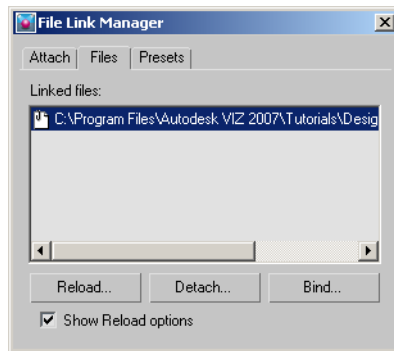

File Link Manager showing an actively linked drawing.

When you use the File Link utility to link a drawing to 3ds Max, the objects have an active link with the original drawing in AutoCAD or Autodesk Architectural Desktop. This means that any edit made to the drawing in AutoCAD or Architectural Desktop can be immediately updated in 3ds Max by reloading the link.

The red flag in the file list means the drawing has been changed in AutoCAD or Architectural Desktop and you should click the Reload button to update the scene in 3ds Max.

The Detach button will cause the drawing file that is linked to 3ds Max to be removed from the scene and removed from the File Link Manager.

Clicking the Bind button will bind the drawing to 3ds Max and sever the active link with AutoCAD or Architectural Desktop.

Active Time Segment

The active time segment is the total range of frames that you can access using the [time slider](#) on page 7528.

By default, the active time segment runs from frames 0 to 100, but you can set it to any range from the [Time Configuration dialog](#) on page 7565. In addition, the active time segment can include negative frame numbers, so you can create keys before frame 0 and work in negative time.

You can change the active time segment whenever you want without affecting the keys you've already created. You might think of it as a window in time, specifying only that portion of your animation in which you want to work. Thus, if you have keys scattered over a range of 1000 frames, you can narrow your active time segment to work on only frames 200–300 without affecting the keys outside of the segment.

Active/Inactive Footsteps



When you first create footsteps for a biped in [Footstep mode](#) on page 4433, they are inactive. You must activate these footsteps using the Create Keys For Inactive Footsteps button. Active footsteps have keys to animate the biped. Inactive footsteps have not been given keys by **character studio**.



You can make active footsteps inactive by clicking Deactivate Footsteps.

Both these buttons are on the [Footstep Operations rollout](#) on page 4438.

In the Track View – Dope Sheet editor, inactive footsteps are displayed with a distinctive color to indicate they are inactive.

If you have upper body animation added to a biped, and you deactivate the footsteps, then re-activate you will lose the existing upper body keys. Use Adapt Locks on the Dynamics and Adaptation rollout to control which tracks are affected by the create keys process.

ActiveShade Initialize and Update

[ActiveShade rendering](#) on page 6102 is a two-step process:

- Initialize
- Update shading

The Initialize Pass

Rendering can be slow. The initialize pass is meant to take care of the most time-consuming portions of rendering, to allow the update pass to take place as quickly as possible. Initialization includes the following steps:

- Evaluate the scene geometry into meshes.
- Apply space warps.
- Do transformations and clipping.
- Evaluate textures and shade materials.
- Perform optimizations to speed later processing, such as merging fragments from the same surface that are in the same pixel.

The result of initialization is a buffer. This is a compressed rendering that, like a [G-Buffer](#) on page 7991, contains the rendering plus additional information used by the second step, updating.

During the initialize pass, progress is indicated by a row of pixels (white by default) that traverses the top edge of the ActiveShade window.

The Update Shading Pass

Updating shading takes the buffer created by the first pass, initialization, and uses information in that buffer to change the color of pixels when you make changes to lights and materials in the scene.

During the update pass, progress is indicated by a row of pixels (white by default) that descends the right edge of the ActiveShade window.

Adapt Locks

By default, **character studio** automatically adapts biped keys when you edit footsteps in a [footstep animation](#) on page 4176. You can avoid this adaptation by using the Adapt Locks toggles on the [Dynamics & Adaptation rollout](#) on page 4417. Each toggle locks a specific track so that **character studio** doesn't adapt it when you edit footsteps.

Adapt Locks applies only to footstep animation, not to freeform animation.

Adaptation

In the [Motion Mixer](#) on page 8052, when the same clip is used more than once on tracks, the clip versions are either [instances](#) on page 8015 or adaptations of one another.

The same clip used more than once for one biped, or for different bipeds of the same size, is an instance. The same clip used for different-sized bipeds is an adaptation.

These terms are used because the Mixer adapts each loaded clip to the biped's size. The first time a clip is loaded, the Mixer adapts the clip as needed. When the clip is cloned or loaded again, the Mixer adapts the new clip to the biped as needed, then compares the change to previously loaded versions to see if it's the same. If so, the new clip and its previous versions are instances of one another. If not, the new clip and previous versions are adaptations of one another.

In footstep animation, the term *adaptation* refers to keys generated for a footstep sequence. When you edit active footsteps, body and leg keys are adapted automatically. By analogy, the footsteps become a kind of "gizmo" for manipulating the keyframes of your character's animation. In most cases, edits you make to footsteps will act upon your keys in an intuitive fashion. See [Footstep Animation](#) on page 4176.

Adaptive Degradation

When you turn on [Adaptive Degradation](#) on page 143, 3ds Max can change the way it displays objects to keep up with the current operation. For example, while you are zooming a viewport, some objects might change from shaded to bounded boxes during the zoom operation, and then switch back to shaded

display when you finish zooming. The settings on the [Adaptive Degradation panel](#) on page 7828 of the Viewport Configuration dialog control how adaptive degradation occurs.

When Adaptive Degradation is off, viewports retain their display settings at all times, but operations such as zooming or animation playback cause a slow screen refresh rate. In this state, animation playback might have to drop frames to keep up with real-time playback.

You can set the parameters that control the trade-off between display quality and display speed. The levels you activate determine which rendering levels the software falls back to when it cannot maintain the desired display speed. You can choose as many levels as you want, but for best results choose only one or two levels.

Additive Opacity

An additive process adds two values together, such as two colors. When you add colors in 3ds Max, the result is brighter than either of the two original colors.

Additive Opacity

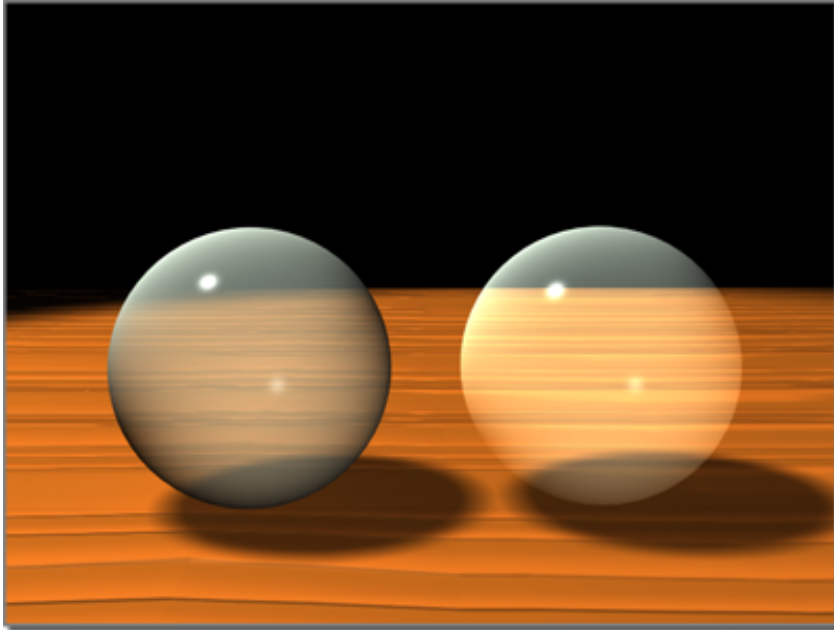

Sphere on the right uses additive opacity.

Additive opacity brightens the colors behind the material by adding the material's colors to the background colors. Additive opacity is good for special effects such as light beams or smoke. You specify the use of additive opacity on the [Extended Parameters rollout](#) on page 5408.

Additive Opacity and the Alpha Channel

By default, additive opacity does not generate an alpha value. In other words, the alpha value is zero, indicating no transparency. This gives correct results with backgrounds in renderings, but if you want to composite objects with additive opacity using video post or a compositing program, you might want to have additive opacity render with transparency. To do so, add the following line to the [Renderer] section of the *3dsmax.ini* file, and then restart 3ds Max:

```
AlphaOutOnAdditive=1
```

To revert to the default method of rendering additive opacity, in the *3dsmax.ini* file, change the value of AlphaOutOnAdditive back to 0 (zero), and then restart 3ds Max.

See also:

- [Subtractive Opacity](#) on page 8140

Adjust Talent Pose

When you animate a biped with [motion capture](#) on page 4574, after you load a [marker file](#) on page 8037, you can use Adjust Talent Pose to correct the biped's position relative to the motion-capture markers. Align the biped limbs to the markers, then click Adjust Talent Pose to compute this offset for all the loaded marker data. This button is on the [Motion Capture rollout](#) on page 4584.

Affine Transformation

A geometric transformation such as move, rotation, or scale, that can alter distances between points or angles between lines, but preserves straight lines and the parallel relation between parallel lines. Transform operations are affine transformations. [NURBS](#) on page 2261 are invariant under affine transformations.

Airborne Period

In [footstep animation](#) on page 4176, a "ballistic gait" is defined as any footstep pattern in which there are periods with no feet on the ground, causing the biped to become airborne, or ballistic. For example, running, hopping, and jumping are ballistic gaits with airborne periods.

Aliasing/Antialiasing

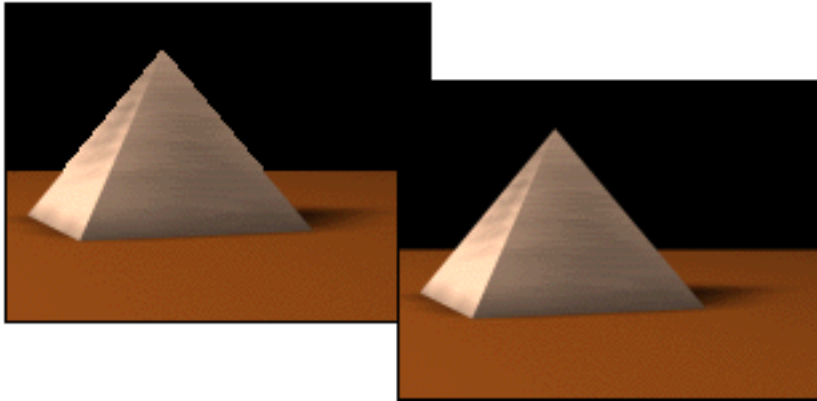

Pyramid is aliased on left, antialiased on right.

Aliasing is the staircase effect at the edge of a line or area of color when it's displayed by an array of discrete pixels.

Antialiasing smooths the staircase effect that occurs when diagonal or curved lines or borders are drawn on raster displays consisting of square or rectangular pixels. Antialiasing can be either on or off. Turn this off only when you're rendering test images and want greater speed. Leave it on at all other times.

You can also turn antialiasing off for the Material Editor sample slots to speed up redraw of the sample objects. Click the Options button in the Material Editor and turn on the Antialias toggle on the Material Editor Options dialog. Default=off.

NOTE To control whether or not a background image is affected by the renderer's antialiasing filter, choose [Customize > Preferences > Rendering](#) and then turn on [Filter Background](#) in the Background group. Default=off.

Alpha Channel

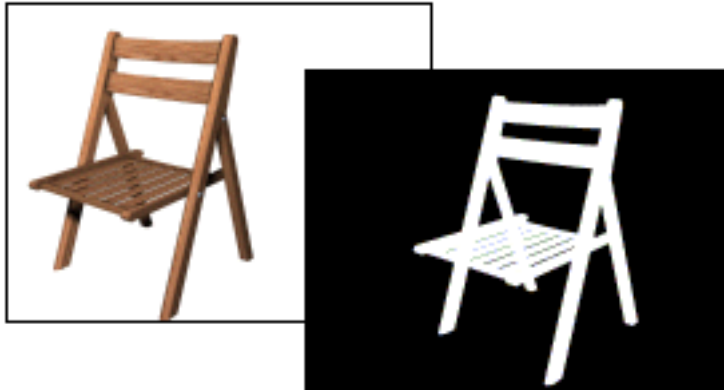

Alpha channel shown in black, on the right

Alpha is a type of data, found in 32-bit bitmap files, that assigns transparency to the pixels in the image.

A 24-bit truecolor file contains three channels of color information: red, green, and blue, or **RGB** on page 8105. Each channel has a particular intensity or value at each pixel. The intensity of each channel determines the color of the pixel in the image.

By adding a fourth, alpha channel, the file can specify the transparency, or opacity, of each of the pixels. An alpha value of 0 is transparent, an alpha value of 255 is opaque, and values in between are semi-transparent.

Transparency is important for [compositing](#) on page 7937 operations, such as those in Video Post, where several images are blended together in layers.

An alpha channel is particularly useful for the partly transparent pixels around the [aliased](#) on page 7904 edge of an object in a rendered image. These pixels are used for compositing. An image such as the one shown above can be composited smoothly onto a different background if an alpha channel is produced and saved with the image.

Each channel of a truecolor bitmap file is defined by 8 bits, providing 256 levels of intensity. Thus, an RGB file is 24-bit with 256 levels each of red, green, and blue. An RGBA file (red, green, blue, alpha) is 32-bit, with the extra 8 bits of alpha providing 256 levels of transparency.

3ds Max creates the alpha channel automatically when you render. Any background pixels in the rendered image are fully transparent, and the alpha channel also accounts for any other transparency that you create via materials,

etc. You can see this in the [rendered frame window](#) on page 6073 by clicking the Display Alpha Channel button on the toolbar: In the resulting display, black pixels are fully transparent, white pixels are opaque, and gray pixels show degrees of transparency. To return to the regular display, click Display Alpha Channel again.

To output a rendered image with alpha, save in an alpha-compatible format such as TIFF or Targa. With Targa, the default settings include saving alpha; with TIFF, be sure to turn on the Store Alpha Channel check box.

Ambient Color

Ambient color is the color of an object where it is in shadow. This color is what the object reflects when illuminated by ambient light rather than direct light.

Ambient color areas in the scene will not appear any darker than the [ambient light setting](#) on page 7906.

You can lock a material's ambient color to its diffuse color so that changing one automatically changes the other.

Ambient Light

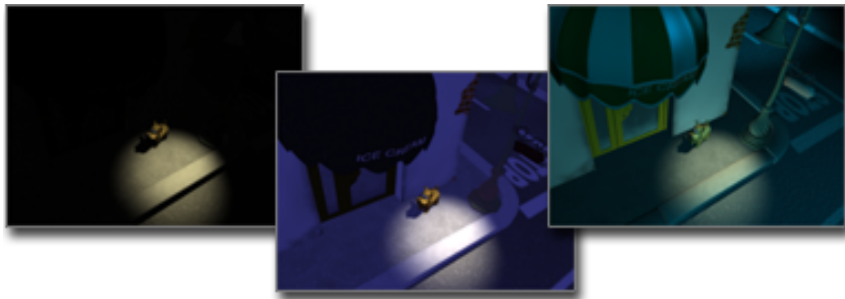

Left: No ambient light

Middle: Low ambient light

Right: User-adjusted ambient light

Ambient light is the general light that illuminates the entire scene. It has a uniform intensity and is uniformly diffuse. It has no discernible source and no discernible direction.

By default, there's no ambient light in a scene. If you examine the darkest shadows on your model with the default ambient light setting, you cannot make out the surface because it's unlit by any light. Shadows in your scene will not appear any darker than the ambient light color, which is why you usually keep ambient light set to black (or a very dark color).

If you use photometric lights and a [radiosity solution](#) on page 6168, ambient light is accurately calculated. The other advanced lighting option, [light tracing](#) on page 6154, also generates ambient lighting.

If you use standard lights, a good lighting test is to set your ambient lighting to black (the default), set up all your lights, and then decide at the end if you need to increase the ambient light.

Animated Texture

An animated texture is a material whose properties change over time. One example of this is assigning a multi-frame bitmap (for example, an AVI file or an IFL image-file sequence) as a map.

Animated textures can also be materials with keyframed parameters. In addition, in the context of particle systems, a material that uses the [Particle Age map](#) on page 5889 or the [Particle MBlur map](#) on page 5891 is considered to be animated.

In general, when applying an animated texture to particles in Particle Flow, be sure incorporate it in a [Material Dynamic operator](#) on page 2925.

Animation

Animation is based on a principle of human vision. If you view a series of related still images in quick succession, your brain perceives them as continuous motion. Each image is called a *frame*.

Historically, the major difficulty in creating animations has been that the animator must produce a large number of frames. Depending on the quality you want, one minute of animation might require between 720 and 1800 separate still images. Creating images by hand is a big job. That's where keyframing comes in.

Most of the frames in an animation are routine, incremental changes from the previous frame directed toward some predefined goal. Early animation studios quickly realized they could increase the productivity of their master

artists by having them draw only the important frames, called keyframes. Assistants could then figure out the frames that were required in between the keyframes. These frames were (and still are) called *tweens*.

Use the software as your animation assistant. As the master animator, you create the keyframes that record the beginning and end of each transformation. The values at these keyframes are called *keys*. The software calculates the interpolated values between each key value, resulting in tweened animation.

3ds Max is not limited to animating transformations (such as position, rotation, and scale). It can animate just about any parameter you can access. Thus, you can animate modifier parameters, such as a Bend or a Taper angle, material parameters, such as the color or transparency of an object, and much more.

Early animation studios also had to employ artists to add the ink and color to each frame. Even today, production of a cartoon usually requires hundreds of crafts people and artists to generate the thousands of images. With 3ds Max, the renderer takes over the job of shading and rendering each frame and storing it as you direct. The end result is a high-quality finished animation.

The quickest way to animate is to turn on [Auto-Key](#) on page 3083 and start transforming objects at different frames. Each time you transform an object, you set a key. Then you can [play the animation onscreen](#) on page 7561, or [render it to a file](#) on page 6086.

Animation Controllers / Transform Controllers

All animation in the software is performed through animation controllers. The most common animation controllers, those for move (position), rotate, and scale, are also referred to as transform controllers.

Each animation track has its own controller, and each controller can be different.

In the hierarchy list, the controller tracks are represented by controller icons. The icons can appear differently depending on the controller that is assigned, for instance a Noise Float icon differs from a Bezier Float icon. You can also see which specific controllers are assigned to each track by turning on the controllers display in the Track View (right-click Filters in the Track View toolbar, and choose Controller Types from the list). The controller names appear beside the tracks to which they're assigned.

You can assign different controllers to the tracks, affecting the way they respond. The Bezier Controller, assigned by default to all the Position tracks, lets you move objects using the Select and Move transform tool, and converts those movements into Bezier splines. You can adjust the splines in Function Curve editing mode.

Animation Layers

When you animate a biped or other object, you can add layers of animation above the original biped animation. This is a powerful way of making global changes to your animation. For example, when you add a layer and rotate the spine forward at any frame, a run cycle becomes a crouched run. The original biped motion is kept intact and can be viewed by switching back to the original layer.

You can view layers individually or as a composite of all the animation in all the layers. Layers behave like a freeform animation; the object can adopt any position.

Layers used in conjunction with Biped let you easily adjust raw motion-capture data, which contains keys at every frame. You do this by adding a layer and keyframing the biped.

Layer controls for Biped are on the [Layers rollout](#) on page 4403. For other objects, use the [Animation Layers toolbar](#) on page 7508.

Applied IK

A type of inverse kinematics where one or more parts of the IK structure follows another animated object exactly. After the scene is set up, Applied IK generates transform keys for every object in the IK chain.

See [Animating with Applied IK](#) on page 3462.

Area Lights (mental ray Renderer)

Area lights are a feature of the mental ray renderer. Instead of emitting light from a point source, they emit light from a broader area around the source. Area lights create soft-edged shadows. This can help improve the realism of your rendering.

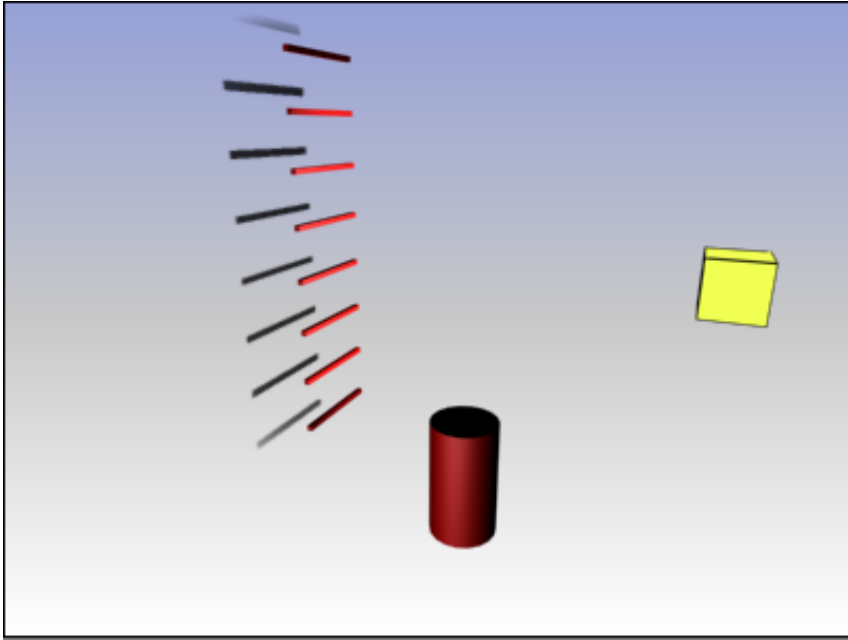

Scene rendered with area light turned off
Shadows are ray-traced.
The yellow cube indicates the light's location.

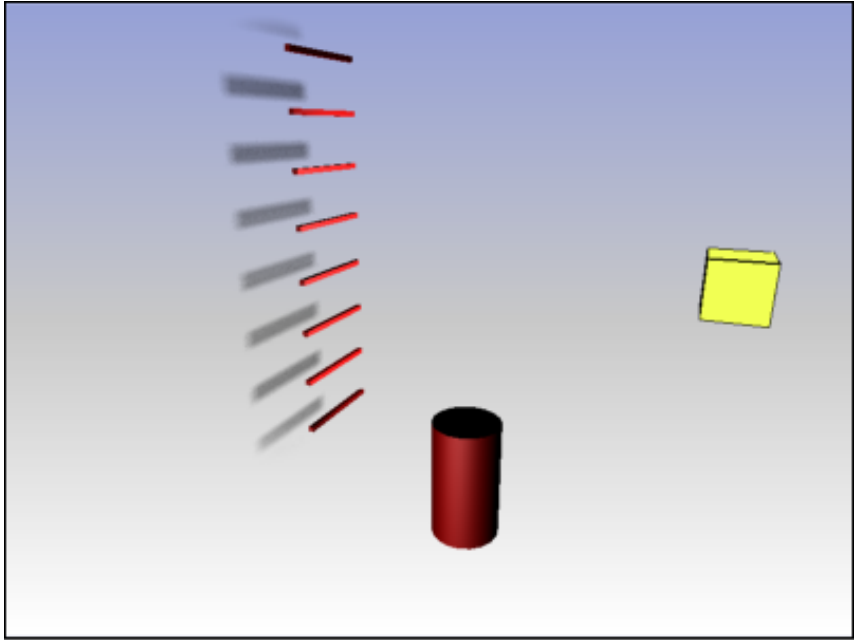

Scene rendered with area light turned on, showing soft shadows

The light in this rendering is a 2D (spot) area light.

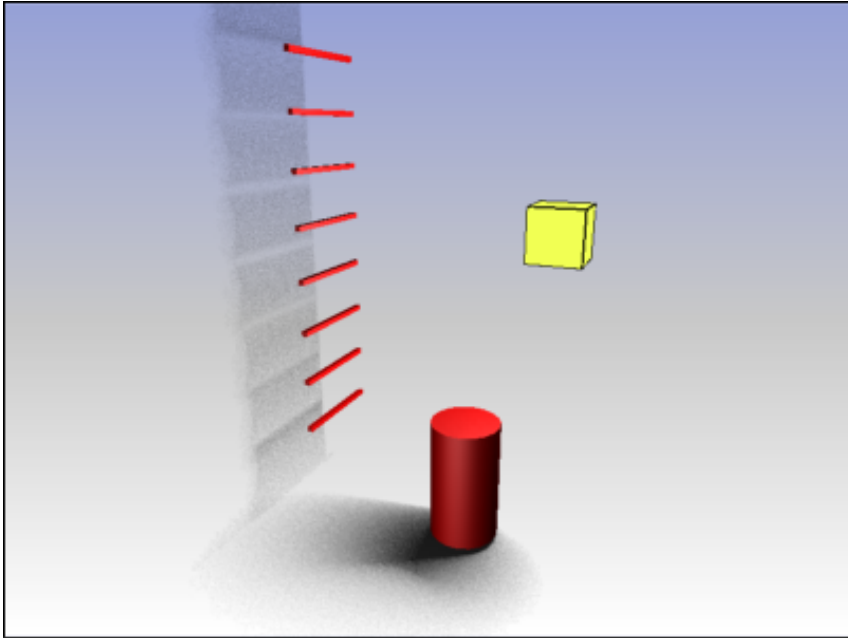

Scene rendered with a 3D (omni) area light

The light uses the default radius of 20.0.

NOTE To render soft-edged shadows, shadows must be ray-traced, not shadow-mapped. See the Render Setup Dialog > Renderer panel > [Shadows & Displacement rollout](#) on page 6292.

Area lights support global illumination, caustics, and other features of the mental ray renderer.

TIP Area lights take longer to render than point lights. If you are interested in creating a quick test (or draft) rendering, you can use the Area Lights/Shadows As Points toggle to speed up your rendering. This toggle is on the Render Setup dialog > Common panel > [Common Parameters rollout](#) on page 6121.

Area Shadows

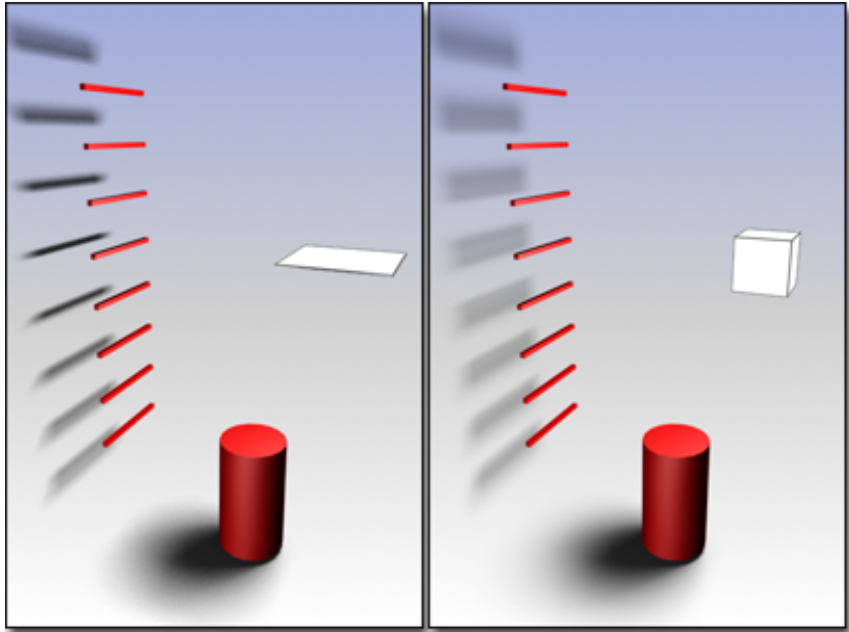

The shape of the shadow-casting region changes the shape of area shadows.

Area shadows simulate shadows generated by a light with area or volume.

Aspect Ratio

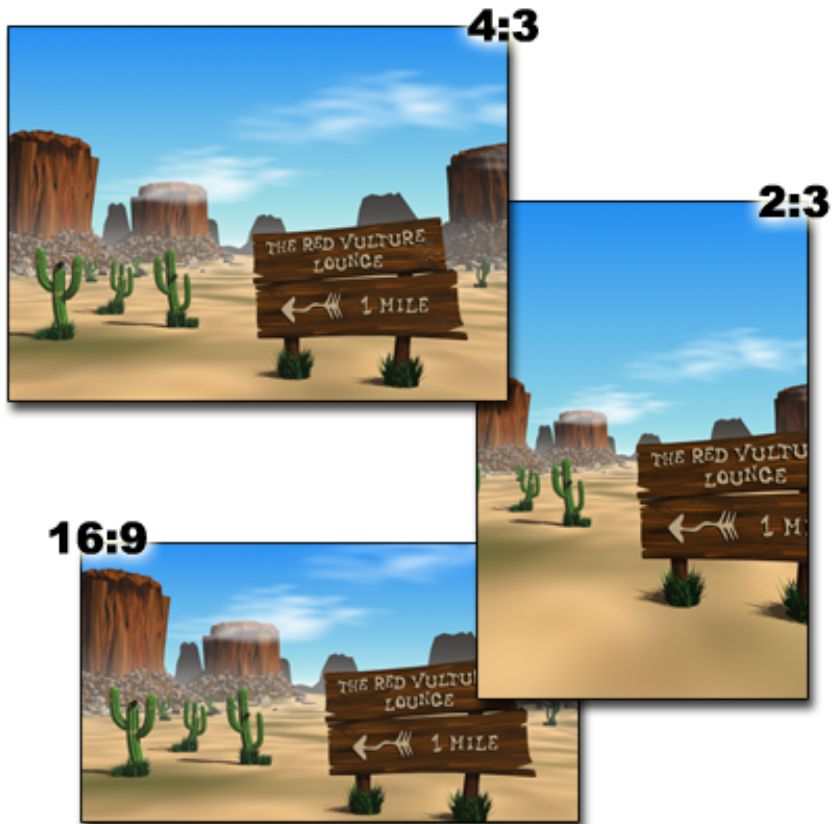

Various aspect ratios

Aspect ratio describes the proportions of a still image or the frames in a movie, expressed as the ratio of width to height, regardless of the image's [resolution](#) on page 8108.

Aspect ratio is usually expressed either as a ratio of width to height (for example, 4:3) or as a real value relative to 1 (for example, 1.333). For example, pre-1950s movies and non-HD TV shows have an aspect ratio of 4:3.

The aspect ratio is used wherever a bitmap is created or used. For example:

- When preparing to render, you can specify an aspect ratio for your rendered images with the Image Aspect parameter on the [Render Setup dialog](#) on page 6067.
- When setting up a [viewport background](#) on page 148, you can specify whether to use the viewport, bitmap or rendering output aspect ratio to display the bitmap.
- When you [make a spotlight a projector](#) on page 5108, you can use the Bitmap Fit option to match the spotlight's aspect ratio to the bitmap's, and thus prevent the bitmap from distorting.

Attachments (IK)

In biped animation, the biped hands and feet can be linked to the world, another object in the scene, or to the biped's own body. This linking is also called IK attachment. Attachment can be blended: this lets you start with one attachment and end with another. For example, if the biped is catching a ball, you can start with the hand in body space and end with the hand in the coordinate space of the ball.

Attenuation

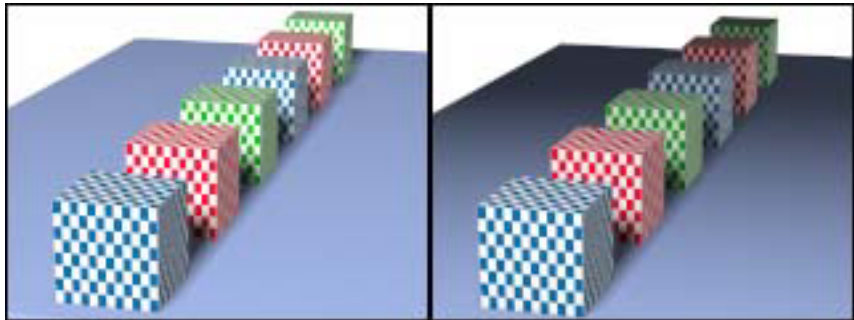

Image on right rendered with attenuation

In the real world, the intensity of light diminishes over distance. Objects far from the light source appear darker than objects near the source. This effect is known as attenuation.

In nature, light attenuates at an inverse square rate; that is, its intensity diminishes in proportion to the square of the distance from the light source. It is common for attenuation to be even greater when light is occluded by small particles in the atmosphere, especially when there are clouds or fog present.

Attenuation and Photometric Lights

Photometric lights *always* attenuate at the inverse square rate. This is one of the reasons it is important for scenes with a radiosity solution to use real-world dimensions and units.

Attenuation and Standard Lights

By default, standard lights don't attenuate. Consequently, an object's distance from the light doesn't matter, and only the angle of light to the surface has any effect on illumination unless you turn on attenuation. You can manually control the rate of attenuation for standard lights. You can also use attenuation with the Raytrace map. If your scene uses standard lights, you should consider adding attenuation whenever possible, for two reasons:

- Attenuation provides greater subtlety and realism in your lighting.
- You can reduce rendering time, since attenuated lights don't have to be calculated for surfaces that are beyond the attenuation range.

For standard lights, you can explicitly set where attenuation begins and ends. This is partly so you don't have to worry about setting up strictly realistic distances between light objects and the objects they illuminate. More importantly, this feature lets you fine-tune the effect of attenuation. In outdoor scenes, attenuation can enhance the effect of distance. In an indoor setting, attenuation is useful for low-intensity light sources such as candles.

For standard lights, you set attenuation parameters on the light's [Intensity/Color/Attenuation rollout](#) on page 5083. For the Raytrace map, you set the parameters on the map's [Attenuation rollout](#) on page 5957.

AutoGrid

AutoGrid is an option on the 3ds Max Create panel. It lets you create an object on the surface of another object. You can turn on AutoGrid when you create a biped, in order to position the biped on another object.

AutoGrid can also be used when creating footsteps manually, to place footsteps on an uneven terrain.

Avoid Behavior

In [crowd animation](#) on page 4761, the Avoid behavior lets you specify any object or objects that delegates must keep away from. As delegates approach designated objects during the crowd simulation, they steer clear of them while turning or braking as necessary. This behavior uses three different methods to let delegates avoid each other and other objects: Steer To Avoid (the preferred method), Repel, and Vector Field. See [Obstacle Avoidance](#) on page 4780.

Avoidance Behavior

In [crowd animation](#) on page 4761, avoidance behavior consists of any combination of slowing down, turning, and stopping. See [Obstacle Avoidance](#) on page 4780.

Axonometric View

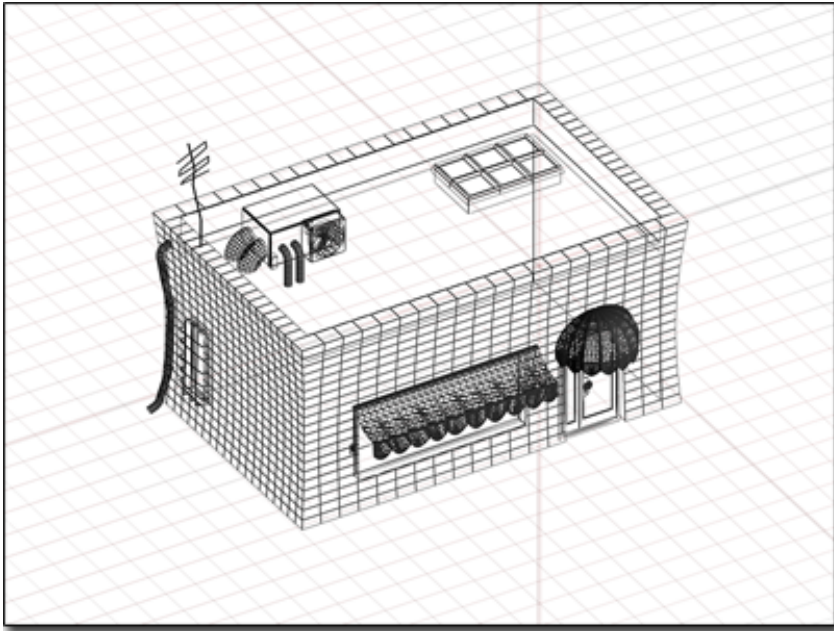

Axonometric view of model

A projected view of 3-dimensional space that displays from one to three sides of an object. The lines in an axonometric view do not converge to vanishing points as they do in a perspective view, so lines that are parallel in 3D space are parallel in the view. For this reason, diagonal and curved lines can appear to be distorted.

[Isometric](#) on page 8019 and [orthographic](#) on page 8073 views are special cases of axonometric views.

B-Spline

B-spline (basis spline) is a kind of spline generated by so-called basis functions. The advantage of B-splines over [Bezier curves](#) on page 7922 is that the control vertices (CVs) of a B-spline affect only their local region of the curve or surface. B-splines also compute faster than Bezier curves.

Balance Factor

Balance Factor positions the biped's weight anywhere along a line that extends from the center of mass to the biped's head, affecting the degree to which the hips or head (or both) swing away from their original vertical alignment when the biped is bent over.

See [Shifting the Biped's Balance](#) on page 4212.

Balance Track

Each biped added to the [Motion Mixer](#) on page 3699 is automatically assigned a balance track. You don't place clips on this type of track as you do with [transition tracks](#) on page 8158 and [layer tracks](#) on page 8021. The [weight curve](#) on page 8169 on the balance track is the only adjustable parameter.

By default, the Motion Mixer compensates for differences in upper and lower body motion that might cause the biped to go off balance over the course of the animation. It accomplishes this by changing the COM, pelvis and spine animation.

When the weight curve across the balance track is set to 1.0 (the default), balance compensation is enabled for the entire animation. You can adjust nodes on the weight curve to disable balance compensation over all or part of the animation. See [Adjusting Biped Balance in the Mixer](#) on page 3737.

Ballistic Gait

A "ballistic gait" is defined as any footstep pattern in which there are airborne periods (periods with no feet on the ground) such as a jumping or running pattern.

Ballistic Tension

Controls the amount of spring or tension when the biped lands or takes off from a jump or run step. See [Adjusting Vertical Motion](#) on page 4217.

Barycentric Coordinates

Given a triangle between points A, B, and C, each point X on the surface of the triangle can be represented by a weighted sum of the corners:

$$X = a*A + b*B + c*C$$

where a, b, and c are numbers between 0 and 1 and $a+b+c = 1$.

These numbers are called the *barycentric coordinates* of the point X. There is one unique set of barycentric coordinates for each point on the triangle.

Examples

The center of gravity of the triangle is given by the barycentric coordinates (1/3, 1/3, 1/3): $X = 1/3 A + 1/3 B + 1/3 C = (A+B+C)/3$.

If one of the barycentric coordinates is zero, the point X must lie on the opposite edge. For instance:

$$\text{if } a=0, X = b*B + c*C$$

where $b+c=1$

This means that X is on the line segment BC.

If $a=1$, on the other hand, then $b=c=0$, and X must be exactly the point A.

Behaviors

In [crowd animation](#) on page 4761, behaviors simulate a range of activities. Seek, avoid, path follow, surface follow, repel, orientation, scripted, space warp, surface arrive, wall repel, wall seek, and wander are all behaviors available in a crowd simulation.

Behaviors let you assign procedural activity types to delegates and objects linked to delegates. You can associate any number of behaviors with each Crowd object, and then link delegates and teams of delegates to each behavior. A specific behavior assigned to a Crowd object belongs only to that crowd; it cannot be assigned to any other crowds.

Bend Links

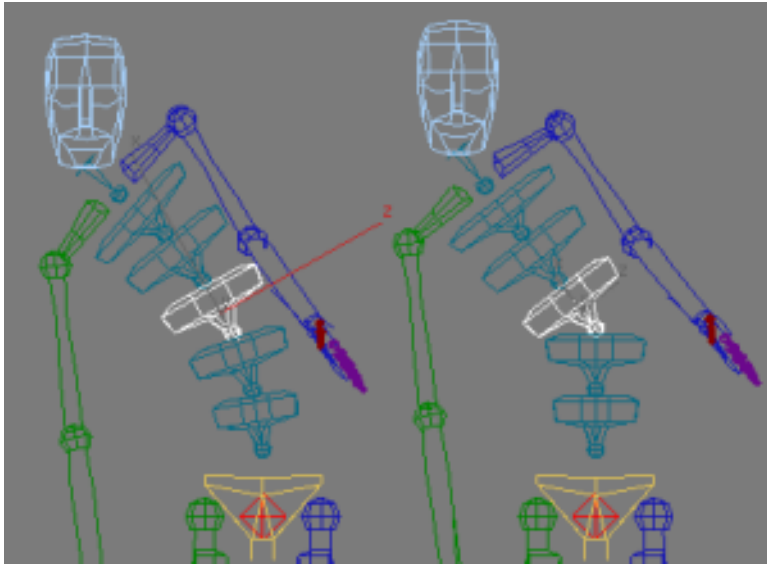

Bend Links Mode active (left) and Bend Links Mode inactive (right)

When you turn on Bend Links Mode (on the [Bend Links rollout](#) on page 4363), rotating a single chain link causes the other links to bend following a natural curvature. When Bend Links Mode is off, rotating one link rotates all its children links by the same amount.

TIP Bend Links works well on the biped spine, neck, tail and ponytail links.

Bezier Curve

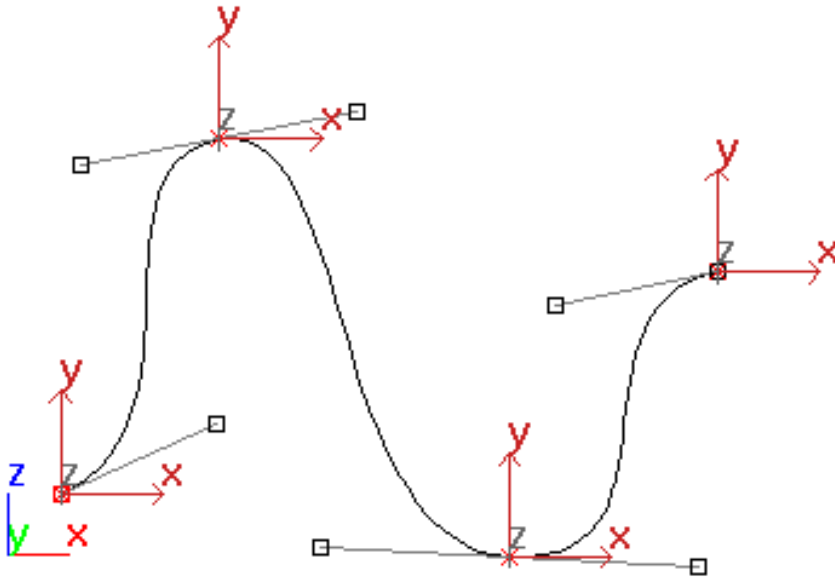

Bezier curve and the control points and tangent vectors about each vertex

A curve modeled using a parametric polynomial technique. Bezier curves can be defined by many vertices. Each vertex is controlled by two other points that control the endpoint tangent vectors. Bezier curves were developed by P. Bezier for computer modeling in automobile design.

A vertex on a Bezier Curve affects the entire curve in that area. Compare with [B-splines](#) on page 7918, where the control vertices (CVs) affect only their local region of the curve or surface.

A segment on an [editable spline](#) on page 675 that has its vertices set to Bezier or Bezier Corner is considered a Bezier Curve.

BioVision Files

The BioVision™ file format stores motion-capture information. A BVH file contains the "actor's" skeletal and limb/joint rotation data, and uses the *.bvh* file name extension.

NOTE For the BVH file specification, see the *BVH.rtf* document on the program disc.

BIP Files

BIP files contain skeletal size and limb rotation data for bipeds. This is the native **character studio** motion file format.

Biped

Biped is a 3ds Max system provided with the **character studio** product. It provides the armature used to pose a character, and facilities to animate it using either footsteps or freeform animation.

Biped Dynamics

Biped dynamics calculate a biped's airborne trajectory, the bending of its knee or knees on landing, and the biped position so it maintains balance when the spine is rotated. When the position or animation of the biped change, dynamics cause the biped to adapt.

There are six parameters that affect biped dynamics. Three are in the Body section of the [Key Info rollout](#) on page 4367:

- [Balance Factor](#) on page 7919
- [Dynamics Blend](#) on page 7959
- [Ballistic Tension](#) on page 7919

The other three are on the [Dynamics & Adaptation rollout](#) on page 4417:

- [GravAccel](#) on page 8000
- Biped Dynamics
- [Spline Dynamics](#) on page 8135

Biped Playback

Biped Playback on the [Biped rollout](#) on page 4331 plays the animation for all bipeds in a scene (unless you use the Display Preferences dialog to exclude them). This playback mode usually gives real-time playback, which you might not get if you use the 3ds Max viewport animation Play button.

In Biped Playback mode, the biped is displayed as bones only, with no other scene objects visible.

Birth Event

A birth event is a special type of [local event](#) on page 8027 that always comes at the start of a [particle flow](#) on page 7983, immediately after the [global event](#) on page 7997. Its first [action](#) on page 7897 is a [Birth operator](#) on page 2844 or [Birth Script operator](#) on page 2847. The birth event can contain any number of additional actions, and can be succeeded by any number of additional events.

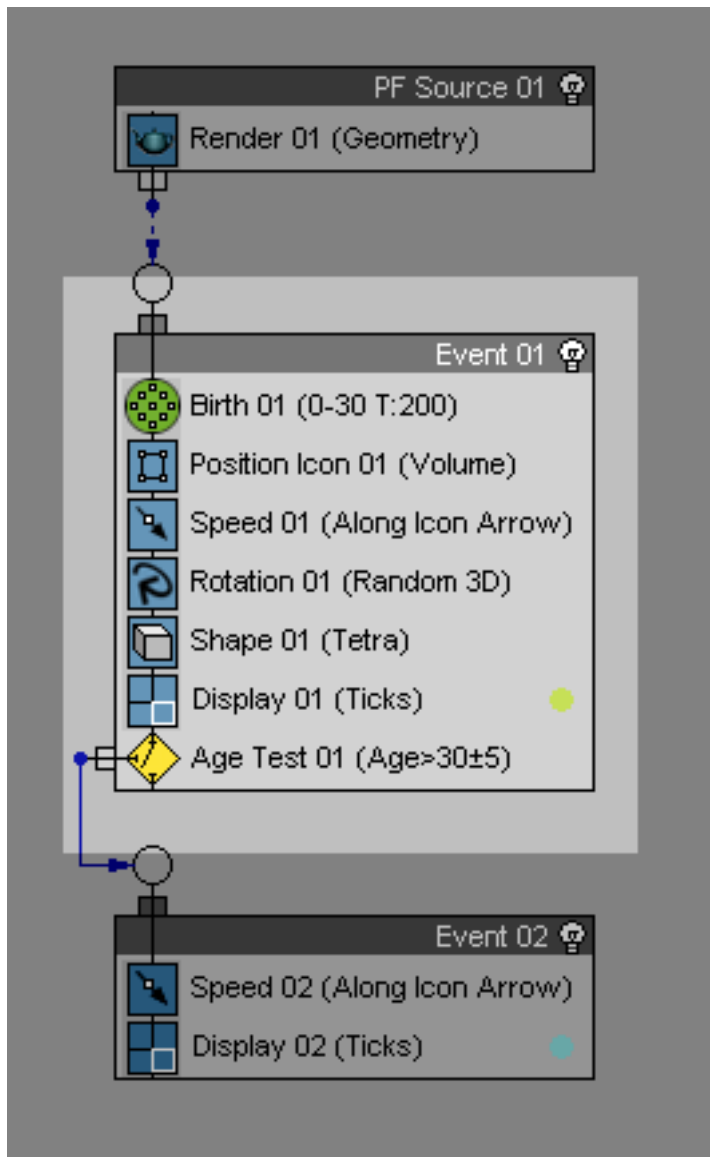

Birth event (highlighted)

Bitmap

A bitmap is a still image produced by a fixed matrix of colored [pixels](#) on page 8092, like a mosaic. You can use bitmaps as textures for materials, as backgrounds to viewports, and as rendered environments.

You can use an animation or video file as a bitmap, in which case the material or background changes over time.

Bitmaps can be reloaded automatically after they have been changed and resaved by a graphic editing program. See the Reload Textures On Change toggle in [Preferences Settings > Files panel](#) on page 7750.

3ds Max can use the following image file formats as bitmaps:

[avi](#) on page 7326

[bmp](#) on page 7328

[cin](#) on page 7328

[cws](#) on page 7329

[dds](#) on page 7330

[gif](#) on page 7334

Radiance Image File: ([hdr](#) on page 7334, [pic](#))

[ifl](#) on page 7339

[jpg](#) on page 7347

[mov](#) on page 7348

[mpg](#) on page 7348

[png](#) on page 7360

[psd](#) on page 7361

[rgb](#) on page 7369

[rla](#) on page 7364

[rpf](#) on page 7366

[tga](#) on page 7370

[tif](#) on page 7372

[yuv](#) on page 7374

NOTE 3ds Max can also render to some of these formats, but not to all of them. See the topic for the individual image format for details.

Blend Object

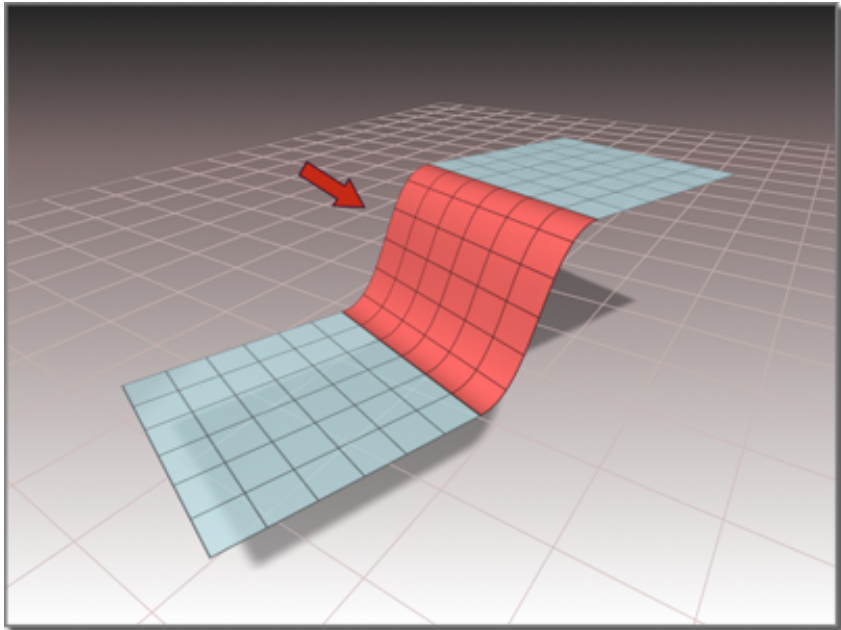

NURBS blend surface

A dependent NURBS object that connects two curves or two surfaces. The curvature of the blend is controlled by the objects it connects, and by two tension parameters that control the "length" of effect of the tangent for each of the "parent" objects.

Block Reference

In AutoCAD, a compound object that is inserted into a drawing and displays the data stored in a block definition. A block reference is also sometimes referred to as a *Block Instance*. Refer to the AutoCAD, Autodesk Architectural Desktop, or Autodesk Mechanical Desktop help files for further information regarding Blocks, Block Instances, and Block References.

Block/Style Parent

A Block/Style Parent is closely related to a [VIZBlock](#) on page 8165 in that it is a compound object similar to a nested AutoCAD block. Just like the VIZBlock, it is used for organizing linked data from DWG files. When linking DWG data to 3ds Max, you need to decide how the incoming entities are to be organized in the scene. Objects in DWG files are commonly organized by layers, blocks, and entities, while 3ds Max scenes are organized by parent/child hierarchies of objects.

The main difference between a Block/Style Parent and a VIZBlock is that a Block/Style Parent allows for a parent/child hierarchy of “components,” but does not display any of its own geometry. A VIZBlock displays its own geometry and lists a set of “components,” or sub-objects.

Blur / Blur Offset

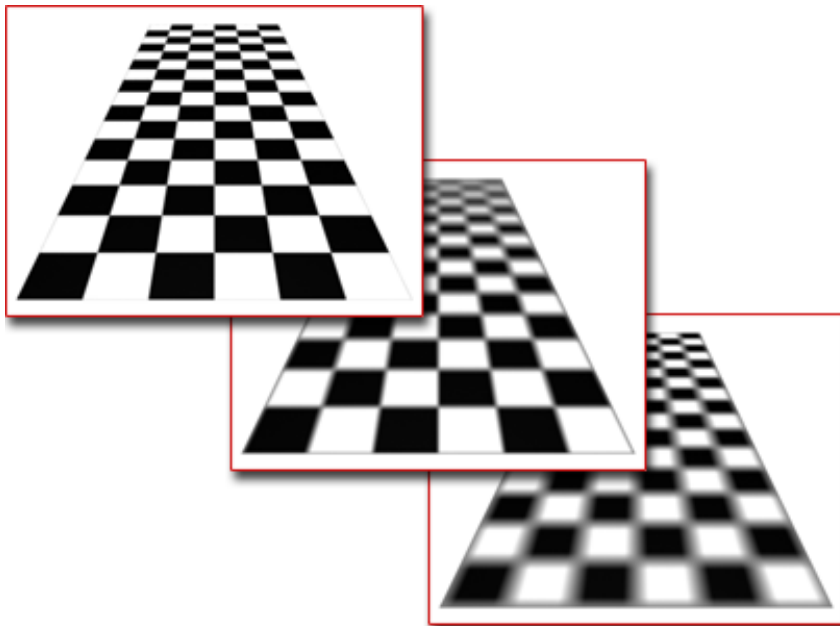

Top: Blur = 1, Blur Offset = 0

Middle: Blur = 10, Blur Offset = 0

Bottom: Blur = 0.01, Blur Offset = 0.2

The Blur and Blur Offset controls determine how a 2D map is blurred, or how it is softened in the rendering. You can't see their effect in the viewport renderer, only in the production renderer.

The Blur setting blurs the map based on its distance from the view. The farther away the map is, the greater the blurring. You should always use some blurring on your maps to avoid the type of scintillation, or aliasing that can occur when pixel details are reduced off in the distance. This effect typically occurs when you use detailed bitmaps viewed at a distance, and is particularly apparent during animations. The Blur default is 1.0, which is a good setting for most purposes.

Blur Offset blurs the map without regard to depth. That is, all the pixels in the map are blurred equally, regardless of how close or how far they are from the camera.

Whereas the Blur value is primarily used to avoid aliasing, Blur Offset is useful when you want to soften, or defocus the details in a map. It's the equivalent of blurring the bitmap in an image-processing program before applying it as a material map.

NOTE For [bump mapping](#) on page 5478, lower Blur and higher Blur Offset values give better results.

Body Space

A biped limb can be put into the coordinate space of the world or an object in the scene as well as body space. Body space moves the biped limbs when the biped moves; if you rotate the biped's hips, the feet, in body space, move as well.

Boolean Operation

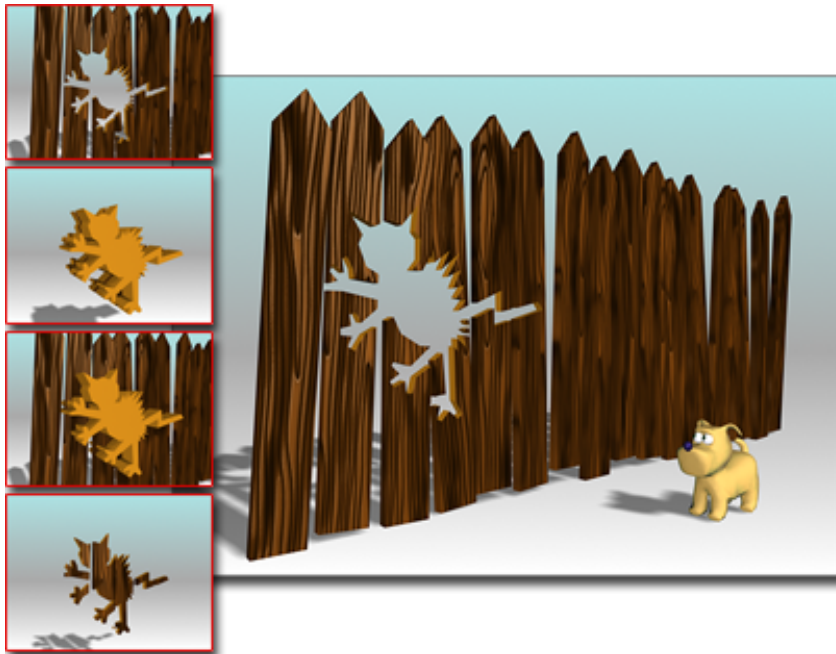

The fence is operand A, and the cat is operand B.

Upper left and right: A minus B

Second to upper left: B minus A

Second to lower left: Union

Lower left: Intersection

A Boolean object combines two objects by performing a Boolean operation on them. In the software, a Boolean object is made from two overlapping objects. The original two objects are the operands (A and B) and the Boolean object itself is the result of the operation.

For geometry, the Boolean operations are:

- **Union:** The Boolean object contains the volume of both original objects. The intersecting or overlapping portion of the geometry is removed.
- **Intersection:** The Boolean object contains only the volume that was common to both original objects (in other words, where they overlapped).

- **Subtraction (or difference):** The Boolean object contains the volume of one original object with the intersection volume subtracted from it.

Bound Vertex

Binding spline vertices via the Refine and Bind functions in [Editable Spline \(Vertex\)](#) on page 675 is useful for connecting splines when building a spline network for use with the [Surface Modifier](#) on page 1766.

Bound vertices are black, allowing them to be easily distinguished from standard vertices. You cannot move a bound vertex directly. However, changing the segment length by scaling it or by moving a connected vertex causes the bound vertex to shift its position in order to remain at the segment's midpoint. You can change a bound vertex's type (right-click the vertex, and then choose the type from the bottom of the right-click menu), and if you convert it to a Bezier or Bezier corner, you can manipulate its handles.

Bounding Box

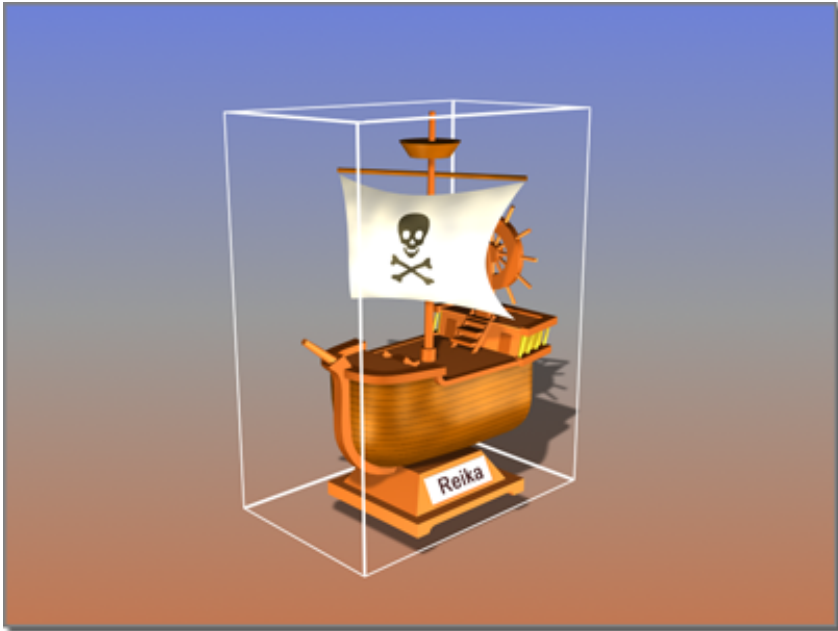

Bounding box shows the extents of the model boat.

The bounding box is the smallest box that encloses the maximum dimensions or [extents](#) on page 7969 of an object.

You can display selected objects in the scene as bounding boxes to speed up screen redraw. Use the [Object Properties dialog](#) on page 305.

The [Align command](#) on page 1009 uses the maximum and minimum extents of the object's bounding box to align objects.

Bulge

Physique allows you to “bulge” a mesh based on the orientation of a limb. Bulging the mesh is used to simulate muscle contraction.

Bulge Angle

In Physique, a bulge angle is a control that sets the limb angle where the bulge will occur. Typically you first orient the limb, and then set the bulge angle. After setting the bulge angle, you then deform the mesh to make it bulge.

BVH Files

BVH is the file name extension for the BioVision™ motion-capture file format. A BVH file contains the "actor's" skeletal and limb/joint rotation data.

NOTE For the BVH file specification, see the *BVH.rtf* document on the program disc.

By Layer



By Layer icon in the Layer Manager dialog

ByLayer is a property setting available to objects listed in the [Layer Manager](#) on page 7441, as well as from the [Object Properties dialog](#) on page 305. When By Layer is set, the object inherits settings for the selected property from its associated layer.

Center of Mass (COM)

The root object of a biped. Transforming the center of mass moves the entire biped. The center of mass can move outside of the biped body; for example, moving the center of mass forward can help simulate lifting a heavy object. The center of mass uses three animation tracks to animate the biped. Two of these tracks, Body Vertical and Body Horizontal, contain [biped dynamics](#) on page 7923 parameters.

Chamfer

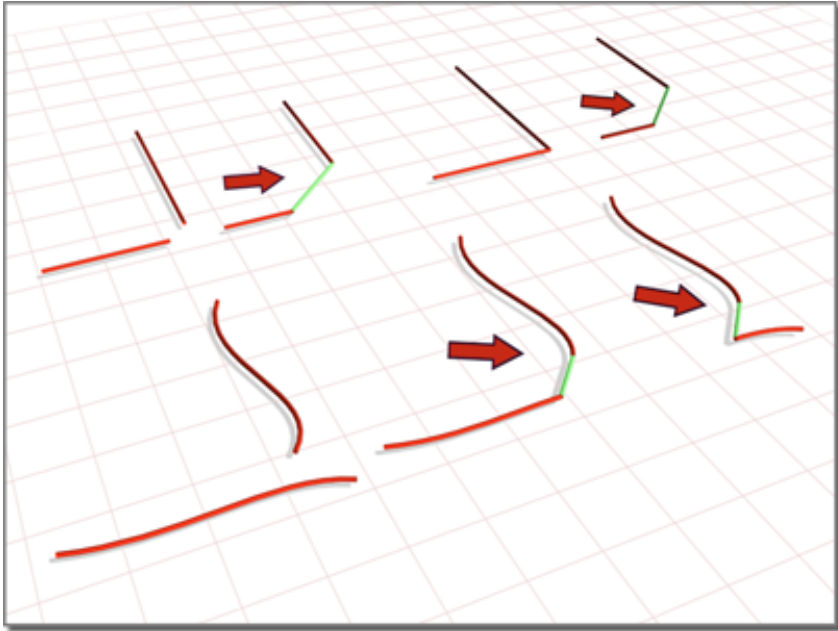

NURBS chamfer curves

A dependent NURBS object that is a line segment connecting two curves. It is controlled by the curves it connects, and by two length parameters that control the distance back from the point of apparent intersection of the "parent" curves.

character studio Marker Files

The **character studio** marker (CSM) file format stores motion-capture data in ASCII (text) format. It uses positional markers rather than limb rotation data. When you import a raw marker file, only marker position data is stored in the motion-capture buffer. **character studio** uses the marker data to extract limb rotation data to position the biped.

NOTE For the CSM file specification, see the *CSM.rtf* document on the program disc.

CIBSE Files

The CIBSE file type is the file format for photometric data adopted by the Chartered Institution of Building Services Engineers. It is used primarily in Great Britain.

Clip Controller

In [crowd animation](#) on page 4761, the GlobalMotionClip and MasterMotionClip controllers are used to create animation for multiple objects. Birds, butterflies, schools of fish, and bugs can be animated using these tools. Clip controllers can be created either as block controllers in Track View, or more directly in the [Crowd helper](#) on page 4819 controls on the [Global Clip Controllers rollout](#) on page 4916. Use clip controllers to animate non-biped creatures in crowds.

Clipping Planes

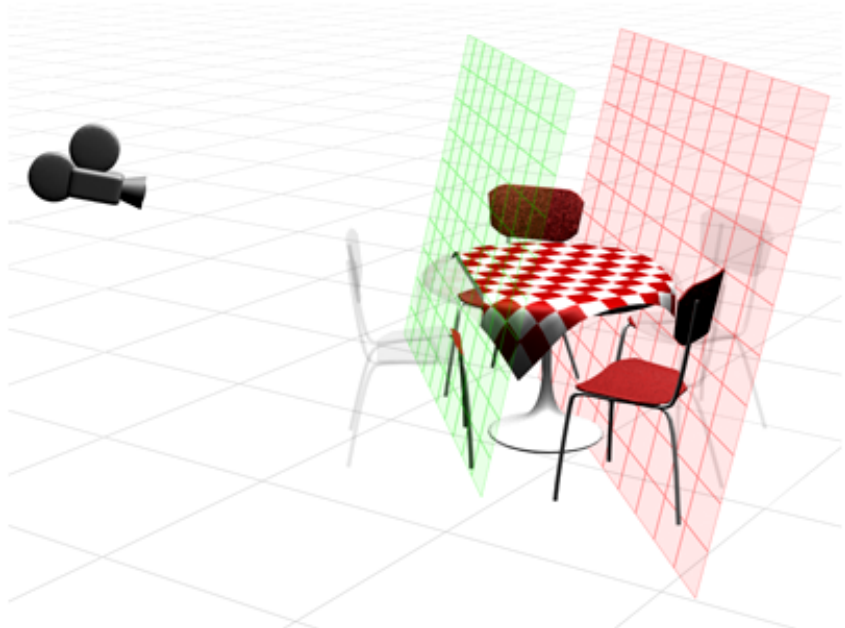

Clipping planes let you exclude some of a scene's geometry to view or render only certain portions of the scene. Each camera has a near and a far clipping plane. Objects closer than the near clipping plane or farther than the far clipping plane are invisible to the camera.

Clipping planes are useful for rendering selected portions of a scene that have a lot of complex geometry. They can also help you create cutaway views.

Clipping plane settings are part of the camera's creation parameters. The location of each clipping plane is measured along the camera's line of sight (its local Z axis) in the current units for the scene.

Clipping planes are part of a camera's [general parameters](#) on page 5210.

Viewports can also have clipping planes. You set a viewport's clipping planes via the [viewport right-click label](#) on page 7576.

Codec

Short for *compressor/decompressor*. An algorithm for compressing and decompressing digital video data, and the software that implements that algorithm.

Cognitive Controller

In [crowd animation](#) on page 4761, the [Cognitive Controller editor](#) on page 4857 lets you sequence different behaviors using state diagrams, where conditionals written in MAXScript impose changes in behavior. For example, you can specify that a character or object is to wander aimlessly until it comes within a certain distance of another object, whereupon it heads straight for that object. Or you can specify that one character is to avoid another only when the second character is avoiding the first.

Composite

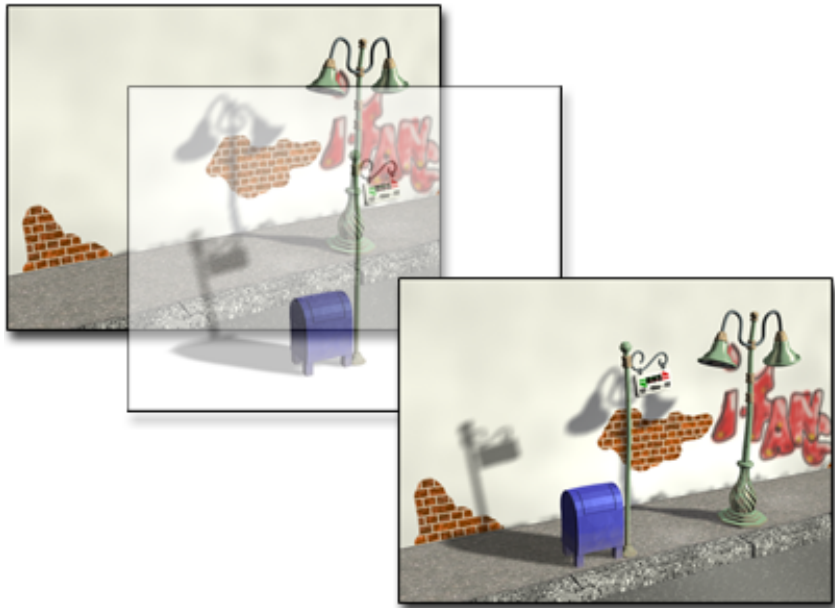

The mailbox with its shadow is composited with the wall and sidewalk to make the finished scene.

(noun) A still image or a motion picture created by overlaying one image or motion picture with another.

(verb) To combine still images or motion pictures by laying one over the other.

Compositing often makes use of an image's [alpha channel](#) on page 7905.

Compound Materials

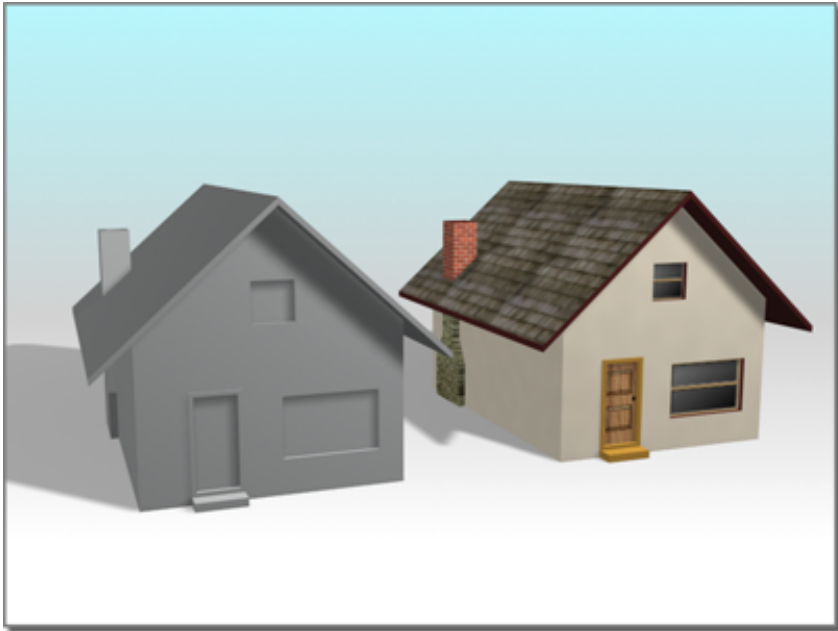

**House on right uses a compound material.
(House on left uses the default standard material).**

Compound (or complex) materials let you create a material consisting of two or more sub-materials.

The real power in using compound materials is that each sub-material can be as complex as any standard material.

The Multi/Sub-Object compound material lets you assign different materials to different sub-objects, at the sub-object level of your geometry.

You load or create compound materials using the Material/Map Browser.

For more information about the types of compound materials you can create, refer to [Compound Materials](#) on page 5706.

Constrained Point

A NURBS Point that is dependent on either another Point, Curve, or Surface, and whose position is either on the parent object or relative to it. The relative cases are XYZ-relative, along a normal, or along a tangent (or set of tangents for a surface-dependent constrained point).

Contact Object

In [Particle Flow](#) on page 2795, in the context of the [Shape Mark operator](#) on page 2911, a contact object is the object that will receive the marks created by the operator.

Containers

Containers are Track View items with multiple branches that provide a complete definition of something in your scene.

Container items that appear in Track View include:

- Materials definitions with all parameters, maps, and sub-materials.
- Maps containers with all map types and map parameters.
- Single Map containers with a single map type and its associated parameters.
- Object containers directly below a named object item defining the creation parameters of an unmodified object.
- Modified Object containers holding all of the modifiers applied to an object as well as the creation parameters.

Continuity

A property of curves, including NURBS curves. A curve is continuous if it is unbroken.

Continuity Level



Levels of curve continuity:

Left: C0, because of the angle at the top

Middle: C1, at the top a semicircle joins a semicircle of smaller radius

Right: C2, the difference is subtle but the right side is not semicircular and blends with the left

The level of continuity is a way to describe curvature. A curve with an angular cusp is C0 continuous. The curve is continuous but its derivative is not. A curve whose curvature changes has C1 continuity. The curve and its derivative are both continuous but its second derivative is not. A curve with uninterrupted, unchanging curvature has C2 continuity. NURBS curves must have at least C0 continuity; a continuity level greater than C2 is unnecessary for most 3D computer modeling.

Control Lattice

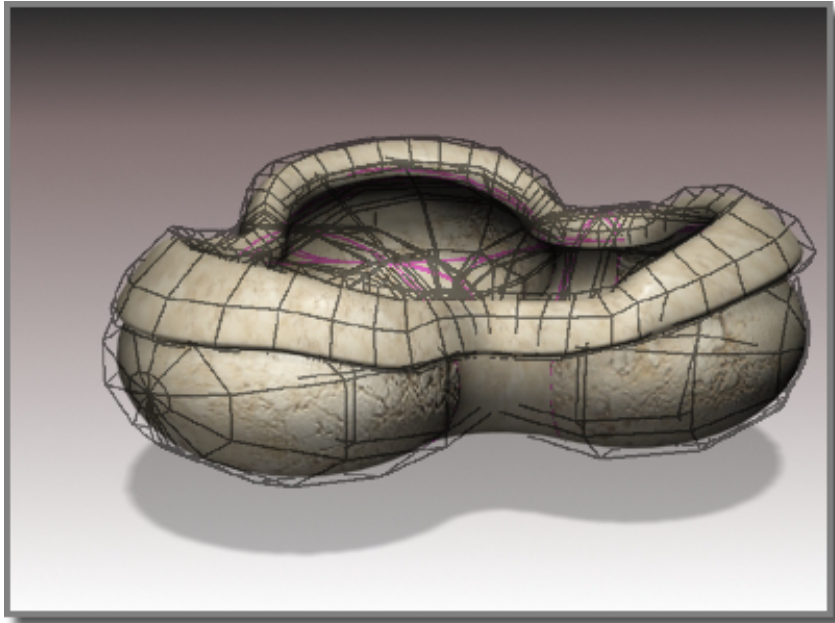

Control lattice surrounding the NURBS model of the fountain basin

In NURBS modeling, the lattice described by the CVs that specify a CV Curve or CV Surface. In viewports, this appears as a dotted yellow framework when you edit the curve or surface at the CV sub-object level. You can also choose to display the control lattice in viewports at all times.

Control Point

In Physique, a vertex used to control the cross sections of envelopes, bulges, and tendons.

Control Vertex (CV)

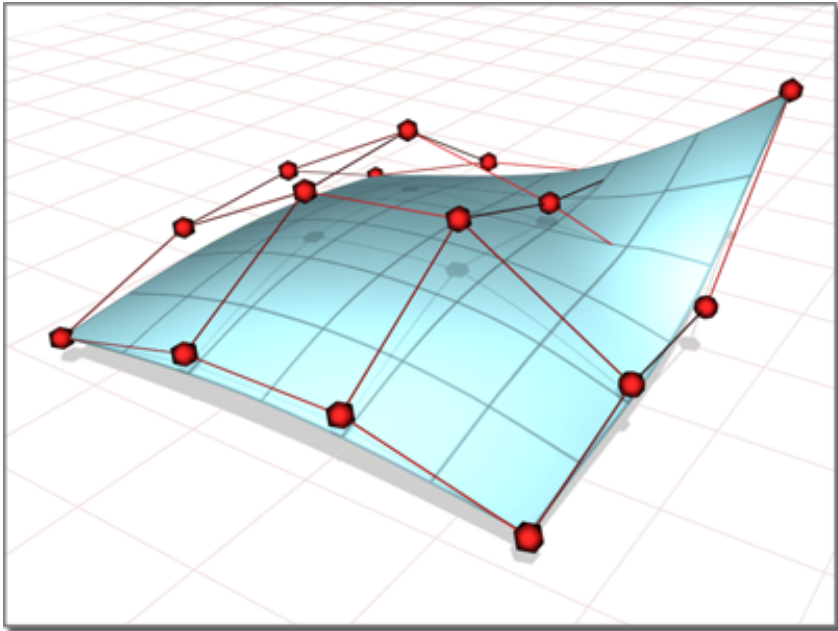

Control vertices in the lattice surrounding a NURBS surface

In NURBS modeling, a vertex that controls a CV Curve or CV Surface. The 3D location of each CV affects the shape of the curve or surface. CVs aren't constrained to lie on the curve or surface. Each CV has a rational weight that can be used to adjust the influence of the CV on the curve's or surface's shape.

Controller

Software that controls animation. Controllers handle the following functions:

- Storing animation key values
- Storing procedural animation settings
- Interpolating between animation key values

Convex Hull Property

The property of NURBS curves and surfaces whereby the control lattice described by CVs forms a convex hull surrounding the curve or surface.

Cool

It's useful to be able to edit a material in the Material Editor and have it immediately updated in the scene. Sometimes you want to work on a material without affecting the scene. You want to adjust a material until you're sure that it's what you want, and then reassign it. In other words, you want to *cool* a [hot material](#) on page 8006.

You cool a material by copying it in the Material Editor sample slots. You can copy a material in two ways:

- Use the Copy Material button.
- Drag and drop to copy the material.

When you drag to copy a sample, you end up with two materials with the same name, but one is cool while the other is hot. In the Material Editor, you can have up to 24 materials with the same name, but every material in your scene must have a unique name.

You can now adjust the cool material, and compare it with the hot material. If you like the changes you've made, you can update the scene.

Coordinate Space

In **character studio** biped animation, the three most-used coordinate spaces are world, object, and body space. These are often used to control the biped's hands and feet.

Another coordinate system is used for the footstep gizmos themselves: a foot on a footstep is in that footstep's coordinate space. If the footstep is moved, the foot moves also. (A sliding footstep is a footstep that moves relative to the coordinate system of the corresponding footstep gizmo.)

CPY Files

CPY files contain postures, poses and tracks you have copied and saved on the [Copy/Paste rollout](#) on page 4389. You can load a CPY created with one biped to another biped. See [Copying and Pasting Postures and Poses](#) on page 4281 and [Copying and Pasting Tracks](#) on page 4311.

Creation Parameters

An object's creation parameters are settings, typically available on its Parameters rollout, that you make when you first add the object to the scene. You can later adjust these settings by accessing the object at the bottom of its modifier stack. For example, a Box primitive's creation parameters are its size and number of segments in each of the three dimensions. You can usually adjust an object's size without scaling it by changing its creation parameters.

If you [collapse](#) on page 2016 an object, its creation parameters are lost, and can no longer be adjusted.

Cross Section

In Physique, [envelopes](#) on page 7963, [bulges](#) on page 7932, and [tendons](#) on page 8144 all have cross sections. Envelope cross sections can be moved and scaled to encompass more or less of the character's skeleton. In bulges, shaping the cross sections controls the amount of bulging and the appearance of the bulge. In tendons, cross sections provide connections between links and the mesh skin.

Crowd

The [Crowd helper object](#) on page 4819, available from Create panel > Helpers, serves as the command center for setting up and solving [crowd simulations](#) on page 4761. The Crowd helper object also lets you add behaviors to the scene, choose the current behavior from a list, and modify that behavior.

Crowd System

In [crowd animation](#) on page 4761, a crowd system comprises the [Crowd helper](#) on page 4819, one or more [Delegate helpers](#) on page 4811, a [Vector Field space warp](#) on page 4917, and [Motion Flow mode](#) on page 4545. These are used in combination to animate characters or other objects.

CSM Files

The CSM (**character studio marker**) file format stores motion-capture data. It is an ASCII (text) file that uses positional markers rather than limb rotation data. When you import a raw marker file, only marker position data is stored in the motion-capture buffer. 3ds Max uses the marker data to extract limb rotation data to position a biped.

NOTE For the CSM file specification, see the *CSM.rtf* document on the program disc.

Curve View

Curve View is the area of the Animation Workbench that displays function curves for the parts of the biped. Curve View is quite similar to the Key Window in the Track View – Curve Editor. The same navigation and key manipulation toolbars are used in both Curve View and the Key Window. Both Curve View and the Key Window let you add or delete, move or scale keys selected on the curves.

Curve View differs from the Key Window in that it also displays errors found by the Analyzer panel, functionality which is not available in the standard Track View. Curve View doesn't use soft-selection like the Key Window, instead it has a specialized Show Layered Edit command for the equivalent of soft selection on biped keys.

CV

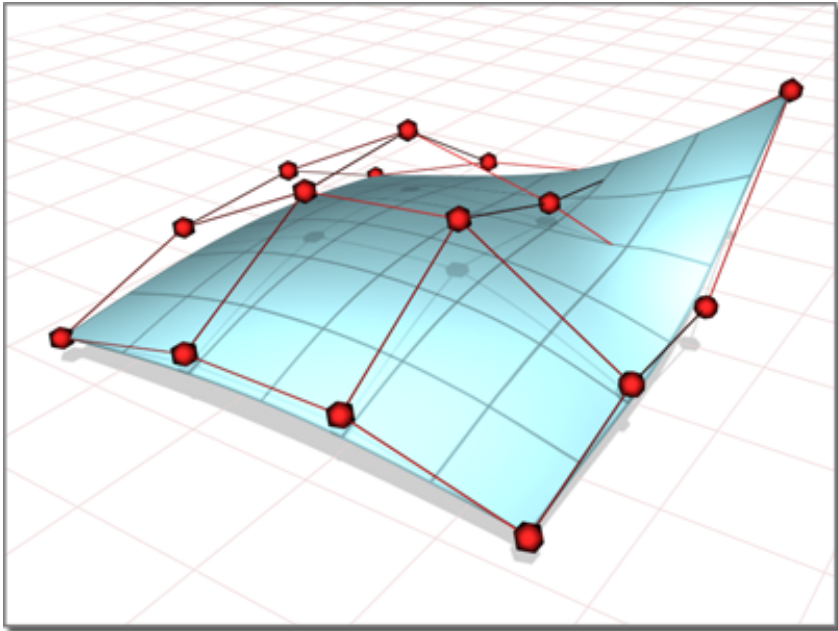

CVs (control vertices) in the lattice surrounding a NURBS surface

Short for *control vertex*.

In NURBS modeling, a vertex that controls a CV Curve or CV Surface. The 3D location of each CV affects the shape of the curve or surface. CVs aren't constrained to lie on the curve or surface. Each CV has a rational weight that can be used to adjust the influence of the CV on the curve's or surface's shape.

CV Curve

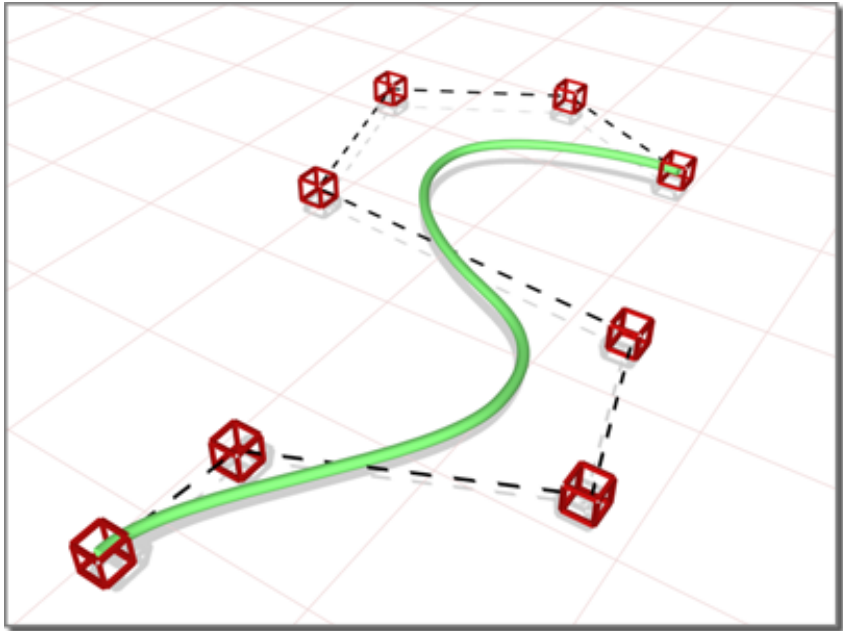

NURBS CV curve

A NURBS curve defined by CVs. The CVs don't necessarily lie on the curve. Instead, they form a control lattice that affects the curvature of the curve.

CV Surface

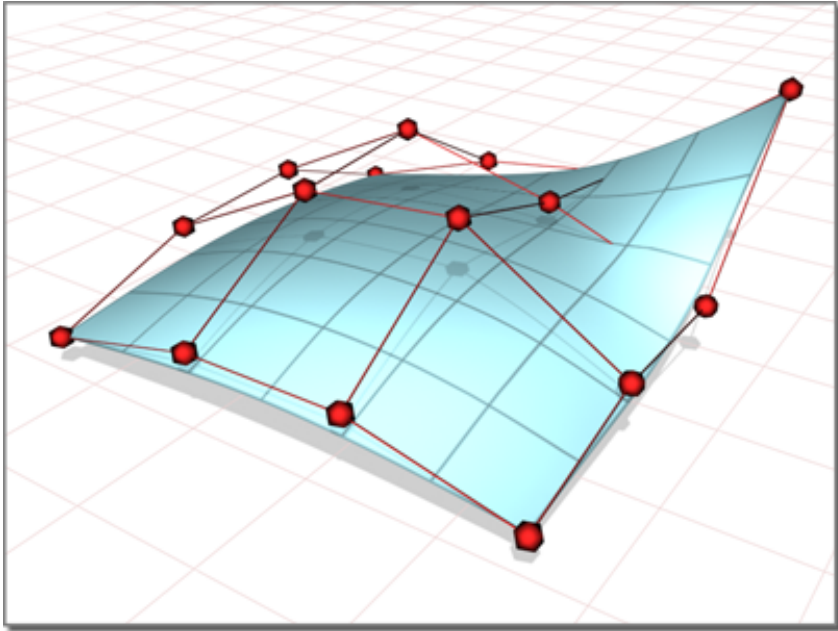

NURBS CV surface

A NURBS surface defined by CVs. The CVs don't necessarily lie on the surface. Instead, they form a control lattice that affects the curvature of the surface.

Deformable Envelope

In [Physique](#) on page 4603, [envelopes](#) on page 7963 follow the Physique [deformation spline](#) on page 7949 that runs through the joints in the skeleton's hierarchy. A deformable (as opposed to rigid) envelope is one that moves the mesh vertices it encloses as the skeleton moves.

A link can have both a deformable and a rigid envelope. When it has both, the effect of the two is averaged, creating a less flexible skin.

In character animation, you typically use deformable envelopes; however, some portions of the body, such as the head, might look best if they are rigid.

NOTE Because of game-engine restrictions, if you are developing for certain engines, you might want to use rigid envelopes exclusively.

TIP If your model consists of articulated rigid segments, such as a marionette, you might not need to use Physique at all. Simply link each part to the corresponding biped object.

Deformation

The effect caused by [Physique](#) on page 4603 on a mesh. Envelopes, bulges, link parameters, and tendons all affect how a mesh deforms.

Deformation Spline

The deformation spline is created when you initialize [Physique](#) on page 4603. It is a continuous curve through several points. The deformation spline is a smooth curve that runs from joint to joint.

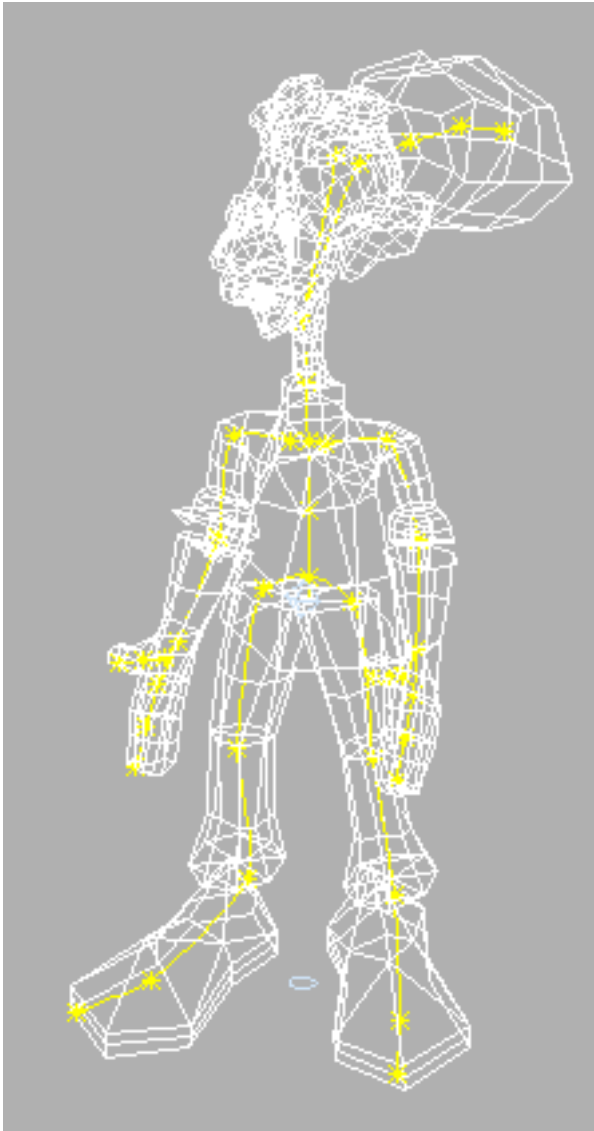

The deformation spline displays as a yellow curve that runs through the mesh.

The Bend, Bias, and Tension spinners can change the shape of the deformation spline.

The deformation spline also takes into consideration twisting and scaling of the skeleton's links. At the [Link sub-object level](#) on page 4725, you take control of the behavior of the deformation spline, and subsequently gain full control of the skin's behavior relative to the skeleton's movement.

Degree

The degree of a curve is the highest exponent in the equation used to represent it. A linear equation is degree 1, a quadratic equation degree 2. NURBS curves typically are represented by cubic equations and have a degree of 3.

Delegates

In [crowd animation](#) on page 4761, the Delegate helper serves as an agent for the motion created by a [Crowd object](#) on page 4819 and its behaviors. The Crowd object controls a delegate or delegates, whose motion can then be imparted to a biped or other object.

In viewports, the delegate object takes the shape of a pyramid. By default, the point of the pyramid indicates the delegate's forward direction. Delegates cannot be rendered.

Dependent

A dependent is an object whose behavior or appearance can be influenced by other objects. Dependents include [instances](#) on page 8014, [references](#) on page 8106, and objects sharing a common modifier (the same objects that appear green when Show Dependencies is on in the View menu). Also, an object whose motion is [constrained](#) on page 3287 by another's is a dependent of the constraining object.

See also:

- [Select Dependents](#) on page 7389 in the Scene Explorer dialog

Dependent (NURBS)

Describes a NURBS sub-object whose definition depends on other NURBS sub-objects. For example, a Blend Curve depends on the two curves that you select when you create it.

Depot

The depot is the section of the [Particle View dialog](#) on page 2811 that holds the Particle Flow [actions](#) on page 2838. In effect, it serves as a library of Particle Flow functionality. Display of the depot can be toggled with the Particle View menu command Display > Depot.

To add an action to the particle system, drag it from the depot to the [event display](#) on page 2822. To view a description of an action in the [description panel](#) on page 7953, click its entry in the depot.

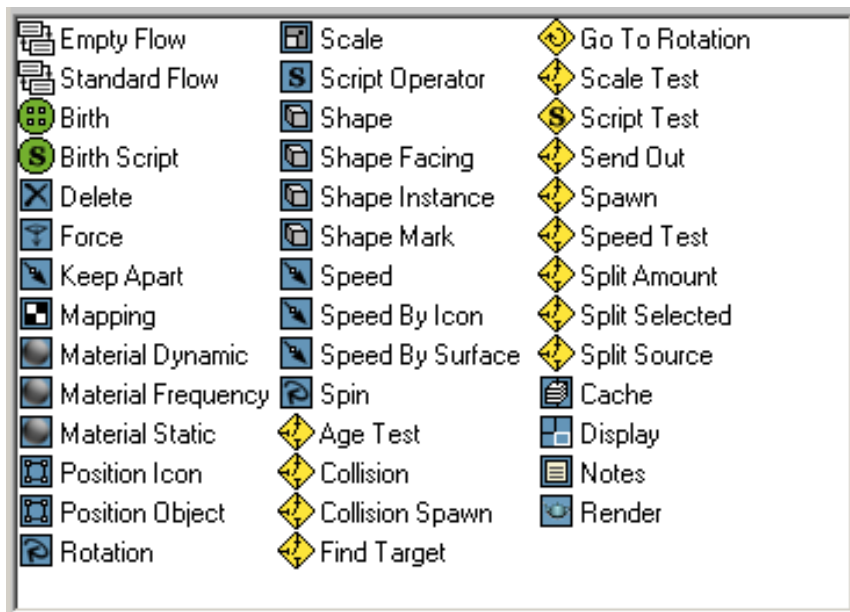

Description Panel

The description panel, found to the right of the [depot](#) on page 7952 in [Particle View](#) on page 2811, displays a text description of any action whose name you click in the depot. Display of the depot can be toggled with the Particle View menu command Display > Description.

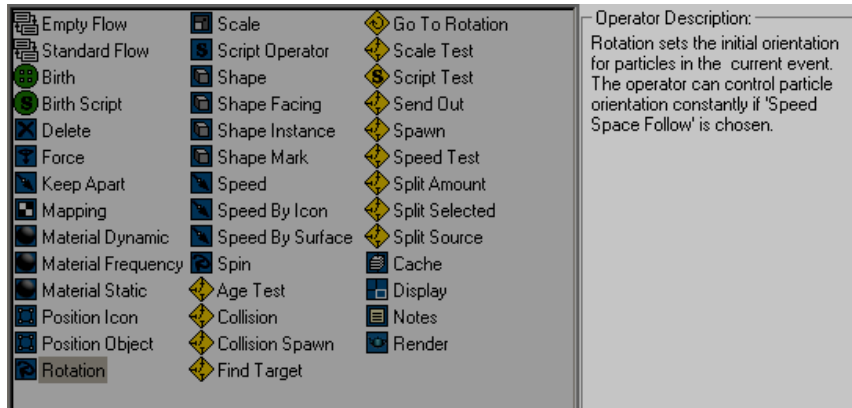

Diagonal

A diagonal is a line that connects polygon vertices in editable poly and Edit Poly objects. Its function is primarily to resolve the polygon into triangles at render time, especially if the polygon becomes non-planar via transformation of its vertices. Such transformation and certain other operations can, incidentally, cause automatic rearrangement of a polygon's diagonals.

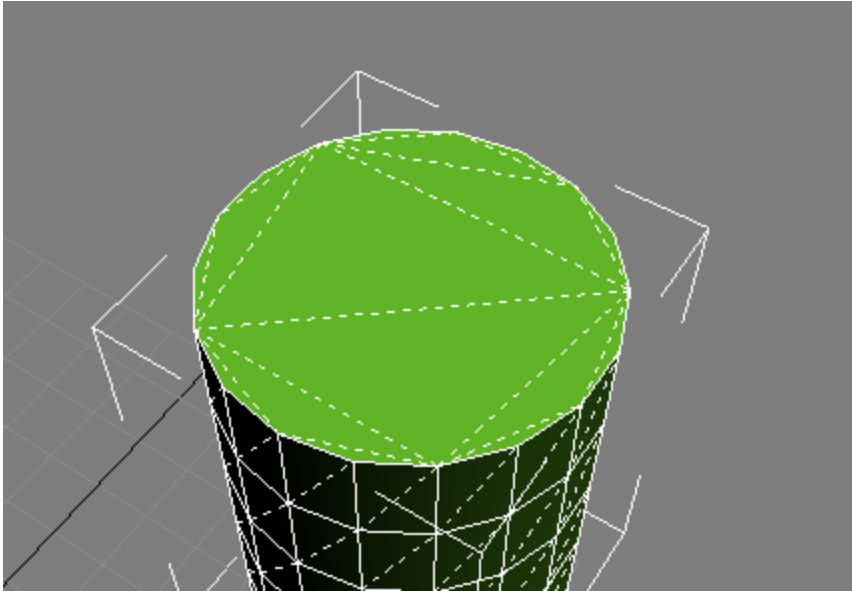

Diagonals on the default Cylinder primitive

Diagonals are normally invisible, but in 3ds Max they appear as dashed lines when you use the Turn or Edit Triangulation tool. Unlike edges, diagonals cannot be transformed, or acted upon with tools like Chamfer. This is different from the hidden edges in editable mesh/Edit Mesh objects, which are actual edges and can be made visible, transformed, and manipulated with any editing tool.

Diffuse Color

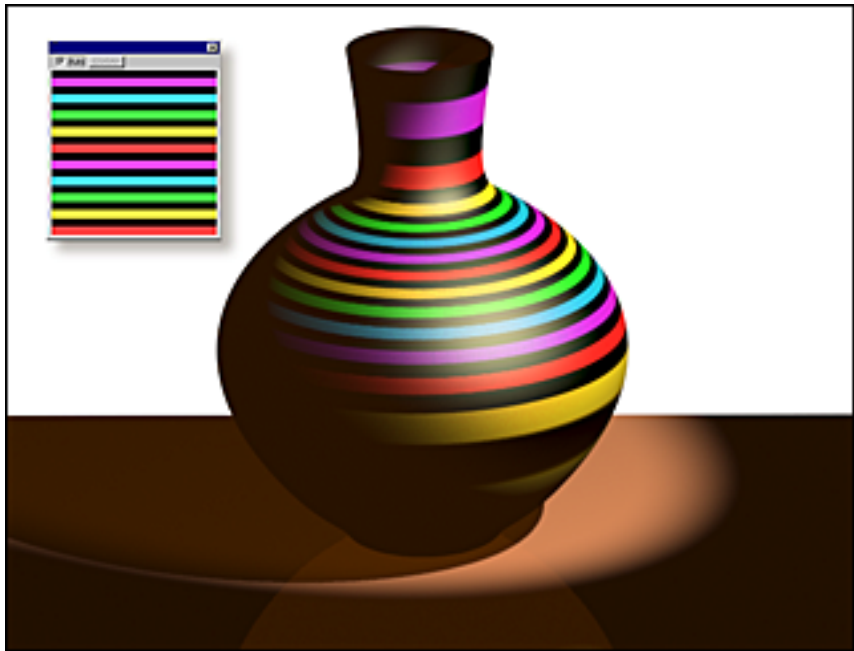

Vase has a mapped diffuse color.

The diffuse color is the color that an object reflects when illuminated by "good lighting," that is, by direct daylight or artificial light that makes the object easy to see.

When we describe an object's color in conversation, we usually mean its diffuse color.

The choice of an ambient color depends on the kind of lighting: for moderate indoor lighting it can be a darker shade of the diffuse color, but for bright indoor lighting and for daylight, it should be the complement of the primary (key) light source. The specular color should be either the same color as the key light source, or a high-value low-saturation version of the diffuse color.

Dithering

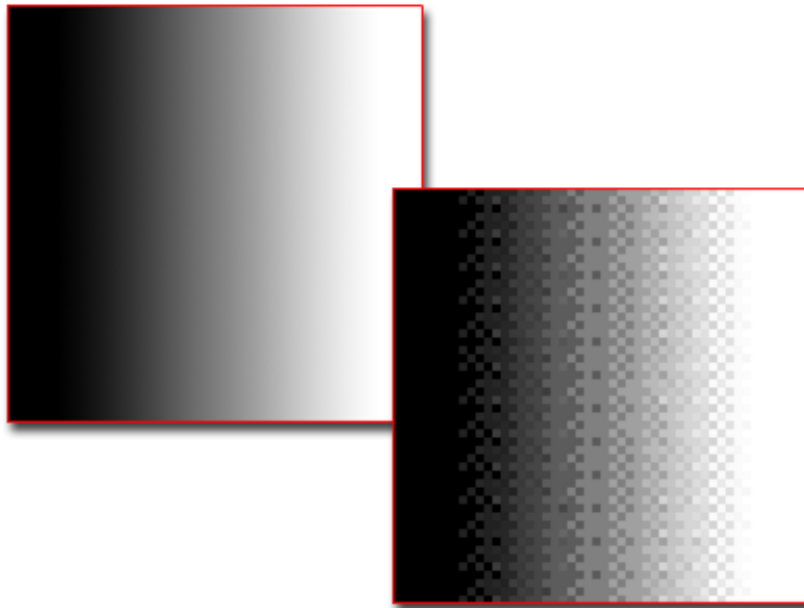

Square on the right shows dithering.

When converting an image with a palette of a greater number of colors to an image with a palette of fewer colors, dithering is a means of simulating colors not in the more limited palette, by mixing different-colored pixels together.

Dithering is also a method of smoothing the edges between two color regions by mixing their pixels so the edges appear to blend together.

If you are rendering for the limited colors of an 8-bit display (256 colors), you have the option of turning on dithering. Dithering can help prevent a banding effect in color gradients. Dithering does increase the size of 8-bit files and can slow the playback speed of animations. You might want to try applying maps to the flat areas in the scene to see if that eliminates banding before you turn on dithering.

By default, 3ds Max renders 64-bit color output. Consequently, you also have the option of setting dithering for [truecolor \(24 or 32-bit color\)](#) on page 8159. The Dither True Color option ensures that you get the best quality on truecolor displays.

You turn dithering on and off in the [Rendering panel](#) on page 7768 of the Preferences dialog. You can also set dithering for scene motion blur in Video Post. Here, dithering provides a smoothing effect between the separate images making up the "blur." Video Post dither is set as a percentage of total dither.

Dock and Float

These terms describe manipulations to user-interface elements, such as toolbars.

You *dock* a toolbar, for example, when you align it with the edge of another interface element, typically a window or panel.

You *float* a toolbar when you detach it from a stationary position, and reposition it elsewhere on the desktop.

Double Support Period

In [footstep animation](#) on page 7986, a period where both of the biped's feet are on the ground.

Dummy Object

A dummy object is a non-rendering object that you use as an animation helper. The primary use of the dummy helper object is to assist you in creating complex motions and building complex hierarchies. Because dummies are invisible in the rendered scene, they are an excellent choice for offset joints, connectors between objects, and handles for manipulating complex hierarchies.

Breaking complex motions into simple components often makes it easier to go back and edit your animations. For example, consider animating a bouncing ball moving around your scene. You could animate the ball by properly positioning it throughout the scene on many frames. The drawback is that it would be very difficult for you to go back and adjust the height of the bounce or the path the ball takes through the scene. You would have to edit the motion of the ball on many frames to make even a simple change.

Using a dummy object easily solves this problem by breaking the motion into two simple components. One component is the bounce of the ball. The other is the path through the scene.

DWG Files

The DWG file is the primary, native file format of drawing files created by AutoCAD, Autodesk Architectural Desktop, and Autodesk Mechanical Desktop®. It is a binary format used for importing and [exporting](#) on page 7206 AutoCAD drawing files.

You can also use the [File Link Manager](#) on page 6987 to create a live link between a drawing file that can be open in AutoCAD and 3ds Max. Changes that are made to the drawing can automatically be updated in 3ds Max without having to reload scenes or re-import drawings.

DXF Files

DXF files are used to import and export objects to and from AutoCAD (and other programs that support this file format).

Keep the following in mind when you are creating your DXF geometry, and when you are deciding whether to convert by layer, color, or entity:

- With AutoCAD Release 12, if you are using the AutoCAD Advanced Modeling Extension (AME), use the SOLMESH command on your AME models prior to saving the *.dxf* file.
- After importing a DXF file, you might want to divide the resulting 3ds Max file into smaller objects.

Entities that are frozen or turned off are ignored.

The successful unification of face normals depends on the welding of coincident vertices. Sometimes, depending upon the precision of the model as it was created in AutoCAD, the vertices may not be close enough to be considered "coincident." They will not be welded, and the faces will not be properly unified. In this case, increase the Weld Threshold value in the Import DXF File dialog.

Converting by layer can result in objects consisting of many [elements](#) on page 7962. In certain cases, some of these elements may have all of their face normals flipped the wrong way. You can detect this in the software by turning off Backface Cull in the Display panel, or by rendering the objects. Use the [Normal modifier](#) on page 1581 to correct this.

If you do not want to flip normals, you can either use 2-sided materials, or turn on the Render Setup dialog > [Force 2-Sided option](#) on page 6128.

If you are loading a large scene containing thousands of entities (such as 3D faces) and have chosen to load an object by entity, the conversion can take a long time. It also produces a huge number of objects to handle in the software. To avoid this, organize your DXF file so that these kinds of entities are grouped by layer, then make the conversion by layer rather than by entity.

Dynalector

A [space warp](#) on page 8132 that lets particles affect objects in a dynamics situation.

Three kinds of space warps are in the dynalector category:

[PDynaFlect Space Warp](#) on page 2738

[SDynaFlect Space Warp](#) on page 2745

[UDynaFlect Space Warp](#) on page 2748

See also:

- [Omniflector](#) on page 8067

Dynamics

[Biped Dynamics](#) on page 7923 calculate a biped's airborne trajectory, the bending of its knee or knees on landing, and the biped position so it maintains balance when the spine is rotated. When parameters change, dynamics cause the biped to adapt.

Dynamics Blend

A parameter in the Body section of the [Key Info rollout](#) on page 4367, used with [freeform animation](#) on page 7988. Blends between biped and spline dynamics. Select the Body Vertical track (the vertical track of the biped's center of mass), and use Dynamics Blend to control the amount of gravity in an airborne period, such as in a running or jumping gait. Dynamics Blend has no effect on a walking motion where footsteps overlap.

Ease Curve

Ease curves vary the timing of a function curve. An unaltered function curve charts the value of an animated parameter over time. An ease curve charts changes to the timing of the function curve. Changing ease curve values shifts the time of the original track left or right.

The horizontal scale of an ease curve represents normal time, just as it does for all function curves. The vertical scale of an ease curve represents the time scale of the function curve the ease curve is applied to. Changing the shape of an ease curve changes the way time is interpreted by the affected function curve.

The value of the ease curve at a particular frame is a frame value from the original track. For example, if the ease curve is 0 at frame 0 and 10 at frame 10, the original track plays at its original speed. If the ease curve value at frame 10 increases to 20, the original track plays to frame 20 by frame 10: it has been sped up by a factor of two.

An Ease Curve Example

Imagine you have animated a bird flying around the sky. After viewing the animation you decide that you want to change the position of the bird so it moves quickly at the beginning of the animation and then slows to a leisurely pace toward the end.

You could accomplish this change by editing position keys, ranges, and function curves but it would require more work than using an Ease curve. Applying an Ease curve to the Position track provides a quick and easy solution.

Dragging the Ease curve causes time to compress near the beginning of the animation and stretch out near the end. You can tell that the bird's motion starts out fast and then slows down by looking at the effect the Ease curve has on the Position function curves.

See also:

- [Multiplier Curve](#) on page 8056

Edge

An edge is a straight or curved line that connects two vertices in a mesh object or spline. You can modify object shapes by transforming its edges; in effect, by doing so you're moving two vertices simultaneously.

Editable Mesh

An [editable mesh](#) on page 2075 is a type of deformable object. An editable mesh is a trimesh: that is, it uses triangular polygons. Editable meshes are useful for creating simple, low-polygonal objects or control meshes for MeshSmooth and HSDS modelling. You can convert a NURBS or patch surface to an editable mesh. Editable meshes require little memory, and are a natural method of modeling with polygonal objects.

An actively linked object cannot be collapsed to an editable mesh. Using the [File Link Manager](#) on page 6987, you have to Bind the object first.

Editable Poly

An [editable poly](#) on page 2123 is a type of deformable object. An editable poly is a polygonal mesh; that is, unlike an editable mesh, it uses more than three-sided polygons. Editable polys are useful in that they avoid invisible edges. For example, if you use a cut-and-slice operation with editable polys, the program doesn't insert extra vertices along any invisible edge. You can convert NURBS surfaces, editable meshes, splines, primitives, and patch surfaces to editable polys.

Element



The antler is one element of the moose head.

An element is one of two or more individual mesh objects (that is, groups of contiguous faces) grouped together into one larger object. For example, if you attach one box to another, you create one mesh object from the two boxes. Each box is now an *element* of the object. Any function you perform on that object affects all its elements. However, you can manipulate the elements independently at the Element sub-object level.

Emitter

An emitter is an object that emits particles; particles are born, or first enter the scene, at the emitter's location. By default, Particle Flow uses the [source icon](#) on page 2829 as an emitter, but alternatively any other object in the scene can emit particles using the [Position Object operator](#) on page 2853.

End Effector

In [history-dependent inverse kinematics \(HD IK\)](#) on page 3422, the end effector is the pivot point of the selected child object at the end of a kinematic chain.

The kinematic chain is a single branch of a hierarchy used for animation with [inverse kinematics \(IK\)](#) on page 8016. The chain starts with the selected child object and travels up through ancestors until it reaches the start of the chain. When you move the end effector, the HD IK solver then uses IK calculations to move and rotate all other objects in the kinematic chain to react to the object you moved.

The end effector has two transforms: one that connects it to its parent, and another that connects it to the End Effector Parent. By default, the End Effector Parent is none (equivalent to World); you can assign this in the Motion panel.

NOTE You can move the end effector away from the child object, which causes the IK chain to straighten out. When you move the end effector back toward the child object, joints in the IK chain will bend again.

See also:

- [IK Goal](#) on page 8008

Envelopes

In [Physique](#) on page 4603, the envelope is the primary tool for controlling skin deformation. An envelope defines an area of influence about a single link in the hierarchy. If the envelope is [deformable](#) on page 7948, mesh vertices within that envelope follow the movement of the Physique [deformation spline](#) on page 7949. An envelope has a pair of inner and outer bounds; the envelope's influence is strongest at the inner bound, and falls off toward the outer bound. By default, each envelope has four cross sections. You can reshape the cross sections, or add new ones, to change the envelope's geometry.

In the [Skin modifier](#) on page 1672, the envelope plays a similar role with respect to bones. Each bone has its own envelope with two or more cross-sections that allow you to shape the envelope to fit the surrounding mesh.

Typically, the envelopes of adjacent links or bones overlap each other. Vertices that fall in the overlap area are weighted to produce smooth blending at joint intersections.

Environment Map

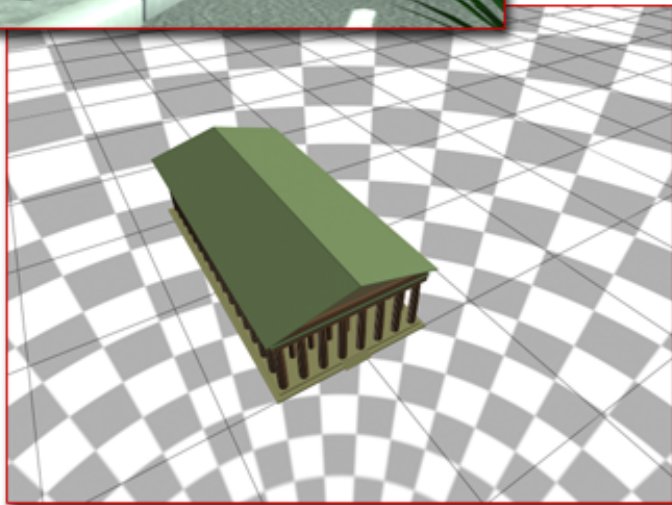

Above: Image uses a picture in screen coordinates as a background.

Below: Image shows spherical mapping coordinates applied using a checker map.

Texture coordinates lock a map to geometry. Environment coordinates, on the other hand, lock a map to the world. If you move the object, the map remains in place. If you move the view (or camera), the map changes. This

type of mapping system is used with reflection, refraction, and environment maps.

There are four types of environment coordinates:

- Spherical
- Cylindrical
- Shrink-Wrap
- Screen

The first three are the same as those used by the [UVW Map modifier](#) on page 1931. If you imagine a sphere, infinite in size, surrounding your scene and mapped with spherical mapping coordinates, you can visualize the effect you get with spherical environment mapping. Shrink-wrap wraps the map around a giant sphere, leaving only one singularity. Cylindrical is like a giant cylinder.

The Screen system maps the image directly to the view, with no distortion. It's similar to planar, in that it's like a giant backdrop hung in the scene. Unlike the other environment mapping methods, Screen is locked to the view. When you move the camera, the map moves with it. Therefore, you can only use it for still renderings, or animations in which the camera doesn't move.

To use a bitmap with any environmental mapping system other than Screen, you need a high-resolution map because of the size of the virtual sphere, or cylinder.

An environment map is not assigned in the Material Editor, because it's not applied to the geometry of an object, but rather to the scene itself. Environment maps appear in the background, as seen from the camera or perspective view.

When you assign a map to the environment, it's the same as if you'd assigned a mapped material to an object in your scene. To edit or adjust the assigned map, you need to place it in one of the sample slots in the Material Editor. You can do that in one of two ways:

- Click the Get Material button in the Material Editor, and then get the map from the scene.
- Put the map from the Environment dialog to one of the sample slots in the Material Editor. You can do this by dragging and dropping from the Environment dialog map button to the sample slot.

NOTE To control whether or not the renderer uses the environment map's alpha channel in creating the alpha for the rendered image, choose Customize > Preferences > Rendering, and then turn on Use Environment Alpha in the Background Antialiasing group. If Use Environment Alpha is turned off (the default) the background receives an alpha of 0 (completely transparent). If Use Environment Alpha is turned on, the alpha of the resulting image is a combination of the scene and background image's alpha. Also, when writing TGA files with Pre-Multiplied Alpha set to off, turning on Use Environment Alpha prevents incorrect results. Note that only background images with alpha channels or black backgrounds are supported when compositing in other programs such as Photoshop.

Event

The event is the basic unit of organization in a Particle Flow [particle diagram](#) on page 8081. There are two types of events: [global](#) on page 7997 and [local](#) on page 8027. A [birth event](#) on page 7924 is a specialized type of local event.

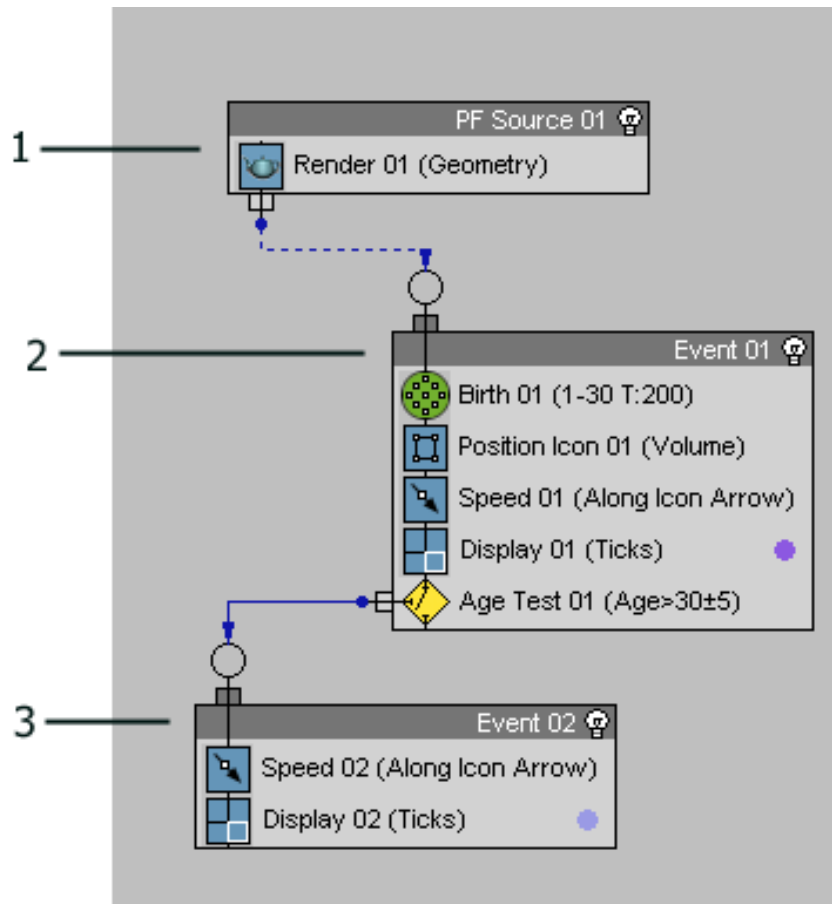

1. Global event
2. Birth event
3. Local event

Each event contains one or more [actions](#) on page 7897, which can affect particle behavior or appearance. You can use [tests](#) on page 8147 to send particles to other events if the particles meet certain qualifications. A single chain of linked events as shown in [Particle View](#) on page 2811 is known as a [flow](#) on page 7983.

Event Display

The event display, the main window in the [Particle View](#) on page 2811 dialog, contains the [particle diagram](#) on page 8081. This is where you build and edit the particle system.

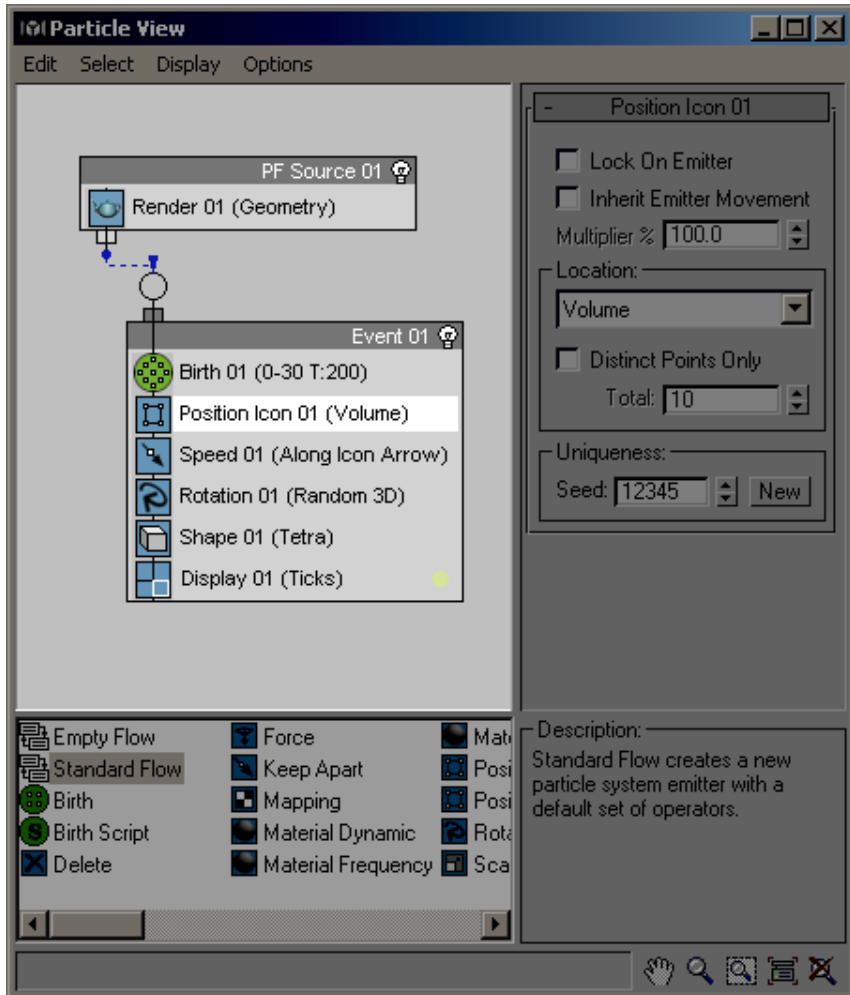

Event Level

In Particle Flow, you can select particles at the Event level or at the [Particle level](#) on page 8082, using controls on the Modify panel > [Selection rollout](#) on page 2833. An Event-level selection can be passed to the Particle level for processing by the particle system by means of the Selection rollout > Get From Event Level command.

Extents



Bounding box shows the extents of the model boat.

An object's extents are its maximum dimensions in X, Y, and Z. These are the dimensions of the rectangular [bounding box](#) on page 7932 that surrounds the object.

Face/Polygon

When you render a scene containing geometry, 3ds Max uses the faces and polygons in a [mesh object](#) on page 8043 to draw the object surfaces. Essentially, faces and polygons are planar objects that fill in the gaps between edges in the object structure. A face typically has three sides; a polygon can have three or more sides. You can treat a polygon as a single object while modeling, but at render time, 3ds Max breaks down all polygons into triangular faces.

Faceted

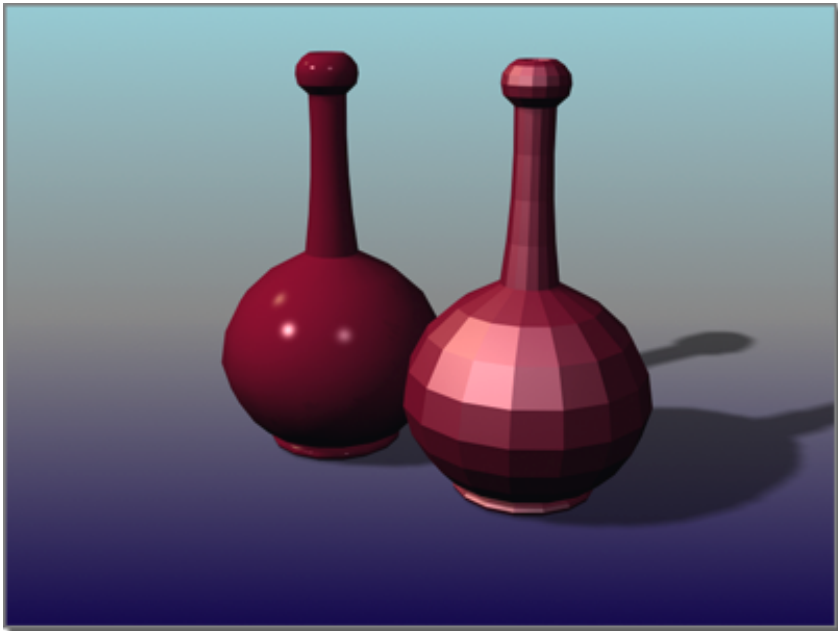

Vase on the right uses a faceted material.

Faceted shading provides a constant shading across each facet, or co-planar surface of the object. The result has the appearance of so-called "flat" shading, except that it provides specular highlights.

Turn on Faceted to provide a faceted look to your geometry without having to explicitly change the smoothing groups in the object with the Edit Mesh modifier.

Both [Standard](#) on page 5395 and [Raytrace](#) on page 5490 materials provide a Faceted toggle.

FFD

FFD stands for *free-form deformation*. It is used in computer animation for effects like dancing cars and gas tanks. You can use it as well for modeling rounded shapes such as chairs and sculpture.

An [FFD modifier](#) on page 1454 surrounds the selected geometry with a lattice box or cylinder. By adjusting the control points of the lattice, you deform the enclosed geometry.

NOTE You can use [Physique](#) on page 4603 to control an FFD space warp. Physique actually deforms the space warp's control points, which in turn deform the model.

FGM File

An FGM file (*.fgm*) is a final gather map file. It is used by the [mental ray renderer](#) on page 6230 to save the results of a final gathering pass. Generating and saving an FGM file can speed up subsequent renderings.

Field of View

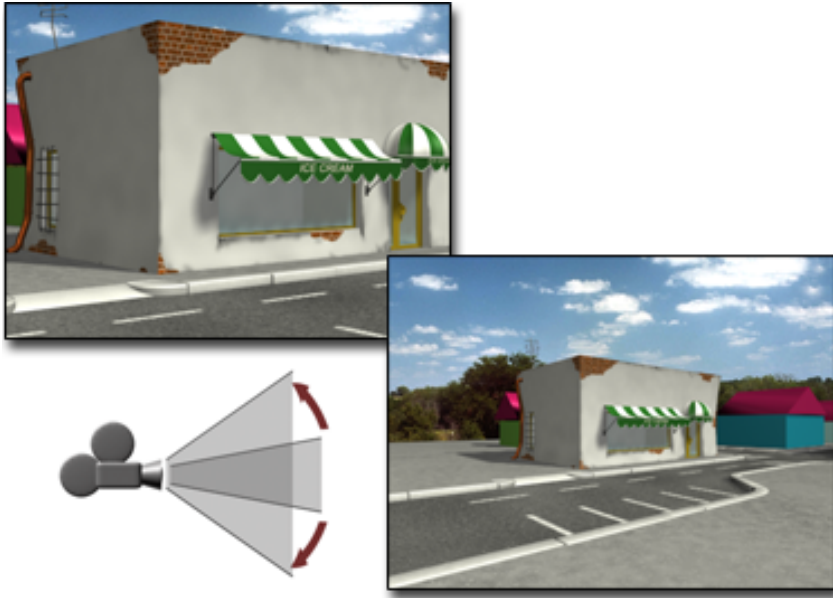

Above: Narrow field of view

Below: Wide field of view

Field of View defines the width of your view as an angle with its apex at your viewpoint and the ends at the sides of the view. The effect of changing FOV is similar to changing the lens on a camera. As the FOV gets larger you see more of your scene and the perspective becomes distorted, similar to using a wide-angle lens. As the FOV gets smaller you see less of your scene and the perspective flattens, similar to using a telephoto lens.

A Perspective view uses an imaginary camera with only one setting, FOV. The FOV angle for the active Perspective view is displayed in the Rendering Methods panel of the Viewport Configuration dialog. You can type a value in the FOV field of the dialog to precisely set FOV for the active Perspective view.

Use Field of View (FOV) to change the amount of the scene visible and the amount of perspective flare applied to a Perspective or Camera view. The Field of View button appears in the viewport navigation control panel when a Perspective or Camera view is active.

Fields

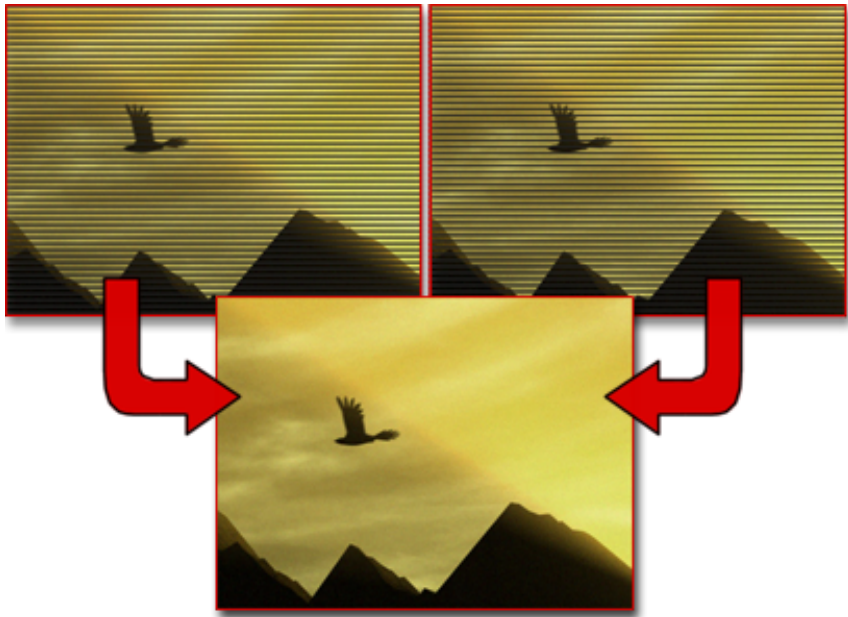

Two fields combine to make a single frame.

Your animations might ultimately be viewed on television monitors. Standard video signals display animation by breaking it down within time segments (frames). The image for each frame is split into horizontal lines (scan lines). A special method for conveying frame information on a video signal has been developed. This method is called field interlacing. Television monitors display a video signal by separately scanning two portions of each frame called fields. One field contains the odd scan lines of a frame, the other field contains the even scan lines. Television monitors scan and display the fields of each frame separately. The fields are alternately cycled through every other horizontal line on the screen so that they "layer" together to form a single interlaced image.

Render to Fields

On the Render Setup dialog, in the [Common Parameters rollout](#) on page 6121 > Options group, the Render To Fields check box sets whether the renderer renders full frames at the specified frame rate, or renders fields at twice that rate. When Render To Fields is on, the renderer renders an extra sub-frame

image between every two frames, and composites each frame and the following sub-frame into a single image with two fields. The result is a 60 fields-per-second animation suitable for play on an [NTSC](#) on page 8059 television monitor.

Field Order

When you render to fields, you also specify a field order to identify which field comes first. The Field Order configuration setting is found in Preferences, on the Rendering page. A frame's scan lines are numbered and each field contains either the odd or even scan lines. The video source (for example, broadcast transmitter, video tape recorder, or digital video recorder) determines which group of scan lines is in each field and which group is delivered to the display first. The fields are referred to as Field 1 (F1) and Field 2 (F2); either could contain the odd numbered (1st, 3rd, 5th, and so on) scan lines or the even numbered (2nd, 4th, 6th, and so on) scan lines in the frame.

Using the default setting of Odd as your Field Order preference, the software renders the first field image (F1) to the odd scan lines. If the field order preference is set to Even, then the first field image is rendered to the even scan lines. For an image to display properly, the field order and the video device field order must match.

Some video systems require odd lines to be rendered first, and others require the even lines to be recorded first. The Field Order parameter is set to Odd by default. If you observe incorrect strobing in your video output, change the parameter to Even.

Figure Mode

When you work with a [biped](#) on page 4147, you use [Figure mode](#) on page 4420 to fit the biped to the [mesh or mesh objects](#) on page 8043 that represent your character. You should have Figure mode turned on when you attach the mesh to the biped with [Physique](#) on page 4603. Figure mode is also used to scale a biped that has a mesh attached to it, to make biped "fit" adjustments after Physique is applied, and to correct posture for motion files that need a global posture change.

When Figure mode is turned on, the biped jumps from its animated position to its Figure mode pose. Animation is preserved when you exit Figure mode.

The parameters on the [Structure rollout](#) on page 4424 are active only in Figure mode, and at creation time.

Fillet

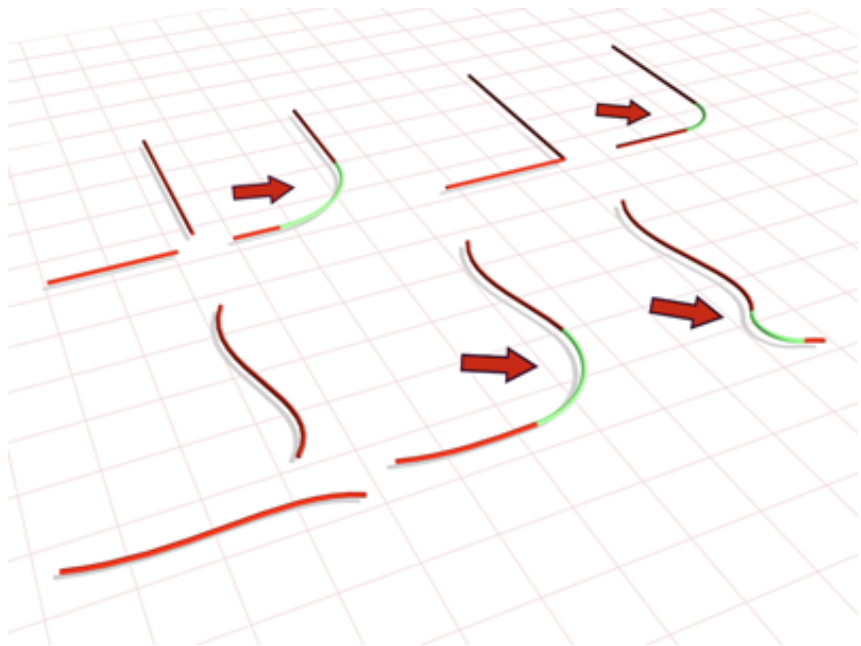

NURBS fillet curves

A dependent NURBS object that is an arc connecting two curves. It is controlled by the objects it connects, and by a radius parameter.

Filter Color / Filter Opacity

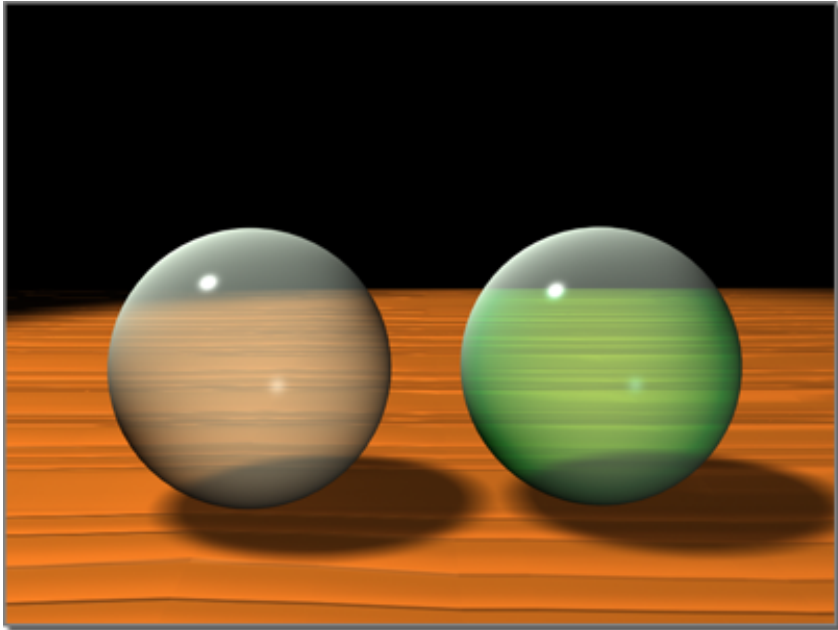

Sphere on the right has a light green opacity filter color.

Filter opacity tints the colors behind the material using a specified transmission color.

Filter opacity is the default system, because it provides a more realistic transparency effect. When the Filter option is set in the Extended Parameters rollout, the color used by the Filter Color swatch tints the transparency of the material.

In life, a transparent material, such as colored glass, affects the colors behind it not by the diffuse or ambient colors (which are reflected colors), but by the transmission color.

The transmission color is that property of a substance that filters certain colors, and allows others to pass. For example, a sheet of red cellophane is a filter that blocks all light not in the red wavelength of the spectrum. By using filter opacity, you can specify a transmission color and achieve strong, saturated colors, no matter how transparent the material.

Filtering (Antialiasing)

Filtering is a technique of antialiasing the bitmaps in mapped materials by averaging pixels. The Pyramidal and Summed Area options provide two methods of pixel averaging. Only one can be active at a time.

Both methods require approximately the same rendering time. Summed-area filtering generally yields superior results but requires much more memory. Pyramidal filtering requires the program to allocate memory equal to approximately 133% of the size of the bitmap. By comparison, summed-area filtering requires the program to allocate approximately 400% of the size of the bitmap.

Use summed-area filtering only for smaller bitmaps, and avoid using any more such bitmaps in a scene than necessary.

Pyramidal filtering is quite adequate for most purposes. However, because it applies filtering as a function of distance, irregular antialiasing might occur on detailed texture maps that are applied to a plane receding into the distance. The effect of pyramidal filtering on extreme perspectives such as this is even more noticeable in animations, where portions of the texture map appear to "swim." If this occurs, turn on summed-area filtering for the material.

NOTE To control whether or not a background image is affected by the renderer's antialiasing filter, choose **Customize > Preferences > Rendering** on page 7768 and then turn on **Filter Background** in the **Background Antialiasing** group.

Filtering (Character Animation)

Filtering is the action of using selected data, rather than all data.

In the **Motion Mixer** on page 3699, you use the **trackgroup** on page 8151 filter to select the biped parts that will be affected by motion clips and transitions on tracks within the trackgroup. See **Filtering Mixer Tracks** on page 3715.

Filtering is also a **motion-capture technique** on page 4574. Motion-capture and marker data typically have keys at every frame. Filtering motion-capture data reduces the number of keys, making the job of altering or personalizing the motion data simpler. Other filtering options include footstep extraction, applying the skeletal structure stored in the motion-capture file to the biped, looping the data, importing a portion of the motion capture file, and selecting tracks to load. See **Filtering Motion-Capture and Marker Data** on page 4577.

Final Gathering (mental ray Renderer)

Final gathering is an optional, additional step to calculating [global illumination](#) on page 6261. Using a photon map to calculate global illumination can cause rendering artifacts such as dark corners and low-frequency variations in the lighting. You can reduce or eliminate these artifacts by turning on final gathering, which increases the number of rays used to calculate global illumination.



Scene rendered with global illumination but no final gather

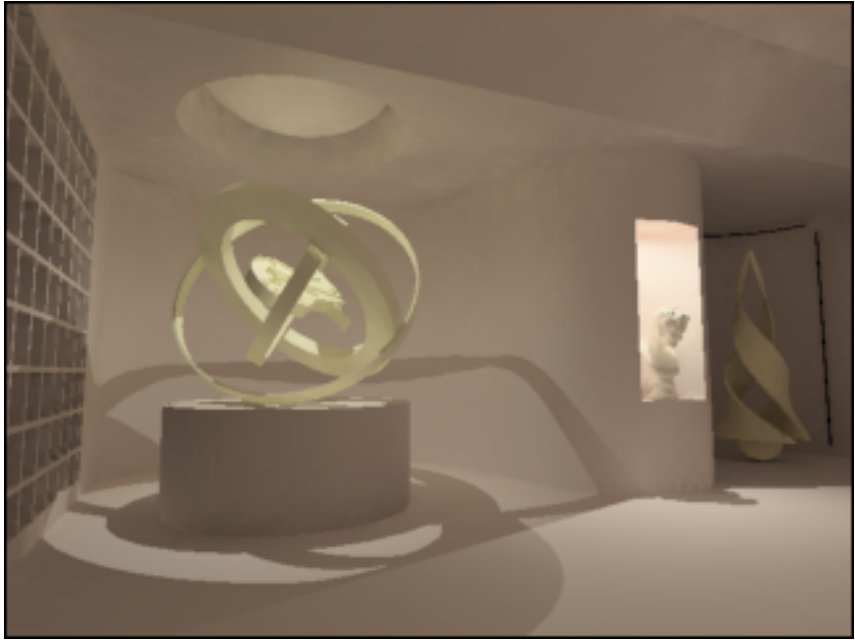

Same scene with final gather used to smooth the global illumination



Same scene with final gather but no global illumination, for comparison

Final gathering can greatly increase rendering time. It is most useful for scenes with overall diffuse lighting, less useful for scenes with bright spots of indirect illumination such as focused caustics.

You turn on final gathering on the Render Setup dialog > Indirect Illumination panel > [Final Gather rollout](#) on page 6295.

First Vertex

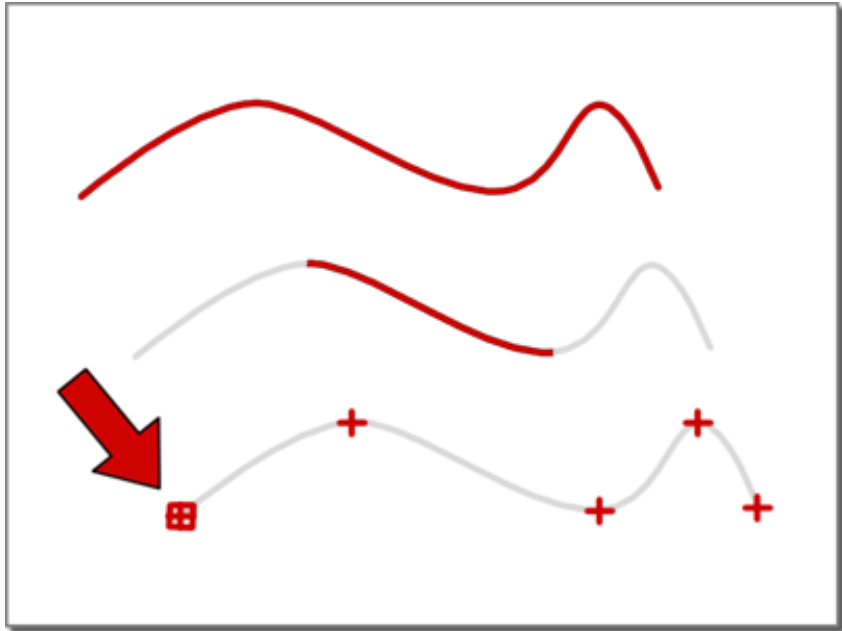

First vertex of a spline

When you create a spline object, the software numbers the vertices from 1 to the total number of vertices in the spline, according to the order of creation. When the spline is displayed in viewports, the first vertex has a box around it.

The first vertex is commonly used as an alignment marker when you place two or more shapes on different path levels when lofting. If you place different shapes on different path levels and you don't align their first vertices, the resulting mesh object is twisted.

To avoid twisting, you can align the first vertices by rotating the splines as necessary. Alternatively, you can change the position of a spline's first vertex by using the Make First button in the Edit Spline modifier (at the Vertex sub-object level).

Flat Mirror



Flat mirror map reflects the ice-cream shop's interior.

If you want to create a flat, mirrored surface in a scene, such as a highly polished floor, you must use a flat mirror reflection map.

Flat mirror reflection maps must be assigned to your geometry in a specific way, and work only on flat surfaces.

When you use flat-mirror reflection maps, keep the following in mind:

The flat-mirror material must be assigned to connected, coplanar faces on a flat surface of the object. If your flat-mirror reflection doesn't work, it's probably because non-coplanar faces have been assigned the flat-mirror material. This can happen during the selection process, if one or more non-coplanar faces are included in the selection set. It can also happen if you've already assigned the same material elsewhere on the object (coplanar faces are two or more adjacent faces that are on the same two-dimensional plane, such as the surface of a floor).

If you want to reflect in multiple planes of the same object, detach each plane into a separate object before you assign the material.

Flow

A [particle system](#) on page 8083 can contain any number of separate particle flows. Each flow consists of an isolated chain or sequence of [events](#) on page 7966, as depicted in [Particle View](#) on page 2811. A flow typically contains a [global event](#) on page 7997 and a [birth event](#) on page 7924, and any number of additional [local events](#) on page 8027.

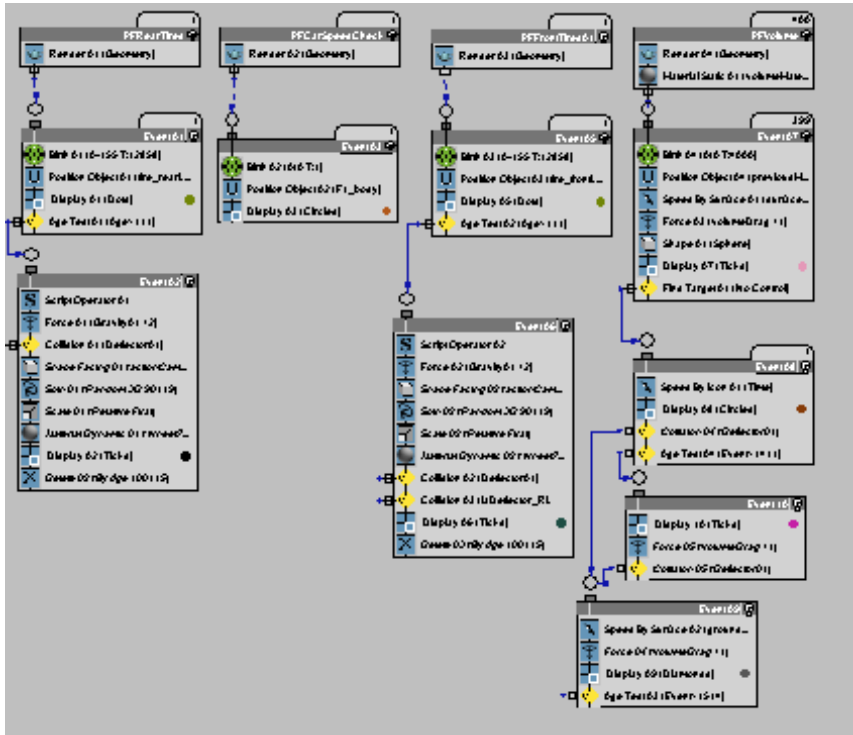

A particle system containing four separate flows

Fluorescence

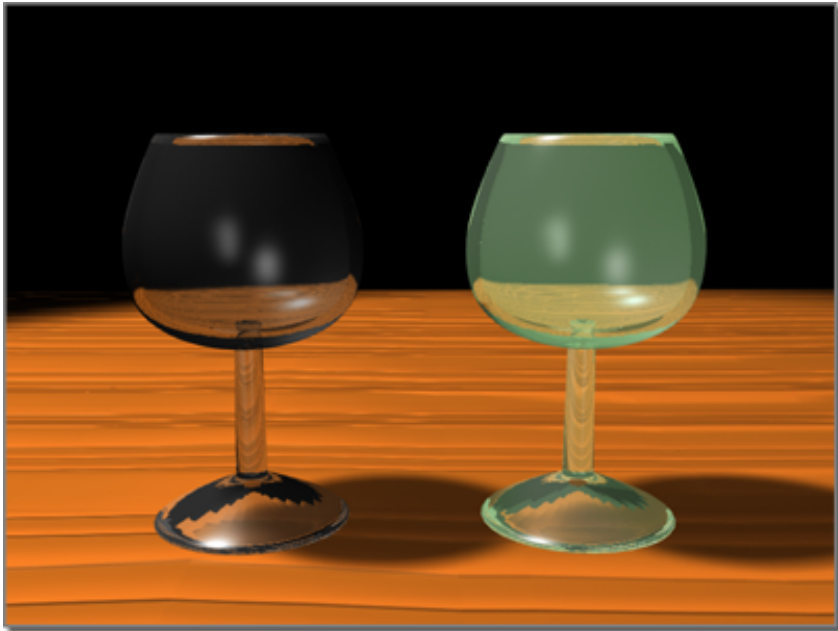

Glass on the right has a light green fluorescence.

Fluorescence is light emitted from an object when it absorbs radiation (for example, ultraviolet light) from another source.

Raytrace materials have the ability to simulate fluorescence.

Flyout

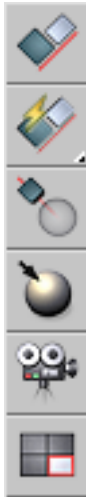

Example: Align flyout (main toolbar)

A flyout is an icon-based menu available from any button that has a small black triangle in the lower-right corner. To access the flyout, click the button and hold or drag a short distance. Then, to activate a flyout menu item, drag to the item and release. As you drag, you can see each item's name on the prompt line of the [status bar](#) on page 7524.

Follow Object

You can bind an object in your hierarchy to any other object (often an object not in the same hierarchy). This other object is called the follow object.

The bound object tries to match the position and orientation of its pivot point to the position and orientation of the follow object's pivot point.

For example, you might want to animate a figure that always points to another object. Bind the hand of the figure to the other object. Turn IK on and as you move the object the hand and arm of the figure move to point at it.

Foot States

The biped feet can be in one of four states: plant, lift, move, and touch:

- **Plant** The biped foot state in full contact with the footstep.
- **Lift** The biped foot state just before leaving a footstep.
- **Move** The biped foot state between footsteps; an airborne period.
- **Touch** The biped foot state at which a biped foot first contacts a footstep.

Footstep Animation

Biped's patented footstep-driven keyframe animation feature allows animators to use footsteps to create broad, global brush strokes for character movement. Once footsteps are in place, keyframes are generated automatically to produce an initial sketch of the 3D character's motion. Throughout edits and revisions, the original nuances of the character are preserved; Biped remembers everything about how a character moves, and it makes all of the appropriate adjustments if the footsteps are changed.

Footsteps Method

Footsteps provide a way to animate a [biped](#) on page 4147. In viewports, footsteps represent support periods in space for the biped's feet. Moving or rotating footsteps in space is done in the viewports. The footstep position and orientation in the viewport controls where the biped will step.

In Track View — Dope Sheet, each footstep appears as a block that represents a support period in time for each of the biped's feet. Moving footsteps in time is done in Track View — Dope Sheet.

TIP  To see the footsteps, you must turn on Edit Keys in the Dope Sheet.

There are three ways to create footsteps for the biped. The first way is to place footsteps individually, one at a time. The second way is to invoke Biped's multiple footstep creation tools to create a walk, run, or jump animation. The third way is to extract footsteps from raw motion-capture data.

A big advantage of the footstep method is the natural adaptation of the biped that occurs when the footsteps are edited in time and space. Also, you can reposition all of the footsteps to move the entire animation.

Forward Kinematics

The default method of manipulating a hierarchy uses a technique called “forward kinematics”. The basic principles employed by this technique are:

- Hierarchical linking from parent to child
- Placement of pivot points to define the connecting joint between linked objects
- Inheritance of position, rotation, and scale transforms from parent to child

In forward kinematics, when a parent object moves, its children must follow. If the child wants to go off on its own, the parent remains behind. For example, in a hierarchical linkage of a human figure, when the torso (the parent) bends over, the head (the child) moves along with it, but you can turn the head without affecting the torso.

Forward Kinematics (Bipeds)

Using an arm to move a hand is an example of forward kinematics. Using the hand to move the arm is an example of [inverse kinematics](#) on page 8016. When you use [freeform animation](#) on page 7988 to animate a [biped](#) on page 4147, you can use both kinds of kinematics.

By planting a hand or foot, you use another object (object space) or the world (world space) to control IK motion. In this method, the IK Blend parameter in the [Key Info rollout](#) on page 4367 determines how forward kinematics and inverse kinematics are blended to interpolate intermediate positions.

Frame Rate

The frame rate of an animation is generally expressed in frames per second (fps). This is the number of frames displayed for every second of real time.

Different recording devices output different frame rates, but the standard rates are as follows:

Film 24 frames per second

You can change the frame rate for your output at any time, outputting the correct number of frames to maintain the correct playback speed for your animation.

For example, if you create a 90-frame animation for video, using an NTSC frame rate of 30 frames per second, the result will be three seconds of animation.

If you later discover you need to output to PAL video (at 25 frames per second), you can switch to the PAL frame rate. The 90 frames are automatically converted to 75, producing the same total animation time with a different number of frames. You can later switch back to NTSC frame rate to restore the original 90 frames of animation.

You can switch back and forth between frame rates at any time without losing animation data.

NTSC video 30 frames per second

PAL video 25 frames per second

Freeform Animation

character studio gives you the option to animate [biped](#) on page 4147 poses both with and without the aid of footsteps. Freeform animation does not use footsteps. In freeform animation, you set all the keys yourself.

Freeform Method

In freeform mode (without footsteps), you can pose every joint of your [biped](#) on page 4147 exactly as you like using traditional keyframe methods. You can even blend dynamically between forward kinematics and [inverse kinematics](#) on page 8016 to introduce higher-level control in just the cases you need it to simulate your character's particular motion.

Freeze/Unfreeze

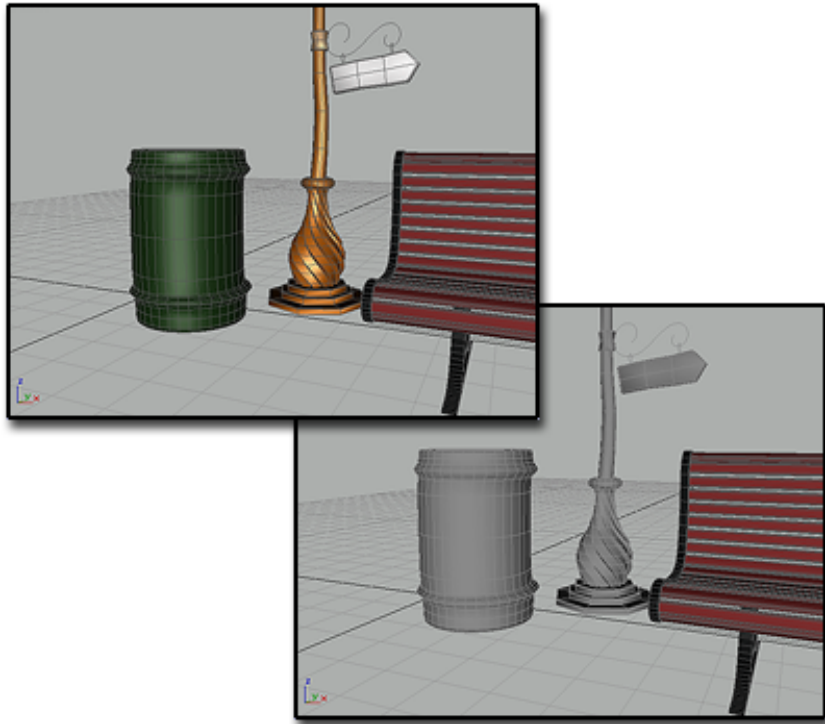

On the right, the trash can and streetlight are frozen.

You can freeze any selection of objects in your scene. By default, frozen objects, whether wireframe or rendered, turn a dark gray. They remain on screen, but can't be selected, and therefore can't be directly transformed or modified. Freezing lets you protect objects from accidental editing and speeds up redraws.

Frozen objects are similar to hidden objects. Linked, instanced, and referenced objects behave when frozen just as they would if unfrozen. Frozen lights and cameras and any associated viewports continue to work as they normally do.

You can choose to have frozen objects retain their usual color or texture in viewports. Use the Show Frozen In Gray toggle in the [Object Properties dialog](#) on page 305.

Function Curve

Function curves are editable splines that represent animation values in a line-graph format. They provide a valuable way of both visualizing and editing your animation tracks.

Function curves appear in the Track View, and provide the best method of viewing and editing animation tracks. With the function curve display, you can actually see the characteristics of the animation as they change over time. The steepness of the curve indicates the velocity of an object in the scene. If the curve steepens, the object is accelerating. If the curve flattens out, the object is slowing.

You can display key dots in function curves, as well as in the key editing displays. In function curves, the key dots appear as small, black squares. The two ways to turn on their display are to click the green icon beside the track label, or to click the function curve itself.

There are two basic ways to edit function curves. You can either change the position of the key dots, thereby altering the curve, or you can edit the tangents and the values of the keys themselves.

Fusing

In NURBS curves and surfaces, fusing connects a point to a point or a CV to a CV. (You can't fuse a CV to a point, or vice versa.) This is one way to connect two curves or surfaces. It is also a way to change the shape of curves and surfaces.

Fused points behave as a single point or CV until you unfuse them. Fusing points does not combine the two point objects or CV sub-objects. They are connected but remain distinct sub-objects that you can unfuse later.

Fused CVs behave much like a single point, but the property of multiplicity for coincident CVs also applies. The fused CVs have proportionally more influence on the curve, which can become more sharply curved in the fused CVs' vicinity, or even angular if more than two CVs are fused together.

FX File

An FX file defines a DirectX 9 (DX9) shader. It is a text file created using the Higher-Level Shading Language (HLSL) standard. The [DirectX 9 Shader material](#)

on page 5758 can apply DX9 shaders to objects, and display them with DX9 shading in viewports.

By default, DX9 shaders are saved in `\maps\fx\` in the 3ds Max program directory.

IMPORTANT For a DX9 shader's parameter to be visible in the DirectX 9 Shader material's interface, the FX file must contain code to label the parameter, define its type, and (optionally) limit its range. (A few other UI settings are also provided.) You can find examples of files that contain this code in the above directory.

NOTE The following Web page provides a specification for the DirectX 9 Shader material 3ds Max:

http://sparks.dsareet.com/knowledgebase/techdocs/searchable/techdoc_DXMaterialFormat/DxMaterial_Effect_format.htm

G-Buffer

G-Buffer (graphics buffer) is a type of rendering channel. Two file formats output by 3ds Max, [RLA](#) on page 7364 and [RPF](#) on page 7366, can incorporate masks that are based on graphics buffer (G-Buffer) channels instead of the more widely used RGB and alpha channels. In addition, some kinds of Filter and Layer events as well as certain [rendering effects](#) on page 6583 can post-process objects or materials designated by the G-Buffer.



- Main image:** G-buffer used to apply a glow to lighting in a scene
- Upper left:** The same scene with no glow applied
- Middle left:** Objects selected using the G-buffer
- Lower left:** Glow applied to the G-buffer objects

You can set two kinds of these channels in the scene to identify and group objects or materials for a particular post-processing effect.

- You set an object's value (see [Object Properties Dialog](#) on page 305) to identify that object to receive a particular rendering or post-processing effect or file mask.
- You set a material's [Material Effects Channel](#) on page 5348 value to identify that material to receive a particular post-processing effect.

You create object-specific or material-specific post-processing by following this general procedure:

- 1 Assign a particular Object Channel ID or Material Effects Channel ID to the objects or the materials you want to be post-processed or affected by rendering effects.

- 2 In the Image Filter or Image Layer event or in each rendering effect's Options tab, choose the channel ID that associates the event with the ID value you assigned in the scene.
- 3 When you render the scene or execute the Video Post queue, 3ds Max singles out objects or materials that have the designated ID, and performs its post-processing only on those objects or materials.

WARNING The [mental ray renderer](#) on page 6230 does not recognize Z-depth with G-buffers. G-buffer data is saved on a single layer. Also, the mental ray renderer does not support the following effects:

- [Glow lens effect](#) on page 6599 (rendering effect)
- [Ring lens effect](#) on page 6606 (rendering effect)
- [Lens effects Focus filter](#) on page 6871 (Video Post)

Gait Pattern

In [footstep animation](#) on page 7986, the pattern created by a gait: walk, run, or jump. When you create new footsteps, the timing for the footsteps is determined by the gait you have chosen and the parameters for that gait. Gait parameters are on the Motion panel in the [Footstep Creation rollout](#) on page 4434.

Gait Type

In [footstep animation](#) on page 7986, **character studio** can create three types of gaits; walk, run, or jump.

- In a walk, at least one foot is always in contact with the ground. The periods when one or both feet are in contact with the ground are known as *support periods*.
- In running, there is a period between each support period in which the body is airborne.
- Jumping is a special case of running. Both feet are in contact with the ground at the same time, or airborne at the same time.

Gamma Correction

Gamma correction compensates for the differences in color display on different output devices so that images look the same when viewed on different monitors.

A gamma value of 1 corresponds to an "ideal" monitor; that is, one that has a perfectly linear progression from white through gray to black.

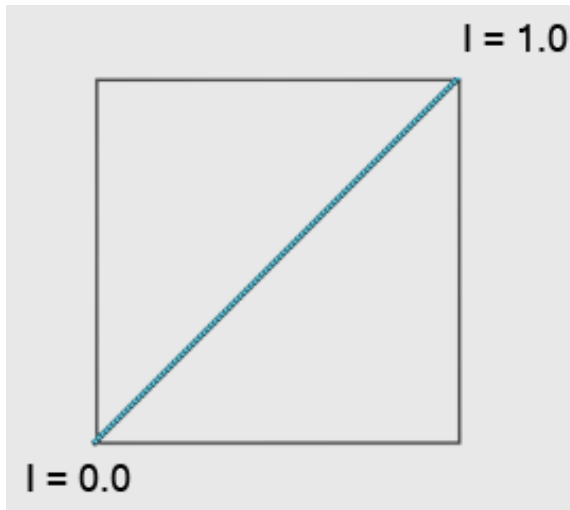

Gamma = 1.0: no correction

I stands for *Intensity*.

However, the ideal display device doesn't exist. Computer monitors are "nonlinear" devices. The higher the gamma value is set, the greater the degree of nonlinearity. The standard gamma value for NTSC video is 2.2. For computer monitors, gamma values in the range of 1.5 to 2.0 are common.

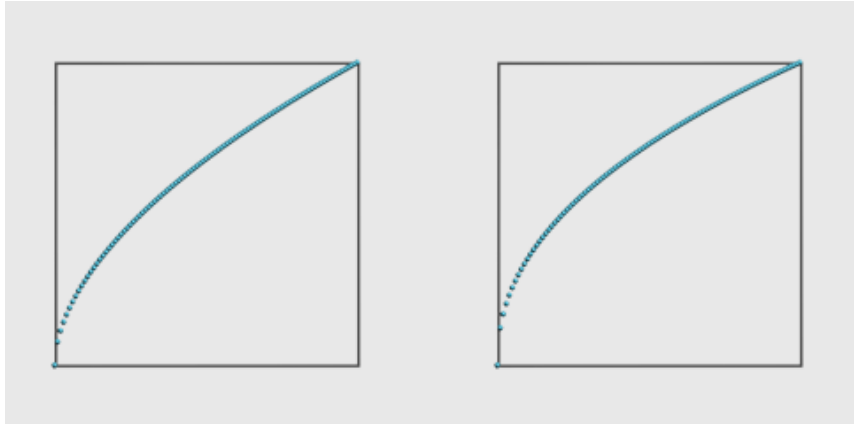

Left: $\gamma = 1.8$

Right: $\gamma = 2.2$, the standard for video

The horizontal axis represents input (the original value) and the vertical axis represents output (the gamma-corrected value).

Computer monitors and videos don't display color in a linear way (as in the first illustration). Also, the brightness of a monitor tends to make an image seem brighter than its intensity values really specify. Gamma correction fixes this problem, and can ensure consistency between different applications or different monitors. When you set gamma, find a value that makes middle gray on your own monitor match a true middle (50 percent) gray.

For more information, see [Gamma and LUT Preferences](#) on page 7758.

Geometric Primitives

Simple primitive objects such as, spheres, boxes, cylinders, and so on.

Gizmo/Center

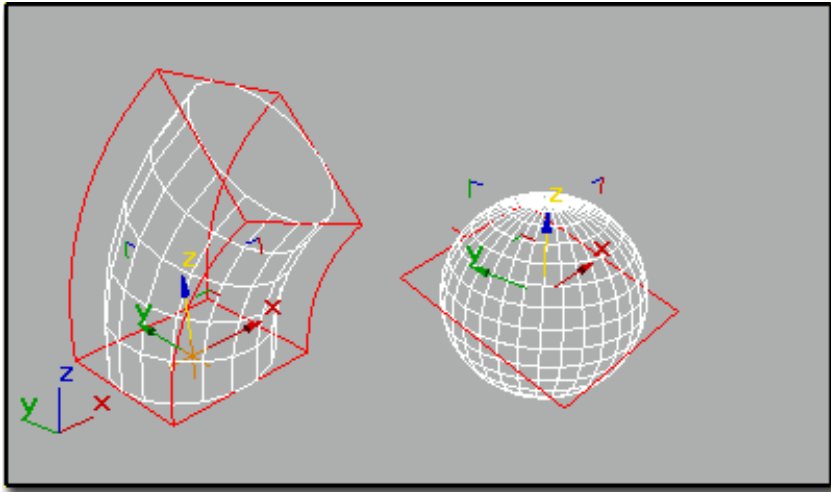

Examples of gizmos:

Left: Gizmo for a Bend modifier

Right: Gizmo for UVW mapping

A *gizmo* is geometry that appears in viewports, but not in the scene. You manipulate a gizmo to modify the scene geometry or other effects. There are gizmos for transforms, modifiers, atmospheric apparatus, and some directly modifiable geometry such as spotlight cones.

For modifiers, a gizmo acts like a kind of container that transfers the modification to the object to which it's attached. You can move, scale, and rotate the gizmo as you would any object, altering the effect of the modifier on the object.

With [bipeds](#) on page 4130, the footsteps in [footstep animation](#) on page 7986 are gizmos that let you edit the position of the biped's feet over time. [Physique](#) on page 4603 uses gizmos to visually identify bulge angles.

Some modifiers with gizmos also have a Center sub-object, which can be manipulated independently of the gizmo to specify the point about which the deformation, etc., takes place. For example, moving the Bend modifier center parallel to the plane of the bend effect changes the size of the bend circle and the location of the modified object within the bend circle.

Global Event

The first [event](#) on page 7966 in a [particle flow](#) on page 7983 is always a global event, whose contents affect all particles in the flow; the rest are [local events](#) on page 8027. Although a global event has the same name as the Particle Flow source icon, selecting the source icon in a viewport doesn't highlight the global event, nor does highlighting a global event select the corresponding source icon.

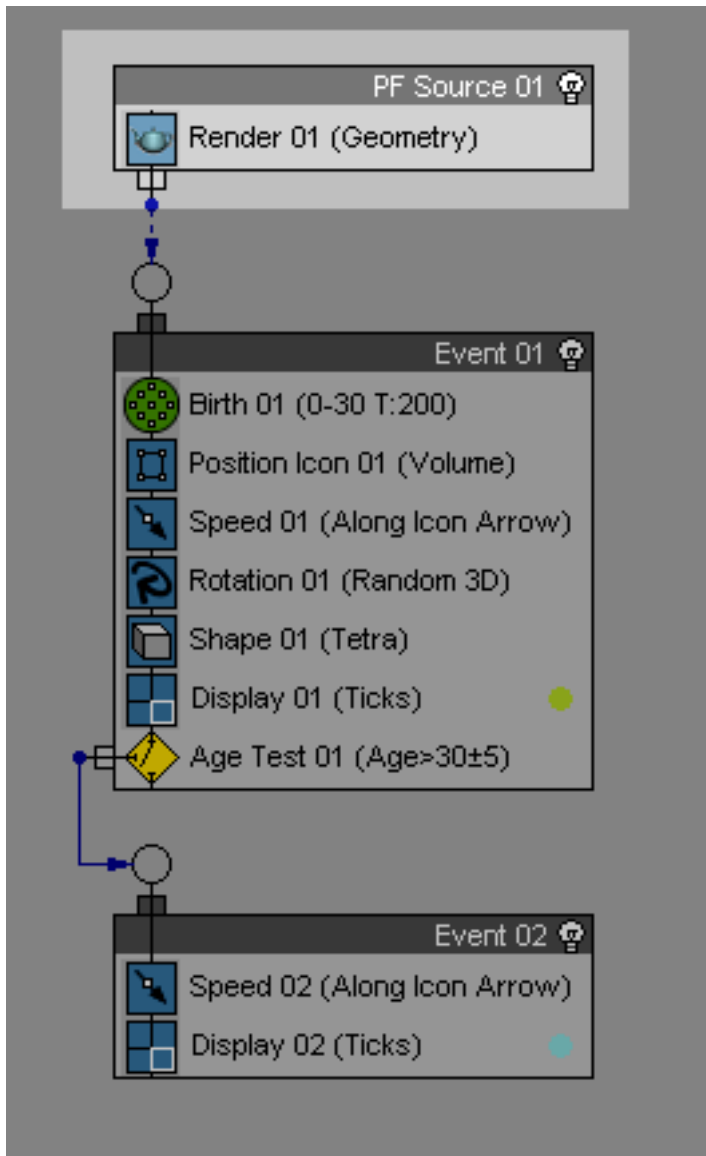

Global event (highlighted)

By default, the global event contains a single [Render operator](#) on page 2951 that specifies rendering properties for all particles in the flow. You can add other operators here to have them act globally, such as Material, Display, and Speed.

NOTE A global event is the only event that can be wired to another event without using a [test](#) on page 8147. It's almost always wired directly to a [birth event](#) on page 7924.

IMPORTANT When you use an operator globally, be sure not to use the same operator locally (that is, in any other events in the system) to avoid potential conflicts.

Global Motion Clip Controller

In [crowd animation](#) on page 4761, a controller that contains the animation necessary to animate a non-bipedal crowd of objects. It consists of a list of motion clips and the logic needed to instance and blend these motion clips for a crowd animation. The Global Motion Clip Controller is accessed via the [Crowd helper object](#) on page 4819.

Glossiness and Specular Level Settings

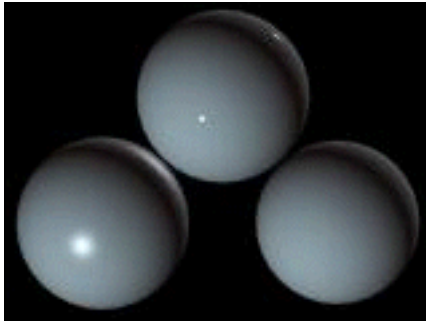

Extremes of the Glossiness and Specular Level settings (Phong shader):

Top sphere: Glossiness=100; Specular Level=100

Left sphere: Glossiness=50; Specular Level=50

Right sphere: Glossiness=0; Specular Level=0

A material's glossiness (or dullness) depends on the size and intensity of its specular highlight. In the Material Editor, the Glossiness spinner affects the size of the specular area, and the Specular Level spinner affects the intensity of the glossiness.

When the Specular Level is too high, and Glossiness is too low, you can get harsh backlights on your surfaces. The Soften option mitigates this.

GravAccel

In [footstep animation](#) on page 7986, the GravAccel (for gravitational acceleration) parameter lets you scale the height of airborne periods. The greater this value, the greater the height. If the biped appears to be going too high, reduce this value; if the biped goes too low, increase it. Each biped has its own Gravitational Acceleration value. The default is based on the height of the biped.

For example, if the active [unit](#) on page 7809 is feet and the biped is 5 feet 10 inches tall, then Gravitational Acceleration equals 32, for 32 ft. per second per second. For other biped heights, 3ds Max scales this value to fit the scene. The Gravitational Acceleration value also changes to agree with other unit systems, such as metric.

GravAccel is located on the [Dynamics & Adaptation rollout](#) on page 4417.

Gravity

In [footstep animation](#) on page 7986, **character studio** calculates the effect of gravity for those periods when a [biped](#) on page 4147 is airborne (a biped becomes airborne when it moves with a running or jumping gait). You can use the [GravAccel](#) on page 8000 setting to scale the effect of gravity.

Grid Object

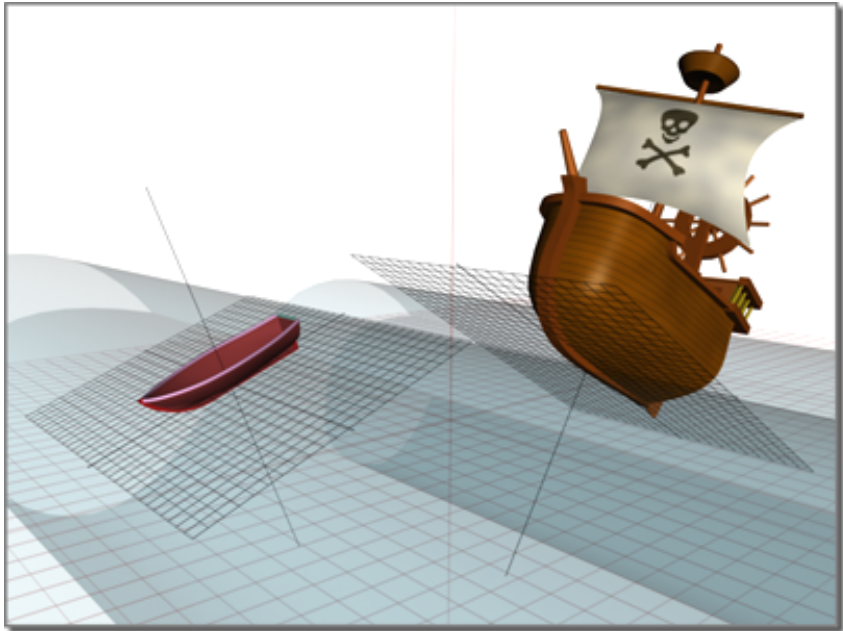

One grid establishes the pitch of the boat, another the pitch of the ship.

A grid object is a type of helper object you can create whenever you need a local reference grid or construction plane somewhere other than the home grid.

You can have any number of grid objects in your scene, but only one can be active at a time. When active, a grid object replaces the home grid in all viewports.

You can freely move and rotate grid objects, placing them at any angle in space, or attach them to objects and surfaces. You can also change viewports to display a plan or top view of any active grid object.

Grid objects can be named and saved like other objects, or used once and deleted.

Head Object

A head object is a component of a Target Camera, Sunlight or Daylight system, or a Tape helper. These objects comprise two components: the target that the camera, sun, or tape points at, and the head that represents the camera, sun, or tape. The head object always points at the center of the target.

Helper Object

3ds Max helper objects are used to help you set up an animation, but do not render. [Crowd animation](#) on page 4761 uses two kinds of specialized helper objects: [crowd](#) on page 4819 and [delegate](#) on page 4811.

Hide/Unhide

You can hide any objects in your scene and you have the option to hide any selection of objects or to hide anything except your current selection of objects. Hidden objects differ from [frozen](#) on page 7989 objects in that they disappear from the viewport instead of turning dark gray. If you are working on a scene that includes many objects or you have many objects in a very tight area, hiding some of them gives you more access to the unhidden objects and speeds up redraws.

You can hide an object that includes a target (such as target cameras, tape helpers, or suns) by choosing either the [head](#) on page 8002 or the target object and then selecting hide.

Hide and Unhide are accessible from the Display panel or from the Display quadrant of the Quad Menus.

Hierarchical Linkage

3ds Max uses a family-tree analogy to describe the relationship between objects linked together in a hierarchy.

Ancestors The parent and all of the parent's parents of a child object.

Branch A path through the hierarchy from a parent to a single descendent.

Child An object controlled by its parent. A child object can also be a parent to other children. An object that doesn't have any parent is by default a child of the world. (The "world" is an imaginary object that acts as the root of all other objects in the scene.)

Descendents The children and all of the children's children of a parent object.

Hierarchy The collection of all parents and children linked together in a single structure.

Leaf A child object that has no children of its own. The lowest object in a branch.

Link The invisible connection between a parent and its child. The link is a conduit for transmitting position, rotation, and scale information from parent to child.

Parent An object that controls one or more children. A parent object is often controlled by another superior parent object.

Pivot Defines the local center and coordinate system for each object. You can think of links as connecting the pivot of a child object to the pivot of its parent.

Root The single parent object that is superior to all other objects in the hierarchy. All other objects are descendents of the root object.

Subtree All of the descendents of a selected parent.

Home Grid

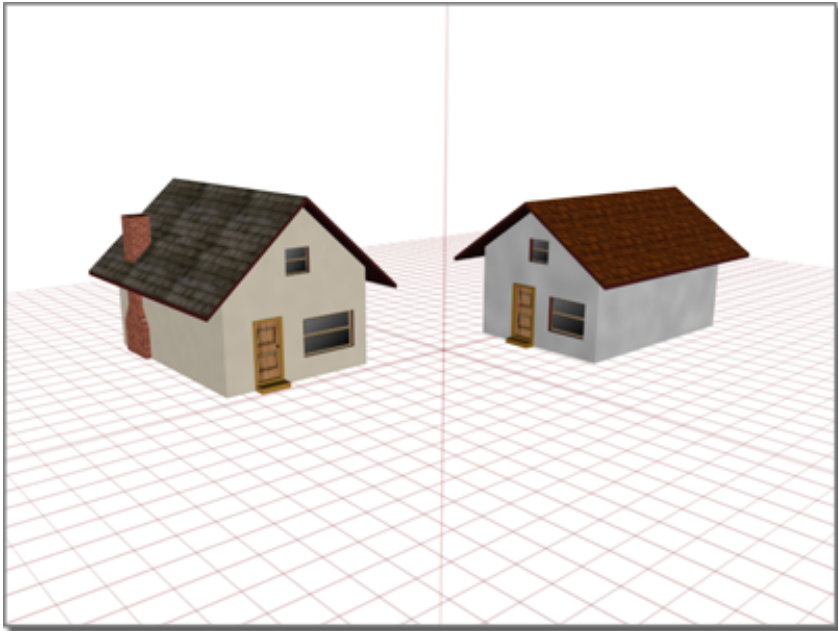

Using the home grid to position houses

Grids are two-dimensional arrays of lines similar to graph paper, except that you can adjust the spacing and other features of the grid to the needs of your work.

Grids have these primary uses:

- As an aid in visualizing space, scale, and distance
- As a construction plane where you create and align objects in your scene
- As a reference system for using snap

The home grid is the basic reference system, defined by three fixed planes on the world coordinate axes. The home grid is visible by default when you start the software, but can be turned off with an option in the right-click viewport menu. You can use any view of the home grid as a construction plane or you can create a [grid object](#) on page 8001 and use that as a construction plane instead.

Horizon



Horizon in the distance of a scene

The horizon of a scene is the edge of vision at the height of the camera, parallel with the world coordinate plane. You can view the horizon in camera viewports.

A camera is level when it and its target are the same height from the world coordinate plane. In other words, the camera's local Z axis is parallel to the world plane. When the camera is level, the horizon line is centered in the viewport. As the camera tilts up, the horizon line lowers; as it tilts down, the horizon line raises.

The horizon line can help you match the perspective of your scene to the perspective of a still image. In general, matching perspective involves the following steps:

- Display the horizon line. Use it to help you adjust the camera and target so they are level.
- Display the image in the camera viewport. Use Views menu > Background Image.

- Display the image in the camera viewport. Use Views menu > Viewport Background.
- Orbit the camera until the perspective of the scene roughly matches that of the still image.
- Adjust the camera's perspective to fine-tune the perspective match.
- Move the camera or target to position the scene against the background.

If you raise or lower the camera, raise or lower the target by an equal amount, in order to keep them level and maintain the horizon.

Hot

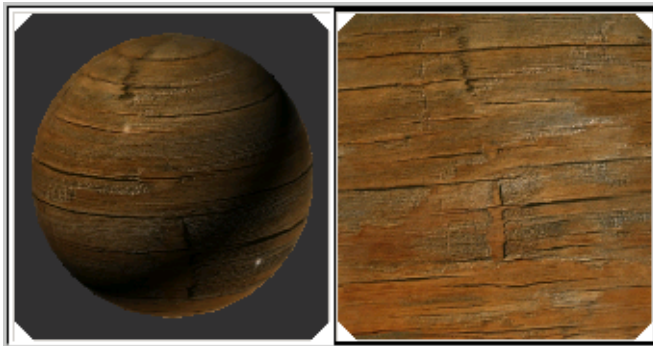

A *hot* material is one that is instanced in both the scene and the Material Editor. When you get a material from an object, that material is hot. Any changes you make to the hot material are reflected in the scene wherever that material is applied.

To edit a material without changing the scene, you can get the hot material from an object, then make a copy of it. The term for the copied material is [cool](#) on page 7943.

White triangular tabs in each corner of the Material Editor [sample slots](#) on page 5304 show that the materials in those slots are hot.

In the Material Editor, the only time you need to select an object is when you're assigning a material to an object. When you're adjusting a material, object selection doesn't matter.

Hotspot/Falloff

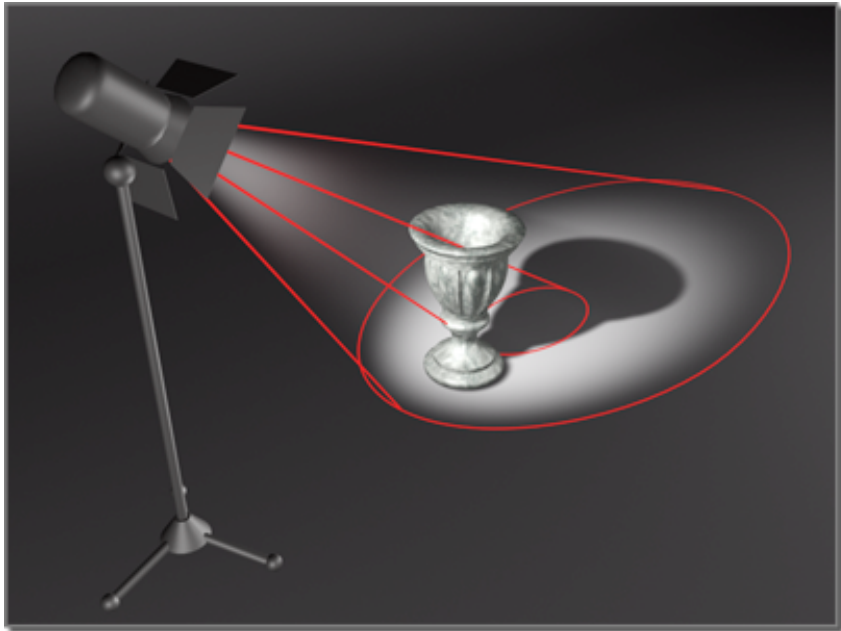

Hotspot and falloff cones, highlighted in red.

You've seen how a flashlight or a theater follow spot casts a circle of light. Depending on the quality of the flashlight, or the adjustment of the follow spot, the edge of the cast pool of light is either blurred or sharp.

In the case of a blurred pool of light, the bright circle in the center is the hotspot, which has an even intensity. The outer extremity of the light, where it meets the darkness, is the falloff. The difference in circumference between the hotspot and the falloff determines the relative sharpness of the pool of light. For example, if the hotspot and falloff are nearly the same size, the pool of light has a sharp edge.

The hotspot angle of a spotlight must always be smaller than the falloff angle. Put another way, the hotspot must always be inside the falloff.

You can hold down the Shift key to have the hotspot and falloff values affect each other. If you increase the hotspot to be larger than the falloff, the falloff is increased as well. Likewise, if you reduce the falloff to be smaller than the hotspot, the hotspot is also reduced.

IGES (Initial Graphics Exchange Specification)

The Initial Graphics Exchange Specification (IGES) is an ANSI standard that defines a neutral form for the exchange of information among dissimilar computer-aided design (CAD), computer-aided manufacturing (CAM) systems, and computer visualization systems.

3ds Max implements the IGES standard for translating files to the software from IGES file formats used by the mechanical engineering and entertainment industries. Using the IGES import feature, you can read in native [NURBS](#) on page 8060 data between 3ds Max and other programs such as Autodesk Mechanical Desktop® (release 3.0 or later), Maya®, Pro/ENGINEER®, SOFTIMAGE®, CATIA®, and others. For complete details on the IGES standard, see [The Initial Graphics Exchange Specification \(IGES\) Version 5.3](#).

IK Blend

In biped [freeform animation](#) on page 7988, the IK Blend parameter determines how [forward kinematics](#) on page 7987 and [inverse kinematics](#) on page 8016 are blended to interpolate an intermediate position. Using an arm to move a hand is an example of forward kinematics. Using the hand to move the arm is an example of inverse kinematics.

This parameter is located in the IK section of the [Key Info rollout](#) on page 4367.

IK Goal

In [history-independent inverse kinematics \(HI IK\)](#) on page 3392 and the [IK Limb Solver](#) on page 3444, the IK goal is the object associated with the end joint of a kinematic chain. By default, its name is *IK Chain01*.

The kinematic chain is a single branch of a hierarchy used for animation with [inverse kinematics \(IK\)](#) on page 8016. The chain starts with the end joint and travels up through ancestors until it reaches the start joint. When you move the IK goal, the IK solver then uses IK calculations to move and rotate all other objects in the kinematic chain to react to the object you moved.

NOTE You can move the IK goal away from the end joint, which causes the IK chain to straighten out. When you move the goal back toward the end joint, joints in the IK chain will bend again.

See also:

- [End Effector](#) on page 7963

IK Solution

Inverse kinematics (IK) uses a goal-directed method where the animator positions a child object and the program calculates the position and orientation of the parent objects. The final position of the hierarchy after all of the calculations have been solved is referred to as the IK solution.

Applied IK requires that one or more parts of your IK structure be pinned to animated follow objects. Once pinned, you select any object in your kinematic chain and click the Apply IK button. The software then calculates the IK solution for each frame of the animation and places transform keys for every object in the IK chain.

Illuminance

Illuminance is the [luminous flux](#) on page 8029 incident on a surface of unit area. It measures how much energy has fallen on a surface.

This quantity is useful for describing the level of illumination incident on a surface without making the measurement dependent on the size of the surface itself. The *lux* (lx) is the International System (SI) unit of illuminance. The American System (AS) unit for illuminance is the footcandle (fc), equivalent to 1 lumen per square foot. Illuminance is a function of the distance from the light source. To specify the illuminance of a light, you must enter a value in lx, and the distance at which that illuminance is measured.

Image Motion Blur



Image motion blur has been applied to the falling coin on the right.

Motion blur can enhance the realism of a rendered animation by simulating the way a real-world camera works. A camera has a shutter speed, and if significant movement occurs during the time the shutter is open, the image on film is blurred.

3ds Max provides a couple of ways to generate motion blur. Image motion blur is one. [Scene motion blur](#) on page 8117, a Video Post [Scene Event](#) on page 6808 effect, is another. For most purposes, image motion blur gives better results than scene motion blur. Scene motion blur is a more exaggerated effect. You can use both image and scene motion blur in the same rendering.

You can also apply image motion blur as a [render effect](#) on page 6681.

(Another option, [object motion blur](#) on page 8063, is not meant to simulate a camera, but to improve the rendered appearance of fast-moving objects.)

Applying image motion blur is a two-step process:

- 1 Turn on image motion blur for the object you want to blur, using the [Object Properties dialog](#) on page 305.
You cannot apply both image motion blur and object motion blur to the same object in the same rendering.
- 2 Before you render, turn on image motion blur in the [Default Scanline Renderer rollout](#) on page 6141 of the Render Setup dialog.

Tips and Limitations

Image motion blur smudges the object by creating a smearing effect, instead of superimposing multiple images the way object motion blur does. It considers camera movement. Image motion blur is applied after scanline rendering is complete.

- Because image motion blur is applied after rendering, it can't account for object overlap. When blurred objects overlap, blurring doesn't work correctly and there are gaps in the rendering. To fix this problem, render each blurred object separately, to a different layer, and then composite the two layers using the Alpha Compositor in Video Post or another compositing tool.
The overlap problem also applies to objects behind an object rendered with raytrace refraction.
- Image motion blur doesn't work with objects that change topology. This includes NURBS objects that are animated so their tessellation ([surface approximation](#) on page 2554) changes. Regular tessellation doesn't change in this way. This also includes Displacement mapping and Optimization.
- Image motion blur can yield strange results with objects that have a [MeshSmooth modifier](#) on page 1532 applied to them. If you see this happening, turn off the MeshSmooth modifier's Keep Faces Convex toggle (in the Settings rollout). This will fix the problem.
- Image motion blur is not applied to reflections of objects. It is applied only to actual geometry.

In Place Mode



When you play an animation of a [biped character](#) on page 4147 that travels, you can use In Place mode to keep the biped visible in the viewports. Use this for biped key editing, or adjusting envelopes with [Physique](#) on page 4603. In Place mode prevents XY movement of the biped's center of mass during playback; motion along the Z-axis is preserved.

This control is a three-button flyout: you can also restrict X movement without restricting Y movement, or vice versa.

The state of In Place Mode is saved with the MAX file.

The In Place flyout is located on the expanded [Biped rollout](#) on page 4331.

Independent

Describes a NURBS object or sub-object that is not dependent on any other object in a NURBS model. For example, a NURBS curve created using the Create command panel does not depend on other objects.

Influence

An influence is the object that is required for the behavior or appearance of another object to be correct. For example, take an “eye” object that should follow the motion of a tennis ball in a match. One way to animate this is to apply a [LookAt Constraint](#) on page 3312 to the eye, with the tennis ball as the target. In this case the tennis ball is an influence of the eye, while the eye is a [dependent](#) on page 7951 of the tennis ball.

See also:

- [Select Influences](#) on page 7389 and Display Influences on page 7390 in the Scene Explorer dialog
- [Select Influences](#) on page 6959 in the XRef Merge dialog

Initial Pose

When you apply [Physique](#) on page 4603 to a skeleton, the initial pose is the original position of the mesh relative to the skeleton. Some of the [Physique sub-object levels](#) on page 4716 have an Initial Skeleton Pose control that temporarily puts the mesh into its initial pose.

Initialize

In [Physique](#) on page 4603, when you attach a [mesh](#) on page 8043 to a skeleton such as a biped, the modifier is initialized. This process creates the links of the [deformation spline](#) on page 7949, the [envelopes](#) on page 7963 around the links to control the mesh, and so on.

Inputs: Event

In Particle Flow, you create a [particle diagram](#) on page 8081 by connecting [events](#) on page 7966 using [wires](#) on page 8170. Each wire links an [output](#) on page 8075 with an event input, which is the connector sticking up from the top of an event.

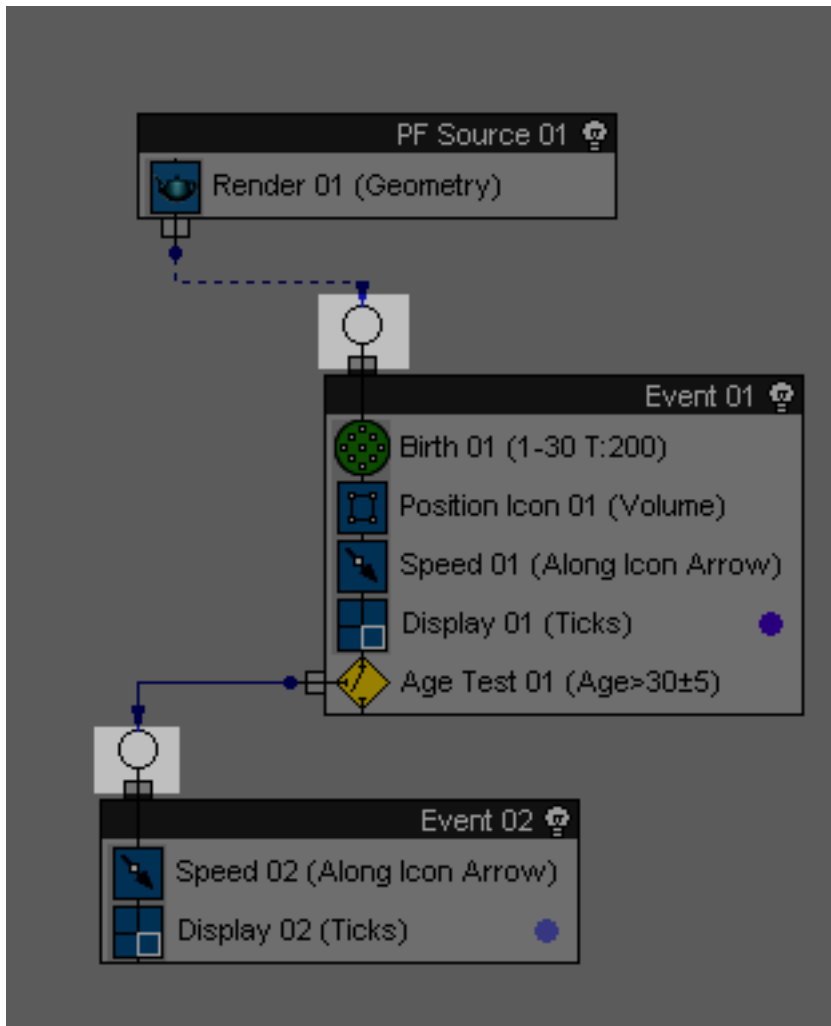

Event inputs

Instance

An instance is an interchangeable clone of the original. You can instance objects, modifiers, controllers, materials, and maps. Changing an attribute of an instanced item also changes the same attribute of all instances.

Object instances are not only alike in geometry, but also share modifiers, materials and maps, and animation controllers. When you change one instance by applying a modifier, for example, all the other instances change with it.

Each instance has its own set of transforms, object properties and space warp bindings; these are not shared among instances.

Within the program, instances derive from the same master object. What you're doing is applying a single modifier to a single master object. In the viewport, what you see as multiple objects are multiple instances of the same definition.

If you wanted to create a school of swimming fish, you might begin by making many instanced copies of a single fish. You could then animate the swimming motion by applying a ripple modifier to any fish in the school. The whole school would swim with exactly the same motions.

Instance (Motion Mixer)

The term *instance* has two meanings in 3ds Max. One is the [standard definition](#) on page 8014; the other is specific to clips in the Motion Mixer.

In general, an instance is a completely interchangeable clone of the original object. Modifying an instanced object is the same as modifying the original.

In the [Motion Mixer](#) on page 8052, when the same clip is used more than once on tracks, the clip versions are either instances or [adaptations](#) on page 7900 of each other.

The same clip used more than once for one biped, or for different bipeds of the same size, is an instance. The same clip used for different-sized bipeds is an adaptation.

For example, suppose you scene contains two bipeds that are exactly the same size, and you use the same clip in both bipeds' mixes. The clips within one biped's mix are instances of one another, and clips within the mixes of the two same-sized bipeds are also instances of one another. Instances have the same number appended to the ends of their clip names in the Mixer.

Suppose you then add a third biped of a different size, and use the same clip in that biped's mix. The new version of the clip is an adaptation of the clip used on the first two bipeds. An incremental number is added to the end of the clip name in the Mixer.

These terms are used because the Mixer adapts each loaded clip to the biped's size. The first time a clip is loaded, the Mixer adapts the clip as needed, but

no distinction is made between instances and adaptations at that point because the clip appears only once .

When the clip is cloned or loaded again, the Mixer adapts the new clip to the biped as needed, then compares the change to previously loaded versions. If the change is the same, the new clip and its previous versions are instances of one another. If not, the new clip and previous versions are adaptations of one another.

Interactive Renderer

Another term for the [Viewport Interactive Renderer](#) on page 8164.

Interpolation

Interpolation is the calculation of intermediate values. For example, when you set two keyframes for a moving object, the object's position on intermediate frames is determined by interpolation.

Inverse Kinematics

Inverse kinematics (IK) is a positioning and animation method that is built on top of the concepts of hierarchical linking. To understand how IK works you must first understand the principles of hierarchical linking and forward kinematics.

Inverse kinematics starts with linking and pivot placement as its foundation and then adds the following principles:

- Joints are constrained with specific positional and rotational properties.
- Position and orientation of parent objects is determined by the position and orientation of child objects.

Because of these added constraints, IK requires greater thought about how you link your objects and place pivots. Where many different solutions for linking objects might be suitable for forward kinematics, there are usually just a few good solutions for any given IK approach. The best solution depends on consideration of both the nature of the hierarchy, and how that hierarchy will be animated.

Inverse kinematics is often easier to use than forward kinematics and you can quickly create complex motions. However, you sacrifice some of your control to the automation of the IK functions.

Inverse Kinematics (Biped)

When you work with a [biped](#) on page 4147, you can use inverse kinematics (IK) by moving the hands or feet in [freeform animation](#) on page 7988. For example, you can position an arm by moving the hand.

A biped has three inverse kinematics parameters that you can vary during the limb's motion by setting them at each key of the arm and leg tracks. As the limb moves through each key:

- **IK Blend** Sets the motion interpolation to be a blend of forward and inverse kinematics. This will allow you to blend swinging motions with directed hand or foot motions. The default is 0.0, or full forward kinematics.
- **Body or Object** Determines the [reference coordinate space](#) on page 7943 of the IK path. This allows you to move the IK path with your character's body, or temporarily attach a hand or foot to follow another object or be attached to world space. The default is Body.
- **Join to Previous IK Key** Determines if the key should be part of the previous key (with the same reference position as the previous key).

These controls are in the IK section of the [Key Info rollout](#) on page 4367.

Iso Line

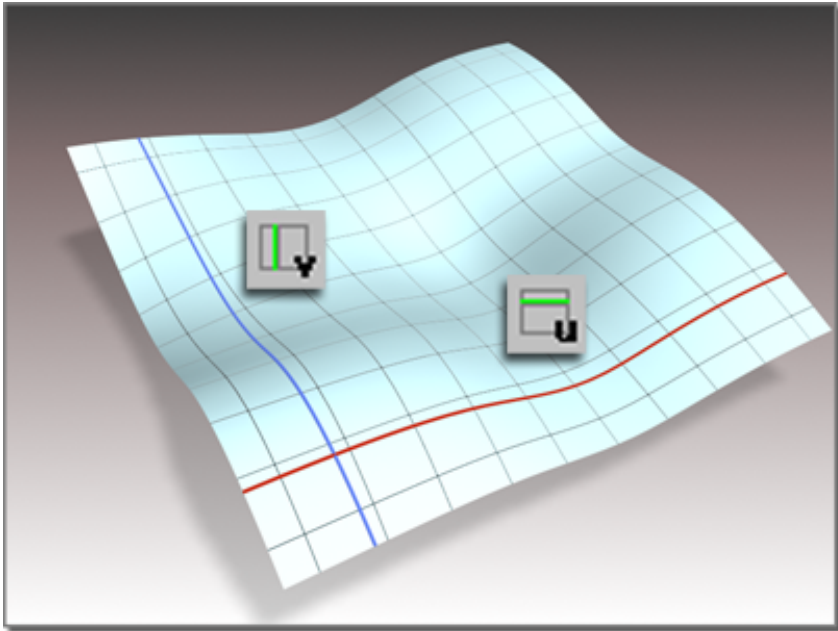

Iso lines on a NURBS surface

Iso is short for isoparametric.

In NURBS modeling, a line of constant parameter value, similar to a contour line. You can use iso lines to display a NURBS surface. You can also create dependent NURBS curves based on a surface's U-dimension or V-dimension iso lines.

Isometric View

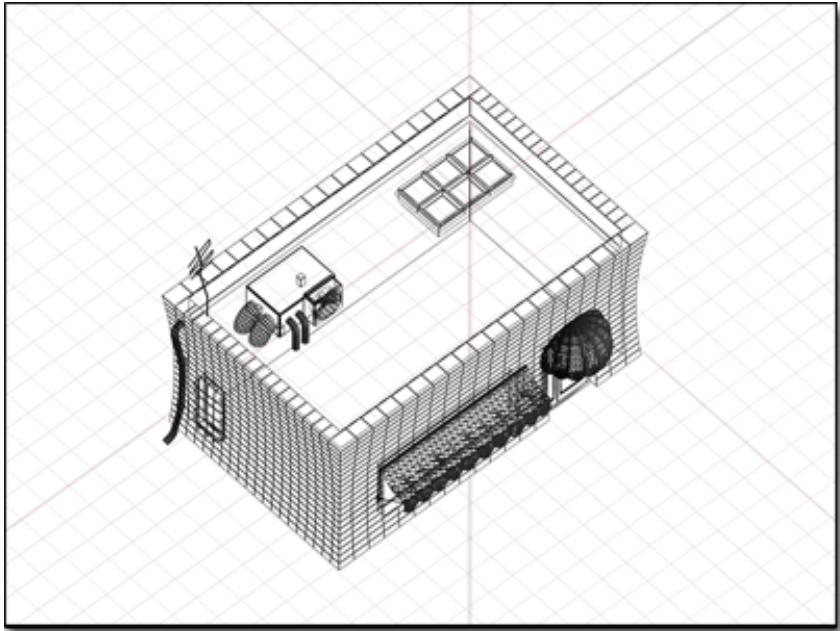

Isometric view of a scene

A special type of [axonometric view](#) on page 7918, where the sides of the object are equally inclined to the screen, producing equal foreshortening along the edges. You can create an isometric view by rotating a User view.

Keyframe Mode

Keyframe mode is active while the [Auto Key button](#) on page 7549 is turned on. While you are in Keyframe mode, transforming an object or sub-object, or changing the value of an animatable parameter, creates an animation key.

WARNING When you use [freeform animation](#) on page 7988 to animate a biped, always use the biped-specific Set Key button and other key controls on the [Key Info rollout](#) on page 4367, not the standard 3ds Max animation controls.

See also:

- [Layout Mode](#) on page 8022
- [Keyframes/Keys](#) on page 8020

Keyframes/Keys

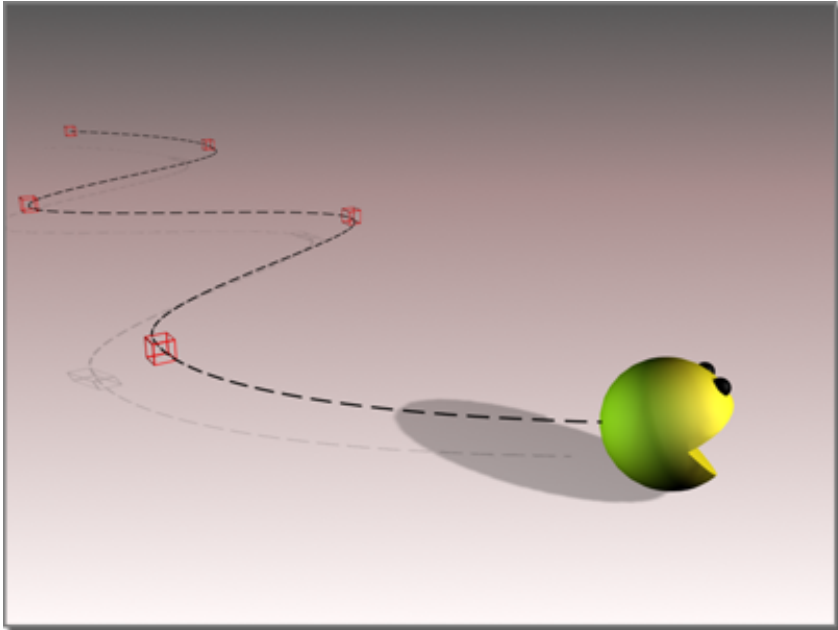

The red boxes indicate keyframes, the dotted line shows the interpolated trajectory.

Keyframes record the beginning and end of each transformation of an object or element in the scene. The values at these keyframes are called *keys*.

For example, if you have an object representing an elevator that has not been animated, no keyframes (or keys) exist for it. If you turn on the Animate button, move to frame 20, and move the elevator along the Z axis to the second floor, Position keys are created at frames 0 and 20. The key at frame 0 represents the position of the elevator before it was moved, while the key at frame 20 represents the position of the elevator after it was moved along the Z axis. When you play the animation, the elevator moves from the ground floor to the second floor over 20 frames.

Kinematic Chain

Inverse kinematics calculates the position and orientation of objects in a kinematic chain.

The kinematic chain is defined as a single branch of the hierarchy that starts with a selected child object and continues up through its ancestors until it reaches the base of the chain. The base of the chain is either the root of the entire hierarchy or an object that you specify as a terminator for the chain.

3ds Max automatically determines the kinematic chain when you select and transform an object with the IK button turned on.

Knot

A value in an array or "knot vector" associated with a NURBS curve. The knots specify the region of influence of the CVs on the curve. You can't see or directly alter knots.

Launch Script

A launch script is a MAXScript script that you run from the command line with the -U switch, instead of from the Utilities command panel.

You use a launch script to run batch operations in the software. For example, you might have a batch rendering in which the script opens a sequence of files, sets up shots in each, and renders them, all without using the user interface.

Layer Track

A Motion Mixer track for a series of motions that do not require transitions between them. Compare with a [Transition track](#) on page 8158, which allows you to stack clips on top of one another and to create automatic transitions between them. When a biped is added to the Motion Mixer, it is automatically assigned a Layer track. See [Adding Tracks to the Mixer](#) on page 3704.

Layers

Layers are like transparent overlays, and allow you to organize and group different types of scene information. The objects you create have common properties including color, visibility, renderability, and display. An object can assume these properties from the layer on which you create it.

You can adjust layer properties from the [Layers toolbar](#) on page 7504 and the Layer Manager.

See also:

- [Using Layers to Organize a Scene](#) on page 7438
- [Layer Manager](#) on page 7441
- [Layer Properties Dialog](#) on page 7451

Layers (Biped)

The [Layers](#) on page 4403 feature lets you add layers of animation above the original biped animation. This is a powerful way to make global changes to your character animation. For example, by adding a layer and rotating the spine forward at any frame, a run cycle becomes a crouched run. The original biped motion is kept intact and can be viewed by switching back to the original layer. You can view layers individually or as a composite of the animation in all layers. Layers behave like a freeform animation; the biped can adopt any position.

Layers allow you to easily adjust raw motion capture data, which contains keys at every frame. You add a layer and keyframe the biped.

Layout Mode

Layout mode is active while the [Auto Key button](#) on page 7549 and [Set Key button](#) on page 7552 are both turned off. While you are in Layout mode, you can transform objects and sub-objects, and change the values of animatable parameters, without generating animation keys.

See also:

- [Keyframe Mode](#) on page 8019
- [Keyframes/Keys](#) on page 8020

Lift

In [footstep animation](#) on page 7986, the state of a foot at the frame when it is about to lift away from a footstep.

Light Map

A light map or lighting map is a [bitmap](#) on page 7926 that stores the lighting levels (intensity and color) falling on an object in the scene. Typically, you create a light map by [rendering to a texture \(texture baking\)](#) on page 6371. Light maps are primarily for use in game engines, but you can also use them to speed up renderings.



Banana object in a lighted room

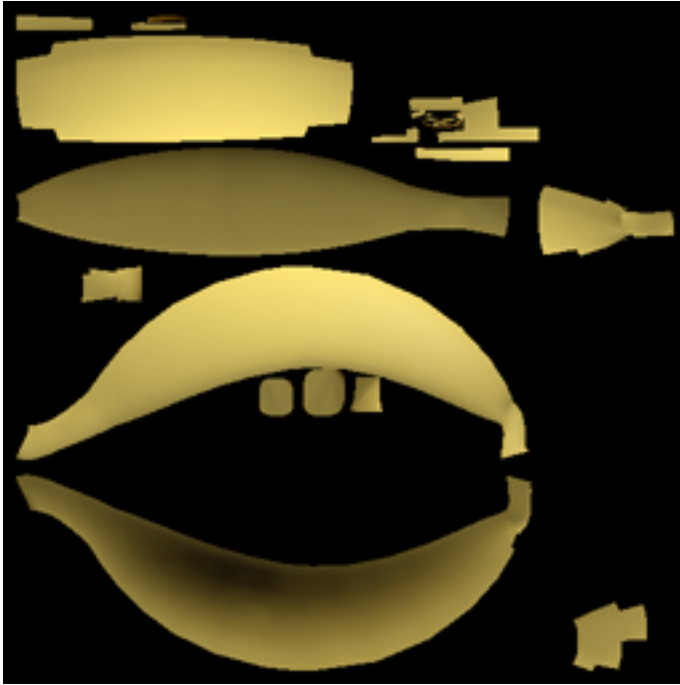

Light map of the banana

If you use the [DirectX Manager](#) on page 5393, you can display light maps interactively in viewports, using either the [LightMap shader](#) on page 5760 or the [Metal Bump shader](#) on page 5761.

See also:

- [DirectX Manager Rollout](#) on page 5393

Linked Geometry

Linked geometry is a by-product of importing or linking a drawing file to 3ds Max. It is a child object, or subcomponent, associated with VIZBlocks or Block/Style Parents.

When you select a linked geometry object, it offers no parameters on the Modify panel. You must first add an Edit Mesh modifier to the object or collapse the linked geometry object to an editable mesh in order to access

sub-object levels. If you add a modifier to linked geometry, the modifier is applied to all instances of that object.

The only direct control you have over linked geometry objects is the Reset Position option that is used to negate and basic move, rotate or scale transforms.

Links

Links are the segments of the [Physique deformation spline](#) on page 7949. Links follow the hierarchy of the skeleton, such as a biped, that has been attached to the [mesh](#) on page 8043. Link parameters in Physique allow you to bend, twist, change sliding behavior, and radially scale the mesh.

Listener Window

In MAXScript, the Listener Window is a command-line window that lets you type in and execute MAXScript commands interactively. In other words, you run the script as you go along, rather than running a pre-saved text file.

You open the listener window using the MAXScript Listener command on the MAXScript menu or from the Utilities > MAXScript > MAXScript rollout > Open Listener command.

Local Coordinate System



A book in object space rests on a table in world space. The book has its own local coordinate system.

The local coordinate system is the coordinate system that relates specifically to the selected object.

Each object has its own local center and coordinate system as defined by the location and orientation of the object's pivot point. The local center and coordinate system of an object combine to define its object space.

The direction of the object's X, Y, and Z axes depend on the current transforms of the object. Contrast with the world coordinate system.

You can see the difference between the two coordinate systems when you unintentionally rotate an object, such as a wheel on a car model, around the world axis instead of the object's local axis. The wheel immediately flies off in a large arc because the center of the rotation is at the origin of the world coordinates.

To rotate the wheel correctly, first change the coordinate system to Local, using the pop-up list on the toolbar. The wheel then rotates around its own hub, which is the origin of its local coordinates.

Local Event

Particle Flow uses two types of [events](#) on page 7966: [global](#) on page 7997 and local. All events in a [flow](#) on page 7983 except the first are called local events, because the [actions](#) on page 7897 they contain take effect only while particles are in that event. The [birth event](#) on page 7924 is a special type of local event that always comes immediately after a global event.

Lofting

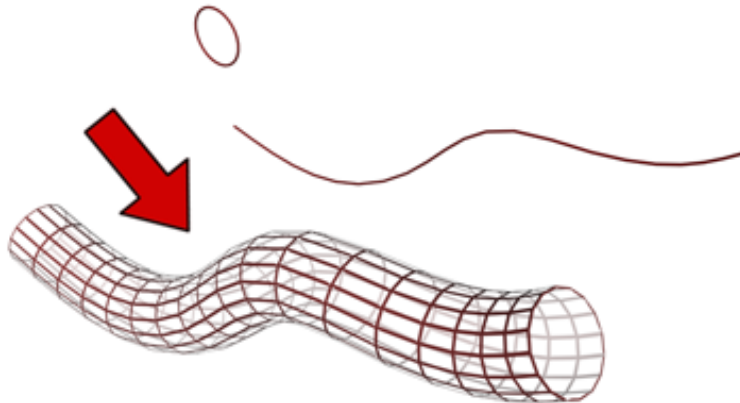

A circle is lofted along a path to construct a tubular shape.

Lofting is an important method for 3D object creation. You create shape objects to serve as a path and any number of cross-sectional shapes. The path becomes the framework that holds the cross-sections forming your loft object.

Once you create a loft object you can change and animate its parameters and sub-objects:

- Add and replace cross-section shapes or replace the path.
- Change or animate the parameters of the path and shapes.
- Change or animate the surface parameters of the loft object.

The lofting process first requires that you create shape objects to serve as the path and cross-sections of your loft object.

The term lofting comes from early shipbuilding. A large framework called a loft was built to hold the hull of a ship while it was assembled. The process of hoisting the ribs (cross-sections) of the hull into the loft became known as lofting.

A traditional method for building three-dimensional models of a modern vehicle design is to draw cross-sections at a number of key points. These cross-sections are cut out to form two-dimensional templates that are then placed on a rail. The model builders fill in the space between the templates to generate the surface of the model.

You create loft objects using a similar process. You first create two or more spline objects. One of these splines will be the rail, which is referred to as the path. The rest of the splines are the cross-sections of your object, which are called shapes. As you arrange your shapes along the path, the software generates a surface between the shapes.

Log File (mental ray Renderer)

The log file (*.log*) is an ASCII text file that contains messages generated by the mental ray renderer. You specify a name and location for the log file, and the "verbosity" level of the messages it contains, in the [mental ray preferences](#) on page 7787.

Look At Object

In the context of the [Shape Facing operator](#) on page 2901, a Look At object is the camera or object toward which particles face.

LTLI Files

The LTLI file type is the file format for photometric data created by the Danish Illuminating Laboratory. It is used primarily in Scandinavian countries.

Luminance

Luminance is the value of light reflected off a surface. It is a measure of how bright or dark we perceive the surface.

Luminous Flux

Luminous flux is the quantity of light energy per unit time arriving, leaving, or going through a surface. The lumen (lm) is the unit of luminous flux in both the International System (SI) of units and in the American System (AS) of units. If you think of light as particles (photons) moving through space, then the luminous flux of a light beam arriving at a surface is proportional to the number of particles hitting the surface during a time interval of 1 second.

Luminous Intensity

Luminous intensity is the light energy per unit time emitted by a point source in a particular direction. Luminous intensity is used to describe the directional distribution of a light source, that is, to specify how the luminous intensity of a light source varies as a function of the outgoing direction. The Candela (cd) is the unit of luminous intensity.

LZF Files

LZF (Lens Effects Flare) files allow you to store all of the settings for a Flare effect in one file. The settings are also saved with the MAX file; however, saving them to a separate file allows you to use the same Lens Effects settings in different scenes, and also allows you to share settings with other 3ds Max users.

LZG Files

LZG (Lens Effects Glow) files allow you to store all of the settings for a Glow effect in one file. The settings are also saved with the MAX file; however, saving them to a separate file allows you to use the same Lens Effects settings in different scenes, and also allows you to share settings with other 3ds Max users.

LZH Files

LZH (Lens Effects Highlight) files allow you to store all of the settings for a Highlight effect in one file. The settings are also saved with the MAX file; however, saving them to a separate file allows you to use the same Lens Effects settings in different scenes, and also allows you to share settings with other 3ds Max users.

LZO Files

LZO (Lens Effects Focus) files allow you to store all of the settings for a Focus effect in one file. The settings are also saved with the MAX file; however, saving them to a separate file allows you to use the same Lens Effects settings in different scenes, and also allows you to share settings with other 3ds Max users.

LZV Files

LZV files allow you to store the settings for several Lens Effects in one file. You can save all of your settings for Glow, Ring, Ray, Auto-Secondary, Manual Secondary, Star, and Streak effects in one file. The settings are also saved with the MAX file; however, saving them to a separate file allows you to use the same Lens Effects settings in different scenes, and also allows you to share settings with other 3ds Max users.

Map Bias



On the right, increased map bias makes the dog appear to float.

Map bias moves the shadow toward or away from the shadow-casting object (or objects).

By default, this value is 1.0 world coordinate unit. Increasing the bias moves the shadow away from the object, and decreasing the bias moves the shadow closer to the object. The Map Bias value can be any positive floating-point number.

For example, if a shadow-casting object intersects another object but its shadow doesn't meet properly at the intersection, the bias is too high. This effect varies with the angle of the spotlight to the object. Extremely shallow spotlight angles usually require higher bias values.

Another purpose of bias is to avoid problems with objects that cast shadows onto themselves. If you see streaks or moiré patterns on the surface of the object, the bias value is too low. If you increase the bias so much that the shadow becomes disconnected from the object, reduce the bias and increase the shadow map Size value instead.

Map Channel

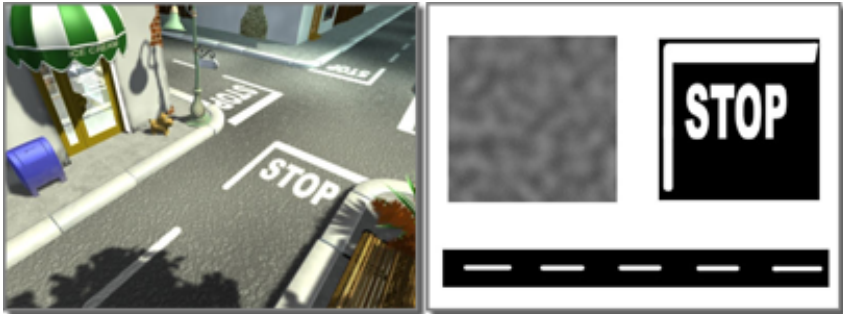

Left: Scene uses different map channels to place different copies of the same maps in different locations.

Right: The three maps used to create the streets and the traffic markers painted on them

When you turn on Generate Mapping Coordinates for an object, the coordinates use map channel 1. You can assign new map channels with new mapping coordinates by applying a [UVW Map modifier](#) on page 1931 to the object. Map channel values can range from 1 to 99.

A map channel associates a map with an object's mapping coordinates. [Texture-baked maps](#) on page 6371 also use map channels.

For [NURBS](#) on page 2237 surface sub-objects, you can assign a map channel without applying UVW Map. The surface sub-object has a different set of mapping coordinates for each map channel you use.

A map's map channel value identifies which of an object's mapping coordinates to use. Different map channels allow maps for the same object to use different coordinates. For example, you might use one channel for [diffuse mapping](#) on page 5460 and a different one for [bump mapping](#) on page 5478. Map channels also let different maps use different coordinates within a [compound material](#) on page 5706, a [compositor map](#) on page 5918, or a [multi/sub-object](#) on page 5720 material.

Different map channels can have different U and V tiling values, different U and V offsets, and so on. In the UVW Map modifier, you can also set different map channels to have different mapping types (planar, cylindrical, spherical, and so on).

If you apply a map that uses a certain map channel to an object that has no mapping coordinates for that channel, the map doesn't appear on the object.

When you render, a [Missing Map Coordinates](#) on page 5780 dialog appears to warn you of the problem. The dialog lists the map channel and the object name.

See also:

- [Coordinates Rollout \(2D\)](#) on page 5782
- [Coordinates Rollout \(3D\)](#) on page 5861

Mapped Material

A mapped material is a [material](#) on page 8041 that contains one or more [maps](#) on page 5767. Typically, it contains a [bitmap](#) on page 7926 as a Diffuse map, but having any map or maps applied qualifies a material as mapped.

In order for a mapped material containing a [2D map](#) on page 7894 to appear properly in the viewports and in the rendered image, any object to which it's applied generally needs mapping coordinates. By default, most parametric objects in 3ds Max already have mapping coordinates applied; you can also use the [UVW Map modifier](#) on page 1931 (link) or [Unwrap UVW modifier](#) on page 1841 (link) to provide mapping coordinates.

NOTE Objects with materials that contain only [3D maps](#) on page 7894 do not need mapping coordinates.

Mapping Coordinates

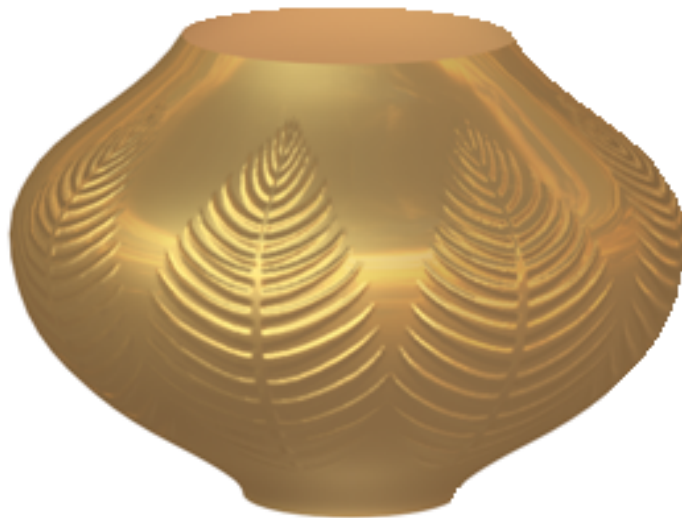
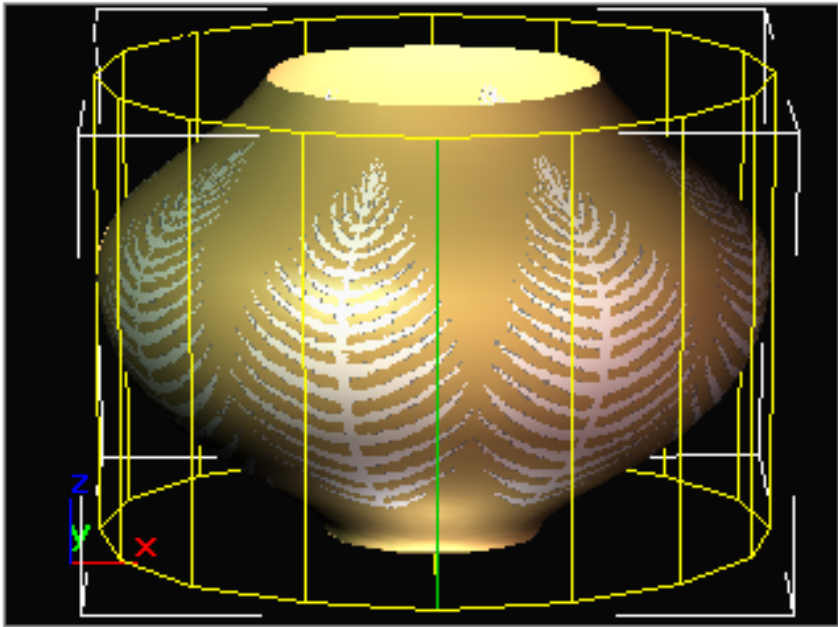

Decoration on the vase is a map positioned by rotating the UVW Map Modifier gizmo.

Mapping coordinates specify the placement, orientation, and scale of a map on the geometry. Coordinates are often specified in terms of U, V, and W, where U is the horizontal dimension, V is the vertical dimension, and W is the optional third dimension, representing depth.

If you apply a mapped material to an object that has no mapping coordinates, the Renderer assigns default mapping coordinates. The built-in mapping coordinates are designed for each object type. The box mapping coordinates place a duplicate map on each of its six sides. For the cylinder, the image is wrapped once around its sides, and duplicates of the image are distorted at the end caps. A sphere has the image wrapped once around the sphere, and then gathered at the top and bottom. Shrink-wrap mapping is also spherical, but truncates the corners of the map and joins them all at a single pole, creating only one singularity.

3ds Max provides a number of ways to apply mapping coordinates:

- Use the Generate Mapping Coords option in the creation parameters rollout of any standard primitive. This option, which is on by default for most objects, provides mapping coordinates specifically designed for each primitive. They require additional memory, so turn the option off if you don't need them.
- Apply a [UVW Map modifier](#) on page 1931. You choose from several types of mapping coordinate systems and customize the placement of the mapping coordinates on the object by positioning a mapping icon. In addition, you can animate the transformations of the mapping coordinates.
- Use special mapping coordinate controls for special objects. For example, Loft objects provide built-in mapping options that let you apply mapping coordinates along their length and around their perimeter.
- Apply a Surface Mapper modifier. This world-space modifier takes a map assigned to a [NURBS](#) on page 2237 surface and projects it onto the modified object or objects. Surface Mapper is especially useful for seamlessly applying a single map to a group of surface sub-objects within the same NURBS model. You can also use it for other kinds of geometry.

There are three cases where you don't need mapping coordinates:

- Reflection/refraction maps and environment maps
These use an environmental mapping system, in which the placement of the map is based on the rendered view, and fixed to the world coordinates in the scene.
- 3D procedural maps (such as Noise or Marble)

These are procedurally generated, based on the local axis of the object.

- Face-mapped materials
The maps are placed based on the facets in the geometry.

Maps

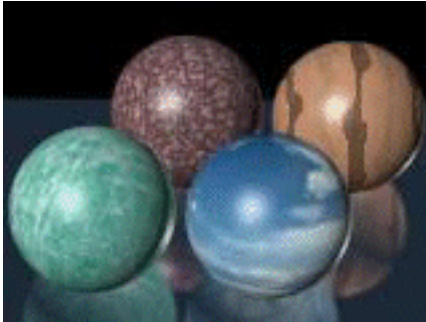

Front left sphere: Marble bitmap

Front right sphere: Clouds bitmap

Back left sphere: Noise procedural map

Back right sphere: Marble procedural map

The images you assign to materials are called maps. The software provides several different map types. They include standard bitmaps (such as *.bmp*, *.jpg*, or *.tga* files), procedural maps, such as Checker or Marble, and image-processing systems such as compositors and masking systems.

You can assign maps to most of the components that make up a material. Materials that contain one or more images are called mapped materials. By assigning maps to different attributes of the materials, you can affect the color, the opacity, the smoothness of the surface, and much more.

Maps offer the level of realism you look for in materials. The different types of maps you can use range from the common bitmap, to the flexible procedural map.

For many map types, the renderer needs instructions telling it where the map should appear on the geometry. These instructions are called [mapping coordinates](#) on page 8034.

Marker Data

Data from a [motion-capture device](#) on page 4574. Rather than limb rotational data, marker data uses marker positions to specify limb position.

Marker Files

A file from a motion-capture device. **character studio** can read two marker file formats:

- [CSM \(character studio marker\)](#) on page 7934
This is the native marker file format of **character studio**.
- [BVH \(BioVision\)](#) on page 7922

Markers

In a motion-capture session, markers are reflective objects placed on the “actor” or “talent.” The markers enable motion-capture hardware to record the position of various parts of the talent's body while performing motions.

Master Motion Clip Controller

In [crowd animation](#) on page 4761, a controller (similar to the Block controller) that consists of a list of motion clips. When instanced, these motion clips can blend from one animation to another. The Master Motion Clip controller is accessed via the [Crowd helper](#) on page 4819.

Match Frame

For the purposes of combining [inverse kinematic \(IK\)](#) on page 8016 and [forward kinematic \(FK\)](#) on page 7987 animation, this is a collection of keyframes that allow a seamless blend between IK and FK control, or vice versa. On the [IK goal](#) on page 8008, this includes IK keys for:

- Position

- Enabled state
- Swivel angle

On the IK bones, a match frame includes FK keys for:

- Rotation
- Preferred angles
- Scale (less frequently)

Material ID

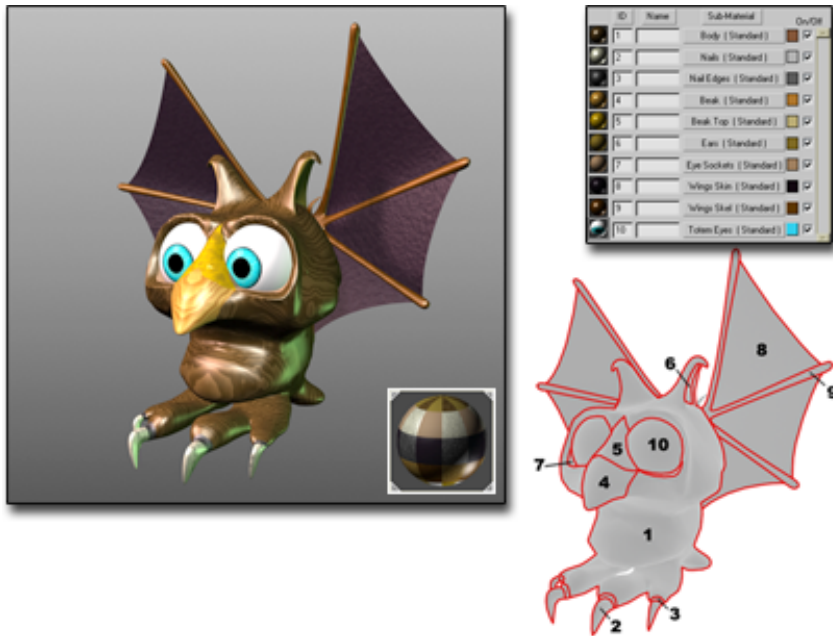

Figure mapped using a multi/sub-object material: material IDs identify the component sub-materials.

A surface's material ID is the value that determines which sub-material the surface will use when you apply a [Multi/Sub-Object material](#) on page 5720 to the object to which the surface belongs.

Geometric primitives have default material identification number assignments, just as they have default smoothing groups. The default material ID assignment depends on the type of geometry. Most curved objects such as spheres have a single material ID. Boxes have six IDs, one for each side. Cylinders have three: ID number 1 and 2 for the two caps, and ID number 3 for the sides. Hedra have three: one for each of their P, Q, and R axes.

When you apply a Multi/Sub-Object material, the materials will match the Multi/Sub-Object material ID numbers to the material ID numbers on the faces of the object. Faces keep a record of the ID number, and not of the material name. If the material is anything but Multi/Sub-Object, the material is assigned to the object's entire surface.

Assigning some defining material ID number to each object before they become compound object operands can be a useful technique for being able to select the separate pieces after they're combined.

You can use material IDs for continuous surfaces that require separate paints or finishes. For example, a car constructed from different types of materials, such as a colored metal body, chrome parts, glass windows, and so on.

You can use the [Material modifier](#) on page 1517 to assign material ID numbers. Also you can reassign material IDs using the Editable Mesh > Surface Properties rollout, or Edit Mesh modifier > Edit Surface rollout.

Material/Map Hierarchy

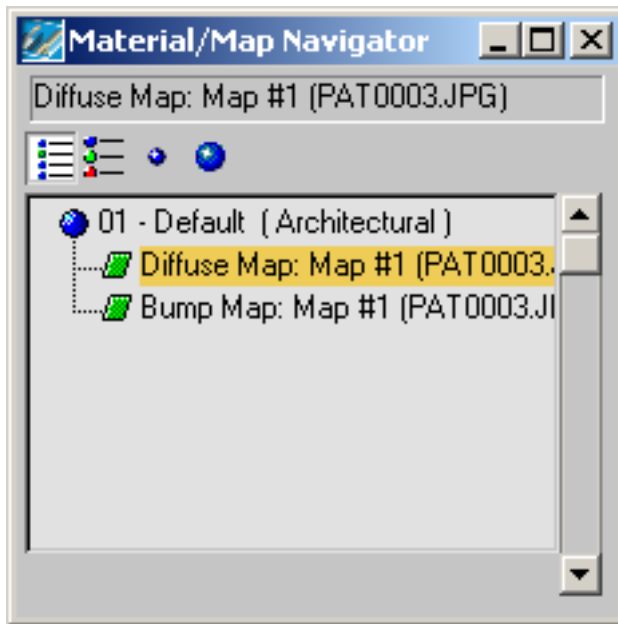

Material/map hierarchy shown in the Material/Map Navigator

The Material Editor could be called the Material and Map Editor, because you can use it to design both materials and maps, and any combination of the two. In addition, you can create material or map hierarchies.

A material hierarchy is a material that consists of other materials (or maps). Similarly, a map hierarchy is a map consisting of other maps. Materials that consist of other materials are called [compound materials](#) on page 7938. Maps consisting of maps are compound maps.

Materials



Spheres with variations of the standard material type (no maps used):

Green sphere: High Glossiness

Red sphere: Constant shading

Blue sphere: 60% opacity

Yellow sphere: Wireframe mode, slight self-illumination

A material is data that you assign to the surface or faces of an object so that it appears a certain way when rendered. Materials affect the color of objects, their glossiness, their opacity, and so on.

A standard material consists of ambient, diffuse, and specular components. You can assign maps to the various components of a standard material.

The standard material is the default material in the six sample slots of the Material Editor. However, you can change the type of material you're working on by clicking the button labeled Type below the sample slots. This displays the Material/Map Browser, and lets you select from a list of alternative material types.

You can also change the type of material you're working on by clicking the Get Material button below the sample slots. This displays the Material/Map Browser, and lets you select from a list of alternative material types.

Matte Object



Matte object reveals part of the background, making the hamburger geometry appear to be inside the oven.

A matte object is invisible but blocks any geometry behind it. However, it does not block the background.

For example, you might make a complex scene for the background of your animation, render it once, then assign the resulting bitmap as a background using only a few animated objects during the rendering of the animation. If you then needed one of your objects to appear from behind some portion of the background, such as a building, you would create a matte object that matches the building. You then place the animated object behind it. The bitmap image of the building appears, but the animated object is blocked until it moves from behind the matte object.

Matte objects, though invisible, can cast shadows.

Matte objects can also receive shadows. When the Matte/Shadow material's Affect Alpha check box is set, shadows cast on the matte object are applied to the alpha channel. This lets you render maps with alpha shadows that you

can composite later. To properly generate shadows on a matte object, turn off the Opaque Alpha check box and then set the Affect Alpha check box.

MAXScript

MAXScript is the general-purpose scripting language for 3ds Max and related products. While it works the same for all products, some functions are specific to each. You can use MAXScript to automate many tasks, including modeling, animation, material construction, and rendering. You can also use MAXScript to add custom command-panel rollouts to the user interface.

The interface to MAXScript is on both the [MAXScript menu](#) on page 7496 and the [Utilities panel](#) on page 7671.

Mesh

A mesh is a type of geometric model of a three-dimensional object in which the basic shape is made up of points, or [vertices](#) on page 8164, connected by [edges](#) on page 7961. The renderable surface of the mesh object is made up of [faces or polygons](#) on page 7970 that connect the vertices and edges. Examples of mesh objects in 3ds Max are primitives such as Sphere and Teapot, as well as Editable Mesh and Editable Polygon objects.

In 3ds Max you can edit a mesh by transforming, adding, and deleting the various elements, or sub-objects: vertices, edges, faces, and polygons. You can also apply various changes with [modifiers](#) on page 8048.

Metaballs

A type of object that joins itself to other objects with a connecting surface. When one metaball object moves within a certain distance of another, a connecting surface is formed between the two. Metaballs are ideal for simulating liquids and thick, viscous substances such as mud, soft foods, or molten metal.

You can create metaballs with the [BlobMesh compound object](#) on page 745.

MFE Files

A MFE file contains a [motion flow graph](#) on page 4549 and any scripts created for the graph. See [Saving, Loading, and Appending Motion Flow Graphs](#) on page 4521.

MI Files

The MI file (.mi, stands for “mental images”) contains a mental ray scene description that a mental ray renderer can use to render your 3ds Max scene. When you render with the mental ray renderer, you can export to a text (ASCII) MI file. (There is a binary MI format as well. The mental ray renderer in 3ds Max does not generate this format.) The exporter always generates mi3 (mental ray version 3) format. It does not support mental ray version 1 (mi1).

You specify a name and location for the MI file on the Render Setup dialog > Processing panel > [Translator Options rollout](#) on page 6316.

See the mental ray manual, *Programming mental ray*, for a complete description of the mental ray scene description language.

Mirroring

When working with a [biped](#) on page 4147, the Mirror control in the [Keyframing Tools rollout](#) on page 4380 allows you to mirror the entire biped animation.

Mix

Data in the [Motion Mixer](#) on page 3699 for a single biped. The term *mix* refers to the arrangement of elements in Motion Mixer ([clips](#) on page 8051, [transitions](#) on page 8157, [balance information](#) on page 7919) as well as the result of the arrangement. A mix is sometimes called a *raw mix* to distinguish it from a [mixdown](#) on page 8045.

You can save a mix to a [MIX file](#) on page 8045.

MIX Files

A MIX file contains data from the Motion Mixer, including information on [trackgroups](#) on page 8151, [tracks](#) on page 8150, [clips](#) on page 8051, [transitions](#) on page 8157 and [balance information](#) on page 7919. Compare with a [mixdown](#) on page 8045, which contains the same data, but in a collapsed format; the data is no longer separated into tracks and clips.



You can save a MIX file in the Motion Mixer by choosing Mix menu > Save Mix File, or by clicking Save File on the Mixer rollout.

Mixdown

A mixdown is a collapsed version of data in the Motion Mixer. In general, a mixdown contains the same data as the [raw mix](#) on page 8044, with one difference. During the process of computing a mixdown, any transitions involving planted feet are corrected to prevent the feet from sliding.

After a mixdown is computed, it is placed on its own track in the Mixer. You can turn the mixdown on and off by clicking it. When the mixdown is turned on, the biped performs the motions in the mixdown; when it is turned off, the biped does the motions in the raw mix. See [Exporting Animation to the Biped](#) on page 3741.

MNM Files

An MNM file (Marker Name file) is a **character studio** file format that matches custom names in a motion-capture [marker file](#) on page 8037 with the preset list of known, supported marker names that are recognized by bipeds. See [BVH Files](#) on page 7933 and [CSM Files](#) on page 7945 for descriptions of how these two motion-capture file formats work with MNM files.

Modal/Modeless

Modal is a command state or dialog that affects all operations. You must change the mode or dismiss the dialog before doing any operations that don't pertain to that mode.

Modeless means a nonexclusive command state or dialog. You can do other operations and commands without changing the mode or dismissing the dialog.

For example, the Track View and Material Editor dialogs are modeless, while the Open File dialog is modal.

Modifier Stack

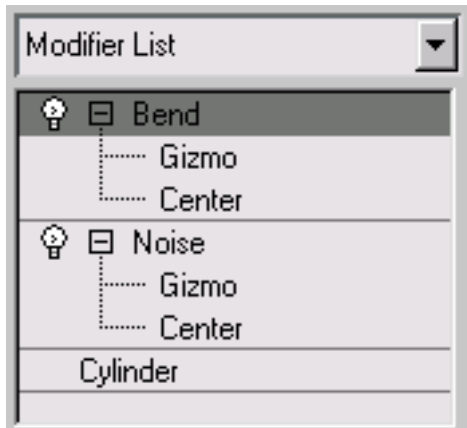

Example: Modifier stack display of cylinder with two modifiers applied to it

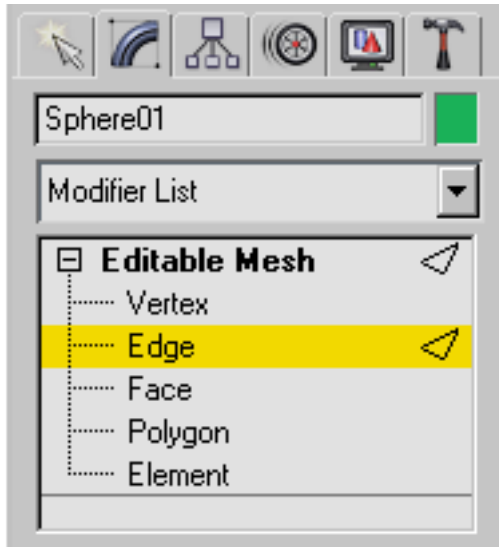

Example: Stack display of mesh showing its sub-object hierarchy, and Edge sub-object level chosen

The [modifier stack](#) on page 7635 is the key to managing all aspects of object modification. You use the stack to:

- View and manipulate the sequence of modifiers
- Find a particular modifier
- Adjust a modifier's parameters
- Select a modifier's gizmo or center
- Activate or deactivate a modifier
- Delete or disable a modifier

The effect of modifiers is directly related to their sequence, or order, in the stack.

Where you put a modifier in the stack is critical, because the program applies modifiers in their stack order, beginning at the bottom, and carries the cumulative change upward.

By clicking any entry in the stack, you go back to the point where you made that modification. You can then rework your decisions or discard the

modification entirely by deleting it. You can also insert a new modifier in the stack at that point.

Modifiers

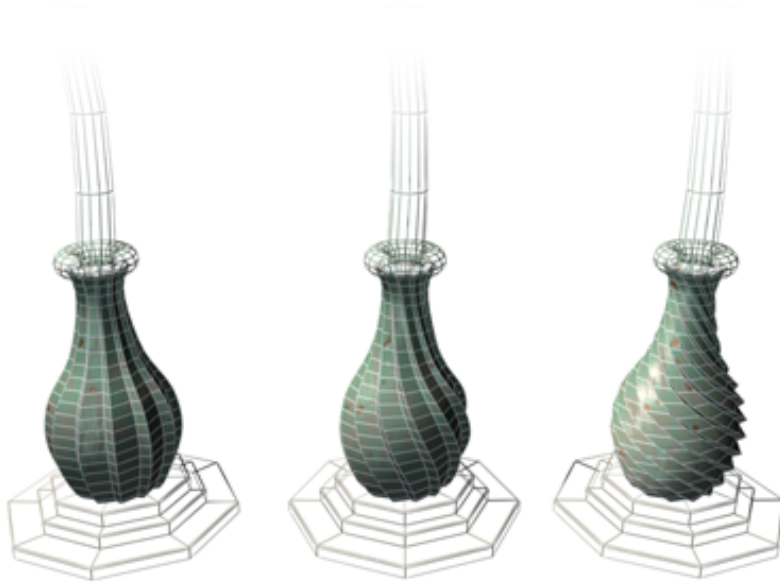

Example: effects of the twist modifier on an object

[Modifiers](#) on page 1085, as the name implies, modify an object's geometrical structure, deforming it in some way. When you apply a [taper modifier](#) on page 1811 to the end of a cylinder, for example, the vertices near the end move closer together. Modifiers make changes in the geometry that stay in effect until you adjust or delete the modifier.

Morphing



Morphing makes the clock appear to melt.

Morphing is a term derived from *metamorphosis*, which means to change physical shape or form.

The purpose of the morph object in 3ds Max is to create an animated object that changes shape by morphing between two or more objects. Although it appears that a single object is changing form, in reality the morphing process translates the position of the vertices from their arrangement in one object to the arrangement in another, relative to their local coordinate system.

Consequently, all objects chosen to make up a morph object must have the same number of vertices. Typically, you achieve this by cloning an object, and then altering the geometry of the clones without changing their vertex count.

Motion Blending

When working with [motion flow](#) on page 4508, you use transitions to blend clips together. By default, a transition is calculated with a method known as “minimum motion loss.” If optimized transitions are used, then a sophisticated algorithm that minimizes foot sliding is used. This alternative method is computationally expensive.

Motion Blur



Motion blur enhances the movement of the sword.

Motion blur can enhance the realism of a rendered animation by simulating the way a real-world camera works. A camera has a shutter speed, and if significant movement occurs during the time the shutter is open, the image on film is blurred.

3ds Max provides a variety of ways to apply motion blur:

- [Image Motion Blur](#) on page 8010 applies motion blur to entire frames of an animation.
- [Motion Blur Rendering Effect](#) on page 6681 lets you apply image motion blur as a [rendering effect](#) on page 6583.
- [Multi-Pass Rendering Effect](#) on page 5227 applies motion blur to frames by offsetting the camera in multiple rendering passes. You can preview multi-pass rendering effects in camera viewports.
- [Particle Motion Blur](#) on page 3010 uses a material map to blur moving particles in a particle system.

- [Scene Motion Blur](#) on page 8117 lets you apply motion blur as a [Video Post](#) on page 6773 effect.
- [Object Motion Blur](#) on page 8063 applies motion blur to specified moving objects in a scene. Object motion blur is best for making fast-moving objects appear to move more smoothly.

Motion Capture

The process of digitizing the movements of a live “actor” or “talent.” This requires a motion-capture device.

Motion Clip

A motion clip is a sequence of motion on a biped or other objects. A motion clip can be a BIP file, or a portion of a 3ds Max animation used in a crowd sequence.

BIP files used in [Motion Flow](#) on page 8052 and the [Motion Mixer](#) on page 8052 are called *motion clips*. You can use these tools to combine several motion clips and make a longer or different animation. A BIP motion clip can be created by [saving animation](#) on page 4300 you have made on the biped, or by [importing motion-capture data](#) on page 4576.

When you create a [crowd animation](#) on page 4761 that uses [motion synthesis](#) on page 8053 on non-biped objects, a *motion clip* is a portion of a 3ds Max animation used by the synthesis. You specify that a range of frames in the animation is to be used when the delegate meets certain criteria, such as turning upward to exceed a certain pitch.

One animation sequence can contain all the motion clips necessary to animate the crowd. For example, a bird animation might have three motion clips: flap, glide, and land. You could specify that when the delegate is pitched upward, the range of frames that animate the flap motion are used in the simulation. Motion clips are used by the [Global Motion Clip Controller](#) on page 7999 and the [Master Motion Clip Controller](#) on page 8037.

Motion Files

character studio can load these types of motion files:

- [BIP files](#) on page 7923
- [BVH files](#) on page 7933
- [CSM files](#) on page 7945

Motion Flow

In [Motion Flow mode](#) on page 4508, you combine [BIP files](#) on page 7923 to create longer character animation. You also use motion flow along with [crowd animation](#) on page 4761 to automatically generate crowd behavior.

One motion can transition into another. To generate a transition, **character studio** uses either velocity-interpolated transitions (“minimum motion loss”), or an algorithm to minimize sliding feet.

Motion Flow Editor

In [Motion Flow mode](#) on page 4508, the Motion Flow Editor allows you to manually create a transition between two clips. You set the start frame and transition duration for both clips, and the orientation of the destination clip.

Motion Flow Scripts

When using [motion flow](#) on page 4508, a script is a sequence of motion files that are played to create a character’s motion. Scripts are created either manually or automatically.

Motion Mixer

The Motion Mixer is a window where you can mix motion clips (BIP files) on a biped. The clips are placed on various [tracks](#) on page 8150 within the mixer.

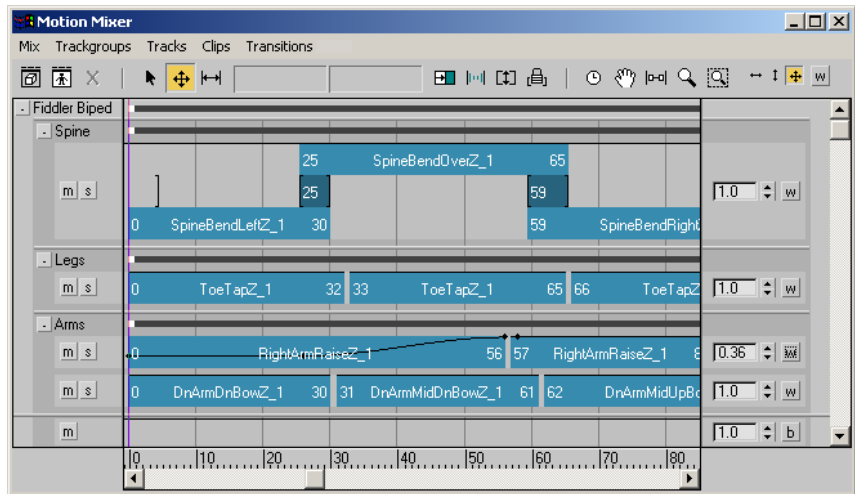

In the Motion Mixer, you can use [trackgroups](#) on page 8151 to affect different body parts with different clips. Each trackgroup can contain [transition tracks](#) on page 8158 and [layer tracks](#) on page 8021, which hold the motion clips.

Each biped in the Motion Mixer is assigned a [balance track](#) on page 7919, which automatically compensates for differences in balance between upper and lower body motion.



To make the motion in the Mixer affect the biped in the scene, you must turn on Mixer Mode in the [Biped rollout](#) on page 4331.

See [Using the Motion Mixer](#) on page 3699.

Motion Synthesis

In [crowd animation](#) on page 4761, motion synthesis is the process of animating bipeds by combining motions (clips) automatically. Clips are added to the Motion Flow Graph, and transitions are created between appropriate clips. In the Crowd system, delegates are animated. During synthesis (solving the motion), the delegates' speed and direction are analyzed by **character studio**. Based on the analysis, clips are selected to animate the bipeds.

MSP (MAXScript Package) Files

A MAXScript Package (MSP) combines the set of files that make up a scripted tool into a single file. An MSP file can contain bitmaps, script sources, icons, and so on.

For more information about MSP files, see the MAXScript Reference: Help menu > MAXScript Reference

Multiplicity

In NURBS modeling, multiplicity is the property of coincident or nearly coincident CVs that reduces the continuity level of the curve or surface. Two coincident CVs locally increase curvature. Three coincident CVs (or more) create an angular cusp. Fusing CVs shows the effect of multiplicity.

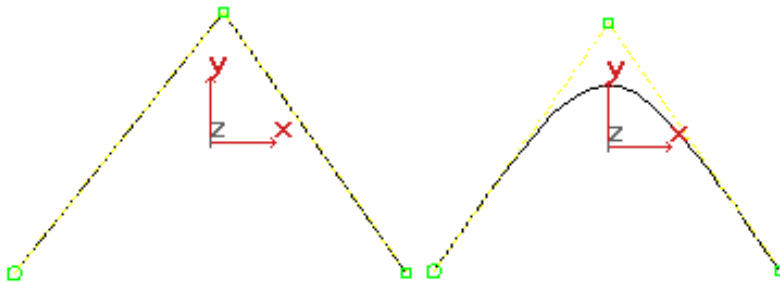

Effects of multiplicity:

On the left, three coincident CVs create a sharp angle.

On the right, only two coincident CVs in the same location create a gentler curve.

Multiplier

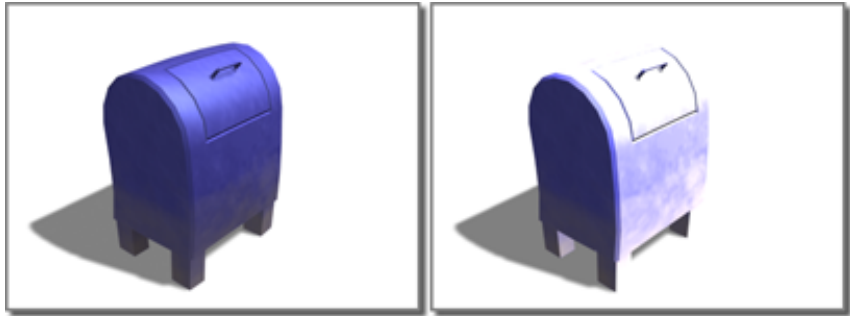

Left: Default light multiplier of 1.0

Right: Multiplier of 5.0 causes burned colors

The Multiplier value in every light lets you increase the intensity, or brightness of the light beyond its standard range.

Since increased Multiplier values tend to wash out, or "burn" portions of the image, you're better off adding lights, or reducing the intensity of other lights when you need to adjust the brightness of areas in your scene. Remember that you can adjust the intensity of a light using its V(alue) spinner. In most cases, it's better to adjust the V spinner than to alter the default Multiplier value.

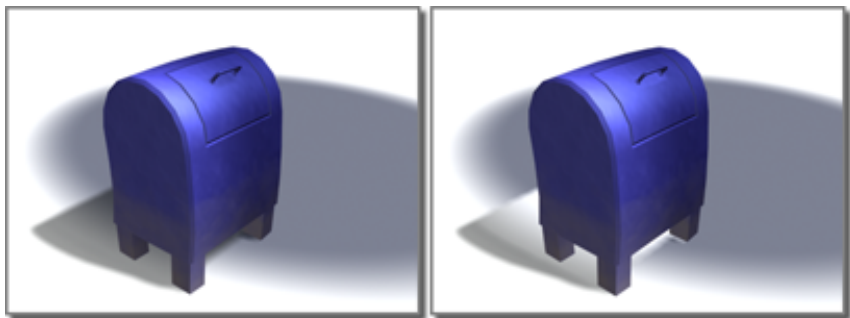

Left: Spotlight with negative multiplier subtracts light from the scene.

Right: Multiplier of 0 and a negative density on a shadow whose color is white creates the effect of a negative shadow.

An unusual characteristic of the Multiplier is that you can use negative values to create negative light. You can use negative lights to further control the

lighting in your scene. For example, you might want a darker area in the corner of a room.

A negative Multiplier value reverses the color of the light, so a red light would become cyan (the complementary color). In addition, the map image in a projector light becomes a negative image.

Multiplier Curve

Multiplier curves are special function curves that you use to apply animated value displacements to other function curves.

When you edit keys and function curves, you apply localized changes to your animation at specific times. By applying a multiplier curve to the original track, you affect the entire range of the original animation.

A multiplier curve shifts the value of the original track up or down. At a given frame, the value of a multiplier curve is a scale factor applied to the value of the original function curve.

- The default value of a Multiplier curve is a horizontal line with a value of 1.0.
- Values greater than 1.0 increase the value of the function curve.
- Values below 1.0 decrease the value of the function curve.
- Values less than 0.0 negatively scale the value of the function curve.

See also:

- [Ease Curve](#) on page 7960

N Links

In [Physique](#) on page 4603, by default, any number of overlapping envelopes can influence vertices. This is specified by the N Links option on the [Vertex-Link Assignment rollout](#) on page 4703 of the Physique Initialization dialog, or at the [Vertex sub-object level](#) on page 4753.

Typically, N Links is the preferred choice. For special purposes, such as developing for a game engine that has limited support of overlap, you can limit the number of links (with their envelopes) that can affect a vertex.

Network Manager

The Network Manager service (Network Manager) is a service that must be installed on at least one computer in each group of computers that will participate in network rendering.

The Network Manager communicates with a specified group of Network Rendering Servers to assign jobs and monitor rendering progress. The Network Manager also handles the scheduling of jobs and the configuration of servers through the Queue Monitor client.

It's often best to place the Network Manager on a computer that isn't in use as a workstation and isn't shut down regularly. The Manager Service can impact CPU and network performance when network rendering is taking place, and the Network Manager must be present at all times for network rendering to work.

The ideal place to install the Network Manager is on a file server. If you have a PC already set up as a texture-map file server, this would be an ideal place for it.

You specify which PC is to be the Network Manager in the Network Job Assignment dialog, a subdialog of the Render Setup and Video Post Execute Sequence dialogs.

Network Rendering

Network Rendering is the rendering of animations using more than one computer connected by a network.

Large and complex animations take many hours to render, even on the fastest PCs. Network rendering allows you to use the power of other computers to speed up the process. Any network-connected PCs that have the software installed can participate. You can even render using computers connected only by the Internet.

Setting up network rendering involves installing three kinds of programs:

- The Network Manager, which should be installed on a central file-server PC.
- The Network Rendering Server, which must be installed on all participating PCs.

- The Queue Monitor client provides a user-interface to monitor and control network rendering. It can be installed on any of the participating PCs.

Network Rendering Server

The Network Rendering Server must be running on any computer dedicated to rendering a job remotely.

The Server communicates with the Network Manager and starts the program on that computer to render network processes. The Server has no user interface itself, but you can set various options for it from the Queue Monitor client. For example, you can specify the times of day that the Server is available to do network rendering.

You specify which PCs are to be servers in the [Job Assignment dialog](#) on page 6481, a subdialog of Render Setup.

Newton

In the metric system, the newton is the unit of force required to accelerate a mass of one kilogram one meter per second. In 3ds Max, you can use the newton in dynamic simulations with objects such as the [spring](#) on page 890 and [damper](#) on page 881.

Node

Every object in a 3ds Max scene is represented in memory (that is, in the data structure of the scene) as a node, which acts as a container for an object's geometry, its transform controllers, assigned materials and modifiers, etc. Nodes also provide the building blocks for hierarchies, in which parent/child relationships are created by linking objects node to node. Two tools that display nodes are Track View and Schematic View.

"Node" is distinct from the term "object," because the "object" refers more narrowly to geometry: the mesh, or NURBS surface, spline, or patch, and so on. The same instance of an object's geometry can be shared by multiple nodes. Each node in the scene is unique and can be identified as such by the commands and tools 3ds Max or plug-ins implement.

Normal

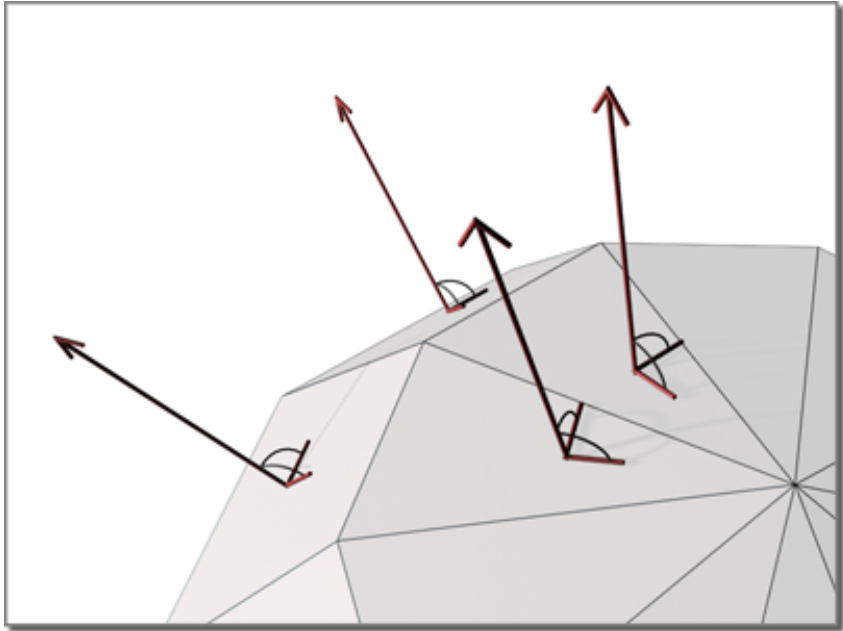

The normal of each face can point in a different direction.

A normal is a vector that defines which way a face or vertex is pointing. The direction of the normal indicates the front, or outer surface of the face or vertex.

You can manually flip or unify face normals to fix surface errors caused by modeling operations or by importing meshes from other programs.

See also:

- [Normal modifier](#) on page 1581

NTSC

NTSC (National Television Standards Committee) is the name of the video standard used in North America, most of Central and South America, and Japan. The frame rate is 30 frames per second (fps) or 60 [fields](#) on page 7973 per

second, with each field accounting for half the interleaved scan lines on a television screen.

NURBS

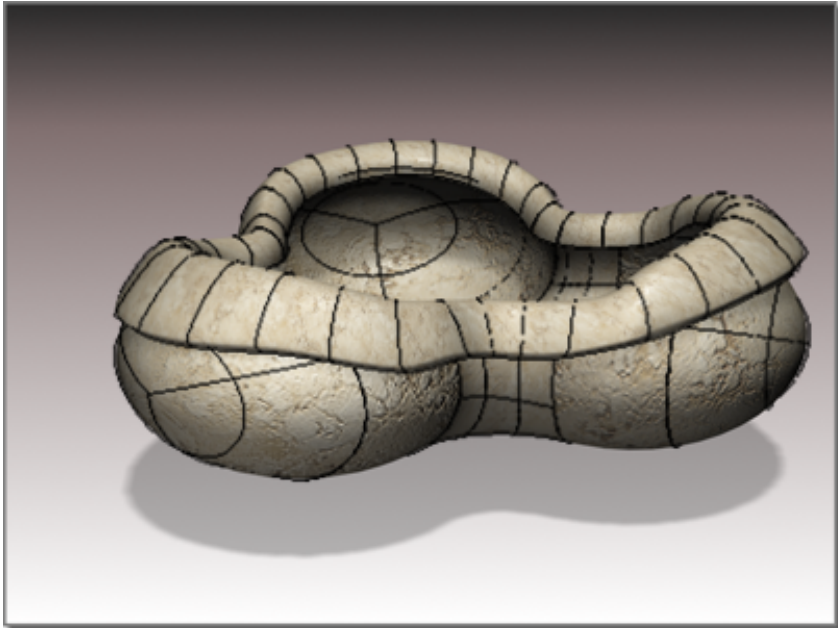

Fountain basin modeled as a NURBS surface

NURBS (Non-Uniform Rational B-Splines) are a technique for interactively modeling 3D curves and surfaces.

NURBS Curve

A curve object created by [NURBS modeling](#) on page 8060. NURBS Curves can be either Point Curves or CV Curves. You can use them as you do spline curves in Shape objects.

NURBS Model



Fountain modeled using NURBS surfaces

A [NURBS object](#) on page 8060 consisting of one or more sub-objects. The 3ds Max documentation uses "NURBS model" to emphasize the final result of NURBS modeling using a variety of sub-objects and techniques.

NURBS Surface

A surface object created by [NURBS modeling](#) on page 8060. NURBS Surfaces can be either Point surfaces or CV Surfaces.

Object

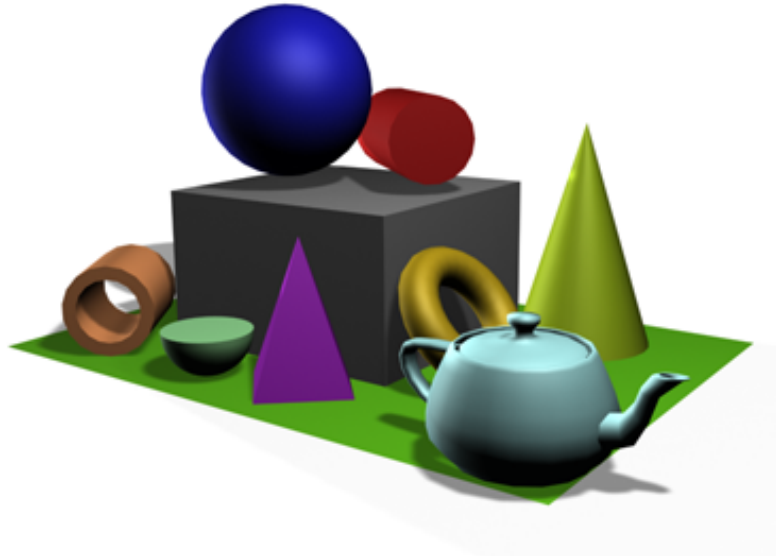

An assortment of geometric primitive objects

"Object" means an object in the scene, such as primitive geometry like boxes and spheres, more complex geometry such as Booleans, and so on. Geometric objects are renderable. A scene can also contain non-renderable objects such as lights, cameras, helpers, and space warps.

You add objects to a scene by selecting the Create menu or from the Create panel.

Object Instance

In 3ds Max, an instance is a completely interchangeable clone of the original object. Modifying an instanced object is the same as modifying the original.

Instances are not only alike in geometry, but also share modifiers and materials. When you change one instance by applying a modifier, for example, all the other instances change with it.

Each instance has its own set of transforms, object properties, and space warp bindings. These are not shared among instances.

Within 3ds Max, instances derive from the same master object. What you're doing is applying a single modifier to a single master object. In the viewport, what you see as multiple objects are multiple instances of the same definition.

For example, if you wanted to create a school of swimming fish, you might begin by making many instanced copies of a single fish. You could then animate the swimming motion by applying a Ripple modifier to any fish in the school. The whole school would swim with exactly the same motions.

Object Motion Blur

Object motion blur applies a blur effect to make fast-moving objects appear to move more smoothly in animations. It is a form of "temporal antialiasing."



Left: Object motion blur. Right: Object motion blur with dithering.

TIP For simulating the blur created by a moving camera [image motion blur](#) on page 8010 or [scene motion blur](#) on page 8117 works better than object motion blur.

Applying object motion blur is a two-step process:

- 1 Turn on object motion blur for the object you want to blur, using the [Object Properties dialog](#) on page 305.
You cannot apply both image motion blur and object motion blur to the same object in the same rendering.
- 2 Before you render, turn on object motion blur in the [Default Scanline Renderer rollout](#) on page 6141 of the Render Setup dialog.

Object motion blur works by rendering multiple copies of the object in between frames and then rendering them together. It is not affected by camera movement.

Object Space

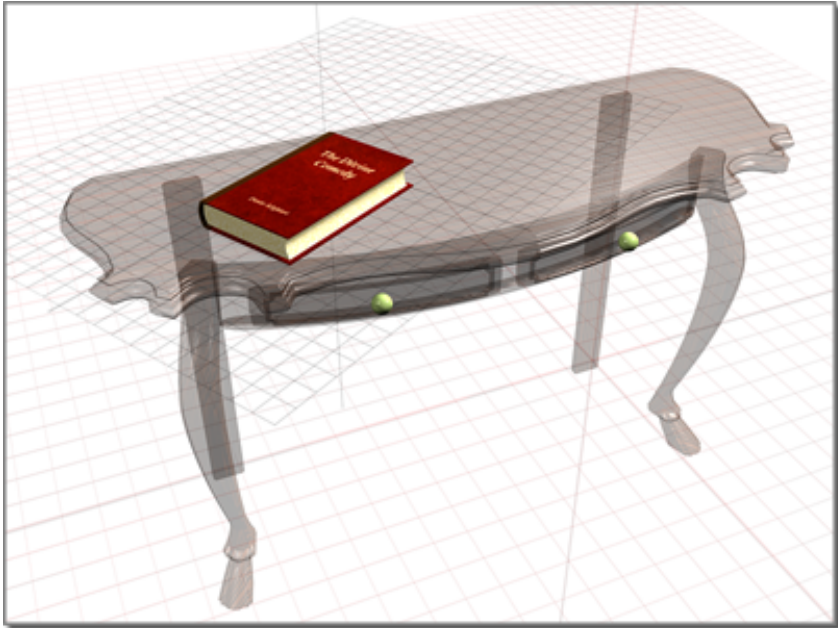

A book in object space rests on a table in world space.

Object space is the coordinate system unique to each object in your scene. It tracks the location of everything applied to an object. The location of object vertices, the placement of modifiers, mapping coordinates, and materials are

all defined in object space. By convention, especially in discussions of texture mapping, object-space coordinates are expressed as UVW coordinates, as opposed to the XYZ coordinates of [world space](#) on page 8175.

Each object has its own local center and coordinate system as defined by the location and orientation of the object's pivot point. The local center and coordinate system of an object combine to define its object space.

When you choose Use Pivot Point Centers from the toolbar or Use Pivot Points from the Modifier List, you are telling the program to use the Object Space origin of one or more selected objects as the center of a transform or modifier effect.

When you choose Local from the [Reference Coordinate System list](#) on page 967 (on the main toolbar), you tell the program to use a selected object's object space for the orientation of the active coordinate axes.

Most [modifiers](#) on page 8048 operate in object space. See [Object-Space Modifiers](#) on page 1202.

Object Space (Biped)

When you use [freedom animation](#) on page 7988 to animate a biped, you can place a biped limb into the space of another object, or into world space. For example, if the biped's hands are in the space of a ball, then wherever the ball moves the hands move with it. If the biped's feet are in world space, then when you move the center of mass, the feet stay planted in the same location.

Obstacle-Avoidance Behavior

In [crowd animation](#) on page 4761, an important part of crowd behavior is avoidance of obstacles. Think of an obstacle as anything that impedes a crowd member's progress. Examples of obstacles include walls, telephone poles, and fences, as well as other crowd members. Encountering such objects can cause avoidance behavior, which consists of any combination of slowing down, turning, and stopping.

Object-Space Modifiers

Object space is the coordinate system unique to each object in your scene. An object-space modifier, as opposed to a [world-space modifier](#) on page 8176, directly affects an object using the object's local coordinates.

Object-space modifiers appear directly above the object in the [modifier stack](#) on page 8046, and their effect can depend on the order they appear in the stack.

Omnidirectional Light

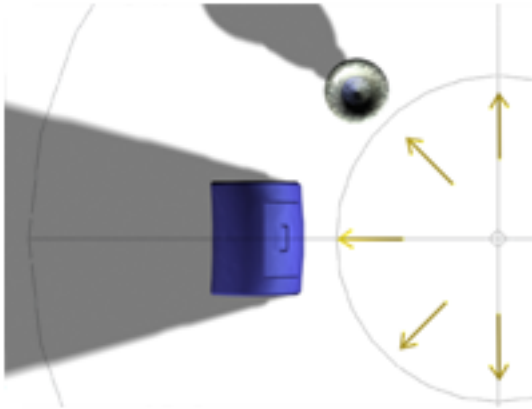

Above: Top view of an omni light

Below: Perspective view of the same light

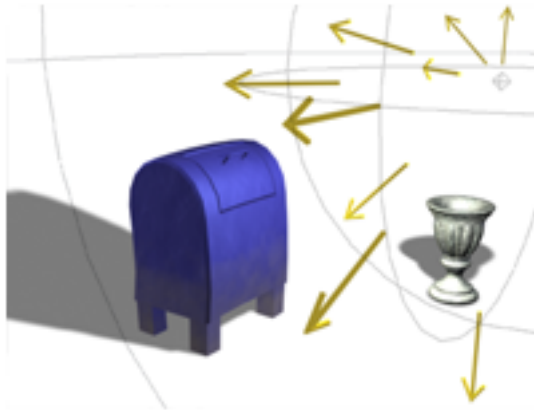

Above: Top view of an omni light

Below: Perspective view of the same light

Omnidirectional (omni) lights are [standard light objects](#) on page 5049 that provide a point source of illumination that shoots out in all directions. They're easy to set up, but you can't restrict the focus of their beam. You can, however restrict which objects are illuminated by an omni light.

When no lights exist in your scene, two invisible omni lights are turned on by default to provide overall illumination in the scene. However, as soon as you create your own light in the scene, the two default lights are turned off.

You can apply attenuation to omni lights.

Omniflector

A [space warp](#) on page 8132 that deflects particles. Omniflectors are also capable of refracting particles and generating spawned particles.

Three kinds of space warps are in the omniflector category:

[POmniFlect Space Warp](#) on page 2732

[SOmniFlect Space Warp](#) on page 2743

[UOmniFlect Space Warp](#) on page 2746

See also:

■ [Dynaflector](#) on page 7959

Opacity Falloff

Real transparent surfaces vary their opacity, depending on the angle of the material to your point of view. For example, a bottle appears more transparent at its center than at its edge because you're looking through more glass at its edge.

In the Extended Parameters rollout, you can specify the falloff of the transparency, based on the angle of the face normals to the view. If a face is perpendicular to the viewer, the angle of its normal is 0 degrees. If the face is edge-on to the viewer, its normal angle is 90 degrees.

Falloff is either inward or outward:

In Transparency increases as the normal angle approaches 0 degrees and decreases as the angle approaches 90 degrees. This gives the appearance of a hollow object such as a glass ball or bottle.

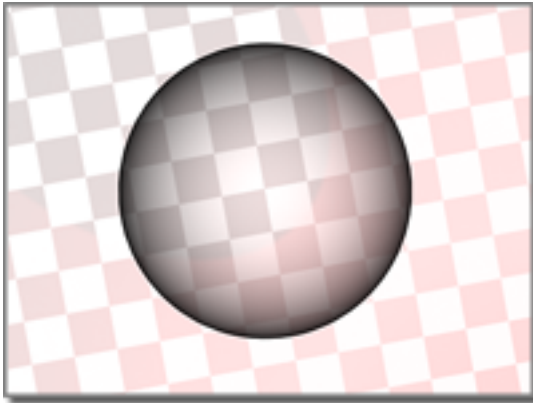

Inward opacity falloff

Top: None

Bottom: 100%

Out Transparency increases as the normal angle approaches 90 degrees and decreases as the angle approaches 0 degrees. This gives the appearance of a solid object such as a cloudy glass marble.

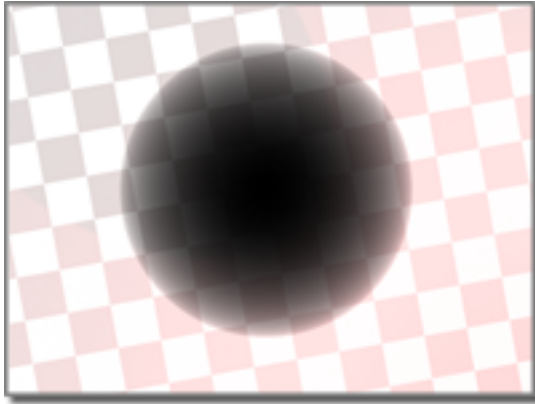

Outward opacity falloff

Top: None

Bottom: 100%

The falloff amount never makes the object less opaque than the value of the Opacity spinner. For example, if Opacity were set to 50, and Falloff set to In, the inner portions would remain at 50 percent opacity, and the Amt. spinner would change the outer edges, until they became opaque at 100.

Operand

An operand is one of a set of objects upon which an operation such as [Boolean](#) on page 757 is to be done. The Boolean operation takes two operands: the first operand is called operand A, and the second operand is called operand B.

Operator

In [Particle Flow](#) on page 2795, the operator is the basic element of the particle system; you combine operators into [events](#) on page 7966 to specify the particles' characteristics over a given period of time. Operators let you describe particle speed and direction, shape, surface properties, and more.

A list of all operators in Particle Flow is available in the [Operators topic](#) on page 2841.

See also:

- [Test](#) on page 8147

Operator Icon

In [Particle Flow](#) on page 2795, adding a [Find Target test](#) on page 2970 or a [Speed By Icon operator](#) on page 2876 to a particle system creates a special viewport icon used by the action. This icon is known as an operator icon. In the 3ds Max scene, an operator icon functions as a Helper object, and, in fact, you can also add these two actions from the Create panel by choosing [Helpers > Particle Flow](#).

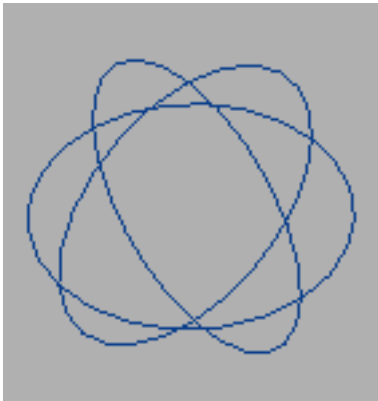

Find Target icon (top); Speed By Icon icon (bottom)

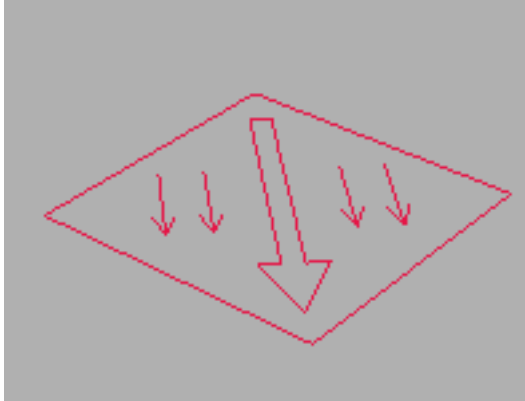

Find Target icon (top); Speed By Icon icon (bottom)

Optical Markers

Reflective markers used by certain motion-capture equipment. In a motion-capture session, markers are reflective objects placed on the “actor” or “talent.” The markers enable motion-capture hardware to record the position of various parts of the talent's body while performing motions.

Orientation Behavior

In [crowd animation](#) on page 4761, the Orientation behavior lets you control whether and how delegates rotate, independent of their direction of motion. Normally, a delegate always faces in the direction it's moving. You can use the Orientation behavior to specify limits to the delegate's rotational activity without affecting its path, which is generated by other behaviors. Use these settings, for example, to keep delegates facing in one direction while moving in another.

NOTE These settings do not affect the path a delegate takes, which is produced by other behaviors such as Seek and Avoid. Orientation influences only the direction the delegate faces as it traverses the path.

Origin

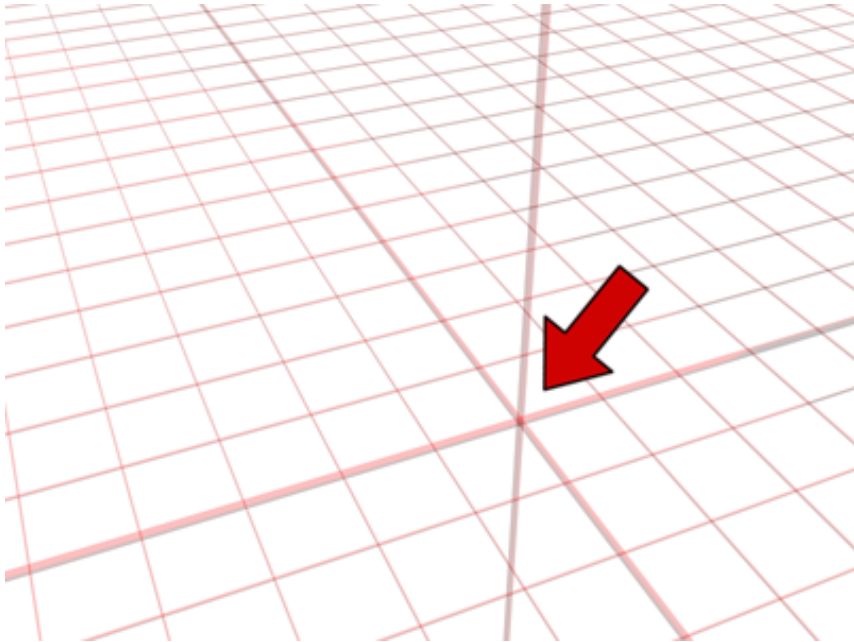

Origin is the 0,0,0 point where the X, Y, and Z axes intersect.

A coordinate system assigns an arbitrary point in space as the origin, and sets each axis at that point to zero.

In the [world coordinate system](#) on page 8174, numbers increase from the origin to the right along the X axis, upward along the Y axis, and away from you on the Z axis. Numbers decrease (-1, -2, -3, and so on) to the left along the X axis, downward along the Y axis, and toward you along the Z axis. The distance between each whole number is called a unit of measurement (a 3ds Max unit).

You can combine the measurements of all three axes to mark specific locations in 3D space. The combined measurements are called coordinates. Thus, at the origin, the coordinates are $X=0, Y=0, Z=0$, which can be expressed more simply as the vector $(0,0,0)$.

From the origin, the coordinates at a location 100 units to the right, 150 units up, and 60 units away are $X=100, Y=150, Z=60$, or $(100,150,60)$.

Orthographic View

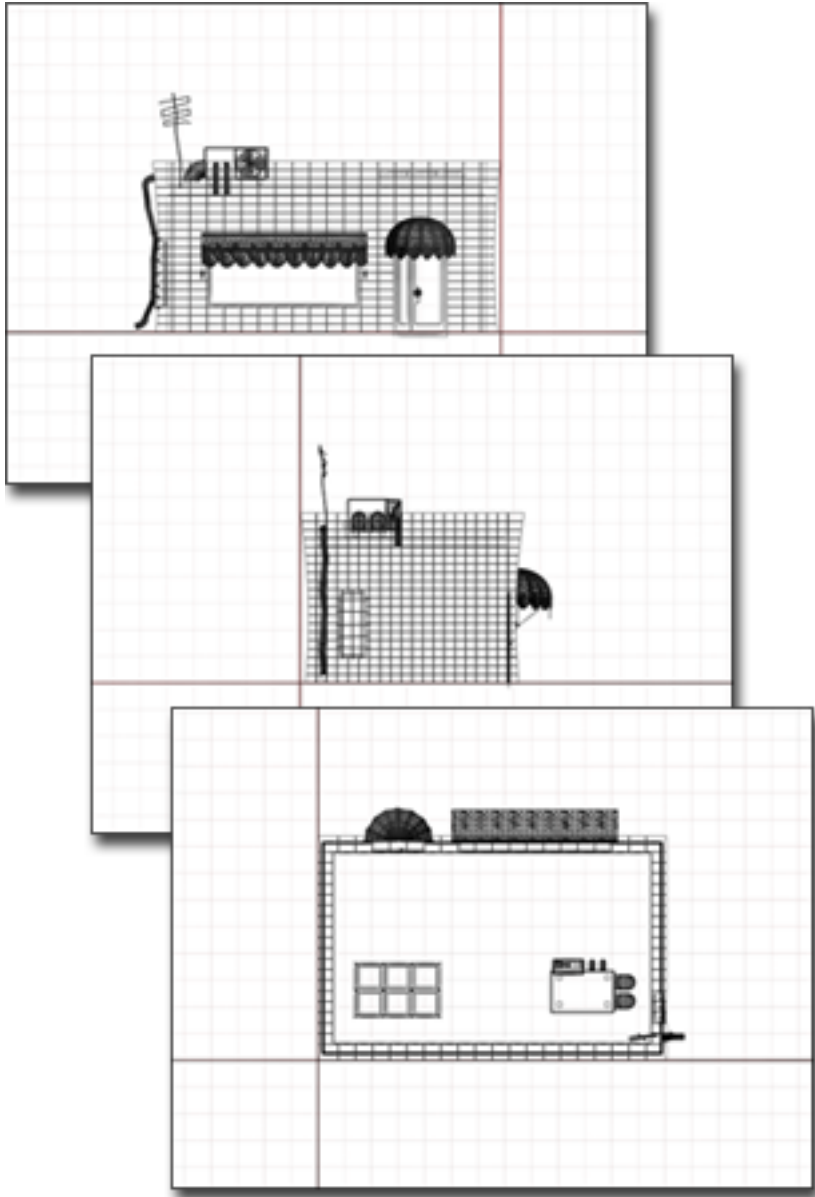

Orthographic views of a model

Whether produced on computer or paper, most 3D design relies on 2D representations for accurate description of objects and their positioning. Maps, plans, cross-sections, and elevations are all examples of 2D representations. Each of these views represents an *orthographic view*. In familiar terms, you might think of these views as "flat" or "straight-on," or as "looking at right angles."

Orthographic views are two-dimensional, each defined by two world coordinate axes. Combinations of these axes produce three pairs of orthographic views: top and bottom; front and back; left and right.

Orthographic views are a special case of [axonometric views](#) on page 7918. You can set viewports to the various orthographic views using the [viewport right-click menu](#) on page 7576 or [keyboard shortcuts](#) on page 7857.

Out-of-Range Types

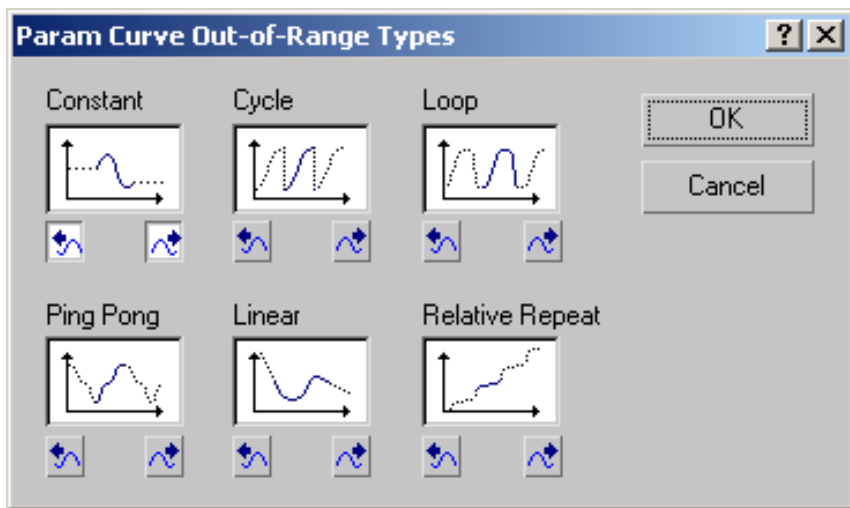

When you specify values and keys for a controller, you are defining animation over a range of time. You choose Out-of-Range Types to determine how the animation continues outside a specified range. Out-of-Range choices include holding a constant value, and various ways of repeating the animated range.

The easiest way to work with Out-of-Range Types is in the Track View Function Curve mode.

You use the Parameter Out-of-Range dialog to project the pattern of the key dots in the selected track. These patterns are applied to the animation outside the range of all keys in the track. This is why they're called out-of-range types.

By default, tracks use a constant out-of-range type. This means that the track values before and after the range of keys remain constant. For example, in a 100-frame animation with keys up to frame 20, the X, Y, and Z values after frame 20 remain the same for the rest of the animation. The objects in this example do not move from frame 20 to frame 100.

Applying the Cycle out-of-range type will make the key pattern in frames 0–20 repeat cyclically for the remaining 80 frames.

Outputs: Source / Test

In Particle Flow, you create a [particle diagram](#) on page 8081 by connecting [events](#) on page 7966 using [wires](#) on page 8170. Each wire links an output with an [event input](#) on page 8013. There are two different types of outputs: ;

- The connector sticking down from the bottom of a [global event](#) on page 7997 is a source output.
- The connector sticking out from the side of a [test](#) on page 8147 is a test output.

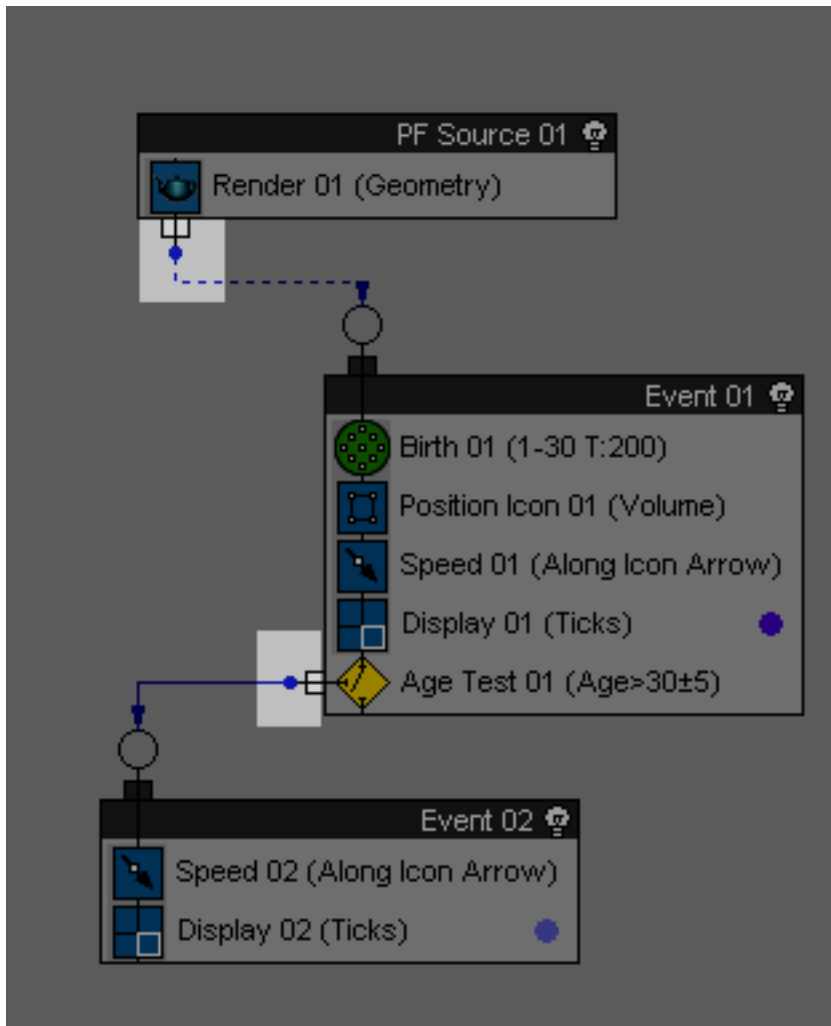

Source output (above); test output (below)

Overshoot



Above: No overshoot

Below: Overshoot turned on

The Overshoot option causes a spotlight to flood beyond its falloff area, and cast light in all directions. With Overshoot turned on, the spotlight casts light in all directions but casts shadows only within its falloff cone.

The Overshoot control effectively turns the spotlight into a hybrid between an Omni light and a spotlight. With Overshoot set, the spotlight casts light in all directions as an Omni light does but still casts shadows or projections as other spotlights do. The shadows and projections are limited to the falloff region: outside the cone of the spotlight, Overshoot casts light but does not cast shadows or projections.

Overshoot is useful when you want to light a large area but need to cast shadows in only a small part of that area. Set the falloff to include the area where shadows must appear, and then turn on Overshoot to light the rest of the scene. This technique can reduce the size of shadow maps and thereby improve rendering speed.

PAL

PAL (Phase Alternate Line) is the video standard used in most European countries. The frame rate is 25 frames per second (fps) or 50 [fields](#) on page 7973 per second, with each field accounting for half the interleaved scan lines on a television screen.

Parameter Space

NURBS objects have, in addition to their existence in 3D space, a parameter space that includes the array of knot values. NURBS curves have a single U dimension in parameter space. NURBS surfaces have two dimensions, U and V, in parameter space.

Parameters Panel

The parameters panel, found to the right of the [event display](#) on page 7968 in [Particle View](#) on page 2811, displays the parameters of any action whose name you click in the depot. The panel uses the same format and editing methods as the command panel in 3ds Max. Display of the parameters panel can be toggled with the Particle View menu command Display > Parameters.

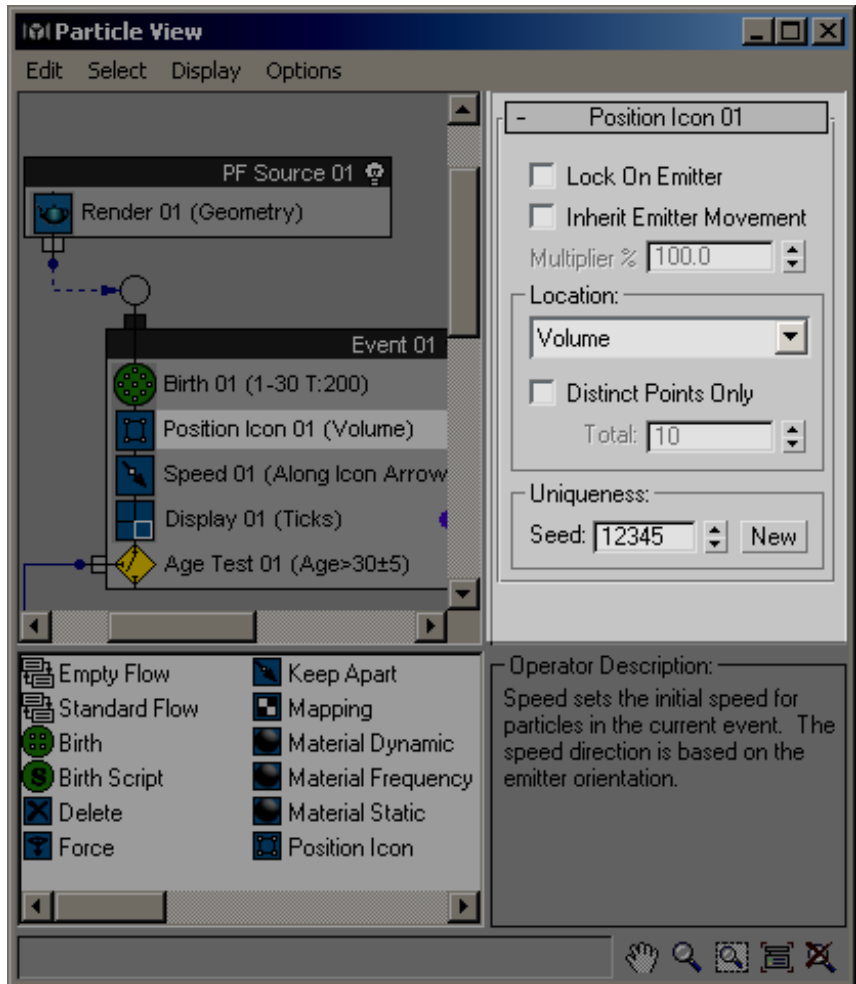

Parameter/Parametric

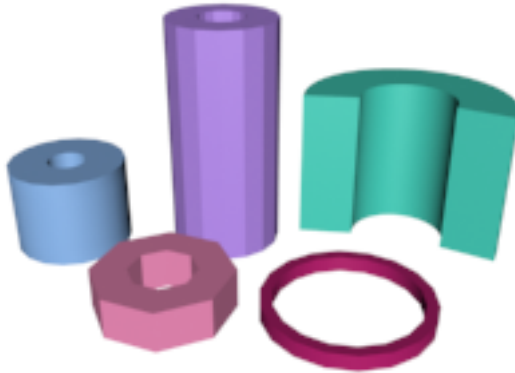

A tube is one example of a parametric object. Varying its parameters creates varying geometry.

A *parameter* is a setting or value that you can change. Many objects in 3ds Max have parameters that you can change to alter the size or shape of the object. This type of object can be described as *parametric*.

Unlike physical building blocks, which have a fixed shape and size, the geometric primitives (box, sphere, torus, and so on) are parametric; you can change their dimensions, segment settings, and other features after you create them. Parametric objects respond to changes in their parameters by dynamically updating their properties.

Changing a parameter can dramatically alter the structure and appearance of an object. For example, you can turn a cylinder into a prism by reducing the number of sides and turning the Smooth option off. Alternately, you can turn a cone into a four-sided pyramid using the same technique.

Objects that you merge from other scenes or from Autodesk VIZ allow you to access parametric values. Objects in drawings that you link from Autodesk Architectural Desktop should be edited in Architectural Desktop, then relinked to 3ds Max with the [File Link Manager](#) on page 6987.

You can animate almost all creation parameters for geometric primitives, and interactively change their settings during animation playback.

Parent Particle

A parent particle is an existing particle from which the particle system generates [spawn particles](#) on page 8132. You can use the [Spawn test](#) on page 2991 to create spawn particles arbitrarily, or the [Collision Spawn test](#) on page 2964 to create spawn particles as the result of physical interaction between a parent particle and a deflector.

Particle Diagram

The particle diagram is the graphical depiction of the [particle system](#) on page 8083 in [Particle View](#) on page 2811. It uses [events](#) on page 7966 and [wires](#) on page 8170 to represent the system's elements and logic. You edit the system by clicking [actions](#) on page 7897 and events in the diagram and changing their values, by adding new actions and events, and by creating wires between events.

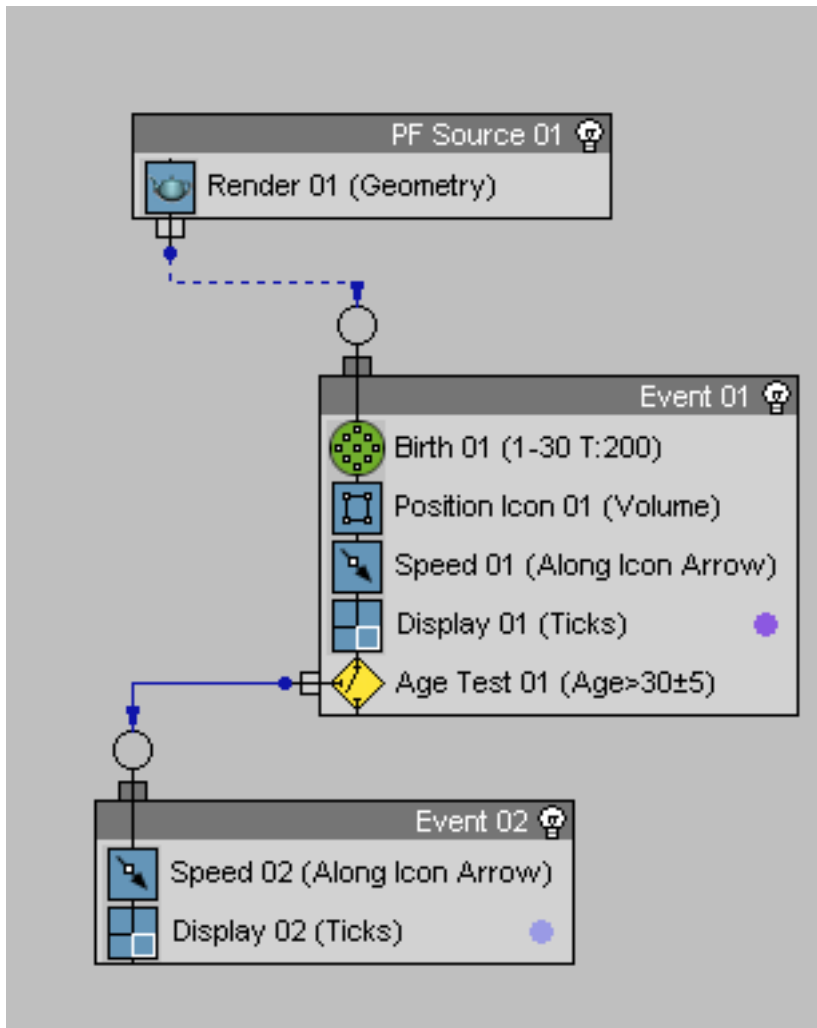

Particle Level

In Particle Flow, you can select particles at the [Event level](#) on page 7969 or at the Particle level, using controls on the Modify panel > [Selection rollout](#) on page 2833. At the Particle level, you select particles using standard 3ds Max methods, such as clicking or dragging a region. A Particle-level selection can

be acted upon by the [Delete operator](#) on page 2848 and the [Split Selected test](#) on page 3000.

Particle System

Particle systems are objects that generate non-editable sub-objects, called *particles*, for the purpose of simulating snow, rain, dust, and so on.

The particle system object generates the particles over time. You use particle systems primarily in animations.

3ds Max provides several built-in particle systems, including Spray and Snow. Your configuration might have other plug-in particle systems installed.

The Deflector, Gravity, and Wind space warps are for use with particle systems. (Gravity and Wind also work with Dynamics.)

3ds Max also offers an event-driven particle system called [Particle Flow](#) on page 2795.

Particle System (Particle Flow)

A particle system in Particle Flow consists of all [flows](#) on page 7983 defined in Particle View, as well as parameters defined for all [Particle Flow sources](#) on page 2829. In effect, it's the totality of settings in Particle Flow.

PASS File

A PASS (*.pass*) file saves the result of a single [mental ray rendering](#) on page 6230 pass. You can create a final rendering by merging multiple passes. The PASS file format includes Z-buffer information to aid in merging passes.

Controls for creating and merging PASS files are on the Render Setup dialog > Processing Panel > [Translator Options rollout](#) on page 6316.

Patch

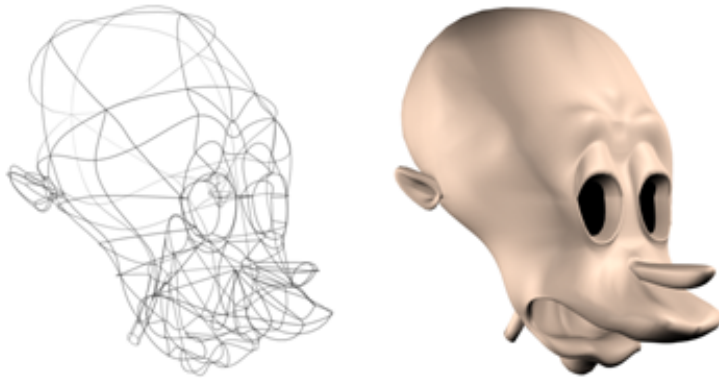

Example of a patch model

A patch is a type of deformable object. A patch object is useful for creating gently curved surfaces, and provides very detailed control for manipulating complex geometry.

When you apply an [Edit Patch modifier](#) on page 1360 to an object or convert it to an [editable patch](#) on page 2019 object, the software converts the object's geometry into a collection of separate Bezier patches. Each patch is made up of three or four vertices connected by edges, defining a surface. Patches also have interior vertices that you can control, or let the software control for you.

You control a patch surface's shape by manipulating the vertices and edges. The surface is the renderable geometry of the object.

Patch-Based Objects

Objects made from patches. [Physique](#) on page 4603 can work with meshes, patches, NURBS, splines, and FFD space warps.

Path

A path is the line (or other shape) along which shapes are lofted to create 3D [Loft objects](#) on page 786.

The [Path constraint](#) on page 3297 also lets you assign a line or other shape as a *motion path*. A motion path is a form of [trajectory](#) on page 8154.

Get Path (Lofting)

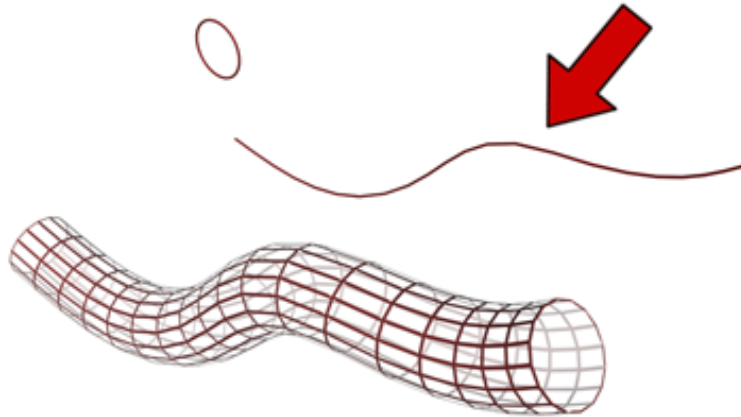

A circle is lofted along a path to construct a tubular shape. Get Path chooses the path spline

You use Get Path as a loft creation method when you want the path to move to the location of the selected shape. For example, you use this method if you have created a shape at the exact location where you want the base of your loft object to be. You use Get Path to create a loft at that location.

Get Path causes the path shape to move and rotate to align itself with the first shape on the path:

- The first vertex on the path is located at the first shape's pivot point.
- The tangent to the first vertex on the path is aligned with the positive Z axis of the first shape.
- The local Z axis of the path is aligned with the local Y axis of the first shape.

- The local coordinate system of the resulting loft object equals the local coordinate system of the path after it has been aligned with the first shape.

Sometimes, aligning the tangent of the path with the positive Z axis of the first shape does not produce the result you want. You can flip the orientation of the path by pressing Ctrl while getting the path. Pressing Ctrl aligns the path so that the tangent to the first vertex of the path is aligned with the negative Z axis of the shape.

Path Follow Behavior

In [crowd animation](#) on page 4761, the Path Follow behavior lets you direct delegates to traverse a specified path during a crowd simulation. Delegates can move forward or backward along paths, and when they reach the end, they can loop back to the start or reverse direction, or even continue in the same general direction.

If the delegate's start position isn't on the path at the start of the simulation, it moves to the path before following the path. During the solution, **character studio** intermittently displays an optional *target* icon to show the delegate's immediate goal; this changes as the simulation proceeds.

Period

When you animate a biped, a freeform period is a period between footsteps where you can animate the biped any way you want. [Biped dynamics](#) on page 7923 are suspended during this period. See [Freeform Animation Between Footsteps](#) on page 4227.

Perspective View

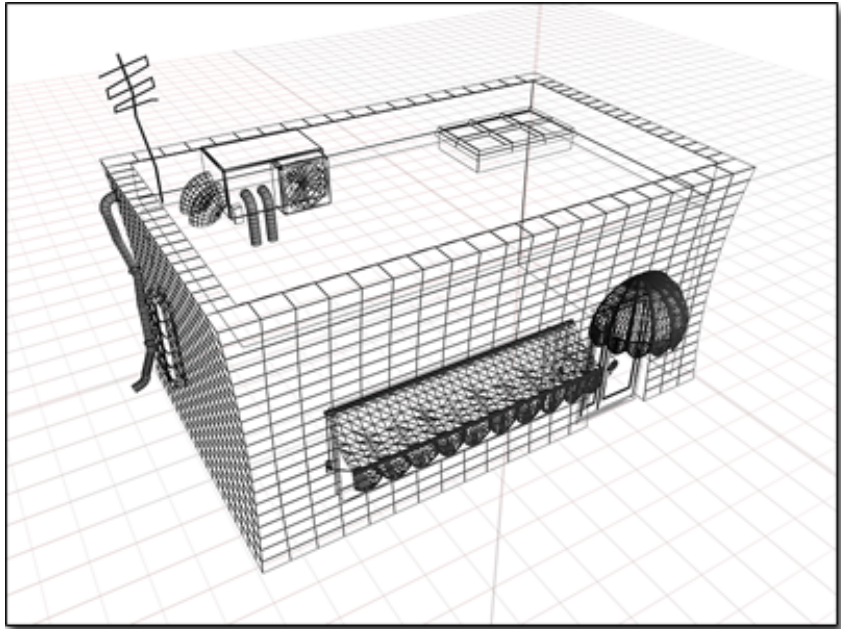

Perspective view of the ice-cream shop

Perspective views most closely resemble human vision. Objects appear to recede into the distance, creating a sense of depth and space. For most 3D computer graphics, this is the view used in the final output that the client sees onscreen or on the page.

There are three ways to create a perspective view in a viewport: perspective view, camera view, and light view.

A perspective viewport, labeled Perspective, is one of the default viewports. You can change any active viewport to this eye-like point of view by pressing the keyboard shortcut P.

A camera view requires that you first create a camera object in your scene. The camera viewport tracks the view through the perspective of that camera. As you move the camera (or target) in another viewport, you see the scene swing accordingly. If you alter the camera's field of view on the Modify command panel, you see the changes as they are applied.

The light view works much like a targeted camera view. You first create the spotlight or directional light and then set the viewport to that light. What you see in the viewport is the view from the light looking into the scene. This is very useful for adjusting the correct distances of hotspot and falloff for the light.

Phases of Leg Motion

A leg's motion has four phases, beginning with the foot on the ground. Then the foot lifts, moves through the air, and returns to the ground again. Biped divides this motion into four phases, as follows:

- **Touch** Occurs at the leg keyframe where the leg's foot first touches the ground and always corresponds with the start frame of a footstep in Track View — Dope Sheet.
- **Plant** Occurs after touching, and before lifting. It is always in between the start and end frames of a footstep in Track View — Dope Sheet.
- **Lift** Occurs at the keyframe where the leg's foot lifts off the ground, and always corresponds to the end frame of each footstep in Track View — Dope Sheet.
- **Move** Occurs while the foot is in the air and is always in the intervals in between steps in Track View — Dope Sheet. In walking, while one foot moves, the body is supported by the other leg. In running or jumping, while a foot moves there is a period where the body is not supported, and moves in midair.

Photometry

When you use [photometric lights](#) on page 5005, 3ds Max provides physically based simulation of the propagation of light through an environment. The results are not only highly realistic renderings, but also accurate measurements of the distribution of light within the scene. The measurement of light is known as *photometry*. This topic introduces the quantities used for defining and measuring light.

There are several theories that describe the nature of light. For this discussion, we define light as radiant energy capable of producing a visual sensation in a human observer. When we design a lighting system, we're interested in evaluating its effect on the human visual response system. Thus photometry

was developed to measure light, taking into account the psychophysical aspects of the human eye/brain system. Four photometric quantities are used in the lighting simulation system:

- Luminous flux
- Illuminance
- Luminance
- Luminous intensity

Luminous flux is the quantity of light energy per unit time arriving, leaving, or going through a surface. The unit of luminous flux is the lumen (lm), which is used in both the International System (SI) of Units and in the American System (AS) of Units. If we think of light as particles (photons) moving through space, then the luminous flux of a light beam arriving at a surface is proportional to the number of particles hitting the surface during a time interval of 1 second.

Illuminance is the luminous flux incident on a surface of unit area. This quantity is useful for describing the level of illumination incident on a surface without making the measurement dependent on the size of the surface itself. The SI unit of illuminance is the lux (lx), which is equal to 1 lumen per square meter. The corresponding AS unit is the footcandle (fc), equivalent to 1 lumen per square foot.

Part of the light incident on a surface is reflected back into the environment. The light reflected off a surface in a particular direction is called luminance, the quantity that is converted to display colors to generate a realistic rendering of the scene. Luminance is measured in candelas per square meter or candelas per square inch. The candela was originally defined as the luminous intensity emitted by a single wax candle.

Finally, luminous intensity is the light energy per unit time emitted by a point source in a particular direction. The unit of measure of luminous intensity is the candela. Luminous intensity is used to describe the directional distribution of a light source, that is, to specify how the luminous intensity of a light source varies as a function of the outgoing direction.

Because 3ds Max works with these physically based photometric values, it can accurately simulate real-world lighting and materials.

Photon Map

A photon map™ is a technique to generate the indirect illumination effects of [caustics](#) on page 6255 and [global illumination](#) on page 6261 when you render with the [mental ray renderer](#) on page 6230. When it calculates indirect illumination, the mental ray renderer traces photons emitted from a light. The photon is traced through the scene, being reflected or transmitted by objects, until it strikes a diffuse surface. When it strikes a surface, the photon is stored in the photon map.

Generating photon maps is time-consuming. To improve performance, you must explicitly specify:

- Which lights emit photons for indirect illumination.
- Which objects can generate caustics or global illumination.
- Which objects can receive caustics or global illumination.

The settings for generating and receiving caustics are on the Object Properties dialog > [mental ray Panel](#) on page 322.

The photon map stores photons only for objects that can receive caustics, global illumination, or both.

To further reduce the time required to generate a photon map, photons are limited by the Trace Depth controls. These limit the number of times a photon can be reflected, refracted, or both.

In animations, another way to save time is to reuse the photon-map file. If lighting doesn't change over the course of an animation, use the [Photon Map controls](#) on page 6312.

The mental ray renderer saves photon maps as [PMAP files](#) on page 8093. Photon map controls are on the Render Setup Dialog > Indirect Illumination panel > [Caustics And Global Illumination rollout](#) on page 6306.

PHY Files

You can save [Physique](#) on page 4603 data to a Physique (PHY) file. This saves data common to all objects that share a given Physique modifier.

Later, you can reload the PHY file, either to restore the data that belongs to a particular skin or portion of skin, or to transfer the Physique of one skin (or portion of it) to a different one.

Physique

Physique on page 4603 is a modifier that, when applied to a mesh, allows the movements of an underlying skeleton to seamlessly move the mesh like bones and muscle under a human skin. Physique will work on any point-based object, including geometric primitives, editable meshes, patch-based objects, NURBS, and FFD space warps. It will attach to any skeleton structure, including a **biped** on page 4147, bones, splines, or any hierarchy.

NOTE For NURBS and FFDs, physique deforms the control points (control vertices), which, in turn deform the model.

Pivot Point

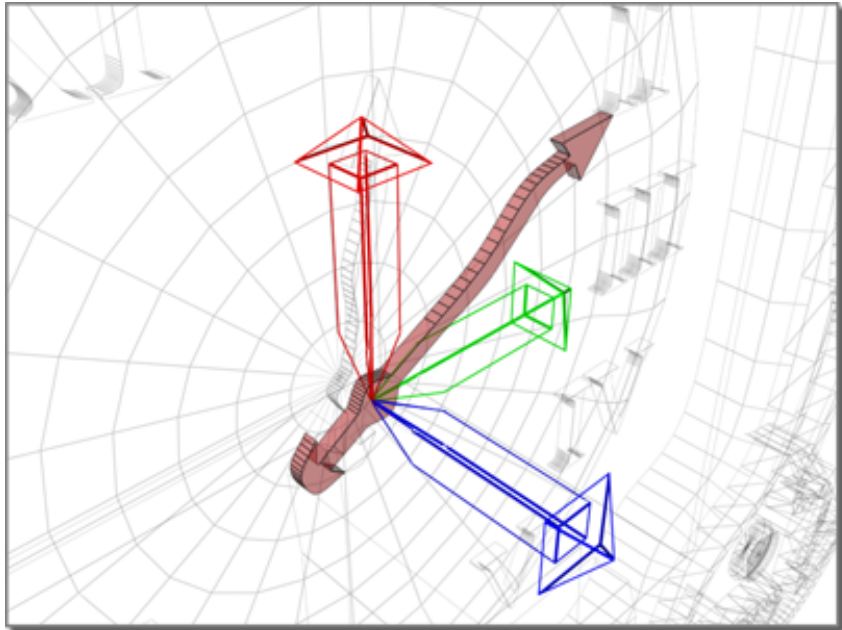

Pivot point sets hand to the center of the clock face.

The transform center, or pivot point, is the spot about which a rotation takes place, or to and from which a scale occurs.

All objects have a pivot point. You can think of the pivot point as representing an object's local center and local coordinate system.

The pivot point of an object is used for a number of purposes:

- As the center for rotation and scaling when the Pivot Point transform center is selected.
- As the default location of a modifier center.
- As the transform origin for linked children.
- As the joint location for IK.

You can display and adjust the position and orientation of an object's pivot point at any time using the Pivot functions in the Hierarchy command panel. Adjusting an object's pivot has no effect on any children linked to that object.

Pixel

A pixel (short for **P**icture **E**lement) is a single point in a graphic image. Graphics monitors display pictures by dividing the screen into thousands (or millions) of pixels, arranged in rows and columns.

Plant

In [footstep animation](#) on page 7986, the state of the biped foot when it is flat on a footstep.

Plug-Ins

A plug-in is a feature or functionality supplied by an independent program or component. Plug-ins can be supplied by third-party vendors or independent software developers.

For example, several Video Post filter and layering plug-ins ship with 3ds Max.

The open architecture provides an API (application programming interface) designed to make it easy for other companies to write plug-ins that extend the core functionality of 3ds Max.

PMAP File

A PMAP (*.pmap*) file is a mental ray [photon-map](#) on page 8090 file. This is a binary file that the [mental ray renderer](#) on page 6230 uses to generate the effects of [caustics](#) on page 6255 and [global illumination](#) on page 6261. You specify a name and location for the PMAP file on the Render Setup dialog > Indirect Illumination panel > [Caustics And Global Illumination rollout](#) on page 6306.

Point

A point in three-space, created when you use NURBS modeling to create a Point Curve or Point Surface, or when you create an individual point sub-object. Points that are part of a Point Curve or Point Surface are constrained to lie on the curve or surface.

Points behave somewhat like vertices for [spline objects](#) on page 611, but their behavior is not identical and they are a distinct object type. [Helper object points](#) on page 2628 are also a distinct object type. You can't use spline vertices or helper points as NURBS points (though you can convert a spline to a NURBS curve).

Point Curve

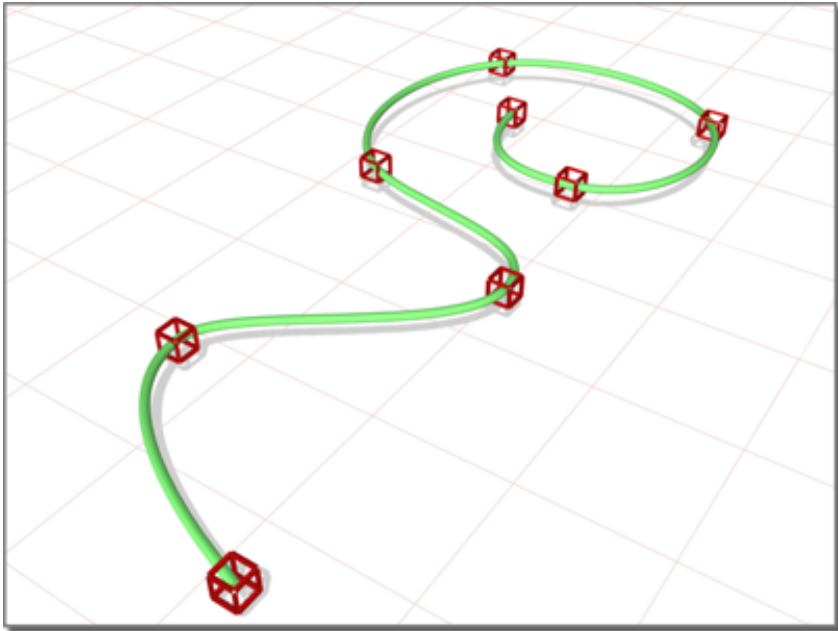

NURBS point curve

A curve defined by points. The points are constrained to lie on the curve. (Or you can think of the curve as being dependent on its point locations.) More than one NURBS solution is possible for a Point Curve; occasionally this can cause unexpected results.

Point Surface

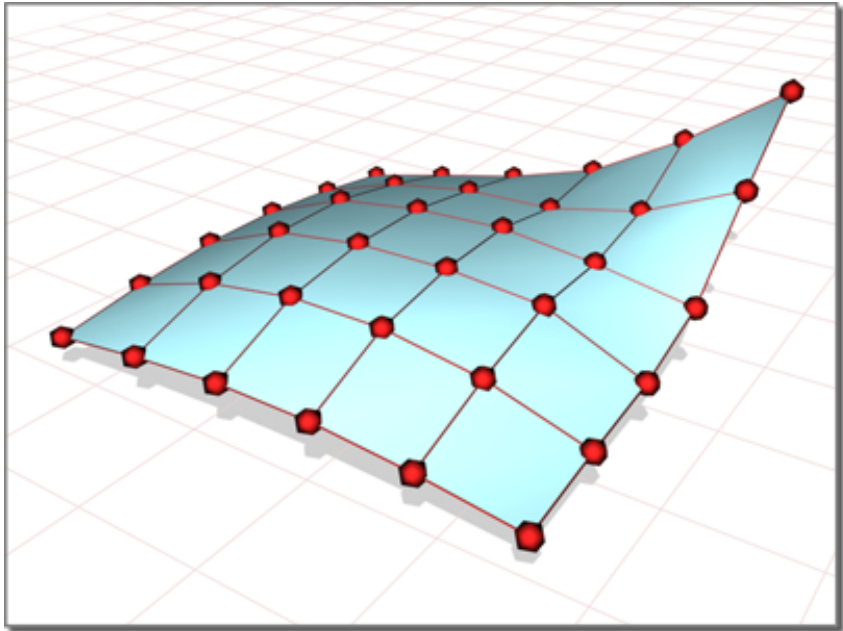

NURBS point surface

A surface defined by points. The points are constrained to lie on the surface. (Or you can think of the surface as being dependent on its point locations.) More than one NURBS solution is possible for a Point Surface; occasionally this can cause unexpected results.

Poses

When you work with a [biped](#) on page 4147, the pose is the stance of the entire biped. You can copy and paste poses. See [Copy/Paste Rollout](#) on page 4389.

Positional Markers

In a motion-capture session, positional markers are reflective objects placed on the “actor” or “talent.” The markers enable motion-capture hardware to

record the position of various parts of the talent's body while performing motions.

Posture

When you work with a [biped](#) on page 4147, the posture refers to the position of selected biped parts, as opposed to the overall [pose](#) on page 8095. You can copy and paste postures. See [Copy/Paste Rollout](#) on page 4389.

Precedence

You control an [IK solution](#) on page 8009 by setting joint precedence to determine which joints contribute the most to the IK solution and which joints contribute the least.

Joints with high precedence values are calculated first, and, therefore, contribute more motion to the IK solution. Joints with low precedence values are calculated last, and, therefore, contribute the least motion to the IK solution.

Joints with equal precedence values are calculated by their order in the hierarchy. Joints deeper in the hierarchy (closer to the end effector) are calculated first and joints closer to the root are calculated last.

Premultiplied Alpha

There are two methods of storing alpha in a bitmap: premultiplied and nonpremultiplied.

To composite an image that is in nonpremultiplied format, the alpha must be multiplied by each of the R, G, and B channels before adding it to the color of the background image. This provides the correct transparency effect, but it must be done each time you composite. With premultiplied alpha, you store the R, G, and B components with the alpha already multiplied in, so compositing is more efficient.

This is not the only reason that 3ds Max stores images in the premultiplied format. When you render an image, you typically want the edges of the objects to be antialiased. This effect is achieved by determining the fractional coverage of pixels on the edge of the object, and then adjusting the alpha of the pixel

to reflect this. For example, a pixel that is 30% covered by the object will have an alpha of 0.30.

To antialias the edges, the alpha must be premultiplied to darken these edge pixels. (This is equivalent to compositing the image over a black image). So it is natural, in a sense, for rendered images to have premultiplied alpha. If you do not premultiply the alpha of a rendered image, then just looking at the RGB you will see jaggies on the edges of objects. You would need to composite it against black using the alpha channel whenever you wanted to display it.

NOTE To control whether or not the renderer uses the environment map's alpha channel in creating the alpha for the rendered image, choose Customize > Preferences > Rendering, and then turn on Use Environment Alpha in the Background Antialiasing group.

If Use Environment Alpha is turned off (the default), the background receives an alpha value of 0 (completely transparent). If Use Environment Alpha is turned on, the alpha of the resulting image is a combination of the scene and background image's alpha channel. Also, when you render to [TGA files](#) on page 7370 with Pre-Multiplied Alpha set to off, turning on Use Environment Alpha prevents incorrect results.

TIP If you plan to composite objects in another program such as Combustion or Photoshop, render the objects against a black background. Otherwise, a fringe of environment or background color can appear around the objects.

Procedural Maps

Unlike a bitmap, which is an image produced by a fixed matrix of colored pixels like a mosaic, a procedural map is generated by a mathematical algorithm. Consequently, the types of controls you might find for a procedural map will vary depending on the capabilities of the procedure.

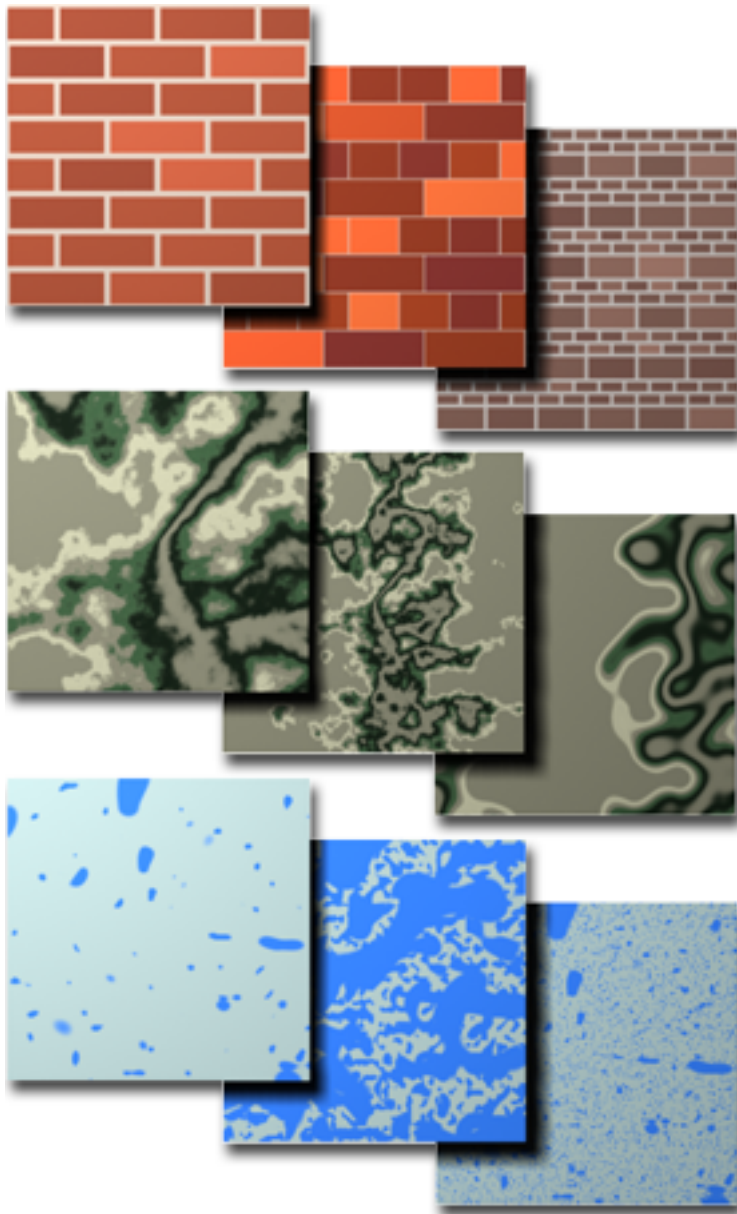

Three procedural maps (bricks, Perlin marble, and splat), with variations

A procedural map can be generated in two dimensions, or in three. For example, Wood has a grain that goes through the assigned geometry. If you cut away part of an object with wood assigned as its texture, the grain in the cutaway portion matches the grain on the object's exterior: it is all generated by the same procedure.

Projector Light

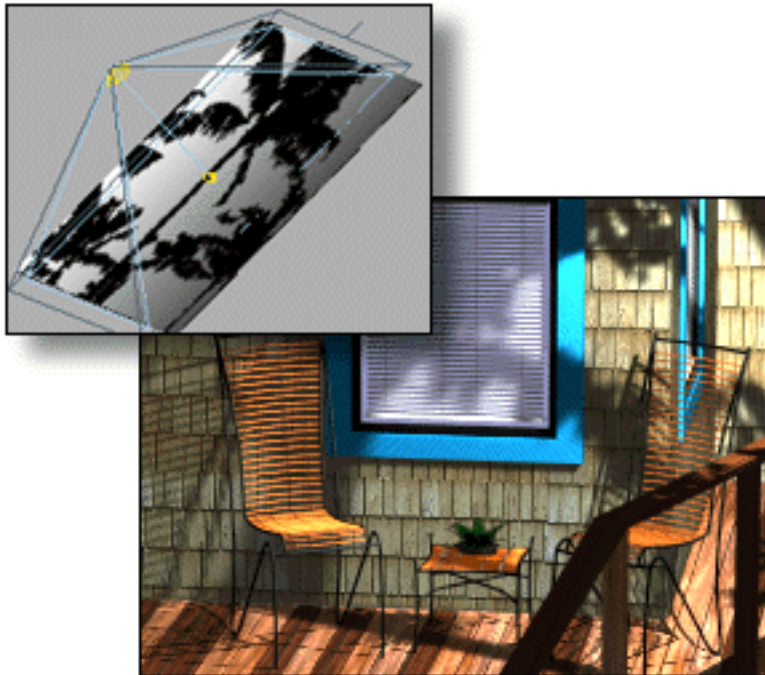

Shadows created by projecting image of palm trees

By adding a map to a light, you turn it into a projector. You can assign a single image, or you can assign an animation to create the effect of either a slide projector or a movie projector.

You can also use projector maps to project black and white bitmaps to simulate shadows seen through leaves or window frames, in the same way that gobos are used in theater lighting.

You're not limited to circular projectors. Since you're usually projecting a rectangular image, you can use a rectangular light to project it. You can use

the Bitmap Fit option to adjust the aspect ratio of the light beam to match that of the projected image.

When you use projection lights, it's often helpful to adjust their roll angle. You can do this with the navigation controls or with the [roll angle manipulator](#) on page 5082.

ProMaterials Library for mental ray

The ProMaterials™ library contains mental ray [ProMaterials](#) on page 5647 based on manufacturing-supplied data and professional images. This includes building and design materials such as professional wall paint with glossy or matte finishes, solid glass, and concrete. The library actually contains multiple library (MAT) files. When you use the Material/Map Browser to browse libraries, you see names such as *autodesk.max.promaterials.ceramic.mat*, *autodesk.max.promaterials.concrete.mat*, and so on.

Prop Bone

The [CSM marker file format](#) on page 7945 supports a prop bone in either or both hands. There are six additional markers for the top, bottom, and middle of the two props. If these tracks are detected, **character studio** creates a 3ds Max dummy object.

The length of the prop is the average distance between the top and bottom prop marker during animation. The prop will be oriented in the plane of the three prop markers, and its origin will be at the bottom prop marker.

Quadtree

A quadtree is a data structure used to calculate [ray-traced shadows](#) on page 8103.

The quadtree represents the scene from the point of view of the light. The root node of the quadtree lists all objects that are visible in that view. If too many objects are visible, the node generates four other nodes, each representing a quarter of the view, each with a list of objects in that portion. This process continues adaptively, until each node has only a small number of objects, or the quadtree's depth limit (which can be set for each light) is reached.

Each shadow-casting light ray needs to test intersection with the objects in only one of the leaf nodes of the quadtree. This helps speed up the ray-tracing process. In general, increasing the maximum quadtree depth can speed up ray-tracing at a cost of memory.

The maximum size of a quadtree is the square of two to the power of the maximum quadtree depth. At a depth of 7, the largest quadtree has 128 x 128 leaf nodes; at a depth of 10, the largest quadtree has a size of 1028 x 1028 leaf nodes, and so on. (On the other hand, because each successive node contains fewer objects, the size of a node's record decreases the deeper it is in the tree.)

NOTE An omni light can generate up to ten quadtrees, so omni lights that cast ray-traced shadows use more memory at render time than spotlights do.

Queue Monitor

The Queue Monitor is a standalone network-administration tool that provides a user interface to monitor and control network rendering.

The Queue Monitor can connect to any computer to which you have network access with the appropriate security permissions, and a Network Manager running on it. You can install the Queue Monitor separately. It will function correctly on any Intel-based computer running Windows NT with appropriate TCP/IP networking services, including over the Internet. In other words, you can monitor and control network rendering services from any computer connected to the Internet, in addition to using the Internet as a wide-area backbone for a network rendering farm.

Radiosity

A technique to calculate indirect light to illuminate a scene. Radiosity calculates the interreflections of diffuse light among all the surfaces in your scene. The result is the [radiosity solution](#) on page 8101. See [Modeling Global Illumination with Radiosity](#) on page 6168.

Radiosity Solution

The calculation of the [radiosity](#) on page 8101 effect in a scene. You compute the radiosity solution as a separate step from rendering. Once the solution is

computed, it can be used for multiple renderings. See [Modeling Global Illumination with Radiosity](#) on page 6168.

Ray-Trace Acceleration (mental ray Renderer)

The [mental ray renderer](#) on page 6230 provides two different methods of accelerating the process of ray tracing. The methods are:

- BSP (Binary Space Partitioning). This method performs best for most purposes.
- BSP2. This method can perform better with large scenes and situations with limited memory.

You set the raytrace acceleration method on the Render Setup Dialog > Renderer panel > [Rendering Algorithms rollout](#) on page 6277.

Ray-Trace Bias



On the right, increased map bias makes the dog appear to float.

A single parameter, Ray-Trace Bias, affects the generation of [ray-traced shadows](#) on page 8103. You set this parameter in the Shadow Parameters rollout.

The Ray-Traced bias control in the Shadow Parameters rollout moves the shadow toward or away from the shadow-casting object (or objects). By default, this value is 1 unit.

Increasing the bias moves the shadow away from the object, and decreasing the bias moves the shadow closer to the object. The Ray-Trace Bias value can be any positive floating-point number.

For example, if a shadow-casting object intersects another object but its shadow doesn't meet properly at the intersection, the bias is too high. This effect varies with the angle of the spotlight to the object. Extremely shallow spotlight angles usually require higher bias values.

Another purpose of bias is to avoid problems with objects that cast shadows onto themselves. If you see streaks or moiré patterns on the surface of the object, the bias value is too low.

Ray-Traced Shadows



Example of ray-traced shadows

Ray-traced shadows are generated by tracing the path of rays sampled from a light source. Ray-traced shadows are more accurate than [shadow-mapped shadows](#) on page 8125. They always produce a hard edge.

Ray-traced shadows are more realistic for transparent and translucent objects. Also, only ray-tracing can generate shadows for wireframe objects.

Because ray-traced shadows are calculated without a map, you don't have to adjust resolution as you do for shadow-mapped shadows. The parameters for ray-traced shadows adjust the shadow's position (known as [ray-trace bias](#) on page 8102) and the depth of the [quadtree](#) on page 8100 used to calculate ray tracing.

Advanced ray-traced shadows are the same as ray-traced shadows, however they provide [antialiasing](#) on page 7904 control, letting you fine-tune how ray-traced shadows are generated.

RAYHOSTS File

The RAYHOSTS file is a text (ASCII) file that lists the name of host systems capable of [mental ray rendering](#) on page 6230 in a distributed network. You turn on distributed rendering on the Render Setup dialog > Processing panel > [Distributed Bucket Rendering rollout](#) on page 6326.

Each line in the RAYHOSTS file contains the name of a host system. The host name can be followed by a semicolon and a port number of the service to connect to. The host name with or without the port number can also be followed by white space and a list of mental ray command-line parameters.

See the manual, *Rendering with mental ray*, for descriptions of the mental ray command-line options.

When you click Add on the Distributed Bucket Rendering rollout and use the [Add/Edit DBR Hosts dialog](#) on page 6334 to add a host or satellite processor, this updates the RAYHOSTS file. So does clicking Remove to remove a processor.

The RAYHOSTS file is named *max.rayhosts*. By default, it is located in the *\mentalray* directory inside the program folder. You can change the default location by creating an environment variable named MAX<X>_MI_ROOT, where <X> is the 3ds Max version number, and setting the variable's value to the path of the *max.rayhosts* file you want to use.

Real Time

By default, viewport animations play in real time, skipping frames where necessary.

You can turn this off by clicking Time Configuration in the time controls, and then turning off Real Time in the Playback group box of the [Time Configuration dialog](#) on page 7565.

When Real Time is turned off, all frames are displayed during playback. The playback may appear slow, but you'll know that you're seeing every frame.

You can also speed viewport animation by minimizing your viewports to quarter size.

Recognize Scene-Loading Technology

Recognize™ is an FBX-based scene-loading feature used for importing geometry, lights, materials and cameras from Revit 2009. This feature includes the numerous settings on the FBX Importer (and Exporter) dialog. Refer to the FBX Plug-in Help for complete details.

Red, Green, Blue / Hue, Saturation, Value

There are two sets of color sliders in the [Color Selector](#) on page 391: the red/green/blue (RGB) set and the hue/saturation/value (HSV) set. You can use either set or both to mix a particular color. As you adjust the color sliders, their RGB and HSV numeric values appear in the spinners.

There are separate RGB and HSV spinners as [light parameters](#) on page 4970.

RGB Sliders



Each of the RGB sliders is a band of red, green, or blue (the primary light colors) shaded from black to the full intensity of the color. When you move any slider, it mixes with the values of the other two, and the result appears in the swatch beneath the sliders.

For example, if you move the Red slider all the way to the right (value 255) and leave the other two at the left (0), the active swatch turns red. If you then move the Green slider all the way to the right, the swatch turns yellow. If you move all three sliders to 0, the result is black; if all three are at 255, the result is white; and all three at any point of equal value produce shades of gray.

HSV Sliders



If you prefer the hue/saturation/value color system, you can use the HSV sliders to mix color. First move the Hue slider to the color band you want (if the Value and Saturation sliders are set to low values, you don't see an immediate result in the swatch). Move the Value slider to set the brightness, or intensity of the color. Move the Saturation slider to determine the purity of the color. The higher the saturation, the less gray the color.

Reference

References are like "one-way" instances. Referenced objects are based on the original object, as are instances, and can have their own unique modifiers. Any modification made to the original object is passed on to its references, but any modification made to a reference is not passed back to the original.

The one-way effect is useful, since you can maintain an original that will affect all its references, while the references themselves can take on individual characteristics.

If you are modeling heads, for example, you might want to keep a family resemblance in your characters. You could model basic features on the original, then model specifics on each reference.

In the modifier stack, a solid line separates the reference from its parent object, so you can see that the effect of modifiers on the reference will not affect the parent object or other references to it.

Reference Object

In [Particle Flow](#) on page 2795, a reference object is a geometry object or collection of objects used as particles by the [Shape Instance operator](#) on page 2904. It can be a single object, a group, a hierarchy, or even a compound object consisting of several elements.

Refine

In NURBS modeling, refining means to increase the number of CVs on a curve or surface. Refining does not change the curvature of the curve or surface.

Reinitialize

In [Physique](#) on page 4603, when you need to reset vertex, envelope, and other skin parameters, click Reinitialize to display the [Physique Initialization dialog](#) on page 4683. Using controls in this dialog, you select which category to update, and apply the new global settings you specify.

For example, if you've added a new bone to the hierarchy and want it included and influenced by the Physique modifier, you'd use reinitialization. Or maybe you've repositioned the biped structure relative to the mesh, or scaled both; you'd need to reinitialize Physique settings to recognize those changes.

Repel Behavior

In [crowd animation](#) on page 4761, the Repel behavior lets you specify any object or objects (sources) that will force delegates to move away from them. This is basically the opposite of the Seek behavior. If you want delegates to back away from an object, as opposed to turning to face the direction they're moving, use Repel in conjunction with the Orientation behavior.

Reservoir

The Reservoir is a storage area for clips ([BIP files](#) on page 7923) used by the [Motion Mixer](#) on page 8052. The Reservoir contains a single entry for each clip

[adaptation](#) on page 7900 used in the Mixer. You can use the Reservoir to load previously used clips, save adaptations to new BIP files, or view a clip's adaptation data. See [Using the Reservoir](#) on page 3745.

The purpose of the Reservoir is to save memory. Instead of storing the animation and adaptation data for each clip inside the clip, it is stored in the Reservoir. When a clip is used more than once in the Mixer, the clip occurrences can share the data from the Reservoir, saving memory.

Resolution

The horizontal and vertical number of pixels in a 2D image. For example, a 640x480 resolution describes an image that is 640 pixels across by 480 pixels down. Resolution can also refer to an image's bit depth, such as 24-bit or 32-bit.

You set the resolution of the image you are going to render on the [Render Setup dialog](#) on page 6067.

Reveal Rendering

Reveal™ is used to perform iterative rendering by isolating regions, selections or calculations to improve rendering speed while working on specific elements to complete a final image. Access the Reveal feature set in the [Render Setup Dialog](#) on page 6067, directly in the Rendered Frame Window and the Viewport.

Review

Review is a previewing feature that can be used to view multiple maps simultaneously in the Viewport. You can preview photometric lights (including IES files) to see how real luminaries will affect the environment and real-time shadowing of objects that use Arch&Design materials. Access the Review feature from the right-click menu in the viewports.

Rotoscoping



Boat is an object composited over video of breaking wave.

Rotoscoping is the process of bringing video frames into a scene to use as the background for matching objects.

The way to use rotoscoping is to specify a digital disk recorder or movie file and read the frames into the viewport using the Animation Synchronization controls in the Viewport Background dialog. Once you've specified your source device or file in the Viewport Background dialog, one frame of the video displays for each scene frame by default. Remember to turn on Animate Background as well as Show Background to have your video frames appear in sequence in the viewport.

To produce the composited, rendered image, use Video Post or a compositing application to composite the background image and the rendered scene together.

Rubber-Band Mode

When you work with a [biped](#) on page 4147, Rubber-Band mode provides a way to proportion the arm and leg links simultaneously, by moving the link with the Move transform, instead of using scale. Rubber-Band mode scales both the link and its child in a single step.

This is particularly useful when fitting a biped to a skin prior to applying the [Physique modifier](#) on page 4603. For example, rubber-banding the upper arm rescales the upper and lower arm objects and moves the elbow link without affecting the position of the shoulder or the wrist. If you've spent a lot of time getting the fingers in the right place, you can reposition the elbow by rubber-banding, without affecting the hands.

RVT Link

When working on Revit projects, you can import/link DWG, DXF, DGN, RVT and image files. These files can contain 2D and 3D geometry to help in the construction of your projects. Raster images can be imported as background images into your Autodesk Revit project or as visual aids needed during the creation of a model.

When you've exported the project to a DWG file, RVT links are comparable to xrefs in an AutoCAD drawing.

For more information about the Import/Link features of Revit, refer to the *Autodesk Revit Help* file.

Safe Frame

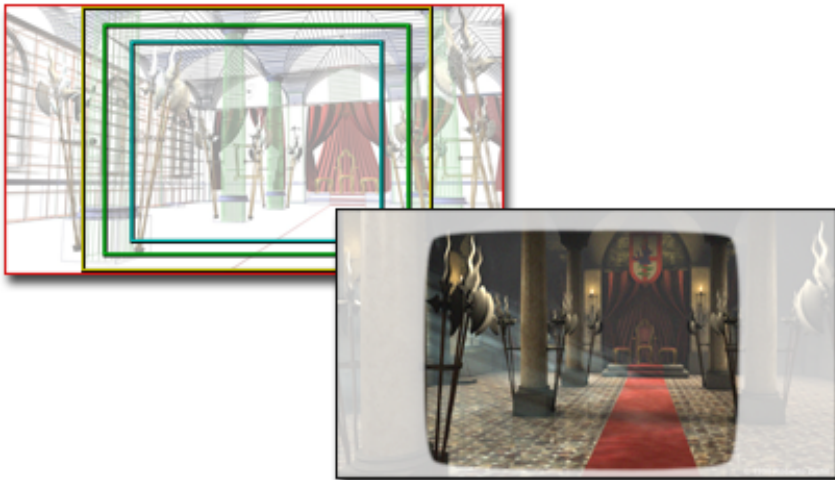

Safe frame borders show which portions of a viewport will be visible when rendered to video.

The Safe Frame provides a guide to help avoid rendering portions of your image that might be blocked in the final output.

For example, to ensure that no unintentional black areas are visible on a television screen, broadcasters intentionally "overscan" the video image. The result is that portions of an image around the edges are not visible on a typical

set. In addition, portions of images on 35mm slides can be partially covered by the slide mounts.

You can adjust the size of the safe frame as a percentage of the outer display rectangle with the Safe-Frame controls on the Viewport Configuration dialog. Depending upon its size, the safe frame can be used as the equivalent of a "title safe frame" (the area inside which it is safe to display titles), or an "action safe frame" (the area inside which action may occur without significant loss of information).

To view the frames, choose Show Safe Frame from the viewport right-click menu (displayed when you right-click the viewport label). Three rectangles, one yellow, one green, and one pale blue, appear in the camera viewport. The outer, yellow video rectangle shows the area and aspect ratio of your current display. The middle, green rectangle represents the action safe zone. The inner, pale blue rectangle shows the title safe zone.

To turn off the display, choose Show Safe Frame again.

Sample Range

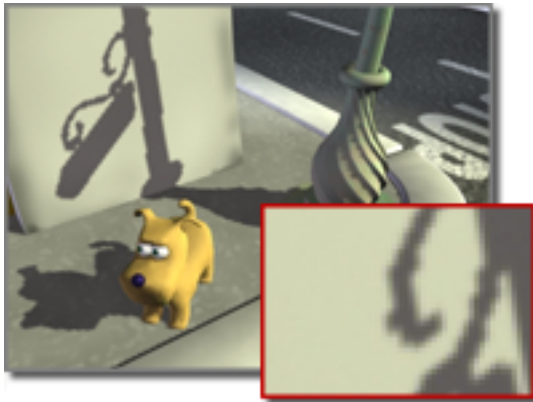

Low sample range can cause jagged-edged shadows.

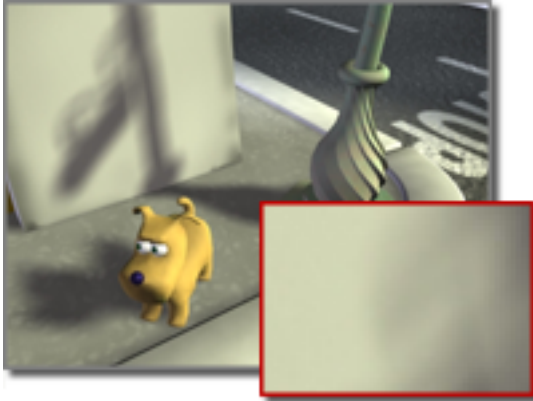

Higher sample range causes soft-edged shadows.

Sample Range affects the softness of the edge of [shadow-mapped shadows](#) on page 8125. The sample range determines how much area within the shadow is averaged.

Small values reduce the area that is averaged, effectively bringing the edge of the shadow inward, producing sharper-edged shadows. Sharper edges can cause aliasing.

Large values extend the area that is averaged, effectively bringing the edge of the shadow outward, producing softer-edged shadows. Soft-edged shadows have more antialiasing. The effect is somewhat like the falloff of a soft-edged spotlight.

The default Sample Range value is 4. The Sample Range value can be any floating-point number from 0 to 20. Values of 2 to 5 are recommended. Values below 3 can produce coarse-edged shadows. You can reduce this effect by increasing the map size.

Values greater than 5 can produce streaking and moiré patterns. You can reduce this effect by increasing the map size or the Bias value.

Rendering time increases exponentially as the Sample Range value increases.

Sampling (mental ray Renderer)

Sampling is an antialiasing technique. It provides a "best guess" color for each rendered pixel. The [mental ray renderer](#) on page 6230 first samples the scene

color at locations within the pixel or along the pixel's edge, then uses a filter to combine the samples into a single pixel color.

(In 3ds Max, this technique is called "supersampling." Because the mental ray renderer performs sampling on a scene basis, in the Material Editor, you *don't* need to turn on supersampling for materials rendered using mental ray.)

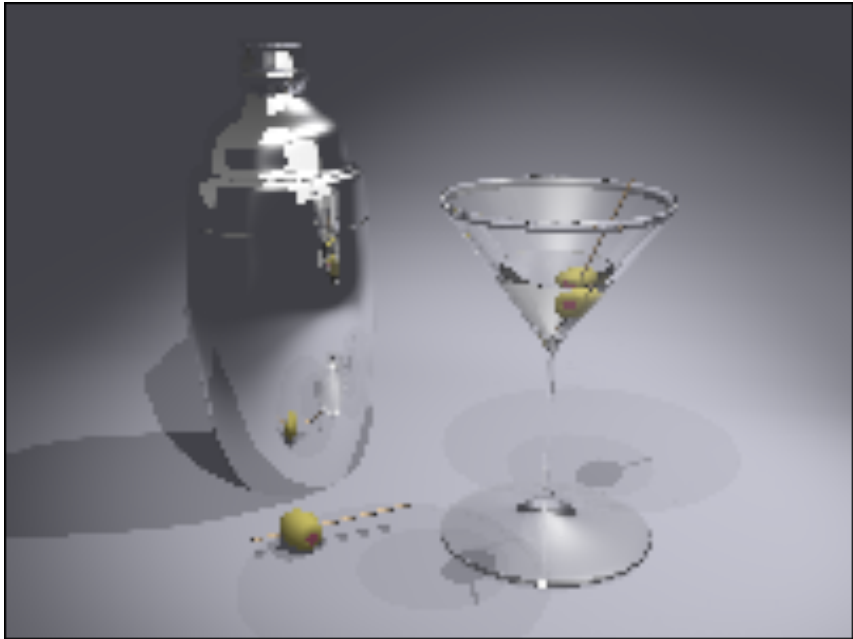

Scene rendered with low sampling is jagged and inaccurate.

Sampling range: 1/64 to 1/4



Same scene rendered with higher sampling shows smooth edges.

Sampling range: 1 to 16

The mental ray renderer provides five filter methods: Box, Gauss, Triangle, Mitchell, or Lanczos. Box, the default, is also the quickest. Mitchell is often the most accurate. The Box filter combines samples evenly, without weighting them. Each of the other filters uses a particular curve to weight samples before combining them.

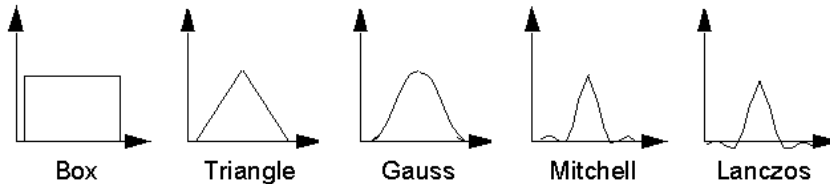

Curves used to weight samples (these are approximate)

You choose the sampling filter and set other sampling options on the Render Setup dialog > Render panel > [Sampling Quality rollout](#) on page 6272.

NOTE Area lights ([Area Omni Light](#) on page 5070 and [Area Spot Light](#) on page 5073) have their own sampling controls. These affect only shadows cast by the area light. They are independent of the sampling used to render the scene as a whole.

Rendering the Sampling Rate

To help you choose a sampling filter, you can render a scene with diagnostics enabled and Sampling Rate chosen on the Render Setup dialog > Processing panel > [Diagnostics rollout](#) on page 6324. The Sampling Rate diagnostic tool gives a schematic rendering that shows how the sampling method behaves with your scene.



Rendering with diagnostic display of the sampling rate turned on

Sampling range: 1 to 16

The intensity of each pixel indicates the number of samples collected within it and on its lower and left edges. The brighter the pixel, the greater the number of samples. Overall, the View Sample rendering is normalized so the brightest pixels have the maximum number of samples. Also, red boundaries indicate the boundaries of sampling tasks.

Lock Samples and Animation

By default, the mental ray renderer introduces a pseudo-random (quasi Monte Carlo) variation in the sampling pattern from frame to frame. This reduces rendering artifacts in animations.

You can turn off the sampling variation by turning on Lock Samples on the [mental ray: Sampling Quality rollout](#) on page 6272.

Jittering

"Jitters" samples by introducing a variation into sample locations. Turning on Jitter can help reduce aliasing. Default=off.

The Jitter control is also on the [Sampling Quality rollout](#) on page 6272.

Scale Stride

In [footstep animation](#) on page 7986, the Scale parameter lets you change the length or width of a footstep selection (or both at once). This setting is on the [Footstep Operations rollout](#) on page 4438.

The selected footsteps are scaled around the first footstep in the selection.

Scanline Renderer

The [scanline renderer](#) on page 6141 is the default renderer. By default, you use the scanline renderer when you render a scene from the [Render Setup dialog](#) on page 6067 or from Video Post. The Material Editor also uses the scanline renderer to display materials and maps.

The image produced by the scanline renderer displays in the [rendered frame window](#) on page 6073, a separate window with its own controls.

As the name implies, the scanline renderer renders the scene as a series of horizontal lines. 3ds Max additionally provides the interactive viewport renderer to provide a quick and simple rendered view of your scene as you work on it. You might also have other plug-in or third-party renderers that you've installed to work with 3ds Max.

Scene Extents

Just as an object's [extents](#) on page 7969 are its maximum dimensions in X, Y, and Z, the extents of a scene are its maximum dimensions in these three axes, and define a box that encloses the entire scene.

Scene Motion Blur

Motion blur can enhance the realism of a rendered animation by simulating the way a real-world camera works. A camera has a shutter speed, and if significant movement occurs during the time the shutter is open, the image on film is blurred.

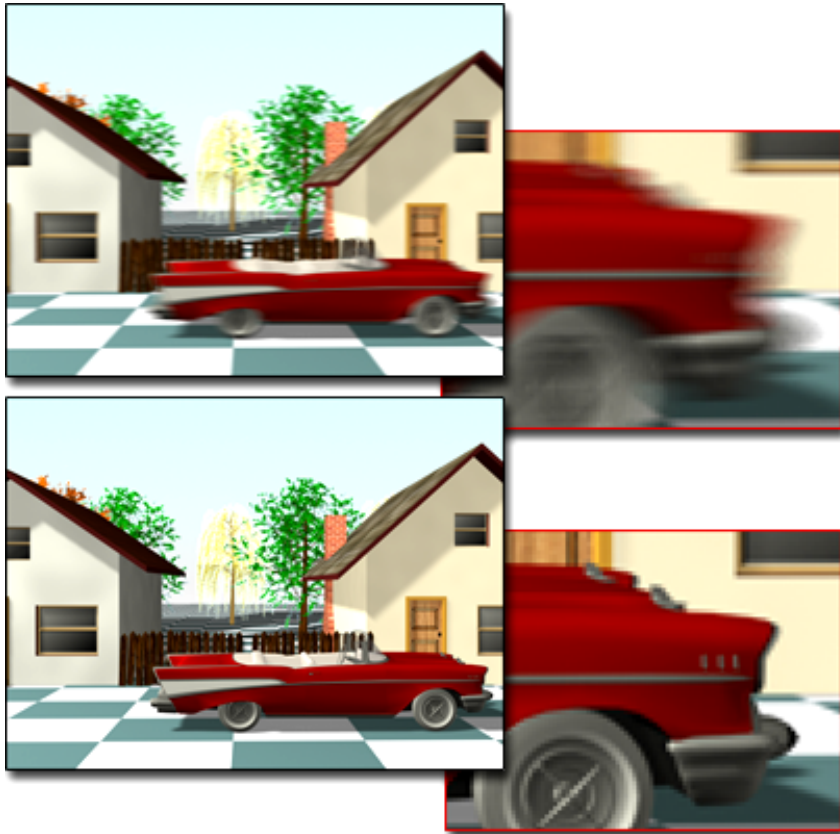

Above: Scene motion blur creates an effect of movement. (The background is blurred because of slow camera panning.)

Below: The same scene with no blurring

3ds Max provides several ways to generate motion blur. Scene motion blur is one. Image motion blur is another. For most purposes, [image motion blur](#) on page 8010 or [multi-pass motion blur](#) on page 5234 give better results than scene motion blur. Use scene motion blur whenever you want to strongly emphasize rapid motion. You can use both image and scene motion blur in the same rendering.

(Another option, [object motion blur](#) on page 8063, is not meant to simulate a camera, but to improve the rendered appearance of fast-moving objects.)

You apply scene motion blur in [Video Post](#) on page 6773. It is one of the options for a [Scene Event](#) on page 6808. In the Add or Edit Scene Event dialog, turn on Scene Motion Blur in the Scene Options group, and then adjust the parameters.

Scene motion blur creates trails behind all moving objects by rendering the entire scene at multiple time increments within each frame, and then creating the frame by compositing the multiple images together.

Schematic View

[Schematic View](#) on page 7411 is a window that lets you see everything in your scene as a node on a graph. The [nodes](#) on page 8058 are repositionable to create custom configurations.

Use Schematic View to see and select all nodes that share a relationship, such as a material or instanced modifier. You can perform basic operations on the nodes such as rename, cut and paste modifiers or materials, or create hierarchical linkages. You can use Schematic View to see and edit other relationships such as wired parameters and constraints.

Script

A sequence of instructions used to automate a task. Scripts are typically text files containing coded instructions for a particular application.

In 3ds Max, the MAXScript utility supports a scripting language.

MAXScript scripts have the file name extension *.ms*. By default, they are saved in the *scripts* folder.

Script Editor Window

A text editing window provided with the MAXScript scripting system. A script editor window can edit any kind of ASCII text file, but is particularly suited to building and modifying MAXScript script files.

You open a script editor using the Open Script or New Script commands from the MAXScript menu.

Scripted Behavior

A behavior defined by MAXScript. When you use the [cognitive controller](#) on page 4857 with [crowd animation](#) on page 4761, you can add conditional expressions written in MAXScript that impose changes in behavior.

Scripted Utility Panel

A scripted utility panel is a custom command-panel rollout created using the MAXScript scripting language. They let you create a graphical user interface to a MAXScript script.

Scripted utility panels are available through the Utilities drop-down menu in the MAXScript rollout of the Utilities panel.

Scripts (Motion Flow)

In [motion flow mode](#) on page 4508, a script is a list of clips (BIP files) that are executed sequentially to animate a character. You can create scripts either manually or automatically using [crowd animation](#) on page 4761.

Scripting

A scripting language is a programming language embedded in a host application, and used to automate tasks within the application. 3ds Max provides MAXScript as its scripting language.

MAXScript controls are located on the Utilities panel.

Seed Value

In NURBS sub-objects, a location in parameter space that is used to resolve ambiguities in some kinds of sub-object creation. The seed value is a location on a parent object, and the location nearest to the seed value that satisfies the creation condition is the one that the software chooses. For a curve, the seed value is a U location in the curve's parameter space. For a surface, the seed location is a pair of UV coordinates in the surface's parameter space.

Seek Behavior

In [crowd animation](#) on page 4761, the Seek behavior lets you specify any object or objects as a stationary or moving target for delegates. Delegates move toward the target during the crowd simulation while turning as necessary.

Segment

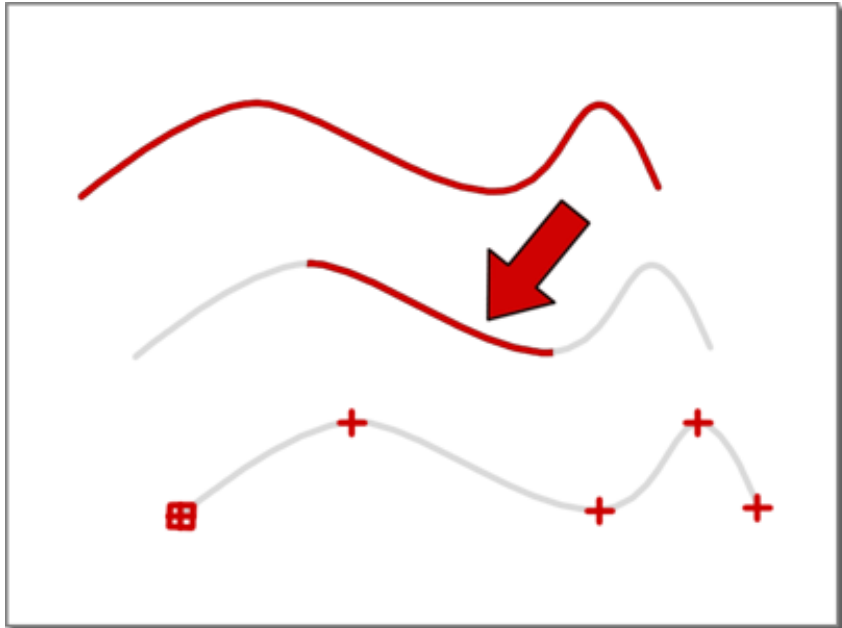

The arrow and highlight indicate a single segment in a spline.

The portion of a NURBS point curve between two of its control points, or the portion of a spline between two vertices. (NURBS CV curves don't have segments, as their control vertices don't lie on the curve.)

Self-Illumination



The lamp on the right uses self-illumination to brighten the bulb and the glass panes.

Self-Illumination creates the illusion of incandescence by replacing any shadows on the surface with the diffuse color. At 100 percent, the shadows are completely replaced by the diffuse color, creating the illusion of self-illumination.

Unless you use environmental effects, only lights illuminate your scene; they don't appear in the rendering. You can use self-illuminated materials on objects that represent lights to provide things like car headlights, and so on.

A self-illumination map lets you use a map to affect the intensity in different areas of the self-illuminated surface. Like many other map types, only the intensity of the map values affects self-illumination. White provides the most, while black blocks the illumination completely.

It's often a good idea to design a self-illumination map to match your diffuse map. For example, the diffuse map might have small, yellow rectangles to represent windows, while the self-illumination map consists of matching white rectangles against black to illuminate the yellow windows.

TIP To have an object behave as an actual light source (for example, a spline that models a neon light), use the [scanline renderer](#) on page 6141, [photometric lights](#) on page 5005 with a [radiosity solution](#) on page 6168, and assign an [Advanced Lighting Override material](#) on page 5734 to make the object luminous.

Shaders (mental ray Renderer)

In mental ray, a shader is a function that calculates light effects. There can be shaders for lights, cameras (lens shaders), materials, shadows, and so on.

In 3ds Max, the mental ray translator provides the functionality of light and camera shaders. Material shaders correspond to 3ds Max materials.

A number of shaders are provided with 3ds Max. See [mental ray Shaders](#) on page 5974, [mental ray Connection Rollout](#) on page 5385, and [mental ray Materials](#) on page 5543.

The mental ray manual, *Programming mental ray*, describes how to write custom shaders.

Shaders (Standard Materials)

For a [standard material](#) on page 5395, the shader is the algorithm that controls how the material responds to light. Shaders especially control how highlights appear. They also provide a material's color components, and control its opacity, self-illumination, and other settings. Shaders are often named for their inventors; they can also be named for the effect they provide. See [Shading Type](#) on page 5265.

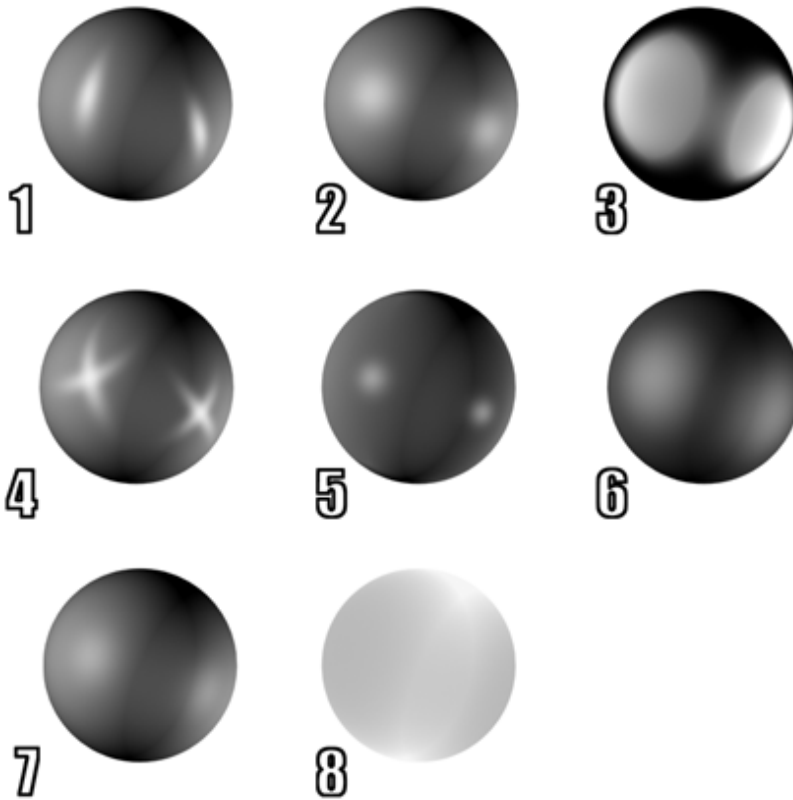

Samples of different shading for a standard material

1. Anisotropic
2. Blinn
3. Metal
4. Multi-layer
5. Oren-Nayar-Blinn
6. Phong
7. Strauss
8. Translucent

For each material, one of the available shaders is always active. You choose the shader on the material's [Shader Basic Parameters rollout](#) on page 5397.

The [raytrace material](#) on page 5490 uses a subset of the standard material shaders: Anisotropic, Blinn, Metal, Oren-Nayar-Blinn, and Phong. You choose the raytrace material's shader on the material's [Raytrace Basic Parameters rollout](#) on page 5493.

The other types of materials in 3ds Max don't give you a choice of shader.

Materials (and lights and cameras) used with the [mental ray renderer](#) on page 6230 can use mental ray shaders, which are not the same as the standard material shaders. See [Shaders \(mental ray Renderer\)](#) on page 8123.

Shadow Maps (Light Objects)

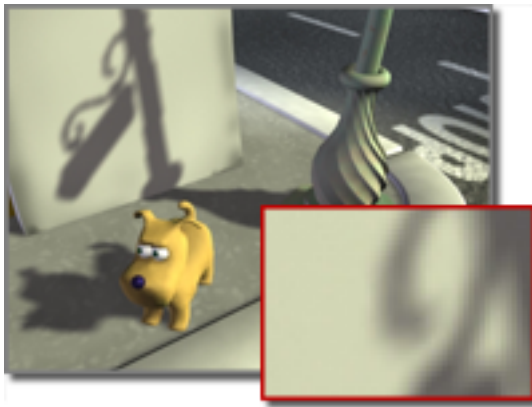

Example of shadow-mapped shadows

A shadow map is a bitmap that the renderer generates during a pre-rendering pass of the scene. Shadow maps don't show the color cast by transparent or translucent objects. On the other hand, shadow maps can have soft-edged shadows, which ray-traced shadows cannot.

A shadow-map is projected from the direction of the spotlight. This method provides a softer edge and can require less calculation time than ray-traced shadows, but it's less accurate.

You can adjust the shadow map settings to achieve a sharper shadow. This involves changing the resolution and the pixel sampling of the shadow's bitmap. Because shadow-map shadows are only bitmaps, you need to keep in mind their resolution in relation to your distance from the shadow, and the detail required by the shadow. If the resolution is too low, and the camera too close, the shadow might look more like sooty smudges.

If shadows appear too coarse when you render them, increase the map size. The size can range from 0 to 10,000. However, be aware that greater size requires more memory and can take longer to generate. A 4096-line shadow map occupies 64 MB of memory (4096 x 4096 x 4).

If you have enough RAM to hold the entire scene including shadow maps, shadows don't affect performance, but if the renderer has to use a virtual memory swap file, rendering time can slow considerably.

The default shadow map size is 256.

The bitmap used by shadow maps must fill the area covered by the falloff of the spotlight. The wider the falloff, the coarser the shadow appears. Keep the falloff as tight as possible given the requirements of your scene.

Shadow Map (mental ray Renderer)

A shadow map is a bitmap that the mental ray renderer generates during a pre-rendering pass of the scene. Shadow maps can require less calculation time than ray-traced shadows, but the shadows they generate can be less accurate.

The mental ray renderer saves shadow maps as [ZT files](#) on page 8177. Shadow map controls are on the Render Setup dialog > Renderer panel > [Shadows & Displacement rollout](#) on page 6292.

Shapes and Splines

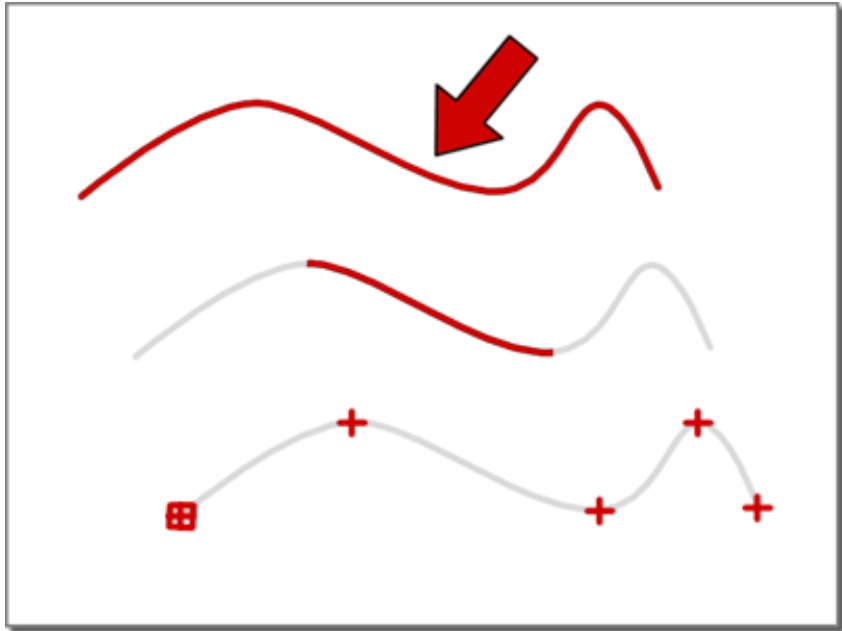

Spline

A shape is an object made up of one or more splines. A spline is a collection of vertices and connecting segments that form a line or curve. By adjusting values in the vertices, you can make portions of the line curved or straight.

Shapes don't usually appear in the rendered scene. They're used for the following purposes:

- As the foundation for extruded objects, by applying an Extrude modifier to the shape.
- As the foundation for a spun object, by applying a Lathe modifier to a shape.
- As the components that make up a Loft object, by combining a shape as a path, and one or more shapes as cross-sections along the path.
- As an animation path for an object by assigning a path constraint to the object, and then picking a shape as the path.

- As one method of linkage for inverse kinematic chains.

You can make shapes renderable to create tubular forms in the rendering. Renderable shapes don't appear any different in viewports.

Shapes can also be [NURBS curves](#) on page 2237. You can use NURBS curves in exactly the way you use spline-based shapes. You can also use a NURBS curve as the basis for a NURBS model that includes multiple curve and surface sub-objects.

Get Shape (Lofting)

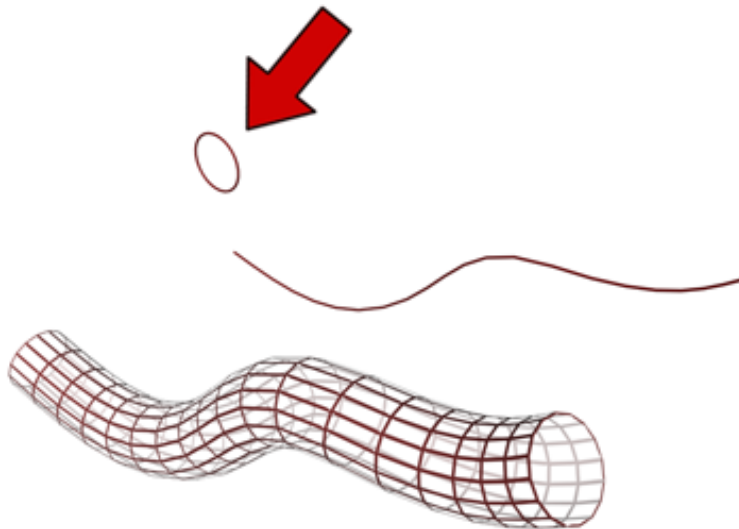

A circle is lofted along a path to construct a tubular shape. Get Shape chooses the contour spline.

You use Get Shape as a loft creation method when you want the shape to move to the location of the selected path. For example, you use this method if you have created a path at the exact location where you want your loft object to be. You use Get Shape to create a loft at that location.

Get Shape causes the shape to move and rotate to align itself with the current level of the path. The exact orientation of the shape is controlled by two other loft settings named Contour and Banking.

The following describes the orientation of the first shape at level 0:

- The pivot point of the shape is located on the path at the current path level.
- The positive Z axis of the shape is aligned with the tangent to the path at the current path level.
- The local Y axis of the shape is aligned with the local Z axis of the path.

Sometimes, aligning the positive Z axis of the shape with tangent of the path does not produce the result you want. You can flip the orientation of the shape by pressing Ctrl while getting the shape. Pressing Ctrl aligns the shape so that the negative Z axis of the shape is aligned with the tangent to the path.

SHP Files

SHP is the 3D Studio R4 (DOS) shape-file format. You can import these files into 3ds Max.

The *.shp* file contains polygons created in the 2D Shaper in 3D Studio.

When importing an SHP file that contains multiple shapes, the software gives you the option to either merge them all into one object or make multiple incoming objects.

The shape importer looks at the vectors on incoming splines, and if they're collinear within a couple of percentage points, it changes the angle to a smoothed Bezier (otherwise, it's a Bezier corner).

Skylight

In the real world, daylight does not just come from direct sunlight; it also comes from skylight that is scattered through the atmosphere. 3ds Max offers great realism and accuracy by calculating not only sunlight, but calculating this scattered light as well.

In 3ds Max, the sky is modeled as a dome of infinite radius placed around the scene. Daylight computes the illumination of a point in the scene with reference to all directions around the point where the sky is visible. The sky brightness is not constant over the sky dome, but rather it changes depending upon the position of the sun.

See also:

- [Sunlight](#) on page 8140
- [Sunlight and Daylight Systems](#) on page 5139

Sliding Footstep

In [footstep animation](#) on page 7986, changing biped foot key parameters enables the biped feet to move or slide during a footstep period. This feature is also available for motion-capture file import to allow the biped feet to slide or pivot. In the viewports, a sliding footstep is displayed as a footstep with a line through the middle.

Smoothing Groups

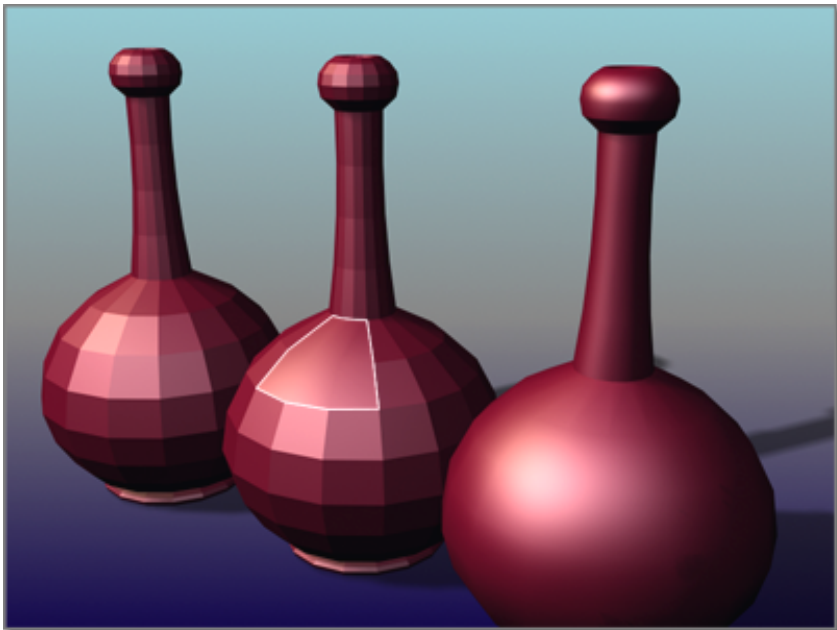

Left: The bottle has no smoothing.

Middle: Smoothing is assigned only to the highlighted group of faces.

Right: The bottle is smoothed using three different smoothing groups: on the body, the neck, and the top edge.

Smoothing groups define whether a surface is rendered with sharp edges or smooth surfaces.

Smoothing groups are numbers assigned to the faces or patches of an object. Each face or patch can carry any number of smoothing groups up to the maximum of 32. If two faces or patches share an edge and share the same smoothing group, they will render as a smooth surface. If they don't share the same smoothing group, the edge between them will render as a corner.

You can manually change or animate the threshold values for smoothing group assignments using such tools as [Editable Poly \(Polygon/Element\)](#) on page 2177 and the [Edit Mesh modifier](#) on page 1353.

SMPTE

SMPTE (Society of Motion Picture and Television Engineers) is the standard time display format for most professional animation work.

From left to right, the SMPTE format displays minutes, seconds, and frames, delineated by colons. For example:2:16:14

represents 2 minutes, 16 seconds, and 14 frames.

As you move through time in a SMPTE display, when the seconds field increments, the frames field recycles to 0 and starts over. For example, given an NTSC frame rate of 30 frames per second, as you move through time, the frames field counts from 0 to 29, at which point the seconds field increments by 1, and the frames field begins again at 0.

As with the Frames display format, the SMPTE format lets the time slider move at single-frame increments.

Space Warp Behavior

In [crowd animation](#) on page 4761, the Space Warp behavior lets you assign a space warp, such as Wind or Gravity, to one or more delegates. The Space Warp behavior can use any space warp in the Forces category. These space warps treat [delegates](#) on page 7951 as if they were particles.

You can also use the Space Warp behavior to bind delegates to the [Vector Field space warp](#) on page 4917 provided with **character studio**. This space warp causes delegates to avoid an object while following its contours.

Space Warps

[Space warps](#) on page 2685 are objects that provide a variety of "force field" effects on other objects in the scene.

Space warps themselves are not renderable. You use them to affect the appearance of other objects, sometimes a large number of objects at the same time. Some space warps deform object geometry by generating ripples, waves, or explosions. Other space warps are meant specifically for use with particle systems, and simulate natural effects such as wind blowing snow or rain about, or a rock in the path of a waterfall.

Space warps behave somewhat like modifiers, except that a space warp influences world space, rather than object space as geometric modifiers do.

When you create a space warp object, viewports show a representation of it. You can transform the space warp as you do other 3ds Max objects. The position, rotation, and scale of the space warp affect its operation.

To have an object or selection set be affected by a space warp, you bind the object to the space warp. A space warp has no effect on objects unless the objects are bound to it. When an object is bound to a space warp, the warp binding appears at the top of the object's modifier stack. A space warp is always applied after any transforms or modifiers.

When you bind a space warp to multiple objects, the space warp's set of parameters affects all the objects equally. However, each object's distance from the space warp or spatial orientation to the warp can change the warp's effect. Because of this spatial effect, simply moving an object through warped space can change the warp's effect.

You can also use multiple space warps on a single object or objects. Multiple space warps appear in an object's stack in the order you apply them.

Spawn Particles

In [Particle Flow](#) on page 2795, spawn particles are new particles that are generated from existing particles ([parent particles](#) on page 8081) in a process called *spawning*. You can use the [Spawn test](#) on page 2991 to create spawn particles arbitrarily,

or the [Collision Spawn test](#) on page 2964 to create spawn particles as the result of physical interaction between a parent particle and a deflector.

Specular Color

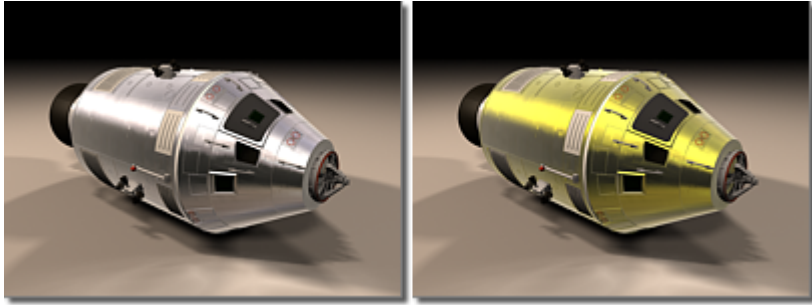

Changing specular color tints highlights on the shiny surface of the spacecraft.

Specular color is the color of highlights on a shiny surface. The highlights are reflections of the lights that illuminate the surface. For a naturalistic effect, set the specular color to the same color as the key light source, or make it a high-value, low-saturation version of the diffuse color.

In 3ds Max, you can set the specular color to match the diffuse color. This gives a matte effect, making the material appear less shiny.



Matching specular color to the diffuse color makes the surface less shiny.

Speed Vary Behavior

In [crowd animation](#) on page 4761, the Speed Vary behavior is useful for objects whose velocity changes as they move, such as strolling tourists who might occasionally slow down to do some sightseeing.

Splice

The term *splice* means to cut a sequence, insert a segment and join the cut ends to the segment. It can also mean a simple joining of ends to a segment.

In **character studio**, you can splice a footstep sequence. You do this by copying a footstep sequence, then moving it to the middle or end of another footstep sequence and placing it there. The ends of the segments are joined automatically to make a smooth footstep sequence.

You can use splicing to extend your footstep animation or build a cyclic sequence.

Spline

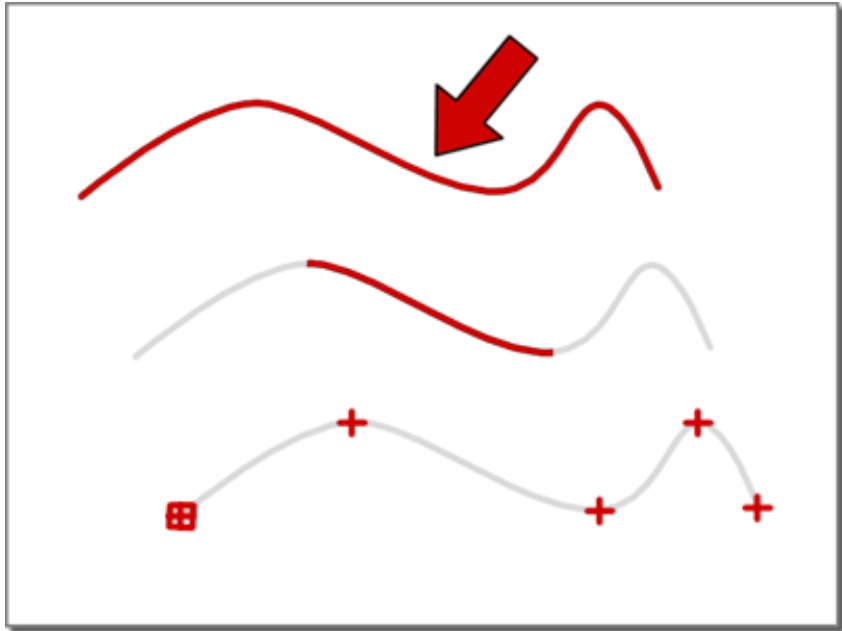

Top: Spline

Middle: A segment of the spline

Bottom: Vertices of the spline

A type of curve that is interpolated between two endpoints and two or more tangent vectors. The term dates from 1756, and derives from a thin wood or metal strip used for drafting curves in architecture and ship design.

Spline Dynamics

Spline Dynamics is a [biped dynamics](#) on page 7923 option located on the [Dynamics & Adaptation rollout](#) on page 4417. Choosing Spline Dynamics creates keys for the biped's center of mass without calculating gravity or balance (Dynamics Blend=0.0 and Balance Factor=0.0).

Startup Script

When 3ds Max first starts, MAXScript searches for any startup script files, which it then automatically loads and runs. This feature is useful if you have function libraries you always use and want preloaded, or if you want to establish custom UI settings, define scripted plug-ins, or load scripted utility rollouts.

MAXScript first searches for *.mcr* (macroScript definition files) in the *ui\macroscripts* directory. These macroScript definitions are not compiled at this time; rather they are just scanned to identify the macroScripts that have been defined.

MAXScript next searches for *.ms*, *.mse*, and *.mzp* files in the plug-in path directories (defined on the [Configure System Paths dialog](#) on page 7732 and [Configure User Paths dialog](#) on page 7729) and their subdirectories, and compiles these files. The base scene and user interface have not been created at this point, so no viewport or scene commands should be executed in these files. These files should primarily define scripted plug-ins and utility functions.

Any utility functions used by the macroScripts defined when reading the *ui\macroscripts* directory should be defined in a *.ms* or *.mse* file in one of these directories. You can prevent a nested directory from being scanned by placing its name in parentheses, for example "(old-versions)", allowing you to enable and disable scripts in handy directory-based groupings.

At this point, 3ds Max creates the base scene and user interface. Any macro scripts used by buttons in the user interface are compiled at this time.

The automatic loading of the following startup script files can be deactivated by turning off the Auto Start MAXScript option in the MAXScript page of the Preferences dialog, as described in [MAXScript Preferences](#) on page 7782.

MAXScript first searches for a file named *startup.ms* in the following directories, in this order:

- 1 The Scripts directory (defined on the Configure User Paths dialog > File I/O panel)
- 2 The Startup Scripts directory (defined on the Configure System Paths dialog)
- 3 The 3ds Max executable main directory
- 4 The Windows NT 32-bit system directory (*system32*)
- 5 The Windows 16-bit system directory (*system*)

- 6 The *Windows* directory
- 7 The directories that are listed in the PATH environment variable

MAXScript stops searching when it finds the first occurrence of *startup.ms*.

MAXScript then recursively scans the Startup Scripts directory (defined on the Configure System Paths dialog) and any nested directories for *.ms*, *.mse*, and *.mzp* script files and loads them. In this pass, any script files with the name *startup.ms* are ignored. You can prevent a nested directory from being scanned by placing its name in parentheses, for example "(old-versions)", allowing you to enable and disable scripts in handy directory-based groupings.

If you specify a script to run in the command line (`-U MAXScript script_name`), the script is executed at this point. (See the MAXScript Reference topic "Running Scripts from the Command Line").

SteeringWheels Navigation

[SteeringWheels™](#) on page 114 are tracking menus that are divided into different sections known as wedges. Each wedge on a wheel represents a single navigation tool. You can pan, zoom, or manipulate the current view of a model in different ways.

SteeringWheels, also known as wheels, combine many of the common navigation tools into a single interface. Wheels are specific to the context that a model is being viewed in. The SteeringWheels feature is on by default.

Sub-Object

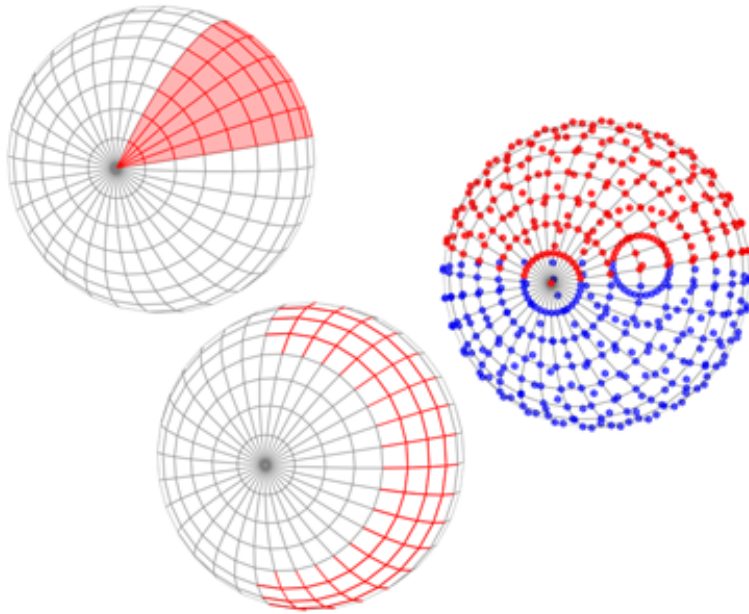

Left: A selection of face sub-objects

Middle: A selection of edge sub-objects

Right: A selection of vertex sub-objects

A sub-object is a subset of an object's geometry. Many objects have various types of sub-objects that you can work with independently. For example, an [editable mesh object's](#) sub-objects are vertices, edges, faces, polygons, and elements. To access sub-objects, go to the Modifier panel. In the modifier stack display, click the plus-sign button to display an object's hierarchy, and then choose the sub-objects level from the hierarchy. At the sub-objects level you can select sub-objects, transform the selections, apply modifiers, and so on.

Many topics in the online reference deal with sub-objects. To see a list of sub-object-related topics, search on the term "sub-object" (include the quote marks in the keyword).

Sub-Object Level

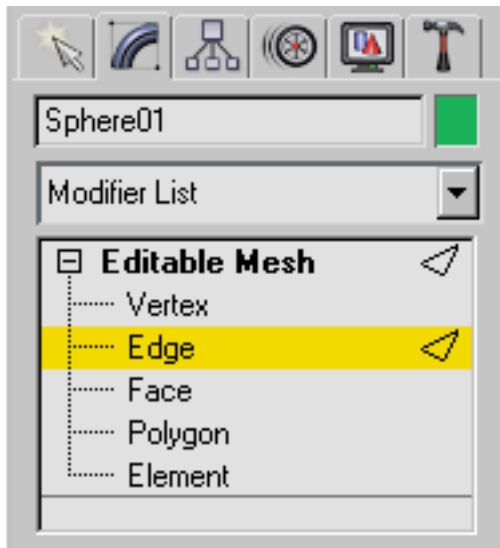

Edge sub-objects level chosen while editing a mesh.

Some types of objects let you change to a sub-object level to edit their component parts. For example, [editable meshes](#) on page 2075 have Vertex, Edge, Face, Polygon, and Element sub-object levels. [NURBS models](#) on page 2237 can have Surface, Curve, Point, Surface CV, Curve CV, and Import sub-object levels.

You change the active sub-object level using the [Modifier Stack display](#) on page 7635 on the Modify panel.

Subtractive Opacity

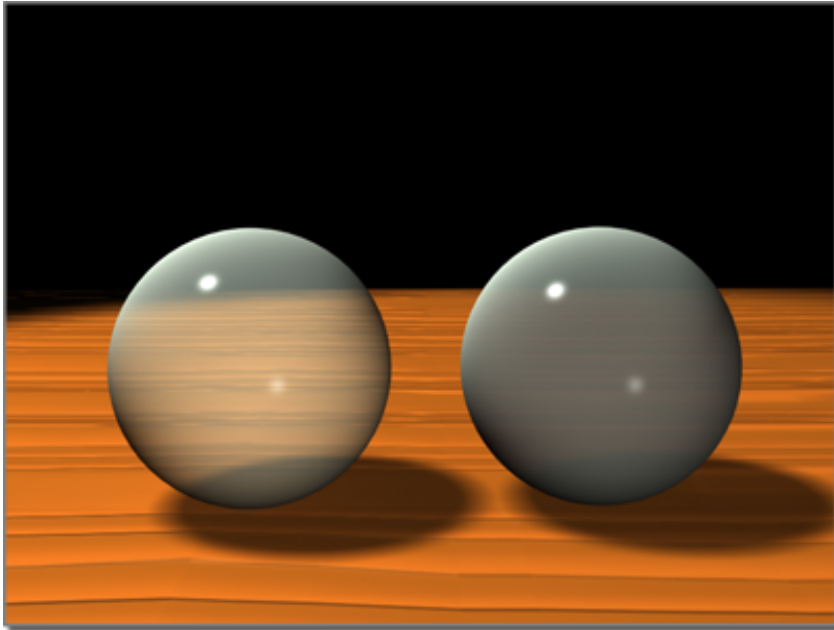

Sphere on the right uses subtractive opacity.

Subtractive opacity darkens colors behind the material by subtracting the material's colors from the background colors.

If you simply want to reduce the apparent opacity of a material, while maintaining the color values of its diffuse (or mapped) properties, use subtractive opacity.

See also:

- [Additive Opacity](#) on page 7901

Sunlight

The Sun is modeled as a parallel light source, which makes the incident direction of sunlight constant over all surfaces in the scene. You can specify the direction and intensity of the sun directly. Alternatively, the direction

and intensity of the sun can be calculated based on geographical location, time, and sky condition settings.

See also:

- [Skylight](#) on page 8129
- [Sunlight and Daylight Systems](#) on page 5139

Super Black

Super Black limits the darkness of rendered geometry. This option is used for video compositing. When compositing, you need pure black for the background, but overlying objects need to be less than pure black so that you can still see exactly where they are. Also, some video systems have problems with black that has RGB values of 0,0,0, and consider it an "illegal" color.

Unless you're sure you need it, leave the Render Setup dialog > Super Black check box off.

The scanline and mental ray renderers use the value of the [Super Black > Threshold preference setting](#) on page 7769 to determine the maximum darkness of the rendered scene. For example, if you're rendering a heavily shadowed object against a black background, although the background will be rendered as pure black, the deepest shadows on the object will be no darker than the intensity level specified by the Threshold setting (default is 15).

NOTE Setting the Threshold value too high can artificially raise low-blended values. This can ruin antialiasing effects in the render.

Supersampling

Supersampling is one of several antialiasing techniques that the software performs. Textures, shadows, highlights, and raytraced reflections and refractions all have their own preliminary antialiasing strategies. Supersampling is an optional additional step that provides a "best guess" color for each rendered pixel. The supersampler's output is then passed on to the renderer, which performs a final antialiasing pass.

See also:

- [SuperSampling Rollout](#) on page 5381

Support Period

In [footstep animation](#) on page 7986, the period where one or both of the biped feet are on the ground.

Surface Arrive Behavior

In [crowd animation](#) on page 4761, the Surface Arrive behavior is similar to the Seek behavior: it lets you specify one or more objects as a stationary or moving target for delegates. The principal difference is that you can use the Approach settings to specify an intermediate target. After reaching this location, the delegates will then make their final approach to the ultimate target surface. An example would be birds flying over a row of telephone poles, and then each one dropping to land on top of a different pole.

Surface Follow Behavior

In [crowd animation](#) on page 4761, the Surface Follow behavior moves delegates with respect to object surfaces. Target objects can be animated. For example, you can apply an animated Noise modifier to a patch grid to simulate a choppy water surface, and objects guided by Surface Follow will stay on top.

Synthesis, Synthesize

Synthesizing is the process of computing (solving) motions for [crowd simulations](#) on page 4761. The resulting simulation is a synthesis.

Talent Figure Mode

When you work with [motion capture](#) on page 4574, after you load a raw [marker file](#) on page 8037, you can turn on Talent Figure mode to scale the biped relative to the markers. Calibration for the entire marker file takes place when you exit Talent Figure mode.

Tangents

The tangent of a function curve affects the interpolated values between the keys of an animation. Most animation controllers use fixed tangents to define the function curve at a key location.

By default, 3ds Max assigns smooth tangents to the keys in a Position function curve. This is the reason that an animated object moves in smooth curves through the key frames. 3ds Max assigns smooth tangents because they usually provide the most natural motion.

Of course, you also need a way to add some corners and abrupt turns when you need them. The [Linear controller](#) on page 3193 uses a discontinuous tangent that points at the preceding and following keys, producing an abrupt change in motion at that key.

The two large flyout buttons at the bottom of the Key Info dialog provide five different types of [predefined tangent types](#) on page 3129, plus a sixth type that lets you create your own custom tangents.

If you look at a single key dot and the line running through it, the line on the left side of the key dot is the incoming tangent, and the line on the right is the outgoing tangent. Using the tangent flyout buttons, you can assign a different tangent type to the incoming and the outgoing lines for each key dot.

The button on the left assigns the incoming tangent at the left side of the selected key dot, and the button on the right assigns the outgoing tangent on the right side of the selected key dot.

TCB (Biped)

TCB is short for Tension, Continuity, and Bias. These parameters quantify the traditional animation technique of ease in and ease out (also known as “slow in and slow out”). In [freeform animation](#) on page 7988 of a biped, you can use them to change the timing of a limb's movement from key to key.

The TCB controls are in the TCB section of the [Key Info rollout](#) on page 4367.

TCB (Tension, Continuity, Bias)

The TCB Position controller provides Tension, Continuity, and Bias controls of the splines of a function curve.

[TCB Controllers](#) on page 3258 also produce curve-based animation much like the [Bezier controllers](#) on page 3138. However, TCB controllers do not use tangent types or adjustable tangent handles. They use numeric values to adjust the Tension, Continuity, and Bias of the animation.

Bias Controls where the animation curve occurs with respect to the key.

High Bias pushes the curve beyond the key. This produces a linear curve coming into the key and an exaggerated curve leaving the key.

Low Bias pulls the curve before the key. This produces an exaggerated curve coming into the key and a linear curve leaving the key.

The default value of 25 distributes the curve evenly to both sides of the key.

Continuity Controls the tangential property of the curve at the key. The default setting is the only value that produces a smooth animation curve through the key. All other values produce a discontinuity in the animation curve causing an abrupt change in the animation.

High Continuity values create curved overshoot on both sides of the key. Low Continuity values create a linear animation curve.

Low continuity creates a linear curve similar to high tension except without the Ease To and Ease From side effect.

The default value of 25 creates a smooth continuous curve at the key.

Tension Controls the amount of curvature in the animation curve.

High Tension produces a linear curve. It also has a slight Ease To and Ease From effect.

Low Tension produces a very wide, rounded curve. It also has a slight negative Ease To and Ease From effect.

The default value of 25 produces an even amount of curvature through the key.

Tendons

When you use [Physique](#) on page 4603, after you adjust envelope parameters for good mesh deformation, you can use [tendons](#) on page 4747 to control the amount of skin stretching across multiple links. While envelopes provide

smooth skin deformations, tendons provide additional stretching in much the same way that actual human tendons might create pulling in the wrist (several joints away) when the fingers are moved.

Tension, Continuity, Bias (Biped)

Tension, Continuity, and Bias (TCB) are parameters that quantify the traditional animation technique of ease in and ease out (also known as “slow in and slow out”). In [freeform animation](#) on page 7988 of a biped, you can use them to change the timing of a limb's movement from key to key.

The TCB controls are in the TCB section of the [Key Info rollout](#) on page 4367.

Terrain

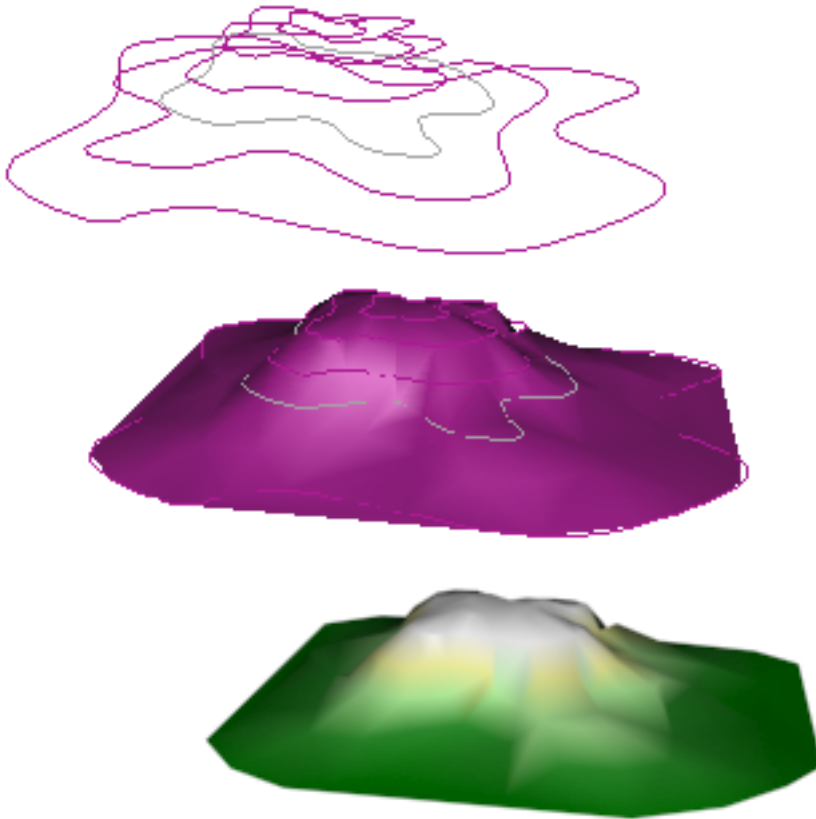

Using contours to build a terrain

Creates [terrain objects](#) on page 774 from contour line data. You select editable splines representing elevation contours and 3ds Max creates a mesh surface over the contours. You can also create a "terraced" representation of the terrain object so that each level of contour data is a step, resembling traditional study models of land forms.

When you import an AutoCAD drawing file to use as contour data, 3ds Max names each object based on the AutoCAD object's layer, color, or object type. 3ds Max appends a number after each name. For example, an AutoCAD object on the layer BASE becomes BASE.01.

After importing the contour data, selecting the objects and clicking the Terrain button, 3ds Max moves all the selected objects out of the scene and into the terrain object. Other splines in the selection are treated in the same way as by the Move copy method. You can only use these splines as operands of the terrain object. This is appropriate if you create splines in order to create a terrain object and have no further use for them.

Test

The basic function of a test in Particle Flow is to determine whether particles satisfy one or more conditions, and if so, make them available for sending to another event. When a particle passes a test, it is said to “test True.” To send eligible particles to another event, you must [wire](#) on page 8170 the test to that event. Particles that don't pass the test (“test False”) remain in the event and are repeatedly subjected to its operators and tests. Or, if the test isn't wired to another event, all particles remain in the event.

A list of all tests in Particle Flow is available in the [Tests topic](#) on page 2956.

See also:

- [Operator](#) on page 8069

Texel

A texel (short for **Texture Element**) is the base unit of a textured graphic, which defines the surface of a three-dimensional object. The base unit of the surface of a 3D object would be a texel, while a 2D object would consist of [pixels](#) on page 8092.

Ticks

Ticks are the way 3ds Max views increments of time. There are 4800 ticks in a second, so you can actually access time down to 1/4800th of a second.

Given a standard, NTSC video frame rate, there are 30 frames in a second, and therefore 160 ticks in each frame.

When you use the FRAME:TICKS display format, time is shown in frames and ticks, delineated by a colon. This format lets you adjust the time slider in

sub-frame increments of 1/160th of a frame. As you move through time, the ticks field counts from 0 to 159, at which point the frames field increments by one, and the ticks field returns to 0.

You can step forward or backward at single increments by clicking the single-frame buttons among the playback buttons.

When you use the MM:SS:TICKS Display format, you see minutes (MM), seconds (SS), and ticks, each separated by colons.

As you move through time in this display format, the ticks field counts from 0 to 4799, at which point the seconds field increments and the ticks field returns to 0.

You can step forward or backward at single increments by clicking the single-frame buttons on either side of the playback button.

Tile/Mirror



Left: A bitmap

Middle: Tiling the bitmap

Right: Tiling and mirroring the bitmap

Tiling and mirroring are useful for creating patterns based on a simple image. Use them when you need wallpaper and other repetitive designs.

The Tile option in the Material Editor is on by default, repeating the image along the U and V directions. You can use the Tiling values to scale the map image. Setting negative Tiling values increases the size of the image.

You can also set tiling values in the UVW Map modifier. These settings are in addition to the tiling values you set for the map in the Material Editor. If the map's base tiling parameter has a value of 2.0 and the UVW Map modifier has a tiling value of 3.0 for the same axis, the net result is $2.0 \times 3.0 = 6.0$. To avoid confusion about where the tiling is coming from, you may want to set the map's tiling in its base parameters or with the UVW Map modifier, but not in both locations.

The Mirror option is a variation on the Tile option. Tile repeats the image side-by-side, while Mirror flips the image repeatedly.

Topology

When objects and shapes are created, each vertex and/or face is assigned a number. These numbers are used internally to determine which vertices or faces are selected at any given time. This numerical arrangement is called *topology*.

When you select vertices or faces and apply a modifier to the selection, the modifier stack keeps track of which faces/vertices the modifier affects. If you later return to the selection level of the stack and change the selection, you change the topology to which the modifier is applied.

The term *topology* refers to the structure of faces and vertices as well as their numbers.

For example, by carefully setting various parameters, you could make a box and a cylinder with the same number of vertices. You might then think you could use the box as a morph target for the cylinder. However, because the two objects are created with such different methods, the vertex numbers on these objects would be ordered very differently. Morphing causes each numbered vertex to go to its corresponding place on the morph target. In a case such as this, with two objects with such different topology, morphing from one to the other would cause the object to crumple or turn inside out as it morphs.

Topology-Dependent Modifier

Topology-dependent modifiers perform operations on explicit, topological sub-object selections. The Edit Mesh and Mesh Select modifiers are examples of modifiers that perform operations or selections on explicit vertex or face numbers. When these modifiers are present in the stack, you can adversely affect their results if you visit previous stack operations and change the topology (the number and order of faces and vertices) being passed to them. When you do this, a topology-dependence warning alerts you to the situation.

Touch

In [footstep animation](#) on page 7986, the state of the biped foot on the first frame of a footstep.

Track

A track is a linear representation of animation occurring over time. You can think of a track as a long, straight railroad track, with the animation start time at one end, and the finish time at the other. Keys are placed on the track at intervals that correspond to the time along the track.

The term *track* is used in several areas of **character studio**, including the following:

- Each animatable object and parameter in 3ds Max and **character studio** has its own animation track, which you can view and edit in [Track View](#) on page 4236.
- Tools are available especially for working with biped tracks. The center of mass is unique in that it has separate tracks for horizontal and vertical animation, which you can select on the Motion panel > [Track Selection rollout](#) on page 4348. You can [copy and paste tracks](#) on page 4311 on biped objects to other bipeds with the [Copy/Paste rollout](#) on page 4389.
- In the [Keyframing Tools rollout](#) on page 4380, you can clear all animation or just selected tracks.
- In the [Motion Mixer](#) on page 3699, the linear areas that hold motion clips are called *tracks*. Several tracks can be stacked on top of one another to use animation from all tracks at the same time.

Track View

Track View provides a visual representation of animation keys, allowing you to view, edit, copy and adjust one or several keys at a time. This is where you control the timing of your animation, through the manipulation of keys, curves and ranges. You can also assign animation controllers to interpolate or control all the keys and parameters for the objects in your scene.

Track View has two windows, a Controller window and a Key window. The Controller window shows the hierarchy of linked objects, as well as the modifier stack and transform tracks. The Key window displays keys, curves and ranges. Keys are color coded to show what is animated.

Track View uses two different modes. [Curve Editor mode](#) on page 3518 displays key interpolation as curves, and allows you to edit the curves. [Dope Sheet mode](#) on page 3519 displays the animation as a spreadsheet of keys and ranges. Dope Sheet has two modes, Edit Key and Edit Ranges.

Trackgroup



In the Motion Mixer, motions are placed on tracks, and the tracks are organized into *trackgroups*. In other words, each trackgroup is a holder for one or more tracks. Each trackgroup can be filtered so the tracks within it affect only certain parts of the biped, such as its arms or legs. Every biped in the Motion Mixer can have multiple trackgroups, each with its own selection of biped parts. See [Adding Tracks to the Mixer](#) on page 3704 and [Filtering Mixer Tracks](#) on page 3715.

Track View Hierarchy Icons

The Track View hierarchy, as displayed in the Controller window, follows the traditional example of organizational headings in an outline. The highest levels of the hierarchy represent the main groupings in 3ds Max of Sound, Environment, Materials, Render Effects, and Objects. Lower levels of the hierarchy progress through the details of your scene, such as individual materials, material maps, and map parameters.

Each type of item in the Track View Hierarchy List is represented by an icon. You can use these icons to quickly identify what each item represents.

 **Controller** Indicate animation controllers. Controllers are the animation workhorses of Track View. They contain the animated values for all parameters and are the only item in the Hierarchy list that can have a track containing keys. Every controller has its own individual icon. Some examples:

-  Position controller
-  Rotation controller
-  Scale controller

Certain types of controllers can contain other controllers. Examples of these are Transform Controllers and List Controllers.

 **Map** Indicates map definitions. All branches below a map definition are part of that map. This includes values used by parametric maps and other map definition that are part of a map tree.

 **Material** Indicates material definitions. All branches below a material definition are part of that material. Because a material can be composed of multiple materials it is possible to have nested material definitions in Track View. Icons also appear in an object's modifier branch when a material is assigned to an object.

 **Modifier** Indicate modified objects and Space Warp bindings. Branches below a modifier contain the modifier's sub-objects and parameters.

 **Object** Indicates objects in the scene. Branches below the square icon contain linked descendents of the object. Branches below the circle icon beside a yellow cube contain transforms and modifications applied to the object.

 **Sound** Indicate sound parameters. 3ds Max provides only one sound source in Track View.

Tracks

Every item in the Track View hierarchy has a track that displays what happens to the item over time.

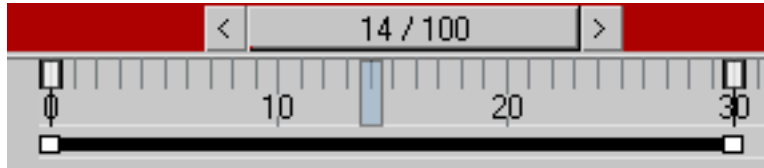

Animation track displayed in track bar below time slider

There are two types of tracks:

- Range tracks indicate the range of time over which the animation occurs. In 3ds Max, range display is turned off by default. To display the range, select the keys in the track bar, then right-click and choose **Configure> Show Selection Range**.
- Range tracks indicate when items below the track are animated. A range bar in the track displays the range of time over which the animation occurs.
- Animation tracks contain the actual animated values for an item. Only controller items have an animation track.

The values in an animation track are usually displayed as keys. Some controllers don't use keys and instead display their values as a range bar or some other graphic symbol. For example, the Wave Form item displays a sound file as a two-channel sound wave.

Animation tracks are also the only track type that can be displayed as a function curve.

Trajectory

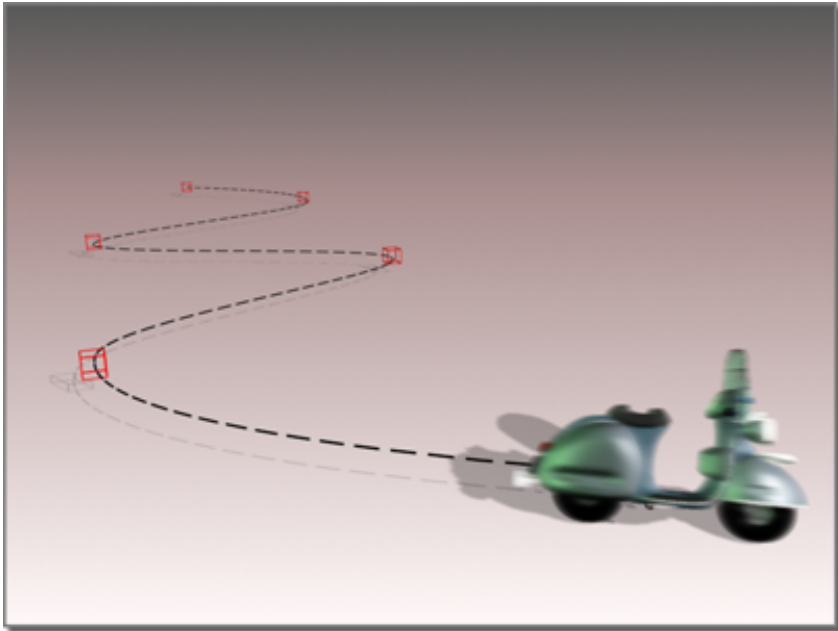

Scooter following a trajectory

Whenever an object moves through world space, you can view its trajectory. A trajectory is the visible path the object makes because of its movement. You can think of a trajectory as a three-dimensional function curve for the Position track of an object.

Object trajectories appear with the following properties:

- The trajectory curve is drawn in blue.
- Frame increments are displayed as yellow dots on the curve.
- Position keys are displayed as white boxes surrounding the appropriate frame dot on the curve.
- Selected keys are displayed in gray.

In 3ds Max trajectories are created from animated objects. You must animate the object first in order to create the trajectory.

The [Path constraint](#) on page 3297 lets you pick a spline in the scene to use as a motion path for an object. The spline becomes the object's explicit trajectory.

Trajectory (Biped)

The path an object follows as it moves through space. In 3ds Max, you can think of a trajectory as a three-dimensional function curve for the Position track of an object.

When you animate a [biped](#) on page 4147, you can turn on the display of its trajectory. See [Trajectory Display](#) on page 4319.

Transform Gizmo

A [gizmo](#) on page 7996 that is displayed in viewports and provides a visual aid when you transform objects.

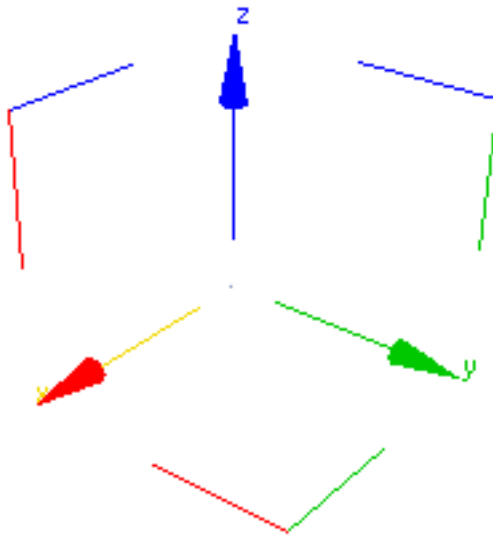

Move gizmo

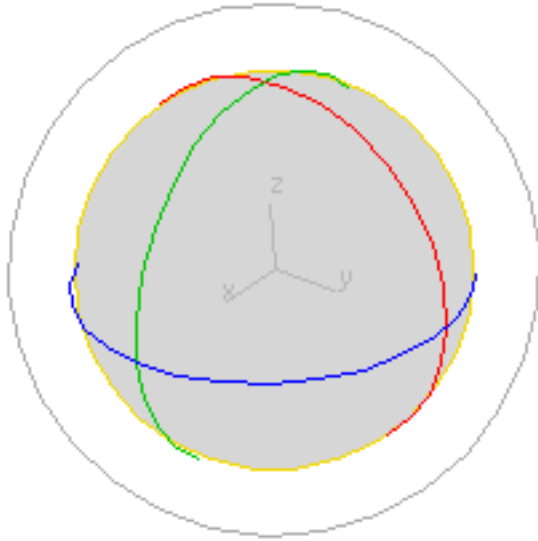

Rotate gizmo

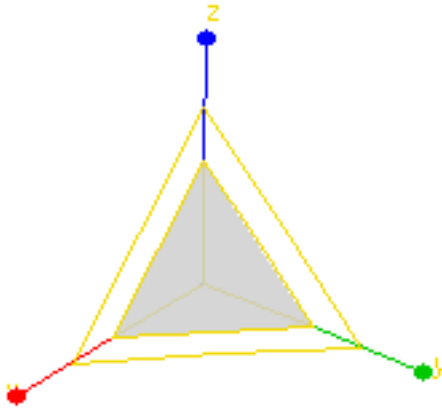

Scale gizmo

Transforms

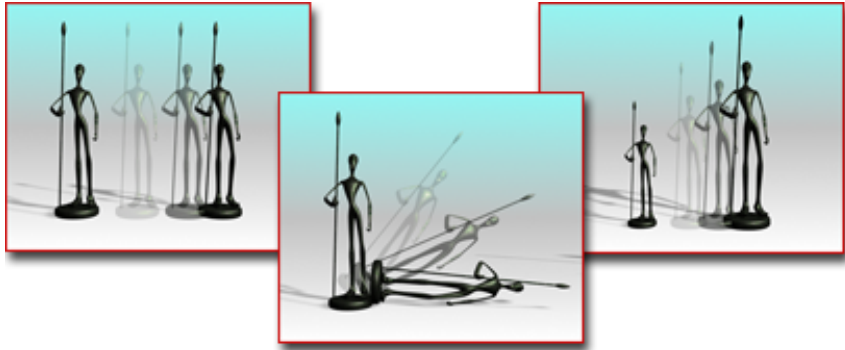

Moving, rotating, and scaling a figure

When you create any object, 3ds Max records its position, rotation, and scale information in an internal table called a transformation matrix. Subsequent position, rotation, and scale adjustments are called transforms.

An object's actual position within the world coordinate system is always calculated in relation to its internal, or local coordinate system, which is based on the object's transformation matrix. The origin of the local coordinate system is the center of the object's [bounding box](#) on page 7932.

An object can carry any number of modifiers, but only one set of transforms. Although you can change transform values from frame to frame, each object always has only one position, one rotation, and one scale transform.

You can animate your transforms by turning on the Auto Key button and then performing the transform at any frame other than frame 0. This creates a key for that transform at the current frame.

Transition

In the Motion Mixer and in Motion Flow, a transition is a gradual change between two motion clips. You can set the frames at which the transition starts and ends in each clip.

To find out how to use transitions in the Motion Mixer, see [Working with Transitions](#) on page 3724. For information on transitions in Motion Flow, see [Customizing Transitions](#) on page 4525.

Transition Track

A Motion Mixer track that allows you to stack clips on top of one another, and to create automatic transitions between them. Transitions on these tracks are similar to those in a Motion Flow network. Compare with a [Layer track](#) on page 8021, which allows cuts only between clips. See [Adding Tracks to the Mixer](#) on page 3704.

Translucency

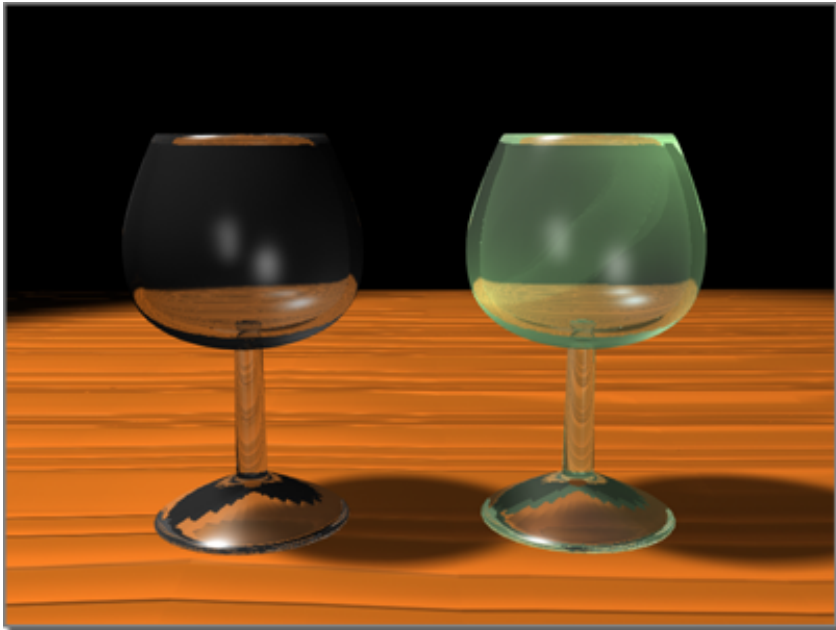

Glass on the right has a light green translucency.

A translucent material transmits light, but unlike a transparent material, it also scatters the light so those objects behind the material cannot be seen clearly.

[Raytrace materials](#) on page 5490 can simulate translucency. A Raytrace material's Translucency color component ignores surface normal directions, giving the effect of light scattering.

You can also obtain translucency effects using the [Standard material's](#) on page 5395 [Translucent shader](#) on page 5434.

Truecolor

Describes hardware and software that can support up to 16 million color values. Also known as 24-bit color, or 32-bit color when saved with [alpha channel data](#) on page 7905.

Twist Links

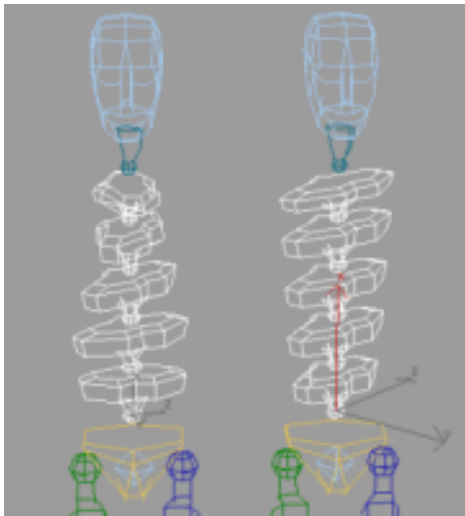

Twist Links Mode active (left) and Twist Links Mode inactive (right)

When you turn on Twist Links Mode (on the [Bend Links rollout](#) on page 4363), a rotation in local X applied to a single chain link is incremented equally throughout the rest of the chain. The remaining two axes (Y and Z) are not affected by this rotation.

Universal Naming Convention (UNC)

The 3ds Max network rendering system uses the Universal Naming Convention (UNC) to identify directories and files. UNC names begin with a double backslash and do *not* include a drive letter. This is the convention:

`\\machine_name\directory\subdirectory\filename`

To simplify network rendering, use UNC names whenever possible within a 3ds Max scene, even if the directory is on the local machine.

TIP When entering UNC names, leave off the \\ before the file name until you've entered the entire path and file name. This eliminates search delays when entering UNC path names into file selection dialogs.

Some networks require drive letters instead of UNC names. Directories on such networks can be mounted as drive letters and shared over the network. See [Mounting a Directory](#) on page 6478.

UVW Coordinates

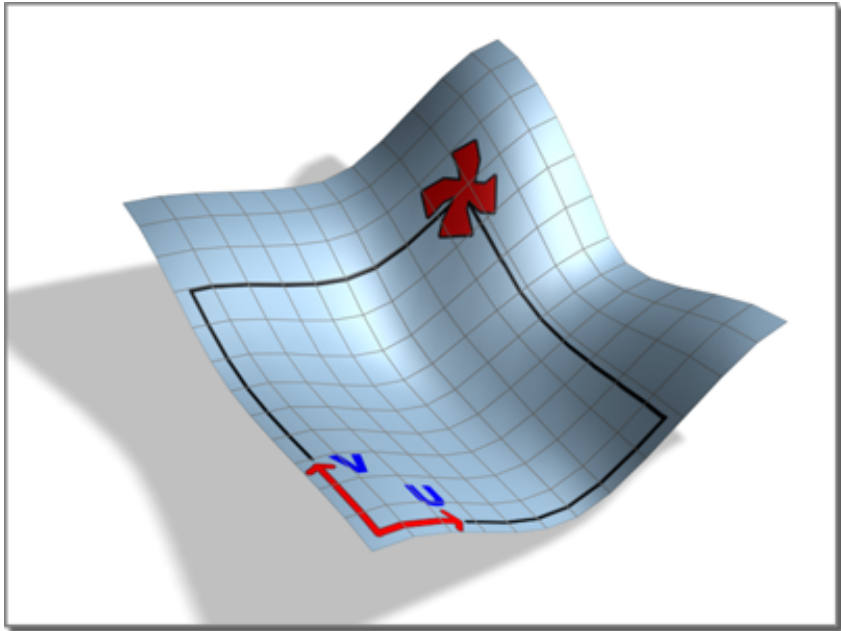

Local UV coordinates shown on a surface

Most material maps are a 2D plane assigned to a 3D surface. Consequently, the coordinate system used to describe the placement and transformation of maps is different from the X, Y, and Z axis coordinates used in 3D space. Specifically, mapping coordinates use the letters U, V, and W; the three letters preceding X, Y, and Z in the alphabet.

The U, V, and W coordinates parallel the relative directions of X, Y, and Z coordinates. If you look at a 2D map image, U is the equivalent of X, and represents the horizontal direction of the map. V is the equivalent of Y, and represents the vertical direction of the map. W is the equivalent of Z and represents a direction perpendicular to the UV plane of the map.

You might question why you need a depth coordinate like W for a 2D plane. One reason is because it's sometimes useful to be able to flip the orientation of a map, relative to its geometry. To do this, you need the third coordinate. The W coordinate also has a meaning for 3-dimensional procedural materials.

Vector Field

In [crowd animation](#) on page 4761, a vector field is a special type of space warp that crowd members can use to move around irregular objects such as a curved, concave surface. The vector field gizmo, a box-shaped lattice, is placed and sized so that it surrounds the object to be avoided. The vectors are generated from the lattice intersections. These vectors are, by default, perpendicular to the surface of the object to which the field is applied; if necessary, you can smooth them out with a blending function. The crowd members move around the object by traveling perpendicular to the vectors.

Vector Field Space Warp

In [crowd animation](#) on page 4761, you can use the [Vector Field space warp](#) on page 4917 as a space warp behavior. A vector field allows crowd members to move automatically around *obstacle objects* of any shape, following the object contours. It also lets crowd members move within the confines of an enclosed space, such as a room, while avoiding the walls. You can also use Vector Field space warps to control particle motion.

The Vector Field space warp works by generating a number of vectors that surround an object and are perpendicular to its surface. Crowd animation then uses these vectors to guide delegates around the object by moving them perpendicular to the vectors.

Vectors and Vector Handles

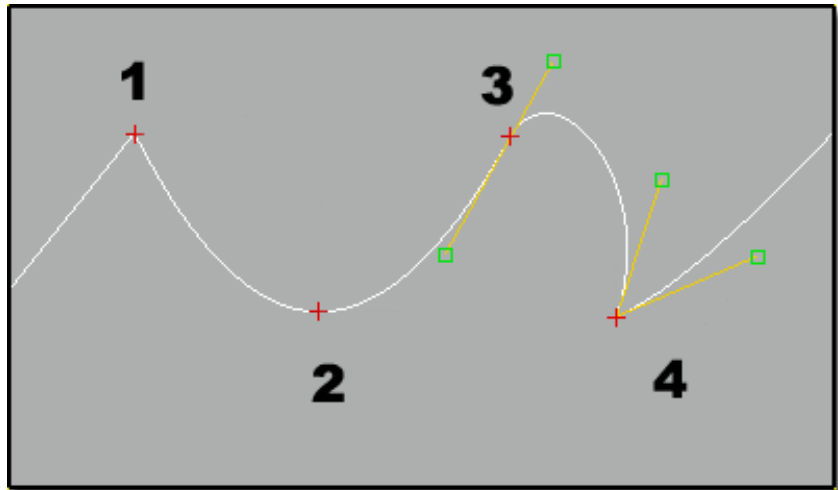

Kinds of vector handles:

1. **Corner**
2. **Smooth**
3. **Bezier**
4. **Bezier corner**

Vectors are secondary control points connected to vertices on a spline or patch object. They are also referred to as handles or vector handles.

Vector handles are visible as small green squares when you select a vertex. However, if the Vectors filter is checked (for a patch object), handles can be selected and transformed without selecting a vertex first. A transform cursor appears when you move onto a vector.

Each vertex in a shape can be one of four types:

Bezier Provide handles, but forces the segments into a tangent through the vertex.

Bezier Corner Provides handles, and allows the segments on either side of the vertex to be any angle.

Corner Allows the segments on either side of the vertex to be at any angle.

Smooth Forces the segments into a smooth curve tangent to the vertex.

Velocity Interpolation

One method of interpolation used in [motion flow editing](#) on page 4508. By default, in a transition between two motion clips, velocity is interpolated to blend smoothly between clips. If transitions are optimized, then a sophisticated algorithm is used that minimizes sliding feet.

Vertex

A vertex (plural form: vertices) is a single point whose sole property is its position in 3D space, which is typically defined by values for the X axis, Y axis, and Z axis. Vertices form the basic structure of geometric objects in 3ds Max, including mesh objects, splines, NURBS, and patches.

ViewCube Navigation System

The [ViewCube™](#) on page 107 is a 3D navigation tool that appears when the 3D graphics system is enabled and allows you to switch between standard and isometric views. The ViewCube is on by default.

Viewport (Interactive) Renderer

The interactive renderer, used for the viewports, is designed for speed so you can easily manipulate your objects in a shaded environment. It's not the same as the production renderer, which is used for your final images. Therefore, a number of effects that are available to the production renderer will not show up in the viewports.

When you design your materials, for example, you have four levels of visual feedback. The lowest level is the shaded viewport. The next level is an ActiveShade viewport (or floater). The next level is the sample slot, which uses the production renderer to display the sample sphere. The highest level is the rendered scene, which uses the production renderer to display the scene.

A single material can contain any number of maps.

Because viewing mapped materials slows the viewport display, it's up to you to decide which map (if any) you want to display. To display a specific map, you go to that map's level in the Material Editor, and then turn on its display.

(If you later go to a different map in the same material, and turn its display on, the other map is automatically turned off.)

VIZBlock

A VIZBlock is a compound object similar to a nested AutoCAD block. It is used for organizing linked data from DWG files. When AutoCAD data is linked to 3ds Max, you need to decide how the AutoCAD entities are to be organized in the scene. AutoCAD drawings are commonly organized by layers, blocks, and entities, and 3ds Max scenes are organized by hierarchies of objects.

VPX Files

VPX (Video Post sequence) files contain all the information relating to the queue and all associated settings and references. They have the file extension *.vpx* and are stored by default in the 3ds Max `\vpost` folder.

All of the Video Post configuration data, queue events, and queue event external data is saved with the MAX file also, however saving it to a separate file allows you to use the same Video Post settings in different scenes, and also allows you to share sequences with other 3ds Max users.

VUE File

A VUE (*.vue*) file is an editable ASCII file. You create a VUE file using the VUE file renderer instead of the default scanline renderer.

A VUE file contains a sequence of frames to render. Each frame is described by a sequence of commands, beginning with a "frame" command, which specifies the frame number, and ending with a viewport command, which specifies the view to render (such as "top" or "camera"). Between these two commands, there can be any number of "transform", "light", and "spotlight" commands.

NOTE VUE files created with 3DS DOS could also contain "morph" commands. This is not supported in 3ds Max because the 3ds Max exporter doesn't export morph targets.

The VUE file commands are as follows:

frame <n>
 transform <object name> <transform matrix>
 light <light name> <x> <y> <z> <r> <g>
 spotlight <light name> <x> <y> <z> <tox> <toy> <toz> <r> <g> <hot angle>
 <falloff angle> <shadow flag>
 top <x> <y> <z> <width>
 bottom <x> <y> <z> <width>
 left <x> <y> <z> <width>
 right <x> <y> <z> <width>
 front <x> <y> <z> <width>
 back <x> <y> <z> <width>
 user <x> <y> <z> <horiz> <vert> <roll> <width>
 camera <x> <y> <z> <tox> <toy> <toz> <roll> <focal>

Frame Command

Begins each frame description. Has a single parameter: the frame number.

Transform Command

Transforms the specified object.

The first parameter is the name of the object. This is the name as it appears when you use 3ds Max, but enclosed in double quotes.

The second parameter is a transform matrix. This consists of 12 real numbers:

T1 T2 T3 T4 T5 T6 T7 T8 T9 T10 T11 T12

The VUE file treats these as if they were arranged in a 4 x 4 matrix (M):

T1 T2 T3 0

T4 T5 T6 0

T7 T8 T9 0

T10 T11 T12 1

The first nine values, T1–T9, describe rotation and scaling. The last three, T10–T12, describe a move, in world coordinates.

The VUE file renderer transforms the points of the object by post-multiplication: $| X' Y' Z' 1 | = | X Y Z 1 | * M$

Omni Light Command

Controls the location and color of an Omni light.

The first parameter is the name of the light. This is the name as it appears when you use 3ds Max, but enclosed in double quotes.

The next three parameters, <x>, <y>, <z>, are the light's location.

The next three parameters, <r>, <g>, , are the light's color. The color values are normalized to range between 0.0 and 1.0.

The last parameter, <shadow flag>, parameter is 1 if the light casts shadows, 0 otherwise.

Spotlight Command

Controls the location, color, and other characteristics of a target spotlight.

The first parameter is the name of the light. This is the name as it appears when you use 3ds Max, but enclosed in double quotes.

The next three parameters, <x>, <y>, <z>, are the light's location.

The next three parameters, <tox>, <toy>, <toz>, are the location of the light's target.

The next three parameters, <r>, <g>, , are the light's color. The color values are normalized to range between 0.0 and 1.0.

The <hot angle> parameter is the angle of the light's hot spot, in degrees.

The <falloff angle> parameter is the falloff angle, in degrees

The <shadow flag> parameter is 1 if the light casts shadows, 0 otherwise.

Orthogonal Viewport Commands

These commands render a particular view—top, bottom, left, right, front, or back.

The <x>, <y>, <z> parameters are the coordinates of the center of the view.

The <width> parameter is the width of the rendered image, in world units.

User Viewport Command

Renders the user view.

The <x>, <y>, <z> parameters are the coordinates of the center of the view.

The <horiz> parameter is the horizontal angle, in degrees.

The <vert> parameter is the vertical angle, in degrees.

The <roll> parameter is a placeholder for the roll angle—but this is an "empty," unused parameter that must always be zero. To use roll in a VUE file, use a camera view instead of a user view.

The <width> parameter is the width of the rendered image, in world units.

Camera View Command

Renders a camera view.

The <x>, <y>, <z> parameters are the camera's location.

The <tox>, <toy>, <toz> parameters are the location of the camera's target.

The <roll> parameter is the camera roll angle, in degrees.

The <focal> parameter is the camera's focal length, in millimeters.

Walking Gait

One of the predefined biped gaits available in [footstep animation](#) on page 7986 (the others are running and jumping). In a walking gait, at least one foot is always in contact with the ground.

Walkthrough Assistant

Walkthrough Assistant lets you easily create a predefined walkthrough animation of your scene by placing a camera on a path and setting the height, turning the camera, and viewing a preview. This feature is available on the Animation Menu.

In a scene, create a path for the camera to follow using a spline or NURBS curve. Then choose Walkthrough Assistant from the Animation menu. With Walkthrough Assistant you can automatically create a camera and animate it along the path. Change a Perspective viewport into the Camera viewport to

view the result. You can adjust the eye height and head tilt. You can animate turning the camera by turning on the Auto Key button. For more information see [Walkthrough Assistant](#) on page 5239.

Wall Repel Behavior

In [crowd animation](#) on page 4761, the Wall Repel behavior uses a grid object to repel delegates. When influenced by the Wall Repel force, delegates turn until they're heading away from the grid. This behavior is useful for keeping objects inside an enclosed, straight-sided enclosure, such as a room in a building.

Wall Seek Behavior

In [crowd animation](#) on page 4761, the Wall Seek behavior uses a grid object to attract delegates. When influenced by the Wall Seek force, delegates turn until they're heading toward the grid. This behavior is useful for moving objects toward a rectangular area, such as a doorway.

You can set the grid to attract from either side or both sides, and optionally specify a maximum distance for attraction. You can also set the behavior to act as though the grid extends infinitely along its plane.

Wander Behavior

In [crowd animation](#) on page 4761, the Wander behavior imparts a random motion to delegates, letting you simulate meandering activity in which delegates move and turn in a haphazard manner. The behavior works by randomly picking a new direction, and then turning and moving in that direction. You can specify how often to pick a new direction, how far to turn, and how fast or slow to turn while moving.

Weight Curve

In the [Motion Mixer](#) on page 8052, weight curves define the amount of influence a [clip](#) on page 8051 or [track](#) on page 8150 has on the mixed animation.

On a [layer track](#) on page 8021, each clip has its own weight curve. On a [transition track](#) on page 8158, one curve defines the influence for the entire track. On a

[balance track](#) on page 7919, the weight curve determines the degree of automatic balance compensation applied to the biped motion.

Wire

Particle Flow uses wires to show connections between events in [Particle View](#) on page 2811. There are two types of wires: one that connects a [global event](#) on page 7997 to a [birth event](#) on page 7924, represented by a dashed blue line; and one that connects a [test](#) on page 8147 to a [local event](#) on page 8027, represented by a solid blue line.

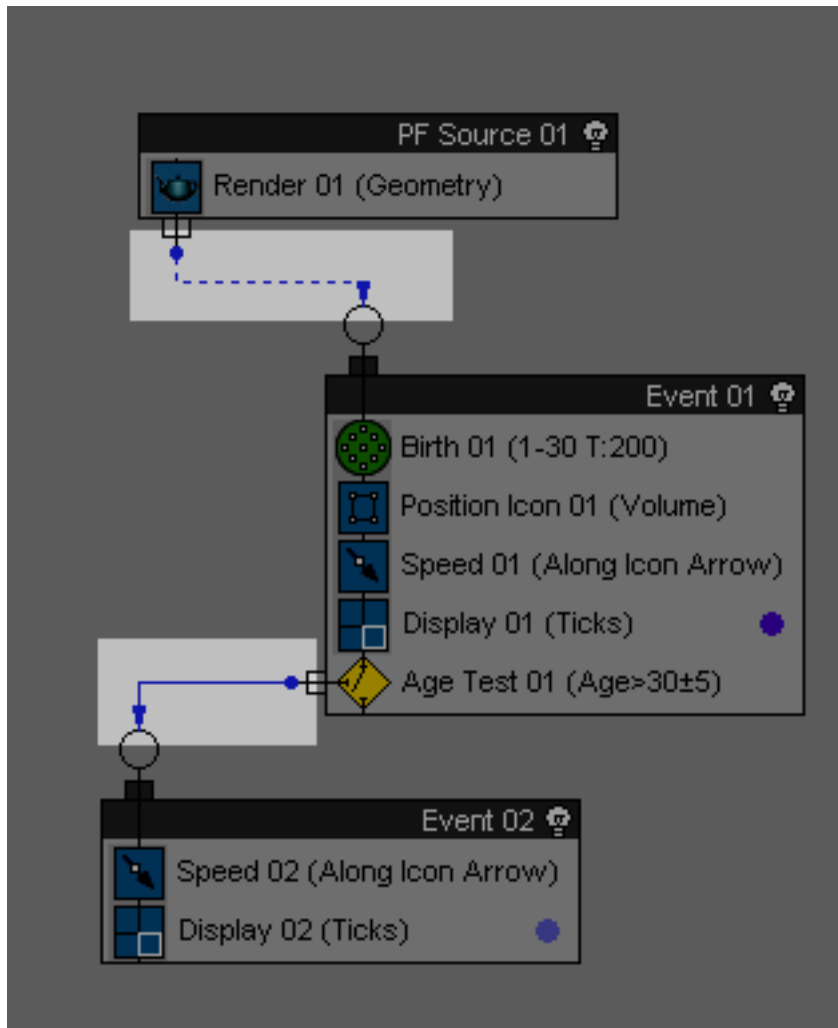

Wire from global event to birth event (above); wire from test to local event (below)

To wire a test to an event, drag from its *test output*, the blue dot that by default sticks out to the left of the test, to the event's *event input*, which sticks out from the top, or vice-versa. Similarly, you can wire a global event to a birth event by dragging between the *source output* on the bottom of the global event and the event input.

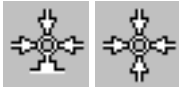

The mouse cursor resembles the first image when you can begin this operation: the bottom portion is the top of a small square. The cursor resembles the second image when you can complete the operation: the square at the bottom has become an arrow.

To delete a wire, right-click it and choose Delete Wire, or click it (it highlights in yellow) and then press the Delete key. Or, with a wire between a test and an event, drag from either connector to a blank area of the [event display](#) on page 7968.

Wireframe Mode



Wireframe mode display of a director's chair and megaphone

Wireframe is a viewport display setting that lets you view objects in a given viewport as a wire mesh. This is the default setting for non-Perspective viewports. You change this setting from the [viewport right-click menu](#) on page 7576.

In addition, you can set the Standard and Raytrace materials to render as wires. Use the Extended Parameters rollout to set the size of the wire, and specify its measurement in either pixels or units.

When you use pixels, the thickness of the wire is based on the screen pixels. Therefore, it's absolute, and remains the same, regardless of its distance from the camera. If you use units, the thickness is based on world units, and varies depending on the distance from the camera. It's easier to compare the effect of pixels and units if you first adjust the camera view to give a greater sense of distance. You can most easily do this with the Perspective viewport

navigation tool, which dollies the camera in one direction while changing the field of view in the other.

Workbench

The Animation Workbench is a customized version of the Track View function curve editor designed to be used with bipeds. It contains a Curve View that displays keys on function curves which you can edit similar to the way you work in Track View. It also contains a set of four panels for selecting bipeds, analyzing their motion tracks for error conditions, and fixing those tracks individually or in groups.

The Workbench can be used to assign SubAnim controllers to multiple biped body parts at once through the display of the Controllers window.

Workbench filters can be used to smooth, blur or boost position and rotation curves, and can also be used to apply controllers or remove keys.

The Workbench uses many of the same toolbars found in Track View for key manipulation and track navigation. It uses manual navigation as the default behavior. When multiple biped body parts are selected it does not display all curves as a default, so you can perform error analysis and correction on many tracks without displaying all the curves simultaneously.

Workflow

A series of steps to perform a task.

World Coordinate System



A book in object space rests on a table in world space. The table uses the world coordinate system.

The coordinate system for world space or the model space as a whole.

World space is the universal coordinate system for all objects in the scene. When you look at the home grid in the viewports, you see the World Space coordinate system. World space is constant and immovable.

In the world coordinate system seen from the front, the X axis runs in a positive direction to the right, the Z axis runs in a positive direction upward, and the Y axis runs in a positive direction away from you.

World Space



A book in object space rests on a table in world space.

World space is the universal coordinate system used to track objects in the scene. When you look at the home grid in the viewports, you see the world-space coordinate system. World space is constant and immovable. By convention, world-space coordinates are always expressed as XYZ coordinates, as opposed to the UVW coordinates of [object space](#) on page 8064.

All objects in your scene are located in world space by their position, rotation, and scale (their transforms).

Some [modifiers](#) on page 8048 operate in world space. See [World-Space Modifiers \(WSMs\)](#) on page 1113.

Space warps also operate in world space. A space warp defines an area in world space that is affected by the space warp's parameters. Any object that is bound to the space warp is affected as it moves through the space warp's area of world space.

World Space (Biped)

When you use [freeform animation](#) on page 7988 to animate a biped, you can place a biped limb into the space of another object, or into world space. For example, if the biped's feet are in world space, then when you move the center of mass, the feet stay planted in the same location.

World-Space Modifiers (WSM)

World space is the universal coordinate system that applies to the entire scene. A world-space modifier, as opposed to an [object-space modifier](#) on page 8066, affects an object but uses world coordinates.

A world-space modifier always appears at the top of the [modifier stack](#) on page 1090. Its effect is independent of its order in the stack.

See also:

- [World-Space Modifiers \(WSMs\)](#) on page 1113

xref (AutoCAD External Reference)

An AutoCAD external reference. An xref is a variation on a block. A block is a collection of geometry that is identified by a unique name, is stored in the AutoCAD symbol table, and essentially behaves as if it is a single object. Xrefs share block characteristics, and they are similarly defined in the symbol table. However, unlike blocks, the geometry associated with an xref definition is not stored in the current AutoCAD drawing; it is stored in another AutoCAD drawing file. Like a block, there can be many instances of an xref in a AutoCAD drawing, but only one definition.

Typically, xrefs are used to display the geometry of a common base drawing in the current AutoCAD drawing without expanding its size. This allows changes to the reference drawing to be reflected in any host AutoCAD drawings that refer to it.

See also:

- [XRef \(3ds Max Externally Referenced File\)](#) on page 8177

XRef (3ds Max Externally Referenced File)

An XRef in 3ds Max is an externally referenced file or object. XRefs allow multiple animators and modelers to work on one scene at the same time without interfering with each other's work.

There are two ways to XRef another scene:

- [XRef Scene](#) on page 6959
The File > XRef Scene command XRefs an entire scene. For example, a classic use of this command is to bring in a scene that appears as a “set” for an animation you create.
- [XRef Objects](#) on page 6936
The File > XRef Objects command XRefs individual objects or materials. For example, you might be working on the model of a building, and fill it with furniture created by other artists.
You can also XRef the manipulators and modifiers associated with the objects you XRef.

ZT File

A ZT (.zt) file is a mental ray [shadow map file](#) on page 8126. This is a binary file that the mental ray renderer uses to accelerate the generation of shadows. You specify a name and location for the .zt file on the Render Setup dialog > Renderer panel > [Shadows & Displacement rollout](#) on page 6292.

