

AutoCAD 2015: Complete Guide to What's New



TABLE of CONTENTS

User Interaction.....	4
New Tab	4
Create	4
Learn.....	5
Help	6
Color schemes	7
Workspaces	8
Ribbon enhancements	8
Galleries.....	8
View Ribbon.....	9
BIM 360 Ribbon.....	9
Layouts	9
Improved graphics	10
Line smoothing.....	10
Create and edit enhancements.....	11
Selection enhancements	12
Command preview	15
Cursor enhancements	17
Model space viewports	19
Layer sort	21
Isometric drafting environment	21
Document.....	22
Mtext enhancements	22
Auto bullets & numbering	22
Caps Lock	23
Autostack	24

Paragraph tabs	24
Match Properties.....	25
Text alignment.....	26
Dimension enhancements	26
Polyline enhancements	27
Geographic location	28
Design	33
Reality capture	33
Display.....	35
Visualization	36
Cropping.....	38
Point Cloud Manager.....	39
Point cloud object snaps	40
3DOrbit	41
Connect	42
Design Feed	42
Autodesk Translation Framework	45
DGN data	45
Customize	45
Autodesk BIM 360 add-in for AutoCAD	45
Configuration	45
Button images	46
Application Manager	47

User interaction

New Tab

One of the first things you'll notice in Autodesk® AutoCAD® 2015 software is the New Tab. It displays as a file tab when you launch AutoCAD, when there are no drawings open, and when you create a new tab. The New Tab contains two sliding content frames: Learn and Create.

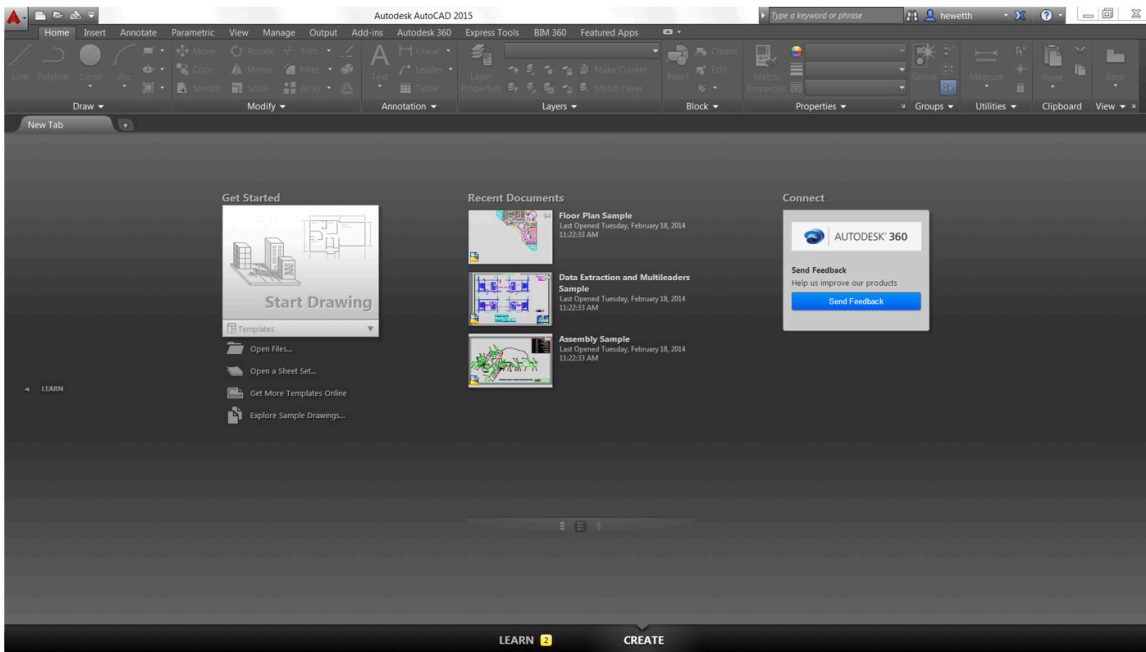

Create

The Create page is displayed by default and serves as a launchpad where you can access sample files, recent files, templates, product updates, and the online community. It's divided into three columns: Get Started, Recent Documents, and Connect

In the Get Started column you can use the Start Drawing tool to quickly begin a new drawing from a default template or choose from the list of available drawing templates organized by groups. The last template you use becomes the new default. Other tools enable you to open existing drawings and sheet sets, get more templates online, and explore sample drawings.

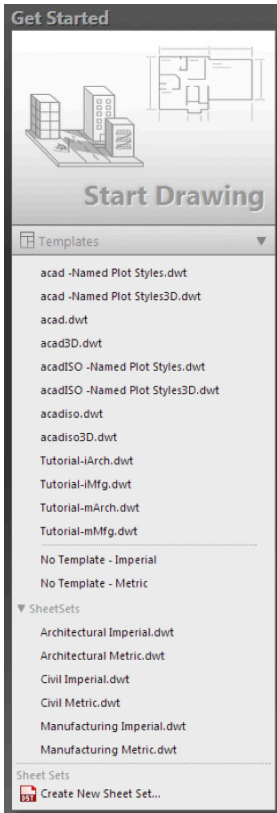

In the Recent Documents column you can view and open your recent drawings. You can pin them to ensure they remain on the list. Icons at the bottom of the column enable you to change how you preview the recent drawings: thumbnail view, thumbnail and text view, or just text view.

The third column displays notifications such as hardware acceleration, trial period, and where to download offline help. It also enables you to sign into Autodesk® 360 cloud-based service and send feedback directly to Autodesk.

Learn

You can slide to the Learn page from the Create page by clicking on Learn at the left or bottom of the page. To return to the Create page, click on Create at the right or bottom of the page.

The Learn page provides tools to help you learn AutoCAD 2015. It's divided into three columns: What's New, Getting Started Videos, and Tip/Online Resources.

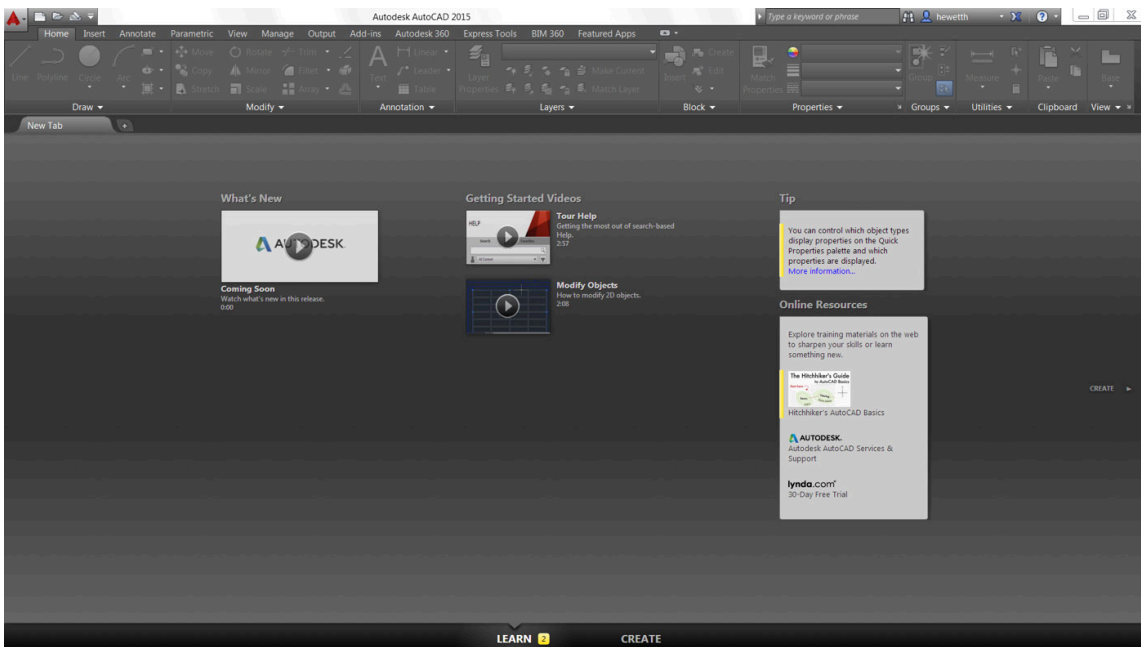

The NEWTABMODE system variable specifies whether clicking the plus (+) button on the file tab bar displays a New Tab or a new drawing.

Help

The AutoCAD Help system includes a new way to help you locate tools in the AutoCAD user interface (UI) directly from the relevant Help content. In the Help window, click the tool you want to use or the Find link next to it. An animated arrow points you directly to that tool in the AutoCAD Ribbon.

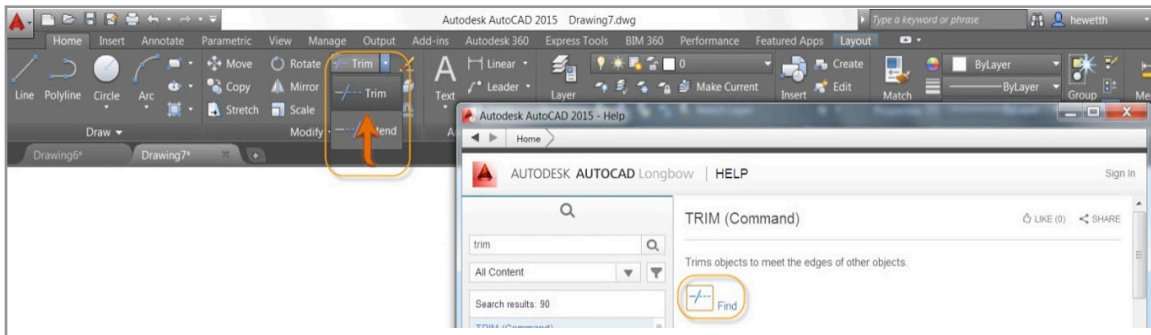

If the tool is not accessible from the current workspace or is located in a hidden tab or panel, a tooltip in the Help window tells you on which Ribbon tab and panel you can find it.

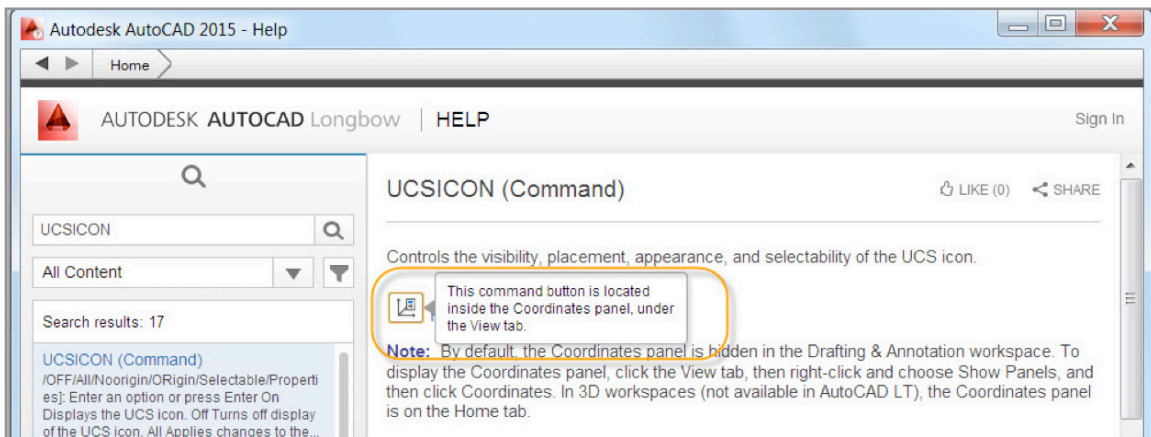

Color schemes

AutoCAD 2015 offers a modern, dark-themed interface that includes the Ribbon, status bar, and palettes. The new dark-themed interface combined with the traditional dark model space minimizes the contrast between the drawing space and the surrounding tools to help reduce eye strain.

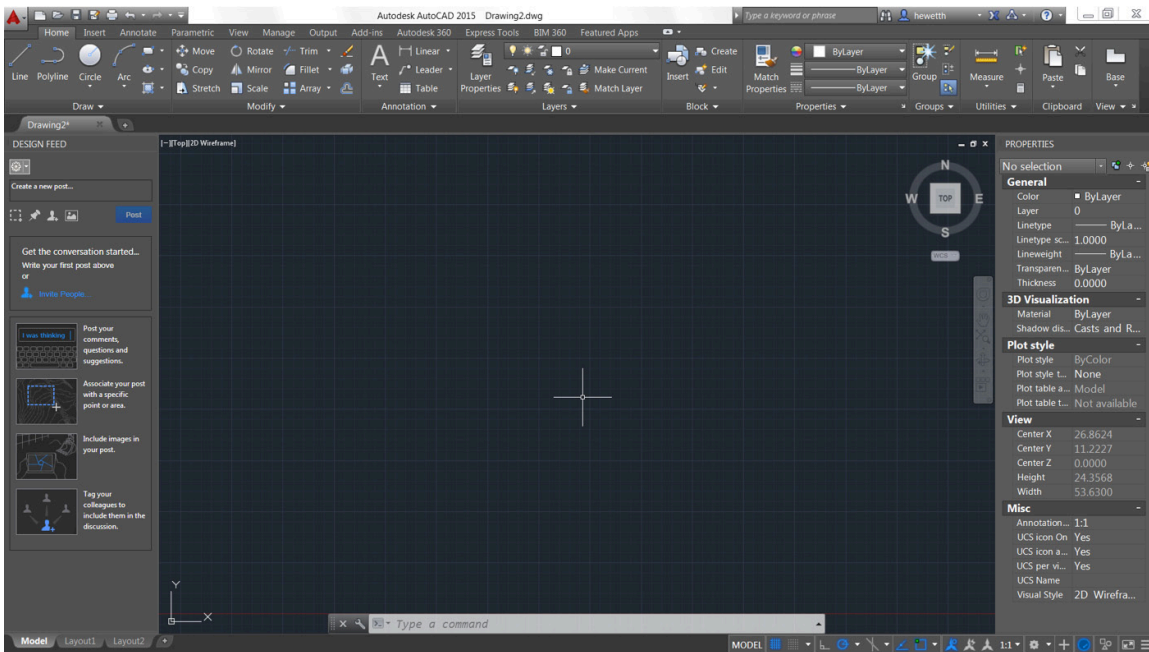

You can easily change between the dark theme and a more traditional light theme using the Color Scheme control on the Display tab of the Options dialog box.

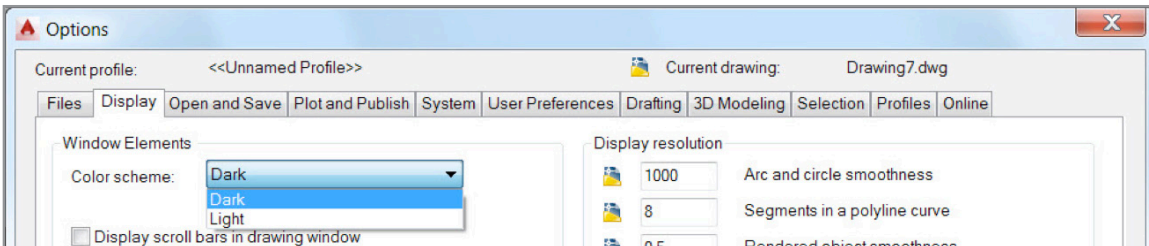

Workspaces

The Workspace drop-down list has been turned off in the Quick Access toolbar. You can turn it on or switch workspaces using the control on the status bar. The option for classic workspace has been removed.

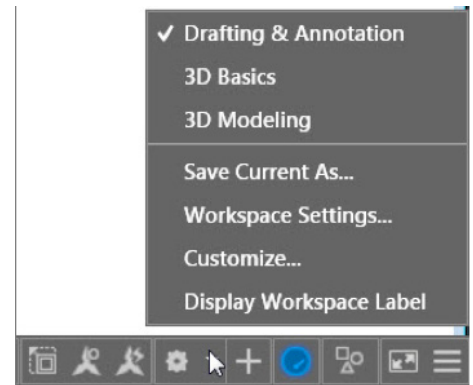

Ribbon enhancements

The Ribbon is updated to support the dark color theme as well as improve efficiency for accessing tools.

Galleries

AutoCAD 2015 offers new block galleries to view and insert blocks directly from the Ribbon for block definitions that are stored in the current drawing.

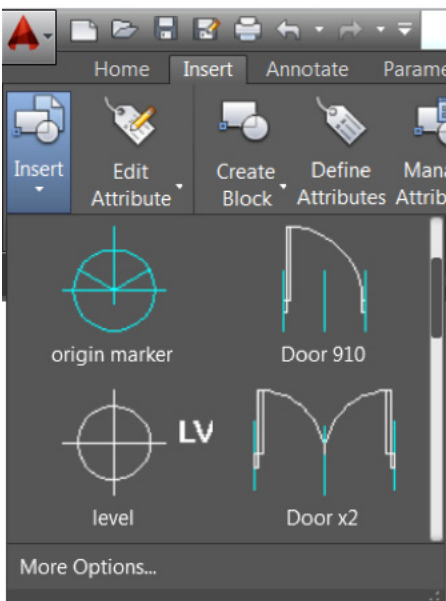

Galleries are also available for styles that are defined in the current drawing, including dimensions, mleaders, text, tables, and table cells.

View Ribbon

Tools on the reorganized View Ribbon tab make it easier to control the visibility of UI elements such as the UCS icon, ViewCube, Navigation bar, and Layout tabs.

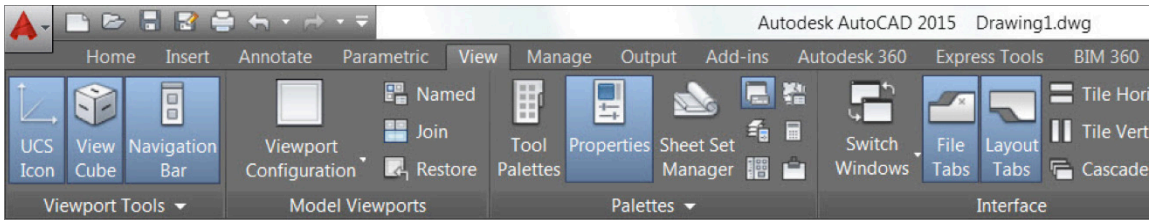

BIM 360 Ribbon

A new BIM 360 Ribbon offers easy access to tools for sharing your AutoCAD models and viewing clash results with the project team using Autodesk® BIM 360 TM Glue® online service.

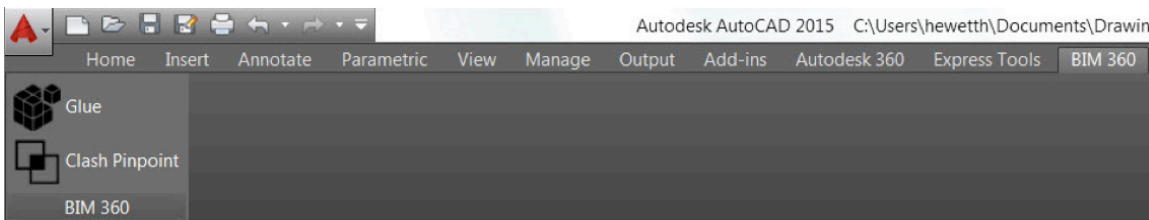

Layouts

Layout tabs are enhanced to include a new plus (+) icon for quickly adding new layouts. A tooltip displays the layout name in addition to the preview image when you pass the cursor over a Layout tab. An overflow menu provides easy access to layouts when they extend beyond the width of the display.



The appearance of layout sheets has been updated and a new color option, accessible from the Colors button on the Display tab of the Options dialog box, enables you to control the paper background color.

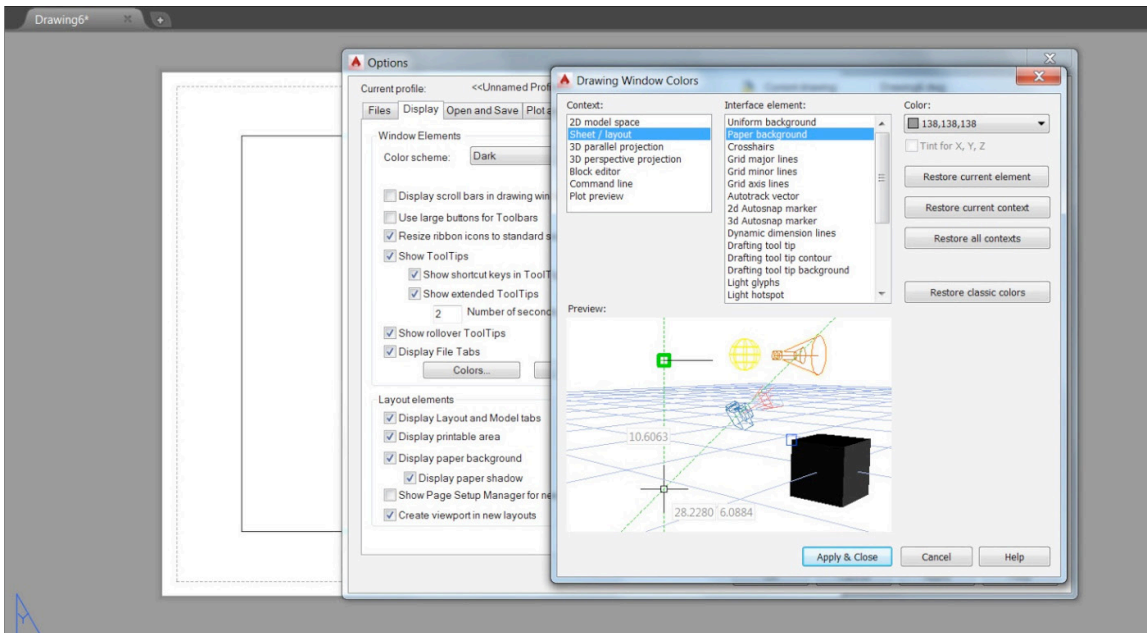

Improved graphics

AutoCAD 2015 offers an improved graphics experience without compromising performance.

Line smoothing

The LINESMOOTHING variable enables you to turn on anti-aliasing of drawings in viewports configured with the 2D wireframe visual style. When enabled, 2D objects—such as lines, arcs, circles, and drawings aids like grid lines—look smoother, especially when drawn at an angle.

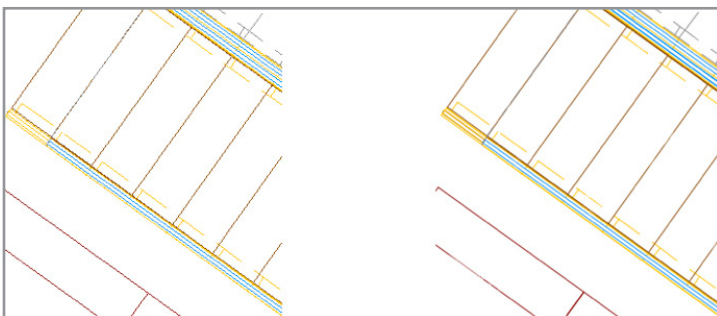

You can enable Smooth Line Display in the Graphics Performance dialog box. It does not affect plotting.

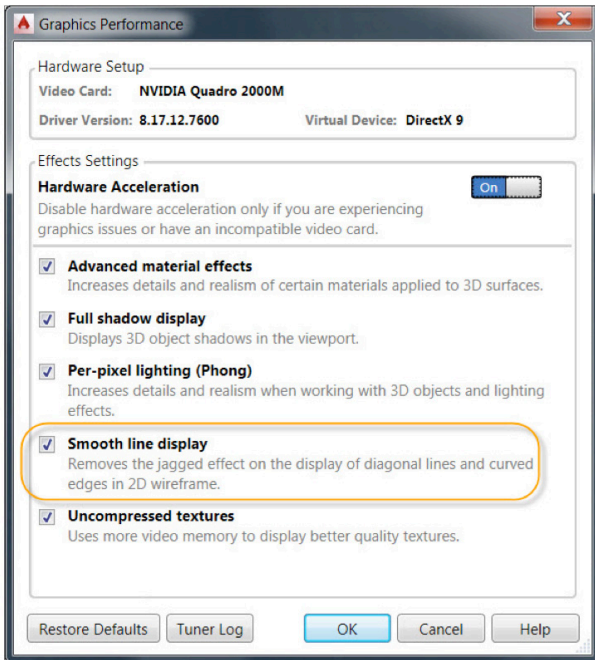

Create and edit enhancements

AutoCAD 2015 offers improved visual feedback when creating and editing objects.

During a move operation, the selected objects are displayed in their original position with a faded deletion effect instead of a dashed selection effect.

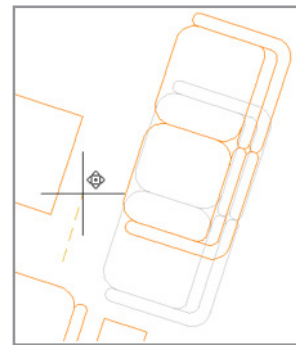

Complex linetypes display as you draw, move, copy, or rotate them, enabling you to more easily place them. You can control this behavior with the new COMPLEXLTPREVIEW system variable.

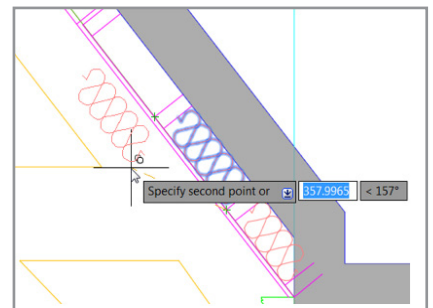

AutoCAD 2015 displays color, linetype, and lineweight for lines and polylines as you draw them.



Selection enhancements

Lasso selection

In AutoCAD 2015 you can click the cursor in a blank area of the drawing and then drag around objects to create a lasso selection. For a traditional rectangular window or crossing selection, click and release to pick each corner of the rectangle.

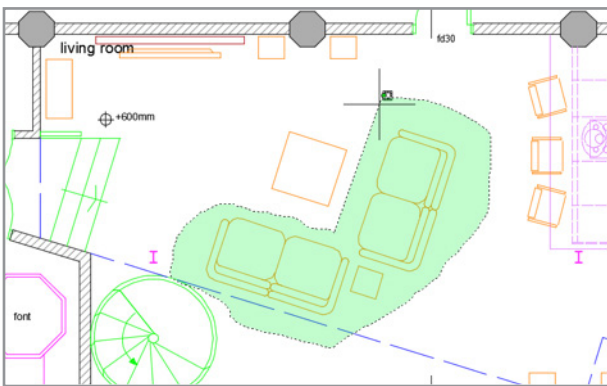

A new control in the Options dialog box on the Selection tab enables you to specify lasso selection.

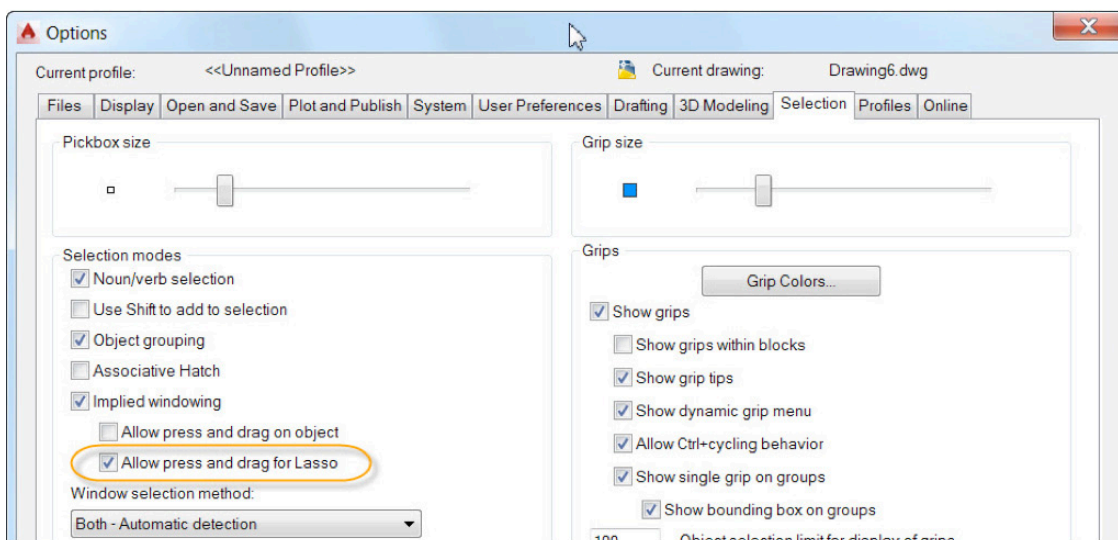

Selection effects

AutoCAD 2015 offers modern and clear feedback when you preselect and select objects. As you pass the cursor over an object in the drawing, the line geometry appears thicker and darker or lighter depending on the background color.

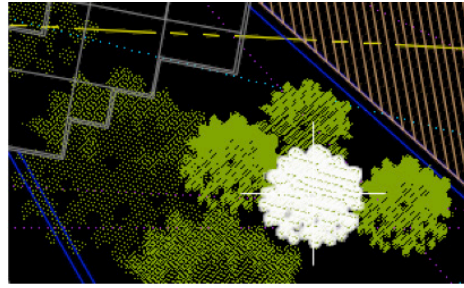
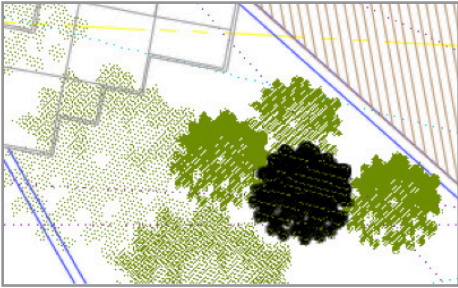

If hardware acceleration is turned on, selecting an object changes its color and it remains thickened to clearly identify it as part of the selection set.

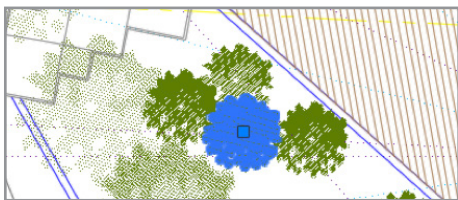

Similar visual enhancements help you clearly identify when faces such as solid hatches are preselected or selected.

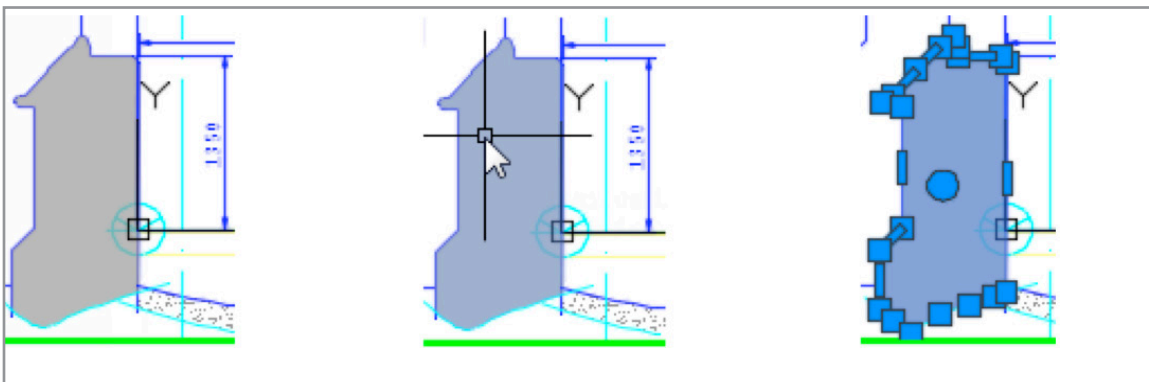

Similar visual enhancements are included when selecting 3D solids.

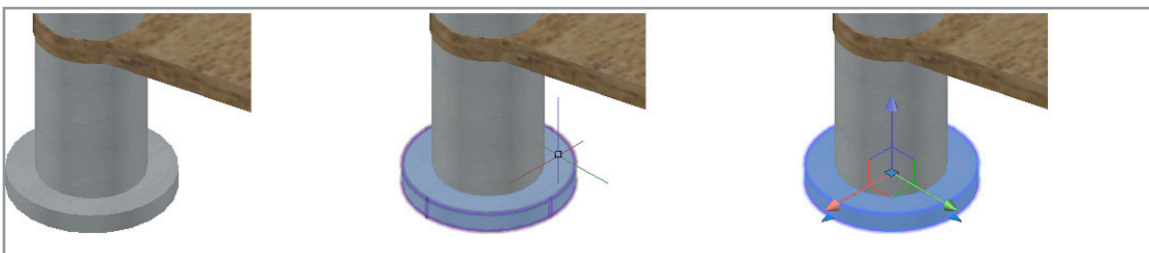

Visual Effect Settings

Improved graphics and performance in AutoCAD 2015 reduces the need to individually control line and face highlighting. Those controls and associated system variables (PREVIEWEFFECT and PREVIEWFACEEFFECT) have been removed from the Visual Effect Settings dialog box, which is accessible from the Selection tab of the Options dialog box. The Advanced Options have been added to the dialog box, eliminating the extra click for accessing the former Advanced Preview Settings dialog.

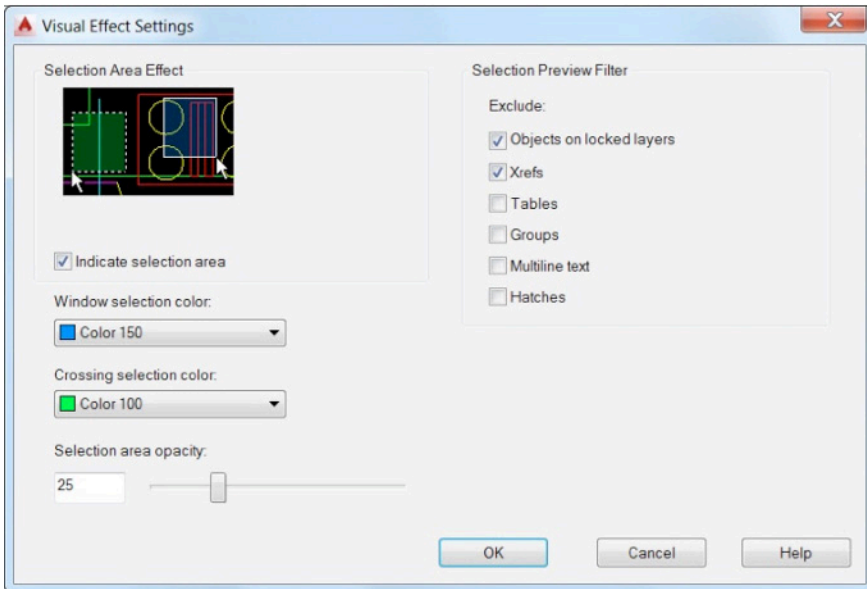

Tolerance object

Double-clicking on a tolerance object opens the Geometric Tolerance dialog box instead of Quick Properties.

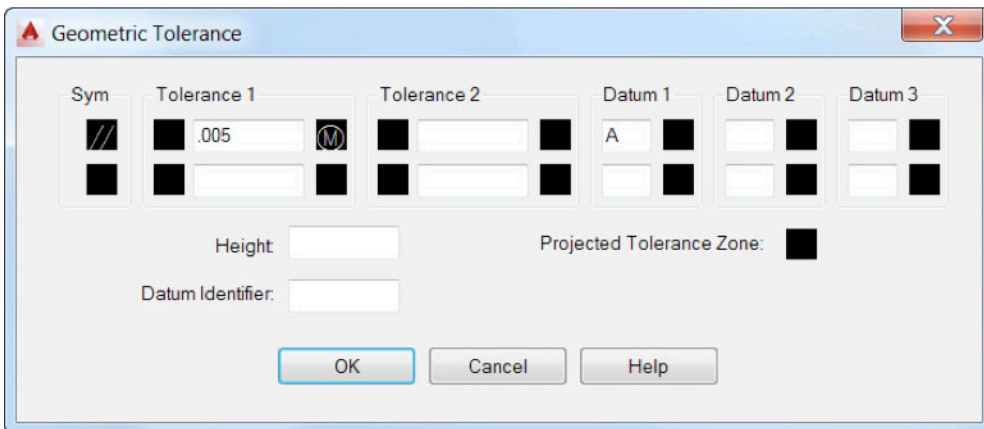

Command Preview

A new Command Preview control on the Selection tab of the Options dialog box enables you to preview the results of Trim, Extend, Lengthen, Break, and MatchProp operations prior to actually selecting the objects. The new Command Preview control also affects preview for Fillet, Chamfer, and Offset operations.

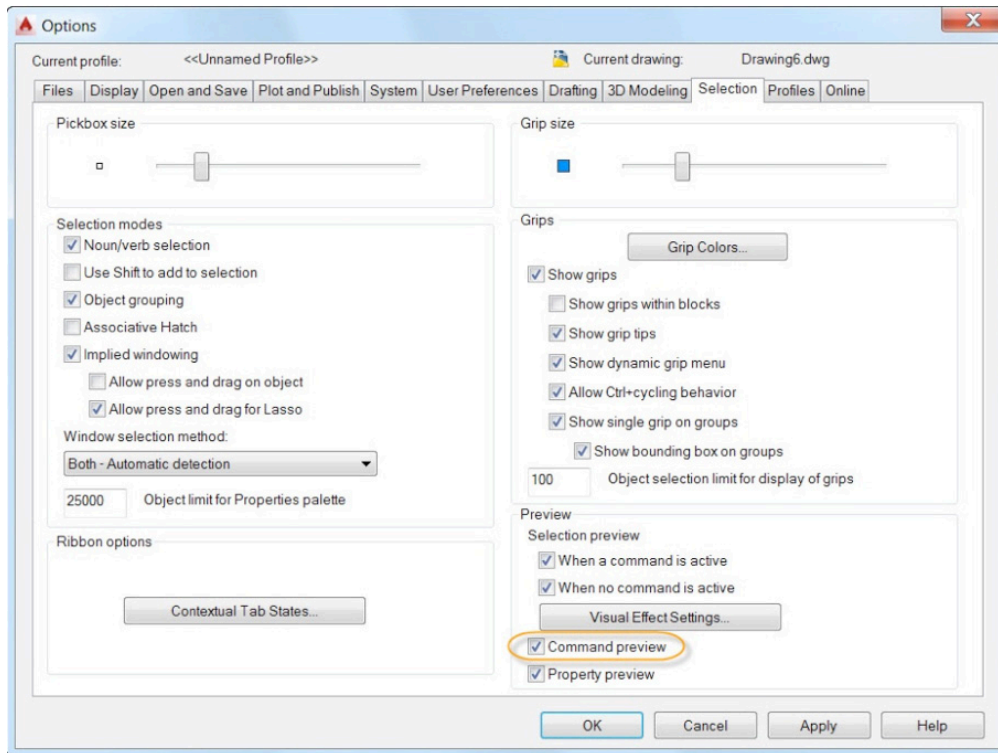

The Trim and Extend tools are enhanced in AutoCAD 2015 to provide a preview of the results before you commit to the selection. After you select the cutting or boundary edges, you simply pass the cursor over the object you want to trim or extend. A preview of the resulting object is displayed. When trimming, the segment to be removed is dimly displayed and a cursor badge indicates that it will be deleted.

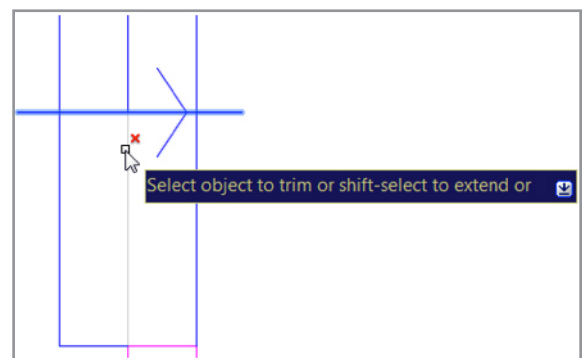

When selecting an object to extend, it is clearly identified and temporarily extended.

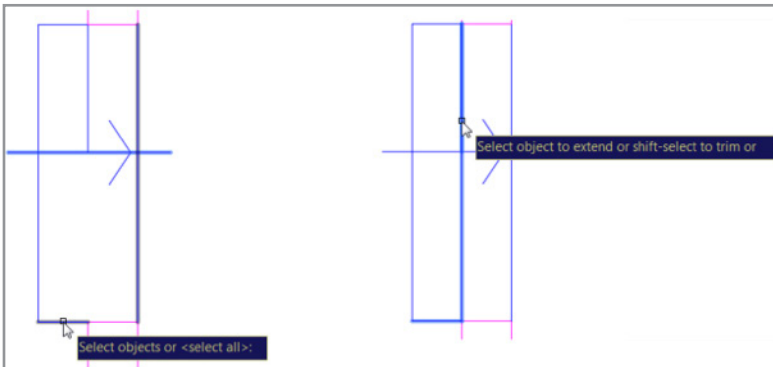

The Lengthen tool also supports command preview. It has been further enhanced in AutoCAD 2015 to default to the last lengthen option (delta, percent, total, dynamic) so you are no longer required to specify an option each time you launch the command.

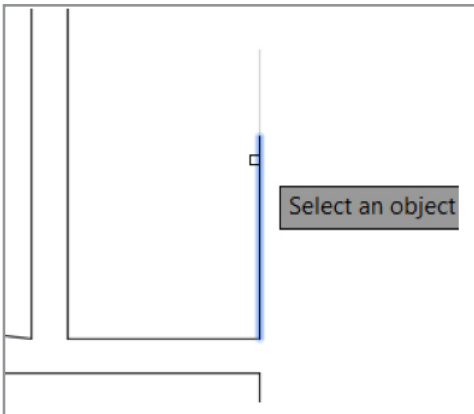

The Break tool displays the results of the Break operation prior to specifying the second break point.

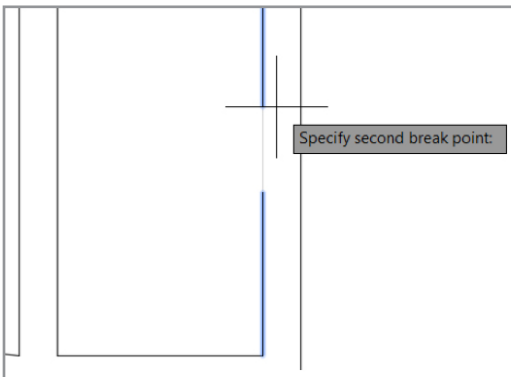

After selecting a source object from which to match properties, the MatchProp tool temporarily displays those properties on the destination objects as you pass the cursor over them to select.

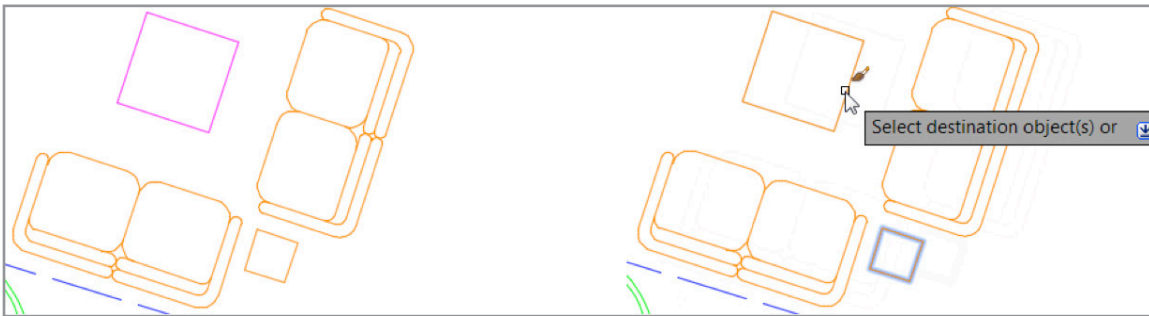

Cursor enhancements

The cursor is enhanced in AutoCAD 2015 to provide contextual feedback. It includes badges to reflect the state of many common operations.

The crosshairs have been removed from the inside of the pick box to make it easier to see what you're picking.

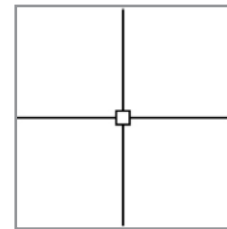

Selection badges indicate when you are creating crossing or window selections.

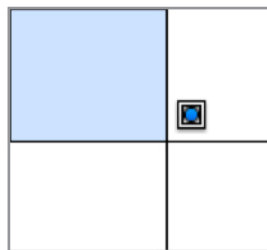
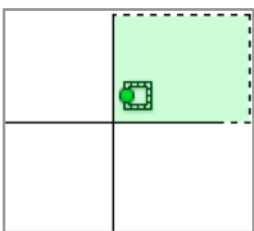

An Inspection badge is displayed when using inquiry tools such as Distance, Radius, Angle, Area, Volume, List, and ID.

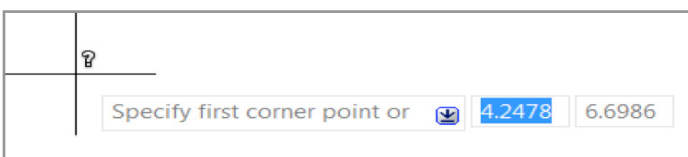

Rotation badges are displayed when specifying the angle of rotation during a Rotate operation.



The badge displays a clockwise or counter-clockwise arrow according to the direction specified by the Drawing Units.

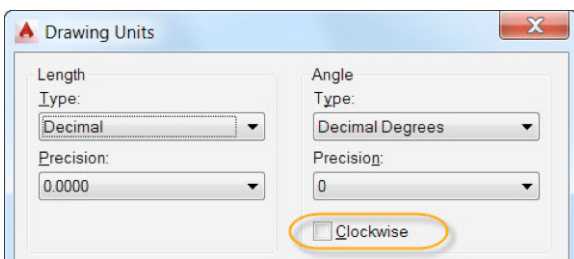

Relevant badges are displayed for other editing commands including Copy, Move, and Scale.

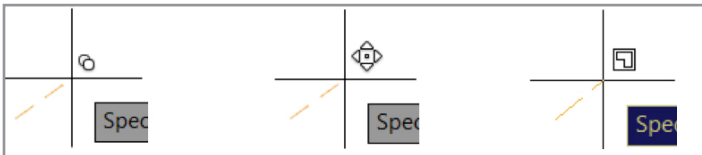

Zoom and Erase/Delete also display relevant badges.

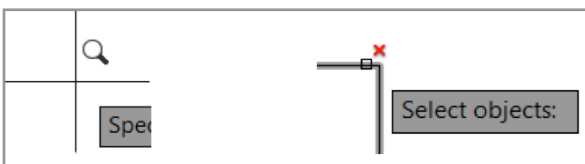

Model space viewports

Model space viewports have been significantly enhanced in AutoCAD 2015 offering more flexibility and greater ease-of-use. After creating multiple viewports in model space, a bright blue boundary clearly identifies the active viewport. You can easily resize any of the viewports by dragging the horizontal or vertical viewport boundaries.

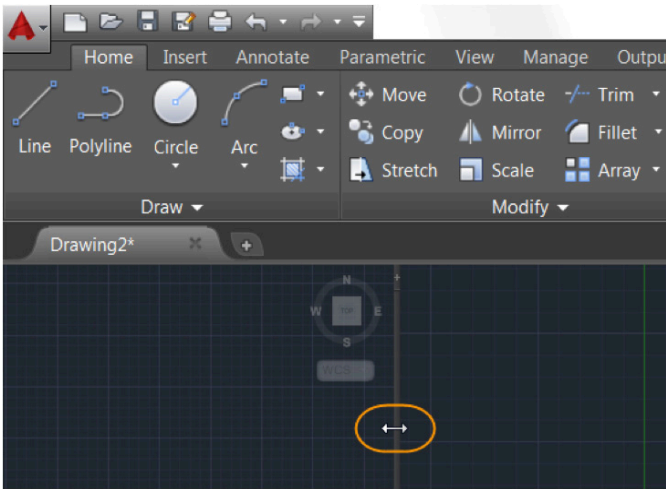

Drag the intersection to resize viewports both horizontally and vertically at the same time.

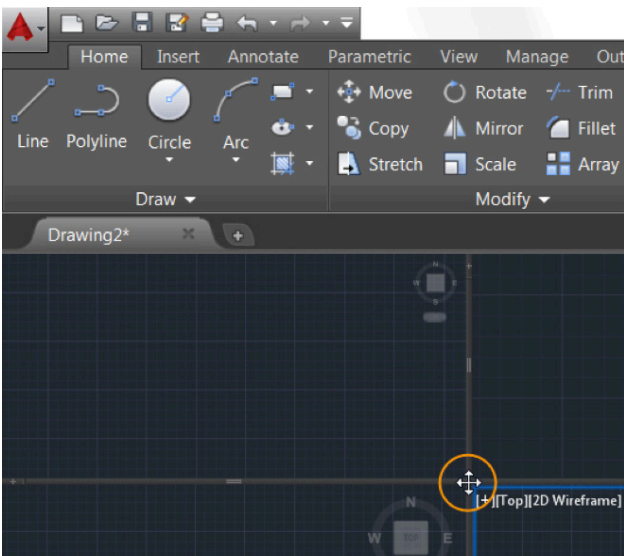

New "+" icons on the viewport boundaries enable you to easily add more viewports by simply clicking on the icon and dragging to size the new viewport. You can also hold the 'Ctrl' key while dragging the boundary to split a model space viewport. Model space viewports can be joined or removed by dragging a boundary to the edge.

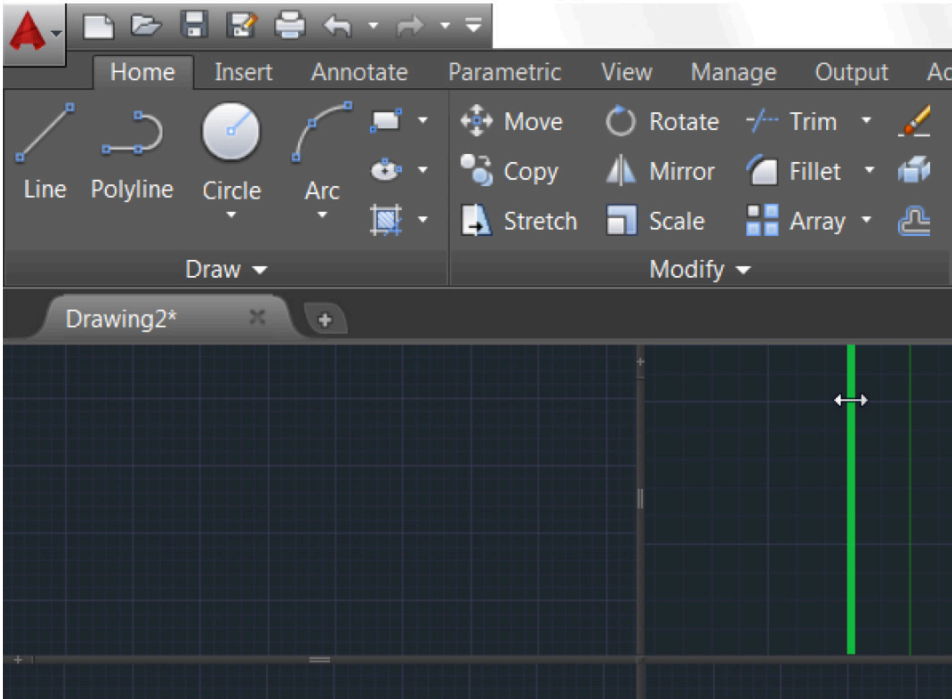
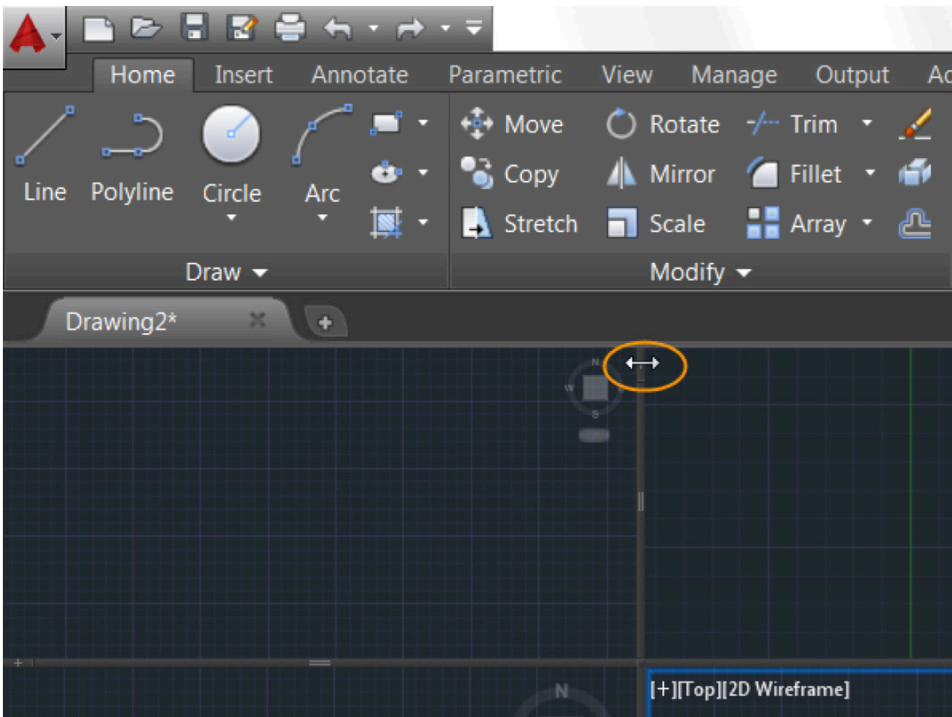

Layer sort

Layer lists are now displayed using natural ordered sort. For example, the layer names 1, 4, 25, 6, 21, 2, 10 are sorted as 1, 2, 4, 6, 10, 21, 25 instead of 1, 10, 2, 25, 21, 4, 6. Natural ordered sort applies to all layer lists including the Hatch Editor Ribbon tab and Quick Select just to name a few. You can restore the ASCII sort used in previous releases by changing the new SORTORDER system variable to 0.

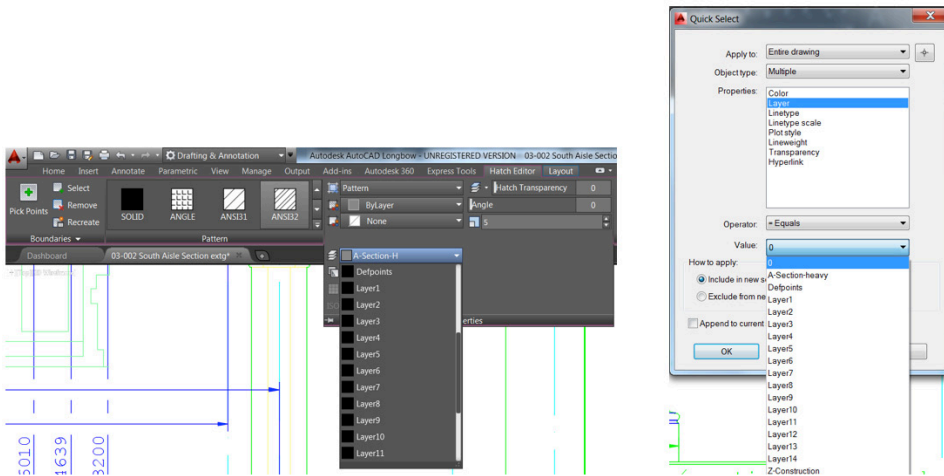

Isometric drafting environment

A new tool on the status bar provides one-click access to set an isometric drafting environment. Turn on isometric drafting by selecting one of the options from the status bar flyout menu: Isoplane Left, Isoplane Top, Isoplane Right. The status bar tool displays colored axes indicating it's in iso drafting mode. Click the icon to quickly turn off iso drafting mode as indicated by the icon with white axes.

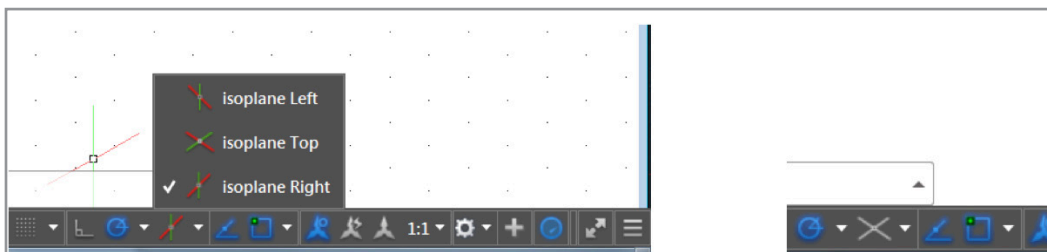

Document

Mtext enhancements

The Mtext editor is updated in AutoCAD 2015 offer better visibility and control. The background is now transparent when hardware acceleration is enabled so you can see drawing geometry even when the editor opens on top of it.



A corner resizer offers more obvious and intuitive resizing of columns, enabling you to adjust both the height and width at the same time. If you pass the cursor over the bottom or right edges of the text editor, you can change either the height or width individually.

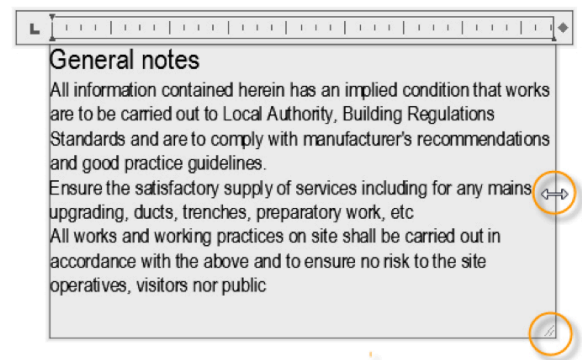

Auto bullets & numbering

When you create mtext in AutoCAD 2015, it automatically applies bullets or numbering. In the Text Editor Ribbon tab, enable the option to Allow Auto Bullets and Numbering.

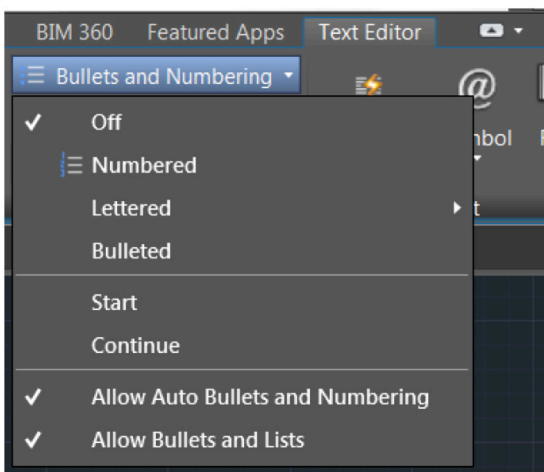

Then when you begin a line with a symbol or with a number or letter followed by one of these characters and a space or tab, AutoCAD automatically creates a bullet or numbered list: ".", ")", ">", "}", ":", or "]". An icon indicates that automatic bullets or numbering has started. You can click on the icon to access relevant controls including an option to remove bullets or numbering. Pressing backspace immediately after pressing the space or tab also removes automatic bullets and numbering.

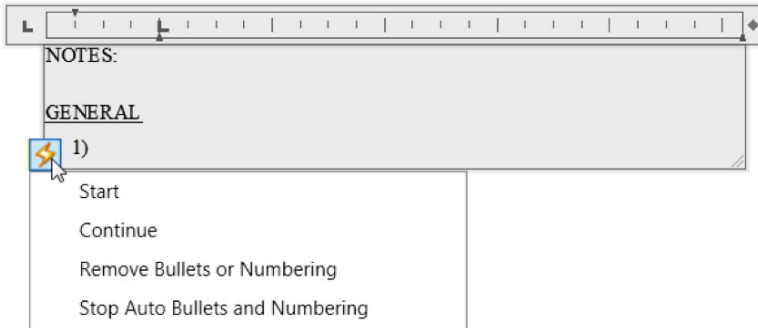

Caps Lock

When you enter text in the Mtext editor, AutoCAD recognizes if Caps Lock is turned on while you're also pressing the Shift key. When you press Enter or the spacebar after typing the first word, AutoCAD automatically corrects the text and turns off Caps Lock so that you can continue typing without interruption.



Subscript and superscript text is easy to create in AutoCAD 2015. Now you can simply highlight the text and use the new Superscript and Subscript tools on the Text Editor Ribbon. They're available anywhere you use mtext, including tables, leaders, and dimensions.

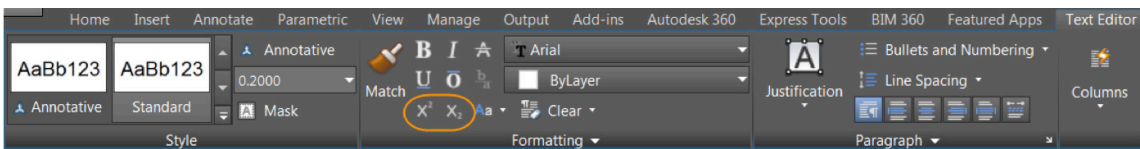

Autostack

Autostacking of fractions is simplified in AutoCAD 2015. When you enter numbers with a forward slash, for example 1/20, AutoCAD automatically treats it as a fraction and displays it as such. An icon indicates that the text has been stacked. You can click on the icon to access relevant controls for that stacked fraction. For example, you can change between diagonal and horizontal stacking, unstack the characters, or access Stack Properties.

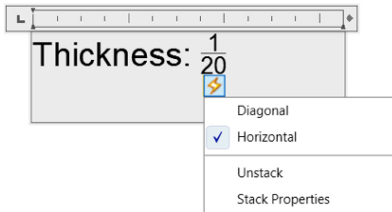

Stack Properties enables you to change additional properties of the current fraction and as well as AutoStack behavior in the enhanced AutoStack Properties dialog box.

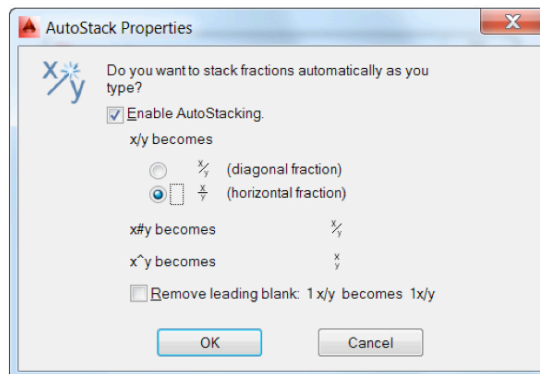
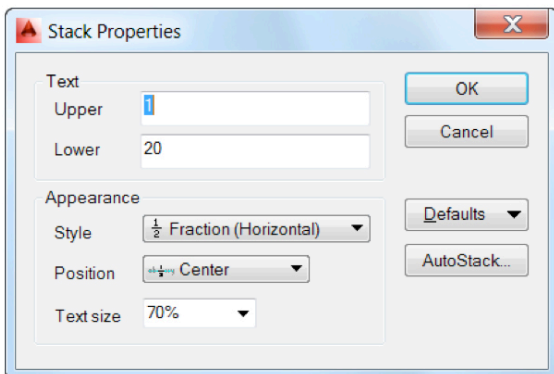

Paragraph tabs

Tooltips have been added to the tab tool and markers in the Text editor to assist you in creating and editing paragraph tabs.



A new Modify button in the Paragraph dialog box enables you to easily modify the values of existing tabs.

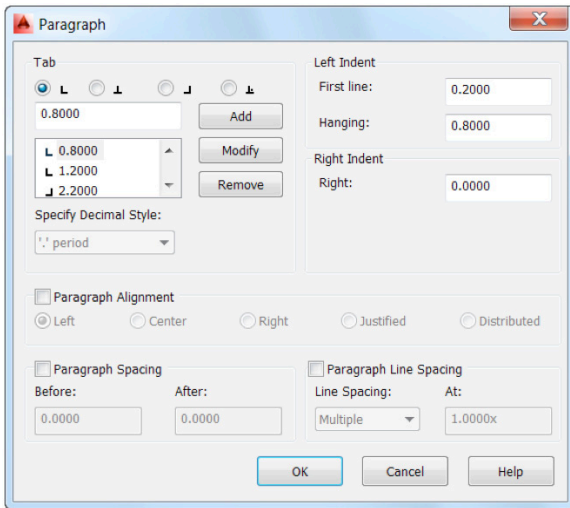

Match Properties

A Match Properties tool has been added to the Text Editor Ribbon tab and toolbar, enabling you to apply properties between selected text within an mtext object. It's available for all objects that use mtext, including dimensions and tables.

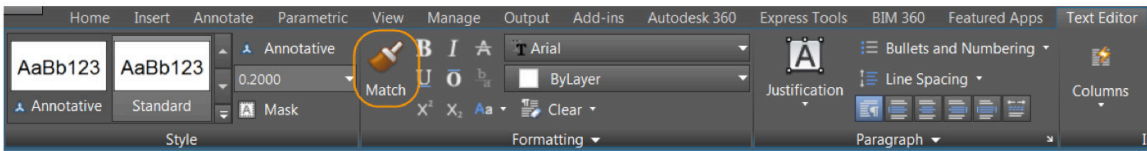

When you choose Match Properties in the Mtext editor, a paintbrush icon is displayed at the cursor.



Text alignment

The new TEXTALIGN command enables you to quickly align single- and multi-text as well as attribute text by selecting the text objects to align and then picking the text you want them to align with or selecting points to manually define the alignment line.

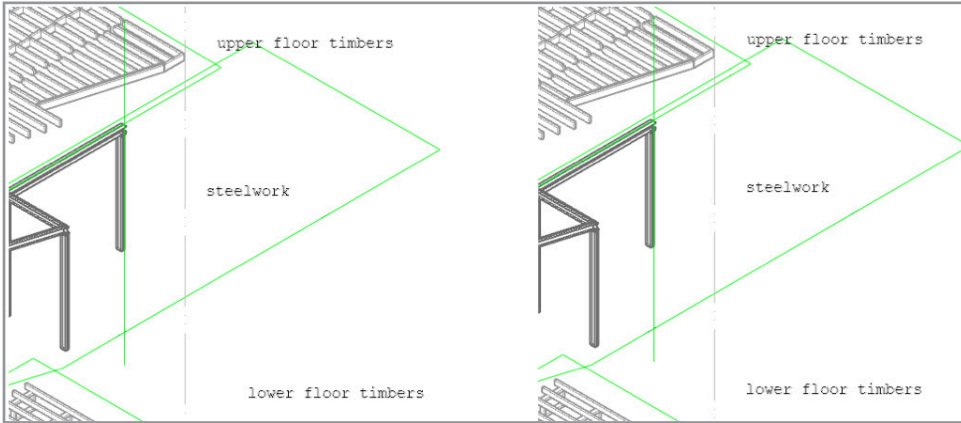

You can also choose from a variety of spacing options including the ability to distribute them evenly, set a spacing value, maintain the current vertical spacing, or maintain the current horizontal spacing.

Enter an option

Distribute
Set spacing
● current Vertical
current Horizontal

Dimension enhancements

AutoCAD 2015 offers more intelligent object snap behavior when creating dimensions. When you place dimensions, existing dimension extension lines are ignored to prevent them from being inadvertently snapped to while attempting to pick nearby geometry.

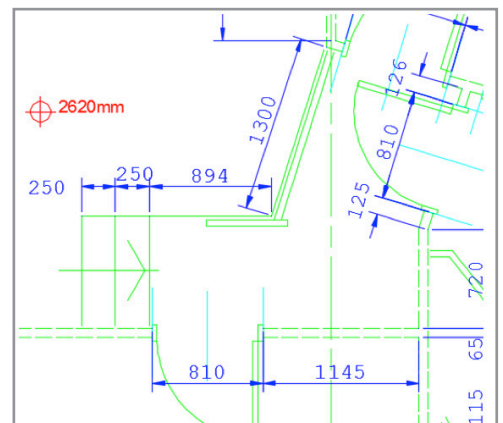

You can control object snap behavior for dimension extension lines with a new option on the Drafting tab of the Options dialog box.

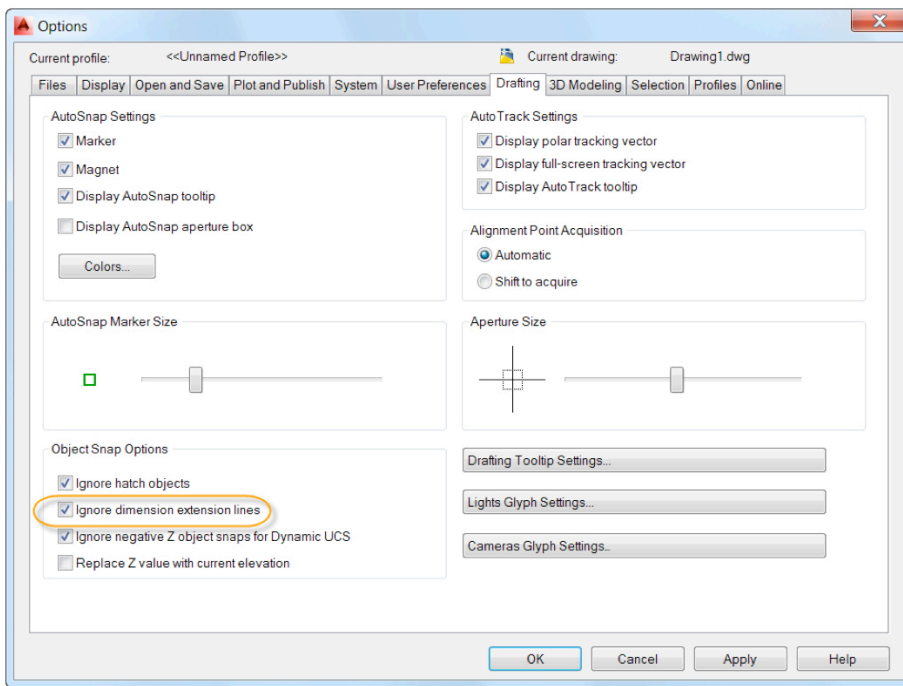

When you create continuous or baseline dimensions with the DIMCONTINUEMODE system variable set to 1, AutoCAD inherits the layer in addition to the dimension style of the dimension that is being continued or used as a baseline.

Polyline enhancements

You can now fillet polyline arc segments.



You can press the Ctrl key while creating a polyline arc to draw it in the opposite direction.



Geographic location

Geographic location functionality is significantly streamlined and enhanced in AutoCAD 2015. You can set the geographic location from a map using the Set Location tool on the Insert Ribbon tab.

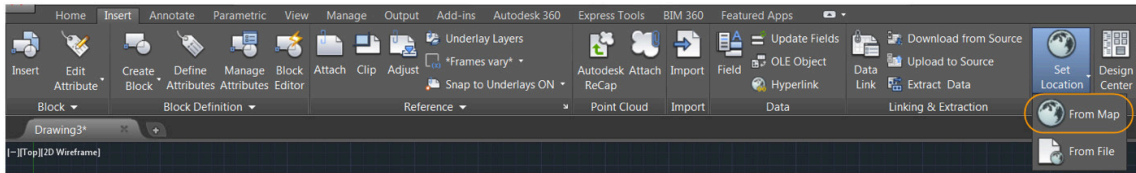

You must be signed into your Autodesk 360 account to access Online Map Data.

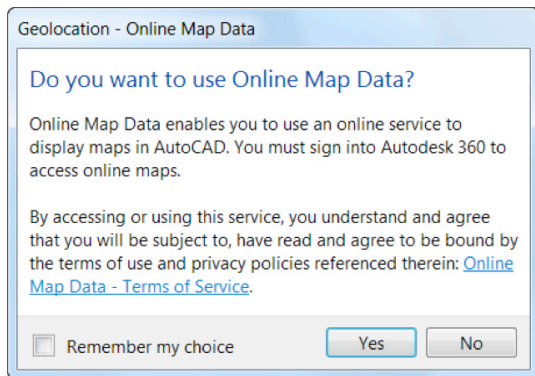

If you're not signed into Autodesk 360 or you choose not to use Online Map data, you can still use the Geographic Location tool to enter latitude and longitude for the location. A new Use Maps button is added at the center of the display in case you change your mind.

When using online map data, the Geographic Location tool has been streamlined to help guide you through the process of specifying a geographic location. The first page of the Geographic Location tool enables you to specify a location and place a marker. You can specify a location by entering an address or zooming in the map tile. Right-click to drop the maker in the map or click on "Drop marker here" from the locations listed. You can move the marker as often as needed with no impact on performance.

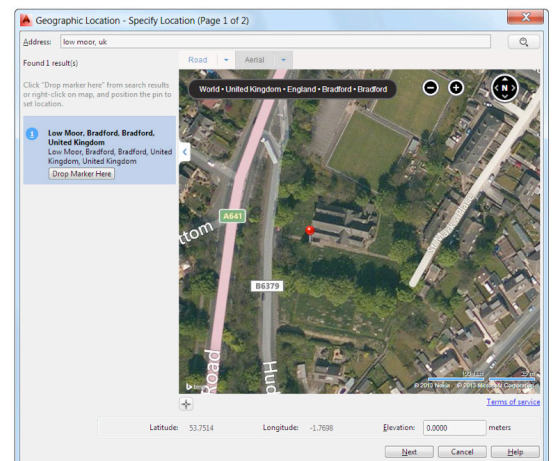

When you're satisfied with the location, the Next button leads you to the second page where you specify the coordinate system. Based on the marker location, AutoCAD 2015 lists only relevant coordinate systems. You can use the search field to further filter the relevant coordinate systems selecting the most appropriate one.

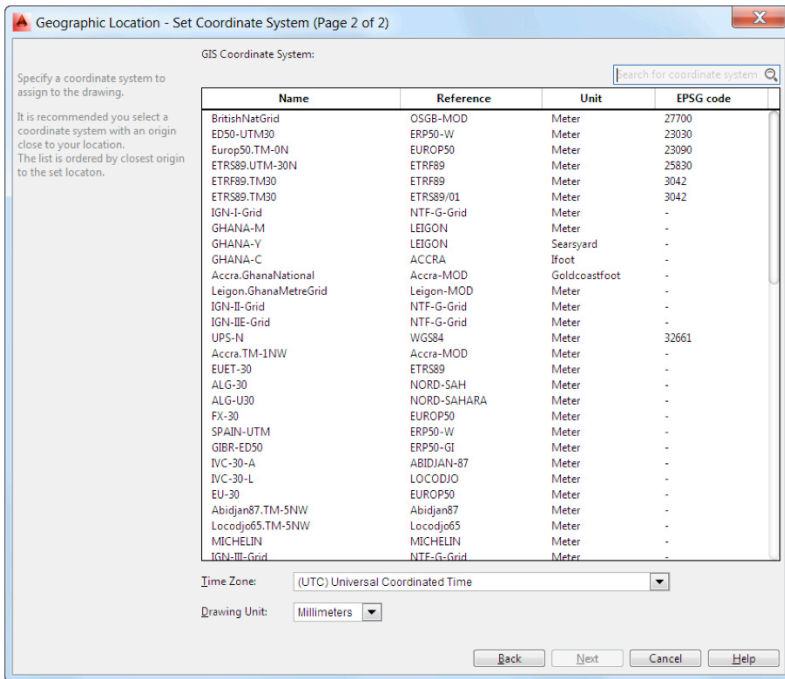

After picking the corresponding geographic location within the drawing, updated prompts for specifying the north direction are easier to understand and more flexible. You can enter an angle, pick a point relative to the geographic location, or pick two new points to define the north direction. The same updated prompts make it easier to reorient the marker after it's been placed.

The resolution improves as you zoom in on an aerial map, assuming higher-resolution data is available.

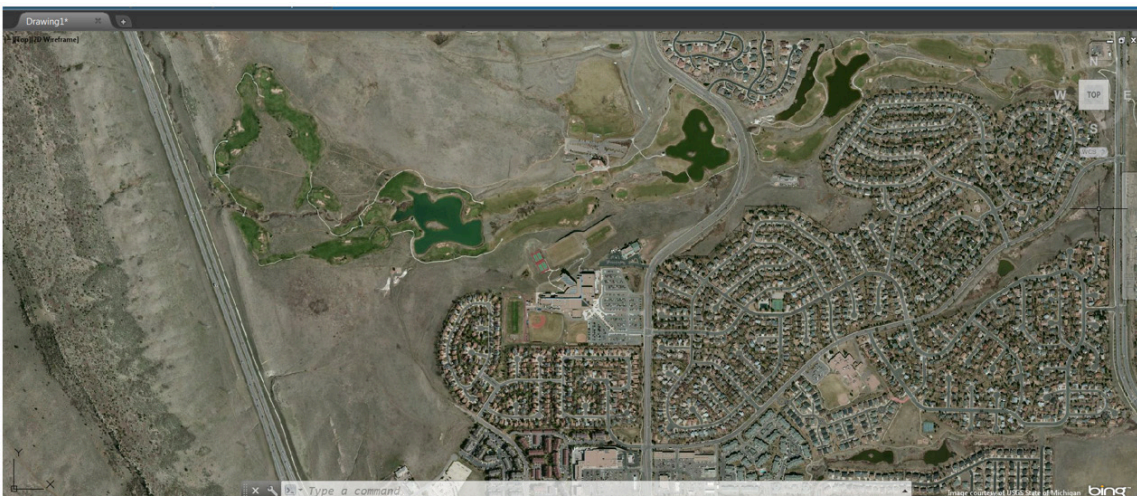



One of the most exciting enhancements to geographic location functionality is the ability to capture and plot map data. New tools on the Geolocation Ribbon tab enable you to capture an area or viewport for plotting purposes and to preserve the current map data.

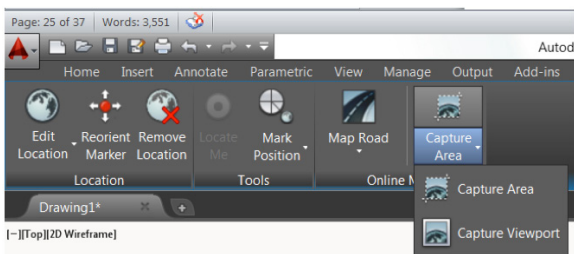

The map that you capture is embedded into the drawing, so that when you turn off online map data or have no Internet access, you can still view and plot the specified map area.





You can select the embedded map image and use grips to move, resize, and even rotate the image boundary. When you change the image boundary, AutoCAD automatically re-queries the online map data and updates the image accordingly. A contextual Map Image Ribbon tab displays additional relevant tools when a map image is selected.

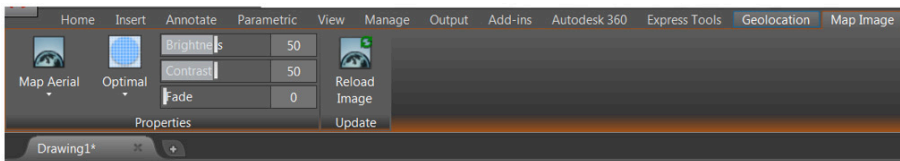

Use these tools to choose from aerial, road, or hybrid representations of the map.



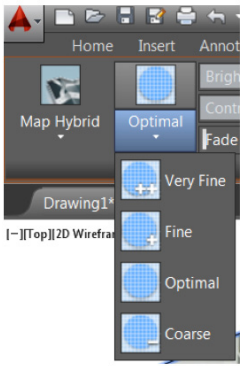

Slider bars on the Map Image Ribbon tab enable you to adjust the brightness, contrast, and fading of the map image so that you can more easily see relevant AutoCAD geometry.

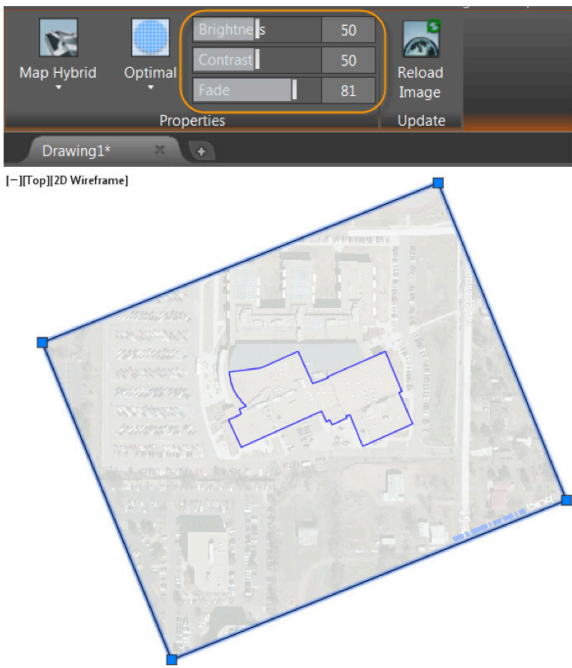

To avoid inadvertently changing the map data, the map image does not automatically update from the map service provider when you open the drawing. The map image is only updated when you move, scale, or edit the boundary of the map image or when you use the Reload Image tool. The Reload Image tool offers two options. The Optimize and Reload option will increase the resolution of an image that was captured by windowing a small area of the online map, while the Reload option simply reloads the map using its current resolution.

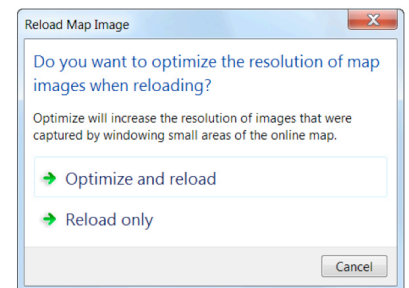

One of the most valuable enhancements to geographic location functionality is the ability to include this valuable map data when printing. If you attempt to print without previously capturing the map, a warning reminds you that the map will not be printed.

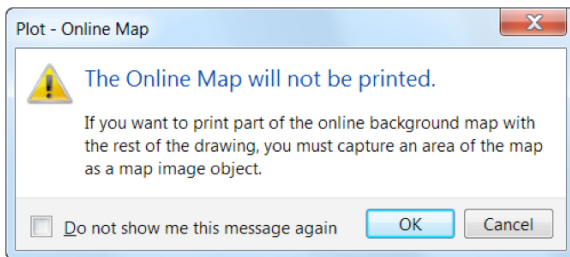

Design

Reality capture

Support for reality capture is significantly enhanced in AutoCAD 2015 to provide better performance and more flexibility when working with point cloud files.

The Create Point Cloud tool that was previously on the Insert Ribbon tab is replaced with a new tool, which launches the Autodesk® ReCap™ application. Autodesk ReCap software is installed with AutoCAD by default. If you chose not to install it, you can do so from the AutoCAD installer at a later time. With the replacement of the former Create Point Cloud tool, the ability to create PCG and ISD file formats in AutoCAD is no longer supported.

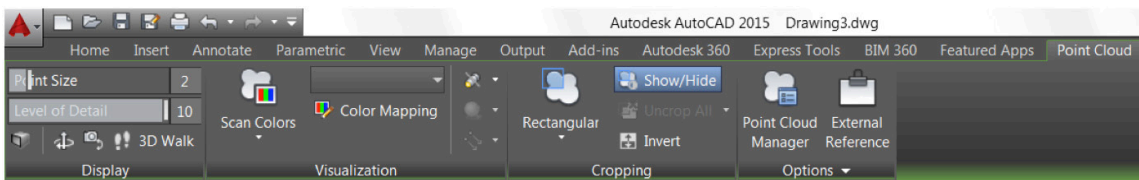

Support for attaching PCG and ISD point cloud file formats has also been removed in AutoCAD 2015. However, if you open a drawing to which those older point cloud files are attached, they will display and you can select them and modify their properties.

The transition from the old point cloud file formats (PCG and ISD) to ReCap point cloud files (RCP and RCS) enables you to view and use point cloud data faster and with greater efficiency. The Attach Point Cloud dialog box includes a new option for using geographic location if it is available. The dialog box also indicates if the point cloud file has additional information, such as classification and segmentation data.

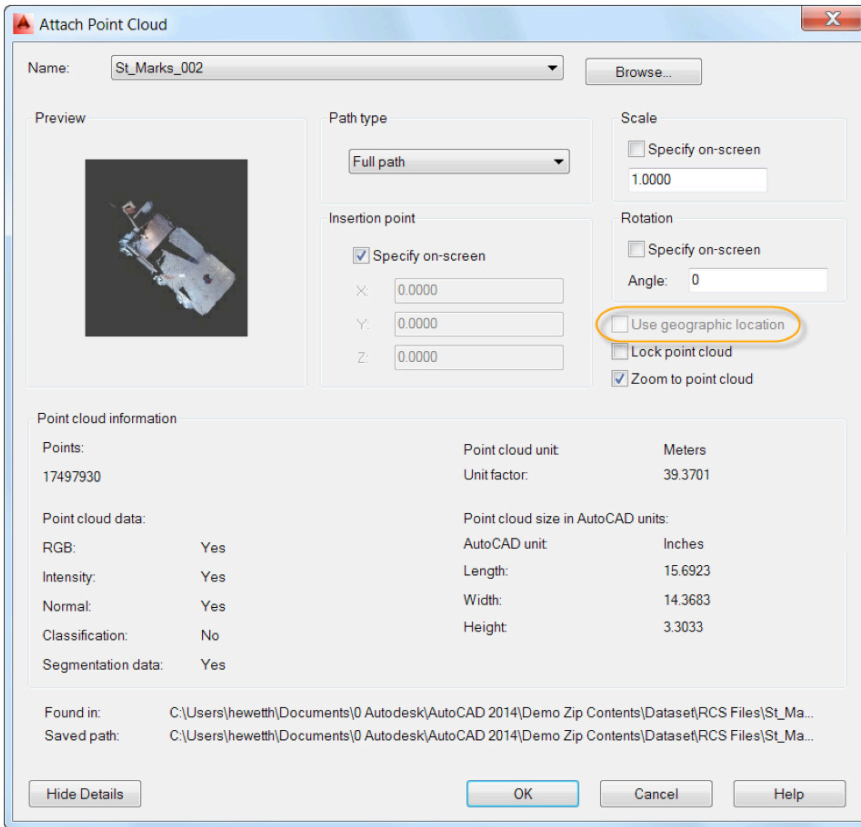

After attaching a point cloud file, you can select it to access the Point Cloud contextual Ribbon, which includes several valuable updates.

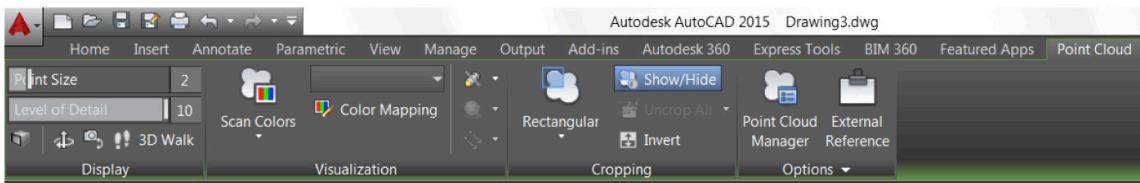

Display

On the Display panel you can now control the point size. For example, if your point cloud file is sparse on points, you can increase the point size to visually fill in the gaps. In this example the point size was increased from 1 to 3.



The Autoupdate tool was removed and the previous Density and Realtime Density sliders were replaced by a single Level of Detail slider. The Level of Detail sets the density for all point clouds in the drawing and is relative to the maximum points as specified on the 3D Modeling tab of the Options dialog box. The maximum points displayed on-screen has increased in AutoCAD 2015 from 10 million to 25 million.

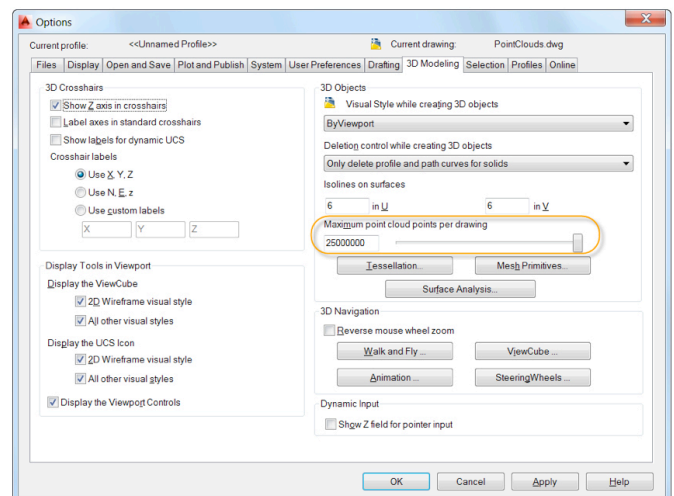

Visualization

New colorization options have been added to help you visualize the point cloud in more ways and the Color Mapping tool is enhanced to support those options. You can now visualize point cloud data based on elevation or classification in addition to scan colors, object color, normal, and intensity if the data exists in the point cloud.

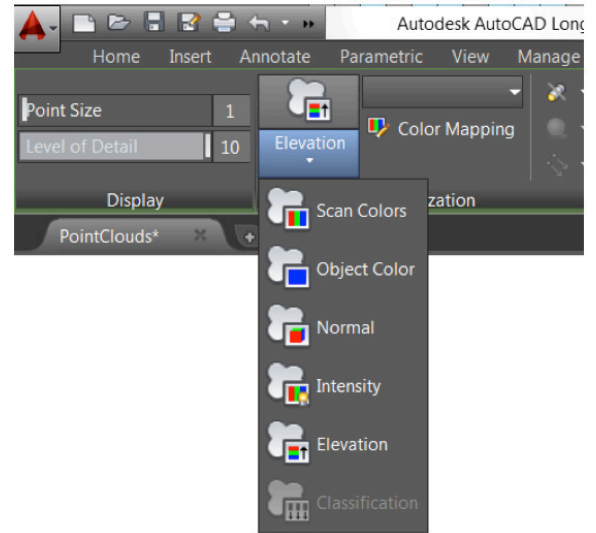

The former Point Cloud Intensity Color Mapping dialog box is replaced with the new Point cloud Color Map dialog box. In it you can select the appropriate tab to customize the colorization based on intensity, elevation, or classification. You can select from predefined color schemes or create and save your own.

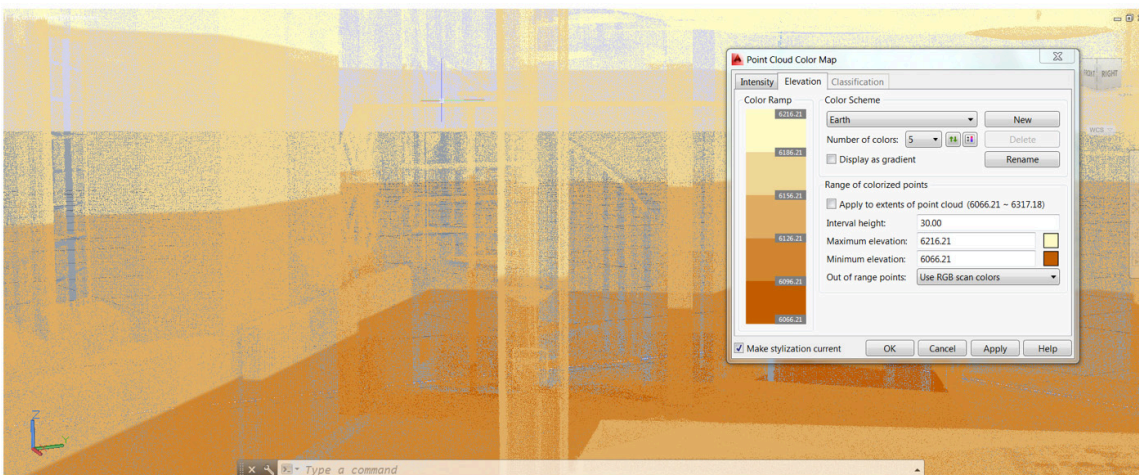
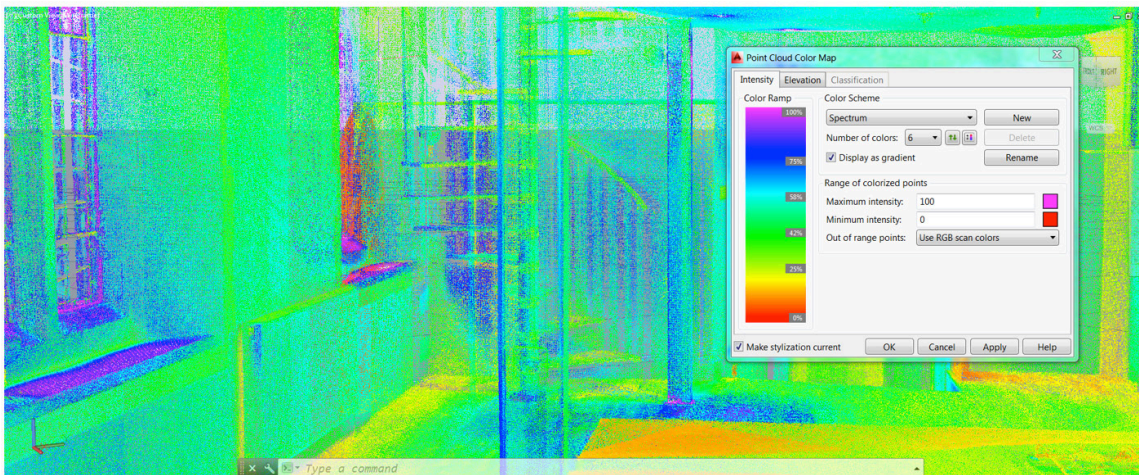

AutoCAD 2015: Complete Guide to What's New

New Lighting tools on the Visualization panel enable you to view point clouds with various lighting effects, such as single- or double-sided, diffuse or specular, and single- or double- source.

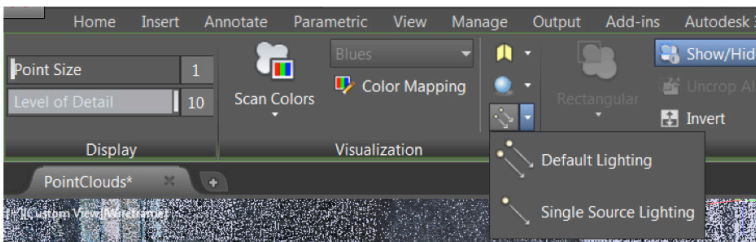
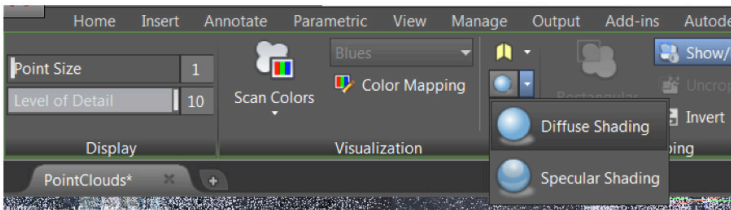
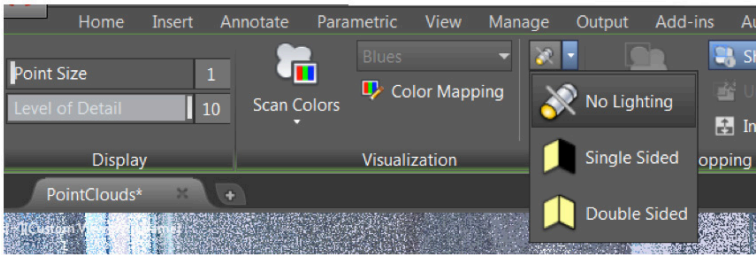

Cropping

Previous point cloud clipping tools are replaced with more intuitive and flexible cropping tools. In AutoCAD 2015, the cropping boundary is always normal to the screen so you can easily specify the cropping boundary from the most intuitive viewpoint. Choose from rectangular, polygonal, or circular boundary shapes.

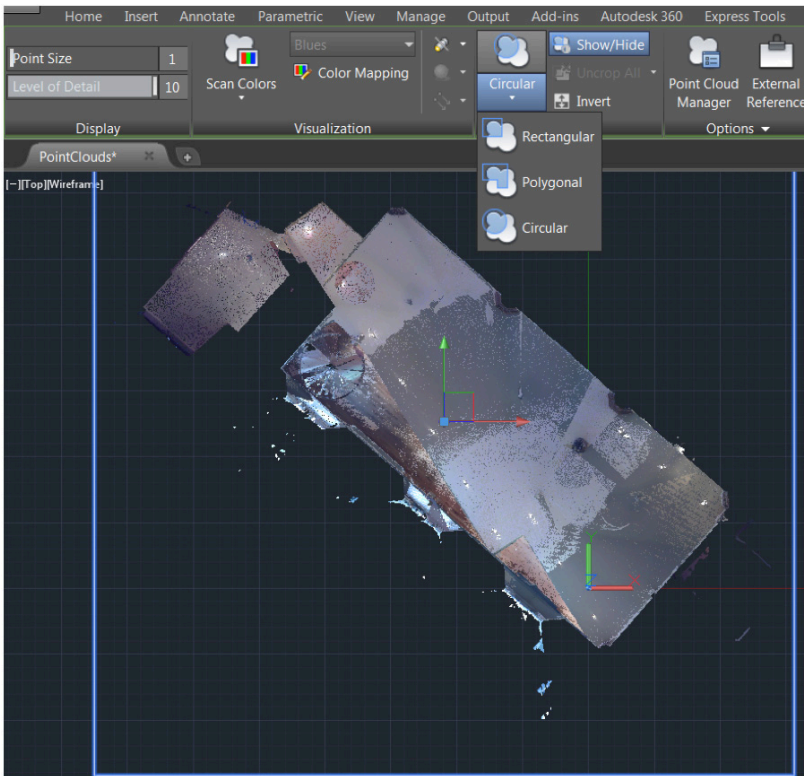

The Invert tool enables you to easily invert the specified boundary to reverse displaying points inside or outside the boundary.

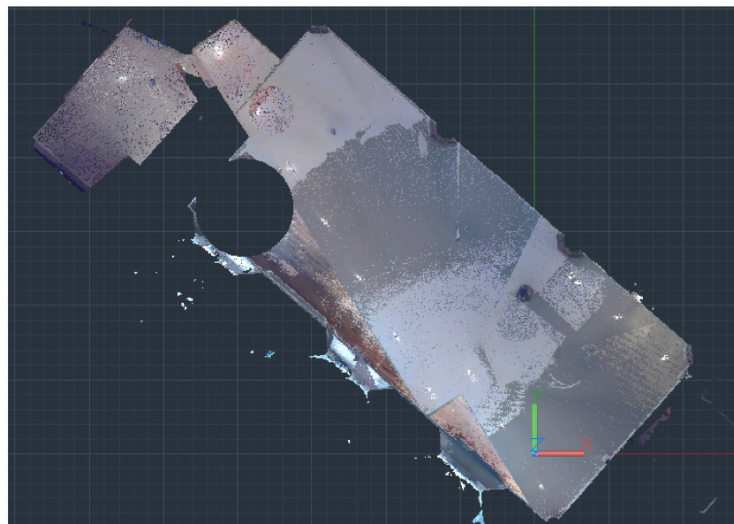
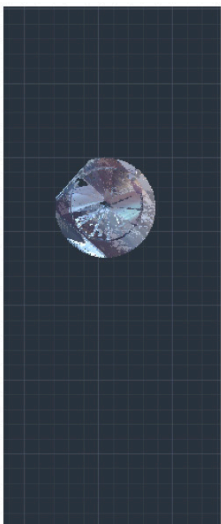

After specifying an appropriate cropping boundary from one view (such as plan), change to another view (such as elevation) to intuitively specify the cropping boundary for the height. You can continue to change views and create cropping boundaries to focus on just the area of the point cloud that you need.

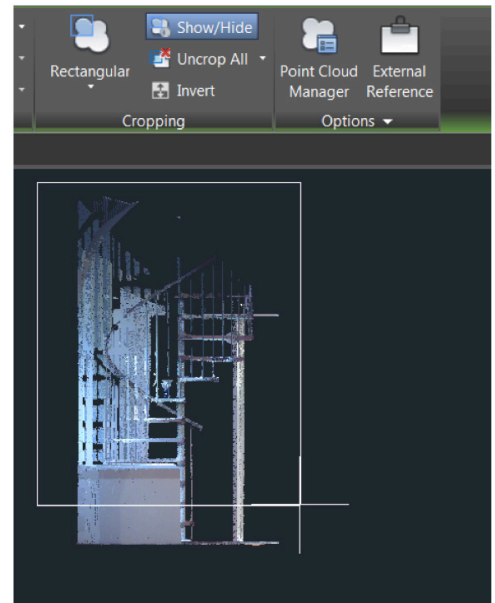

Point Cloud Manager

A new Point Cloud Manager makes it easier than ever to work with multiple point clouds.

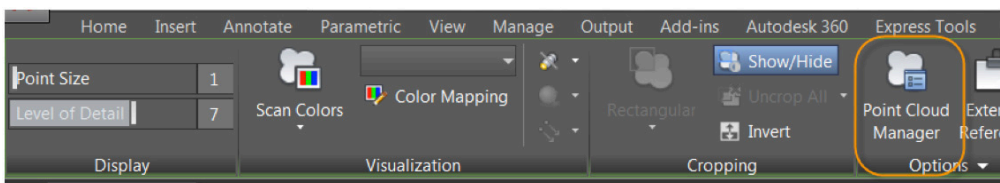

The Point Cloud Manager lists all the point clouds that are attached to the current drawing. If those point clouds include regions (defined in Autodesk ReCap), the regions are also listed in the Point Cloud Manager. You can click on the icon to the right of each region or scan to turn it on or off. The icons update to indicate the status. Double-click on a point cloud scan in the list to view the model from its scan position. You can use tools such as 3DWalk, Orbit, and Steeringwheel to navigate around the model from there.



Point cloud object snaps

AutoCAD 2015 offers new Point cloud object snaps, which are accessible from the 3D Object Snap tab of the Drafting Settings dialog box.

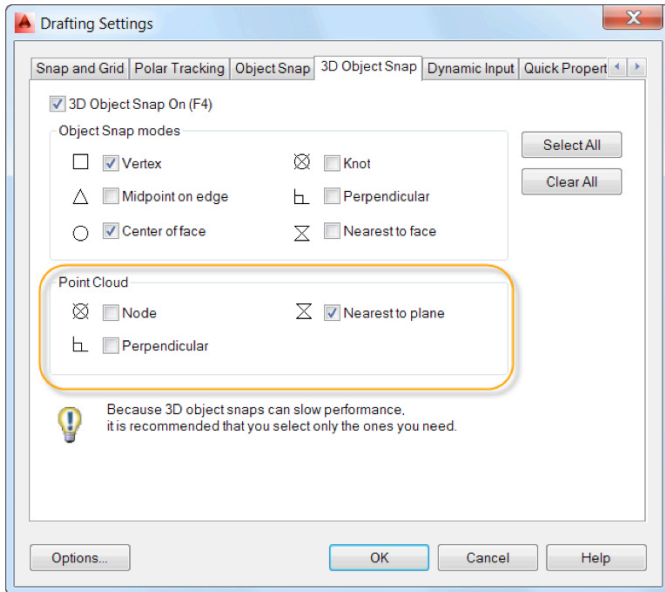

For easier access to point cloud object snaps, customize the status bar to display the 3D Object Snap tool.

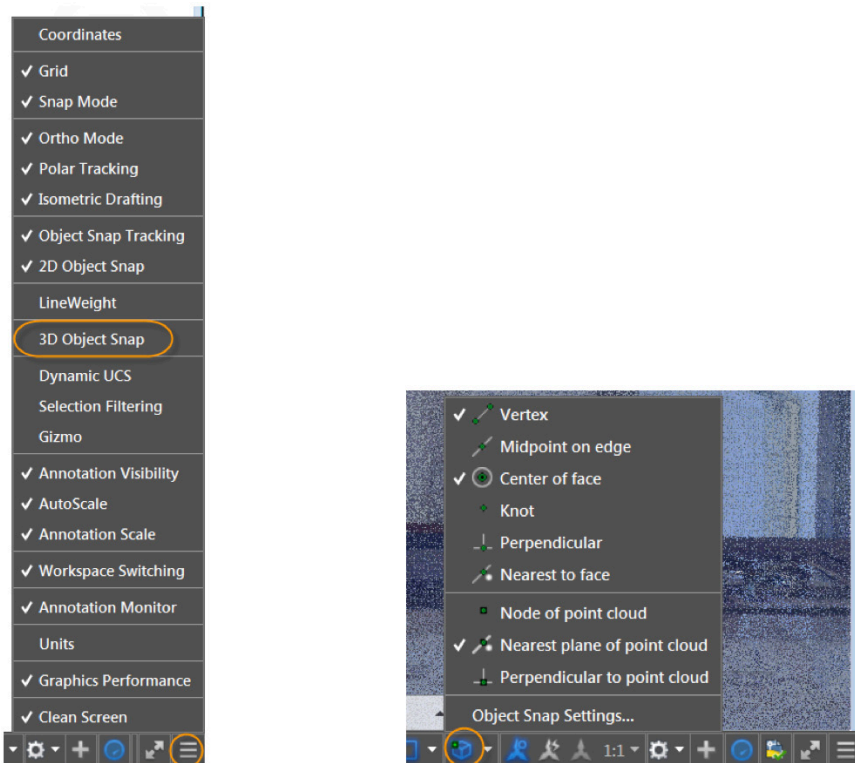

You can snap to points on the point cloud with the Node point cloud object snap. If the point cloud has segmentation data, you can snap to the nearest point on planar segments or perpendicular to planar segments.

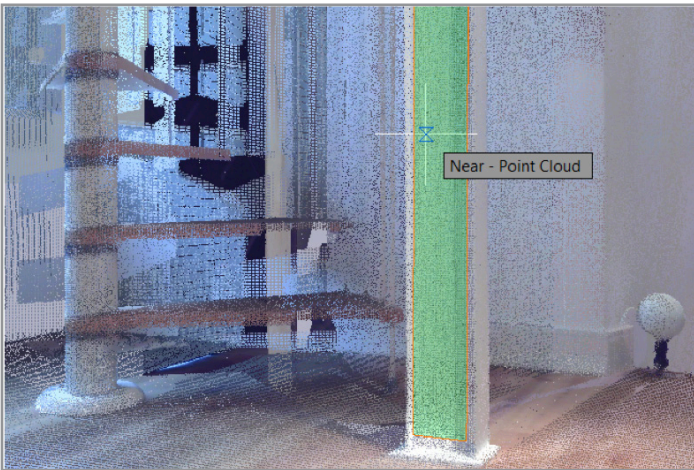

You can use the UCS tool and specify the Object function to align the current UCS to a plane in a point cloud.

3DOrbit

To further help with navigation, 3DOrbit functionality is enhanced to offer better control of the target point of the orbit. If you turn off the option from the 3DOrbit right-click menu that enables Orbit Auto Target, you can click and hold the cursor during a 3DOrbit operation to specify the pivot point of the orbit. A small spherical icon indicates the pivot point. It automatically snaps to the nearest point, enabling you to continue the 3DOrbit around that location.

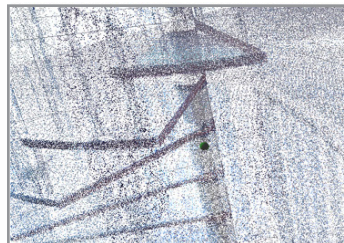
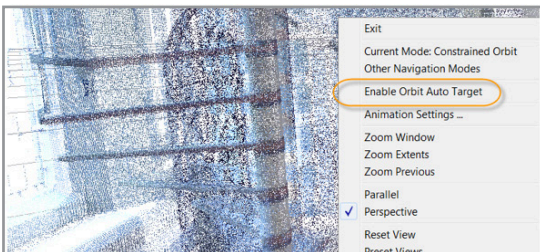

Connect

Design Feed

The Design Feed palette provides a way of adding messages and images to a drawing, which you can then share with colleagues, clients, and consultants online through Autodesk 360. The Design Feed posts are available in a drawing whether you access them on the desktop, on the web, or with a mobile device.

As an alternative to storing drawing files in your Autodesk 360 account, AutoCAD 2015 enables you to store them locally on your computer's hard drive. In this case, the Design Feed data for these drawings are still stored in Autodesk 360, but the association to the Design Feed data is maintained by a unique Design Feed ID, which is saved in the drawing. If your company uses a network, it might be more convenient to manage your drawing files through a server rather than through individual computers. In this case, anyone with an Autodesk 360 account and who has access to the server can access the Design Feed associated with each drawing. Unlike saving drawings in your Autodesk 360 account, authorized access to the drawings is managed only by the permissions set by the server.

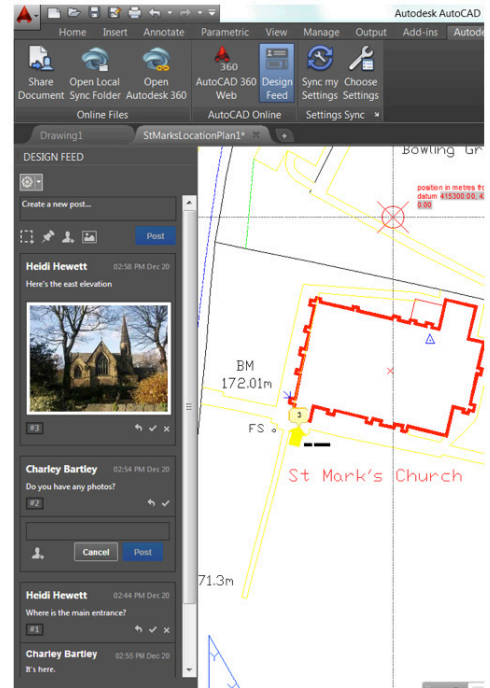

Open the Design Feed palette from the Autodesk 360 Ribbon tab.

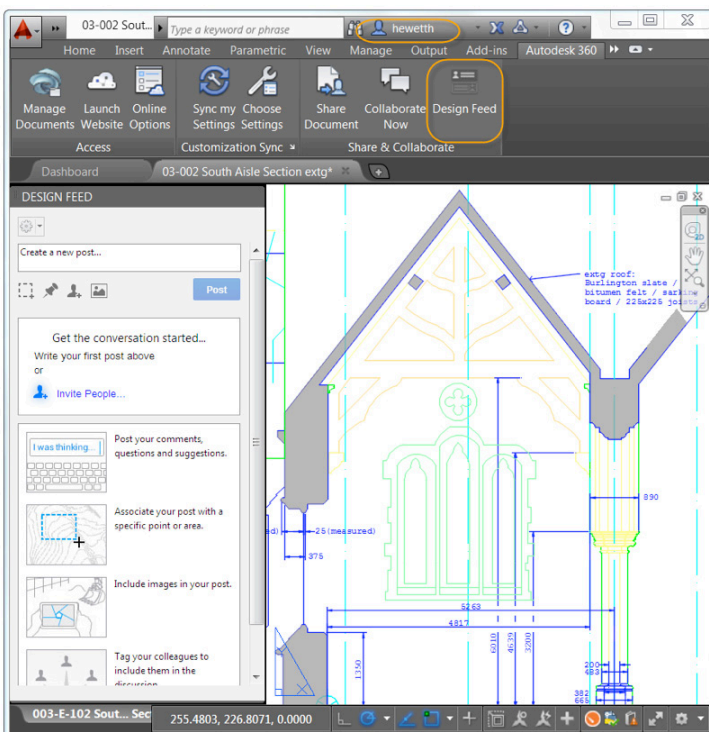

If you associate your comment with a location or area within the drawing, a corresponding bubble is displayed. When you select a comment in Design Feed, AutoCAD zooms to the corresponding part of the drawing. If you select a bubble in the drawing, the corresponding comment is selected in Design Feed. The Settings drop-down menu on the Design Feed palette lets you control the display of the bubbles.

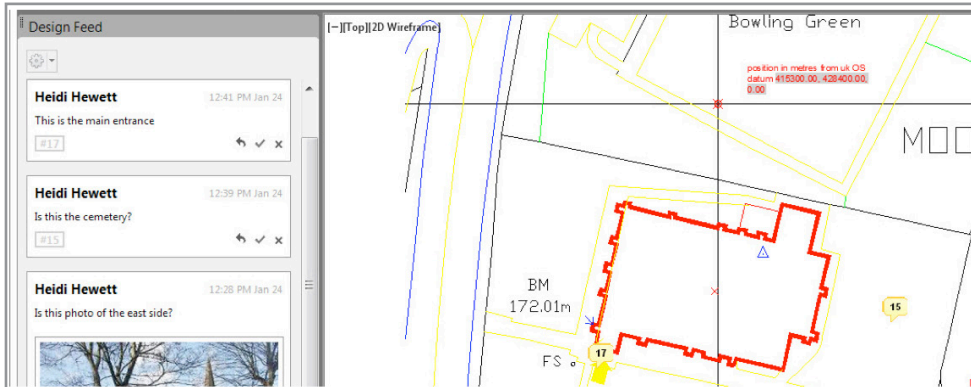

You can tag colleagues, clients, and consultants to notify them of your post; notifications are sent to them by email and also appear within Design Feed.

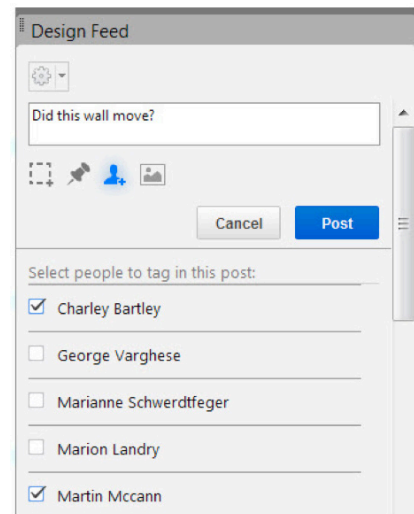

After you finish creating a post, the updated Design Feed data and associated images are saved to Autodesk 360. Then you or anyone else who has been authorized to view the drawing can see the associated posts. When the comment and its replies are no longer needed, you can resolve the thread to hide it in the Design Feed palette.

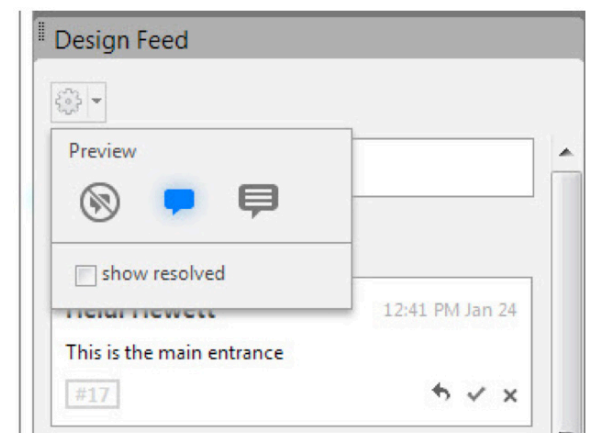

If you save a local or network drawing under another file name, you can choose to copy the Design Feed comments as well. Choosing this option saves an independent copy of the Design Feed data for the new drawing. The Design Feed for both the original and the new drawing are initially identical, but any subsequent changes to the Design Feed of one of the drawings is not duplicated in the other.

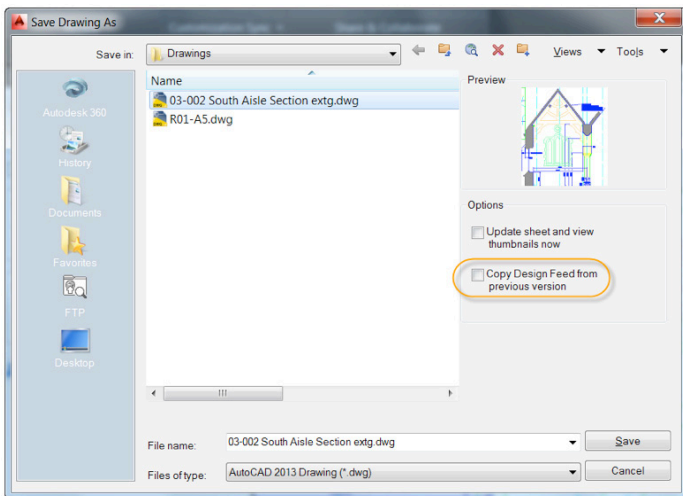

If you create a copy of a drawing using eTransmit, Archive, or DWG Convert, you can specify whether Design Feed data is removed from the drawing using the relevant setup for each of those tools. By default, the option to remove Design Feed is enabled.

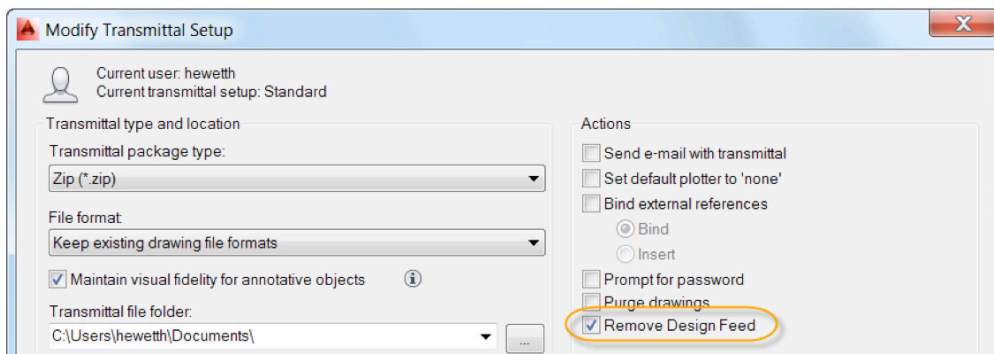

Autodesk Translation Framework

The new Autodesk Translation Framework (ATF) is used when importing model data from popular file formats, including CATIA® (V4 and V5), Pro/ENGINEER, SolidWorks®, Parasolid®, JT, NX, STEP, Rhino®, and IGES/IGS. ATF supports importing of meshes and curves as well as object colors and layers when you select any of these file formats from the Import tool and when using the IGESIMPORT command.

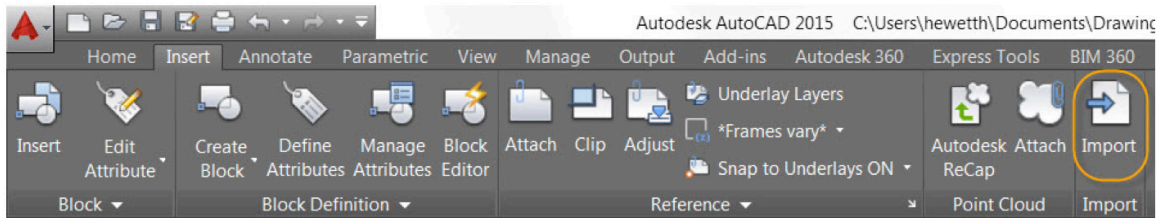

The ATF is also used when exporting to IGES/IGS format with the EXPORT and IGESEXPRESS commands.

DGN data

You can now purge orphaned DGN data.

Customize

Autodesk BIM 360 add-in for AutoCAD

The AutoCAD 2015 installation includes a new option to include the Autodesk BIM 360 add-in. This add-in supports round-trip BIM coordination workflows between AutoCAD and the BIM 360 cloud. If you choose to install the add-in, a BIM 360 tab and tools are added to the AutoCAD Ribbon.

Configuration

You can configure AutoCAD 2015 for either hardware or software display rendering modes using the new Graphics Performance dialog box. Access it from the Hardware Acceleration icon on the status bar.

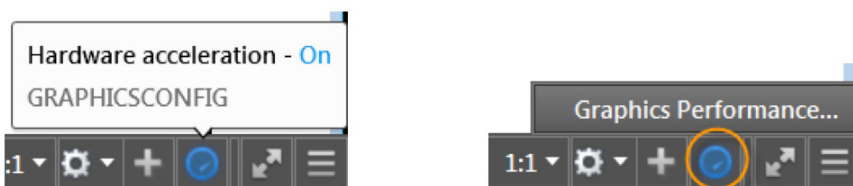

When Hardware Acceleration is turned on, you have access to a variety of controls that can improve the appearance of your display.

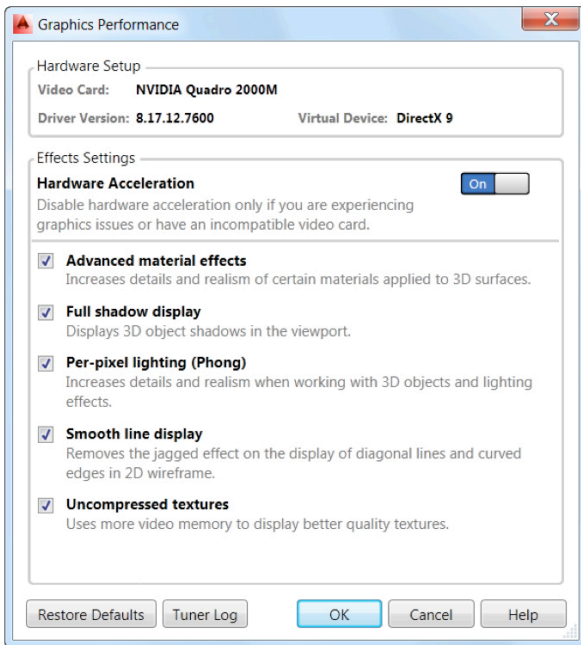

Button images

Portable Network Graphics (PNG) is added to the list of supported file formats for button images.

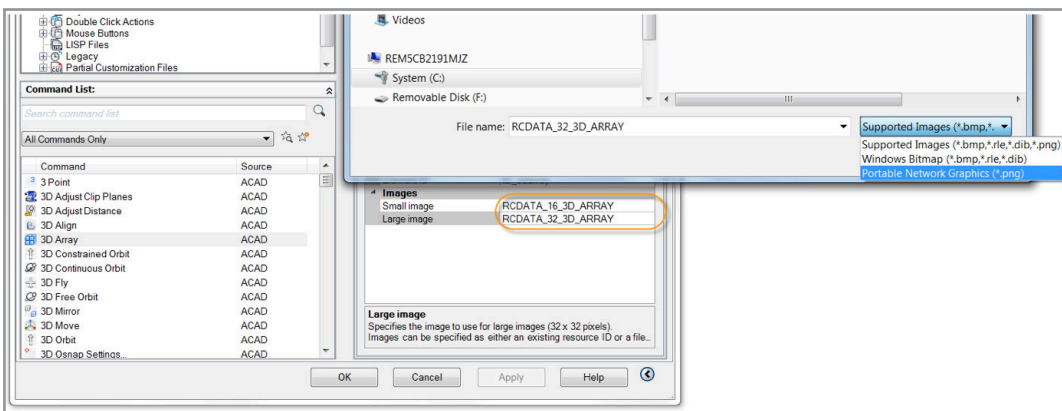

Application Manager

The Autodesk Application Manager is integrated into AutoCAD 2015. You can access it from a new icon on the system tray.



The Autodesk Application Manager is a desktop tool that helps you stay current with the latest updates for all your installed Autodesk applications and suites by delivering timely messages about new service packs, hotfixes, and other important files as they become available. When you decide to apply an update, Autodesk Application Manager downloads the files from the cloud and installs them on your machine.

